

# BYTE®

JUNE 1983 Vol. 8, No. 6  
\$2.95 in USA  
\$3.50 in Canada/£2.10 in U.K.  
A McGraw-Hill Publication

the small systems journal



**16-BIT  
DESIGNS**



# Inside Apple

Apple Computer Inc., 20525 Mariani Avenue, Cupertino, California 95014

Vol. 1 No. 2

For the authorized Apple dealer nearest you, call 800-538-9696 (800-662-9238 in California.)

## Fruitful Connections.

There are more people in more places making more accessories and peripherals for Apples than for any other personal computer in the world.

Thanks to those people — in hundreds of independent companies — you can make the humblest 1978 Apple II turn tricks that are still on IBM's Wish List for 1984.

But now we're coming out with our very own line of peripherals and accessories for Apple® Personal Computers.

For two very good reasons.

First, compatibility. We've created a totally kluge-free family of products designed to take full advantage of all the advantages built into every Apple.

Second, service and support.



Now the same kindly dealer who keeps your Apple PC in the pink can do the same competent job for your Apple hard-disk and your Apple daisywheel printer.

So if you're looking to expand the capabilities of your Apple II or III, remember:

Now you can add Apples to Apples.

## A joy to behold.

The new Apple Joystick II is the ultimate hand control device for the Apple II.

Why is it such a joy to use?

With two firing buttons, it's the first ambidextrous joystick — just as comfortable for lefties as righties.

Of course, it gives you 360° cursor control (not just 8-way like some game-oriented devices) and full X/Y coordinate control.

And the Joystick II contains high-quality components and switches tested to over 1,000,000 life cycles.

Which makes it a thing of beauty. And a joystick forever.



## Gutenberg would be proud.

Old Faithful Silentype® has now been joined by New Faithfuls, the Apple Dot Matrix Printer and the Apple Letter Quality Printer.

So now, whatever your budget and your needs, you can hook your Apple to a printer that's specifically designed to take advantage of all the features built into your Apple. With no compromises.

The 7x9 Apple Dot Matrix Printer is redefining "correspondence quality" with exceptional legibility.

With 144x160 dots per square inch, it can also create high resolution graphics.

The Apple Letter Quality Printer, which gets the words out about 33% faster than other daisywheel printers in its price range, also offers graphics capabilities. See your authorized

Apple dealer for more information and demonstrations. Because, unfortunately, all the news fit to print simply doesn't fit.



# A storehouse of knowledge.

If you work with so much data or so many programs that you find yourself shuffling diskettes constantly, you should take a look at Apple's ProFile™, the personal mass storage system for the Apple III Personal Computer.

This Winchester-based 5-megabyte hard disk can handle as much data as 35 floppies. Even more important for some, it can access that data about 10-times faster than a standard floppy drive.

So now your Apple III can handle jobs once reserved for computers costing thousands more.

As for quality

and reliability, you need only store one word of wisdom:  
Apple.



## Up the creek without a paddle?

Or lost in space? Or down in the dungeons?

Whatever your games, you'll be happy to know that someone has finally come out with game paddles built to hold up under blistering fire. Without giving you blisters.

Apple Hand Controller II game paddles were designed with one recent discovery in mind:

People playing games get excited and can squeeze very, very hard.

So we made the cases extra rugged. We used switches tested to 3,000,000 life cycles. We shaped them for holding hands and placed the firing button on the right rear side for maximum comfort.

So you'll never miss a shot.

## Launching pad for numeric data.

Good tidings for crunchers of numerous numbers:

Apple now offers a numeric keypad that's electronically and aesthetically compatible with the Apple II Personal Computer. So you can enter numeric data faster than ever before.

The Apple Numeric Keypad II has a standard calculator-style layout. Appropriate,

because unlike some other keypads, it can actually function as a calculator.

The four function keys to the left of the numeric pad should be of special interest to people who use VisiCalc®. Because they let you zip around your work sheet more easily than ever, adding and deleting entries.

With one hand tied behind your back.



VisiCalc is a registered trademark of VisiCorp, Inc.



Page 110



Page 128



Page 150

## Themes

- 52 16-Bit Designs** by Phil Lemmons / Powerful 16-bit microprocessors coupled with greater memory capacity and advanced memory-management techniques promise to elevate the micro to new levels of power and speed. And the winners are the users. In our theme articles you'll read about what's new in the 16-bit arena.
- 54 Sunrise Systems** by Bruce Roberts / This Texas-based startup company produces portable 8- and 16-bit microcomputer systems that are labeled and marketed by OEMs.
- 74 The Gavilan Mob Computer** by Phil Lemmons / Lightweight, powerful, and portable, this battery-powered 16-bit computer can go anywhere. And its optional printer fits in a standard-size briefcase right along with the computer.
- 96 Digital's Professional 300 Series** by Wesley Melling / Owning a 325 or 350 is almost like having a personal minicomputer. They both share the PDP-11 instruction set and memory management and provide about 90 percent of the throughput of a PDP-11/24.
- 104 A DEC on Every Desk?** by John J. Snyder / A look at Digital Equipment Corporation's representatives in the microcomputer world.
- 110 Tight Squeeze: The HP Series 200 Model 16** by John Monahan / How Hewlett-Packard crammed a powerful 16-bit microcomputer into one square foot of desk space.
- 128 Texas Instruments' 99/2 Basic Computer** by Harry Littlejohn and Mark Jander / Software compatible with the 99/4A, this 16-bit, less-than-\$100 machine makes a good home computer.
- 138 Implementing Minicomputer Capabilities In a Desktop Microcomputer** by Colin Nayler / Multiple users, Xenix, and local-area networks characterize the Altos 586.
- 150 A Machine for All Processors: The Fujitsu Model 16s** by Wayne Clingingsmith / Its plug-in processors allow the Model 16s to run a variety of operating systems and applications programs.
- 168 The Pronto Series 16** by Skip Hansen / An explanation of the design philosophy behind this business-oriented Intel-80186 based microcomputer.
- 188 A Sleek Import: The Docutel/Olivetti M20** by Sergio Mello-Grand / A personal computer that marches to the beat of a different drummer—the Z8000.
- 194 Modular Architecture** by Sudha Kavuru / Some insights into designing a modular computer around the IBM Personal Computer.
- 208 Digital Research's DR Logo** by Gary Kildall and David Thornburg / This user-friendly language comes of age.
- 230 An Inside Look at MS-DOS** by Tim Paterson / The history of and design decisions behind MS-DOS, how it works, and where it's going.
- 256 BYTE West Coast: A Guided Tour of Visi On** by Phil Lemmons / Visicorp's Bill Coleman discusses in detail the development, workings, and operation of Visi On, the company's new operating environment.

[1985] 727-7261. Office hours: Monday 8:30 AM - 4:30 PM, Friday 8:30 AM - 1:00 PM, Eastern Time. Address subscriptions, change of address, USPS Form 3579, and fulfillment questions to BYTE Subscriptions, POB 590, Martinsville NJ 08836. Second class postage paid at Peterborough, N.H. 03458 and additional mailing offices. USPS Publication No. 528890 (ISSN 0360-5280). Postage Paid at Winnipeg, Manitoba. Registration number 9321. Subscriptions are \$21 for one year, \$38 for two years, and \$55 for three years in the USA and its possessions. In Canada and Mexico, \$23 for one year, \$42 for two years, \$61 for three years. \$53 for one year air delivery to

## Features

**35 Use ADPCM for Highly Intelligible Speech Synthesis** by Steve Ciarcia / Integrated circuits from Oki Semiconductor compress digitized speech data efficiently.

**282 NEC PC-8201** by Stan Wszola / Yet another portable computer vies for a place in the executive briefcase.

**306 The User Goes to the Faire** by Jerry Pournelle / Our redoubtable critic reports on his journey from Chaos Manor to the Eighth West Coast Computer Faire.

**339 Design Philosophy Behind Motorola's MC68000, Part 3: Advanced Instructions** by Thomas W. Starnes / Special MC68000 instructions allow programmers to write complicated code quickly and compactly.

**352 The Bazerles Cylinder** by Rinaldo F. Prisco / How to create ciphertext using methods based on the Bazerles Cylinder's time-proven cryptographic principles.

**387 AVL Trees** by W. D. Maurer / Introducing a scheme for searching and updating sorted data efficiently.

**395 Build a Simple Light Pen for the Apple II** by David J. Lilja / Avoid complex hardware by using software strategically.

**411 User's Column: Zenith Z-100, Epson QX-10, Software Licensing, and the Software Piracy Problem** by Jerry Pournelle / Our intrepid columnist shoots from the hip and takes a little flak.

**450 The 8086—An Architecture for the Future, Part 1: Introduction and Glossary** by Stephen A. Heywood / The advanced 8086 microprocessor overcomes the limitations of previous designs.

## Reviews

**288 HMS3264 EPROM Programmer** by Marvin L. De Jong / This program package lets an Apple II handle the programming tasks for a variety of software-development tasks.

**298 Electrohome Supercolor Board and Color Monitor** by Jon N. Swanson / A color-graphics display system for the Apple II.

## Nucleus

- |   |                                  |
|---|----------------------------------|
| <b>4</b> Editorial: High-Tech Morrill Act   | <b>458</b> Clubs and Newsletters |
| <b>7</b> MICROBYTES   | <b>462</b> Ask BYTE              |
| <b>10</b> Letters   | <b>466</b> Software Received     |
| <b>364</b> Programming Quickies: Novel Methods of Integer Multiplication and Division | <b>470</b> Event Queue           |
| <b>379</b> Technical Forum: Random Numbers from an All-Digital Generator              | <b>479</b> Books Received        |
| <b>446</b> Book Review: 6502 Assembly-Language Subroutines                            | <b>482</b> What's New?           |
|   | <b>541</b> Unclassified Ads      |
|   | <b>542</b> BOMB, BOMB Results    |
|   | <b>543</b> Reader Service        |

Cover painting by Roger Landesmark

Europe. 17,100 yen for one year surface delivery to Japan. \$37 surface delivery elsewhere. Air delivery to selected areas at additional rates upon request. Single copy price is \$2.95 in the USA and its possessions, \$3.50 in Canada and Mexico, \$4.50 in Europe, and \$5.00 elsewhere. Foreign subscriptions and sales should be remitted in United States funds drawn on a US bank. Printed in United States of America.

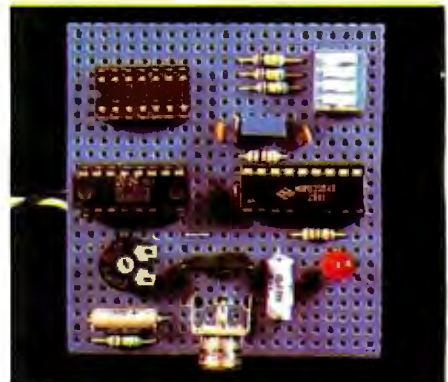
Subscription questions or problems should be addressed to:  
**BYTE Subscriber Service, P.O. Box 328, Hancock, NH 03449**



Page 188



Page 208



Page 35



Page 306

**Editor In Chief**

Lawrence J. Curran

**Managing Editor**

Pamela A. Clark

**Senior Editor**

Gregg Williams

**Technical Editors**

Richard S. Shuford, Curtis P. Feigel,  
Stanley Wszola, Arthur A. Little,  
Richard Malloy, Bruce Roberts;  
Phillip Lemmons, West Coast Editor;  
Steve Ciarcia, Mark Dahmke, Consulting  
Editors; Jon Swanson, Drafting Editor

**Copy**

Beverly Cronin, Chief;  
Faith Hanson, Warren Williamson, Anthony J.  
Lockwood, Hilary Selby Polk, Elizabeth Kepner,  
Nancy Hayes.; Margaret Cook, Junior Copy  
Editor

**Assistants**

; Beverly Jackson, Lisa Jo Steiner

David R. Anderson, Assoc. Director;  
Jan Muller, Virginia Reardon, Michael J.  
Lonsky; Sherry McCarthy, Chief Typographer;  
Debi Fredericks, Donna Sweeney, Valerie Horn

**Advertising**

Deborah Porter, Supervisor;  
Marion Carlson, Rob Hannings, Cathy A. R.  
Drew, Lisa Wozmak, Jeanne Cilley, Jeanna  
Reenstiema; Patricia Akerley, Reader Service  
Coordinator; Wai Chiu Li, Advertising/  
Production Coordinator; Linda J. Sweeney

**Circulation**

Gregory Spitzfaden, Manager;  
Andrew Jackson, Asst. Manager;  
Agnes E. Perry, Barbara Varnum, Louise  
Menegus, Jennifer Price, Sheila A. Bamford;  
James Bingham, Dealer Sales; Deborah J.  
Cadwell, Asst; Linda Ryan

**Marketing Communications**

Horace T. Howland, Director;  
Vicki Reynolds, Coordinator;  
Timothy W. Taussig, Graphic Arts Manager;  
Michele P. Verville, Research Manager

**Manager**

Kenneth A. King, Asst. Controller;  
Mary E. Fluhr, Acct. & D/P Mgr.; Karen  
Burgess, Linda Fluhr, Vicki Bennett,  
Vern Rockwell

**Traffic**

N. Scott Gagnon, Manager;  
Scott Jackson, Brian Higgins

**Receptionist**

ers

**Manager**

Cheryl A. Hurd

**Publisher**

Wendell W. Simpson;  
John E. Hayes,  
Associate Publisher/Production Director;  
Doris R. Gamble, Publisher's Assistant

Officers of McGraw-Hill Publications Com-  
pany: John G. Wrede, President; Executive Vice  
President: Paul F. McPherson; Senior Vice  
President-Editorial: Ralph R. Schulz; Vice  
Presidents: Kemp Anderson, Business Systems  
Development; Shel F. Asen, Manufacturing;  
Harry L. Brown, Special Markets; James E.  
Hackett, Controller; Eric B. Herr, Planning and  
Development; H. John Sweger, Jr., Marketing.

Officers of the Corporation: Harold W.  
McGraw Jr., Chairman and Chief Executive  
Officer; Joseph L. Dionne, President and Chief  
Operating Officer; Robert N. Landes, Senior Vice  
President and Secretary; Ralph J. Webb,  
Treasurer.

**Editorial**

# High-Tech Morrill Act

*Lawrence J. Curran, Editor in Chief*

The U.S. Senate has begun deliberations on a bill that would create a highly desirable partnership whose goal is the revitalization of high-technology education in this country. The bill, S.631, would join the federal government, state governments, and educational institutions with high-tech companies in an effort to ensure that the human resources required for this nation to compete in worldwide high-tech markets will be available. Sen. Paul Tsongas (D., Mass.) is the primary sponsor of the initiative, which he calls "the high-technology Morrill Act."

The Morrill Act established the federal land-grant college system in 1862 and is credited with revolutionizing U.S. agriculture education and, eventually, agricultural production. It helped foster an industrialization that led to global agricultural leadership for the U.S., a position we still maintain. Sen. Tsongas' bill could do the same for high-tech education by providing \$500 million per year over five years. Half the money would come from the federal government, state governments would be asked to contribute 30 percent, and industry 20 percent. We heartily support this legislation, and urge you to support it by contacting your representatives.

Among other things, the money would be used to establish computer literacy programs in elementary and secondary schools; make the teaching of math, science, and engineering more attractive as a career; modernize university lab equipment and establish university research and education centers; expand technician training programs at community colleges; and develop programs to teach the management of technological innovation.

The education grants established by the bill would be administered by the director of the National Science Foundation, who would be authorized to establish an advisory committee representing industry, education, state government, professional societies, and labor organizations. We think that such an advisory committee can be effective, but we also believe it's critical that it receive strong direction from high-tech industries that compete globally so that it is responsive to real-world competitive considerations.

Sen. Tsongas is to be commended for his astuteness in seeking counsel from people who should be especially well qualified to understand global competition and education in high-technology industries. Those assisting with the legislation include the authors of a recent book that we think is an enlightening contribution to the literature: Ray Stata, president of Analog Devices Inc., Norwood, Massachusetts; and James Botkin and Dan Dimancescu, consultants in high technology from Cambridge, Massachusetts. The book is *Global Stakes, The Future of High Technology in America* (written with John McClellan. Ballinger Publishing Co., Cambridge, MA, 1982).

It's time that this nation started to deal more effectively with global competition. Through its emphasis on education, S.631 seeks to keep U.S. high-tech industry on the leading edge. Education is the long-fallow ground that must be fertilized so that the engineers, scientists, and technicians it produces are prepared for ever more formidable competition in future decades. ■

# How to buy a computer by the numbers.

Introducing the Cromemco C-10 Personal Computer. Only \$1785, including software, and you get more professional features and performance for the price than with any other personal computer on the market. We've got the numbers to prove it.

The C-10 starts with a high-resolution 12" CRT that displays 25 lines with a full 80 characters on each line. Inside is a high-speed Z-80A microprocessor and 64K bytes of on-board memory. Then there's a detached, easy-to-use keyboard and a 5¼" disk drive with an exceptionally large 390K capacity. That's the C-10, and you won't find another ready-to-use personal computer that offers you more.

But hardware can't work alone. That's why every C-10 includes software — word processing, financial spread sheet, investment planning and BASIC. Hard-working, CP/M<sup>®</sup>-based software that meets your everyday needs. Software that could cost over \$1000 some-

where else. FREE with the C-10. There's really nothing else to buy.

But the C-10's numbers tell only part of the story. What they don't say is that Cromemco is already known for some of the most reliable business and scientific computers in the industry. And now for the first time, this technology is available in a personal computer.

One last number. Call **800 538-8157 x929** for the name of your nearest Cromemco dealer, or to request literature. In California call 800 672-3470 x929. Or write Cromemco, Inc., 280 Bernardo Avenue, P.O. Box 7400, Mountain View, CA 94039. In Europe, write Cromemco A/S, Vesterbrogade 1C, 1620 Copenhagen, Denmark.

CP/M<sup>®</sup> is a registered trademark of Digital Research, Inc. All Cromemco products are serviced by TRW.



**Cromemco**  
Tomorrow's computers today

Circle 102 on inquiry card.



Z-80A  
64K RAM  
390K DISK DRIVE  
12" CRT  
COMPLETE SOFTWARE

**\$1785**

**CROMEMCO**



# CHAMELEON BY SEEQUA... TWICE THE COMPUTER FOR \$1995 (Introductory Offer).

## BOTH WORLDS OF PROCESSING

16 bit 8086 IBM compatible software runs under MS-DOS and industry standard 8 bit Z80A software runs under CP/M.

## TWICE THE MEMORY

128K bytes RAM are standard, internally expandable to 256K. And dual IBM PC compatible 5 1/4" disks with 160K formatted each are included.

The following are registered trademarks:  
CP/M-80 — Digital Research Inc.  
MS-DOS — Microsoft  
PC-DOS — IBM  
Perfect Writer — Perfect Software  
Perfect Calc — Perfect Software  
MBasic — Microsoft

## SOFTWARE INCLUDED

Your computer is delivered with SEEQUA's MS-DOS, compatible with the IBM standard 16 bit PC-DOS operating system. It includes Perfect Writer for word processing and Perfect Calc for financial analysis. And it has MBasic to let you write your own routines. Chameleon comes standard with 640 x 200 resolution black and white graphics and 320 x 200 resolution color graphics.

## EXPANDABLE

Chameleon has both serial and parallel ports standard. You can add an additional serial port or the IEEE-488 port. You can even use IBM PC compatible add-on boards in our optional expansion interface package.

## FITS IN YOUR ENVIRONMENT

Chameleon is at home in your office. But its compact packaging makes it easy to carry elsewhere.

To learn more about Chameleon's power, call us at 800-638-6066. We'll put you in touch with our closest dealer.

# CHAMELEON

by



**SEEQUA  
COMPUTER  
CORPORATION**

209 West Street  
Annapolis, MD 21401  
(301) 268-6650  
(800) 638-6066





# MICROBYTES

Staff-written highlights of late developments in the microcomputer industry.

## **OPERATING SYSTEMS BATTLE LINES INVOLVE IBM, DEC, AMERICAN BELL**

International Business Machines, Digital Equipment Corporation, and American Bell will make separate moves that together could reshape the world of microcomputer operating systems. IBM is believed ready to make available more operating systems for the IBM PC and may emphasize for the business market an operating system other than PC-DOS. One account says that IBM sees the need for a multitasking operating system with more flexible data structures. Another account says IBM is developing its own operating system for the IBM PC to be compatible with the CPIX version of Unix that runs on the IBM Series 1. IBM's alternate channels marketing department has also arranged for CDI in Bellevue, WA, to install the Pick operating system on the PC late this year. A Microsoft spokesman, however, says, "We have a long-term relationship with IBM and have solid plans involving PC-DOS."

Microsoft has strengthened its position elsewhere by reaching a large OEM agreement with American Bell. At least some of American Bell's computers will run Microsoft's Multi-Tool application programs and some version of the Unix operating system. Other American Bell microcomputers, however, will run well-known application programs from a variety of major software houses. Meanwhile, Digital Equipment Corporation is working closely with Digital Research and Visicorp. DEC's low-end microcomputers such as the Rainbow 100 will run Concurrent CP/M-86 and Visicorp's Visi On operating environment.

## **DIGITAL RESEARCH INTRODUCES PERSONAL BASIC AND MARKETS LANGUAGES FOR IBM PC-DOS**

Digital Research has introduced Personal BASIC, an interpretive BASIC designed to compete with Microsoft BASIC but to sell for only \$150, compared to MBASIC's \$350, and at OEM prices far below that. Personal BASIC checks syntax as statements are entered and reports syntax errors before the program is run. It has advanced error trapping, informative error messages, and debugging aids such as statement-number tracing, variable tracing, and breakpoints with single-step operation. Version 1.0 of Personal BASIC runs source code written in Microsoft BASIC or IBM PC BASIC except for PC BASIC's graphics commands. Version 2.0 will support fully integrated graphics statements through the GSX implementation of the graphics kernel standard.

Digital Research's Language Division has broadened its marketing strategy and is selling all DR languages in versions to run under IBM PC-DOS. These include CBASIC-86, CB-86, Pascal/MT + -86, PL/I-86, C-8086, Microfocus COBOL, and the programming aids Display Manager and Access Manager. CB-80 and CB-86 have been enhanced to include some graphics support. Digital Research says its languages will provide portability of applications programs across microprocessors and operating systems.

## **SYDIS SYSTEM INTEGRATES VOICE AND VISIWORD**

Sydis Inc., a startup company in San Jose, CA, has introduced the Voicestation System, a 68000-based system with desktop-manager software that incorporates the functions of a personal computer, a telephone, a dictating machine, a card file, and a calendar. Each terminal has its own 68008 microprocessor, 128K bytes of graphics RAM, and 832 by 608 resolution. The combination of voice input, mouse, and programmable-function keys may greatly reduce or eliminate the need for many users to have a keyboard. While the Sydis system does not provide voice recognition, it does provide voice memos and voice annotation of text documents generated with Visicorp's Visiword. The central Sydis Information Processor uses multiple 68000s and manages a shared 160-megabyte hard disk. Price of a 16-user system is less than \$7000 per user.

## **MICROSOFT ANNOUNCES MULTI-TOOL WORD, MOUSE**

Microsoft has introduced Multi-Tool Word, the second of the company's planned series of productivity tools. Developed under the guidance of Charles Simonyi, formerly of Xerox PARC, Multi-Tool Word provides sophisticated printer support and text-editing. Use of the new Microsoft mouse for the IBM Personal Computer is optional. The two-button mouse and three programs that demonstrate its use cost \$195.

## **SOFTOFFICE TO OFFER IBM PC INTEGRATED SOFTWARE**

The Softoffice Co., San Rafael, CA, is developing both networking and stand-alone versions of an integrated software system for the IBM PC. President Bruce Van Natta describes the product, also called Softoffice, as an object-oriented structure and says it will provide fully integrated applications, electronic mail, and videotex, all accessible through a pictorial desktop manager for professional and administrative users.

## **MICROBYTES**

### **OCTAGON 80286 SUPPORTS THREE OPERATING SYSTEMS SIMULTANEOUSLY**

Octagon Computer Systems will announce the first 80286/Z80-based dual-processor multiuser system at PC '83 in San Francisco June 17. Software will allow users to run PC-DOS, Concurrent CP/M-86, and CP/M-80 applications software at the same time on different terminals. The system's standard equipment includes a 5¼-inch IBM-PC-format floppy disk, an 8-inch floppy disk, and a 5¼-inch Winchester hard disk. As a result, the system supports convenient transfer of files between the two sizes. Other hardware features include up to 4 megabytes of onboard memory, 8 high-speed serial ports, 8 video-display controllers, 6 parallel ports, 64K bytes of PROM, and a calendar/clock with battery backup. The system, including the 15-megabyte formatted hard disk, is priced at \$8750.

### **PFS:WRITE COMING THIS MONTH FROM SOFTWARE PUBLISHING**

PFS:WRITE, a what-you-see-is-what-you-get word processor, will be available this month for \$140. Developed by Software Publishing for the IBM PC, PFS:WRITE works with PFS:File to do mailing lists and can print data tables from PFS:Report, bar charts from PFS:Graph, and spreadsheets from Visicalc.

### **MICROPRO IMPROVES WORDSTAR AND INTRODUCES PLANSTAR, STARBURST, STARINDEX**

Micropro International, San Rafael, CA, recently announced three new products and an updated version of Wordstar. Wordstar (3.30) for the IBM PC has user-definable function keys, faster screen updating through memory-mapped video, a new install program, and support for color displays.

Planstar, a financial modeling tool that runs on PC-DOS or any microcomputer with CP/M version 2.2 or later, includes bar charts and line graphs and can build large multidimensional models and consolidate worksheets. With Starburst, users create menus for their own office "script" to link Micropro or other programs and automate a series of tasks. Starburst performs repeat sequences and conditional logic. The program runs on CP/M version 2.0 or later, an Apple with a CP/M board, PC-DOS 2.0, MS-DOS, and CP/M-86. Starindex works with any version of Wordstar to create alphabetized indexes with subentries and a four-level table of contents.

### **ASHTON-TATE INTRODUCES FRIDAY**

Ashton-Tate of Culver City, CA, publisher of dBASE II, is offering a new user-friendly personal filing system called Friday that permits adding, deleting, and changing of fields and creating and changing of files from anywhere in the system. Every screen display shows a reference to a related section in the user's manual. Data from Friday and dBASE II can be combined. Friday costs \$295 and is available now.

### **SHARP ENTERS PORTABLE-COMPUTER MARKET**

Sharp Electronics has introduced the Super Portable Computer, an IBM-PC data-compatible unit. The SPC has a flip-up liquid-crystal display providing 8 lines by 80 characters and a full-size keyboard. It uses the 8088 microprocessor and comes with 128K bytes of CMOS RAM expandable to 256K bytes, MS-DOS and BASIC in ROM, and two slots for ROM cartridges (64K to 128K bytes), RAM cartridges (64K bytes), or bubble memory cartridges (128K bytes). The unit is powered by rechargeable batteries. The SPC is expected to be bundled with word-processing, electronic spreadsheet, communications, and executive planner programs. Suggested retail price for the SPC with one bubble memory cartridge will be in the \$2495 to \$2995 range.

## **NANOBYTES**

**American Bell** may market Apple computers through its 461 Phone Center stores. . . . **The Hewlett-Packard** 85B and 86B are the first micros to have built-in semiconductor virtual disks as standard equipment. . . . **Quarterdeck** of Santa Monica, CA, showed a desktop manager that integrates existing PC-DOS and CP/M-86 applications programs. . . . **Schuchardt Software Systems** will offer applications-oriented database-modeling systems that "take advantage of recently developed artificial-intelligence techniques to simplify the user/machine interface," according to Frederick H. Schuchardt, president and founder of the new San Rafael, CA, company. A software hotline service will be available by subscription to end users, dealers, and OEMs. Schuchardt was formerly president of Micropro's World Trade division and before that managed applications development for the American Airlines Sabre System. . . . **Fujitsu's \$2400** 1-megabyte RAM board for its Micro 16s uses 256K-bit RAM chips. . . . **3Com Corp. has reached agreement** with 25 retail stores to distribute the company's Ether/Series Ethernet products. Businessland and independent Computerland stores are among those handling the 3Com products. 3Com reports selling 1000 Etherlinks for the IBM Personal Computer since the beginning of 1983.

# ONE



Special Introductory  
Prices  
5 meg — \$1595.  
15 meg — \$2495.  
10 meg — \$1995.  
20 meg — \$2995.

# FOR ALL

## ONE • IBM-PC • APPLE II • TRS-80 • R

Percom Data Corporation has one hard disk drive system for just about ALL personal computers . . . including of course . . . IBM®-PC, APPLE® II, and TRS-80®. Percom Data's innovations with 5¼" Winchester technology mean that for most personal computers . . . having a reliable hard disk system is as easy as hooking up a cable.

A Percom Data PHD™ will interface with your present system . . . and your future system . . . so if you do change computers, you can still keep your most important investment . . . your Percom Data Hard Disk Drive.

Because Percom Data helped create the industry standards of today . . . new designs in software and hardware will make your selection of a Percom Data Hard Disk Drive pay off tomorrow through system compatibility.

A Percom Data PHD works to capacity because we take the time to correctly develop interface software to your computer which leaves no performance holes for you to fall into. Percom Data knows software functionality is the key to hardware performance.

Today, Percom Data PHD supports a variety of software to match your computer:

**IBM®-PC, PC DOS™ 1.1 OR 1.0**

**CP/M-86®, CONCURRENT CP/M-86™**

**APPLE®, DOS 3.3, CP/M™**

**TRS-80® MODELS III & I, DOPLUS, LDOS**

IMAGINE . . . Percom Data Winchester 5¼" technology . . . for today's computers . . . and tomorrow's.

To receive an informational booklet describing Percom Hard Disk Systems, or to determine if we have a system for your computer call our **Hard-Line Hot-Line at 1-800-527-1222.**

We will also give you the name of a nearby authorized Percom Data Dealer. Dealer inquiries are welcome.

**PERCOM DATA**  
CORPORATION

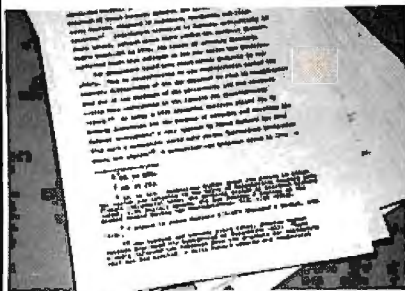
## Expanding Your Peripheral Vision

**DRIVES • NETWORKS • SOFTWARE**

(214) 340-7081 • 1-800-527-1222 • TELEX: 73-0401 (PERCOM).

IBM is a registered trademark of International Business Machines. APPLE is a registered trademark of Apple Computer, Inc. TRS-80 is a registered trademark of Tandy Radio Shack Corp. PHD is a registered trademark of Percom Data Corporation. COPYRIGHT 1983 PERCOM DATA CORPORATION

## FOOTNOTE™ The Bottom Line in Word Processing



FOOTNOTE automatically numbers and formats footnotes in a WordStar® or Select™ document file.

As you type a manuscript, you can enter the footnotes anywhere in the text or in a separate note file. When you exit the text - editor, run FOOTNOTE.

FOOTNOTE places the notes at the bottom of the correct page or removes them to a separate endnote file. You can re-edit the formatted file to add, delete or modify text and notes. Then run FOOTNOTE again to correctly re-number and re-format the file.

Word processing users who underline or boldface phrases often discover that they forgot to terminate the print command. PAIR checks that print commands, parentheses, brackets and quotations are properly terminated.

FOOTNOTE and PAIR together are \$125. They require CP/M® 2.2, CP/M-86™ or IBM PC DOS and a minimum of 48K RAM. They are available in many popular microcomputer formats.

**DIGITAL MARKETING**  
DIGITAL MARKETING™



DIGITAL MARKETING CORPORATION

(800) 826-2222

2363 BOULEVARD CIRCLE • WALNUT CREEK • CA 94595  
(415) 947-1000 • TELEX 17-1852 (DIGMKTG WNCK)

FOOTNOTE and PAIR are trademarks of Pro/Tem Software. CP/M is a registered trademark of Digital Research, Inc. CP/M-86 is a trademark of Digital Research, Inc. WordStar is a registered trademark of Micro-Pro International. Select is a trademark of Select Information Systems.

A DIVISION OF  
**PRO/TEM®**

# Letters

## Vox Populi

The recent issue on standards missed an important new trend in the standards-making process. It is all the more significant because it is the result of the proliferation of microcomputers, where the BYTE readership is strongest. The trend is the democratization of standards.

Ten years ago the ANSI (American National Standards Institute) rule for a balanced representation of committee members between users, implementers, and general-interest members was easily satisfied from the large corporations willing to ante up the high membership fees required by CBEMA because only large companies could afford computers.

With the advent of microcomputers this is no longer true. Consider Chuck Card's new working group for a standard floppy-disk format. To be a member of this committee costs you \$150 per year for three to five years, plus travel and lodging costs four times a year to the other side of the country. For a large company with a vested interest, this is not too much. But users like you and me cannot afford \$1000 or so each year for this kind of activity. The result is that ANSI activities are going to be increasingly biased away from the users toward the manufacturers. Note that CBEMA (the official secretariat) stands for Computer and Business Equipment Manufacturers' Association, which is hardly likely to encourage participation of independent users.

But I mentioned a new trend; it is developing within the IEEE Computer Society. The Computer Society, through the IEEE (Institute of Electrical and Electronics Engineers), is a member of ANSI, and thus a full-fledged standards-making body. But there is no \$150 membership fee, and many of the active working groups stay in one place so that there is a possibility for participation by users. True, a committee meeting in Silicon Valley is still out of the budget for East Coast participants, but at least West Coast participants are not locked out also. Furthermore, the Microprocessor Standards Committee rules permit membership by correspondence, so everyone has the opportunity to have a say in the formation of these far-reaching standards. Finally, unlike the traditional ANSI procedures, the Microprocessor Standards Committee has a policy of publishing full drafts for public review and comment in

widely read trade journals, so you can see what is going on and have the opportunity to participate.

As with any new trend, there are reactionary forces. Even within the Computer Society there are those who want to inhibit the democratization by squelching publication or insisting on peripatetic meeting places. You, the readers of BYTE, can put in your vote for democracy. Write ANSI and/or the Governing Board of the Computer Society and demand to be a part of the standards process. Insist on public review of work in process (i.e., publication of drafts) and working groups that stay in one place long enough to permit the participation of unfunded users like you. Remind them of the success of IEEE-696 (S-100 bus) and the soon-to-be standard P754 (Binary Floating Point) that benefited from this open process. Your voice counts.

Some organizations to write to are the American National Standards Institute (1430 Broadway, New York, NY 10018), the IEEE Computer Society (POB 80452, Worldway Postal Center, Los Angeles, CA 90080), and the Microprocessor Standards Committee, Michael Smolin, Chair (Synertek Inc. MS61, POB 552, Santa Clara, CA 95051).

Please don't everybody write to me expecting replies. I am another unfunded user trying to get some work done to pay the bills.

Tom Pittman  
POB 6539  
San Jose, CA 95150

## Another Standards Organization

The February articles on standards were excellent. Richard S. Shuford's editorial, "Standards, The Love/Hate Relationship" (page 6), and especially his analysis of forces hindering standardization were right on target.

Your readers may be interested in a standards organization that was not mentioned in the issue, ASTM Committee E-31 on computerized systems. ASTM (American Society for Testing and Materials) was founded in 1898. It is the oldest voluntary consensus standards organization in the United States. It is also among the most prolific, with over 6500 separate standards in the 64-volume *An-*



# TOUGH TO OUTGROW

It's no surprise so many businesses today are using our CompuStar® multi-user microcomputer. All sorts of businesses, those at the top and those on the way, know that only CompuStar can give them the big system performance they'll need as they grow. And they know that *only* CompuStar can deliver that performance at a fraction of the cost of most other systems.

CompuStar® solves the small business computer dilemma. It's ideal for those first time business users who need only single-user capability. But it's also perfect when those small businesses grow into large corporations. That's because CompuStar is *truly* expandable... all the way up to 255 workstations, each with its own processor and internal computer memory. And that means fast, fast response, even when many users are on-line at the same time.

Whether you're a small business with big plans or a big business with an eye for economy, CompuStar® has the performance and versatility that's tough to outgrow... the price/performance ratio that's impossible to beat!

## STANDARD FEATURES

- 350K/750K/1.5 MB workstation disk capacities
- 64K RAM and twin processors in each workstation
- An easy-to-read 12-inch non-glare screen
- Operator convenience features—numeric keypad and visual text highlighting
- Microsoft® Basic
- CP/M+ operating software
- Truly multi-user and multi-processor

## STORAGE OPTIONS

- 10 MB—compact, low-cost and tabletop
- 96 MB—80 fixed and 16 removable megabytes
- 144 MB—reliable, rugged Winchester storage

CompuStar® is built and backed by the company that's been in the microcomputer business as long as microcomputers have been in business. Would you trust your business to anything less? CompuStar. Tough to beat. Tough to outgrow!

Microsoft is a trademark of Microsoft Corp.  
®Registered trademark of Digital Research

**INTERTEC  
DATA  
SYSTEMS**

CORPORATE HEADQUARTERS 2300 BROAD RIVER ROAD • COLUMBIA, SOUTH CAROLINA 29210 • (803) 798-9100 • TWX 810-666-2115

# QUADRAM™ INAUGURATES THE

## **Use Apple software in your IBM PC and XT**

Who said you can't mix Apples and IBMs? Innovation by Quadram makes it possible with Quadlink™. A simulated Apple computer on a revolutionary new enhancement board.

Most programs designed for the Apple II, II Plus or IIe — including educational software and entertainment options — are now com-

patible with IBM PCs sophisticated business capabilities. That's right. An Apple and an IBM. In one computer with no software limitations. Quadlink by Quadram opens a whole new world of possibilities.

## **Easy to use**

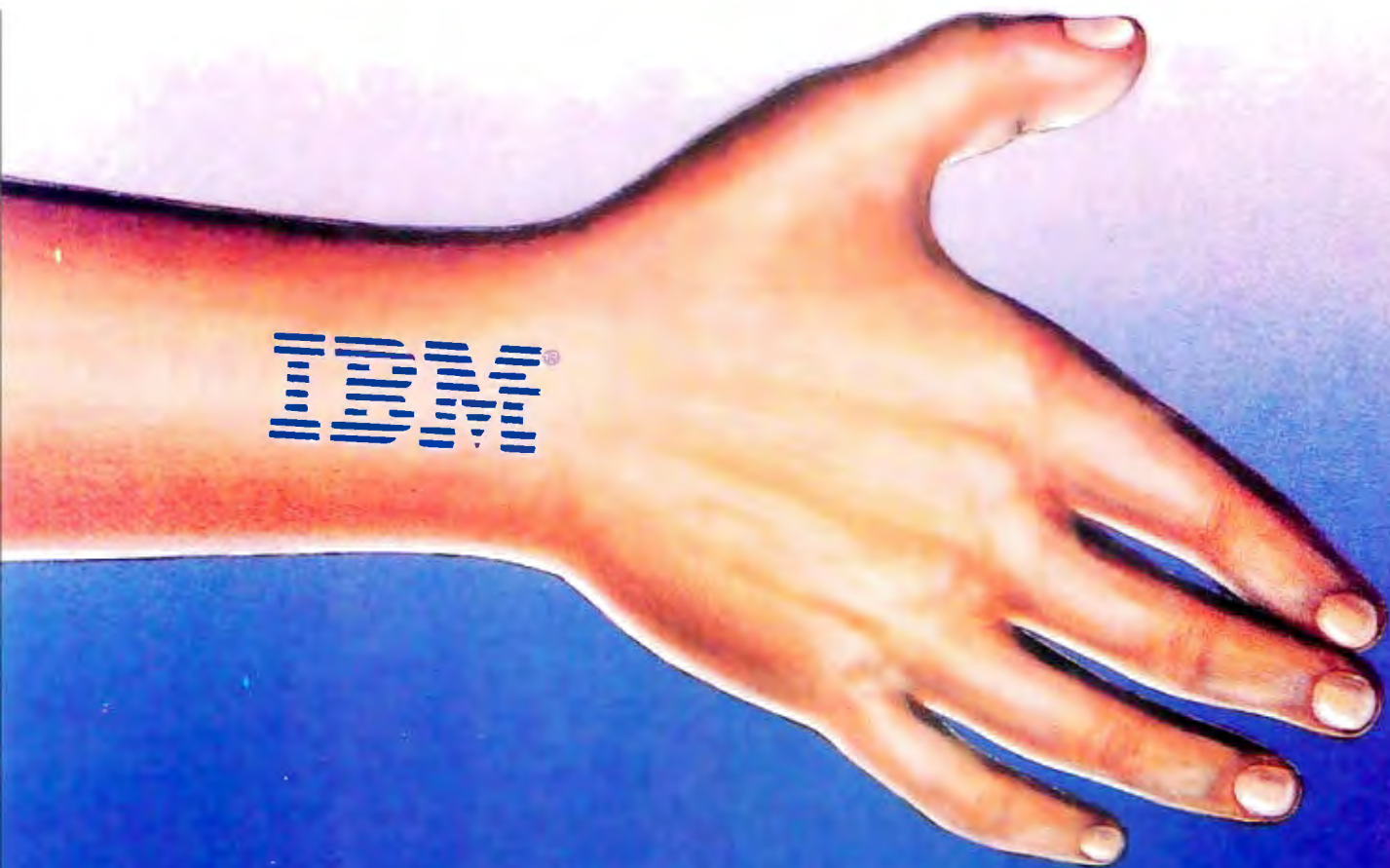
Quadlink plugs inside IBM PCs. No conversion or reformatting of diskettes needed. Just load Apple software in the IBM and key one command. That puts you in the Apple

mode. When ready to switch back, just press a different key. It's that simple. Like having an Apple 64K computer inside your IBM.

## **Keep the extras**

Quadlink allows use of all IBM enhancements while running Apple software. Printers, buffers, monitors and more.

When using a monitor there's no plugging or unplugging cables.



Apple and the Apple logo are registered trademarks of Apple Computer, Inc.  
IBM and the IBM logo are registered trademarks of International Business Machines Corporation.

# MERGER OF APPLE AND IBM

Apple programs will appear on an IBM monochrome or color monitor, like Quadram's vivid RGB color monitor Quadchrome, more clearly than Apple's own screen — even while working with Apple's high resolution color graphics.

## Explore your options

Quadlink comes standard with 64K memory. Requiring only one expan-

sion slot, it offers a game port and works with all installed I/O devices designed to enhance the IBM PC. Like parallel and serial ports for operating printers, modems and other peripheral accessories. There's nothing like Quadlink. And nothing like reliable Quadram Quality to stand behind it.

Quadram Corporation is a division of Intelligent Systems, for over a

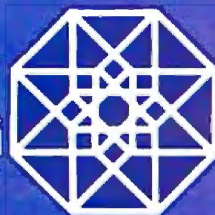
decade an innovator in personal computer enhancements and color graphics peripherals.

Quadram products are available only through authorized dealers worldwide. Visit one and ask for a demonstration of Quadlink. Priced at only \$680, we think you'll like what we've discovered.

Check on our other enhancements too, especially Quadboard, the original multifunction board for the IBM PC.



**QUADRAM**  
CORPORATION  
An Intelligent Systems Company



4357 Park Drive / Norcross, Ga. 30093 / (404) 923-6666  
TWX 810-766-4915 (QUADRAM NCRS)

Available for delivery to retail stores worldwide in late June.

Circle 322 on Inquiry card.

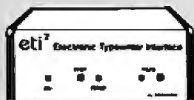
# PRINTER OPTIMIZER



Why buy a mere "spooler" when you can have THE PRINTER OPTIMIZER?

- \* 64k to 256k spooling buffer
- \* adapts different brands - can mix Serial and Parallel
- \* character conversion: 1 to 1, 1 to many, many to 1, ignore
- \* pushbutton automated access to your printer's various type styles and printing modes
- \* several ways to PAUSE printing
- \* access any character, graphic design or printer "trick" from any program at any time
- \* special features for use as a MODEM buffer

## ETI<sup>2</sup>



The cost effective alternative. Converts IBM, Adler/Royal, Olympia and other Electronic Typewriters into letter quality printers.

- \* 2K memory buffer
- \* access all typewriter characters and automated features
- \* Serial or Parallel versions
- \* Many proprietary features and commands insure compatibility with your system and software
- \* Typesetting capability!

## PETI<sup>2</sup>



Super low cost adaptor for new inexpensive portable Electronic Typewriters can yield typewriter and letter quality printer combination for around \$500 total!

- \* perfect for "personal use"
- \* easy "plug-in" Parallel connection to most computers
- \* compatible with popular word processing programs

## APPLIED CREATIVE TECHNOLOGY INC.

2723 Avenue E East, Suite 717  
Arlington, Texas 76011  
(817)-261-6905  
(800)-433-5373

## Letters

nual Book of ASTM Standards. ASTM was one of the four organizations that, in 1918, founded what has become the American National Standards Institute.

Committee E-31 on computerized systems was organized in 1970. E-31's standards focus on the needs of people who use computerized systems. (A computerized system is one in which a digital computer is a significant part.) There are draft or approved standards for computerizing clinical laboratories, manufacturing operations, hospital pharmacies, and scientific laboratories, as well as more general standards to guide any computerization project. A standard specification for software documentation is now in the final stages of approval.

All meetings of Committee E-31 and its subcommittees are open. Anyone is welcome who wants to learn, to participate, and to join in the work of developing standards. Many of us learned a good deal of what we know about computerized systems with Committee E-31. We are all still learning.

People can contact me for more information or they can write directly to ASTM at 1916 Race St., Philadelphia, PA 19103.

**Peter E. Schilling, Chairman**  
ASTM Committee E-31 on Computerized Systems  
Aluminum Company of America  
Alcoa Technical Center  
Alcoa Center, PA 15069

### More on the Proposed ANSI BASIC Standard

Ronald Anderson's "The Proposed ANSI BASIC Standard" (February, page 194) raised some questions to which I would like to respond.

First, it should be pointed out that the ANSI (American National Standards Institute) public review period is indeed open to the public; any interested party may submit comments directly to ANSI/X3 committee (X3 Secretariat, CBEMA, 311 First St., NW, Washington, DC 20001). It is also possible to channel these comments through the Association for Computing Machinery (ACM).

The standard is organized in the form of a core specification plus some independently optional modules (e.g., real-time and graphics). This was done to provide standardization for a given well-demarcated functional area without forc-

ing it on all implementations. In the case of real-time operations, for instance, there is widespread use and implementation, and so the need for standardization exists. At the same time, it doesn't seem reasonable to require all vendors to implement this rather ambitious module because their users may have no need of it.

The article implied that the standard did not provide data typing. In fact, the standard does specify a DECLARE statement for the typing of variables. Variables need not be declared explicitly, but they are still typed, according to the usual BASIC convention of a trailing dollar sign for strings and no such dollar sign for numerics. Assignments and comparisons between incompatible types are not allowed. Furthermore, the standard even guarantees type-checking for I/O (input/output) to so-called INTERNAL files; no other language of which I am aware provides this protection.

Finally, I take exception to the statement that "the new standard appears to be more loosely defined than most other language standards." This certainly was not the intention nor, I believe, the result of X3J2's efforts. There are indeed a number of instances in which a result is explicitly implementation-defined; such is the case in all language standards. But I believe the clarity of the specification compares favorably with that of other recent and proposed standards, e.g., for FORTRAN, Pascal, or Ada. X3J2 would certainly welcome hearing about any specific aspect of the standard that is vague or ambiguous and will, I'm sure, do its best to remedy such lapses.

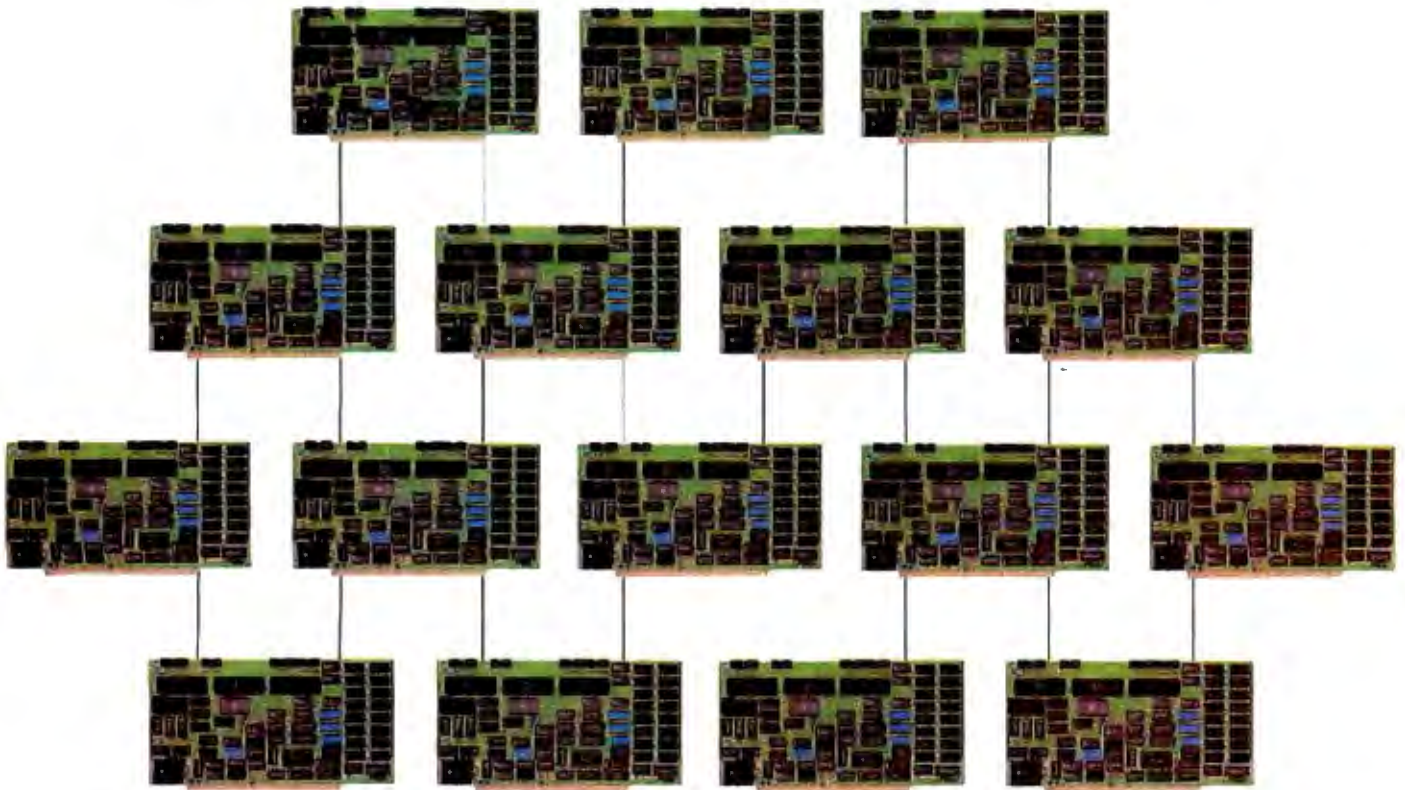
**John V. Cugini**  
Programming Languages Group  
Data Management and Programming Languages Division  
United States Department of Commerce  
National Bureau of Standards  
Washington, DC 20234

### Standard Priorities

Thank you for the informative articles on standards in February. However, I was wondering if there is a standards committee on documentation. If there is anything the computer industry needs today it is a set of standards for documentation. Much of the software and hardware produced today is of good quality, yet the documentation is so poor that these pro-



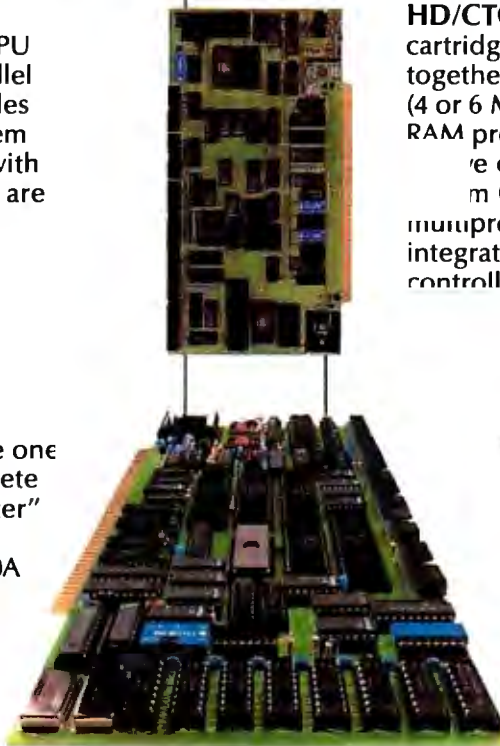
# Now Our Family Tree Is Complete



**SBC-1 (Above)** A multiprocessing slave board computer with Z-80 CPU (4 or 6 MHz), 2 serial ports, 2 parallel ports, and up to 128K RAM. Provides unique 2K FIFO buffering for system block data transfers. When used with TurboDOS or MDZ/OS the results are phenomenal!

**HD/CTC** A hard disk cartridge controller combined together on one board! A Z-80 CPU (4 or 6 MHz); 16K ROM, and up to 8K RAM provide intelligence required to relieve the disk I/O burden from host main CPU. Round out your multiprocessing system with an integrated mass storage/backup controller.

**Systemmaster® (Right)** The ultimate one board computer; use it as a complete single-user system or as the "master" in a multi-processing network environment. Complete with Z-80A CPU, 2 serial and 2 parallel ports, floppy controller, DMA, real time clock, and Teletek's advanced CP/M BIOS. Also supports MP/M-II, MDZ/OS, and TurboDOS.



## TELETEK

9767F Business Park Drive  
Sacramento, CA 95827  
(916) 361-1777  
Telex #4991834  
Answer back-Teletek

Circle 380 on inquiry card.

# Your Single Source Family of S-100 Products.

ducts are under-used or not used at all. My word-processor program, for example, does not have an index. A book of over 100 pages without an index is all but ludicrous, not to mention the fact that one page of the table of contents is missing. If standards for documentation are developed, they should include both a table of contents and an index for each volume of the document.

Most of the standards dealt with by the articles in your February issue seem to be long overdue and should be implemented. Yet, somehow I feel that some of these standards may become too restrictive and burdensome, such as the proposed floppy-disk-format standard. Even more critical is that program languages such as BASIC, Pascal, COBOL, and others undergo further needed standardization. Take, for example, Visicalc. It can be used with relative ease on any of the computers for which it is designed, provided users have the appropriate copy of Visicalc for each computer they wish to use. Visicalc is not a program language; yet its virtue of commands that are similar if not identical for the various computers for which it is designed should be the goal for program-

language standardization. Standardization of program languages is much more important than the standardization of floppy-disk formatting or of operating systems.

**John H. A. Deal**  
RFD 2, Box 77  
Malta Bend, MO 65339

**Lisa Feedback**

Like everyone else, I awaited with great anticipation Gregg Williams' in-depth review of Apple's new Lisa machine (February, page 33). However, upon completing the article, I found myself wishing that the author had provided more searching analysis and less parroting of the manufacturer's promotional fog and vague promises.

As a longtime admirer of Apple's corporate verve, I've hoped that the Lisa would provide the transfusion of fresh blood necessary to keep the company from otherwise inevitable crushing under the IBM juggernaut. From the article, I'm not sure this is the case. Maybe Williams

just missed some fundamental points, but I'm sure that the corporate purchasing agents who will be making searching evaluations of this very expensive machine will not miss such points as these:

**The microprocessor:** The 68000 is more or less current state-of-the-art, but what's the point if the multiuser, multitasking, networked operating systems aren't in place? Trying to separate promises from deliverable hardware, it seems that quite a bit of such support has yet to be implemented.

**Drives:** What's so "revolutionary" about an 860K-byte variable speed drive? Chuck Peddle put 1.2-megabyte variable-speed drives (double-sided version) in the Sirius I (Victor 9000) two years ago.

**Display:** It's hard to tell from the photos, but the display seems to be just black on white or pale blue. If so, it may be a serious mistake. While such a display may be necessary for logic implementation of the desktop-with-icons metaphor, it sacrifices the utility and pizzazz of the full-color graphics rapidly becoming industry standard with Apple's competition. And black on white is just hopeless for long-term word processing; even executives must sometimes draft long reports.

**Input Devices:** People doing any serious spreadsheet work will surely long for cursor movement keys and curse the need to remove hands from the keyboard to use the mouse. The mouse itself seems pointless; why replace a device you're afraid the executive is afraid of (the keyboard) with another unfamiliar device? If Apple was seriously interested in the psychology involved it would have given said executive a light pen.

**Software-Bundle Concept:** Certainly Apple must be applauded for its willingness to take the software-bundle concept to new heights. However, I wonder whether in some areas it goes too far. For example, while the desktop-with-icons metaphor may be useful, were I a Fortune 500 company vice-president, I would be mortally insulted that a designer felt my computer had to show me a picture of a wastebasket to direct me to the delete-file function. Such offensive condescension shows up throughout the design, even in the hardware (e.g., labeling the disk release button "Disk Request").

The individual programs seem well thought out, except for the word processor. If this machine is really aimed at executives, it probably ought to trade

# BYTEWRITER®

## DAISY WHEEL PRINTER

- Full Olivetti typewriter warranty
- U.L. Listed



\$695

plus shipping

**FEATURES**

- Typewriter operation with nothing to disconnect
- 10, 12 or 15 characters per inch switch selectable
- Portable with carrying case
- Entire interface mounted internally in the Olivetti Praxis 30 typewriter
- Underlining
- Cables available for most computers
- Service from Olivetti dealers
- Centronics compatible parallel input
- Built in self test
- Cartridge ribbon
- 2nd keyboard switch selectable.

BYTEWRITER

125 NORTHVIEW RD., ITHACA, N.Y. 14850

(607) 272-1132

# RENT SOFTWARE BEFORE YOU BUY!

## from our SOFTWARE RENTAL LIBRARY

You can now RENT the most popular software available for just **20-25%\*** of Manufacturers' Retail Price

- Eliminate the risk—rent first!
- 100% of rental fee applies toward purchase
- All purchases are 20% Off of Manufacturer's Suggested List
- Rentals are for 7-days (plus 3 days grace for return shipping)
- No Membership Fees

Now currently available for:

Apple

IBM, PC

Standard CP/M 8''

Eagle

TRS-80 II

Xerox 820

Northstar

Osborne

Heath/Zenith 89

Franklin

**REMEMBER, THESE ARE NOT DEMOS, BUT ORIGINAL UNRESTRICTED SOFTWARE PROGRAMS**

(complete with manuals in original manufacturers' packages)

**To Immediately Order, or for more information:**

**UNITED COMPUTER CORP.**  
Software Rental Library  
Culver City, California

Toll Free CALL 1-800 992-7777  
In California CALL 1-800 992-8888  
In L.A. County CALL 1-213 823-4400



\*Plus postage and handling.

## Letters

some of the sophisticated manipulation and formatting for a spelling check (they probably aren't much as typists), grammar checker (they want their reports to be readable and articulate), style manual, and thesaurus. They'll want to be able to creat sharp, lucid *drafts*; they'll expect their stenographers to take care of formatting and printing with the right margins and other details.

**Image:** I'd hoped (apparently in vain) that Apple finally understood how badly its cutesy, whimsical image hurts its

chances of executive-suite penetration. This image crops up in too many ways in the Lisa: the Apple (control) key, the mouse, and on and on. Please, guys, the next time you're in the executive-suite waiting room, flip through the magazines on the table. You'll find *Fortune*, *Barron's*, *Forbes*, etc., but certainly not *Nibble*. There's a lesson there.

**Price:** \$10,000 is ludicrous. Most customers may feel that with existing competitive hardware and other software bundles that will reach the market before

the Lisa, they can get good enough performance. Why pay \$2000 to \$3000 more to be condescended to by a machine? And it becomes hopelessly worse if Apple goes through with the imbecility of locking machine and software together with electronic serial numbers. What company in its right mind is going to spend \$4000 many times over for repetitive bundles of software? Times are gettin' hard, boys. Money's gettin' scarce, in case you didn't realize it already. It would be far more sensible to license the package to a network of stations.

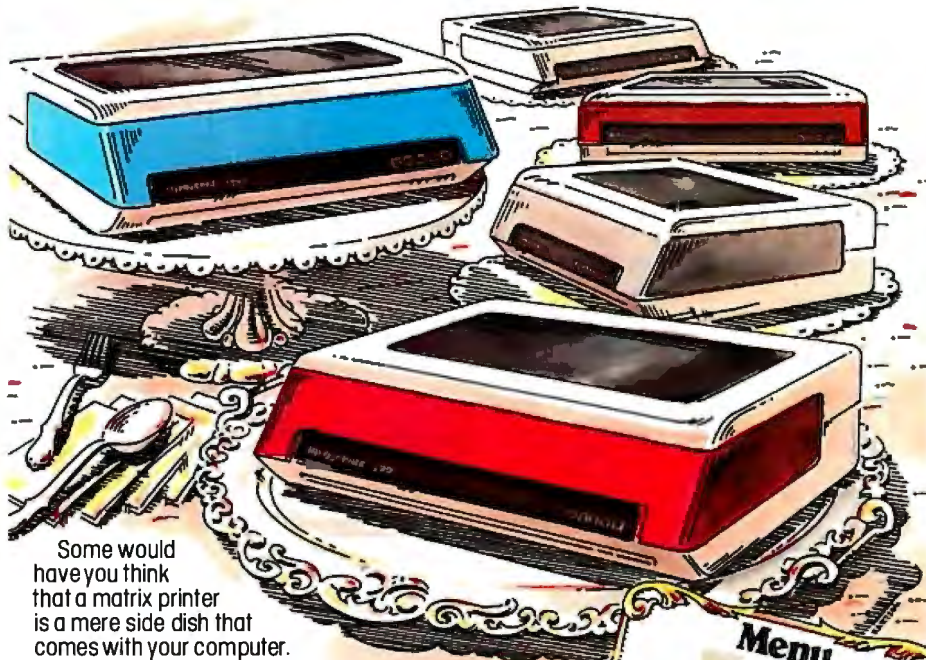
Don't get me wrong. I vigorously applaud the effort, initiative, and obviously deep consideration that Apple has given to the Lisa. I really hope it succeeds. My remarks are not a debunking diatribe, but an earnest effort to point out that there are still some significant bugs in a generally pretty snazzy machine.

**Del Palmieri**  
3 Maple Ridge  
Ballston Lake, NY 12019

Thank you for your comments on the Lisa system and my review of it. I think you summed it up when you said that the Lisa is the result of "effort," initiative, and obviously deep consideration." Of course, no project of such complexity can satisfy everyone, and many of your criticisms are valid personal objections. I particularly agree with you that the \$10,000 price is regrettably high (although I would not call it ludicrous) and that the capabilities of Lisa Write do not mesh well with Apple's intended audience of corporate executives. I also thank you for pointing out that the Victor 9000 (as it's called in the U.S.) disk drives do outperform the Lisa's; I was dead wrong on that, although I still think that other aspects of the drives (like the redundant directory and the Disk Request button) are very valuable.

At this point, however, we part company. Your opinions as a potential Lisa customer have the utmost validity but may not be widely shared. For example, I don't think that most people are "mortally insulted" by icons that give them visual clues about the machine's operation, nor do I think they find a Disk Request button, which keeps them from taking a disk out and losing data, to be "offensive condescension." You imply that Apple's use of the mouse is perhaps not the best pointing device for the typewriter-shy executive; maybe so, but Apple spent a lot of money on research that caused them to

# Soup to Nuts.



Some would have you think that a matrix printer is a mere side dish that comes with your computer.

Don't believe it.

What you get out of your printer is what you get out of your computer. If your printer is small, slow, noisy or unreliable, your computer will be limited, sluggish, irritating, or inoperable. Just telling it like it is.

That's why Infoscrite has come up with a gourmet line of multifunction matrix printers specifically for business and professional users.

You can switch from high-speed data processing to business letters, at will; handle up to 16-inch-wide paper; make up to five crisp carbons; generate gorgeous graphics in up to eight colors; and enjoy truly elegant and incredibly quiet operation, day-in and day-out.

Check the menu for the printer that meets your exact needs. Why go with the computer manufacturer's combo plate when the same money will let you buy Infoscrite, a la carte?

Your favorite computer dealer or systems specialist will be delighted to arrange a demonstration for you. Or contact the *matrix d'*: Infoscrite, 2720 South Croddy Way, Santa Ana, California 92704, USA, Phone (714) 641-8595, Telex 692422.

MODEL		DRAFT (CPS)	CORRESPONDENCE (CPS)	LETTERS (CPS)	GRAPHICS (72 x 72)	GRAPHICS (144 x 144)	PROGRAMMABLE FONTS	COLOR
500	150	75						
1000	200	100	X	X				
1100	200	100	X	X	X	X		
1200	200	100	X	X	X	X	X	
1500	400	200	X	X				

# PRINT WITH INFOSCRIBE

# INTRODUCING ULTRATERM™



## YOU'LL LOVE THE VIEW!

With UltraTerm, the revolutionary new card from Videx, you'll enjoy sweeping panoramas of spreadsheets that you've never seen before: 128 columns by 32 lines, 132 columns by 24 lines and even 160 columns by 24 lines. You'll revel in the scenics of a whole year of records stretching out across your screen.

You'll also delight in the new horizon of 80 columns by 48 lines—double the lines you normally have. So your word processing will reveal a "depth of character" never possible before!

Another breath-taking view of UltraTerm—it delivers absolutely flicker-free, state of the art display, with 8 x 12 character matrix giving you preposterously clear, readable characters. Not only will you see **more** characters on your screen (a whopping 4096 possible), but they'll also be larger and more readable than the characters you read every day in



Photo of actual-size characters on Apple Monitor III.

your newspaper! And you can differentiate those characters in several modes: normal (white on black), inverse (black on white), bright intensity and dim intensity.

**UltraTerm. Come on over and enjoy the view.**  
Suggested retail price: \$379



897 NW Grant Ave. • Corvallis, Oregon 97330  
(503) 758-0521

UltraTerm features a built-in soft video switch and has complete firmware support for BASIC, Pascal and CP/M®. Use it with the Apple® II, Apple IIe, Apple III and Franklin.

Apple and the Apple logo are registered trademarks of Apple Computer, Inc.

CP/M is a registered trademark of Digital Research, Inc.

Circle 408 on inquiry card.

# CompuPro's Latest... the Industry's Finest.



## System 816/68K™

If you're excited about FORTH, you couldn't find a better companion than this 68000-based system. **System 816/68K** includes CompuPro's indomitable new CPU 68K, 256K bytes of 16-bit memory, 1.5 megabytes of M-Drive/H™, System Support 1, Interfacer 4, Disk 1 controller, Desktop Enclosure 2, disk enclosure with two Qume drives for 2.4 megabytes of storage, all cables, and software: CP/M-68K™, mapFORTH and C languages. \$8,995.



Call (415) 562-0636 for information on pricing and availability and the location of the Full Service CompuPro System Center nearest you. CompuPro products are backed by a one-year limited warranty (two years for boards qualified under the Certified System Component high-reliability program).

Send for our catalog for  
complete product information.

CompuPro, a Godbout Company, Box 2355, Oakland Airport, CA. 94614

Circle 75 on Inquiry card.

We've wired **CompuPro** savvy into three of the industry's most potent new processor chips. The results: more performance, more quality, more reliability, and higher speed for greater throughput than ever before.

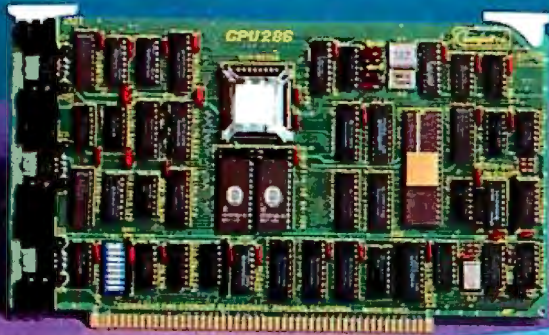
**CPU 286** and **CPU 16032** can upgrade present systems to state-of-the-art operation, or serve as powerful foundations for new systems. **CPU 68K**, aside from being a superb CPU board, is also the core of our **System 816/68K**.

As always, **CompuPro** kept an eye on the future in designing these CPUs. With a **CompuPro**, you don't shudder at fast-changing technology — you welcome it.

**We give you brains and brawn in one box, and that's beautiful.**

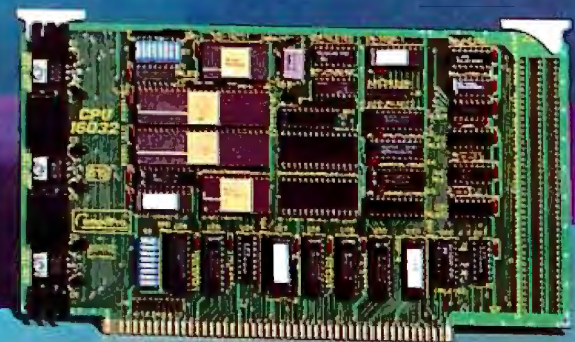
## CPU 286

No more fighting to get on the bus, multi-users. **CPU 286** is based on Intel's ultra-high performance 16-bit iAPX 286/10; it includes sockets for both the 80287 math co-processor and up to 16K bytes of on-board EPROM. To protect your existing investment, **CPU 286** accepts 8-bit as well as 16-bit memory, is downward compatible with the vast library of 8086 and 8088 software, and works with all DMA devices meeting IEEE 696/S-100 standards. Operates up to 10 MHz.



## CPU 16032

Power? This one crunches catalogs for breakfast. **CPU 16032** is based on National Semiconductor's NS16032 16-bit microprocessor, with provisions for on-board memory management unit, floating point arithmetic unit, and up to 32K bytes of ROM. Although its internal architecture is 32-bit all the way, **CPU 16032** works with 8- and/or 16-bit memories and peripherals meeting IEEE 696/S-100 standards.



## the Rest of CompuPro's Family:

### SYSTEMS\*

Single user (expandable to multi-user): **System 816/A™** and **816/B™**. Multi-user: **System 816/C™**, **System 86/87™**, **System Oasis-8™**, **System Oasis-16™**.

### OPERATING SYSTEMS

CP/M-80™, CP/M-86®, MP/M-816™, FORTH, CP/M-68K™, CP/M-816™, OASIS-8™ and OASIS-16™.

### MEMORY BOARDS

RAM 16, RAM 17-48, RAM 17-64, RAM 21, RAM 22 and 512K M-Drive/H™.

### DISK CONTROLLERS and SUBSYSTEMS

DISK 1, 2, 3 controllers, Dual Floppy Disk Subsystem, Add-On Hard Disk Drives.

### INTERFACERS

Interfacer 1, 2, 3-5, 3-8 and 4.

### CPUs

CPU Z, CPU 8085/88 and CPU 86/87.

### MOTHERBOARDS and ENCLOSURES

6-, 12- or 20-slot motherboards, Enclosure 2 (desktop or rack mount).

### STD BUS BOARDS

CPU Z, RAM-16, MB-8, MB-16, RAM 32, and RAM 64.

**\*Software bonus!** All CompuPro 816 systems include the following prepackaged software: Sorcim's powerful **SuperCalc-86** for business and financial planning, Ashton-Tate's **dBase** for data base management, and now, Lorand Andahazy's **Field Companion** for increased administrative productivity.

These high-technology products require skilled installation. They are intended for OEMs, system integrators and experimental researchers only.

CP/M-86 is a registered trademark of Digital Research; Oasis is a trademark of Phase One Systems; M-Drive/H is a trademark of CompuPro.

choose a mouse over light pens and other input devices. Such research also recommended a black-text-on-white-background video display, which you call "hopeless for long-term word processing."

Finally, you make several misleading statements. You say that the Lisa is at fault for not having color graphics, which are "rapidly becoming industry standard." This is simply not the case. Machines like the IBM Personal Computer and the Texas Instruments Professional Computer have color, but most business software does not make routine use of it. The reason for this is simple: software vendors, attempting to maintain product portability to other computers, shy away from implementation-dependent features like color graphics. Also, the "imbecility of locking machine and software together" does not exist because the Lisa is sold only with legal copies of its software. The idea of Apple licensing the software to a network of Lisa machines does have merit and is a good compromise between paying for each copy and pirating multiple copies from one legal one.

I agree with you that "there are still

some significant bugs" in this "pretty snazzy machine," but I think that Apple (or other companies) will iron them out as the price of such technology decreases and more variations of it become available to suit more people's needs. As it turns out, you are not alone in your dissatisfaction, as you will see from the next letter. . . . G. W.

I read "The Lisa Computer System" by Gregg Williams and "An Interview with Wayne Rosing, Bruce Daniels, and Larry Tesler" by Chris Morgan, Gregg Williams, and Phil Lemmons (February, pages 33 and 90) with hopes that I would learn some of the shortcomings of the Lisa. Instead, these articles, like so many others, read like they were written by Apple's marketing department.

I have not set eyes on a Lisa, but from what I know about the Star and the Worm (remember the Worm that was going to eat the Apple?), and from what I have read about the Lisa, I do not think that the Lisa will be the success that the media have presented.

I dislike being negative because the Lisa

does have many marvelous features, which were well presented in your article. However, I think the mistakes made in designing the Lisa and its predecessors should be pointed out by someone.

**Mistake #1:** The philosophy that computer designers know what users need is arrogant and usually wrong. Every computer user has different desires and needs. The Apple II successfully caters to this market by allowing users to select a machine configuration to meet basic start-up requirements. Users can later purchase additional hardware and software from numerous sources. Users can also customize their machines or software, attaching all sorts of devices and making all kinds of modifications to both hardware and software.

It appears there is one configuration of hardware and software available to potential Lisa users. The Lisa software has six application programs for what appear to be basically word-processing applications. The graphics are excellent, but what if I am offended by the garbage-can concept? How do I change the graphics sym-



# CompuPro

## 8 and/or 16 Bits.

A Full Service CompuPro System Center is much more than a computer store: It is the first place to look for business, scientific and industrial computing solutions. When you're ready for professional level, state-of-the-art microcomputing, turn to the professionals listed below . . . they're ready for you.

### ARIZONA

S-100  
14425 N. 79th St. #B  
Scottsdale, AZ 85260  
(800) 528-3138

### CALIFORNIA

**Creative Computing Services**  
230 S. Montclair #103  
Bakersfield, CA 93309  
(805) 325-9877

**Track Computer Center**  
1514 University Avenue  
Berkeley, CA 94703  
(415) 845-6366

**Menizer Computer Systems**  
1441 Rollins Rd.  
Burlingame, CA 94010  
(415) 340-9363

**Creative Computing Services**  
20613 Soledad Canyon Rd.  
Canyon Country, CA 91351  
(805) 251-9877

**Logic Systems**  
5830 Jameson Ct.  
Carmichael, CA 95608  
(916) 971-3133

**Priority One Electronics**  
9161 Deering Ave.  
Chatsworth, CA 91311  
(213) 709-5464

**Byte Shop of Hayward**  
1122 B St.  
Hayward, CA 94541  
(415) 886-4732

**Priority One Electronics**  
18241 McDermott  
Irvine, CA 92714  
(714) 660-1411

**American Computers & Engineers**  
2001 S. Barrington Ave. #204  
Los Angeles, CA 90025  
(213) 477-6751

**Gifford Computers**  
2323 Cornth Ave.  
Los Angeles, CA 90064  
(213) 477-3921

**ACC**  
883 Steirlin Rd. #B110  
Mountain View, CA 94043  
(415) 969-4969



bols to ones I prefer? How do I change the commands to ones I like?

What language was this all written in anyway, and why isn't it available to the user? These questions and their answers are missing from all the articles I've read about the Lisa and imply to me that its designers do not believe purchasers of the machine should modify what they have bought.

**Mistake #2:** The mouse. The mouse is an inexpensive graphics input device that is beloved by graduates of Stanford's computer science program. It has been around for about 15 years in a variety of forms. The Lisa's designers have improved upon the mouse by reducing the number of buttons on it to one. Whether they have removed the other problems with the mouse—poor reliability, intermittent behavior, and inability to move in a natural direction—remains to be seen.

The poor reliability and the intermittent behavior both result from the fact that mice get dirty rolling around on a table. Dirt gets into the potentiometers, which then have "bad spots" and eventually do not work at all. A badspot is a spot on the

display which you cannot point to. You can work around this by lifting the mouse and moving it so the bad spot moves too, but this rapidly becomes annoying.

The unnatural direction results from two wheels mounted perpendicularly to each other. To move diagonally, you need to move along the x-axis and then the y-axis rather than along a diagonal as you can with a joystick.

Because I have no experience with Lisa's mouse, these comments may be unfair. My experience is based on Star's mouse, which had these problems. Gregg Williams' article only pointed out the button improvement, so I assume the rest remains the same.

**Mistake #3:** The disk. Why the designers of Lisa needed a nonstandard disk package is beyond me. This will make the disks far more expensive with no great improvement in performance. That is, there is no great improvement in the amount of information being stored or in the speed of access. The reliability claim is nice, but in terms of reliability, floppy disks are not a weak link in a system. If anything, the mechanics of the disk need

looking at, not the recording technique. The method of storing two directories is a good redundancy technique that can be done in standard packages.

**Mistake #4:** Performance. This is a difficult issue to evaluate by reading glowing articles about the Lisa. This is mostly a worry because of the size of the programs mentioned in the article and because of the lack of a display processor, not because of the chip chosen for the Lisa. I have seen old PDP-8 word processors with a tiny memory outperform 16-bit word processors with large memories, so it is a matter of software, not hardware.

If I were to check a Lisa, I would type in a page of text. Then I would block copy the page to create 2 pages of text, then block copy the 2 pages to create 4 pages and so forth until I had 128 pages. This would require only seven block copies and should be done relatively fast if the machine performs well, I would then go to page 50 and cut out a paragraph and insert it in page 1. I have done this on a variety of word processors. Some will not even allow a small number of block copies.

# Spoken Here...

## Track Computer Center

2100 Broadway St.  
Oakland, CA 94612  
(415) 444-8725

## System Interface Consultants

17440 Revello Dr.  
Pacific Palisades, CA 90272  
(213) 454-2100

## Advanced Information Mgmt.

145 Kentucky St.  
Petaluma, CA 94952  
(707) 763-7283

## Best Computer Stores

5516 Springdale Ave.  
Pleasanton, CA 94566  
(415) 463-2233

## Gifford Computers

230 California St. #207  
San Francisco, CA 94104  
(415) 391-4570

## Gifford Computers

1922 Republic Ave.  
San Leandro, CA 94577  
(415) 895-0798

## Computer House

501 B St.  
San Rafael, CA 94901  
(415) 453-0865

## Data Bank

629 State St.  
Santa Barbara, CA 93101  
(805) 962-8489

## Data Bank

600 S. Broadway  
Santa Maria, CA 93456  
(805) 922-1333

## Matrix Computers

720 Mendocino Ave.  
Santa Rosa, CA 95401  
(707) 542-0571

## Pragmatic Designs, Inc.

950 Benicia Ave.  
Sunnyvale, CA 94086  
(408) 736-8670

## FLORIDA

## Micro Computer Technology

1549 W. Brandon Blvd.  
Brandon, FL 33511  
(813) 685-7659

## GEORGIA

## General Software, Inc.

1360 Georgia Ave.  
Macon, GA 31201  
(912) 742-6959

## HAWAII

## Capacity Plus Computers

250 Alamaha St. N14  
Kahului Maui, HI 96732  
(808) 877-3496

*(Please turn the page)*

## ILLINOIS

## Computers Plus

201 N. Main St.  
Athens, IL 62613  
(217) 636-8491

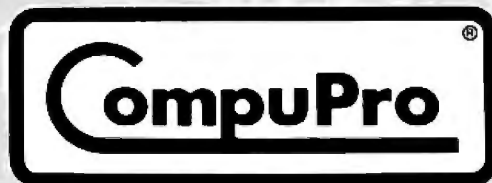
## Lillipute Computer Mart, Inc.

4446 Oakton St.  
Skokie, IL 60076  
(312) 674-1383

## INDIANA

## General Software, Inc.

1454 S. 25th St.  
Terre Haute, IN 47803  
(812) 234-9421



CompuPro, a Godbout Company,  
Box 2355, Oakland Airport, CA 94614

## Letters

We will be seeing more small computers that use the Motorola 68000. I hope we will someday see one that shares Apple's original philosophy of letting users decide what they need.

**Sabina Saib**  
1500 Holiday Hill  
Goleta, CA 93117

Thank you for raising concerns that I have not heard elsewhere. You bring up some important points: why doesn't the Lisa allow you a choice of ways to do things? Is the mouse reliable enough and easy enough to use? Why did Apple choose an expensive, nonstandard floppy disk? Will the computer be responsive enough when dealing with large, "real-world" tasks? Let me respond to each of these in turn.

You say that the Lisa does not have the protean nature of the Apple II. That opinion is not quite fair to the Lisa computer; after all, it does have three expansion slots for extra hardware, and Apple will be releasing a "programmer's toolkit" that will allow third-party vendors to create

whatever software they feel is best. Aren't these the very features you applaud the Apple II for? I grant that you will never have the wide variety of hardware and software add-ons for the Lisa that you have for the Apple II, but that is because of three factors. First, the Lisa doesn't need them—many Apple II add-ons correct deficiencies in that computer's design. Second, nobody has had time yet to develop new software and hardware for the Lisa. (Remember, when the Apple II was first introduced, nothing was available for it, either.) Third, the Lisa is a more expensive machine that will not sell as widely as the Apple II; this will significantly influence the number of vendors who will consider creating products for it.

Your criticism about the Lisa coming in only one configuration is certainly a valid one. Probably the only customization you will be able to do is what Apple allows you to do; the software is written in 68000 machine language and is too complex to be modified by the user. The Lisa computer is the first of an entirely new kind of computer. The computers that follow it

will improve on the first design; if people like you convince the designers that they must include more customization to satisfy the potential user, they will probably do so.

I think your fears about possible unreliability in the mouse pointing device are unfounded. Of the many details I didn't have time to put in my product description of the Lisa (please note that the article was a description, not a review), one was that Apple designed a new kind of mouse that is meant to be cleaned by the user. The design also isolates the rolling ball from the decoding mechanism as much as possible so that dust and eraser shavings entering the mouse have little effect on the performance of the device. Also, the mouse I tested rolled equally well in all directions; I did not have any difficulty making diagonal movements with it.

I agree with you that the Lisa floppy disks will be more expensive than similar disks because of their nonstandard design. However, I disagree with your opinion that software enhancements such as redundant directories "can be done in

# ...And Here.

## MARYLAND

JR Systems  
8227 Woodmont Ave. #200  
Bethesda, MD 20814  
(301) 657-3598

## NEW YORK

John D. Owens Associates, Inc.  
12 Schubert St.  
Staten Island, NY 10305  
(212) 448-6283

## NORTH CAROLINA

General Semantics, Inc.  
125 S. Elm St., Dixie Bldg. #400  
Greensboro, NC 27401  
(919) 288-1117

## MASSACHUSETTS

New England Electronic Exch.  
138 Arlington St.  
Boston, MA 02116  
(617) 491-3000

## Key Micro Systems

822 Boylston St.  
Chestnut Hill, MA 02167  
(617) 738-7306

## OREGON

### Microwest Computer Products

811 E. Burnside #117  
Portland, OR 97214  
(503) 238-6274

## RHODE ISLAND

### Key Micro Systems

1606 Nooseneck  
Coventry, RI 02816  
(401) 828-7270

## WISCONSIN

### Byte Shop of Milwaukee

4840 S. 76th St.  
Greenfield, WI 53220  
(414) 281-7004

## CANADA

Dynacomp Business Computers Ltd.  
3258 Beta Ave.  
Burnaby, British Columbia V5G 4K4  
(604) 299-3747

## CSC System Center Ltd.

2403 Canoe Ave.  
Coquitlam, British Columbia V3K 6A9  
(604) 941-0622

## UNITED KINGDOM

Comcen Technology Ltd.  
45/46 Wychtree St., Morrision  
Swansea SA6 8EX  
(0792) 796000



CompuPro, a Godbout Company,  
Box 2355, Oakland Airport, CA 94614



# THE NEW EXECUTIVE PACKAGE™ FROM ALPHA.

## FORTY BUSINESS PROGRAMS YOU'LL USE EVERY DAY. STARTING TODAY.

All of a sudden, there are forty new ways to help run your business with an IBM PC.

Ways to help you plan, budget, schedule and forecast with the skill and insight of a b-school grad. But without attending business school, and without learning complicated programming.

It's called the Executive Package from Alpha. And it puts together forty powerful business analysis and projection formulas into ready to use programs for all types of executives, in every kind of business.

Use CASHPLAN for tighter cashflow management.

Call up INFLATE to help calculate profits in a changing market.

Optimize production scheduling and project planning with any of three CRITICAL PATH METHOD formulas.

Analyze your competition with GROWTH.

There's even BETA for objective weighing of stock investment risks.

### SIMPLIFIES VISICALC®, 1-2-3™ AND MULTIPLAN.™

Plus, the programs are designed to work together with VisiCalc®, 1-2-3™, Multiplan™ and BASIC. So now you'll have more of the tremendous power of these popular programs at your fingertips, ready to go.

To help keep things simple, each program in the Executive Package is presented with a real-world example of how another company used it and the results they got. You simply plug in *your* numbers and out come *your* company's solutions.

And like all software from Alpha, the Executive Package comes with a concise instructional audio tape to introduce you to the programs and get you started solving business problems right away. Nothing else is this easy! And with a suggested retail price of just \$145 complete, nothing else you buy for your computer will pay back as fast.

Start doing the kind of critical everyday business calculations you'd be doing right now, if only you could. Because now you can.

See the remarkable new Executive Package from Alpha at leading computer and software stores. Or call us at 1-800-451-1018 (in Massachusetts call 1-617-229-2924 collect) for the name of the Alpha dealer nearest you.



### THE NEW EXECUTIVE PACKAGE FROM



Circle 16 on inquiry card.

12 New England Executive Office Park, Burlington, Massachusetts 01803

™ Signifies manufacturer's trademark. ® Signifies manufacturer's registered trademark. © 1983 Alpha Software Corp.

# CAST BETTER, FASTER SPELLS WITH OUR CI-C86 C COMPILER



Weave  
a spell with  
the CI-C86 C Compiler,  
especially designed for use with:

- CPM86 and MPM86
- MS-DOS
- IBM Personal
- IBM Displaywriter
- DEC Rainbow
- Victor 9000
- Sirius
- NEC APC
- Zenith Z100
- Lomas 8086
- Altos 8600
- CompuPro 86/87
- Seattle
- Eagle
- Columbia 1600
- And Many More

CI puts all the magic of C at your fingertips with all of K&R, a full support library, 8087 support and much more.

**Merlin would approve!**

Disk and documentation \$395.  
Overseas airmail \$20.

For further information, please contact:



**Computer Innovations, Inc.**  
75 Pine Street  
Lincroft, New Jersey 07738  
Telephone: (201) 530-0995



CPM and MPM are trademarks of Digital Research.  
MS-DOS is a trademark of Microsoft.  
IBM is a trademark of International Business Machines.  
DEC is a trademark of Digital Equipment Corp.

## Letters

standard packages." The place to put such enhancements is in the operating system, so they will be there regardless of the opinions of individual software designers who will either reinvent the wheel and charge you for it or leave it out. Redundant directories take up relatively little space and will save you a lot of grief if they are ever needed; other operating system designers would do well to follow Apple's example.

I like your word-processor test and will keep it in mind for future evaluations. However, I'm not sure you can fault the Lisa for not having a dedicated video-display processor. As I said on page 43 of the description, "... according to the designers, the use of a dedicated hardware graphics chip would limit itself and slow down the system. . . ." It would be hard to check this point directly, so we will have to rely on the technical explanation given by the Lisa designers on page 106 of the February BYTE.

I hope you find some merit in my opinions. Thank you for writing; the quality of future microcomputers will, I think, be influenced by discussions such as ours. . . G. W.

## A Slight Improvement

It was ironic that the reviews of the two new Apple products, the Lisa and the Apple IIe, both appeared in the same issue (February, pages 33 and 68). It was hard for me to believe that both computers are made by the same company. In the case of the Lisa, it sounds like Apple did a superior job of design and implementation. The modular approach displayed by both the hardware and software demonstrates a mature, serious product.

On the other hand, the Apple IIe seems like only a slight improvement over the engineering hodge-podge that was the Apple II. For example, checking a game-paddle port to see if a shift key is pressed, pressing Control-R (unless between quotes) to restrict the keyboard to uppercase, and the presence of numerous seemingly incompatible graphic modes (to name a few) make me feel that the Apple IIe isn't much of an improvement. Actually, the whole thing contributes to my suspicion that the Apple II's primary reason for success was its being at the right place at the right time. The design errors (or perhaps oversights) in the Apple II were serious enough to make the inven-

tors of replacement processor cards, 80 column boards, and the like rich. While there's no doubt that the Apple IIe is an attempt to rectify some of the most serious difficulties, further repackaging and advertising hype don't contribute to a solution.

**Jon Forrest, Computer System Manager  
Physics Department  
University of California  
Santa Barbara, CA 93106**

### Monte Carlo Fix

Roger C. Millikan's article "The Magic of the Monte Carlo Method" (February, page 371) leaves out a very important ingredient in the program for finding the area under a curve. The author should have made it clear that the given program will work only for functions that are evaluated in an area of one square unit (as was the example). For all other examples line 2115 of listing 2 should be changed to:

2115 PRINT " the integral is ";A\*U/N

where A is the area over which the function is being evaluated. This must be done because U/N is an approximation of the ratio of the area under the curve to the total area A. For example, to find the area under the example curve  $Y=X^2$  when X varies from 0 to 2, the value of A would be 8 because the area over which the function is being evaluated is a rectangle of width 2 (X varies from 0 to 2) and length 4 (Y varies from 0 to 4). Of course, the corresponding RND functions must also be changed.

I believe this added bit of information would make the program much easier for the average user to adapt to his or her application.

**Ronald W. Guffin  
Box 1111  
Bethel, AK 99559**

### Alternatives to the Monte Carlo Method

I agree with Roger C. Millikan that the Monte Carlo Method is an important statistical tool (February, page 371). That said, I object to a number of suggestions in his article.

It should be clearly understood that the Monte Carlo method is a shotgun tech-

nique, one that tends to converge slowly compared to methods derived analytically from the specific parameters of the problem in question. It is also a statistical technique, meaning that any Monte Carlo simulation should generate a sample standard deviation and/or a distribution histogram where feasible. Clearly both results should have been generated in the problem of the staggering drunk.

Millikan's example of finding the area under a parabola is as badly chosen as possible—rather like demonstrating recursion through the use of the factorial function. Any textbook on numerical methods is full of simple techniques to find areas under curves—a process known as numerical integration or numerical quadrature. Simpson's Rule, for example, would converge more rapidly in almost every case and would have a lower margin of error.

Finally, Millikan's area example does not even converge properly, probably because of a lack of refinement in assigning areas to points where the point is on the curve or is very close to it.

In any case, there is no point in using a random-number generator where you are going to use as many as 10,000 trials. It would be simpler to cover the unit square with 10,000 evenly spaced points.

**William J. Sohn  
293 Crest Dr.  
Tarrytown, NY 10591**

### Apple-Cat Changes

When I read James A. Pope's review of the Apple-Cat II (January, page 110) my initial reaction was akin to that of a parent listening intently to a guidance counselor's evaluation of a precocious child. I adored the overall favorable findings and wanted to interrupt with a rebuttal every time a negative comment was made.

However, after carefully rereading Pope's article, I must admit it is both fair in its evaluation and constructive in its recommendations. In fact, most of the changes he suggested for the Apple-Cat II have already been included in the product available today.

Let me get specific. The review is based on an early version of our software (ComWare II 3.2), which was current through mid-1982. Since then we have updated the software three times and revised the docu-

# ERG/68000 MINI-SYSTEMS

- Full IEEE 696/S100 compatibility

## HARDWARE OPTIONS

- 8MHz, 10MHz or 12MHz 68000 CPU
- Memory Management
- Multiple Port Intelligent I/O
- 64K or 128K STATIC RAM (70 nsec)
- 256K/512K or 1MB Dynamic RAM, with full parity (150 nsec)
- 5¼" - 8" D/D, D/S floppy disk drives
- 5MB-40MB hard disk drives
- Full DMA Disk Interface
- SMD Disk Interface
- ¼" tape streamer
- 10 to 20 slot backplane
- 20 or 30A amp power supply
- Desk top or Rack mount cabinets

## SOFTWARE OPTIONS

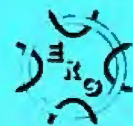
- 68KFORTH<sup>1</sup> systems language with MACRO assembler and META compiler, Multi-user, Multi-Tasking
- Fast Floating Point package
- Motorola's MACSBUG
- Unix<sup>2</sup> Type Operating System with C, PASCAL, FORTRAN 77, 68K-BASIC<sup>3</sup>, CIS COBOL<sup>4</sup>, RDBMS
- CP/M-68K<sup>3</sup> O/S with C, Assembler, 68K-BASIC<sup>3</sup>, 68KFORTH<sup>1</sup>, Z80 EMULATOR<sup>1</sup>, APL
- VED68K<sup>1</sup> Screen Editor

Trademark <sup>1</sup>ERG, Inc.

<sup>2</sup>BELL LABS    <sup>3</sup>Digital Research  
<sup>4</sup>Micro Focus

30 day delivery  
with valid Purchase Order

OEM prices available  
For CPU, Integrated Card Sets  
or Systems.



**Empirical Research Group, Inc.**  
P.O. Box 1176  
Milton, WA 98354  
206-631-4855

# GUESS W MICRO

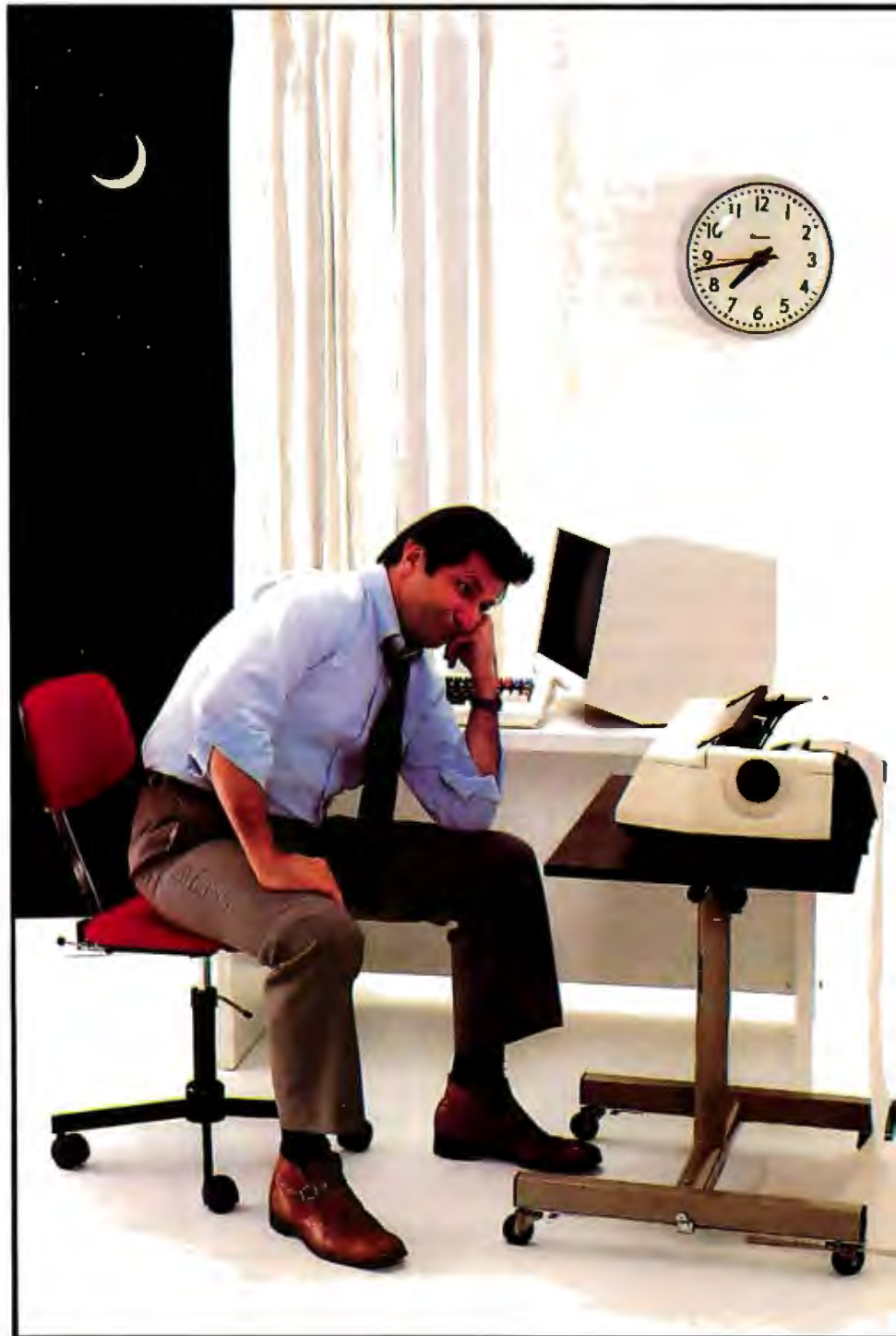
If you guessed that a Practical Peripherals Microbuffer™ printer buffer saves time, you're right. For the way it works, this inexpensive product is the most practical addition to your microcomputer system ever.

With Microbuffer, you don't have to wait for your printer to finish before you resume using your computer.

Data is received and stored at fast speeds, then released from Microbuffer's memory to your printer.

This is called buffering. The more you print, the more productive it makes your workflow.

Depending on the version of Microbuffer, these buffering capacities range from a useful 8K of random access memory — big enough for 8,000 characters of storage — up to a very large 256K — enough for 256,000 characters of storage.



# HO HAS BUFFER.™



Practical Peripherals makes stand-alone Micro-buffers for any computer and printer combination, including add-on units especially for Apple II computer and/or Epson printers.

Each has different features like graphics dumps and text formatting besides its buffering capabilities. You can choose one that's just right for your system.

Best of all, they're built to last and work exactly like they're supposed to.

If you're still guessing whether you can afford to have one, talk with any computer dealer. That's the best way to find out how practical a Practical Peripherals Microbuffer is.

**PRACTICAL  
PERIPHERALS**

Practical Peripherals, Inc.  
31245 La Baya Drive, Westlake Village,  
California 91362, (213) 991-8200

Circle 306 on Inquiry card.

mentation. For example, the review's "At a Glance" box designates the software as DOS 3.2. Since June of last year the system has been formatted in the more widely used DOS 3.3 system. The "At a Glance" box also indicates that the Apple-Cat II is designed for the Apple II Plus. This could be misleading because the system is engineered for the Apple II as well.

Pope wasn't thrilled by our documentation. Frankly, neither were we. We've published a new owner's manual and Com-Ware II operating instructions book-

let. We've done our best in this new literature to state instructions and descriptions clearly, to organize the content in the most logical manner and to represent exactly what is included with the unit and what are optional features or equipment. With regard to optional equipment, Pope felt that the expansion module should have been part of the basic system rather than a \$39 add-on. Here we disagree. The expansion module provides for features not all customers want or need, particularly to start up. To include it in the

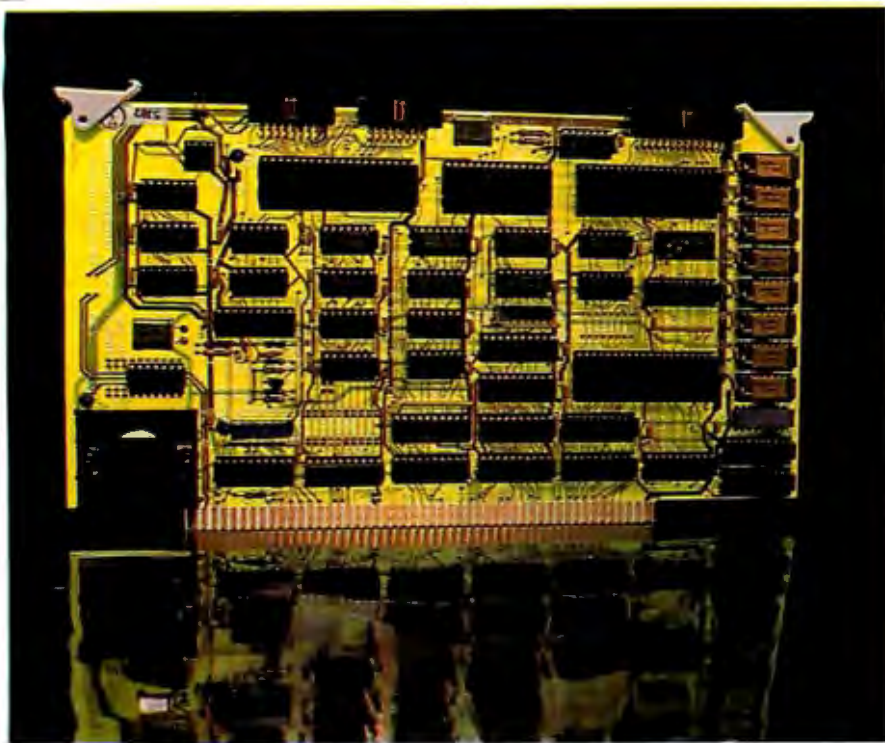
basic system would force customers to pay for something they might not use.

The table of Com-Ware II features used in the article is accurate but outdated. Our newest revision (5.0) includes an additional four functions. All Apple-Cat II buyers are given the opportunity to obtain each new Com-Ware revision free of charge. They just send us their old disk and we send them an updated one.

The article listed a number of expansion capabilities and conjectured that they would probably all be available by the time the January BYTE was out. These are available now, including the tape recorder output. One note of clarification: Novation is not developing a speech synthesizer card.

The article states, "Novation has just recently developed an EPROM that will allow you to access the Apple-Cat II from the BASIC environment." Pope is referring to our firmware ROM chip. Because he mentions the ROM chip earlier in the review, it might appear to some that the ROM and the EPROM chips are different. They are not. The firmware ROM allows access to the Apple-Cat II from BASIC, features the same commands as those used for the Hayes Micromodem, and is compatible with many of the programs written for the Micromodem.

Agnes A. Nagy  
 Vice President-Administration  
 Novation Inc.  
 18664 Oxnard St.  
 Tarzana, CA 91356



## Leading Edge Z-80, S100 Distributed Processing. \$475.00

Memory transfer rates of 517Kbytes/second, direct memory access, memory mapping and host to slave requests via interrupt control make the CPS-MX fast. And easy to integrate. Fully compatible with TURBOdos™. Intercontinental Micro System's slaves are available in four versions: synchronous or asynchronous serial port, 4Mhz or 6Mhz. The choice is yours. The CPS-MX also allows the bus master to utilize slave memory at the user's discretion. The slave then acts as a 64K RAM card.

The CPS-MX is also easy to integrate with Intercontinental's full line of S100 products: CPZ-48000 SBC single board computer with 64K on board RAM, 4 I/O

channels, memory management, on board floppy controller, DMA and vectored priority interrupts; and 256K bank selectable or contiguous memory.

A complete line of personality boards allow easy interface to anything from a floppy to a winchester, including modems and printers, and don't take up any S-100 bus space.

Best of all is the price. The CPS-MX starts at \$475.00. That's right, up to 65% less than what you have been paying for products that may not measure up.

Call Intercontinental Micro Systems today. We'd like to send you information on the S-100 slave alternative.



1733 South Douglass Road, Suite E, Anaheim, California 92806 (714) 978-9758 Telex: 678401-TAB-IRIN

TURBOdos is a trademark of Software 2000, Inc.

### Sieve Corrections

After seeing "Eratosthenes Revisted" in the January BYTE, I wrote a version of the Sieve of Eratosthenes in CRAY-1S assembly language. My program performs one repetition of the Sieve in exactly 385.7 microseconds. This program makes good use of both the scalar- and the vector-processing capabilities of the CRAY-1S. It breaks the Sieve into four steps, as given below. The timing (in microseconds) for each step is interesting: initializing the flag array, 111.3; unflagging multiples of primes, 156.9; counting the number of primes found, 117.1; and searching for the last prime found, 0.4. The times total 385.7.

Of this 385.7 microseconds, the CRAY-1S's memory is fully occupied for at least 361.375 microseconds. Thus, at



# Sakata COLOR MONITORS

... we promise performance



SAKATA offers fine quality CRT DISPLAY MONITORS which are compatible with IBM, APPLE, ATARI 800, NEC and other fine personal computers.

Unusually attractive design with neutral color will enhance the appearance, provide unexcelled quality performance. Illustrated Model SC-100 is 13" **COLOR** Display Monitor with linear circuitry, composite color and a host of other quality features.

Also available: Model SG-1000 . . . 12" monochrome, high resolution CRT MONITOR. Model SC-200 . . . 13" RGB high resolution **COLOR** CRT MONITOR. Model SC-300 . . . 13" RGB, super high resolution **COLOR** CRT MONITOR. Priced below competition—if there is any.

SAKATA CRT MONITORS are available wherever personal computers are sold or write for technical and illustrated literature and prices.



## SAKATA SC-100 COMPATIBILITY CHART

COMPUTER	SC-100 COLOR
APPLE II	✓
APPLE III	
ATARI-800	✓
COMMODORE-64	✓
IBM-PC	✓
NEC-PC	✓
OSBORNE	✓
TI-99	✓
VIC-20	

NOTE: ON CERTAIN COMPUTERS  
ADAPTER CABLE REQUIRED.

SAKATA U.S.A. CORPORATION  
651 Bonnie Lane, Elk Grove Village, IL 60007  
(312) 593-3211/800-323-6647 (outside Illinois)

"SAKATA . . . serving industry worldwide . . . since 1896"

# PROCESS CONTROL

(TAURUS ONE) + (YOUR PC) = (PROCESS CONTROL SYSTEM)

Now a new micro computer based data acquisition and control front end that gives you:—

**Power that's easy to use:—** Plugs into any RS232C, RS422, or IEEE 488 port on your Personal Computer • Powerful Command functions that include: simple reads and writes, high speed block analog reads, pulse counting, frequency, change of state detection, direct thermocouple input, and more • Results in engineering units • Convenient screw terminal panels • Compatible isolated AC/DC 3 amp switchers and isolated input sensing •

**Power that's easy to cost justify:—**

A full range of input output modules provide: 12 bit analog inputs with 4 programmable ranges for inputs from  $\pm 10\text{mV}$  to  $\pm 10\text{V}$ , digital I/O, counters, pulse output, 12 bit analog output, 4-20 MA input/output, thermocouples • Stand alone mode with direct terminal support • Remote operation • Communicates simultaneously to three computers • Internal diagnostics •

**Power that's easy to expand:—** Plug in expansion to 1024 points • User memory allows downline load of user written functions and programs • EPROM space for special user functions • Rack mount hardware available for all options •

# TAURUS ONE®

Write for more information to:

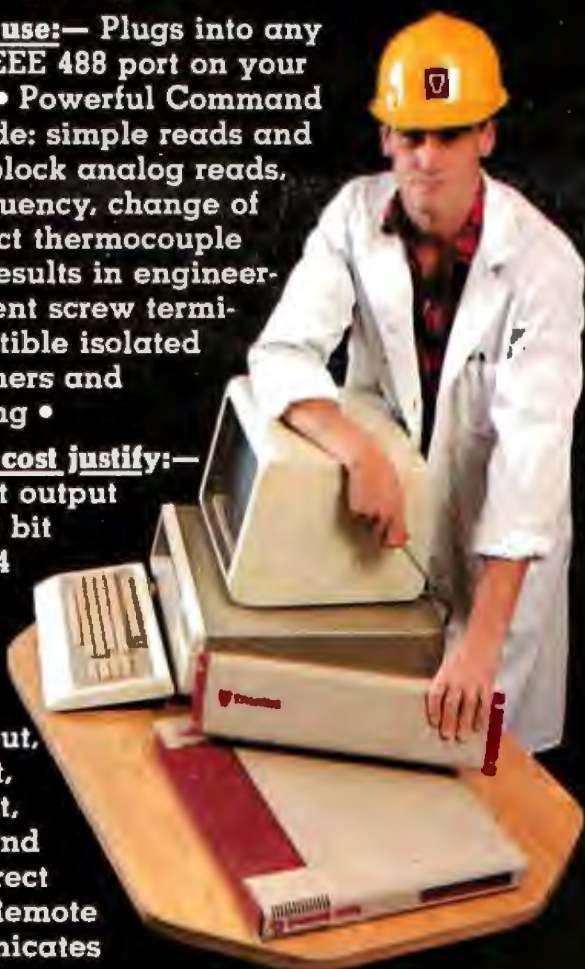
 **TAURUS  
COMPUTER  
PRODUCTS  
INC.**

IN U.S.A.:

C/O I.M.S.  
P.O. BOX 1663  
BUFFALO, N.Y.  
14203

IN CANADA:

P.O. BOX 911  
STATION "U"  
TORONTO, ONT.  
M8Z 5P9



## Letters

best, the program could be improved by only a few percent. I believe it is unlikely that more than one or two microseconds of processing time could actually be eliminated.

For 10 repetitions of the Sieve, multiply by 10 and add 1.275 microseconds for loop counting, giving 3859 microseconds. This number is about one-half the fastest time reported in the article, and returns the CRAY-1S to its rightful position as the world's fastest computer.

David S. Dodson  
3824 South 255th Place  
Kent, WA 98032

I have just seen Jim Gilbreath and Gary Gilbreath's article, "Eratosthenes Revisited: Once More Through the Sieve" (January, page 283).

I was dismayed to find that my contributions for the Prime 300 computer and the PRIMOS operating system were printed incorrectly. The numbers printed were *per iteration*. They have not been "adjusted for . . . 10 iterations." Also the times for BASIC and COBOL are reversed. My contributions to table 1, adjusted, should read: assembly language, 4.5; FORTRAN, 7.8; FORTH (RLM), 104.0; BASIC, 504.0; and COBOL, 6707.0.

This gives PRIME 300 COBOL the dubious distinction of being the slowest computer/language combination in the article.

Richard L. Maurer  
National Life and Accident Insurance  
Company  
National Life Center  
Nashville, TN 37250 ■

## BYTE's Bits

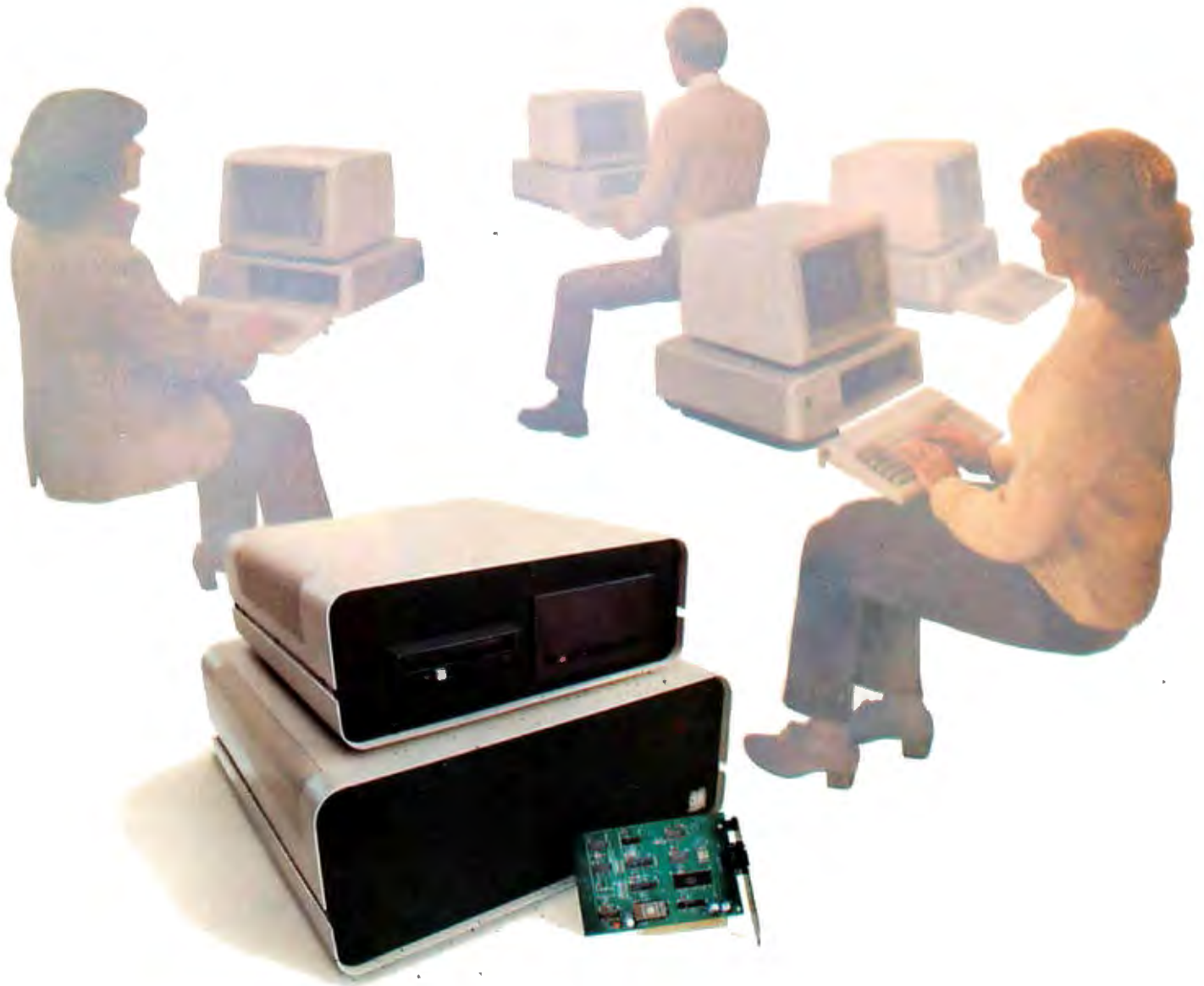
### Z100 Software Directory Being Compiled

Zenith Data Systems is compiling a directory of available software for its Z100 desktop computer. The Z100, a dual 16/32-bit computer, uses Digital Research's CP/M as its 8-bit operating system. Z-DOS, marketed by Microsoft as MS-DOS, is used for 16-bit processing. Software vendors with Z100-compatible packages are asked to contact Victoria M. Lerner, Zenith Data Systems Corp., 1900 North Austin Ave., Chicago, IL 60639. ■

← Circle 374 on inquiry card.

# ShareNet™ is Now

*Others Talk of Tomorrow.*



## The Only Complete Personal Computer Local Area Network

Others are just talking about tomorrow's technology... **ShareNet** has it now!

With power and capabilities found only in minicomputers and mainframes;

Best of all it can be yours today.

**ShareNet** Local Area Network gives you a true multi-user system enabling you to link up to 24 personal computers, five printers and use ...

Multiple Operating Systems

Extensive Data Security

Hierarchical Directory

Default File Locking

Concurrent File Sharing

Print Spooling

Redundant Directories

Cartridge Disk Back-up

Public & Private Directory

Electronic Mail

Network Interface Cards available for IBM/PC.

Soon available: APPLE, VICTOR, DEC RAINBOW, OSBORNE, & Others.

For tomorrow's technology, today ... call 1-800-453-1267.

**ShareNet.**

The Local Area Network of the Future Today

TELEX: 669 401 AIR COURS PHX

Novell Data Systems, Inc. 1170 N. Industrial Park Drive Orem, Utah 84057 Phone: 801-226-8202

Circle 287 on Inquiry card.

# 5000 IS "The Desktop Mainframe"



## The Most Versatile Integrated System Available! — Without Compromise.

From the crystal clear monitor with a true typist keyboard to the high performance switching power supply—an engineered solution—the 5000IS system is designed to be an economical single-user system (basic system price is \$3,295) which is easily field expandable to be the master of a four-user system.

Now you can have hi-density floppies, 19 megabyte Winchester with true error detection and correction, extended RAM memory, and various

peripheral controllers. Up to four users may be supported by the 5000IS, with each user having a dedicated microprocessor, 64K of memory and two serial I/O channels.

With this flexibility you can configure the highest performance, lowest cost multiuser/multiprocessing system available. A four-user IS system gives you higher performance at a lower cost than comparable systems configured with personal computers or other single-user micros!

For complete information and specifications on the 5000 IS plus the location of your nearby IMS International dealer, call or write today!  
(714) 978-6966 or (702) 883-7611

**IMS**  
INTERNATIONAL

2800 Lockheed Way  
Carson City, NV 89701  
Telex: 910-395-6051

**We Build Computers As If Your Business  
Depended On Them.**

IMS INTERNATIONAL DISTRIBUTORS:

Argentina	Canada	France	India	Korea	Netherlands	So. Africa	Sweden	United Kingdom
Australia	Chile	Greece	Israel	Malaysia	New Zealand	Singapore	Switzerland	U.S.A.
Austria	Ecuador	Hong Kong	Italy	Mexico	Philippines	Spain	United Arab Emirates	West Germany

## Use ADPCM for Highly Intelligible Speech Synthesis

*Some new integrated circuits from Oki Semiconductor compress digitized speech data efficiently.*

---

Steve Ciarcia  
POB 582  
Glastonbury, CT 06033

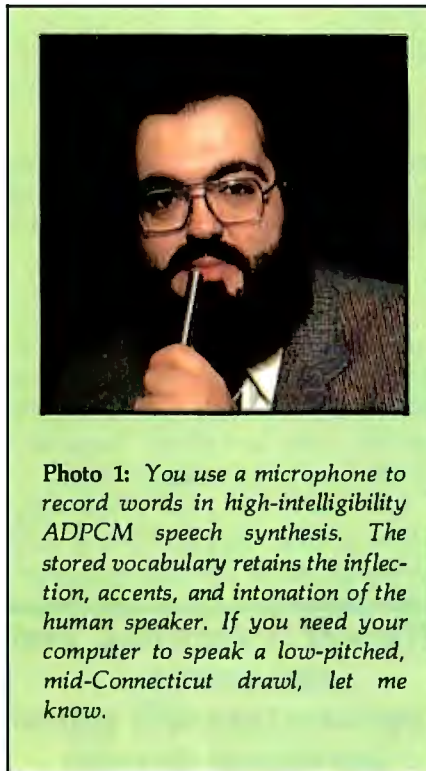
---

During the past few years I have presented four different computer speech-synthesizer projects (see references). With each article I have tried to present the latest technology and describe successively more cost-effective synthesis methods. This month I'd like to describe a new variation on digitized speech that uses adaptive differential pulse-code modulation.

### What Is Digitized Speech?

Computers communicate in a digital language, but the language of humans is analog. If computers are to speak as we do, this obvious barrier must be overcome. Fortunately for us, a number of techniques have been devised to allow a computer to synthesize a human voice, some of them quite effective.

Some synthesized voices employ electronic circuitry to simulate the throat and vocal tract, but the purest form of machine-generated speech is simply a digital recording of an actual human voice, using digital circuitry to mimic the action of a tape record-



*Photo 1: You use a microphone to record words in high-intelligibility ADPCM speech synthesis. The stored vocabulary retains the inflection, accents, and intonation of the human speaker. If you need your computer to speak a low-pitched, mid-Connecticut drawl, let me know.*

er. For example, in most parts of the United States you can dial a telephone number and hear a recorded voice saying something like, "The number you have reached has been changed. The new number is 924-9281." The voice is distinctly human in quality, highly intelligible, and machine-generated—an excellent example of digitized speech. Al-

though it uses a lot of memory, digitized speech is the most intelligible machine-generated speech currently possible.

The basic concepts of producing stored digital speech are fairly simple. The process begins with data acquisition. A voice waveform can be treated like any other fluctuating voltage input; the computer can record the waveform by periodically taking a sample of the signal's voltage through an analog-to-digital (A/D) converter and storing it as a binary value. (The number of samples needed per second depends upon the frequency of the input signal.) Once the samples have been stored, the computer can recreate the original waveform by sequentially sending the stored values to a digital-to-analog (D/A) converter at the same rate as the original sampling.

### Pulse-Code Modulation

A common method of representing continuous analog values in digital form is pulse-code modulation, or PCM. In PCM, distinct binary representations (pulse codes) are chosen for a finite number of points along the continuum of possible states. Whenever the value is being measured and it falls between two encoded points, the code for the closer point is used.

---

*Special thanks to Bill Curlew for his software expertise.*

---

---

Copyright © 1983 Steven A. Ciarcia.  
All rights reserved.

---

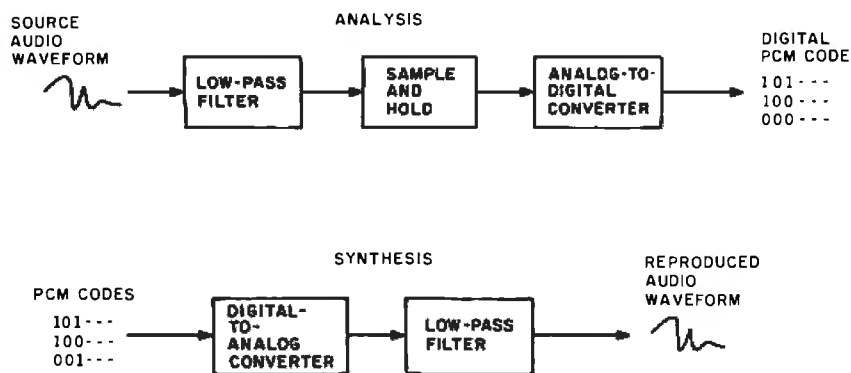


Figure 1: Functional block diagram of a digitized speech-reproduction system that employs pulse-code modulation.

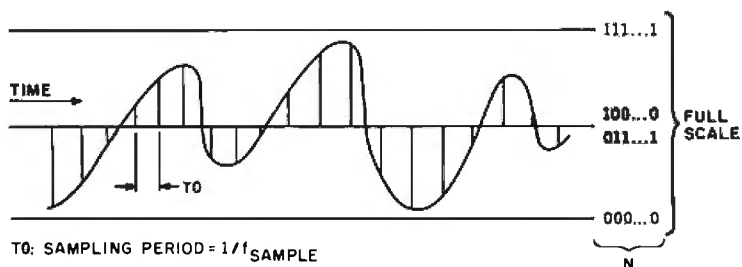


Figure 2: Waveform sampling by pulse-code modulation (PCM). The interval between samples is  $T_0$ ; the sampling frequency is the reciprocal of the interval. Each sample of PCM data consists of  $N$  bits; the leftmost is the most significant bit and the rightmost is the least significant bit.

(This process is called *quantization*: the dividing of the range of values of a wave into subranges, each of which is represented by an assigned value.) A series of these pulse codes can be transmitted in a pulse train, resulting in a pulse-code modulated signal.

Because the samples of digitized speech referred to above are stored in the form of digital pulses, the stored speech waveform can be thought of as an example of pulse-code modulation. Figure 1 shows a block diagram of a speech synthesizer that reproduces speech stored in pulse-code-modulated form.

### Sampling Rates and Other Messy Stuff

The sampling rate you use in recording any signal must be chosen with awareness of a theoretical limit called the *Nyquist interval*. At the very minimum, the sampling rate must be at least twice the highest fre-

quency found in the input signal. With an input bandwidth of 2 kHz (kilohertz), adequate for intelligible speech, the sampling frequency would have to be at least 4 kHz.

This rule holds strictly true only when an ideal low-pass filter is used on the output of the D/A converter.

**The ear is sensitive, and too coarse a reproduction will sound unnatural or even unintelligible.**

In real equipment, sampling rates of 3 or 4 times the input bandwidth are sometimes necessary. So for speech reproduction, a sampling rate around 6 or 8 kHz is good. (Optical digitized-music recordings, which are just now coming to market, use 16-bit A/D conversion at a 50-kHz sample rate to achieve high fidelity. The resulting

data rate is 800,000 bps—bits per second.)

Other technical limitations crop up. Once you have determined the sampling rate, you must consider the resolution of the analog-to-digital converter. A/D converters operate in discrete steps (quanta) rather than continuous levels, as shown in figure 2. If a 4-bit A/D converter is used, then only 16 values are available to define the signal. Any reading could potentially be in error by  $\pm 1/16$ , or about 6 percent. A 12-bit converter, which has 4096 potential levels, would have a possible quantization error of only 0.02 percent.

### Achieving Fidelity

In dealing with analog voice signals, we must accurately reproduce the input signal for it to be understood. The ear is sensitive, and too coarse a reproduction will sound unnatural or even unintelligible.

A direct relationship exists between the PCM data rate and reproduced speech quality. Let's consider a case in which we have an 8-kHz sampling rate. If we use 12-bit A/D conversion, then the data rate (in bits per second) is found using the following equation:

$$\begin{aligned} \text{bit rate} &= \text{sample rate} \times \text{conversion bits} \\ &= 8000 \text{ Hz} \times 12 \text{ bits} \\ &= 96,000 \text{ bits/second} \end{aligned}$$

Using standard PCM on a voice signal with a 4-kHz bandwidth would require a 96,000-bps data rate. The average personal computer could store only about 8 seconds of speech in its 64K-byte memory.

The data rate can be reduced somewhat by using an 8-bit A/D converter rather than a 12-bit unit. The raw data rate now becomes  $8000 \times 8$  or 64,000 bps. (This reduces the signal-to-noise ratio from 66 to 42 dB (decibels), but the sound quality is more than adequate for experimentation. For commercial applications, however, I recommend a 12-bit converter.)

### Delta Modulation

The pulse-code modulation we

have been examining uses no data compression. In playback, the data bits representing the absolute values of each successive signal sample are sent to a full-resolution D/A converter and reproduced at the same rate at which they were recorded: 96,000 bps in, 96,000 bps out. The circuit can operate with no assumptions made about the signal it is to process.

On the other hand, voice waveforms contain much redundant data. Long periods of silence are interspersed with sounds that vary in pitch slowly. If you take some time to analyze the A/D samples, you will notice that the changes are, for the most part, gradual and that the variations in the signal between adjacent samples are a limited portion of the full dynamic range.

One method of reducing the data rate used in PCM voice reproduction is called *delta modulation*. This process assumes that the input signal's waveform has a fairly uniform and predictable slope (rate of rising and falling). Rather than storing an 8- or 12-bit quantity for each sample, a delta modulator stores only a single bit. When the computer samples the input signal from the A/D converter, it compares the current reading to the preceding sample. If amplitude of the new sample is greater, then the computer stores a bit value of 1. Conversely, if the new sample is less, then a 0 will be stored. Figure 3 shows how this works. Reproduction of the waveform is accomplished by sending the stored bits in sequence to the output, where their values are integrated.

But, like other techniques, delta modulation has limitations, one of them the familiar sampling-rate restriction. Because only a single bit changes between samples, the rate at which samples are taken must be sufficiently fast that no significant information is lost from the input signal. Furthermore, if the slope of the input waveform varies a lot, the reproduced waveform may be audibly distorted. So using delta modulation may not reduce the data rate much, although there are many different variant schemes, and it's difficult to

(3a)

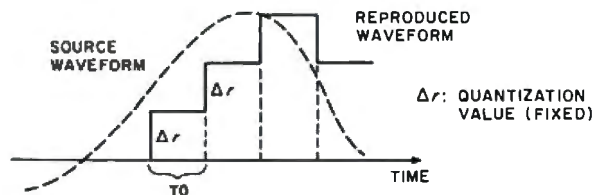


Figure 3a: Waveform sampling by delta modulation. Each sample of the source waveform is tested to see if its amplitude is higher or lower (within the resolution of a fixed quantization value  $\Delta r$ —delta-r) than that of the previous sample. If the amplitude is higher, the single-bit delta-modulated encoding value is set to 1; if lower, the encoding value is set to 0.

(3b)

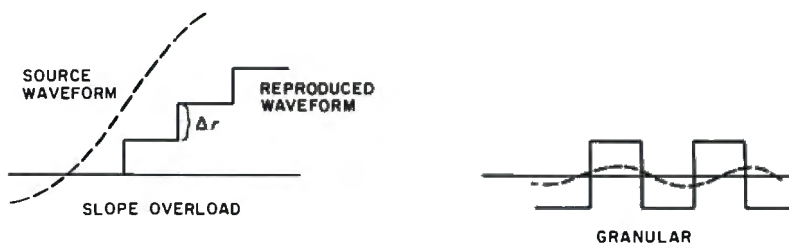


Figure 3b: Two potential problems occurring in delta modulation. When the source waveform changes too rapidly, the fixed quantization value may be too small to express the full change in the input; this slope overload causes a compliance error. Or when there is little change in the input waveform (at the extreme, a DC signal), vertical deflection in the quantization value results in granular noise in the output.

### Competing Digitizing Methods

By the time you read this, you may have heard the results of a standardization proceeding that put two of the speech-digitizing methods discussed here in competition. (See reference 7.)

American Telephone and Telegraph (AT & T), in the throes of beginning its divestiture of its 22 local Bell operating companies (BOCs), submitted a proposal to the CCITT (Comité Consultatif International Téléphonique et Télégraphique) to standardize a certain form of adaptive differential pulse-code modulation as the worldwide preferred method of digitizing voice telephone signals for long-distance transmission. The proposed CCITT scheme uses a 4-bit sampling size with an 8-kHz sampling rate, for a 32,000-bps overall data rate. This would be a change from the two different 64,000-bps digitizing systems now in use.

A competing digitizing scheme, developed by Satellite Business Systems (SBS—a company jointly owned by IBM, Comsat, and Aetna Life & Casualty), employs delta modulation: 1-bit samples taken at a rate of 32 kHz, arriving at the same 32,000-bps data rate by a completely different route.

Standards published by the CCITT are called "recommendations," but they are quite strictly followed in most regions of the globe.

Telecommunication experts outside of AT & T have expressed concerns that the local BOCs and the independent long-distance common carriers will face both financial and technical problems in upgrading equipment to interface with the proposed CCITT 32,000-bps ADPCM circuits. At this writing, it is not known when AT & T will begin installing the new system. . . . R. S. S.

predict which is optimal in a given situation.

The most effective application of delta modulation that I have observed is the technique developed by Dr. Forest Moser at the University of California and implemented in the National Semiconductor Digitalker voice-synthesis chip set (see reference 1). However, while the Digitalker's process is definitely a variant of delta modulation, the data-compression and zero-phase-encoding algorithms that produce the stored bit patterns take hours of processing per word; it's very difficult for you to program your own custom vocabulary.

### Differential PCM

We can actually reduce the amount of data stored for reproduction of speech by using a concept related to delta modulation as follows. When the speech waveform is being sampled, for each sample a value is stored that represents the amplitude difference between samples. This scheme, called *differential pulse-code modulation*, or DPCM, allows more than a single bit of difference between stored samples, accommodating more variation in the input waveform before severe distortion sets in. The DPCM value can be expressed as a fraction of the allowed input range or the absolute difference between samples (see figure 4).

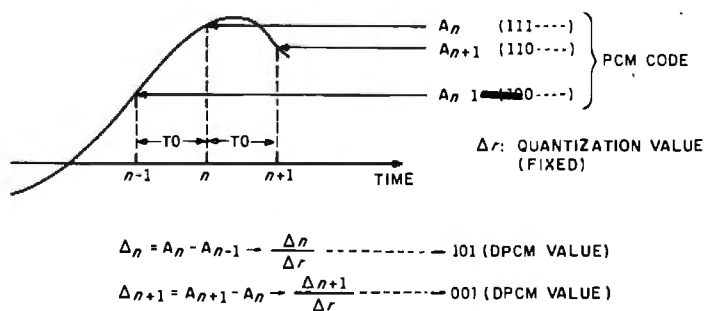


Figure 4: Differential pulse-code modulation (DPCM) is an attempt to reduce the amount of data stored or transmitted, as compared with regular PCM. For each sample, the difference between the previous PCM code and the current code is expressed in terms of a fixed quantization value  $\Delta r$  (delta-r), which must be chosen with attention to the characteristics of the source waveform. If too large or small a quantization value is used, compliance errors occur.

DPCM exhibits some of the same limitations as simple delta modulation but to a lesser degree. Only when the difference between samples is greater than the maximum DPCM-encoding value will distortion (called a *compliance error*) occur. Then the only solution is to reduce the input bandwidth or raise the sampling frequency.

## ADPCM Is a specialized form of PCM that offers significantly improved intelligibility at lower data rates.

### Adaptive Differential PCM

The real breakthrough in digitized speech is the technique known as *adaptive differential pulse-code modulation* (ADPCM), a specialized form of PCM that offers significantly improved intelligibility at lower data rates. This system was devised to overcome the defects of the delta-modulation techniques described thus far while still reducing the overall data rate and improving the output's compliance with the source waveform.

ADPCM improves upon DPCM by dynamically varying the quantization between samples depending upon

their rate of change while maintaining a low bit rate, condensing 12-bit PCM samples into only 3 or 4 bits. (The variations in the quantization value are regulated with regard to the characteristic complex sine waves that occur in voice. The technique is therefore not applicable to other kinds of signals, such as square waves.)

In ADPCM, each sample's encoding is derived by a complicated procedure that includes the following steps: a PCM-value differential  $dn$  is obtained by subtracting the previous PCM-code value from the current value; the quantization value  $\Delta n$  (delta-n) is obtained by multiplying the previous quantization value times a coefficient times the absolute value of the previous PCM-code value; the PCM-value differential is then expressed in terms of the quantization value and encoded in four bits, as shown in figure 5.

### Build an ADPCM Speech Analyzer/Synthesizer

The Oki Semiconductor Corporation produces a number of integrated circuits (ICs) that perform ADPCM encoding and decoding. Of these, the MSM5218RS and the MSM5205RS are worthy of attention. The 5218 is designed to perform both storing and reproducing of digitized speech, while the 5205 provides only the reproducing function. Using these CMOS (complementary metal-oxide semiconductor) components, we can put together a cost-effective speech-synthesis system that produces highly intelligible output and yet makes efficient use of memory.

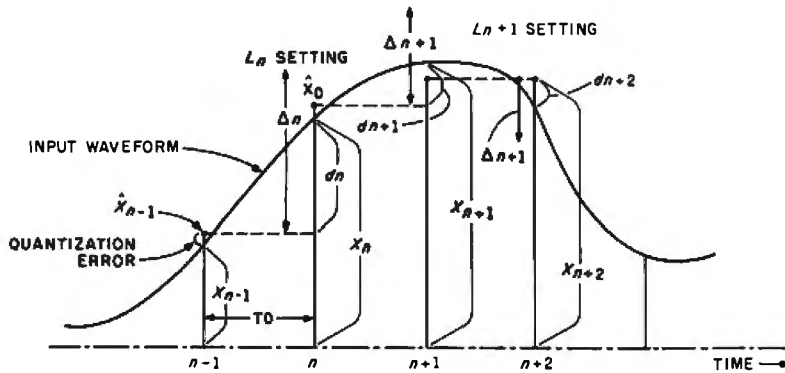
Figure 6 on page 40 is the block diagram of the MSM5218RS IC. It is designed to work with 12-bit analog-to-digital converters and contains both an ADPCM analyzer and synthesizer. An internal 10-bit D/A converter is provided to reconstruct the waveform where direct analog output is wanted, or the decoded PCM data may be routed to an external D/A converter.

The schematic in figure 7 on pages 42 and 43 diagrams a speech-synthesis circuit built around this chip (see photo 2 on page 41). In the



(5a)

$x_n$  IS THE PCM CODE VALUE  
 $\hat{x}_n$  IS THE REPRODUCED PCM CODE VALUE  
 $dn$  IS THE DIFFERENTIAL (PCM-CODE VALUE)  
 $\Delta n$  IS THE QUANTIZATION VALUE  
 $L_n$  IS THE ADPCM CODE VALUE  
 $M$  IS A COEFFICIENT



$$dn = x_n - \hat{x}_{n-1}$$

$$\Delta n = \Delta n-1 \times M (|L_{n-1}|)$$

(5b)

circuit, a low-cost 8-bit A/D converter is used in place of a higher-resolution, more costly 12-bit converter. The Oki MSM5204RS 8-bit CMOS A/D converter, employed here, uses a successive-capacitor-ladder conversion system. It also incorporates a sample-and-hold stage that enables direct input of rapidly changing analog signals. An external clock signal provides timing for the chip; the clock's frequency is not critical and can be anywhere from 450 to 500 kHz.

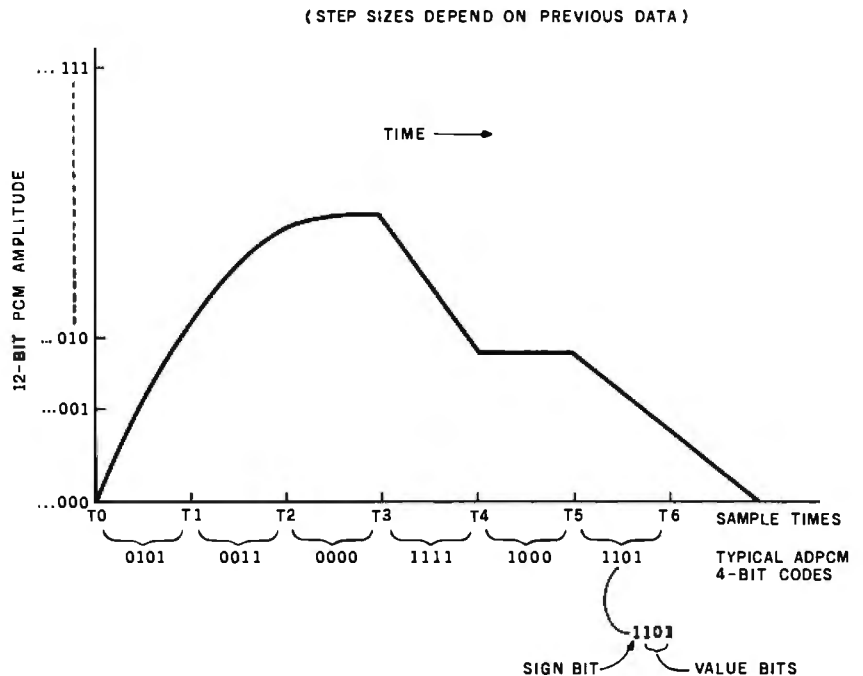
The frequency bandwidth of the signal input to the A/D converter is limited by an active low-pass filter, IC2, an Oki ALP-2 filter with a 1.7-kHz cutoff frequency. Attenuation is 18 dB per octave above the cutoff frequency. (Although frequencies up to 4 kHz can theoretically be captured with an 8-kHz sample rate, in this application the lower cutoff frequency gives better-sounding reproduction.)

### A/D Conversion in Operation

Data conversion is started when the  $\overline{S\text{-CON}}$  (start conversion) line (pin 13) of the MSM5218 forces the write line ( $\overline{WR}$ ), pin 15) on the 5204

**Figure 5:** Adaptive differential pulse-code modulation (ADPCM) improves upon DPCM by dynamically varying the quantization between samples, depending upon their rate of change, while maintaining a low bit rate, condensing 12-bit PCM samples into only 3 or 4 bits.

In ADPCM, each sample's encoding is derived by a procedure that includes the following steps. A PCM-value differential  $dn$  is obtained by subtracting the previous PCM-code value from the current value. The quantization value  $\Delta n$  (delta- $n$ ) is obtained by multiplying the previous quantization value times a coefficient times the absolute value of the previous PCM-code value. The PCM-value differential is then expressed in terms of the quantization value and encoded in four bits. The mathematical relations are shown here in figure 5a, whereas figure 5b shows a typical encoded waveform.



ADPCM CODE STRUCTURE

SIGN BIT	VALUE BITS	COMMENTS
1	000	MINIMUM EXCURSION
1	100	MEDIUM EXCURSION
1	111	MAXIMUM EXCURSION
0	000	MINIMUM EXCURSION
0	100	MEDIUM EXCURSION
0	111	MAXIMUM EXCURSION

A/D converter into a low state. After conversion is complete, the A/D read line ( $\overline{RD}$ ), pin 14) is brought low to latch the data onto the 5204's output lines. At a clock rate of 450 kHz, the 5204 completes the 8-bit conversion in approximately 73 microseconds.

The digital representation of the input data from the 5204 is fed into a CD4014 serial-to-parallel converter (IC9) for transposition into the serial format required by the MSM5218's input. Because we are using an 8-bit converter and the MSM5218 expects 12-bit input, the four remaining low-order bits are clocked in as zeros by the CD4024 counter (IC7) and sections of the quad NAND gate (IC6). These components provide four extra SI-CK (serial input OR clock) pulses with zero-logic-level data.

### Selectable Parameters

The MSM5218 can analyze or synthesize ADPCM speech using a variable sampling rate. Three internal preset VCLOCK rates can be selected, or an externally supplied signal up to 384 kHz can be used. The logic levels on the 5218's pins S1 and S2 define the VCLOCK reference in both analysis and synthesis modes, as shown in the lower right corner of figure 7. The host computer, or any other external hardware, synchronizes itself with the 5218 by monitoring the state and transition timing of the VCLOCK signal (pin 1).

In addition to selecting the VCLOCK rate, you can choose encoding of the ADPCM data in either 3 or 4 bits, depending upon the logic level on the 4B/ $\overline{3B}$  line (pin 7). A logic 1 selects 4-bit ADPCM values.

### Data Transfer and Rates

In the dual-function MSM5218, the data lines D0 through D3 are bidirectional and used either for output of analyzed ADPCM data (for storage) or for input to the speech-synthesizer circuitry. In the analysis mode (with pin 6 held high), the current encoded ADPCM value is available on D0 through D3 at the occurrence of the rising edge of VCLOCK. If you have set S1 and S2 for 8 kHz and 4B/ $\overline{3B}$  for 4-bit data, the resulting bit rate is calculated as follows:

$$8000 \times 4 \text{ bits} = 32,000 \text{ bps}$$

Remember that we originally calculated that a rate of 96,000 bps would be needed to reproduce speech with this same fidelity. (Here we used an 8-bit A/D converter for economy; the bit rate would be the same for a 12-bit converter.)

With a slight sacrifice in fidelity, the bit rate can be reduced further. By selecting the 4-kHz sample rate and 3-bit ADPCM codes, a 12,000 bps rate is achieved.

This may still sound like a lot of data, especially when you compare it to phoneme and LPC (linear-predictive coding) speech synthesizers like the Votrax SC-01A and the Digitalker, which by comparison use data rates of 70 to 1000 bps. The difference, of course, is speech quality and intelligibility. A phoneme or LPC synthesizer generates its own sounds and forms them into words. An ADPCM synthesizer, on the other hand, retains the inflection and in-

tonation of the original human voice. With ADPCM, as with an analog recording, it's possible to have a voice output that reproduces the regional accents of the human speaker.

The circuit of figure 7 can be used as both an analyzer and a synthesizer. Both subsystems function concurrently when the MSM5218 is in the analysis mode; the results, the reconstructed waveform, can be heard in real time (delayed by 3 VCLOCK periods). In figure 7, this output is smoothed by a low-pass filter and externally amplified to drive a speaker.

### Use of the ADPCM Circuit

As I said at the beginning, the purpose of this project is to create intelligible machine-generated speech. With the circuit of figure 7 connected to a Z80-based computer, and using the LOAD routine in the program of listing 1 (the algorithm shown in the flowchart of figure 8), you can analyze and store 10 seconds of speech (or 20 seconds at the 4-kHz

MSM5218 INTERNAL BLOCK DIAGRAM

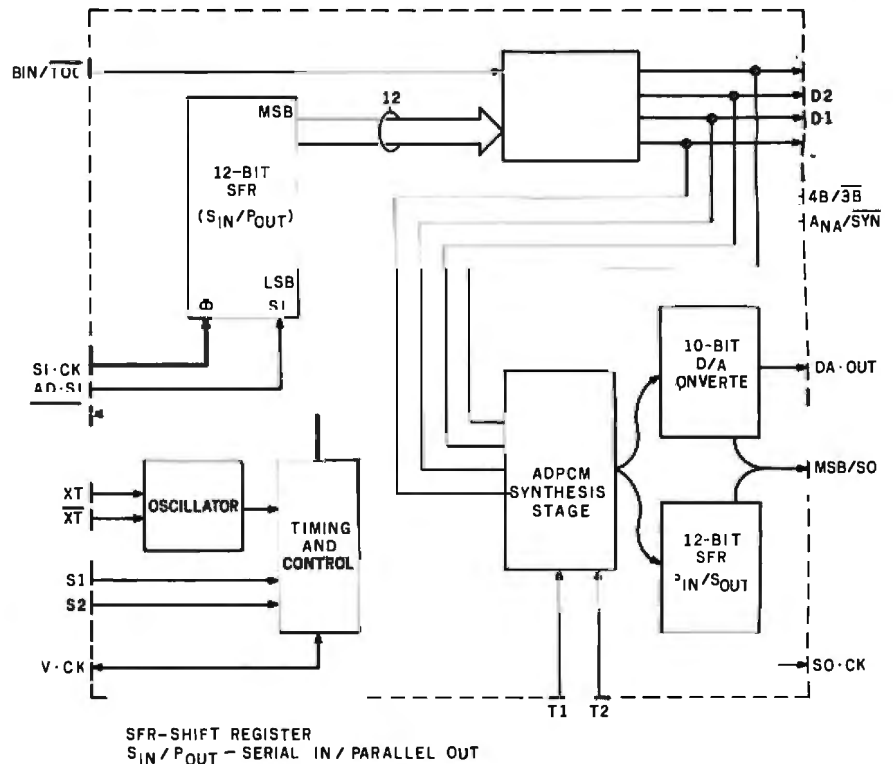


Figure 6: Functional block diagram of the Oki Semiconductor MSM5218RS ADPCM integrated circuit.

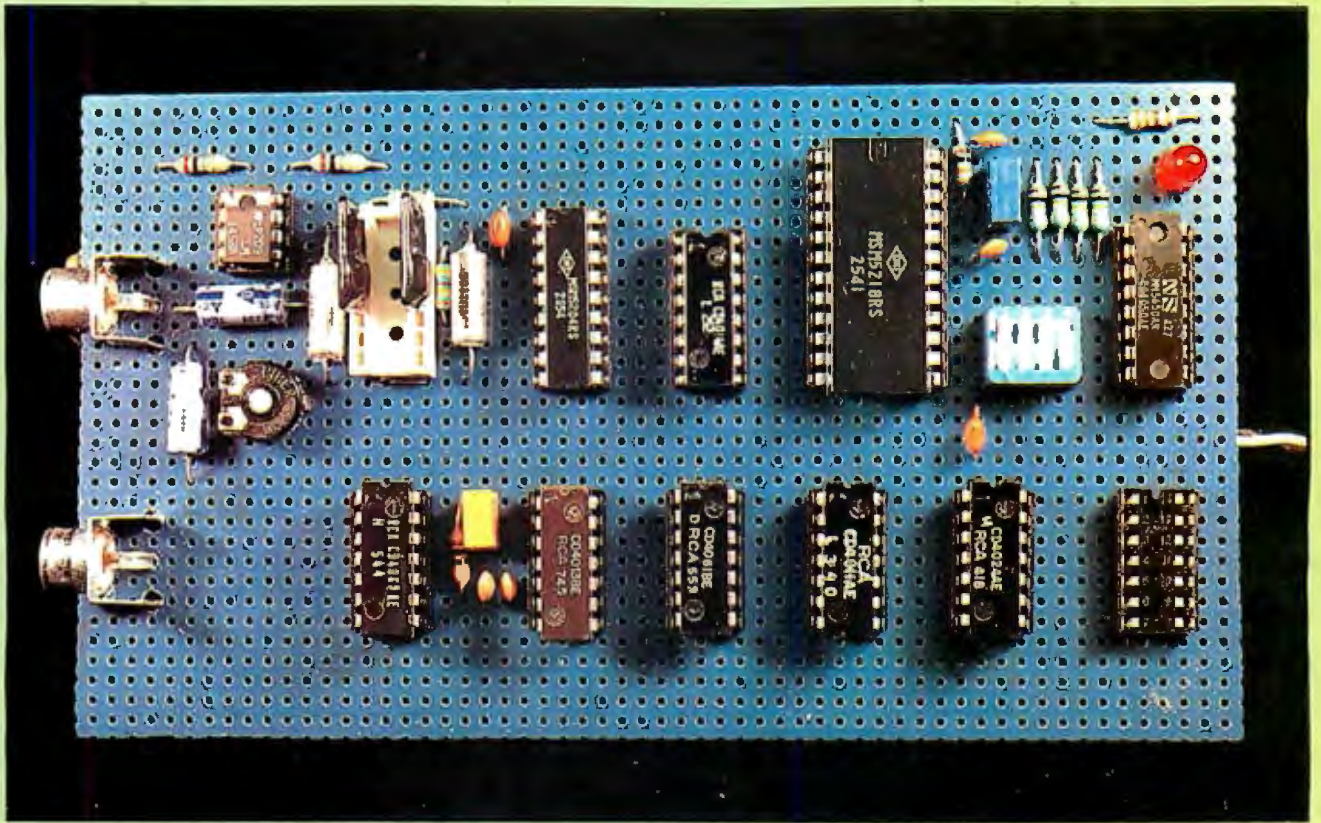


Photo 2: Prototype of the speech analysis and synthesis circuit of figure 7, built around the Oki Semiconductor MSM5218RS integrated circuit. The empty IC socket is used for ribbon-cable connection to the host computer.

sample rate). The program simply turns on the synthesizer by lowering the reset line and then observing VCLOCK. At every negative-going transition it reads a 4-bit ADPCM nybble (there are 2 nybbles per byte) and stores it in a memory-resident table.

For experimental purposes I set this table to occupy a rather large region of user memory (40K bytes). For most practical applications, you might prefer to store segments of speech on disk and load them into memory in smaller increments.

Once some speech has been stored, you can play it back using the DUMP routine from listing 1 (whose algorithm appears in figure 9). With the MSM5218 set to the synthesis mode, the ADPCM codes are sequentially loaded on each rising edge of VCLOCK.

If you want to store some speech permanently and then play it back in a dedicated application (as an annunciator, for instance), you won't need the analysis part of the circuit after the ADPCM codes have been stored.

### **One significant aspect of ADPCM speech synthesis is the ease of producing a custom vocabulary.**

For such cases you may wish to use the synthesize-only circuit of figure 10, which uses the 18-pin MSM5205RS ADPCM-synthesis chip instead of the dual-function 24-pin 5218 (see photo 3 on page 48). The 5205's synthesis capabilities are equal in every way to those of the 5218, but the 5205 saves the expense and complication of the

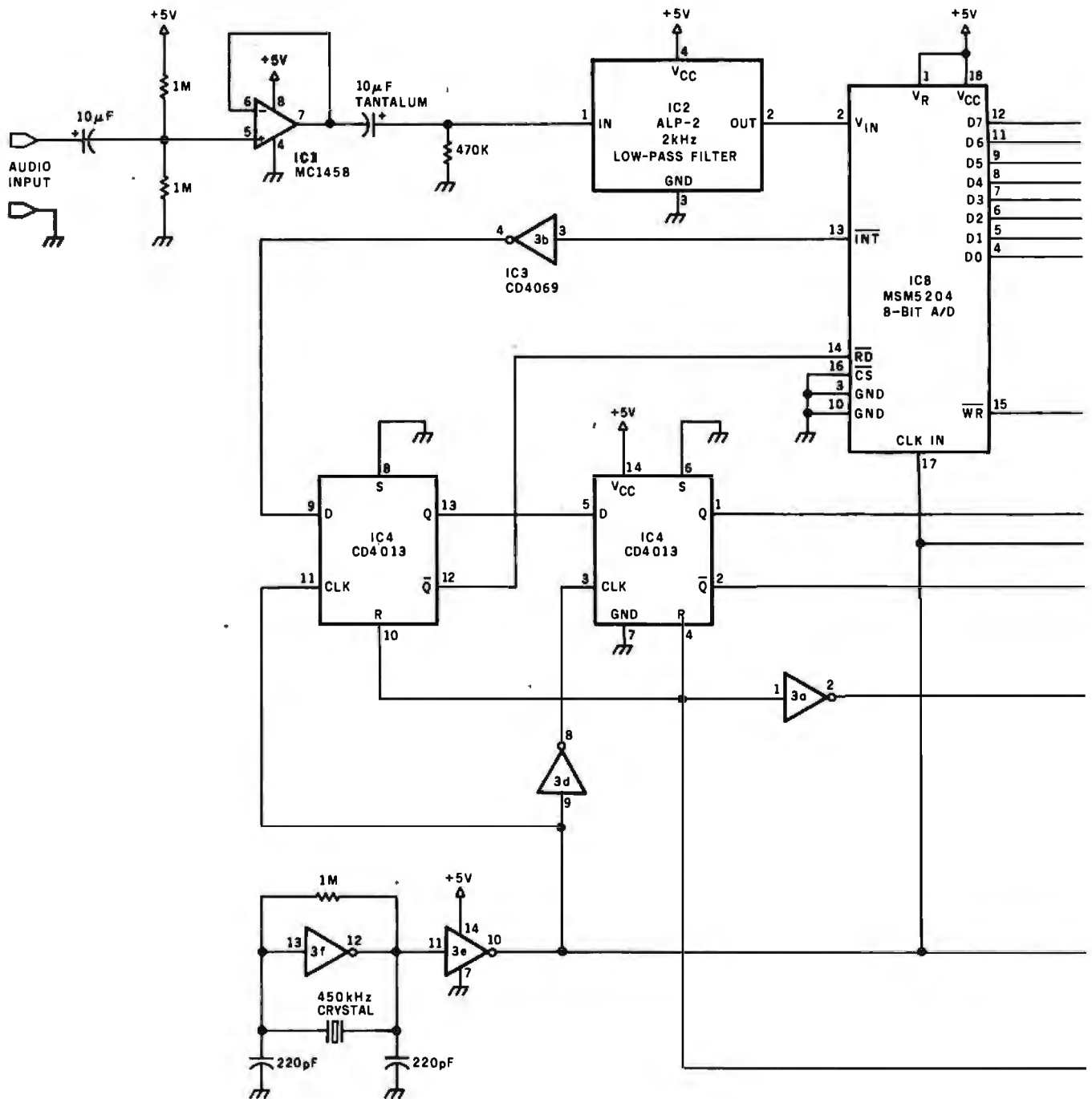
analysis section. The resulting 2-chip circuit, the parts of which cost less than \$15, can be easily manufactured for a variety of applications.

I was pleasantly surprised at the fidelity using ADPCM at 32,000 bps. It was still more intelligible than the majority of current synthesis techniques even at 12,000 bps. While testing the software I attached the input of the analysis unit to an FM radio. Even when using the 1.7-kHz filters, I was surprised how good even music sounded.

### **Summary of ADPCM Synthesis**

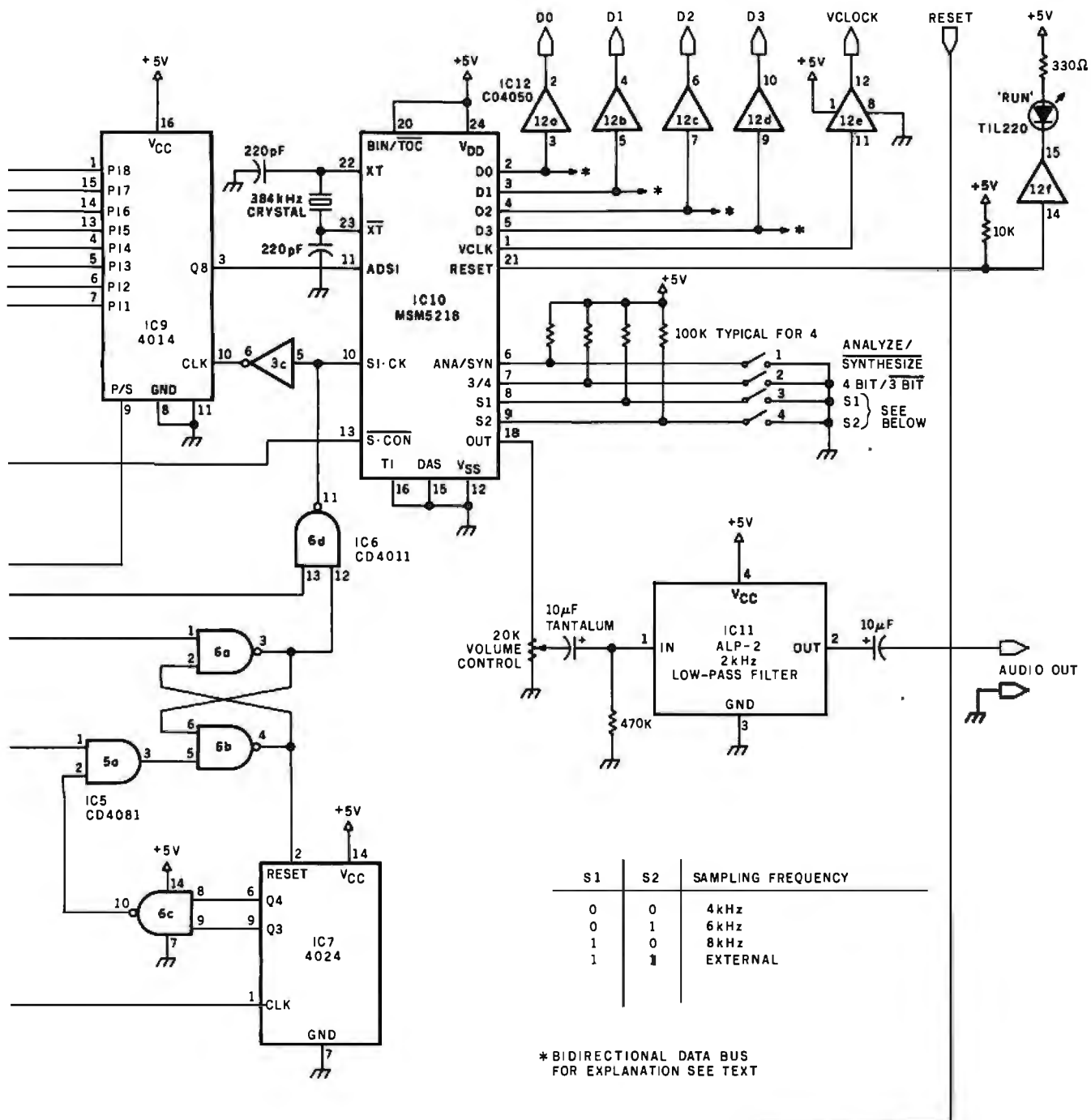
Probably the most significant aspects of ADPCM speech synthesis are the simplicity of the hardware and the ease of producing a custom vocabulary. You don't have to send a word list and recording tape to a manufacturer and wait for the com-

*Text continued on page 48:*



**Figure 7:** An ADPCM speech analysis and synthesis (storage and reproduction) circuit built around the Oki MSM5218RS chip. A low-cost 8-bit A/D converter is used in place of a higher-resolution and more costly 12-bit converter. The Oki MSM5204RS 8-bit CMOS A/D converter, used in this circuit, contains a successive-capacitor-ladder conversion system. It also incorporates a sample-

TTL INPUT INTERFACE



S1	S2	SAMPLING FREQUENCY
0	0	4 kHz
0	1	6 kHz
1	0	8 kHz
1	1	EXTERNAL

\* BIDIRECTIONAL DATA BUS FOR EXPLANATION SEE TEXT

and-hold stage that enables direct input of rapidly changing analog signals. An external clock signal provides timing for the chip; the clock's frequency is not critical and can be anywhere from 450 to 500 kHz.

The frequency bandwidth of the signal input to the A/D converter is limited by an active low-pass filter, IC2, an Oki ALP-2 filter with a 1.7-kHz cutoff frequency and attenuation of 18 dB per octave above the cutoff frequency.

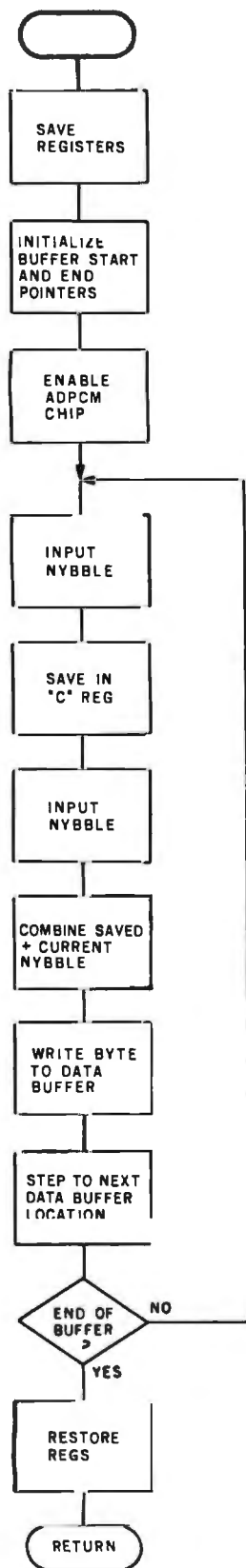


Figure 8: Algorithm of the LOAD routine in the program of listing 1. Used with the circuit of figure 7, LOAD takes analog voice signals from a microphone or other source and stores them in ADPCM-encoded form in user memory.

Listing 1: Z80 assembler program to control the speech-synthesis circuit of figure 7.

```

00010 ;
00020 ; THESE ROUTINES ARE USED TO ALLOW A Z-80
00030 ; BASED MICRO TO LOAD AND DUMP THE 4 BIT
00040 ; NYBBLES CREATED BY THE OKI ADPCM CHIP.
00050 ;
00060 ; ONE I/O PORT IS USED FOR BOTH INPUT AND
00070 ; OUTPUT. THE BIT MAP FOR THE PORT IS AS
00080 ; FOLLOWS :
00090 ;
00100 ;
00110 ; B7 B6 B5 B4 B3 B2 B1 B0
00120 ; # # # #
00130 ; D3 D2 D1 D0
00140 ;
00150 ; * CLOCK ON INPUT, RESET
00160 ; ON OUTPUT
00170 ;
00180 ; # # # UNUSED
00190 ;
00200 ;
00210 ; SINCE THE MASTER CLOCK OF THE OKI CHIP IS
00220 ; USED BY THIS PROGRAM, ANY OF THE CLOCK
00230 ; RATES MAY BE SELECTED WITHOUT MODIFYING
00240 ; THIS CODE.
00250 ;
00260 ; AT 8KHZ, YOU WILL FILL 4K BYTES PER SECOND.
00270 ;
00280 ;
4000 00290 ORG 4000H ; START AT 4000H ON D/G CPU.
4000 00300 LOAD EQU $
4000 F5 00310 PUSH AF ; SAVE ANY REGS
4001 C5 00320 PUSH BC ; THAT I WILL CLOBBER
4002 E5 00330 PUSH HL ; DURING THE ROUTINE
4003 2641 00340 LD H,41H ; BUFFER STARTS AT
4005 2200 00350 LD L,00H ; 4100H
4007 06DF 00360 LD B,0DFH ; AND ENDS AT DFOOH
00370 ;
00380 ;
4009 3E00 00390 LD A,00H ; PICK UP 0.
400B D311 00400 OUT (11H),A ; AND TURN OFF RESET TO ADPCM
00410 ;
400D CD2740 00420 LOOP1 CALL NIN ; BIT UP NYBBLE FROM ADPCM
4010 07 00430 RLC A ; PUT THE
4011 07 00440 RLC A ; NYBBLE AT THE
4012 07 00450 RLC A ; TOP OF THE
4013 07 00460 RLC A ; REGISTER.
4014 4F 00470 LD C,A ; AND SAVE IN THE C REG
4015 CD2740 00480 CALL NIN ; PICK UP ANOTHER NYBBLE
4018 B1 00490 OR C ; COMBINE WITH SAVED NYBBLE
4019 77 00500 LD (HL),A ; AND SAVE IN THE BUFFER
401A 23 00510 INC HL ; STEP TO NEXT LOCATION
401B 73 00520 LD A,B ; PICK UP END POINTER
401C BC 00530 CP H ; ARE WE AT THE END ?
401D 20EE 00540 JR NZ,LOOP1 ; NO, DO ANOTHER
401F 3E7F 00550 LD A,0FFH ; YES, PICK UP ALL 1'S
4021 D311 00560 OUT (11H),A ; AND RESET THE ADPCM
4023 E1 00570 POP HL ; RECOVER THE
4024 C1 00580 POP BC ; SAVED REGISTERS
4025 F1 00590 POP AF ; WE SCRAMBLED
4026 C9 00600 RET ; AND RETURN TO THE CALLER.
00610 ;
00620 ;
00630 ;
4027 00640 NIN EQU $
4027 DB11 00650 INHW IN A,(11H) ; PICK UP INPUT FROM ADPCM
4029 CB67 00660 BIT 4,A ; CHECK FOR A 1 ON THE CLOCK
402B 28FA 00670 JR Z,INHW ; WAIT FOR ONE TO COME
402D DB11 00680 INLOW IN A,(11H) ; PICK UP INPUT FROM ADPCM
402F CB67 00690 BIT 4,A ; CHECK FOR A 0 ON THE CLOCK
4031 28FA 00700 JR Z,INLOW ; WAIT FOR ONE TO COME
00710 ;
00720 ; WHEN A 1 TO 0 TRANSITION HAS OCCURRED, THE DATA
00730 ; IN THE A REG IS THE NYBBLE WE WANT TO STORE.
00740 ;
4033 E60F 00750 AND 0FH ; MASK OFF THE HI BITS

```

Listing 1 continued on page 46



# UDS gives 212 users three ways to go!

**212A**—Today's most popular modem. UDS offers a fully Bell-compatible unit with complete local and remote test capability. Select 0-300 or 1200 bps for full-duplex asynchronous communication. The UDS 212A is FCC certified for direct connection to the dial-up telephone network, and available in multi-channel, rack-mounted configuration.

SINGLE UNIT PRICE ..... **\$675**

**212 LP** — Compatible with 212As at the 1200 bps, full-duplex asynchronous communication rate. No power supply or AC connection required; the 212 LP derives its operating power directly from the telephone line. Ideal for applications requiring 212A capability at 1200 bps only. The 212 LP is direct-connect certified.

SINGLE UNIT PRICE ..... **\$445**

**212A/D** — Identical to the 212A, with automatic dialing capability added! The unit stores and dials up to five 30-digit numbers. CRT menu prompting, single-stroke commands and automatic test capabilities are provided. The 212A/D is direct-connect certified.

SINGLE UNIT PRICE ..... **\$745**



**Universal Data Systems**



**MOTOROLA INC.**  
Information Systems Group

5000 Bradford Drive, Huntsville, AL 35805. Telephone 205/837-8100; TWX 810-726-2100

DISTRICT OFFICES:

Old Bridge, NJ, 201/251-9090 • Blue Bell, PA, 215/643-2336 • Atlanta, 404/998-2715 • Chicago, 312/441-7450 • Columbus, OH, 614/895-3025 • Boston, 617/875-8868  
Richardson, TX, 214/680-0002 • Englewood, CO, 303/694-6043 • Houston, 713/988-5506 • Tustin, CA 714/669-8001 • Sunnyvale, 408/738-0433

Circle 402 on Inquiry card.

Created by Dayner/Hall, Inc., Winter Park, Florida

Listing 1 continued:

```

4035 C9      00760      RET                ; AND RETURN TO CALLER
              00770      ;
              00780      ;
              00790      ;
              00800      ;
              00810      ;
              00820      ;
              00830      ;
4036          00840 DUMP EQU $
4036 F5      00850 PUSH AF          ; SAVE THE REGS
4037 C5      00860 PUSH BC          ; JUST LIKE
4038 E5      00870 PUSH HL          ; BEFORE
4039 2641    00880 LD H,41H        ; SET UP START
403B 2E00    00890 LD L,0H          ; ADDRESS OF BUFFER
403D 06DF    00900 LD B,ODFH       ; SET UP END TOO
403F 3E00    00910 LD A,00H        ; PICK UP ALL 0'S
4041 D311    00920 OUT (11H),A      ; AND TURN OFF RESET TO ADPCM
              00930      ;
              00940      ;
4043 7E      00950 LOOP2 LD A,(HL)    ; PICK UP STORED DATA BYTE
4044 E6F0    00950 AND OFOH        ; ISOLATE THE UPPER NYBBLE
4046 07      00970 RLC          ; AND SWING
4047 07      00980 RLC          ; IT TO
4048 07      00990 RLC          ; THE LOWER
4049 07      01000 RLC          ; NYBBLE
404A CD6040  01010 CALL NOUT      ; WRITE THE NYBBLE TO THE ADPCM
404D 7E      01020 LD A,(HL)    ; PICK UP THE BYTE AGAIN
404E E60F    01030 AND OFH        ; LOWER NYBBLE THIS TIME
4050 CD6040  01040 CALL NOUT      ; WRITE IT TO THE ADPCM
4053 23      01050 INC HL          ; STEP TO NEXT BUFFER POSITION
4054 78      01060 LD A,B          ; PICK UP END OF BUFFER POINTER
4055 BC      01070 CP H          ; ARE WE THERE YET ?
4056 20EB    01080 JR NZ,LOOP2    ; NO, DO SOME MORE
4058 3EFF    01090 LD A,OFFH       ; PICK UP ALL 1'S
405A D311    01100 OUT (11H),A      ; TURN ON RESET TO ADPCM
405C E1      01110 POP HL         ; RECOVER THE
405D C1      01120 POP BC         ; REGS THAT WE
405E F1      01130 POP AF         ; HAVE CLOBBERED
405F C9      01140 RET                ; AND RETURN TO CALLER
              01150      ;
              01160      ;
              01170      ;
4060          01180 NOUT EQU $
4060 4F      01190 LD C,A          ; SAVE A FOR LATER
4061 DB11    01200 LOW IN A,(11H)    ; PICK UP ADPCM BYTE
4063 CB67    01210 BIT 4,A        ; TEST FOR 0 BIT
4065 20FA    01220 JR NZ,LOW      ; WAIT FOR ONE TO COME
4067 DB11    01230 HIW IN A,(11H)  ; PICK UP ADPCM BYTE
4069 CB67    01240 BIT 4,A        ; TEST FOR 1 BIT
406B 28FA    01250 JR Z,HIW      ; WAIT FOR ONE TO COME
              01260      ;
              01270 ; WHEN 0 TO 1 TRANSITION IS DETECTED, WE PUT OUR DATA
              01280 ; OUT TO THE ADPCM.
              01290      ;
406D 79      01300 LD A,C          ; RECOVER THE SAVED DATA
406E D311    01310 OUT (11H),A      ; WRITE TO THE ADPCM
4070 C9      01320 RET                ; AND GO BACK TO CALLER
              01330      ;
              01340      ;
              01350      ;
              01360      ;
              01370 ; END OF LOAD/DUMP ROUTINES
              01380      ;
              01390      ;
0000          01400      END
00000 TOTAL ERRORS

```

```

DUMP 4036 00840
INHIV 4027 00650 00670
INLOW 402D 00630 00700
LOAD 4000 00300
LOOP1 400D 00420 00540
LOOP2 4043 00950 01080
NIN 4027 00640 00420 00480
NOUT 4050 01180 01010 01040
HIW 4067 01230 01250
LOW 4061 01200 01220

```

## Now Attractive Industrial Quality Mainframes Enclosures as low as \$200

Dual LED Display  
Shock Mounted 6 Slot  
Motherboard/Card Cage  
PS-101 Power Supply  
Power & Reset Switches, A/C Filter,  
Fan, Etc.



**SDS-S100-SL**  
8" Floppy Drive Enclosure/System  
Special Lift Out Drive Rack  
Fits all Regular and Slim-Line 8" Drives  
Also Will Support 5-1/4" Hard Disk



**SDS-S100-MFL**  
5-1/4" Floppy and/or Hard Drive  
Enclosure/System



**SDS-MF2 SDS-MIC**  
12 Slot S100 Computer Chassis or  
8" Hard Disk Cabinet



**PS-101 Power Supply**  
This solid supply gives you the  
capability of running any variety of  
8" floppy or 5-1/4" floppy or hard disk  
drive as well as provides power for a  
full S100-Buss Motherboard.

<b>Regulated:</b>	<b>Unregulated:</b>
8V @ 8 amp	+16V @ 1 amp
+5V @ 5 amp	-16V @ 1 amp
+12V @ 5 amp	
+24V @ 5 amp	
-5 or -12V @ 1 amp	

**SIERRA DATA SCIENCES**  
Fresno, California/

Product Support Division  
25700 First Street, Westlake, Ohio 44145  
(216) 892-1800 TELEX: 980131 WDMR





# On the Threshold of 8-Bit Hyperspeed


At 8MHz, Sierra Data Sciences' new Z80 single-board computers are the first—and the fastest—microcomputers in their class.

Under CP/M™ they perform like single user minis. Teamed with networking TurboDOS™ their 16-bit-buss-transfers amaze the demanding 16-bit multiuser world. And at Sierra Data's production-oriented price, they bring an ever-expanding universe of CP/M compatible software into a whole new realm of price/performance reality.

Solve your need for speed. Only a reliable manufacturer with Sierra Data's undisputed technical lead and established reputation for support can deliver these features—all on board our new slave/satellite single-board computers:

• Meets IEEE 696/S-100 Standards • Z80H (8MHz) Z80B (6MHz), or Z80A (4MHz), • 64K/128K\*/256K\*/512K\* bank-selectable RAM in 4K increments • High speed integer or Floating-point math chip\* • 2 Serial ports • 2 Parallel ports • 4 Counter timers • 4K CMOS cache buffer, buss addressable in 16-bit or 8-bit increments • 4K/8K/16K EPROM • Operates under Sierra Data supported CP/M 2.2\*\*, CP/M 3.0\*\* and TurboDOS 1.2\*\*

Make Sierra Data the heart of your advanced system or discover one of Sierra Data's cost-effective, turnkey systems. Sierra Data's single or multiuser 20M byte hard disk system with 8 inch slimline floppy-disk backup is shown above. Other popular configurations are shown on the previous page. Ask for Sierra Data's product catalog today.



\*Optional

\*\*TurboDOS is a Registered Trademark of Software 2000 Inc.

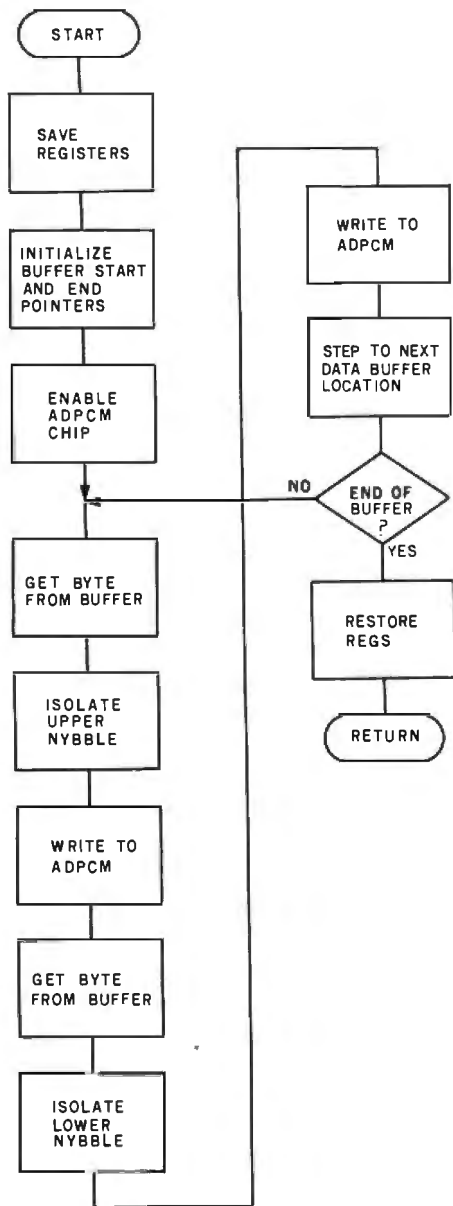
\*\*CPM is a Registered Trademark of Digital Research

HARDWARE  
SOFTWARE



**SIERRA DATA SCIENCES**

Fresno, California/  
Product Support Division  
25700 First St., Westlake, Ohio 44145  
(216) 892-1800 TELEX: 980131 WDMR



**Figure 9:** Algorithm of the DUMP routine from listing 1. This routine takes the stored ADPCM-encoded speech from memory and causes the circuit of figure 7 to reconstruct the voice waveforms.

Text continued from page 41

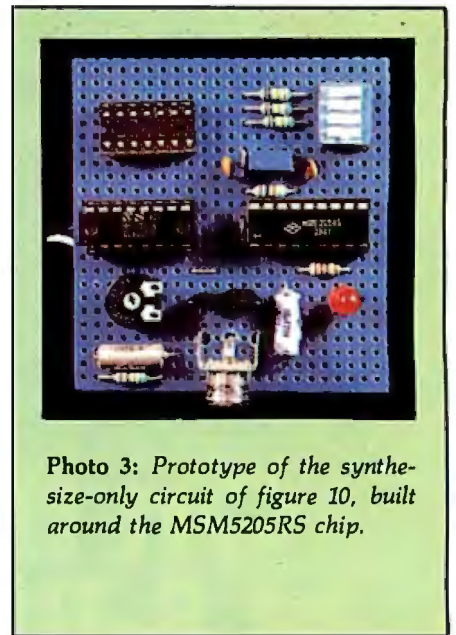
pany to spend days doing a Fourier analysis of the tape. To produce a ROM (read-only memory) containing your custom vocabulary, you can use merely a microphone and a simple LOAD/DUMP routine. It may require 4 to 5 times more memory space than other high-intelligibility speech-synthesis schemes, but the price of that memory is minuscule compared to the cost of producing vocabularies for the other schemes.

### Future Applications of ADPCM

We've looked at ADPCM here only

as it relates to voice synthesis, but in actuality, the possible applications of ADPCM to speech recognition prompted my initial interest.

The first phase of any speech-recognition technique is digitizing the waveforms and getting them into the computer for analysis, compression, and comparison. My previous article on voiceprints (reference 5) demonstrated the large quantity of hardware necessary to merely condition the waveform for traditional speech-recognition methods. With ADPCM and these Oki chips, we have an inex-



**Photo 3:** Prototype of the synthesize-only circuit of figure 10, built around the MSM5205RS chip.

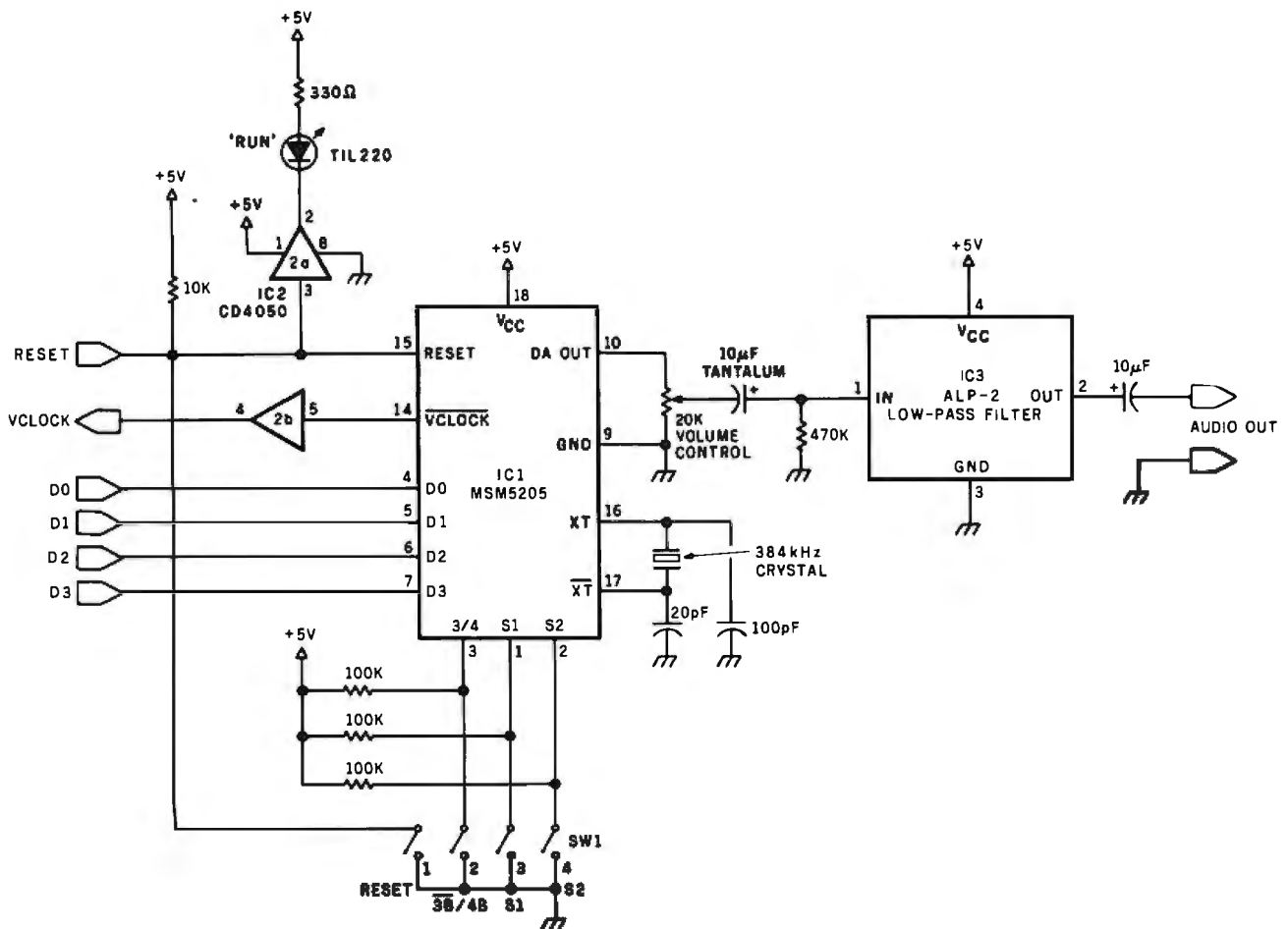
pensive (under \$30) circuit for digitizing voice waveforms and presenting them to a computer in a form that it can digest.

Even though 1500 to 4000 bytes of raw data per second of speech stream into the computer, the data thus recorded should be unique for each individual word. Speech recognition could be accomplished by brute-force comparison of all the data, or perhaps there exists some applicable compression algorithm that might reduce one second of data to 200 bytes or so. The final compacted data would not be for reconstruction of the original waveform but rather stored as a signature of the input word (derived from an ADPCM code table) for use in comparison.

We have accomplished the first step and now have means to place the ADPCM codes in memory. In the course of the next few months I will be experimenting with various compression and comparison techniques in hope of developing a practical speech-recognition project. But if by chance you happen upon the solution to the problem overnight, let me know.

### Next Month:

A four-channel real-time appliance controller using a TMS1000-series 4-bit microprocessor. ■



**Figure 10:** A voice-reproduction circuit built around the Oki MSM5205RS speech-synthesis chip. This circuit is useful in applications where you need a fairly inexpensive means of reproducing a custom vocabulary. You can store your vocabulary with the circuit of figure 7, and load the encoded speech into this simple circuit for output.

### References

1. Ciarcia, Steve. "Build a Low-Cost Speech-Synthesizer Interface." June 1981 BYTE, page 46.
2. Ciarcia, Steve. "Build the Microvox Text-to-Speech Synthesizer." Part 1, September 1982 BYTE, page 64; Part 2, October 1982 BYTE, page 40.
3. Ciarcia, Steve. "Build an Unlimited-Vocabulary Speech Synthesizer." September 1981 BYTE, page 38.
4. Ciarcia, Steve. "Talk to Me: Add a Voice to Your Computer for \$35." June 1978 BYTE, page 142.
5. Ciarcia, Steve. "Use Voiceprints to Analyze Speech." March 1982 BYTE, page 50.
6. *General Explanation of Oki ADPCM Speech Synthesis LSI (MSM5205RS)*. Tokyo: Oki Electric Ltd., 1982.
7. Mier, Edwin E. "Competitors Fear AT & T's New \$1 Billion Scheme." *Data Communications*, December 1982, page 39.

**Editor's Note:** Steve often refers to previous *Circuit Cellar* articles as reference material for each month's current article. Most of these past articles are available in reprint books from *BYTE Books*, McGraw-Hill Book Company, POB 400, Hightstown, NJ 08250.

Ciarcia's *Circuit Cellar*, Volume I covers articles that appeared in *BYTE* from September 1977 through November 1978. Ciarcia's *Circuit Cellar*, Volume II contains articles from December 1978 through June 1980. Ciarcia's *Circuit Cellar*, Volume III contains the articles that were published from July 1980 through December 1981.

*Digitalker* is a trademark of National Semiconductor Corporation.

To receive a complete list of Ciarcia's *Circuit Cellar* project kits available from the Micromint, circle 100 on the reader service inquiry card at the back of the magazine.

For those of you who would like to construct an ADPCM analyzer/synthesizer, the chips are readily available from Oki Semiconductor Corporation as part of an experimenter's kit.

Included are:

- Oki MSM5218 analyzer/synthesizer
- Oki MSM5205 synthesizer
- Oki MSM5204 8-bit A/D converter
- 384-kHz ceramic resonator
- Oki MSM5128-15 CMOS 2K by 8-bit static RAMs (eight)
- ALP-2 hybrid 1.7-kHz filter
- ALP-4 hybrid 3.4-kHz filter

The package is called the *Real-Voice Application Kit*. It sells for \$89 post-paid (check or money order only—no CODs or company purchase orders) and can be ordered from:

Oki Semiconductor, Inc.  
1333 Lawrence Expressway, Suite 401  
Santa Clara, CA 95051  
telephone: (408) 984-4842  
TWX: (910) 338-0508

# If you want it fast, call us first.

As are, we have just what you want right in our warehouse. We can ship it out right now. At the right price.

## DISK DRIVES.....13.95

Double Density 40 Tracks,  
10. Guaranteed one year.

## 3.....21.95

Double Density 40 Tracks,  
10. Guaranteed one year.

## COTCH 3M

S.D. DEN 40 TRK.....23.50  
S.D. DEN 40 TRK.....36.50

## 3ATIM D

350-01, 10, 16.....26.50  
350-01, 10, 16.....44.50  
357-01, 10, 16.....45.60  
.....34.80  
357-01, 10, 16.....36.00  
357-01, 10, 16.....36.00  
357-01, 10, 16.....45.60  
357-01, 10, 16.....48.60

## ESTOP GE

3RARY CASE.....2.50  
LIBRARY CASE.....3.50  
STORAGE BINDER w/ Inserts.....9.95  
PROTECTOR 5 1/4" (50 Disk Capacity).....21.95  
PROTECTOR 8" (50 Disk Capacity).....24.95  
DISK BANK 5 1/4".....5.95  
DISK BANK 8".....6.95

## PERSONAL COMPUTERS

at our low NEC prices.

## COMPUTER

80 COLUMN W/64K.....362.50  
TEAC SLIMLINE.....325.00  
QUENTIN APPLEIMATE DRIVE.....258.00  
SUPER CLOCK II.....129.00  
VERSA WRITER DIGI.....259.00  
ABT APPLE KEYPAD.....119.00  
SOFTCARD PREMIUM S.....517.00  
MICROSOFT Z-80 SOFTC.....249.00  
MICROSOFT RAMCARD.....79.00  
VIOEX 80x24 VIDEO CARD.....260.00  
VIOEX KEYBOARD ENHANCER II.....129.00  
VIOEX FUNCTION STRIP.....74.00  
M & R SUPERTERM 80x24 VIDEO BO.....315.00  
M & R COOLING FAN.....44.95  
M & R UNIVERSAL MOO.....54.95  
T/G JOYSTICK.....44.95  
T/G PADDLE.....29.95  
T/G SELECT-A-PORT.....54.95  
T/G TRACKBALL.....47.50  
KRAFT JOYSTICK.....48.00  
VERSA E-Z PORT.....21.95  
THE MILL-PASCAL Speed.....97.00  
PROMETHEUS VERSACAR.....00  
MICROBUFFER II+ 16K W/ RAPHIC.....299.00  
MICROBUFFER II+ 32K W/ RAPHIC.....299.00  
SUPERFAN II.....62.00  
SUPERFAN II W/ZENEP.....RA 50  
RANA CONTROLLER.....104.00  
RANA DRIVE ELITE I.....335.00  
SNAPSHOT.....119.00  
GRAPPLER+.....145.00

C-ITOH F-10 40 CPS PARALLEL.....1390.00  
C-ITOH F-10 40 CPS SERIAL.....1390.00  
C-ITOH F-10 55 CPS PARALLEL.....1639.00  
C-ITOH F-10 55 CPS SERIAL.....1639.00  
C-ITOH PROWRITER PARALLEL.....410.00  
C-ITOH PROWRITER SERIAL.....590.00  
C-ITOH PROWRITER II PARALL.....715.00  
C-ITOH PROWRITER II SERIAL.....767.00  
EPSON MX-80 W/GRA.....\$CALL  
NEW! EPSON FX-80.....\$CALL  
EPSON MX-100 W/GRAFT PLUS.....\$CALL  
EPSON GRAFTRAX PLUS.....60.00  
COMREX CR-1 PARALLEL.....769.00  
COMREX CR-1 SERIAL.....829.00  
COMREX TRACTOR FEED.....109.00  
NEC 8023A.....165.00  
NEC SPINWR.....1995.00  
NEC SPINWRITER 7710.....2545.00  
RITER 7730.....2545.00  
PINWRITER 7700 D S UM.....2795.00  
NEC PINWRITER 3500 SEL A.....2295.00  
OKIO TA MICROLINE B2A.....460.00  
OKIO TA MICROLINE.....700.00  
OKIOATA MICROL.....1170.00  
OKIGRAPH B2.....49.95  
OKIGRAPH B3.....49.95  
MICROBUFFER.....299.00  
MICROBUFFER IN-LINE 64K.....349.00  
MICROBUFFER 64K EXPANSION MOD.....179.00

## BOOKS

THE CUSTOM APPLF.....24.95  
BASIC BETTER & FA 10 DISK.....18.00  
THE CUSTOM TRS.....24.95  
MICROSOFT BASIC FASTER & BETTER.....24.95  
CUSTOM I/O MACHINE LANGUAGE.....24.95  
TRS-80 DISK & MYSTERIES.....16.95  
MICROSOFT BASIC & DECODE.....24.95

## APPLE HARDWARE

### MICROSOFT CP/M ][e

80 COLUMN W/64K.....362.50  
TEAC SLIMLINE.....325.00  
QUENTIN APPLEIMATE DRIVE.....258.00  
SUPER CLOCK II.....129.00  
VERSA WRITER DIGI.....259.00  
ABT APPLE KEYPAD.....119.00  
SOFTCARD PREMIUM S.....517.00  
MICROSOFT Z-80 SOFTC.....249.00  
MICROSOFT RAMCARD.....79.00  
VIOEX 80x24 VIDEO CARD.....260.00  
VIOEX KEYBOARD ENHANCER II.....129.00  
VIOEX FUNCTION STRIP.....74.00  
M & R SUPERTERM 80x24 VIDEO BO.....315.00  
M & R COOLING FAN.....44.95  
M & R UNIVERSAL MOO.....54.95  
T/G JOYSTICK.....44.95  
T/G PADDLE.....29.95  
T/G SELECT-A-PORT.....54.95  
T/G TRACKBALL.....47.50  
KRAFT JOYSTICK.....48.00  
VERSA E-Z PORT.....21.95  
THE MILL-PASCAL Speed.....97.00  
PROMETHEUS VERSACAR.....00  
MICROBUFFER II+ 16K W/ RAPHIC.....299.00  
MICROBUFFER II+ 32K W/ RAPHIC.....299.00  
SUPERFAN II.....62.00  
SUPERFAN II W/ZENEP.....RA 50  
RANA CONTROLLER.....104.00  
RANA DRIVE ELITE I.....335.00  
SNAPSHOT.....119.00  
GRAPPLER+.....145.00

7710A ASYNCHRON. SER. INTERFACE.....149.00  
7712A SYNCHRON. SER. INTERFACE.....159.00  
7742A CALENDAR CLOCK.....99.00  
7728A CENTRONICS INTERFACE.....105.00  
VISTA VISION 80-80 COL CARD.....259.00  
VISTA 8" DISK DRIVE CONTROLLER.....549.00

## MONITORS

USI AMBER 9".....145.00  
USI AMBER 12".....160.00  
NEC 12" GREEN MONIT.....169.00  
NEC 12" COLOR MONIT.....399.00  
BMC GREEN MONITOR.....89.00  
AMDEK COLOR I.....365.00  
AMDEK RGB COLO.....774.00  
AMDEK RGB INTF.....169.00  
TAXAN RGB.....359.00  
TAXAN 12".....125.00

## MOUNTAIN HARDWARE

CPS MULTIFUNCTION BOARD.....154.00  
ROMPLUS W/ KEYBOARD FILT I.....165.00  
ROMPLUS W/O KEYBOARD FILT I.....125.00  
KEYBOARD.....49.00  
COPYROM.....49.00  
MUSIC SYSTEM.....369.00  
ROMWRITER.....149.00  
EXPANSION CHASSIS.....580.00  
RAMPLUS 32K.....160.00

## S-100 HARDWARE

### CALIFORNIA COMPUTER SYSTEMS

2200A MAINFRAMF.....459.00  
2065C 64K D.....539.00  
2422 DISK C.....359.00  
2710 4 SERIAL I.....279.00  
2719 2 SERIAL / I.....289.00  
2720 4 PARALLEL.....219.00  
2810 Z-80 CPU.....259.00

## MODEMS

NOVATION J-CAT.....125.00  
NOVATION SMARTCAT.....499.00  
NOVATION SMARTCAT.....209.00  
NOVATION D-CAT (1200 Baud).....619.00  
NOVATION APPLE-CAT (300 Baud).....310.00  
NOVATION APPLE-CAT (1200 Baud).....605.00  
UOS 212 LP (1200 Baud).....429.00  
UOS 103 JIP AUTO ANS.....209.00  
HAYES MICROMODEM II.....289.00  
MICROMODEM W/ TERMINAL PKG.....309.00  
HAYES 100 MODEM (S-100).....325.00  
HAYES SMART MODEM (300 Baud).....227.00  
HAYES SMART MODEM (1200 Baud).....540.00  
HAYES CHRONOGRAPH.....199.00  
SIGNALMAN MODEM W/RS-232C.....85.00

## TERMINALS

HAZELTINE ESPRIT I.....510.00  
VISUAL-50 GREEN.....690.00  
TELEVIDEO 910.....630.00

## TRS-80 MOD I HARDWARE

PERCOM DATA SEPARATOR.....27.00  
PERCOM DOUBLER II W/ DOS 3.4.....150.00  
4 DRIVE CONTROLLER P/S.....259.00

TANODN 40 TRK DISK DRIVE  
LNW 5/8 DOUBLER W/OOSPL  
LNW EXPANSION INTERFACE

## IBM HARDWARE

SEATTLE 64K RAM +.....  
QUADBOARD 64K.....  
64K MEMORY UPGRADE.....  
APPARAT COMBO BOARD.....  
AST.....  
MICROSOFT 64K.....278.00  
T/G JOYSTICK.....47.90  
T/G TRACKBALL.....47.90  
HERCULES GRAPHICS CARD.....546.00  
TECHMAR 5 MB HARD DRIVE.....294.00  
CORONA 5 MB WINCHESTER.....  
KRAFT JOYSTICK.....  
Oavng Systems, Inc. Call for

## ALPHA BYTE IBM MEMORY EXPANSION BOARDS

256K W/RS-232C.....349.00  
256K W/RS-232C & SUPERCAL.....529.00  
512K W/RS-232C.....579.00  
512K W/RS-232C & SUPERC.....749.00

## IBM DISK DRIVES

Alpha Byte's add-on drive kits for the IBM-PC -  
each kit includes installation instructions.  
Tandon TM100-1 Single head 40 trk.....195.00  
Tandon TM100-2 Double head 40 trk.....  
Tandon TM55-2 1/2 Height.....

## ISOLATION

ISO-1 3-SOCKET.....  
ISO-2 6-SOCKET.....

## BARE DR

### TANDON 5 1/4

100-1 SINGLE HEA  
100-2 DUAL HEAD  
100-3 SINGLE HEAD  
100-4 DUAL HEAD

### TANDON 8 1/4

848-1 SINGLE SIDE  
848-2 DUAL SIDE.....

## MICRO PI

### APPLE CP/M

WORDSTAR\*1  
SUPERSTOR\*1  
MAILMERGE\*1  
DATASTAR\*1  
SPELLSTAR\*1  
CALCSTAR\*1.....

## MICROS

### APPLE

FORTRAN\*.....  
BASIC COMPIL  
COBOL\*.....550.00

### Z-80 SOFTCARD.....

RAMCARD.....  
TYPING TUTOR II.....  
OLYMPIC DECATHLON.....  
TASC APPLESOFT COMP  
ALDS  
MULTIPLAN NAT  
PREMIUM PAK.....

\*Requires Z-80 Softcard.

†Reg. trademark of Micro Pro

‡Trademark of Practical Peripherals, Inc.

\*\*Tradema

## IBM SOFTWARE

LOTUS 1.2.3.	397.00
MULTIPLAN	209.00
INFOSTAR	279.00
HOWARD SOFT TAX PREP.	209.00
VOLKSWRITER V 1.2.	145.00
WRITE ON	90.00
EASYWRITER II	247.00
EASY SPELLER	149.00
EASY FILE	285.00
HOME ACCOUNTANT +	105.00
FIRST CLASS MAIL	85.00
SUPERCALC	179.00
WORDSTAR	279.00
MAILMERGE	174.00
DATASTAR	207.00
SPELLSTAR	174.00
SUPERSORT	179.00
d BASE II	429.00
THE WORD PLUS	117.00
T.I.M. III	379.00
JFORMAT	39.00
MOVE IT	109.00
THE TAX MANAGER	188.00
VISICALC / 256K	189.00
VISITREND / VISIPILOT	235.00
VISIDEX	192.00
VISIFILE	249.00
VISISCHEDULE	229.00
VERSA WRITER GRAPHICS TABLETS	270.00
VERSAFORM	312.00
CONCURRENT CP/M® 86	315.00
GRAPHICS HARD COPY SYSTEM	19.50
PFS: FILE	97.50
PFS: GRAPH	97.50
PFS: REPORT	97.50
BENCHMARK	388.70

Call for additional IBM software prices.

## IBM GAME SOFTWARE

ZORK I, II, III	28.00
WIZARDRY	46.76
STARCROSS	28.00
DEADLINE	35.00
GALAXY	19.50
MIDWAY CAMPAIGN	17.00
THE WARP FACTOR	31.16
LOST COLONY	23.36
CONQUEST	23.36
GALACTIC ATTACK	25.00
APPLE PANIC	23.61
TEMPLE OF ASPHALT	34.95
CROSSFIRE	24.95
FROGGER	27.26
M SOFT FLIGHT SIMULATOR	38.95

If you don't see the software you want, call. Our software stock is constantly expanding.

## APPLE SOFTWARE

HOWARD SOFT TAX PREP.	189.00
MAGIC WINDOW II	117.00
MAGIC WINDOW	79.00
MAGIC WORDS	59.00
MAGIC MAILER	59.00
DB MASTER	169.00
DB MASTER UTILITY PACK I OR II	69.00
DATA CAPTURE 4.0/80	59.95
PFS: GRAPH	89.95
PFS: (NEW) PERSONAL FILING SYSTEM	85.00
PFS: REPORT	79.00
Z-TERM*	89.95
Z-TERM PRO*	129.95
ASCII EXPRESS PRO	98.00
EASY WRITER-PRO	136.00
EASY MAILER-PRO	117.00
BEAGLE BROTHERS UTILITY CITY	23.00
APPLE MECHANIC	23.00
TIP DESK #1	15.95
BEAGLE BAG	23.00
SUPER TEXT 40/56/77	97.50
LISA 2.5	59.95
TRANSCEND II	115.00
SCREENWRITER II	99.00
DICTIONARY	79.00
GENERAL MANAGER	179.00

## CONTINENTAL SOFTWARE

G/L	165.00
A/R	165.00
A/P	165.00
PAYROLL	165.00
PROPERTY MGMT	325.00

THE HOME ACCOUNTANT	59.95
F.C.M. w/term letter	75.00
TAX ADVANTAGE	45.00

## VISICORP

DESKTOP PLAN II	189.00
VISIPILOT	158.00
VISITREND/VISIPILOT	229.00
VISIDEX	163.00
VISITERM	79.00
VISICALC	189.00

## 1983 Word Processor Special

FRANKLIN ACE 1000	1395.00
FRANKLIN ACE SYSTEM DISK DRIVE W/ CONT.	539.00
ACE WRITER WORD PROCESSOR	129.00

EPSON MX-80	645.00
B.M.C. GREEN	129.00
SCOTCH 3M DISKETTES	44.00
APPLE TO EPSON INTERFACE & CABLE	129.00

Now \$1983

\* \* FRANKLIN 1200.....CALL \* \*

This system may be modified to your needs. Call for special price quote.

VISIFILES	189.00
VISISCHEDULE	229.00

## CP/M® SOFTWARE

We carry CP/M® software in all popular disk formats — Northstar, Televideo, and Heath/Zenith formatted programs in stock! Call for availability and price. Most software also available on IBM.

THE WORD PLUS	117.00
d BASE II	429.00
QUICKCODE	230.00
DUTIL	91.00
SUPERCALC	189.00
SPELLGUARD	230.00
P & T CP/M® MOD 2 & 16 TRS-80	175.00
PASCAL Z	349.00
PASCAL/M Z-80 OR 8080	295.00

## DIGITAL RESEARCH

MAC	82.00
ZSIO	92.00
PASCAL MT+ W/ SSP	429.00
PL/ 1-80	439.00
C BASIC 2	109.00

## SUPERSOFT

DIAGNOSTIC II	89.00
'C' COMPILER	179.00
RATFOR	89.00
FORTRAN	239.00
DISK DOCTOR	78.00

## MICROPRO

WORDSTAR	279.00
SUPERSORT	179.00
MAILMERGE	174.00
DATASTAR	207.00
SPELLSTAR	174.00
CALCSTAR	109.00

## MICROSOFT

MULTIPLAN	209.00
BASIC 80	249.00
BASIC COMPILER	299.00
FORTRAN 80	359.00
COBOL 80	585.00
MACRO 80	156.00
mu MATH/mu SIMP	200.00
mu LISP/mu STAR	165.00

## TRS-80 GAMES

Specify MOD I or III	
DEADLINE	38.00
STARCROSS	31.16
FROGGER	16.45
FLITE SIMULATOR	28.31

Call for more TRS-80 games.

## TRS-80 SOFTWARE

NEWDOS/80 2.0 MOD I,III	139.00
LAZY WRITER MOD I,II	165.00
PROSOFT NEWSRIPT MOD I,III w/labels	109.00
SPECIAL DELIVERY MOD I,III	119.00
X-TRA SPECIAL DELIVERY MOD I,III	199.00
TRACKSEC MOD I	24.95
OMNITERM SMART TERM MOD I,II	89.95
MICROSOFT BASIC COMP FOR MOD I	165.00
LDOS 5.1 MOD I,III	119.00

WIZARDRY	37.95
NIGHT OF DIAMONDS	27.26
STARBLAZER	24.95
CRISIS MOUNTAIN	26.32
EVOLUTION	33.80

## SIRIUS SOFTWARE

SPACE EGGS	23.36
GORGON	27.26
SNEAKERS	23.36
PHANTOMS FIVE	22.00
BANDITS	25.00

## EDU-WARE

PERCEPTION PKG	19.95
COMPU-MATH: ARITHMETIC	39.95
COMPU-SPELL (RED DATA DISK)	24.95
COMPU-SPELL DATA DISKS 4-8, ea.	17.95
RENDEZVOUS	28.50

## ON-LINE SYSTEMS

ULTIMA II	42.00
MISSILE DEFENSE	27.26
LUNAR LEEPER	23.36
TIME ZONE	77.96
CRANSTON MANOR	25.95
CANNON BALL BLITZ	25.95

## MUSE SOFTWARE

ROBOT WARS	32.95
THREE MILE ISLAND	31.61
A.B.M.	19.46

To order or for information call

In Chicago:

(312) 454-1236

In New York:

(212) 509-1923

In Los Angeles:

(213) 706-0333\*

In Dallas:

(214) 744-4251

By Modem:

(213) 991-1604

CALL OUR MODEM LINE FOR WEEKLY SPECIALS.

# Alpha Byte COMPUTER PRODUCTS

31245 LA BAYA DRIVE  
WESTLAKE VILLAGE, CA 91362

\* For all your computer product needs, come visit us at our new California store.

Satisfaction Assurance — Your satisfaction is assured by our 30 day moneyback guarantee on all hardware products we sell. No refunds after 30 days. All manufacturers' warranties are honored by manufacturers. Defective software will be replaced free during the first 30 days, however, no refunds or exchanges on software. Proof of purchase required. All returns must be authorized in advance. How To Order — All orders must be paid prior to shipment. Order by phone or by mail. Use Visa, M/C, check or COD. COD limit \$300. Shipping charges: Visa, M/C orders = actual shipping costs. Prepaid orders add \$3 (under 25lbs.) or \$6 (over 25lbs.) COD's use prepaid rates and add \$4 surcharge. Foreign, FPO and APO orders add 15% of order total. Calif. orders add 6% sales tax, L.A. County add 6 1/2% sales tax. Prices quoted are subject to product availability and may change without notice.

# 16-BIT



The state of the art in microprocessor technology has advanced a great deal in just one year. New applications programs and systems software designed specifically for 16-bit microcomputers make this new group of machines perform in a way that's all but impossible for 8-bit micros. Last year the theoretical advantages of 16-bit microprocessors were clear but using revamped 8-bit software made their performance disappointing. The 16-bit world is just opening up.

In this issue we look at several new 16-bit micros, both portable and desktop models; a popular 16-bit operating system; a new 16-bit language; and a 16-bit operating environment for applications programs.

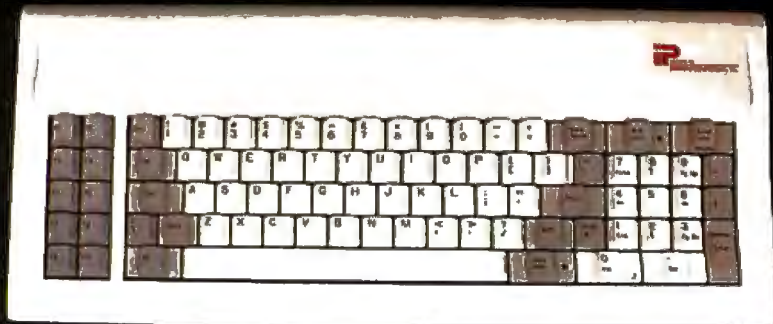
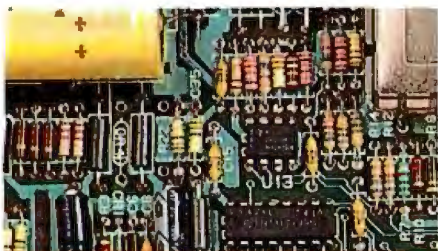
I'll begin with the Sunrise. This new machine has three microprocessors, with an 8088 as its main processor. It's an office computer that is portable in two different senses: the entire computer will fit in an attache case, but the keyboard is also a separable, very light, battery-powered computer with its own 8-bit processor and liquid-

crystal display.

A good-looking machine, the Gavilan portable combines the computing power of an Intel 8088 microprocessor with a software architecture that an 8-bit processor could not support. The hardware is at least a year ahead of its time. Gavilan designers have packaged 336K bytes of RAM, a bit-mapped 8 by 66 liquid-crystal display, and 320K bytes of disk storage in a machine less than a foot square and only 2.7 inches thick.

The DEC Professional 350 is a single-chip microcomputer version of a 16-bit Digital Equipment Corp. minicomputer—an arrangement that brings minicomputer software and processing power into the microcomputer world. With the telephone management option, this computer offers advanced voice and data features.

The Hewlett-Packard Series 200 Model 16 uses HP's own 16-bit BASIC and reveals the great computational power of its microprocessor unhampered by an 8-bit language. The Series 200 Model 16 also represents a milestone in concentrated



# DESIGNS

computing power. In a remarkably small box (233 square inches), the computer holds up to three quarters of a megabyte of RAM, which gives the 68000 processor plenty of room in which to work.

The 16-bit Texas Instruments 99/2 costs less than \$100, and at that price is the world's best bargain in computing power. It is an excellent home computer for students who use the TI 99/4A in school. Software for the 99/2 will also run on the older 99/4A.

The Altos 586 uses a 10-MHz 8086 as its central processor and Intel's companion 16-bit input/output processor, the 8089, as an intelligent disk controller. A Z80 manages the system's serial ports. Together, the three processors create a high-performance six-to-ten-user system in a compact desktop unit.

The Fujitsu Micro16s has five microprocessors in its standard configuration, with an 8086 as the main processor and a Motorola 6809 managing the display. Fujitsu also offers optional 68000 and Z8000 processor boards, giving

buyers a choice of today's three most popular 16-bit microprocessors. Fujitsu is the first company to install Concurrent CP/M on its own microcomputer, providing a degree of multitasking impossible in an 8-bit processor.

The Pronto Series 16 uses the Intel 80186 and an unusual physical architecture to minimize the desk space that it occupies. The 80186, which incorporates the functions of 20 to 30 chips in addition to the processor itself, can be used to create a very compact yet powerful machine.

The Docutel/Olivetti M20 uses the Zilog Z8001 microprocessor and its own Professional Computer Operating System. The M20's underrated Zilog 16-bit chip provides a unique ability to redefine some internal 16-bit registers as 8-bit, 32-bit, or even 64-bit.

The Sritek processors and memory boards for the IBM Personal Computer turn that popular machine into a powerful, 8-MHz Xenix system capable of supporting several users. Buyers can choose the Motorola 68000, the National

Semiconductor 16032, or the Intel 8086 or 80286 to be the heart of the PC.

## 16-Bit Software

Gary Kildall and David Thornburg describe DR Logo, Digital Research's 16-bit version of a language already popular in the 8-bit world.

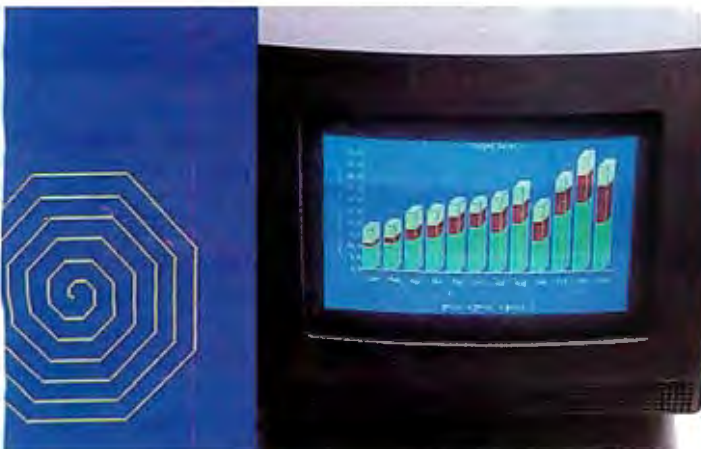
Tim Paterson, who wrote the original version of MS-DOS while at Seattle Computer, explains the workings of this 16-bit operating system in great detail.

In an interview with BYTE, Bill Coleman of Visicorp provides a close look at the Visi On operating environment and the applications programs that will run under it.

## A Year's Progress

Microcomputer technology is moving ahead fast and furiously. What's next? By June 1984, 256K-bit RAMs will be commonplace, 16-bit software will be in full flower, and even more powerful microprocessors will begin to appear in products.

— Phil Lemmons



# Sunrise Systems

*A Texas computer company produces a system to be custom-tailored by OEMs.*

---

Bruce Roberts  
Technical Editor

---

Down in Texas the good ol' boys make good ol' computers. North of Dallas the Silicon Ranch stretches for miles in Texas's answer to California's Silicon Valley and Massachusetts' Route 128. Striking, futuristic buildings and industrial parks house many high-technology start-ups funded with venture capital as free-flowing as Texas crude oil. One of these companies is Sunrise Systems Inc.

After looking at the numerous existing computer systems, the lack of shelf space and dealers, and the costs of service and support staffs, Sunrise Systems decided to take a different

approach in bringing its computers to market. Sunrise would design and produce computers, but let other companies worry about selling and servicing them. As an original equipment manufacturer (OEM) supplier, Sunrise set out to design a system that could be easily customized to the particular needs of an individual vendor. The "Swiss Army" business computer that resulted has a little something for everyone but manages versatility in a practical, commonsense way. The most distinctive characteristic of the C8/16 system is the wealth of applications programs included with it.

When you turn on the system, your

program choices are shown immediately on the screen: an appointment calendar, a four-function calculator, a speaker telephone and auto dialer, a tape recorder for dictation, a teletype terminal, a typewriter/electronic note taker, Microsoft BASIC, and more. It sounds like a general-purpose business machine and it is.

The C8/16 system from Sunrise Systems (see photo 1) consists of a portable computer with a 40-character by 6-line or 80-character by 3-line liquid-crystal display (LCD) that can be connected to a main system unit complete with disk drives and both 8- and 16-bit microprocessors. The portable portion, called the KP-C8 keyboard processor, has an 8-bit CMOS (complementary metal-oxide semiconductor) NSC800A microprocessor and can be battery powered. The microprocessor is National Semiconductor's low-power version of the Zilog Z80 that can run all the popular CP/M software. This unit is loaded with features, including a microcassette drive for voice and digital storage, an integral high-speed modem, a real-time clock, serial and parallel input/output (I/O), television and color-monitor outputs, telephone and data links, 64K bytes of dynamic random access read/write memory (RAM), and 16K bytes of CMOS static RAM (expandable to 64K bytes) for battery-powered use. All of the built-in programs just mentioned are stored in the 32K bytes of read-only memory (ROM). The keyboard processor with all these abilities weighs less than 5 pounds.

The main system unit, or FP-8/16



**Photo 1:** The C8/16 computer system from Sunrise Systems. The KP-C8 keyboard processor in the foreground with a 40-character by 6-line LCD is a prototype with six function keys instead of 10. The microcassette tape recorder is on the right side of the unit, above the speaker grill. The ROM pack on the left plugs into the side of the keyboard by the display. The FP-8/16 flat pack in the rear has two half-height 5¼-inch disk drives and a P-4/4 color graphics printer.



flat pack, is designed to stay in the office and has a 16-bit 8088 and an 8-bit Z80A microprocessor. The list of standard features includes 128K bytes of RAM (expandable to 512K bytes), two 5¼-inch disk drives that store 160K or 320K bytes in an IBM PC-compatible format, a 300- to 1200-bit-per-second (bps) modem, serial and parallel ports, RGB (red-green-blue) color-monitor output, an external disk-drive connector, and telephone and data input/output. This unit is the heavy portion, and it weighs a manageable 15 pounds.

### Marketing the Sunrise System

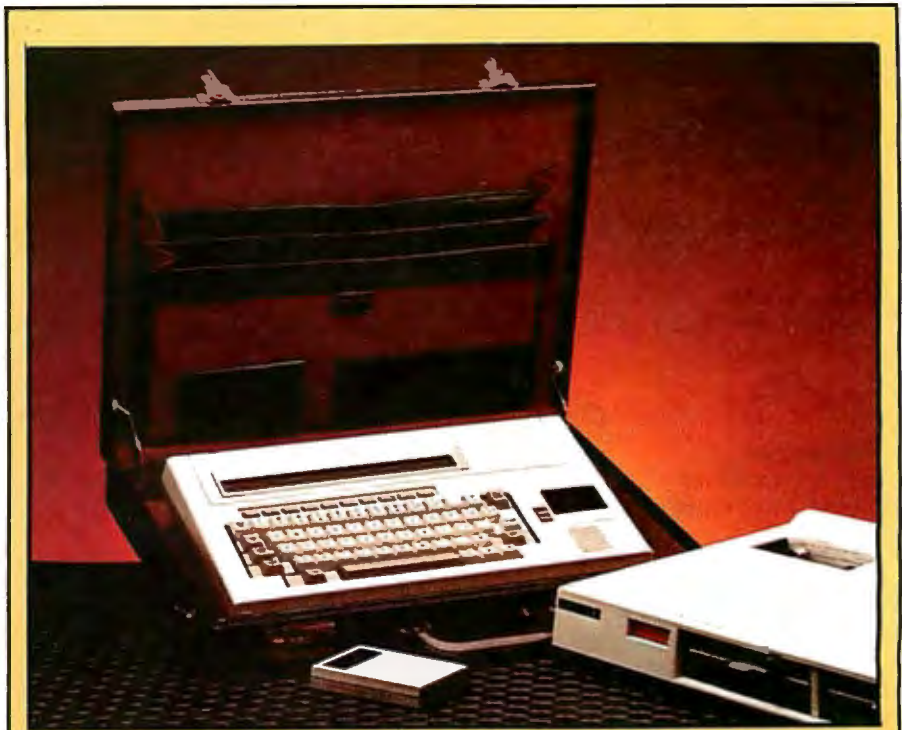
Sunrise is orienting this system toward professionals and managers with limited computer experience. The designers think the middle managers of business have been ignored by the computer industry or presented with computers that are not very easy to use. Sunrise is aiming for the over-35, first-time computer user, with sales representatives, managers, and business professionals at the center of the marketing efforts.

The main criteria for business computers as Sunrise sees it are reliability, service availability, general-purpose multiple functions, simplicity, price, and portability, in about that order.

The concept of an office in a briefcase should appeal to many business people on the go. The lightness of the keyboard processor will also be appreciated. The C8/16's improved communications give rise to an extended office; salespeople can call in orders from the field and receive price updates in return, or people can take the portable unit home and access information back at the office in the flat pack unit.

### The Keyboard Processor Software

The terminology and focus for this computer system are different from those of most existing microcomputers. With this system, you push buttons; you don't type keystrokes. The advanced programs in cartridge



**Photo 2:** The Xerox 1800 portable computer is a custom version of the C8/16 computer system from Sunrise Systems. Note that the Xerox model uses the 80-character by 3-line LCD. The briefcase is optional.

### The Xerox 1800 Portable Computer

*From the folks who brought you the Memorywriter, Xerox's answer to the IBM Selectric typewriter, we now have the Xerox 1800 portable computer. All five of the founders of Sunrise Systems worked at Xerox previously, so it should not be a surprise that Xerox will be among the first customers relabeling and marketing the Sunrise system. In fact, Xerox gave rise to Sunrise Systems by looking for an outside supplier to redefine initial Xerox designs and produce an integrated, portable business computer. Thus, Sunrise Systems was formed in June 1982 and in October began producing the first prototypes of the computer.*

Xerox handles all marketing, service, and support for its version of the Sunrise. Sunrise designs and manufactures the units for Xerox to its specifications.

The Xerox 1800 portable computer uses the 80-character by 3-line liquid-crystal display (LCD) version of the keyboard processor, and the case design, layout, and colors are unique, but most of the other specifications remain the same. Xerox is offering its own cathode-ray tube (CRT) terminal as an option.

The estimated prices are \$2000 for the keyboard processor and \$4000 for the keyboard, printer, and the flat pack together.

form aren't called software; they are applications packs, similar to video game cartridges.

For example, to simplify the system, Sunrise uses the built-in microcassette drive, a tutorial ROM pack, and the LCD display to introduce the computer to the first-time user. A tutorial audio cassette gives a brief overview of the computer and walks you through all the different programs and functions. The user's

manual has been kept concise and very short, 30 pages. Realizing that most people don't read manuals but just start using the machine, Sunrise made the manual short and simple with a style similar to the two-level approach of the menus on the screen. After being selected from the menu of programs, each program presents a menu of its options. The nesting of the programs doesn't get any more complicated than that on the screen.

## At a Glance

### Name

C8/16 Computer System

### Manufacturer

Sunrise Systems Inc.  
2209 Midway Rd.  
Carrolltown, TX 75006

### Components

#### KP-C8 keyboard processor

Size: 16 inches wide, 9 inches deep, 2 inches high

Weight: 4.5 pounds

Electrical needs: rechargeable nickel cadmium batteries or 110 VAC adapter

Processor: 2.5-MHz National Semiconductor NSC800A (CMOS version of Z80)

Memory: 32K bytes of system ROM, 16K bytes of CMOS RAM, 64K bytes of dynamic RAM, 64K-byte ROM packs with applications, 64K bytes of CMOS RAM optional

Keyboard: standard typewriter-style keyboard with 63 keys, 10 function keys, and 4 cursor-control keys

Display: 40-character by 6-line or 80-character by 3-line liquid-crystal display with graphics capability (240 by 64 or 479 by 24 dot matrix). Television output: 40-character by 24-line text, 256 by 192 pixel bit-mapped graphics with 15 colors; software-labeled function keys

Standard: built-in direct-connect modem, 300 or 1200 bps; real-time clock; microcassette tape recorder, with 512K bytes of digital data or 15 minutes of analog voice; input/output ports: RS-232C serial, Centronics parallel, RGB monitor, television RF modulator, telephone, data link, and external microphone/speaker; built-in speaker; power-on self-test of components; cartridge slot for ROM packs

Software: calendar, calculator, speakerphone and auto dialer, tape recorder/dictation, teletypewriter terminal, typewriter/note taker, Microsoft BASIC

#### FP-8/16 flat pack

Size: 18 inches wide, 12 inches deep, ¾ inch high

Weight: 15 pounds

Electrical needs: 110 VAC

Processors: 4.77-MHz Intel 8088 and 3.58-MHz Zilog Z80

Memory: 128K bytes of dynamic RAM, expandable to 512K bytes

Disk drives: two 5¼-inch floppy-disk drives, 160K or 320K bytes each

Display: RGB or 8/W monitor output: 80-character by 25-line or 40-character by 25-line text; 160-by-200-pixel 16-color, 320-by-200-pixel 4-color, or 640-by-200-pixel B/W bit-mapped graphics.

Standard: built-in direct-connect modem, 300 or 1200 bps; real-time clock; input/output ports: RS-232C serial, Centronics parallel, RGB or 8/W monitor, telephone, data link, power, internal printer port, and memory expansion

Software: CP/M-80, CP/M-86, and MS-DOS operating systems

#### EB-SS expansion box

Size: 18 inches wide, 12 inches deep, ¾ inch high

Electrical needs: 110 VAC

Disk drives: two 5¼-inch single-sided floppy-disk drives, 160K bytes each

Standard: disk-drive controller; data-link input/output port

Software: CP/M-80 operating system

#### P-4/4 color graphics printer

Size: 4½ inches wide, fits into flat pack unit

Standard: 4-color text and graphics printer, roll paper; installs in the flat pack unit or the expansion box

### Typical System Price

Approximately \$2000 for the keyboard processor, and \$4000 for the complete C8/16 system with keyboard processor, flat pack, and color graphics printer.

Software ergonomics guided the layout of the 10 function keys for the applications built into the system ROM. Certain functions are assigned to a key and remain consistent throughout the different programs. One example is the quit function (software-labeled EXIT) on the rightmost function key.

The software labels for the function keys appear across the bottom of the screen, showing what each key does when pressed. Initially, the labels provide a main menu of what applications are available on the computer. When you choose an application, the labels across the screen change to reflect the new meaning of the function keys under that program. The menus are never nested more than two deep.

The basic functions in the Sunrise keyboard-processor firmware are calendar, calculator, loading other software from a ROM pack or disk, speakerphone and auto dialer, tape recorder, teletypewriter terminal, typewriter/note taker, Microsoft BASIC, time and date, and setup. All functions work in the battery-powered (portable) mode except for the typewriter (print mode), terminal, and telephone, which require full power for operating I/O devices.

The calendar holds as many as 250 entries (limited to 10K bytes of CMOS memory), more than enough for a week's appointments. Each 40-character entry is automatically stored in CMOS memory. Entries can be added, changed, or deleted, with three entries visible on the LCD screen and more on an external monitor. Alarms may be set for each event that will sound if the system is on.

The four-function calculator is simple and straightforward, with a memory and the ability to use variables. The basic math functions and three memories are provided. If a printer is attached to the system, the results may be printed as well as displayed on the LCD screen.

A ROM pack function allows other software to be loaded and run from ROM packs that plug into the keyboard unit. Similarly, a link function allows software to be loaded and

*Text continued on page 60:*



## QUADCHROME™ BY QUADRAM™ DOESN'T DRAW THE LINE AT COLOR GRAPHICS

If you have an IBM PC you don't have to sacrifice color graphics for high quality resolution. Because now there's Quadchrome by Quadram. A monitor that displays graphs and charts plus accounting and word processing projects with flying colors.



Quadram is an RGB high resolution color monitor that delivers an 80 character, 25 line text display. And 690(H) dots × 480(V) lines resolution. Not to mention, 16 brilliant colors.

With a monitor that gives you such an excellent screen image and a rainbow of colors to choose from, all your applications will be picture perfect.

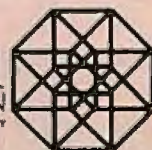
You'll find this .31 mm dot pitch CRT is both FCC and UL approved. And backed by a tradition of Quadram Quality.

Get the color monitor that really gets down to business. Quadchrome by Quadram. It's the only monitor your IBM PC will ever need.



**Quadchrome,  
All The Monitor  
You'll Ever Need.**

**QUADRAM**  
CORPORATION  
An Intelligent Systems Company

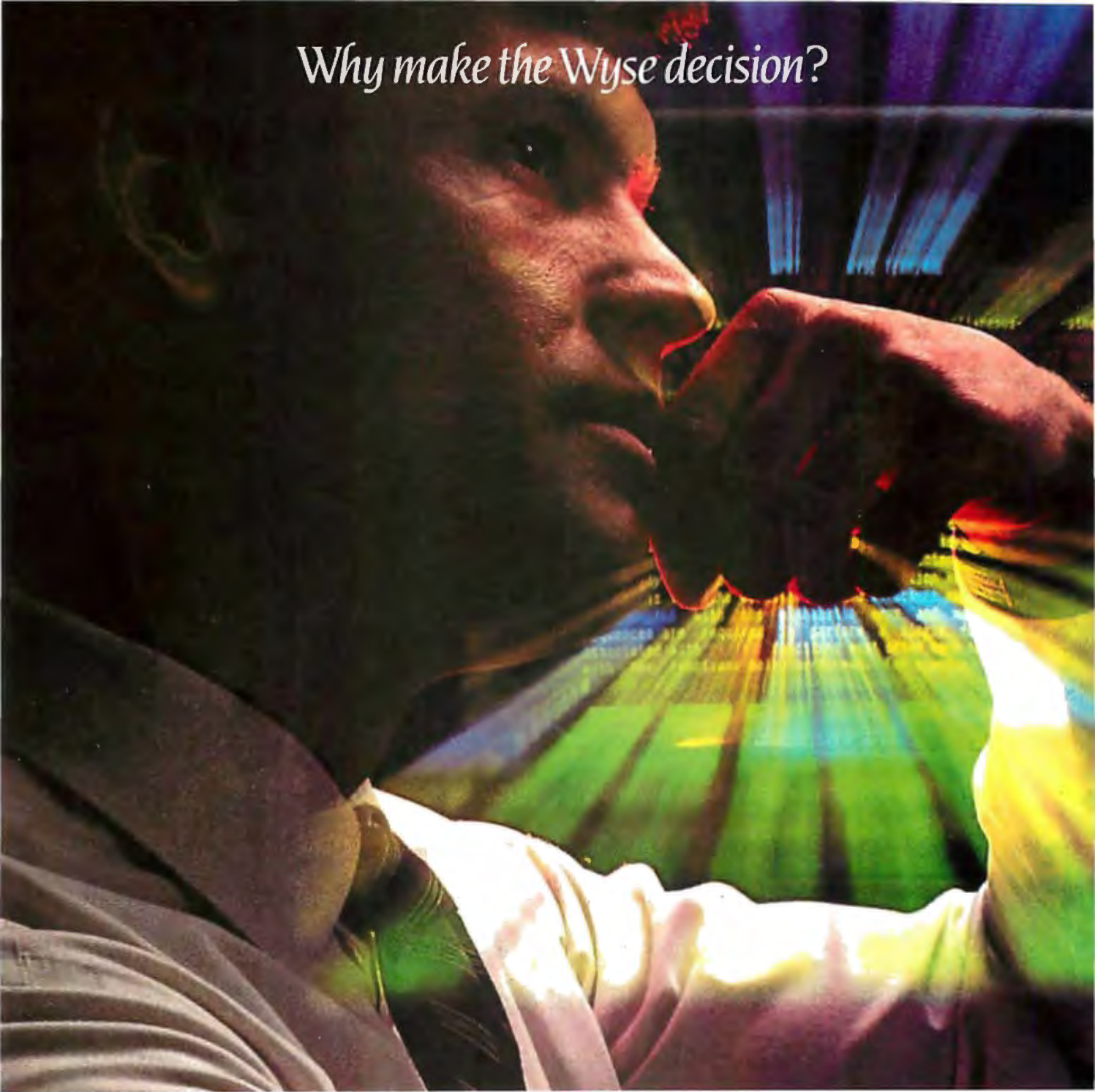


Circle 321 on Inquiry card.

4357 Park Drive / Norcross, Ga. 30093 / (404) 923-6666  
TWX 810-766-4915 (QUADRAM NCRS)

Split screen demo is for ad purposes only.


*Why make the Wyse decision?*



*IF COLOR IS A LUXURY YOU  
THINK YOU CAN'T AFFORD,  
THINK ABOUT OUR WY300-  
the smart color terminal as low as \$975.\**

*The WY300's high-resolution 8-color  
display adds vivid relief to any text  
editing or data entry task, without  
adding significantly to the price you'd  
pay for monochrome.*

*\*Quantity 100*



*Our new WY300 color terminal gives you great color  
for less than \$1000.*

*Ergonomically designed with a swivel and tilt CRT and a detachable keyboard, the compact WY300 fits into the workplace as comfortably as it does into your budget.*

*On top of that, the WY300 gives you a host of features like a soft downloadable character generator; extensive alphanumeric and line drawing symbols; and*

*compatibility with most standard, monochrome oriented, off-the-shelf software.*

*Best of all, the WY300 is plug compatible with our monochromatic WY100's and most ASCII terminals. So, using color is as easy as it is inexpensive.*

*Need more information? Call or write us today. We'd like to convince you our smart color terminal is your wisest buy.*

**WYSE**

Circle 424 on inquiry card.

WYSE TECHNOLOGY, 3040 N. First St., San Jose  
CA 95134. 408/946-3075. TLX 910-338-2251.  
in the east, call 516/293-5563, call toll free,  
800/538-8157, e. t. 932, in CA, 800/672-3470, ext. 932.

run from a floppy disk when the flat pack unit or expansion box is attached.

The telephone program has options for a speaker telephone (using the keyboard's speaker), an answering machine, an auto dialer that can redial the last number, manual dialing, call answering, hanging up, hold, volume controls, and a directory of phone numbers. The telephone answering machine uses the cassette to answer the phone and play a recording, gives a tone, records a message, and then resets for the next call. The telephone directory can hold 30 entries for your most frequently called numbers. Each number can be dialed with a single key command that is as many as 30 characters long. This will fit an alternate long-distance service number and access code. The telephone dialer can automatically strip off the area code when calling local numbers.

In tape recorder mode, you can use the keyboard processor as a dictation machine with all the functions of a portable audio-cassette recorder. The

function keys provide rewind, find (a tape block name), fast forward, stop (the tape), play, volume up, volume down, record, pause, and exit (to return to the main menu) capabilities.

The terminal program lets you use the keyboard as a dumb terminal to send and receive data over the telephone line. The software permits either automatic or manual dialing of a remote computer as well as determination by you of the settings for duplex modes and parity. The internal modem handles communications at 300 bps (Bell 103 compatible) or at 1200 bps (Bell 202 compatible). When the keyboard is connected to the flat pack, data transfer takes place at the higher rate. The time of connection and length of the call are displayed with the help of the real-time clock.

The typewriter function expects a printer to be attached to the system for printer output after each character is typed, after each carriage return, or upon command. You can specify margin and tab settings. Before the characters are sent out to the printer, the output can be edited. All the nor-

mal typewriter characters are available, but underlining and boldface are not supported.

The note-taking mode uses 10,000 characters of the nonvolatile CMOS memory, which you can save as a file on the cassette before continuing to enter another note. The program prompts you as the memory fills up. Files may be entered, edited, deleted, printed (in the full power mode), saved to the tape, or retrieved from the tape. You provide the file name for the document, and the system keeps track of the time and date it was created, as well as the last date that it was revised.

The setup program lets you change many of the default values for the system. You can suppress the software labels at the bottom of the screen if you want a larger window area, or if you are familiar with the functions and don't need to be reminded.

The cassette drive turned out to be a better storage device than was anticipated. You can store as many as 512K bytes of digital information on

# Continuous CHECKS, Statements, and Invoices for Desk-Top Computers

- Compatible with software from over 300 sources. Or program to NEBS standard forms yourself.
- Also continuous labels, diskettes, other supplies and accessories.
- Continuous Micro-Perf™ Letterheads and matching continuous Envelopes provide a clean, trim look.
- Our policy is to process forms printed with your name **within 6 working days**. Then ship direct to you (we pay shipping charges on prepaid orders).



**FREE** full-color, one-stop catalog

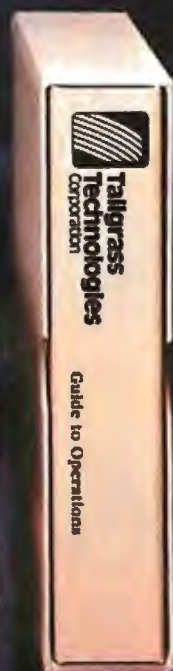
SMALL QUANTITIES • QUALITY PRODUCTS  
LOW PRICES • MONEY-BACK GUARANTEE

fast service by mail or phone

**TOLL FREE 1 + 800-225-9550**  
(Mass. residents 1 + 800-922-8560)

11106

# Innovators in Winchester Subsystems!



## TALLGRASS AND YOUR IBM® PC

Tallgrass Technologies is the industry leader in Winchester HardFile™ and streaming tape subsystems for the IBM® PC and related computers. Fortune 500 corporations, banks, governmental agencies, and small businesses throughout the world depend on Tallgrass HardFile subsystems for their mass storage and backup requirements.

Tallgrass offers formatted capacities from 6.25 Mb to 70 Mb with integral streaming tape back-up. Our proprietary disk/tape controller with integral 10K track buffer optimizes read/write activity and, coupled with our DMA host interface, offers high performance previously unavailable with 5 1/4" disk systems.

## WHAT ABOUT DATA INTEGRITY?

Tallgrass offers backup on ANSI standard 1/4" tape cartridges, instead of the usual floppies, video cassettes, or low-capacity removable Winchester devices. The Tallgrass 12.5 Mb formatted HardFile can back itself up on a \$39.95 data cartridge in less than 10 minutes!

## TALLGRASS IS UNSURPASSED

We've done our homework in engineering and building a reliable HardFile subsystem with remarkable performance and convenient backup for the most stringent on-line mass storage and off-line archival requirements.

From \$2,995 U.S. including integral tape back-up. Available from COMPUTERLAND® and other participating computer dealers.

Exclusive Canadian Distributor  
Micro-Ware™  
440 Phillip St.  
Waterloo, Ontario N2L 5R9  
(519) 884-4690

Exclusive European Distributor  
CPS Computer Group, Ltd.  
Birmingham,  
England B27 6BH  
(021) 7073866



**Tallgrass  
Technologies**  
Corporation

Circle 371 on Inquiry card.

11667 W. 90th, Overland Park, KS 66214, (913) 492-6002  
Telex: 215406 TBYT UR

a microcassette. The cassette can be used to provide backup storage for data and programs on the Sunrise system. When used as a dictation machine, the Sunrise will store 15 minutes of speech on each side of the tape.

The software follows the same "open architecture" concept that the hardware does. The machine can be custom configured by putting together the appropriate existing modules along with specialized accounting, financial, or insurance programs that a customer would like included. Putting the programs into system ROM and setting up the menus and function keys should be fairly easy for Sunrise.

### Software Expandability

More sophisticated programs can be used by plugging in the ROM cartridges (ROM packs) or loading disk-based software from the flat pack or a disk expansion box. The ROM packs contain as many as 64K bytes of memory, leaving room for larger programs like the Suncalc electronic

spreadsheet, expanded calculator and calendar programs, and maybe even games. Games? Why not? Virtually every business computer has some games. The new electronic office worker should be allowed a little levity. All work and no play makes the Sunrise a dull computer.

An integrated office-function pack

## More sophisticated programs are possible by using ROM packs or loading software from the flat pack.

has extended versions of the phone, calendar, and text/note-taker programs. This may be expanded into an integrated word-processor, spreadsheet, database, and graphics program, too, given the current popularity of the 1-2-3 and Context MBA all-in-one programs.

ROM packs can be used to address vertical markets without creating new versions of the machine. A program that helps keep track of field sales by

outside salesmen is near the top of the list for applications to be put into ROM packs.

Sunrise systems plans to produce a graphics pack designed to utilize the keyboard's 80-character by 3-line LCD with its bit-mapped graphics. The keyboard system will support the CP/M graphics system extension (GSX) and its utilities for the 479 by 24 dot display. Most graphics for this display thus far have been limited to games.

The management of files or lists of information with a database manager is another likely candidate for a ROM pack program. This capability would let you organize the type of information and how it is stored in, for example, a mailing list.

An IBM 3270-series terminal emulator is a logical choice for an additional program that will handle communications with corporate mainframes. Many data-processing managers are getting more involved in microcomputer access to company information and insisting on 3270 communications protocols. This op-

# PICK A SYSTEM!



**\$2295.**  
**.5 MB STORAGE**



**◀ COMPLETE ▶**



**\$2795.**  
**1.2 MB STORAGE**

We're offering you our SB-80 system in either 5 1/4" or 8" disk drives, your choice. Either way your system comes with a full size (12" diagonal) non-glare tiltable green screen with 24 lines by 80 character format. Its multi-character set offers blinking cursor, underlining, reverse video, and half and zero intensity. The movable, detachable keyboard has a numeric pad with cursor control and function keys.

- Single Board Technology ■ CP/M® Operating System
- 4 MHz Z80A CPU ■ 64K 200ns Main Memory
- 8-Inch Dual Density Floppy Drives
- 5 1/4-Inch Dual Density Floppy Drives
- 2-Serial Ports ■ 2-Parallel Ports
- 4-Counter/Timers ■ Expandable

For further information about this limited offer call or write:



**Colonial Data**

Nationwide on-site and depot repair service through the professionals at INDESERV.

©CP/M is a registered trademark of Digital Research, Inc.

Colonial Data Services Corp., 105 Sanford Street, Hamden, Conn. 06514 • (203) 288-2524 • Telex: 956014





# The Professional's Editor for Program Development Word Processing Source Code Translations

Widely acclaimed as an editor, VEDIT has evolved to be much more. Only VEDIT offers the combination of a versatile full screen editor integrated with a powerful command language. For the first time you'll be able to perform complex, yet useful, text manipulations that are virtually impossible with other editors or word processors. Plus, its customizability and hardware support ensure that VEDIT will be perfectly matched to your individual needs and to any microcomputer you are ever likely to own.

With two modes of operation, VEDIT never compromises its speed or ease of use for its power and sophistication. As one reviewer (Bradford Thompson, BYTE) wrote: 'If this review gives you an appetite for simplicity while editing, then VEDIT is well worth considering.' Its command language, based on TECO, is virtually a text oriented programming language, allowing command macros to be created, loaded and saved on disk. Yet its simplicity allows even a novice to perform tasks beyond the capabilities of any word processor.

VEDIT cuts programming time in half - with multiple file handling, macro capability and special features for Pascal, PL/1, 'C', Cobol, Assembler and other languages. And it can help with source code translations (example ZILOG to/from INTEL translator macros are included). A complete line of translators will be available by the year's end.

Word processing is a snap with word wrap, paragraph and print functions. Command macros free you from tedious search/replace operations. Hundreds of search/replace on dozens of files can be performed by VEDIT without waiting or intervening.

VEDIT easily configures to your favorite keyboard layout. Use any function or cursor keys you wish. It optimally supports nearly every 8080, Z80 and 8086 computer.

Go ahead and expect a lot from VEDIT. Its performance and our support will satisfy your most exacting needs.

To order, please specify your 8080, Z80 or 8086 microcomputer, operating system and disk format.

## COMPARE VEDIT'S FEATURES

- True Full Screen Editing
- Horizontal scrolling
- Edit files one disk in length
- Automatic Disk Buffering
- Compact (only 16K) and Fast
- Display of line and column #
- Set/Goto text markers
- 'Undo' key to restore line
- Automatic Indent/Undent
- Adjustable Tab positions
- Repeat function key
- Text Move and Copy
- 10 Scratchpad Buffers
- Load/Save buffers on disk
- Powerful command macros
- Directory display
- Edit additional (small) files simultaneously
- Insert another disk file
- Unlimited file handling
- Recovery from 'Full Disk'
- Change disks while editing
- Word wrap, format paragraph
- Simple Printing
- 150 page indexed manual
- Startup command file
- Menu driven installation
- Program CRT function keys
- Support newest CRT terminals
- Support smart CRT functions
- Flexible Memory Mapped support
- Customizable keyboard layout

IBM PC, Displaywriter<sup>®</sup> Zenith Z100 and Z89<sup>®</sup> NEC APC<sup>®</sup> DEC Rainbow and VT180<sup>®</sup> Teletype 802 TRS-80 I, II and 16<sup>®</sup> Xerox 820<sup>®</sup> Apple II Softcard<sup>®</sup> SuperBrain<sup>®</sup> NorthStar MP/M<sup>®</sup> CP/M-86<sup>®</sup> MP/M-86<sup>®</sup> Concurrent CP/M-86<sup>®</sup> Cromix<sup>®</sup> Turbo DOS<sup>®</sup> MSDOS<sup>®</sup> PCDOS

VEDIT - Disk and Manual  
8080, Z80 or IBM PC ..... \$150  
CP/M-86 or MSDOS ..... \$195  
Manual only ..... \$18



CP/M and MP/M are registered trademarks of Digital Research Inc. Apple II is a registered trademark of Apple Computer, Inc. MS-DOS and Softcard are trademarks of Microsoft. TRS-80 is a trademark of Tandy Corporation. IBM is a trademark of International Business Machines.

**CompuView**  
PRODUCTS, INC.

Circle 95 on inquiry card.

1955 Pauline Blvd., Suite 200<sup>®</sup> Ann Arbor, Michigan 48103<sup>®</sup> (313) 996-1299

## ACCOUNTING &amp; TAXES

**"Quick Tax****has the finest software I've ever seen for the Accounting and Tax Professional."**

The programs are so well designed and supported, we had no start-up problems."— Ronald Braun, C.P.A.

If *you're* looking for easy to run professionally designed and supported software for:

- 1040 Indiv. Tax Prep.
- Client Write-Up – G/L
- After the Fact Payroll
- CPA Client Time & Billing
- Amortization & Depreciation Schedules – and more.....

Available Soon:

- 1120 Corporate Return
- Partnership Returns
- Fiduciary Returns

Quick-Tax Software is available for Victor 9000; IBM PC; Xerox 820; Radio Shack II, 16; Vector Graphic; Northstar and other CP/M based computers. See your nearest computer dealer. Or, call or write for more information.

CP/M is a registered trademark of Digital Research Inc.

**Quick Tax**

319 Clawson St. Dept. BM  
S.I., N.Y.C., N.Y. 10306  
(212) 351-6143

Gentlemen: I would like to see your program in action. I presently own:

\_\_\_\_\_ or am thinking of purchasing

\_\_\_\_\_ for my \_\_\_\_\_  
Name of Computer Type of Profession

Send information to:

Name \_\_\_\_\_ Title \_\_\_\_\_

Company \_\_\_\_\_ Phone \_\_\_\_\_

Address \_\_\_\_\_

City \_\_\_\_\_ State \_\_\_\_\_ Zip \_\_\_\_\_

tion would allow the Sunrise to interact directly with the mainframe instead of just uploading and massaging information. This disk-based program would require the use of the flat pack with its disk drives. The 3270 program would turn the keyboard and flat pack units into a 3270 look-alike terminal. The keyboard processor would talk to the flat pack, which would send information on to the mainframe computer.

The flat pack provides the disk drives and microprocessors that enable the C8/16 system to run the CP/M-80, CP/M-86, or MS-DOS operating systems and their numerous business programs. The programs can be used as they are with an 80-character by 25-line external monitor. To fit the smaller LCD-screen formats, however, they will probably need to be modified. A version of BASIC for the 8088 microprocessor is available in a ROM pack.

**The KP-C8 Keyboard Processor**

The KP-C8 keyboard processor has a standard typewriter-style keyboard, as its name implies. Sunrise kept the keyboard simple so that novice computer users would not be intimidated or overwhelmed by an array of keys and functions (like the IBM Personal Computer keyboard). With the exception of the Shift Code, all of the 63 keys automatically repeat after being held down for 1/2 of a second. The 10 function keys are integrated into all the software modules and reduce the number of dedicated function keys. They are not labeled on the keyboard; their functions are controlled by the software and identified by labels that appear on the bottom row of the LCD screen. The cursor (arrow) keys can be used alone or with the Code and Shift keys to move the cursor one character, to the edges of the display, or to the beginning or end of a file, or to scroll the display up and down.

The receptivity of the business market to LCDs seems to be good. Sunrise Systems is currently offering a 40-character by 6-line or an 80-character by 3-line display on the keyboard processors. Sunrise uses

only bit-mapped LCDs (429 by 24 dots on the 80 by 3 display) to get limited LCD graphics capabilities. The labels across the bottom of the screen for the 10 function keys provide one example of this. The brightness and contrast of the liquid-crystal display are adjustable through software as part of the setup program.

The 8-bit NSC800A microprocessor runs at 2.5 MHz in either a batter-powered or full-power mode. This low-power CMOS Z80 work-alike is conservatively rated to run for two hours off the batteries. Ten hours seems to be a more realistic estimate. A low-power indicator warns you if the batteries are low. When you turn the power on, the system performs its own diagnostics and checks out the various components.

The keyboard processor can switch between as many as four 64K-byte banks of memory. The first bank of memory contains the 32K bytes of system, extended system, and identification ROMs and 16K bytes of battery-powered CMOS RAM. Theoretically, you can use a full 64K bytes of CMOS memory instead of just the 16K bytes supplied with the system, but you probably won't need to. The system seems to get along fine with its current setup. The design will accommodate the new 8K by 8 CMOS static RAMs. These RAMs will provide four times the current CMOS memory capacity.

The second bank of memory allows for as many as 64K bytes of expansion memory in each ROM pack. The system switches from internal memory to the external memory in the ROM cartridges as if the memory chips on the printed-circuit board had been replaced by the ROM chips.

The third bank of main system memory uses the 64K bytes of dynamic RAM in the full-power mode. A fourth bank of auxiliary RAM will allow for future system expansion of 64K bytes of CMOS RAM.

The Sunrise system has three methods of getting software into the computer's memory. A program can be part of the 32K bytes of system

# CP/M® gives you a new world of PC power



## ...for a new low price.

Now, for just \$60, you can have the world's most popular operating system for your IBM® PC. Only \$60 for instant access to the largest collection of applications software in existence—literally hundreds of proven, professional software programs for every business and educational need.

### **New highs in productivity.**

New enhanced CP/M-86® comes with print spooling, an exclusive feature that increases the work power of your IBM PC like no other operating system can. With print spooling you can print documents and run applications programs *at the same time*. And, for the ultimate in efficiency, all CP/M-86 programs are upward-compatible to Concurrent CP/M™ the productivity breakthrough that lets your PC run as many as four different programs simultaneously!

### **New high-performance graphics.**

Another unique advantage of enhanced CP/M-86 is GSX™ the new graphics extension that allows CP/M to operate the latest graphics hardware devices.

This lets you choose from a growing array of exciting, sophisticated graphics applications packages which run under the widely-accepted GSX standard.

### **Great high-level languages.**

For programming under CP/M, Digital Research offers the most complete selection of professional-quality languages and utilities for the IBM PC: CBASIC® and CBASIC Compiler™ Pascal/M+™ CIST™ and Level II COBOL™ "C," PL/I, DR Logo™ and more.

### **High time to buy!**

Before now, you'd pay \$250 for CP/M-86 and another \$75 for GSX. That's what makes new enhanced CP/M-86 such a terrific value. At \$60 it puts PC Power within reach of any budget! You'll find this enhanced CP/M-86 value in The CP/M Library™ a selection of the finest in CP/M software for your IBM PC. Look for it today at your IBM PC dealer. Or contact Digital Research Inc., (408) 649-5500, 160 Central Avenue, Pacific Grove, CA 93950.



# DIGITAL RESEARCH™

The best of everything in software.

IBM is a registered trademark of International Business Machines, Corp. CIS and Level II COBOL are trademarks of Micro Focus, Ltd. The logo and tagline, CP/M, CP/M-86, Concurrent CP/M, GSX, CBASIC, CBASIC Compiler, Pascal/M+, DR Logo and The CP/M Library are either trademarks or registered trademarks of Digital Research Inc. © 1983, Digital Research Inc.

ROM inside the keyboard processor, it can be loaded by plugging in a ROM pack, or it can be loaded from an external floppy disk into system memory (RAM). The operating systems, computer languages, and application programs are available in several combinations of these forms.

All of the keyboard features work in the full-power mode of operation. Under battery power only the microprocessor, 16K bytes of CMOS RAM, internal ROM, liquid-crystal display, keyboard, ROM packs, and tape drive features may be used.

If you look at the back of either unit, you will be greeted by connectors of every sort. The I/O ports on the back of the keyboard include data in and out, telephone in and out, RS-232C serial I/O, parallel I/O, television output, external monitor output, and auxiliary speaker/microphone I/O. The data port attaches the keyboard processor to the flat pack or expansion box with a high-speed data-packet link, but it does not use a full synchronous data-link control (SDLC) protocol. The two telephone

jacks enable you to connect a telephone device to the computer along with the keyboard unit.

The keyboard processor can be hooked up to a television via the radio frequency (RF) modulator connector, with 40 characters by 24 lines of text in an alphanumeric mode and 256 by 192 pixels with 15 colors in a bit-mapped graphics mode. These display modes are provided by a Texas Instruments 9918 chip, complete with sprite graphics capabilities that are not yet used by the computer.


The keyboard also has a TI 76489 sound-generator chip that can produce three independent musical voices and one voice of noise. This could give the Sunrise computer musical abilities equal to the best of the low-cost color computers like the Commodore 64. At this time, the company is not actively supporting this feature.

The underside of the keyboard processor presents a graphic description of the system layout and cable interconnections. Once you begin to con-

nect the keyboard processor to other system units, the mobility can be hampered by the cables attached to the back. In your office you will probably want to have the power plugged in, a data link or telephone cable connected to the flat pack unit, and possibly a cable hooked up to a printer. All those cables coming out the back of the keyboard make it more cumbersome to hold in your lap or to move around the room.

### FP-8/16 Flat Pack Features

The flat pack unit is designed to make it easy and comfortable to move up to floppy disk and networking capabilities. The flat pack expands the keyboard processor's capabilities with the floppy disk's faster data storage and retrieval, the downloading of programs and data, a hard copy or disk "message server," IBM PC-compatible disk formats, and dual processors that can run both the CP/M and MS-DOS operating systems with their numerous programs. The flat pack can also function as a computer using the



## GRAPHICS-PLUS

an enhancement

## For Z19 Terminals

from

## Northwest Digital Systems

- Tektronix<sup>2</sup> 4010 Compatible Graphics
- 512 Horiz by 250 Vert Resolution
- 80/132 Col and 24/49 Line Text Displays
- Seven Page Off-Screen Text Memory
- Menu-driven "Plain English" Set-up Mode
- 16 Programmable Keys- 128 Chars Each
- Optional Hardcopy Port
- Simple Field Installation

GRAPHICS-PLUS is a field installable enhancement board for the popular Zenith<sup>1</sup> Z19 video terminal adding many powerful features found only on terminals costing much more. GRAPHICS-PLUS provides Tektronix<sup>2</sup> 4010 compatible vector drawing graphics, VT400<sup>3</sup> compatible 80 and 132 column display formats, off-screen scrolling memory, programmable function keys, "Plain English" menu-driven Set-up mode, and a host of other enhancements. Installation can be accomplished within 15 minutes using only a screwdriver.

1 TM Zenith  
2 TM Tektronix  
3 TM DEC

GP-19 Upgrade for Z19 Terminal	\$ 849
Z19 Terminal With GP-19 Installed	\$ 1495

Northwest Digital Systems  
P.O. Box 15288, Seattle, WA 98115 (206) 362-6937

# Monte Carlo Card

The distinguishable card for the discerning user

The only true FIVE function card  
for the IBM Personal Computer

- 64K to 1 Megabyte of Memory
- ONE IBM Compatible Centronics Parallel Port
- ONE IBM Compatible Asynchronous Communications Port
- Clock/Calendar (Battery Backed) with Alarm Features
- Dual-Port Joystick Interface
- **Future Upgrade Option:**  
Direct Connect Plug-On Modem

Monte Carlo

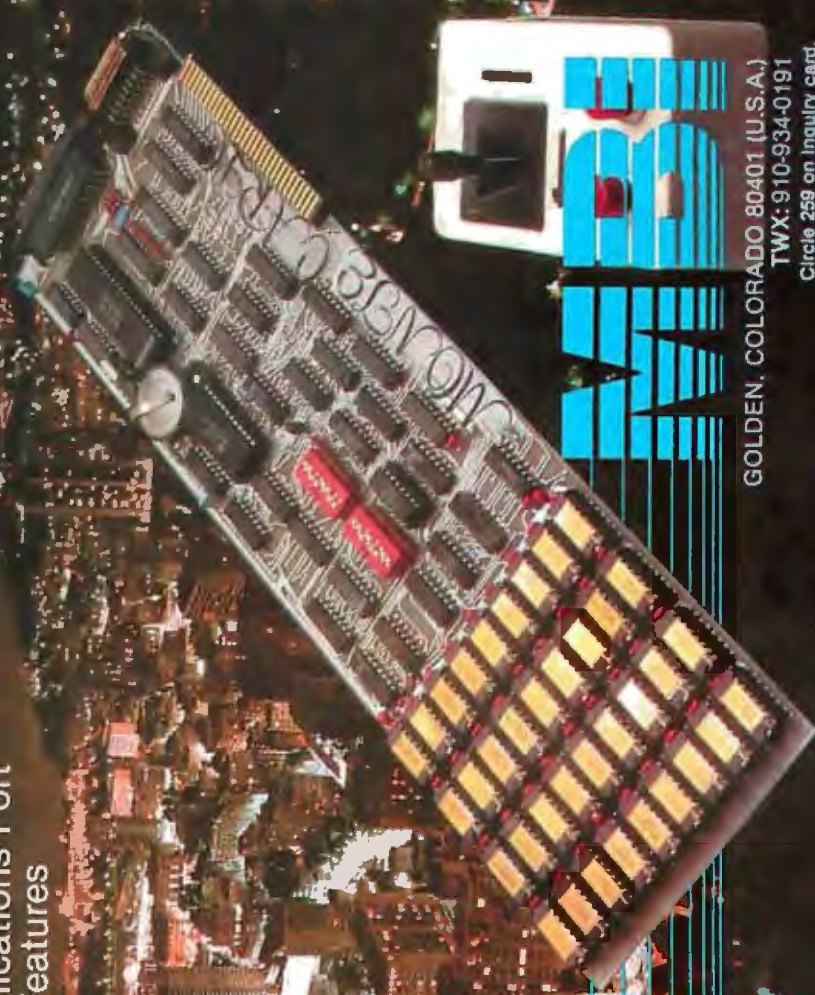
**MICROCOMPUTER  
BUSINESS  
INDUSTRIES  
CORPORATION**

ADMINISTRATIVE OFFICES: 1019 4TH STREET  
TELEPHONE: (303) 279-8438

GOLDEN, COLORADO 80401 (U.S.A.)

TWX: 910-834-0191

Circle 259 on inquiry card.



Hank: Here's the report you've been waiting for. Hope you put your system on automatic and didn't wait up.

To all reps: Price changes on following items effective immediately: No. 10-111A, 10-114A, 10-AL.

Take that, bud. (And retaliate fast. I know phone rates are low now, but game's cutting into sack time.)



# Your computer's telephone. Hayes

Wouldn't it be great if, somehow, you could connect your computer to your accountant's, down the street? To the IBM\*\* PC at the branch office, upstate? Or to your favorite chess challenger, across country?

over ordinary phone lines, all across America.

But any modem will send and receive data.

Smartmodems also dial, answer and disconnect calls. Automatically. Without going through the telephone receiver, making them far superior to acoustic coupler modems.

**Choose your speed; choose your price.** The lower-priced Smartmodem

300 is ideal for local data swaps and communicates at 300 bps.

For longer distance and larger volumes, Smartmodem 1200 communicates at 1200 bps or up to 300 bps, with a built-in selector that automatically detects transmission speeds.

Both work with rotary dials, Touch-Tone\* and key-set systems; connect to most timesharing systems; and feature an audio speaker.

Either Smartmodem is a perfect match for many different computers. And if you have an IBM PC, Hayes also provides the perfect communications software.

**Smartcom II™** We spent a lot of time developing our software, so you can spend less time using it. Smartcom II prompts you in the simple steps required to create, send, receive, display, list, name and re-name files. It even receives data completely unattended—especially helpful when you're sending work from home to office, or vice versa.

And if you need it, there's always "help." One of several special functions assigned to IBM function keys, this feature explains prompts, messages, etc. to make communicating extra easy.

With Smartcom II, it is. The program remembers communication parameters for 26 different remote systems. Just punch a key, you're all set.

You can treat dial-up and log-on sequences the same way. In fact, Smartcom II comes with codes already set up for four popular information services. COMPUSERVE® DIALOG'S KNOWLEDGE INDEX™ DOW JONES NEWS/RETRIEVAL® SERVICE, and THE SOURCE™ AMERICA'S INFORMATION UTILITY.™ Procedures for obtaining an account with each of the services are included in the Smartcom II manual. But that's not all.

**Special offers for Smartcom II**

owners! Dow Jones News/Retrieval Service has a special introductory offer for

Smartcom II owners. By calling a toll-free number, they receive a free password and one free hour of service anytime after 6:01 p.m., local time.

You'll also be entitled to a valuable



With a telecomputing system by Hayes, you can.

Quickly. Easily. And for the price of a phone call.

**Hayes Smartmodem. Think of it as your computer's telephone.** Hayes Smartmodem 300, and the faster Smartmodem 1200, work with any computer with an RS-232 I/O port. They allow you to communicate,

 **Hayes**®

Welcome to TELEMAIL! Your last access was Tuesday, Jan. 4, 1983 11:07 a.m. CHECK these bulletin boards: TELEMAIL...TELESOFT...



subscription offer for THE SOURCE. Smartcom II owners who subscribe to THE SOURCE will receive one free hour of daytime service.

Like all our products, Smartcom II and both Hayes Smartmodems are backed by excellent



documentation and full support from us to your dealer.

So see him today. Break out of isolation. Get a telephone for your desktop computer.

Hayes Microcomputer Products, Inc., 5923 Peachtree Industrial Blvd., Norcross, GA 30092. 404/449-8791.

Smartcom II is a trademark of Hayes Microcomputer Products, Inc.

\*TM American Telephone and Telegraph

\*IBM is a registered trademark of International Business Machines, Corp.

© 1983 Hayes Microcomputer Products, Inc.

Sold only in the U.S.A.

COMPUERVE INFORMATION SERVICE is a registered trademark of CompuServe, Incorporated, an H & R Block Company.

KNOWLEDGE INDEX is a service mark of DIALOG Information Services, Inc.

DOW JONES NEWS/RETRIEVAL is a registered trademark of Dow Jones & Company, Inc.

THE SOURCE and AMERICA'S INFORMATION UTILITY are service marks of Source Telecomputing, a subsidiary of The Reader's Digest Association, Inc.

keyboard processor as a display terminal.

A 16-bit 8088 microprocessor controls the flat pack unit, making larger program workspaces possible because the 8088 can address 1 megabyte of memory. The Z80A microprocessor enables this dual-processor system to run all the CP/M-80 software. Disk-based software on the flat pack can be loaded into the keyboard processor and run, or the keyboard unit can act as a display for the flat pack. ROM packs can also be plugged into the flat pack.

For the flat pack the possible connections include telephone in, telephone out, data in, data out, external monitor output, serial I/O, parallel I/O, external disk, and power. The reset button and power switch are also on the back of the flat pack unit. A real-time clock with battery backup uses an LED display that shows through the little window on the front of the flat pack to indicate the power is on.

The built-in modem can transfer data at 300 bps (Bell 103-compatible) or 1200 bps (Bell 202-compatible) through the telephone connectors. The data connectors are the other half of the high-speed data-packet link to the keyboard processor, which passes blocks (packets) of information back and forth. The video output can display 80 or 40 characters by 25 lines of text; it can display, with bit-mapped graphics, a 160 by 200 dot array in 16 colors, a 320 by 200 dot array in 4 colors, or a 640 by 200 dot array in black and white, all on an external black and white or RGB monitor.

Part of Sunrise's concept of a computer system is that the main processing unit with the disk drives doesn't need to be on someone's desk. The flat pack can easily be on a credenza or table in the office, accessible by a cable or telephone link to the keyboard processor. This approach allows a flat pack unit to be shared between several keyboard processors that call the flat pack up at different times. Two keyboard processors can also be continuously sharing one flat pack in a local area network arrangement. Using a printer, the flat pack

can act as a hard-copy "message server," or by putting data on the disk, it can act as a disk message server. Sunrise is planning on adding an Ethernet interface later.

### Options and Extensions

You can get the keyboard processor without the microcassette tape drive if you like, but it seems to provide several useful features that justify including it in a typical system. The flat pack can be considered an upgrade option too; the alternative is the EB-SS expansion box with just the floppy-disk drives and a disk controller. This would provide a minimal expansion unit for a single keyboard processor.

The P-4/4 color graphics printer fits into the left rear corner of the flat pack and uses an internal printer port. Only 4½ inches wide, it prints text and graphics in four colors on a roll of paper.

A portable letter-quality printer that can handle multiple copies should be available soon. The low-profile printer uses 8½-inch-wide paper, is only 2 inches high by 4 inches deep, and prints as fast as 80 characters per second.

One insurance salesman says he could increase his closings by 100 percent with hard-copy printouts of contracts at the client's office. Real estate agents, insurance salespeople, and auditors could use the printer to leave copies of calculations and agreements with their customers. The ability to make multiply-copy impressions is important because many business forms have multiple layers.

Sunrise is offering an optional briefcase into which the keyboard and flat pack units fit in two compartments. The briefcase splits apart between the compartments to offer a smaller carrying case for just the keyboard processor.

Battery-powered disks are also now possible. It might not be long before the disks and a printer could be put together into a portable unit that fits into a briefcase.

Sunrise is planning to offer 80-character by 6-line displays by the fourth quarter of 1983. You can have a display as large as 80 characters by 8

lines without any change to the architecture of the computer. Laboratories such as Thompson-CFF Corporation have produced 40-character by 24-line displays, but they need to be more reliable. Eighty-character by 24-line LCDs may be economically competitive with other types of displays by the end of 1984.

Sunrise does not currently offer a cathode-ray tube (CRT) terminal with the common 80-character by 24-line format, although representatives did demonstrate one in their office with multicolor high-resolution graphics. Customers can get larger conventional displays now, but Sunrise will not sell the larger LCD screens or plasma displays until they come down in price.

### Summary

Several configurations of the Sunrise computer system are possible due to the dynamic architecture of the C8/16 system. The system has been designed to be as flexible as possible and will accommodate future

developments when advanced chips become inexpensive. The engineers at Sunrise have an ambitious goal of outperforming the product specifications, so many capabilities are understated or conservative. A hard-disk drive interface and bit-mapped color graphics have already been put in the system.

The specifications for the computer are updated every 3 to 4 months. The use of modular blocks of hardware that can be easily modified for customers makes this easy. The keyboard processor, for example, is made of seven blocks that can be powered up or down separately to conserve energy in the battery-powered mode. The software also follows this modular approach, giving customers a choice of which programs or functions are built into the keyboard unit. The system could easily be a dedicated financial or accounting processor.

But Sunrise will be facing stiff competition from lower-cost battery-powered portable computers like the

TRS-80 Model 100 with similar applications. The Epson QX-10 also offers an easy-to-use package of integrated programs, called Valdocs (valuable documents), in a stay-at-home computer. However, the Epson HX-20 portable computer is limited in its business capabilities when compared to the Sunrise keyboard processor.

One way of viewing the Sunrise system is as a vastly improved version of the Sony Typecorder for the same price. All of the components of the Sunrise C8/16 computer system have feature-rich hardware and a flexibility of operation not that common in personal computers. Sunrise Systems has modest plans for its first year; it will be happy selling about 20,000 machines. End users will be getting an excellent deal, a custom computer for less than the price of an IBM Personal Computer. The specifications of the customer come first at Sunrise. Perhaps this is the dawning of a new age of dedicated computers. ■

## Marymac INDUSTRIES, INC.

In Texas Orders  
Questions & Answers  
1-713-392-0747

22511 Katy Freeway  
Katy (Houston) Texas 77450

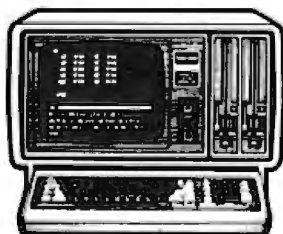
To Order  
1-800-231-3680  
800-231-3681

### SAVE BIG DOLLARS ON ALL TRS-80<sup>®</sup> HARDWARE & SOFTWARE

TRS-80<sup>®</sup> BY RADIO SHACK. Brand new in cartons delivered. Save state sales tax. Texas residents add only 5% sales tax. Open Mon.-Fri. 9-6, Sat. 9-1. We pay freight and insurance. Come by and see us. Call us for a reference in or near your city. Ref: Farmers State Bank, Brookshire, Texas.

#### WE OFFER ON REQUEST

- Federal Express (Overnight Delivery)
- Houston Intercontinental Airport Delivery (Same Day)
- U.P.S. BLUE (Every Day)
- References from people who have bought computers from us probably in your city. We have thousands of satisfied customers. **WE WILL NOT BE UNDERSOLD!**



No Tax on Out of Texas Shipments!

Save  
**10% 15%**  
OR MORE

Telex 77-4132 (Flecks Hou)

#### WE ALWAYS OFFER

- We accept Master Card, VISA, and American Express.
- We use Direct Freight Lines. No long waits.
- We always pay the freight and insurance
- Toll free order number
- Our capability to go to the giant TRS-80<sup>®</sup> Computer warehouse 5 hours away, in Ft. Worth, Texas, to keep *you* in stock.

ED McMANUS



JOE McMANUS



® TRS-80 is a Registered Trademark of Tandy Corp



# ZERO TO MULTIPLAN™ IN 5.2 MINUTES.

## FINANCE OR ACCOUNTING WORKSHEETS FAST.

**SELLING AND ADMINISTRATIVE - BASIC INFORMATION**

Enter company name: MODERN FURNITURE

Enter project number: BUDGET PLANNING

Enter report name: SALES/ADMINISTRATIVE EXPENSES

(Description of budget period) 1983

COMMAND: Example Help Load Next Quit Review Save

Enter responses:  
Press Tab to move to command line. Expert System response

Gentlemen, start your computers.

**Time: 0**

**SELLING AND ADMINISTRATIVE - INTERVAL SELECTION**

Monthly

Quarterly

Semiannually

Other

COMMAND: Example Help Load Next Quit Review Save

Type an "x" through one choice  
Press Tab to move to command line. Expert System response

Select budget intervals.

**Time: 0.5**

**SALES REVENUE**

Enter sales revenue for each quarter

1st Qtr 1983: 2,560,000

2nd Qtr 1983: 3,265,000

3rd Qtr 1983: 3,250,000

4th Qtr 1983: 3,200,000

COMMAND: Example Help Load Next Quit Review Save

Enter responses:  
Press Tab to move to command line. Expert System response

Enter sales revenue.

**Time: 1.0**

**VARIABLE SELLING EXPENSES - EXPENSES REQUIRED**

List desired categories to format or data category under you list  
If supported, separate them by not wanted, delete them or  
replace them with your own preferred categories

Variable Selling Expenses: 1 - Commissions

Variable Selling Expenses: 2 - Other

Variable Selling Expenses: 3 -

Variable Selling Expenses: 4 -

Variable Selling Expenses: 5 -

Variable Selling Expenses: 6 -

Variable Selling Expenses: 7 -

Variable Selling Expenses: 8 -

Variable Selling Expenses: 9 -

Variable Selling Expenses: 10 -

COMMAND: Example Help Load Next Quit Review Save

Select options or type command letter  
Press Tab to move to command line. Expert System response

Enter selling expenses.

**Time: 1.5**

BUDGET PLANNING		SALES/ADMINISTRATIVE EXPENSES	
1983		1st Qtr	2nd Qtr
Name		1983	1983
7	SALES REVENUE	2,560,000	2,650,000
8	VARIABLE SELLING EXPENSES		
9	Commissions	39,600	36,550
10	Other	30,720	31,650
11			
12	TOTAL VARIABLE SELLING	70,320	68,200
13	FIXED SELLING EXPENSES		
14	Salaries	117,140	117,140
15	Advertising	200,000	200,000
16			
17	TOTAL FIXED SELLING	317,140	317,140
18			
19	VARIABLE ADMINISTRATIVE EXPENSES	23,040	23,900
20	Accounting	0	0
21	Other	23,040	23,900
22			
23	TOTAL ADMINISTRATIVE EXPENSES	23,040	23,900
24			
25	TOTAL BUDGET PLANNING		

Your sales budget on the Multiplan electronic worksheet-in record time.

**Time: 5.2**

and build financial or accounting worksheets tailored to your specific needs. In minutes.

You won't have to worry about developing formulas or formatting screens to build your Multiplan worksheets. Because the expert systems literally do it for you.

For example, the Multi-Tool Budget expert system creates seven inter-related

Multiplan worksheets for a total budget planning and control environment.

What's more, each system is developed by experts: business professionals and leading authorities in finance and accounting.

You'll benefit from their knowledge immediately, through the powerful worksheets each Multi-Tool expert system builds for you. And with the

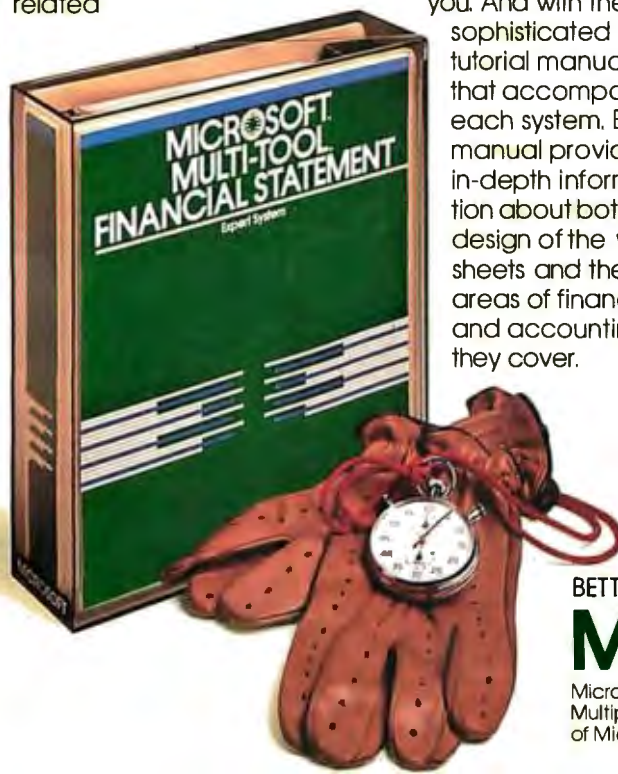
sophisticated tutorial manuals that accompany each system. Each manual provides in-depth information about both the design of the worksheets and the areas of finance and accounting they cover.

The result: a tailored electronic worksheet that helps you make high quality decisions.

That's just what you'd expect from Microsoft. The people who let you concentrate on your business rather than on your computer.

Ask your computer dealer to let you test drive the new Multi-Tool expert systems. Better tools that help you put your business in first place.

**THE MULTI-TOOL EXPERT SYSTEMS. A POWERFUL ADDITION TO THE MULTIPLAN ELECTRONIC WORKSHEET.** Available now: The Multi-Tool Budget expert system. The Multi-Tool Financial Statement expert system.



BETTER TOOLS FOR MICROCOMPUTERS

**MICROSOFT™**

Microsoft is a registered trademark, and Multi-Tool, Multiplan and the Microsoft logo are trademarks of Microsoft Corporation.



# Quark introduces

## **A deceptively simple solution to your word processing dilemma.**

If you're serious about word processing on your Apple\*IIe, you may be bewildered by the sheer number of programs available. And a tad perplexed by their claims and promises. After all, a glamorous package that says "easy to use," may not even be easy to open.

The dilemma is real. And Quark is happy to provide the solution.

### **A proven program for serious word processing.**

Quark's new Word Juggler IIe turns your computer into a dedicated word processor. You get the extraordinary ease of use, sophisticated capabilities and straightforward documentation that make our original Word Juggler a best seller on the Apple III.

For example, there's virtually nothing to memorize. Because principal editing functions are identified on a unique keyboard template

— and nineteen, easy-to-install, replacement keycaps.

Changing keys is quick and simple, too. Just slide our special keycap remover over the key — twist — and pull. Your new keycaps can be in place in less than two minutes.

### **A flexible tool to increase your productivity.**

But don't be deceived by Word Juggler IIe's disarming simplicity. The program packs the powerful features you need to quickly perform the most complex editing tasks.

Characters, words, even entire paragraphs can be deleted with a single keystroke. There are search and replace keys. Block move and copy keys. And you always have instant control over page length, margins and any other formatting parameters.

Document display and print out are easy, also. One keystroke displays your document on the screen. Another prints it. And whether

# Word Juggler™ IIe.

you need to print only specific pages, multiple copies, or even documents too large to fit in memory, Word Juggler IIe can easily accommodate you.

## A clever way to foil Mr. Murphy.

Even the best of us occasionally forgets when “i” does not come before “e” — and even the most agile fingers can press the wrong key. So you should also give serious consideration to Quark’s new Lexicheck™ IIe — a spelling checker with a highly compressed, 50,000 word dictionary.

Accessed from within the word processor, this program lets you virtually eliminate typographical errors and common misspellings. Lexicheck IIe will scan your document at up to 8,000 wpm — then highlight, in context, the first occurrence of any word it does not recognize.

If the word is correct, as in the case of industry jargon or abbreviations, you can simply add it to your personal dictionary. If the word is actually misspelled, you can swiftly correct it.

\*Apple is a registered trademark of Apple Computer, Inc.  
Quark, Word Juggler and Lexicheck are trademarks of Quark, Incorporated, Denver, Colorado.

## A lot more.

These are only some of the ways Word Juggler IIe and Lexicheck IIe can help solve your word processing dilemma. Your Quark dealer has even more details, as well as complete information on our line of office automation tools for the Apple III.

**Ask for a demonstration today.**



**Quark™**  
INCORPORATED  
Office Automation Tools  
2525 West Evans Avenue  
Suite 220  
Denver, CO 80219

Word Juggler IIe \$239. sug. U.S. retail price  
Lexicheck IIe \$129. sug. U.S. retail price

Circle 323 on inquiry card.

# Product Description



## The Gavilan Mobile Computer

---

Phil Lemmons  
West Coast Editor  
BYTE/McGraw-Hill, 4th Floor  
425 Battery St.  
San Francisco, CA 94111

---

The Gavilan portable computer is a traveling professional's dream come true. Lightweight and powerful, this new 16-bit computer promises to redefine industry standards for truly portable micros.

Weighing only 9 pounds and measuring 11.4 by 11.4 by 2.7 inches, the Gavilan, along with its optional 4-pound printer, fits comfortably in a standard-size attache case. Yet this battery-powered machine has up to 208K bytes of RAM, a built-in 320K-byte 3-inch disk drive, an 8-line by 66-character bit-mapped liquid-crystal display that flips up from its resting place on the keyboard, a full-size keyboard with numeric pad, and a touch panel that's used as a pointing device.

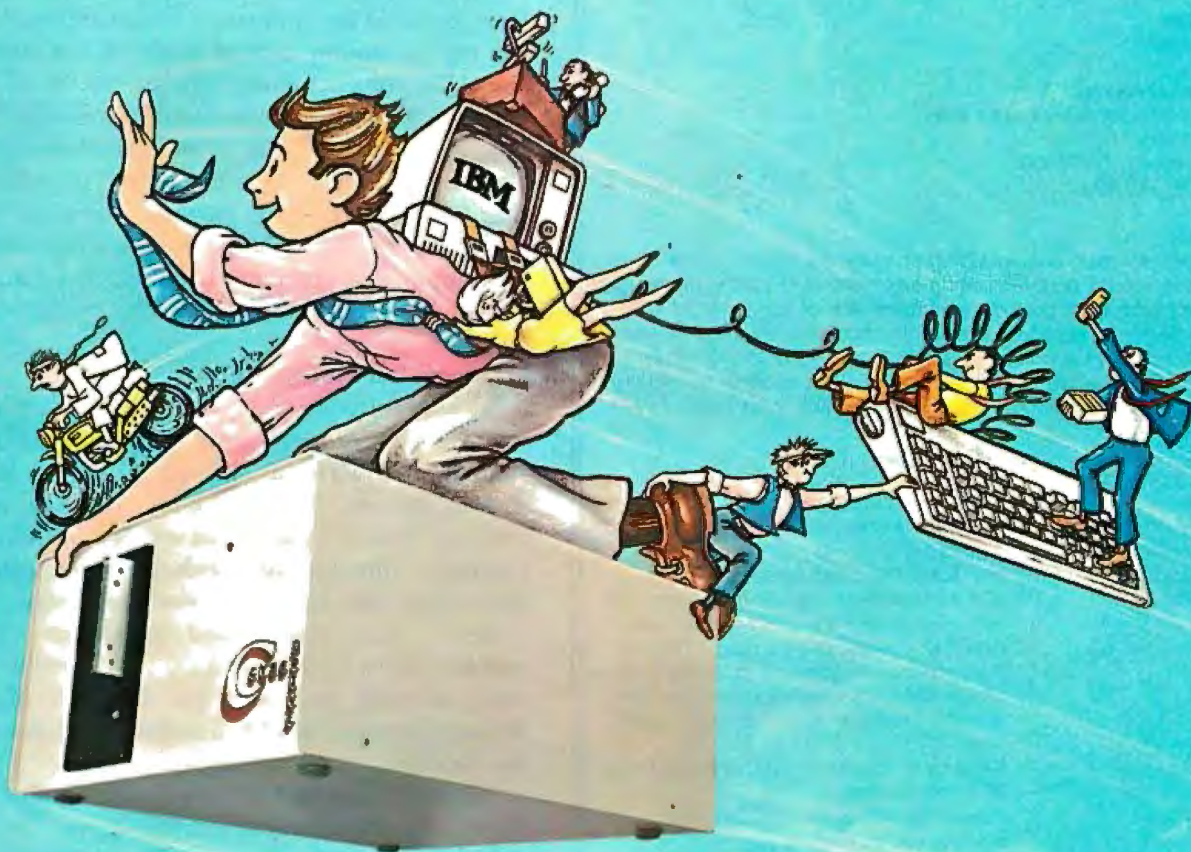
The Gavilan is expected to sell for \$3995 when volume deliveries begin late in the third quarter of this year. For an additional \$1000 you can get the 50-character-per-second dot-matrix printer that clips onto the back of the computer.

The touch panel, a potential rival to the mouse for nonkeyboard input, lets you manipulate integrated applications programs by pointing at objects on the screen, selecting objects to act on, and choosing an action from menus that appear on demand. Much like Lisa's operating system, the Gavilan's uses a desktop manager with pictorial symbols for applications, file "drawers," file "folders" in the drawers, and "documents" in the folders. Symbols indicate which files are open and which programs are available and running at any time. The Gavilan saves the "state of the desktop" in battery-backed RAM when the system is turned off, then restores the desktop when the machine is turned back on.

### A New Standard for Portables

Until now, portable computer users have had to choose between battery-powered machines that are easy to carry but much less useful than desktop computers, and larger machines that are useful but heavy and dependent on

# Performance Breakthrough...



## ... the **CYBERDRIVE™** for the IBM Personal Computer 13.5 or 27 million bytes of disk capacity in a single cabinet with an integrated mini-cartridge tape for secure data backup.

Setting an exciting new microcomputer standard, the **CYBERDRIVE**<sup>1</sup> combines a full package of features.

It offers new, higher performance levels, with an integrated business-oriented backup device.

As the **CYBERDRIVE** is made available for other systems, media transfer is assured regardless of the host hardware or Operating System.

The **CYBERDRIVE** slashes the seek time dramatically—e.g. the usual 5 Megabyte stepper-motor Winchester disk offers average seek time typically in the range of 100 to 200 milliseconds (incl. head settling).

With the **CYBERDRIVE**, the average seek time across more than five times as much data is only 33 milliseconds (incl. head settling).

This basic speed, coupled with disk cache buffering and a peak transfer rate of 1 million bytes per second, make the **CYBERDRIVE** a performance champ!

The integrated mini-cartridge tapes used for backup of data allow dumping of (for example) 10 million bytes of data in about 10 minutes... much faster than other tape or floppy disk backup techniques. Hardware read-after-write error checking is incorporated in the tape device.

... And don't fail to ask about our superb lineup of serious business software (also offered in **CYBERDRIVE** format) including:

**RM/COBOL**<sup>2</sup> compiler—the micro industry standard.

**MBSI**<sup>3</sup> **RM/COBOL** general business applications (derived from **MCBA**<sup>4</sup> minicomputer packages)... thousands in use... money back guarantee... source program license.

**CRT!**<sup>5</sup> from Cybernetics (COBOL Reprogramming Tool!)-Program generator for **RM/COBOL** to ease program development and maintenance... an alternative to a Data Base System.

**CBASIC2**<sup>6</sup> & **CBASIC86**<sup>6</sup> compilers... for aficionados of a useful BASIC.

The software is available on a variety of industry-standard Operating Systems including **CP/M**<sup>7</sup>-**MP/M**<sup>7</sup> (both -80 & -86), **OASIS**<sup>8</sup>, **PCDOS**, and **UNIX**<sup>7</sup>. Inquire for specific details and prices.

Trademarks of:

1 Cybernetics, Inc. 2 Ryan-McFarland Corp. 3 Micro Business Software, Inc.  
4 Mini-Computer Business Applications, Inc. 5 Digital Research, Inc. 6 Phase One Systems, Inc. 7 Bell Laboratories

© Copyright 1982 by Cybernetics Inc. All rights reserved.  
Prices and specifications subject to change without notice.

**CYBERNETICS**  
INC.

8041 NEWMAN AVE., SUITE 208  
HUNTINGTON BEACH, CA 92647  
714/848-1922

## At a Glance

### Name

Gavilan

### Manufacturer

Gavilan Computer Corporation  
240 East Hacienda  
Campbell, CA 95008  
(408) 379-8005

### Price

\$3995 for main unit, including one disk drive, liquid-crystal display, modem, serial port, recharging external power supply, printer port, communications port, disk controller, 48K of ROM, 64K of RAM, connector for second disk drive and additional memory, Gavilan Office Pack (4 applications), MBASIC and MS-DOS 2.0, carrying case. Optional printer approximately \$1000; optional second disk drive, \$695; with additional 64K RAM, \$975; with 128K of RAM, \$1245.

### Components

Size:	width 11.4 inches; depth 11.4 inches; height 2.7 inches
Weight:	9 pounds
Processor:	Intel 8088 16-bit microprocessor
Memory:	80K bytes of RAM, including 48K bytes for operating system and 32K bytes for user data. Up to four 32K-byte plug-in capsules with applications software in battery-backed CMOS RAM. Optional external 128K bytes of RAM. Total maximum memory of 336K bytes
Display:	8-line by 66-character LCD; optional 24 by 80 video monitor
Keyboard:	integral full typewriter keyboard with numeric pad
Nonkeyboard input:	touch panel that allows fingertip to serve as a pointer device and to select various commands built into the panel, such as Help, View, and Select
Storage:	integral 3-inch, 320K-byte floppy disk; a second drive (same size as printer) that connects by cable to the main unit is optional
Expansion:	up to four 32K-byte RAM capsules
Input/output:	300-bps built-in direct-connect modem; telephone jack for modem; interface for optional printer, disk drive, and expansion memory; RS-232C port for transmission up to 9600 bps; jack for video output; jack for external power supply
Power supply:	integral rechargeable nickel-cadmium battery pack containing 10 half-D cell batteries; AC adapter that plugs into standard AC outlet and recharges batteries in approximately one hour if system is not in use

### Software

MS-DOS and MBASIC are standard. Supercalc, Superwriter, PFS File and PFS Report are available for a total price of \$425. The Gavilan Office Pack (4 applications) and operating system will be available by September.

### Optional Printer

4-pound thermal-transfer printer that clips onto back of main computer unit; 11.4 by 4.9 by 3.0 inches. Prints at 50 characters per second and will print up to 6000 characters per charge of battery unit. Other options: 32K-byte RAM capsules; second 320K-byte, 3-inch floppy disk with 128K bytes of RAM in same housing; acoustic modem; 24-line by 80-character video monitor; adapter for power from vehicle cigarette lighter.

plug-in power. Both users and designers of portables have faced trade-offs—to get true portability they've had to sacrifice usefulness. Intended for the traveling professional, the Gavilan combines the best of both worlds.

John Banning, chief of Gavilan's software development team, explains the company's design approach: "The person who is moving around in the field is often a professional but not a computer professional. He or she needs a computer that is easy to learn and easy to use. The traveling professional is likely to be in an environment where there's no support for a computer." Gavilan designers thus concluded that a portable computer must offer more, not less, than a stationary desktop system. "From that point of view," Banning says, "the software really drives what's going on."

## Demands on Hardware

Friendly software requires a lot of memory and a 16-bit microprocessor to manage it. Gavilan chose Intel's 8088, running at 5 MHz, as the central processing unit, for several reasons. First, its 8-bit data bus would save precious board space. According to John Zepecki, Gavilan's director of hardware engineering, fitting everything onto the board was the hardest part of the project. "Also, the second generation of industry-standard software for personal computers of this size is really growing up around the 8086/8088 architecture," explains Banning. MS-DOS software will be available for the Gavilan.

Minimizing the use of power was another challenge. Apart from the central processor and the Western Digital disk-drive controller chip, the Gavilan uses CMOS (complementary metal-oxide semiconductor) technology. Power is turned off frequently to limit the power consumption of the disk controller and the central processor. Whenever the 3-inch Hitachi disk drive is not in use, both the drive and its electronics are turned off. The 8088 shuts down the Western Digital WD 1797 disk controller and saves information about its state. Whenever the operating system has no task scheduled for the central processor, the 8088 is turned off. In that case, the 8088 first saves its own state in battery-backed RAM, then disables the memory-write lines, and finally turns itself off. When power is restored to the 8088, it resets in one of several ways depending on what information was previously saved.

The rest of the machine uses high-speed CMOS logic, has 32K bytes of 8-bit wide CMOS static RAM (random-access read/write memory) and 48K bytes of 8-bit wide CMOS ROM (read-only memory). A single gate array controls either the liquid-crystal display (LCD) or a 24 by 80 video monitor. An 80C51 CMOS UART (universal asynchronous receiver/transmitter) manages the keyboard, the touch pad, and the asynchronous communications port.

Of the 80K bytes of memory contained in the Gavilan main unit, the 32K bytes of RAM are used for data storage and the 48K bytes of ROM for the operating-system and user-interface firmware. Up to four additional

# If you stick with timesharing after reading this ad, you haven't read this ad.

Typically, financial planning on a timesharing service runs \$2,000 a month and more. Month after month after month.

And it doesn't take a spreadsheet to figure that as a \$24,000-a-year-after-year expense.

## The incredibly cheap alternative.

The Financial Planner™ from Ashton-Tate can stop this cash drain once and for all.

You pay \$700 — one time — for the Planner. And handle your financial planning quickly, easily and completely on your microcomputer.

Without having to share your time or your money with anyone.

## A forecaster's dream come true.

The Financial Planner has enough depth to solve the most complex business problems you can foresee, yet can be used almost intuitively.

The Planner automatically performs calculations on individual items, rows, columns and entire models. Understands conditional logic. Solves simultaneous equations. Computes Present Value and Internal Rate of Return. Reads and writes dBASE II™ files. And much, much more.

But you use abbreviated names, not mysterious formulas. And you communicate with the computer in the English-like vocabulary of FPL™ (Financial Planning Language), so you can easily set up your budgeting and evaluation models.

Editing and report-writing are an integral part of the package, and you can preview results on the screen, then produce presentation-quality financial reports directly.

And when you have your models and reports just right, you can automate them so even your President can run them.

With the Planner, you produce P & L forecasts and financial consolidations in minutes. Explore

Circle 30 on inquiry card.



"what if" alternatives. Analyze new business ventures and mergers. Plan real estate acquisition and development. And fine tune operations until you reach the financial objectives you've set.

It's one of the most comprehensive business tools available on any computer. All for a fraction of what you've been spending on timesharing services to do the same things.

## For the ardent skeptics.

It may sound too good to be true, but you can check out the Financial Planner with no financial risk.

Run through a hands-on demo at your nearest computer or software store. Then take a package home and use it for 30 days on your IBM PC or CP/M microcomputer. If it's not everything we said it was, just return it and you'll get your money back.

For the name of your nearest dealer, contact Ashton-Tate at 10150 West Jefferson Boulevard, Culver City, CA 90230. Or better yet, call (213) 204-5570 today.

Time's a-wasting.

**The  
Financial  
Planner™**

ASHTON · TATE 

## Gavilan's History

*Gavilan Computer Corporation of Campbell, California, was founded in February 1982 under the name Cosmos Computer Corporation. The company chose that name because it believed it suggested "OS" for operating system and "CMOS" for the complementary metal-oxide semiconductor technology around which the company wished to build a portable computer with an advanced operating system. But to assure better trademark protection in world markets the company changed its name to Gavilan Computer Corporation in March 1983.*

*Manny Fernandez, Gavilan's president and chief executive officer, is a former president of Zilog Inc. Gavilan is a private corporation and has obtained substantial capital from a group of venture-capital investors that includes New Enterprise Associates, San Francisco; Smith Barney Venture Corporation, New York; Abingworth Ltd., London, England; Associated Venture Investors, Menlo Park, California; Genesis, Los Gatos, California; and Robertson, Colman, Stephens & Woodman, San Francisco.*

*Gavilan recently moved into a 30,000-square-foot building in Campbell and has arranged to move later into a 250,000-square-foot building to be built in an industrial park in San Jose, adjacent to Campbell.*

*The software staff has grown from an original 12 to 18 by March 1983. John Banning, chief of Gavilan's software development team, is a former director of software and architecture at Zilog. Working under him are two former Apple programmers, three alumni of the Xerox Palo Alto Research Center, and others from Hewlett-Packard, Tandem, and Tektronix. The hardware staff includes four electrical engineers and three mechanical engineers. John Zepecki, the hardware director, is a former vice-president of systems engineering for Magnuson Computer Systems.*

*Gavilan announced in April that IMCOSS, a major German company in the computer industry, has signed a contract as an OEM of the Gavilan. As well, Gavilan has signed other major OEM and end-user agreements.*

RAM or EPROM (erasable programmable read-only memory) capsules can be plugged into the top rear left of the main unit. The capsules can contain either applications programs or user workspace. If the capsules contain RAM, lithium batteries in the capsule are used to save the contents of memory for as long as a year. Another 128K bytes of RAM can be supplied in a small module along with an optional second microfloppy disk drive. The interface connections for managing both the drive and the memory are standard equipment and are located on the back of the main unit.

The liquid-crystal display was chosen for considerations of space and power. A full-size 24 by 80 video display is optional and plugs into a standard equipment jack on the right side of the machine. The telephone jack for the modem and the jack for the external power supply are in the same area.

The internal power supply consists of 10 half-D cell nickel-cadmium DC batteries. Seven are arranged parallel to the long dimension of the display and three are perpendicular to that dimension. The Gavilan will run off the batteries for eight hours. An AC adapter is standard equipment and provides power for either operating the machine or recharging the batteries. The adapter can restore the batteries to 80 percent of capacity in one hour.

Other standard hardware includes an RS-232C serial interface for communications at up to 9600 bits per second (bps) and a built-in 300-bps direct-connect modem, for which the telephone jack is provided as noted earlier.

The 4-pound optional printer contains its own batteries and can print up to 60,000 characters per charge. The printer operates by thermal transfer of ink from a ribbon and can print on regular letterhead or thermal paper. A platen feeds sheets to the printing mechanism. The printer plugs directly into the system input/output bus

through a connector on the back of the main unit. Some of the lines on that connector can be cabled to the optional second disk drive to manage expansion RAM of up to 128K bytes housed in the drive. The optional outboard RAM and four capsules that plug into the main unit can increase system RAM to a maximum of 336K bytes.

Other options are an acoustic modem and an adapter for using a car cigarette lighter as a power source.

### Gavilan Software

Gavilan will supply its own built-in operating system, capsules containing Gavilan's own generic applications programs, development software to enable OEMs to write programs for specific applications, and MS-DOS for running software developed for the broader personal computer market. The Gavilan's multitasking operating system supports print spooling and background communications.

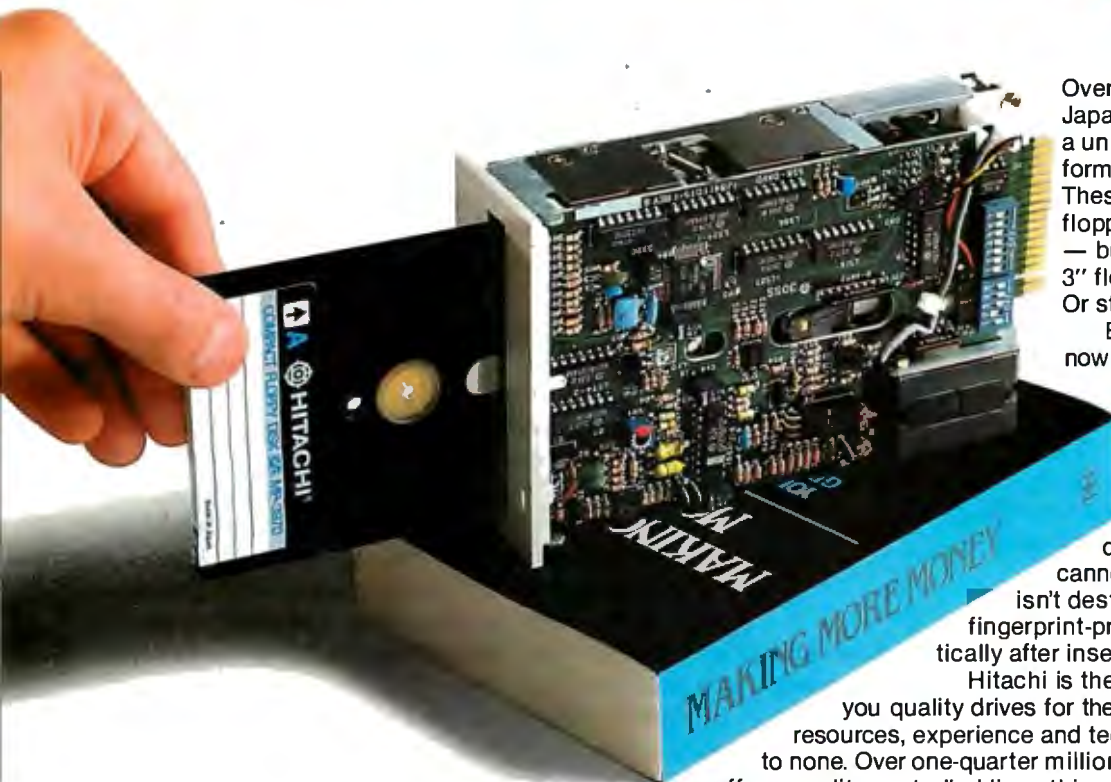
The software is novel in several ways. For one, the user interface actually controls the software. Another major innovation is the degree of integration of the applications, supported by underlying data structures. The Create command, available to the user in all applications, can create elements in one application that we think of as belonging exclusively in another application. In the middle of text, for example, Create can embed a spreadsheet cell. A formula determines the value in the cell. The cell can have a name, such as "annual revenues," and when there is a change in the values from which the annual revenues are calculated, a corresponding change is automatically made in the text.

### The Built-in Software

The built-in software corresponds in some respects to a conventional operating system and occupies the first 48K



# Hitachi takes a big stride toward the smaller footprint.



Over 22 leading American and Japanese makers have agreed on a unified 3" compact floppy disk format for powerful reasons. These 3" floppies have 5 1/4" floppy capacity — 500 kilobytes — but are far more compact. A 3" floppy fits in the shirt pocket. Or standard mailing envelope.

Equally important, the drive now has a smaller footprint than ever before. It's quite light. And portable.


And new 3" compact floppy disks surpass any other format when it comes to protecting valuable data. The case is hard. You cannot bend the 3" floppy so data isn't destroyed. The dust-sealing and fingerprint-proof shutter opens automatically after insertion in the drive.

Hitachi is the first manufacturer to offer you quality drives for the 3" revolution. Hitachi has resources, experience and technological expertise second to none. Over one-quarter million Hitachi drives will be rolling off our quality-controlled lines this year. Wouldn't it be wise to have Hitachi dependability behind your products?

**Specifications:** Storage capacity unformatted: 500 K bytes. Total no. of tracks: 80. Recording density: 8,946 bpi. Track density: 100 tpi. Transfer rate: 250 K bits/sec. Track-to-track positioning time: 3 ms/track. Dimensions (W x D x H) mm: 90 x 40 x 150. Wt.: 0.68kg.

**HFD305D:** double sided drive. **HFD305S:** single side drive with same specs if a double sided floppy is inserted again for the second side.



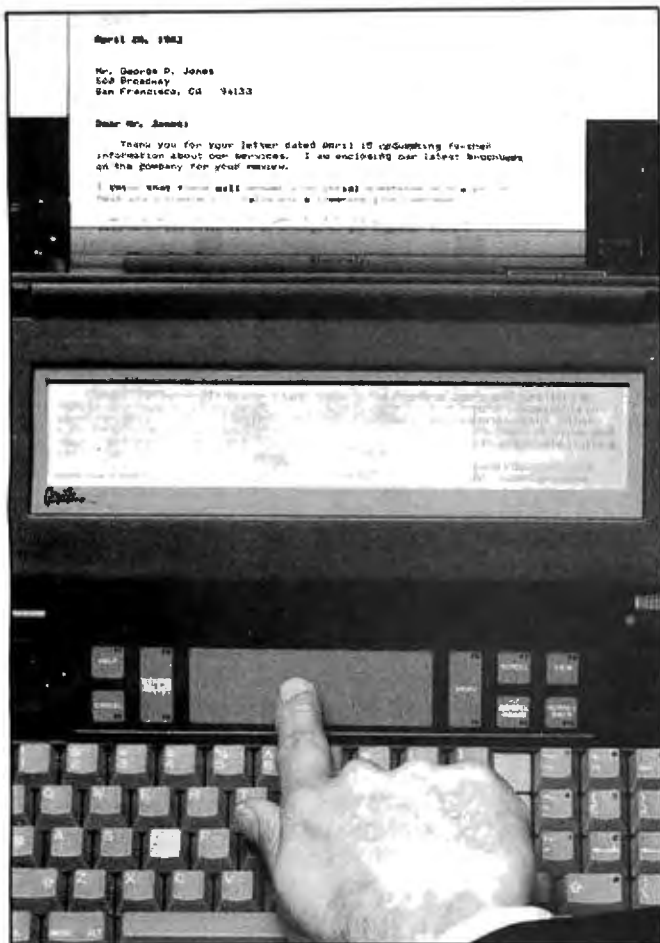
Floppy disk marked  can be used with this floppy disk drive.

**3" Compact Floppy Disk Drive HFD305**



For further information:

Mr. Takao Ichiki, Mid-Western Regional Office, Hitachi Sales Corporation of America, 1400 Morse Ave., Elk Grove Village, ILL. 60007 Phone: (312) 593-1550 Fax: (312) 593-2436  
Mr. T. Koderu, New Jersey Office, Hitachi America, Ltd. 59 Route 17, Allendale, N.J. 07401 Phone: (201) 825-8000 Fax: (201) 825-4781



**Photo 1:** Pressing Gavilan's touch panel activates a wide array of functions. Moving your fingertip across the unlabeled central area gives you control of the pointer. Pressing any of the other areas will perform the function indicated.

bytes of the 80K bytes of RAM built into the Gavilan's main unit. Into those 48K bytes are packed the operating system kernel, the FORTH-like interpreter, the human-interface software, and the data-structuring software.

Gavilan chose to use an interpreted operating system to minimize use of memory and developed its own extended dialect of FORTH for use as the interpreter. John Banning says that use of sophisticated compiler technology enables the Gavilan interpreter to generate very compact code. The extensions of FORTH make programs in the language easier to document and maintain. Banning describes FORTH as "a language that can be efficiently interpreted and in which programs can be performance-tuned by taking little pieces of a program and recoding them in assembly language." Gavilan started tests in March to determine which parts of the software to recode for faster operation.

The Gavilan file system stores "documents" and indexed data structures. "Documents" are files that the human-interface software can display and manipulate using the various human-interface commands. The indexed data structures form the basis of operations such as the personal filing system and record processing systems.

The human-interface software controls all interaction with the user. Applications software communicates with the human interface through the data-structuring software.

The data-structuring software holds documents, which are sequences of elements where an element is any of the things that can be shown on the display and manipulated by the human interface. This underlying data structure permits mixing many different kinds of elements in one document and is responsible for the remarkable degree of integration in the Gavilan applications software. According to Banning, the data structures were the hardest part of the software development. "The worst thing was figuring out not only what these data structures would be, but what was the interface between these structures and the human interface. In other words, what was the interface between the data structures and an application program?"

Gavilan's main approach to application programming is one in which each element in a document has associated with it an "element manager." The element manager is a piece of software that implements a number of standard actions that the human interface knows about, such as "display yourself, a selection has been made." This is reminiscent of Smalltalk and other object-oriented languages in which data objects include both data and information about how the data can be manipulated.

"Every element that's held in the data structuring software has a tag on it, and there's a translation mechanism of what you get from that tag to a particular element manager," Banning explains. "When the human interface decides what part of the document to display, depending on what the user has been doing, the interface calls down to the data-structuring software and says, 'display this particular element.' The structuring software decides which application, which element manager, is associated with that element, and invokes that element manager to do that particular operation—moving data, changing properties, displaying yourself, setting up a selection, things like that. There is a standard list of operations that each element manager has to define. The element managers are inside the plug-in RAM capsules; all the element managers that go with one application are in a single capsule. Once you have the word-processing capsule, for example, your Gavilan can read documents that contain textual elements."

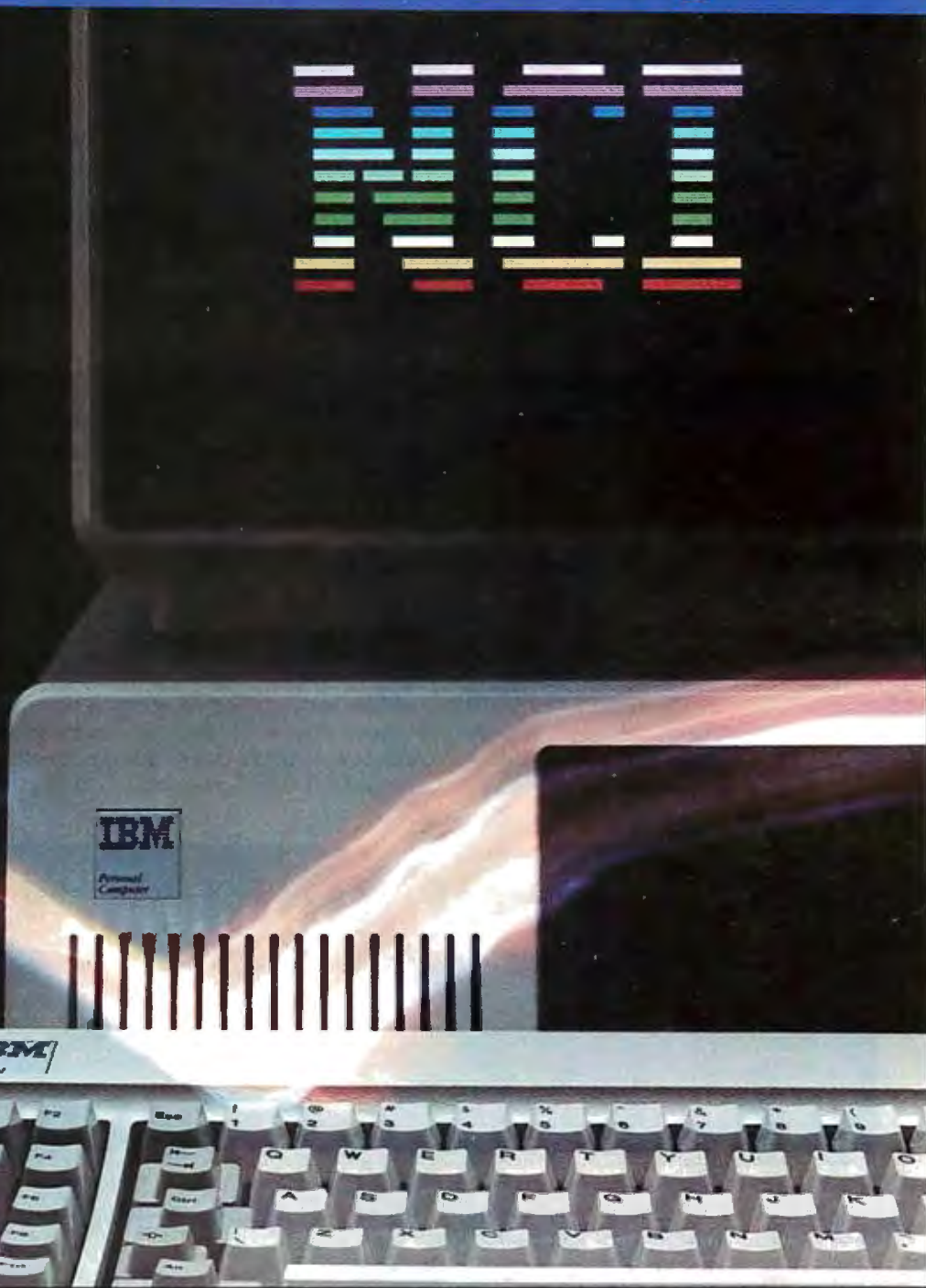
Banning stresses that the operating system "puts the user in charge of what's going on. The human interface is the user's representative in the software world."

### The User Interface

When you open the Gavilan by flipping up the display, it shows a view of a desktop. The desktop shows file drawers, file folders, or whatever documents you have open on your desk. Drawers contain folders and folders contain documents. The degree of indentation on the display indicates what contains what.

The desktop also shows symbols for various capabilities that you can invoke, such as an appointment

# The UCSD p-System. With Speed.



## The new NCI implementation of the p-System. For IBM personal computers and compatibles.

NCI now makes the UCSD p-System run 1½ to 5 times faster on the IBM Personal Computer, including the new XT and RX models and compatibles like Columbia, Compaq, Corona, Colby, Dot, Hyperion and Victor 9000. This speed is possible only with our new interpreter. **NCI includes more features for your PC.**

NCI offers a wide range of software and hardware support that lets you tailor the p-System to your needs, including:

HARD DISK SUPPORT compatible with most hard disk suppliers, including IBM Personal Computer XT, Davong, Corvus-Systems and

Tallgrass Technologies.

- AUTOMATIC RAMdisk SUPPORT (up to 512 K) stores files for much faster access.
- PRINT BUFFER (up to 64K) eliminates printing bottlenecks.
- 8087 SUPPORT speeds numeric and graphics applications.
- GRAPHICS SUPPORT with much faster Turtlegraphics software or Tektronix emulation for business and scientific applications.
- COMMUNICATIONS SUPPORT LIBRARY links computers across continents.
- NCI CUSTOMER SERVICE - we're there when you need us to support the most reliable p-System ever developed for the IBM PC.

For all the advantages of the NCI version of the UCSD p-System call or write:

**Network Consulting Inc.**  
Discovery Park, Suite 110-3700 Gilmore Way  
Burnaby, B.C., Canada V5G 4M1. (604) 430-3466

NAME \_\_\_\_\_

COMPANY \_\_\_\_\_

ADDRESS \_\_\_\_\_

CITY \_\_\_\_\_ STATE \_\_\_\_\_

ZIP \_\_\_\_\_



Portability. Reliability. Speed.

Circle 278 on inquiry card.

IBM, IBM XT and IBM RX are trademarks of International Business Machines Corporation.

UCSD p-System is a trademark of the Regents of the University of California.

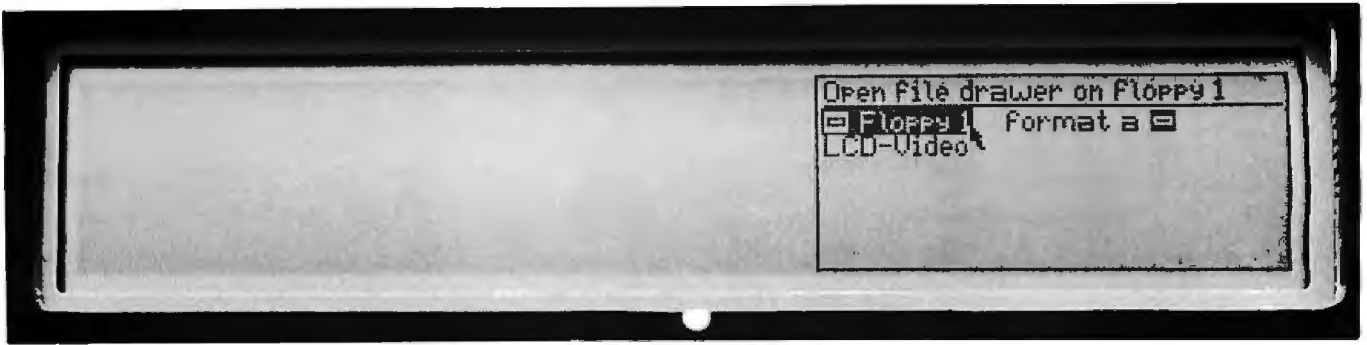


Photo 2: The Gavilan desktop view summarizes the state of the system. Here the arrow is pointing to floppy-disk drive 1, and the command "Open file drawer on floppy 1" is highlighted. When you tap the touch pad (not shown), the operating system opens the file drawer (a metaphor for the floppy disk) on the disk.



Photo 3: After the file drawer is opened, the screen displays the three file folders in the drawer. Each folder's name is preceded by a bar that indicates one level of nesting within the drawer, by a + sign that indicates the folder is closed, and by the symbol for a file folder. The + sign preceding the folder "A-L Client File" is highlighted because the pointer is on it. If you touch the pad now, the operating system will open the file folder and change the + sign to the open box that symbolizes an open folder.



Photo 4: The A-L Client File is now open, and three files are shown inside it. Each of these three files is preceded by two bars, which indicate the level of nesting with the file drawer, and by the + sign that indicates a closed file. The operating system will open the Al Jones file, now highlighted, if you tap the touch pad.



Photo 5: The Al Jones file is now open and the display shows its contents: an insurance folder and a folder of letters. The pointer is on the "Letter of 3 Aug. '82," which you can open by tapping the touch pad.

# IS THIS LEVEL OF RELIABILITY REALLY NECESSARY?

## ACCUTRACK



If you've ever lost data due to a faulty disk, you know how important reliability can be.

That's why Accutrack disks are critically certified at 2-3 times the error threshold of your system. Why they're precision fabricated for higher signal quality, longer life and less head wear. And why we take such extra steps as testing single-density mini disks at double-density levels. So you don't have to worry about the reliability of your media.

Accutrack disks. OEMs have specified them for years. You can trust them for your data. Call toll-free (800 225-8715) for your nearest dealer.



**ACCUTRACK**  
Dennison KYBE Corporation

82 Calvary Street, Waltham, Mass. 02254  
Tel. (617) 899-0012; Telex 94-0179  
Outside Mass. call toll free (800) 225-8715  
Offices & representatives worldwide

**Dealers: Give your customers a choice—Accutrack's OEM performance as well as your heavily advertised brand. We have the industry's only complete line of disks, cassettes and mag cards, including virtually all special formats. If you want a quality line, small minimums, the ability to mix and match, private labeling, fast delivery and great price, call today. Find out how responsive a media supplier can be.**

Circle 118 on inquiry card.



Photo 6: Now the letter is open and its beginning is displayed. The pointer can be maneuvered for editing. You can get a list of editing commands by pressing the Menu area of the touch pad.

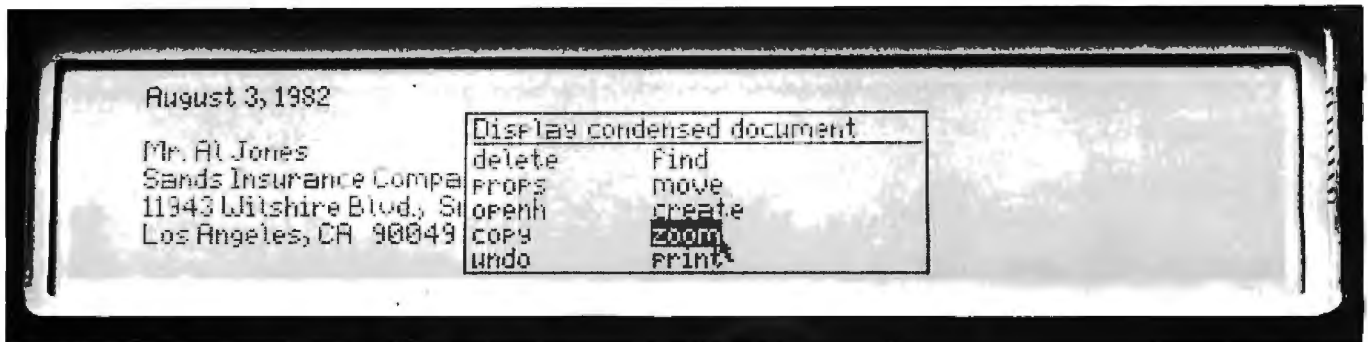


Photo 7: A menu of commands has popped up over the letter, and the Zoom command is highlighted. The line above the menu always displays a brief description of the highlighted command. The Zoom command gives you a distant view of the document, which will be shown condensed.

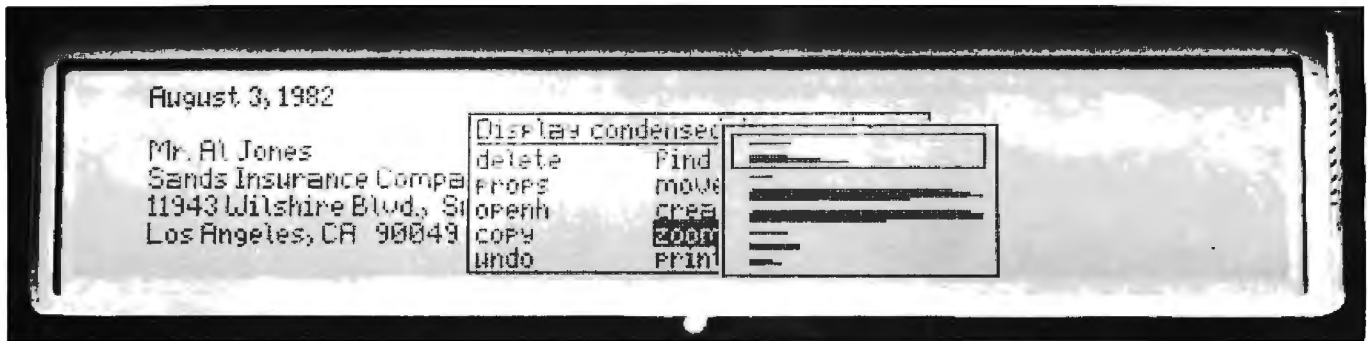


Photo 8: When the Zoom command is in effect, the pointer is replaced by a frame that encloses the part of the document that is displayed full-sized on the screen. This helps orient the user and gives a preview of the appearance of the entire letter.

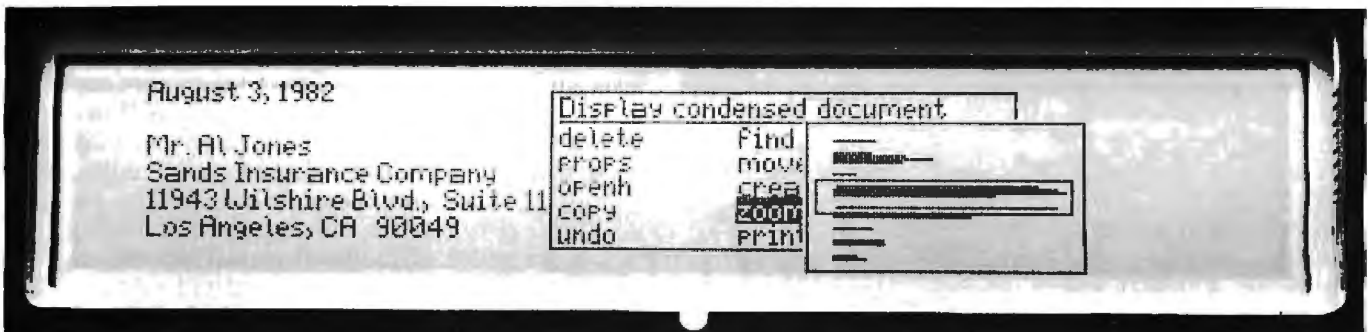


Photo 9: The user has moved the frame to another section of the letter. When you tap the touch pad, the selected paragraphs will be displayed.



The QX-10.  
No ad can do it justice.

# Epson.

There's an awful lot of computer hype these days. And we think it's time for a little old-fashioned honesty.

So we're going to give you a few solid reasons why — even if you look at nothing else — you should go to your dealer and take a close look at the new Epson QX-10.

**Anybody can use it.**

What makes the QX-10 the most remarkably usable computer to date is a unique software system called VALDOCS, coupled with a new keyboard design called HASCI. VALDOCS reduces the time it takes to master the QX-10 from hours to minutes by displaying exactly what your options are, while the straightforward, detachable HASCI keyboard places all the most-used functions right in front of you, grouped logically and labeled in plain English.

**You may never buy software again.**

VALDOCS may be all the software you'll ever need. Right out of the box it's a sophisticated *word processor*; an *information indexer* for easy access to files; an *electronic mail system*; a *calcula-*

*tor*; an *appointment book and notepad*; and a *high resolution business graph drawing system*.

**A little price tag.**

Mere words are not enough. To fully appreciate the powers of this machine, you must experience it for yourself. So visit your dealer and see what it can do. And if that doesn't sell you, the comfortable price tag will. It sells for under \$3000. And that's no hype.



**EPSON**  
EPSON AMERICA, INC.  
COMPUTER PRODUCTS DIVISION

Call (800) 421-5426 for the Epson dealer in your area.

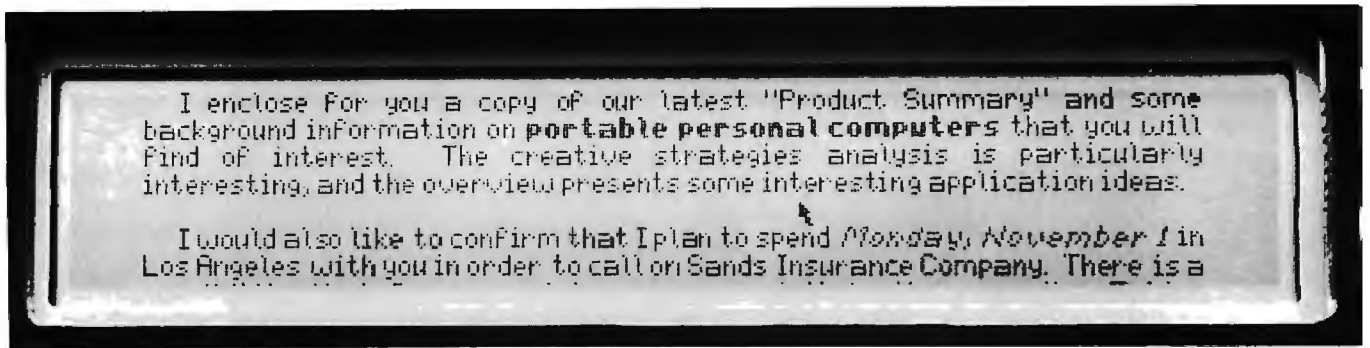


Photo 10: Here are the new paragraphs. Note the use of bold and italic characters. (The camera angle obscures the last line of the eight-line display.)



Photo 11: By pressing the View area of the touch pad, you can return to the desktop. The desktop now shows that the file drawer and the letter of August 3 are open. When you return to the letter, you'll return to where you were when you pressed the View area of the touch pad.

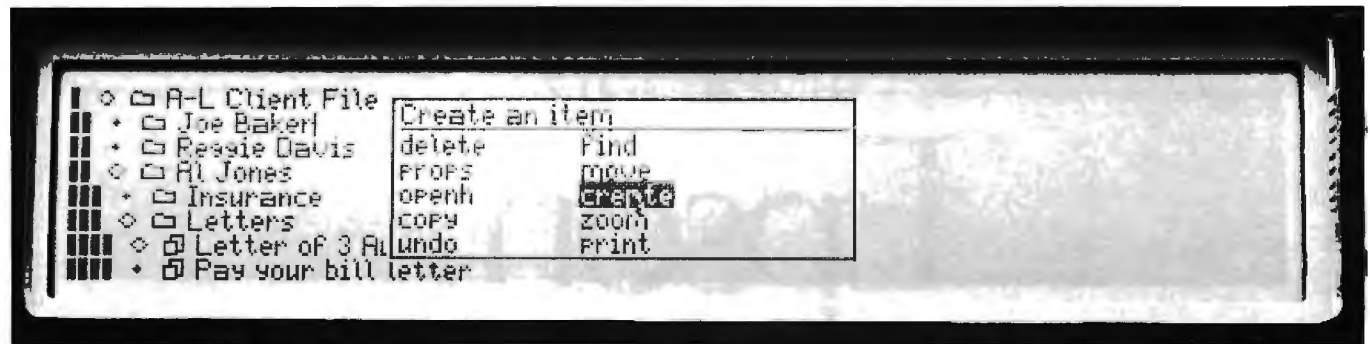


Photo 12: You're ready to create a new file folder. The vertical bar after "Joe Baker" indicates an insertion point. If you create a file folder now, it'll be inserted between "Joe Baker" and "Reggie Davis."

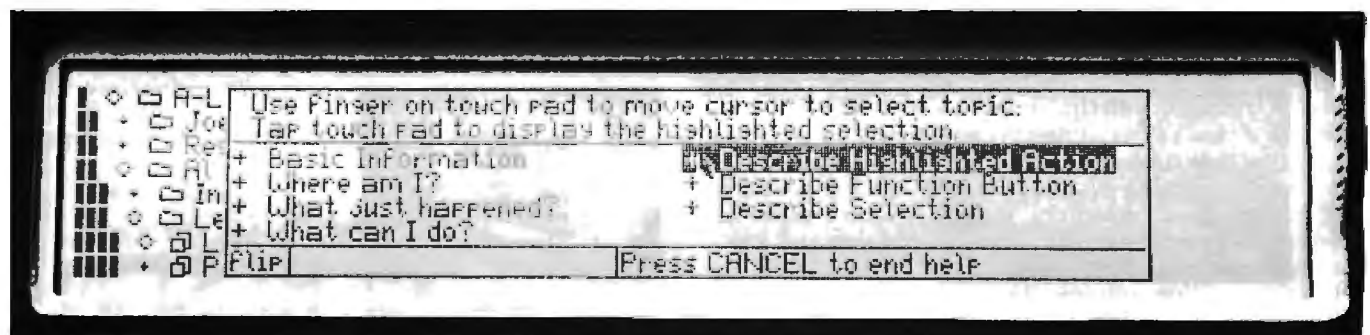


Photo 13: If you're unsure about how to use a command you can always press Help. The Flip command at the lower left of the Help area can be selected to toggle the display between the help menu and the work area about which help is sought.

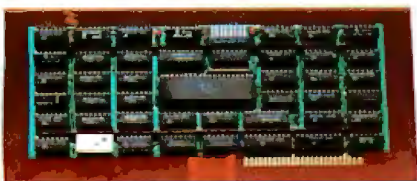


# "What if ..."



## ***"I want it faster?"***

Now you can speed up your VisiCalc® (and almost everything else your Apple® II does) with the Accelerator II. Just plug in one board, and watch your models recalculate in less than a third of the usual time! Data bases, Applesoft, Pascal, etc. (even Apple Invaders) run about 3.6 times faster with the Accelerator II.



The Accelerator II is designed for the Apple II and II Plus. The Accelerator IIE will be available soon for the Apple IIE. The Accelerator boards are based on a fast 6502 processor with its own memory and built-in, high speed Language Card. The fast 6502 runs in parallel with the Apple's standard 6502. It's like putting an extra, faster Apple inside your original Apple.

For even more VisiCalc power, add a Saturn RAM Board and the VC-Expand software to get more memory, FAST SAVE/FAST LOAD, and VARIABLE COLUMN WIDTH.

See your local computer dealer or contact Saturn Systems for more

details. In Europe, contact Pete and Pam Computers, New Hall Hey Road, Lancashire, UK; Telephone 706-227-011, Telex 635740 PET PAM G

VisiCalc is a registered trademark of VisiCorp. Apple is a registered trademark of Apple Computer, Inc. The VisiCalc expansion software (VC-Expand, etc.) is written for Saturn by Micro Solutions, Inc.

### **SATURN SYSTEMS INC.**

P.O. Box 8050  
3990 Varsity Drive  
Ann Arbor, MI 48107  
1 (313) 973-8422

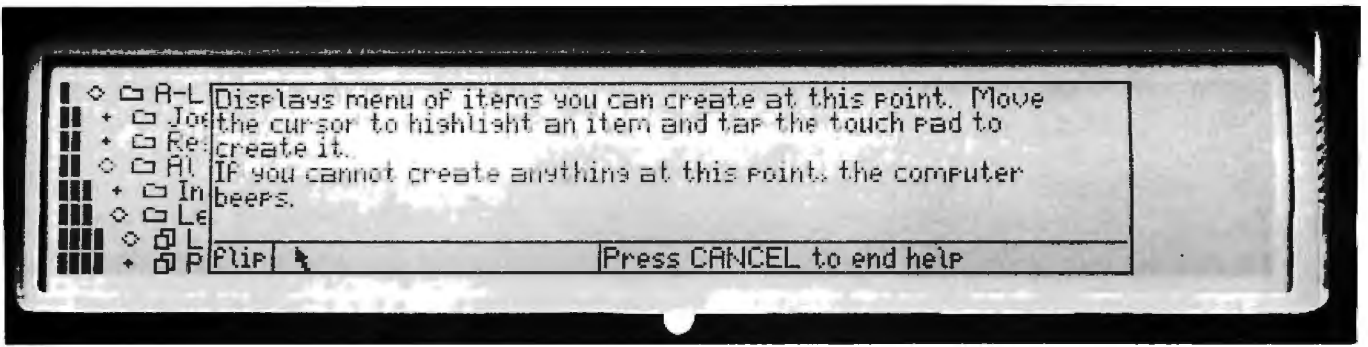


Photo 14: The Gavilan's help text for the Create command.

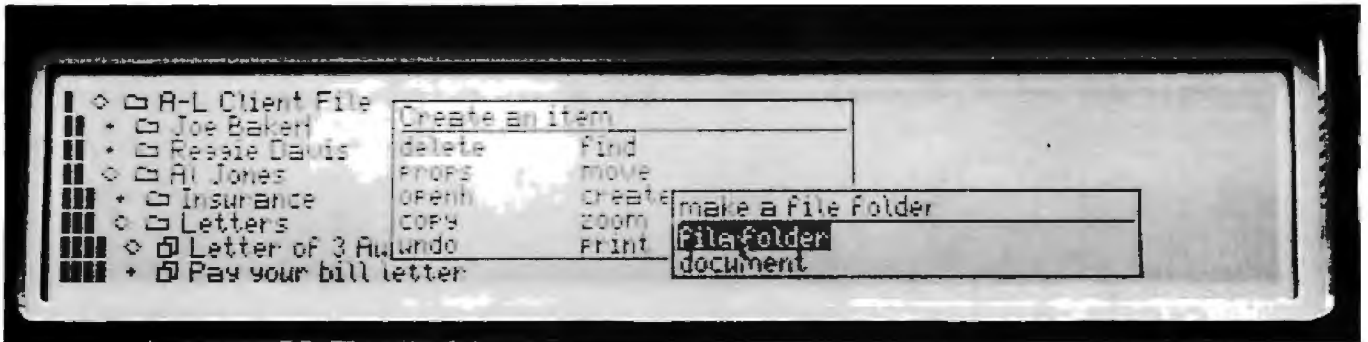


Photo 15: By pressing the Cancel area on the touch pad, you can return from the Help display to the desktop. The Create command is still active and you have a choice of creating a new file folder or document. The pointer is on file folder, and by tapping the touch pad, you can create a new folder.

calendar, different kinds of communication methods, the ability to switch over to video display from the LCD display, and so on. From anywhere in the system, you can always get back to the desktop by pressing the View button on the touch panel (see photo 1 on page 80).

The touch panel has nine labeled areas. In addition to the View area, there are Help, Select, Extend, Menu, Scroll, Scroll Again, Scroll Back, and Cancel.

The tenth and central area of the touch panel lets you control the pointer, or cursor, by moving your fingertip across the touch panel in the desired direction. The movement of the pointer is independent of where you put your finger down in this central area of the touch panel; the pointer follows the direction of your finger's motion. As you move the pointer over the symbol for an action, that symbol is highlighted. Then you invoke the action by tapping the touch pad.

You select an object for the action by moving the pointer over a character and then tapping the Select area with your fingertip. The character is highlighted to show that you can now work on it. To select a whole word, tap twice. Three taps select a sentence, four a paragraph. Another way to select larger units of data is to tap once to highlight the first character, then tap the Extend area of the touch panel, then move the pointer to the other end of the desired data and tap the Select area again. To insert something new, you move the cursor between two characters, and a vertical insertion bar appears. Then you type in the new information.

To get a list of your choices, you tap Menu. If you need

assistance, you tap the Help area; the feedback depends on the context. The help information tries to answer the four most likely questions: What just happened? Where am I? What am I looking at? What can I do next?

While the Help command is in effect, an area at the lower left of the LCD shows the word "Flip." If you move the pointer onto that word and tap the touch panel, you can flip back and forth from help text to the data that you were trying to work on. Because Flip remains highlighted, you have to tap only once to toggle from help text to data.

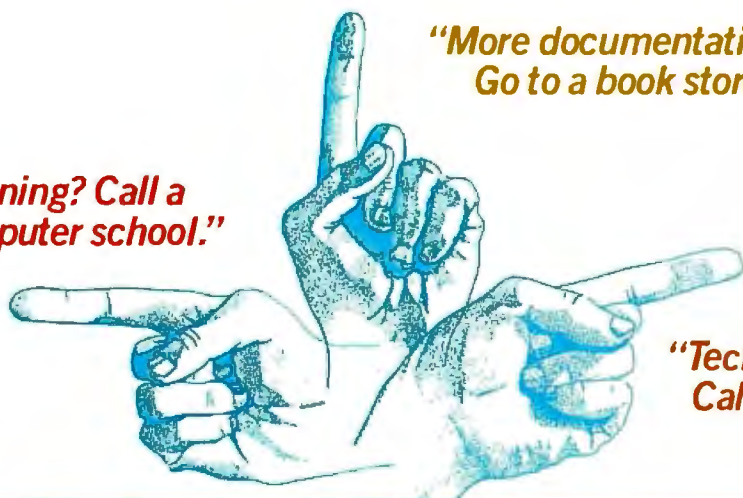
The Scroll, Scroll Back, and Scroll Again areas of the touch panel move your view to different areas of the data. The Cancel command terminates Help, Select, Menu, and so on.

Touching the Menu area of the panel always brings the standard menu. This contains 10 fundamental commands arranged on the display in 2 columns:

Delete	Find
Props	Move
Open	Create
Copy	Zoom
Undo	Print

Props, or "properties," lets you change the **display** output from LCD to video, or, in word processing, the paragraph formatting, or, in the spreadsheet, the column widths. Delete, as its name implies, deletes what has been selected. Similarly, Undo nullifies your last action and is

**“Training? Call a computer school.”**



**“More documentation? Go to a book store.”**

**“Technical support? Call the publisher.”**

## Interested in dBASE II™ or 1-2-3™? Beware The Dreaded Finger Pointers!

Sound familiar? Does your dealer turn into a “finger pointer” when you need help?

At SoftwareBanc we offer a complete system that doesn't stop when your software is delivered.

### Careful Product Selection

Do you get bewildered by the endless lists of software you find in most ads? Let us be your quality control department.

We only sell the best programs on the market. After a thorough evaluation we chose dBASE II™ for data processing, and 1-2-3™ for financial management.

Our complete line of add-on products help you to continue to get the most from your software.

### Expert Technical Support

When you buy software from us, you can rest assured that help is only a phone call away. Just call us at (617) 641-1235 for all the free support you need.

### Free dBASE II™ User's Guide

Order dBASE II™ from us, and you'll receive a free copy of our dBASE II™ User's Guide. You can also buy the User's Guide first for only \$29, and then receive a full credit when you buy dBASE II.™

French Translation  
La Commande Electronique  
5 Villa Des Entrepreneurs  
75015 Paris, France

Japanese Translation  
JSE Int'l  
9F Toyo Bldg. 6-12-20 Jingmae  
Shibuya-ku Tokyo, Japan 150

1-2-3 TRANS is a menu driven program that will quickly and easily transfer files from dBASE II™ to 1-2-3™ and back again. Free with 1-2-3™ purchase!

### 1-2-3™ & dBASE II™ Classes

Want more in-depth information about dBASE II™ or 1-2-3™? Attend a SoftwareBanc seminar near you. Each session runs from 9 to 5, and costs \$175.

**Los Angeles**

July 18-22

**Washington, D.C.**

Aug. 29-Sept. 2

**Anchorage**

August 11-12

**New York City**

September 19-23

### Prices You Can Afford

†1-2-3™	.....Call for price*
†dBASE II™	.....\$479
†ABSTAT™	.....\$379
dBASE II™ User's Guide	.....\$29
DBPlus™	.....\$95
dGRAPH™	.....\$199
dUTIL™	.....\$69
dNAMES™	.....\$109
QUICKCODE™	.....\$199
TEXTRA™	.....\$70*

\*Only available for IBM PC with MS-DOS.

†No-risk 60 day money back guarantee

If you want to learn more about SoftwareBanc, call or write for our free product catalog.

661 Massachusetts Avenue  
Arlington, Mass. 02174

To order call: (800) 451-2502  
(617) 641-1241 in Mass.

For technical support call:  
(617) 641-1235

™ Manufacturer's trademark

Payment may be made by: MasterCard, Visa, check, C.O.D., money order. Mass. residents please add 5% sales tax. Add \$5.00 for shipping and handling.



actually implemented in the file system, which is returned to a previous state.

Zoom makes the information on the display appear farther away. In combination with the Scroll command on the touch panel, Zoom lets you maneuver rapidly around a large document.

Create lets you generate a paragraph, document, spreadsheet, section heading, chapter of a document, form for data entry, or cell in a spreadsheet.

A sequence using Create might go like this. You select Create and are given the options—files, folders, spreadsheets, section headings, chapters, forms, or cells. If you select file folder, you are taken to the desktop, where you are asked to type in the name of the file alongside a newly displayed folder symbol. Then you go back to the Create menu, where you select document. That takes you back to the desktop, where you enter the name of the document. You open the document by selecting it and tapping the touch panel or by pressing the Menu area of the touch panel and using the Open command. You then produce the document, creating whatever kinds of elements you need.

From the standard menu, you can go to another menu more specific to the context. What defines the context is not the application program you're using, but the kind of data you selected in the document. This interpretation occurs because each document can include spreadsheets and word processing and other kinds of elements.

The menu's Move and Copy commands, as their names

suggest, move or copy information both within the same document and from one document to another. You first select the data to copy or move. If the desired destination is in a different document, you press the View area of the touch panel, which takes you to the desktop. There you can select any document or program and go look at a document, then get the standard menu and select Move or Copy to transfer the selected block of data. There is no formal procedure for moving data from one application to another because the documents consist of data elements. Thus, as long as your capsules contain the right element manager, you can use different types of elements in any application.

The files on the desktop display are preceded by either a plus symbol, which indicates the file is closed, or an open box, which indicates the file is open. You change the files by moving the pointer over one of those two symbols and tapping the touch panel. Once you've opened the file, you can examine it. The Zoom command gives you a "map" of the whole document.

Then the Scroll commands let you find a particular area of the document. Pressing the Scroll area of the touch panel causes a frame to appear on the screen, which represents a window. You can then move the frame over the part of the document that you want to see next by moving your finger on the touch pad. When the frame surrounds the data you want to see next, you tap the pad and that selected area displays at closer range.

Once you've used a Scroll operation, you can repeat it or reverse it by pressing the Scroll Again and Scroll Back areas of the touch panel. Find lets you search for a string. Print is self-explanatory.

### Gavilan Applications Software

Gavilan is developing its own word processor, spreadsheet, "portable secretary," communications and mail system, and forms control software. (As of March, the word processor was in an advanced stage of development and the other applications were in earlier stages.)

The word processor includes global search and replace, the Move and Copy commands described earlier, and will support multiple fonts and page and paragraph formatting. The spreadsheet will handle the usual financial calculations in the familiar format. The portable secretary will provide a "to do" list, appointment scheduling, a "tickler" reminder file, time recording, expense reporting, travel routes and schedules as well as reports of calls and other activities. The communications software will provide access to databases, company computers, and electronic mail. The forms system will permit designing forms in which some fields are prompts, some are for data entry, and others result from calculations done on data-entry fields.

### Languages and Development System

Gavilan plans to sell BASIC and Pascal to run under MS-DOS. The company will also sell a development system that permits outside programmers to develop applications software in the UCSD Pascal p-System. The re-

## PROGRAMMERS FLIGHT SIMULATOR Apple II Plus DOS 3.3 48K



This total IFR System disk features gobs of menu selectable flight programs each with breath taking realistic picture graphics, moving scenery, airport approaches, holding patterns and much much more.

\$50.00 At your Computer Store or direct from  
Visa Mastercard

Programmers Software  
2110 N. 2nd Street  
Cabot, Arkansas 72023  
(501) 843-2988



sulting programs will be able to take advantage of the standard Gavilan user-interface software and interpreter.

The development system will consist of the UCSD p-System, a "capsule builder," and a "message builder." The capsule builder takes Pascal code and organizes it in such a way that it can work with the Gavilan user-interface software and data-structuring software. The program can then be loaded into one of the RAM capsules that plug into the four slots at the left rear of the machine. Another development tool called the "message builder" receives all of the program-message text that will be used to interact with the user, from the level of individual words in menus up to paragraphs of help information. The message builder compacts the messages by compressing individual characters and by assigning unique codes to commonly occurring phrases.

### Market Impact

Successful and timely completion of the Gavilan project may influence several important trends in microcomputing. The use of the touch panel as a pointing device may challenge the popularity of the mouse as a nonkeyboard input device. A successful touch panel requires sophisticated algorithms to interpret the movements of the user's fingertip across the panel. In March, Gavilan had two different algorithms working, the more recent one much more efficient than its predecessor. Once the algorithm is perfected to give the on-screen pointer instantaneous and extremely precise response, the touch

panel would seem to be a more natural pointing device than the mouse. People are accustomed to pointing with the fingertip, not the palm.

More important, the Gavilan mobile computer promises to set new industry standards not only for truly portable computers, but also for integration of applications software. The use of elements and element managers may achieve such a high degree of integration as to make the traditional concept of applications programs obsolete.

Beta-test deliveries of the MS-DOS version of the Gavilan start this month. The proprietary operating system and applications software begin alpha tests at Gavilan in August and beta tests by selected outside users in September. In early March, the Gavilan user interface appeared almost complete, the word processor included everything but printing and pagination, and the spreadsheet and other applications were in earlier stages of development.

Portables as useful and light as the Gavilan will probably lead even more people to use computers in their offices. One reason not to buy a desktop computer today is that you must work with paper while traveling; when you return to the office, you have to type your handwritten notes into the computer. That is precisely the kind of duplication of effort that computers should eliminate, and the Gavilan portable computer is doing just that while simultaneously moving the whole industry forward. ■

## JUST SAY THE PASSWORD TO GET 1200 BAUD, PROGRAMMABLE AUTO DIAL, FOR \$449\*

- 300/1200 Baud
- Auto Dial, with Telpac software available
- Full or Half Duplex
- Audio Phone Line Monitor
- Two-Year Limited Warranty

PASSWORD is the new USR friendly modem, designed for use with any small computer on the market today. We have compressed into its miniature case every operating feature for unattended high speed telecomputing. With auto dial/answer and auto mode/speed select there is little to do but turn it on. So compact it mounts on the computer with Velcro™; when you carry your computer you can pocket your Password. So brilliantly conceived it achieves all this with just 12 tiny integrated circuits (a presage of long trouble-free service). If your distributor doesn't know the Password yet, write or call for complete specifications.

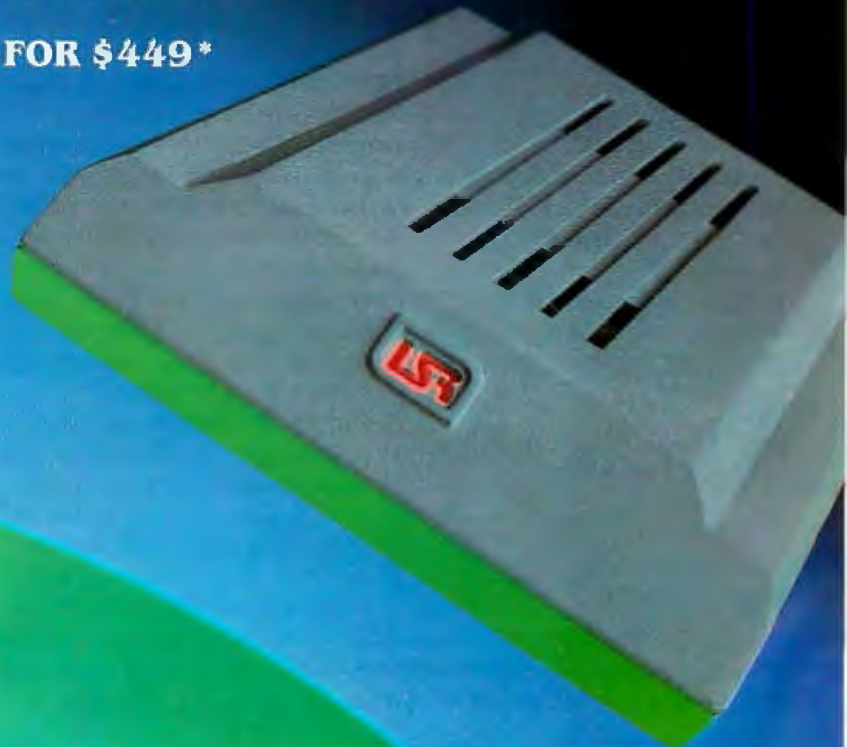
*\*Suggested list for Password complete with power, phone, RS232 interface cables. Telpac software optional extra, \$79.*



**U.S. ROBOTICS INC.™**

1123 WEST WASHINGTON  
CHICAGO, ILLINOIS 60607  
(312) 733-0497

Circle 397 on Inquiry card.





## Whitesmiths, Ltd. Introduces the Newest Idea in Software: The Craftsman's Seal.

Like the craftsman's seal on a fine work of art, Whitesmiths' Authorization Seal is more than just a means of identification. It represents the pride in workmanship, sense of tradition, and commitment to value on which we have always prided ourselves.

At Whitesmiths, we've established a tradition of producing some of the industry's most innovative and dependable software. Our C and Pascal compilers and cross compilers run in over 30 environments on DEC, Intel, Motorola and Zilog computers. Idris, our highly portable

operating system, is compatible with UNIX and runs on all those vendors' machines too. And our full line of Software A La Carte items – from assemblers to special purpose tools – permits our customers to pick and choose what they need to tailor our products for unusual requirements.

The Authorization Seal is one more way we can take pride in our products. Once affixed to the machinery on which the software is to run, the Authorization Seal verifies, at a glance, ownership, product

code, and the software copyright – all of which reduce order turnaround time and upfront expenses for both OEMs and end-users. No contracts to sign, no documents to read. Just good software, plain and simple.

The Whitesmiths, Ltd. Authorization Seal. It's one more way that we're committed to becoming a software tradition in your time.



Contact Whitesmiths, Ltd.,  
97 Lowell Road, Concord,  
MA 01742, (617) 369-8499  
TLX 951708 SOFTWARE CNCM.

# Whitesmiths, Ltd.

## Software Craftsmen

One-stop communications. One-step installation. Smartmodem 1200B and Smartcom II software are available now.

Thanks to Smartcom II companion software, telecomputing is a breeze. You'll be creating files and sending data in no time.

Need important information from the main office...today? Get it quickly, efficiently, accurately. From their computer to yours.



# Hayes

## Your computer's telephone.

Hayes is still leading the way with new telecomputing products. And now combining every bit of sophisticated technology into one communications package for your IBM\* PC. Smartmodem 1200B and Smartcom II™ software. Everything you need. And more.

Whether you're receiving updates from the field, placing orders with suppliers a thousand miles away, or taking advantage of the diverse resources offered by networks and information services. Let Hayes provide the communications link. With our popular 1200 bps Smartmodem. Now available as a convenient plug-in board for the IBM PC. And packaged with our own communications software.

**Smartmodem 1200B. Your computer's telephone.** That's really what it is. A telephone that allows your computer to communicate over ordinary phone lines at up to 1200 bits per

second. For speedy, economical transmission of data to any Bell 212A or Bell 103 type modem. And it's the one peripheral that vastly expands the usefulness of your computer.

Our single board Smartmodem 1200B can be installed by your computer dealer in minutes. It connects directly to your phone jack, operating with rotary dial, Touch-Tone\*\* and key-set systems. Smartmodem 1200B will dial, answer and disconnect all of your calls automatically. It will even redial your last number upon command.

Smartmodem 1200B also features an automatic speed selector, that detects incoming transmission speeds. Along with screen displays to show you its current operating status. And, unlike some

1200 baud modems, Smartmodem 1200B operates at full or half duplex, for compatibility with most time-sharing systems.

For those who enjoy designing their own programs, Smartmodem 1200B is controllable using *any* programming language. But none of that is necessary. Thanks to Smartcom II. The communications program designed by Hayes, specifically for Smartmodem!

**Smartcom II companion software. Maximizes Smartmodem's capabilities. Minimizes your effort.** The first time out, you'll be creating messages, sending, printing and storing them to disk. Simultaneously.

And when you're on the receiving end, your IBM PC will do all the work, completely unattended!

But that's just part of Smartcom II's innovative story. For instance, before you communicate with another system,





Imagine. Your computer can receive, print and store data, concurrently. Without your even being there!



A complete plug-in communications package for the IBM PC.

Smartmodem 1200B. (Includes telephone cable.)

Smartcom II communications software.

you need to "set up" your computer to match the way the remote system transmits data. With Smartcom II, you do this only once. After that, parameters are stored in a directory on Smartcom II. Calling or answering a system listed in the directory requires just a few quick keystrokes.

You can store lengthy log-on sequences the same way. Press one key, and Smartcom II automatically connects you to a utility or information service.

And if you need it, there's always "help." One of several special functions assigned to your IBM function keys, this feature explains prompts, messages, etc. to make communicating even easier.

Smartcom II also provides a directory of the files stored on your disk. Letting you create, display, list, name, re-name or erase any file right from the screen.

Like all our products, Smartcom II and Smartmodem 1200B are backed by excellent documentation, a limited two-year warranty, and full support. From us to your dealer to you.

So, see your dealer today. Link up to the exciting world of telecomputing. With Hayes complete plug-in communications package for your IBM PC.

**Hayes Microcomputer Products, Inc.,** 5923 Peachtree Industrial Blvd., Norcross, Georgia 30092. 404/449-8791.



Requires an IBM PC with minimum 96K bytes of memory; IBM DOS 1.10 or 1.00; one disk drive; and 80-column display. No serial card or separate power source is needed.

Smartcom II is a registered trademark of Hayes Microcomputer Products, Inc.  
 \*IBM is a registered trademark of International Business Machines Corp.  
 \*\*TM of American Telephone and Telegraph.  
 ©1983 Hayes Microcomputer Products, Inc.  
 Sold only in the U.S.A.

# Digital's Professional 300 Series

## A Minicomputer Goes Micro



**Photo 1:** The Professional 300 Series includes both the Model 325 and the Model 350, the only differences being the number of available slots and the option of a Winchester hard disk.

Microcomputer architecture must complement the work habits of the people who use computers as tools. Most managers and office workers perform various tasks in a given day and often switch quickly from one to another. People who work as part of a team spend a considerable amount of time communicating with one another. Digital Equipment Corporation designers took these factors into account in creating the Professional 300 Series. They decided that new machines must be able to perform several tasks at once, apply the same user interface to each task, communicate efficiently, and, as an added bonus, use the same software as Digital's popular minicomputers.

The Professional 300 Series consists

---

Wesley Melling  
Professional Product Manager.  
Digital Equipment Corporation  
4 Mount Royal Ave.  
Marlboro, MA 01752

---

of two models that differ only in storage capability and slot space. The 325 has one dual floppy-disk drive and three option slots and can be upgraded to a 350 model, which has an optional Winchester hard disk and three additional slots.

These personal computers are really desktop-sized versions of the PDP-11, one of Digital's popular minicomputers. Both models share the PDP-11 instruction set and memory management and provide the user with about 90 percent of the through-

put of a PDP-11/24. Both have an operating system based on Digital's RSX-11M+. For the user, this means that software applications developed for more than 500,000 installed PDP-11 and VAX systems are candidates for easy migration to a desktop personal computer.

Three major components—the system unit, the monitor, and the keyboard—comprise the Professional 300 system (see photo 1). The system unit contains the processor, memory options, power supply, and mass storage in a case that measures 23¼ by 14⅞ by 6½ inches. The main logic module contains the F-11 central processing unit, a chip set equivalent to a PDP-11/23-Plus (see photo 2). Its instruction set includes 87 instructions

and eight addressing modes of either 16-bit words or 8-bit bytes. Although the system works with 16-bit addresses, providing for 64K bytes of logical address space, the Memory Management Unit (MMU) constructs 22-bit addresses that allow up to 4 megabytes of RAM (random-access read/write memory).

Two memory modules totaling 256K bytes of RAM connect to the main system logic module with 40-pin connectors without occupying an option slot (see photo 3). The standard configuration also includes 16K bytes of ROM (read-only memory) and 32K bytes of RAM for bit-map control. Options requiring extra memory include the necessary additional RAM on the option module. A non-volatile clock and RAM use a rechargeable nickel cadmium battery to maintain the time and date even when the system power is turned off. Each Professional System also includes a unique 47-bit identification ROM that is readable from software and can be used for either system verification or as part of a piracy-protection scheme.

A 208-watt power supply that comes with an integral fan handles a Professional 350 equipped with all available options. The disk-drive units are easily accessible from the front of the chassis. Both Professional Series systems come with an RX50 dual-disk subsystem that is capable of storing up to 800K bytes of formatted data in fixed-length blocks on two 5¼-inch floppy disks. This subsystem includes a separate single-board controller module and extensive internal self-testing and diagnostic firmware. An optional 5-megabyte Winchester disk is available for the 350 model. The 350's module cage contains six slots for the addition of peripherals. In the standard configuration, one slot is occupied by the floppy-disk controller and another is taken by the video controller. The back panel of the system unit enclosure has connectors for a serial printer port, the video monitor port, an RS-232C/423A serial-communications port, AC power, the telephone-management interface, and a 16-pin Ethernet plug.

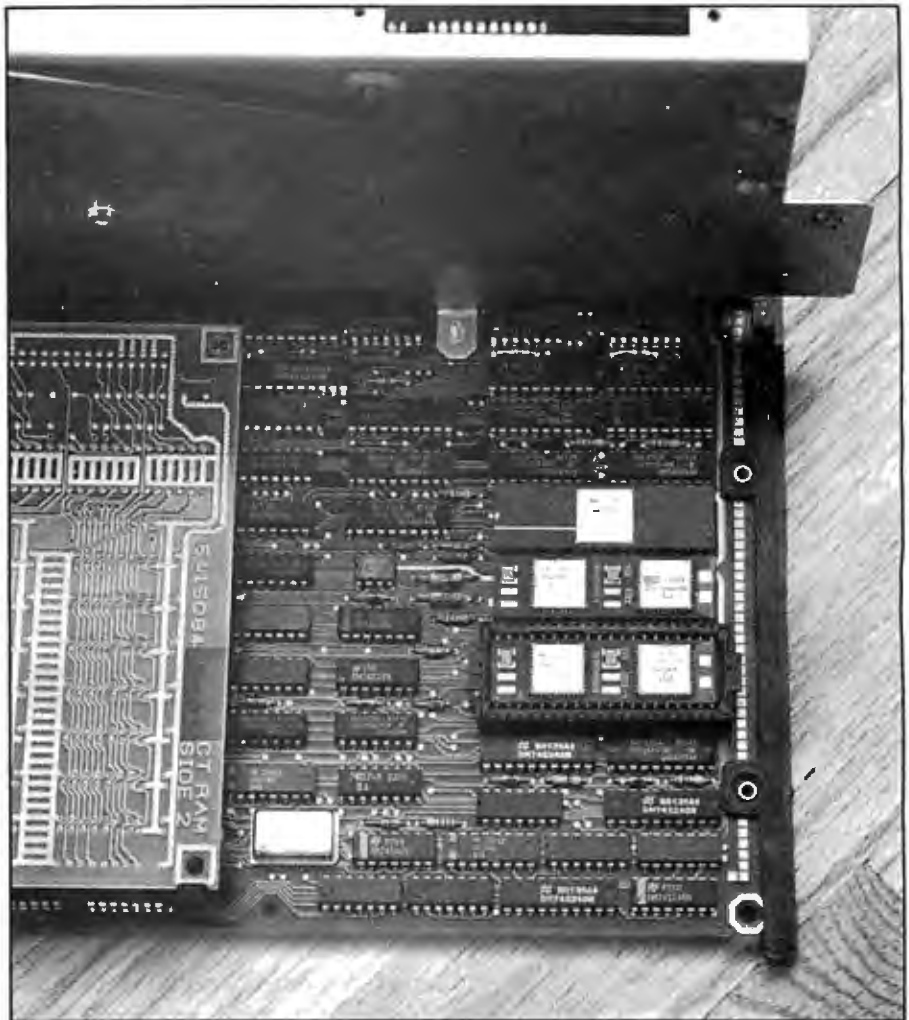


Photo 2: The F-11 chip set provides users with the power of a minicomputer in a microprocessor-based desktop computer.

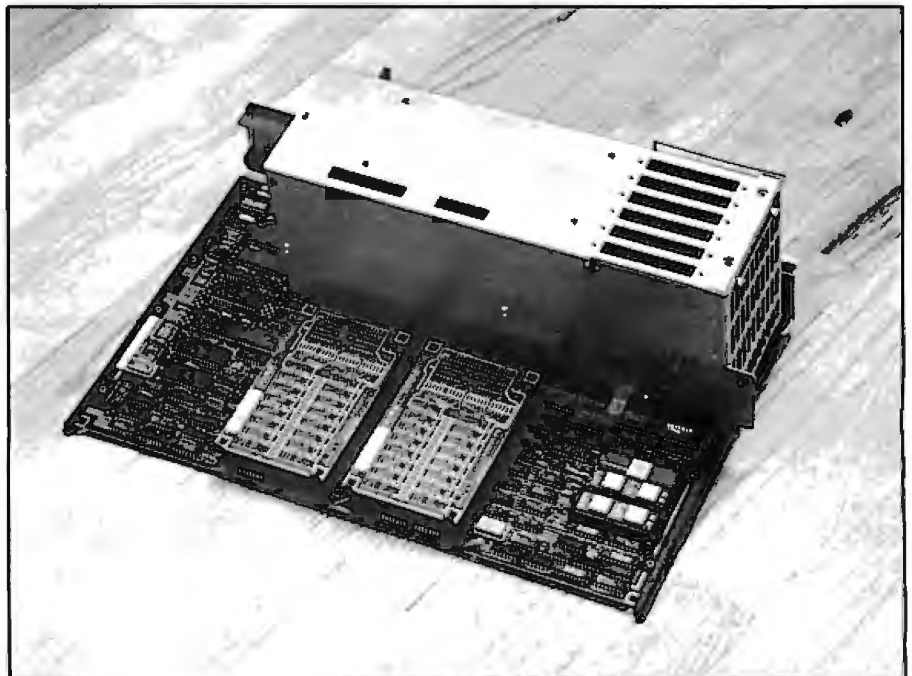


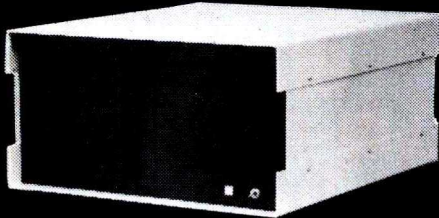
Photo 3: By using daughter boards for additional memory, the designers were able to avoid occupying an expansion slot.

# Main/Frames

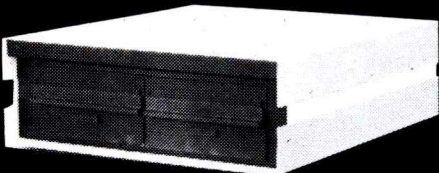
# Main/Frames

from  
**\$200**

- 30 Models of Enclosures
- Assembled and tested
- Quasi-Coax Motherboards
- Power Supply
- Card cage and guides
- Fan, line, cord, fuse, power & reset switches



8" Floppy Main/Frame  
**\$482**



8" Disc Enclosure  
**\$250**



**\$525**  
Phase/80 8" Floppy Mainframe



**\$900**  
Phase/80 Desk + Mainframe

Write or call for our brochure which includes our application note:

"Building Computers — A Recipe"

## INTEGRAND

8620 Roosevelt Ave. • Visalia, CA 93291  
209-651-1203

We accept BankAmericard/Visa and MasterCard

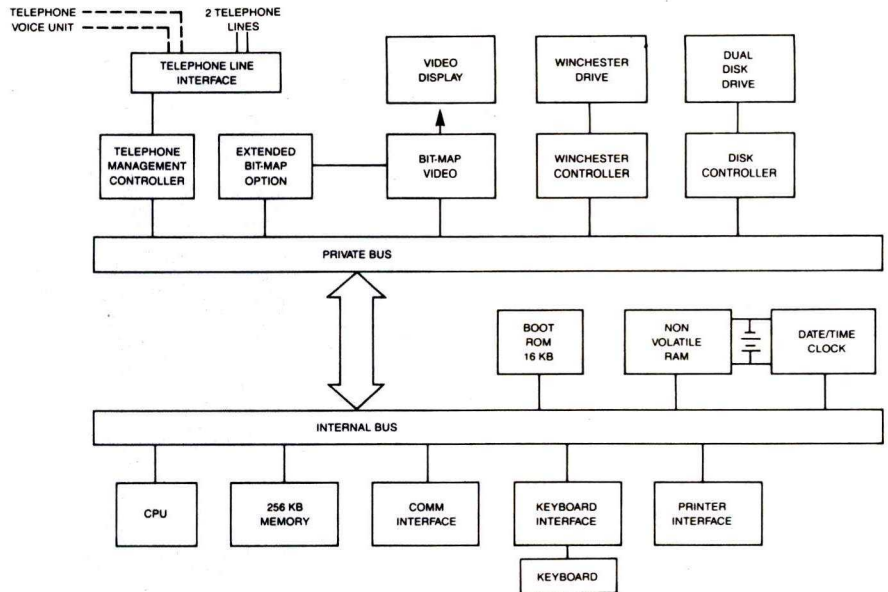


Figure 1: A block diagram of the Professional 350 system.

The Professional's designers assumed that managers and office workers rarely work alone. Instead, they spend their time communicating with others and accessing data from larger computers, activities that require powerful and concurrent communications facilities. The standard communications port on the Professional handles asynchronous or synchronous communications. By using available software, the system manages VT102, VT125, 3276 BSC, 3276 SNA, and 3780 communications. Other communications facilities are available as options. A real-time interface module provides an IEEE-488 bus interface, two EIA RS-232C-compatible asynchronous ports that are programmable from 50 to 9600 bps, and a 24-bit bidirectional parallel port. An Ethernet connection is also provided at the rear of the system unit, although currently that connection is supported by neither an option card nor software.

A 12-inch monochrome monitor and a 13-inch color monitor are available for the Professional Series. The standard monochrome video controller provides full bit-mapped graphics with 32K bytes of memory on the board, supporting a 960 by 240 pixel (picture element) display. An

extended bit-mapped option provides memory for two additional bit planes as well as RGB (red-green-blue) control for the color monitor. Both monitors are designed to be as small as possible to keep the computer system's footprint—the size of the surface it occupies—as unobtrusive as possible.

The keyboard was designed to meet three major criteria: it must conform to international standards, accommodate Digital's multinational character set, and provide user-defined function keys. Using these criteria and basing their work on ergonomic studies, the designers provided 105 keys and separated them into four logical groups. A main typing array of 57 keys conforms to the international touch-typist layout. Immediately to the right of the main keyboard are the editing pad and the cursor-control keys. The most commonly used editing keys—Find, Insert, Remove, Select, Next Screen, and Last Screen—are located just to the right of the main array. The cursor controls are arranged in an inverted T, the most efficient configuration for touch-typists. To the right of the cursor controls is an 18-key numeric pad that makes it possible to enter large amounts of numeric data

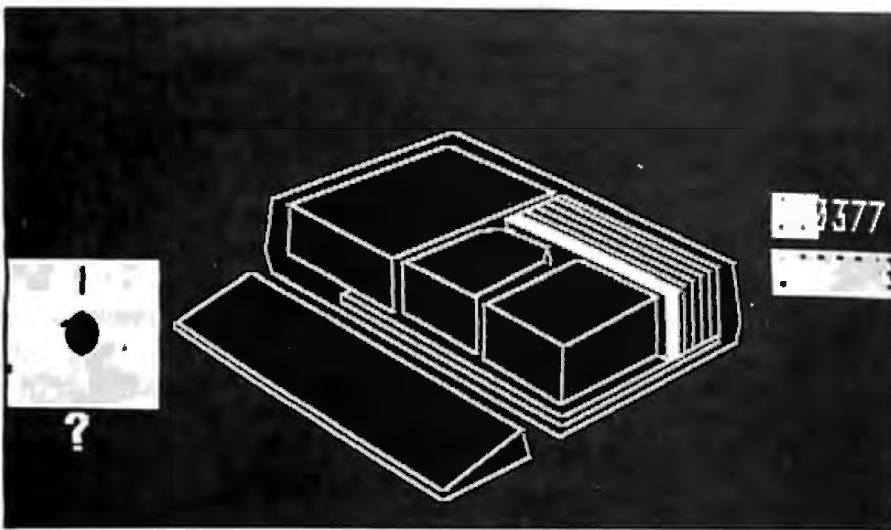


Photo 4: The use of graphic error messages is another example of the designers' goal of reducing the confusion and complexity often associated with computers.

quickly. The pad layout is compatible with all existing software dependent on Digital's VT100 keypad arrangement. Across the top of the keyboard is a row of 20 function keys. Applications programmers can program all but four of these keys. Digital's designers also provided a special windowed area at the top of the keyboard for key labels. Digital did extensive tests with computer novices to help ensure that the functions of the keys are obvious from their labels.

### User Interface

Digital made a concerted effort on the design of the user interface for this family of personal computers. In all aspects, from installation and maintenance features to the operating system, the designers anticipated prospective users' habits and needs. A novice user can install the hardware, the operating system, and application software and do minor maintenance without technical help. The system components assemble quickly. For example, you simply connect the keyboard to the monitor with a cable, connect the monitor to the system unit in the same way, plug the power cord on the system unit, insert the Winchester disk, plug into an AC power outlet, and hit the switch. The option cards were designed with zero-insertion-force connectors and install on a system bus designed to eliminate the need for switches and jumpers.

The Professional's CTI system bus

has many notable features. Like the older LSI-11 bus, the Professional's system bus has 22-bit addressing and multiplexes addresses and data by combining 16-bit data signals with the 22-bit address signals on 22 signal lines. Each option module installed on the bus generates two different hardware-interrupt signals with an associated register indicating the memory location of the interrupt-handling routine associated with this signal. The design of the interrupt-handling hardware makes the interrupt priority independent of the slot position.

When the user installs a module, an option-present signal alerts the main system logic module. Because each option contains identification information in ROM, the system easily locates and identifies all installed options. Each bus slot has a fixed address, and an option card assumes the address of the slot it occupies. And except for the hard disk and the floppy-disk controllers, any option card works in any slot.

The installation of the operating system is equally simple. A series of copies from floppy disk to hard disk with software prompts guide the way. Application programs use a similarly simple procedure under control of an automatic installation utility. The Professional 350 also offers diagnostics both in ROM and on disk that run every time the system boots. The diagnostics for the main system

logic run first and are followed by a segment that detects which options are installed. Then diagnostics on each module transfer to RAM to be run by the central processing unit. Error messages take advantage of the machine's bit-mapped graphics by drawing a picture of the system and highlighting the failing component in reverse video (see photo 4). All the system's modules can be replaced and can be removed either with fingers or a ballpoint pen. These features reflect Digital's belief that a user who has to call a technician soon becomes convinced that the computer is complex and difficult to use.

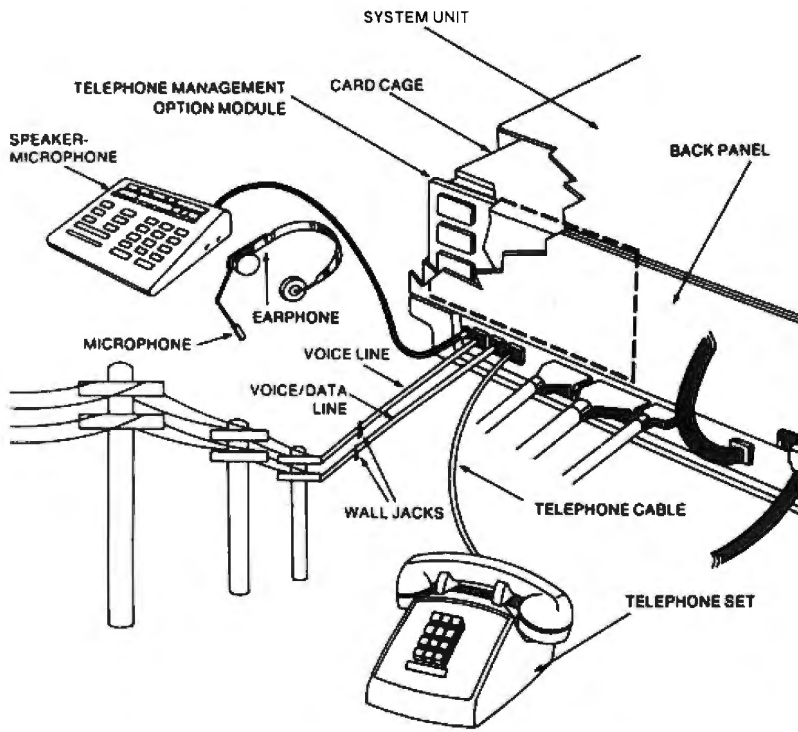
### Software Availability

Digital's design goals are further evident in the company's three-pronged software effort: the Professional Operating System (P/OS), the Professional Developer's Toolkit, and third-party application programs.

The operating system is derived from Digital's RSX-11M+, an event-driven multitasking software system. The design team regarded multitasking capabilities as mandatory. As the personal computer becomes an integral part of the professional's working patterns, the designers reasoned, the machine must function in the same manner as its user, which means working at multiple tasks.

Throughout the design process, the goal of a consistent user interface was cardinal. Today, some operating systems force users to have as many different interfaces as they have application packages. Digital believed that a continual proliferation of interfaces would impose a major constraint on the perceived usefulness of personal computers. P/OS removes that constraint by making it simple for programmers to work with a consistent user interface that controls every application on the system. The combination of multitasking, the user interface, and published standards, tools, and guides for application is a design that responds to the needs of the Professional's market.

In the initial release of the operating system, a single menu-tree structure, help-message handler, error-message handler, and a common file



**Figure 2:** The Telephone Management System incorporates voice and data communication through telephone connections.

menu. During this process you can also rename that application program or position it at a particular place in the menu tree. All of the application programs Digital developed use this same installation approach. One advantage of a consistent user interface is that you can get online help at any time simply by pressing the Help key.

Other P/OS features include a file-structure protocol identical to that on PDP-11 and VAX systems, which makes file transfers between the Professional and those systems much easier. A set of file services, print services, disk utilities, and a memo editor called PROSE are included with the operating system. The designers also furnish an interactive BASIC interpreter, PRO/BASIC, to meet the user's everyday programming requirements. PRO/BASIC is a compatible subset of Digital's BASIC-Plus-2 and VAX-11 BASIC, the only exception being that the PRO/BASIC has additional graphics commands. Features of the language include 31 character variable names, extended IF...THEN...ELSE statements, single and double precision, program chaining, and online help.

### Development Tools

For special applications that require the user to design custom software, Digital has provided the Professional Developer's Toolkit. This package of tools lets a programmer use the power and resources of a VAX or PDP-11 minicomputer to write programs for the Professional Series microcomputers. The Toolkit supports seven languages (see box on page 102) and contains programming utilities RMS (Record Management System), FMS (Forms Management System), and CGL (Core Graphics Library).

In a typical development scenario on the Professional, a programmer enters and edits source code using PROSE. Then the programmer uses the communications utilities provided with the Toolkit and takes advantage of the identical file structure protocols to pass the source code to a larger PDP-11 or VAX system. The minicomputer compiles the code and transmits the result back to the Professional system, where the program-

Application	Product; Company
Word processing	Prose, Prose Plus; Digital Equipment
Calendar/tickler	Executive Desk Set; Cortex
Spreadsheet	Advanced Visicalc; Visicorp
Graph	Visiplot/Visitrend; Visicorp. Corgraph; Cortex
Decision support	MAPS; Ross Systems
Project management	micro/MAPPS; Structural Programming Inc.
Data management	Visifile; Visicorp. NPL; Desktop Software
Statistics	SPSS; SPSS Inc.

**Table 1:** Professional Series users have access to these application software packages, which incorporate the consistent user interface.

structure characterize the user interface. While the hardware architecture makes it possible to take advantage of windowing and various cursor-positioning schemes such as mice or bit pads, the software design team felt that the first priority should be establishing a consistent interface. The other options will evolve as users demand them.

For an example of how the user interface works, consider what happens

when you want to use a new application package on the Professional system. First you insert the disk and call the automatic application installation utility, which copies the program into the program library. At the same time, the utility copies the error messages into the appropriate library, puts text in the help library, integrates the application's menu into the menu tree, and places the name of the application package in the main

# IN 1982, THE COMPETITION WAS BUSY TRYING TO COPY THE SemiDisk™



## WE WERE BUSY, TOO

They say a moving target is harder to hit. Well, we've been moving very fast recently. Last year we introduced the **FIRST** and, until now, the best dedicated disk emulator ever designed for S-100 microcomputers, with unparalleled price and performance, the SemiDisk I. The original. Naturally, we had imitators. But nobody managed to duplicate SemiDisk's features, let alone improve on the idea. And now the original is even better: only \$1495 for 512 Kbytes, including the sophisticated SemiSpool print-spooler software system (only \$2350 for 1 Mbyte). Far better performance for much less money.

But we couldn't stop there. So we designed the S-100 SemiDisk II. It includes powerful features, such as storage capacity of up to 2 Mbytes per board, 8 Mbyte total disk size, automatic power-fail check and battery backup provision, and on-board hardware parity checking for exceedingly fast operation. Features the competition can only wish they could offer. And at \$1795 for 512K (\$2650 for 1 Mbyte), it still costs less than inferior imitations.

Twice as fast as the SemiDisk I, SemiDisk II runs wide circles around hard disks, and blows floppies off the road. Needless to say, it leaves the competition crawling in the dust. So if you want the benefit of truly extraordinary computer performance, you'll find it in the SemiDisk II.

Make no mistake about it, SemiDisk II is the fastest, highest density, easiest to use, most compatible, most cost-effective microcomputer disk emulator ever built. And considering the SemiDisk I, that's really saying something.

SemiDisk

It's the disk the others are <sup>still</sup> trying to copy.

## SemiDisk Systems, Inc.

P.O. Box GG Beaverton, OR 97075 (503) 642-3100

Call 503-646-5510 for CBBS™/NW, a SemiDisk-equipped computer bulletin board.

SemiDisk trademark of SemiDisk Systems, Inc. Copyright © 1983 SemiDisk Systems, Inc.



The Professional Developer's Toolkit supports these languages:

**BASIC-Plus-2** is an extended BASIC compiler that offers structured programming constructs; access to global variables, functions, and constants; and support for implicit or explicit data types.

**FORTRAN 77** is an extended implementation of the ANSI (American National Standards Institute) subset Fortran-77 standard (X3.9-1978). Professional Tool Kit FORTRAN-77 contains many of the full-set language features and extensions not included in the standard. Full-language features include double-

precision and complex data types, intrinsic functions, exponentiation forms, format editor descriptors, and generalized DO loop parameters.

**COBOL 81** is based on the 1974 ANSI COBOL Standard (X3.23-1974) and includes some of the features planned for the next standard.

**DIBOL** allows for the use of P/OS system services while maintaining many of the standard DIBOL features found on VAX/VMS, RSTS/E, CTS-300, and CTS-310.

#### Professional Macro Assembler

**Pascal** is a true optimizing compiler with an extended implementation of the Pascal language. The extensions assist the application programmer in accessing P/OS system services and simplify application design. Extensions include ISAM (indexed sequential-access method), separately compiled procedures, sets of up to 256 elements, 31 character identifiers, FIND and LOCATE I/O procedures, and an OTHERWISE clause for the CASE statement.

C (available from Whitesmiths Ltd.)

mer uses an interactive debugger to refine the program. Later, the programmer uses the frame-development tools to create menus and error messages for the program. Additionally, an application-builder program creates floppy-disk copies for distribution. Finally, the programmer may develop algorithms that use the identification number located in ROM to combat software piracy.

A Toolkit style guide helps programmers maintain the consistency of the user interface. For example, execution of a command should be initiated by pressing the DO key rather than Enter or Return. Digital's design goal is that end users will get some applications programs from Digital, some from their own programming staff, and some from third-party vendors, but all the programs will look and act as if they came from the same programmer. Already, Professional Series users have access to software that has been developed with the consistent user interface (see table 1). Much of this application software is also available for both the Professional and Digital's larger systems, and the common file structure provides an easy migration path to established minicomputer software.

#### Telephone Management

In another example of designing a personal computer around the work habits of the user, Digital introduced a Telephone Management System

(TMS) option (see figure 2). A potential user of the Professional system probably spends at least 20 percent of the day on the telephone. That time can be made more productive by using TMS, which lets the computer maintain a personal directory of numbers, dial calls, log and file messages, and answer the phone when necessary. Additionally, TMS can provide facilities for dictation and transcription. Perhaps most impressive is that the TMS hardware will support *composite documents*, which combine text, graphics, and voice—which are necessary components of the automated office.

The TMS has three components: a controller board that fits into the option-card cage of the system unit, an attachment plate that goes on the rear of the system unit, and an accessory box designed to resemble the keyboard. The controller board contains most of the TMS logic, including the modems, DTMF transceiver, tone-detection circuitry, and Codec, a voice encoding and decoding chip.

Bell Laboratories' 103J/212A equivalent modems provide the user with 300- or 1200-bps (bit-per-second) data communication over standard telephone lines, and Touch-Tone signals can be transmitted with the DTMF transceiver. The tone-detection circuitry detects dial, busy, and ring-back tones. Analog voice signals from the telephone line or voice unit are converted into digital

signals by the Codec circuitry. These signals can then be stored on the Professional's Winchester disk, on a file server, or on a larger system. The process also reverses to reconstruct analog signals from transmission on the phone line or voice unit. A CVSD (continuously variable slope delta modulation) 32K-bps encoding scheme maintains high-quality voice playback.

A plug-in attachment on the back of the system provides modular-jack connections for two telephone lines, allowing the user simultaneous voice and data connections. Additionally, this attachment provides the necessary connections for the user's telephone and the optional voice unit, which contains a full telephone dial pad, conference phone buttons, and dictating-machine control keys. The unit also has a speaker and a microphone.

The TMS hardware operates through a standard handset or an external speaker. In combination with an optional communication-services software package, the user can maintain a personal calling directory and automatically invoke dialing of either voice or data calls. The communications software also provides for VT102 and VT125 terminal emulation using the TMS modems and permits file transfer between other Professionals as well as to RSX and VMS systems. The hardware's potential, however, still remains to be reached,

Text continued on page 106



# AST & PCnet™ for IBM® PC



PCnet is the first local area network designed specifically for the IBM Personal Computer. It consists of the necessary hardware and software to set up a powerful, yet cost effective local area network for the IBM PC. While others make claims, PCnet is a local area network proven to be successful by hundreds of installations in IBM Personal Computers.

Circle 3 on inquiry card.

**AST RESEARCH INC.**

2372 Morse Avenue, Irvine, CA 92714

Telephone (714) 540-1333

Call or write for immediate response.



**AST & PCnet Hardware:**

- CSMA/CD LAN technique
- 7000 feet max. distance
- Low cost CATV Coaxial cable as medium for transmission
- 1 Megabit per second transmission
- Optional Mainframe connection (e.g., AST-SNA; AST-5251; AST-3780 etc.)

**AST & PCnet Software:**

- Disk Sharing
- Unlike other networks,

PCnet does not demand expensive file server or proprietary hard disk systems for disk sharing. Almost any PC-DOS compatible hard disk including IBM's can be used for disk sharing

- File locking Provides locking to common data files so that common files are only accessed by one user at a time
- PC Sharing (Multi-tasking) Allows user on 1 PC to run command on another PC in the same network

as if the command had been entered on that PC's keyboard

- Printer Sharing Allows PCs to share printers installed in other PCs.

**AST & PCnet Future Products:**

- Universal File Server
- Gateway

**Other AST Products**

- I/O Plus II
- MegaPlus
- ComboPlus
- PlusModem
- Etc....

# A DEC on Every Desk?

---

John J. Snyder, Ph.D.  
POB 6046  
Boulder, CO 80306

---

Each floppy disk has 180K bytes of storage, and the system can access up to four drives in two enclosures.



The VT180



The Rainbow 100



The DECmate II



The Micro/PDP-11.

Digital Equipment Corporation has developed an entire line of microcomputers to meet the needs of a variety of users. In addition to the Professional Series, the following machines are available:

- The VT180, an 8-bit microcomputer based on the CP/M operating system and floppy-disk drives
- The Rainbow 100, a dual-processor 8-bit and 16-bit microcomputer based on CP/M, CP/M-86, and MS-DOS operating systems with an optional hard disk
- The DECmate II, a 12-bit microcomputer with an optional hard disk; compatible with Digital's vintage line of workhorse PDP-8 minicomputers
- The Micro/PDP-11, a 16-bit multi-user microcomputer with a built-in hard disk, also compatible with Digital's line of PDP-11 minicomputers; runs six of the PDP-11 operating systems (see table 1 for a comparison of the Digital lineup).

## The VT180

The VT180 Personal Computing Terminal is Digital's entry-level microcomputer and has been available since early last year. Actually, the name VT180 is an unofficial designation for the combination of a standard VT100 terminal with the VT18X option. Although the VT100 is a "smart" terminal, it is not user programmable in terms of applications software. The VT18X option for the VT100 terminal consists of two circuit boards that fit inside the terminal and a pair of 5¼-inch floppy-disk drives in a separate low-profile enclosure.

The resulting VT180 contains a standard Z80 microprocessor running at 2 MHz with 64K bytes of RAM (random-access read/write memory).

## The Rainbow 100

The Rainbow 100 is a dual-processor model featuring both the 8-bit Z80 and the 16-bit 8088 microprocessor chips. This machine's distinctive appearance is highlighted by the long, very thin, detached keyboard and a video display in a truncated pyramid barely larger than the monitor tube itself.

The unit also has an overgrown attaché case, which doesn't always appear in the ads. The system unit contains the processors, memory, disk drives, power supply, and slots for three option cards in a case that measures 19 by 14.3 by 6.6 inches. The unit can be mounted horizontally on a desktop or, even better, vertically on a floor stand to save valuable desktop space.

The Rainbow 100 uses Digital's special CP/M 86/80 operating system. This system automatically senses whether an application program has been written in CP/M-80 (for the 8-bit Z80) or in CP/M-86 (for the 16-bit 8088) and then executes the program on the appropriate microprocessor. MS-DOS, from Microsoft, will also be available and will offer the possibility of running software developed for the IBM Personal Computer.

The standard Rainbow 100 starts with 64K bytes of main memory, expandable to 256K bytes. The dual floppy-disk drive stores 400K bytes on each disk and uses one spindle motor to spin both disks. And the size of this package is identical to a standard single-disk drive. A second dual-disk drive as well as a 5-megabyte Winchester hard-disk drive may be installed in a separate cabinet. Color and bit-mapped video graphics options are also available.

## The DECmate II

The DECmate II resembles the Rain-

Specification	VT180	Rainbow 100	DECmate II	Professional 325	Professional 350	MICRO/PDP-11
Word size	8-bit	8-bit and 16-bit	12-bit	16-bit	16-bit	16-bit
Processor	Z80	Z80 and 8088	DEC 6120	LSI-11/23-Plus	LSI-11/23 Plus	LSI-11/23-Plus
Main memory (bytes)						
Standard	64K	64K	96K (64K words)	256K	256K	256K
Maximum	64K	256K	96K (64K words)	512K	1 megabyte	4 megabytes
Operating system(s)	CP/M	CP/M-86/80 (combined 8- and 16-bit CP/M), MS-DOS (16-bit)	WPS-8, COS-310	P/OS (from RSX- 11M-Plus)	P/OS (from RSX- 11M-Plus)	CTS-300, DSM-11, RSTS/E, RSX-11S, RSX11-M, RSX11-M- Plus, RT-11, Unix*, others
Optional coprocessor	—	—	Z80	Z80	Z80	—
Private memory	—	—	64K	64K	64K	—
Operating system	—	—	CP/M	CP/M	CP/M	—
Expansion slots	—	3	3	1	4	6 (dual LSI-11 cards)
5¼-inch floppy disks						
Number (std-max)	2-4	2-4	2-4	2-4	2-4	2
Storage per disk	180K bytes	400K bytes	267K words	400K bytes	400K bytes	400K bytes
Maximum storage	720K bytes	1.6 megabytes	1.1 megabyte words	1.6 megabytes	1.6 megabytes	1.6 megabytes
8-inch floppy disks						
Number (std-max)	—	—	0-2	—	—	—
Storage per disk	—	—	128K words	—	—	—
Maximum storage	—	—	256K words	—	—	—
5¼-inch Winchester disk						
Availability	—	optional	optional	(must upgrade to 350)	optional	standard
Storage	—	5.0 megabytes	5.0 megabytes		5.0 megabytes	10.0 megabytes
Ports						
Serial**	2	2	2	2	2-3	6
External disk	—	—	—	—	—	1
Graphics						
Colors	—	16 or 4 from 8	4 from 8	8 from 256	8 from 256	(via optional graphics terminal and software)
Resolution (characters)	80 by 24	320 by 240 or 800 by 240	320 by 240	960 by 240	960 by 240	
Prices						
Base	\$1795 (plus VT100 terminal)	\$3495	\$3745	\$3995	\$4995	\$10,225 (without any terminals)
5-megabyte Winchester	—	\$4200	\$4000	(upgrade to 350)	\$3500	(10-megabyte Winchester standard)
CP/M module	—	—	\$495	\$695	\$695	—

\*Unix and others are available from software houses.

\*\*One serial port is for a printer and a second is for data communications with modem control.

**Table 1: An overview of six microcomputers from Digital Equipment Corporation.**

bow 100 but is a very unique micro-computer in its own right. It uses Digital's proprietary 12-bit 6120 micro-processor, which executes the instruction set of the PDP-8 minicomputer family. The operating systems are Digital's WPS-8 Word Processing System and COS-310 Commercial Operating System, featuring DIBOL (Digital's Business-Oriented Language, similar to

COBOL). With the addition of a Z80 microprocessor on a circuit card, the DECmate II can also run a CP/M program while the 6120 processor runs another application.

Like the Rainbow, the DECmate II comes with a dual-disk drive that stores 400K bytes on each 5¼-inch floppy disk. Another dual-disk drive may be installed in the main cabinet. In

separate enclosures, a 5-megabyte Winchester hard disk and a pair of 8-inch DEC-compatible (RX02) floppy-disk drives may be included in the system. The 8-inch drive controller permits direct transfer of information to and from the earlier DECmate I machines. A graphics option of four

Text box continued on page 106

Text box continued:

simultaneous colors is also available. With the standard DECmate II screen, the colors appear as different shades of gray. A color monitor will soon be available.

### The MICRO/PDP-11

The MICRO/PDP-11 is basically a more powerful multiuser version of the Professional 350 with 6 serial lines, each of which supports a terminal, printer, or communication link.

The basic system comes with 256K bytes of main memory and an operating system license but without a terminal. Initially, Digital's popular VT100 series terminals are available for use with the system. Any of the Digital microcomputers mentioned above, with or without their own Winchester disks, can also be used as terminals.

Because the MICRO/PDP-11 will be serving as many as six users, it comes with a larger-capacity 10-megabyte Winchester hard disk. Along with the greater disk-storage capacity, the system can support up to 4 megabytes of main memory with its PDP 11/23 Plus processor. Again, a dual-disk drive is included (400K bytes of storage on each 5¼-inch floppy disk).

The MICRO/PDP-11 supports Digital's standard 16-bit PDP-11 minicomputer operating systems: CTS-300, DSM-11, RSTS, RSX-11S, RSX11-M, RSX-11-M-Plus, and RT-11. Unix and other operating

systems are available from software houses.

Digital also supplies several high-level language compilers including BASIC, COBOL, DIBOL, FORTRAN, MACRO, and Pascal. Virtually any available PDP-11 minicomputer software can be run on the MICRO/PDP-11.

The system cabinet for the MICRO/PDP-11 is somewhat larger than that for the Professional 350, so it can accommodate the larger-capacity 10-megabyte disk, larger power supply, and additional card slots for memory and other options. The backplane has slots for as many as 6 dual LSI-11 option cards. A wide variety of specialized options for the LSI-11 bus are available from Digital and other vendors. The unit measures 27 by 21½ by 6 inches. It can be mounted either vertically on a floor stand or horizontally. A rack mount kit is also available.

The CP/M Option Module consists of a Zilog Z80 microprocessor with 64K bytes of memory onboard. Included with the unit is a floppy disk containing the CP/M operating system. This option is available only for the DECmate II and the Professional Series, which do not come with a built-in Z80 processor. With the CP/M Option Module installed, the Z80 can run any of the popular CP/M software while the microcomputer's main processor is busy working on something else.

converted to digital signals and transmitted across Ethernet to a secretary's Professional Series system.

● **Transcription:** Using the earphone and foot pedal, which are available as accessories for the voice unit, a secretary can transcribe the dictated text.

● **Voice annotation on text:** Text being read from the video screen will be annotated simply by positioning the cursor where the comment is to occur. When the Comment key on the voice unit is depressed and the comment has been dictated, it will be converted from analog to digital signals and imbedded in the text. The technique can, of course, be used to edit text prepared by a typist.

● **Voice messaging:** The Telephone Management System, with proper application programming, will be able to accept and digitize voice messages. This ability permits the caller to dictate a message that can be appended to a text header prepared by the secretary. Under proper program control, the TMS system can alternately provide a complete telephone answering service.

### Conclusion

The Digital Professional Series family was designed to meet the needs of the modern business organization. Whether the need is for desktop computing power, personal computer clusters, or system-to-system communications, the 325 and the 350 offer functionality with ease of use. Perhaps most important is the Professional's ability to expand capabilities within a consistent user interface. ■

Text continued from page 102:

and the Professional's design ensures additional uses. The following applications can be expected in the near future:

● **Dictation:** A dictation wand can be obtained as an accessory for the voice unit. Using the wand, a manager will be able to dictate text, which can be

## BASIS 108

U.S. #1 DEALER FOR  
AUTHORIZED SALES & SERVICE

"COLOSSUS™ BASIS"

128K RAM; BASRAM 256K CARD;  
CP/M 3.0; APPLE DOS 3.3  
DR#1: RANA ELITE THREE 680K  
DR#2: SEAGATE 10MG HARD DISK  
METACARD - THE 16-BIT BOARD FOR MS-DOS;  
CP/M-86, UCSD PASCAL VER. IV  
COMPATABILITY

"BASIC BASIS"

128K RAM ON BOARD  
2 SIEMANS 40 TRACK DRIVES  
BASIS SYSTEM AUTO DIAGNOSTICS  
W/ CONTROLLER; CP/M 3.0; APPLE DOS 3.3

★ CUSTOM BASIS CONFIGURATION AVAILABLE ★

CALL FOR CONSULTATION & WRITTEN PRICE QUOTE  
48 HR. CONTINENTAL U.S. WARRANTY SERVICE  
REPLACEMENT. FREE 24 HR. SIGN ON TO OUR  
BASIS BULLETIN BOARD.

### STATE OF THE ART MICROS



1400 GRANT AVE., NOVATO, CALIFORNIA 94947

ORDER TOLL FREE 1-800-421-6594

IN CALIFORNIA CALL COLLECT 415-892-7139

CLIENT TECH SUPPORT 415-897-1414

BUY COMPUTERS FROM PEOPLE WHO KNOW HOW TO USE THEM.

SERVICES AVAILABLE: SOFTWARE APPLICATIONS • HARDWARE PERIPHERALS  
COMPUTER SECURITY • TELECOMMUNICATIONS • BUSINESS • SCHOOLS  
CORPORATIONS • CONSULTATION SERVICES • 24-HR. AIR EXPRESS AVAILABLE

Ask about our clients. All equipment tested prior to shipment.  
If you don't see it, please ask us.

## COLUMBIA

CP/M & IBM PC COMPATABILITY  
128K RAM, 8 SLOTS  
DUAL 320K DRIVES

EPSON PRINTERS • COMPUTERS  
HAYES MODEMS • THUNDERCLOCK  
NEC PRINTERS • MONITORS  
SOFTWARE BY MICROSOFT,  
MICRO PRO, SORCIM, PERFECT & MORE



Minimum order \$100. Cashiers checks and money orders accepted. Add 3% for Visa or MC. Add 3% for shipping/insurance/handling, UPS. No COD. Prices subject to change. Call to verify. Order hours 10-7PDT, Mon-Fri. Personal checks allow 20 days to clear. All products with full manufacturer's warranty, factory sealed. Calif. residents add 6% sales tax. Bank wires and P.O.s accepted. Retail prices may vary.

ALL BRAND NAMES ARE REGISTERED TRADEMARKS.



# Amdek's new business system meets your graphic needs

Amdek's Business System is designed to allow your IBM/PC to do more for you. This graphic system can document your data with pie, bars, horizontal bars, lines, points, areas or any combination of professional looking graphs.

## THE SYSTEM

### HARDWARE

Amdek Color II High Resolution Monitor  
 Amdek Model — DXY Plotter  
 Amdek Multiple Adapter Interface Board

### SOFTWARE

BPS Business Graphics™

### OPTIONAL HARDWARE

Amplot II Plotter — Automatic, 6 Pens  
 Amdisk III — 3" Microfloppy Disk Drive System

The system is designed to save you time and money, and to make the computer work for you.

Here's how it works: The computer's data appears on the Color II monitor and the Model DXY plotter will recreate the screen on a 10" x 14" format using the BPS Software.

It's easy to use — the system interfaces with the most popular software packages, including dBase II, VisiCalc, SuperCalc and WordStar. And it understands English, so there's no need to learn any foreign computer languages. It's fast — charts can be produced in about two minutes. It's powerful — the system with the MAI board will more than double the memory capacity of your computer. It's economical — the Amdek package will save you over \$800 on the individual components.

Now you can make sophisticated graphic presentations to your clients, customers and colleagues using your Amdek Business System.

\* BPS and Business Graphics are trademarks of Business & Professional Software, Inc.

\* IBM PC is a registered trademark of International Business Machines, Inc.

\* VisiCalc, SuperCalc, dBase II and WordStar are trademarks of VisiCorp, Sorcim Corporation and Ashton-Tate, respectively.

2201 Lively Blvd. • Elk Grove Village, IL 60007  
 (312) 364-1180 TLX: 25-4786

**AMDEK** CORP.

**Amdek . . . your guide to innovative computing!**

Circle 352 on inquiry card.

# How to get the best out of (and into) your computer.

You've invested in your computer to get data accurately, intelligibly. The modem is no place to compromise and slip in a weak link.

With Novation Cat<sup>®</sup> modems you don't. Our Cat line is a full one. At one end—our small, handy J-Cat. It purrs along at 300 bps, excellent for home use. At the other end, with all the features and conveniences you want for business—our full blown smart, automatic communication systems that can roar along at 1200 bps.

All have one thing in common—unique, highly advanced LSI chips. Our engineers have designed these little marvels, eliminating

the complexity and costs of typical modems, and producing instead modems elegantly simple in execution with absolutely state-of-the-art reliability and features.

There's nothing quite like working with the latest and the best. Come see.

The Cats are at leading computer stores.

---

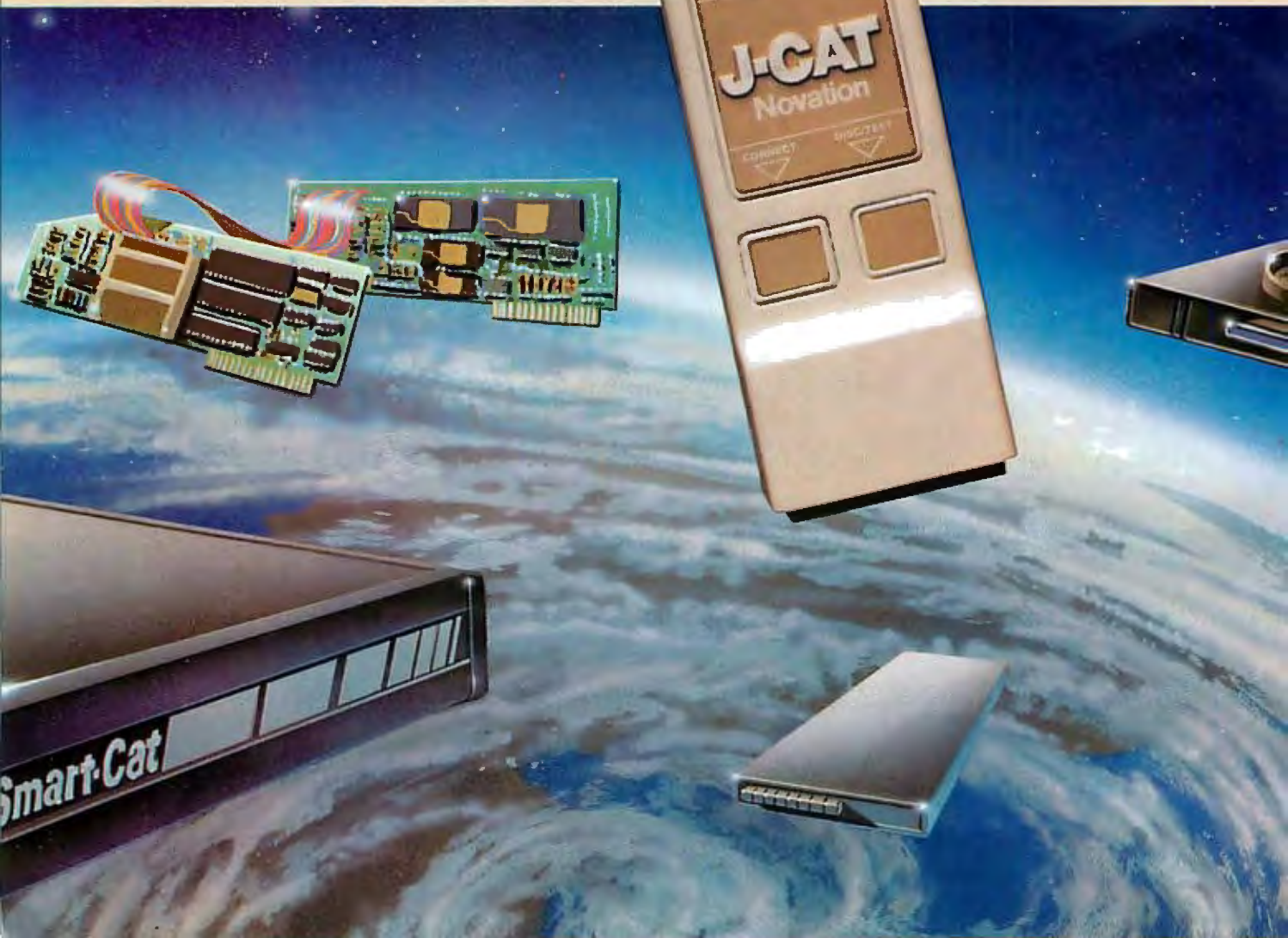
## There's another good reason to buy right now.

Tucked inside every Cat package, you'll now see a special "get acquainted" subscription to **The Source**<sup>SM</sup>. You might as well get started right.

---

### J-CAT<sup>TM</sup> MODEM

It's smaller. 1/5th the size of an ordinary modem. Easy to stick-on, tuck-in, put anywhere you want. Auto-answer. Also, no fussing to get into the right mode, answer or originate—J-Cat does it automatically. \$149\*



## 103 AND 103/212 SMART-CAT™ MODEMS



They do more, do it easier and do it in less space. And with LSI technology they run better and cooler—and will for years. Built-in dialer, redialing on busy signal, auto answer, plus extensive software command set.

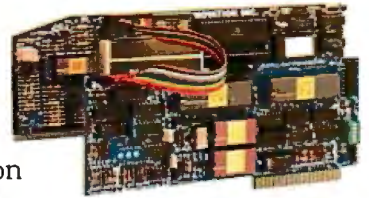
103 Smart-Cat (300 BAUD, full duplex) \$249\*  
103/212 Smart-Cat (300 or 1200 BAUD full duplex) \$595\*

## 212 AUTO-CAT™ MODEM



You get all the options of a full duplex Bell 212A compatible modem and more. It's an advanced modem with custom micro-processors and LSI circuits that have let us cut parts count and costs drastically—while improving performance in every way. Auto-answer and auto selection of 1200 bps or lower speed. Both synchronous and asynchronous. \$695\*

## APPLE®CAT™ II WITH 212 OPTION



Complete communication system for Apple owners.

Modular design lets you grow into—not out of—the system. Comes with excellent software—our own Com-Ware™ is a simple-to-use, menu driven terminal program. Full range of speeds up to 1200 bps. All auto functions—phone directory with auto configuration and auto dial, redial, answer, disconnect. Binary or text modes. VisiCalc™ and CP/M™ compatibility—and the list is growing. Installation can still be just one slot in your Apple II, even with optional 212 card. \$389\* and up.



*The recognized leader in personal communications.*

Novation, Inc., 18664 Oxnard Street, Tarzana, CA 91356  
(800) 423-5419 · In California: (213) 996-5060

Cat is a registered trademark of Novation. VisiCalc is a trademark of Personal Software, Inc. CP/M is a trademark of Digital Research Inc. Apple is a registered trademark of Apple Computer Inc. \*Suggested retail

Circle 286 on Inquiry card.



*B. DAVIL*

# Tight Squeeze

## The HP Series 200 Model 16

*How Hewlett-Packard crammed a powerful 16-bit microcomputer into a square foot of desk space.*

---

John Monahan  
Desktop Computer Division  
Hewlett-Packard  
3404 East Harmony Rd.  
Fort Collins, CO 80525

---

Although Motorola's powerful 68000 microprocessor may be fairly new to many people in the personal computer field, Hewlett-Packard has been using this processor in its desktop computers since 1981. Not only was HP one of the first large manufacturers to adopt the

68000, but last November, the company released its *fourth* 68000-based machine, the Series 200 Model 16 (see photo 1).

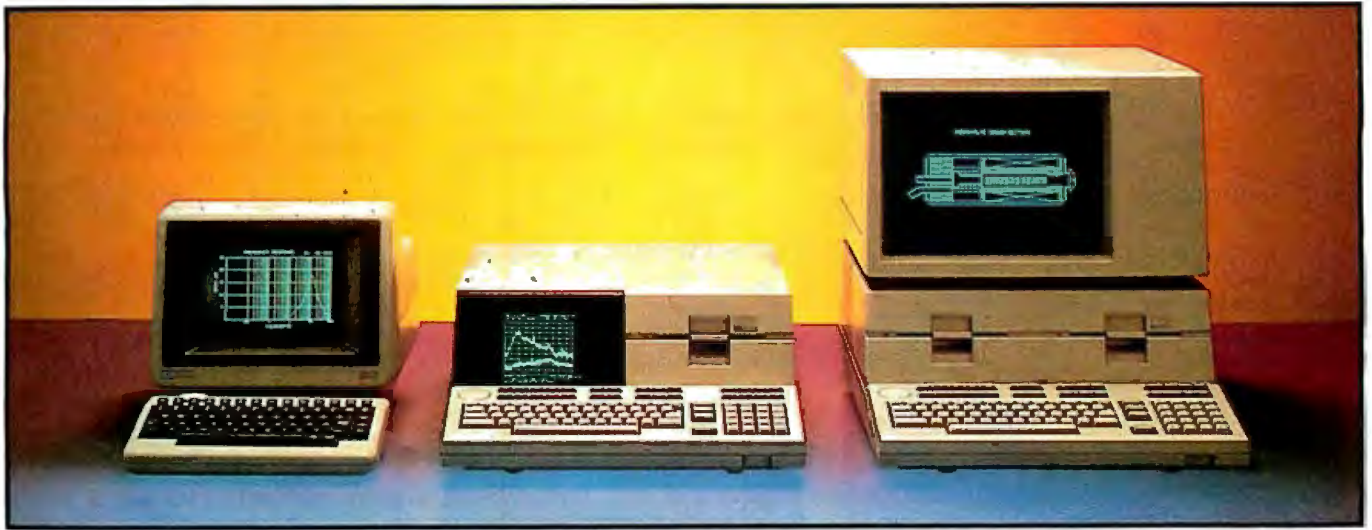
The Model 16 is intended to be a lion packaged as a house cat. In addition to its 16-/32-bit microprocessor running

at a clock rate of 8 MHz, this machine offers an RS-232C interface, an HP-IB (Hewlett-Packard Interface Bus, IEEE 488) interface, 128K to 512K bytes of volatile memory or RAM (random-access read/write memory) with provisions for up to 4 megabytes, a



**Photo 1:** The Hewlett-Packard Series 200 Model 16 microcomputer (formerly the HP 9816). Even with the optional dual microfloppy-disk drive (3½-inch disks), the unit is extremely compact.





**Photo 2:** The Hewlett-Packard Series 200 family. From left to right, the Model 16, the Model 26, and the Model 36. Each of these machines shares a common architecture based on the 68000 microprocessor. The Model 26, introduced in June 1981, is designed for computer-aided testing applications. The Model 36, introduced in January 1982, has a high graphics resolution for use as a computer-aided design workstation.

9-inch display with 400- by 300-pixel graphics resolution, a variety of mass-storage options (from 3½-inch floppy to 64-megabyte hard disks), and a large library of software already available. And thanks to an intricately designed printed-circuit board and Sony's new 3½-inch floppy-disk format, the Model 16 is probably the smallest desktop machine around.

To understand what the Model 16 does, it's important to know how it came about. The Model 16, originally known as the HP 9816, is the third member of the Series 200 family (see photo 2). First came the Model 26 (or HP 9826), which is primarily a rack-mountable, testing and data acquisition machine with several backplane slots (eight compared to the Model 16's two). Then came the Model 36 (or HP 9836), which has extensive graphics capabilities and two built-in floppy-disk drives. This unit is intended for engineers and scientists who design and analyze at their desks or laboratory benches.

The Model 16 was designed to perform all the technical tasks of the 26 and 36 and to be software-transportable with them and with HP's 32-bit workstations in the HP 9000 computer family. The Model 16, however, is packaged and priced as a personal computer for more general use. The basic unit, with 128K bytes of memory

and no disk drives, is \$3985. Because its 16-bit architecture greatly increases the speed of software packages such as Context MBA and Visicalc, the Model 16 is now finding its way into business applications as well as the analytical applications that have been HP's traditional market.

I'll now relate how HP came to select the 68000 microprocessor for its line of 16-bit microcomputers and implement it in Series 200 machines. I'll also discuss the Model 16 itself, including its growth potential, hardware packaging, and peripheral compatibility.

### The First Step

In 1979, HP's Desktop Computer Division in Fort Collins, Colorado, conducted a study to determine which microprocessor should be used in a new test/control computer, the HP 9826, which would later become known as the Model 26.

According to Sandy Chumbley, then research and development manager for the Model 26, "There were two primary factors that led to the 68000. First, we had a design objective to develop a product with two times the performance of the machine it was to replace [the HP 9825].

"Second, we were designing a pretty sophisticated software system and believed that the 68000 was a better fit for what we were trying to accomplish."

In May 1979, when HP started looking at the 68000, the company already had a Model 26 design and a fairly good prototype based on the Intel 8086 processor. However, it became apparent to software engineers that the 8086 would not meet performance expectations because its address space was segmented into 64K-byte blocks and provided only 1 megabyte of total address space.

"We were design-centered around the BASIC interpreter," Chumbley says, "so we did some extensive analysis on the 68000, the 8086, and an HP-built processor. The 68000 turned out to be faster than either one by a factor of 1.5 to 2.0." Also, the 68000, with its 24-bit address bus, offered a 16-megabyte linear address space that made coding much easier. And like the 8086, it provided memory-mapped I/O (input/output). This meant that memory or I/O cards plugged into the backplane could be mixed and matched without special instructions or signals.

Other advantages engineers saw in the 68000 were its 16-bit external data bus; its 32-bit internal data bus; its instruction set with 14 addressing modes and 5 main data types; its 8-MHz clock rate; and its 17 registers, each containing 32 bits (in addition to a 32-bit program counter and a 16-bit status register). Motorola's enhancement program for the 68000 chip was

Benchmark	Model 16 Integer	Model 16 Real	IBM PC MS-DOS 1.0	Victor 9000 BASIC-86, 5.21, MS-DOS 1.2	Apple II Plus Applesoft	TRS-80 Model II Model II Basic
empty DO loop	0.34	0.82	6.43	7.7	6.66	7.98
division	3.12	3.61	23.8	21.8	29.0	19.4
subroutine jump	1.02	1.50	12.4	16.9	13.9	17.1
substring	1.96	2.55	23.0	24.6	32.3	24.8
prime number program	13.27	18.64	190.0	197.0	241.0	189.0
disk write	70.0	—	32.0	50.3	175.0	—
disk read	40.3	—	22.9	21.3	217.0	—

**Table 1:** BASIC language benchmark results. All times are given in seconds. The benchmark programs employed are the same as those used in previous BYTE articles (see January 1982, page 54, and November 1982, page 246). Benchmarks for the Model 16 were run with looping variables in both real and integer formats for comparison. Data for machines other than the Model 16 is from the November 1982 issue of BYTE. Note that with the large memory of the Model 16, disk write and read operations could be improved to about 6 seconds by using two 32K-byte character strings.

another plus. In the future, Series 200 products will be able to evolve as the main processor family does.

To illustrate the power of the 68000 processor, we have compared the Model 16 with several other personal computers (see table 1). For the comparison we used a series of BASIC benchmark programs and results that appeared in the November 1982 BYTE (page 246).

### The Footprint Feat

For all its power, the Model 16 takes up about as much desk space as an "in" basket (see table 2). Its "footprint" is 1.7 square feet. HP also supplies a "garage," to be placed under the unit, for the keyboard. When the keyboard is "parked" in this garage, the Model 16's footprint is 1 square foot exactly.

To ensure that the Model 16 would have such a small footprint, HP decided to package the Model 16 in the same case as the HP 2382 terminal. But despite this small size, the computer's architecture could not be compromised, nor could costs be increased.

"We looked at a number of alternative architecture implementations," says Joe DeWeese, then project manager for the Model 16's hardware, "and decided that one main board containing the majority of the functionality was the best solution in terms of cost, reliability, and serviceability."

This decision posed some real chal-

lenges for the man chosen to design the microprocessor board, Lyle Frey. "There was a lot of interplay in the selection of parts and, to some extent, the function of the board," Frey says. "Many of the features were negotiated by what would fit," he adds. "In fact, many of the parts for the original board didn't fit, so they were implemented differently."

Packaging requirements further complicated the board's design. For instance, the case for the HP 2382 terminal offered no provisions for physically supporting processor boards

vertically (the 2382 was designed for horizontal boards). This was remedied by installing two horizontal boards and plugging the vertical boards into them.

Cooling problems were solved by using the processor and video-display boards to direct the air flow of the cooling fan. Also, cut-outs were designed into the boards so that air could flow through them. After considerable testing, a board arrangement was devised that directed the air in a U-shaped pattern—an air plenum—so that there was less than a 15-degree Celsius internal rise in temperature under worst-case conditions.

The result of our work was an eight-layer circuit board for the main processor, with special integrated circuits that allow a chip density equivalent to two ordinary integrated-circuit chips per square inch, making it perhaps the densest board in any personal computer today. It slides out of the Model 16 without requiring the removal of other boards. Furthermore, it's totally operational with just a 2-pin power connector (5 volts and ground). Photo 3 shows the 9-inch by 10.3-inch board with its 125 special-purpose integrated circuits.

"What's impressive about the design," says Frey, "is not so much high technology as the fact that we stayed within PC [printed-circuit] board design rules and manufacturing techniques shown to be reliable and still

Computer	Footprint (square inches)
HP Series 200 Model 16	238
IBM Personal Computer	420
Victor 9000	310
Apple III	361

**Table 2:** Footprint comparisons. The Model 16's footprint is an incredible 238 square inches (1.7 square feet), which makes it a little over half the size of the IBM Personal Computer. To make the footprint even smaller, a keyboard "garage" is available to allow you to "park" your keyboard underneath the system when not in use. This brings the footprint down to 144 square inches (1 square foot).



A printer for your hand-held computer, telex communication, home computer, banking application, or medical instrumentation. Standard product comes with both Serial RS232 Asynchronous and centronic parallel printer interface.



**\$145**

**printelex** 

paper feed

- Serial transmission speed switch selectable for 110 Baud rate to 4800 Baud rate.
- Data transfer for speed at 160 CPS.
- Graphic capability, 280 dots across.
- Small enough to be hand-held, compact, slimline, lightweight, quiet, and portable.
- Ideal for Sharp, Epson HX20, Atari, T.I., or Commodore Computers.

**computer peripherals**

1117 Venice Blvd., Los Angeles CA 90015  
Out of State Call Toll-Free 1-800-854-7600 In California Call Toll-Free 1-800-922-1113  
Telex: 194561 LSA

Sharp, Epson Atari, T.I. And Commodore are trademarks of Sharp Corporation, Epson America Corp., Atari & Warner Communications Co., Texas Instruments, and Commodore Corp.

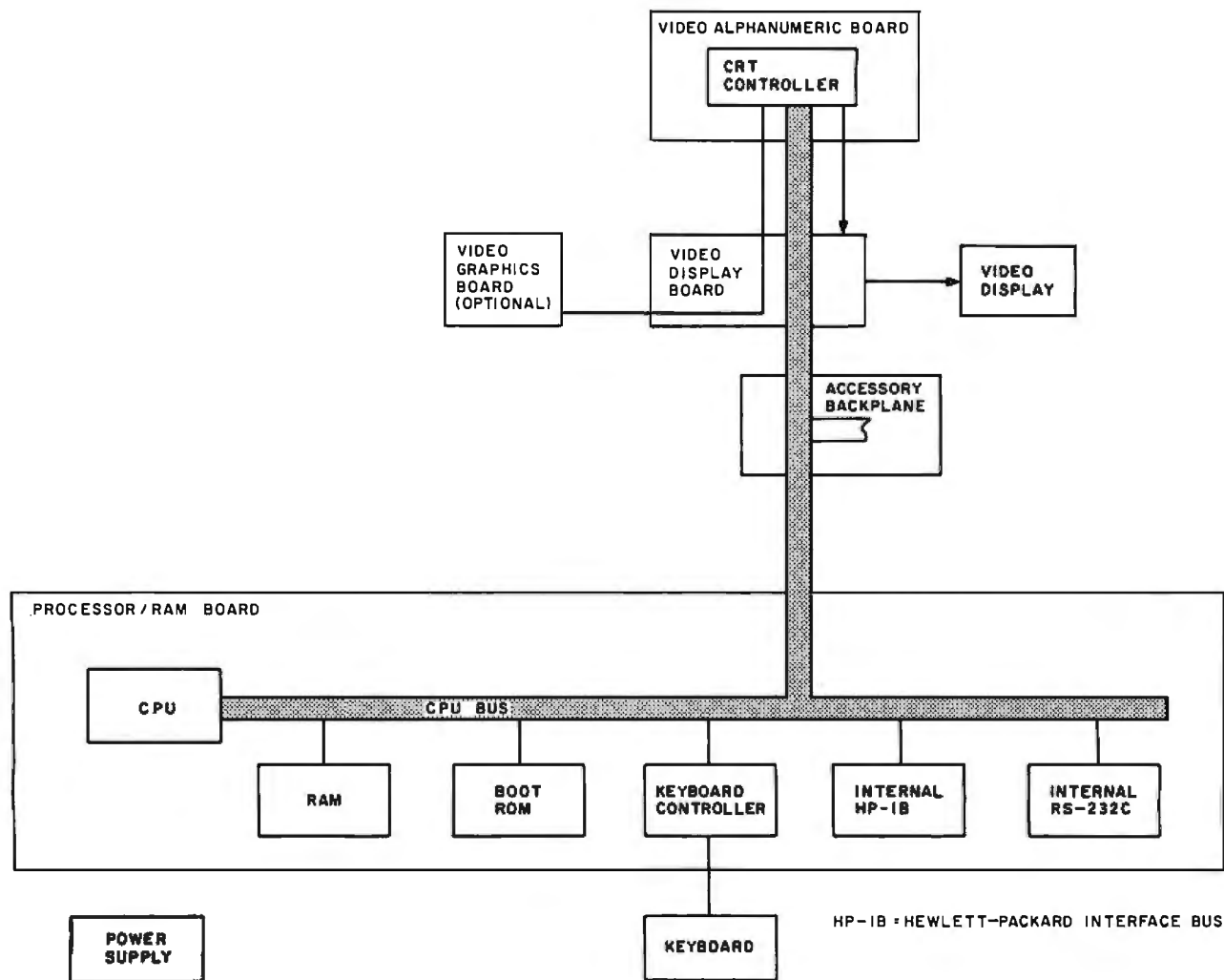


Figure 1: Block diagram of the Model 16 hardware system.

packed everything on such a small board."

Figure 3 shows the processor board's layout. It contains the entire central processor system, plus 128K or 256K bytes of RAM, an RS-232C interface, an HP-IB (IEEE 488) interface, the keyboard processor, connections for other boards, and either 16K or 48K bytes of bootstrap code in ROM (read-only memory).

### Getting the Boot

The bootstrap ROM performs two major tasks to ensure quality and flexibility. Task one is the testing of all hardware when the Model 16 is switched on. The results of this self-test are displayed on the video screen. If a noncritical resource has failed, the bootstrap ROM allows you to decide whether you want to continue opera-

tion. The ROM further tests and reports the status of all I/O or memory cards plugged into the rear expansion slots.

The second function the boot ROM performs automatically is to search all mass-storage devices connected to the Model 16 and to load the operating system that has been given the highest priority. Thus, you can store operating systems on any of several supported mass-storage devices. These devices include ROMs, floppy disks, Winchester disks, and disks on HP's Shared Resource Management network. Pressing any key on the keyboard during power-up signals the bootstrap ROM to list all operating systems available, so you can decide which one to load.

### Assuring Quality

Once the packaging problems were

solved, the final six months of development were spent building pilot production units for later evaluation in HP's STRIFE (stress and life) program. The idea behind STRIFE is to force failures by pushing products beyond "the edge of the envelope," as test pilots say.

In addition to the extensive environmental tests that HP performs, 3 of the 20 prototype Model 16s were subjected to simultaneous temperature, humidity, and power cycling conditions far beyond their specified tolerances. Design and component flaws that appeared even once in a single machine were analyzed and corrected in all 20. This method of failure acceleration uncovered about 20 problems that were solved before the Model 16 was released to production. Also, before public introduction, some Model 16s were placed in an office environment in

# Plot your next meeting yourself.

## Read how 2 pens can become your best presentation tools.

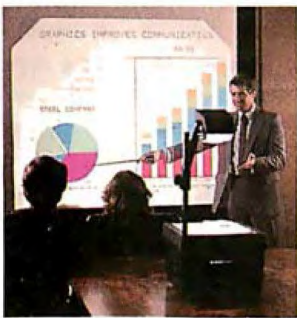
### Introducing the New Personal Computer Plotter from Hewlett-Packard.

Now you can use your personal computer to generate your own presentation charts, graphs, and pie charts. How? Simply add on the new high quality, low cost HP 7470A Personal Computer Plotter.

The 7470A helps you save time and save money, and lets you communicate quickly, accurately and *effectively*.

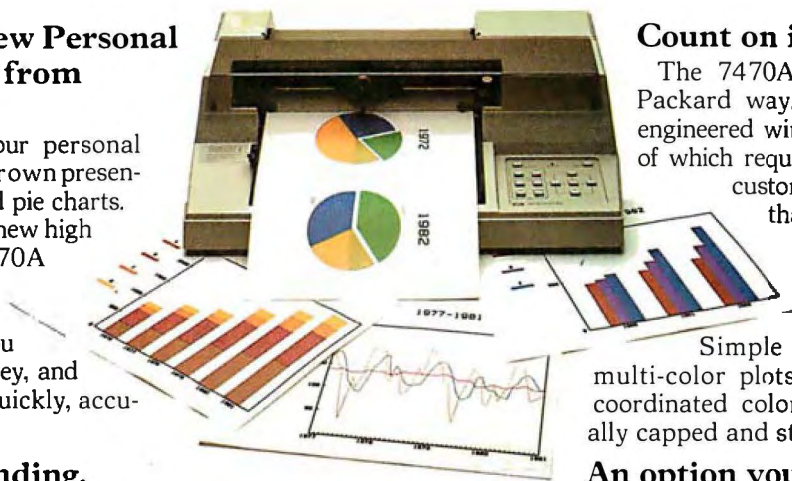
### Quicker understanding.

Data, when visualized graphically, becomes information fast. Charts and bar graphs can make any presentation clearer and more readily understood. But asking your staff to produce the graphics manually for your next presentation doesn't ensure accuracy or artistic talent. And going to outside graphics suppliers can be costly. Combined with your personal computer, the new HP 7470A plotter does the communicating for you. Quickly. Logically. And with off-the-shelf software available from most HP dealers.



### Fast and pretty.

The 7470A gives you high plotting speed with excellent line quality...faster than any competitive small plotter. On top of all that, it comes in an attractive design package that looks nice on your desk. And it does it for only \$1,575. (U.S.A. domestic suggested retail price.)



### Count on it.

The 7470A is built the Hewlett-Packard way. To last. Designed and engineered with only a few parts, none of which require adjustment. And with customized integrated circuits that ensure reliability.

### Pen pals.

The HP 7470A has two single-pen stables. Simple pen changes give you multi-color plots in your choice of ten coordinated colors. Pens are automatically capped and stored.

### An option you'll want, too.

For only \$95, you can also get a 17057 Overhead Transparency Kit that turns your plots into transparencies for overhead projectors. For "I need it tomorrow at 9:00 A.M.!" meetings, it's a necessity.

### Start plotting your next presentation today. Clip and mail the coupon below. Now.

Mail the coupon below and we'll send you—absolutely free—a sample plot, a more detailed brochure, and a sample overhead transparency.

Then...stop in at your nearest Hewlett-Packard Dealer. See the HP 7470A in action. Once you see it demonstrated you'll find a hundred ways to make your own applause-winning presentations.

*When performance must be measured by results*



Seeing is believing. Send me a sample plot, an overhead transparency, and more detailed information.

Name \_\_\_\_\_ Title \_\_\_\_\_

Company \_\_\_\_\_

Address \_\_\_\_\_

City, State & Zip \_\_\_\_\_

Phone Number ( ) \_\_\_\_\_

My computer is \_\_\_\_\_

Send to: Hewlett-Packard, 16399 W. Bernardo Drive, San Diego, CA 92127 — Attn: Nancy Carter

11203 BT6

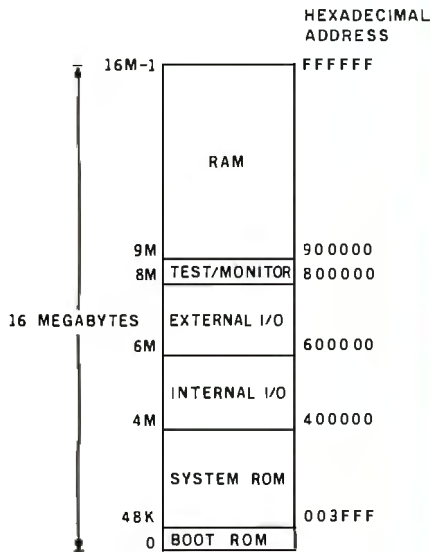


Figure 2: Memory map for the Model 16.

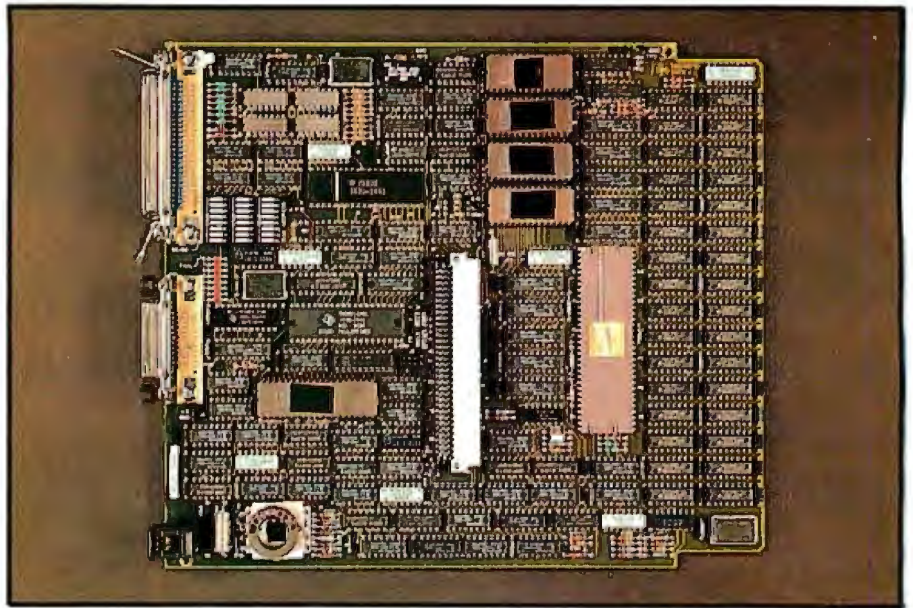


Photo 3: One of the most tightly packed boards in the microcomputer industry. The main processor board of the Model 16 is only 9 by 10.3 inches but contains 125 special integrated circuit chips, the equivalent of 185 normal (14- to 18-pin) chips. The result is a chip density equivalent to approximately 2 chips per square inch.

order to detect any flaws that might occur in a more normal situation.

### Decentralized Processing

Figure 1 describes the Model 16's internal architecture. All system resources are memory-mapped within the 16-megabyte address space of the 68000. This address map provides room for 7 megabytes of RAM in addition to all of the internal and external I/O subsystems (figure 2). Both internal and external RAM areas

are made up of 64K-bit dynamic RAM chips.

In addition to the powerful 68000 processor, which was highlighted earlier, there are three more processors and LSI (large-scale integration) controllers inside the Model 16. This multiprocessor architecture allows decentralized processing, freeing the 68000 for system and processing tasks. Three processors provide this decentralized processing:

Motorola 6845: The Model 16's

9-inch video display is controlled by a Motorola 6845 CRT controller. This chip has access to the character (alpha-numeric) and graphics buffers contained in the 68000's address space, and thus display refreshing is performed independently of the 68000. The alpha-numeric display information is stored in a separate RAM area as character codes and is displayed through a ROM routine containing the dot patterns for all 256 characters in the Model 16's repertoire.

## DATA TRANSFER PROBLEMS?

Your Simple Solution is **REFORMATTER®** Diskette Conversion Software



- Avoids serial communication protocols.
- Needs only one system to transfer data.
- Converts source code and data files.
- Allows 2-way transfer.
- Quick, reliable, and inexpensive.

### VERSIONS

Runs On	Reads/Writes
CP/M	↔ IBM 3740
CP/M	↔ DEC RT-11
CP/M-86*	↔ <b>NEW</b> IBM 3740
TRSDOS II	↔ CP/M
TRSDOS II	↔ DEC RT-11
DEC RT-11*	↔ CP/M
CROMIX	↔ DEC RT-11
PRICE:	\$249 *\$350

Requires 8" floppy drive.



(415) 324-9114 TWX: 910-370-7457  
467 Hamilton Avenue, Suite 2, Palo Alto, Calif. 94301

# S-100 World News

MACROTECH International Corporation

22133 Cohasset Street, Canoga Park, California 91303 • 213-887-5737



Image achieved by DGS' CAT 1600 Series color video graphic workstation. Picture courtesy of Digital Graphic Systems, Inc. See story below.

## GRAPHICS: NOW MAX-IMIZED

CANOGA PARK—March 30, 1983—The decreasing costs and increasing density of memory made possible the present boom in digital graphics. Graphic systems designers are now able to take another major step with the introduction of MAX-M, a one megabyte memory board for S1983. As large size system memory and multi-megabyte Virtual Disk, MAX-M opens up major new low cost implementations.

Wayne Maw, Director of R&D for RGB Dynamics, Salt Lake City, Utah, reports, "My application is dependent on speed. With the Macrotech dynamic board, I have the needed speed!" The RGB system is a Z80-based,

high resolution color directory system for shopping malls, due for April release.

Empirical Research Group of Kent, Washington, creates a state-of-the-art high resolution color video graphics system by integrating their fast 68000 computer, Macrotech system memory, and the color video image processor from Digital Graphic Systems, Inc., Palo Alto, California. Radcliffe Goddard of Digital Graphics states, "High speed image processing requires large system memory to provide instantaneous display frame paging"

The demand for MAX-M by the graphics industry was nearly instantaneous following the initial Macrotech announcement. ■

## MAX—256K to 1M S-100 Memory

CANOGA PARK—March 30, 1983—Mike Pelkey, Macrotech International president, today released details of the revolutionary MAX line of S-100 memory boards. Pelkey stated: "IEEE-696 now has a new standard for dynamic memory. The MAX product line offers 256K to 1M, at a price that ranges down to less than \$0.00023 per bit!" Pelkey continued, "The MI product line now includes our ultra fast (70 ns) 128K static memory, with battery backup capability, plus the 150 ns dynamic memories—in every 128K step from 256K through 1M (1024K) bytes, and add-on kits to permit field upgrade of sizes!"

The extreme density of the MAX family is made possible through the use of proprietary PALs (programmable array logic). Also stated as available for add-on to any size MAX is

Macrotech's popular M<sup>3</sup> memory mapping architecture. M<sup>3</sup> permits the 16-bit address space of an 8-bit processor to be dynamically mapped in 4K pages into as much as 16 megabytes of physical memory.

Parity error detection and 8/16 bit data transfer capabilities are provided as standard on the MAX series memory board. ■

## Software for M<sup>3</sup> Available

BURBANK—March 30, 1983—"M<sup>3</sup> bank switching for 8-bit processors is much more useful with the new creative systems programs," states Dan West of Westcom Systems Inc. MP/M II\* disk intensive applications are greatly improved with the new Virtual Disk routines now available through Macrotech OEM's and dealers for their M<sup>3</sup> memory boards.

Westcom Systems, as the software consulting firm for Macrotech, has also provided sub-routine listings to easily incorporate M<sup>3</sup> mapping into the new CP/M 3.0\* (CP/M Plus\*) Bios module. The advantages of CP/M 3.0\* with disk buffering, hashed directories, and user program expansion go hand in hand with Macrotech's flexible "bank switched" memory capabilities.

**All Macrotech software and manuals are available through Dan West's Comuserve account #70250,102. Leave comments/questions as E-Mail.**

These new techniques can combine the above features with custom needs of the future, such as printer buffering, multi-page display and memory-intensive graphics displays.

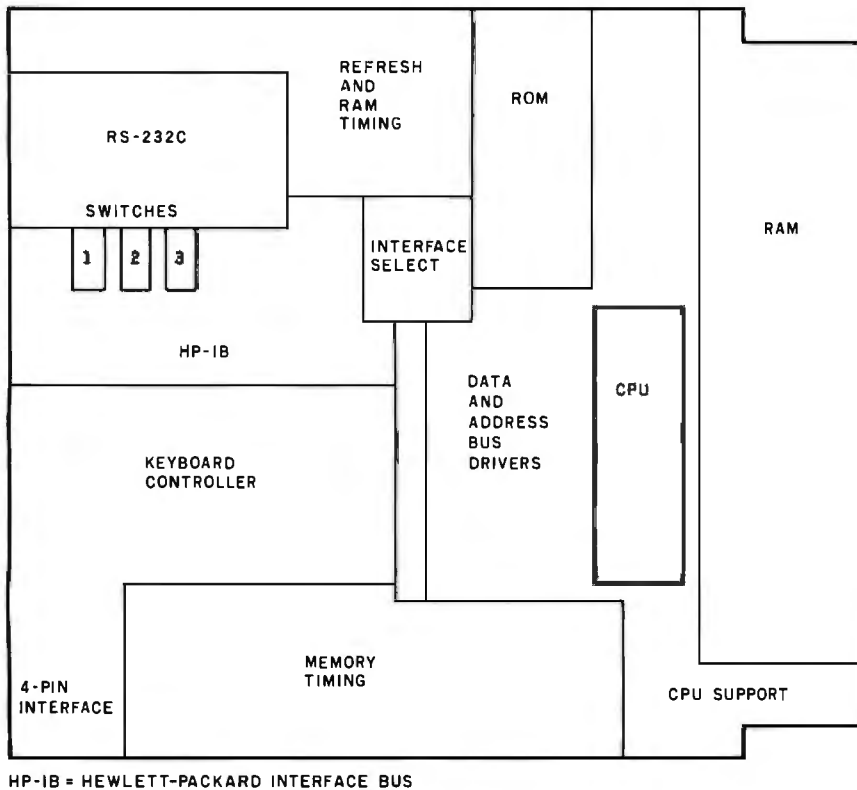
The software listings are included in the Macrotech memory board manuals and are optionally available on 8" diskettes. ■

INDEX			
	SIZE		PRICE
	128K	I-ST	\$1232
	256K	I-256	\$1108
	384K	MAX-384	1292
	512K	MAX-512	1647
	768K	MAX-768	1815
	896K	MAX-896	1899
	1M	MAX-1	1983
	FROM/TO	P/N	PRICE
<b>Upgrade Kits</b>	256K/384K	MKT-1	192
	256K/512K	MKT-2/5	692
	256K/768K	MKT-2/7	876
	256K/896K	MKT-2/8	967
	256K/1M	MKT-2/M	1060
	384K/512K	MKT-3/5	600
	384K/768K	MKT-3/7	784
	384K/896K	MKT-3/8	876
		(T-3/M	8
	512K/768K	MKT-5/7	284
	512K/896K	MKT-5/8	376
	512K/1M	MKT-5/M	468
	768K/896K	MKT-7/8	192
	768K/1M	MKT-7/M	284
	896K/1M	MKT-R/M	192

CP/M 3.0 Bios mod  
CP/M memory tests

Manuals (old separate  
128/ST  
MAX Technical Manual

\$ 15  
15



HP-IB = HEWLETT-PACKARD INTERFACE BUS

Figure 3: The layout of the main processor board of the Model 16.

The graphics information is also stored in a separate RAM area. It is combined with the alphanumeric image into the video pattern. The alphanumeric and graphics video can be switched on or off independently or displayed simultaneously.

**Intel 8041:** User input to the system is provided by the detached keyboard or by HP's rotary control knob. When a key is pressed, the Intel 8041 microprocessor generates an interrupt to the 68000. This information is transferred to the 68000 only as needed, so the processor does not have to monitor or poll the keyboard.

The rotary control knob is an analog-like input device that generates 120 pulses per revolution. In practice it is more efficient than a keyboard, especially for repetitive tasks like moving a cursor through an electronic spreadsheet.

**Texas Instruments 9914:** Both RS-232C and HP-IB interfaces come standard in the Model 16. (HP-IB is the industry model for the IEEE Standard 488-1978.) The Texas Instruments 9914 chip provides controller/talker/listener

functions for increased I/O performance.

With the 9914 chip, data transfer rates on the HP-IB range up to 60K bytes per second. These rates can be increased fivefold to over 300K bytes per second when HP's DMA (direct memory access) controller card is used. With DMA, data can be transferred directly to or from an interface or the system memory, independently of the 68000, at a rate that is limited only by the memory itself.

### The Twivel

What HP calls the Twivel is not a new dance, but a device designed to make the Model 16 easier to use. The Twivel (for tilt and swivel) is a carriage that holds the Model 16 so that you can tilt the display screen up or down, left or right.

### The Microfloppy

The Model 16 was further designed to sit atop the HP 9121 floppy-disk drive that's built around the Sony 3½-inch microfloppy disk. Interestingly, the microfloppy holds as much data

on one side as one of HP's 5¼-inch floppy-disks holds on two.

The reason for this is density. HP engineers packed 7100 bits per inch on the Sony disk, compared with the 5100 to 5400 on the 5¼-inch disk. Moreover, the Sony disk runs at 135 tracks per inch; the larger disk runs at 48 tracks per inch. The Sony disk has 70 tracks per side, and the 5¼-inch disk has 35 tracks on each side (for a total of 70). The bit density on the Sony disk allowed HP engineers to get the same number of sectors on it as are on the 5¼-inch disk. Thus, because the number of tracks and number of sectors are equal for both disks, capacity is the same.

The 9121 spins at 600 revolutions per minute (rpm), which provides much better performance than a 5¼-inch disk spinning at 300 rpm. The other differences are that the 9121 is 20 percent less expensive than HP 5¼-inch drives (\$1775 versus \$2230) because no double buffering is required, and it is half the size of the 5¼-inch drives.

Another contribution of the 9121 is its unique disk monitor. The 9121 constantly monitors disk use and tells you when it's time to replace a disk.

The 3½-inch disk is made to the reliable. It's encased in a hard polymer jacket and has a sliding protective cover for the read/write opening. This makes it much less susceptible to damage from mishandling than the 5¼-inch disks.

### Software

As I mentioned earlier, the 68000 was chosen over the Intel 8086 primarily for software reasons. HP's next logical step was to make sure that a diversity of software was available when the Model 16 was introduced.

To marshal resources inside and outside Hewlett-Packard, a software attack team (SWAT) was formed. "This marshalling of applications resources, with visits to independent software vendors, was one of the most fun parts of the program," says Gilbert Sandberg, then research and development section manager for the Model 16 project.

"The applications available at introduction and those continually



# 64K STATIC RAM MEMORY



## S-100 STATIC MEMORY BREAKTHROUGH

Finally, you can buy state-of-the-art S-100/IEEE 696 static memory for your computer at an unprecedented savings.

Memory Merchant's memory boards provide the advanced features, quality and reliability you need for the kind of operational performance demanded by new high-speed processors.

### Completely Assembled.

These memory boards are not kits, nor skeletons — but top-quality, high-performance memories that are shipped to you completely assembled, burned-in, socketed, tested and insured with one of the industry's best warranties.

### Superior Design & Quality.

Memory Merchant's boards are created by a designer, well known for his proven ability in advanced, cost-efficient memory design. Innovative circuitry provides you with highly desired features and incredible versatility.

Only first-quality components are used throughout, and each board is rigorously tested to assure perfect and dependable performance.

### No Risk Trial.

We are so convinced that you will be absolutely delighted with our boards that we extend a no-risk trial offer. After purchasing one of our boards, you may return it (intact) for any reason within 15 days after shipment and we will refund the purchase price (less shipping).

## NEW S-100 PRODUCTS COMING SOON:

- \* DUAL 8/16 BIT CPU BOARD
- \* 128K 8/16 BIT STATIC RAM
- \* 256K 8/16 BIT DYNAMIC RAM

# \$629.

**48K PARTIALLY POPULATED \$519.**  
**32K PARTIALLY POPULATED \$409.**

### 64K RAM, MODEL MM65K16S

- 64K × 8-bit
- Speed in excess of 6 MHz
- Uses 150ns 16K (2K × 8) static RAMS
- Ultra-low power (435 Ma. max. — loaded with 64K)
- Bank Select **and** Extended Addressing
- A 2K window which can be placed anywhere in the 64K memory map
- Four independently addressable 16K blocks organized as:
  - Two independent 32K banks **or**
  - One 64K Extended Address Page **or**
  - One 48K and one 16K bank for use in MP/M<sup>1</sup> (option)
- Each 32K bank responds independently to phantom
- 2716 (5V) EPROMS may replace any or all of the RAM
- Field-proven operation in CROMEMCO CROMIX\* and CDOS\*.
- Compatible with latest IEEE 696 systems such as Northstar, CompuPro, Morrow, IMS, IMSAI front panel, Altair and many others.

**OEM and DEALER Inquiries Invited.**

**Memory Merchant™**

14666 Doolittle Drive  
San Leandro, CA 94577  
(415) 483-1008

Circle 245 on Inquiry card.

## FULL TWO-YEAR WARRANTY.

The reliability of our boards, through quality-controlled production and proven performance, has enabled us to extend our warranty to a full two years. That's standard with us, not an option. This includes a 6-month exchange program for defective units.

### Shipped direct from stock.

All Memory Merchant's boards are shipped direct from stock, normally within 48 hours of receipt of your order. Call us at (415) 483-1008 and we may be able to ship the same day.

### 16K RAM, Model MM16K14



**16K STATIC RAM \$169.**  
16K × 8 Bit  
Bank Select & Extended Addressing  
Four independently addressable 4K blocks  
One 4K segment equipped with 1K windows  
Uses field-proven 2114 (1K × 4) RAMS  
Low Power (less than 1.2 Amps)  
Runs on any S-100 8080, 4 MHz Z-80 or 5 MHz 8085 system.

Prices, terms, specifications subject to change without notice.

\*Cromix and CDOS are trademarks of CROMEMCO.  
<sup>1</sup> MP/M is a trademark of Digital Research



Photo 4: The Model 16 was designed for business as well as technical applications. Here the Context MBA software package takes advantage of the Model 16's graphics capability.

being added are the results of this effort," says Sandberg. One of the newer packages is Context MBA (from Context Management Systems), which integrates an electronic spreadsheet, word processing, graphics, data communications, and a database (see photo 4). Visicalc, graphics presentations, forecasting, and project management are also offered. Technical software ranges from digital-filter design to numerical analysis, statistics, AC-circuit analysis, and linear systems analysis. Dozens of other programs are available from independent vendors. (Table 3 is a partial listing of software available for the Model 16.)

Operating-system software and programming languages are key elements in the Model 16's power and performance. Two HP-developed operating systems/languages are currently available for the Model 16: Pro-BASIC and Pascal. Additional languages and operating systems are available from third parties or are under development by HP (see table 4).

HP's Pro-BASIC has a number of powerful features and is very fast (see the text box on page 124).

The Model 16's Pascal uses a true compiler rather than a p-code interpreter. This results in a much faster execution speed. This Pascal is also compat-

ible with UCSD Pascal and has powerful graphics and I/O libraries, a full 68000 assembler, and systems programming extensions.

## Growth

Compatibility is a family trait within Series 200. Starting with the Model 16, it's possible to move up to the Model 26, Model 36, or even the 32-bit HP 9000 because software is highly transportable among these computers. This, however, represents just part of the Model 16's potential. The personal computer can also act as an intelligent terminal or be connected to HP's Shared Resource Management (SRM) network.

Series 200 Terminal Emulator software enables the Model 16 to respond like an intelligent terminal for transferring ASCII (American National Standard Code for Information Interchange) files to or from a host mainframe.

SRM permits up to 68 Series 200 computers in any combination (including the HP 9835, 9845, and HP 9000 computers) to share files and peripherals. The computers are connected via twisted-pair cables to a Model 26, which controls the network. The maximum cable length allowed is 60 meters between computers and 240 meters end to end. Consider a hypothetical SRM network: design engineers using the Model 36 and an HP 9000 computer can share the same specifications or diagrams from a graphics library; two Model 26s could be loading the same program simultaneously from a shared disk, or one computer could be logging data while the other analyzes it.

With this system, the Model 16 could easily be used for software development where everyone on the network has a current copy of the source code. Or the Model 16 could be used for planning because a master file of schedules can be updated by anyone in the group. Each user has a private directory where sensitive files can be protected from destruction or unauthorized access. Users can even leave electronic messages or charts for each other.

One of the design objectives for the SRM network is transparency; the

# With ASCOM™...



## personal computer communication has never been this easy.

That's why Big 8 accounting firms and Fortune 500 companies use ASCOM.

ASCOM is an interactive microcomputer telecommunications program for timesharing and data transfers. It is easy to use because it employs menus, simple commands and features an on-line help facility.

A typical use of ASCOM is to access a data base to retrieve data for storage and analysis on your microcomputer. It can also be used to transmit program files to another machine running ASCOM. This can be done locally through direct connection, or over telephone lines by using a modem.

ASCOM works on IBM PC, MS-DOS, CP/M-86, and CP/M-80 compatible micros.

### WESTICO

25 Van Zant Street • Norwalk, CT 06855  
(203) 853-6880 • Telex 643-788

Dial up our 24-Hour Computer Hotline for 300 baud modems: (203) 853-0816

- Please send me an ASCOM program & documentation: \$175.00 \*
- The ASCOM documentation only: \$30.00 \*
- FREE: Catalog of over 250 available programs.

C.O.D. \_\_\_\_\_ Visa \_\_\_\_\_ MasterCard \_\_\_\_\_

Card No. \_\_\_\_\_ Exp. \_\_\_\_\_

Model of Micro \_\_\_\_\_ 5 1/4" \_\_\_\_\_ 8"

Name \_\_\_\_\_

Company \_\_\_\_\_ Tel: \_\_\_\_\_

Address \_\_\_\_\_

City \_\_\_\_\_ St. \_\_\_\_\_ Zip \_\_\_\_\_

(\*Plus \$3.00 shipping and handling in N. America. Ct. residents add 7 1/4% sales tax.)

ASCOM is a trademark of Dynamic Microprocessor Associates. CP/M is a trademark of Digital Research © Copyright 1983 Westico, Inc. WA + 2

### ASCOM features:

- Works with modems or by direct connection at speeds from 110 to 19,200 baud.
- Transfers both text and program files between computers.
- Protocols to synchronize large file transfers.
- Remote mode permits control of another micro running ASCOM.
- Automatic processing with command files.
- Commands for displaying directories and files.

To order ASCOM, call or write today:

## WESTICO

The Software Express Service

25 Van Zant Street • Norwalk, CT 06855  
(203) 853-6880 • Telex 643-788

# Less for Your Money

If you do word processing on your personal computer, you probably know that there are many programs for sale to help you with your spelling. But the biggest spelling error you'll ever make is paying too much for your spelling correction software. The Random House ProofReader gives you less for your money – less trouble, that is, and fewer spelling errors. The Random House ProofReader is based on the world famous Random House Dictionary. It contains up to 80,000 words, depending on your disk capacity. You can add new words with the touch of a key. It shows you the error and the sentence it's in. It instantly suggests corrections. It even re-checks your corrections. And it costs half as much as other programs with far less power. The Random House ProofReader is compatible with all CP/M 2.2<sup>®</sup>, MS-DOS<sup>®</sup> and IBM Personal Computer<sup>®</sup> systems.



## The Random House ProofReader \$50

For orders or information, see your local dealer or call 505-281-3371. Master card and VISA accepted. Or write Random House ProofReader, Box 339-B, Tijeras, NM 87059. Please enclose \$50 and specify your computer model, disk size and memory.

Random House and the House design are registered trademarks of Random House, Inc. CP/M is a registered trademark of Digital Research, Inc. IBM and IBM Personal Computer are registered trademarks of International Business Machines, Inc. MS-DOS is a registered trademark of Microsoft, Inc.

Application Software	Distributor	Price
Context MBA	Context Management Suite 101 23864 Hawthorne Blvd. Torrance, CA 90505	\$795
Visicalc	Hewlett-Packard dealers	\$250
Master Word Processor	University Software RFD #1, Box 6 Fitchville, CT 06334	\$475
Protrastar (WP)	Protracoa 1134 Aster Ave., Suite K Sunnyvale, CA 94086	\$500
Forecasting	Hewlett-Packard dealers	\$500
Graphics Presentation	Hewlett-Packard dealers	\$750

**Table 3:** A partial list of application software currently available for the Model 16. More than 27 other programs are available from Hewlett-Packard or independent vendors.

Operating System or Language	Price
Pro-BASIC	\$355 (on disk)
HP Standard Pascal	\$1515
* FORTRAN	—
Assembly language	(included in Pascal)
* Multiforth	—
* CP/M-68K	—
* C	—
* HP-UX (Unix-based operating system)	—
HPL (APL)	\$355

**Table 4:** Operating systems and languages for the Model 16. An asterisk (\*) indicates that the product is presently under development. FORTRAN will be available from IEM Inc., POB 1818, Fort Collins, CO 80522. Unix is a trademark of the Bell System.

same mass-storage commands are used to talk to a network disk that are used to talk to a personal disk. To access an SRM disk, for example, you simply change one line of code in a BASIC program. That is, the mass-storage specifier in the MASS STORAGE IS command is changed from :HP8290X to :REMOTE. From here on, all mass-storage commands, such as ENTER or OUTPUT, have access to files on the SRM disk.

### Expandability

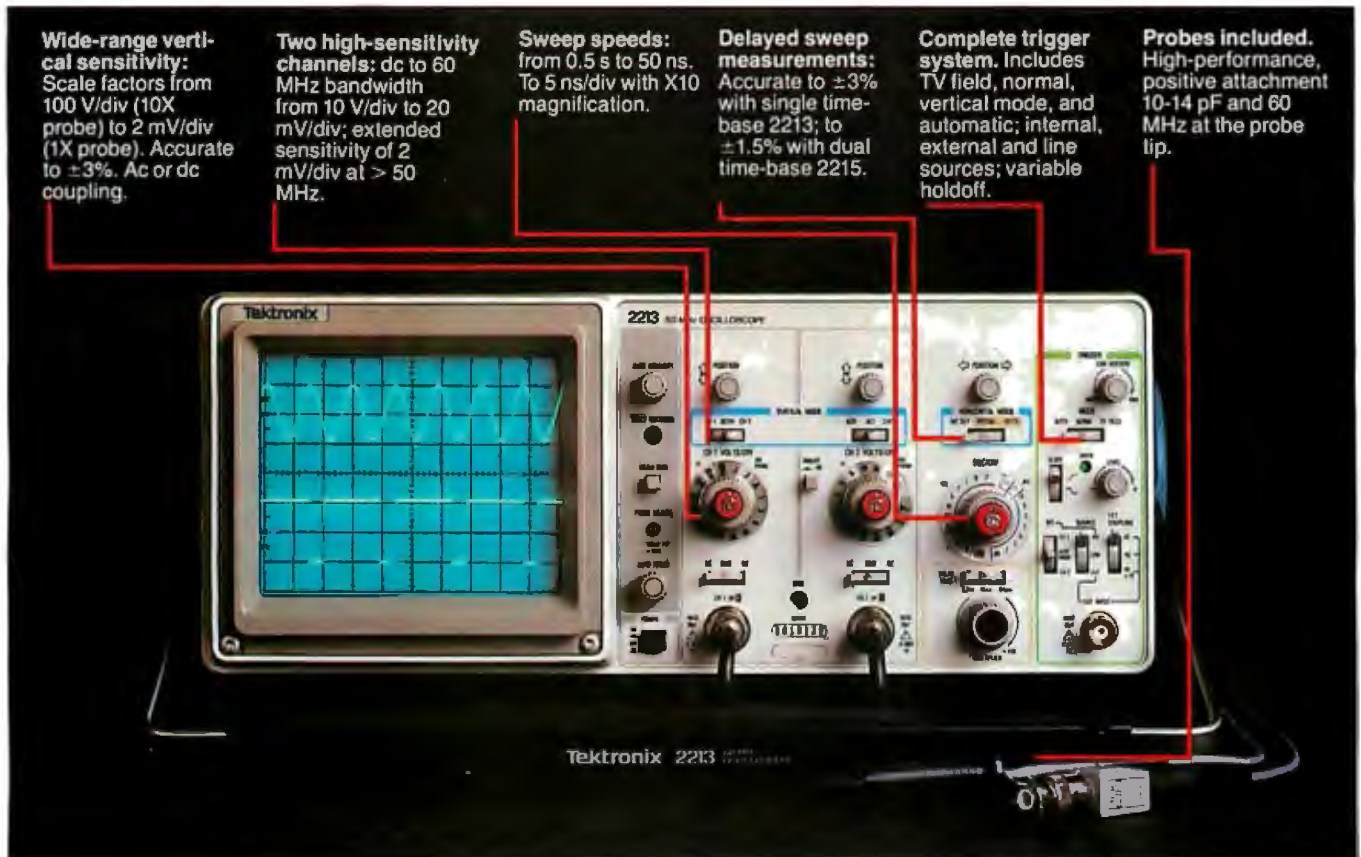
Directly related to the Model 16's growth potential is the number of pe-

ripherals and instruments that can connect to it on the two backplane ports. The first port is a 24-pin HP-IB connector. A variety of HP peripherals, including disks, printers, plotters, and the 9111A graphics tablet, are interfaced via this port. See table 5 for a partial list of supported peripherals.

Of course, HP has been known for its scientific and technical instruments for many years, and hundreds of these instruments can be quickly connected to the HP-IB port.

The second port on the back of the Model 16 is a data communications interface. This 50-pin connector can be

# Now. Tektronix 60 MHz Performance is just a free phone call away!



**Wide-range vertical sensitivity:** Scale factors from 100 V/div (10X probe) to 2 mV/div (1X probe). Accurate to  $\pm 3\%$ . Ac or dc coupling.

**Two high-sensitivity channels:** dc to 60 MHz bandwidth from 10 V/div to 20 mV/div; extended sensitivity of 2 mV/div at  $> 50$  MHz.

**Sweep speeds:** from 0.5 s to 50 ns. To 5 ns/div with X10 magnification.

**Delayed sweep measurements:** Accurate to  $\pm 3\%$  with single time-base 2213; to  $\pm 1.5\%$  with dual time-base 2215.

**Complete trigger system.** Includes TV field, normal, vertical mode, and automatic; internal, external and line sources; variable holdoff.

**Probes included.** High-performance, positive attachment 10-14 pF and 60 MHz at the probe tip.

**These easy to order scopes are proof that it's not expensive to have advanced, 60 MHz performance from Tektronix on your bench. It's just practical!** Feature for feature, the Tek 2213 and 2215 set a price/performance standard unmatched among portable scopes. And are backed by the industry's first three-year warranty on all labor and parts, including the CRT.

**So advanced they cost you less: \$1200\* for the 2213! \$1450\* for the dual time base 2215!** These low costs are the result of a new design concept that utilizes

fewer mechanical parts than any other scope.

Yet there's no scrimping on performance and reliability. You have the bandwidth for digital and analog circuits. The sensitivity for low signal measurements. The sweep speeds for fast logic families. And delayed sweep for fast, accurate timing measurements.

**Scope. Probes. Three-year warranty and expert advice. One free call gets it all!** You can order, or obtain literature, through the Tektronix National Marketing Center. Technical personnel, expert in oscil-

loscope applications, will answer your questions and can expedite delivery. Direct orders include probes, operating manuals, 15-day return policy, full Tektronix warranty and worldwide service back-up.

**Get all the facts.  
Call toll free:  
1-800-426-2200**

**Extension 91**  
In Oregon, call collect:  
(503) 627-9000 Ext. 91

Circle 379 on Inquiry card.

\*Price F.O.B. Beaverton, OR. Price subject to change.

## HP's Pro-BASIC

Over the last 10 years, Hewlett-Packard's Desktop Computer Division (DCD) and Engineering Systems Division (ESD) have added capabilities to HP's version of BASIC to a point where its name requires some distinguishing adjective. Hence, Series 200 computers, including the Model 16, and HP's 9000 family of 32-bit computers use what HP calls Pro-BASIC.

According to Martin Nielsen, a computer scientist at DCD, Pro-BASIC's "power and features make it as good or better than languages like Pascal or FORTRAN."

What has HP added to BASIC that extends its capabilities? First, Pro-BASIC provides more than 200 operators, functions, and statements—four times what ANSI BASIC offers—plus 20 general-purpose I/O (input/output) statements and 14 special HP-IB (IEEE Standard 488-1978) statements for controlling instruments and peripherals.

For instance, interrupts and the overhead processing they involve are performed automatically. This permits transparent control of input or output instructions to an HP-IB device or file.

For computer-aided design applications, matrix extensions permit the designer to invert a matrix with one statement: `MAT A=INV(B)`.

Similarly, operations like finding matrix determinants and performing element-by-element multiplication, subtraction, division, or addition, plus mixed and scalar/matrix operations, are also performed with single statements.

For the programmer, one of Pro-BASIC's notable advantages is a com-

plete set of program constructs. The `LOOP . . . EXIT`, `REPEAT . . . UNTIL`, and `WHILE` statements are what Nielsen calls "flexible looping constructs," which, unlike a `FOR . . . NEXT` statement, enable you to exit a loop on different conditions that are not sequential.

`REPEAT . . . UNTIL` repeats statements in a structured loop until the expression following `UNTIL` is true. The `WHILE` statement repeats a structured loop as long as its expression is true. `LOOP . . . EXIT` repeats statements in a structured loop as long as the `EXIT` expression is false. Further, you can have multiple exit points within the loop.

Another powerful Pro-BASIC statement is designed to eliminate crossing GOTOs, or what Nielsen calls "spaghetti code." `IF . . . THEN` and `IF . . . THEN . . . ELSE . . . END IF` provide conditional branching or execution of one or more statements depending on whether the specified condition is true or false.

Pro-BASIC also makes branching more efficient. In most BASIC systems, n-way branching can be performed only if the value X is an integer (e.g., `ON X GOTO 1102, 1470, 2655`). Pro-BASIC provides a `SELECT` statement, allowing it to branch on strings as well as numbers. Those numbers need not be integers.

With Pro-BASIC a programmer can use the statement `SELECT X, CASE 1, CASE 47, CASE 92 to 117`; in other words, a whole range for each case may be specified. If, then, X happens to be 1, CASE 1 is executed; if X is 47, then CASE 47 is executed, and so on. Moreover, an `ELSE` statement will execute `CASE ELSE` if X happens to be

other than 1 or 47 and does not occur from 92 to 117.

Subprograms in Pro-BASIC are just like procedures in Pascal and subroutines in FORTRAN in that they provide separate, independent environments functioning as "little black boxes" that do one job each. Variables, for instance, may be used in one subprogram without being confused with variables of the same name in another subprogram. Moreover, parameters, even optional parameters, can be passed in, allowing the subprogram to default the ones that are not passed in.

Pro-BASIC subprograms are recursive; they can call themselves. This is useful in data structures, where trees that define other trees are set up, and for array sorting, polynomial evaluations, and the like.

Another feature of Pro-BASIC is interrupt branching. A large number of events can be established to cause branches in the program.

Many BASICs, especially in the microcomputer class, are fairly limited in their editing capabilities. Pro-BASIC allows indentation for easy reading, cross-referencing for documentation (broken down by main program and subprogram), plus key words like `FIND` and `CHANGE` for searching and replacing.

The use of Pro-BASIC has also spread to HP 1000 minicomputers in addition to the HP 9835, 9845, Series 200, and HP 9000 lines. As Nielsen says, "It's an excellent language for first-time users to learn, yet it provides the features that allow the experienced programmer to really squeeze the most from the power of the machine."

hooked directly to data communications devices or data terminal equipment via an adapter cable that terminates in a standard RS-232C-compatible DB-25 connector.

Also on the back of the Model 16 are two other I/O slots located under a removable protective cover. These provide external access to the 68000 address, data, and control buses.

The top slot is used to add RAM or ROM cards or a DMA controller. A RAM card provides 256K bytes of

additional memory. ROM cards provides up to 512K bytes of storage for languages such as HP's Pro-BASIC. The lower slot accepts these cards plus a number of I/O cards. The I/O cards permit you to expand the system to include a second HP-IB or RS-232C port, a BCD (binary-coded decimal) interface, a programmable data-communications interface card, a color video (RGB—red-green-blue) card, or a general-purpose input/output (GPIO) interface card.

For still more flexibility, HP offers the HP 9888A I/O Expander. It provides 15 additional I/O slots, which allow you to expand the system to over 4 megabytes of RAM or add up to 8 more interface cards.

### Summary

Motorola's 68000 microprocessor is an important element in HP's Series 200 computers. The processor can meet the performance objectives HP has set for these computers, and future en-

Device	Product Number	Description	Price	
floppy disks	9121S	3½-inch single floppy-disk drive	\$1200	
	9121D	3½-inch dual floppy-disk drive	\$1775	
	82902M	5¼-inch single floppy-disk drive	\$1520	
	82901M	5¼-inch dual floppy-disk drive	\$2230	
	9895A	8-inch dual floppy-disk drive	\$5910	
hard disks	9133A	4.6-megabyte Winchester plus 3½-inch floppy	\$4260	
	9134A	4.6-megabyte Winchester	\$3500	
	9135A	4.6-megabyte Winchester plus 5¼-inch floppy	\$4760	
	9134B	8.2-megabyte Winchester	\$4360	
	9133B	38.2-megabyte Winchester plus 3½-inch floppy	\$5160	
	7908P	16½-megabyte disk/tape drive	\$11,130	
	7911P	28.1-megabyte disk/tape drive	\$14,800	
	7912P	65.6-megabyte disk/tape drive	\$17,350	
	printers	82905B	serial impact printer	\$795
		2602A	letter-quality daisy-wheel printer	\$2100
2671G		serial thermal graphics printer	\$1540	
plotters	7470A	"A" size two-pen plotter	\$1575	
	9872C	"B" size eight-pen plotter	\$5860	
bit pad	9111A	graphics tablet	\$2275	

Table 5: A partial list of peripherals supported by the Model 16.

hancements for the 68000 mean that these computers will also be enhanced. Further power is provided by three co-processors in the Model 16's decentralized processing scheme.

For all its power, the Model 16 remains a personal computer. Its small footprint, made possible by its eight-layer processor board with a chip density equivalent to two 14- to 18-pin integrated circuits per square inch, enables the computer to fit easily on a desk. Other features, such as the rotary control knob, user-definable keys, and the Twivel help make the Model 16 easy to use.

The Model 16 was designed to be affordable. The basic unit with 128K bytes of RAM sells for \$3985, without disks. An enhanced unit with 512K bytes of RAM and a ROM-based Pro-BASIC interpreter costs \$5550. The HP 9121D dual floppy-disk drive, which fits neatly under the Model 16 and uses 3½-inch disks (270K bytes per disk), costs \$1775.

The Model 16 was built to be reli-

able. Environmental and STRIFE testing assure a very low failure rate prior to delivery, even for early production models.

The Model 16 was designed with a wide growth path. Software is interchangeable with that of the other Series 200 computers, as well as with the HP 9845 and the 32-bit HP 9000 computers. HP's Shared Resource Management network allows files and disks to be shared among groups of users.

More than 30 different peripherals and over 200 instruments easily connect to the Model 16 over its HP-IB interface. An RS-232C interface is also built-in for increased flexibility. Other available interfaces include binary-coded decimal, data communications, color video, and a general-purpose card.

A variety of HP and third-party software is available for technical and management applications.

All in all, the HP Series 200 Model 16 is indeed a lion packaged as a housecat. ■

# DOUBLE the EXPANSION CAPACITY of your IBM PC:



- Brings system total to ten slots
- Six expansion slots plus power supply
- No special addressing, part of PC I/O bus
- Compatible with all PC expansion cards
- No noise—no fan

An expansion chassis is a must for anyone who needs to go behind the PC's minimum configuration. Simply plug the I-Bus Six-Pac Expansion Chassis into one slot of your PC—and you've doubled your expansion slots from five to a total of ten. There's no special addressing or software required. Cards plugged into the Six-Pac perform exactly as if they were in the main system unit.

And there's plenty of power, too, because chances are your PC will run out of power before it runs out of slots. The Six-Pac's 40W supply quietly powers its own slots, with negligible power drawn from the PC.

It's only \$695, including 18' shielded interface cable (or \$755 with a four-foot cable). Call us today for all the details.

Call toll free:

**(800) 382-4229**

in California call (619) 569-0646

## The I-Bus Six-Pac Expansion Chassis

**I-BUS**  
SYSTEMS

8863 Balboa Avenue  
San Diego, CA 92123

# You're looking at the only word processor that's as easy to use as SuperWriter.™

If you're like most people,  
you don't want to make a career out of  
word processing. When you have to write a simple  
letter or memo, all you want to do is roll up your sleeves  
and get down to business.

And if you're buying a personal computer,  
now there's a new software package that  
makes things just that simple.

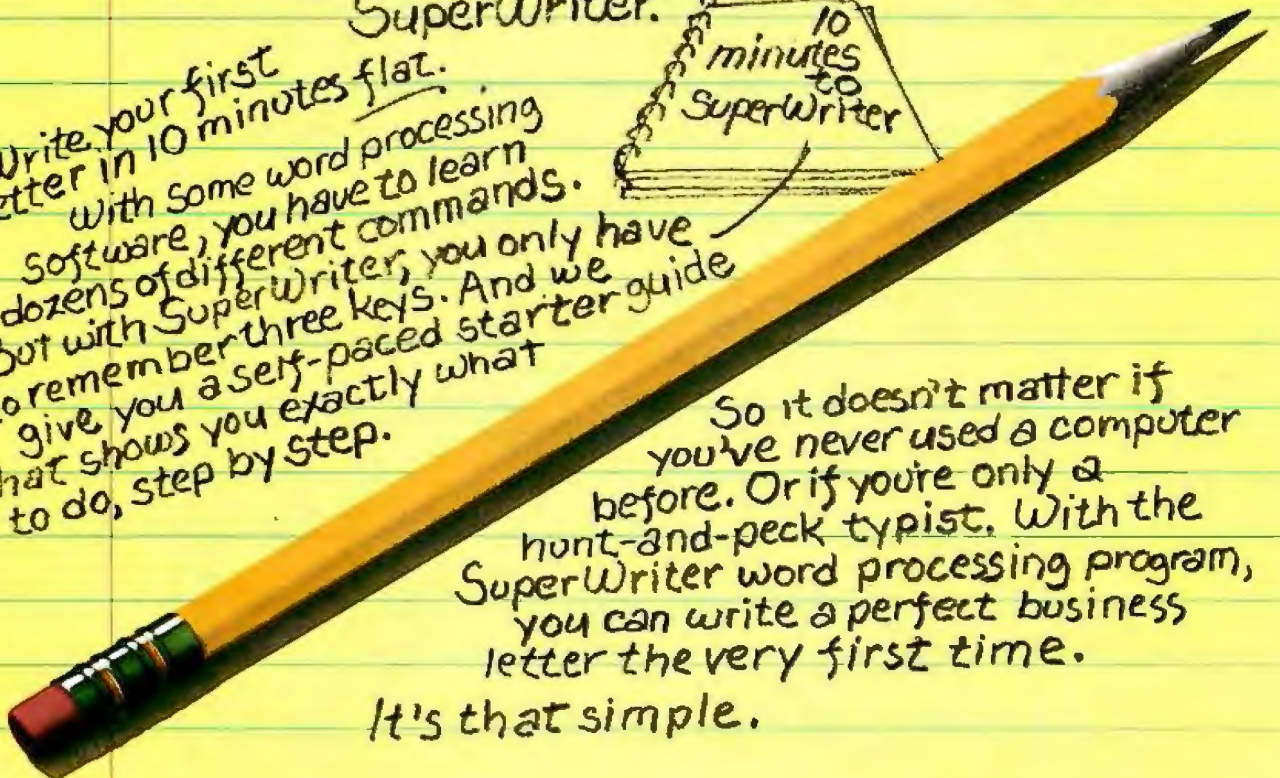
Write your first  
letter in 10 minutes flat.  
With some word processing  
software, you have to learn  
dozens of different commands.  
But with SuperWriter, you only have  
to remember three keys. And we  
give you a self-paced starter guide  
that shows you exactly what  
to do, step by step.

SuperWriter.™

10  
minutes  
to  
SuperWriter

So it doesn't matter if  
you've never used a computer  
before. Or if you're only a  
hunt-and-peck typist. With the  
SuperWriter word processing program,  
you can write a perfect business  
letter the very first time.

It's that simple.





Everything you need for only **\$295<sup>00</sup>** - even a spelling checker.

We're talking about a really complete package here. You get a full-function word processor, our 20,000-word Super SpellGuard™ spelling checker, and a form letter generator. All for \$295.00 suggested retail. To get all these functions any other way, you might have to spend \$900.00 or more.

You never knew your letters could look so good.

We've built all kinds of professional features into SuperWriter. Like proportional spacing. Bold face highlighting. Memo formatting. And more. So even if you're a complete beginner, you'll wind up with completely professional results.

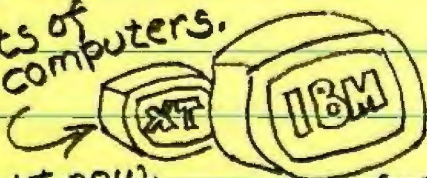
Help is closer than you think.



SORCIM®

If you get stuck on a problem with any other word processing software, you'll probably have to go back to the store for help. But if you have any questions at all about SuperWriter, all you do is pick up the phone. We've got a full-time crew of customer service experts on call, ready to help you out.

Works on lots of personal computers.



About the only thing it can't do is doodle.



Right now, SuperWriter is available for the IBM PC and the new IBM PC XT. Of course, it takes full advantage of their features - full color, hard disk and more. By June 15, we'll have SuperWriter ready for CP/M, CP/M-86 and MS/DOS operating systems, which means you can use it on most of the popular personal computers.

So stop by your nearest computer or software store soon and ask about SuperWriter. In just 10 minutes, you can learn everything you ever need to know about word processing. And see why every other system is too complicated for words.

**SuperWriter™**  
**SORCIM®**

2310 Lundy Ave.  
San Jose, CA 95131  
(408) 942-1727

# Texas Instruments' 99/2 Basic Computer

*A look at the design process from concept to prototype*

---

Harry Littlejohn and Mark Jander  
Texas Instruments Inc.  
Consumer Products Group  
POB 10508, MS 5849  
Lubbock, TX 79048

---

Designing a new low-cost computer system is a delicate balancing act. Your system must satisfy the needs of your market, respond to the challenges presented by your competitors, and still be profitable to build and market. In designing the new Texas Instruments 99/2 Basic Computer, we managed to achieve all of the above requirements in only four and a half months, which may be record time for a new system.

The TI-99/2 was developed to compete directly with such low-cost computers as the Sinclair ZX81 and the Timex/Sinclair 1000. The tremendous demand for computers that sell for less than \$100 demonstrated a growing need for a low-cost computer-literacy product for both children and adults. Our primary goal as designers of the TI-99/2 was to build a home computer that would enable people of all ages to take part in the computer revolution around them. It would also be used as a learning computer for students from grade school through college.

To satisfy consumers' needs, a low-cost computer must function beyond the computer-literacy stage; only then can it enable novices to improve their newly developed skills, through activities such as personal record keeping, education aids, and even mind-challenging games. Furthermore, the computer must be capable of growing with individuals who want to develop more advanced skills



**Photo 1:** *The Texas Instruments Basic Computer 99/2 is designed to compete directly with low-priced computers such as the Timex/Sinclair 1000. BASIC programs written on the 99/2 can run on the TI-99/4A, but the reverse is not true.*

or applications.

Texas Instruments set what we considered to be very aggressive goals in the design and manufacture of the TI-99/2. In this article we'll discuss those goals and how we met and sometimes, in our opinion, surpassed them in the course of the four and a half months between the initial concept and the completion of working prototypes for the January 1983 Consumer Electronics Show (see photo 1).

## Design Requirements

We believed a major portion of our market would be first-time computer buyers looking for a minimal investment in the world of computers. We kept the price low, hoping that those who decided computer programming was not for them would not regret the expense. Our basic assumption about

these potential buyers was that they would base their purchase decisions on price, not features. Computing power, expandability, and the availability of peripherals would be a relative measure for choosing from among several computers in the same price range.

We felt strongly that the first-time buyer must not be intimidated by the product. The console, we decided, must be simple, and the keyboard must be no more complicated than a typewriter keyboard. A cluttered keyboard, with multiple-function keys—and, therefore, multiple legends—would generate an immediate "I'll never learn to use that" attitude. In addition, we thought the computer should be sufficiently simple to operate and self-contained enough to ensure ease of use.

Once the beginner starts to develop computer skills, the computer needs peripherals that make new applications accessible. An economical program and data-storage unit was necessary, as were preprogrammed application software packages to increase the computer's utility. We decided that the system would also need a low-cost printer for listings and as a way of keeping track of program output. In addition, the system needed to handle the memory expansion that becomes necessary as programming expertise increases.

For computer owners who progress to more advanced applications, a

range of more sophisticated peripherals is necessary. We saw a need for communications or networking devices; high-density, fast-access mass storage; and printer/plotter-type peripherals to provide a very powerful but low-cost computer system (see photo 2). Growth beyond these levels of sophistication would probably entail buying a computer with greater capabilities.

To ease the upward migration to more sophisticated computers, we decided to make our computer part of an integrated product line based on the 99/4A. Integrating the computer with other TI products would enable us to provide compatible software and peripherals for other members of the TI Home Computer Family. Programming techniques and computer programs developed on a low-cost machine could be used on the more advanced machine without being rewritten. Peripherals for the new machine would then be compatible with the more expensive console, and none of the equipment and programming exchanges would become obsolete.

Having identified these requirements, we selected the following characteristics for the TI-99/2:

- 1) a computer system for less than \$100 that consists of a console, an external AC adapter for power, and a minimum of 2K bytes of RAM (random-access read/write



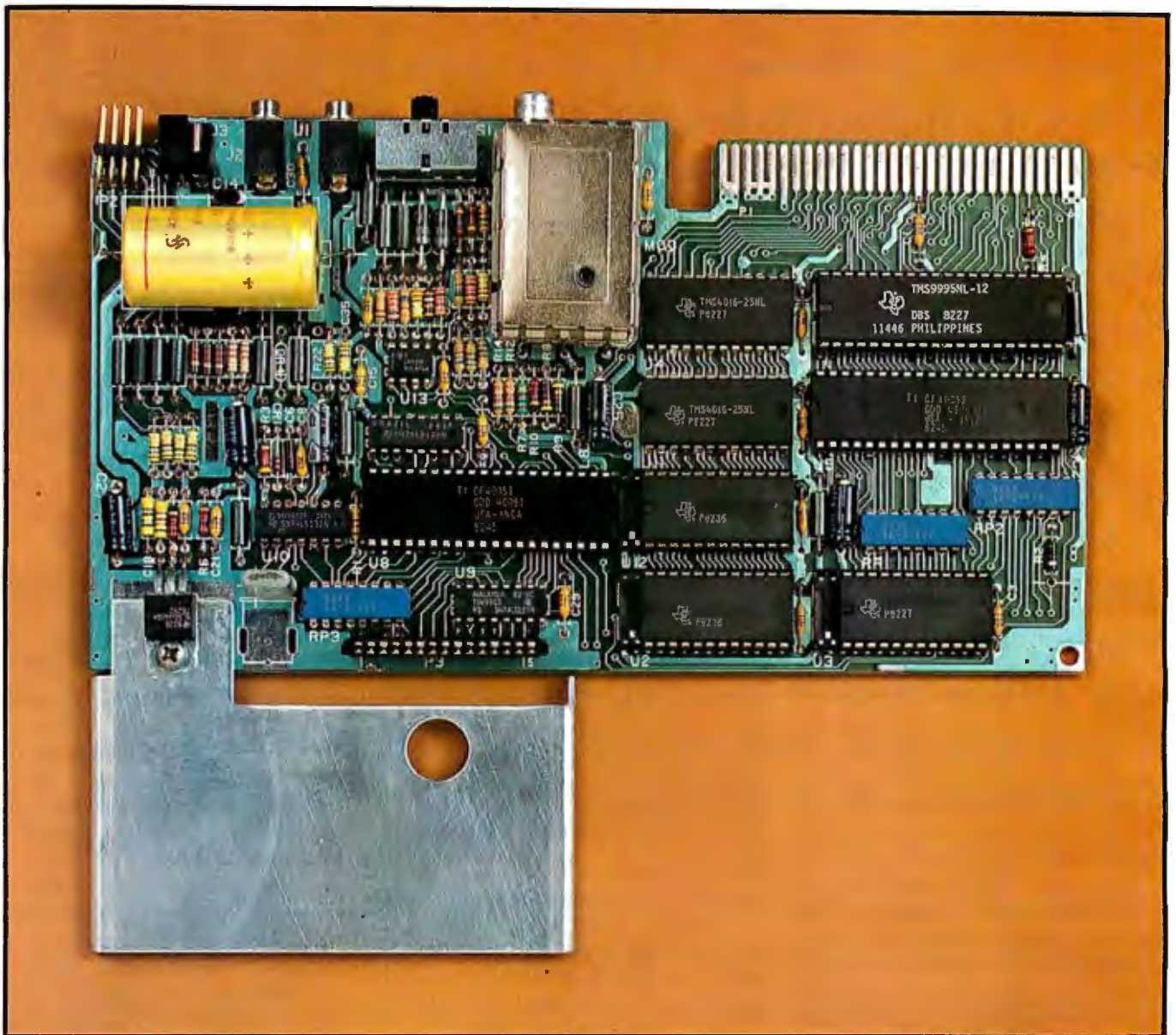
Photo 2: Peripherals for the 99/2. The line of low-cost peripherals includes, from top to bottom: the HX-1000 printer/plotter, the HX-2000 Wafertape Digital Drive tape unit, and the HX-3000 RS-232C interface.

- memory) and 16K bytes of ROM (read-only memory)
- 2) a built-in, two-channel black-and-white RF modulator (channels 3/4) for connecting the system to a standard TV (use of black and white was necessary to achieve cost goals)
- 3) a built-in interface for a standard audio-cassette recorder to provide economical mass-storage capability. Only audio in/out would be supported by the system. Cost would not allow support of motor control
- 4) a built-in Hex-bus interface to provide compatibility with the line of low-cost peripherals
- 5) an operating system that would be a subset of TI-BASIC as used on the TI-99/4A Home Computer console. Thus the software written

on the 99/2 would be upward compatible with the 99/4A. For cost reasons, the 99/2 would not use the Graphics Read-Only Memory (GROM) programming language of the 99/4A and, therefore, 99/4A command cartridges would not be compatible with the 99/2. Software compatibility would be provided by BASIC programs stored on cassette

- 6) no sound, color, or joystick capability would be supported, again because of cost constraints
- 7) the full system bus structure would be available at an expansion port on the rear of the console. This would facilitate memory-expanding Solid State Software cartridges (not 4A compatible) or any other future system expansion
- 8) a nonintimidating, 48-key typewriter-like keyboard with only two legends per key top. Layout and functionality of the keyboard would match that of the 99/4A. To achieve the goal of two legends per key, lowercase letters would not be supported.

To enhance user acceptance and utility of the keyboard, we needed a raised key that provided tactile feedback as it was pressed. But we also needed the economy of a Mylar key material. Our mechanical design team came up with a keyboard system that provided both advantages: using a Mylar key matrix under an



**Photo 3:** The main circuit board of the 99/2 contains the TMS9995 microprocessor, video controller chip, I/O controller chip, two static RAMs (4K bytes), three ROMs (the final version will have one 32K-byte ROM), a two-channel RF modulator, and the 5-volt DC regulator with heat sink.

"elastomeric" key-top assembly. The elastomeric system provides 48 raised keys in a single molded sheet, an arrangement that takes advantage of the elastomeric properties of the material. Depressing the key actuates the Mylar underneath.

### Internal Architecture

We decided to use the new high-speed TMS9995 microprocessor that runs at 10.7 MHz, a standard crystal frequency. We chose the TMS9995 over the TMS9900 because it requires fewer external control components and less circuit-board space due to its smaller package (see photo 3).

The 99/2 uses a standard address/data bus system. By using a 16-bit microprocessor and DMA (direct memory access) video processing, we attained a high-speed system performance. Initially, the system had only 2K bytes of RAM. But when we expanded the system from 16K bytes of ROM to 32K bytes of ROM to allow the software to run a full file-management system without a plug-in module, we decided our overhead use of RAM was too high. We added 2K bytes of RAM to carry the overhead of the system BASIC and still give us a reasonable amount of space for the program.

The total RAM in the computer is actually 4.2K bytes, including the 256 bytes of scratch-pad memory in the TMS9995 microprocessor. That scratch-pad memory helps improve the speed of the system. The 32K-byte ROM has a physical address space of 24K bytes, and the last 8K bytes of ROM are bank switched to preserve a 32K-byte expansion-port capability (see figure 1).

The expansion port has all system control address and data bus signals available. This allows expansion with RAM, ROM, or I/O (input/output) cartridges. The 32K-byte expansion address space can be configured in



# 13 TIMES FASTER THAN dBASE II™

If you bought your computer to save time, then you need SUPER, the most powerful database system you can use. Power is a combination of speed, ease of use and versatility. SUPER has them all.

**FAST** - To demonstrate SUPER's speed, ISA retained a professional dBASE programmer to benchmark SUPER vs. the acknowledged leader. A simple mailing list application was chosen to minimize dBASE programming cost. The results:

Task	SUPER Time	dBASE II Time
Set up/Program	5:20 min.	12:18:00 hrs.
Input 100 records	50:29 min.	1:27:50 hrs.
Sort & Print Labels	6:41 min.	4:18 min.
Totals	1:02:30 hrs.	13:50:08 hrs.

Notice that SUPER was faster at every task where *your time* is involved—and saving your time is probably the whole reason you bought a computer.

**EASY TO USE** - SUPER won because of its ease of use. Since it is menu-driven, office personnel can easily learn to use SUPER to set up their own applications, speeding and simplifying dozens of tasks without the need of programmer support.

**VERSATILE** - SUPER, unlike other business programs, doesn't dictate how to run your business. With SUPER the computer does what *you* want, when *you* want, the way *you* want it. **SUPER may be the only business program you'll ever need.** It can handle customer files, payables, receivables, depreciation, appointments, cost accounting, time charges, commissions, inventory, manufacturing control, and even matrix accounting systems!

**SUPER PERFORMANCE AT A SUPER PRICE** - That SUPER beats the \$700 dBASE program may surprise you, but in terms of price vs. performance SUPER has no competitors. Among its features are: production input, data compression, multiple databases on line, transaction posting, file reformatting, stored arithmetic files, flexible report formats, hierarchical sort and multi-disk files for up to 131,068 records. It can select by ranges, sub-strings, and field comparisons. It interfaces to word processors such as WordStar™, SuperSCRIPTSIT™, Model II/16 SCRIPTSIT™, and NEWSRIPT™. In fact SUPER has so many features that

it takes a six-page product description to cover them all. Write or call and we'll send you one.

SUPER is available for TRS-80™ Models I & III under NEWDOS™, LDOS™, and DOSPLUS; for TRS-80 Models II, III and 16 under TRSDOS™; and CP/M™ systems.

**Prices:** TRS-80 and Osborne versions \$250.00  
Other CP/M versions \$295.00  
Manual (Price applicable to purchase) \$ 25.00

**Now available for the IBM PC \$250.00**  
MasterCard and VISA accepted.

## OTHER SOFTWARE

- **ManageMint™:** A PERT/CPM project management system compatible with SUPER. It includes scheduling, resource and financial management modules.
- **Sales Planning and Data Extraction System:** Improves hit rates while cutting costs.
- **Small, economical program packages** for accounting, business and office applications as well as utilities.

*Write for Catalogue*



*Institute For Scientific Analysis, Inc.*

## SOFTWARE FOR HARD USE™

Dept B-3 Institute for Scientific Analysis, Inc.  
P.O. Box 7186 Wilmington, DE 19803 (215) 358-3735

**ORDERS ONLY**  
**800-441-7680 EXT. 501**

Trade mark owners: dBASEII-Ashton-Tate. SCRIPTSIT, SuperSCRIPTSIT, TRSDOS, and TRS-80-Tandy Corp. NEWDOS/80-Apparat, Inc. WordStar-MicroPro Intl. Corp. NEWSRIPT-PROSOFT. LDOS-Logical Systems, Inc. CP/M-Digital Research.

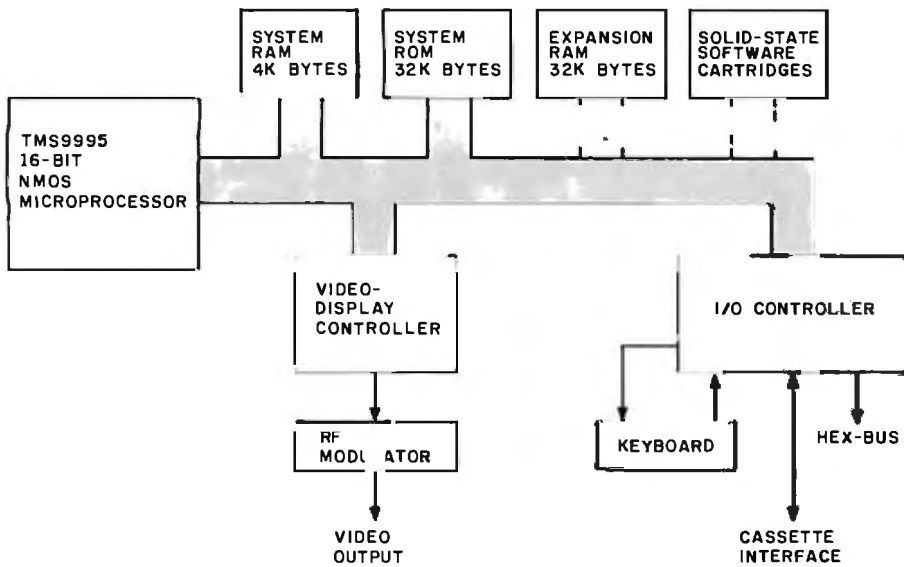


Figure 1: Internal architecture of the TI-99/2.

8K-byte increments of memory with ROM building up at the low end of the expansion address space and RAM building down from the high end of the expansion address space.

The system contains two gate arrays; one controls the video display, and the other handles I/O functions. Gate arrays are a low-cost method of designing custom ICs (integrated circuits). Starting with an array of logic elements on an IC, the manufacturer simply designs a mask to connect the elements in the final metalization procedure. To change the logic on a chip, you simply change the mask.

The video-display controller is a DMA processor that shares RAM and ROM with the microprocessor. The shared-memory structure improves the ability to effectively update and scroll the video display, thus allowing more time to be allotted to the central processing unit.

The I/O controller handles the Hex-bus interface, cassette interface, keyboard, I/O, clock generation, system reset, and RAM/ROM chip-select generation. This gate array allows higher system integration and therefore lowers the cost of the system.

The 99/2's BASIC language is architecturally different from the BASIC used in the 99/4A. To the user it appears the same, but to meet our goal of cost reduction we had to redesign the internal modules. For ex-

ample, the RAM and ROM are in different places in the 99/2 and 99/4A. Still, for the most part the BASIC commands produce the same responses as the 99/4A BASIC. In addition, the system is faster to execute and uses fewer parts.

We decided to go with Solid State Software to meet the need for a plug-in module that would allow the user to personalize the system through configuration software. The user could turn the system into a terminal emulator, a learning aid, or a game machine.

---

### **We didn't want the beginning user to have to hook up too many external parts.**

---

We built the RF modulator into the system to simplify use. We didn't want the beginning user to have to hook up too many external parts.

The 99/2 uses a 128-character set. Each character is an 8 by 8 dot matrix. It takes 8 bytes, or 64 bits, of information within the ROM to define each character. There are 1024 bytes of ROM in the system committed to screen generation; these are unavailable for system BASIC.

One byte of RAM is required for every character location on the screen (768 bytes for a 24-character by 32-line screen display). The central

processing unit writes a code into each of those RAM locations. The gate array then reads that code and knows which of the 128 characters to display on the screen. The video controller chip and the microprocessor share the system in order to keep the display from flickering, which can be annoying to the first-time user.

The video controller chip has dominant control of the bus system. When it wants the bus, it gets it—no matter what the central processing unit is doing. We designed it that way to satisfy the refresh-rate requirements. The processor can compute only when the video controller is not using the system. The central processing unit can compute only during border times, when the electron beam is not drawing a trace on the screen, such as during the horizontal retrace, vertical retrace, and top and bottom border times.

When the screen is full of characters, the video controller has the bus 90 percent of the time, and the central processing unit can be used for computing only about 10 percent of the time, which slows down the computer drastically. To overcome this limitation, we designed the video controller with enough intelligence to know not to tie up the system when nothing is displayed on a line. At the end of every line that is generated, the processor writes what is called a blank end-of-line character. The video controller responds to this character by releasing the bus for the rest of that row on the line.

When the screen is blank, the video controller accesses the memory only 1/768 of the maximum computation time available. Because a line of BASIC code seldom fills an entire screen line, the computing time is greatly increased by this feature. If we need to compute quickly, the system has the ability to disable the video chip; then there are no interruptions to computing time. The software controls the screen and can be accessed through BASIC.

### **BASIC**

To facilitate our computer-literacy goals for the 99/2, we provided three additional BASIC statements that are

not compatible with the 99/4A but that do allow the user to develop some assembly-language programming skills. These are the PEEK, POKE, and MCHL (machine-language execute) commands that let the user read/write directly into memory. By using the MCHL command, the user can execute an assembly-language program. Most applications on the 99/2 will not require the PEEK, POKE, and MCHL commands, but their availability gives users a chance to do assembly-language programming, even though it is not supported by the 99/4A console BASIC.

The 99/2 users manual explains any of the incompatibilities. It is important for the user to know these when writing a program that uses the assembly-language capabilities of the 99/2. Those instructions will be flagged as errors on the 99/4A. We felt that anyone who can program in assembly language will understand how to change the program to run on the 99/4A. Anything written totally in BASIC will be compatible.

### System Software

The system software of the 99/2, we decided, would provide power-up initiation and system configuration definitions and would allow users to select operation in BASIC or to use an application module that had been previously inserted into the expansion port. We decided to implement a subset of the TI-99/4A console BASIC to satisfy the upward software compatibility users need to migrate to another computer system.

Because of architectural limitations, the 99/2 does not support several features—CALL COLOR, CALL SOUND, CALL JOY, CALL CHAR\$, and CALL SCREEN. The cost of the additional hardware required to support these features would have caused us to exceed our pricing goals.


In addition, the system would not use the TI-99/4A GROM language because of the cost of the hardware required to support GROM chips. We had to develop a completely new BASIC interpreter for the 99/2 that was optimized to use the speed advantages of our architecture yet pro-

vide a meaningful subset of TI-BASIC. We included a full file-management system in the system software to take full advantage of the Hex-bus peripheral system.

Within the time frame we gave ourselves, we didn't have sufficient resources to develop a complete software system for the 99/2, so we decided to go to an independent third party for the software generation. We needed a group that was willing to undertake a task of this magnitude in

the time allotted.

We contacted the University of Southwestern Louisiana (USL) in Lafayette, Louisiana, because its computer science department had worked with TI before and came highly recommended. After we discussed our concepts and needs with them, the USL team accepted the challenge. During the course of the four and a half months in which we prepared prototypes for the January 1983 Consumer Electronics Show






# EXPOTEK

2723 W. Windrose Suite 3  
Phoenix, Arizona 85029

## 1-800-528-8960

All Prices Subject To Change



COMPUTERS		PRINTERS		
<b>ALTOS</b>		<b>OKIDATA</b>		
5-15D - \$2120	5-5D - \$3985	M92A - \$480	M93A - \$830	
580-10 - \$4695	586-10 - \$5698	M82A - \$385	W/Tractor & Grap. - \$465	
580-14 - \$9395	8600-12 - \$8950	M84P - \$965	M84S - \$ CALL	
<b>NORTHSTAR</b>		Pacemark 2350P - \$1999		
Advantage - \$2250	280A - \$1950	<b>CITOH</b>		
5m Byte - \$3350	15m Byte - \$4499	F10 40 cps - \$1170	F10 55cps - \$1580	
<b>TELEVIDIO</b>		1550P - \$659	1550CD - \$709	
802 - \$2599	802H - \$4450	8510P - \$399	8510BCD - \$499	
806 - \$4950	800A - \$1250	<b>DATASOUTH</b>		
803 - \$1890	1603 - \$2695	DS120 - \$595	DS180 - \$1175	
<b>APPLE-LOOK-A-LIKE</b>		<b>DIABLO</b>		
<b>CALL</b>		630RO - \$1749	620 - \$895	
<b>APPLE CARDS</b>		<b>NEC</b>		
16K RAM - \$78	Z80 CARD - \$235	8023 - \$425	7710 - \$2045	
Videx Card - \$227	Viewmax-80 - \$175	3510 - \$1375	3550 - \$1834	
Microsoft Prem. Pk - \$475		<b>TRANSTAR</b>		
<b>SOFTWARE</b>		140 - \$1290	130P - \$715	
All Major Brands		<b>TERMINALS</b>		
25% off List		<b>ADDS</b>		
\$ CALL		A1 - \$485	Viewpoint A3 - \$485	
<b>DISK DRIVE</b>		<b>HAZELTINE</b>		
Microsci Apple Dr. - \$265	Rana Elite I - \$275	1500 - \$995	ESPRIT - \$498	
Rana Elite III - \$550	Rana 1000 - \$375	<b>TELEVIDEO</b>		
<b>MODEMS</b>		910 - \$569	925 - \$718	
HAYES - MICROMODEM - \$263	HAYES - SMARTMODEM - \$199	970 - \$1040	950 - \$899	
HAYES - 1200 Baud - \$530	<b>ZENITH</b>		Z19 - \$670	
<b>DISKETTES/BOXES</b>		Z89 - \$2129	<b>MONITORS</b>	
Elephant - \$19	Scotch - \$25	Dysan - \$35	Amdtek 300 - \$135	Color I - \$295
<b>GUARANTEED LOW PRICES</b>		Amdtek Color II - \$625	Amber - \$149	BMC Green - \$85
<b>Customer Service</b>		<b>COMPUTER IC'S COMPLETE LINE</b>		USI Amber - \$149
<b>602-863-0759</b>		SPECIAL 4164 (150ns) \$6.50ea.		

(CES) in Las Vegas, Nevada, the USL team members provided very useful feedback on the 99/2 system architecture.

### Development Schedules

The entire 99/2 system was conceived, designed, and developed in time to introduce working prototypes at the CES show. The full development cycle, from concept through production, including qualification and certification, was approximately eight months long. This achievement required the cooperative dedicated efforts of many TI groups both inside and outside the Consumer Group.

Our Semiconductor Group developed two new gate array ICs, from layout to working prototypes, in two months. Logic design of the gate arrays was done in Lubbock, Texas, by the IC design organization of the Personal Computer Division in approximately one month.

The mechanical design team of the Personal Computer Division designed and developed the console, AC

adapter, cassette/video connections, and the keyboard in time to have prototypes at the CES show, also in about four and a half months. Development included implementation of advanced assembly techniques to allow reduced manufacturing time and lower cost. Our Industrial Design team provided the styling of the console.

**The full development cycle, from concept to production, was approximately eight months.**

Other members of the TI Consumer Group also contributed greatly to the successful introduction of the TI-99/2. Our packaging design and artwork team worked many extra hours to provide the appropriate packaging material for the unit, while our manual-writing staff developed a series of four manuals for the 99/2 that gradually progress in complexity

to handle the range from novice to computer hobbyist.

### Final Thoughts

The TI-99/2 is not just another low-cost, entry-level computer. It is a computer system designed for education and personal use. Users will find it an inexpensive introduction to microcomputers. With the use of Solid State Software cartridges such as Learn to Program and Learn to Program BASIC, individuals and schools can easily obtain instruction in computer programming.

By introducing peripherals and inexpensive software simultaneously with the computer, Texas Instruments believes this system will grow with an individual, inspire confidence in the use of computers, and foster the continued growth of the computer revolution. ■

### About the Authors

*Harry Littlejohn was program manager and project engineer and Mark Jander was project design engineer for Texas Instruments' TI-99/2 design group.*

# COMPUTER DEALERS

## THIS AD WRITTEN FOR YOU ...

BYTE INDUSTRIES WANTS TO BE YOUR COMPUTER CONNECTION

Byte Industries is your one STOP shopping place for over 50 lines of microcomputers, terminals, printers and various other computer peripherals and accessories. Byte won't leave you at a STOP waiting for equipment to complete a sale. If you call in your order by 1:00 PST, we'll ship it out THE SAME DAY!

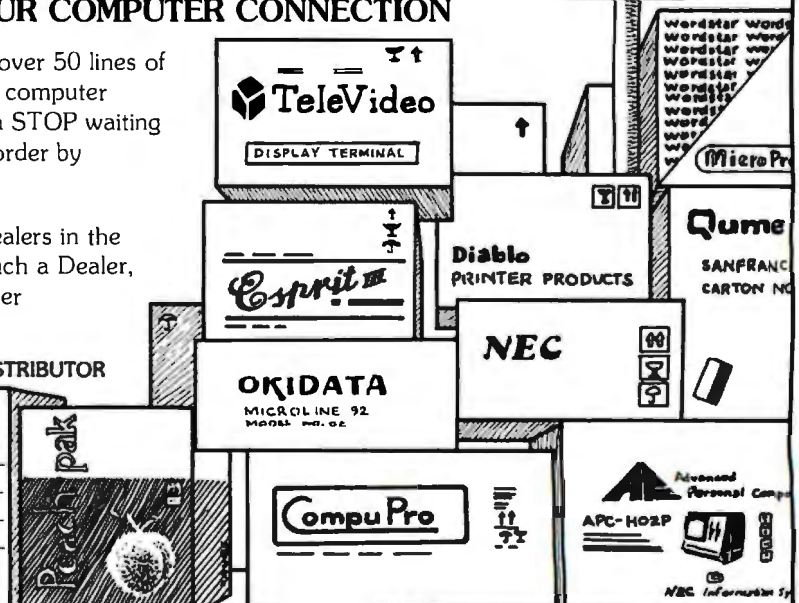
Byte Industries is searching for qualified Computer Dealers in the business of reselling the product we stock. If you're such a Dealer, you may have just found the best wholesale "Computer Connection" available.

BYTE INDUSTRIES IS THE AUTHORIZED COMPUPRO DISTRIBUTOR

I am in the business of reselling computers and related products. I would like a sales representative to contact me and tell me how I can receive my free Wholesale Pricelist and open a Dealer Account.

Name: \_\_\_\_\_  
 Store Name: \_\_\_\_\_  
 Address: \_\_\_\_\_  
 City: \_\_\_\_\_ State: \_\_\_\_\_ Zip: \_\_\_\_\_

Return to: Byte Industries, Inc. (415) 783-8272  
 21130 Cabot Blvd., Hayward, CA 94545







## DAWN OF A NEW GENERATION

RELIANT • EFFICIENT • UPGRADABLE

### CMC 8/16 SUPERSYSTEM II

- TurboDOS\*, CPIM\*\* and CPIM-86\*\* operating systems
- Floppy and hard disk drives
- SuperNet, local area networking, accommodates up to 16 users with 6 MB to 52 MB storage
- All stand-alone models utilize 750K to 19 MB storage and can be field-upgraded to SuperNet status
- All 8-bit SuperSystems are easily upgraded to our new 8/16-bit system which features Intel's 80186 Processor and full CPIM-86 compatibility
- "Perfect Writer" word processing standard with all models
- Generous dealer and OEM discounts
- 6 month warranty
- National on-site service in over 150 cities

## CMC International

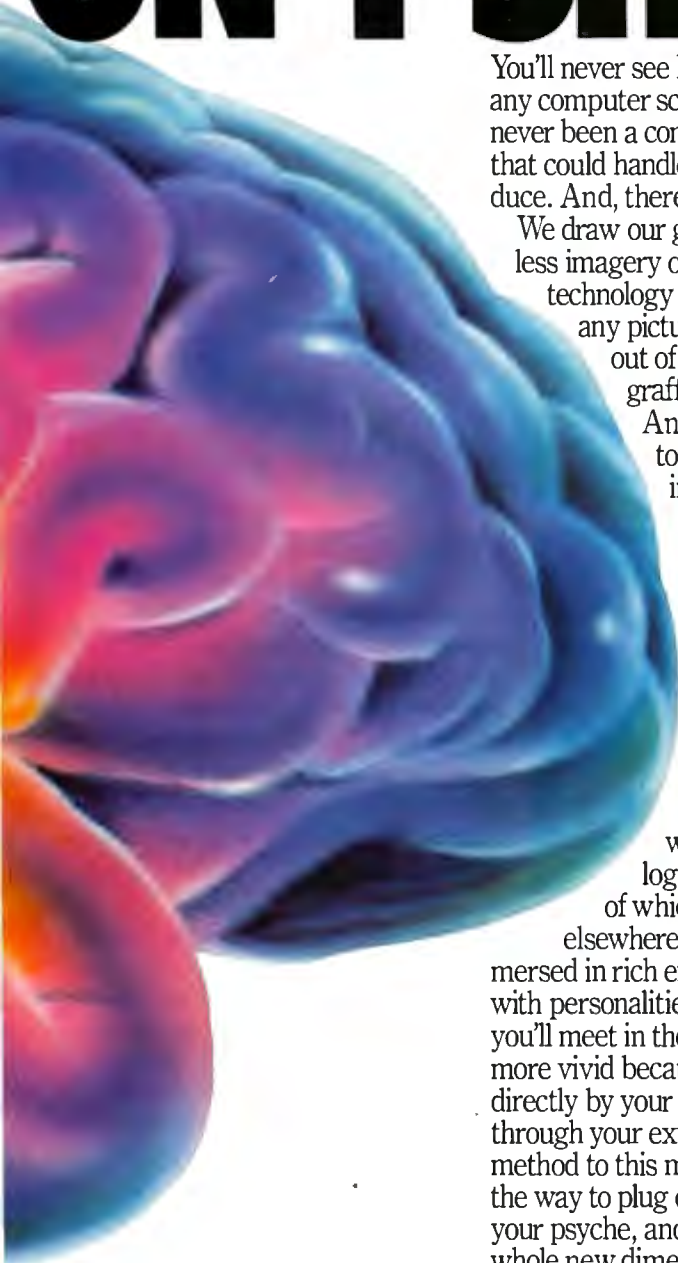
1720 130th Avenue N.E.  
Bellevue, Washington 98005  
(206) 885-1600 Telex 152556 SEATAC

\*TurboDOS is registered Trademark of Software 2000  
\*\*CPIM is a registered Trademark of Digital Research, Inc.

**WE STICK OUR G  
THE SUN D**



# GRAPHICS WHERE ON'T SHINE.



You'll never see Infocom's graphics on any computer screen. Because there's never been a computer built by man that could handle the images we produce. And, there never will be.

We draw our graphics from the limitless imagery of your imagination—a technology so powerful, it makes any picture that's ever come out of a screen look like graffiti by comparison.

And nobody knows how to unleash your imagination like Infocom.

Through our prose, your imagination makes you part of our stories, in control of what you do and where you go—yet unable to predict or control the course of events.

You're confronted with situations and logical puzzles the like of which you won't find elsewhere. And you're immersed in rich environments alive with personalities as real as any you'll meet in the flesh—yet all the more vivid because they're perceived directly by your mind's eye, not through your external senses. The method to this magic? We've found the way to plug our prose right into your psyche, and catapult you into a whole new dimension.

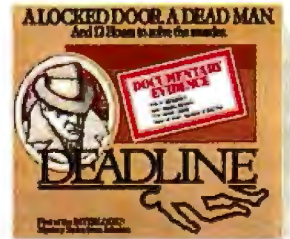
Take some tough critics' words about our words. *SOFTALK*, for example, called *ZORK® III*'s prose

“far more graphic than any depiction yet achieved by an adventure with graphics.” And the *NEW YORK TIMES* saw fit to print that our *DEADLINE™* is “an amazing feat of programming.” Even a

journal as video-oriented as *ELECTRONIC GAMES* found Infocom prose to be such an eye-opener they named one of our games their Best Adventure of 1983.

Better still, bring an Infocom game home with you. Discover firsthand why thousands upon thousands of discriminating game players keep turning everything we write into instantaneous bestsellers.

Step up to Infocom. All words. No graffiti. The secret reaches of your mind are beckoning. A whole new dimension is in there waiting for you.



## INFOCOM™

The next dimension.

Infocom, Inc., 55 Wheeler St., Cambridge, MA 02138

For your: Apple II, Atari, Commodore 64, CP/M 8; DEC Rainbow, DEC RT-11, IBM, NEC APC, NEC PC-8000, Osborne 1, TI Professional, TRS-80 Model I, TRS-80 Model III.

Circle 187 on inquiry card.

# Implementing Minicomputer Capabilities in a Desktop Microcomputer

*Multiple users, Xenix and local-area networks characterize the Altos 586.*

---

Colin Nayler  
Altos Computer Systems  
2641 Orchard Park Way  
San Jose, CA 95134

---

The advent of powerful 16-bit microprocessors that support high-performance operating systems has set the stage for desktop microcomputers in the \$8000-to-\$12,000 price range that perform on a par with the much more expensive minicomputers. The 586 from Altos Computer Systems is one such machine. It was designed to offer a multiuser system with the Xenix operating system and support for a variety of local-area networking (LAN) and communications protocols.

In using the Xenix operating system, a joint development of Altos and Microsoft based on Bell Laboratories' Unix System III, the 586 is one of the first desktop microcomputers to offer the sophisticated facilities of Unix software. The 586 runs Xenix—as well as the MP/M-86, MS-DOS, Oasis-16, and Pick operating systems—in a stand-alone configuration, and it also supports LAN and communications protocols including Ethernet and bisynchronous, and will soon support X.25 and IBM's Systems



**Photo 1:** *The new Altos 586 microcomputer offers affordable, fast 16-bit processing to accommodate five users, expandable to eight. The 586 uses the Xenix operating system and provides integral networking capability.*

Network Architecture (SNA) protocols. Such communications support allows this desktop machine to be a mode for corporate-wide office automation.

Although the 586 is designed to meet multiuser and multitasking re-

quirements, it can also be configured for single users who require large storage capacity or Unix software capabilities. The computing power of the Intel 8086 processor is enhanced for both single and multiple users by a design that employs two auxiliary I/O (input/output) processors and a proprietary memory-management scheme, all of which aid the efficient use of Xenix.

## Memory Management and Xenix

Xenix presents problems for any 8086-based multiuser system because the microprocessor lacks certain important protection features that minicomputers running Unix software have, such as individual protection for memory contents when more than one user resides in memory at the same time. To overcome this obstacle, Altos's designers developed proprietary memory-management hardware, built with PAL (programmable arrayed logic) and RAM (random-access read/write memory) circuitry around the central processor.

This memory-management system enables the central processor to set a user-mode bit when the machine runs

---

*Unix is a trademark of Bell Laboratories.  
Xenix is a trademark of Microsoft Corporation.*

---

# Olympic Sales

SERVING YOU SINCE 1947

Company

P.O. Box 74545 216 So. Oxford Ave. Los Angeles, CA 90004  
 Phone: (213) 739-1138 Cable: "OLYRAN" LSA  
 Telex: 67 34 77 Toll-Free Phone Orders:  
 Toll-free (in CA) 800-252-2153 800-421-8045 (out of CA)  
 Order desks open 8 days a week! 7:00 AM to 8:00 PM Mon-Sat

We carry close to \$5,000,000 inventory at all times. Corp. acct. invited. Good subject to availability. This ad supersedes all previous ads. For our warehouse, prices subject to change without notice; not responsible for typographical errors; all orders subject to verification; minimum order \$3.95. Send \$2 for \$3 foreign for our famous catalog.

**IBM Selectric II \$779.95**  
 15" Carriage-BRAND NEW IN IBM FACTORY CARTONS! DUAL PITCH, CORRECTING, includes TWO ELEMENTS, cover & instruction manual. (IBM Service Dept. will accept service contract from you, the buyer).

**\$100 COMMODORE 64 TRADE-IN REFUND**  
**COMMODORE 64 \$289.95**  
 COMMODORE 64 COMPUTER after trade-in



free RF modulator  
 Full color graphics, upper/lower case  
**3 INTELLIGENT WAYS TO BUY A COMMODORE 64**  
 1) You buy one from us at \$389.95  
 2) You buy one from us at \$389.95, then you send in an old/new (in any condition) computer or TV game to Commodore & receive \$100.00 from them!  
 3) You buy one Commodore 64 from us at \$389.95 then you buy one Times TS-1000 from us for \$44.95 then send the Times to Commodore & get \$100.00. You invest \$44.95 & get \$100.00, net gain: \$55.05

Z-80 Card For Commodore 64 \$269.95  
 80 Column Card For Commodore 64 \$189.95  
 40 Column Card For VIC-20 \$99.95  
 40 Column Card w/8K mem built-in for VIC-20 \$139.95  
 Video Pack 64K For VIC-20 \$29.95  
**FREE WITH PURCHASE of each Z-80 card, 80 column, 40 column or Video Pack 64, you receive the following:**  
 Word Master word processor software  
 Mailing List software  
 Telecommunications software  
 Due to the tremendous demand of these products, goods are subject to availability. Place your orders now!

**Commodore VIC-20 \$99.95\***  
 \*When purchased as part of this package ONLY.  
 VIC-20 \$129.95 when purchased alone.  
**DISK DRIVES & OTHER PERIPHERALS**  
 1541 Disk Drive \$369.95 These peripherals  
 1530 Datasette 69.95 work with the  
 1525E Printer 339.95 VIC-20 as well as  
 1600 VicModem 99.95 Commodore 64.  
 1520 NEW! Color printer/plotter 189.95  
 1701 NEW! 14" color monitor 289.95

**TIMEX TS-1000**  
 Timex TS 1000 Computer  
 Pay us \$59.95 and get a \$15.00 REBATE from Timex!  
 FREE RF modulator  
 16K RAM Expansion \$45.95  
 Timex Thermal printer/graphics 94.95  
 Panasonic(program) recorder 39.95

**BUY 3 PIECES OF SOFTWARE & GET THE FOURTH ONE FREE!**  
 TIMEX Software (75 programs for you!)  
 Stock Option Analyzer 16.95  
 IRA Planner 15.95  
 Real Estate Investment Analysis 14.95  
 Personal Finance Planner 14.95  
 Portfolio Analysis 14.95  
 Budgeter 15.95  
 Organizer 16.95  
 Checkbook Manager 15.95  
 and more and more... Call us!

**DON'T BUY ANY PORTABLE COMPUTER UNTIL YOU SEE THE NEW COMMODORE!**  
 \*\*\* COMMODORE'S SX-100 PORTABLE! \*\*\*  
 \* Full 64K  
 \* Color Monitor built-in  
 \* Disk drive built-in  
 \* FREE software package  
 \* Completely compatible with the Commodore 64  
 \* LOTS OF SOFTWARE AVAILABLE! Retail: \$995  
**COMPLETELY PORTABLE!**  
 Special Introductory Offer  
**\$899.95 COMPLETE**

**Texas Instruments Home Computer TI-99/4A**

**\$1499.95\***  
 Plus FREE \$50 RF Modulator with purchase of TI-99/4A  
 1200 Peripheral Expansion Box 219.95  
 1220 RS-232 Card 149.95  
 1240 Disk Controller Card 199.95  
 1250 Expan. Sys. Disk Drive 319.95  
 1260 Memory Exp. Card (32K) 239.95  
 1270 P-Code Card (req. 1600) 199.95  
 1600 Telephone modem 179.95  
 4100 Monitor 339.95  
 Extended Basic 79.95 LOGO 99.95  
 TI-59 Prog. calc 169.95  
 PC-100C Printer for TI-59 159.95  
 TI Programmer (LCD) 59.95  
 TI-58C Prog. calc 89.95  
 TI-57 (LCD) 37.95

**NEW COMPACT COMPUTER FROM TI CC 40 \$199.95**  
 CC 40 portable computer (22 ounces) has more features than some \$795 & \$995 portable computers, 31 character display, numeric pad, 200 hours on 4 AA batteries, TI enhanced Basic language, 6K RAM, 34K ROM, full typewriter keyboard, application port for solid state software.

**brother**  
 EP-20 NEW FROM  
 Fits in a briefcase!  
 Personal Electronic TYPEWRITER  
 Sugg. retail: \$299.95  
 The ultimate portable typewriter!  
 Operates on batteries or AC adaptor  
**\$179.95**

**ATARI 1200XL \$569.95\***  
 ATARI 1200XL - THE 'STATE OF THE ART' MACHINE!  
 Full 64K RAM/256 Color/16 Function keys & special 'Help' key  
 \*Your net price after \$180 rebate from Atari

**ATARI 400 \$99.95\***  
 CALL FOR DETAILS  
 \*After \$50 cash rebate from Atari & \$70 software offer - you pay us \$219.95

**STAR GEMINI**  
 THE HOTTEST COMPUTER PRINTER TODAY!  
 100 cps-Epson pin & plug compatible-180 day warranty-9 X 9 dot matrix-friction & tractor feed-proportional spacing font-bit image graphics-bi-directional logic seeking  
 2.3K buffer built in high quality printer for a LOW cost!  
 \$379.95 10" carriage (80/96/132 col)  
 \$489.95 15" carriage (136/163/233 col)

**NEW LINE OF CASIO WATCHES**  
 CFX 200 Scien calc, 3 const mem, metric conversion, 8 dig mantissa, trig, log, roots, P1, sign, etc, alarm, calendar, etc. 39.95  
 CFX 200 Scien calc same as above plus chrome plated case 49.95  
 TC 500 Calc watch w/finger touch face-no keypad, just touch each number & it works-stop watch, cal, alarm, alarm & more! 69.95  
 CS 82/83 Calculator watch, "E" sign, alarm, stop watch, constants & more! 29.95  
 CS 821/831 Calc watch, similar to above (82/83) w/chrome plated case 39.95  
 DW 1000 Water sports, 600 ft, 12/24 hr, stop watch, stainless steel, etc. 59.95  
 DW 1000C Water sports, 600 ft, same as DW 1000 S/S case only, resin bracelet 49.95  
 W 450C Water sports, 300 ft, stop watch, alarm, etc, down, 12/24 hr, S/S case 39.95  
 W 24 Water sports, 150 ft, stop watch, alarm, etc, down, 12/24 hr, etc. 24.95  
 TS 1000 Temperature watch, 300 ft, prog. temp. -10C(13F) to 60C(140F), alarm mode, 10 zone world time, thermometer, more, stop watch, etc. 49.95  
 J 30 Jogger's watch, 150 ft, alarm, timer, pace mode & more! 24.95  
 LW 6 Ladies' water sports, 150 ft, calendar, second display 19.95  
 LW 601C Ladies' water sports, 150 ft, S/S case, alarm, calendar, & more! 34.95  
 AQ 200 Analog Seiko Dignita type, dual time, calendar, alarm, stop watch, bly time signal funct., chrome plated, beautiful! 29.95  
 AQ 200G Same as AQ200 but goldtone (Gold plated) 39.95  
 AQ 510L Super deluxe analog Seiko Dignita type, dual time, alarm, etc. stop watch, bly time signal funct., stainless steel case. 69.95  
 AQ 510GL Super deluxe, similar to AQ510L, with gold plated case. 79.95

**HEWLETT PACKARD HP-75C**  
 Handheld Computer \$759.95  
 HP-12C Financial calculator 99.95  
 HP-11C Scientific calculator 73.95  
 HP-10C Scientific calculator 58.95  
 HP-15C Scientific calculator 99.95  
 HP-16C Financial/business calc 99.95  
 HP-97 Programmable print calc 595.00  
 \*Buy one of these products now & receive a coupon worth one FREE Series 40 enhancement module from HP! Limited offer!  
 HP-41C Programmable calc \* 158.95  
 HP-41CV Programmable calc \* 213.95  
 Optical wand \* 97.95  
 Printer for 41CV \* 283.95  
 Card reader for 41CV/C \* 152.95  
 IL thermal print/plotter \* 389.95  
 Video interface (HP 82163A) \* 249.95  
 HP 1L Systems on hand  
 IL interface module 99.95  
 Digital cassette drive \* 439.95  
 Extended function mem mod 61.99  
 Extended memory module 61.99  
 Time module 61.99  
 Memory module for 41C/CV 25.00  
 Quad memory mod for 41C 65.00

**TELEVIDEO 910 599.95**  
**TERMINALS 925 794.95**  
 950 999.95  
 970 1144.95  
 Second pg memory 69.95

**ATARI 800 \$499.95\***  
 \*Call us for info about possible \$100 rebate.  
 410 Program recorder 79.95  
 810 Disk drive 449.95  
 850 interface module 189.95  
 Opt! PROGRAMMER KIT with BASIC \$69.95  
 Good on all Atari computers

**NEW! ATARI 1025 - SPECIAL INTRODUCTORY PRICE \$449.95**  
 DOT MATRIX PRINTER - 40-88-132 Column with buffer includes I/O cable - NO INTERFACE REQUIRED!

**ATARI 400 \$99.95\***  
 CALL FOR DETAILS  
 \*After \$50 cash rebate from Atari & \$70 software offer - you pay us \$219.95

**TRANSTAR MODEL 315**  
 4 COLOR PRINTER  
**\$499.95**  
 • 80-column  
 • Tractor or Friction  
 • Parallel IFC  
 • 6-month warranty

**AMDEK Monitors**  
 V 300 12" Green 139.95  
 V 300-A 12" Amber 149.95  
 V 310 12" Green-TTL 162.95  
 V 310-A 12" Amber-TTL 162.95  
 Color I 13" Composite 309.95  
 Color II 13" RGB TTL 719.95  
 Color III 13" RGB TTL 389.95  
 Color IV 13" RGB Analog 1049.95  
 Amplot 4-color 11x 14 bed 759.95

**NEC SPINWRITERS**  
 8032 \$499.95 also available  
 Serial IFC 149.95 Call for best price!

**QUME PRINTERS**  
 Model 1140+/Sprint 1395.00  
 IFC Serial or Parallel (required) 84.95  
 Tractors 185.95  
 Cut sheet feeder 659.95

**OKI/OATA PRINTERS 84P 1069.95**  
 80 347.95 84S 1149.95  
 82A 419.95 92 529.95  
 83A 694.95 93 937.95

**EPSON \$349.95**  
 MX-80 WITH GRAFTRAX  
 All other EPSON models available at exceptional prices. CALL US TODAY!

**olivetti**  
 ELECTRONIC TYPEWRITER Call us about \$50 U.S. BOND offer!  
 PRAXIS 35 Portable w/case \$369.95  
 3 pitch/5 language; sugg. list: \$750.00  
 PRAXIS 30 Portable w/case 319.95  
 Single pitch/5 language; sugg. list: \$640.00  
 PRAXIS 40 Heavy duty office T/W 499.95  
 3 pitch/5 language; sugg. list: \$995.00  
 PRAXIS 41 Heavy duty office T/W 539.95  
 3 pitch/5 language; sugg. list: \$1095.00  
 has built-in port for interface to computer  
 Optional carrying case for 40/41 (hvy duty) 89.95  
 Interfaces available for above models to connect to computer, serial or parallel. 249.95

**ALTO COMPUTER SYSTEMS**  
 All systems available - call for best price!  
**FRANKLIN ACE 1000 & ACE 1200**  
 Much better than Apple for Much LESS!

**SOFTWARE FOR: IBM - Atari - Apple - Timex - Commodore - TRS 80 - and MORE!**  
 We have thousands of programs for you. Please call - 11 full pages in our catalog!

**SONY SANYO TOSHIBA**  
 AIWA PERSONAL STEREO  
 WM DB The Professional, rec/playback/dolby \$289.95  
 W 33 AM/FM stereo cass. rec/built-in spkrs 124.95  
 ICR 4800 Pocket-size 5-band short wave radio 67.95  
 M 100B Ultra-slim microcass. rec. (Thinnest X") 168.95  
 ICR 7600A AM/FM 7-band short wave radio, great unit! 109.95  
 SRF 30 FM Walkman w/headphones, in stereo 48.95  
 M 7 Extra-light weight micro-rec., edit, one touch Walkman Stereo player/FM stereo rec., etc. 57.95  
 WM F2 Walkman Stereo player/FM stereo rec., etc. 159.95  
 TCM 5 Lightweight cass. rec., edit, microphone 68.95  
 WM 4 Walkman stereo cass player/headphones, beltclip 64.95  
**SANYO**  
 MG 35 AM/FM stereo, cass. player & more! Fantastic! 69.95  
 MG 12 Minimize stereo cass. player, tone cont. case 37.95  
**AIWA**  
 HSJ02 Compact AM/FM stereo cass. rec./play. auto. rev. 149.95  
 TRM02 Voice-activated microcass. rec; 2 split-2 hrs rec. + 159.95  
 CSJ1 Stereo AM/FM cass. rec./player & more 139.95  
 World's smallest auto rev/rec/player, more! 149.95  
**TOSHIBA**  
 RP 700F AM/FM short wave radio, stereo 3" speakers 59.95  
 RPS5 Credit card FM stereo receiver, headphones 57.95

an application program. When this bit is not set, the system is in system mode, which runs the operating system kernel. The memory-management system also disables certain operations in user mode, such as I/O instructions and memory accessing not belonging to a currently active user. If a user attempts any of these operations, the system issues a non-maskable interrupt that clears user mode and puts the machine in system mode. Without this protection, these operations can corrupt the system for all users.

The heart of the memory management system is a 256-by-14-bit logical RAM section, into which Xenix writes the control bits for as many as 256 memory segments (pages) of 4K bytes each, along with a page-relocation value that relates logical and physical address space. The control bits define legal memory access and are read by PALs, which function as comparators to detect the execution of illegal instructions and alert the central processor to prevent illegal writes. The relocation value becomes part of the physical memory address, permitting memory segments to be assembled noncontiguously while the central processor makes accesses as if the memory were a solid block.

The memory-management system thus makes it possible for the 8086 to run Xenix efficiently by providing a paging system that permits "scattered loading" of processes into logical memory: the 4K-byte pages can be scattered throughout the 1-megabyte logical memory (i.e., mapped anywhere), eliminating the time-consuming search for extensive contiguous physical memory to load a process. Unlike some minicomputers, the 586 can swap pages of lengthy programs back and forth between the scattered areas of noncontiguous main memory and a swap area on the hard disk. The 586's intelligent hard-disk controller further speeds swapping by writing and reading multiple pages in less than one revolution, rather than the several revolutions required by many minicomputers.

### **Making Xenix Universal**

Regardless of its processing power,

disk storage, and communications capabilities, however, the 586 would not be appropriate for corporate-wide office automation without some way to make its Xenix operating system amenable to the typical business user. To this end, Altos has created a "business shell" that presents Xenix's capabilities in an easy-to-use menu-driven format.

This Xenix business shell is compatible with virtually any RS-232C terminal and is accompanied by several integrated applications programs for nonprogramming personnel, including an electronic mail package developed by Altos, a financial planner based on Microsoft's Multiplan, the Horizon word-processing system, a Business Basic III interpreter, a seven-module accounting package, and an interactive tutorial.

---

## **A "business shell" presents Xenix's capabilities in an easy-to-use format.**

---

System programmers can use the shell's facilities to customize software for end users by modifying menus and prompts. The menu system is composed of a collection of ASCII (American National Standard Code for Information Interchange) files that may be viewed and modified either through the menu development portion of the system or directly with any text editor. Data is stored almost exactly as it will appear, which allows precise control over the final screen displays. Moreover, the menus and prompts themselves are structured around the Xenix file system as a convenient mechanism for customizing software.

The shell frees a user from having to learn the myriad commands that make Xenix a versatile and powerful tool, but not an easy one to master. The Xenix command "mkdir," for example, creates a new directory; "cat" concatenates files and displays them; and "rm" removes them. In contrast, the 586's Xenix interface offers clear menu choices at each stage of a user's interaction with the system. When

additional input is required, the system prompts for it at the bottom of the screen. For inexperienced users, the 586's business shell provides complete online assistance, displaying information about any menu or selection. Sophisticated users can execute Xenix commands directly simply by prefacing them with "!" or by entering the standard Bourne shell or C-shell.

### **Local Networking and Remote Communications**

Xenix capabilities and 16-bit architecture in a desktop computer are impressive, but the range permitted by ribbon or RS-232C cable between a terminal and the microprocessor is not great. A stand-alone multiuser system cannot address the processing requirements of users on another floor or another continent. Sophisticated networking and communications capabilities are required, which the 586 solves by offering two LAN configurations and the bisynchronous, X.25, and SNA communications protocols.

The more modest networking scheme is Altos's proprietary RS-422 twisted-pair LAN software called Altos-Net, which is supplied in the 8K bytes of ROM (read/only memory) in the main board's Z80 processor. Based on UNET software from 3COM, Altos-Net runs at 800 bits per second (bps) and uses a bit-oriented synchronous data-link control (SDLC) protocol to link as many as 32 Altos 16-bit machines. Implementing this protocol was greatly simplified because Altos-Net is not an inter-vendor LAN. At the physical layer of the seven-layer International Standards Organization (ISO) model, for example, a single-chip RS-422 driver can produce a differential signal for both the clock and data transmissions, each of which is sent as a pair of "mirror images" that cancel external noise. At the link layer, a Zilog communications chip functions in a low-level SDLC-like mode, offering the speed of a bit-oriented, carrier-sense protocol without the expense of collision detection. Transmission is in packets consisting of an opening flag (six "1"

# ScratchPad

## The Ultimate Spreadsheet for CP/M-86<sup>®</sup>, IBM PC DOS<sup>®</sup>, and CP/M<sup>®</sup>

### **The Ultimate Spreadsheet? YOU BET!**

Packed with more important features and performance than any other spreadsheet, ScratchPad is perfect for "what if" analyses and financial modeling of all kinds.

The features tell the story:

### **Flexible Spreadsheet**

A ScratchPad innovation. Now you can design the spreadsheet to fit your application, rather than redesigning your application to fit the spreadsheet. For example, if you need a worksheet that is extremely wide but not very deep, ScratchPad can do it. The matrix dimensions are up to you.

### **Virtual Memory**

Another ScratchPad innovation. When your computer runs out of memory in RAM, your disk drives act as a backup memory for additional spreadsheet data. (This is something other spreadsheet people don't talk about in their ads. They can still run out of memory!)

ScratchPad with a hard disk on the IBM PC, for example, allows in excess of 20,000 entries! NEVER see those disastrous OUT of MEMORY messages again.

### **Consolidation**

This lets you combine several spreadsheets, adding or averaging the numeric data. It is especially useful to businesses that want to combine data from several departments, or add or average spreadsheets from different months of the years. Just another reason why ScratchPad is the ultimate spreadsheet.

These features and many others make ScratchPad the most powerful spreadsheet available! So, find out why we call ScratchPad the Ultimate Spreadsheet.

Write: ScratchPad Information, SuperSoft, Box 1628, Champaign, IL 61820.

### **This is what others are saying:**

#### **Small Business Computers**, July/August '82

"In our opinion ScratchPad is an excellent business-oriented spreadsheet program, easy to learn, easy to use, and well documented."

#### **InfoWorld**, Sept. 6, '82

"ScratchPad . . . [is designed] for users who want entry simplicity and fast answers."

#### **Business Computer Systems**, Sept. '82

". . . a new memory innovation from SuperSoft . . . ScratchPad[s] virtual memory can accommodate an essentially unlimited number of entries by tapping the disk drive for secondary memory."

Available for IBM PC DOS, CP/M-86<sup>®</sup> and CP/M<sup>®</sup>  
ScratchPad: \$295.00

(Requires 96K\* with PC or MS DOS, 64K\* with CP/M-86<sup>®</sup> and 56K with CP/M<sup>®</sup>)

Now available for OASIS: call 802-658-5600.

**Japanese Distributor:** ASR Corporation International, 3-23-8, Nishi-Shimbashi, Minato-Ku, Tokyo 105, Japan. Tel. (03)-4375371 Telex: 0242-2723.

**European Distributor:** Micro Technology Ltd., 51 The Pantiles, Tunbridge Wells, Kent, England TN2 5TH. TEL. 0892-45433. Telex: 95441 Micro-G.

\*Additional memory recommended for optimal performance of all features.

CP/M and CP/M-86 are registered trademarks of Digital Research.

Circle 370 on inquiry card.

# SuperSoft<sup>®</sup>

FIRST IN SOFTWARE TECHNOLOGY P.O.Box 1628 Champaign, IL 61820 (217) 359-2112 Telex 270365

# SAT/GRE STUDY SKILLS

FOR ALL MODELS OF THE  
APPLE II

## Math Skills Pak

**Math 1** - Basic Skills, Algebra,  
Geometry, and Word Problems  
300 Entries - \$25

**Math 2** - Same Level as Math 1 with  
Graphic Display of Problems.  
Pie Charts, Line Plots, Bar Graphs,  
Geometry Constructions and  
Flow Charts. Math 1 is Needed.  
\$35

**Math Skills Pak** (Both Diskettes)  
\$50

## Verbal Skills Pak

**Vocabulary Builder** - Over 1600  
Entries with Antonyms and  
Synonyms - \$25

**Word Analogy** - Over 1200 Entries  
Stored with Hints - \$25

**Sentence Completion** - Over 300  
Entries of Completion, Correction  
and Construction Formats - \$25

**Verbal Skills Pak** (All Three  
Diskettes) - \$60

## Key Features of SEI™ Software:

- All Diskettes are Date Base Systems Complete with Editors for Modification or Expansion.
- Built in Program Documentation for Easy Use by Students.
- Hints to Aid Students Develop Test Taking Strategies.
- Instant Grading on Virtually Limitless Questions.
- 30 Day Money Back Guarantee if Not Satisfied.

SEI

P.O. Box 7266-B  
Hampton, VA 23666  
804/826-3777



bits), a station address, data, two bytes of cyclic redundancy check (CRC), and a closing flag.

The remaining five layers of the ISO model are implemented by the UNET software, which offers file transfer, virtual terminal capability, transmission control protocol, electronic mail and internet protocol.

## Ethernet on a Chip

The 586 is one of the first systems to offer Ethernet capabilities on a chip for users who need a more expansive, higher-performance LAN or who seek to implement an industry standard to link machines from several vendors. Altos expects this protocol to become the de facto standard for local-area networks because of Ethernet's high performance, availability, low cost, and acceptance by a rapidly growing list of vendors.

In the 586, the Intel Ethernet chip set resides on half of the system's communications board, while the other half provides either remote synchronous communications or four additional serial I/O channels. "Ethernet on a chip" actually consists of two separate chips hardwired together—a controller and an encoder/decoder. The controller chip is located on the system's lone Multibus interface and is programmed from the 8086. At the opposite end of the board, the encoder/decoder chip connects with the half-inch Ethernet transceiver cable through an Ethernet port.

The Ethernet chip replaces a far more expensive Ethernet controller board from 3COM, which Altos previously used in the 586. The chip runs the Ethernet protocol and also contains small numbers of FIFO (first-in, first-out) registers to buffer the packets. Moreover, it has a built-in DMA (direct memory access) interface, which replaces an external DMA channel and provides an internal I/O port. As a result, the Ethernet chip does not need to make two memory accesses to manipulate data (one to read from memory and one to write to I/O, or vice versa); it gets the data from memory in a single access.

The Ethernet chip's intelligence rivals that of the central processor in certain respects. A user can tell the

chip what to do by writing a program into memory because the chip gets all of its instructions directly from memory, not from another processor. For the same reason, the chip can run the Ethernet protocol while remote communications protocols are being run by their own processor. Were the networking and communications protocols to share a processor, they could not run simultaneously.

Unlike the Ethernet chip set, the serial I/O communications chips on the other half of the communications board must receive instructions from an Intel 80186, which shares the board and runs 128K bytes of local memory. This extra processor is necessary because Xenix is not a real-time operating system and is thus not designed to service communications protocols efficiently.

Each of the board's two serial I/O chips supports two channels, and two of these four channels support synchronous communications. Unlike the Z80 on the main board, which has most of its code in immutable ROM, the communications board contains only minimal ROM but has a large amount of RAM. This makes it an excellent candidate for economical communications software upgrades. Augmented versions of X.25, SNA, and other protocols can be implemented simply by loading them onto the communications board from a disk. Because the 80186 contains 128K bytes, it will probably be several years before a hardware upgrade will be needed to accommodate these newer protocols. The communications board also contains a socket for an optional 212-type 1200-bps full-duplex modem module.

More limited communications capabilities are standard on the 586 through its six serial I/O ports. Five of these channels can operate in asynchronous mode at all 15 standard data rates between 75 bps and 19,200 bps. In addition, two external registers can be loaded with a 16-bit unsigned integer to generate a unique rate setting for these channels. Each channel has its own programmable timer, which allows the channel to have its own data rate. The sixth channel provides external clocking on



No computer can go faster than its memory.

Even the lightning-fast 68000 processor can be slowed to a snail's pace by a sluggish main memory design.

For that reason, we designed the memory for 16-bit SAGE computers to keep pace with the 68000. It's a close-coupled, straightforward design that lets the processor run full bore at 2 million instructions a second.

Anything less simply wouldn't be state of the art.

### Simple Isn't Always Easy.

To make a memory simple is simple.

But to make a simple memory fast is difficult.

And to incorporate it into a computer that doesn't cost a fortune is next to impossible. That is, unless some highly-creative circuit solutions can be found.

And that's precisely how the totally unique SAGE memory was born.

### One MBYTE Of 64 KBYTE Devices.

In keeping with the no-compromise spirit of SAGE memory design, we

naturally use only 64K, dynamic 150-nanosecond memories. SAGE IV™ computers can be equipped with a megabyte of this type of memory.

And you can specify as few as one or as many as four built-in Winchester, plus floppy drive.

What's more, thanks to its exclusive memory design, your SAGE computer can take data as fast as its floppy disk



can dish it out. In fact, with no need for skewing or interleaving, the SAGE Computer actually lets its floppy run as fast as Winchester do on some machines.

So when you select a computer for serious development or serious business, remember the importance of memory.

For more information and the name of your nearest SAGE dealer, call us today.

Sage Computer Technology, Corporate Office, 4905 Energy Way, Reno, Nevada 89502. Phone (702) 322-6868. TWX: 910-395-6073/SAGE RNO

### Eastern United States

Sage Computer Technology, 15 New England Executive Park Suite 120, Burlington, MA 01803 (617) 229-6868

### In UK

TDI LTD, 29 Alma Vale Road, Clifton, Bristol BS8-2HL  
Tel: (0272) 742796  
Tx: 444 653 Advice G

### In Germany

MM Computer GmbH, Hallwanger Str. 59, 8210 Prien

Tel: 08051/3074

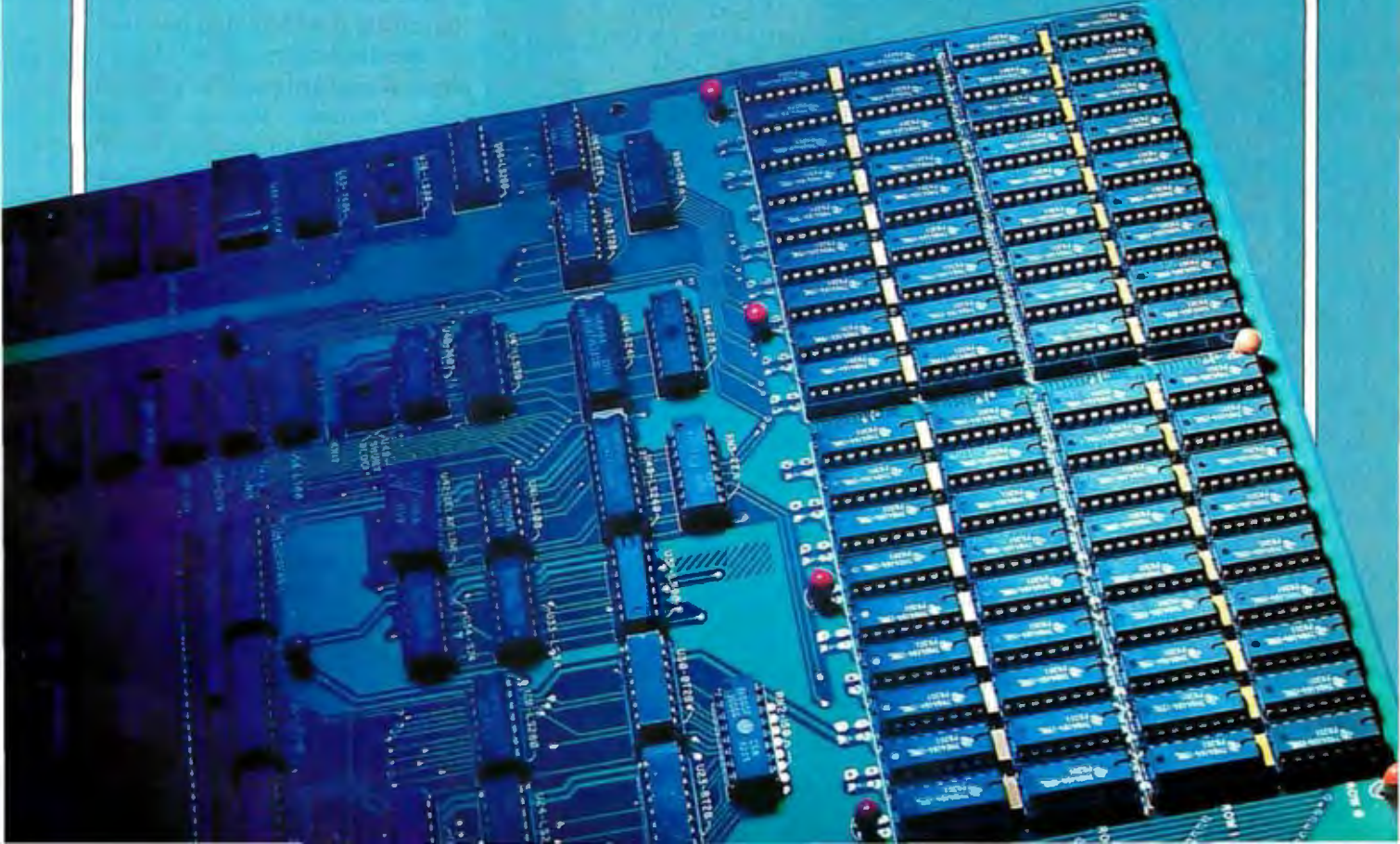
Tx: 525 400 mmco-d

p-System standard, supporting Pascal, FORTRAN 77, BASIC and 68000 Micro Assembler. CP/M-68K, Hyper-Forth, Modula 2 optional. SAGE and SAGE IV are trademarks of SAGE Computer Technology.

© 1983 SAGE Computer Technology all rights reserved.

Circle 338 on inquiry card.

**SAGE**  
COMPUTER TECHNOLOGY



# 100%

## CERTIFIED ERROR FREE



**QUALITY  
YOU MAY NEVER NEED.  
But it costs no more!**

The expert technicians who produce and monitor the quality of our diskettes have developed new state-of-the-art technology using equipment we design and build ourselves, unlike any other diskette maker. That's why our burnishing method uses a unique, dual-sided technique which provides an advanced degree of surface smoothness, the key to consistent high quality



**SENTINEL®**

performance. In addition, a superior, high quality lubricant assuring extra long life and a quality control program which includes certifying every Sentinel Diskette are reasons we can offer you the industry's most exacting guarantee. For unsurpassed information security, choose Sentinel brand, and ask your dealer about the new 2-PACK in a resealable storage case.

**The Professional's Diskette — Ideal for Personal Use.**

Sentinel Computer Products, Division of Packaging Industries Group, Inc.,  
Hyannis, MA 02601 Tel: 617-775-5220

both transmit and receive clocks to support synchronous serial devices.

### Architecture of the 586

A fully loaded 586 contains four printed-circuit boards. The main board holds the 8086 and 512K bytes of memory; a Z80 I/O processor supporting six serial I/O ports, floppy-disk accesses, and an RS-422 LAN port; and sundry memory-management components enabling the system to support Xenix. A second board holds an intelligent hard-disk and tape controller with an Intel 8089 I/O processor. An optional communications board provides an Ethernet chip set and processors supporting either the bisynchronous, X.25, or SNA protocols, or four additional serial I/O ports. The fourth board is an optional memory-expansion board providing an additional 512K bytes of RAM. A standard 586, consisting of the central processor board with 512K bytes of RAM, six serial ports, a 10-megabyte hard-disk drive, a 1-megabyte floppy-disk drive, and Altos-Net, sells for \$7990.

The 586 system multimaster bus is electrically identical to the Intel Multibus, using the same signals and signal timing. This compatibility allows the 586 to accommodate the standard slotted Multibus interface of the communications board. Here the physical similarity to Intel's Multibus ends, however. Instead of using Intel's card cage or backplanes, Altos placed the hard-disk controller board atop the main board and provided a short ribbon connector between the two. Because the central processor and the Z80-based I/O processor are on the same board, they are simply hard-wired together. The 512K-byte memory expansion board plugs directly into the central processor.

The 10-MHz 8086, which includes parity error detection per byte on the main memory, can fully direct its power to run applications and the heart of the operating system, leaving the I/O details to the Z80 and the 8089. The 586 offers superior performance to systems using an unaided central processor to handle I/O book-keeping duties partly because these three processors can run simultane-

# TIME-PROVEN PERFORMANCE



Now Available Nationwide  
Through Participating  
COMPUTERLAND Stores

While new printers with impressive specifications are introduced on an almost daily basis, only time will tell the true quality of the product. Over the past 2 years our customers have continued to buy the DS180 printer, not only because of its impressive performance and competitive price, but also because of our outstanding track record for product reliability and customer support.

We have continually improved on the performance of the DS180 by incorporating such enhancements as dot addressable graphics, 6 user-selectable print sizes and a 2000 character buffer. These features coupled with 180 cps printing, parallel and serial interfaces, adjustable tractor feed and over 40 other programmable features, make the DS180 one of the most versatile matrix printers available today.

Before you select your next printer, why not take a look at a time-proven performer—the Datasouth DS180.

The DS180 printer is available nationwide through our network of sales/service distributors.

Circle 113 on inquiry card.

**datasouth** computer corporation

P.O. Box 240947 • Charlotte, NC 28224 • 704/523-8500  
Telex: 6843018 DASOU UW

# HARDWARE / SOFTWARE - WHOLESALE!

Purchase your Hardware and Software directly from an OEM/Systems Integrator. Take advantage of our buying power! We stock a full line of Board Level Components, Software, and Peripherals. Call for your needs. We'll give you the Lowest Prices, and the Technical Support and Know-How we are quickly becoming well-known for. Satisfied Customers Nationwide! The Nation's Custom Systems House for Business, Education, Science.

## SOME OF OUR CURRENT SUPER-SPECIALS

**IMMEDIATE DELIVERY! MORROW MICRO DECISION ALL CCT TESTED! MORROW TERMINAL**  
**1 DRIVE - \$819 2 DRIVE - \$1149 ~~2 DS DRIVE - \$1299~~ \$499**

MICROSOFT MBASIC - 8" CP/M - \$199 • ASHTON-TATE dBASE II \$459  
 MICROPRO WORDSTAR - 8" CP/M - \$259 • WYSE 100 TERMINAL - \$769  
 MITSUBISHI DSDD 8" DRIVES - FULL OR HALF HEIGHT - \$449 (THE BEST)  
 SIEMENS SSDD 8" DRIVES - \$239 • OKIDATA 82 - \$419 / 83 - \$679 / 84 - \$1029

### BOARDS/SYSTEMS **COMPUPRO** CUSTOM BUILT BUSINESS SYSTEMS

**LIMITED SPECIAL:** SYSTEM 816A - \$4395 816B - \$5595 816C - \$7195

M-DRIVE CP/M - 128K - \$959 • DISK 1 W/CP/M - \$489 • M-DRIVE H - \$1395  
 8085/88 - \$319 • 8086/87 - \$519 • CPU-Z - \$229 • DISK 1 - \$369 DISK 2 - \$599  
 INTERFACER 1 OR 2 - \$199 • INTERFACER 3-5 - \$449/3-8 - \$519 • INTERFACER 4 - \$279  
 RAM 17 (12 MHZ) - \$359 • RAM 16 (12 MHZ) - \$399 • SYSTEM SUPPORT 1 - \$309  
 ENCLOSE 2-DESK - \$659/RACK - \$699 • RAM 21 - \$849 • CPU 68K - \$519  
 CP/M - \$149 • CP/M 86 - \$259 • MP/M 8-16 - \$769 • HARD DISKS, CABLES, ETC. - CALL US!

SIEMENS DUAL 8" SSDD SUBSYSTEM - \$699 MITSUBISHI DUAL 8" DSDD SUBSYSTEM - \$1099 w/AllCabling!  
 20 MEG FUJITSU HARD DISK SUBSYSTEM W/DISK 2, BIOS, & ALL CABLING - \$3199

WE ARE THE LARGEST IN THE CUSTOM CONFIGURATION OF COMPLETE STATE-OF-THE-ART S-100 SYSTEMS. AT PACKAGE PRICING, WITH INTEGRATION, BURN-IN & PROGRAMMING. WE CUSTOM BUILD COMPUPRO SYSTEMS/HARD DISK SYSTEMS FOR BUSINESS APPLICATIONS.

WE NOW FEATURE A SPECIAL LEASE/OPTION AND FINANCING ON BUSINESS SYSTEMS - CALL!

**WOW! \$\$\$ SPECIALS \$\$\$ GOOD THROUGH MONTH END.** As supplies last. Rainchecks may be given if possible. Cash Sales Only!

## CUSTOM COMPUTER TECHNOLOGY

1 CRAFTSMAN COURT, BOX 4160, SEDONA, ARIZONA, 86340 (602) 282-6299

PRICES & AVAILABILITY SUBJECT TO CHANGE. ALL PRODUCTS NEW. AND CARRY FULL MANUFACTURER'S WARRANTIES. CALL FOR CATALOG. FREE TECHNICAL HELP TO ANYONE. WE CAN CONFIGURE BOARDS & SOFTWARE FOR YOUR SYSTEM. PLUG-IN & GO. AZ RESIDENTS ADD APPLICABLE SALES TAX. CP/M® DIGITAL RESEARCH

ously and more or less independently.

Although the 8086 and the Z80 are on the same board, they perform different logical functions. The central processor performs 8- and 16-bit signed and unsigned arithmetic functions in binary or decimal, including multiplication and division, data transfers, string operations, and bit manipulation.

With 8K bytes of ROM and 2K bytes of RAM, the Z80 handles the serial I/O channels for six RS-232C ports, sparing the 8086 from character interrupt processing. The Z80 also controls a 5¼-inch floppy-disk drive, containing either a 512K-byte single-sided or 1-megabyte double-sided disk. As part of its serial I/O duties, the Z80 permits asynchronous and bisynchronous communications. It also supports an RS-422 port for Altos's proprietary limited-range 800,000-bps local-area network, called Altos-Net. Finally, the Z80 accesses a battery-backed calendar and clock on the main board, eliminating the need for the software to ask the time and date when the system is turned on each day. The Z80 always talks with the 8086 through DMA and a pair of interrupt lines.

The 8089 I/O processor, which resides with 16K bytes of RAM on the hard-disk controller board, also communicates with the 8086 through main memory. This controller can support two 5¼-inch hard-disk drives—typically the Miniscribe 2012 or Seagate ST412—and one 12-megabyte (formatted) start/stop (funnel) tape drive. The controller handles seeking, serial data transfers, and DMA into system memory. The 8089 can read a full track in one disk revolution, which is important for running Xenix.

### Conclusion

By offering virtually all levels of users ready access to the powerful features of a minicomputer running Unix software, the 586's Xenix business shell provides a capstone for the system's networking and communications capabilities and marks an important step in the direction of corporate-wide distributed data processing. ■

# We've lowered your IEEE-488 BUS fare.



## The Model 609 GPIB Controller.

When you need an IEEE 488/RS-232 Bus Controller—nothing more—get just what you need:

The new Model 609 micro-processor-based controller is a low-cost, industrial grade controller compatible with all instruments using the IEEE 488 bus. Use it as the controller instead of a more expensive programmable calculator, micro-computer or mini-computer. Or use it as the intelligence to create a data collector / logger system. *Save on bus fare by investing in the controller that's made for the job.*

### \$995 FOB factory.

- 4K RAM for program development and data storage.
- BASIC language with "Blast" instruction to burn EPROMs.
- Programs quickly changeable with 4K E PROM plug-in cartridges.
- Two RS-232 ports interface with data communication equipment.
- "Service request" structure—serial and parallel poll.
- Transmission or reception of BCD or ASCII messages.
- 16-bit integer arithmetic.
- Sturdy yet portable for field use. Less than 10 pounds.



### PHYSICAL DATA

Division of Hathaway Corp.  
 8089 S.W. Cirrus Dr.  
 Beaverton, OR 97005  
 Phone (503) 644-9014

# SUPER BARGAINS

**ACE 1000 COLOR COMPUTER!** ..... List \$1545  
**SHARP COMPUTER** ..... 249



## SUPERBRAIN II

Double Density ..... 1894  
 Quad Density ..... 2274  
 Super Density SD ..... 2649  
**COMPUSTARS**  
 TO DEALERS ..... CALL & SAVE

Advanced Micro Digital S-100 Super-Quad Single Board Computer. Z80 64K RAM, Disk Controller, RS-232 ..... Only 699

**ALTOS — single and multi-user**  
 ACS-8000-15D ..... List 5990  
 Only 4699

**ATARI 400** ..... 289  
 800 ..... 655

## PRINTERS

OKIDATA 82A ..... 489  
 CENTRONICS 739-1 ..... 499  
 IDS PRISM 80 ..... 743

**EPSON MX-80 FT** ..... 547  
 MX-80 ..... 459  
 MX-100 ..... 749

ANADIX 9501A ..... 1345  
 Silent Scribe ..... 1623  
 NEC #3510 Letter Quality ..... 1399  
 C. ITOH F10 Letter Quality ..... 595  
 Smith Corona TP-1

**TRAXX 5 1/4" Add-on Drives** ..... 249

Memory Merchant 16K static ..... 159  
 Central Data RAM S-100 64K ..... 299  
 Systems Group  
 RAM S-100 64K ..... 449  
 Microangelo Video Graphics ..... 715

**AMERICAN SQUARE COMPUTERS** is organizing a World Wide Association of Computer Dealers. Open a Store or Start Work Out of Your Home! We Charge **NO FRANCHISE FEE!** (Our Competitors charge a FRANCHISE FEE of from \$15,000.00 to \$45,000.00.) Be a Winner! Let US help YOU get started **MAKING MONEY** by **HELPING PEOPLE** to put **COMPUTERS TO WORK**. Write or Phone today.

Which Computers are Best? ... Free  
 Insured Shipping at Low Rates.

**We Repair Computers**



## TELEVIDEO

Televideo 910+ ..... 518  
 Televideo 925 ..... 718  
 Televideo 950 ..... 899  
 Televideo Computers ..... Call

ADDS VIEWPOINT A-1B ..... 469  
 ZENITH Z-19 Terminal ..... 649  
 Z-89 48K Computer ..... 2119  
 Z-90 64K DD ..... 2399  
 ZVM-121 ZENITH  
 Green Screen monitor ..... 125

INTERTUBE III  
 or EMULATOR ..... \$710  
 AMDEK Color Monitor ..... \$329

**GODBOUT COMPUPRO**  
 Super Sixteen 8085/8088. The fastest 8-16 bit computer! Runs 8 and 16 bit code! 128K Static RAM, 6MHz CPU's LIST 3440 ..... SPECIAL 2569

**New: Systems 816/A, B, and C with enclosure and drives.**  
 816/A ..... List 5495 ..... Only 4395

**SEATTLE** pure 16 bit computer is the fastest microcomputer by actual test! S-100, 128K Static RAM, 8 MHz 8086, 22 slot Mainframe  
 Model #2 ..... List 3785 ..... Only \$3025  
 #1 as above  
 but 64K ..... List 2990 ..... Only \$2392

**IBM PC memory made by SEATTLE.**  
 Now with "Flash Disk" .. 192K = 697  
 64K = 427

**CALIFORNIA COMPUTER 2210A**  
 List \$1995 ..... Only \$1595  
 Z80, 64K, I/O, Disk controller + CPM.  
 California main frame ..... 484

**SYSTEMS GROUP** computers run **FRIENDLY OASIS** Call ..... SAVE

**QUAY COMPUTER**  
 Two drives + CPM ..... \$1745  
 Four user MPM 208K  
 Hard Disk ..... \$5945

**TARBELL'S**  
 Empire I & II have two 8" disk drives. The I is single sided, the II is double sided.

**FREE Business Software**  
 Empire I ..... List 4888 ..... Only 3495

Corvus Hard Disk ..... SAVE  
 SSM Video BRD VB3 kit ..... 361  
 Spectrum Color ASM ..... 223

**One hour free troubleshooting on business systems.**



## NORTH STAR

ADVANTAGE 64K Green Phosphor. The Best Business Graphics, 2 Disks, Serial Port. Options CPM — Business programs ..... \$2894



**NORTH STAR Horizon**  
 Powerful North Star BASIC Free  
 Superb for Business & Science  
 Free Secretary Word Processor

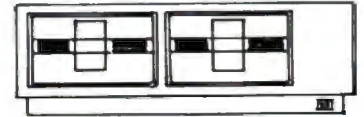
Horizon Standard is now HRZ-2-64K Quad  
**Factory Assembled & Tested** ..... Only  
 Horizon-2-64K-Quad ..... \$2894  
 Horizon-1-64K-QHD 5 ..... 3999  
 Horizon RAM 64K ..... 594  
**Big Sale on Multi-User**  
 Time-Sharing ..... SAVE  
 North Star Hard Disk 18Mb ..... 4295  
 English to Basic Translator ..... 75  
 Zbasic 2 to 5 times faster! ..... 325  
 Secretary Word Processor ..... 69  
 Wordstar Word Processor ..... 278  
 Floating Point Board ..... 690  
 Oasis ..... 690  
 CPM for N-Extra features ..... 147  
 Micro Mike Software ..... CALL  
**MICROSTAT** ..... \$355  
 Pascal-80 ..... 539  
 Extra Precision BASIC ..... 49  
 Northword ..... 179  
 Infomanager ..... 329  
 General Ledger ..... 399  
 Accounts Receivable ..... 399  
 Accounts Payable ..... 399  
 Inventory ..... 399  
 Order Entry ..... 399  
 PROPAC ..... 1299  
 DOS + BASIC 5.2 ..... 28

**INTEGRAND** main frames S-100. Many models to choose from  
 Only 200 & UP

## MODEMS

DC HAYES — S-100 ..... \$329  
 POTOMAC MICRO MAGIC ..... 369  
 SIGNALMAN ..... 97  
 CAT NOVATION ..... 159  
 AUTOCAT ..... 215

**Full Time Graduate Technician on Duty.**



## MICRO DECISION

"A DEAL YOU CAN'T REFUSE"

64K RAM, Z80, 4MHz, 2 Serial Ports, Disk Controller. FREE SOFTWARE: CPM — Microsoft BASIC — BaZic — Wordstar — Logicalc — Correct-It.

List ..... Only  
 with 1 5 1/4" Disk .. \$949 ... \$1049  
 with 2 5 1/4" Disks .. 1545 ... 1400



## DECISION I

"The IBM-360 on the Z-80 & S-100 BUS!"

Sixteen Programs running simultaneously! Free CPM, Microsoft BASIC, and WORDSTAR with complete system!

DECISION 1 + 65K Static +  
 8" Disks DMA ..... 3403  
 DECISION 1 + 65K Static +  
 2 5 1/4" Disks ..... 2795  
 DECISION 1 + 65K Static +  
 5" Disk + 5 Mb Hard Disk ..... 4235  
 DECISION 1-2user 256K Static +  
 5" Disk + 5 Mb Hard Disk +  
 MICRONIX ..... 5830  
 DECISION 1 — Z-80 + I/O + 65K 1915  
 DECISION 1 — Rackmount + 20 Mb  
 HD - 8" DRV ..... Reg. 6235  
 Inventory Sale 5415

## MORROW Hard Disks up to 26 MEGABYTES

HDC-M26 ..... \$3333  
 HDC-M20 ..... 3333  
 HDC-M10 ..... 2955  
**DMA-M5** ..... Reg. 1775  
 Inventory Sale 1400  
 DMA-M10 ..... 2235  
 DMA-M16 ..... 2795

## MORROW 8" Disk

Discus 2D + CPM 600K ..... Only \$834  
 Discus 2 + 2 + CPM 1.2 Mb ..... 1068  
 Add Drives 2D = 599 2 + 2 = 1795  
 Discus 2D dual + CPM ..... Only 1384  
 Free Microsoft BASIC from MORROW with Discus system or hard disk.

**FAST FIGURE** — Most powerful spread sheet. 5 1/4" or 8" ..... 99

Wordstar ..... 278  
 All MicroPro Software for IBM, Apple, North Star, Morrow, etc. SAVE! CALL

Call for latest prices & availability

Factory Guarantees

We Beat Prices

**AMERICAN**



**COMPUTERS**

919-889-4577

4167 Kivett Dr.

Jamestown N.C. 27282

919-883-1105





# A Machine for All Processors

## The Fujitsu Micro 16s

*The Micro 16s, with its plug-in processors, was designed to run a large variety of operating systems and applications programs.*

---

Wayne Clingingsmith  
Fujitsu Professional Microsystems  
3320 Scott Blvd.  
Santa Clara, CA 95051

---

The Fujitsu Micro 16s personal business computer (see photo 1) offers a unique architectural design: interchangeable microprocessors. It lets users choose from among the most popular processors available today. Eventually, more microprocessors will be added to this group, ensuring that the Micro 16s will not become obsolete.

The primary advantage, of course, is the ability to interchange operating systems, which provides the path to a wide assortment of applications programs.

### Applications Processors

The main circuit board of the Micro 16s does not contain a central processor (see photo 2). By pulling the central processors off the main board and configuring them on plug-in boards, the designers of the Micro 16s have made it possible to use any of several Primary Applications Processors. One or two processor boards can be plugged into the Micro 16s, and either one can be in control of the bus, the memory, etc.

Boards are available now for a 16-bit processor, the 8086, and the Z80A 8-bit processor. In the near

future, boards will be available for 16-bit processors such as the 68000 and 80286.

The 68000 board should be particularly attractive. It will have an 8-MHz clock rate letting it perform 1 million instructions per second. And it will be capable of running the Unix operating

---

**The Micro 16s can  
easily adopt whatever  
operating system is  
currently in style.**

---

system along with a wealth of applications programs that have primarily been confined to minicomputers and mainframes.

### Flexibility

Flexibility is the cornerstone of this computer's architecture. It confronts head-on an issue that is often swept under the rug: the finite life span of an operating system. Like many things, operating systems go in and out of style. One sometimes wonders, "What is the operating system of the day?" The Micro 16s is the first microcomputer to address this problem directly.

For example, a person who owns a computer that uses an 8086 microprocessor with the MS-DOS operating system—and who makes a substantial investment in hardware, software, and peripheral devices—may learn that the particular industry involved has subsequently adopted the Unix operating system. Now a 68000, a Z8000, or some other chip would be needed.

Micro 16s owners won't lose any investment in existing peripheral devices. The Micro 16s, because of its architecture and its bus system, can adopt whatever operating system turns out to be au courant. It becomes a simple matter to add the appropriate applications processor board and the new software, rather than acquiring an entirely new system with new peripheral devices and converting all the old programs. With the Micro 16s, the old programs would still be usable with the old processor.

### A Look Inside

Inside the Micro 16s there's a main circuit board with a card cage having six card slots. A diagram of this is shown in figure 1. On this board are 128K bytes of volatile memory, a



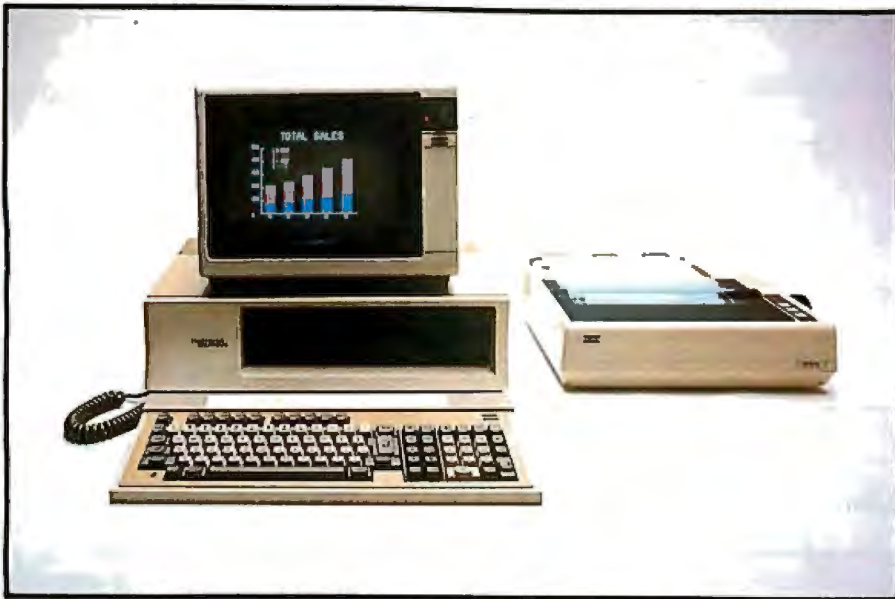


Photo 1: The Fujitsu Micro 16s personal business computer.

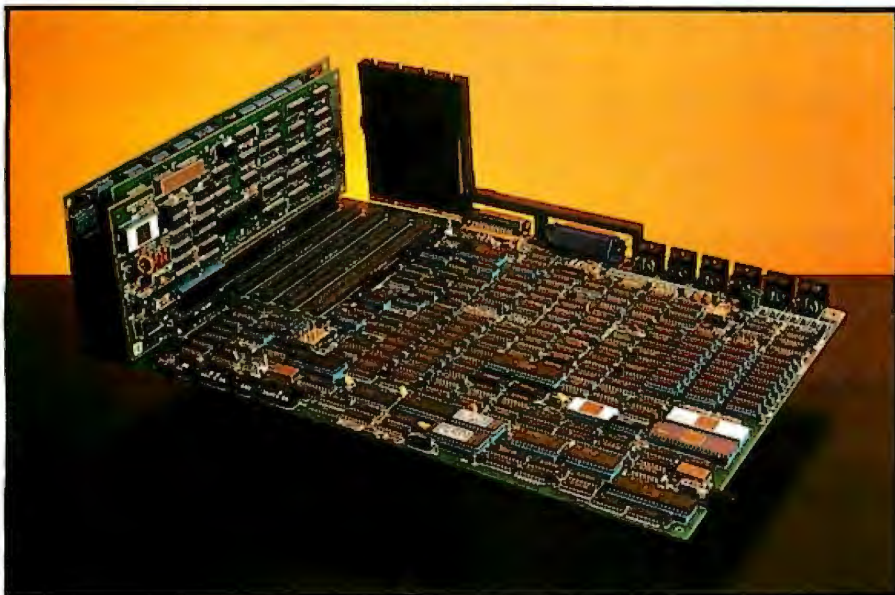


Photo 2: The main circuit board of the Fujitsu Micro 16s. Two processor boards are plugged into the expansion slots.

dedicated video subprocessor (based on the 6809 processor), and 64K bytes of additional memory for this processor. Because these memory chips have an extremely low failure rate, the chips are soldered to the board rather than merely plugged in.

What's more, the Micro 16s has a floppy-disk controller, an RS-232C serial controller, a Centronics parallel controller, a light-pen controller, and a 4-channel A/D (analog-to-digital) converter all built in.

It is important to note that all these basic I/O (input/output) controllers

are located on the motherboard. They don't take up any of the six plug-in slots.

The applications processors are configured on plug-in boards. The system, as delivered, comes with both an 8086 and a Z80A applications processor board plugged into slots 1 and 2. The 8086 board has a socket for the 8087 arithmetic processor and controllers for DMA (direct memory access). Either or both of the boards can be replaced as a user's requirements change.

The package as described so far, in-

cluding an RGB color monitor, CP/M-86, the Wordstar word-processing program, and Supercalc<sup>2</sup>, retails for \$3995.

### Extra Memory

The first upgrade that one is likely to want is Concurrent CP/M-86, which offers a single-user/multitasking operating environment. It enables you, with a single keystroke, to switch between a spreadsheet, a word-processing program, and a calendar operation. If the Micro 16s is functioning as a terminal in regard to a mainframe, you may want to switch back and forth to an operation running on that remote processor. For example, in slot 3 you might add the memory necessary to support this operating environment.

Four single-board memory options will be available—128K, 256K, 512K, or 1024K bytes. Yes, I said 1024K bytes of volatile memory on a single board. This will be made possible by the new 256K-bit volatile-memory chips.

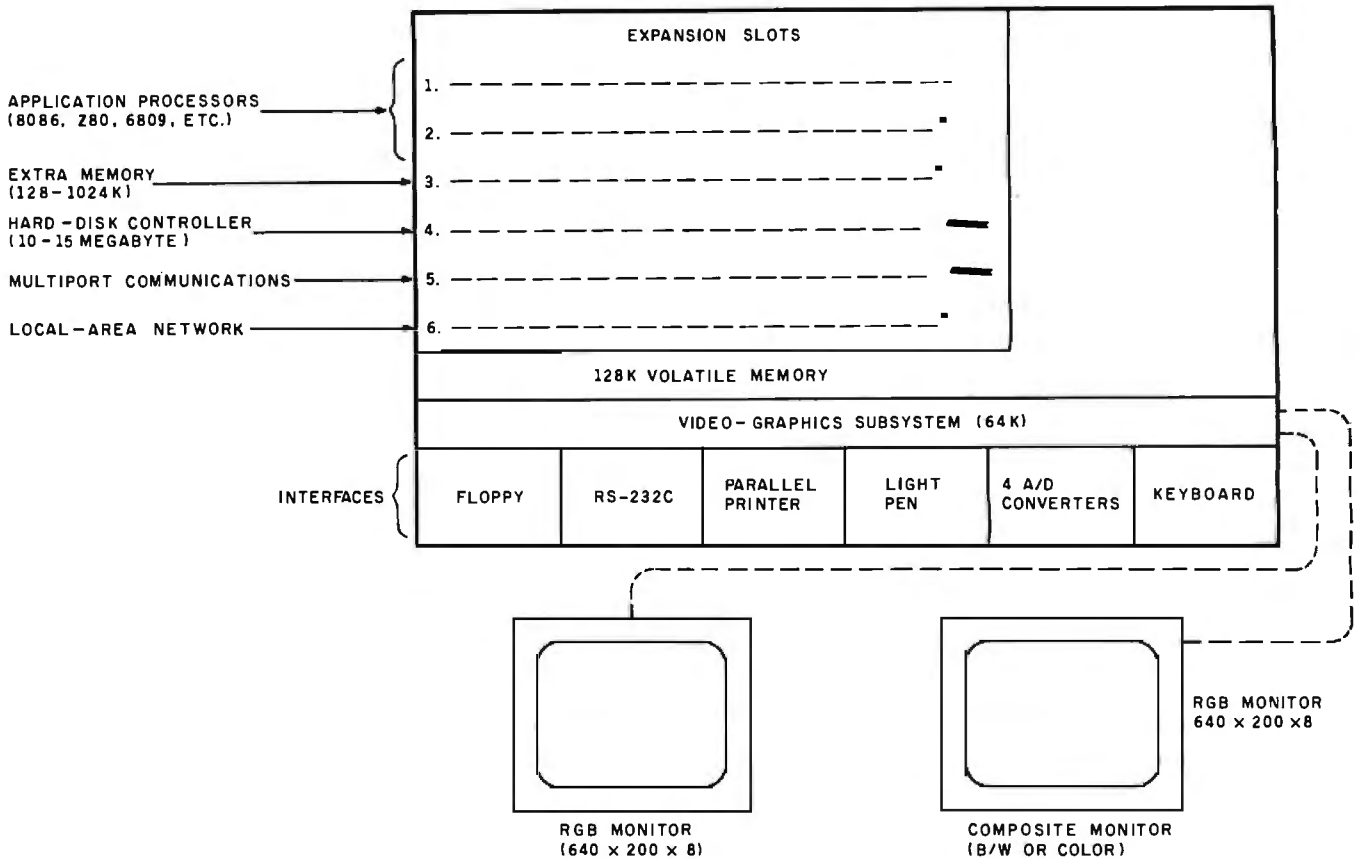
The 128K-byte memory board will have two additional RS-232C ports. This is valuable for addressing both a serial printer and a modem. Also, if you are using the MP/M operating system, these extra ports enable other users to access your database through remote terminals.

### Other Peripheral Devices

A hard-disk controller will soon be available using one slot on the main circuit board. Fujitsu will be offering a 5-, 10-, and 20-megabyte Winchester disk drive for this computer.

The remaining two slots (after memory and hard-disk controller) provide room to add a mix of additional peripheral devices. For example, you may want to attach a number of terminals to the system. A multiport RS-232C controller card will soon be available to allow this. Under MP/M-86, the Micro 16s would be able to run several terminals and printers at the same time.

If you have many applications and you would like local-area networking, the Micro 16s will offer two choices: Omnet (with a data-transmission rate of 1 megabit per second)



**Figure 1:** Diagram of the Fujitsu Micro 16s computer. Two applications processors (the 8086 and the Z80A) come standard with the unit along with an RGB monitor and dual disk drives. The video-graphics subsystem uses a 6809 processor and has its own 64K bytes of memory. Slots 2 through 5 are identical and can house any combination of cards.

Operating System	Description	Available
Concurrent CP/M-86	Single-user, multitasking on 8086-based systems	6/83
MP/M-86	Multuser, multitasking on 8086-based systems	12/83
MS-DOS	Microsoft's version of IBM PC-DOS	11/83
GSX	Graphics system extension	8/83
Unix	68000-based, powerful networking system	5/84

**Table 1:** Additional operating systems for the Fujitsu Micro 16s.

and Ethernet (10 megabits per second).

Omninet allows you to interconnect several microcomputers. For example, several users could then share a hard disk. Ethernet is designed for those in high-throughput environments, where you may want to interface with a DEC computer or other mainframe computer systems.

An IBM 3278 controller board will

be available to connect the Micro 16s to mainframe computers over a coaxial cable at 2.5 megabits per second.

### Operating Systems

The power and flexibility of the Micro 16s rely heavily on a variety of operating systems, listed in table 1. Many are significant new operating systems being made available by Digital Research Inc., the developer

of the popular CP/M operating system.

Concurrent CP/M-86 from Digital Research enables you to perform multiple tasks, such as entering data and printing the hard copy of a letter, at the same time. This permits an operator to perform other tasks while waiting for input or output functions to complete. MP/M-86 lets several users perform multiple tasks on the Micro 16s. MS-DOS enables programs developed for the IBM PC to operate in the Micro 16s, while Unix extends the multiuser, multitasking capability of the machine still further, including features such as networking.

Digital Research's GSX graphics interface is an extension to the CP/M system that provides a universal graphics protocol for graphics devices. It significantly eases the interface to the video-terminal sub-processor and provides portability for CP/M-based programs.

# BASF QUALIMETRIC™ A TOTALLY NEW DIMENSION OF QUALITY.



From BASF comes a totally new level of excellence in magnetic media—the Qualimetric standard, a standard so advanced that BASF FlexyDisks® are confidently backed by an extraordinary new lifetime warranty.\* The Qualimetric standard is maintained without compromise through every step of BASF design, production, inspection, and testing... reflecting an unwavering BASF commitment to media fidelity and durability.

Our FlexyDisk jacket incorporates a unique two-piece liner that not only traps damaging debris away from the media surface, but also ensures precise media-to-head alignment. The result—certified 100% error-free performance, backed by BASF's exclusive lifetime warranty.\*

For information security, tomorrow and beyond, look for the distinctive BASF package with the Qualimetric seal. Call 800-343-4600 for the name of your nearest supplier.

Circle 38 on inquiry card

ENTER TOMORROW ON BASF TODAY



# BASF

\*Contact BASF for warranty details. © 1982, BASF Systems Corporation, Bedford, MA

	Jan	Feb	Mar	Apr	May	Jun
<b>ASSETS</b>						
Acct.s Receivable	-500.00	100.00	105.00	110.25	115.76	121.55
Cash	300.00	-250.00	50.00	52.50		57.00
Unsold Goods	-125.00	26.25	6.56	27.56	28.94	30.39
<b>Total Assets</b>	<b>-325.00</b>	<b>-123.75</b>	<b>161.56</b>	<b>190.31</b>	<b>199.83</b>	<b>209.82</b>
<b>LIABILITIES</b>						
Acct.s Payable	1000.00	916.67	840.28	770.25	706.07	647.23
Storage Cos s	50.00	50.00	50.00	50.00	50.00	50.00
Labor	100.00	-235.00	-246.7	-259.09	-272.84	-285.64
Materials	50.00	52.50	55.13	57.88	60.78	63.81
<b>Total Liabilities</b>	<b>1200.00</b>	<b>784.17</b>	<b>690.65</b>	<b>619.85</b>	<b>544.00</b>	<b>475.48</b>
<b>NIBT</b>	<b>-1525.00</b>	<b>-987.92</b>	<b>-537.89</b>	<b>-428.74</b>	<b>-344.97</b>	<b>-265.55</b>
Dep. Allowance	100.00	100.00	100.00	100.00	100.00	100.00
Taxable Income	-1625.00	-1087.92	-637.89	-528.74	-444.97	-365.55

Form=0,5NES  
 ^ F6 Width: 9 Memory: 73 Last Col/Row:025 ? for HELP  
 1)

Photo 3: An example of the colors available in the character mode of the Micro 16s. Shown is a Supercalc<sup>2</sup> table.

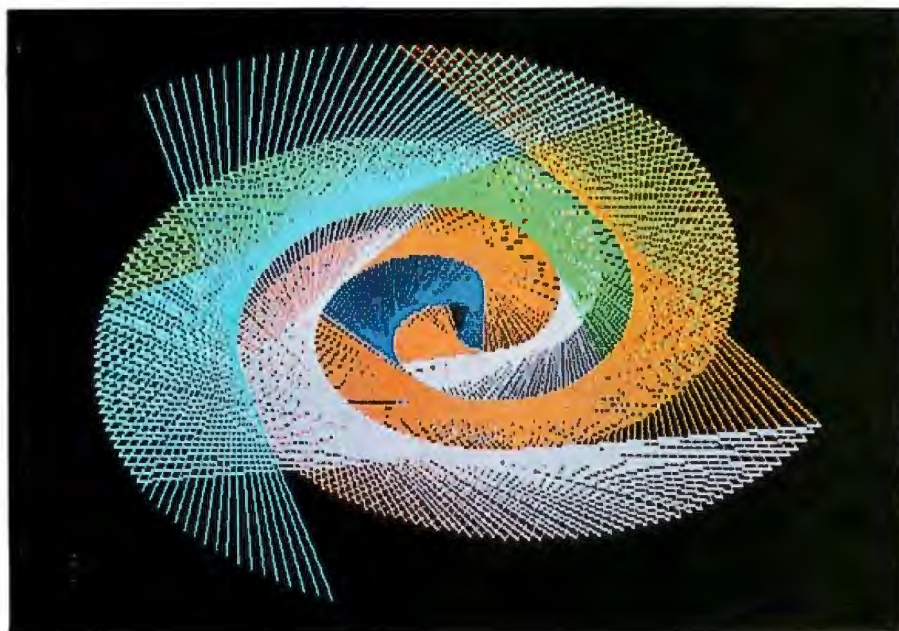


Photo 4: An example of the color-graphics capability of the Micro 16s.

## Video Display

The Micro 16s's video display is a self-contained video-display terminal handling not only video, but also keyboard interrupts and I/O processing.

Video display is handled by the independent video processor that is sent high-level commands by the main processor. The video processor resides on its own bus and does not use an expansion slot. By running in

parallel and not requiring any main processor bus cycles, it supplies the main system with characters and high-resolution graphics without taking up user address space. This makes it easy for the Micro 16s programmer to manage the video display without worrying about which operating system or main applications processor plug-in board is used. Parallel processing also increases throughput and allows the main system to maintain a

high clock rate because it does not have to be synchronized with the video display.

The Micro 16s can display 221 characters, including the standard ASCII (American National Standard Code for Information Interchange) character set, engineering symbols, graphics, and forms graphics (see photo 3). Each character can be displayed in one of eight colors, with a choice of eight background colors (black, blue, red, purple, green, light blue, yellow, or white). Two levels of intensity are also possible in character mode, allowing a total of 16 displayable colors. In addition, "blink" and "reverse" attributes are available.

The video display supports the ADM 3 terminal mode and uses escape sequences for performing certain smart terminal functions. These include setting video and cursor attributes and setting and getting cursor position.

The video display also has a graphics mode that features 640 by 200 pixels, displayable in one of eight colors. In addition, the video processor supports high-level commands such as to draw a line, draw a box, paint, and print. Table 2 lists some of the 45 commands, which also include functions for a light pen, timer, and displayable time-of-day clock.

You can generate a graphics display by computing the appropriate set of points to be drawn using a BASIC program and then passing high-level line commands along with the necessary parameters to the video processor.

Photo 4 is an example of a complex display that can be quickly drawn by a BASIC program. The program computes the three apexes of a triangle and places them, as (x,y) coordinate pairs, into an array. A video-processor command is then invoked to place the parameters into the video terminal's 128-byte interface buffer. This is usually in the form of a line command (see table 2). For each line of the triangle, you send the code for the line command in the following format: command code, color code, function code, first coordinates, second coordinates, and box flag.

**CP/M<sup>®</sup>  
IBM<sup>®</sup>  
APPLE<sup>®</sup>**

# PRICE WAR!

<b>WordStar<sup>®</sup> \$269</b>	<b>dBASE II<sup>™</sup> \$489</b>	<b>SuperCalc<sup>™</sup> \$189</b>	<b>Multiplan<sup>™</sup> \$199</b>	<b>Perfect Writer<sup>™</sup> \$289</b>
<b>WordStar<sup>®</sup> MailMerge<sup>™</sup> \$369</b>	<b>WordStar<sup>®</sup> dBASE II<sup>™</sup> \$749</b>	<b>VisiCalc<sup>®</sup> \$189</b>	<b>SuperWriter<sup>™</sup> \$249</b>	<b>InfoStar<sup>™</sup> \$299</b>

A.L.S. <sup>™</sup> Z-80 Card \$129 CP/M Card \$359	FOX AND GELLER <sup>™</sup> Quickcode \$229 dUlti \$ 69 dGraph \$229	WordStar/MailMerge \$369 WordStar/MailMerge/SpellStar \$509 WordStar/InfoStar \$549 InfoStar \$299 CalcStar \$ 89 DataStar \$179 SuperSort \$149 SpellStar \$149 ReportStar \$229 DataStar Update CALL	DASIS <sup>™</sup> The Word Plus \$129 Punctuation and Style \$109	SORCIM <sup>™</sup> SuperCalc \$189 SuperWriter \$249 SpellGuard \$129
ASPEN SOFTWARE <sup>™</sup> Grammatik \$ 60 Random House Proofreader \$ 39 Random House Thesaurus \$119	HOWARDSOFT <sup>™</sup> Tax Preparer (Apple) \$179 Tax Preparer (IBM) \$189	MicroStar DataStar \$179 SuperSort \$149 SpellStar \$149 ReportStar \$229 DataStar Update CALL	ORGANIC <sup>™</sup> Milestone \$269	TCS ACCOUNTING <sup>™</sup> Accounting Package (4 Modules) \$289 GL, AR, AP, PR or Inv. Mgmt. \$ 99 ea.
ASHTON-TATE <sup>™</sup> dBase II \$489	IUS <sup>™</sup> Easywriter II \$239 EasySpeller II \$139 Easylier \$269 Financial Management Series CALL	MICROSOFT <sup>™</sup> SoftCard \$259 Ram Card \$ 89 Videxterm (Videx <sup>™</sup> ) \$269 All Three Above \$509 Multiplan \$199 Enhancer II (Videx <sup>™</sup> ) \$119 BASIC 80 \$275 BASIC Compiler \$295 COBOL Compiler \$549 FORTRAN 80 \$349 Flight Simulator \$ 45	PEACHTREE <sup>™</sup> Series 4 PeachPak (GL, AR & AP) \$369	PERFECT SOFTWARE <sup>™</sup> Perfect Writer \$289 Perfect Speller \$169 Perfect Writer/Speller \$389 Perfect Calc \$169 Perfect Filter \$279 All Four Perfect Products \$749
COMPUTING <sup>™</sup> Power \$119	LEXISOFT <sup>™</sup> Spellbinder \$259	MICROSOFT <sup>™</sup> BASIC 80 \$275 BASIC Compiler \$295 COBOL Compiler \$549 FORTRAN 80 \$349 Flight Simulator \$ 45	PICKLES AND TROUT <sup>™</sup> CP/M for TRS Model II \$169 CP/M for TRS Model 16 \$189 Hard Disk CALL	VISICORP <sup>™</sup> VisiCalc \$189 VisiTerm \$ 85 VisiDex \$189 VisiFile \$249 VisiSchedule \$249 VisiTrend/Plot \$249 Business Forecaster \$100 Desktop Planner \$249
CONTINENTAL SOFTWARE <sup>™</sup> Home Accountant CALL	LIFETREE SYSTEMS <sup>™</sup> Volkswriter \$145	MICROSOFT <sup>™</sup> BASIC 80 \$275 BASIC Compiler \$295 COBOL Compiler \$549 FORTRAN 80 \$349 Flight Simulator \$ 45	SILICON VALLEY SYSTEMS <sup>™</sup> Word Handler \$149 List Handler \$129	FLOPPY DISKETTES (Boxes of Ten) 8" \$ 25 5" (SS) \$ 25 5" (DS) \$ 35
DIGITAL RESEARCH <sup>™</sup> CBASIC \$109 CB-80 Compiler \$379 PASCAL/MT+ \$259 Access Manager \$225 CBASIC 86 \$149 PASCAL/MT+ 86 \$299 Concurrent CP/M 86 \$259	METASOFT <sup>™</sup> Benchmark \$379	MICROSTUF <sup>™</sup> Crosstalk \$135		

## NOW, PAY LESS, AND GET GREAT SERVICE, TOO!

If you're looking for rock-bottom prices *and* fast, personal service, take a close look at 800-SOFTWARE.

Because we buy in volume, we're able to sell the products you want at prices that finally make some sense. But don't take our word for it. Compare prices and see for yourself!

### OUR SERVICE CAN'T BE BEAT.

We take care of you like our business depends on it. Because it does.

When you call 800-SOFTWARE, you get the fastest delivery available anywhere. Which means that every order is filled the day we get it. And that our unique

Order Tracking System<sup>™</sup> is on the job, keeping tabs on your order, every step of the way.

Our giant inventory—one of the largest in the United States—also assures you of the fastest possible service. Everything's in stock so you don't have to wait.

Technical support? Business software expertise? We've got it—and it's the best you'll find *anywhere*.

But, put us to the test. Let us prove what we've proven to satisfied customers around the world.

That our prices *are* lower. That our service *is* better. That there really and truly *is* a difference.

We look forward to your call.

TO ORDER, CALL TOLL-FREE:

**800-227-4587**

In California, 800-622-0678  
or 415-644-3611  
CA residents add sales tax.

OR WRITE:  
**800-SOFTWARE, INC.**

3120 Telegraph Avenue,  
Berkeley, CA 94705



- Purchase orders accepted.
- Prompt UPS 3 day Blue Label.
- Call for shipping charges, *free catalog*, and other low software prices.
- Now open Mon. Sat.
- International and national dealer requests welcome.
- Quantity discounts available.
- Prices may change.

©1983 800-Software, Inc.



**ANADEX**

**Epson**

**DATASOUTH**

**NEC**

**Daisywriter**

**Diablo**

**Ribbons**

**Gemini**

**MANNESMANN TALLY**

**Okidata**

**MPI**

**PRICES SO LOW—**

**WE CAN'T LIST THEM!**

**ADDS**

**Smith Corona**

**QANTEX**

**LEAR SIEGLER**

**SUPPLIES**

**AMPEX**

**ESPRIT**

All equipment is in factory cartons with manufacturers' warranty. Prices subject to change without notice. Most items in stock or shipped as received.

**1** **NATIONWIDE SERVICE, MOST PRODUCTS**  
**SUPER WAREHOUSE**

P.O. BOX 373 WALLINGFORD, CONNECTICUT 06492  
ORDER LINE ORDER HOURS  
**203-265-1223** 9:00 AM - 5:00 PM-EST  
MONDAY-FRIDAY

**PHONE ORDERS FREE**  
(ONE DOLLAR CREDIT FOR PHONE ORDERS)

Command Name	Function
PUT STRING	Displays a character string
PUT CHARACTER BLOCK 2	Writes characters and attributes to VRAM
GET CURSOR POSITION	Reads the cursor position
TAB SET	Sets tab positions
CHARACTER LINE	Draws a character line or box
CHARACTER OUT	Displays a character
GET LIGHT PEN POSITION	Reads the coordinates indicated by the light pen
LINE	Draws a line or box
CHAIN	Draws a broken line
POINT	Displays one or more points
PAINT	Paints the area inside a boundary
SYMBOL	Displays a character string in a specified location, orientation, and size
LINE2	Draws a line (for CIRCLE FULL)
GET BLOCK1	Reads a specified color
PUT BLOCK2	Displays a pattern in a specified color
GRAPHIC CURSOR	Reads specified coordinates
ERASE GRAPHIC VRAM	Erases the graphic VRAMs
DEFINE PF STRING	Defines a character string for a program function key
GET PF STRING	Reads the string defined for a PF key

Table 2: Some of the graphics commands used by the video-graphics subsystem of the Micro 16s.

The command code indicates what type of command it is; the color code selects one of the eight specified colors; and the function code selects how the output video will combine with other colors in the same area of the screen (foreground, background, OR, AND, XOR). The box flag selects a choice of a line, a box, or a box filled with the indicated color. For example, in photo 4 the line command was used and the triangle was rotated. Large colored-block areas could have been added with only slight changes in the line command. This is but one example of the power of the video-terminal processor.

**A Detailed Look**

Figure 2 is a block diagram showing the components of the Micro 16s in detail. The two slots for the processor boards do not have equal priority. Slot 1 is for the master processor. The 8086 and the 68000 processor boards can be inserted into these slots. These boards are equipped with controllers for DMA and a bootstrap-loader program in ROM (read-only memory). When the system is turned on, the master processor initially has control.

The master processor that comes with the machine uses an Intel/Fujitsu

16-bit 8086 microprocessor running at a clock rate of 8 MHz. As mentioned above, this board contains the master clock, driver circuits, a 4-channel DMA controller, and a bootstrap loader. At power-up, the loader program also performs power-up diagnostics. If a problem is detected, an error message is displayed to indicate where the problem is, and the ROM monitor program takes over to let the operator investigate the error in more detail, using DMA, input/output, and disk commands.

In slot 2 of the standard unit is an 8-bit Z80A microprocessor board. It operates at 4 MHz and has memory-bank-selection circuitry that enables it to address the full 24-bit (16-mega-byte) address space of the Micro 16s. It also contains an offset register that allows its addresses to be offset by 64K bytes to avoid conflicts with the 8086 processor. Under the CP/M 2.2 operating system, all disk accesses are performed by the 8086 processor.

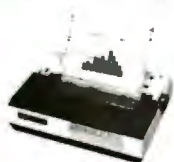
It should be noted that the Micro 16s does not come with a complete CP/M 2.2 system. Instead, the computer's CP/M-86 system can use the Z80A to simulate a CP/M 2.2 environment. Thus, all 8-bit CP/M programs can be run, but system components such as the 8-bit CP/M

# OUR PRICES, SELECTION AND SAME-DAY SHIPPING MAKE US COMPETITIVE. OUR PEOPLE MAKE US EXPERTS.

## Red Baron. Home of the Nation's Largest Computer Printer Inventory.

### NEC 8023

Outstanding Graphics, Print  
Quality & Performance

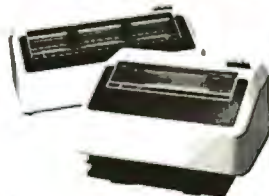


144 x 160 dots/inch • Proportional Spacing  
• Lower case descenders • N x 9 dot matrix  
• 8 character sizes • 5 unique alphabets • Greek  
character set • Graphic symbols • 100 CPS  
print speed • Bi-directional, logic-seeking  
• Adjustable tractors • Single-sheet friction  
feed • Vertical & horizontal tabbing

**\$Call**

### IDS Prism 80/132

Affordable Color, Speed



200CPS • Bi-directional, logic-seeking • 24 x 9 dot  
matrix • Lowercase descenders • 8 character sizes  
• 80-132 columns • Proportional spacing  
• Text justification • Optional color and dot resolu-  
tion graphics

Prism 80 . . . . . Base List \$1,299  
Prism 132 . . . . . Base List \$1,499 **\$Call**  
Microprism 480 . . . . . List \$799

### Brothers HR-1 Daisy Wheel

Perfect for quality,  
quiet word processing.



• 16 CPS • Prints up to 6 copies • Bi-directional  
• Cloth or carbon quick-change cassette ribbon  
• Quiet, efficient operation for word processing

Brothers HR-1  
Parallel . . . . . List \$1,100  
Serial . . . . . List \$1,200 **\$Call**  
Ask about the Brother HR-15

### CRT's and Monitors Price, Performance & Reliability

Televideo	List	Discount
910 . . . . .	\$ 699	<b>\$575</b>
925 . . . . .	\$ 995	<b>\$730</b>
950 . . . . .	\$1195	<b>\$945</b>
970 . . . . .	\$1495	<b>\$Call</b>
<b>Amdek</b>		
Video 300, Green . . . . .	\$ 249	<b>\$155</b>
Color-1 . . . . .	\$ 499	<b>\$345</b>

### The Epson Series High-Quality Printers at a Low Price.

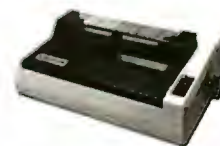


160 CPS • Dot graphics • Proportional spacing •  
Downloadable character sets • 10 and 12 CPI •  
Super/subscripting • Underlining • Reverse line  
feed

Epson FX series . . . . . **\$Call**

Full Line of Epson Accessories.

### Star Micronics Gemini 10/15



120 x 144 dot graphics • 100 CPS • 2.3K buffer  
• 2K User programmable ROM •  
Underlining • Super/subscripts  
• Friction feed and adjustable  
tractors

Gemini 10 . . . . .  
Gemini 15 . . . . .

**Lowest  
Priced  
Dot  
Matrix**

### Other Quality Printers at Red Baron

	List	Discount
Anadex DP-9501A . . . . .	\$1,725	<b>\$1,325</b>
Anadex DP-9620A . . . . .	\$1,845	<b>\$1,475</b>
Anadex WP-6000 . . . . .	\$3,450	<b>\$2,900</b>
Smith-Corona TP-1 . . . . .	\$ 895	<b>\$Call</b>
NEC Spinwriter RO Serial Parallel 7710 . . . . .	\$3,085	<b>\$2,425</b>
Serial 3510 . . . . .	\$1,895	<b>\$1,600</b>
Okidata Series . . . . .		<b>\$Call</b>
Toshiba P-1350 . . . . .	\$2,195	<b>\$Call</b>

### Interface Equipment Complete Stock of Options, Cables and Accessories.

GRAPPLER + APPLE INTERFACE . . . . .	\$175
BUFFERBOARD . . . . .	\$175
CCS APPLE SERIAL Interface & Cable . . . . .	\$150
SIGNALMAN MODEM . . . . .	\$Call
HAYES MICROMODEM II . . . . .	\$300
COMPLETE STOCK OF EPSON ACCESSORIES . . . . .	\$Call
CUSTOM PRINTER CABLES FOR Apple, Atari, IBM, TRS-80 (all models) . . . . .	\$Call
PRINTER STANDS: Large . . . . .	\$ 99
Small . . . . .	\$ 25
PRINTER RIBBONS—Most Types . . . . .	\$Call
Color Coder Diskette Cases . . . . .	\$ 16
VERBATIM DISKETTES . . . . .	\$Call



### Our People, Our Product: Both Are Specialized.

Red Baron is an organization of computer printer  
specialists. They know the capabilities of each  
printer, and how to match one to your exact need.  
Call for expert consultation today!



### Here's How To Order:

Phone orders are welcome; same-day shipment on  
orders placed before 11:00 a.m. Free use of Master-  
Card and Visa. COD's accepted. Personal checks  
require 2 weeks clearance. Manufacturer's warranty  
included on all equipment. Prices subject to revision.  
APO/FPO Orders Welcome.

### ORDERS ONLY CALL:

**(800) 854-8275**

CA, AK, HI (714) 779-2779



4501 E. Eisenhower Circle, Anaheim, CA 92807

# Aural Gratification

With the ECHO speech synthesizer from Street Electronics whatever you type on the keyboard, your computer can say. The ECHO's text-to-speech system gives your computer an unlimited vocabulary while using a minimum of memory. And now a diskette of fixed, natural sounding words is available to enhance the ECHO II's voice output.

Nearly 400 language rules are contained in the ECHO's text-to-speech algorithm. These rules enable the computer to pronounce most correctly spelled words. When in the text-to-speech mode the user can select any of 63 different pitch levels, and have words spoken either monotonically or with intonation by using simple control character sequences. The rate of speech can be fast or slow; words can be spoken in their entirety or spelled letter by letter. The ECHOs also pronounce punctuation and numbers. Words can be encoded using phonemes and diphthongs when the text-to-speech or fixed vocabulary is not required.

Applications are unlimited, ranging from phone answering, educational and training programs, to games and aiding the sight and speech impaired. The ECHO is a complete stand alone unit which is compatible with most any computer; it sells for \$299.95. The ECHO II, which plugs into the Apple II, is priced at \$149.95.

Contact us about the ECHO/PC for the IBM Personal Computer.



**Street Electronics Corporation**

1140 Mark Avenue Carpinteria, CA 93013

Telephone (805) 684-4593

Call toll free for demonstration (800) 221-0339



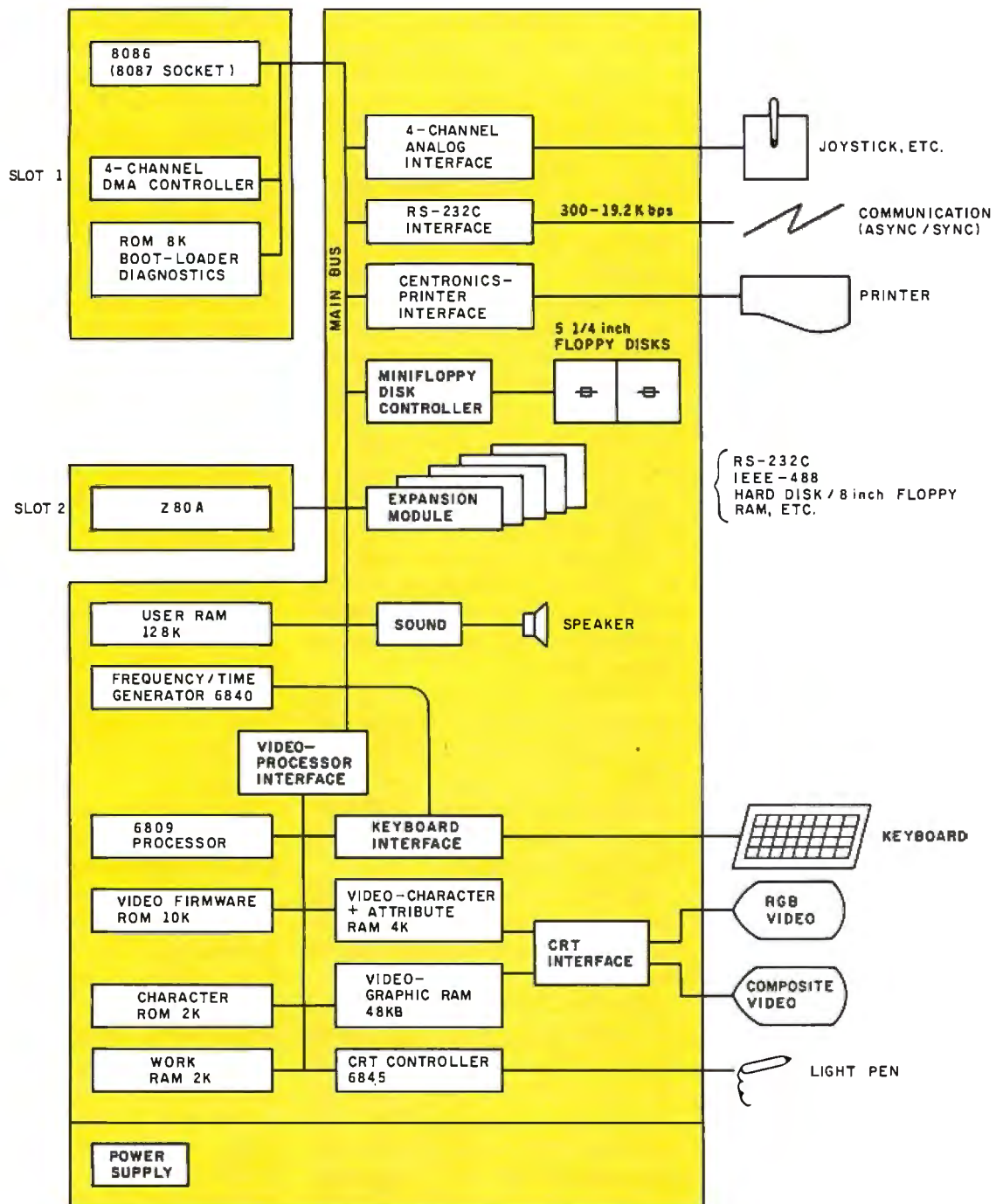


Figure 2: A block diagram of the Micro 16s system. The 8086 processor is plugged into slot 1 and the Z80A into slot 2.

assembler have been left out.

In order to accommodate the various processor boards, the main circuit board has a data bus unique to Fujitsu. The bus contains 130 pins on a positive-contact connector, ensuring high reliability. All the various control lines run to each of the expansion slots, including lines for interrupts, DMA-bus-requests, signals to refresh the dynamic RAM (random-

access read/write memory) chips, system clocks, 16 bits of data, and 24 bits of address information. All the expansion slots have both maskable and nonmaskable interrupts available for use by expansion cards.

Slot 1, which is occupied by the master processor, has two extra control lines that go to control logic circuits on the main board rather than running the extent of the bus. These

are the HREQA (halt-request A) and HACKA (halt-acknowledge A) signals.

Figure 3 is a simplified diagram showing how control is transferred from one processor to the other. "Flip-flop R" is set during power-on/reset, thereby clearing a halt-request line to CPU-A and enabling a halt-request to CPU-B. CPU-A then takes control of the bus and the boot-

**!!!!FANTASTIC PRICES!!!!  
FROM DIGITAL DIMENSIONS**

**OKIDATA**

ML-80..80 COL., 80 CPS.....	\$317
ML-82A..80 COL., 120 CPS.....	\$395
*ML-83A..136 COL., 120 CPS.....	\$639
*ML-84..PARALLEL, 136 COL., 200 CPS.....	\$969
*ML-84..SERIAL, 136 COL., 200 CPS.....	\$1,083
<b>**ML-92..80 COL., 160 CPS PARALLEL.....</b>	<b>\$509</b>
<b>*ML-93..136 COL., 160 CPS PARALLEL.....</b>	<b>\$832</b>
SERIAL INTERFACE FOR ML92&ML93.....	\$99
PACEMARK 2410..350 CPS.....	CALL
PACEMARK 2350..SERIAL, 350 CPS.....	CALL
*Includes TRACTOR FEED	
**Inc.,OKIGRAPH™ DOTADDRESSABLE GRAPHICS	

**SEIKOSHA**

DOT MATRIX, PARALLEL 50 CPS PLUS GRAPHICS.....	\$269
---	-------

**IDS**

PRISM 80..3.4K & 200 Sprint.....	\$1,036
Inc. sheet feed, color & graphics.....	\$1,429
PRISM 132..3.4K & 200 Sprint.....	\$1,195
Inc. sheet feed, color & graphics.....	\$1,591
MICROPRISM 480.....	\$569

**STAR MICRONICS**

GEMINI-10..100 CPS, 2.3K BUFFER.....	\$329
GEMINI-15.....	\$519

**C. ITOH**

Prowriter..80 Col., 120 CPS, Parallel.....	\$396
Prowriter 2..80 Col., 120 CPS, Parallel.....	\$696
Starwriter F-10..40 CPS.....	\$1,425
Printmaster F-10..55 CPS.....	\$1,595

**SMITH CORONA**

TP-1..12 CPS.....	\$649
-------------------	-------

**MODEMS**

Hayes 300 Baud Smart Modem.....	\$219
Hayes 1200 Baud Smart Modem.....	\$515
NOVATION, ANCHOR AUTOMATION AND VETUTEL MODEMS ALSO AVAILABLE.	

**MONITORS**

AMDEK Color I.....	\$309
AMDEK Color II.....	\$609
NEC JB1201 Green.....	\$169

**FOR THE IBM P.C.**

NEC Spinwriter 3550..33CPS.....	\$1,990
Quadram Quadboard w/64K.....	\$469
Quadram Quadboard w/128K.....	\$519
Quadram Quadboard w/192K.....	\$609
Quadram Quadboard w/256K.....	\$699
Monte Carlo Card 64K.....	\$429

**E-Z COLOR BOARD**

For the Apple II or Apple II Plus.	
Includes demo software and	
E-Z COLOR SUPER EDITOR.....	\$199
S-100 Systems.....	\$279
TRS-80.....	\$239

**INTEX TALKER text-to-speech synthesizer.**

Serial and parallel interface included.....	\$280
---	-------

**DIGITAL DIMENSIONS**

190 Chapel Rd., Manchester, CT 06040

Info & Orders Call 203-649-3611  
Orders Only 1-800-243-5222

C.O.D. Welcome Allow 2-3 Weeks For Checks MC VISA OK  
All Prices Include UPS Ground Freight In U.S.  
CT Residents Add 7 1/2% Sales Tax  
Prices Subject To Change Without Notice

loader ROM program on that processor card starts its diagnostics and proceeds to load the operating system. Control of the bus can be transferred from one processor to the other under program control by setting or resetting a flip-flop. When this is done, a halt-request command is issued to the operating processor, which then completes its instruction, halts, issues a halt-acknowledge signal, and drops off the bus. The inactive processor then synchronously uses this acknowledge to end its previous halt state and regain control of the bus. It will later relinquish control over the bus if the procedure is repeated. This allows an orderly transfer of control.

The 5¼-inch floppy-disk controller can handle up to four drives. Because it plugs directly into the motherboard, it does not use any of the expansion slots.

The Micro 16s comes with two 5¼-inch double-sided double-density disks that provide 320K bytes of formatted storage each. The disk-controller chip is a Fujitsu (MB8877) version of the Western Digital 1793 floppy-disk controller.

The Micro 16s comes with 128K bytes of volatile parity-checking memory on Fujitsu MB8265 64K-bit dynamic-RAM chips on the motherboard. These RAMs can be refreshed using either pin 1 or the RAS refresh signal, which is controlled by the main processor on the bus. This combination assures easy interfacing with additional main processor cards (such as the 68000) that will be supported by Fujitsu. Additional RAM, up to 1 megabyte per slot, can be added using the expansion bus slots.

The printer interface is a standard Centronics 36-pin parallel interface. The RS-232C interface has a software-programmable data-rate generator and uses the Intel 8251A USART (universal synchronous/asynchronous receiver/transmitter) enabling both asynchronous and synchronous serial communications. Data rates from 300 to 19,200 bps (bits per second), asynchronous, and 0 to 64,000 bps, synchronous, are available.

The speaker interface uses the 6840

timer chip connected to an audio amplifier to allow a full range of tones to be generated. The analog interface uses a Fujitsu MB4052, 8-bit, 4-channel, multiplexed, A/D converter. It delivers analog-to-digital conversion to a main applications processor in 5 milliseconds (ms).

The keyboard interface converts serial information from the keyboard into parallel data. Under software control, interrupts are directed to either the main processor or the video processor to handle keyboard inputs.

The keyboard uses a Fujitsu single-chip (MB88401), 4-bit microprocessor to scan the matrix and serialize the key-closure data. The keyboard data is then sent serially to the keyboard interface on the motherboard. Also, a built-in self-check function, a character-code table, and a key-matrix table are programmed into the 4-bit microprocessor. The low-profile detachable keyboard has a total of 98 keys with cylindrically sculptured key tops laid out in typewriter arrangement.

The power supply is designed to meet the power requirements for the standard system and allow for future expansion. It is even capable of supporting a Fujitsu 5¼-inch 5-, 10-, or 20-megabyte Winchester hard-disk drive in place of one of the 5¼-inch floppy-disk drives, along with a full megabyte of volatile memory.

The lower portion of figure 2 outlines the video-terminal section. This section is a completely independent video terminal. It has a 68B09E (2-MHz) processor as its controller and 10K bytes of video firmware contained in ROM. This firmware program operates on the high-level commands and the data sent from the main processor to control the character and graphics modes of the Micro 16s. The character data is stored in 2K bytes of Fujitsu MB8128 static RAM, along with 2K bytes of character-attribute RAM. A 6845 video-controller chip is used in conjunction with the character-attribute RAM, along with 2K bytes of character-generating ROM. This combination of components provides a color terminal running at internal bus speeds.

# Taxan monitors when precision counts

Dedicated to quality and precision, TAXAN offers a complete line of monitors including green and amber, ultra-high resolution monochrome, plus medium and high resolution RGB monitors.



⊗ TAXAN also offers the 410-80, 80 column and RGB card to interface with the Apple IIe.

⊗ TAXAN monitors stand alone.

See your local ⊗ TAXAN dealer, or call us for details!

⊗ TAXAN

TSK Electronics Corporation  
18005 Cortney Court  
City of Industry, CA 91748  
(213) 810-1291

Circle 393 on inquiry card.

The 68B09 processor also controls 48K bytes of dynamic RAM that provide a 640- by 200-pixel graphic display terminal. Each pixel, which can be displayed in one of eight colors, is supported by the high-level com-

mands discussed earlier, and soon it will be supported by Digital Research's GSX-86 graphics-system extension for the CP/M family of operating systems.

The video section has two output

interfaces available for the user: a high-quality RGB color output that supports two levels of intensity in character mode, and a composite video output with eight levels of gray scale for black-and-white monitors or eight colors on lower-quality color monitors.

Though a color monitor is standard with the Micro 16s, switches located on the motherboard control the polarity of the horizontal and vertical synchronization pulses to allow easy interfacing with the various RGB color monitors on the market.

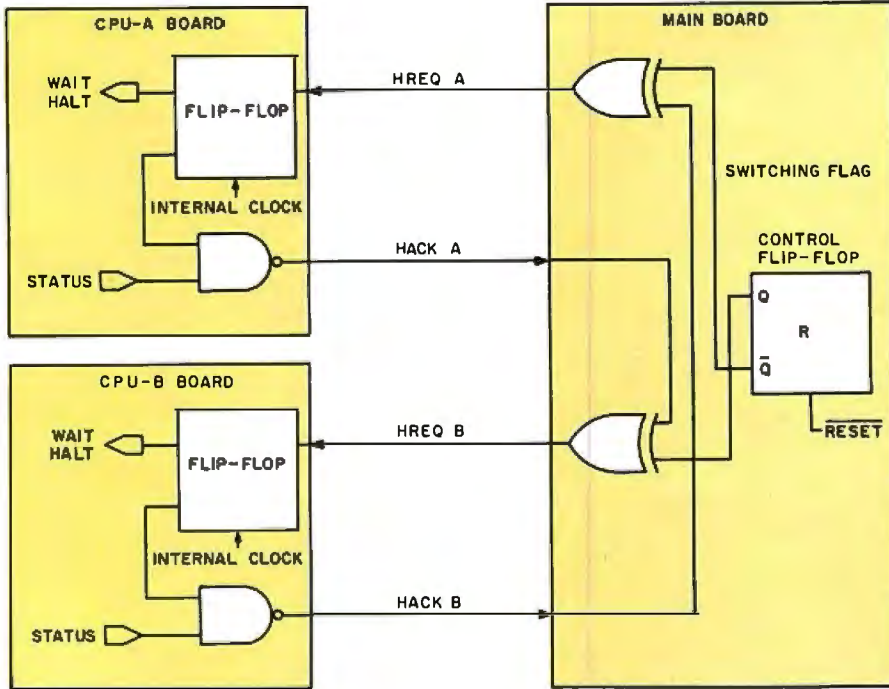
A light-pen input interfaces through the 6845 video controller to the 68B09 processor. It is supported by high-level commands for easy program interfacing to the applications programs.

The method of passing data from the main processor bus to the video-terminal processor bus is accomplished via the 128-byte RAM common to both processors, a set of attention registers, and some control lines (see figure 4). The four attention registers were designed using a Fujitsu gate array. Three of these registers allow data to pass from the main processor to the video processor so that it can be asynchronously read or written. The video processor can also interrupt the main processor. Such interrupts can be generated, for example, by the interval clock timer or one of the function keys.

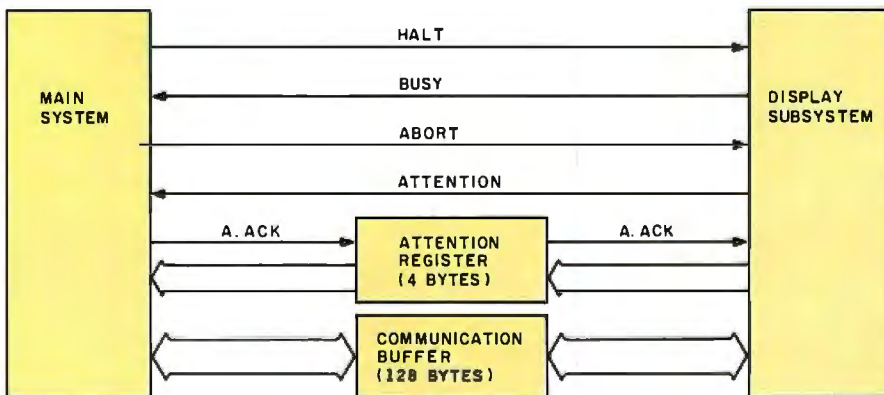
The main processor issues commands to the video-terminal processor through the 128-byte common RAM. After receiving this command, the video processor sends a busy signal to the main processor. The main processor then does not read or write to the remaining common RAM area until the busy signal is removed.

This prevents both processors from accessing the 128 bytes of RAM at the same time. The main processor can stop the video processor with an interrupt at any time should it become necessary to stop an operation in process. This gives it master control over the common RAM section.

Accessing common memory is inefficient when the data quantity is small: the video processor must send an attention interrupt that a com-



**Figure 3:** A simplified diagram showing how control is transferred from one processor to another. The control flip-flop on the main board can be set under program control. When this happens, a halt-request signal is sent to the operating processor, which then sends a halt-acknowledge (HACK) signal, which then gives the other processor control. The HREQA, HACKA, HREQB, and HACKB signals are on the Fujitsu 130-pin bus. CPU-A refers to the processor in slot 1; CPU-B, the processor in slot 2.



**Figure 4:** A diagram illustrating how information is exchanged between the main system and the video-graphics subsystem. A large part of the information transfer is done through the 128-byte RAM known as the communication buffer. For faster transfers of small amounts of information, the 4-byte attention registers can be used.

Presenting Hyperion™, the world's most powerful, portable computer developed for the busy professional.

*A Star is Borne* ★



## StarLight

Hyperion is a true portable, weighing in at only 18 pounds. It is light on the eyes with its European amber screen and styling. But heavy on performance with many standard features which are expensive necessities for other personal computers. And all for a price that's less than you'd expect.

## StarBright

Hyperion is bright. Communicating with the world is easy with our integrated voice and data package. Standard is our 256K RAM memory, essential for the new generation of application programs.

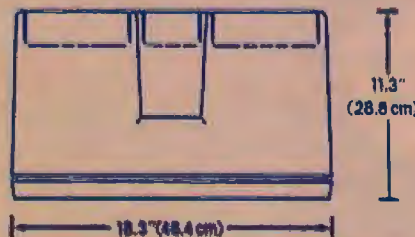
Hyperion has the same processor, graphics and operating system as the IBM P.C. However, an improved keyboard ties the function keys to our screen soft keys. All this means Hyperion can run popular IBM software right off the shelf — Visi Calc†, Word Star†, Data Base II† and many, many others.

Hyperion is the rising star in personal computers. Catch a rising star today.

### Standard Features

Processor	Intel 8088
Software	MS DOS Advanced Basic (Microsoft) Advanced User Interface*
Memory	256K User Ram*
Drives	5 1/4", 320K bytes, IBM compatible Virtual Ram Disk (Up to 160K)*
Display System	7" Non-glare amber Graphics — IBM PC compatible Full 80 x 25 character format Auto screen off for prolonged life
Serial Port	RS 232C* RS 423*
Parallel Port	Centronics/IBM compatible*
Other Features	Time and date clock with battery back-up* Additional video output for external monitor*

\*These extras worth over \$1000.



### Optional Extras

Drive	Additional 5 1/4" 320K drive
Communication	IN:TOUCH telephone management system Built in 300 baud modem (103J) Direct connect
Acoustic Cups	Uses internal modem
Expansion Chassis	5 or 10 MB of hard disk Up to 7 slots for IBM compatible cards
Carrying Case	Attractive case with accessory pockets
Multiplan†	Hyperion enhanced
123†	Hyperion enhanced
IN:SCRIBE	Word processor

†Visi Calc is a trademark of VisiCorp

†Word Star is a trademark of Micropro International Corp.

†Data Base II is a trademark of Ashton Tate

†Multiplan is a trademark of Microsoft Corp.

†123 is a trademark of Lotus Development Corp.

# Hyperion™

the world's most powerful  
portable computer

The Bytec Group

North America: (613) 226-7255; Telex 053-3358

Europe: U.K. 04026 4926; Telex 894222

NOW!

## GET IBM-PC Capacity at a Fraction of IBM's Price!

New **NETRONICS 16 Bit EXPLORER 88-PC Kit**  
Starts at Just **\$399.95** - Accepts All IBM Peripherals.



It's true! Now you can enjoy the power of the Intel 8088—the same microprocessor which powers the IBM-PC—and run any program compiled for the IBM-PC...starting at only \$399.95!

Take this easy, low cost way to learn 16-bit technology! Two-board system features:

- 8088 mother board with 5-slot expansion bus; accepts any hardware designed for IBM-PC; and
- 64K memory board, expandable to 256K; with IBM compatible RS232 communications port.

Any disk-operating system which works on the IBM will work directly on the EXPLORER 88-PC, and all programs compiled for the IBM will run on it.

The system monitor ROM included in the Starter system features a user-friendly operating system that allows easy program generation and debugging. The commands include display/modify memory...display/modify registers...input/output data to I/O ports...block moves...single-step trace mode...go/run with optional breakpoint and register reports...cassette load/save with file labels...plus a complete system test program that tests and reports condition of ROM, RAM, cassette interface, timer, DMA controller, interrupt controller, and the communications port. These test programs not only allow easy debugging of software but they serve as hardware and software learning tools.

The EXPLORER 88-PC STARTER KIT includes a mother board, memory/I/O board, all components needed, sockets for IC's used, one 62-pin bus connector and complete assembly/test instructions. All you need is a soldering iron, solder, a power supply, and a standard RS232 terminal (Netronics has 2 low-cost ones to choose from).

- Explorer 88-PC Starter Kit...\$399.95 + 10.00 p&i
- (wired & tested, add \$100.00)
- Extra 62-pin connectors at \$4.25 ea. + 1.00 p&i.

Use your own terminal with the EXPLORER 88-PC or, if you plan to expand it to be fully IBM compatible, we offer our IBM compatible keyboard and an IBM compatible color graphics board (only available wired and tested).

- IBM compatible keyboard...\$299.95 + 10.00 p&i.
- IBM compatible color board...\$299.95 + 10.00 p&i.
- Additional ROM required...\$35.00.

Set your own pace! Invest and learn, at the rate YOU want! Add to your EXPLORER 88-PC:

Deluxe heavy-duty steel cabinet that houses either two 5 1/4" floppies or a 5 1/4" hard disk with one floppy. This cabinet features a brush-finish front panel and a wood-grained sleeve.

- EXPLORER 88-PC Cabinet...\$199.95 + 18.00 p&i.

A heavy-duty open frame power supply with fan that can be used in your own cabinet or installed into the Netronics cabinet is available as follows:

- 10 amp power supply for system + 2 floppies...\$149.95 + 8.00 p&i.
- As above + extra power for 1 hard disk...\$169.95 + 8.00 p&i.

IBM compatible disk controller board. Controls four 5 1/4" floppy drives (w/2 drive cable). Available wired and tested only...\$250.00 + 8.00 p&i.

Monitors and BIOS source listings: available on either disk or hard copy at \$35.00. Please specify format and system required.

INTEL 8086/8088 user manual...\$15.00 + 1.50 p&i.

THE 8086 BOOK by RECTOR & ALEX...\$16.00 + 1.50 p&i.

Special IBM compatible system: with keyboard, color graphics board, floppy disk controller, 64K RAM, cabinet, standard power supply and a single 5 1/4" floppy drive...\$1899.95 + 25.00 p&i.

IBM compatible hard disks, built-in modern board, screen burner, print buffer system plus more will be available shortly.

Over 100 EXCLUSIVE Products and Kits—including the 'Speak Easy' universal voice synthesizer, a Diagnostic card with built-in logic probe for the IBM-PC, terminals, monitors, the ELF and EXPLORER 85 computers, and much more, are described in our upcoming catalog. It's yours FREE if you check here



"p&i" stands for "postage and insurance".

CALL TOLL FREE 1-800-243-7428 for Charge Card Orders.  
In Conn., call 203-354-9375, Conn. res. add sales tax.

TO ORDER BY MAIL, CHECK BOXES FOR PRODUCTS DESIRED AND MAIL ENTIRE AD TO:



**NETRONICS R&D LTD.**

333 Litchfield Rd., New Milford, CT 06776

Amount enclosed OR Charge my  VISA  MASTERCARD

Acct. No. \_\_\_\_\_ Exp. Date \_\_\_\_\_

Signature \_\_\_\_\_

PRINT NAME \_\_\_\_\_

Address \_\_\_\_\_ City \_\_\_\_\_ State \_\_\_\_\_ Zip \_\_\_\_\_

mand that was sent to the video processor has been completed. Then the main processor must read the resulting data and status. To increase efficiency, another method can be used to transfer data. Separate attention registers are provided through which processing data and status information can be passed.

### Data Storage

The Micro 16s lets you select from a powerful assortment of disk-storage subsystems. Currently, the Micro 16s comes with two 5 1/4-inch double-sided double-density floppy-disk drives. The floppy-disk controller provides addressing for four such drives.

Additional controllers are available for 8-inch floppy-disk drives and Winchester hard-disk drives.

Fujitsu provides an optional freestanding dual-drive double-sided double-density 8-inch floppy-disk subsystem. This subsystem allows up to 1.2 megabytes of data per drive.

Fujitsu also offers 5 1/4-inch Winchester drives in 5-, 10-, and 20-megabyte capacities.

### Summary

The Micro 16s was designed to be a versatile package of hardware and software in a professional business system. Its unique bus architecture and integrated high-resolution graphics subsystem, coupled with the wide variety of applications processors, operating systems, memory expansion, and hard-disk options, offer the business user the growth and flexibility necessary to cope with ever-changing application requirements. ■

*The Fujitsu Micro 16s personal business computer is marketed in the U.S. by Fujitsu Microelectronics, Professional Microsystems Division, Santa Clara, CA.*

### About the Author

Wayne Clingsmith has 12 years of experience in LSI, component, applications, and systems design. Currently the hardware systems manager for Fujitsu's Professional Microsystems Division, he has a bachelor's degree from San Jose State University in electrical engineering.

# ALF COPY SERVICE

FAST • RELIABLE • LOW COST

If you produce software, ALF's disk copying service is the quick, convenient answer to your disk duplication needs. Most orders are shipped in less than a week. Every disk we copy is verified bit by bit and guaranteed 100% flawless. Standard formats include Apple II (including nibble-copy proof and double-boot), Apple III, Atari, IBM, Osborne, and TRS-80.

Our "no frills" pricing means you don't have to buy extras you don't need — set-up charges are \$10 to \$25 per disk to be copied, copying charges are 30¢ to 40¢ per side (minimum: 50 copies).

Of course, we have the frills too — including custom printing and packaging. Call us today for complete details.

We also sell blank disks in bulk pack boxes of 100. All are 5 1/4", single sided, double density (except Nashua single density), unlabeled, with hub ring. Add \$7 per hundred for sleeves, \$2.50 per hundred for shipping.

<b>3M</b>	<b>\$165/100</b>
<b>CDC</b>	<b>\$165/100</b>
<b>MEMOREX</b>	<b>\$165/100</b>
<b>NASHUA</b>	<b>\$160/100</b>
(double density)	
<b>NASHUA</b>	<b>\$140/100</b>
(single density)	
<b>VERBATIM</b>	<b>\$185/100</b>

ALF (303) 234-0871 1315F NELSON ST. DENVER, CO 80215

# THE NEW STANDARD. THE MICROSOFT MOUSE.



**standard for software,  
have done it again with the  
Microsoft® Mouse.**

Our expertise in both hardware and software has gone into the development of the Microsoft Mouse. Now you can plug in the most exciting computer product of the year and put it to work.

The Mouse lets you move the cursor freely and naturally, then execute commands at the push of a button.

The Microsoft Mouse is a complete system. It comes with an on-screen tutorial, a practice application, and the Multi-Tool™ Notepad, a mouse-based text editor, so you can begin using the Mouse right away. And for application developers, the Mouse includes a programmable

interface driver to give your application program complete control over the Mouse's operation.

That's the kind of support you'd expect from Microsoft. After all, we were the world's first microcomputer software company. Today, more than a million microcomputers are running Microsoft languages, operating systems, application programs, and hardware-software combinations.

You can get the Micro-

dated versions for the IBM®-PC, PC XT, and in a version for MS™-DOS machines with serial interfaces, including the IBM-PC. The Mouse supports all versions of MS-DOS, including version 2.0. Ask your Microsoft dealer for a demonstration of the Microsoft Mouse—a whole new standard.

**BETTER TOOLS FOR MICROCOMPUTERS**

**MICROSOFT™**



Microsoft is a registered trademark, and MS and the Microsoft logo are trademarks of Microsoft Corporation.

Circle 266 on inquiry card.

# AST Quality Add-On P

## Communications



### Advanced Comm. Card (CC-232)

- Programmable to communicate in Bisync, SDLC, HDLC, and Async protocols.
- Two Ports of RS 232

AST products are available from Computerland, Entré, ComputerMart and selected dealers worldwide. Call factory if your dealer does not have the AST products you want.



### CC-332 For use with AST-3780

- An IBM 2780/3780 RJE Emulator • Supports Bisync point-to-point communications protocol • Allows file transfer between Host & IBM PC • Ideal for IBM System 34, 38, 4300

### AST-SNA

- Emulates IBM 3274 Model 51C Control Unit
- Emulates 3278 Display Station
- Emulates 3278 Type Printer
- Optional 3770 Emulation
- Cluster Controller Operation
- Protocol Converter Support



### ComboPlus™

#### Standard Features:

- 64K-256K Memory
- One Battery Backed-up Clock
- One IBM Compatible Async Port
- One IBM Compatible Printer Port
- SuperDrive™
- SuperSpool™
- From \$395



# Products for IBM PC/XT

## Multifunction Cards

### NOW! New Product Highlight

**AST-5251** – An interactive IBM 5251 Model 12 remote work station emulator using PC  
**PCnet<sup>5</sup>** – A Local Area Network for IBM PC featuring disk sharing, file locking, printer sharing and supports up to 64,000 PCs. One M bit CSMA/CD technology using 75 ohm CATV Cable. Hundreds of PCnets have been installed in IBM PCs.  
**PlusModem<sup>™</sup>** – Integrated Direct Connect 212, 1200 band auto-dial modem, clock, game port, printer port and second Async port.

Call Factory For Details



### New! With Game Port I/O Plus II<sup>™</sup>

is an enhanced version of I/O Plus featuring:

- One Clock Calendar (std.)
- Two IBM Compatible Async Ports (1 std., 1 opt.)
- One IBM Compatible Printer Port (opt.)
- One IBM Compatible Game Port (opt.)
- SuperDrive<sup>™</sup>
- SuperSpool<sup>™</sup>
- From \$165

Async #1  
Printer  
Clock  
Battery  
Async #2  
64-512K (with MegaPak)  
MegaPak<sup>™</sup>

Async #1  
Printer  
Clock  
Async #2

**MegaPlus<sup>™</sup>**

- 64K-512K (with MegaPak)
- Two IBM Compatible Async Ports (1 std., 1 opt.)
- One IBM Parallel Printer Port (opt.)
- One Battery Backed-up Clock Calendar (std.)
- SuperDrive<sup>™</sup> (std.)
- SuperSpool<sup>™</sup> (std.)
- Ideal for Concurrent CP/M, MBA, VISI Series software packages.

**ConnectALL<sup>™</sup>**  
NEW! AST Proprietary Connector Mounting Bracket for PC only (does not include cables shown in illustration)

**AST RESEARCH INC.**  
Dealer Inquiries Welcome  
Circle 434 on Inquiry card.

2372 Morse Avenue  
Irvine, Calif. 92714  
(714) 540-1333



# The Pronto Series 16

*The design of a new business-oriented microcomputer based on the Intel 80186 microprocessor.*

The challenge of developing a new business microcomputer is to produce a machine that is better than its competition. In designing the new Pronto Series 16 microcomputer we aimed to meet that challenge by concentrating on three vital areas: speed, storage capability, and ergonomics.

The new 80186 microprocessor chip makes the Pronto Series 16 run very fast. The Pronto comes with two 5¼-inch floppy-disk drives, each capable of storing 800K bytes of data. For even more storage, a Syquest 5-megabyte removable disk cartridge is available as an option. As for ergonomics, the Series 16's relatively small size, the arrangement of its components, and the design of its keyboard and display allow the machine to fit unobtrusively into your work space.

In establishing our design goals, we

---

Skip Hansen  
Pronto Computers Inc.  
3170 Kashiwa St.  
Torrance, CA 90505

---

decided that our machine would be aimed at a specific audience: the individual user in a modern business office, an environment where the benefits of desktop computing would be most readily apparent. And our machine would come as a complete package. Some options, such as expanded memory and graphics, would be available, of course, for particularly demanding applications.

The result of our designs is a small 16-bit desktop computer based on the Intel 80186 microprocessor and Microsoft's MS-DOS 2.0 operating system. Its standard features include 128K bytes of volatile memory or RAM (random-access read/write

memory), a high-capacity floppy-disk drive, a high-resolution monochrome monitor, communications interfaces (serial and parallel), and a bundle of software, including a word processor, a spreadsheet calculator, a database manager, and a graphics program. The complete package will sell for approximately \$3000.

I will now describe the various components of the Pronto Series 16 system and explain the reasons for their selection. In every case, component selection has been made on the basis of how well that component can perform its particular job.

## The Processor

To decide on our hardware we first considered software. Our goal was to have a machine that could go right to work in the average office; therefore, the essential software for this



Photo 1: The keyboard of the Pronto Series 16.

machine should be immediately available.

It would then seem logical to choose an 8-bit processor because a large library of software has already been established in past years for 8-bit computers. But on the other hand, the library of 16-bit material is growing every day, and it is unquestionably the trend of the future. And given the fact that a 16-bit machine has a greater capacity in terms of computational power and memory, we decided to use a 16-bit processor, confident that most of the essential software required for most business operations would be available, and that much of the new software to be produced for tomorrow's market will be for 16-bit systems.

Having committed ourselves to a 16-bit processor, we had to settle on a particular 16-bit family. Because we wanted a substantial software base for our system at the time of its introduction, our choice was limited to families already accepted in the marketplace. Many processors with good technical merits have not found great public acceptance, which results in a poor software base. Such processors were ruled out, and only three processor families remained: the Intel 8086, the Motorola 68000, and the Digital Equipment Corporation LSI-11.

The LSI-11 is the oldest of the three, having descended from the very successful DEC PDP-11 family. Consequently, it has a great software base. However, this software, with a few notable exceptions, is not aimed at the small-business user with a desktop machine. Another drawback of the LSI-11 is its relatively high cost in comparison with the 8086 and 68000 families.

The Intel family is descended from the very successful 8080/Z80 family of 8-bit processors, and much of the initial software support for the new 8086 family was derived by using an Intel assembly-language conversion program that allowed existing 8080 programs to be converted for the 8086. The Intel 8086 family was the first single-chip 16-bit microprocessor to achieve general acceptance in the marketplace.

The Motorola 68000 processor is generally viewed as having a more elegant architecture than the Intel family, but the 68000's later release has resulted in a great lag in software availability, particularly for the small business market.

We finally chose the Intel 8086 family of processors primarily because of the existing and potential software support. But within the Intel family there are four processors from which to choose, each with its own

advantages and disadvantages:

- the 8086, Intel's original 16-bit chip, which has full 16-bit external and internal data buses
- the 8088, a downgrade of the 8086 with a 8-bit external bus (i.e., data is sent in and out of the processor 8 bits at a time rather than 16 bits at a time). This chip is less expensive and uses the same software
- the 80186, an enhancement of the original 8086, which features increased performance at a given clock rate and an extended instruction set; it has a higher level of integration, allowing many peripheral devices to be included on the processor
- the 80188, an enhancement of the 8088 that retains the 8-bit external data bus

Because one of our primary design goals was high performance, we opted for the full 16-bit external bus, eliminating the 8088 and 80188 as possibilities. We then selected the 80186 as our processor, even though it is more expensive than the 8086. The 80186, however, includes many necessary peripheral functions right on the chip. Because functions such as direct memory access (DMA), interrupts, timers, wait-state logic, and chip-select functions would have to be provided in our design anyway,



# Introducing SooperSpooler's™ Little Brother

Who knows spoolers better than Consolink? We pioneered this industry with our revolutionary SooperSpooler, the Intelligent Printer Interface.

Now meet the newest family addition:

## MicroSpooler™

especially designed and engineered for those who need cost-effective solutions to their spooler requirements without sacrificing quality and sophistication.

### No More Waiting on the Printer

The new MicroSpooler stores data and then feeds it to a printer as fast as the printer can handle it.

That means no down time: in a matter of seconds, your computer is free for the next job **without waiting** for the printer to finish the last job.

### Quality, Reliability, Flexibility

As with the SooperSpooler, the new MicroSpoolers are the product of the highest engineering standards to insure trouble-free operation. Now Consolink offers a complete line of stand-alone spoolers that can be installed in-line between virtually any printer and any computer.

Easy to install. Easy to use. Easy on the budget.

### Features include:

- 16K Memory: User or factory expandable to 32K or 64K
- Multiple Copy Function
- Status Readout: Tells you how much data is stored or how many copies are left to run
- Pause Function: To let you change paper, make adjustments
- Self-Test Routine: Performs a comprehensive check of most internal functions and memory
- Internal Power Supply: No bulky plug adapters
- Vertical Mount Configuration: Saves desktop space
- Plug-in connections to most computer combinations

- Independently Selectable Baud Rates on Serial Ports
- One Year Limited Warranty\*\*
- Thirty-Day Money Back Guarantee\*\*
- Four Models: Any Combination of Parallel or Serial I/O
- \$199 for 16K parallel to parallel unit with an internal power supply

### And When You Need the Very Best...

Remember SooperSpooler, the Intelligent Printer Interface with a remarkable range of software controlled features and formatting capabilities.

See our new MicroSpoolers at quality dealers everywhere. For immediate answers to your questions, call Toll Free 800-525-6705

**Spoolers by Consolink—  
Now you have an Intelligent Choice.**

## CONSOLINK CORPORATION

Circle 96 on inquiry card.



**Without MicroSpooler  
21 Minutes**

CPU time for 20 pages†  
80 CPS Bidirectional



**With MicroSpooler  
16 Seconds**

CPU time for 20 pages†

**For immediate answers to your questions, call Toll Free: 800-525-6705**

Consolink Corporation, 1840 Industrial Circle, Dept. MLI-200 Longmont, CO 80501 (303) 652-2014

\* Formerly Compulink Corporation

\*\* Consult your dealer or Consolink for details.

† 60 lines per page, random line lengths, 40 char/line.

Assumes CPU can output text at a minimum of 3000 char/sec.

**OUR DAISIS  
THRIVE WITH  
THE NEW  
APPLE IIe**

# PICK A DAISI

(Data Acquisition and Instrumentation Systems Interface)

**To automate your lab—**

Exciting new capabilities can blossom in your lab—when you automate it with the DAISI family of data acquisition peripherals for your Apple Computer.

DAISI interfaces, from Interactive Structures, turn your economical Apple into a personal electronic lab assistant. DAISI products are designed to read instruments and sensors, control temperature and pressure . . . with reliability and precision.

Here's a rundown on some DAISI interfaces

**AI13, 12-Bit Analog Input System—\$550**

■ 16 input channels ■ 20 microseconds conversion time.

**AI02, 8-Bit Analog Input System—\$299**

■ 16 input channels ■ 70 microseconds conversion time.

**AO03, 8-Bit Analog Output System—\$195-\$437**

■ up to 8 independent channels ■ range and offset adjustable.

**DI09, Digital Interface with Timers—\$330**

■ timing and interrupt capability ■ direct connection to BCD digits, switches, relays.

Don't settle for garden variety equipment for your laboratory applications. Get the best—at a great price. Pick a DAISI!



Call us for the DAISI dealer near you.

**Interactive Structures Inc.**  
146 Montgomery Ave.  
Bala Cynwyd, PA 19004  
(215) 667-1713

All DAISI interfaces come complete with cable, instructional diskette and comprehensive manual.

necessary to add 1 parity bit for each byte, rather than 1 bit for a whole 16-bit word.

Adding ECC capability greatly increases the cost of the memory subsystem. Depending on the number of bits in error that the correction circuitry is designed to rectify, the cost of the circuitry can exceed the cost of the memory itself. Because memory errors should be rare, we decided that a better price/performance ratio would be achieved using simple parity error detection rather than elaborate and expensive ECC circuitry. When the detection circuitry finds a memory fault it issues a nonmaskable interrupt to the 80186 that causes the operating system to report the memory malfunction to the user.

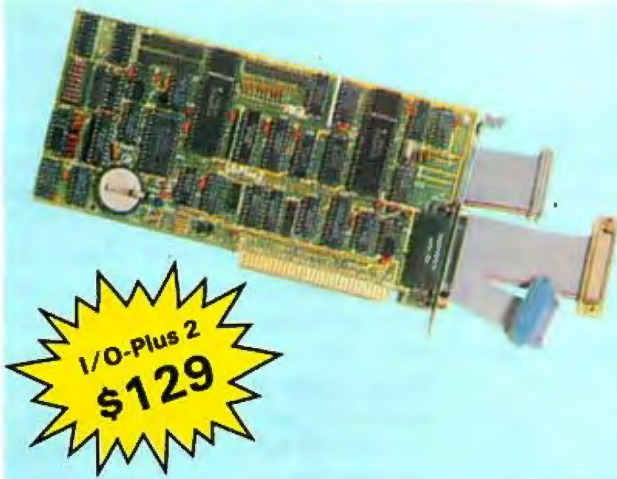
To further ensure reliability and confidence in the system, the software provides a memory test on power-up to determine if the memory is functioning properly.

### Refreshing the Memory

Maintaining the dynamic memory's high performance requires careful attention to its refresh circuitry. Each dynamic memory cell needs to be refreshed or recharged periodically. We elected to use burst-refresh rather than distributed-refresh circuitry to minimize time lost to processor arbitration. We have achieved a very low memory overhead of 3 percent for the refresh operation, roughly half of the typical figure. Also, by implementing the dynamic RAM controller using standard TTL (transistor-transistor logic) parts instead of an LSI (large-scale integration) memory controller, we were able to minimize the total memory cost.

### Read-Only Memory

Our design choices for the ROM (read-only memory), like those for the main system memory, were influenced by the considerations of size, speed, and component selection. Because we wanted to offer complete systems with disk storage, we chose not to constrain ourselves with the requirement of a large ROM size to accommodate a BASIC interpreter. Therefore, the only software that we



## Now you can buy a QUAD function IBM PC board without having to buy more memory.

MegaPlus™ and I/O-Plus 2™ are the ultimate add-on products you will need to expand your IBM PC and XT. Which board you decide on depends on where you are headed. To take full advantage of your IBM PC and XT beyond 256k, you will want to expand with the MegaPlus™. It's features include two asynchronous ports, clock/calendar, printer port, and up to 512k of memory expansion. Ah! You say you already have all the memory you need? The I/O Plus 2™ gives you all the features of Mega-Plus™ to cooperate your printers, plotters and modems, set your time and date automatically with the clock/calendar, without adding memory. Also a special game adapter is available, but more about that later. Both boards include SuperDrive™ disk emulation and SuperSpool™ print buffer software.

### MEGA WITH MEMORY

The MegaPlus™ has three functions standard: Parity checked and fully socketed memory up to 256k in 64k increments; clock/calendar with battery back-up for automatic loading of time and date when the computer is turned on; and an asynchronous communication port (RS232C serial) which can be used as COM1 or COM2, (DTE for a printer, or DCE for a modem). Optional is a 100% IBM compatible parallel printer port, and a second asynchronous port for another \$35 each. The MegaPak™ option plugs onto your Mega-Plus™ "piggyback" style to give you 512k of additional memory. Now you can create disk drives in memory up to 360k, set aside plenty of space for print spooling, and still have memory for your biggest programs.

### I/O-PLUS 2 WITHOUT MEMORY

The I/O-Plus 2™ comes standard with a clip-on battery powered clock/calendar, and asynchronous communication port (RS232C serial). Optional is a second asynchronous port (DTE for a printer, or DCE for a modem), a parallel printer adapter, and the best game paddle adapter on the market. What's so special about our game adapter? Not only is it an IBM standard game port, but it can also use low cost, widely available Apple compatible paddles and joysticks. If your memory needs are satisfied, for less than the price of most single function boards, I/O-Plus 2™ gives you all the input and output ports you might need.

### FREE SOFTWARE

SuperDrive™ disk emulation software creates "disk drives" in memory which access your programs at the speed of RAM memory. SuperSpooler™ print buffer software allows the memory to accept data as fast as the computer can send it and frees your computer for more productive work. Some manufacturers sell hardware print buffers that do only this for hundreds of dollars. SuperSpooler™ eliminates the need for these slot robbing products. Both of these powerful pieces of software can be used with any expansion memory for your IBM PC or XT.

### CHEAP SOFTWARE TOO

What good is great hardware without some great software to use it with? We offer some terrific prices on some of the popular programs you will want to use your board with. How about the cream of the spreadsheet programs, SUPERCALC, for just \$159, or SUPERWRITER for \$239. If you are looking for data base management you can get dBASE II by Ashton-Tate for \$419.

### WHY BUY IT FROM US?

Because we provide the service and support most companies just talk about. Each board is fully tested and burned in prior to shipment. We realize how integral this board is to the use of your computer. What good is a warranty if it takes weeks for repairs to be made? We offer 48 hour turnaround or a replacement board on all warranty repairs. Do you hear anyone else making this promise? If you still are not convinced, and want to compare prices, remember we don't charge extra for credit cards, shipping, or COD fees. We think the ultimate testimony to our good service and high quality is that one of our largest customers is none other than IBM! If you still want to buy elsewhere, ask any competitor if they will face the acid test.

### THE ACID TEST

Qubie' (say que-bee-A) gives you a 30 day satisfaction guarantee on all board purchases. If you are not completely satisfied we will refund the entire cost of your purchase as well as pay the postage to return it. If you can get one of our competitors to give you the same guarantee, buy any other board you think compares and return the one you don't like. We're not worried because we know which one you

will keep. We also offer a one year parts and labor warranty. An additional one year extended warranty is available for \$50.

### TO ORDER BY MAIL SEND:

- your name and shipping address
- board type, size, and options requested
- daytime phone number
- California residents add 6% sales tax
- company check or credit card number with expiration date (personal checks take 18 days to clear)



### TO ORDER BY PHONE:

In California (805) 482-9829

Outside California

TOLL FREE (800) 821-4479

### PRICES:

I/O-Plus 2™ with Clock/calendar, asynchronous communication adapter, SuperDrive™ and SuperSpool™ - \$129

MegaPlus™ with memory, clock, async, SuperSpool™ and SuperSpool™ software:

64k	\$289		
128k	\$339	256k	\$439
192k	\$389	512k	\$788

### OPTIONS:

Parallel Printer Port	\$35
Second Async Port	\$35
Game Adapter (I/O-Plus 2 only)	\$35
MegaPak™ with 256k of memory	\$349
Cable to parallel printer	\$35
Cable to modem or serial printer	\$25
Memory Diagnostics Program	\$10
SUPERWRITER by Sorcim	\$239
SUPERCALC II by Sorcim	\$159
dBASE II by Ashton-Tate	\$419

### SHIPMENT

We pay UPS surface charges. UPS 2 day air service \$5 extra. Credit card or bank check orders shipped next day.

## QUBIE' DISTRIBUTING

4809 Calle Alto  
Camarillo, CA 93010

European Inquiries:  
129 Magdalen Rd.,  
London, SW18, England  
Phone (01) 870-8899

have included within ROM is the power-on self-test and the disk boot-strap routines. We chose the 2764 chips for our ROM because they are projected to be the most cost-effective device for our requirements. Lower-density ROM chips are attractively priced now, but we feel their price will start climbing shortly as production shifts away from obsolete devices. The selection of 2764 gives us a total ROM space of 16K bytes with only two chips. For any unforeseen future needs we have provided two additional sockets and jumpers for 27128 chips, allowing an ultimate ROM expansion to 64K bytes. These selected chips have access times of 450 ns, and so the 80186 must insert wait states. However, because the ROM is only used during the first few seconds each day as the system is first awakened, we felt the slight performance penalty was justified.

### Floppy Disks

We believe that the amount of desk space a system occupies is a crucial consideration. In designing the Pron-

to Series 16 we decided to separate the system components that required frequent access from the space-consuming system electronics that don't require the operator's attention. This allows us to reduce the desktop area covered by our system to the space needed for bare essentials, namely, the keyboard, the disk drives, and the monitor.

We achieved this by adding buffering to the floppy-disk drives and bringing all of the data lines down on a twisted-pair cable (using a differential RS-422 line). This keeps the crosstalk interference down so that the cable can be lengthened without creating problems. The cable has substantial shielding to protect it from interference caused by nearby electronics and to keep it, in turn, from radiating interference to television sets, radios, etc.

For our floppy-disk system we selected the established 5¼-inch format. We avoided some of the latest-technology drives because standards, even with regard to size, have not yet emerged and several suffer from

media-availability problems. Additionally, we desired compatibility with the older systems to ensure an ample software base. To keep the system's volume to a minimum we opted for half-height rather than full-height drives.

We have achieved improved floppy-disk storage capacity in two ways while maintaining compatibility with older systems. First, we use a 96-tpi (track per inch) drive, which allows 80 tracks per side, rather than the older 48-tpi spacing with 40 tracks per side. Second, double-sided drives are standard on our system, rather than an extra-cost option. Also, the Series 16 system supports both double-density and single-track density. The fact that the 96-tpi drive is exactly twice the track density of the older drives allows the controller to read older 48-tpi disks by skipping the odd-numbered tracks. Thus, the machine is able to read and write disks in the IBM Personal Computer format.

We selected the recently introduced Western Digital 2797 disk controller,

## ADALAB™ Automates Lab Instruments



- Interactive Microware's general-purpose ADALAB™ data acquisition and control system interfaces with virtually any lab instrument using a recorder or meter, including GC and HPLC systems, spectrophotometers, pH meters, process control apparatus, thermocouples, etc.
  - Lab Data Manager™ software facilitates single or multi-channel acquisition, storage, display and chart recorder style output of lab instrument data. IMI QUICKI/O software operates within easy-to-use BASIC!
  - Thousands of scientists currently use IMI software and/or ADALAB products worldwide!
- \*Price includes 48K APPLE+ II+ CPU, disk drive with controller, 12" monitor, dot matrix printer with interface, IMI ADALAB™ interface card.
- †Trademark of Apple Computer, Inc.



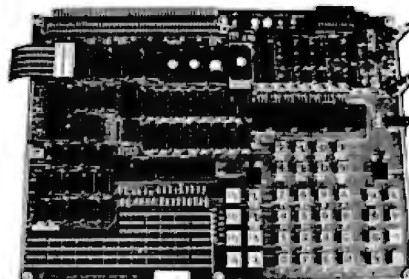
**IMI's ADALAB INTERFACE CARD IS AVAILABLE SEPARATELY FOR ONLY \$495**

(Includes 12-bit A/D, 12-bit D/A, 8 digital sense inputs, 8 digital control outputs, 32-bit real-time clock, two 16-bit timers plus QUICKI/O data acquisition software.)



**INTERACTIVE MICROWARE, INC.**  
P.O. Box 771, Dept. 3  
State College, PA 16801 (814) 238-8294

## ENGINEERS: EPROM DEVELOPMENT SYSTEM Deluxe model for an economy price, \$495 ONLY!

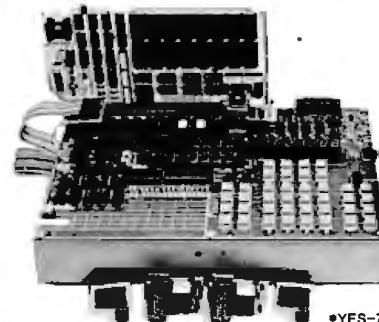


simulates EPROM from RAM, tests new codes before burning a EPROM, accomodates direct code loading, examines RAM locations in both directions, copies EPROMs, diagnoses problems, supports a DEBUGGER, saves BASIC program in EPROM, enables the user to build, trouble-shoot, analyze, evaluate the microprocessor and emulates-programs the EPROMs.

A PRACTICAL ALTERNATIVE to an expensive in-circuit emulator.

**KIT: \$299 ONLY!**

KIT does not include power supply nor chassis.



**EDUCATORS:  
SINGLE BOARD  
MICRO COMPUTER  
TRAINING SYSTEMS:  
YES-5 (Z80 CPU)  
YES-6 (MC 6800)  
• YES-7 (8088 CPU)  
• YES-8 (MC68000)  
Memory Board  
Emulator Adaptors  
Personality Modules**

\*YES-7 & YES-8 will be available 4th Qtr. '83.  
2758, 2716, 2516, 2732, 2532, 2764, 2564, 27128, 25128 (with memory extension board). TINY BASIC and DEBUGGER are available for YES-5.  
Intel Hex Format, CP/M Dump Format and User Programmable Format.

**Yang Electronic Systems, Inc.**

307 Compton Avenue, Laurel, Maryland 20707

**(301) 776-0076 Telex: 469362**



# ONLY

**ATARI® DOES MORE THAN ANYONE ELSE TO GIVE YOU TWO HELPFUL KINDS OF SERVICE.**  
**LOCAL. LONG DISTANCE.**



If you need someone to fix your ATARI® Video Game or Home Computer, you'll find the best place is also the closest. We have over 1,600 ATARI SERVICE™ Centers coast to coast; just look in the Yellow Pages under *Video Games* or *Computers*.

And if you have any kind of question about your ATARI Home Computer—how to do something new with it, how to debug one of your own programs, what kind of peripherals are best—call the ATARI Help Line. Our toll-free number is 1-800-538-8543.\*

At ATARI SERVICE, we take care of you. As well as your ATARI system.

# ATARI®



**WE ANSWER YOUR CALL FOR HELP.**

© 1983 Atari, Inc. All Rights Reserved. \*A Warner Communications Company

ATARI \*CALIFORNIA: 1-800-672-1404

Circle 35 on inquiry card.

# FOR INTER-COMPUTER DATA TRANSFER, YOU NEED "PORT AUTHORITY."

It's yours with the TLC-1: the three-port solid state data switch. Say good-bye, at last, to the inefficiencies and limitations of the electrical-contact switch. Thanks to the remarkable TLC-1: the solid state data switch with three independent RS232 ports. Repeat... three independent ports.

Because of this unique design, the TLC-1 resolves all configurations of switching among any three units... computers, modems and printers. This means 63 possible connection configurations - using any combination of DCE and DTE equipment - with all received and transmitted data independently switched. That's "port authority"!

And it's accomplished with very simple controls. Just three buttons and six status lights. You need no special software.

Moreover, because it processes every function with solid state switching, the TLC-1 participates in each connection while the power is on. So there's no switching noise, no junk data, no glitch of any kind. Just incomparable data transfer. And for \$245.00, that's an awful lot of power.

To order, or request more information, please write or call:



**Digital Laboratories Inc.**

600 Pleasant Street, Watertown, MA 02172. (617) 924-1680

a descendant of the industry-standard Western Digital 1791 that includes an on-chip phase-lock loop data separator. This eliminates the need for external analog circuitry. The floppy-disk controller is interfaced to our system using one of the DMA channels provided by the 80186. Interfacing the disk using DMA instead of the usual processor-controlled I/O (input/output) allows the system to be used in a multitasking environment and makes it possible for more sophisticated software to overlap disk activity with processor activity to achieve a greater overall throughput.

## Hard Disks

Designing the optional hard-disk subsystem for the Series 16 involved another key design decision. One possibility was the commonly available 5¼-inch, fixed-media Winchester drive. Certainly the proliferation of that drive demonstrates its technical soundness. However, one major disadvantage of this approach is that the media is fixed and you can't simply purchase additional media to provide increased storage capacity when your needs grow. For the Pronto Series 16 we selected the recently introduced Syquest 100-millimeter, 5-megabyte removable-media Winchester drive. This drive is the same size as the 5¼-inch floppy-disk drive and allows you to mount either the removable Winchesters or the floppy-disk drives as system needs dictate. The option of having either a single floppy and a single hard disk or a pair of hard disks alleviates the problem of Winchester-disk backup. Using dual hard-disk drives of identical capacity with removable media, you will have little trouble backing up your original data cartridge onto an archive cartridge in a short period of time.

The design of the hard-disk controller is an art in itself. We chose to leave the design of the critical error checking and correction circuitry and the data-separation circuitry to specialists and selected a ready-made controller. This controller makes good use of the available custom LSI technology to produce a cost-effective product. We interfaced the hard-

# WE WON THE PRICE WAR

In every battle, we came up the victors. Not only in price, but in service and support as well.

Call to order: **1-800-257-5217**  
(in NJ 609-424-4700)

**We carry:**

- Intertec Data Systems
- Corvus Concept
- Corvus Hard Disk
- C. Itoh Printers
- Victor 9000

TriStar Data Systems  
2 Keystone Avenue  
Cherry Hill, NJ 08003  
609-424-4700  
215-629-1289

When you visit your dealer and compare the Princeton IBM-compatible HX-12 side-by-side with the IBM color monitor, your eyes will see the difference.

The HX-12 gives you higher resolution and finer dot pitch (.31mm) than the IBM 5153's medium resolution (.43mm) for a cleaner, sharper image.

Compare our full range of colors and our crisp whites without red bleed. You'll also see a difference in

our non-glare screen—a feature your eyes will really appreciate in a long work session.

The Princeton HX-12 comes with a cable that plugs directly into the IBM PC, ready to burst forth into 16 superb colors. All at a suggested retail price (\$695) that's a pleasure for sore eyes and overworked budgets.

**Apple IIe users:** call us to learn how you, too, can now enjoy the visible superiority of the Princeton HX-12.

Ask your local dealer for a demonstration and let your eyes decide. Or call us at 800-221-1490 for more information and the name of your nearest dealer.

If you're ready to move up to color, graduate to the Princeton HX-12. It's right at the head of its class.



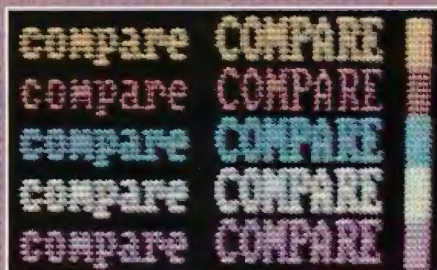
**Princeton  
Graphic  
Systems**

1101-1 State Road Princeton New Jersey 08540  
609 683-1660 TLX:6857009 PGS Prin.  
800-221-1490

## DON'T COMPROMISE:



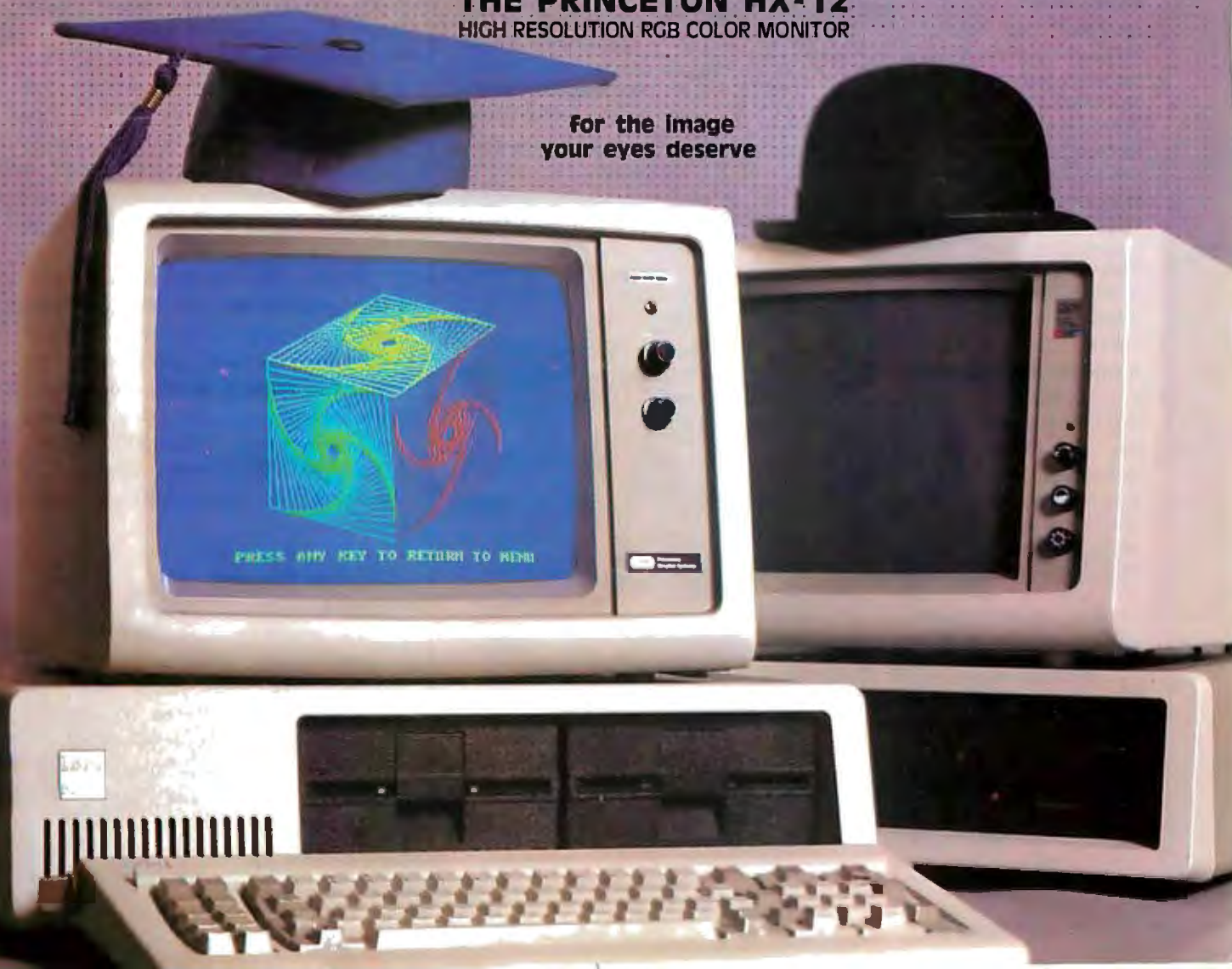
**OURS:** .31 mm dot-pitch, 80 column text.



**THEIRS:** .43 mm dot-pitch, 80 column text.

### THE PRINCETON HX-12 HIGH RESOLUTION RGB COLOR MONITOR

for the image  
your eyes deserve



disk controller to our processor using processor-controlled data transfers. This may seem to contradict our statements about the merits of a DMA interface; however, because the 80186 is a markedly powerful processor, the I/O-to-memory Move instruction executes at the full bus bandwidth, 4 megabytes per second. As a result, DMA would not improve the performance of the system. The key here lies in the difference between the Winchester and the floppy disk.

The Winchester controller has a buffer that can accommodate the data for a full sector. When the processor begins the transfer, all of the information is available in the buffer and ready to be transferred at full bus speed. In contrast, the floppy-disk controller transfers 1 byte every 32 microseconds; that's much slower than the processor's speed. For this reason the floppy-disk controller can use the DMA transfer to its best advantage. Because the 80186 provides

for two DMA channels, the second channel has been reserved for a future network controller.

### Security

We considered using several components in the system design to obtain a high level of security. In the past, software-based security schemes have been used to prevent unauthorized access to systems and their data. In many cases, an unauthorized system user can employ low-level software tools to read or corrupt data protected in this way. But, by incorporating system-access passwords in nonvolatile memory, we have minimized this problem.

The first step was to incorporate electronically erasable read-only memory (EEROM). We selected the NMC-9306 EEROM for our system because its capacity is well matched to our needs. A further advantage is that the 9306 is a bit serial device with a fairly obscure programming method. This is an added obstacle for the potential intruder to overcome.

Another function of the EEROM is to record a network identification number assigned at the factory. This is a unique 24-bit number designed so that, when the computer is hooked up to a future network system, there will be no problem assigning nodes within that system.

Removable Winchester's also add to the system's security. Besides being able to run several multimegabyte applications on the system separately, you can remove sensitive data from the machine and store it in a secure area away from the desktop system. No fixed Winchester scheme can guarantee the same level of protection.

### General-Purpose Communication Ports

We began the Series 16's I/O subsystem design with an analysis of typical user needs. Most if not all business applications require a printer, and many applications require serial interfaces for such peripherals as modems and plotters. The vast majority of printers use either a Centronics-compatible parallel port or the industry-standard RS-232C

# How To Turn Good Ideas Into Good Documents.

## Unique Writing Spreadsheet

FirstDraft™ is a writing tool that handles text much as a spreadsheet handles numbers. Working with your word processor, it speeds and enhances the writing process helping you create better documents, faster. And, when your document is complete, it builds a table of contents and index.

## A Document Data Base

DocuMentor™ (optional) helps you create writing templates for standard documents. It's a sophisticated document

Articles  
Lectures  
Form Letters  
Legal Documents  
Engineering Specs  
Procedures  
Proposals  
Manuals  
Reports  
Novels  
Plans  
Etc.

management system that helps you organize and assemble boilerplate in data base fashion. It's a true productivity booster.

## Use It Risk-Free. For 30 Days!

The best way to evaluate software is to use it. Buy it today, use it for 30 days, and if you're not convinced you need it, return it for a full refund.

## FirstDraft \$195. With DocuMentor Option \$390

MasterCard/VISA accepted.

See your dealer or call  
(303) 471-9875.

833 W. Colorado Ave.  
Colorado Springs,  
Colorado 80905



If you write with a personal computer, you need  
**FirstDraft™: The Writing Spreadsheet™** and  
**DocuMentor™: The Document Data Base Manager**

# PromptDoc®

We invented Computer-Assisted Writing

# You come first.

With NEC's PC-8800 personal computer, you don't have to ask yourself which comes first, the hardware or the software.

It's designed to be uncompromising in both areas. So you come first. In the office or at home.

The hardware gives you your choice of **8-bit or 16-bit processor, 5¼" or 8" disk drive, high-speed dot matrix or letter-quality printer, and standard green or high-resolution color monitor.**

The software includes advanced, user-friendly programs for all types of banking, accounting, and business management. Plus **free\* WordStar® word processing and MailMerge®, Multiplan™ spread sheet, BASIC (two versions), and CP/M.®**

You come first again with NEC's high-quality graphics and ultra-high reliability.

The PC-8800 from NEC Home Electronics. It puts you first. So you can break out of your shell and grow.

## NEC

**NEC Home Electronics (U.S.A.), Inc.  
Personal Computer Division**

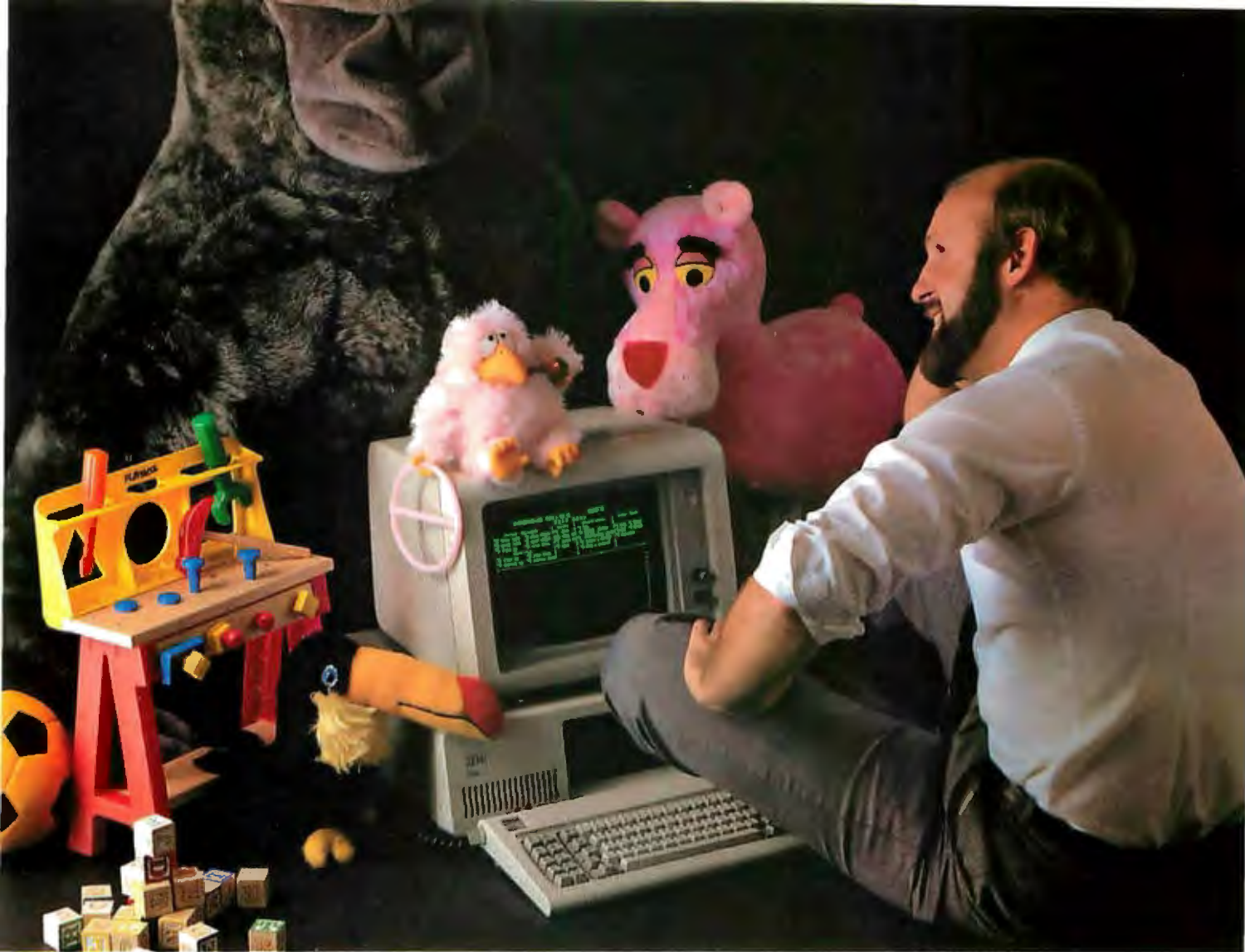
1401 Estes Avenue  
Elk Grove Village, IL 60007

NEC Corporation, Tokyo, Japan

\*With purchase of complete system.

Circle 275 on inquiry card.





## This Programming professional deserves a lot more from his personal computer.

He's earned it. As a seasoned professional, he's learned to master some of the world's most advanced programming tools. Tools specially designed to meet the everyday demands of programming experts.

But as the owner of a personal computer, he's come to expect less. Less performance. Less sophistication. And less flexibility.

### Why should programming a personal computer be any different?

Prior to the announcement of micro/SPF™ development software, experienced programmers felt programming a personal computer was a lot like playing with a toy. You couldn't take it seriously.

But today, there's micro/SPF™ a solution to elementary program editing tools now offered with most micro-computers.

With micro/SPF™ you get the same procedures and commands experienced programmers are accustomed to using at work. By mimicking features found in

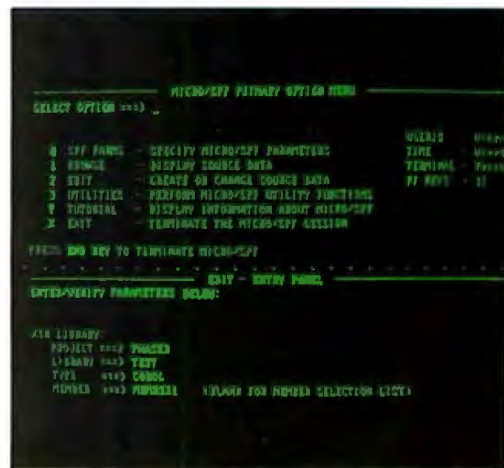
standard SPF software, micro/SPF™ provides all the sophisticated utilities programming professionals expect.

### Programming experts can take advantage of skills they've spent years perfecting.

Now, for the first time, mainframe software is available for personal computers. SPF screens are fully reproduced in logical sequence and each screen is formatted identical to those found in the SPF system.

In addition, micro/SPF™ comes equipped with the same primary and line commands, tutorial messages and program editor (with program function keys) experienced programmers are used to.

Programming professionals who've spent years perfecting the art of writing sophisticated code deserve to work with state-of-the-art tools, not toys. Find out how micro/SPF™ can help you do work-compatible programming on your personal computer today!



# PHASER

PHASER SYSTEMS, INC 24 CALIFORNIA STREET  
SAN FRANCISCO, CA 94111 (415) 434-3990

serial interface. We decided to provide both types of interface.

The parallel port uses standard TTL components. We did not select the usual MOS (metal-oxide semiconductor) parallel-port peripheral chips for the system because they would have required TTL buffering before driving the possibly long printer cable. Instead, we chose the 74S374 chip, which can perform the I/O port function and buffering in a single package. We provided an interrupt from the parallel handshaking to allow real-time support of the printer in multitasking applications and to provide a printer-spooler capability.

The serial port is based on an Intel 8251A universal synchronous/asynchronous receiver/transmitter chip (USART). We selected this time-proven device instead of a more sophisticated serial communications controller chip because it provides the functions required without supporting unnecessary and costly bit-oriented modes. One reason for the great cost-effectiveness of the 8251A lies in its lack of an on-chip data-rate generator. In the Pronto Series 16 system this is not a problem because the 80186 processor includes three on-chip timers that may be pressed into service to provide data-rate generation with software-programmable data rates for 50 to 9600 bits per second.

Our system keyboard communicates with the processor over a serial line and is interfaced to the system using the receive half of a serial port. Two full serial ports are available for use with other industry-standard serial devices. To support multitasking, serial ports are fully supported by interrupts.

### The Clock/Calendar Function

We feel a clock and calendar are absolute necessities in a small business machine. Our requirements for a clock system were as follows: battery life of one year or longer; hardware support of year, day, and month information; and continuously available time. Several otherwise-acceptable clock chips did not support year information, but supported tenths-of-a-second data instead. A few chips re-

quire up to 2 milliseconds to update the time after a clock tick, during which time the processor may not access the time information.

The chip we selected, the MSM5832, meets all of our requirements. Software for the system protects the integrity of the information in the clock/calendar and requires a system password in order to change the time and date.

### The Display

Because we intended our computer to accommodate already existing software, we were somewhat constrained in the design of the monochrome display. Nevertheless, in significant areas we were able to improve the display while still maintaining software compatibility. First, we replaced the character-generator ROM that normally defines the character set of a system with a RAM-based character generator to provide a programmable character set. This allows programmers to customize the character fonts for individual applications, such as those requiring foreign language characters or mathematical symbols. [The monochrome monitor for the Pronto Series 16 can display 25 lines of 80 characters. Each character is composed of an 8- by 12-pixel map inside a 9- by 14-pixel area. . . . R. M.]

Second, we improved the way the processor accesses the display memory. In many displays, when the processor accesses the display memory, a glitch (a disruption of the screen) occurs. To avoid glitches, many manufacturers require the processor to wait for the horizontal or vertical retrace interval before accessing the screen. This wastes a tremendous amount of time.

In the Pronto Series 16 we increased the speed of the display memory so that we are able to perform two access cycles within a 562-ns character time. During the first cycle of 250 ns the screen memory is read for the display, and during the second cycle of 312 ns the processor has access to the screen without any glitching. As a result, the processor has to wait a maximum of only 562 ns instead of a maximum of 50 *microsec-*



## Forever amber!

**NEC's new amber monitor is so easy on your eyes, you'll feel you could look at it forever.**

The JB-1205MA is a professional-quality computer monitor that gives you 80 characters by 25 lines of sharp, clear text. It's ideal for word processing and other work-intensive business applications. And it's amber, the color shown to be easiest on human eyesight.

Designed for use with NEC computers, the JB-1205MA is also easily adaptable for use with Apple,<sup>®</sup> Osborne<sup>®</sup> and most other popular computers. See it at your authorized NEC Home Electronics Dealer.

Compare these specs with your present monitor:

**12-Inch diagonal screen**

**80-character, 25-line display**

**8x8 dots, 8mhz video bandwidth**

**1.0-watt audio output**



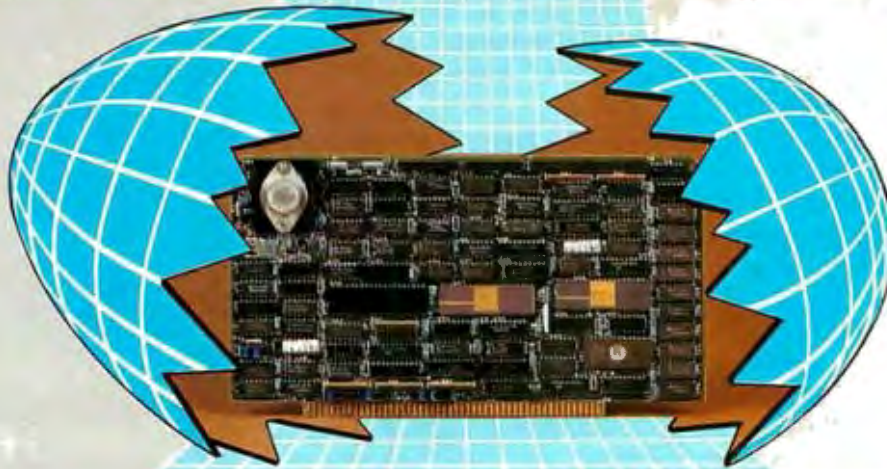
**Productivity at your fingertips**

# NEC

**NEC Home Electronics (U.S.A.), Inc.  
Personal Computer Division  
1401 Estes Avenue  
Elk Grove Village, IL 60007  
(312) 228-5900**

**NEC Corporation, Tokyo, Japan**

# Incubation Complete



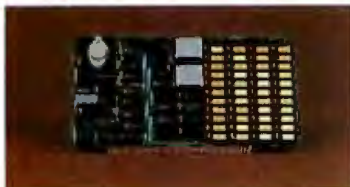
## A Third Generation is Born

### SBC 300

(Pictured above)

**A Z80 based microcomputer board with memory and I/O functions**

- Fully complies with IEEE 696 Standard
- 4/6/8 MHz Z80 A/B/H\*
- Supports CP/M® Plus
- Operates as bus master/slave for multi-user, multi-processor architecture.
- 64K on board memory, dual ported, parity checked
- 2 serial ports, 1 full SASI port
- All I/O drivers on board
- Memory management
- Full 24 bit address capability
- 3-16 bit CTC's



### ExpandoRAM IV—Random access memory board utilizing 64K or 256K NMOS RAM chips

- Fully complies with IEEE 696 Standard
- 256K capacity with 64K chips
- 1024K capacity with 256K chips
- Error checking and correction (2 bit detection, 1 bit correction)
- On board refresh
- Supports both 8 and 16 bit data transfers
- 24 bit addressing



### SD300—A new series of compact yet expandable 5-100 microcomputers.

- Compact size approximately 4" x 14" x 17"
- 6 Slot motherboard
- Rugged metal enclosure
- Supports up to 5 users

**OEM Version:** Designed for ease of integration and maximum flexibility

- Z80 CPU
- 256K RAM
- Versafloppy II with free CP/M Plus™

**Discless Version:** An ideal high performance system for disk intensive applications. Eliminates disk wait states for spreadsheet, spelling checkers, and network operation. Utilizes SDSystems RAMDisc and ROMDisc modules.

### VFW-3: A single board controller for floppy and Winchester disk drives:

• Fully complies with IEEE 696 Standard • Free copy of CP/M Plus™ included • Up to 4 floppies and three Winchester drives may be controlled by VFW-3 • Data transfers to and from board under DMA or programmed I/O control • Supports 24 bit address space.

### CP/M Plus™ high performance single user operating system.

• CP/M® 2.2. compatible—no modification! • When used with SDSystems 256K memory board speeds are up to 7 times faster than CP/M® 2.2. • High performance file system • MP/M® II file password protection • Time and date stamps on files • Support for 1 to 16 banks of RAM • Support for 1 to 16 drives of up to 512 MB each • Easy to use system utilities with HELP facility • Powerful batch facility • Sophisticated programmer utilities.

### RAMDisc 256: A solid state disk emulator that greatly increases system performance by eliminating disk waits in disk intensive applications. Excellent for spreadsheets, spelling checkers and software development.

• 256K capacity • 1 mb total bus capacity • CP/M® 2.2, PLUS™ compatible • I/O port addresses user selectable • Storage locations addressed by on board 20 bit counter • On board refresh.

### ROMDisc 128: An EPROM board that replaces a floppy disk drive for the purposes of booting CP/M® and loading application programs.

• Provides non volatile, permanent storage of programs and data • Utilizes 2732 or 2764 EPROMS, (16 max) • 128K capacity per board • 512K system capacity • Use with SDSystems RAMDisc to configure a stand alone or network discless system • CP/M Plus™ available in eproms • Serial port provided.

CP/M® 2.2 and CP/M Plus™ are registered trademarks of Digital Research, Inc. \*Z80 product of Zilog Corp.

# SDSYSTEMS

A Syntech Company

10111 Miller Road • Dallas, Texas • (214) 340-0303 • TLX-682 9016

Circle 343 on Inquiry card.



onds for the horizontal retrace interval. This low-overhead design yields a significant speed advantage in applications that require considerable access to the screen for things like character inserts and deletions in word-processing programs.

Our primary requirement for the system monitor was low operator fatigue. It is well known that screen flicker and blurred characters combined with improper phosphor color are leading contributors to operator fatigue. To minimize fatigue we selected a monitor with high bandwidth for sharp character definition, an antiglare coating for reduced reflection, and a long-persistence green phosphor to eliminate flicker and reduce eye strain.

### Ergonomics

We have taken three notable steps to ensure that the Pronto Series 16 is a pleasant co-worker. I mentioned earlier that one of our major concerns is the desk space required by the system, and that by removing the system electronics from those components that require frequent operator access, we were able to reduce the desktop area covered by the system to the space occupied by the keyboard, the disk drives, and the monitor. The result of this modular approach is that the "footprint" of the system, the area it occupies on table or desk, is 230 square inches, significantly less than any competitive system on the market.

All of the components that do not require access by the operator are placed in a system box. While we believe that the system box is best located away from the work space, we designed the enclosure to be functional and attractive on a desktop as well. A clip on top of the system box allows the front surface of the unit to serve as a copy stand.

Unlike many others, the Series 16 monitor swivels in a wide horizontal arc and tilts to allow you to adjust the monitor's angle to suit your taste and eye level. For additional convenience, we have oriented the disk drives at an angle so that the face of the drive is perpendicular to your line of sight. This makes it easier to insert or

remove disks. An added advantage of this orientation is that it reduces the footprint of the system even further by allowing the keyboard to nestle under the ledge formed by the disk drives.

### The Keyboard

In order to minimize the time needed to get familiar with our system, we selected a keyboard layout fairly close to that of the IBM Selectric typewriter, with which most office workers are familiar. There are, of course, additional keys around the periphery of the keyboard for the enhanced capability of the computer, such as editing keys, cursor controls, and function keys (see photo 1 on page 169).

Our keyboard has a low profile and an adjustment mechanism to allow you to select from three different heights. Because it uses capacitive switches, the keyboard requires very little effort to operate and is very quiet. However, if you prefer audio response to your keystrokes, you can choose to have adjustable acoustic feedback provided from the system's speaker. We selected a standard coiled telephone cord and modular jack for the connection between the keyboard and the system. The modular jack presents a low visual profile for the inserted connector, which is at the front right-hand side of the desktop unit. Many machines have the keyboard connector on the back of the machine, but when the keyboard connector is on the front, near the normal location of the keyboard, the keyboard can be easily extended up to 6 feet from the system unit.

The Caps Lock key and the Numeric key (which turns the cursor control keys into a numeric keypad) have an electronic latching mechanism and include an LED (light-emitting diode) to indicate if they are activated or deactivated.

### The Expansion Bus

In any computer system design, the selection of the bus structure is a critical issue. Initially, we considered using a structure that would be compatible with existing expansion cards



## Read the fine print.

**Improve the output of your present system with a dot-matrix printer from NEC.**

For good-looking copy in a hurry, it's hard to beat NEC's hard-working PC-8023A. This is a bi-directional 120 CPS, 80-column printer that can operate in a compressed-print mode to yield 132 columns. Special 2K buffer holds a page of data, so the unit can print while you're typing in something else. Compatible with a wide range of computers, from Apple\* to Zenith\*.

Compare these features with your present printer:

**Tractor and friction feed**

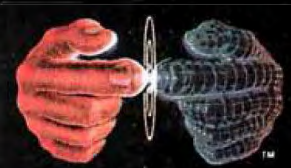
**Complete ASCII characters plus Greek, math, and graphic characters**

**Elite, pica, compressed print, proportional spacing, subscript and superscript**

**Standard parallel Centronics interface, serial optional**

**Prints clear original and up to three copies simultaneously**

\*Special cables may be necessary. Contact your local NEC Home Electronics dealer



**Productivity at your fingertips**

# NEC

**NEC Home Electronics [U.S.A.], Inc.**

**Personal Computer Division**

1401 Estes Avenue

Elk Grove Village, IL 60007

(312) 228-5900

NEC Corporation, Tokyo, Japan

Circle 277 on Inquiry card. →

designed for older 8088-based designs by providing an overflow connector to pick up the additional 8 bits of the 80186's 16-bit external bus. However, the high performance of the 80186 would be lost on several of the popular cards.

To avoid potential incompatibility, we elected to take a different route. We investigated several of the popular 16-bit industrial bus formats, but we were not satisfied with the size of the cards; we would have to split the system card (the only card in the minimum system) into two cards, a costly limitation. Even with the high level of integrated circuitry used on the system card we still have 160 chips in the design (see figure 1 on page 170). We selected a size of 14½ by 11 inches for our card, and we squeezed the entire system onto a double-sided card (see photo 2). This fairly large card size, combined with the 5-slot motherboard in which it resides, allows us to expand the system to include high-resolution color graphics, a full megabyte of memory, and a network interface card with one slot to spare, in a total size of 15.4 inches high by 6.3 inches wide by 11 inches deep.

As should be the case with any high-performance system, the motherboard is shielded and terminated. The short width of the motherboard (4½ inches) further reduces the possibility of noise. The total bus bandwidth is 4 megabytes per second.

### The Color Graphics Option

We felt the color graphics option of the Pronto Series 16 should measure up to the high performance that the rest of the system provides. The resolution we selected is unusually high for a general-purpose system: 640 by 480 pixels with 8 simultaneous colors (see photo 3). We selected the vertical resolution (480) based on the highest possible resolution with the standard 15.75-kHz scan monitor. The horizontal resolution was selected to generate a square pixel based on the 4:3 aspect ratio of the color tube. The resulting video frequency is 13.33 MHz.

We based the graphics design on the newly introduced NEC 7220

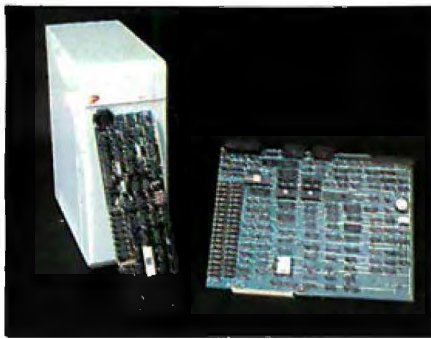


Photo 2: The graphics adapter of the Pronto Series 16 leaning against the system housing, and large main system card.

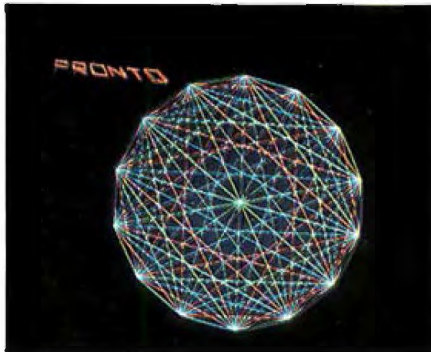


Photo 3: An example of the graphics possible with the color-graphics option of the Pronto Series 16.

graphics-display controller (GDC) because not only does the 7220 support the required resolution, but it contains hardware support for drawing basic graphic primitives, including lines, arcs, rectangles, and characters, and further supports very high performance area fills. The system provides the user with a vector-drawing rate of up to 400,000 pixels per second and an area-fill rate of up to 6,400,000 pixels per second. Another powerful feature of the graphics board is that it provides hardware-based panning along both axes and has the ability to zoom from 1 to 16 times normal size.

We added a RAM-based color table (which allows you to use 8 out of a possible 16 colors) and included an address line from a flash oscillator to allow individual pixels to be programmed to flash automatically or to alternate between two colors. The color table also provides animation capability by allowing alternating bit planes to be modified and displayed, making complex image transformations appear to be instantaneous.

To fulfill this high-resolution display's screen memory requirement of 113K bytes, we selected the same 64K-bit dynamic memory chips chosen for the system's main memory. Sixteen chips provide a graphics memory size of 128K bytes. This memory is isolated from the main processor bus by the GDC, so it does not affect the main processor. The three bit planes are contained in the same physical memory. The memory is cycled three times during one display cycle to read each bit plane.

When the graphics option is selected, the format in alphanumeric mode is 80 characters by 24 lines with a 7-by 9-dot matrix. The alpha characters may be positioned anywhere on the screen, limited only by pixel boundaries, and may be aligned at a 45-degree angle from either axis.

### Summary

As I mentioned earlier, bringing out a new business microcomputer is quite a challenge. It must do more than any of its competitors, and it must do it at a reasonable price. Although the real test of a product is in the marketplace, I believe that the Pronto Series 16 computer, which combines the new Intel 80186 microprocessor with the MS-DOS 2.0 operating system, floppy-disk drives, 128K bytes of RAM, a high-resolution monitor, communications interfaces, and a bundle of applications software, has met this challenge. ■

#### Sales and Service for the Pronto Series 16

Pronto Computers is setting up a dealer network to market the Series 16. This network will include approximately 200 dealers who will be fully

operational by 1983.

Service for the machines will be provided by the dealers and by a third party that has not yet been named. You can obtain more information from Pronto Computers Inc., 3170 Kashiwa St., Torrance, CA 90505; (800) 634-6400. In California and outside continental U.S. call (213) 539-6400.

#### About the Author

Skip Hansen is vice-president of engineering for Pronto Computers Inc.

# Color for the Price of Black and White



## Transtar 315 Color Printer for only \$599 suggested retail price

- New technology four-hammer print head
- Unique diagonal ribbon provides simpler and more reliable operation
  - Prints 7 colors plus more than 30 shades
- All colors and shades are printed in a single pass of the print head
- Built by Seikosha, the oldest manufacturing company of the famous Seiko group—providing precision products since 1892.

Transtar · Box C-96975 Bellevue, Washington 98009

Circle 390 on Inquiry card.

# IBM UNLEASHED



Now you can move your IBM PC<sup>1</sup> from the fast lane into the jet stream. With the Personal Hard Disk™ from Corona.

## **More power to you.**

The Corona Personal Hard Disk really revs up your IBM PC, with none of the floppy bottlenecks, headaches and hassles.

You get 5 to 10 megabytes of storage.

Speeds up to ten times faster than floppy disc drives.

The high reliability of a hard disk.

In an easy add-on external package, or a convenient internal plug-in.

## **Lightning strikes twice.**

If that's not enough, you also get a lot of the features of the Corona PC, our own 16-bit desktop and portable personal computer.

Like free RAM "disk." Just define blocks

of main memory as a disk and load your programs, then run them at incredible microsecond speeds.

Like disk partitioning that supports several operating systems at the same time, so MS-DOS<sup>2</sup>, CP/M-86<sup>3</sup> and Pascal are all right there when you need them.

Like simple menu operation that makes your PC friendlier than you would have believed possible. Small directories. Automatic backup. And much more.



All backed by Corona's exclusive DataGuard™ and FailSafe™ data protection systems for maximum reliability.

So if you're hungry for power and your IBM

just can't keep you fulfilled, get your hands on the Personal Hard Disk from Corona.

It'll set you free.

The Personal Hard Disk is available in internal and external, 5 and 10 megabyte versions. For the name of your nearest Corona dealer, just call us toll-free at 800-621-6746. Or write Corona Data Systems, 31324 Via Colinas, Westlake Village, CA 91361. (213) 991-1144.



**FEEL THE POWER.**

Circle 98 on Inquiry card.

© Corona Data Systems, 1983. 1. tm IBM Corp. 2. tm Microsoft. 3. tm Digital Research.

# The Docutel/Olivetti M20 A Sleek Import

---

Sergio Mello-Grand  
811 Haverhill Dr.  
Sunnyvale, CA 94087

---



*A personal computer that marches to the beat  
of a different drummer—the Z8000.*

The Docutel/Olivetti M20 is the maverick of the second-generation personal computers. It has no function keys, an "unfashionable" micro-processor, and a 16-bit disk operating system that is incompatible with the rest of the micro world. A closer look at this machine, the company's initial foray into the microcomputer market, may shed some light on the reasoning that went into its intriguing design.

Olivetti is an industry giant in the office products arena, a market that has been changing rapidly since digital electronics invaded the business world. Not to be left behind, Olivetti aggressively converted its product line from electromechanical to electronic operation. The company's products ranged from intelligent typewriters and dedicated word processors to minicomputers, peripherals, and networks; a computer/workstation was an obvious addition. So in 1979, Olivetti's California-based Cupertino Advanced Technology Center began the design of the M20. The system was officially announced in the spring of 1982, and more than 50,000 units are estimated to have been shipped in its first year. Manufactured in Italy, the M20 is distributed in the United States by Docutel/Olivetti.

The M20 is based on the Z8001, Zilog's 16-bit microprocessor, and it runs a proprietary operating system called PCOS (Professional Computer Operating System). Although there is a rationale for taking such a nonstandard route, the reality is that software vendors have little use for the exotic. In a marketplace in which the IBM Personal Computer has become a de facto standard, the M20 suffers as a result of its uniqueness. In response to its compatibility problem, Olivetti has developed a coprocessor board based on the Intel 8086 chip, which offers the M20 owner access to software running under MS-DOS and CP/M-86.

## System Overview

The M20 hardware is divided into two parts: the central unit and the video unit (see photo 3). The central unit houses the processor board, the keyboard, and the disk drives. This represents another interesting departure from the current industry trend toward detachable, low-profile keyboards.

Even more remarkable in an industry that deems function keys essential is the M20's apparent lack of general-purpose, user-definable func-



Photo 1: The M20's color graphics capability.

tion keys. Apparently the designers believe that an overcrowded keyboard will confuse the user and slow down user input. Once again, the manufacturer has hedged its bets: although the M20 has no discrete function keys, it is capable of providing alternate functions for some of its standard keys. Furthermore, two auxiliary keys can be redefined using an operating system utility.

Special functions are invoked by two color-coded keys. When either the orange key, Command, or the light-blue key, Control, is pressed along with another key, it creates a new output that can be assigned a logical function. Although the use of compound keys is hardly new, Olivetti has added one interesting twist to identifying key functions. Above the top row of numeric keys is a channel designed to hold a plastic strip that identifies the two additional user-defined functions for those keys.

These strips, colored orange and light blue, match the correspondingly colored Command and Control keys, a scheme that effectively offers you 24 user-definable function keys.

The Delete, Tab, and Backspace keys are also conspicuous by their absence. But this deficiency is also surmountable. Two keys, marked S1 and S2, were apparently added in order to maintain keyboard compatibility with Olivetti's previous business systems. The default functions of S1 and S2 are equivalent to Return. If you don't need three Return keys, an operating system utility called Change Key lets you redefine the functions of these auxiliary keys. Typically, you would redefine S1 as Delete (or Backspace) and S2 as Tab. Change Key lets you define any of the 252 unique ASCII (American National Standard Code for Information Interchange) codes that can be generated from the M20's keyboard.

The alpha keys also double up their functions for prospective programmers. On the front of the keys are 26 BASIC statements that can be input by compound keying, as with the numeric keys. On the right of the keyboard is a 16-key numeric keypad that features the numbers 0-9 and 00 as well as the four arithmetic functions (addition, subtraction, multiplication, and division). This keypad also doubles as the cursor controls.

## The Processor Board

Inside the central unit, a large motherboard holds the electronic components of the system (see photo 2). There are two reasons for the ample size of this board. First, a true 16-bit microprocessor requires additional data and address lines as well as "wider" memory (16-bit rather than 8-bit), which means more discrete chips. Second, the M20 includes all of the peripheral control functions on the board rather than use the add-on expansion boards. The

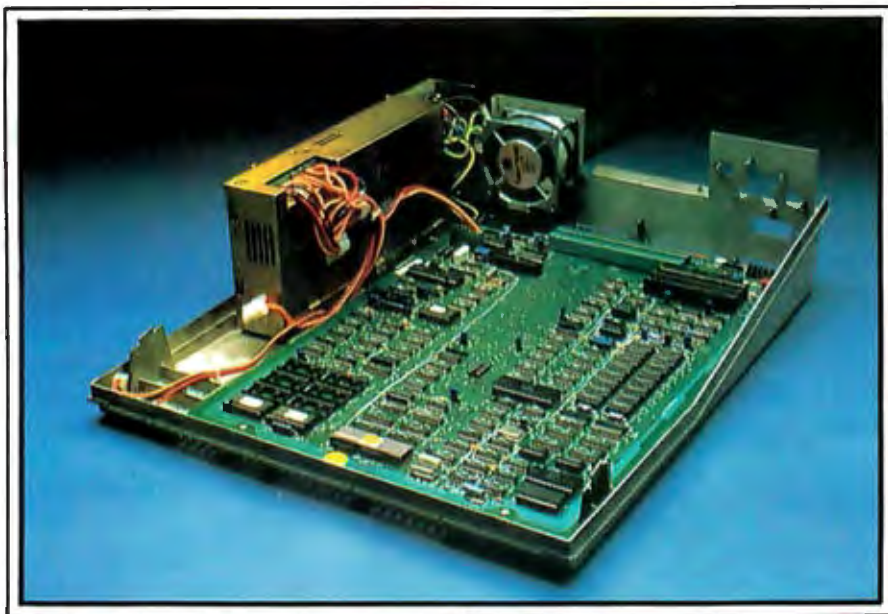


Photo 2: The large motherboard (approximately 13 by 18 inches).

standard M20 offers 128K bytes of RAM (random-access read/write memory), a parallel interface, a serial interface, a floppy-disk controller, and high-resolution graphics (black and white or color).

The heart of the motherboard is its microprocessor, a Z8001 that runs at 4 MHz. The Z8000 family offers an extremely advanced instruction set and the unique capability of redefining some of its internal 16-bit registers as 8-, 32-, or even 64-bit registers. This flexibility enables the Z8000 to carry out complex 32-bit arithmetic as well as perform compact byte-size operations.

The Z8001 is capable of addressing as many as 8 megabytes of memory in 64K-byte segments. The designers chose to limit the M20 to 16 of these segments, for a total (theoretical) memory of 1 megabyte. It is worth noting, however, that currently the system can be expanded only from its standard 128K bytes to 512K bytes because the expansion memory boards are limited to 128K bytes each. Presumably, when denser (256K-byte) memory boards become available, the M20 will be able to expand to its full megabyte capability.

### Mass Storage

Initially, the standard M20 came with dual 5¼-inch floppy-disk drives

with an unformatted storage capacity of 320K bytes (or 286K bytes formatted). Recently, Docutel/Olivetti introduced 160K-byte and 640K-byte drives in order to provide a broader range of system configurations; these can read programs or data from the original 320K-byte disk format, a feature that simplifies software distribution. The 640K-byte drive is particularly appropriate for backing up files from the optional hard-disk unit.

The 5¼-inch Winchester hard-disk drive can replace one floppy-disk drive in the central unit. This three-platter disk offers 9.2 megabytes of formatted storage and requires a separate add-on controller board. This board is inserted into one of the two I/O (input/output) expansion slots on the motherboard.

### I/O Expansion

In addition to the hard-disk controller card, other optional cards can be mounted in the I/O expansion slots. Docutel/Olivetti offers both an IEEE-488 parallel interface that can daisy-chain up to 14 peripherals and a twin serial-interface card that can be configured as twin RS-232C ports, as twin 20-milliamp (mA) current-loop ports, or as one RS-232C interface and one 20-mA current-loop interface. Remember that these interfaces are in addition to the standard RS-232C

serial port and the Centronics-compatible parallel port provided with the system.

Docutel/Olivetti is reported to be developing a local area network based on the Corvus Omninet CSMA (carrier-sense, multiple access) architecture. By the time that this article is published, a network may be available to connect several M20s together to share such resources as hard disks and high-speed printers.

Both color and black-and-white versions of the video unit are available. The video unit sits atop the central unit on a pedestal that adjusts to the user in three ways. The unit can tilt vertically, rotate horizontally, or move to either side of the central unit. It also has an antiglare screen to reduce eyestrain.

Both monochrome and color units have the same text and graphics characteristics and are completely software compatible. In text as well as graphics modes, the screen displays a high-resolution bit map of 512 pixels (horizontal) by 256 pixels (vertical). Unlike other systems that use a traditional character generator for text, the M20 creates text characters as it would graphics characters—pixel (picture element) by pixel. This approach allows users to modify the existing character fonts and has led to the development of several international character sets, including kanji and Arabic. In normal text mode, two display formats are available: 16 lines of 64 characters or 25 lines of 80 characters.

The system's extraordinary graphic capability emerges when you use the color display (see photo 1). An M20 with two additional memory boards (either the 32K-byte or the 128K-byte) can display eight colors simultaneously. With only one additional memory board, the M20 displays four colors simultaneously from a palette of eight. If you have a monochrome display, the colors are displayed as different shades of gray.

### PCOS Operating System

By adopting the Z8001 instead of the more common 8088/8086, designers of the Docutel/Olivetti could not use off-the-shelf operating sys-



tems such as MS-DOS or CP/M-86, so they developed PCOS, a proprietary operating system. Essentially, PCOS is a single-user, single-tasking operating system. Like CP/M, PCOS is built on a nucleus and a set of resident commands that is enriched with a set of transient commands. When the computer boots up, the nucleus and the resident-commands module are loaded into RAM; together, they take up more than 20K bytes of memory. Also, 16K bytes of RAM are reserved for the screen memory; thus, of the original 128K bytes of RAM, about 90K bytes remain.

PCOS has some advanced features worthy of mention. First, it can be custom-made, so you can change transient commands into resident commands and easily modify the PCOS to "remember" such changes. To explain these features properly, we must define the terms "permanent memory" and "user memory."

Permanent memory is that portion of RAM in which you can store information that will not be overwritten or erased until the system is reset. User memory is that portion of RAM that's left over for program and data storage; this area can and will be overwritten in the course of using the system. The division between permanent and user memory is only logical; no physical boundary exists between the two.

For frequently used transient commands, you could spend much of your time waiting for disk accesses. Moreover, the system disk containing those commands must always be mounted on the drive. To avoid these problems, the PLOAD command transfers a transient command into permanent memory. Such a command will be executed immediately upon being called. Naturally, the more commands you transfer, the less user memory remains.

When you turn off the system or reset it, the previously transferred commands will be lost. To avoid a series of PLOADs every time the system is booted, the command PSAVE lets you create a personalized version of PCOS. Once you have performed a PLOAD on the commands



Photo 3: The M20 with its cover removed. Note the modular construction.

you want resident (and have re-assigned function-key values, etc.), you save a customized version of the operating system by using the utility PSAVE.

### Memory Usage

In addition to flexibility, PCOS is unique in that its memory-segmentation design features dynamic allocation of memory—a concept that has been passed down from mainframes and minicomputers. PCOS (version 2.0) allows the software developer to use all of the available system memory without any difficulties created by the boundaries between the 64K-byte segments.

What this means to the programmer is that Pascal and Z8000 assembly-language code do not necessarily reside in contiguous memory. That's because the compiler and the assembler generate an intermediate z-code that is processed by the linker, which remaps the code in an effort to optimize memory usage.

The drawback to this scheme is that you don't know where your code resides within memory. Some programmers, accustomed to direct access to memory to perform software tricks, won't appreciate the PCOS dynamic-allocation feature. As always, when the M20 creates an obstacle, it offers you some software

wizardry to bypass it. The PCOS utility DCONFIG gives you a memory map showing where the various pieces of code are located, so you can find all the memory pointers you need.

### BASIC

Obviously, the PCOS memory management cannot override the addressing limits of Microsoft BASIC. All computers using this popular BASIC are limited to 64K bytes. Because the M20 has no BASIC ROM (read-only memory), the whole interpreter (37K bytes) is loaded into RAM. Without memory management, you would have had only 20 to 25K bytes of user memory available. Even with memory management, the stock 128K-byte system has only about 40K bytes of usable BASIC memory. The serious BASIC user needs 32K bytes more RAM.

The M20's Extended BASIC features excellent graphics, control of the IEEE-488 interface, program segmentation by using the CHAIN and COMMON commands, and the ability to call and execute object code routines and PCOS commands.

The graphics statements take full advantage of the bit-mapped screen and let you manage multiple windows. You can also draw points, lines, boxes, circles, and ellipses.

## Windows

The integrated bit-mapped approach lets you use multiple (up to 16) windows, each with its own attributes. Each window can display both alphanumerics and graphics and can scroll independently of other windows. These windows can be created either through PCOS calls or BASIC instructions. Although windows may not overlap and do not support multi-tasking, they have some interesting properties. Among these are automatic word wrap and graphics scaling, in which drawings automatically shrink to fit within previously defined windows.

## Data Security

PCOS offers three varieties of data security. The first makes it possible to protect a BASIC program against listing, editing, or copying. The second lets you define a volume password that is thereafter required to enable that volume. The third password protects your individual files.

Finally, PCOS provides support

for the serial (RS-232C) and parallel (Centronics-compatible and IEEE-488) interfaces. It also includes a real-time clock feature in two formats, hours:minutes:seconds and day/month/year.

---

**The uniqueness of PCOS places the M20 out of the software mainstream as compared to machines that run MS-DOS and CP/M-86.**

---

## Coda

The uniqueness of PCOS places the M20 out of the software mainstream as compared to machines that run MS-DOS and CP/M-86. Furthermore, the choice of the Z8001 limits the portability of software packages from other 16-bit personal computers.

Although Docutel/Olivetti has

adopted Microsoft BASIC (which should encourage the transfer of BASIC programs) and has acquired and developed some good application packages such as Multiplan and Data Factory Plus, its nonstandard hardware/software environment represents the most serious limitation to the M20's prospective sales. For this reason, Docutel/Olivetti just introduced its Alternate Processor Board (APB 1086), which is based on an 8-MHz 8086. This board, designed by Tecmar, gives the M20 access to MS-DOS and CP/M-86 software and makes the system "data compatible" with the IBM Personal Computer.

In the near future, you can expect a new release of PCOS, the UCSD p-System, and CP/M-8000 to be running on this elegant, but slightly puzzling, import. ■

---

## About the Author

*Sergio Mello-Grand is a Silicon Valley-based editor for the Italian technical magazines Bit and Informatica Oggi.*


---

# The Most Promising Duet For An Orchestra.

**Our duet is perfect for a single user system.**

**The same duet performs even better in a multi-user orchestra.**

## MCM ★ 80:



- S-100 Single Board Computer
- Single or multi processor capability
- Programmable master or slave selection
- Redundant processor manipulation
- 4MHz Z80A or 6MHz Z80B CPU
- 64K RAM and 2K EPROM with monitor
- 2 serial, 2 parallel, 4 timer ports
- Bi-directional inter-processor channel
- Dual mode serial ports interface
- Multi-layer PCB construction.

**\$495.** Circle 203 on inquiry card.

**DCM ★ 80:** S-100 Disk Controller Module ■ 8" and/or 5 1/4" floppy disk controller ■ SASI (ANSI, SCSI) hard disk host adapter ■ Single and double density, single and double side ■ Software implementation on CP/M<sup>1</sup> 2.2 and TurboDOS<sup>2</sup>

<sup>1</sup> TM of Digital Research, Inc.  
<sup>2</sup> TM of Software 2000, Inc.

**\$345.**



**JC SYSTEMS**

469 Valley Way  
Milpitas, CA 95035  
408-945-0318  
TWX#910-381-7041

# FOR THE FUN OF IT

## Arcade Excitement for Your Atari® Home Computer



### Midway's GORF

"Faithful to the arcade version." —Book of Atari Software 1983

In the dark reaches of hyperspace, confront the fierce Gorflan Empire. Battle Gorfis, Droids, Lasers and

Subquark Torpedoes in your attempt to survive. Multi-screen action for one or two players. ROM Cartridge or 24K disk.



### Midway's WIZARD OF WOR

"An action-packed shoot-em-up; an outstanding job." —Book of Atari Software 1983

Battle hideous and deadly creatures of doom. Survive the changing mazes and defeat the fiendish Wizard of Wor. Multiple screens, simultaneous one or two-player action. ROM Cartridge or 32K disk.



### DELUXE INVADERS

"By far the best Space Invaders program ever released for a personal computer." —Electronic Games

Be warned! The Invaders have broken arcade boundaries to bring their awesome challenge to your home computer. The better your defense, the

more fierce their assault. Nine difficulty levels. One or two-player action. ROM Cartridge or 16K disk.



### ANTI-SUB PATROL

**NEW!** Tactical Search and Destroy Mission

Anti-Sub Patrol puts you in command of a squadron of sub-hunting destroyer escorts. Your mission—rid the seas of two subs whose single goal is to blast you from the waters. Stand by for suspense! 32K disk, 24K cassette.

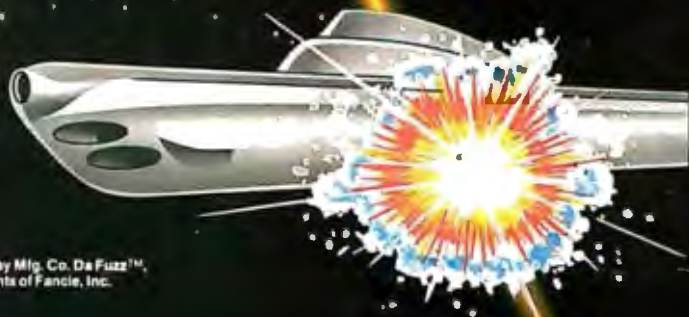
COMING SOON FOR EVEN MORE FUN: Da Fuzz™, Lifespan™, Rockball™, Eyes™, and Castle Hassle.

Ask for Roklan Software at leading software dealers nationwide.

 **Roklan  
Software**  
3335 N. Arlington Heights Road  
Arlington Heights, IL 60004

ATARI is a registered trademark of Atari, Inc. Gorf™ and Wizard of Wor™ are trademarks of Bally/Midway Mfg. Co. Da Fuzz™, Rockball™ and Eyes™ are trademarks of Techstar, Inc. Lifespan™ is a trademark of Admacaplan-Flyghts of Fancy, Inc.

Circle 333 on Inquiry card.



# Modular Architecture

## *Designing a modular computer around the IBM PC*

---

Sudha Kavuru  
Sritek Inc.  
10230 Brecksville Rd.  
Cleveland, OH 44141

---

IBM's Personal Computer (PC) has become a de facto standard for the personal computing industry. As the range of its applications programs expands, more performance in terms of powerful system software, multitasking and multi-user capabilities, and raw throughput will be required of the PC. Unfortunately, the IBM PC is limited by its 8088 microprocessor. As designed, the PC can neither adequately nor efficiently support the advanced and commercially successful multiuser operating systems such as Unix and RM/COS. These applications require a more powerful processor and a memory management scheme available in the advanced microprocessors. The combination of these facts prompted our design of a modular computer: a computer system using IBM's PC as a base but incorporating a variety of processors and memory options (see photo 1).

### The Void

The 16- and 32-bit microprocessors have ushered in a new era in the design of commercial and engineering workstations. Recently introduced products show a definite trend toward systems configured around Intel's 8086-family of processors and Motorola's 68000. Na-



**Photo 1:** *The Sritek modular expansion system for the IBM Personal Computer. The center circuit card is the Versacard, a 256K-byte dual-ported memory card that fits in a single slot of the IBM's expansion bus. Above it are a RAM Module (left), with an additional 256K bytes of memory, and a 68000 Microcard. Below the Versacard is a Z80 Microcard and an 8086 Microcard.*

tional Semiconductor's introduction of the 16032 microprocessor has created considerable enthusiasm among designers of computer systems.

The availability of this exciting

hardware is paralleled by unprecedented software development. A recent survey indicates that more than 90 percent of software development efforts in the microcomputer industry are targeted toward 16- and 32-bit processors. The time is ripe for the 16-bit microprocessor marketplace to explode.

### Designing with Modular Architecture

Because in a computer the cost of the processor is a small percentage of the cost of the total system, we decided that it would be most cost-effective to upgrade the processor, maintaining the rest of the PC—with its software, peripherals, and memory—as a one-time investment. This protects the user's investment in the PC and allows upgrading according to the user's needs.

Our goals were to allow maximum flexibility yet require the user to do a minimum of problem solving. Thus, if users required higher performance than is normally available from a PC, they

could choose a higher-performance processor from the Intel family (i.e., the 8086 or the 80286) and run their existing software with no modifications. In this way, money and time already spent on software would not



# A Colorful Introduction to Computers

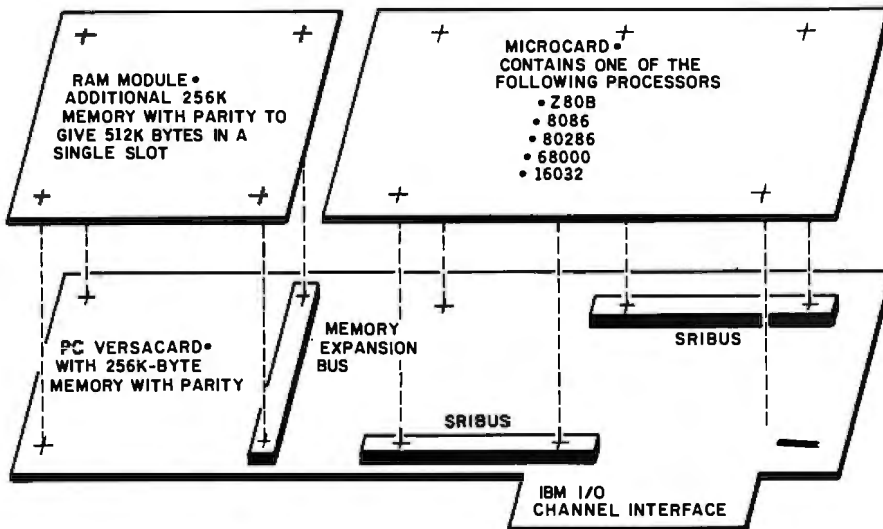
Here's a fun and educational coloring book to introduce your home computer to the youngest members of your family. *The Magic Machine* explores the excitement and wonder of computers from a young child's point of view. Theodore Cohen's story, written for beginning readers, answers many of the basic questions children ask about the magic machines that are coming into our homes in ever-growing numbers, and Jacqueline Bray's line drawings capture the vivid and often funny images that arise from the inquisitive minds of children as they seek to understand the world around them. Packaged complete with its own set of crayons, *The Magic Machine* will help children appreciate computers even before they are old enough to begin using them.

Order Now Directly from BYTE      The Magic Machine \$2.00  
 Prepayment Required

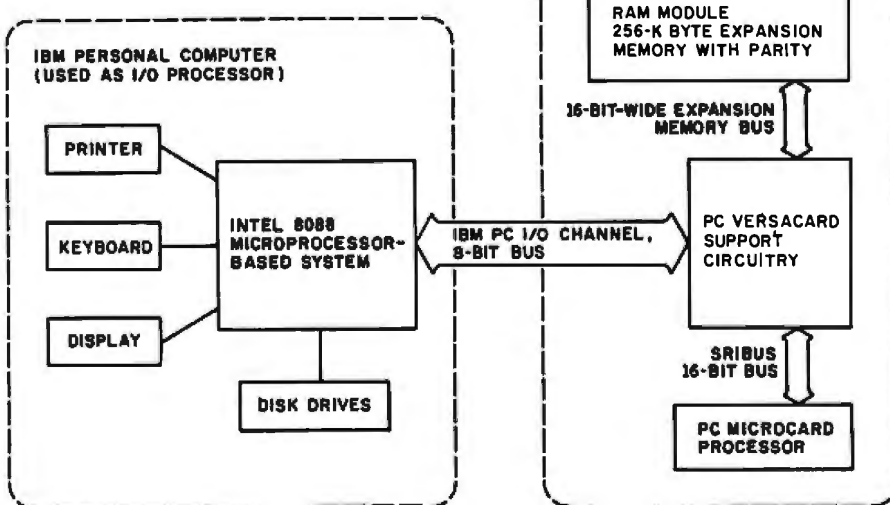
BYTE/McGraw Hill  
 70 Main St  
 Peterborough, N.H. 03458



(1a)



(1b)



**Figure 1:** Architecture and mechanical arrangement of the Versacard. The extra memory and the additional processor plug into the Versacard (figure 1a), so that the whole unit requires only one IBM expansion slot. The architecture of the complete system, including the IBM PC, is shown in figure 1b.

be wasted.

On the other hand, we felt users who upgraded to another incompatible processor (i.e., the Motorola 68000 or the National Semiconductor 16032, etc.) should not be limited to software written only for those machines while their computer systems still had the original Intel 8088 processor intact. We had in mind making available a wealth of time-tested software, such as CP/M-80, Unix, RM/COS, the UCSD p-System, and others, while allowing programs that normally execute under

IBM DOS to continue to run as special tasks. For example, consider Wordstar under Unix: though Wordstar actually runs on the 8088, this fact should be transparent to the Unix user.

Besides offering performance improvements and software compatibility, we decided that the ability to handle multiple users and multiple tasks is essential. It is particularly important in commercial applications in which sharing of databases is common. Further, any multiuser system must be efficient, reliable, and secure.

We felt the product should be convenient to install in any IBM PC and able to accommodate all possible add-on devices for the PC. The system should be able to use Unix, or any other operating system associated with the expanded processor, with all of the PC's facilities and without any modification to the hardware or software. This applies equally to local area networks, hard-disk drives, graphic terminals, and any other I/O (input/output) devices made to work with the PC.

And finally, we decided to consider the IBM DOS floppy-disk format as the standard format for software distribution, independent of the processor and the operating system. This encourages much-needed standardization in the personal computer industry and the exchange of information among users.

## System Details

To meet the criterion of flexibility, we chose a building-block approach that would allow us to interchange processors at will, without having to redesign the complete computer. The system can be divided into four main units (or modules, see figure 1), each of which performs a specific function:

- **I/O Processor:** the IBM Personal Computer, the framework on which the system is built. It provides for all the physical needs of the system (electrical power, cooling, a cabinet, etc.) and is also the system's interface to the rest of the world. The PC's processor handles I/O between the user and the system, and between the system and other peripherals.

- **The Versacard:** a single-circuit card designed to fit in the PC's expansion slots. This card hosts the RAM (random-access read/write memory) Module, which is a dual-ported expansion memory, and the additional processor module (called a Microcard), and provides the support circuitry necessary to interface the two to the PC's bus. This card is required in order to use the processor Microcards.

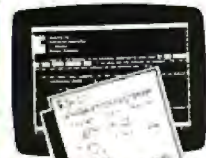
- **Microcard:** contains any one of the processors previously mentioned and the necessary support circuitry to

# NATIONAL COMPUTER PRODUCTS



### Video Monitors

- AMDEK 300 12" hi-res green . . . 145<sup>99</sup>
- AMDEK 300A 12" amber . . . 150<sup>99</sup>
- AMDEK Color Plus 13" color . . . 329<sup>99</sup>
- AMDEK Color II hi-res RGB . . . 649<sup>99</sup>
- AMDEK Color III hi-res RGB . . . 379<sup>99</sup>
- BMC 12AU 12" hi-res green . . . 39<sup>99</sup>
- COMREX 5600 12" hi-res amber . . . 179<sup>99</sup>
- COMREX 6900 13" color . . . 299<sup>99</sup>
- NEC 1201M 12" hi-res green . . . 159<sup>99</sup>
- NEC 1203M 12" composite color 319<sup>99</sup>
- NEC 1203H 12" RGB for IBM PC 679<sup>99</sup>
- NEC 1260 12" green . . . 119<sup>99</sup>
- PRINCETON 12" RGB . . . CALL
- TAXAN Vision 1 12" mid-res RGB . . . 329<sup>99</sup>
- TAXAN Vision 3 12" hi-res RGB . . . 409<sup>99</sup>
- TAXAN 12" hi-res amber . . . 149<sup>99</sup>
- USI 12" Amber display . . . 169<sup>99</sup>
- ZENITH 12" hi-res green . . . 110<sup>99</sup>



### MicroPro

- WordStar . . . 289<sup>99</sup>
- Random House Thesaurus . . . 129<sup>99</sup>
- MailMerge . . . 129<sup>99</sup>
- SuperSort . . . 129<sup>99</sup>
- SpellStar . . . 129<sup>99</sup>

Only **\$169<sup>99</sup>** ea.

Call for special package deal pricing.

### Popular Software

- dbase II (MS-DOS or CP/M 86) . . . 449<sup>99</sup>
- LOTUS 1-2-3 Please call for details.
- PC Tutor by Comprehensive . . . 69<sup>99</sup>
- Home Accountant Plus . . . 119<sup>99</sup>
- T.I.M. III by Innovative . . . 339<sup>99</sup>
- Easy Writer II . . . 239<sup>99</sup>
- Crosstalk by MicroStuf . . . 149<sup>99</sup>
- Concurrent/CP/M Digital Research Call
- Peachtree GUI/AVAP Series 4 Pak . . . 399<sup>99</sup>
- SuperCalc by Sorcim . . . 199<sup>99</sup>
- SuperWriter by Sorcim . . . 269<sup>99</sup>
- VersaForm . . . 269<sup>99</sup>
- VolksWriter by Lifetree . . . 139<sup>99</sup>



### Kaypro

The anytime anywhere computer. Includes CP/M, BASIC, a spreadsheet and wordprocessing software.

PLEASE CALL FOR MORE DETAILS.



### OSBORNE I

New! Includes double density drives, and software: CP/M, WordStar, MailMerge, SuperCalc, CBASIC & MBASIC.

PLEASE CALL FOR OUR PRICE.

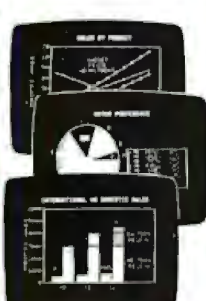


### Sweet-P Graphic Plotter

A simple to operate plotter which easily interfaces to the PC using a centronics parallel port. Complete with software, set of pens, paper and operators manual. List Price \$795.00 Special Offer . . . 599<sup>99</sup>

### Diskettes

- Buy 100 3M Scotch 5 1/4 SS/DD for only **\$219<sup>99</sup>** diskettes
- 3M Scotch 5 1/4 SS/DD Box of 10 . . . 25<sup>99</sup>
- 3M Scotch 5 1/4 SS/DD Box of 10 . . . 35<sup>99</sup>
- Verbatim 5 1/4 SS/DD Box of 10 . . . 29<sup>99</sup>
- Head Cleaning Diskette 5 1/4 . . . 27<sup>99</sup>

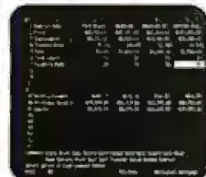


### VISICORP

### VisiCalc

Only **\$179<sup>99</sup>** ea.

- VisiFile . . . 229<sup>99</sup>
- VisiTrend/Prot . . . 229<sup>99</sup>
- VisiSchedule . . . 229<sup>99</sup>
- VisiWord (req. 128K) . . . 239<sup>99</sup>



### MICROSOFT

- Microsoft Multi-Plan . . . 179<sup>99</sup>
- Flight Simulator . . . 399<sup>99</sup>



### COMMODORE 64

- CALL FOR NEW SPECIAL PRICE
- COMMODORE 1541 Disk Drive . . . 329<sup>99</sup>
- Datasette program recorder . . . 65<sup>99</sup>
- DATA 20 Z 80 & 80 column pac. . . 229<sup>99</sup>
- CARDCO Centronics interface . . . 79<sup>99</sup>
- Toit Taxi Processor . . . 35<sup>99</sup>
- Sprintmaster . . . 35<sup>99</sup>
- MacroSystem RS-232 interface . . . 59<sup>99</sup>
- APPLE Emulator . . . 99<sup>99</sup>



### ATARI 1200XL

Only **\$679**

- ATARI 800 with 48K . . . 499<sup>99</sup>
- ATARI 810 Disk Drive . . . 429<sup>99</sup>
- ATARI LIGHT PEN by Symlec . . . 129<sup>99</sup>
- Alien Voice Box . . . 129<sup>99</sup>
- File Manager Plus database box . . . 79<sup>99</sup>

We carry much more for Atari . . . Call

- Defender - Dig Dug
- Donkey Kong - Galaxian
- Pac Man - Centipede
- Qix - Star Raiders
- Missile Command - Miner 2049
- YOUR CHOICE Only \$39<sup>99</sup> ea.



### corona.

### IBM PC COMPATIBLE DESKTOP COMPUTER

128K, dual 320K disk drives, 9" display, serial & parallel ports, and MS-DOS.

Please call or write for more details.

### IBM PC COMPATIBLE PORTABLE - PORTABLE

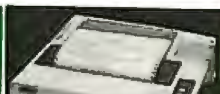
128K dual 320K disk drives, 9" display, serial & parallel ports, and MS-DOS.

Please call or write for more details.



### Modems

- Hayes Smartmodem 300 . . . 219<sup>99</sup>
- Hayes Smartmodem 1200 . . . 519<sup>99</sup>
- Novation II Cat 0-300 baud . . . 159<sup>99</sup>
- Anchor Mark I 300 baud . . . 94<sup>99</sup>
- Anchor Mark VIII 300/1200 baud . . . 339<sup>99</sup>
- RIXON PC212A (IBM PC) . . . 379<sup>99</sup>
- CACTUS Technology (IBM PC) . . . 299<sup>99</sup>



### EPSON FX-80

180 cps 10" carriage, 2K buffer Epson FX-80 Tractor 39.95

- Epson FX-100 . . . Please call for our low price
- GEMINI 10 . . . 59<sup>99</sup>
- C. ITOH 8510 . . . 59<sup>99</sup>
- C. ITOH 1650 . . . 59<sup>99</sup>
- NEC 8022A . . . 59<sup>99</sup>
- FACT 4810 . . . 59<sup>99</sup>



### OKIDATA ML92

160 cps, 10" carriage, 80 columns Only **\$499<sup>99</sup>**

- Tractor for ML 92 . . . 59<sup>99</sup>
- OKIDATA 93 . . . 89<sup>99</sup>
- OKIDATA 82A with tractor . . . 459<sup>99</sup>
- OKIDATA 84A per. w/tractor . . . 99<sup>99</sup>



### TRANSTAR 315 Color Printer

Prints 7 colors plus more than 30 shades, all in a single pass of the print head. And it's built by Seiko. Only **\$549<sup>99</sup>**



### Letter Quality Printers

- C. ITOH F-10 Starwriter 40 cps . . . 1369<sup>99</sup>
- C. ITOH F-10 Starwriter 55 cps . . . 1649<sup>99</sup>
- Delaywriter 40 cps w/10K buffer 1249<sup>99</sup>
- NEC 2610 33 cps RS-232 serial . . . 1449<sup>99</sup>
- NEC 3530 33 cps parallel . . . 1589<sup>99</sup>



### NEC 3550 Sprintwriter for IBM PC

Only **\$1995<sup>00</sup>**



### Apple IIe

Please call for prices on Apple IIe system packages and other accessories.

### Call for Lowest Price.



### Apple Disk Drives

Special buy! Fourth Dimension drive w/controller Only **\$299<sup>99</sup>**

- Fourth Dimension . . . 249<sup>99</sup>
- MicroSci A2 . . . 299<sup>99</sup>
- MicroSci A2 with controller . . . 369<sup>99</sup>
- Rane Elite I . . . 299<sup>99</sup>
- Rane Elite I w/controller . . . 389<sup>99</sup>
- Corona 5 megabyte hard disk . . . 1895<sup>99</sup>



### FRANKLIN ACE 1000 & 1200

Apple II compatible computer - 84K upper/lower case, and more!

PLEASE CALL FOR DETAILS System packages at special prices.



### Apple II Accessories

- ALF 9 Voice music card . . . 159<sup>99</sup>
- 16K Ram Card . . . 59<sup>99</sup>
- Grappler Plus . . . 129<sup>99</sup>
- PKASO interface . . . 135<sup>99</sup>
- Wizard 80 column card . . . 189<sup>99</sup>
- GRAPPLER Butterboard 16K . . . 139<sup>99</sup>

### Hayes

- MicroModem II by Hayes . . . 269<sup>99</sup>

### Videx

- Videx 80 column card . . . 239<sup>99</sup>
- Enhancer II . . . 119<sup>99</sup>
- ULTRATERM 128x48 Video card 339<sup>99</sup>

### MICROSOFT MICROSOFT PREMIUM SYSTEM

Includes: Z-80 SoftCard, 16K Ram-Card, Videx Videoterm, Softswitch, & CP/M User Guide by Adam Osborne. List 755.00

Special Price Only **\$459<sup>99</sup>**

- Z-80 SoftCard by MicroSoft . . . 239<sup>99</sup>
- 16K RamCard by MicroSoft . . . 69<sup>99</sup>



### IBM Personal Computer

includes 64K, 2 DD/DS 320K drives, keyboard, color video card, & MS-DOS.

### PLEASE CALL FOR SYSTEM PRICES.



### Columbia MPC

IBM PC compatible system includes 128K, 2 DS/DD 320K drives, keyboard, video card, MS-DOS & CP/M 86 software. Monitor not included.

PLEASE CALL FOR SYSTEM PRICES.



### IBM PC ACCESSORIES Quadram Quadboard

64K Only **\$289<sup>99</sup>**

- 128K 359<sup>99</sup> 192K 429<sup>99</sup> 256K 499<sup>99</sup>
- 512K Quadboard . . . 749<sup>99</sup>

### AST MegaPlus

- 64K with serial & clock . . . 349<sup>99</sup>
- 128K 429<sup>99</sup> 192K 499<sup>99</sup> 256K 549<sup>99</sup>
- 64K with parallel & serial . . . 419<sup>99</sup>
- 128K 489<sup>99</sup> 192K 559<sup>99</sup> 256K 629<sup>99</sup>
- MegaPak option (256K) for 512K total . . . 329<sup>99</sup>

### ComboPlus

- 64K with serial, parallel & clock . . . 349<sup>99</sup>
- 128K .419<sup>99</sup> 192K .489<sup>99</sup> 256K .559<sup>99</sup>

### I/O System

Serial, parallel, clock, and game adapter port . . . 269<sup>99</sup>

### Apparat, Inc.

ComboCard with parallel printer port, Asynchronous communications I, RS-232 port, and clock/calendar 169<sup>99</sup>

### Monte Carlo Card

64K .449<sup>99</sup> 128K .529<sup>99</sup> 256K .649<sup>99</sup>

### IBM PC Disk Drives

- 5 megabyte internal drive & p/s . . . 1529<sup>99</sup>
- 10 megabyte internal drive & p/s . . . 269<sup>99</sup>
- Trak DS/DD 500K 40 track drive . . . 149<sup>99</sup>
- Trak 5 megabyte 5 1/4" hard disk . . . 759<sup>99</sup>
- PC Mouse . . . 249<sup>99</sup>
- Big Blue Z-80 Card . . . 489<sup>99</sup>
- Nine 4164 200ns Ram Chips . . . 69<sup>99</sup>

**SATISFACTION GUARANTEED**

We will accept the return of most items within 15 days of your receipt of the merchandise. At your request we will repair, exchange, or issue a prompt refund. Understandably, software is not returnable. Please call for more details.

To order please send money order or cashier's check. Personal checks 3 weeks to clear. Prices reflect 2% cash discount. We accept VISA, MasterCard, American Express, Diners Club and Carte Blanche. Shipping, handling & insurance charges, add 3% of merchandise total (min. \$5.00). California residents add 6% sales tax. Foreign customers please call or write. Prices and availability subject to change without notice. All equipment is new and warranted by the manufacturer.

**It's Here!**

National Computers Spring 1983 collection of State-of-the-Art computer merchandise is available now. You'll find hundreds of products, including computers, printers, video monitors, modems, and accessories for the Apple II, IBM PC, and CP/M systems, all at the great prices you expect from us. It includes dozens of illustrations and some very informative comparison charts. For your copy send \$1.00, which we will credit to your next order.

Circle 1 on inquiry card.

**TOLL FREE ORDERING 800 - 854-6654**

# VIC-20

(a real computer at the price of a toy)

## \$89.00

(when you buy 6 programs)

You get the Commodore VIC-20 computer for only \$89.00 when you buy 6 tape programs on sale for only \$59.00. These 6 programs list for \$100.00 to \$132.00. You can choose one of three packs: 6 games pack, 6 home finance pack, or 6 small business pack. The VIC-20 computer includes a full size 66 key typewriter professional keyboard, color command keys, upper/lower case, full screen editor, 16K level II microsoft basic, color, sound and music, real time, floating point decimal, easy to read self teaching instruction book, connects to any TV, includes console case.

**33K COMMODORE VIC \$159.00**  
with 2½ times more power

You get the VIC-20 computer plus we expand the total memory to 33,000 bytes to give you 2½ times more programming power.

**41K COMMODORE VIC \$199.00**  
with 4 times more power

**49K COMMODORE VIC \$249.00**  
with 6 times more power

**40-80 COLUMN BOARD \$99.**

A fantastic price breakthrough for VIC-20 owners on this most wanted accessory!! "Now you can get 40 or 80 Columns on your T.V. or Monitor Screen." Plus we add a word processor with mail merge, electronic spread sheet, time manager and terminal emulator!! These PLUS programs require only 8K RAM memory.

**TRACTION FRICTION PRINTER \$279.00**

Comstar FT deluxe line printer, prints 8½x11 full size, single sheet, roll or fan fold paper, labels etc. 40, 66, 80, 132 columns. Impact dot matrix, bi-directional, 80 CPS.

**60K MEMORY EXPANDER \$69.00**

Sixslot — Switch selectable — Reset button — Ribbon cable. A must to get the most out of your VIC-20 computer.

**VOICE SYNTHESIZER \$79.00**

Makes your VIC-20 talk. VOTRAX based plus features found only in \$295 versions. GREAT BUY — DON'T MISS THIS SALE!!

# COMPUTER AND SOFTWARE SALE

# COMMODORE 64

(more power than Apple II at half the price)

WE HAVE THE LOWEST PRICES — CALL US!

## \$197.00

(with factory rebate and software savings applied)

You pay only \$397.00 when you order the powerful 84K Commodore 64 computer! We pack with your computer a VOUCHER good for \$100 rebate from the factory when you send in your old Atari, Mattei, Coleco electronic game or computer. This includes Sinclair, Timex, Texas Instruments, VIC-20 computers and others!! PLUS we also include a \$100 software COUPON FREE that allows you to buy PROFESSIONAL SOFTWARE from the items shown in the center column of this ad! Call us today (312) 382-5244 for best prices and best service.

## VIC20 PERSONAL COMPUTER

### TOP 10 ARCADE GAMES

VIC-20 TAPE PROGRAM SALE!!

Rank	Name	Sale
1.	Super Paratrooper (Fantastic)	\$19.95
2.	Exterminator-Plus (Better than Centipede)	\$19.95
3.	Cricket (Better than Frogger)	\$19.95
4.	Snackman (Better than Pacman)	\$15.95
5.	Galactic Crossfire (you in the middle)	\$16.95
6.	Anti-Matter Splatter (Nuclear Disaster)	\$19.95
7.	Bug Blast (Creepy)	\$16.95
8.	Bombs Away (Great)	\$15.95
9.	3-D Maze-Esc.	\$14.95
10.	Krazy Kong	\$14.95

BUY ANY FOUR — DEDUCT 10% MORE

### VIC-20 PROGRAMMING AIDS!!

	Sale
• Introduction to basic programming (manual and tapes)	\$22.95
• Advanced basic programming (manual and tapes)	22.95
• Programmers reference manual (288 pages — you must have this!)	15.95
• Programmers easy reference card (tables/lists/drawings)	3.95
• VIC-20 Revealed (267 pages of VIC secrets)	11.95
• 6502 Machine Language Assembler	24.95
• 16K Programming cartridge (gives 400% more programming power — get \$24.95 16K adventure game free!)	79.00

## Commodore 64 Computer

### PROFESSIONAL SOFTWARE

Name	Sale
word processing pack	\$69.00
complete Data Base pack	\$69.00
Electronic spreadsheet pack (like visicalc)	\$69.00
Accounting pack (personal & business)	\$49.00
Programmers Helper	\$59.00
Programming Reference guide	\$18.95
Basic Tutor	\$19.95
Typing Tutor	\$19.95

### 80 column BOARD

80 characters per line on the screen at one time. Includes word processing pack (list \$89.00), complete data base pack (list \$89.00), Electronic spreadsheet pack (list \$69.00). ALL FOR ONLY \$179.

We have over 300 Programs for the Commodore 64 Computer  
WE LOVE OUR CUSTOMERS

### PROFESSIONAL WORDPROCESSING PACKAGE

This wordprocessor is specially designed for the Commodore-64 utilizing the latest techniques. Allows powerful text editing capabilities without long hours of orientation or training. Complete cursor and insert/delete key controls are used. Block movement and/or duplication, line insertion and/or deletion, automatic centering, margin settings, tab settings, copy, disk or tape handling, and all printer types. Up to 99 continuous pages of text can be output to the printer. List \$89.00. Sale \$69.00

### COMPLETE DATABASE PACKAGE

A user friendly data base system that makes information easy to find and store. You can add, change, delete, and search for data. Print the information on a printer in any format desired. When combined with the word processor pack you have a powerful merge program that allows custom documents and personalized mailing lists. List \$89.00. Sale \$69.00

### COMPLETE ACCOUNTING PACKAGE (Home or Small Business)

This general ledger program is perfect for small business as well as home. It utilizes a double entry bookkeeping system. You only need enter one transaction and the computer will handle the other. All accounts are user defineable and will build for 1 year, resulting in a file of all transactions by account number, month and year to date. Each month a current month's transactions can be viewed at any time (99 accounts 187 entries per month). With this accounting program you will be able to monitor your financial growth as well as your expenses. List \$59.00. Sale \$49.00

### COMMODORE-64 PROGRAMMERS REFERENCE GUIDE

This is the in-depth guide that goes into the heart of the 64. All aspects of the basic and machine language are covered. (A must for anyone wishing to program the Commodore-64). Sale \$16.95.

• LOWEST PRICES • 15 DAY FREE TRIAL • 90 DAY FREE REPLACEMENT WARRANTY  
• BEST SERVICE IN U.S.A. • ONE DAY EXPRESS MAIL • OVER 500 PROGRAMS • FREE CATALOGS

Add \$10.00 for shipping, handling and insurance. Illinois residents please add 6% tax. Add \$20.00 for CANADA, PUERTO RICO, HAWAII orders. WE DO NOT EXPORT TO OTHER COUNTRIES.

Enclose Cashiers Check, Money Order or Personal Check. Allow 14 days for delivery, 2 to 7 days for phone orders, 1 day express mail! Canada orders must be in U.S. dollars.

# PROTECTO ENTERPRISES (WE LOVE OUR CUSTOMERS)

BOX 550, BARRINGTON, ILLINOIS 60010  
Phone 312/382-5244 to order



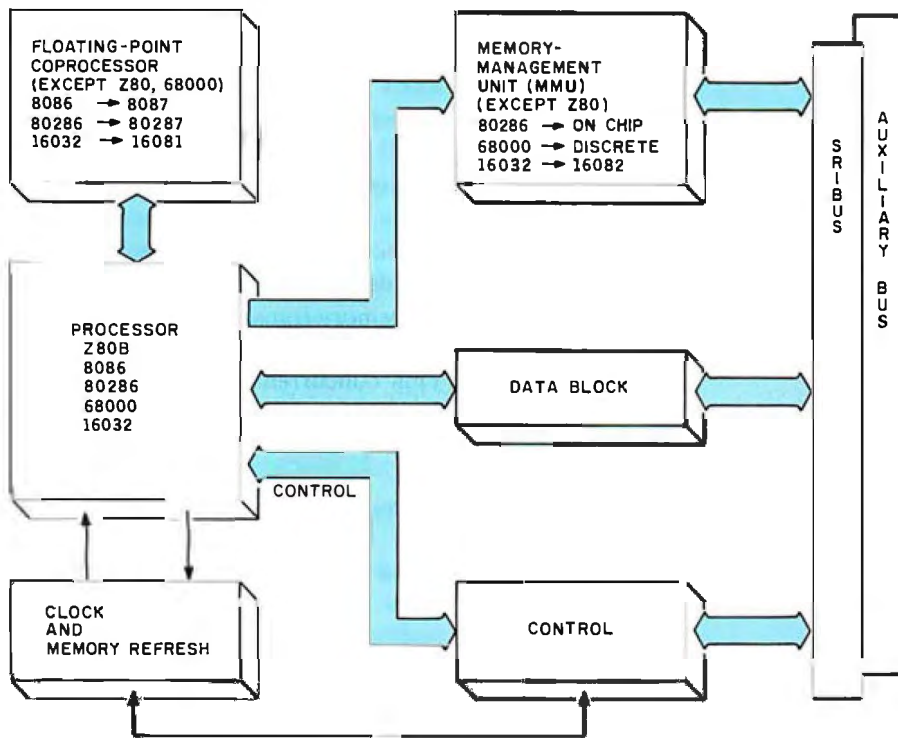


Figure 2: Architecture of the Microcard.

communicate with the Versacard. Its function is to execute the operating system and the user's applications programs. The Microcard does not directly interact with the I/O devices installed in the PC but employs the PC for that purpose.

- RAM Module: a simple circuit card containing 256K bytes of memory that may be installed on the Versacard for a total of 512K bytes.

A Microcard typically consists of the following: processor, data block, multiprocessor-control block, clock-and-memory refresh, MMU (memory-management unit), and floating-point coprocessors (see figure 2). The memory refresh circuitry provides the refresh timing to the Versacard memory when it is under Microcard control. The clock circuitry synchronizes all activity on the Micro-

card. The multiprocessor-control block comprises the communication registers necessary for dual-port control; this enables both the Microcard's and the PC's processors to access the Versacard memory without contention. The data block consists of a few simple buffers.

In short, the Microcard is a module that contains the "personality" of the system; replacing this module alters the essence of the system. There are five versions of Microcard currently available: The Z80 Microcard is the simplest and has neither an MMU nor a floating-point unit. The 8086 Microcard has an 8087 floating-point processor, within which is a simple memory-mapping scheme. The 68000 Microcard has a sophisticated paged MMU to support advanced multiuser and multitasking operating systems. Both the 80286 Microcard and the 16032 Microcard have advanced MMU and floating-point hardware support.

When the processor residing on the Microcard seeks an I/O transaction, it must create a message block in the shared memory. The block contains the I/O command and the appropriate parameters to direct the transfer of information between the processors. When the Microcard issues an I/O command, the PC is alerted by way of an interrupt; the message block is read by the PC, and the appropriate I/O process is in-

**ENHANCE YOUR COLOR COMPUTER WITH THESE GREAT PRODUCTS!**

**MACRO-80c DISK BASED EDITOR/ASSEMBLER**

This is a powerful macro assembler, screen oriented editor and machine language monitor. It features local labels, conditional assembly, printer formatting and cross reference listings. Assemble multiple files. Program comes on Radio Shack compatible disk with extensive documentation. Price: \$99.95

**MICROTEXT COMMUNICATIONS**

Make your computer an intelligent printing terminal with off-line storage! Use Microtext for timesharing interactions, printing what is received as it is received and saving text to cassette, and more! Price: \$59.95

**P180C PARALLEL PRINTER INTERFACE**

Use a parallel printer with your Color Computer! Serial-Parallel converter plugs into the serial port and allows use of Centronics-compatible printers. You supply the printer cable. Price: \$69.95

**THE MICRO WORKS COLOR FORTH**

Color Forth is easier to learn than assembly language, executes in less time than Basic and is faster to program in than Basic. Rompack comes with 112-page manual containing glossary of system-specific words, full standard FIG glossary and complete source. A fascinating language designed for the Color Computer! Price: \$109.95

**SDS-80C SOFTWARE DEVELOPMENT SYSTEM**

SDS-80C is a Rompack containing a complete editor, assembler and monitor. It allows the user to write, assemble and debug assembly language programs with no reloading, object patching or other hassles. Supports full 6809 instruction set. Price: \$89.95

**80C DISASSEMBLER**

Runs on the Color Computer and generates your own source listing of the Basic interpreter ROM. Documentation includes useful ROM entry points, complete memory map, I/O hardware details and more. Cassette requires 16K system. Price: \$49.95

GAMES: Star Blaster ★ Pac Attack ★ Berserk ★ Cave Hunter ★ Starfire ★ Astro Blast ★ Starship Chameleon ★  
Adventure: Black Sanctum ★ Adventure: Calixto Island ★

**THE MICRO WORKS**

Also Available: Machine Language Monitor  Books  Memory Upgrade Kits  
Parts and Services  Call or write for more information

California Residents add 6% Tax  
**Master Charge/Visa and  
COD Accepted**

P.O. BOX 1110 DEL MAR, CA 92014 619-942-2400

## The Serious Game Design Tool For The Serious Designer At The Price Of A Toy For The Hobbyist

The Game Cartridge  
Development System  
for the Atari® 2600  
Video Computer System™  
Optional:  
Atari 5200 Supersystem  
Adapter Package.

The FROB-26™

Features Include:  
Real-time development  
No machine modification  
Apple II® 48K/ one disk  
drive required.

Now Only \$495  
Call today to order  
408-429-1551  
All major credit  
cards accepted.

For high profit rewards, purchase  
the tool that can do the job at an  
unbeatable price.

**frobco**

A Division of Tri-comp Polytechnical, Inc.

P.O. Box 8378, Santa Cruz, CA 95061  
408-429-1551

The Miracle of Creation Can Be Yours™



Atari and Apple are  
registered trade-  
marks of Atari, Inc.  
and Apple  
Computer, Inc.,  
respectively.  
Video Computer  
System is a trade-  
mark of Atari, Inc.

initiated. Likewise, the PC creates a message block in the memory and alerts the Microcard via an interrupt in order to transfer information.

All I/O transactions are performed in blocks in such a way that the I/O delay is considerably reduced; to the Microcard, all I/O devices appear as fast devices, and all transactions occur at memory transfer rates. This reduces interrupt overhead on the Microcard. This concurrent processing arrangement increases the overall system performance.

### Memory Management

In a multiuser system, the processor appears to attend to several users simultaneously, though, in reality, the processor's attention is being switched between the users several times a second. In order for this to be possible, each user's program must be in a form that can reside at any physical address and still run. This gives the operating system the freedom to determine where the program should be stored. The relocation facility in an MMU provides address translation by mapping the logical addresses into physical addresses, so that programs may be written as though they will be loaded starting at location 0, even though they may end up scattered throughout various portions of memory. The MMU is totally transparent to the user programs, and the processor appears as an exclusive resource to each user.

A memory management scheme is available for the 68000, 80286, and 16032 Microcards. The MMU on the 68000 uses a paging scheme and has the facility to handle 16 simultaneous processes or users. The MMU on the 80286 Microcard is incorporated on the processor itself, and no special hardware scheme is needed. The processor provides a segmented virtual memory with four-level hierarchical memory protection. The 16032 Microcard has a 16082 MMU, which is a VLSIC (very large scale integrated circuit) that uses a demand-paged virtual-memory scheme. These three Microcards support any multiuser and multitasking operating system, as they are functional replications of the

# VERRA INTERFACING!

## 2 FOR THE PRICE OF 1

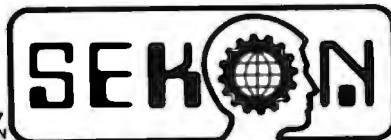
SEKON Computer is now selling Interface cards for Apple IIe and SEKON 64 at half price. Listing at only \$278, you will receive a Z80 card and an 80-Column Card so you can start using thousands of CP/M or Turbo-DOS applications. At similar low prices we also have Printer Card, Serial Card, Epron Card and others. Ask also about our NEW RF Modulator with sound. All our products have a one year warranty. Call your dealer or us for our extra special introductory offer.

Dealer enquiries are invited.



products

(800) 423-4302 IN CALIF (213) 936-1577  
TELEX 181121 INTERCON



2210 Wilshire Boulevard, Suite 577, Santa Monica, CA 90403

# In the world of emulating terminals... **VISUAL** is a world apart.



## VISUAL EMULATION CAPABILITY

**VISUAL 50/55 are low cost smart terminals.** The VISUAL 50 emulates DEC VT52<sup>®</sup>, Lear Siegler ADM3A,<sup>™</sup> Hazeltine Esprit<sup>™</sup> and ADDS Viewpoint<sup>®</sup>. VISUAL 55 emulates the same plus Hazeltine 1500/1510 and VISUAL 200/210.

**VISUAL 100 is 100% compatible with the DEC VT100<sup>®</sup>** and also emulates the VT52.

**VISUAL 300/330 are versatile terminals that can be easily customized.** The VISUAL 300 emulates the DEC VT100 and VT52. VISUAL 330 emulates the DEC VT52, ADM3A, Hazeltine 1500 and Data General D200.

**VISUAL 500/550 are low cost, high resolution graphic terminals with powerful alphanumeric capabilities.** The VISUAL 500 emulates the VT52, ADM3A, Hazeltine 1500, D200 and Tektronix<sup>®</sup> 4010/4014. The VISUAL 550 emulates the VT100, VT52 and Tektronix 4010/4014.

VISUAL terminals feature extended ergonomics including tilt and swivel non-glare 12" or 14" screens, detached keyboard, large character size, menu-style setup, sculptured keycaps and more.

VISUAL has earned for itself an exclusive place . . . a solitary niche . . . in the arena of emulating terminals. Four great terminal series offer a combination of advanced features found on no other terminals anywhere in the world. Each series delivers higher performance at lower cost for its particular market segment. And nobody else gives such a wide choice of emulations as VISUAL . . . the pioneer in the field.

So check the chart before you choose your next terminal. See for yourself why VISUAL stands alone as the first choice for emulating terminals.

Service available in principal cities through Sorbus Service, Division of Management Assistance, Inc.

# VISUAL

See for yourself

**Visual Technology Incorporated**  
540 Main Street, Tewksbury, MA 01876  
Telephone (617) 851-5000. Telex 951-539

Circle 411 on inquiry card.

MMU schemes available on minicomputers and mainframes.

### I/O Architecture

Typical business application programs are limited more by I/O than by computation. In an office environment, it is important that the system's I/O performance be worthy of the processor's power. A multiuser system with four users, all actively performing screen-oriented editing, probably generates an interrupt approximately every 400 microseconds ( $\mu$ s). Servicing these interrupts would

put a tremendous burden on a single processor, and very little processor time would be left for data processing. Such a system would have limited commercial appeal.

Minicomputers and mainframes have overcome this limitation by using special block-buffered I/O processors. In our modular system, the IBM PC takes over the I/O load, concurrently processing I/O tasks, while the Microcard processor takes care of operating-system and user business.

Mass-storage devices present a different type of problem: compared to

the large hard-disk drives used with minicomputers and mainframe systems, the 5¼-inch Winchester drives are generally slow. In a multiuser system, disk accesses are frequent (especially in Unix, with its hierarchical disk directories); therefore, program swapping and file transfers degrade performance. The problem of slow hard-disk drives can be handled by a cache-memory scheme. The cache memory decreases apparent disk-access time by keeping frequently accessed disk sectors in memory.

The IBM PC, functioning as an I/O processor, can significantly reduce the I/O burden on the Microcard processor by handling I/O-device interrupts and providing buffering. Printing a large file, for example, can consume enormous amounts of processor time, so a print-spooling mechanism is provided.

### I/O Processor Software

The I/O Processor Monitor is a multitasking, interrupt-driven program, resident in the PC, that serves all I/O requests (see figure 3). The processor communicates via a well-defined data structure that is independent of the processor and operating system being used. The Monitor software is easily configurable, and the user can readily alter system parameters or add new device-specific routines without having to rewrite a lot of software.

The request types are character output, spooled-block output, unspooled-block output, character input, block input, and device status checks. All character-type I/O requests are for serial devices, and all block-type I/O requests are generally for mass-storage devices and network communications. Special-request types are assigned for setting protocols for serial devices, covering such things as data rate, number of bits per word, and number of stop bits. Other types include direct access to mass storage devices for device-formatting purposes and user-defined request types, which enable access to operating-system calls and user-installed hardware.

An internal polling loop in the I/O



## VistaDaVinci

### GREAT INNOVATORS

Da Vinci in the 15th century was fascinated with machines and how they operate. He designed many types of sophisticated machines to improve life. Vista is trying to improve the level of technology in mass storage for your Apple™ and IBM PC.

Rapidly becoming the benchmark standard for removable mass storage, the Vista V1200 for IBM and Apple Computers continue to set the state of the art in durability, speed & storage. Both the IBM™ Apple™ V1200 drives offer 6 megabytes of storage at incredibly high speeds through our proprietary DMA Controllers. Our new IBM Controller supplied with each V1200 also controls your 8" and IBM mini floppy drives.

The V1200's on-board processor and unique ServoTrac™ System lock in data with unerring accuracy while providing you with the ultimate in storage capacity.

Before V1200 you had, on one hand the exotic, expensive hard disks with no cost efficient means of backup. On the other hand, the 5¼" Floppy were lacking the speed and storage necessary to satisfy today's professionals.

Vista offers both an incredibly attractive price. The removable VistaPak cartridges offer 6 Megabytes of removable storage, each backed up like a floppy.

Now hard disk storage can be yours with the added capability of interchangeable media. The V1200 eliminates the worries of head crashes, drive alignments, lost data, or backup with a new application of field proven floppy technology.

The VistaPak cartridges hold 6MB of formatted data each. The removable cartridges allow you to keep duplicates of your valuable data as well as to keep separate paks for your accounting, word processing, spread sheet, and other applications. No other storage device offers more flexibility and capability.

Both the Apple version and the IBM PC version contain these features: Microprocessor controlled drive, DMA Controller, Removable Data Cartridges, 1 VistaPak Cartridge, and the Vista 120 Day Warranty.

Features unique to the Apple version are: CP/M, DOS & Pascal compatible. Quickcharge and DOS Enhancement.

Features unique to the IBM PC version are: MS-DOS Compatible. Controller that accommodates V1200 as well as your 8" and IBM 5¼" Drives.

Contact Your Local Vista Dealer or Call our Vista Hotlines.



## Vista V1200

™Apple is the Registered Trademark of Apple Computers, Inc.  
 ®IBM PC is the Registered Trademark of International Business Machines.

# Vista

COMPUTER COMPANY, INC.

1317 East Edinger / Santa Ana, CA 92705  
 (714) 953-0523 / (800) 854-8017

**Distributors**

California - Strategic Electronics  
 (714) 971-2846 / (800) 712-1207

California - M&B  
 (714) 991-9199

Texas - R.P. & Son  
 (214) 952-3983

New York - Electronics & Telecommunications  
 (516) 478-6664

London - British International  
 (0441) 146-0994

Germany - Professional Film  
 (49) 31 848-0366

# Computer OEMs: Now's the time to team with Altos.



As an OEM, you're aware there's a lot of 16-bit computers on the market. But what you may not be aware of are the many advantages to doing business with ALTOS® Computer Systems. Here's just a few:

- Altos currently offers the broadest range of cost-effective, single and multi-user 8086- and 68000-based computer systems.
- Altos supports the most popular commercial operating systems (XENIX™/UNIX,™ MP/M-86,™ MS™-DOS, OASIS-16, PICK, RM/COS,™ and UNIX System III™) plus most high-level languages.
- Altos microcomputers can run more existing applications software than any other computer in the world.
- Altos offers a large selection of utilities and compilers for converting existing Z80™ and mini-computer applications, such as those written in DEC's® DIBOL.™
- Altos provides full communications support; both local networking and remote communications.
- Altos provides the widest range of 5¼" and 8" storage options, including floppy, Winchester disk and mag tape backup.
- Since 1977, Altos has delivered more than 35,000 multi-user systems and peripherals to satisfied customers throughout the world.

- Altos backs its computers with responsive, world-wide service and support. (Customer Service Division of TRW, Inc. in the U.S.)

If you're an OEM looking to remain on top, now's the time to team with Altos. Call, write or clip the coupon today.

- Please send me more information on Altos' single and multi-user 8086- and 68000-based computer systems.
- My application is \_\_\_\_\_
- Please have an Altos representative contact me.  
Name \_\_\_\_\_ Title \_\_\_\_\_  
Company \_\_\_\_\_  
Address \_\_\_\_\_  
City/State/Zip \_\_\_\_\_  
Phone (\_\_\_\_\_) \_\_\_\_\_

Mail to: Altos Computer Systems, Attn: Marketing Services, BT-6  
2641 Orchard Park Way, San Jose, CA 95134, Telex 470642 ALTO UI  
**800-538-7872 (In Calif., 800-662-6265)**



Packed with \_\_\_\_\_ value for OEMs

ALTOS is a registered trademark of Altos Computer Systems. 8086 is a product of Intel Corporation. 68000 is a product of Motorola, Inc. Z80 is a trademark and product of Zilog, Inc. XENIX and MS are trademarks of Microsoft Corporation. XENIX is a microcomputer implementation of the UNIX operating system. UNIX is a trademark of Bell Laboratories. RM/COS is a trademark of Ryan-McFarland, Inc. MP/M-86 is a trademark of Digital Research, Inc. OASIS-16 is a product of Phase One Systems, Inc. PICK is a product of Pick & Associates and Pick Computer Works. DEC is a registered trademark and DIBOL is a trademark of Digital Equipment Corporation. UNIX System III is a trademark of Western Electric.

©1983 Altos Computer Systems

Circle 17 on inquiry card.

BYTE June 1983 203

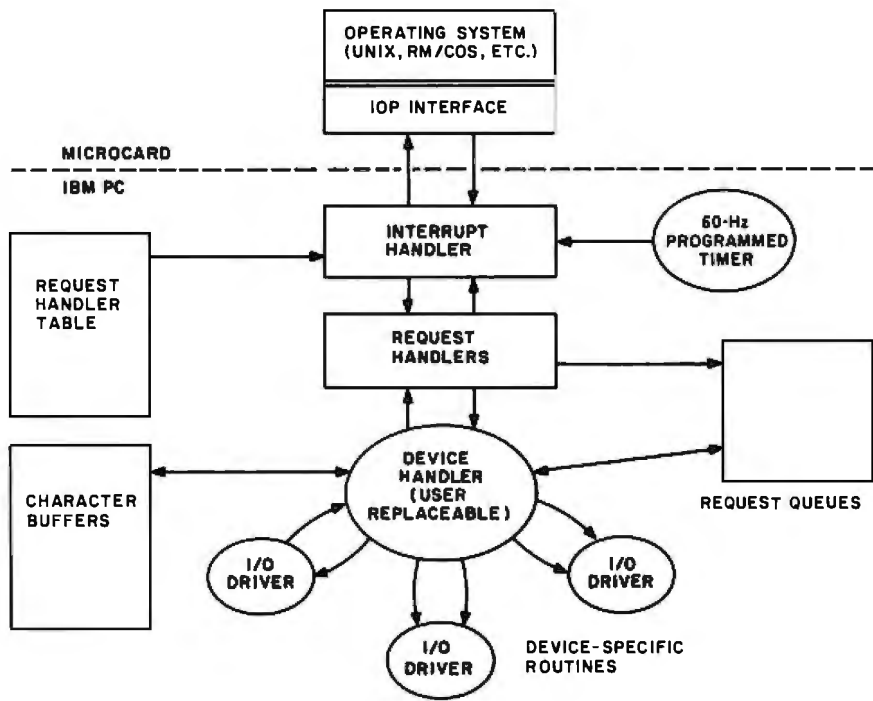


Figure 3: Flow diagram of the I/O Processor software.

Processor Monitor is controlled by a programmable timer set to 60 Hz. Whenever there is a block I/O in progress, this polling loop attends to character input or output. This concurrent processing scheme is used to improve I/O response. When an I/O task is finished, the Monitor will normally interrupt the Microcard processor; but if the Microcard is processing some critical section of a program, the I/O Processor keeps the message block number in a separate queue and interrupts the Microcard at a later time. The polling loop is used to keep track of this also. This feature not only prevents a "deadly embrace"

condition (when two processors access the same resource at the same time) but also enhances overall system performance.

### Final Remarks

The 8-bit microcomputer industry has had little success in creating a market for multiuser systems. Multiuser operating systems (such as MP/M from Digital Research and Oasis from Phase One) suffer when they are limited by 8-bit microprocessor architecture. The 64K-byte address limitation, lack of memory management, and limited processing capability are just some of the factors

that have prevented the 8-bit microprocessors from making a dent in the multiuser market.

The Unix operating system has emerged as a de facto standard for 16-bit multiuser and multitasking systems. The elegant design and supreme flexibility offered by Unix provides individuals with a powerful single-user system and a lot of advanced application software. Unix, with its multitasking, electronic mail, and networking capabilities, also seems ideal for office automation applications. Other operating systems, like the 16-bit MP/M and RM/COS, offer efficient multitasking and multiuser facilities. But this advanced operating system software demands a sophisticated architecture. Critical elements in these systems are memory management and carefully designed I/O processing. The IBM PC, and the hard-disk-based IBM XT, properly enhanced, can set the trend in high-performance, cost-effective personal computer systems. ■

### About the Author

Sudha Kavuru is president of Sritek Inc.

### Design Credits

The following members of the Sritek engineering staff were primarily responsible for the product design and implementation: Madhav S. Kavuru, formerly of IBM, for product definition and system design; lead engineer Jim Bias and Jeff Centanni, for the hardware design; Neal Somos and Scott Fluhrer, for the design and implementation of the systems software; and Mike Kopolka, for the mechanical and printed-circuit board design.

## XEROX SLASHES PRICES UP TO 40%

### XEROX 600-II SYSTEMS

	OLD LIST	NEW SALE
5 1/4" DS/DD	\$3295	\$1795*
5 1/4" DS/DD	\$3895	\$2045*
8" SS/DD	\$4095	\$2495
8" DS/DD	\$4895	\$2795*
10 Mb Hard	\$7895	\$3595

\*with Tandem Drives

### microNEST

Box 645, 1700 Pfond Street  
Fort Benton, MT 59442  
CALL COLLECT TO ORDER:  
(408) 625-6661 9-5 MST, 9P-F

MSA, HQ, CA, MD, CO, HI, IL, IN, IA, MI, MN, MO, NY, ND, SD, VA, WA, WI, WY, and other states. © 1983 Xerox Corp.

XEROX is a trademark of Xerox Corp. DMI is a trademark of Digital Research Corp.

820-II FEATURES: 4MHz, 280A, CPM BASED, 64K RAM, 12" HI RES SCREEN (24 x 80), DD DISK CONTROLLER, THIN LINE GRAPHICS, ENHANCED SCREEN FEATURES (HL INTENSITY, REVERSE VIDEO, FLASHING CHARACTERS), TONE GENERATOR, 2 RS-232 PORTS, TWO PARALLEL PORTS, ALSO BOOTS AS INTELLIGENT TERMINAL.

8088 Co-Processor, 128K RAM	\$499	820 Double Density Kit	\$249	5MB Hard Disk - exp. to 20MB	\$1995
256K Co-Processor	\$799	8204 Extended DD (61K/side)	\$ 99	32K Printer Buffer	\$ 250
256K Co-Processor + CP/M-86	\$999	Amber or Green CRT Replacement	\$ 99	Hayes Smartmodem	\$ 229
MSDOS	Call	Parallel Printer Cable	\$ 49	Anti-Static Floor Mat	\$ 25

### 820/820 II OPTION PKG I SAVE 10%

• 280B CPU SPEEDUP - to 5MHz for 820 II	\$149
• 280C CPU SPEEDUP - to 8MHz for 820 II	\$189
• DISPLAY RISER - Elevates 5" Steel Construction	\$ 29
• ACRYLIC GREEN SCREEN - Mounted to CRT	\$ 19
• ANTI-GLARE SCREEN - Nylon, stretches over CRT	\$ 29
• SYSTEM DUST COVERS - (3) (8" slightly higher)	\$ 29
\$229 for 820, \$265 for 820 II	

### OPTION PACKAGE II Save 10%

• INCLUDES ALL THE OPT. PKG. I PLUS -	
• 10 Diskettes (DS & 8" slightly higher)	\$ 25
• Surge-Protected Multiple Outlet Strip	\$ 29
• Enter Key for Numeric Keypad	\$ 19
• Cooling Fan - Blows dust off processor	\$ 25
• Disk Drive Head Cleaning Kit - 5" or 8"	\$ 25
\$349 for 820, \$385 for 820-II	

Xerox 25 cps Doty \$1199  
Xerox 48 cps Doty \$2095  
Qerox Sprint 11 + 149 \$1385

Wordstar \$250  
Multiplan \$219  
d BASE II \$409

Old IBM2 \$ 629  
IBM3 \$ 919  
IBM4 \$1049

DEALER INQUIRIES WELCOME!



# The Choice of

**DEALERS  
WE BUY  
EXCESS  
INVENTORIES**

## Computer Exchange — The Supply Center for the IBM-PC or XT

### SOFTWARE for the IBM-PC or XT

#### BUSINESS

	LIST PRICE	OUR PRICE
ASHTON-TATE, dBase II, requires CP M-86 & 128K	\$ 700	\$ 439
dBase II, requires PC-DOS & 128K	\$ 700	\$ 439
The Financial Planner	NEW! \$ 700	\$ 439
dBase II User's Guide by Software Banc	\$ 30	\$ 20
APPLIED SOFTWARE TECHNOLOGY, Versaform	NEW! \$ 389	\$ 265
CONTINENTAL, The Home Accountant Plus	\$ 150	\$ 112
FCM (Filing, Cataloging, Mailing)	\$ 125	\$ 85
Properly Management	NEW! \$ 495	\$ 329
DATAMOST, Real Estate Investment Program	NEW! \$ 130	\$ 89
Write-On	\$ 130	\$ 89
EAGLE SOFTWARE, Money Decisions	NEW! \$ 150	\$ 129
HOWARDSON, Real Estate Analyzer II	\$ 250	\$ 189
INFORMATION UNLIMITED, EasyWriter II (a WPS)	\$ 350	\$ 239
EasySpeller (8BK Words)	\$ 175	\$ 129
EasyWriter (a DBMS)	\$ 400	\$ 299
INNOVATIVE SOFTWARE, TIM III (a DBMS)	\$ 495	\$ 369
INSOFT, Data Design (a powerful easy to use DBMS)	NEW! \$ 225	\$ 169
ISM, MathMagic	\$ 90	\$ 69
LOTUS, 1-2-3	\$ 495	\$ 329
MICROCRRAFT, Requires CP M-86		
Legal Billing & Time Keeping—Verdict	\$ 995	\$ 669
Professional Billing & Time Keeping—Billkeeper	\$ 995	\$ 669
MICROLAB, The Tax Manager	\$ 250	\$ 189
MICROPRO, WordStar* plus free WordStar Training Manual	\$ 495	\$ 329
MailMerge*	\$ 250	\$ 179
SpellStar*	\$ 250	\$ 179
3 Pak Word & Mail & Spell, above 3	\$ 845	\$ 589
2 Pak, WordStar* + SpellStar*	\$ 845	\$ 589
InfoStar*	NEW! \$ 495	\$ 369
Report Star*	NEW! \$ 350	\$ 199
MICROSOFT, Multilan, in MSDOS	\$ 275	\$ 199
NORTON AMERICANBUS SYSTEM, The Answer	\$ 250	\$ 169
PBL CORPORATION, Personal Investor	NEW! \$ 145	\$ 99
PEACHTREE SOFTWARE, PeachPak 4 (GL, AR & AP)	\$ 595	\$ 385
PERFECT SOFTWARE, Perfect Writer*	\$ 389	\$ 219
Perfect Speller*	\$ 189	\$ 129
SELECTINFO, Select (a WPS)	\$ 595	\$ 339
SOFTWARE PUBLISHING, PFS: File	NEW! \$ 140	\$ 95
PFS: Report	NEW! \$ 125	\$ 85
SORCOMISA, SuperCalc	\$ 295	\$ 199
SuperWriter	\$ 395	\$ 269
SpellGuard	\$ 195	\$ 139
STC, The Creator	NEW! \$ 300	\$ 195
SYNAPSE, File Manager	NEW! \$ 150	\$ 99
SYNERGISTIC, Data Reporter	NEW! \$ 250	\$ 179
VISICORP, VisiCalc* 256K	\$ 250	\$ 179
VisiDex or VisiSchedule, each	\$ 250	\$ 199
VisiTrend Pilot	\$ 300	\$ 219
VisiFile or Desktop Plan I, each	\$ 300	\$ 239

#### UTILITY

### 1983 CE SOFTWARE AWARD:

"Copy II PC by Central Point Software is the best CE software buy of 1983. It will copy more copy protected software and faster than any other backup system. Unlike other copiers it makes an exact duplicate of your original and it does 100% verification of copy. Documentation is excellent."

★ CENTRAL POINT, Copy II PC, Backup and Utility	NEW! \$ 40	\$ 25
Comix, FastMail*, RAM Disk emulator and printer spooler program.		
Works on any PC-DOS version or RAM Card		
Menu Driver	NEW! \$ 100	\$ 69
DIGITAL RESEARCH, Concurrent CP M-86	\$ 350	\$ 235
CBASIC86	\$ 200	\$ 135
CP M86	\$ 60	\$ 40
HAYES, Hayes Terminal Program	\$ 100	\$ 65
Smartcom II		
MICROCOM, Microterminal	\$ 100	\$ 65
MICROSTUF, Crosstalk	\$ 195	\$ 129
NORELLE DATA, System Backup	\$ 50	\$ 39
NORTON, Norton Utilities, 14 powerful programs, 3 disks	\$ 80	\$ 65

#### HOME & EDUCATIONAL

EPYX Automated Simulations, Temple of Apeah	\$ 40	\$ 29
OXBarons	NEW! \$ 100	\$ 75
BRODERBUND, Apple Panic	\$ 30	\$ 22
CONTINENTAL, The Home Accountant Plus	\$ 150	\$ 112
DATAMOST, Pip/Pan or SpaceStrike, each	\$ 30	\$ 22
DAMSDON, The Speed Reader	\$ 75	\$ 55
INFOCOM, Deadline	\$ 50	\$ 39
Zork for Zork/II or Zork/III, each	\$ 40	\$ 29
INSOFT, WordTrax	NEW! \$ 35	\$ 29
QuoTrax	NEW! \$ 35	\$ 29
MICROSOFT, Flight Simulator (by Sub-Logic)	NEW! \$ 50	\$ 35
BIERRA ON-LINE, Golf Challenge	NEW! \$ 25	\$ 18
	\$ 35	\$ 25
PBL CORP., Personal Investor	\$ 145	\$ 99
SEMENT, Cyborg	NEW! \$ 35	\$ 25
SIRIUS, Conquest or Tail to Arms, each	\$ 30	\$ 23
SIR-TECH, Wizardry, Scenario #1	\$ 60	\$ 40
SPYNAKER, Snopser Troops, #1 or #2, each	\$ 45	\$ 35
Story Machine or FaceMaker, each	\$ 35	\$ 25
STRATEGIC, The Warp Factor	\$ 40	\$ 30

Portland, Oregon Cash & Carry Outlet, 11507-D S.W. Pacific Highway, Terrace Shopping Center, Portland, Oregon. Over-the-counter sales only. On SW between R out 217 and Interstate 5. Open Monday through Saturday 10-5. Call 242-1020.

★ Means a BEST buy **AD #970**

IBM is a trademark of IBM Corporation.

### IBM-PC

System Includes  
Two 320K Disk Drives  
90 Day Warranty By Us  
Call For Details And  
Configurations



### HARDWARE

**MEMORY CHIP KITS**, 64K add-on to your memory cards 9 chips  
200NS, tested and burn-in 90-day warranty.  
Combo Plus 64K w/async para & clock cal \$ 150 \$ 49  
Above Combo Plus, 128K, S-P-C \$ 395 \$ 295  
Above Combo Plus, 192K, S-P-C \$ 495 \$ 375  
Above Combo Plus, 256K, S-P-C \$ 595 \$ 455  
\$ 695 \$ 525



**ComX** 128K RAM Card with Fasttrak™ RAM disk emulator and printer spooler software. 2 Year Warranty \$ 675 \$ 250  
**CURTIS, PC Pedestal** for Display on PC \$ 80 \$ 65  
9 Foot Cable for IBM Keyboard (extends 3 to 9') \$ 50 \$ 35  
**MICROSOFT** 64K RAM Card w/Parity \$ 350 \$ 250  
128K RAM Card w/Parity \$ 525 \$ 380  
256K RAM Card w/Parity \$ 875 \$ 625

**MBI** Monte Carlo 64K Five Function (to 1000K) \$ 625 \$ 395  
**QCS** Big Blue, 280 CPU plus five functions \$ 595 \$ 449

**QUADRAM CORPORATION**  
Quadboard 64K, expandable to 256K, 4 function board \$ 385 \$ 295  
Quadboard 128K, expandable to 256K, 4 function board \$ 465 \$ 345  
Quadboard 192K, expandable to 256K, 4 function board \$ 525 \$ 385  
Quadboard 256K, four function board \$ 895 \$ 425  
Quad S12+, 64K plus serial port \$ 365 \$ 275  
Quad S12+, 128K plus serial port \$ 380 \$ 440  
MicroLazer, w/ Copy, Par Par, 8K, #MP64 w/Power Supply \$ 195 \$ 110  
MicroLazer, w/ Copy, Par Par, 64K, #MP64 w/Power Supply \$ 225 \$ 225  
MicroLazer, w/ Copy, Par Par, 128K, #MP128 w/Power Supply \$ 445 \$ 345  
MicroLazer, Snap-on, 8K, Par Par, Epson, #ME84, w/Par. Supply \$ 150 \$ 140  
MicroLazer, Snap-on, 64K, Par Par, Epson, #ME84, w/Par. Supply \$ 299 \$ 235  
All Microlazers are expandable (w/copy to S120) (Snap-on to 64K)

**Tecmar Inc.** ALL IN ONE Board, 64K \$ 389 \$ 290  
ALL IN ONE Board, 128K \$ 499 \$ 349  
ALL IN ONE Board, 256K \$ 589 \$ 439

TG PRODUCTS, Joystick \$ 85 \$ 49

#### DRIVES

AMDEK, 3 Dual Floppy Drive, 500K PC Compatible \$ 899 \$ 775  
**ControlData or Tandon**  
DISK DRIVES, Double Sided 360K-320K. Same as now supplied with IBM-PC & XT. Tested, burn-in, INW. 1 each \$ 629 \$ 239  
2 or more \$ 529 \$ 229  
Installation instructions, 90 day warranty by us.

**DAVONG** INTERNAL Hard Disk (alt w/Power Supply and w/controller Card, etc.)  
5-6MB \$1395  
10-12MB \$2395  
15-19MB \$2795  
21-27MB \$3295  
32-40MB \$3995  
DSIPower Supply (for older PC) \$ 200 \$ 159  
Tape Backup Unit  
Other Davong HD Products in Stock  
MAYNARD, Floppy Drive Control Board, for up to 4 drives, same with Serial Port \$ 195 \$ 165  
\$ 325 \$ 235  
\$ 275 \$ 205

### PRINTERS AND ACCESSORIES

EPSON MX80 FX PRINTERS CALL CALL  
NEC Dot Matrix, 80x24 Printer FT \$ 695 \$ 495  
★ STAR MICRONICS, 9x9 Dot Matrix, 100cps 2.3K Gemini 10' \$ 499 \$ 349  
9x9 Dot Matrix, 100cps 2.3K Gemini 15' \$ 649 \$ 469  
ANADEx, DP8000 Dot Matrix, 120cps, Serial & Cent. Para I/F Special \$ 995 \$ 695  
IBM-PC to Epson/Star Micros Cable \$ 60 \$ 35  
Apple Interface and Cable for Epson or Gemini \$ 95 \$ 59  
Grappler + w/Orange Micro, specialty printer \$ 165 \$ 119  
Apple Graphics Dump Program \$ 15 \$ 9  
MICROTEK Apple Dumping GX, Graphics Interface & Cable \$ 249 \$ 169  
Apple Dumping 64, Buffered 64K Spooler & Cable \$ 349 \$ 239  
LETTER QUALITY - DAISY WHEEL PRINTERS  
COMREX, Comriter CR-11, F 200MHz \$199 \$ 845  
Comriter Tractor Feed/CR-11 \$ 118 \$ 99  
SMITH-CORONA, TPI Printer, specialty serial or parallel I/F \$ 899 \$ 579  
TPI tractor feed \$ 149 \$ 129  
SUPPLIES: Tractor Feed Paper, Ribbons, Heads, Gume Daisy Wheels and Ribbons.

### 8" CP/M-80 BUSINESS & SYSTEM SOFTWARE - PARTIAL LIST, CALL

	LIST PRICE	OUR PRICE
ASHTON-TATE, dBase II	\$ 700	\$ 439
dBase II User's Guide by Software Banc	\$ 30	\$ 20
INFOCOM, Zork for Zork/II or Zork/III Starcross, each	\$ 50	\$ 39
MICROCRRAFT, Legal Billing & Time Keeping - Verdict	\$ 995	\$ 669
Prof. Billing & Time Keeping - Billkeeper	\$ 995	\$ 669
MICROPRO, WordStar* plus free WordStar Training Manual	\$ 495	\$ 269
MailMerge*	\$ 250	\$ 129
SpellStar*	\$ 250	\$ 129
3 Pak, Word & Mail & Spell, 3 above	\$ 845	\$ 445
2 Pak, WordStar* + MailMerge* + WSTraining Manual	\$ 645	\$ 345
InfoStar	NEW! \$ 495	\$ 269
ReportStar	NEW! \$ 350	\$ 199
MICROSOFT		
Multilan	\$ 275	\$ 199
Fortran 80	\$ 500	\$ 325
BASIC Compiler	\$ 395	\$ 295
COBOL-80	\$ 750	\$ 545
BASIC-80	\$ 350	\$ 275
multiLisp, multiStar-80	\$ 200	\$ 145
M-Sort-80	\$ 195	\$ 145
Edit-80	\$ 120	\$ 80
Macro-80	\$ 200	\$ 145
PEACHTREE, Magic Wand	\$ 500	\$ 395
Series 4GL, AR or AP, each	\$ 600	\$ 395
Series 8GL, AR, AP or Inver Pay, each	\$ 750	\$ 495

### MONITORS

PRINCETON, RGB Hi Res	\$ 795	\$ 639
NEC, 12" Green, Model JB1201M	\$ 249	\$ 159
12" Color, Composite, Model JC1212M	\$ 450	\$ 349
TAXAN, RGB Vision I, 380 Lines	\$ 399	\$ 339
SANYO, 9" Green, Model DMS109	\$ 200	\$ 139
12" Green, Model DM8112CX	\$ 260	\$ 199
13" Color, Composite, Model DMG013	\$ 470	\$ 349
ZENITH, 12" Green, Model ZVM121	\$ 150	\$ 99
AMDEK, 12" Green, #300	\$ 200	\$ 159
12" Amber, #300A	\$ 210	\$ 159
13" Color I, Composite	\$ 449	\$ 359
13" Color II, RGB, Hi Res (Ap. II, III & IBM-PC)	\$ 899	\$ 799
13" Color III, RGB, Commercial (Ap. II, III)	\$ 569	\$ 469
DVM, Color II or III to Apple II Interface	\$ 199	\$ 175

### MODEMS

AXLON, Datalink 1000 Hand Held Communications Terminal	\$ 399	\$ 299
HAYES, Microcom II (for the Apple II)	\$ 379	\$ 275
IBM or Apple Terminal Program for Microcom II	\$ 40	\$ 65
Stock Chronograph (RS-232)	\$ 249	\$ 199
Stock Smartmodem (RS-232)	\$ 289	\$ 235
Smartmodem 1200 (RS-232)	\$ 669	\$ 525
Microcom 100 (S100bus)	\$ 369	\$ 275
IBM-PC to Modem Cable	\$ 39	\$ 29
MICROCOM, Micro Courier for Apple II	\$ 250	\$ 125
Micro Telegram for Apple II	\$ 250	\$ 125
NOVATION, AppleLink II Modem	\$ 389	\$ 269
212 Apple Cal	\$ 725	\$ 599
SIGNALMAN, Modem MKI (RS-232)	\$ 99	\$ 79
SSM, Transcend I for Apple II Data Comm. Modem Card for the Apple II	\$ 89	\$ 69
	\$ 299	\$ 259

### ★ CORVUS SYSTEMS

★ 6 Meg Hard Disk, w/o Interface	\$2395	\$1895
★ 11 Meg Hard Disk, w/o Interface	\$3195	\$2695
★ 20 Meg Hard Disk, w/o Interface	\$4195	\$3495
IBM-PC Interface (IBM DOS), Manual & Cable	\$ 300	\$ 239
Mirror built in for easy backup	\$ 790	\$ 595
Apple Interface, Manual & Cable	\$ 300	\$ 239
Omni Disk Server for Apple II (Special)	\$ 990	\$ 495
Other Interfaces, Omni-Net, Constellation, Mirror, All in Stock		

**hp** HP 75C Portable Computer, 48K, load to 168K \$ 995 \$ 795  
HP 7470 A Graphics Printer \$1550 \$1195  
HP 41C Calculator \$ 195 \$ 149  
HP 41CV Calculator with 2.2K Memory \$ 275 \$ 219  
Full line of HP 75C and HP 41 accessories and software, Call.

### DISKETTES

CONTROL DATA CORPORATION Certified Top of the Line Diskettes		
CDC, 100 each, 5-1/4, with ring, SS, DD, 48T (Apple, IBM, etc.)	\$ 550	\$ 195
10 each, 5-1/4, with ring, SS, DD, 48T (Apple, IBM, etc.)	\$ 55	\$ 25
10 each, 5-1/4, with ring, DS, DD, 48T (IBM, HP, etc.)	\$ 75	\$ 39
DYSAN, 10 each, 5-1/4, SS, DD, 48T (Apple, IBM, HP, etc.)	\$ 69	\$ 39
10 each, 5-1/4, DS, DD, 48T (IBM, HP, etc.)	\$ 89	\$ 49
MAXELL, 10 each, 5-1/4, MD-1, SS, DS or SS, DD	\$ 55	\$ 35
<b>GENERIC™ DISKETTES</b>		
With jackets, no labels, produced by the top of the line manufacturer. 90 day warranty by us.		
100 each SS, SD	\$ 415	\$ 160
100 each SS, SD	\$3200	\$1000
100 each SS, DD	\$ 626	\$ 160
1000 each SS, DD	\$4550	\$1200

**ORDERING INFORMATION AND TERMS:** All Mail: P.O. Box 23068, Portland, OR 97223, include telephone number. All items usually in stock. We immediately honor Cashiers Checks, Money Orders, Fortune 1000 Checks and Government Checks. Personal or Company Checks allow 20 days to clear. No. C.O.D. Add 3% for VISA or MC. Add 3% for shipping, insurance and handling (S.I&H) with \$5 minimum. UPS ground is standard so add 3% more for UPS Blue with \$10 minimum. Add 12% total for S.I&H for US Postal, AP or PP with \$15 minimum. For Hawaii, Alaska and Canada, UPS is in some areas only, all others are Postal so call, write, or specify Postal. Foreign orders except Canada for S.I&H add 18% or \$25 minimum except for monitors add 30% or \$50 minimum. Prices subject to change and typo errors, so call to verify. All goods are new, include warranty and are guaranteed to work. Due to our low prices, ALL SALES ARE FINAL. Call before returning goods for repair or replacement. Orders received with insufficient S.I&H charges will be refunded. ORDER DESK HOURS 8 to 6 PST, Monday through Friday and 10 to 4 Saturday. 1 P.M. here is 4 P.M. in New York.

**OUR REFERENCES:** We have been a computer dealer since 1978 and in mail order since 1980. Banks: 121 Interstate Bank, (503) 643-4678. We belong to the Chamber of Commerce (503) 644-0123, or call Dunn and Bradstreet if you are a subscriber. Computer Exchange is a division of O'Tech Group, Inc. Fasttrak™ and Generik™ are trademarks of ComX Corporation.

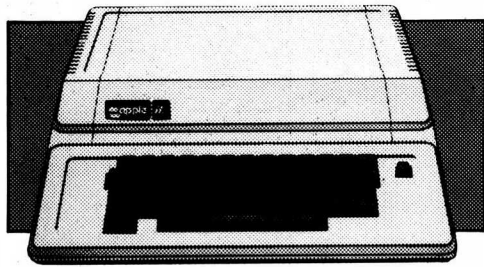


# Professionals™

LOW PRICES TO PROFESSIONALS WHO KNOW WHAT THEY WANT AND KNOW HOW TO USE IT.



## apple II+//IIe supply center



**APPLE IIe 64K, 40 COLUMN** \$1,175  
**APPLE IIe 128K, 80 COLUMN** \$1,395  
**APPLE IIe, STARTER SYSTEM BY APPLE (System A)**  
 64K and 80 column  
 1 Disk II with controller  
 Apple Monitor III  
 Monitor Stand \$1,750  
**APPLE IIe STARTER SYSTEM BY COMPUTER EXCHANGE [SYSTEM B] Includes 64K/80 Col. Card by Apple or ComX.**  
 128K and 80 column  
 1 Micro-Sci Drive with controller  
 Filer, Utility and DOS 3.3 Diskette  
 Sanyo 9" Green Monitor  
 RF Modulator (for color TV)  
 Game Paddles  
 Game with color graphics and sound \$1,875  
**WARRANTY is 100% Parts & Labor for 90 days by us on all above.**  
 To substitute or delete drive on System B, subtract \$245 and add drive price.  
 To add Micro-Sci A2 Drive to above, add \$245.  
 To substitute or delete monitor on System B, subtract \$130 and add other monitor price (System M).

**DISK DRIVES for APPLE II+ //IIe**

	LIST PRICE	OUR PRICE
<b>U-SCI MICRO-SCI</b> A2, 5-1/4", 143K Disk Drive	\$ 479	\$ 259
Controller Card for A2 Drive	\$ 100	\$ 79
A40, 5-1/4", 160K Disk Drive	\$ 449	\$ 339
A70, 5-1/4", 286K Disk Drive	\$ 599	\$ 399
Controller for A40 or A70	\$ 100	\$ 79
Filer, Disk Utility Software	\$ 20	\$ 15

**VISTA** Solo, 5" 143K Disk Drive  
 Std. Height \$ 300 \$ 249  
 Duet, 5", Double Sided, 320K Half Height \$ 420 \$ 329  
 Quartet, 5", 2 Duets Side by Side or Standard Cabinet \$ 715 \$ 575  
 Controller Card \$ 89 \$ 75  
 V1000 Dual 8", Std. Format w/Controller, Complete \$2195 \$1495  
 V1200, 5", 6MB Disk Pack System \$1549 \$1199

**TEAC** 143K Disk Drive, 1/2 High Controller Card. \$ 379 \$ 279  
 \$ 89 \$ 69  
**C.P. SOFTWARE, Filer, Utility and DOS 3.3** \$ 20 \$ 15

## HARDWARE for Apple II

### RAM EXPANSION

	LIST PRICE	OUR PRICE	
ComX, for I/e, 80 col./64K Adder	\$ 295	\$ 145	
★ Apple, RAM Card, 2 Yr. Wty.	\$ 16K	\$ 179 \$ 39	
★ Microsoft, RAM Card	16K	\$ 100 \$ 79	
★ Saturn Systems, RAM Card	32K	\$ 249 \$ 169	
	64K	\$ 425 \$ 319	
	RAM Card	128K	\$ 599 \$ 459
★ Axlon RAM Disk System	320K	\$ 1395 \$ 995	

### VIDEO CARDS

★ ALS, Smartem II	\$ 179	\$ 139
Dirt Cheap Video, 64 col.	\$ 89	\$ 69
ComX, for I/e, 80 col./64K Adder	\$ 295	\$ 145
Videx, Videoterm 80 col.	\$ 345	\$ 229
UltraTerm	\$ 379	\$ 299
Soft Video Switch	\$ 35	\$ 25
Enhancer II	\$ 149	\$ 99
Function Strip	\$ 79	\$ 59
UltraTerm	\$ 379	\$ 279
Full Videx Line. Call. Up to 35% off.		
Vista, Vision 80	\$ 289	\$ 199

### MISCELLANEOUS

ALS, The CP/M Card	\$ 399	\$ 299
Z Card	\$ 169	\$ 129
Color II	\$ 179	\$ 139
ASTAR, RF Modulator	\$ 35	\$ 25
CCS, Serial Interface 7710A	\$ 150	\$ 129
Dan Paymar, Lower Case Chip	\$ 50	\$ 39
Don't Ask, DAO 003 S.A. Mouth	\$ 125	\$ 85
★ Eastside, Wild Card, copier	\$ 130	\$ 99
Kensington, System Saver	\$ 90	\$ 69
Kraft, Joystick (Ap II+)	\$ 65	\$ 49
Paddle (Ap II+)	\$ 50	\$ 39
M&R, Sup II	\$ 50	\$ 39
★ Microsoft, 280 Softcard	\$ 345	\$ 245
Softcard Premium Pack	\$ 695	\$ 495
280 Softcard Plus	\$ 645	\$ 459
MicroTek, Dumping 64, Buffered		
64K Spooler	\$ 349	\$ 239
★ Orange Micro, Grappler Plus	\$ 165	\$ 119
Practical Peripherals.		
MBS8K Serial (Epson)	\$ 159	\$ 129
MBP 16K Para (Cpson)	\$ 159	\$ 129
Microbuffer II 16K, (specify)	\$ 259	\$ 209
Microbuffer II 32K, (specify)	\$ 299	\$ 229
★ PCPI, Appli-Card, 14 features.		
4Mhz	\$ 295	\$ 235
6Mhz	\$ 375	\$ 275
RH Electronics, Super Fan II	\$ 75	\$ 59
★ Saturn Systems, Accelerator II	\$ 599	\$ 449
SSM, A10 II, Serial/Para Interface	\$ 225	\$ 169
TG Products, Game Paddles (II+)	\$ 40	\$ 29
SELECT-A-Port (II+)	\$ 60	\$ 45
Joystick (II+)	\$ 60	\$ 45
Trak Ball (II+)	\$ 65	\$ 44
Videx, PSIO, Para/Ser Interface	\$ 229	\$ 169
WICO, Trackball (Ap II+)	\$ 80	\$ 55

## SOFTWARE on disk for Apple II//IIe

### BUSINESS

	LIST PRICE	OUR PRICE
<b>Apple Computer, Inc.</b>		
Apple Writer II	\$ 150	\$ 119
Apple Pascal	\$ 250	\$ 199
50% of other Apple Inc. software		
<b>Applied Soft Tech., VersaForm</b>	\$ 389	\$ 265
Artsci, MagicWindow II	NEW!	\$ 150 \$ 99
Ashton-Tate, dBase II (CP/M)	\$ 700	\$ 439
Financial Planner	\$ 700	\$ 419
User's Guide by Software Banc	\$ 30	\$ 20
Broderbund, Bank St. Writer	\$ 70	\$ 47
Continental, GL, AR, AP or PR ea	\$ 250	\$ 169
1st Class Mail	\$ 75	\$ 49
Home Accountant	\$ 75	\$ 49
FCM (FILE, CAT, MAIL)	\$ 100	\$ 68
Hayden, Pie Writer (Specify brd.)	\$ 170	\$ 99
<b>Howard Soft,</b>		
Real Estate Analyzer II	\$ 195	\$ 129
Tax Preparer	\$ 225	\$ 149
Info, Unlim., Easywriter (PRO)	\$ 175	\$ 119
LJK, Letter Perfect w/Mail Merge	\$ 150	\$ 99
★ Micro Craft, (Z80 Card)		
Professional Billkeeper	\$ 995	\$ 469
Verdict, (Legal Billing)	\$ 995	\$ 469
★ Micro Lab, Tax Manager	\$ 180	\$ 119
<b>Micro Pro, (all CP/M)</b>		
InfoStar™	\$ 495	\$ 335
Report Star™	\$ 350	\$ 199
WordStar™ + Training Manual	\$ 495	\$ 269
MailMerge™	\$ 250	\$ 129
SpellStar™	\$ 250	\$ 129
3 Pak: Word + Mail + Spell, 3 above	\$ 845	\$ 449
beyond "Some Com Bas Prog"	\$ 645	\$ 349
Data Star™ + MailMerge™ 2 Pak	\$ 295	\$ 159
<b>Microsoft, Multi-Plan (CP/M)</b>	\$ 275	\$ 199
Multi-Plan (Apple DOS)	\$ 275	\$ 199
<b>On-Line, ScreenWriter II</b>	\$ 130	\$ 89
The Dictionary	NEW!	\$ 100 \$ 69
General Manager II	NEW!	\$ 230 \$ 155
<b>Osborne C.P. Soft, (Disk and Book)</b>		
Some Common Basic Programs	\$ 100	\$ 49
75 Business, Statistics and Math programs for the Apple II		
Practical Basic Programs		
40 more very valuable programs		
beyond "Some Com Bas Prog"	\$ 100	\$ 49
<b>Peachtree, (Requires CP/M &amp; MBasic, 40 columns)</b>		
Series 40 GL & AR & AP, all 3	\$ 595	\$ 395
Series 40 Inv. or Pay., each	\$ 400	\$ 275
Series 9 Text & Spell & Mail, all 3	\$ 595	\$ 395
<b>Perfect, Perfect Writer</b>	\$ 495	\$ 219
Perfect Speller	\$ 295	\$ 129
Perfect Writer Speller 2 Pak	\$ 695	\$ 299
Perfect Filer	\$ 595	\$ 259

Quality, GBS w/3 gen. (a DBMS)	\$ 650	\$ 325
Sensible, Sens. Speller, specify	\$ 125	\$ 85
★ Silicon Valley, Word Handler	\$ 250	\$ 119
Sof., Sys., Executive Secretary	\$ 250	\$ 169
Executive Speller	\$ 75	\$ 55
<b>System Plus./Software Dimensions</b>		
Acctg. Plus, General Ledger	\$ 425	\$ 295
Acctg. Plus, GL, AP and A/R	\$ 995	\$ 595
Acctg. Plus, above + Inventory	\$ 1395	\$ 775
Software Publishing, PFS: File	\$ 125	\$ 85
PFS: Report	\$ 125	\$ 85
PFS: Graph	\$ 125	\$ 85
<b>Southeastern Data Capture, call to specify.</b>		
Stoneware, DB Master	\$ 229	\$ 155
Videx, DB Utility I or II	\$ 99	\$ 69
<b>Videx,</b>		
Applewriter II preboot disk	\$ 20	\$ 15
Visicalc 80 col. preboot disk	\$ 50	\$ 39
Visicalc 80 col. to 176K disk	\$ 90	\$ 69
Videoterm Utilities Disk	\$ 37	\$ 28
<b>VisiCorp/Personal Software,</b>		
Visicalc 3.3	\$ 250	\$ 179
VisiFile or VisiDex, each	\$ 250	\$ 179

### UTILITY & DEVELOPMENT

Beagle, Utility City	\$ 30	\$ 22
DOS Boss	\$ 24	\$ 18
Apple Mechanic	\$ 30	\$ 22
<b>Central Point Software</b>		
Filer, DOS Utility	\$ 20	\$ 15
★ Copy II Plus (bit copier)	\$ 40	\$ 35
Epson, Graphics Dump	\$ 15	\$ 9
Insoft, GrafORTH by Paul Lutus	\$ 75	\$ 59
<b>Microsoft,</b>		
A.L.D.S.	\$ 125	\$ 75
BASIC Compiler	\$ 395	\$ 299
Cobol 80	\$ 750	\$ 559
Fortran 80	\$ 195	\$ 149
TASC Compiler	\$ 175	\$ 159
★ Omega, Locksmith (bit copier)	\$ 100	\$ 75
Penguin, Comp. Grphcs. Sys.	NEW!	\$ 70 \$ 53
Graphics Magician	NEW!	\$ 60 \$ 41
Phoenix, Zoom Grafx	\$ 40	\$ 29
Quality, Bag of Tricks	NEW!	\$ 40 \$ 29
Saturn Systems, VC-Expand	\$ 100	\$ 49
VC-Expand 80	\$ 125	\$ 69
Sensible, Back It Up, (bit copier)	\$ 60	\$ 49

### HOME & EDUCATION

Broderbund, Chopflifer	\$ 35	\$ 26
BudgeCo, Pinball Constr. Set	\$ 40	\$ 27
Continental, Home Accountant	\$ 75	\$ 49
Datamost, Aztec or Zaxxon, each	\$ 40	\$ 27
Infocom, Zork I or II, each	\$ 40	\$ 27
Deadline	\$ 50	\$ 34
Lightning, Mastertype	\$ 40	\$ 27
Micro Lab, Miner 2049er	\$ 40	\$ 27
Muse, Castle Wolfenstein	\$ 30	\$ 23
Sierra/On-Line, Ultima II	\$ 60	\$ 40
Softporn (X Rated)	\$ 35	\$ 22
Sir-Tech, Wizardry	\$ 50	\$ 39
Sub Logic, Flight Simul.	\$ 34	\$ 25
OTHER BRANDS AND PROGRAMS IN STOCK. CALL.		

**WHILE THEY LAST**

● OVERSTOCK SPECIALS ●

FOR APPLE II//IIe

★ ComX, 16K RAM Card, 2 Yr. Warranty	\$ 179	\$ 39
Mountain, CPS Multifunction	\$ 239	\$ 119
Microsoft, 16K RAM Card	\$ 100	\$ 89
Saturn Systems, 32K RAM Card	\$ 249	\$ 169
M&R, SupIIterm 80 col.	\$ 375	\$ 199
Videx, Videoterm, 80 column card	\$ 345	\$ 229
CCS, Serial Interface 7710A	\$ 150	\$ 129
Calendar Clock 7424A	\$ 120	\$ 95
MicroCom, Micro Courier	\$ 250	\$ 125
Micro Telegram	\$ 250	\$ 125
Anadex, DP8000, Dot Matrix Printer	\$ 995	\$ 495
ALS, Synergizer + Supercalc + Condor	\$ 749	\$ 499

**SYSCOM 2**

Syscom 2, 64K (Apple II+ Compatible)	\$ 869	\$ 659
Syscom 2, 64K Starter System (same as Apple IIe System B above except 64K, 40 columns)	\$ 1810	\$ 1195

Note: Substitutions and deletions same as System B apply. Syscom 2 is software and hardware compatible to the Apple II+.

**AXLON** The Leader in Atari Add-ons

Rampower 128K System (800)	\$ 475	\$ 350
Rampower 48K Module (for 400)	\$ 185	\$ 135
Rampower 32K (400 or 800)	\$ 120	\$ 89
Ramscan Diagnostic Diskette	\$ 15	\$ 12

★ Means a BEST buy.

**AD #970**



# Computer Exchange™

ALL MAIL: P.O. Box 23068, Portland, OR 97223  
 SHOWROOM AT 11507D SW PACIFIC HWY., PORTLAND, OR, OPEN M-SAT 10-5

NATIONAL ORDER DESK **TOLL FREE (800) 547-1289**

All Other Orders Including Portland: 245-6200

Oregon TOLL FREE (800) 451-5151	Hot Line For Information On Your Order (503) 245-7404
---------------------------------	---

# Digital Research's DR Logo

*A user-friendly language comes of age.*

---

Gary Kildall  
Digital Research Inc.  
POB 579  
Pacific Grove, CA 93950

David Thornburg  
Innovision  
POB 1317  
Los Altos, CA 94022

---

Logo for personal computers has been heralded by some as the beginning of a revolution in computer languages that promises to be as far reaching as the introduction of the personal computer itself. Yet many people think that Logo is not much more than a graphics language for children. Adding to this confusion is the fact that some commercial implementations of Logo are weak (somewhat akin to a version of English that contained no adjectives). Because of the confusion surrounding Logo itself, the appearance of a sophisticated version of this language on a professional microcomputer such as the IBM Personal Computer might be expected to raise some eyebrows. The development of a powerful Logo for 16-bit computers such as the IBM PC can change our way of thinking about programming.

In this article we will show what makes Logo truly powerful, what it can be used for, and how Digital Research's DR Logo, with its powerful language, large workspace, and complete program-development environment, sets a new benchmark by which to measure the

properties of useful computer languages.

To help you understand the power of Logo, we'll give you some background about the earlier language LISP. LISP, developed more than 20 years ago by John

McCarthy, is overwhelmingly the language of choice for researchers in the field of artificial intelligence. Unlike many other languages, LISP lets users perform operations on several data types, including numbers, words,

and lists. A list can consist of a collection of words, numbers, or lists themselves. Because the names of LISP primitives or procedures are also words, one can write LISP programs that automatically generate other LISP programs. It is the ability to manipulate this type of data that gives LISP its name (*LIS*t Processing).

LISP has been used to explore topics as diverse as image processing, the analysis of natural language, the computer solution of certain types of "intelligence" tests, and theorem proving. More mundane programs in LISP (such as word processors) have also been created. Viewed from any angle, it is a powerhouse of a language.

---

**DR Logo incorporates the list-processing capabilities of LISP with a syntax that can be learned by children. And Logo and LISP share other powerful features, too.**

---



# Some people drive fine German machines to work. Some people drive them once they arrive.

The tradition of high quality, high performance German craftsmanship and engineering is legend. And while we most often see that tradition in action on America's streets and highways, it is in America's business offices that its future holds the most promise.

The BASIS 108 is the proof.

This powerful small business computer passes higher-priced competitors with ease. Its dual processors—for CP/M® and Apple II® compatibility—open up the largest library of microcomputer software and plug-in peripherals available today.

This unique combination also provides compatibility with other popular languages, including Pascal™ and LOGO™.

The detached keyboard is a work of art and practicality. Lightweight and low profile, it features a full one-meter cord for comfortable operation on your desk—or your lap. There's a full 128-key ASCII character set. Fifteen user-definable function keys that can provide access to 60 distinct functions. A nine-key cursor control block. And a convenient eighteen-key numeric pad. For special applications, you can also custom map the keyboard with a simple exchange of ROMs.

And there's more. RGB and composite NTSC or PAL video. Keyboard-selectable 80- or 40-column display.

High resolution color graphics. Parallel and serial printer interfaces. Easily accessible outboard I/O connectors. Six Apple II-compatible card slots for peripherals expansion. Even a two-inch alarm or music speaker.

The BASIS chassis is cast aluminum, eliminating heat and RFI interference problems. And there's plenty of room for internal expansion to include hard disk drives and other peripherals.

The BASIS 108. Microcomputing's "Best Of Both Worlds." German craftsmanship and American business savvy. CP/M-based business computing and Apple II-based personal computing. High performance and surprisingly low cost. The BASIS 108. A computing machine finely tuned to handle the fast tracks of business today. Call your BASIS dealer for a test drive. Or call toll free in the U.S. (800) 222-0626.



**BASIS**  
INCORPORATED

5435 Scotts Valley Drive  
Scotts Valley, CA 95066  
(408) 438-5804 TWX: 910-598-4512

CP/M® is a registered trademark of Digital Research, Inc. Apple II® is a registered trademark of Apple Computer, Inc. Pascal™ is a trademark of the Regents of the University of California at San Diego. LOGO™ is a trademark of Logo Computer Systems, Inc.

Circle 39 on inquiry card.

## Nodes, Bytes, and Bits

The popularity of personal computers has brought new words into our vocabulary, such as bits and bytes (that describe storage capacity). With the introduction of list-processing languages like Logo, yet another term to describe units of memory has been added—the node. In Logo terminology you operate with a workspace that holds a certain number of nodes. Like bits and bytes, you want as many nodes in your Logo workspace as possible because your programs and data values are built from workspace nodes. Because nodes are themselves made up from a fixed number of bytes for any particular Logo interpreter, the exact number of nodes you have depends upon the brand of your computer and its memory size.

When you write procedures, enter data values, and run Logo programs, you use nodes from your workspace. Some of these nodes are used permanently, perhaps to store a portion of your Logo program. Others are used to keep track of a temporary value, then later discarded when not of any use.

When you run out of nodes, Logo automatically searches your workspace for temporary nodes that have been discarded. This "garbage collection" reclaims nodes so that Logo can continue operating. If no nodes are reclaimed, Logo stops and tells you about the situation so that you can erase some of your permanent procedures or data values.

Eight-bit computers generally store fewer nodes than 16-bit computers because the Logo interpreter and workspace must coexist in the same 64K-byte memory area. Logo for the 8-bit Apple II computer gives you about 2800 nodes to work with.

Sixteen-bit computers, however, let you operate with more nodes because the memory size is not limited to 64K bytes, as long as you're willing to invest in more memory boards. An 8086- or 8088-based computer, such as the IBM

PC, can potentially address up to 1 megabyte of main memory, giving you more than 100,000 nodes.

For the first-time Logo user, a 2800-node workspace is large enough to write simple procedures, work with turtle graphics, and learn the basics of list processing. When you become serious about your Logo programming, your requirements will increase because of the complexity of the procedures you write and the amount of data you want active in your workspace.

Now your local computer salesperson has one more term to confuse you. If the computer doesn't have enough bits and bytes for you, he'll throw in some nodes at no extra charge.

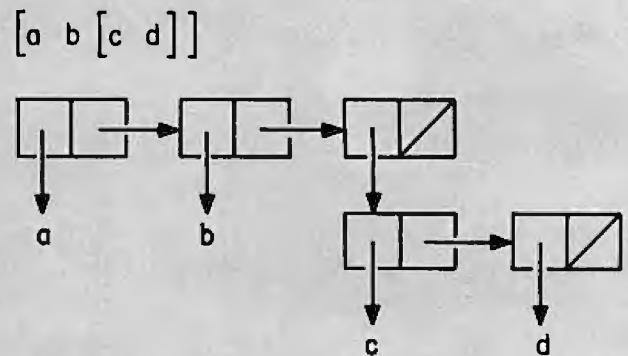


Figure 1: The list containing the two atoms "a and "b and the list [c d] is shown above in its node representation. Each node consists of two 2-byte fields that can be used as data or pointers to more data.

DR Logo incorporates the list-processing capabilities of LISP with a syntax that can be learned by children. More than the utility (and beauty and simplicity) of turtle graphics, it is this list-processing capacity that gives it so much power.

Other important characteristics are shared by Logo and LISP. Among these is the ability to extend the language through the creation of procedures that are treated just as if they were part of the language itself. As with some FORTH devotees, many Logo enthusiasts see themselves as not writing programs, but as creating new "words" in Logo tailored to the solution of their particular programming task. While this may appear to be a subtle distinction, it has a tremendous effect on programming style. This style affected the design of Digital Research's Logo in several ways, especially in the debugging and procedure-management tools.

### The Power of DR Logo

Before showing what Logo procedures look like, we will list a few of the characteristics of DR Logo. To provide maximum power to the user, we designed the first

implementation of DR Logo for the 16-bit IBM Personal Computer. The use of a 16-bit processor greatly increased the amount of workspace available to the user and also yielded a modest speed improvement over 8-bit versions of the language. A DR Logo user with 192K bytes of RAM (random-access read/write memory) has about 10,000 nodes available for use. (See the text box above.) For comparison, an Apple II user running Apple Logo has only about 2800 free nodes to work with. It goes without saying that sophisticated applications require comparably more workspace than simple ones, and it was important to its designers that DR Logo be able to handle sophisticated applications.

In addition to list processing and turtle graphics primitives, DR Logo can work with integers (30 bits long plus a sign) and both single-precision and double-precision floating-point numbers. A full set of transcendental functions (log, square root, etc.) allows this language to be used for scientific programs as well.

DR Logo is a superset of Apple Logo and more than just a language. A complete programming environment, it includes its own operating system, program editor,

◊ indicates price decrease  
● indicates new item

### COMPUTERS

Apple II-E STARTER SYSTEM	\$1715◊
Chameleon, Columbia, Compac	Our staff knows!!
Franklin ACE 1000 with color	\$985●
Franklin ACE 1200 - 1 drive, 80 column, Z-80, software	\$1735
IBM PC	Complete systems start at \$2650
Kaypro II w/Software	\$1595◊
Kaypro II+ - 400K drives	\$1875
NEC APC HO2 - green/2 drives	\$3050◊
NEC APC HO3 - color/2 drives	\$3750◊
Osborne Double Density	\$1735◊
Slimline S-100: Z-80, CP/M, 64K, 2 MByte drives	Under \$2000
Syscom II - Apple II Plus Emulator - not a #@! kit	\$595◊

### PRINTERS

Epson MX-80FT Type III - STILL AVAILABLE	\$505
Epson MX-100 - w/Graphtrax	\$685
Epson FX-80 - 160cps, friction, sprocket	\$565
Brother HR-1A 17cps daisywheel, enhanced	\$715◊
F-10 Starwriter - 40cps, Diablo codes	\$1195◊
Graphic Printer - 50cps, 5 x 7 matrix, sprocket	\$199◊
Mannesmann-Tally 160L - uses Daisy software	\$775◊
NEC 3550	\$1965
NEC 7730	\$2145
Okidata - uses standard spool type ribbons	
u82A - serial/parallel/friction/sprocket	\$405◊
u84AP - 200cps, 132 column, parallel	\$955
u92 - 160cps, 80 column, parallel	\$495◊
u93 - 160cps, wide	\$895◊
Prowriter (C. Itoh 8510A) - 120cps, proportional	\$372◊
Prowriter II (C. Itoh 1550A) - wide carriage	\$665◊
Gemini 10 - 80 column, 100cps	\$325◊
Gemini 15 - 15" wide	\$455◊
Toshiba #1350 - top of the line dot matrix	\$1555◊

### VIDEO MONITORS

Amdek 300G	\$142◊
Amdek 300A	\$165
Amdek 310G - for IBM monochrome adaptor	\$175
Amdek 310A - amber for IBM	\$185
Amdek Color I - 13" color composite	\$294◊
BMC 12" Green - not fancy, but it works	\$94
BMC 13" Color - composite	\$294◊
BMC 13" RGB with card for Apple II+	\$395
Dynax 12" Green (GM-120) - BEST BUY	\$129
Dynax 12" Amber (AM-121) - 970line resolution!	\$145
IBM MONOCHROME green	\$345
Princeton Graphics HX-12 RGB for PC	\$485◊
Taxan VISION-III - hi-res for IBM & II-E	\$533◊

### FOR APPLE & FRANKLIN

Advanced Logic Systems - high performance/low price	
CP/M Card - 2/64K, CP/M 3.0	\$290◊
Z-Card II - list \$169	\$135
Smarterm II - list \$179	\$145
dBase II (requires CP/M)	\$419◊
Davong 10 MByte hard disk - BEST BUY	\$1695◊
Davong 18MByte tape backup	\$1465●
Dumpling GX - like Grappler+	\$105◊
Dumpling 16K - graphics and buffer, expandable	\$160◊
Grappler+	\$125◊
Hayes Micromodem II	\$275
Hayes Micromodem II with Terminal Program	\$295
Magic Window/Word/Calc software pkg	\$235
Microsoft MULTIPLAN	\$192●
Rana Elite One - YES, it works	\$265◊
Rana Elite One Plus - with controller	\$355◊
Rana Elite Two - double storage	\$435◊
Rana Elite Three - quad storage	\$555◊
Serial Interface	\$105
SSM Modemcard w/SOURCE	\$285
SuperCalc	\$155
VISTA QUARTET (2 drives, thin, 640K, controller)	\$615
Vista V-1200, 6MB removable cartridge system	\$1225
Wordstar	\$185

### MODEMS

Hayes Smartmodem 300	\$215
Hayes Smartmodem 1200 - outsells the rest	\$515◊
Novation J-CAT	\$110●
Novation 103/1212 SMART (direct connect)	\$385●
Novation 103 SMART (direct connect)	\$179●
RIXON R212A - 300/1200 SMART	\$365●

## 64K RAM SETS

9 CHIPS, FOR IBM

\$50

## PROWRITER

#8510A PRINTER

\$372

## PC

64K/320K DRIVE

\$1975

## XT

\$4750

**Some lead. Some don't.  
Some lurk in the shadows  
of "CALL" and "we'll beat  
any price." Being leaders,  
we've expanded our  
custom order handling,  
trained more technicians,  
and doubled and tripled  
inventory levels on  
popular items.  
Comparisons are  
welcome.**

### TELEVIDEO TERMINALS

TV-910-Plus	\$565
TV-910	\$565
TV-925	\$725
TV-950	\$915
TV-970	\$1095

Verify prices by phone. Add 2 1/4% for Visa or Mastercard. Add 6 1/4% on California orders. Orders prepaid with check, cashiers check, money order or wire transfer are shipped prepaid within the Continental U.S. COD's require 10% non-refundable deposit (re-stocking fee).

## IRONSIDES COMPUTER CORP



**Customer Service—  
Product Selection Advice  
(213) 344-3563  
ORDERS (800) 528-9537  
18905 Sherman Way  
Reseda, CA 91355**

Visit our new, enlarged showroom.

### NEC APC

Advanced Personal Computer  
We have the lowest price because we sell the most. Or do we sell the most because we have the lowest price?

### FOR IBM PC

AST I/O + II Serial, Game, Clock	\$149●
AST ComboPlus with 64K, serial, parallel, clock	\$257◊
AST MegaPlus 64K, serial, parallel, clock	\$292◊
AST MegaPak 256K for MegaPlus	\$245◊
Davong 10MByte Hard Disk	\$1735◊
Davong 18MByte TETAPE (PC or XT)	\$1650●
dBase II - for PC-DOS	\$429
Lotus 1-2-3	\$335
Keytronic keyboard	\$195◊
RAM SETS (64K with parity) - EXPANDS ALL IBM	\$50◊
RIXON PC212A MODEM	\$375●
Tandon TM100-2	\$245◊
Tandon TM100-4 - with DOS-FIX	\$335
TEAC 320K Half-Height	\$285

### FOR ATARI

Printer Cable	\$35
Rana Elite 1000 - single/double density floppy	\$385●
Serial Cable	\$35

### S-100 THINLINE COMPUTER SYSTEM

• Sierra Data Master (Z-80 4MHz, 64K, 2 Serial, Parallel, CP/M)	
• 2 Thin line 8" drives, 2MByte + 6 slot mainframe. 12" x 19" x 10" high	
• Add any standard video terminal and printer	
COMPUTER	\$1955
Mainframe only	\$450

### SIERRA DATA SCIENCES

Z-80 4MHz Master (64K/2 serial/floppy controller/hard disk port - SBC-100	\$655
Z-80 4MHz Slave (2 serial/2 parallel/64K/EPROM programmer) - SBC-100S	\$565
CP/M for Master with BIOS - CPM/BIOS	\$150
Turbo-Dos for Master with Slaves - TURBO-DOS	\$645

### FOR COMMODORE 64

DATA 20 VideoPak80 - 80 column display	\$165
Z-80 VideoPak - CP/M and 80 column	\$275
Serial to Parallel Printer Cable	\$75

### CORONA DATA SYSTEMS

Systems include half-height 320K drives, 128K RAM expandable to 512K on-board, 640 x 325 graphics, green monitor with 16 x 13 matrix characters, serial port, parallel port, DOS, Basic, and spreadsheet software.	
PC-1 1 drive - list \$2595	\$2095
PC-2 2 drives - list \$2995	\$2375
PC-HD 10MByte hard disk - list \$4495	\$3495
PPC-1 Portable/1 drive - list \$2395	\$1950
PPC-2 Portable/2 drives - list \$2795	\$2250

### WABASH DISKETTES

Single Side Single Density	5 boxes at \$17.50/box
Single Side Double Density	5 boxes at \$21/box
Double Side Double Density	5 boxes at \$32/box

### Chameleon "The Compatible Computer"

LOCAL SALES ONLY  
\$1995

### FOR OSBORNE

Corvus 6MB hard disk	\$1975
OSMOS 1 - double density mod	\$175
OSMOS 2 - 370K drives - compatible with software	\$855
OSMOS 3 - 750K drives	\$999
OSMOS 4 - Disk Format/Convert - read/write 20 formats	\$215
OSMOS 5 - 80 Column - select 52/80 display	\$235
OSMOS 6 - Drive Diagnostics	\$29

debugger, and a set of workspace-management tools designed to speed the successful implementation of even the most convoluted artificial-intelligence program.

The graphics system is designed to use either the color monitor alone or to use the color monitor for turtle graphics or mixed text/graphics applications and the monochrome monitor for procedure editing, debugging, and pure text programs. The color display uses the 320-by 200-pixel medium-resolution mode and supports 16 background colors (eight colors that are either bright or dim). It also supports two foreground color sets of four colors each.

### A Brief Glimpse at Logo Procedures

Before describing the editor and workspace-management tools, we will examine what a Logo procedure looks like by illustrating the creation and manipulation of a list. A list in Logo is a collection of words, numbers, or lists that are enclosed in square brackets. Each item in the list is separated by a space. For example, [cow horse sheep snake] is a list; so is [1 1 2 3 5 8]. The first list consists of the words cow, horse, sheep, and snake; the second list consists of the first six numbers of the Fibonacci series. A more complex list would be [car [dump truck] airplane [railroad engine]], in which two of the elements are words (car and airplane) and two elements are lists of two words each ([dump truck] and [railroad engine]). Also, a list can have one

word in it ([yellow]) or even be empty ([]).

In common with other computer languages, Logo allows values to be assigned to names. For example, you can assign a list to a name with the make command, e.g.:

```
make "friends [Pam Roy Pat George]
```

The quotation mark is used by Logo to indicate that friends is a word, a variable name in this case, and not a command. If we tell Logo to

```
print :friends
```

we will see

```
Pam Roy Pat George
```

on the screen. The colon in front of friends lets Logo know that we want to see what is bound to the variable rather than the variable name itself. If we had entered

```
print "friends
```

we would have seen

```
friends
```

on the screen instead.

**Serial**



**Parallel**



only **\$89.95**

Connector Option \$10.00  
CA Residents 6% tax  
UPS Shipping \$3.00



1501-B Pine Street  
Post Office Box 2233  
Oxnard, California 93030

*Printers! Plotters! Punches! Robots!*

## Convert What You Have To What You Want!

- ★ RS232 Serial
- ★ 8 Baud Rates
- ★ Latched Outputs
- ★ Centronics Parallel
- ★ Handshake Signals
- ★ Compact 3¼ × 4¾ × 1½

No longer will your peripheral choices be limited by the type of port you have available! Our new High Performance 700 Series Converters provide the missing link. Based on the latest in CMOS technology, these units feature full baud rate selection to 19.2K, with handshake signals to maximize transfer efficiency. Detailed documentation allows simplified installation. Order the Model 770 (Ser/Par) or Model 775 (Par/Ser) Today!

**Buffer Products  
Coming Soon!**



CALL (805) 487-1665 or 487-1666 For *FAST* Delivery





# Oryx systems inc.

## QUALITY DISCOUNTS

for a complete selection of microcomputer hardware, software and accessories.

### Apple/Franklin

Hayes Smartmodem, Serial Card, Dow Jones Analyzer — or — Micromodem & Dow Jones Analyzer  
Reg. 779 . . . . . NOW \$ 619

**ASHTON-TATE**  
D-Base II . . . . . \$ 450

**ASPEN SOFTWARE**  
Grammatik . . . . . \$ 60  
Proofreader . . . . . 42

**CDEX**  
\*Visicalc Training . . . . \$ 45

**CHARLES MANN**  
Basic Teacher . . . . . \$ 30  
Teacher Plus . . . . . 32  
Medical II . . . . . 879  
Class Scheduling . . . . 299

**CONTINENTAL SOFTWARE**  
Home Accountant . . . \$ 65

**DOW JONES**  
Market Analyzer . . . . \$ 279  
Market Manager . . . . 240  
Microscope . . . . . 569

**HOWARD SOFTWARE**  
Real Estate Analyzer . . \$ 145

**KRELL CO.** Logo . . . . \$ 75  
Abelson Book . . . . . 15

**LINK SYSTEMS**  
Datafax . . . . . \$Call  
DataLink . . . . . 79

**MICROPRO**  
Wordstar (Reg. CP/M) . \$Call  
Mailmerge . . . . . 149  
Infostar . . . . . 275  
Word Pak (Special) . . . 299

**MICROSOFT**  
Cobol-80 . . . . . \$ 550  
Fortran-80 . . . . . 155  
Time Manager . . . . . 125  
TASC Compiler . . . . . 135  
A.L.D.S. . . . . 99  
Multiplan (DOS) . . . . 215

**OMEGA**  
Locksmith . . . . . \$ 79  
Inspector . . . . . 47  
Watson . . . . . 44

**PEACHTREE (CP/M)**  
Peachpak 40 G/L + A/R  
+ AP (Special) . . . \$ 359  
Series 40  
G/L, A/R, A/P ea. . . . 225  
Inventory . . . . . 225

Series 9  
Peachcalc . . . . . 279  
Telecommunications . . 279

**PENGUIN SOFTWARE**  
Complete Graphics . . \$ 57  
Graphics Magician . . . 48

**SYSTEMS PLUS (Z80 req.)**  
Landlord . . . . . 375

**TERRAPIN Logo** . . . . \$ 135

**VISICORP**  
Visicalc . . . . . \$ 185  
Visischedule . . . . . 225

**MISC.**  
ISM Mathemagic . . . . \$ 80  
ISA Spellguard . . . . 199  
LJK Edit 6502 . . . . . 82  
On-Line Screen Writer II 95  
PFS: Filing, Report  
or Graph. . . . . 112

### CP/M

**ASHTON-TATE**  
\*D-Base II . . . . . \$ 450

**SOFTWAREBANC**  
D-Base User's Guide  
w/ D-Base Purchase. \$ 15  
w/o D-Base Purchase. 20

**COMPUVIEW**  
V-Edit 8080 Z80, IBM PC\$ 130  
V-Edit CP/M86, MS DOS 160

**DIGITAL RESEARCH**  
Pascal Mt + W/SP . . . \$ 389  
MAC . . . . . 85  
SID (8080 Debugger) . . 68  
ZSID (Z80 Debugger) . . 90  
CP/M 2.2 . . . . . 140  
C Basic 2 . . . . . 125  
PU1-80 . . . . . 425

**FOX AND GELLER**  
Quick Screen . . . . . \$ 125  
Quick Code . . . . . 222  
D-Util . . . . . 89

**MARK OF UNICORN**  
\*Final Word . . . . . \$ 239

**MICROPRO**  
\*WordStar . . . . . \$Call  
\*MailMerge . . . . . 149  
\*SpellStar . . . . . 149  
\*InfoStar . . . . . 275  
Wordstar/Mailmerge . . 340  
3-Pack (WS/MM/SS) . . 399

**MICROSOFT**  
Basic 80 . . . . . \$ 275  
Basic Compiler . . . . . 289  
Fortran 80 . . . . . 330  
Cobol 80 . . . . . 550

Macro 80 . . . . . 150  
MuMath/MuSimp . . . . 199  
Multiplan . . . . . 199

**OASIS**  
\*The Word Plus . . . . \$ 120  
\*Punctuation and Style . 99

**PEACHTREE**  
\*Peachpak 4 (G/L, A/R,  
AP) (Special) . . . . \$ 359  
General Ledger Series 4 399  
Accounts Receivable  
Series 4 . . . . . 399  
Accounts Payable  
Series 4 . . . . . 399  
Inventory Series 4 . . . 399  
CPA Client Write-up . . 799  
Series 8 Modules each 425  
Peachtex . . . . . 350

**PICKLES & TROUT CP/M** . \$ 170

**PRO/TEM SOFTWARE**  
\*Footnote . . . . . \$ 105

**REVASCO**  
Z80 Disassembler . . . \$ 85

**SORCIM**  
Supercalc . . . . . \$ 225  
Trans 86 . . . . . 115  
Act . . . . . 155

**STAR COMPUTER SYSTEM**  
G/L, A/R, A/P or Pay . . \$ 350  
Legal Time, Billing . . . 845  
Property Management . . 845

**SUPERSOFT**  
Diagnostic II . . . . . \$ 99  
Disk Doctor . . . . . 84  
Fortran 4 . . . . . 325  
Basic-8086 . . . . . 225  
Lisp . . . . . 120  
Z8000 Assembler . . . 400  
C Cross Assembler . . 400  
\*ScratchPad . . . . . 219

### IBM PC

\*Please see CP/M listing for products with a "\*\*\*\*". All programs with a "\*\*\*\*" will run on PC DOS.

Peachpak 4 (GL-AR-AP) \$ 359  
Peachtext 5000 . . . . 350  
Graphic Software  
"Chartman II" . . . . 345  
\*Multiplan (Microsoft) 199  
IUS EasiWriter II . . . . 199  
IUS EasiSpeller . . . . 129  
IUS Accounting Module 399  
Alpha DataBase  
Manager II . . . . . 170  
Alpha Mailing List . . . 85  
Woolf Move It . . . . . 125

Sorcim Spellguard . . . 247  
Lifetree Volkswriter . . 145  
Ecosoft Microstat . . . 257  
Northwest Statpak . . . 397  
Organic Software  
Milestone . . . . . 269  
Datebook II . . . . . 269  
\*Microstuf Crosstalk . . 139  
Copy II Plus . . . . . 34  
\* Infostar . . . . . 275  
Landlord (drop. mgmt.) \$ 375

### Accessories/ Hardware

**BOARDS**  
**APPLE/FRANKLIN**  
CoProcessors 88 card . \$ 795  
Softcard (Z80 CP/M) . . 245  
Videx 80 Col. Board . . . 247  
Microsoft Premium Pak 599  
Videx Enhancer I . . . . 149  
K & D Enhancer . . . . . 115  
ALS Smarterm . . . . . 379  
ALS Z-card . . . . . 225  
Versacard . . . . . 160  
Bit 3 Dual Comm-plus . 209  
16K RAM WIZARD . . . . 79  
Microsoft 16K RAM . . . 89  
Echo II Speech  
Synthesizer . . . . . 159  
East Side Software  
Wild Card . . . . . 110

**IBM PC**  
BYAD DS-1  
(64K, Z80, CP/M) . . . \$ 599  
Datamac 64K . . . . . 399  
Zedex Baby Blue . . . . 495  
Quadram Quad Board . 350  
Quadram 128K Ram . . . 425  
AST Combo + 64K w/serial  
& parallel port . . . . 350  
\* Hercules Graphics  
Board . . . . . 515  
Orchid Monochrome  
Graphic Adptr. . . . . 432  
OuCeS Big Blue . . . . 499  
Vista Maxicard 64K . . . 325

**MISCELLANEOUS**  
Percom Doubler II . . . \$ 167  
Symtec Light Pen  
(IBM PC) . . . . . 140  
Symtec Light Pen  
(APII/III) . . . . . 200  
Microfazer 8K Printer  
Buffer . . . . . 135  
Maynard Floppy Drive  
Controller w/Par. Port  
(IBMPC) . . . . . 229  
Prometheus (64K upgrade)  
Apple Surance . . . . . 120  
64K Upgrade . . . . . 75

### COMPUTERS

Franklin/Televideo  
Nec/Xerox — Call for  
Price Information

**MONITORS & TERMINALS**  
PGS RGB Color . . . . \$Call  
Amdek Video 300 . . . . 160  
Amdek RGB Color . . . . 699  
NEC 12" Hires Green . . 159  
Sanyo 12" Hires Green 199  
USI Hi-RLS 12" Amber. 199  
Zenith ZVM 12" Green . 115  
Quadchrome . . . . . \$Call

**MODEMS**  
Novation Apple-Cat II . \$ 269  
Novation 212 Auto Cat 585  
Hayes Smartmodem . . . 225  
Hayes Smart Modem  
1200 . . . . . 520  
Micromodem II . . . . . 319  
Hayes Chronograph . . 189  
US Robotics:  
\* Auto-Dial (Full  
Auto300/1200) . . . . 439  
Auto-Line (Auto  
Answer/300/1000) . . . 399

**PRINTERS**  
C. Itoh Starwriter . . . 1450  
C. Itoh Prowriter . . . 485  
Generic Prowriter . . . 425  
NEC 3530 . . . . . 1850  
NEC 3550 . . . . . \$Call  
NEC 8123A . . . . . 489  
Okidata Microline 82A . 460  
Okidata Microline 83A . 685  
Prism 80 (w/4 options)  
color . . . . . 1399  
Prism 132 (w/4 options) 1547  
Smith-Corona TP-1 . . . 625

**DISK DRIVES**  
Rana Elite I (AP II)  
(Special) . . . . . \$ 299  
Rana Elite II . . . . . 420  
Rana Elite III . . . . . 550  
Rana Controller (AP II) . 90  
Micro Sci A35 (AP II) . . 399  
CDC 1800 . . . . . 270

### GAMES

Sir-Tech, InfoCom, Broderbund, Hayden, etc.

... and many more!

\* Monthly Specials.

ORDER TOLL FREE - Outside WI - 1-800-826-1589

- Please:
- Wisconsin residents — add 5% for sales tax.
  - Add \$3.50 for shipping per software and small items. Call regarding others.
  - Foreign — add 15% handling & shipping for small items & software.
  - Prices subject to change without notice.
  - All items subject to availability.

- We welcome:
- Visa, Mastercharge — (Add 4%)
  - Checks (Allow 1-2 weeks for clearing)
  - COD (Add \$2.00 per shipment — cashiers check required)
- Working Hours: Mon.-Th. 8:30 - 5:30 • Fri. 8:30 - 6:30 • Sat. 10:00 - 2:00

For technical information & in Wisconsin: 715-848-2322  
Store prices differ from mail order.

Oryx systems inc.

205 Scott St. • P.O. Box 1961 • Wausau, WI 54401  
Int'l. Telex — 260181 ORYX SYS WAU



## Logo, Turtles, and Kids

Anyone who has watched the personal computer industry for the past few years has probably seen the evolution of certain myths regarding computer languages. Many devotees of BASIC, for example, claim that it is the optimal choice for the home user because of its nearly universal adoption as the default language for personal computers. The fact that BASIC was the only high-level language that was readily available in compact form in the late 1970s is not considered to be relevant by many users. Fortunately, the recent availability of other languages on personal computers (Logo, Pascal, FORTH, and PILOT, to name but a few) has afforded programmers other choices. But some of these languages have myths of their own.

In the case of Logo, the common myth is that it is a turtle graphics language designed to be used exclusively by children. As evidence in support of this myth, one is pointed to Seymour Papert's book *Mindstorms*. It is true that Papert devotes the bulk of his book to the use of turtle graphics as a powerful programming and discovery tool for children, and that he stresses the accessibility of Logo to the young and inexperienced.

The problem with the Logo myth is that it suggests that

Logo is exclusively for children's use. As with many myths, the reality of the situation is quite different. First, it is true that Logo supports turtle graphics. In this regard it is similar to some versions of Pascal, PILOT, and FORTH. Note also that, while turtle graphics is accessible to children, it also has applications of value to advanced programmers as well. Anyone who doubts this would benefit from reading *Turtle Geometry* by Abelson and diSessa or *Discovering Apple Logo* by Thornburg.

The point is that Logo is no more a "kid's" language than is English. Yes, English is the language of "Mary Had a Little Lamb," but it is also the language of Moby Dick and Shakespeare's sonnets.

At its base, Logo is a symbol-manipulation language in the finest sense of the word. Rooted in the artificial-intelligence language LISP, Logo allows the user to extend its vocabulary, to use recursion, and to manipulate various types of data in ways that are nearly impossible with languages like BASIC.

It would be a shame if the myth of Logo kept serious programmers from exploring a language whose foundation goes to the heart of computer science itself.

You can take lists apart in Logo with commands such as `first`, `butfirst`, `last`, and `butlast`. For example, if we enter

```
print first :friends
```

the screen will show

```
Pam
```

The command

```
print butfirst :friends
```

prints

```
Roy Pat George
```

Now that we know a little about lists, let's explore Logo's extensibility by creating a new command in the language. Suppose you did a lot of work with lists and you found that you would like to rotate a list by moving its first element to the rear end and pushing everything else up front. We can create a word (e.g., `rotate`) to do this for us. If we had such a procedure, we could make a rotated version of `friends` by entering

```
make "neworder rotate :friends
```

Because Logo doesn't have a primitive called `rotate`, we can create a procedure with this name that looks like the following:

```
to rotate :list
```

```
output sentence butfirst :list first :list  
end
```

This procedure accepts a list (denoted by the local variable name `:list`) and makes a new list starting with all but the first word and then appending the first word to the end of the list. The sentence primitive (or native instruction) is used to assemble a list from two parts. The output command passes the new list back out of the procedure to any procedure that used `rotate`, or to the command level.

Once defined, Logo procedures are treated just as if they were part of the language's native vocabulary. For example, if you were to enter

```
print rotate :friends
```

the list

```
Roy Pat George Pam
```

would appear on the screen.

Logo's ability to manipulate lists by taking them apart, adding to them, examining their contents, and altering their order is central to the use of Logo in the creation of knowledge-based programs. For an excellent introduction to the use of lists in the creation of a knowledge "tree" that "sprouts" new nodes as the program gets "smarter," you should read Harold Abelson's discussion of the program *animals* in his book *Apple Logo*.

In addition to the ability to perform list processing and



# S-100 AND IBM PC

COMPATIBLE PRODUCTS BY

# ZOBEX



2 SERIAL PORT \$165



\* 20MB HARD DISK \$1995



256K RAM \$335



64K DYNAMIC RAM



ZOBEX MULTIUSER COMPUTER



HOST ADAPTER FOR WD 100X



DD DMA FLOPPY DISK CONTROLLER



Z80A WITH 7 I/O PORTS



CLOCK, SERIAL I/O, IEEE 488

For the past five years, ZOBEX has brought you the most reliable S-100 products available. In answer to the overwhelming demands of the rapidly growing market for microprocessors and their peripherals, we have enlarged our inventory. You can now get expansion products for your IBM PC from ZOBEX. Our 12 or 20 MByte Hard Disk Subsystem, 256K RAM, and Serial I/O boards reflect the same excellent quality and efficiency which our S-100 products demonstrate. Our confidence in

our designs and craftsmanship allow us to back up these products with warranties of six months up to one year. Today's technology has enabled microprocessors to attain the same level of speed and sophistication already achieved by the larger computers and ZOBEX has the experience to provide you with the most advanced micros and add-on products the industry has to offer. Top quality and low pricing make all ZOBEX products a valuable investment, so when you buy a ZOBEX expandable 8 or 16 bit

microcomputer, you are assured of getting the most for your money.

Call or write to:

**ZOBEX**<sup>®</sup>  
7343-J Ronson Rd.  
San Diego, CA. 92111  
**(619) 571-6971**

\* For DEC additional Concurrent CP/M Hard Disk version available for IBM PC

ZOBEX IS A TRADEMARK OF ZOBEX CORPORATION

IBM IS A TRADEMARK OF INTERNATIONAL BUSINESS MACHINES CORP.

CONCURRENT CP/M IS A TRADEMARK OF DIGITAL RES. INC.

arithmetic, DR Logo also supports an excellent turtle graphics environment. While much has been written about turtle graphics, especially on its use with children (see the text box on page 214), it is important to understand that turtle graphics is of tremendous value to expert programmers as well. The power of this graphics environment comes through its description of the shape of an object as a series of incremental steps that create it. Once a procedure describing an object has been written, the object can be displayed at any screen location, orientation, and size without having to tamper with the basic description. For example, the procedure

```
to square :size
  repeat 4 [forward :size right 90]
end
```

can be used to create a square at any screen position, angular orientation, or size. To draw a square at a given place, you first instruct the turtle (a cursor that has both position and orientation) to move to a specific *x-y* coordinate and heading (angle). Next you type `square 50`, for instance, to create a square with sides 50 units long. This property of turtle graphics procedures, coupled with Logo's capacity to run recursive programs, has allowed the easy exploration of geometrical shapes and their properties. See photo 1 for an example of turtle graphics.

### Programming Tools

DR Logo provides many tools to assist the programmer. While smaller Logo systems can adequately survive with a rudimentary procedure editor, larger Logo environments benefit from some of the extra tools that make program analysis and debugging less tedious. DR Logo's procedure editor allows the use of both uppercase and lowercase letters for programs and data. Two primitives, uppercase and lowercase, allow the conversion of a word from one case to the other. Also, procedure listings can be indented to make decision branches and nesting easier to see. While not essential to the creation of good programs, such formatted listings are easier to read.

While Logo's syntax generally makes procedures easy to read, it is valuable to have comments appended to certain program lines. This ability is provided in DR Logo, along with the ability to strip these comments from procedures with the `noformat` primitive if more workspace is needed. If the name or syntax of a Logo primitive or editing command is forgotten, online help is available.

Once procedures are created, DR Logo has several primitives that help show how procedures interact with each other. This is especially important for those Logo enthusiasts who experiment with several coexisting versions of procedures before settling on the final choices. Most versions of Logo will print the names of resident procedures on receiving the `pots` command (`print out titles`). If, in DR Logo, you enter `potl`, the workspace will be examined for all top-level procedures (those not called by other procedures) and their names will be displayed on the screen. If you enter `potcall` followed by the name of a procedure, DR Logo will examine the calling structure of the named procedure and print the names of the procedures used by the one mentioned, as well as the names of the procedures used by these secondary procedures, and so on until the calling sequence is complete. This gives a great deal of information on the internal organization of the Logo workspace. If, on the other hand, you enter `potref` followed by a procedure name, all the procedures that reference this name will be found and displayed.

Many Logo programmers create procedures in a haphazard sequence. Because a listing of multiple pro-

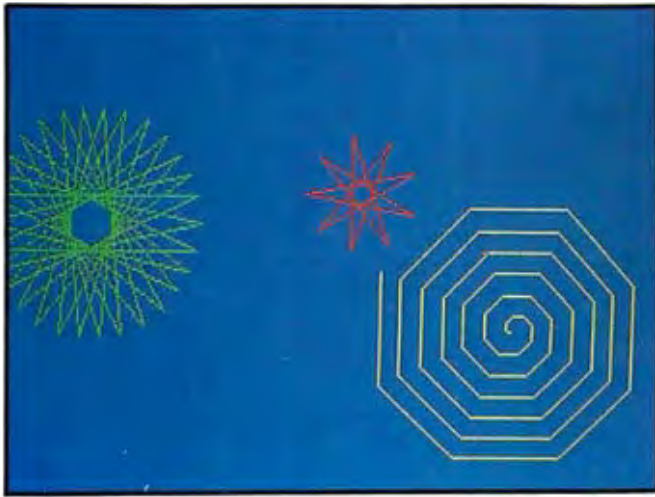


Photo 1: An example of turtle graphics with DR Logo.



Photo 2: Multiple text windows in the debugging mode, with the trace function turned on. The upper left window is the Logo interpreter where you enter Logo commands. The debug window in the upper right displays information on the current program that is running. Output from the program and input that it requests are handled by the program window at the bottom. The trace function follows the program as it runs, showing the level at which a procedure is called, the name of the procedure, and the values of variables as they are defined. The island procedure being traced has two inputs: a list and a number. This shows up as level 1 in the debug window. The gosper subprocedure is called and begins to execute at level 2 with its variables, size and limit. The gosper subprocedure is recursive and calls a copy of itself that begins executing at level 3.

cedures follows the sequence in which they were entered, large listings can be hard to assimilate. By using the DR Logo follow command, procedures can be resequenced in any order, thus allowing large listings to be more easily scanned.

Once you are ready to try a Logo program, DR Logo provides additional tools to assist in debugging. One of these tools allows the text screen to be split into windows corresponding to the command level, a user I/O (input/output) port, and the debugger (see photo 2). The trace command traces the procedure and displays what is happening and at what level the procedure is relative to the top (command) level. Because a single recursive procedure (that calls a copy of itself) may oscillate through many levels, knowing the level at which an error occurs is helpful when fixing the fault. The command watch allows single-step execution of a procedure with the ability to change values and see the effect of each statement. See photo 3 for an example of the watch function.

The use of multiple text windows in debugging is only one application for this powerful tool. The development of good window-management tools can, by itself, increase the simplicity, flexibility, and power of this programming environment.

### Applying DR Logo in Education

Perhaps because of its historic use as a discovery tool for children (and because of the typically small workspace found with most implementations), Logo is not generally perceived as an applications language. It is anticipated that DR Logo will prove to be an exception in this regard.

The educational applications for Logo have typically focused on the use of turtle graphics. The beauty of turtle graphics is that children simultaneously acquire skills in programming, geometry, and art. Many children who are "turned off" by math have discovered it to be an exciting field through their exploration with turtle graphics. Furthermore, it has been found that once a child uses Logo to discover new ways of thinking about mathematics, this new way of thinking continues to produce beneficial results—even if the child is no longer exposed to Logo.

In the physical sciences, Logo can be used to construct *microworlds* in which bodies obey different natural laws, such as gravitation. By exploring these artificial microworlds, children can develop better intuitions about the properties of their own corner of the universe. (See "Designing Computer-Based Microworlds" by R. W. Lawler on page 138 of the August 1982 BYTE devoted to Logo.)

Given Logo's powerful list-processing capability, one would expect it to be of value in the language arts as well. To pick one simple example, suppose a child created several lists called nouns, verbs, adjectives, articles, etc., and assigned appropriate words to each list. The word order in each list can be randomized with the shuffle command, and a random sentence can be constructed by assembling words from each list in a syntactically

```

?animal
In animal, pr (Think of an animal. I will try to guess it by asking questions)

Think of an animal. I will try to guess it by asking questions
In animal, choose.branch :knowledge
In choose.branch, if ( word? :node ) ( guess :node stop)
In choose.branch, make "response ask.yes.or.no ( question :node )
In question, op first :node
In ask.yes.or.no, pr :question
Does it bark
In ask.yes.or.no, make "input readlist
no
In ask.yes.or.no, if :input = [yes] [op [yes]] :input
[no]
In ask.yes.or.no, if :input = [yes] [op [yes]]
In ask.yes.or.no, if :input = [no] [op [no]] _

[U-00]12/07/81[06:28:48]

```

**Photo 3:** The watch function lets you interact with a program line by line as opposed to the trace function that runs continuously. The animal procedure is being run while the watch function is on. (The question mark on the first line is the Logo prompt.) The name of the current procedure being called is given at the beginning of each line. This is followed by a line from the procedure that is about to be executed. You can hit the return key to execute that line or you can type in a Logo command to display values that the procedure is using. Program input and output occur separately on their own lines.

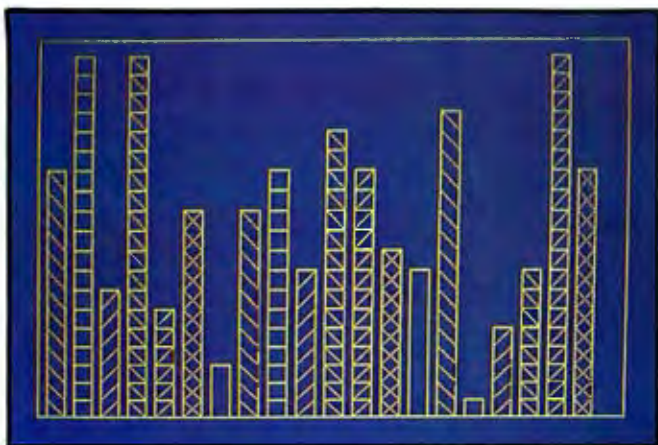
valid order. Legitimate nonsense sentences can be automatically generated in this fashion (e.g., No yellow toad smells tall people.) while bringing the child to look at and solve the structure of English.

The educational value of this program can be seen on several levels. First, if the child creates the lists of words, a misplaced word will show up as a misplaced part of speech. Having a verb appear when a noun is expected results in an obviously invalid sentence structure. The result is a self-reinforcing mechanism for learning the parts of speech. Second, the student can learn to identify valid sentence forms without sample words (sort of the reversal of the traditional parsing process). This helps to cement sentence structure concepts as well. Finally, the student learns some of the challenges awaiting those who want to create natural-language interfaces between people and computers.

### DR Logo in Business

While Logo is not usually thought of as a language for business applications, DR Logo has several characteristics that may change this perception. The creation of an interactive illustration generator using an inexpensive graphics tablet is quite easy in DR Logo. Photo 4 shows a possible display of business graphics, and listing 1 is the program that produced it.

In addition to business graphics, the list-processing capability of DR Logo makes it suitable for database management. In fact, one might envision incorporating some of the results of research in natural-language understanding to generate a query system that responds to questions such as: "If we increase our salaries by 10



**Photo 4:** An example of business graphics possible with DR Logo. The program that produces this picture is in listing 1.

percent this year and increase our sales by 20 percent next month, what will our profit be in the fourth quarter?"

There is no question that many business applications will be found for DR Logo, but it is premature to set limits on the scope of these applications.

### DR Logo in Artificial Intelligence

There has been much talk lately about knowledge-based or "expert" systems. The noble efforts of personal computer software experts notwithstanding, sophisticated microcomputer programs that can adapt to various queries are few and far between. The major reason for this is the inadequacy of most computer languages for dealing with the types of data and operations natural to adaptive systems. Because of DR Logo's close connection with LISP, we expect to see artificial-intelligence techniques appearing in personal computer software rather than being limited to university and large industrial research centers as they have in the past.

This movement is valuable for several reasons. First, it will help to demystify artificial-intelligence research. Second, it will result in the application of advances in artificial intelligence to the development of practical programs. To pick one example, suppose you had a computer program (called car repair) that allowed the following dialogue:

User: I hear noises when I steer the car.

Computer: Do you think the problem is in your steering mechanism?

User: Yes, I think so.

Computer: Do you have power steering?

User: Yes.

Computer: Is the noise loudest when you turn the steering wheel?

User: Yes, but I hear it when the car is idling too.

Computer: You should check the level of your steering fluid before proceeding. Do you know how to do that?

User: Yes.

Computer: Fine. Check the fluid level. If it is low, fill the reservoir and see if the problem is fixed, otherwise we will continue to explore other causes.

Programs that allow this type of interaction can be used for many diagnostic applications and might be far more valuable applications for home computers than checkbook balancers or recipe files.

Domestic applications for artificial intelligence represent a sleeping giant. The list-processing capability and large workspace of DR Logo will allow this giant to be awakened and will enable the creation of a whole new class of applications software.

DR Logo is the first of a new family of languages that promises not only to change our programming style, but to alter the way we think about computing itself. ■

---

#### About the Authors

David Thornburg is an author and lecturer who has been actively involved in the development and support of user-friendly programming environments. His most recent book, *Discovering Apple Logo*, shows how Logo can be used to explore the art and patterns of nature.

Gary Kildall is the president of Digital Research Inc. He is active in research and was the developer of CP/M, Digital Research's version of PL/I, and DR Logo.

---

#### References

Logo:

1. Abelson, Harold. *Apple Logo*. Hightstown, NJ: BYTE/McGraw-Hill, 1982.
2. Abelson, Harold and Andrea diSessa. *Turtle Geometry: The Computer as a Medium for Exploring Mathematics*. Cambridge, MA: MIT Press, 1981.
3. BYTE. August 1982.
4. Papert, Seymour. *Mindstorms: Children, Computers, and Powerful Ideas*. New York: Basic Books, 1980.
5. Thornburg, David. *Discovering Apple Logo: An Invitation to the Art and Pattern of Nature*. Reading, MA: Addison-Wesley, 1983.

Artificial Intelligence:

1. Bundy, A., ed. *Artificial Intelligence: An Introductory Course*. New York: North Holland, 1978.
2. Winston, Patrick. *Artificial Intelligence*. Reading, MA: Addison-Wesley, 1977.

LISP:

1. BYTE. August 1979.
  2. McCarthy, John et al. *LISP 1.5 Programmers Manual*. Cambridge, MA: MIT Press, 1965.
  3. Winston, Patrick and Berthold Horn. *LISP*. Reading, MA: Addison-Wesley, 1981.
-

# Our Prices Will Get Your Attention. Our Service Will Keep It.

ORDER NO. DESCRIPTION LIST AEI PRICE ORDER NO. DESCRIPTION LIST AEI PRICE ORDER NO. DESCRIPTION LIST AEI PRICE

ranklin ACE 1000 ..... 1330 Call  
ranklin ACE 1200 ..... 2495 Call

NE-3510-1 NEC 3510 Spinwriter R/O  
Serial 35 CPS ..... 1895 Call  
NE-3515-1 NEC 3515 Spinwriter R/O  
Serial Diablo Compatible ..... 1925 Call  
NE-3530-1 NEC 3530 Spinwriter ..... 1995 Call  
NE-3550-1 NEC 3550 Spinwriter R/O  
Parallel IBM Compatible ..... 2350 Call  
NE-35-TRAC Bi-directional Tractor ..... 265 Call  
NE-7710-1 NEC 7710 Spinwriter R/O  
Serial 55 CPS ..... 2795 Call  
NE-7715-1 NEC 7715 Spinwriter R/O  
Serial Diablo Comp. .... 2825 Call  
NE-7720-1 NEC 7720 Spinwriter KSR  
Serial 55 CPS ..... 3610 Call  
NE-7725-1 NEC 7725 Spinwriter KSR  
Serial Diablo Comp. .... 3710 Call  
NE-7730-1 NEC 7730 Spinwriter ..... 2795 Call  
NE-PC-8023 Parallel ..... 695 Call  
PLUS OTHER ACCESSORIES

## AVAILABLE FOR THE FOLLOWING SYSTEMS:

Altos CP/M 5 1/4" .....  
Apple CP/M 5 1/4" .....  
Apple DOS - Cassette .....  
Apple DOS - Diskette .....  
Atari 400/800 Diskette .....  
Atari Cartridge .....  
Atari Cassette .....  
Basic 4 CP/M 5 1/4" .....  
CP/M-86 Display Writer .....  
Crammeo CP/M 5 1/4" .....  
DEC V1-180 CP/M 5 1/4" .....  
Eagle CP/M 5 1/4" .....  
Heath Z-90 CP/M 5 1/4" .....  
Heath Zenith CP/M 5 1/4" .....  
Hewlett Packard 125 CP/M 5 1/4" .....  
Hewlett Packard 87 CP/M 5 1/4" .....  
IBM P.C. CP/M 86 .....  
IBM P.C. DOS .....  
NEC CP/M 5 1/4" .....  
Northstar Advantage CP/M 5 1/4" .....  
Northstar Horizon CP/M 5 1/4" .....  
Ohio Scientific C-3 CP/M 5 1/4" .....  
Osborne CP/M 5 1/4" .....  
Otrona CP/M 5 1/4" .....  
QD-Micropolis Mod II/Vector Graphic .....  
Sanyo 1000 CP/M 5 1/4" .....  
Sirius Victor 5 1/4" .....  
Software for 8086 Computers .....  
Standard CP/M 8" .....  
Superbrain 5 1/4" .....  
Timex/Sinclair ZX81 .....  
TRS-80 Cassette Models I & III .....  
TRS-80 Diskette Models I & III .....  
TRS-80 Model II CP/M .....  
Televideo CP/M 5 1/4" .....  
Vic 20 .....  
Wang CP/M 5 1/4" 8" .....  
Xerox 820 CP/M 5 1/4" .....

## TELEVIDEO SYSTEMS

TS-802 Integrated Single User  
Computer ..... 3295 2632  
TS-802H Integrated Hard Disk  
Computer ..... 5995 Call  
TS-803 Computer ..... 4495 Call  
TS-1602G 16 Bit 802 Type Computer ..... 4495 Call  
TS-1602GH 16 Bit 802H Type  
Computer ..... 6995 Call  
TS-806-20 Multi-User Computer ..... 7195 Call  
TS-816 Multi-User Computer ..... 8995 Call  
TV-910-P Televideo 910 Plus ..... 699 573  
TV-910 Televideo 910 ..... 699 573  
TV-925 Televideo 925 ..... 995 745  
TV-950 Televideo 950 ..... 1195 921  
TV-970 Televideo 970 ..... 1495 Call  
TV-9051 One Additional Page for  
925/950 ..... 95 62  
IV-MM Three Additional Pages  
for 950 ..... 120 95  
TS-24-001 For Any Televideo Terminal  
..... 60 53  
TS-803 Televideo Graphics  
Computer ..... 2495 Call  
TS-806H/20 TeleSolutions WordStar  
- CalcStar ..... 790 Call  
TS-1W 20 MB Expansion for TS-803  
Teletwriter - NEC 3500 ..... 3600 2948  
2195 1629

## STAR MICRONICS

DP-8480-TP 80 Column Dot Matrix  
Printer - Parallel ..... 449 Call  
DP-8480-TS 80 Column Dot Matrix  
Printer - Serial ..... 464 Call  
Gemini-10 10" Carriage - Parallel ..... 399 Call  
Gemini-15 15" Carriage - Parallel ..... 649 Call  
Serial Interface Card ..... 85 Call  
DP-8240 40 Column Dot Matrix -  
Parallel or Serial ..... 250 Call

## OKIDATA

OK-82A Okidata Microline 82A  
with Tractor Feed ..... 719 486  
OK-83A Okidata Microline 83A ..... 1195 713  
OK-84A-P Okidata Microline 84A  
- Parallel ..... 1395 Call  
OK-84A-S Okidata Microline 84A  
- Serial ..... 1495 Call  
OK-G-82 Okigraph I for 82A ..... 99 45  
OK-G-83 Okigraph I for 83A ..... 99 45  
OK-92 Okidata Microline 92 ..... 699 Call  
OK-93 Okidata Microline 93 ..... 1249 Call  
OK-2K 2K Buffer/Serial BD  
all Models ..... 140 119

## NORTHSTAR

NS-94404 Adv-2Q-64K Computer .. 3599 Call  
NS-97404 Adv-1Q-64K-HD-5  
Computer ..... 4999 Call  
NS-94401 Hz-2Q-64K Horizon ..... 3599 Call  
NS-97401 Hz-1Q-64K-HD-5MB ..... 4999 Call  
PLUS OTHER NORTHSTAR PRODUCTS

## ZENITH

ZVMI-121 Green Screen Monitor ... 160 99  
Z-29 Z-29 Terminal ..... 849 Call  
ZT-1-A Auto-Dial Terminal ..... 699 526  
Z-25-AA Z-25 Dot Matrix Printer ... 1499 1198  
Z-89-81 Z-89 Computer System .. 1995 Call  
Z-90-82 Z-90 Computer System .. 2799 2176  
Z-89-X Z-89 w/o Integral Drive .. 2495 1749  
Z-90-80 Z-90 w/o Integral Drive .. 2895 1950  
Z-37 Z-37 Dual 5" Disk Drives .. 1995 1593  
Z-87-89 Z87 Dual 5" Disk Drives .. 999 898  
Z-87-90 Same Disk add 400K  
to Z-90 ..... 999 898  
ZS-67 Z-67 Winchester -  
Floppy Drive ..... 5995 4747  
Z-47-DA Z47 Dual 8" Disk Drives .. 3695 Call

## MANNESMANN

MT1600's Serial & Parallel ..... 1695 1441  
MT1800's Serial & Parallel ..... 1995 1441  
MT160L S or P - 160 CPS ..... 990 809

PLUS: MORROW • ALTOS • EAGLE •  
NEC PERSONAL • ANADEX • C-ITOH  
• DIABLO • COMEX • TOSHIBA

ALSO AVAILABLE: MODEMS • DISKETTE STORAGE BOXES •  
DISKETTES • CLIPSTRIP • RIBBONS

## JUNE

### SILVER — REED 550 Letter Quality Printer

- DAISY WHEEL PRINTER
- EXTRA QUIET OPERATION

Available with:

- Bold Face • Sub Script • Super Script

LIST \$895.00

CALL FOR SPECIAL PRICING!

These prices prepared 4/83

Prices change daily —  
call for current pricing  
and shipping charges.



CALL TOLL FREE:

# 800-854-7635

IN CALIFORNIA CALL:  
**(619) 562-7571**

## AUTOMATED EQUIPMENT, INC.

8775 Olive Lane, Suites I & J • Santee, CA 92071



### GUARANTEE

- PROVEN PRODUCTS
- SYSTEM DESIGN HELP
- BENCH TESTING AND CONFIGURING
- TECHNICAL SUPPORT STAFF
- SERVICE AFTER SALE.

(800) 854-7635 TECHNICAL SERVICE SUPPORT

We will pay the freight — both ways — for repair  
on verified returns within 30 days of sale.

### TERMS AND CONDITIONS

Prices change daily. Call for current pricing and availability. Prices based  
on prepaid cash orders. We accept: cashiers checks, money orders  
bank wires, or personal checks (10 days to order). C.O.D. — standard  
charges plus 2% handling for orders outside California. MasterCard &  
Visa — 5% handling. California residents add state and local sales tax.

# LOWEST SOFTWARE

We hereby certify that your purchase from Discount Software represents the lowest price sold anywhere. If you find a lower price on what you purchased within 30 days, send the ad and we'll refund the difference.

	Discount Price		
<b>CP/M</b>		WordStar/Mailmerge	\$399
<b>ARTIFICIAL INTELLIGENCE</b>		WS/MM/SpellStar	\$549
Medical (PAS-3)	\$849	Customization Notes	\$44
Dental (PAS-3)	\$849	<b>\$199</b> SpellStar	
<b>ASHTON-TATE</b>		<b>DataStar</b>	\$249
<b>\$4??</b> dBASE II	call for price	InfoStar	\$349
Financial Planner	\$595	ReportStar	\$254
Bottom Line Strategist	\$349	Wordmaster	\$119
<b>ASYST DESIGN/FRONTIER</b>		Supersort I	\$199
Prof Time Accounting	\$549	Calc Star	\$129
General Subroutine	\$269	<b>MICROSOFT</b>	
Application Utilities	\$439	<b>\$229</b> Basic-80	
<b>DIGITAL RESEARCH</b>		<b>\$329</b> Basic Compiler	
CP/M 2.2		<b>\$349</b> Fortran-80	
Intel MDS	\$135	<b>\$549</b> Cobol-80	
<b>\$149</b> Northstar		M-Sort	\$175
<b>\$159</b> TRS-80 Model II	(P&T)	<b>\$159</b> Macro-80	
Micropolis	\$175	MuSimp/MuMath	\$224
<b>\$98</b> CBasic-2		MuLisp-80	\$174
Display Manager	\$319	<b>ORGANIC SOFTWARE</b>	
Access Manager	\$239	Textwriter III	\$111
Multiplan	\$219	Datebook II	\$269
<b>\$449</b> PL/1-80		Milestone	\$269
BT-80	\$179	<b>OSBORNE (Mcgraw/Hill)</b>	
MAC	\$85	G/L, or AR & AP, or PAY	\$59
RMAC	\$179	All 3	\$129
Sid	\$65	All 3 + CBASIC-2	\$199
<b>\$90</b> Z-Sid		Enhanced Osborne	\$299
DeSpool	\$49	<b>PEACHTREE</b>	
CB-80	\$459	G/1, A/R, A/P, PAY, INV	(each) \$399
Link-80	\$90	P8 Version	Add \$234
<b>FOX &amp; GELLER</b>		Peachcalc	\$249
Quickscreen	\$135	Other	Less 10%
Quickcode	\$265	<b>STAR COMPUTER SYSTEMS</b>	
<b>\$65</b> DUtil		G/L, A/R, A/P, Pay (each)	\$349
<b>MICRO-AP</b>		All 4	\$1129
S-Basic	\$269	Legal or Property Mgt.	\$849
Selector IV	\$295	<b>STRUCTURED SYSTEMS</b>	
Selector V	\$495	Business Packages (call)	
<b>MICRO DATA BASE SYSTEMS</b>		<b>SORCIM</b>	
HDBS	\$269	<b>\$249</b> SuperCalc	
MDBS	\$1099	Act.	\$157
DRS or QRS or RTL	\$319	<b>SUPERSOFT</b>	
MDBS PKG	\$1999	Ada	\$270
<b>MICROPRO</b>		Diagnostic II	\$89
<b>\$289</b> WordStar		Disk Doctor	\$89
<b>\$199</b> Mail Merge		Forth (8080 or z80)	\$149
		Fortran	\$319
		Ratfor	\$79
		C Compiler	\$225
		Star Edit	\$189
		Scratch Pad	\$266
		StatsGraph	\$174
		Analiza II	\$45
		Disk Edit	\$89
		Encode/Decode II	\$84
		Optimizer	\$174
		Term II	\$179
		Utilities I or II	\$54
		<b>SOFTWARE DIMENSIONS/ACCOUNTING PLUS</b>	
		1 Module	\$399
		4 Modules	\$1499
		All 8	\$2799
		<b>UNICORN</b>	
		Mince or Scribble (each)	\$149
		Both	\$249
		The Final Word	\$270
		<b>WHITESMITHS</b>	
		"C" Compiler	\$600
		Pascal (incl "C")	\$850
		<b>"PASCAL"</b>	
		Pascal/MT+ Pkg	\$429
		Compiler	\$315
		SP Prog	\$175
		Pascal Z	\$349
		Pascal/UCSD 4.0	\$670
		<b>DATA BASE</b>	
		dBASE II	Call 4??
		FMS-80	\$799
		FMS-81	\$399
		Condor I & III	Call
		Superfile	\$159
		<b>"WORD PROCESSING"</b>	
		Perfect Writer	\$189
		WordSearch	\$179
		SpellGuard	\$199
		Peachtext	\$289
		Spell Binder	\$349
		Select	\$495
		The Word	\$65
		<b>\$145</b> The Word Plus	
		Palantier-1 (WP)	\$385
		<b>"COMMUNICATIONS"</b>	
		Ascom	\$149
		BSTAM or BSTMS	\$149
		<b>\$139</b> Crosstalk	
		<b>\$89</b> Move-it	
		<b>"OTHER GOODIES"</b>	
		Micro Plan	\$419
		Plan 80	\$495
		Target PlannerCalc	\$79
		Target Financial Modeling	\$299
		Target Task	\$299
		Tiny "C"	\$89
		Tiny "C" Compiler	\$229
		MicroStat	\$224
		Vedit	\$130
		MiniModel	\$449
		StatPak	\$449
		Micro B+	\$229
		String/80	\$84

# PRICES GUARANTEED

These remarkable savings represent only half the story of Discount Software. The other half is our reputation for prompt, courteous, and informative service. We are always available, always ready to help.

String/80 (source).....	\$279
ISIS CP/M Utility.....	\$199
Lynx.....	\$199
Supervyz.....	\$95
ATI Power (tutorial).....	\$75
Mathe Magic.....	\$95
CIS Cobol.....	\$765
Forms II.....	
Graph Magic.....	\$79
Basic.....	\$249
Zip MBasic, CBasic.....	\$129

<b>PEACHTREE</b>	
G/L, A/R, A/P, PAY, (each)....	\$224
PeachPack P40.....	\$395
<b>ACCOUNTING PLUS</b>	
G/L, AR, AP, INV, (each).....	\$385
<b>"OTHER GOODIES"</b>	
Super-Text II.....	\$127
Data Factory.....	\$269
Mini Factory.....	\$269
DB Master.....	\$184
Versaform VS1.....	\$350

Fortran (MSDOS).....	\$429
"C" (MSDOS).....	\$429
CP/M 86.....	\$239
<b>"OTHER GOODIES"</b>	
Lotus 1-2-3.....	\$329
SuperCalc.....	\$269
VisiCalc.....	\$219
Visiplot/trend.....	\$259
Visidex.....	\$219
Easyfiler.....	\$359
Mathemagic.....	\$95
dBase II.....	Call 4??
Condor Q & R, Others.....	Call
Statpak.....	\$449
Optimizer.....	\$174
Desktop Plan.....	\$259

<b>ASHTON-TATE</b>	
(See CP/M Ashton-Tate)	
<b>BRODERBUND</b>	
G/L (with A/P).....	\$444
Payroll.....	\$355
<b>INFO UNLIMITED</b>	
EasyWriter (Prof).....	\$155
EasyMailer (Prof).....	\$134
Datadex.....	\$129
<b>MICROSOFT</b>	
Softcard (Z-80 CP/M).....	\$239
Fortran.....	\$179
Cobol.....	\$499
Tasc.....	\$139
Premium Package.....	\$549
RAM Card.....	\$89
<b>MICROPRO</b>	
(See CP/M Micropro)	
<b>VISICORP</b>	
Visicalc 3.3.....	\$189
Desktop/Plan II.....	\$219
Visiterm.....	\$90
Visidex.....	\$219
Visitrend/Visiplot.....	\$259
Visifile.....	\$219
Visischedule.....	\$259

<b>"WORD PROCESSING"</b>	
Wordstar.....	\$289
Spellstar.....	\$199
Mailmerge.....	\$199
Easywriter.....	\$314
Easyspeller.....	\$159
Select/Superspell.....	\$535
Write On.....	\$116
Spellguard.....	\$189
Textwriter III.....	\$189
Spellbinder.....	\$349
Final Word.....	\$270
<b>"LANGUAGES &amp; UTILITIES"</b>	
Crosstalk.....	\$174
Move-it.....	\$129
BSTAM or BSTMS.....	\$149
Pascal MT+ /86, SPP.....	\$679
CBasic 86.....	\$294
Act 86.....	\$157
Trans 86.....	\$115
XLT 86.....	\$135
MBasic (MSDOS).....	\$329
MBasic Compiler (MSDOS).....	\$329
Both.....	\$629
CBasic Compiler (MSDOS).....	\$495
Cobol (MSDOS).....	\$649
Pascal (MSDOS).....	\$429

## FORMATS AVAILABLE.\*

8" single density  
8" OS/2  
Superbrain  
Micropolis/Vector Graphic  
NorthStar Horizon  
NorthStar Advantage  
Osborne  
Heath/Zenith  
Cromemco  
Televideo  
Xerox 820  
Dynabyte  
Hewlett-Packard 125  
NEC  
Eagle  
Apple II/III  
Otrona  
TRS-80 Model I/II/III  
DEC VT-180  
Altos  
CP/M-86  
IBM PC  
\*New formats added weekly. Call for information.

## FREE WITH PURCHASE:

**Complete Software Buyer's Guide**  
(\$5.00 value)  
Filled with facts and usable advice about scores and scores of software programs from accounting and business systems to word processing and utilities.

**Exclusive Service "Hotline"**  
Our reputation for courteous and knowledgeable service has resulted in calls from people who never purchased our products. Now a separate "hotline" is available to customers only.

**Confidential Software BargainGrams**  
Regular notices of insider's bargains not available to the general public.



ORDER TOLL-FREE  
VIA VISA OR  
MASTERCARD:

**1 800 421-4003**  
Calif: 1 800 252-4092

6520 Selma Avenue, Los Angeles, CA 90028

**DISCOUNT SOFTWARE**  
Outside Continental U.S.—add \$10 plus Air Parcel Post. Add \$3.50 postage and handling per each item. California residents add 6% sales tax. Allow 2 weeks on checks. C.O.D. \$3.00 extra. Prices subject to change without notice. All items subject to availability. \*Mfr. trademark. Blue Label \$3.00 additional per item. CP/M is a registered trademark of DIGITAL RESEARCH, INC.

**Listing 1:** A DR Logo business-graphics program. See photo 4 for an example of the screen display. Note the indentation and embedded comments possible with DR Logo.

```
to graphics
; A sample business graphics program for bar graphs
make "screen.height 198
make "yfactor .25
make "zfactor .575
make "zdeg 22.5
make "xmin -139
make "xmax 139
make "ymin -79
make "ymax 119
make "return char 13
get.request
end

to get.request
(local "reply "h.or.v "s.or.o "2.or.3)
cleartext
make "reply prompt [Horizontal or vertical bars (h or v)] "char
if :reply = "h
    [make "h.or.v "h]
    [make "h.or.v "v]
if :reply = :return
    [stop]
make "reply prompt [Solid or open bars (s or o)] "char
if :reply = "s
    [make "s.or.o "s]
    [make "s.or.o "o]
if :reply = :return
    [stop]
make "reply prompt [2 or 3 dimensional (2 or 3)] "char
if :reply = 2
    [make "2.or.3 2]
    [make "2.or.3 3]
if :reply = :return
    [stop]
make :reply prompt [Values to be graphed] "list
if "reply = []
    [stop]
bar.graph :h.or.v :s.or.o :2.or.3:reply
get.request
end

to prompt :text :type
local "reply
(type :text " : char 32)
if :type = "char
    [make "reply readchar print :reply output :reply]
    [output readlist]
end

to bar.graph :h.or.v :s.or.o :2.or.3 :values
cleartext
(local "max.value "min.value "origin "width "depth "axis "reply
    "graph.width "graph.height "proc "spacing)
if empty? :values
    [stop]
make "max.value 0
```

Listing 1 continued on page 224



# Don't let price get in the way of owning a quality printer.

Adding a printer to your computer makes sense. But deciding which printer to add can be tricky. Do you settle for a printer with limited functions and an inexpensive price tag or buy a more versatile printer that costs more than your computer? Neither choice makes sense.

Here's a refreshing option — the new, compact STX-80 printer from Star Micronics. It's the under \$200 printer that's whisper-quiet, prints 60 cps and is ready to run with most popular personal computers.

The STX-80 has deluxe features you would

expect in higher priced models. It prints a full 80 columns of crisp, attractive characters with true descenders, foreign language characters and special symbols. It offers both finely detailed dot-addressable graphics and block graphics.

And, of course, the STX-80 comes with Star Micronics' 180 day warranty (90 days on the print element).

The STX-80 thermal printer from Star Micronics. It combines high performance with a very low price. So now, there is nothing in the way of owning a quality printer.

\*Manufacturer's suggested retail price.



**THE POWER BEHIND THE PRINTED WORD.**  
Computer Peripherals Division, 1120 Empire Central Place,  
Suite 216, Dallas, TX 75247 (214) 631-8560



# The new STX-80 printer for only \$199.\*

*Listing 1 continued:*

```
make "min.value 999999999
if :h.or.v = "h
  [make "origin list :xmin :ymax make "graph.height :screen.width
  make "graph.width :screen.height make "axis 90]
if :h.or.v = "v
  [make "origin list :xmin :ymin make "graph.height :screen.height
  make "graph.width :screen.width make "axis 0]
if :2.or.3 = 2
  [make "spacing (:graph.width / count :values) * :yfactor]
  [make "spacing (:graph.width / count :values) * :zfactor]
if :2.or.3 = 2
  [make ":width (:graph.width / count :values) * (1 - :yfactor)]
  [make ":width (:graph.width / count :values) * (1 - :zfactor)]
make "depth :width * :zfactor
minmax :values
make "values scale :values :graph.height * .8 / :max.value
cleanup
penup setpos :origin pendown
if :h.or.v = "h
  [line [] list :screen.width ycor]
  [line [] list xcor :screen.height]
penup setpos :origin pendown
draw.bars :axis :width :spacing :2.or.3 :values
splitscreen
setcursor [0 23]
type [Return to continue]
make "reply readchar
end

to minmax :list
if empty? :list
  [stop]
if first :list > :max.value
  [make "max.value first :list]
if first :list < :min.value
  [make "min.value first :list]
minmax butfirst :list
end

to scale :list :factor
if empty? :list
  [output []]
output sentence (:factor * first :list) scale butfirst :list :factor
end

to cleanup
hideturtle
setbg 6
penup
home
clean
pendown
end

to draw.bars :axis :width :spacing :2.or.3 :values
if empty? :values
  [stop]
setheading axis
draw.1.bar :s.or.o :2.or.3 first :values :width :depth :zdeg
```

*Listing 1 continued on page 226*



# "TI's Home Computer. This is the one."

A lot of computers offer a lot. Only one in its price range offers the most. The TI Home Computer.

**Better to begin with.** Anyone can start right away with our Solid State Software™ Command Cartridges. Dozens of programs are available in home management, education and entertainment.

**Easy to expand.** Our Peripheral Expansion System gives you plug-in cards for memory expansion, P-Code capabilities, a disk drive controller and the RS232 Interface. You can also add a modem, speech

synthesizer, disk drive and 80 column dot matrix printer.

**Programming flexibility.** TI BASIC is built into the Home Computer. But it can also handle TI Extended BASIC, UCSD Pascal\* Version IV.0, TI LOGO II, TMS 9900 Assembly Language and TI PILOT. Programs can be stored in the optional Mini Memory Command Cartridge.

**High-Tech specs.** 16-bit microprocessor, 16K bytes RAM (expandable to 52K), 26K bytes internal ROM, up to 30K bytes external ROM. 3 simultaneous tones from

110 HZ to 40,000 HZ. High resolution video. U. & l.c. Single line overlay for 2nd function. Control & function keys. 16 color graphics with 4 modes & sprites.

Sound impressive? Compare a TI Home Computer with the competition and really be impressed. You won't even need a computer to tell you this is the one.



**TEXAS  
INSTRUMENTS**

© 1982 Texas Instruments

\*UCSD Pascal is a trademark of the Regents of the University of California

Listing 1 continued:

```
setheading :axis + 90
forward :spacing + :width
draw.bars :axis :width :spacing :2.or.3 butfirst :values
end
```

```
to draw.l.bar :s.or.o :2.or.3' :height :width :depth :zdeg
(local "origin "direction)
make "origin pos
make "direction heading
if :s.or.o = "o
  [make "proc "open.bar]
  [make "proc "solid.bar]
run (list :proc :height :width)
if 2.or.3 = 2
  [stop]
forward :height
right 90 - :zdeg
forward :depth
right :zdeg
forward :width
right 180 - :zdeg
forward :depth
back :depth
left 90 - :zdeg
forward :height
right 90 - :zdeg
forward :depth
penup setpos :origin pendown
setheading :direction
end
```

```
to open.bar :height :width
repeat 2 [forward :height right 90 forward :width right 90]
end
```

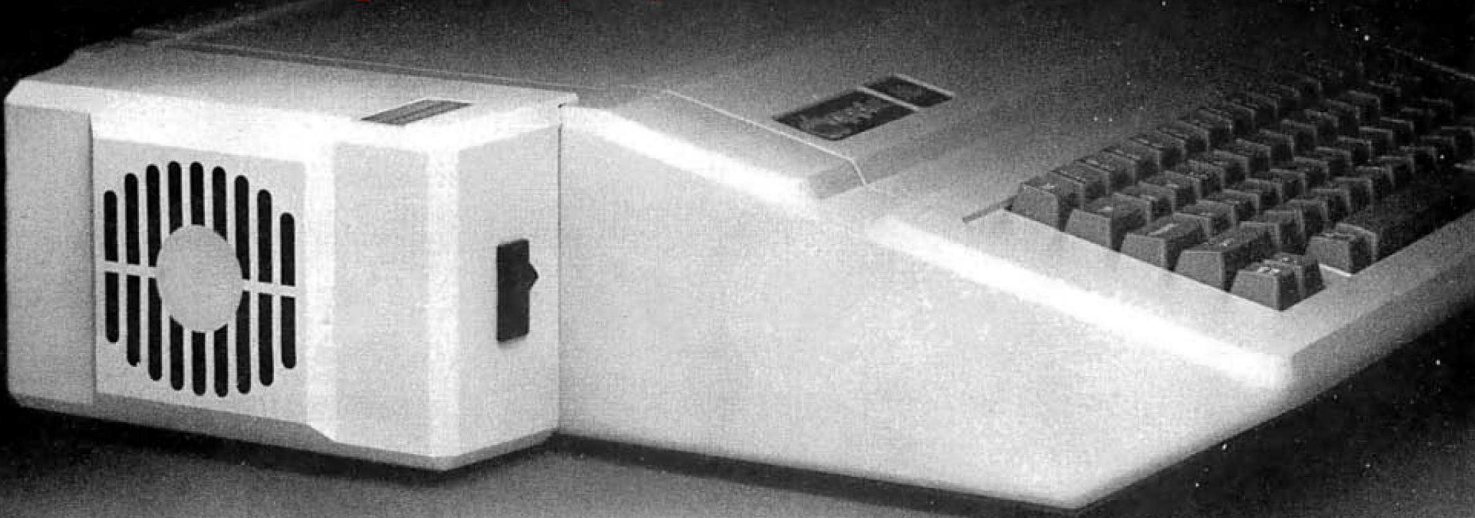
```
to line :pos1 :pos2
if not empty? :pos1
  [penup setpos :pos1 pendown]
make "pos1 pos
setheading towards :pos2
forward sqrt sum
  sq ((first :pos1) - (first :pos2))
  sq ((last :pos1) - (last :pos2))
end
```

```
to sq :num
output :num * :num
end
```

```
to solid.bar :height :width
(local "course "origin)
make "course heading
make "origin pos
repeat :width / 2 [forward :height right 90 forward 1 right 90
  forward :height left 90 penup forward 1 pendown left 90]
if remainder :width 2 = 1
  [forward :height]
penup setpos :origin pendown
setheading :course
end
```

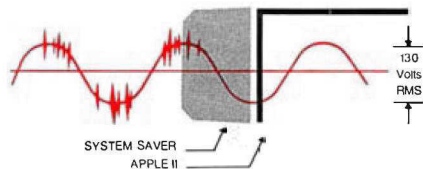
# System Saver™

The most important peripheral for your Apple II and IIe.



## For Line Surge Suppression

The SYSTEM SAVER provides essential protection to hardware and data from dangerous power surges and spikes.

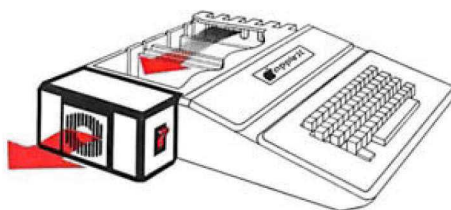


By connecting the Apple II power input through the SYSTEM SAVER, power is controlled in two ways: 1) Dangerous voltage spikes are clipped off at a safe 130 Volts RMS/175 Volts dc level. 2) High frequency noise is smoothed out before reaching the Apple II. A PI type filter attenuates common mode noise signals by a minimum of 30 dB from 600 khz to 20 mhz, with a maximum attenuation of 50 dB.

## For Cooling

As soon as you add 80 columns or more memory to your Apple II you need SYSTEM SAVER.

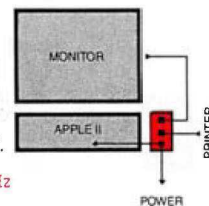
Today's advanced peripheral cards generate more heat. In addition, the cards block any natural air flow through the Apple II creating high temperature conditions that substantially reduce the life of the cards and the computer itself.



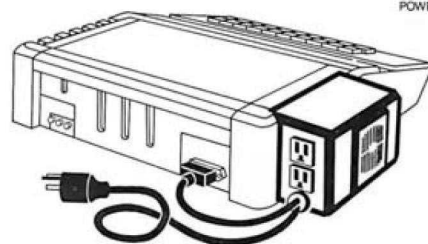
SYSTEM SAVER provides correct cooling. An efficient, quiet fan draws fresh air across the mother board, over the power supply and out the side ventilation slots.

## For Operating Efficiency

SYSTEM SAVER contains two switched power outlets. As shown in the diagram, the SYSTEM SAVER efficiently organizes your system so that one convenient, front mounted power switch controls SYSTEM SAVER, Apple II, monitor and printer.



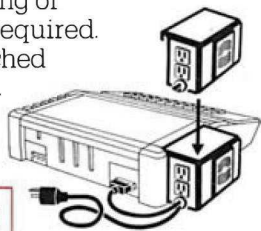
Available in 220/240 Volt, 50 Hz



The heavy duty switch has a pilot light to alert when system is on. You'll never use the Apple power switch again!

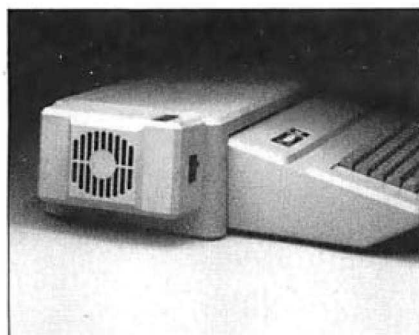
## Easy Installation

Just clips on.  
No mounting or hardware required.  
Color matched to Apple II.



PATENT PENDING

## Compatible with Apple Stand



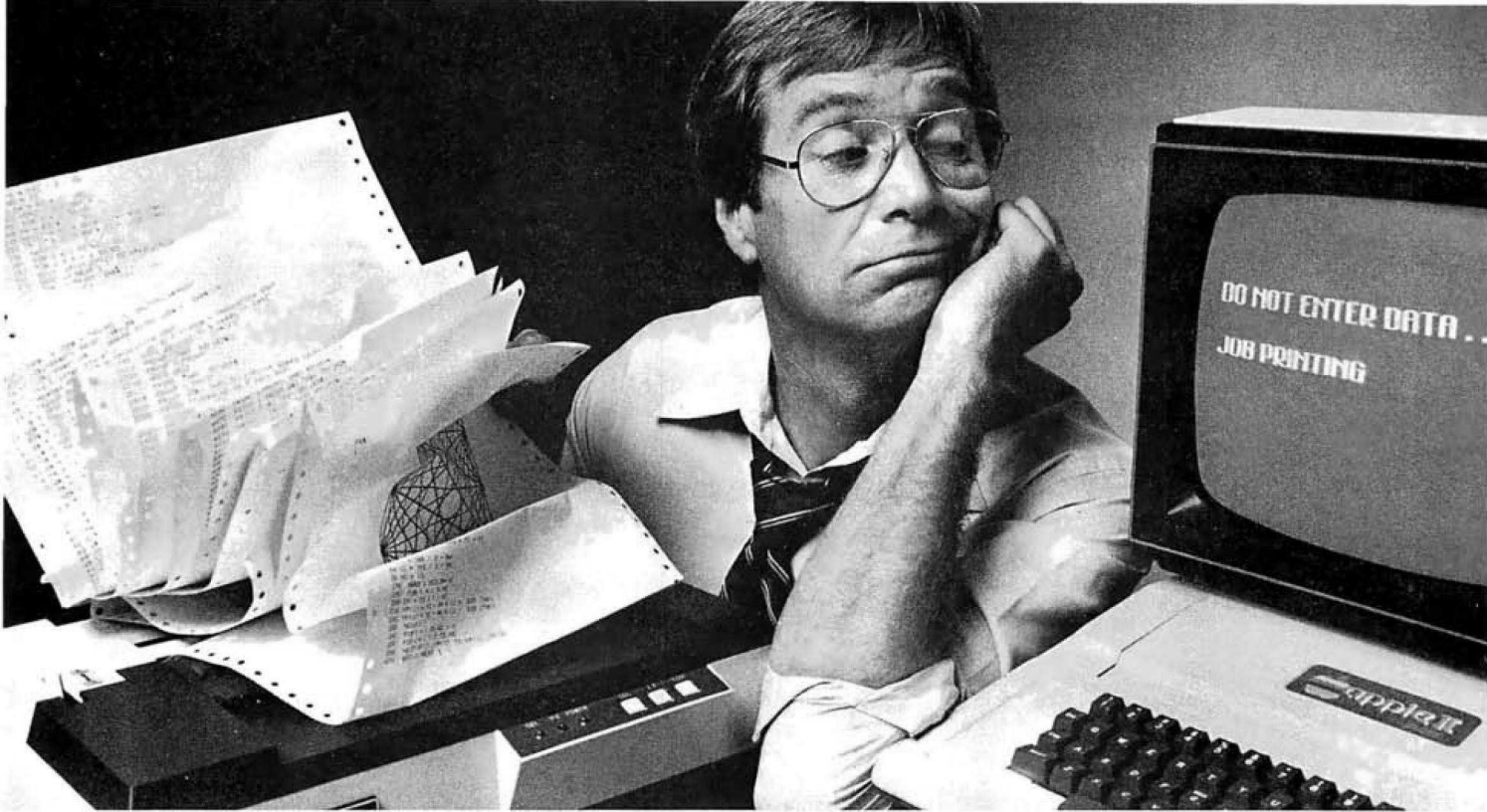
**\$89.95 at your local dealer or order direct by phone or mail.**

For phone or mail orders include \$2.50 for handling. New York State residents add sales tax. VISA and MASTERCARD accepted. Dealer inquiries invited. Circle 211 on inquiry card.

Kensington Microware Ltd.  
919 Third Avenue, New York NY 10022  
(212) 486-7707 Telex: 236200 KEN UR

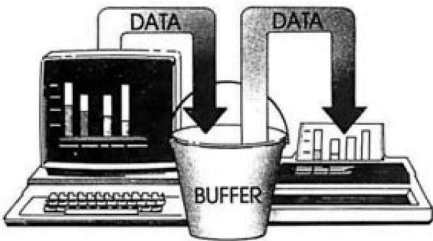


**KENSINGTON  
MICROWARE**



# If your printer uses your Apple<sup>®</sup> more than you do, you need The Bufferboard.<sup>™</sup>

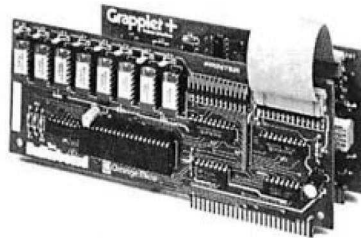
If your Apple is locked into the "PRINT" mode so much that you've taken up solitaire to kill the boredom, you need a buffer. And if your computer is the Apple II or III, the only buffer for you is The Bufferboard. Expandable to 64K of storage, The Bufferboard stores an instantaneous **bucketful** of print data from your computer. Then it feeds the data to your printer at its own printing rate. Your Apple is set free from driving your printer and is ready for more data from you.



**Take your existing interface—  
and buffer it!**

Only The Bufferboard has a simple Interface-Docking System. No bulky boxes

or expensive power supplies are needed because The Bufferboard fits right into your Apple—and docks onto your existing printer interface. The result is convenient



and economical buffering of most popular printer interfaces, including the Grappler +<sup>™</sup> interface, Epson interface, and Apple printer interface. Thirty seconds and a single hook-up are all you need to end the printer waiting game forever.

**Up to 20 letter-size pages  
stored at a time.**

The Bufferboard comes standard with 16K, and is expandable to 32K or 64K of buffering capacity with the addition of

memory chips. This "bucket" will hold up to 20 pages of a print job, allowing you freedom to use your Apple.

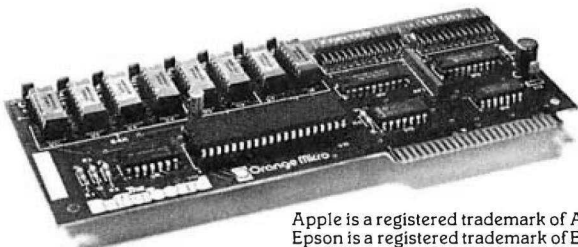
**The Bufferboard—designed  
exclusively for the Apple Computer.  
Specifications:**

- Versions for Grappler + interface, Epson interface, Apple interface, and other popular printer interfaces • 16K buffer standard
- Upgradeable to 32K or 64K • Automatic memory configuration • Automatic self test • Includes interface docking cable.

The Bufferboard is made by Orange Micro, Inc.; the same people who brought you the popular Grappler + printer interface. Both the Grappler + and The Bufferboard are now available at your local Apple dealer.

**Orange Micro  
inc.**

1400 N. Lakeview, Anaheim, CA 92807  
U.S.A. (714) 779-2772  
TELEX: 183511 CSMA



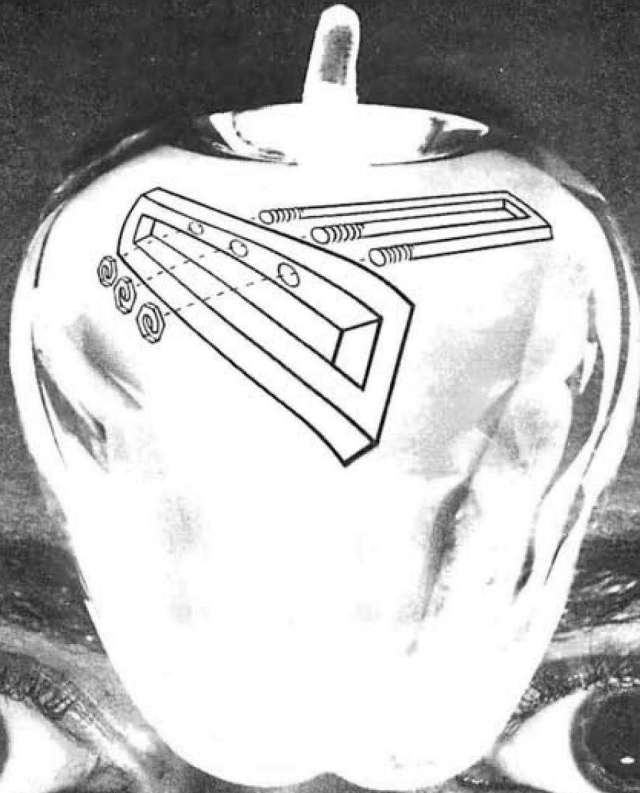
Apple is a registered trademark of Apple, Inc.  
Epson is a registered trademark of Epson America, Inc.

**The  
Bufferboard<sup>™</sup>  
For Apples and Printers**

Circle 289 on inquiry card.

© Orange Micro, Inc. 1983.

# IMAGINE IT...



## CAPTURE IT

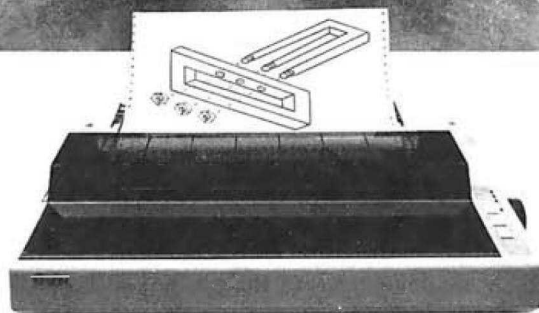
### COMPLETELY REDESIGNED. NOW, THE GRAPPLER +.

The original Grappler was the first graphics interface to give you hi-res screen dumps from your keyboard. The new Grappler + adds flexibility with on-board printer selection and 23 different commands for text and graphics. Exclusive *Dual Hi-Res Graphics* allow a side-by-side printout of graphics pages 1 and 2.

The Grappler + is compatible with the Apple II, II+, IIe and III\* computers. Its extensive printer menu has been expanded to include the Apple Dot Matrix, Okidata 84 and Star Gemini, along with most popular printers. In addition, the IDS Grappler+ is currently available with color capability, including color graphics screen dumps.

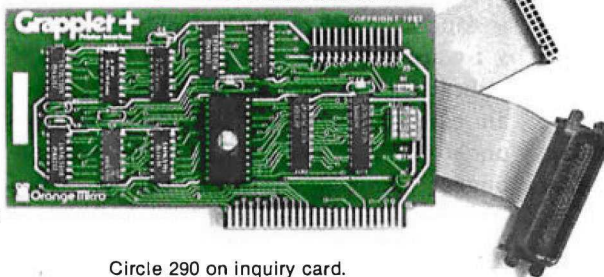
#### UP TO 64K BUFFER OPTION

An optional Bufferboard can now be added to all existing Grappler and Grappler + interfaces. See your Apple Dealer for details.



ACTUAL APPLE II PRINTOUT USING GRAPPLER AND EPSON MX100

With The  
**Grappler +**  
Printer Interface



Circle 290 on inquiry card.

Apple is a registered trademark of Apple Computer, Inc.

### NOW AVAILABLE THE BUFFERED GRAPPLER +

The best of both worlds... the Buffered Grappler +

All of the popular Grappler + features with the time-saving benefits of a printer buffer.

- 16K of Buffer
- Expandable to 64K
- Interfaces with all popular dot matrix printers

Make the most of your Apple and printer, with the Grappler + or the Buffered Grappler +.

 **Orange Micro**  
inc.

1400 N. Lakeview Ave.,  
Anaheim, CA 92807 U.S.A.  
(714) 779-2772 Telex: 183511 CSMA  
Foreign Dealer Inquiries Welcome

\* Requires additional software driver.

© Orange Micro, Inc. 1983

# An Inside Look at MS-DOS

*The design decisions behind the popular operating system*

---

Tim Paterson  
Seattle Computer Products  
1114 Industry Dr.  
Seattle, WA 98188

---

The purpose of a personal computer operating system is to provide the user with basic control of the machine. A less obvious function is to furnish the user with a high-level, machine-independent interface for application programs, so that those programs can run on two dissimilar machines, despite the differences in their peripheral hardware. Having designed an 8086 microprocessor card for the S-100 bus and not finding an appropriate disk operating system on the market, Seattle Computer Products set about designing MS-DOS. Today MS-DOS is the most widely used disk operating system for personal computers based on Intel's 8086 and 8088 microprocessors.

## MS-DOS Design Criteria

The primary design requirement of MS-DOS was CP/M-80 translation compatibility, meaning that, if an 8080 or Z80 program for CP/M were translated for the 8086 according to Intel's published rules, that program would execute properly under MS-DOS. Making CP/M-80 translation compatibility a requirement served to promote rapid development of 8086 software, which, naturally, Seattle Computer was interested in. There was partial success: those software developers who chose to translate their CP/M-80 programs found that they did indeed run under MS-DOS,

often on the first try. Unfortunately, many of the software developers Seattle Computer talked to in the earlier days preferred to simply ignore MS-DOS. Until the IBM Personal Computer was announced, these developers felt that CP/M-86 would be *the* operating system of 8086/8088 computers.

Other concerns crucial to the design of MS-DOS were speed and efficiency. Efficiency primarily means making as much disk space as possible available for storing data by minimizing waste and overhead. The problem of speed was attacked three ways: by minimizing the number of disk transfers, making the needed disk transfers happen as quickly as possible, and reducing the DOS's "compute time," considered overhead by an application program. The entire file structure and disk interface were developed for the greatest speed and efficiency.

The last design requirement was that MS-DOS be written in assembly language. While this characteristic does help meet the need for speed and efficiency, the reason for including it is much more basic. The only 8086 software-development tools available to Seattle Computer at that time were an assembler that ran on the Z80 under CP/M and a monitor/debugger that fit into a 2K-byte EPROM (erasable programmable

read-only memory). Both of these tools had been developed in house.

## MS-DOS Organization

The core of MS-DOS is a device-independent input/output (I/O) handler, represented on a system disk by the hidden file MSDOS.SYS. It accepts requests from application programs to do high-level I/O, such as sequential or random access of named disk files, or communication with character devices such as the console. The handler processes these requests and converts them to a very low level form that can be handled by the I/O system. Because MSDOS.SYS is hardware independent, it is nearly identical in all MS-DOS versions provided by manufacturers with their equipment. Its relative location in memory is shown in figure 1.

The I/O system is totally device dependent and is represented on the disk by the hidden file IO.SYS. It is normally written by hardware manufacturers (who know their equipment best, anyway) with the notable exception of IBM, whose I/O system was written to IBM's specifications by Microsoft. The tasks required of the I/O system, such as outputting a single byte to a character device or reading a contiguous group of physical disk sectors into memory, are as simple as possible.

The command processor furnishes



# Before you buy a printer look at the fine print.

There's a big difference in printers, and the proof is right before your eyes.

This is an actual printout from Digital's Letterprinter 100. As you can see, it's good enough to send out to customers.

But that's not all the Letterprinter 100 can do. Suppose, for instance, you're in a hurry.

JUST PUSH A BUTTON AND YOU CAN PRINT OUT A WHOLE PAGE OF DRAFT COPY IN LESS THAN TEN SECONDS.

There are other fine points. You can see how the Letterprinter 100 can print multiple typefaces. It can also print in **BOLD**, **double-width** and *condensed*. And do all these styles automatically, without stopping. And with its wide range of graphics capabilities, you can even draw your own conclusions.



You simply can't find a more versatile printer than the Letterprinter 100. And it's just one of a family of printers we offer for Digital's personal computers and video terminals. Including a daisy-wheel printer, the LQP02, and a low-cost Personal Printer, the LA50, that still make you look good on paper.

So now that you've read the fine print, see our fine printers.

Call 1-800-DIGITAL, extension 700, for the distributor near you.

Or write Digital Equipment Corporation, Terminals Product Group,

2 Mt. Royal Avenue, UP01-5, Marlboro, Ma. 01752.

digital

the standard interface between the user and MS-DOS and is contained in the visible file COMMAND.COM. The processor's purpose is to accept commands from the console, figure out what they mean, and execute the correct sequence of functions to get the job done. It is really just an ordinary application program that does its work using only the standard MS-DOS function requests. In fact, it can be replaced by any other program that provides the needed user interface.

There are, however, two special features of the COMMAND file. First, it sets up all basic error trapping for either hard-disk errors or the Control-C abort command. MSDOS.SYS provides no default error handling but simply traps through a vector that must have been previously set. Setting the trap vector and providing a suitable error response is up to COMMAND (or whatever program might be used to replace it).

The second special feature is that COMMAND splits itself into two pieces, called the *resident* and *trans-*

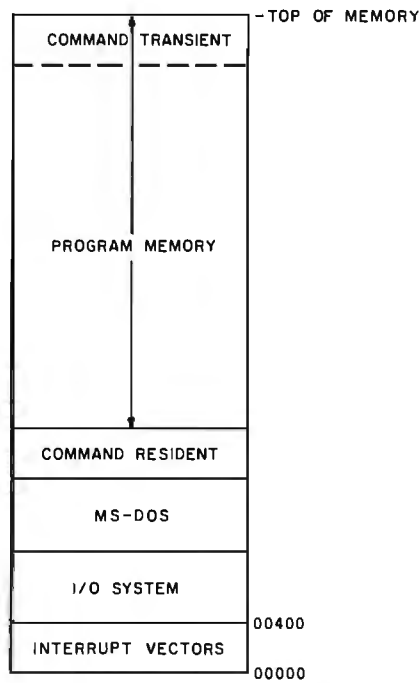


Figure 1: Map of memory areas as assigned by MS-DOS.

sient sections. The resident, which sits just above MS-DOS in low memory, is the essential code and in-

cludes error trapping, batch-file processing, and reloading of the transient. The transient interprets user commands; it resides at the high end of memory where it can be overlaid with any applications program (some of which need as much memory as they can get). This feature is of limited value in systems with large main memory, and it need not be imitated by programs used as a replacement for COMMAND.

COMMAND provides both a useful set of built-in commands and the ability to execute program files located on the disk. Any file ending with the extensions .COM, .EXE, or .BAT can be executed by COMMAND simply by typing the first part of the file name (without extension). You can normally enter parameters for these programs on the command line, as with any of the built-in commands. Overall, the effect is to give you a command set that can be extended almost without limit just by adding the command as a program file on the disk.

The three different extensions

MODEMS/CRTS/PRINTERS/SWITCHES/MICRO COMPUTERS/CABLES		LIST	YOUR COST
MODEMS	UDS 103LP, 300 bps, Modem	145	130
	UDS 202LP, 1200 bps, Half Duplex Modem	195	150
	UDS 212LP, 1200 bps, Full Duplex (212A) Modem	445	CALL
	U.S. Robotics Auto Dial 212A, 300/1200 Full Duplex Modem	599	475
	Incomm Auto Dial 212A, 300/1200 Full Duplex Modem	599	450
	Cermetec Auto Dial 212A, 300/1200 Full Duplex Modem	595	495
	Microband Auto Dial 212A, 300/1200 Full Duplex Modem	695	495
	Rixon Intelligent Modem, 300/1200 (10 Number)	495	CALL
	Rixon PC 212A (IBM PC Modem Card) 300/1200	495	CALL
	Incomm Multi Dial 300/1200 (10 Number)	795	550
	U.S. Robotics Password 300/1200 (Auto Dial) Modem	495	CALL
	U.S. Robotics Courier, Osborne, 300/1200 Modem	518	CALL
U.S. Robotics S-100, 300/1200 Auto Dial Modem	495	CALL	
CRTS	Visual 50 CRT	695	550
	Freedom 100 CRT, w/20 F. keys & Editing	595	550
	Incomm Remote Station 1, w/Integrated 300/1200 Modem	1295	995
PRINTERS	Epson MX80/Graftrax +	650	399
	Epson MX80 FT/Graftrax +	700	498
	Epson MX100/Graftrax +	700	700
	Epson FX 80	750	556
	Star Micronics Gemini 10	399	350
SWITCHES	Star Micronics Gemini 15	649	548
	AJ Letter Quality Printer, 30 CPS (KSR)	1450	1250
	Incomm AB Switch, 8 Pin	120	84
BOB	Incomm AB Switch, 25 Pin	159	98
	Incomm ABC Switch, 25 Pin	198	138
COMPUTERS	ID5 Breakout Box (Blue Box)	159	140
	Incomm Breakout Box (Bob)	150	120
	Epson, HX-20-AA	795	CALL
CABLES	Epson QX-10/256K	2995	CALL
	Zenith Z-100	4000	CALL
	T-7MM, 7 Pin, 4 Wire, Telephone Cable (Modular Plugs)	10	7
	S-975, Modular Double Adapter	7	5
SOFTWARE	EIA 9/5, RS 232, 9 Pin Cable, 5 FT MM/FF/MF	15	12
	EIA 25/5, RS 232, 25 Pin Cable, 25 FT MM/FF/MF	22	14
	EIA 50/5, Centronics Parallel Cable, 5 FT (36 Pin)	30	21
	MC 0050/10, Centronics 10 Ft. MM Cable, 36 Pin (10 FT)	36	25
	7010/5, IBM PC Printer Cable w/36 Pin	40	22
	8010/5 Apple II Printer Cable w/36 Pin	27	18
	9010/5, Atari Printer Cable w/36 Pin	30	21
	U.S. Robotics Telpac	79	CALL
	Rixon PC Com 1 (IBM PC Software)	69	CALL

ORDER TOLL FREE - 1-800-323-2666

TOUMAYAN & ASSOCIATES  
115 N. Wolf Rd.  
Wheeler, IL 60090 312-459-8866

We Welcome: ●Visa, Mastercharge  
●Checks  
●Company P.O.  
●C.O.D. (Add \$1.50/Shipping)

## ZX FORTH

Simplicity of BASIC with the speed of machine code!

A complete implementation of the FORTH language for the ZX81 and TS1000 computer. FORTH's most distinctive feature is its flexibility. It can turn your computer into a "word processor". The basic unit is the **WORD** — the programmer uses existing **WORDS** to define his own which can then be used in further definitions. This makes program development much faster than other languages. FORTH is an interactive compiled language that expands the capabilities of your own ZX81/TS1000. Programs run up to 10 times faster than BASIC. The more programs you have written, the more words, therefore you can draw on those for further programs. FORTH is supplied on cassette and is accompanied by a 56 page users manual and an 8 page editors manual.

Z43 \$29.95

Call toll free 1-800-833-8400  
N.Y. (716) 874-5510

In Canada call toll free 1-800-268-3640

**GLADSTONE ELECTRONICS**

1585 Kenmore Ave., Buffalo, N.Y. 14217

Cheques or money orders. No C.O.D.s. Add shipping

In Canada: 1736 Avenue Rd., Toronto, Ont. M5M 3Y7 Canada: Prices may vary

# INSTANT BUSINESS GRAPHICS WOW PROFESSIONALS.

## \$795. Personal Plotter Makes Waves.

When Whiz Kid Richard Murray invented the Personal Plotter™, he wanted it to perform every graphic task professionals would ever need.

And, he wanted it to be easily plug-compatible with Apple®, IBM®, Osborne® and most other personal computers. He also wanted it to come complete with software, and slip neatly into a briefcase.

Well, because he is a Whiz Kid, Richard Murray's plotter does all of these things—all for a nifty \$795.

Introducing the Sweet-P™ Personal Plotter.

## More Presentable Presentations.

With Sweet-P you quickly create, store and draw colorful



## Sweet-P Software for Success.

Not familiar with how a plotter works. Not to worry. Sweet-Plot™ I Software will have you drawing standard graphs in minutes. And, for complex business graphics there's Sweet-Plot II by Business and Professional Software, Inc. With a few keystrokes, it lets you extract and graph data you've already generated in VisiCalc® or software. No can compactness and fit results, graph performance against projections and even plot trends.

So, when the personal plotter that means business, plug into the very professional Sweet-P.

Your local computer



Enter Computer's Whiz Kid Chairman makes business make sense.

Circle 145 on Inquiry card.

**Sweet-P™**

Enter Computer, Inc.  
6867 Nancy Ridge Drive  
San Diego, CA 92121  
Tel: 619-450-0601

**\$795**  
SOFTWARE  
INCLUDED

allowed on program files represent different internal file formats.

- .COM files are pure binary programs that will run in any 8086 memory segment; in order for this to be possible, the program and data would ordinarily have to be entirely in one 64K-byte segment.

- .EXE files include a header with relocation information so that the program may use any number of segments; all intersegment references are adjusted at load time to account for the actual load segment.

- .BAT (batch) files are text files with commands to be executed in sequence by COMMAND.

### File Structure

Disks are always divided up into tracks and sectors, as shown in figure 2. To access any particular block of data, the program first moves to the correct track, then has you wait while the spinning disk moves the correct sector under the head.

A somewhat more abstract view of disks was taken in developing MS-DOS. MS-DOS views the disk, not in terms of tracks and sectors, but as a continuous array of  $n$  logical sectors, numbered from 0 to  $n-1$ . Figure 2 shows the usual method of numbering the logical sectors. Logical sector 0 is the first sector of the outermost track; the rest of the track (and the next, etc.) is numbered sequentially. Logical sector  $n-1$  is the last sector on the innermost track.

The mapping of logical sectors to physical track and sector is done by the hardware-dependent I/O System and is completely transparent to the

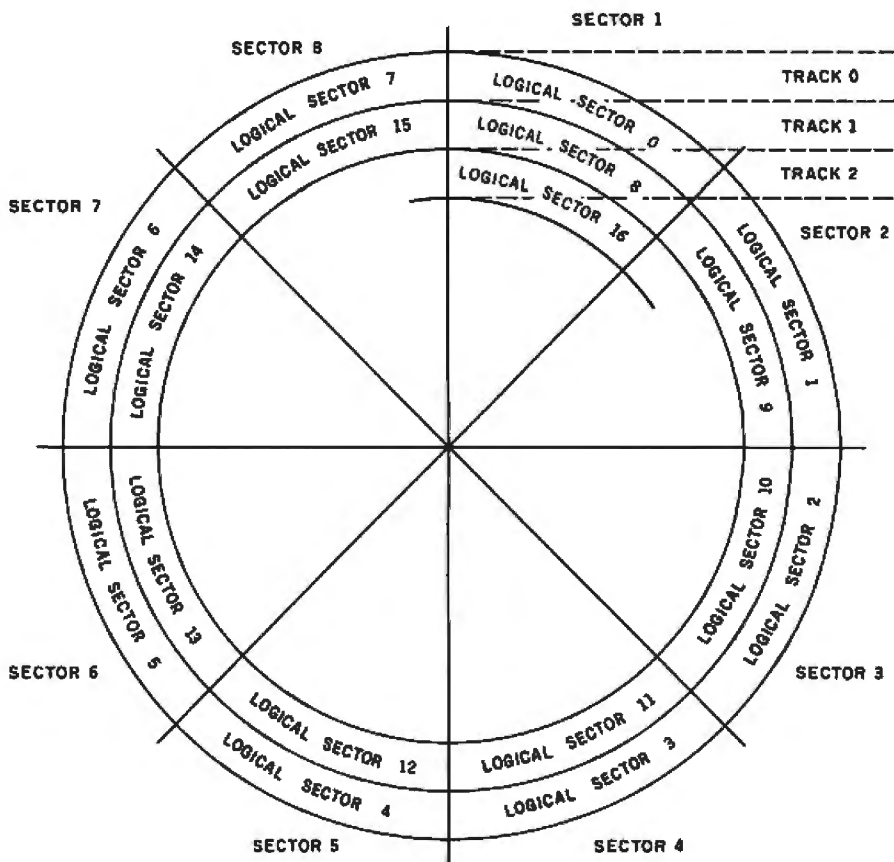


Figure 2: Placement of disk sectors in IBM Personal Computer (single-sided) format.

MS-DOS file system. Any other method may be used, and MS-DOS wouldn't know the difference. Having a standard mapping, however, is essential for interchanging disks between computer systems with different peripheral hardware.

As shown in table 1, the MS-DOS file system divides the linear array of logical sectors into four groups. The first of these is the reserved area, whose purpose is to hold the boot-

strap loader. Because the loader is usually very simple, only one sector is normally reserved.

The FAT (file allocation table), a map of how space is distributed among all files on the disk, comes next. Because it is so important, two copies are usually kept side by side. If one copy cannot be read because of a failure in the medium, the second will be used.

The directory follows the FAT.

Logical Sector Numbers	Use
0	Reserved for bootstrap loader
1-6	FAT 1 } file allocation tables (FATs)
7-12	
13-29	Directory
30-2001	Data

Table 1: Map of disk areas on an 8-inch single-sided, single-density floppy disk.

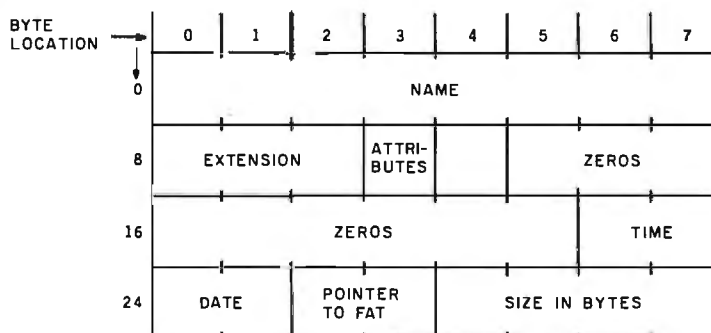


Figure 3: Arrangement of bytes in disk directory entry.

# Match the 68000 Competition with UNIX<sup>™</sup> operating systems.

## Beat it with UniFLEX<sup>™</sup>.

# W

e can't keep a good thing secret. Our new UniFLEX Operating System for the 68000 is better than the competition's UNIX operating systems or like offerings. Better in several ways. A whole new generation of users can now enjoy the efficiency, flexibility, and reliability that built our reputation.

Want the full story? Call us. Or watch for more details.

There *is* a superior alternative.

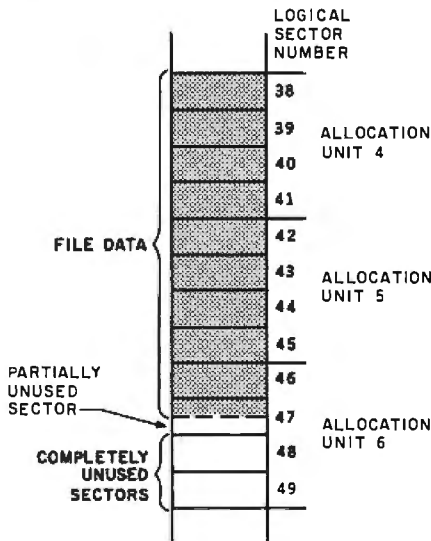


Technical Systems Consultants, Inc.  
111 Providence Road  
Chapel Hill, NC 27514 USA

Telephone: (919) 493-1451  
Telex II: 510-920-0540

Logical Sector Numbers	Allocation Unit Number
30—33	2 (first allocation unit)
34—37	3
38—41	4
42—45	5
•	•
•	•
•	•
1998—2001	494

**Table 2:** Allocation unit numbering for the 8-inch single-density format. To compute the logical sector number of the first sector in an allocation unit, you use the following equation:  $\text{sector number} = 4 \times \text{allocation unit number} + 22$ .



**Figure 4:** Assignment of logical sectors to allocation units. Note that, in the file shown, more than two sectors are wasted because they are in an unused part of the last allocation unit.

Each file on the disk has one 32-byte entry in the directory, which includes the file name, size, date and time of last write, and special attributes. Each entry also has a pointer to a place in the FAT that tells where to find the data in the file. Figure 3 shows the layout of a directory entry.

The rest of the disk is the data area. It is divided into many small, equal-sized areas called *allocation units*. Each unit may have 1, 2, 4, 8, 16, 32,

64, or 128 logical sectors, but the number is fixed for a given disk format. Allocation units are numbered sequentially. The numbering starts with 2; the first two numbers, 0 and 1, are reserved. Table 2 shows this numbering system applied to the 8-inch single-density disk format.

The allocation unit is the smallest unit of space MS-DOS can keep track of. The amount of space used on the disk for each file is some whole number of allocation units. Even if the file is only 1 byte long, an entire unit will be dedicated to it.

For example, the standard format for 8-inch single-density disks uses four 128-byte sectors per allocation unit. When a new file is first created, no space is allocated, but an entry is made in the directory. Then when the first byte is written to the file, one allocation unit (four sectors) is assigned to the file from the available free space. As each succeeding byte is written, the size of the file is kept updated to the exact byte, but no more space is allocated until those first four sectors are completely full. Then to write 1 byte more than those four sectors worth, another four-sector allocation unit is taken from free space and assigned to the file.

When writing stops, the last allocation unit will be filled by some random amount of data (figure 4). The unused space in the last allocation unit is wasted and can never be used as long as the file remains unchanged on the disk. This wasted space is called *internal fragmentation*, because it is part of the space allocated to the file but is an unusable fragment. On the average, the last allocation unit (regardless of size) will be half filled and, therefore, half wasted. Because each file wastes an average of one-half an allocation unit, the total amount of space wasted on a disk due to internal fragmentation is the number of files times one-half the allocation unit size.

The phenomenon called *external fragmentation* occurs when a piece of data space is unallocated yet remains unused because it is too small. This cannot happen in the MS-DOS file system because MS-DOS does not require files to be allocated contiguous-

ly. It is, however, present in more primitive systems, such as the UCSD p-System.

It would certainly seem desirable to minimize internal fragmentation by making the allocation unit as small as possible—always one sector, for example. However, for any given disk size, the smaller the unit, the more there must be. Keeping track of all those units can get to be a problem. Specifically, the amount of space required in the file allocation table would be quite large if there were too many small allocation units. For every unit, 1.5 bytes are required in the FAT; there are normally two FATs on the disk, each of which is rounded up to a whole number of sectors.

Now take a standard 8-inch single-density floppy disk that has 2002 sectors of 128 bytes. To minimize internal fragmentation, choose the smallest possible allocation-unit size of one sector. Two thousand allocation units will require 3000 bytes (24 sectors) per FAT, or 48 sectors for two FATs. If the average file size is 16K bytes (128 sectors), the disk will be full when there are 16 files on it. Waste due to internal fragmentation would be

$$16 \text{ files} \times 64 \text{ bytes per file} = 1024 \text{ bytes (8 sectors)}$$

Far more space is occupied by the FATs on the disk than is wasted by internal fragmentation!

To provide maximum usable data space on the disk, both internal fragmentation and FAT size must be considered because both consume data area. The standard MS-DOS format for 8-inch single-density disks strikes a balance by using four sectors per allocation unit. Two sectors per unit would have been just as good (assuming a 16K-byte average file size), but there is another factor that always favors smaller FATs and larger allocation units: the entire FAT is kept in main memory at all times.

The file allocation table contains all information regarding which allocation units are part of which file. Thus by keeping it in main memory, any file can be accessed either sequentially

# Powerful CP/M Software.

For Apple, Osborne, Xerox, Kaypro, North Star, SuperBrain, Heath/Zenith, and others.

Now only **\$29.95** each!

## NEVADA COBOL

was \$199.95 now only **\$29.95.**

- When we introduced Nevada COBOL in 1979, it was loaded with innovations. Today's Edition 2 is even better!
- Extremely Compact. You can compile and execute up to 2500 statements in 32K RAM, 4000 statements in 48K, etc.
  - It's based upon the ANSI-74 standards with level 2 features such as compound conditionals and full CALL CANCEL.
  - You can distribute your object programs royalty FREE!
  - You get a diskette, 153-page manual with lots of examples and 16 complete COBOL source code programs.

Also available: COBOL Application Packages, Book 1 \$9.95

## NEVADA PILOT

was \$149.95 now only **\$29.95.**

- Perfect for industrial training, office training, drill and testing, virtually all programmed instruction, word puzzle games, and data entry facilitated by prompts.
- John Starkweather, Ph.D., the inventor of the PILOT language, has added many new features to Nevada PILOT. There are commands to drive optional equipment such as Video Tape Recorders. There's a built-in full-screen text editor, and much more.
- Meets all PILOT-73 standards for full compatibility with older versions.
- You get a diskette, 114-page manual and ten useful sample programs.
- See Review in *Microcomputing*, January 1983, page 158.

## NEVADA FORTRAN

was \$199.95 now only **\$29.95.**

- Based on ANSI-66 standards with some 1977 level features.
- IF . . THEN . . ELSE constructs.
- A very nice TRACE style debugging.
- 150 English language error messages.
- You get a diskette, 174 pages of Documentation and five sample programs. Requires 48K RAM.

## NEVADA EDIT

was \$119.95 now only **\$29.95.**

- High quality text editing for micros!
- A character-oriented full-screen video display text editor designed specifically to create COBOL, BASIC and FORTRAN programs.
- Completely customizable tab stops, default file type, keyboard control key layout and CRT by menu selection.
- The diskette comes with an easy to read manual.

To make our software available to even more micro users, we've slashed our prices. What's more, we're offering a money back guarantee. If for any reason you're not completely satisfied, just return the package—in good condition with the sealed diskette unopened—within 30 days and we'll refund your money completely.

This is a limited time offer, so order yours today!

Shipping/handling fees. Add \$4.00 for first package and \$2.00 each additional package. OVERSEAS Add \$15.00 for first package and \$5.00 each additional package. Checks must be in U.S. funds and drawn on a U.S. bank!

Trademarks: CP/M, Digital Research; TRS-80, Tandy Corp.; TeleVideo, TeleVideo Systems, Inc.; Apple II, Apple Computer Inc.; Osborne 1, Osborne Computer Corp.; Xerox 820, Xerox Corp.; Kaypro, Non-Linear Sys.; Heath/Zenith, Heath Co.; IBM, International Business Machine, Corp. © 1983 Ellis Computing.

MAIL TODAY! To: Ellis Computing  
3917 Noriega St.  
San Francisco, CA 94122  
(415) 753-0186



**ELLIS COMPUTING**

The CP/M-80 Operating Systems and 32K RAM are required.

Indicate diskette format:

- 8"  SSSD (Standard IBM 3740 format)
- 5 1/4"  Apple CP/M  Osborne  
 North Star DD  North Star SD  
 TRS-80 Mod I (4200 hex)  TRS-80 Mod I/Mapper  
 Heath, Hard Sector  Heath, Soft Sector  
 Micropolis Mod II  Superbrain DD DOS 3. X  
(512 byte sectors)  
 Xerox 820 (Kaypro)  TeleVideo

Indicate software packages:  COBOL  PILOT  
 FORTRAN  EDIT

Send my order for \_\_\_\_\_ packages @ \$29.95 each Total \_\_\_\_\_  
COBOL Applications Package @ \$9.95 each Total \_\_\_\_\_

Check enclosed  MasterCard  VISA  
In CA add sales tax \_\_\_\_\_  
Shipping/handling \_\_\_\_\_  
TOTAL \_\_\_\_\_

# \_\_\_\_\_ Exp. Date \_\_\_\_\_

Signature \_\_\_\_\_

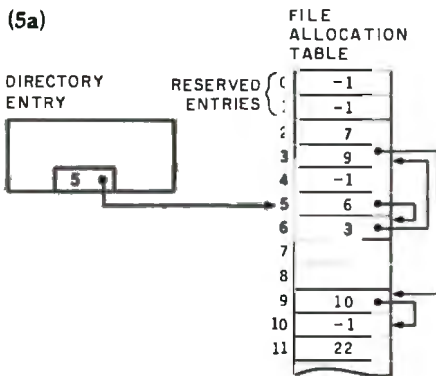
Ship to: \_\_\_\_\_

Name \_\_\_\_\_

Street \_\_\_\_\_

City/St/Zip \_\_\_\_\_

Country \_\_\_\_\_



or randomly without going to disk except for the data access itself. Schemes used in other operating systems (including CP/M and Unix) may require one or more disk reads simply to find out where the data is, particularly with a random access. In an application such as a database inquiry, where frequent random access is the rule, this can easily make a 2 to 1 difference in performance.

are also allocation unit numbers. Think of the FAT as a map, or translation table, that takes an allocation unit number as input and returns a different allocation unit number as output. The input can be any unit that is part of a file; the number returned is the next sequential unit of that file.

Let's look at the example in figure 5a. Suppose that the directory entry for a file specifies allocation unit number 5 as the first of the file. This locates the first four logical sectors (512 bytes). To find the next allocation unit of the file, look at entry 5 in the file allocation table. The 6 there tells you two things: first, the next four logical sectors of the file are in allocation unit number 6; and second, to find the unit after that, look at FAT entry number 6.

This process is repeated as you locate each allocation unit in the file. After number 6 comes number 3, then number 9, then number 10. In each case, the allocation unit number returned by the FAT tells you both

### How the FAT Works

The directory entry for each file has one allocation unit number in it: the number of the first unit in the file. If, as in the previous example, an allocation unit consists of four sectors of 128 bytes each, then just by looking at the directory you know where to find the first 512 bytes of the file. If the file is larger than this, you go to the FAT.

The FAT is a one-dimensional array of allocation unit numbers. As with any array, a given element is found with a numeric index. The numbers used as indexes into the FAT


(5b)

```
FF FF FF 07 90 00 FF 6F
00 03 80 00 FF AF 00 FF
6F 01
```

Figure 5: Finding data via the directory and the file allocation table. Figure 5a shows how pointers are used to direct the operating system to the sequential parts of a file. The data stored in the sample file-allocation table is displayed in hexadecimal in figure 5b.

# INTERSTELLAR DRIVE™

## A SOLID STATE DISK EMULATOR



**Save valuable time!**  
5 to 50 times faster  
performance than floppy disks  
and Winchester drives

PION'S INTERSTELLAR DRIVE is designed for use with a family of interfaces and software packages. Currently available are interfaces for IBM, S100, TRS80, Apple, SS50, and most Z80 uP, and software for most popular operating systems. Additional interfaces are continually being developed for the most popular computers.

**Basic Price for 256KB unit [includes interface and software]**  
**\$1095.** plus tax (where applicable) and shipping

Visa and Master Card accepted.

**PION, INC.**  
101R Walnut St., Watertown, MA 02172

TRS80 trademark of Tandy Corp. Apple trademark of Apple Computers  
Interstellar Drive trademark of PION, Inc.

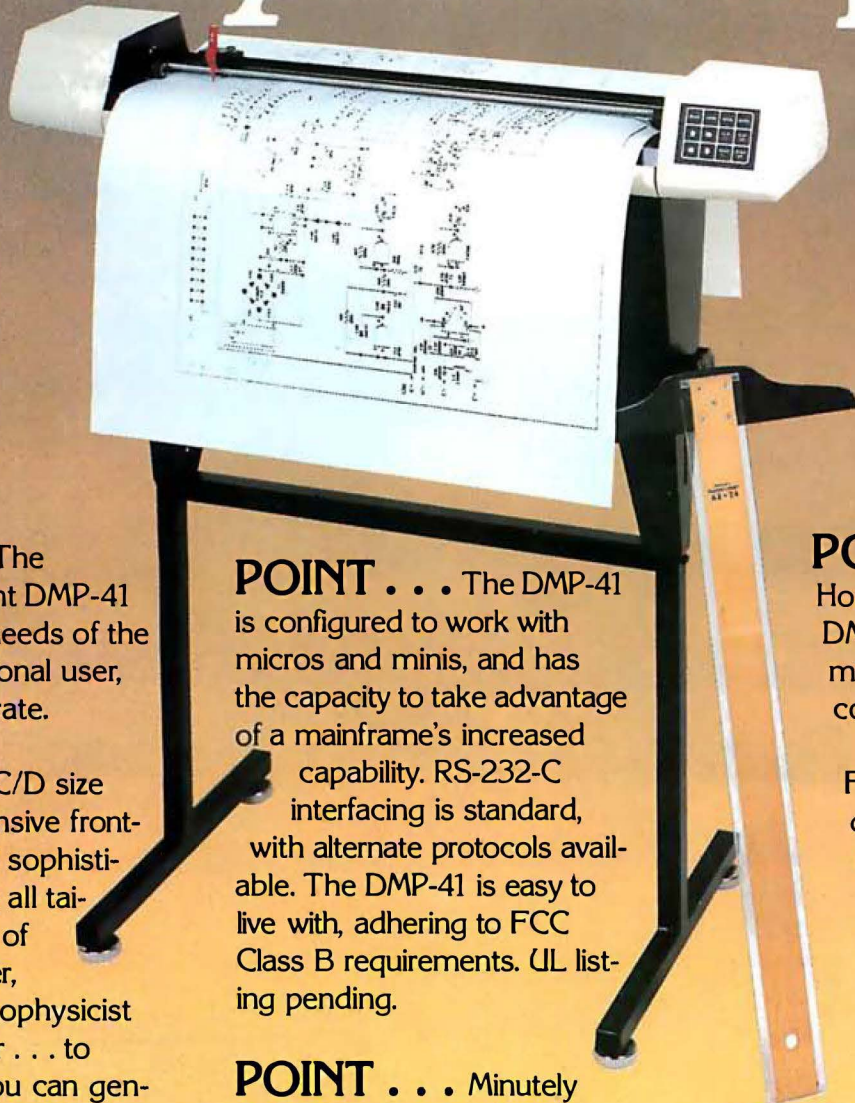
**Tel. (617) 923-8009**

**SAVE MONEY!**  
Increase your  
computer's productivity

The INTERSTELLAR DRIVE is a high performance data storage subsystem with independent power supply, battery backup, and error detection. It has 256KB to 1 Megabyte of solid state memory integrated to perform with your operating system.



# It's easy to make points when you're a pro.



**POINT . . .** The Houston Instrument DMP-41 plotter meets the needs of the serious or professional user, yet it's easy to operate.

**POINT . . .** C/D size format, comprehensive front-panel controls and sophisticated firmware are all tailored to the needs of the surveyor, drafter, oceanographer, geophysicist and land developer . . . to name but a few. You can generate superior architectural elevations, contour maps, circuit-board layouts and assembly drawings quickly and accurately on bond, vellum or synthetic media.

**POINT . . .** The DMP-41 is configured to work with micros and minis, and has the capacity to take advantage of a mainframe's increased capability. RS-232-C interfacing is standard, with alternate protocols available. The DMP-41 is easy to live with, adhering to FCC Class B requirements. UL listing pending.

**POINT . . .** Minutely defined step size and high-resolution logic—combined with robust drives and optimized pen ballistics enable you to create plots of high precision and surpassing quality.

**POINT . . .** The Houston Instrument DMP-41 is one of your most cost effective considerations.\*

For the name, address and phone number of your nearest distributor, write Houston Instrument, 8500 Cameron Road, Austin, Texas 78753. Phone 512-835-0900, or 800-531-5205 if outside Texas. In Europe contact Bausch & Lomb Belgium NV, Rochesterlaan 6, 8240 Gistel, Belgium. Tel 059-27-74-45, tlx 846-81339.

**BAUSCH & LOMB**   
houston instrument division

\*suggested US retail \$2,995

Circle 40 on inquiry card.



# Congratulations. We published your program.

The envelope, please.  
There's an acceptance letter inside. And a check that could have your name on it. (If we select your program, that is.)  
But remember.  
We pick our winners carefully.

Because the software we publish for the IBM Personal Computer has to be good enough to complement IBM Personal Computer hardware. (See the box at right.)

Like our hardware, this software should be simple to use. Friendly. Fast. And written to help satisfy the needs of the individual.

Our Personal Editor is a perfect example. A versatile text file editor, it not only helps the user save time, but lets him easily self-tailor a task with definable function keys. And it sets a standard of excellence.

Of course, every person will use the IBM Personal Computer differently. That's why we plan on publishing many different programs.

Entertainment programs.  
And educational programs. And business programs. And personal productivity

programs. And graphics. And games.  
And more.

We'll also consider software written by programmers *for* programmers. For example, the BASIC Program Development System, Professional Editor and Diskette Librarian

## IBM PERSONAL COMPUTER SPECIFICATIONS

<b>User Memory</b> 64K-640K bytes	<b>Display Screens</b> Color or monochrome High-resolution 80 characters x 25 lines Upper and lower case	<b>Permanent Memory</b> (ROM) 40K bytes
<b>Microprocessor</b> 16-bit, 8088	<b>Auxiliary Memory</b> 2 optional internal diskette drives, 5 1/4" 160KB/180KB or 320KB/360KB per diskette	<b>Color/Graphics</b> Text mode: 16 colors 256 characters and symbols in ROM Graphics mode: 4-color resolution: 320h x 200v Black & white resolution: 640h x 200v Simultaneous graphics & text capability
<b>Operating Systems</b> DOS, UCSD p-System, CP/M-86†	<b>Languages</b> BASIC, Pascal, FORTRAN, MACRO Assembler, COBOL.	<b>Communications</b> RS-232-C interface SDLC, Asynchronous, Bisynchronous protocols Up to 9600 bits per second
<b>Keyboard</b> 83 keys, 6 ft. cord attaches to system unit 10 function keys 10-key numeric pad	<b>Printer</b> All-points-addressable graphics capability Bidirectional 80 characters/second 18 character styles 9 x 9 character matrix	
<b>Diagnostics</b> Power-on self-testing Parity checking		

are high-quality, full-function tools that were submitted by authors like you and subsequently published by us.

Now you might have the chance to win.

Who knows? You could open the mailbox and find one of the envelopes shown here.

For information on how to submit your program, if completed and running, write:  
IBM Personal Computer External Submissions,  
Dept. 765 PC, Armonk,  
New York 10504.



## The IBM Personal Computer A tool for modern times

Circle 180 on inquiry card.

<p>CARTRIDGE RIBBONS FOR <b>APPLE PRINTERS</b> NEC 8023A C. ITOH PROWRITER</p> <p><b>\$9.95</b> EA <b>\$107.46</b> DOZ</p>	<p>CARTRIDGE RIBBONS FOR <b>EPSON</b> <b>MX-80 MX-100</b></p> <p><b>\$6.99</b> EA <b>\$11.95</b> EA <b>\$86.29</b> EA <b>\$129.06</b> DOZ</p>	<p>DUAL SPOOL RIBBONS FOR <b>OKIDATA PRINTERS</b></p> <p>80, 82, 83 EA DOZ 92, 93 <b>\$2.77</b> <b>\$29.92</b> 84 <b>\$5.99</b> <b>\$64.69</b></p>
<p><b>LABEL SPECIAL</b></p> <p><b>\$2.99</b> /K (5K MIN)</p> <p>ACROSS 3" x 15/16 CONTINUOUS LABELS</p>	<p><b>MAXELL DISKETTES</b> 5 1/4" SINGLE SIDE DUAL DENSITY MD-1</p> <p><b>\$29.90</b> 10 PAC.K</p>	<p><b>INNOVATIVE CONCEPTS</b> <b>FLIP'N'FILE</b> DISC STORAGE BOX HOLDS UP TO 60 DISKETTES</p> <p>5 1/4" 8" <b>\$24.95</b> EA <b>\$29.95</b> EA</p>

COMPLETE LINE OF OTHER RIBBONS AVAILABLE. PLEASE CALL  
ALL ABOVE PRICES INCLUDE SHIPPING.

# Check-Mate™

51 DIAUTO DR.  P.O. BOX 103  
RANDOLPH, MA 02368 

TOLL FREE 800-343-7706 IN MASS 617-963-7694  
WE ACCEPT MASTER CARD & VISA  
MASS. RESIDENTS ADD 5% SALES TAX  
PHONES OPEN 9AM-7PM EASTERN TIME

# For Those Who Seek.

Bible study aids from Bible Research Systems include the complete KJV Bible text on disks. THE WORD processor can search the Scriptures for any word or phrase. Any portion of the Bible can be printed or displayed. Create your own library of research materials or use ours, called TOPICS. TOPICS contains cross-reference indexes on over 200 of the primary subjects discussed in Scripture.



Bible Research Systems applies computer technology to personal study of the Scriptures.

**TOPICS** **\$49.95**

Bible Research Systems  
9415 Burnet, Suite 208  
Austin, TX 78758  
(512) 835-7981

**THE WORD**  
processor  
**\$199.95**  
Plus \$3 postage/handling

Requires APPLE II+, IBM-PC, TRS80-III or CP/M 8" (Trademarks of APPLE, IBM, Tandy, Digital Research Corporation)

where the data is (i.e., in which unit) and where to look in the FAT for the next allocation unit number.

If you followed the example all the way through, you should have noticed that entry 10 in the FAT contains a -1. This, as you might have guessed, is the end-of-file mark. Allocation unit number 10 is last in the file, so its entry contains this special flag. (Another special value in the FAT is 0, which marks a free allocation unit.)

Now you know that this file occupies five allocation units, numbers 5, 6, 3, 9, and 10 in order. The file could be extended by finding *any* free unit, say 27, putting its number in entry 10 (where the -1 is now), and marking it with the -1 for end of file. That is, entry 10 in the FAT will contain 27, and entry 27 will contain -1. This demonstrates how you can extend any file at will and that you can use any free space on the disk when needed, without regard to its physical location.

If you ever want to look at a real FAT, there's one more thing you'll need to know. Each FAT entry is 12 bits (1.5 bytes) long. These entries are packed together, so two of them fit in 3 bytes. From a programming viewpoint, you would look up an entry in the FAT this way: Multiply the entry number by 1½, truncating it to an integer if necessary. Fetch the 16-bit word at that location in the FAT. If the original entry number was odd (so that truncation was necessary in the first step), shift the word right 4 bits; the lowest 12 bits of the word is the contents of the FAT entry. Reading a FAT from a hexadecimal dump isn't nearly as simple! Figure 5b shows the hexadecimal version of the sample FAT I've been using.

### File System in Action

To put all this in perspective, you need to look at how MS-DOS handles a file-transfer request from an application program. With MS-DOS, application programs treat files as if they were divided into logical records. The size of the logical record is entirely dependent on the application and may range from 1 byte to 65,535 bytes. It is not a permanent feature of

# SuperSoft FORTRAN

Now for CP/M-86, MS DOS, and IBM PC DOS®

SuperSoft FORTRAN is the answer to the growing need for a high quality FORTRAN compiler running under CP/M-86 and IBM PC DOS. It has major advantages over other FORTRAN compilers for the 8086. For example, consider the benchmark program used to test the IBM FORTRAN in InfoWorld, p. 44, Oct. 25, 1982. (While the differential listed will not be the same for all benchmark programs, we feel it is a good indication of the quality of our compiler.) Results are as follows:

**IBM FORTRAN:** 38.0 Seconds  
**SuperSoft FORTRAN:** 2.8 Seconds

In its first release SuperSoft FORTRAN offers the following outstanding features:

1. Full ANSI 66 standard FORTRAN with important extensions
2. Standard data types, double precision, varying string length, complex numbers
3. Free format input and free format string output
4. Compact object code and run time support
5. Special functions include string functions, dynamic allocation, time/date, and video access
6. Debug support: subscript checking, good runtime messages
7. Full IEEE floating point
8. Full 8087 support—available as option (\$50.00).

#### Program developers:

SuperSoft's family of FORTRAN compilers means you can write your programs once and they will run under CP/M-80, CP/M-86, and MS DOS. This lets you get your applications running fast no matter what the environment.

The current compiler allows 64K code space and 64K data space with expansion anticipated in future releases.



"At last, a FORTRAN compiler that works great on my 8086, 8087, and 8088 based systems!"

**SuperSoft FORTRAN: available NOW and working great!**

Requires: 128K with CP/M-86® and MS DOS

Price: \$425 (in each environment)  
CP/M-80 version also available.

In conjunction with SuperSoft, SuperSoft FORTRAN was developed by Small Systems Services, Urbana, IL, a leader in FORTRAN development.

CP/M and CP/M-86 are registered trademarks of Digital Research.

**Japanese Distributor:** ASR Corporation International, 3-23-8, Nishi-Shimbashi, Minato-Ku, Tokyo 105, Japan, Tel. (03)-437571 Telex: 0242-2723.

**European Agent:** Micro Technology Ltd., 51 The Pantiles, Tunbridge Wells, Kent, England TN2 5TH TEL 0892-45433. Telex: 95441 Micro-G.

Circle 369 on Inquiry card.

# SuperSoft®

FIRST IN SOFTWARE TECHNOLOGY P.O.Box 1628 Champaign, IL 61820 (217) 359-2112 Telex 270365

(6a)

$$\frac{\text{byte position } 1200}{128 \frac{\text{bytes}}{\text{sector}}} = 9, \text{ remainder } 48$$

Therefore, first byte to transfer is sector 9, byte 48

$$128 - 48 = 80 \text{ bytes to transfer in first sector}$$

$$1200 - 80 = 1120 \text{ bytes left after first sector}$$

$$\frac{1120 \text{ bytes}}{128 \frac{\text{bytes}}{\text{sector}}} = 8, \text{ remainder } 96$$

Therefore, transfer 8 whole sectors, then 96 bytes of last sector

(6b)

$$\frac{9 \text{ sectors}}{4 \frac{\text{sectors}}{\text{allocation unit}}} = 2, \text{ remainder } 1$$

Therefore, first sector to transfer is allocation unit 2, sector 1.

**Figure 6:** Calculating physical, byte-level operations from logical definitions. The process outlined in figure 6a shows how the amount of data is calculated in physical terms. The actual position of data on the disk is computed in figure 6b.

a file but in fact may vary from one file-transfer request to the next. The logical record size currently being used is passed to MS-DOS for each transfer made. It is, of course, completely independent of the physical sector size the disk uses.

To read a file, an application program passes to MS-DOS the size of a logical record, the first logical record to read, and the number of sequential logical records to read. Let's follow an example of how MS-DOS uses this information. Assume the application program is using 80-byte records and is set up to read a file 15 records at a time. Let's pick things up on its second read, that is, after it has already taken the first 15 records and is about to read the second 15. The request will be for an 80-byte record, the first record is number 15, and you want to read 15 records. Now pretend you're MS-DOS and analyze this request.

You immediately convert the request into byte-level operations. First multiply the logical record size by the record number, to get the byte position to start reading ( $80 \times 15 = 1200$ ). Then multiply the record size by the number of records, to get the

number of bytes to transfer (also 1200).

Next, these numbers must be put in terms of physical disk sectors. This requires some divisions and subtractions involving the physical sector size and results in the breakdown of the transfer into three distinct pieces: (1) the position in the file of the first physical sector and the first byte within that sector to be transferred, (2) the number of whole sectors to transfer after the first (partial) sector, and (3) the number of bytes of the last (partial) sector to be transferred. The calculations and their results are shown in figure 6a. It is quite common for one or two of these pieces to be of length 0, in which case some of the following steps are not performed.

At this point, there is still no hint as to where the data will actually be found on the disk. You know that you want the tenth sector of the file (sector 9 because you start counting with 0), but you're not yet ready to check with the FAT to see where it is. The sector position in the file must be broken into two new numbers: the allocation unit position in the file and

the sector within the allocation unit. For this example with single-density 8-inch disks (four sectors per allocation unit), this would be the third unit from the start of the file and the second sector within the unit (figure 6b).

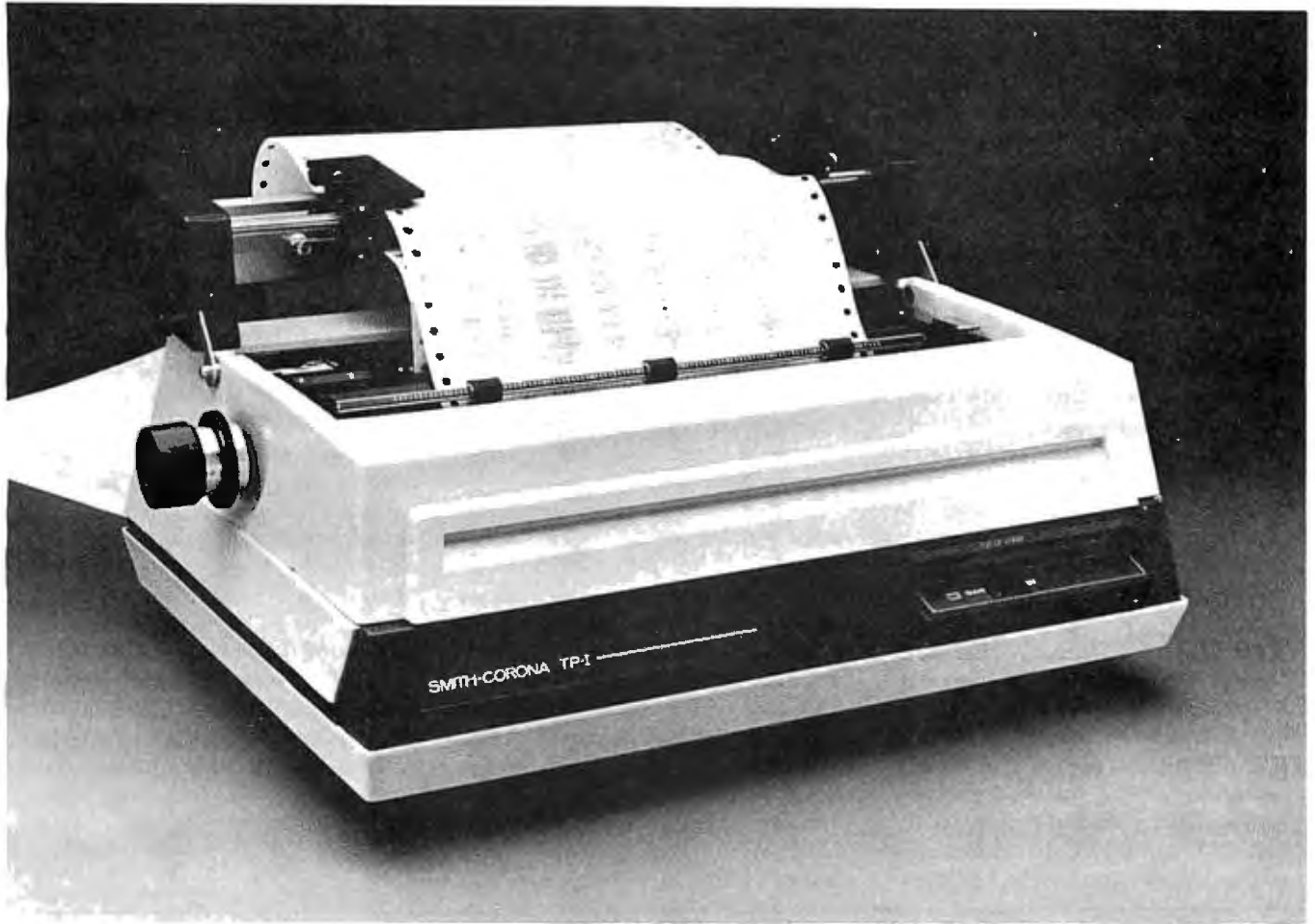
What you need to do now is skip through the FAT to the third allocation unit in the file. If your file is the same one shown in figure 5, then from the directory entry you learn that the first unit is number 5. Looking at entry 5 of the FAT, you see the second unit is number 6. And finally, from entry 6 of the FAT, you find the third unit of the file, number 3. Table 2 reminds you that allocation unit number 3 is made up of physical sectors 34, 35, 36, and 37; therefore, physical sector 35 is what you are looking for.

Now the disk reads begin. Physical sector 35, only part of which is needed, is read into the single buffer kept in MS-DOS solely for this purpose. Then that part of the sector that is needed is moved as a block into the place requested by the application program.

Next, the whole sectors are read. MS-DOS looks ahead in the FAT to see if the allocation units to be transferred are consecutive. If so, they are combined into a single multiple-sector I/O system transfer request, which allows the I/O system to optimize the transfer. This is the primary reason why MS-DOS disks do not ordinarily use any form of sector interleaving: a well-written I/O system will be able to transfer consecutive disk sectors if told to do it in a single request. The overhead of making the request, however, would often be too great to transfer consecutive sectors if it were done on a sector-by-sector basis.

Back to the example. MS-DOS will request that the I/O system read sectors 36 and 37 directly into the memory location called for by the application. Then, noting that allocation units 9 and 10 are consecutive, the corresponding sectors 58, 59, 60, and 61 from unit 9 and sectors 62 and 63 from unit 10 will be read by the I/O system in a single request. This completes the transfer of the eight whole sectors.

# Smith-Corona makes a good deal better. With a \$50 rebate.



## The Smith-Corona™ TP-I™ daisy wheel printer with optional tractor feed.

Ever since the Smith-Corona TP-I was introduced, it's been a great success with critics and users. And it's been a good deal at its low price.

Now, it's a better deal than ever. Because now you can get this high-quality, low-cost printer for even less.

Buy a Smith-Corona TP-I letter-quality printer any time between June 1 and July 31, and Smith-Corona will send you a \$50 refund.

Of course, what you'll be getting is more than a good deal. Because the Smith-Corona TP-I is a printer with the same excellent print quality as found on the finest office typewriters.

The TP-I handles letter and legal sized paper. And with the new tractor feed option, the TP-I can handle both fanfold and single sheet paper—without ever having to remove the tractor feed!

The TP-I is very simple to operate. It's compatible with most personal and home computers and available with either standard serial or parallel data interface. And, unlike many printers, the

TP-I is made in America.

There's a choice of state-of-the-art daisy wheels to give you a wide variety of fonts. (At \$7.95 each, you can easily afford several.)

So if you're in the market for a high-quality, low-cost daisy wheel printer, get the Smith-Corona TP-I. Get it now and make a good deal a good deal better—with a \$50 rebate.

Please send me more information on the Smith-Corona TP-I daisy wheel printer.

Name \_\_\_\_\_ Title \_\_\_\_\_  
Company Name \_\_\_\_\_  
Business Address \_\_\_\_\_  
City \_\_\_\_\_ State \_\_\_\_\_ Zip \_\_\_\_\_  
Type of Business \_\_\_\_\_

Mail coupon to:  
Jerry Diener—V.P. Sales, Smith-Corona  
65 Locust Avenue  
New Canaan, Connecticut 06840

# Smith-Corona

86

## A Short History of MS-DOS

Known variously as Seattle Computer 86-DOS, IBM Personal Computer DOS, and Zenith Z-DOS, MS-DOS was developed by Seattle Computer Products for its 8086-based computer system. The MS-DOS history is intertwined with the general development of software for 8086-based computers.

In May 1979, Seattle Computer made the first prototype of its 8086 microprocessor card for the S-100 bus. There were brief discussions with Digital Research about using one of Seattle Computer's prototypes to aid in developing CP/M-86, which was to be ready "soon." Although Seattle Computer was considering using CP/M-86 when it became available (expected no later than the end of 1979), there were only two working prototypes of the 8086 processor card, and it was felt that both were needed in house. Therefore, there wasn't one free for Digital Research.

Microsoft had already started a strong 8086 software-development program. The firm was ready to try the 8086 version of Stand-Alone Disk BASIC, which is a version of its BASIC interpreter with a built-in operating system. During the last two weeks of May 1979, this BASIC was made completely functional using the hardware

that Seattle Computer provided for Microsoft. Seattle Computer Products displayed the complete package (8086 running disk BASIC) in New York the first week of June at the 1979 National Computer Conference. (This was the first-ever public display of an 8086 BASIC and of an 8086 processor card for the S-100 bus.)

Seattle Computer shipped its first 8086 cards in November 1979, with Stand-Alone Disk BASIC as the only software to run on it. The months rolled by, and CP/M-86 was nowhere in sight. Finally, in April 1980, Seattle decided to create its own DOS. This decision resulted just as much from concern about CP/M's shortcomings as from the urgent need for a general-purpose operating system.

The first versions of the operating system, called QDOS 0.10, were shipped in August 1980. QDOS stood for Quick and Dirty Operating System because it was thrown together in such a hurry (two man-months), but it worked surprisingly well. It had all the basic utilities for assembly-language development except an editor. One week later, Seattle Computer had created an operating system with an editor, an absurdity known as EDLIN (editor of lines). A primitive line-oriented system, it was supposed to

last less than six months. (Unfortunately, it has lasted much longer than that as part MS-DOS.)

In the last few days of 1980, a new version of the DOS was released, now known as 86-DOS version 0.3. Seattle Computer passed this new version on to Microsoft, which had bought non-exclusive rights to market 86-DOS and had one customer for it at the time. Also about this time, Digital Research released the first copies of CP/M-86. In April 1981, Seattle Computer Products released 86-DOS version 1.00, which was very similar to the versions of MS-DOS that are widely distributed today.

In July 1981, Microsoft bought all rights to the DOS from Seattle Computer, and the name MS-DOS was adopted. Shortly afterward, IBM announced the Personal Computer, using as its operating system what was essentially Seattle Computer's 86-DOS 1.14. Microsoft has been continuously improving the DOS, providing version 1.24 to IBM (as IBM's version 1.1) with MS-DOS version 1.25 as the general release to all MS-DOS customers in March 1982. Now version 2.0, released in February 1983, has just been announced with IBM's new XT computer.

To finish the job, sector number 64 is read into the internal MS-DOS sector buffer. Its first 96 bytes are moved to the application program's area.

### The Sector Buffer

This example shows the internal MS-DOS sector buffer being used in a very simple way. In reality, MS-DOS would normally perform the disk read in the example more efficiently than described here due to its optimized buffer handling. By keeping track of the contents of the buffer, disk accesses are minimized. The resulting speed improvement can be dramatic particularly when the requested transfer size is small (a fraction of a sector).

In the example, I assumed the application program was sequentially reading 15-record chunks (at 80 bytes per record) and had already com-

pleted the first such read. This would mean that sector 35 (the first one read in this example) would already be in the sector buffer because its first 48 bytes were needed for the previous

---

### The presence of only one sector buffer in MS-DOS is a design inadequacy that is difficult to defend.

---

read. MS-DOS would not reread this sector but instead would simply copy the remaining 80 bytes into the area designated by the application.

Likewise, when the application is ready to read the third chunk of the file, MS-DOS will find sector 64 already in the sector buffer. The last

32 bytes of the sector will be moved into place without a disk read.

For its own internal simplicity, MS-DOS has only one sector buffer. Between the 15-record reads, should the application request some other transfer that requires use of the buffer, then the buffer contents will be changed, and these optimizations are not possible. In this particular case, in which most of the disk transfer does not need the buffer, there will be very little difference in speed either way. Let's look at a different case where this optimization is practically essential.

Suppose the application wishes to write a file sequentially, one 16-byte record at a time. When the first record is written, MS-DOS simply copies the 16 bytes into the first part of the sector buffer. As each of the next seven records is written, it too



512 SIMULTANEOUS COLORS DISPLAYED FROM A 16 MILLION COLOR PALETTE.

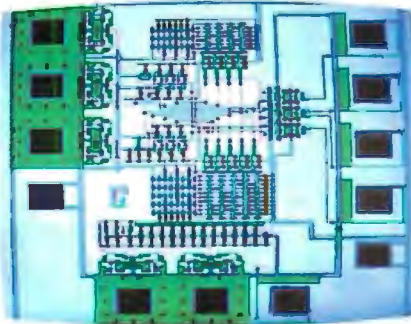
# IT'S UNBELIEVABLE.



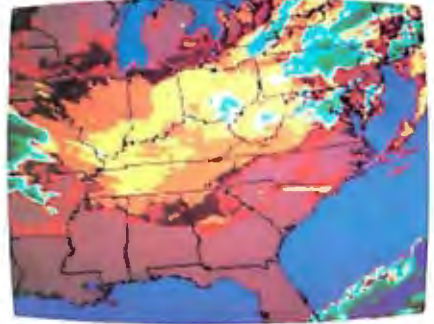
## \$4295 COLOR GRAPHICS.



*"In The Beginning"* By Richard Katz, Vectrix Corporation



*"Integrated Circuit Design"* Courtesy of Floyd J. James, University of North Carolina at Chapel Hill



*"Weather Satellite Image"* Copyright WSI Corporation

- VX384**
- VERY HIGH RESOLUTION 672 by 480 pixels
  - 512 COLORS PER PIXEL, 384K of graphics RAM
  - COLOR LOOK UP TABLE with 16 million color palette
  - ON-BOARD 16 BIT MICROCOMPUTER
  - 3D GRAPHICS SOFTWARE PACKAGE, including rotation, scaling, translation, perspective, clipping, viewport, polygon and filled polygon
  - HARDWARE LINE AND ARC GENERATION
  - ON-BOARD AND USER DEFINABLE CHARACTER SET



- SERIAL OR PARALLEL INTERFACE to almost any host computer
- VX128**
- 8 COLORS PER PIXEL, 128K of graphics RAM
  - INCLUDES ALL FEATURES OF VX384 without look-up table for \$2,495
  - VXM HIGH RESOLUTION RGB COLOR MONITOR \$1295
  - COLOR GRAPHIC PRINTER with interface cable \$1695
  - FOR ADDITIONAL INFORMATION call Toll Free or write VECTRIX Corporation, 1416 Boston Road, Greensboro, NC 27407

IF YOU STILL DON'T BELIEVE IT, CALL TOLL FREE:

1-800-334-8181

# VECTRIX

**NEW  
FROM  
COLUMBIA**



Shown are IBM-PC\* compatible programs. The Columbia VP portable runs MS-DOS\* plus five other operating systems.



# **INTRODUCING THE COLUMBIA VP PORTABLE. IBM-PC COMPATIBILITY AT AN AFFORDABLE PRICE.**

**World Headquarters:**  
9150 Rumsey Road  
Columbia, MD 21045  
(301) 992-3400  
TWX 710-862-1891

**West Coast:**  
3901 MacArthur Blvd.  
Suite 211  
Newport Beach, CA 92660  
(714) 752-5245  
Telex 277778

**Europe:**  
Limitenstr. 94  
4050 Moenchengladbach 2  
West Germany  
02166-47097  
Telex 852452

**Call our distributor nearest you.**  
Access Systems  
Wellesley, MA  
(617) 237-7743  
Advanced Management  
Systems  
Aurora, CO  
(303) 752-2972

Peripherals Plus, Inc.  
Montreal, Quebec, Canada  
(514) 849-7533  
N.I.D.I. (National Instru-  
ment Distribution Inc.)  
Dayton, OH  
(513) 435-4503

Distributors in Australia, Austria, Belgium, Colombia, Denmark, Hong Kong, Israel, Italy, Malaysia, Netherlands-Antilles, Norway, Portugal, Spain, Sweden, Switzerland, United Kingdom, Venezuela.



**Ahead in industry compatibility.**

Today, the Columbia VP portable takes on hundreds of IBM-PC compatible software programs and IBM-PC add-ons or peripherals.

What's more, six other Columbia-supported operating systems are available — CP/M-80<sup>®</sup>, CP/M-86<sup>®</sup>, (Concurrent CP/M-86<sup>®</sup>, OASIS-16<sup>®</sup> and XENIX<sup>™</sup> available soon) — stretching the Columbia VP's software compatibility beyond any other personal computer you can buy.

**Get started with thousands of dollars worth of software FREE.**

Every Columbia VP portable is shipped with fully supported software that will save you thousands of dollars on your initial purchase. That means your Columbia is up

and running right out of the box.

Included is:

- |                          |                      |
|--------------------------|----------------------|
| Perfect Writer™          | Perfect Speller™     |
| Perfect Filer™           | Perfect Calc™        |
| MS-DOS <sup>®</sup> with | BASICA <sup>®</sup>  |
| RAM disk                 | Asynchronous Com-    |
| Macro/86 Assembler       | munications Support  |
| MS-BASIC <sup>™</sup>    | Columbia Tutor       |
| Diagnostics              | Home Accountant      |
| Space Commanders™        | Plus™                |
| Fast Graphs™             | CP/M-86 <sup>®</sup> |

**Full feature performance at an affordable price.**

The Columbia VP portable features an 8088 16-bit CPU, 128K RAM, (additional 128K, optional). 640K in dual disk drives, one IBM-PC compatible expansion slot, one serial and one parallel I/O, IBM-PC-compatible keyboard, and a 9" built-in monitor with graphics.

The best news of all is the price: \$2,995—including software. And

the Columbia is built with lasting value in mind. Rugged single board design plus the flexibility to expand and personalize your Columbia VP.

**Made in U.S.A.—supported worldwide.**

All Columbia hardware and software are backed by our dealers and distributors worldwide with national service provided by Bell & Howell. Call for the name of the dealer in your area. Let us show you a whole new world of performance and value.



Circle 65 on inquiry card.

Commercial Computer Sales  
Atlanta, GA  
(404) 256-9190

Renaissance Technology  
Corp.  
Concord, CA  
(415) 676-5757

Compatible Data Systems, Inc.  
Rochester, NY  
(315) 437-3909

Southeastern Data  
Products  
Lynchburg, VA  
(804) 237-6286

MP Systems  
Dallas, TX  
(214) 385-8885

Commercial Computer  
Sales  
Miami, FL  
(305) 266-9569

Mid Tech Associates  
Desoto, KS  
(913) 441-6565

Tele-Terminals  
Brooklyn Park, MN  
(612) 536-6045

Mid Tech Associates  
Florissant, MO  
(314) 837-5200

Waybern Corporation  
Garden Grove, CA  
(714) 554-4520

Micro Distributing, Inc.  
Coquitlam, B.C. Canada  
(604) 941-0622

Tele-Terminals  
Milwaukee, WI  
(414) 785-9221

Perfect Software, Perfect Writer, Perfect Speller, Perfect Filer, and Perfect Calc are trademarks of Perfect Software, Inc. Home Accountant Plus is a trademark of Continental Software Company. Fast Graphs is a trademark of Innovative Software, Inc. IBM and IBM-PC are trademarks of International Business Machines. CP/M and MP/M are registered trademarks of Digital Research, Inc. OASIS is a trademark of Phase One. MS-DOS, MS-BASIC and XENIX are trademarks of MICROSOFT.

# SOLID, OAK SOFTWARE.



**DISTINCTIVE COMPUTER FURNITURE.  
FACTORY DIRECT.  
UNCONDITIONALLY GUARANTEED.**

All the peripherals you can buy won't help the productivity of your computer system if you don't have an organized way to utilize them. System VII Furniture gives you an efficient, comfortable workspace. With the warmth and beauty of hand-rubbed Oak

and the affordability of factory-direct delivery. Write us, or call our toll-free number to order a full-color catalog. Send \$1.00 plus \$1.00 shipping and handling. \$2.00 will be credited toward first purchase.

**SYSTEM VII FURNITURE**

CALL: 1-800-547-8888 Dept. F  
P.O. Box 427 • Lafayette, Oregon 97127

## Introducing SPL the first multi-mode spooler for CP/M computers

If you believed that your computer couldn't do better than a single task system think again. You can convert your machine into a dual-task computer with **SPL**, the amazing Spooler program developed by Blat R+D. **SPL** enables you to use hidden capacity available on your CP/M computer to print documents and run your ordinary programs, all at once.

While printing, your regular programs won't stop processing, waiting for the printer to finish. **SPL** will store the information to be printed in internal or external (disk drives) memory until the printer is ready to receive the data. Result: your programs will run at full speed.

As **SPL** can use up to the full capacity of your disks for temporary storage, it's much more powerful than hardware spoolers, which are limited to 64k memory or less.

**SPL** is an advanced product with several modes of operation. In addition to intercepting the output to the printer, **SPL** can print your existing text files, or those that your programs will create from now on. **SPL** will even take care of tab expansion. As an added bonus, **SPL** needs no installation on most CP/M 2.x computers.

## If you have a computer Get A Second Computer FOR \$139



Registered Trademark of Digital Research

You could get an equivalent increase in computing power by spending \$1000 to \$3000, but **SPL** is only \$ 139, including disk and manual.

To order your **SPL** program call us today specifying what disk format you require. You can charge it to your VISA or Master Card if you prefer.

**Blat Research+Development Corp.**  
8016 188th SW, Edmonds WA 98020  
Call toll-free 1-800-LOBO-BAY  
In WA call [206] 771-1408

is just copied into the appropriate position in the sector buffer. Again with a 128-byte sector of an 8-inch single-density format, the sector buffer would be full at this point. Upon attempting to write the ninth record, MS-DOS would find it needs to put the record in a different sector from the one currently in the buffer. The current buffer contents are marked "dirty," meaning they must be written to disk rather than discarded. MS-DOS does this and then moves the ninth 16-byte record into the buffer.

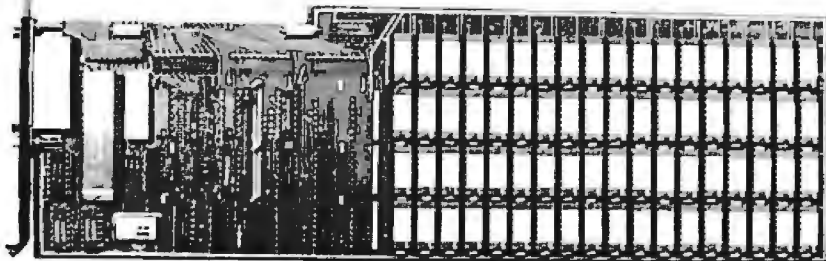
Note that MS-DOS did not write the sector buffer automatically after 128 bytes had been written to it. This is because the DOS has no notion of a sequential file: every disk transfer has an explicitly specified record position and record size. Thus, it does not think of the buffer as "full"—for all it knows, the application program might back up and write the first 16 bytes over again. So the data is simply kept in the buffer until the file is closed or until the buffer is needed for something else.

Another optimization was taking place here that may have gone unnoticed. MS-DOS is always aware of the exact size of its files, and the assumption in the previous example was that this file was being newly written. Had it already existed, MS-DOS would have been forced to pre-read each sector into the sector buffer before copying any records into it. This is essential in case the program does random writes, intending to change only selected portions of the file. When the file is being extended (as in this case), the pre-read is not performed.

The possible outcome of this approach to buffer handling is that when the application program requests a write and is told it was successfully completed, the data may, in fact, not yet be written to the disk. The alternative approach is called *buffer write-through*, in which the data in the sector buffer would be written to disk each time the application requested a write. This would mean, in the example, eight rewrites of the same sector before moving on to the next, requiring a minimum of 1.2 seconds to write just 128 bytes! As

**NEW  
UP TO 2MB  
ON  
A SINGLE  
CARD!**

# STATE OF THE ART MEMORY SYSTEMS

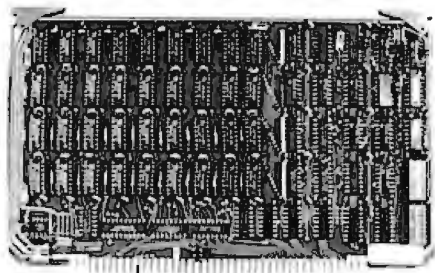


## 512KB SINGLE BOARD IBM MEMORY W/RS232-C PORT

- Addressable as a contiguous block in 64KB increments thru 1 megabyte.
- On board parity with interrupt on parity error.

**SINGLE QTY. PRICE: \$795.00**

**MEMDISK 1** Allows memory to emulate disks. Increases system performance!!  
FREE with purchase of memory.

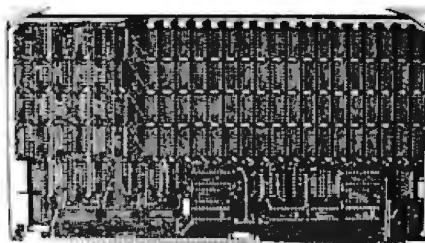


## 64KB SINGLE BOARD EXORCISER I, II, AND ROCKWELL SYSTEMS 65 MEMORY

- Parity checker on board.
- Addressable as a contiguous block in 4K increments with respect to VXA or VUA.
- Pin to Pin compatibility.

**SINGLE QTY. PRICE: \$250.00**

**NEW**



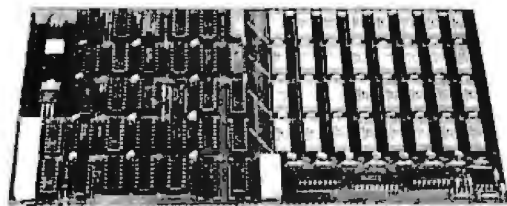
## 512MB TO 2MB SINGLE BOARD MULTIBUS MEMORY

- Pin to Pin MULTIBUS compatibility for both 8 bit and 16 bit systems.
- On board parity with selectable interrupt on parity ERROR.
- Addressable up to 16 megabytes.

**SINGLE QTY. PRICE:**

<b>512KB</b>	<b>\$ 895.00</b>
<b>1MB</b>	<b>\$4495.00</b>
<b>2MB</b>	<b>\$8700.00</b>

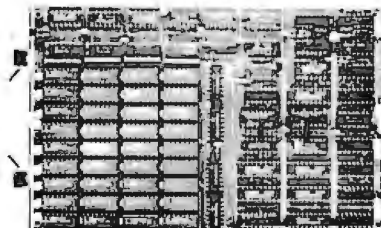
**NEW**



## 64KB SINGLE BOARD S100 MEMORY

- Addressable as a contiguous block in 4K word increments.
- Battery back-up capability.
- Functions with on-board refresh.

**SINGLE QTY. PRICE: \$250.00**



## 256KB TO 1 MB SINGLE BOARD LSI 11 MEMORY

- On board parity generator checker.
- Addressable as contiguous block in 256KB increments through 4 megabytes.
- Battery back-up mode.

**SINGLE QTY. PRICE:**

<b>256KB</b>	<b>\$ 595.00</b>
<b>512KB</b>	<b>\$2650.00</b>
<b>1MB</b>	<b>\$3995.00</b>

**DON'T ASK WHY WE CHARGE SO LITTLE, ASK WHY THEY CHARGE SO MUCH.**



# Chrislin Industries, Inc.

31352 Via Colinas • Westlake Village, CA 91362 • 213-991-2254  
TWX 910-494-1253 (CHRISLIN WKVG)

**P&T CP/M<sup>®</sup> 2 is GROWING**

**TRS-80 MODEL II**  
\$185

Still the best CP/M for the Mod II with features like 596 Kb per diskette, typeahead, full serial port support, and more.

**TRS-80 MODEL 12/16**  
\$220

Includes full support for thinline drives; gives 1.2 Mb per diskette for the Mod 16 (2-80 mode), Mod 12 and Mod II's with double sided drives.

**RADIO SHACK HARD DISK**  
\$250

Includes all the features of P&T CP/M 2 plus support for the 8.7 and 12 Mbyte hard disk drives.

**CAMEO HARD DISK**

Support for the standard Cameo hard disk system (\$250) or the multiplexer (for multiple computers) system \$400.

**CORVUS HARD DISK**  
\$250

Support for a 5, 10, or 20 Mb Corvus hard disk system.

Start with a Model II floppy system and grow into a hard disk. Since all P&T CP/M 2 systems are fully compatible, you will have no conversion worries.

**Special note:** P&T hard disk systems allow you the user to configure logical drive assignments to your specifications. Write for more details.

Prepaid VISA, M/C, or COD orders accepted. All prices FOB Goleta and subject to change.

CP/M is a registered trademark of Digital Research. TRS-80 is a trademark of Tandy Corp.

**PICKLES & TROUT**  
P.O. BOX 1206  
GOLETA, CA 93116  
(805) 685-4641



the logical record size gets smaller, the time required to write becomes greater.

The presence of only one buffer does bring about the definite possibility of buffer "thrashing." Take the example of an application such as a compiler that will alternately read a small amount from one file and write a little bit to another. If both the reads and writes consist of a single 16-byte record, then the following sequence will be performed for each pair of records:

- read input file, get record from buffer
- read output file, put record into buffer
- write output file

For each record pair, three disk transfers are required. The result would be unbearably slow. The presence of only one sector buffer in MS-DOS is a design inadequacy that is difficult to defend (but it does help keep the DOS small). The practical solution is for applications that must access more than one file at a time to provide their own internal buffering. By requesting transfers that are at least half as big as the sector size, thrashing can be substantially reduced.

### MS-DOS 2.0

Microsoft has now made available MS-DOS version 2.0 to all OEM (original equipment manufacturer) customers of previous versions. The 10 months put into version 2.0 by the MS-DOS team probably exceeds the total effort behind the previous 1.25 release, including the original development at Seattle Computer Products. While the changes have been substantial, the basic structure is still recognizable. I have been discussing the DOS at such a low level that most of what I've talked about applies directly to version 2.0 as well. Here are the three main differences, along with my personal comment as original author of the DOS. I was not involved in the MS-DOS 2.0 project.

MS-DOS 2.0 allows multiple-sector buffers. The number is determined by a configuration file when the DOS is loaded. It can be easily ad-

justed to the user's needs: for example, to accommodate more buffers to prevent thrashing (this is the ideal solution to the buffer thrashing problem previously discussed) and fewer buffers to make more system memory available.

The new MS-DOS does not keep the file allocation tables in memory at all times. Instead, the tables share the use of the sector buffers along with partial-sector data transfers. This means that at any one time, all, part, or none of a FAT may be in memory. The buffer-handling algorithms will presumably keep often-used sectors in memory, and this applies to individual sectors of the FAT as well. This change in the DOS goes completely against my original design principles. Memory is getting cheaper all the time, so dedicating a few thousand bytes to the FATs should be completely painless. Now we're back to doing disk reads just to find out where the data is. In the case of a random access to a large fragmented file (for example, when accessing a database that fills half of a small Winchester disk), it is possible that several sectors of the FAT would need to be visited, in random order, to find the needed allocation unit.

While MS-DOS retains the original fixed-size main directory, it now can have files as subdirectories. This hierarchical (tree-structured) directory system may be extended to any depth. This approach is nearly essential for users to keep track of all the files that might be on a hard disk.

MS-DOS version 2.0 is, on the whole, a substantial upgrade of the previous releases. The three preceding paragraphs are intended only to point out the way the 2.0 file structure differs from the file structure I've discussed, not to give you a complete product description. ■

### About the Author

*Tim Paterson worked for Seattle Computer Products on the design of its 8086 computer system and the operating system now called MS-DOS. He then worked for Microsoft for about a year. Since returning to Seattle Computer Products as director of engineering, he has been primarily involved with new hardware development.*

Since 1978

- REPUTATION BACKED BY YEARS OF EXPERIENCE.
- PIONEER IN DIRECT TO CONSUMER SALES OF MICRO COMPUTERS AND ELECTRONICS
- MILLIONS OF DOLLARS IN SALES OVER THE YEARS
- TENS OF THOUSANDS OF CUSTOMERS
- HONEST
- RELIABLE
- LARGE INVENTORY
- NAME BRAND PRODUCTS



**Micro Management Systems, Inc.**

2803 Thomasville Road East  
Cairo, Georgia 31728  
(912) 377-7120

**DISCOUNT PRICES**



**BUY DIRECT**

**It's simple. . . .  
CALL & SAVE MONEY**

**1-800-841-0860  
CONVENIENT ORDER ENTRY**

Go & Info 912-377-7120

**COMPUTERS & EQUIPMENT**

**EPSON PRINTERS**

- MX-80..... \$369
- FX-80..... \$CALL
- MX-100..... \$CALL
- NEW PRODUCTS. \$CALL

**TRS-80 COMPUTERS**



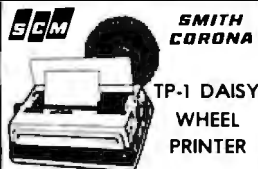
WE CARRY THE COMPLETE LINE OF TRS-80 COMPUTERS

- DISCOUNT PRICED FROM
- MODEL 12..... \$2639
  - MODEL 16..... \$4012
  - MODEL III..... \$588
  - COLOR COMPUTER... \$235

**OKIDATA PRINTERS**

- MICROLINE 80    MICROLINE 92P
- MICROLINE 82A    MICROLINE 93P
- MICROLINE 83A    PACEMARK 2350
- MICROLINE 84P    PACEMARK 2410

DISCOUNT PRICED FROM **\$339**



**SMITH CORONA**  
TP-1 DAISY WHEEL PRINTER

- LOW COST • 12 CPS
- MICROPROCESSOR ELECTRONICS
- 10 OR 12 PITCH
- SIMPLE RELIABLE MECHANISM

FROM **\$499**

**C. Itoh PRINTERS**

- FROM **\$397**
- PROWRITER. \$CALL
- STARWRITER. \$CALL
- PRINTMASTER \$CALL



**PRINTERS**

- GEMINI - 10
- GEMINI - 15

DISCOUNT PRICED FROM **\$339**

**ATARI**

- ATARI 800
- ATARI 1200

**\$CALL**

**brother.**

- DAISY WHEEL PRINTERS

**\$CALL**

**commodore COMPUTERS**

- FROM **\$139**
- COMMODORE 64 ..... \$CALL
- VIC 20..... \$CALL
- VIC 1541 DRIVE..... \$CALL
- VIC 1530 DATASETTE..... \$CALL
- VIC 1525 PRINTER..... \$CALL
- VIC 1600..... \$CALL
- AND MORE..... \$CALL

**TRS-80 PRINTERS**

- DMP-100 ..... \$309
- DMP-200..... \$CALL
- DMP-400..... \$CALL
- DMP-500..... \$CALL
- DMP-2100..... \$CALL
- DWII..... \$CALL
- DWP-410..... \$CALL
- CGP-115..... \$199

- TRS-80 DISK SOFTWARE
- TRS-80 MODEMS AND TERMINALS
- PANASONIC MONITORS
- AMDEK MONITORS
- COMREX MONITORS



- ACE 1000 COMPUTER
- ACE 1200 COMPUTER

DISCOUNT PRICED FROM **\$898**



**MODEMS**

DISCOUNT PRICED FROM **\$119**

ALL PRODUCTS WE SELL ARE BRAND NEW AND COVERED BY THE MANUFACTURER'S SPECIFIC WARRANTIES. COPIES AVAILABLE UPON REQUEST. WE DO NOT SELL ANY USED, RECONDITIONED, FOREIGN OR INFERIOR MODIFIED EQUIPMENT. PRICES AND PRODUCTS SUBJECT TO CHANGE WITHOUT NOTICE.



**MODEMS \$CALL**

- NEW PRODUCTS
- TRS-80 MODEL IV... \$CALL
- TRS-80 PORTABLE.. \$CALL

**\$CALL**

**Verbatim® DATALIFE DISKETTES**

5 YEAR GUARANTEE **\$CALL**

- SPECIAL PRICES LIST \$2695
- OKIDATA PACEMARK 2350P PRINTER

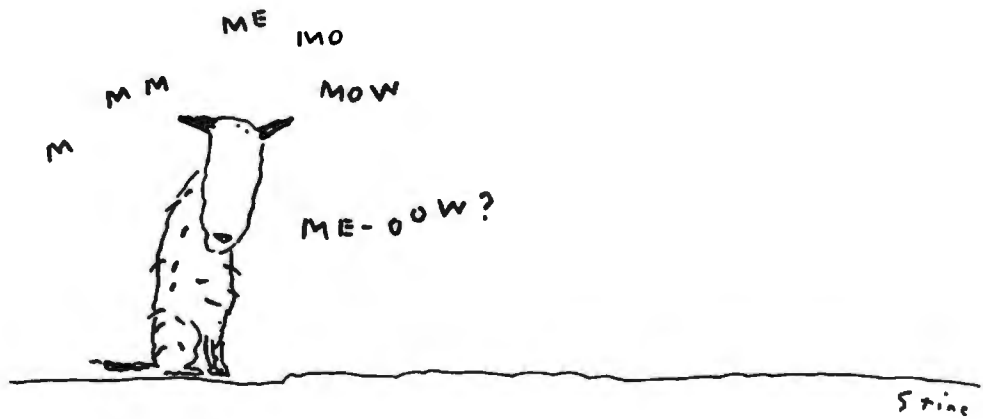
350 CPS **\$2066**

- CARDCO VIC 20/64 PERIPHERALS
- COMREX COMRITER CR-1 DAISY WHEEL
- NEC
- QUADRAM, IBM, APPLE PRINTER BOARDS AND MICROFAZER BUFFERS

**FREE UPON REQUEST**

- DISCOUNT PRICE LIST AND INFORMATION KIT
  - COPY OF MFR'S WARRANTY
- WRITE  
**MICRO MANAGEMENT SYSTEMS**  
TELEMARKET DEPT NO. 1  
2803 THOMASVILLE RD E. • CAIRO, GA. 31728

Dogged attempt to learn a second language.



IBM, Apple and CP/M are registered trademarks of IBM Corp., Apple Computers Inc. and Digital Research Corp. respectively.

For the name of the dealer nearest you, phone (800) 227-2400, ext. 948; in California, (800) 772-2666, ext. 948. For more information



# And now, InfoStar.<sup>™</sup>

## The first DBMS you can use without speaking programmerese.

So put away your GO TOs and DO WHILEs.

InfoStar is one microcomputer data base system that doesn't ask you to write in code. Or learn a programming language. Instead you make selections from an on-screen menu written in one easy language. English.

Which means you don't have to be a programmer or computer jock to use it. But, in case you are, there's something in it for you, too.

With InfoStar, you can generate a custom application four times faster than with other DBMS software.

Reason being it has a lot of the features that made WordStar<sup>®</sup> the standard of the industry. For instance, select-as-you-go menus prompt you through all procedures. And to format a data entry form or report, you simply draw it on the screen.

We've said it before: what you see is what you get.

But, of course, that's not all you get. Fact is, InfoStar has more informative (and self-documenting)

capabilities than you've come to expect from any microcomputer DBMS.

Starting with report writing. A custom report feature — complete with transactional updating and exception processing abilities — lets you format, manipulate and merge countless different ways. And a quick report feature lets you finish faster than you can count them — usually in 60 seconds or less.

Not that you have to slow down to sort things out either. Because InfoStar can sort five to six times faster than any other DBMS in its class.

And for data entry, there are high-end minicomputer features. Like batch editing. And 200 editing mask combinations, to name a few.

All that's required of you is that you have an IBM PC, Apple II or CP/M<sup>®</sup>-based computer. And that you take a trip over to your local computer store to ask about InfoStar.

They don't speak programmerese.

But they're happy to talk business.



**MicroPro**<sup>™</sup>  
The Microcomputer Software Company

## A Guided Tour of Visi On

*William T. Coleman, a group manager at Visicorp, is responsible for Visi On and the applications programs that run under it. He started work on the Visi On project soon after joining Visicorp less than three years ago. Prior to that he served as a consultant for Visicorp.*

*He has also been a department manager at GTE, where he managed development of minicomputer and microcomputer systems that automated the use of analog equipment to collect, analyze, and disseminate information. Before that, he worked at the artificial-intelligence lab at Stanford University, where he did graduate work. A graduate of the Air Force Academy, Coleman served in the Air Force as a programmer at the Satellite Test Center.*

*Bill Coleman talked with BYTE's West Coast Editor Phil Lemmons in March at Visicorp's headquarters in San Jose, California. Lemmons' questions are in bold; Coleman's responses follow in lightface.*

**When did you decide to do applications software that uses mice?**

The original decision wasn't necessarily to involve mice. It was to develop an environment in which users could run applications programs. We started in the first quarter of 1981. We came up with three overall requirements for a system that

---

Phil Lemmons  
West Coast Editor  
Byte/McGraw-Hill, 4th Floor  
425 Battery St.  
San Francisco, CA 94111

---

we wanted to develop, and those requirements were the appearance of multiple product activation . . .

**What does that mean?**

To give the users the impression of actually having multiple applications programs available to them at any time. Users were to believe that they could use and interact with multiple products very generally. We were seeking the appearance of multiple-product interaction as opposed to actual multiprocessing.

**So you're not "timesharing" the central processing unit?**

In reality, when you get down to the depths of what we've done, there is a concurrent operating system. That's what the Visi On layer of Visi On is. The Visi On layer keeps the mouse up to date all the time, keeps one application program running, always keeps interacting with one program, or one activity, as we call it, and can also do background processing for handling output devices, whether they're printers or plotters or communication lines.

So while it is in some sense multitasking, it's **not** a multiprocessing environment, meaning that you can ac-

tually tell one program to start computing here and immediately switch to another one and watch the first program computing while you're interacting with the second. You can do that only in the context of output processing of the background.

**What were the other two requirements for your system?**

The second requirement was ease of learning and use, which we called "ELU," and the third requirement was simple transfer of data between products. That meant not a procedure-oriented transfer. In brief, we wanted users to be able to have multiple programs on the screen at one time, ease of learning and use, and simple transfer of data from one program to another.

From that we've developed a whole series of objectives. The key ones were that programs be installable. That differs from Smalltalk, which lacks a concept of programs or products and uses a concept of objects. Objects make up classes, and the class provides a set of methods that tell what will happen to an object in the class when an object receives messages. You can increase the methods in a class. There are also objects that are communications between classes and subclasses, and it's the class and subclass that have a method, etc. But our products had to be installable. (See "The Smalltalk-80

System," August 1981, page 36.)

We also wanted to live with the vendor-supplied operating system. We wanted our system to be portable across a series of machines, portable to many personal computers. We wanted the system to have a consistent user interface. And a series of other objectives don't come to mind at the moment.

Basically we've gone through four development phases. Phase one was specification of the system and development of the human factors—those were two separate projects that we happened to call Quasar and Nova. During the specification of the system we decided to develop four different external product specifications so that we could approach the problem from four different angles, and we approached it from as wide and diverse a set of angles as we could. We developed all four. One was a Smalltalk system, one resembled a Xerox Star system, one was a virtual-terminal system, and one was a split-screen system. We developed about 15 or 20 pages of specifications for each of the four different approaches.

The second project was human factors, and for that we built two models. One was a model of the user, and the second was a model of the product. We wanted to answer the question, What should a product



*William T. Coleman*

look like conceptually to the user? And from those two models we developed a set of interactions between the user and the product model.

We drew on all of Visicorp's experience in customer support and on problems we had with building previous products. From that we derived two things. One was a set of principles of design that are applied to the system. Their names might sound a little funny. There are 16 of them. They're things like the principle of display inertia, the principle of the illusion of direct manipulation, the principle of guidedness, etc. We said, okay, these are the principles upon which we want to build systems from now on.

**Could I get a list of those principles?** It's a proprietary document. I just want to mention it because we've been going through phase one of the development of Visi On, and this was part of phase one.

Next we said, okay, now we have these principles of design and we have this user and this product; now let's classify the interactions between the user and the product. So we developed the concept of what we called BITs, (basic interaction techniques).

We specified 16 of these; they are basically the atoms of the interaction of human factors in the system. Each BIT encapsulates and specifies one kind

of interaction between the user and the system. There's a menu BIT, an error BIT, a forms BIT, a list BIT, a sound BIT, a BIT for giving confirmation, etc. The BITs are the smallest atoms of things that we want to use consistently in any product.

At the end of phase one, we did a review and we came out of it with an overview of our external product specification. That consisted of a drawing and a set of descriptions of the functions. If I showed you that today, you'd see that what we had in the mid-summer of 1981 looks very much like the system we have now. **So there weren't any major reversals of course?**

Well, no. There was quite a bit of tuning because we evaluated each of the four designs and said what we liked and didn't like about each. We tried to put the best things into one system, guided by our principles of design.

**Did you come to a time when you had to make trade-offs between functions in the programs and ease of use?** That's what the whole month of July and August was, until we came out with this specification. That was the end of the first phase.

The second phase was a prototype phase, and we actually built the system from scratch. We built the front end of the system as fast as we could on an Apple III and got it working on an Apple III, just the front end. You could actually interact with most of the commands that are on the global menu line. Only about five people were working on this project full-time then, and we brought it up and got it working. We had to modify the motherboard of the Apple to use 160K bytes of memory, and we had to use an Apple II with a graphics tablet over an RS-232C line to simulate the mouse, but we actually got it so you could play with it and simulate using the mouse and open windows and frame them and things like that.

At the end of the prototype phase, in November 1981, we entered phase three. We went through a three-month period in which we analyzed and respecified the system. We changed a fair number of things in the system at that time and began building it at the end of the first quarter of last year.

Phase four, what we're in right now, is the development phase. I made a big point of the human factors throughout. This is a very layered architecture, as required by our needs for portability and compatibility with an operating system. In the upper layer, we not only have all of the calls—the Visi Ops, we call them—the operations that you would expect if you were using a very high level windowing system, but we also have the BITs. The BITs are actually implemented in the upper layer. When someone is developing a program for Visi On, he or she calls something named "menu" and just passes it a bunch of the data structures, and all the interaction is taken care of. So when we say if you've learned to use one product, you've learned to use them all, the location of the BITs means that's true. The programmer still has to design the actual algorithms for all the interaction, of course.

That's the history of Visi On's development. We're in the process of finishing the coding in some areas of

Visi On and developing the products, the applications programs. They are in different stages of testing and quality assurance so that we can get Visi On out this summer.

**Are you producing two sets of all the applications programs, one to go into Visi On and one to go outside?**

Yes. Every product under Visi On and under my group is being developed from scratch to work with Visi On and to take optimal advantage of the use of the mouse in the environment, and they'll all be introduced for Visi On. They'll be much upgraded from our current products. We hope we've learned something in the last four years about where we have deficiencies.

---

**We're in the process of finishing and coding in some areas of Visi On so we can get it out this summer.**

---

**Will Visiword be very different from the demonstration that I saw a few months ago? It looked easy to use.**

From an appearance point of view, it won't be very different. I think it's much easier to use with the mouse added to it, to begin with, and we've done some restructuring to take advantage of the features. For example, it will let you put pictures and graphs into the document anywhere, and it doesn't just bring the pixel representation in, it brings in the line representation of the actual drawing and draws it to scale. You know, there are a fair number of upgrades for things like that. But as far as when you physically see the interface and use the rulers and whatever, there won't be a lot of changes. There are a couple of other upgrades that it's a little premature to talk about.

### **The User Interface**

**What, in general, are you aiming for in the human interface?**

We were looking for something that was intuitive to use, very guided, and consistent across all products. What we ended up having to do in all of the definitions of BITs was to try to break

down the interaction to its lowest possible common denominator and determine what's appropriate.

Consistency and intuitiveness are very important. We also wanted to provide very obvious ways to do things but not necessarily provide multiple ways to do the same thing. We developed a motto early on that "Two is much, much greater than one." The motto means that any time you offer somebody two ways of doing a task, he has to decide which way to do it. That becomes an *n*-factorial problem—2 times 2 times 2 to the second power, etc. In designing products we believe that there are so many ways of doing things that people get afraid to try anything. They don't know at a given time just what using this key or doing some other specific action will do.

On the other hand, in certain instances we didn't want to restrict the product to be able to use only the mouse or to require the user to do something only in an arcane and difficult manner.

The human factors involved in product design is probably the most underrated issue. Everybody claims to have ease of learning and use. Not everybody is qualified to design a product, but everybody in the world is qualified to say whether they like or don't like some aspect of using the product. The hardest issue is not necessarily coming up with something that's good, but finding an approach that everyone involved agrees is the best. There have been deep philosophical issues here as in other companies in the valley for years.

**About the number of buttons on a mouse, for example?**

We really haven't had a problem with the number of buttons on a mouse, but about what special keys to allow.

I should go into my mouse diatribe here for a minute. We specifically decided that we wanted only one button on the mouse for selection, and that's all we have. A two-button mouse is confusing, because you don't know when to use one and when to use the other. The only reason for our second button is that we didn't like to have lots of little modes that you have to look at to

# DataVu™

A Complete Information Management Facility

## Here's What They're Saying About Us

"DataVu is High Octane in a field of Low-Test competitors, and one of the 'best kept secrets' in the software marketplace! The terrific thing about it is it's extremely powerful and yet you don't have to be a programmer to run it. To use it is to LOVE it!"

**B. W. Stark**

Computer Tutor, Inc., New York, NY

"The menu generation is good enough to be sold by itself. . . relational data base itself is one of the most powerful I've had the pleasure to use. . . one of the finest pieces of software available today. You can't beat the price. . .\$149.00.

**Scott M. Baker**

Assistant Manager, Heathkit, Jericho, NY

"The problem seems to be that at \$149. 'how can it be good'? Take it from a programmer, it beats those Data Base Manager Systems that are priced over \$500. (no need to mention names)."

**Ernie Johnson**

Stanford Software System, Minitou Springs, CO

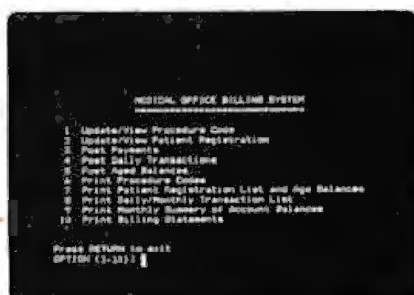
After experimenting with and using 10 to 20 microprocessor based databases over the last few years, I have finally found the most powerful and cost-effective tool available to the micro-computer user.

**Tom Potter**

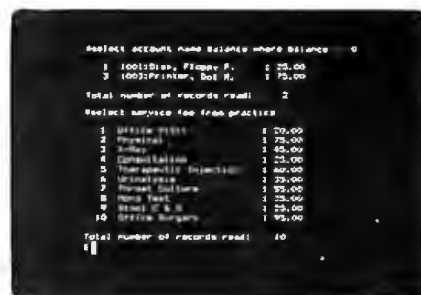
Roseville Computer Store Roseville, Michigan



**Automatic Screen Design (ASD):** This feature permits you to specify the design of a form (which may be multi-page) that you wish to use for data entry and data viewing. You simply layout a screen mask and within seconds, without any programming, a data entry program can be generated.



**Automatic Menu Generation:** This feature permits you to design your own menus in which each option in the menu will invoke an executable program or a batch file. You simply layout the menu pages, and within seconds, without any programming, your menu program can be generated. This allows you to construct user-friendly menu-driven packages.



**Relational Data Base Management:** Having established data base(s) through use of the ASD feature, you may use the Relational DataBase Management feature to manipulate and retrieve these data. This feature supplies 12 commands and four utility programs to support activities like Select, Sort, Index, Join, Reformat, and so on.

See DataVu™ at your local software dealer. We also have a demonstration system up and running. You can dial in and try most of the DataVu™ features. Call us for more information.

## Thinkers Soft, Inc.

P.O. Box 221

Garden City, NY 11530

**(516) 294-8104**

Circle 385 on inquiry card.



**Report Generation:** Reports generated from your data base(s) that become routine and have enduring value may be specified by you in detailed format to the Report Generation feature. It is designed to retrieve information from the data base with simple statements and perform arithmetic operations.

## All This. . .

for only

**\$149\*** complete

prices subject to change Aug. 1

Available for IBM PC, CP/M®-80: Osborne, Northstar, Micro Decision, Kaypro, Superbrain, Heath 89/Z100, Televideo, NEC, Sanyo, Xerox, Apple II, and 8" SSSD disk. CP/M™-86 available soon.

CP/M is a registered TM of Digital Research, Inc.

\* If you want to impress your boss, or your friends, we'll gladly charge you \$700. for this software package.



# PRESENTING THE S100-PC™ FOR \$2999.



**The S100-PC by Lomas Data Products:  
Offering high performance at a "low" price...  
and it's IBM-PC diskette compatible.**

The S100-PC is a cost effective high performance floppy based system ideally suited to business and scientific applications.

The system offers the following standard features:

- Two 5¼" double sided disk drives (640 Kbytes of storage)
- Two serial ports, Two parallel ports
- Battery protected clock calendar
- MS-DOS\*\* operating system (others optional)
- 128K RAM
- 8 MHZ 8088 processor (8087 optional)
- 15 slot S100 mother board
- Attractive desktop enclosure

And, the S100-PC is diskette compatible with the IBM-PC and most programs will operate without any changes. Plus, with its S100 bus expansion capability... your system will never be outdated.

## LDP also offers a complete line of S100 bus board products & support for the system integrator . . .

■ **LIGHTNING ONE\*\*\* 8086/8088 CPU**  
8086 or 8088, with 8087 and 8089 coprocessors. Up to 10MHZ operation. . . . . **PRICES start at \$425.00**

■ **HAZITALL SYSTEM SUPPORT BOARD**  
2 serial, 2 parallel ports, battery protected clock calendar, Hard disk controller host interface. . . . . **PRICE \$325.00**

■ **LDP128/256K DYNAMIC RAM**  
Advanced dynamic RAM with LSI controller for failsafe operation, parity. . . . . **Price 128K — \$495.00, 256K — \$795.00**

■ **RAM67 HIGH PERFORMANCE**  
**STATIC RAM** High speed (100ns) low power CMOS static RAM. 128K bytes, extended addressing. . . . . **PRICE \$1200.00**

■ **LDP72 FLOPPY DISK CONTROLLER**  
Single/double density, single/double sided disks, both 8" and 5¼" inch drives simultaneously. . . . . **PRICE \$275.00**

■ **LDP88 8088 SINGLE BOARD**  
**COMPUTER** 8088 CPU, 1K RAM, 8 K EPROM, Monitor RS232 serial port, 8 vectored interrupts. . . . . **PRICE \$349.00**

*Two additional boards are available for JULY delivery.*

■ **LIGHTNING 286 — 80286 CPU BOARD**  
Offers 4 times the performance of a 5MHZ 8086 CPU while maintaining software compatibility. . . . . **PRICE . . . . . CALL**

■ **OCTAPORT 8 PORT SERIAL BOARD**  
8 serial ports 0 to 19200 baud operation real time clock interrupt. Ideal for multi-user systems such as MP/M-86.\* . . . . . **PRICE . . . . . CALL**

All of LDP boards are fully tested to exacting standards and carry a one year warranty. We specialize in 16-bit products & support the four major operating systems for 16-bit processors: CP/M-86\*, MP/M-86, CONCURRENT CP/M-86\*, and MS-DOS (PC-DOS).

If your application requires 16-bit computing power and versatility, call Lomas Data Products today.



*Dealer inquiries invited.*

LOMAS DATA PRODUCTS, INC. □ 66 Hopkinton Road, Westboro, MA 01581 □ Tel: (617) 366-6434

\*CP/M-86, MP/M-86 and CONCURRENT CP/M-86 are trademarks of Digital Research.  
\*\*MS-DOS is trademark of Microsoft.  
\*\*\*Lightning One is trademark of Lomas Data Products, Inc.

# DIAMOND DELIVERS!

SEE US AT PC'83 BOOTH #145

Superwriter \$179 Infostar \$275  
 Wordstar \$259 dBase II \$ call  
 Multiplan \$195 Supercalc 2 \$179  
 Wordstar/Infostar \$519 Superwriter/Supercalc 2 \$329

	LIST	OUR PRICE		LIST	OUR PRICE
Micropro*	\$250	\$138	Visicorp*	\$250	\$188
MAILMERGE	\$250	\$145	VISICALC	\$375	\$289
SPELLSTAR	\$645	\$350	VISIFILE	\$300	\$219
WORDSTAR/MAILMERGE	\$350	\$219	VISITREND/PLOT	\$300	\$219
SUPERSORT	\$145	\$ 89	DESKTOP PLAN	\$300	\$219
REPORTSTAR			VISISCHEDULE	\$300	\$219
CALCSTAR			Microsoft*	\$345	\$249
WORDSTAR/MAILMERGE	\$845	\$469	SOFTCARD	\$100	\$ 83
SPELLSTAR 3 PAK			RAMCARD	\$345	\$239
Sorcim*	\$195	\$129	VIDEX (80 COL. CARD)	\$695	\$479
SUPERCALC	\$295	\$179	PREMIUM SYSTEM		
SUPERCALC 2	\$295	\$179	Condor*	\$850	\$489
SUPERWRITER	\$195	\$129	CONDOR 20-3		
SUPERSPELLGUARD			Fox & Geller*	\$295	\$225
Ashton-Tate*	\$700	\$call	QUICKCODE	\$ 99	\$ 99
dBASE-II	\$400	\$309	dUTL	\$295	\$ 99
THE STRATEGIST	\$700	\$495	dGRAPH	\$150	\$ 99
FINANCIAL PLANNER			Continental*	\$125	\$ 99
Supersoft*	\$425	\$329	HOME ACCOUNTANT	\$495	\$359
PORTRAN	\$500	\$359	FIRST CLASS MAIL		
C COMPILER	\$125	\$ 99	Innovative*		
PERSONAL DATA BASE	\$295	\$225	T.I.M. III	\$350	\$259
SCRATCHPAD			Digital Research*	\$400	\$295
Lexisoft*	\$495	\$255	CONCURRENT CP/M 86	\$200	\$145
SPELLBINDER	\$195	\$129	PASCAL MT+ 86		
Lifetree*			C BASIC 86	\$300	\$199
VOLKSWRITER	\$195	\$135	NEW! NEW!	\$300	\$229
Microstuf*			THE CREATOR	\$389	\$275
CROSSTALK	\$500	\$365	THE FINAL WORD		
Metasoft*			VERSAFORM		
BENCHMARK	\$350	\$199	RAM Expansion Boards*	\$395	\$289
Information Unlimited*	\$175	\$129	QUADRAM QUADBOARD	\$595	\$425
EASYWRITER II	\$400	\$285	64K EXPANDABLE		
EASYSPELLER			256K		

At Diamond Software we offer the best selling business application software for your IBM PC, CP/M or Apple Computer at the lowest possible prices. And we maintain a complete technical department to assist you before, during and after your system purchase. Not only that, we offer same day shipment on most items and we accept Visa, Mastercard and also American Express. We'll even pay the shipping charges if you send us a money order, cashiers, company or personal check. Purchase orders are gladly accepted from qualified organizations and we welcome dealer inquiries. Call Diamond today, you'll be glad you did.

**TO ORDER CALL TOLL-FREE 1-800-227-0545**

**Diamond Software Supply** 484 Lake Park Ave., Suite 123 • Oakland, CA 94610

For price quotes, information, or in California call 1-415-893-7676. We credit your order for the call. Technical Department (415) 893-7678. International Telex 338139 (attn. 149)

## Support, Service and Price.

Shipping/Handling UPS surface \$3.00 plus an additional \$3.00 per item for UPS Blue. C.O.D. orders add \$4.00. For personal check allow 2 weeks for delivery. All items subject to availability. prices subject to change without notice. Calif. residents please add 6% sales tax \* IBM is a registered trademark of International Business Machines CP/M is a registered trademark of Digital Research.

whole bunch of DOS files with arcane 8-character names with 3-byte trailers on them. I want to show them a name in the context and the way it's defined in the context of the kind of product.

Now, above this, the volume layer knows about password protection/encryption, so a user can password protect/encrypt, and the object layer knows about file types. We have multiple file types, but I won't go into them.

Simply, we have multiple file types, there is a layer called the object store in which all the data is stored, and all transfers are done through Visi On. Products don't have to do anything about transfers or conversion of data. What happens when the user selects Transfer and points at a source object to transfer, be it a block of data in the middle of a Visicalc spreadsheet or some abstraction of that—like pointing at the name of a Visicalc spreadsheet—is that Visi On will transfer the whole spreadsheet. Or if you're pointing at two column headers, Visi On will transfer all the columns between those two points, something obvious like that.

Once the user points at that and points at the destination location, Visi On takes over. First, it actually queries the product: "In the context in which data was pointed at, what types of data can you pass?" And the program or product will say, "I can pass type X, X, and X." And then Visi On will query the destination product the same way and do a match.

Then Visi On will actually physically transfer the highest-order pairing, meaning that the higher the order, the more context is transferred with it. The highest-order data type actually is called "owned," and that means the data will probably be transferable only to another instance of the same product. For a spreadsheet that will have all the formulas underneath it, all the formatting information, column widths, the whole nine yards. But if you're transferring that into a word processor that doesn't know anything about calculating formulas, all it's going to want is enough data to know whether it's character, numeric, and what the precision is.

That gives you some idea of how



the transfer actually takes place. Therefore, as far as the product is concerned, transfer is a general process. All the product has to do is respond, "I can give you this and this," and then when the other product says, "Okay, give it to me," that passes the data. Visi On takes care of everything else.

And the objects you described are like the objects in Smalltalk—they carry some information about how they can be handled?

An object in Smalltalk basically is a message, yes, that carries with it something that says what can be done to it. Visi On objects are not that complex. They're objects . . . yes, they do have context of what their formatting is, but they aren't Smalltalk objects. We just call them an object store. The lowest level of the system is an object-oriented system, though.

#### Visi On's Architecture

Could you talk about Visi On's architecture?

Sure, I don't have any problem with that. Visi On basically is composed of three levels. The lowest layer is called the Visihost. That's the machine-dependent code. At completion time, it will be approximately 35K bytes of code, of which two-thirds is C and one-third is assembly language. Now, the Visihost and the host operating system in the first version of Visi On, which is for MS-DOS 2.0, must always be resident. So you're talking about 50K bytes that must always be resident. That's the base system.

Visihost is an object-oriented operating system, and it's composed of 10 object types. A better description would be abstract data types. The objects or types include things like file device, keyboard, sound-maker, raster, segments, ports, etc. But what they actually implement is a layer above which is the Visihost interface. The Visihost interface is machine independent and provides the services that are required by Visi On itself.

Visihost uses the concept of objects to implement above it what look to the user like a lot of concurrently processing activities. You can establish

# Eye-Guard™... the only anti-glare shield\* made with lead to cut eye fatigue caused by glare, X-rays, UV radiation & microwaves from computer terminals.

The new Eye-Guard anti-glare screen shield is made of strong, impact-resistant, lead-impregnated acrylic.

It is identical to the material used as windows by nuclear power plants and hospital x-ray facilities to block radiation and protect personnel. And, even though Eye-Guard screen shields contain 30% lead (by weight), they are completely transparent.

Whether your eye-fatigue is caused by glare, radiation, or both, from your computer terminal, Eye-Guard will give your eyes relief.

Eye-Guard is the only anti-glare shield on the market made with lead. It's the only product that can make that claim.

It is so effective at reducing eye-fatigue and

\*Attaches to computer terminal with convenient Velcro tabs.



eliminating the possibility of damage to your eyes from computer generated radiation that it's sold with a 100% money-back guarantee of satisfaction.

If your eye-fatigue isn't absolutely eliminated in the first 30 days, we'll buy back the Eye-Guard Leaded Screen Shield for the full purchase price.

Order your Eye-Guard Leaded Acrylic Anti-Glare Radiation Shield today. 9½" x 11½" or 10" x 13" complete with velcro fasteners for easy attachment to most monitor screens, \$129.95.

Eye-Guard Leaded Acrylic Radiation Shields (without anti-glare filter), \$119.95.

Dealer inquiries invited.

Mail to:  
Langley-St. Clair Instrumentation Systems, Inc.  
132 W. 24th St., New York, NY 10011

Please ship the following Eye-Guard Leaded Acrylic Radiation Shields:

— 9½" x 11½" and/or 10" x 13" with anti-glare filter @ \$129.95 \$ \_\_\_\_\_

— 9½" x 11½" and/or 10" x 13" without anti-glare filter @ \$119.95 \$ \_\_\_\_\_

Total number ordered \_\_\_\_\_

Ship Regular  UPS  UPS Blue Label   
Parcel Post  Overseas

Add \$4.00 each for shipping and handling.

Add \$10.00 for shipping overseas, parcel post or UPS Blue Label.

Add sales tax where applicable.

Charge to my MasterCard  Visa

No. \_\_\_\_\_ Expires \_\_\_\_\_

My check for \$ \_\_\_\_\_ including shipping costs enclosed.

Ship to:

NAME \_\_\_\_\_

ADDRESS \_\_\_\_\_

CITY \_\_\_\_\_ STATE \_\_\_\_\_ ZIP \_\_\_\_\_

••• Langley-St. Clair Instrumentation Systems, Inc.

132 W. 24th St., New York, NY 10011

Circle 437 on Inquiry card.

# HIGH RESOLUTION GRAPHICS

FOR SUPERBRAIN, COMPUSTAR, Z-89 & TRS-80 MODEL II.

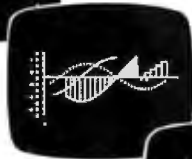
**XCEL™ HARDWARE:** A retrofit package for graphics display with 512 x 240 resolution. TRS-80 Mod. II, \$595. All others, \$895.

**XCEL™ SOFTWARE:** Operates under CPM™ and is compatible with Basic, Fortran, Cobol, PLI and Pascal.



## SYMBOL GENERATOR - \$175

Alternate character sets with bold face, 90° rotation, circles, quadrants, vectors, rectangles and area fills.



## GRAPH PLOTTER - \$175

Line, graph, histogram, bar graph and scatter plot with automatic annotation of axes scaling.



## 3-D GENERATOR - \$345

Creating, editing and viewing "wireframe" objects from any angle with scaling zoom and graphics editor.



## SURFACE PLOTTER - \$395

True perspective view with hidden line removal.

## GRAPHICS TERMINAL - \$395

Configures computer as a low cost graphics terminal.

## "NEW" SCREEN PRINTER - \$65

Allows hard copy printout on most dot matrix printers.

**SAVE UP TO \$950 ON PACKAGE PRICE OFFERS!**

FOR MORE INFORMATION CALL (213) 320-6604



**MAXTEK, INC.** 2908 Oregon Court, Torrance, CA 90503

Available in Europe from Micronex Ltd., Chew Magna, England 3042 (STD 027-589 3042)

IBM, PC registered trademarks. Tandy, Corp. registered trademarks. Inteltek, Data Systems, Telex, Commodore registered trademarks. CPM registered trademark. Digital Research.

instances of the objects by just sending messages to them on a Smalltalk message-class type interface. You end up with a process ID or an object ID, which is very similar to a concept in Smalltalk.

The whole concept here is that everything is machine dependent, and the whole virtual machine upon which Visi On rests is isolated. Above that sits Visi On itself; internally we call it the Visi On Operating System, VOS.

## The Visi On Operating System

Visi On, or VOS, is an activity to Visihost, as are all products—applications programs. As far as Visihost is concerned, everything that sits above it is an activity to it. What's special about VOS to Visihost is two unique capabilities. First, VOS is the only activity that actually does direct Visihost calls. All other calls come through VOS itself. In other words, VOS does a pass-through, so a product thinks it's doing all calls to VOS. Second, VOS is the only activity that communicates with the user, meaning the only activity that directly receives keystrokes and mouse points. So the VOS is a very key activity; it's the one that sits in the middle of everything. It's the one that is really the concurrent operating system.

Now, what VOS implements is all of the Visiops, the basic operations for reading and writing the files and all the things you'd expect an operating system to do. Included in that is also all of the device layer. That is a layer in itself, because we have not only developed this archive, but also a Graphics Kernel Standard (GKS) Virtual Device Interface. And we extended that to include alpha text, so it's not just the GKS. We can handle, from the same interface, total device-independent printing to output devices.

The other thing that Visi On implements directly is the BITs, which a product merely calls and says, "Do it, and here's what I need," and then Visi On handles the whole thing. Visi On will even replace its screen, its part of the window, and then put back the initial contents when it's done.

Something else that looks to a

# How to make dBase II™ work magic. It's a snap with Autocode.™

Finally, the first practical application of artificial intelligence in personal computer software. Autocode 1 is a powerful program generator for dBASE II. No prior knowledge of programming required.



## STEMMOS LTD.

666 Howard Street, San Francisco, CA 94105

Just send the following to address above today.

- Your diskette format & hardware
- Your name & complete address
- How many Autocodes you want at \$200 each.\*
- A check or money order.

ORDER TOLL FREE 800-227-1617 (Ext. 417) IN CA CALL 800-772-3545 (Ext. 417)

Credit card buyers may substitute their card number and expiration date for the check. Or call us toll free and save the trip to the mail box.



U.S. Address: 666 Howard St. San Francisco CA 94105 / U.K. Address: 344 Kensington High Street, London W1. Tel: (415) 777-3800 Dealer Inquiries invited Tel: 01 602 6242

dBASE: II™ Ashton Tate

\*In California add 6% sales tax.

Autocode 1™ Stemmoss Ltd

# The new COMPAQ Portable Computer. IBM compatibility to go.

**S**imple, isn't it? The COMPAQ™ Portable Computer can do what the IBM® Personal Computer does. To go.

It runs all the popular programs written for the IBM. It works with the same printers and other peripherals. It even accepts the same optional expansion electronics that give it additional capabilities and functionality.

There's really only one big difference. The COMPAQ Computer is designed to travel.

Carry the COMPAQ Computer from office to office. Carry it home on the weekend. Or take it on business trips.

If you're a consultant, take it to your client's office.

If you use a portable typewriter, you can use the COMPAQ Computer as a portable word processor instead.

If your company already uses the IBM Personal Computer, add the COMPAQ

you'd probably need to buy an additional display screen because the built-in screen is too small for certain tasks, like word processing. The COMPAQ Computer's display screen is nine inches diagonally, big enough for any job, and it shows a full 80 characters across. And the built-in display offers high-resolution graphics and text characters on the same screen.

The bottom line is this. The COMPAQ Computer is the first uncompromising portable computer. It delivers all the advantages of portability

In the standard configuration, the COMPAQ Computer has three open slots for functional expansion electronics as your needs and applications grow. It accepts standard network and communications interfaces including ETHERNET™ and OMNINET™.

If you're considering a personal computer, there's a new question you need to ask yourself. Why buy a com-

puter that isn't portable?

For more information on the COMPAQ Portable Computer and the location of the Authorized Dealer nearest you, write us. COMPAQ Computer Corporation, 12330 Perry Road, Houston, Texas 77070. Or call 1-800-231-9966.

without trading off any computing power capability. And what do those advantages

cost?

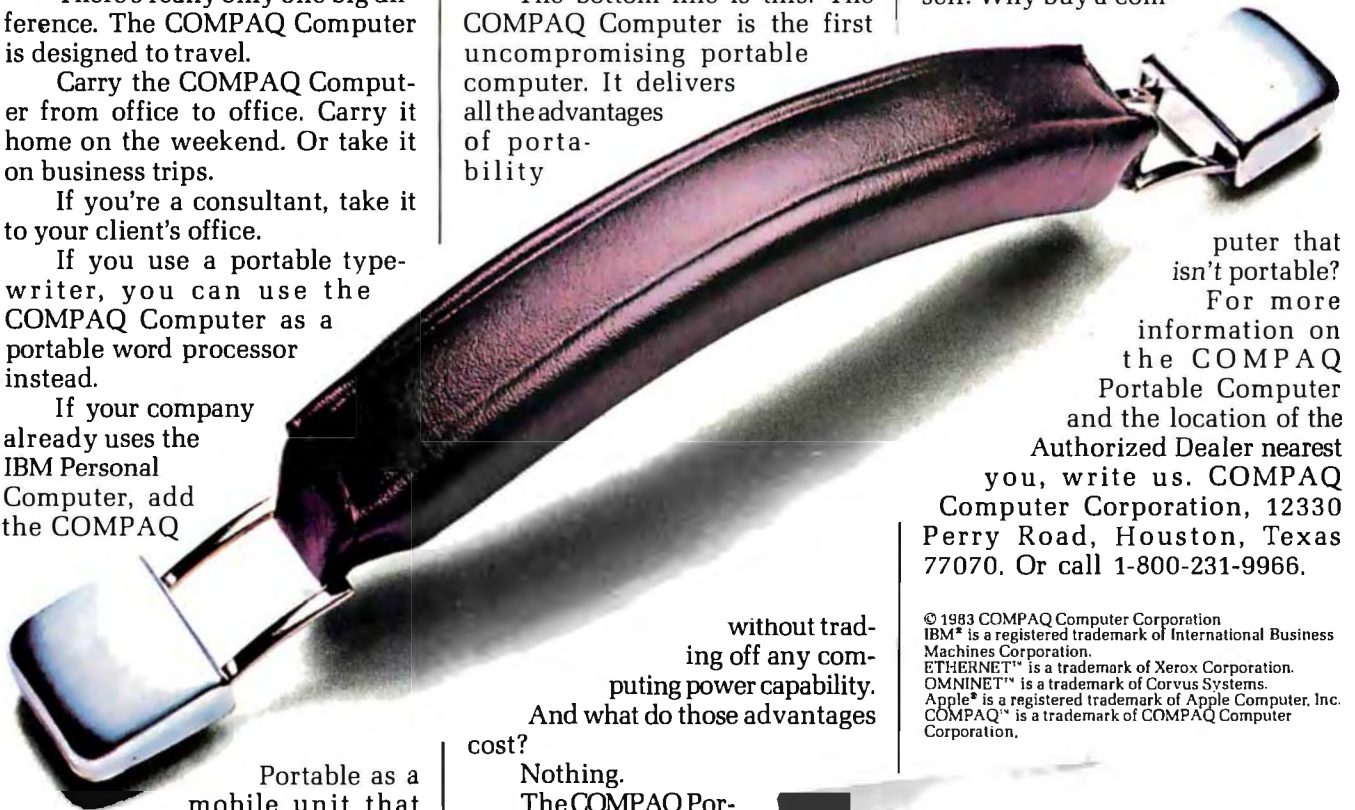
Nothing.

The COMPAQ Portable sells for hundreds less than a comparably equipped IBM or APPLE® III. Standard features include 128K bytes of internal memory and a 320K-byte disk drive, both of which are extra-cost options on the IBM. Memory and additional disk drive upgrades are available options to double those capacities.

Portable as a mobile unit that can use the same programs, the same data disks, and even the same user manuals.

There are more programs available for the COMPAQ Computer than for any other portable. More, in fact, than for most non-portables. You can buy them in hundreds of computer stores nationwide, and they run as is, right off the shelf.

With most other portables



## COMPAQ™

PORTABLE COMPUTER

The most computer you can carry Circle 71 on Inquiry card.

product as if it's part of Visi On is a series of activities which are really separate. That series includes the files window, the workspace window, the scripts window, and the services window. Even though they might appear to be part of Visi On, they really sit on top of Visi On and use the services that happen to . . .

#### Just as applications do?

Just as applications do.

#### So all the applications go to these same services?

All the applications use these services, but they do so through Visi On. What you have above Visi On or VOS itself is an interface we call the Visimachine interface. That is all of the calls that you need as a product designer to use all of the facilities provided by Visi On.

#### This is the virtual machine?

For product designers, this is the virtual machine.

#### What's the relation to Visihost?

It's much more extended than Visihost. The whole idea of this architecture is that of nested abstract machines. The concept originated

with Edsger Dijkstra back in his THE (Technische Hochschule Eindhoven) operating system in the early 1960s. You have a low-level machine that implements all the very very basic functionality, and that's Visihost. That does the reading and writing of basic files. But the archive does a lot more—and that's in Visi On. It will do your basic device puts and gets—whatever it takes to read and write to a device—but it doesn't know anything about this whole virtual device interface above it. You have to have a driver that knows in between the two.

So what you have is a very low-level machine that provides just basically a virtual memory machine. That's very important. All these products run in the pseudovirtual memory that we developed in software. You have this low-level machine, and above that is Visi On itself, which is much higher level services for products, and it's machine independent. We've nested the greatest amount of coding in the smallest possible area.

The Visimachine spec is the specification for all of these high-level services: the Visiops, the BITs, and all of the higher-level functions that Visi On provides through the services windows. For a product sitting on top of the Visimachine, it is as if the product is running all by itself in its own virtual machine, in its own virtual memory, so it has as much memory as it wants, and all the product is doing is communicating with Visi On.

The theory of the interface comes from Brinch Hansen's concept of concurrent processes, which he calls "communicating sequential processes." What it means to us is that as far as calls are concerned, the Visimachine and the activity interface look to each other like two big programs with dual entry points.

Every call that Visi On makes—remember, Visi On is the only thing that gets a keystroke or listens to the user—every time the user does something that causes an input to the product, Visi On says to the product, "Here, do this," and then Visi On's blocked for I/O (input/output).

## Make your micro work like a mainframe.

First, neatly tape the "370" label onto your IBM Personal Computer.

Now slip a dBASE II™ disk into your main drive.

That's it: your IBM PC is now ready to run a relational database system, the kind IBM put on their mainframes last year.

And you're ready with more data handling power than you would have dreamed possible before dBASE II.

With a word or two, you *create* databases, *append* new data, *update*, *modify* and *replace* fields, records and entire databases. *Display* any information, *report* months worth of data in minutes and *zip* through input screens and output forms.

You can use it interactively for answers right now. Or save your instructions and repeat everything with two words: *do Manhours*, *do Project X*, *do* whatever has to be done.

To try dBASE II free for 30 days, drop by your local computer store. Or if they're sold out, call us at (213) 204-5570. If you don't like it, you get your money back.

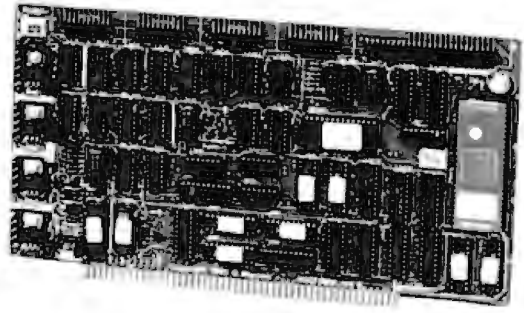
But if you do that, you'll have to remove the label. Because nothing short of a mainframe works like dBASE II.



## Ashton-Tate

© 1982 Ashton-Tate  
CP/M is a trademark of Digital Research

# NEW TARBELL 5-INCH HARD DISK SYSTEMS



Tarbell now offers you a line of 5-inch hard disk systems with amazingly low cost per megabyte. The systems come in 5, 10 or 16 megabyte formatted configurations.

Each system includes: 5-inch disk drive, 8-inch metal frame with 5-volt and 12-volt regulators,

hard disk controller and cable, CP/M 2.2 for Tarbell floppy and hard disk, and documentation.

Features include data transfer rate of 5 megabits per second and average seek time of 120 milliseconds.

## LESS COST PER MBYTE

5 Mbyte hard disk subsystem .....	\$2095
10 Mbyte hard disk subsystem .....	\$2265
16 Mbyte hard disk subsystem .....	\$2375
Cabinet including power supply .....	\$200

## EMPIRE COMPUTER SERIES ALSO NOW OFFERS 5-INCH HARD DISKS.



The Empire series of computers are now available with 5-inch hard disk systems in the 5, 10 or 16 megabyte versions.

All Empire computers can be purchased as multi-user systems offering additional ports for 4 CRTs and 2 printers, and including 256K main memory.

*Tarbell*  
Electronics

950 Dovlen Place, Suite B  
Carson, California 90746  
(213) 538-4251

Manufacturers of computers, components and software.

# COMPUShACK



**Special  
of the  
Month!**

## IBM PC- COMPLETE LINE

### IBM

PC System includes 64K IBM-PC with 320KB Floppy Disk Drive, Controller, Color Graphics Card, Monochrome Monitor. All for only . . . . . **\$2599.00**

**LOTUS 1-2-3 SOFTWARE . . \$459**

### TAVA CORP. PRODUCTS



#### TRUMPCARD

A unique memory card with 256K Ram Game I/O and Serial I/O . . . **\$499.00**

#### TRUMP CARD II

Serial I/O and 512K fully populated memory card . . . . . **\$699.00**



#### TRUMP CARD V

Features Parallel and Serial I/O. Game I/O and a Clock/Calendar with battery back-up. A fully populated 256K memory board . . . . . **\$599.00**

#### PERSYST

Time Spectrum, Four Function Card 64K Ram, Clock Calendar, Parallel Port Serial Port . . . . . **\$399.00**

#### QUADRAM

Quad Board - 256K, Parallel Port, Serial I/O. Clock Calendar with battery backup . . . . . **\$599.00**

512K Ram with Serial I/O . . . **\$799.00**

#### AST RESEARCH

Combo Plus- 256K, Parallel & Serial Port, Clock Calendar W/Bat. back-up, Superdrive, Superspool . . . . . **\$499.00**

Mega Plus- 512K, Parallel & Serial Port, Clock Calendar W/Bat. back-up **\$999.00**

#### MAYNARD ELECTRONICS

Floppy Disk Controller . . . . . **\$179.00**

Floppy Disk Controller w/Parallel Port . . . . . **\$229.00**

Floppy Disk Controller w/Serial Port . . . . . **\$239.00**

#### HERCULES GRAPHICS CARD

This card gives you 720 x 350 graphics . . . . . **\$499.00**

### BIG BLUE

Dual I/O ports, dual processing, Serial port, Parallel port, 5 MHz, Z80 B, 64K, Hard disk interface, Clock/Calendar, lets you run existing CP/M® software.

List **\$589** . . . . . Ours **\$479**

### DISK DRIVES

For IBM PC

Tandon 100-2 . . . . . **\$249**

Teac 55-B Slimline 320KB . . . . . **\$279**

Shugart SA-455 Slimline 320KB . . **\$259**

### OTHER PRODUCTS FOR IBM

### MODULE CONVERSIONS FOR YOUR IBM-PC



**Z-80  
8086  
68000**

**80286  
16032  
UNIX/XENIX™**

Visit our Stores for more details!

### FLOPPY DISK DRIVES

#### SHUGART

SA400 SS/SD . . . . . **\$169.00**

SA450 DS/DD . . . . . **\$239.00**

SAB00/801 SS/SD . . . . . **\$365.00**

SA850/851 DS/DD . . . . . **\$459.00**



#### TANDON

TM-100-1 SS/DD . . . . . **\$189.00**

TM-100-2 DS/DD . . . . . **\$249.00**

TM-100-4 DS/DD . . . . . **\$359.00**

TM-848-1 SS/DD . . . . . **\$425.00**

TM-848-2 DS/DD . . . . . **\$499.00**

#### SIEMENS

FDD 100-5 . . . . . **\$159.00**

FDD 200-5 . . . . . **\$199.00**

#### QUME

DT-5 DS/DD . . . . . **\$269.00**

DT-8 DS/DD . . . . . **\$469.00**

### HARD DISK SYSTEMS FOR IBM AND APPLE

#### DATAMAC

6MB . . . . . **\$1395.00**

12MB . . . . . **\$1595.00**

18MB . . . . . **\$1995.00**

Complete subsystem with software, cables and power supply.

#### DAVONG FOR IBM

	Internal	External
5MB . . . . .	<b>\$1495</b>	<b>\$1695</b>
10MB . . . . .	<b>\$1795</b>	<b>\$1995</b>
15MB . . . . .	<b>\$2295</b>	<b>\$2495</b>
21MB . . . . .	<b>\$2595</b>	<b>\$2795</b>
32MB . . . . .	<b>\$2995</b>	<b>\$3195</b>

### PRINTERS



#### EPSON

FX-80 FT w/Graftrax Plus . . . . . **\$599**

FX-100 FT w/Graftrax Plus . . . . . **\$799**

MX-80 FT w/Graftrax Plus . . . . . **\$499**

MX-100 FT w/Graftrax Plus . . . . . **\$699**

#### STAR MICRONICS

Gemini 10 . . . . . **CALL**

Gemini 15 . . . . . **CALL**

#### SMITH CORONA

TP-1 parallel . . . . . **\$579.00**

TP-1 serial . . . . . **\$579.00**

#### C-ITOH

GX-100 (50 CPS Dot Matrix) . **\$249.00**

8510 . . . . . **\$469.00**

1550 (15") . . . . . **\$699.00**

F-10 (40 CPS, Letter Qual.) **\$1395.00**

F-10 (55 CPS, Letter Qual.) **\$1695.00**

#### NEC

#### SPINWRITER



**NEC**

7710-1 . . . **\$1995** 3510 . . . **\$1395**

7715-1 . . . **\$2195** 3515 . . . **\$1395**

7730-1 . . . **\$1995** 3530 . . . **\$1595**

7720-1 . . . **\$2595** 3550 . . . **\$1895**

7725-1 . . . **\$2595** PC8023A . **\$ 495**

#### OKIDATA

82A . . . . . **\$429.00**

83A . . . . . **\$699.00**

84AP parallel . . . . . **\$999.00**

84AS serial . . . . . **\$1099.00**

92A . . . . . **\$525.00**

93A . . . . . **\$999.00**

\*IBM is a registered trademark of IBM Corporation

\*APPLE is a registered trademark of Apple Computers, Inc

\*CP/M and CP/MB6 are registered trademarks of Digital Research, Inc

**WE'VE MOVED  
TO BIGGER FACILITIES  
TO SERVE YOU BETTER  
PLEASE NOTE OUR NEW PHONE**

# (714) 261-1000

Sales and Service: Business & Home Computers

PRICES AND AVAILABILITY SUBJECT TO CHANGE WITHOUT NOTICE

## TAVA PRINTERS BY DIABLO



620 (125 CPS) ..... \$899.00  
630 (CALL) ..... \$2395.00

## ANADIX PRINTERS

### DP9500A

150 CPS, Dot Matrix 132 Col \$1395.00

**DP9501** Same as (DP9500A)  
W/Graphics ..... \$1495.00

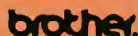
### DP9620

200 CPS ..... \$1495.00

## IDS PRISM

Prism 132 (8 & W) ..... \$1395.00

## BROTHER

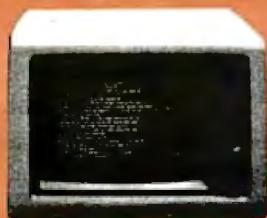


HR-1 A parallel ..... \$769.00

HR-1 A serial ..... \$869.00

Tractor feed option ..... \$135.00

## MONITORS



AVAILABLE (All Models) ..... CALL

### AMDEK MONITORS

Color I ..... \$359.00

Color II ..... \$699.00

Color III ..... \$399.00

300A ..... \$199.00

310A ..... \$239.00

### PRINCETON GRAPHIC SYSTEMS

His Res. Color ..... \$599.00

### TELEVIDEO

910 ..... \$699.00

925 ..... \$799.00

950 ..... \$999.00

### SINCLAIR/TIMEX PRODUCTS

### MEMOTECH PRODUCTS

16K Memopack ..... \$ 59.00

32K Memopack ..... \$ 99.00

64K Memopack ..... \$169.00

Memopack High Res. Graphics ..... \$139.00

Memopack Centronics parallel Interface ..... \$139.00

### EPSON QX-10

Z-80 CPU, w/64K Ram Video Graphics Processor, 12" monitor and many more features ..... CALL

### HX-20

Notebook Computer ..... CALL

## EPD PRODUCTS

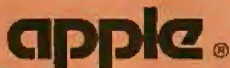
Lemon Surge Protector ..... \$49.95

Lime Surge Protector ..... \$79.95

Peach Surge Protector ..... \$89.95

Orange Surge Protector ..... \$129.95

Plum Surge Protector ..... \$48.95



**Apple IIe** 64K Complete System, 80 Column Card, One Disk Drive w/Controller, Monitor, Stand, plus 20 diskettes ..... \$1995.00

**Apple II+** Compatible Computer System W/48K of memory. One "Data Drive" disk drive, Controller card, 12" green screen Hi-Resolution Monitor. All Cables are included for a Compushack price of ..... \$999.00

## OTHER PRODUCTS FOR APPLE

### Special of the Month!

TAVA CORP.  
DATA DRIVE®

**\$259**



100% Compatible Disk drive for APPLE II+ and APPLE IIe. Runs DOS, CPM®, Pascal software.

Suggested retail price ..... \$399.00

Z80 card CPM® included ..... \$159.00

80 column card ..... \$179.00

Disk drive controller card W/ diagnostics software ..... \$99.00

Disk drive controller ..... \$79.00

## HAYES MICROCOMPUTER PRODUCTS

Micromodem II 300 baud ... \$299.95

Smartmodem 1200 baud full duplex ..... \$529.95

## KAYPRO II COMPUTER SYSTEM

64K Ram, Perfect Writer, Perfect Filer, Perfect Speller, Perfect Calc, S-Basic, CPM® version 2.2, two disk drives, 9" (green) monitor, RS232 interface, Parallel Printer interface ..... \$1699.00

## DEC Rainbow 100

Keyboard, CPU, Z-80/8088, 64K, Serial RS232 Port, Two X-400KB Disk Drives, Monitor, CP/M86®/80 Software, Printer and cable ..... \$3495.00

## DECMATE II

Complete System, Keyboard, CPU, 64K Words Ram, two 400 KB disk drives, monochrome monitor, operating system ..... List \$4500.00

## DEC PROFESSIONAL 300

Complete System, Keyboard, CPU, 256 KB Ram, two 400 KB disk drives, monochrome monitor, operating system ..... Under \$5000.00

## CALL YOUR LOCAL COMPUSHACK DEALERS:

# CompuShack®

California	Tustin	(714) 730-7227
	San Ramon	(415) 838-2233
	Glendale	(213) 340-7000
	La Mirada	(213) 947-9505
	Pasadena	(213) 792-8889
	San Fernando Valley	(213) 906-7000
	San Jose	(408) 973-1444
	Irvine	(714) 261-1000
	Walnut Creek	(415) 945-8011
	West L.A.	(213) 906-7306
Colorado	Woodland Hills	(213) 888-0030
	Denver	(303) 422-4545
Idaho	Twin Falls	*
	Chicago	(312) 964-4612
Illinois	Great Falls	*
	Missoula	(406) 721-1811
Montana	New York	(800) 228-5525
	Rochester	(716) 924-2544
	Rome	(315) 336-0266
New York	Austin	(512) 258-1062
	Richland	*
Texas	Spokane	*
	Verona	(608) 845-7110
Washington	Toronto	(416) 593-8974
	London	01-935-0480
Wisconsin		
Canada		
U.K.		

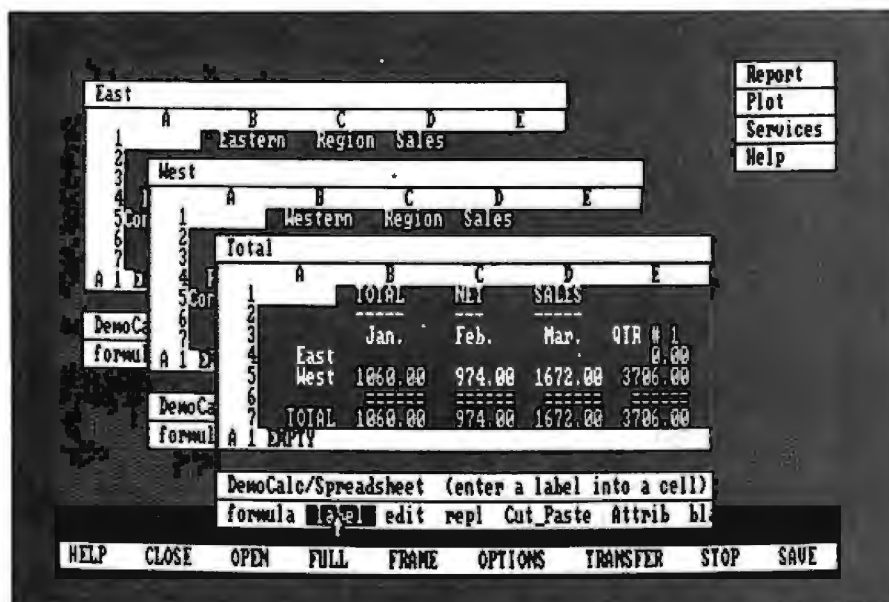
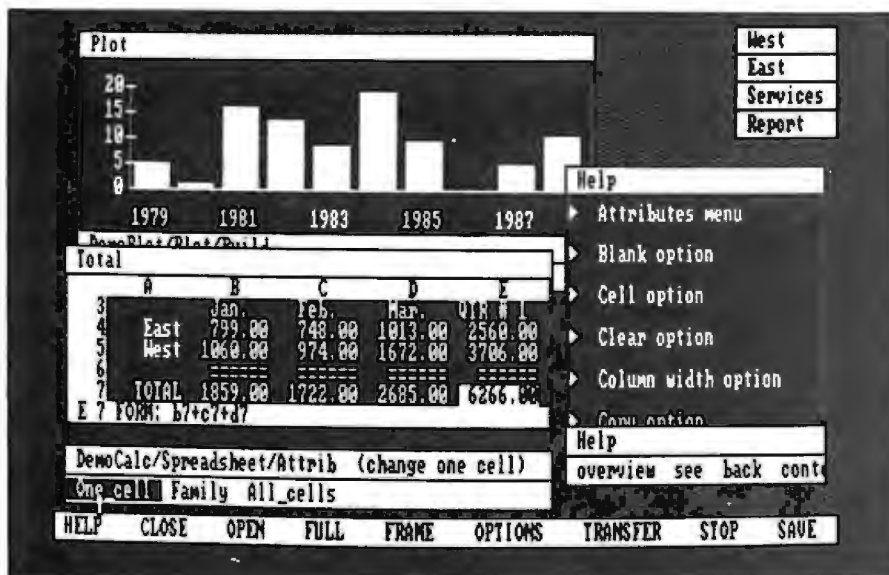
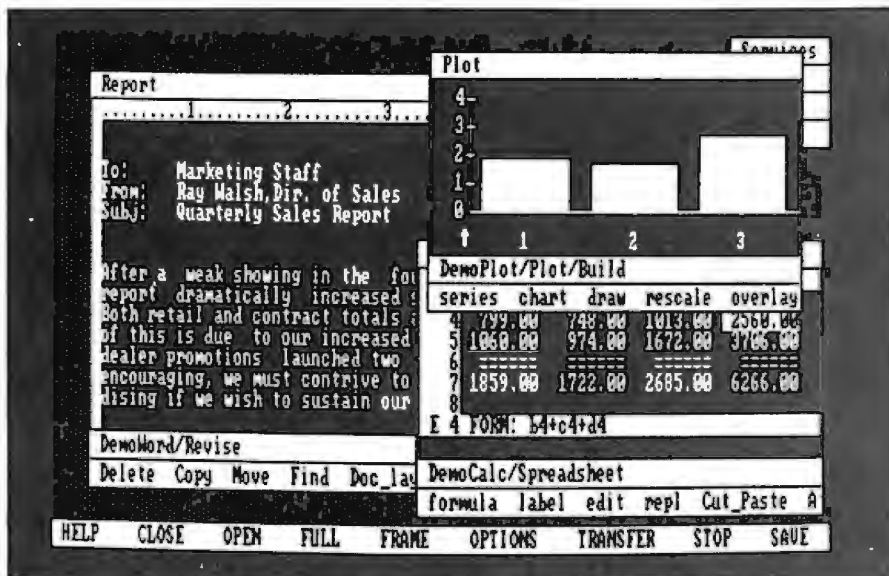
\*CALL FOR NUMBER

ALL FLOPPIES REPAIRED QUICKLY AT LOW COST

\*DATA DRIVE, APPLETTTE 1, APPLETTTE 2, and TRUMP CARD are registered trademarks of TAVA Corporation

16861 ARMSTRONG, IRVINE, CA 92714

HEADQUARTERS/TELEX: 181667—ANSWER BACK: COMPSHACK IRIN



You'll see the hour-glass come up; Visi On can't do anything. The product will execute whatever processing it has to do and will say to Visi On, "Here, here's your response." Then Visi On will come to life, and the product is blocked. That's the communicating sequential processor.

The real idea of making this into a concurrent process is that as far as Visi On is concerned, it has a lot of those products or processes going on, and in its tightest inner loop, Visi On is also keeping track of the mouse and keeping this background printer printing or whatever happens to be going on.

### The Programs under Visi On

At the top end, you have the applications activities themselves. They're programs that have been developed for this high-level operating system, running in their own memory, using these very high level calls. When these programs are compiled, they have this large header file that you have to include at compile time. This header has all the definitions of all those calls and all the definitions of all the data types and so on, so that now all you have to do is develop your routines underneath that. It's a fairly complex architecture.

You're doing this all in C, you say, or two-thirds in C?

VOS is about 100K bytes of C, plus about 20K bytes of data. . .

It's compiled C, 100K bytes?

Yes, this is really 100K bytes of object code, but it's from C. Plus about 20K bytes of data space. Visi On itself and the products are all in virtual memory, so only a part of that has to be resident at any one time.

Visi On requires 256K bytes of RAM? 256K minimum. With MS-DOS 2.0, that only leaves us about 230K bytes to use, and we're going to need between 128K and 150K bytes to efficiently run multiple activities. In reality, our concept of virtual memory means you could run in less memory, but not with high performance, and if the system isn't very interactive, you lose everything. We did a lot of testing when we were going through our prototyping phase,

Sample screen displays of Visi On windows.



# Microsoft languages connect your software to more 16-bit systems.

**The largest market for 16-bit software.** Over 95% of all 16-bit microcomputers run Microsoft® operating systems, languages, or both. That means your programs written in Microsoft languages find their market in the largest installed base of 16-bit systems. The IBM® PC, and systems from Wang, Zenith, DEC, Victor, Altos, Texas Instruments and Radio Shack, to name just a few. And, if you're working with Microsoft operating systems and languages, you'll find that it's far easier to transport software between systems.

**A full range of languages.** The versatile MS BASIC interpreter and the fast MS-BASIC compiler. Microsoft Business BASIC and MS-COBOL for business use. MS-FORTRAN for scientific and engineering applications. Microsoft C, a complete C, that provides a productive alternative to assembly language. And MS-Pascal, a high-level language compiler specifically designed for microprocessor system software implementation. All these languages are compatible with ANSI or ISO standards.

**A total programming environment.** Compatible

first production microcomputer. Since then, we've added a full range of 8-bit and 16-bit languages, plus the MS™-DOS and XENIX™ operating systems. What's more, we are constantly enhancing both languages and operating systems. And we make those enhancements available to our customers. That means Microsoft programming languages are state-of-the-art programming tools. Tools that allow your applications programs to reach more systems. More effectively.

**More information?** See your Microsoft dealer for complete information on Microsoft's 16-bit languages and operating systems. Or, write for our booklet, "The Microsoft Language Family." A family

MICROSOFT CORPORATION  
10700 NORTHUP WAY  
LEEVUE, WASHINGTON 98004

to write software that s  
**Leadership in micros**



Microsoft is a registered trademark, and MS, XENIX and the Microsoft logo are trademarks of Microsoft Corporation.

and there is a threshold under which, if the system doesn't respond fast enough, you just may as well not have the system at all.

**It doesn't look as if having a lot of memory will be a problem in most systems for much longer.**

That's one of our hopes. A significant part of this system is the virtual memory, which is quite a bit of work for us to implement. The virtual memory requires that, at least early on, all of the programming development will have to be done in C. We have to use our linker because we've created a concept of segments of memory that can be paged in and out. It's obviously not real virtual memory because we don't have hardware support to do virtual pages. But a segment looks like a virtual object page in Smalltalk with what they're trying to do, which says that a segment is more like an overlay than it is a page. It includes a whole bunch of objects that should be run together. As far as we're concerned, a segment can be of adjustable size. You can have both code segments and data segments. Data can be swapped in and out and paged as well. Everything will be in virtual memory, of course, but only so much will be resident at any one time. The whole memory manager is down in Visihost.

Complicating this, of course, is the need for all the code to be position independent. That's one of the things we had to do with our linker. Everything can be relocated to any position. Another complication in this architecture is that we have to contend with the segmented architecture of the 8086 family and those chips' idea of long calls (outside a 64K-byte segment) and short calls (within a 64K-byte segment). We have to straighten up all of those calls at load time and at run time. But the memory management does work rather efficiently.

### Porting Visi On

You wanted to talk about how we port the system. The concept is a two-phase portation, where we actually do the portation of Visi On to any

new architecture. To us, a new architecture is a combination of any change in operating system or any change in the central processing unit. That's the major portation, when the Visihost has to be rewritten. Visihost is actually assembly language. So we will have different versions of it. Initially we have one for the 8086/8088, 80186 family with MS-DOS. The new one we're intending is a 68000 version, probably with Unix, maybe with MS-DOS as well, but we will extend those versions. That's number one. We'll do that work in-house.

Let me back up. The second part of the portation is the target conversion, where we actually take the adaptation for one processor and one operating system and put it on a specific target machine. We configure it to the bit map of the screen, to any calls that are different for the keyboard, any changes in how they handle fonts, and so on. We do allow loadable fonts.

What we do on the second part of the portation is sort of like doing your BIOS (basic input/output system) for CP/M, but we're going to provide to the OEM (original equipment manufacturer) the source for the Visihost, a specification, and a test program to assure that all the calls work. And the idea is that the OEM would do that part of the conversion. It could target to its machine. There will be small changes. If its mouse is different from our mouse, it will have to change a driver to take advantage of that, and so on.

**You've talked about MS-DOS so far, and not CP/M-86. Your announcement said you were going to do Visi On for that as well.**

We do intend to do it for CP/M-86.

**But not until the second version. What about CP/M-68K or the other Digital Research operating systems?**

We do intend to do it across CP/M lines. The number one objective is to get one version out late this summer. We have announced on DEC, we have announced on TI, and there'll be other announcements coming.

**More on Applications Programs  
Can you talk a little more about the**

**applications programs themselves? Are they being managed as a separate project?**

Well, they're all managed as separate projects, but they're all under my group. Right now, we intend to release all five—one product for each of the five applications that we consider major: spreadsheet, word processing, business graphics, database, and communications. Most of those five programs will be released right at ship time or within a few weeks of the Visi On system itself.

They're being developed totally independently. I mean they'll be developed as independent projects, from scratch. They're being designed to take full advantage of the system and all the utilities provided by the system. And they are significantly upgraded in features and functions above our stand-alone product line. We hope we've learned quite a bit about what our competition has taught us and what the marketplace has taught us.

I will tell you that one of the major things we're trying to do is adapt to our conception of human factors—context, guidedness, the principle of direct manipulation where users directly manage the data and receive immediate responses to their actions. We think that's very important. Visicalc was the first product out that let users do that. They could build very complex models by building them one number at a time and seeing that something was right or wrong and changing it and actually not have to go through a series of steps to rebuild it. We think that's important throughout all the products. Users don't want to have to learn some pseudoprogramming technique to get to an ending, to go through lots of steps and not necessarily see if something is right or wrong. So we're making a heavy effort on that.

As a matter of fact, we not only have this Visimachine specification and a lot of tools to go with it, but our human factors project—the Nova project, which still has resources devoted to it—produced a manual we call the *Designer's Guide to Well-Behaved Products*. That not only details the whys and wherefores of

# FACIT 4510



*Engineered for quality*



*Intelligent block and pin graphics*



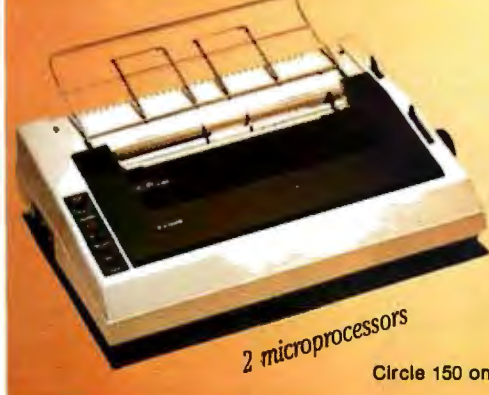
*Both industry compatible*



*Smart, Low Cost Printer*



*Fully configured*



*2 microprocessors*

## To put your micro computer on printing terms

**T**he Facit 4510 Low Cost 80-column Serial Matrix Printer is a thoroughbred micro printer. Engineered for quality and professional computer outputs.

Facit 4510 fully configured features most printer options as standard. State-of-the-art micro-processor concept and a 2K-work buffer accepts printing data as fast as your computer can send it. Versatility comes from industry compatible interfaces – both parallel and serial RS-232-C.

Block graphics and pin graphics secure optimum system performance and give complete printing freedom.

Emphasizing multifont and high resolution capabilities including 8 national character sets as standard.

Fan fold tractor feed, single sheet and telex roll with friction feed completes your thoroughbred micro printer. The Facit 4510.

**FACIT  
DATAROYAL**

235 Main Dunstable Road P.O. Box 828 Nashua, N.H. 03061.  
Phone: (603) 883-4157.

Europe: S-10545 Stockholm, Sweden. Phone: (8) 738 6000.

Circle 150 on Inquiry card.

NOW AVAILABLE ON THE APPLE LISA™ under XENIX

# ACCOUNTING SOFTWARE FROM OPEN SYSTEMS GETS YOU UP AND RUNNING... FAST.

Looking for on-track accounting solutions to increase your company profits? Look to the software champion... The SOFTWARE FITNESS PROGRAM.

Our competition can't come close. Since 1974, we've built a track record as the pacesetter supplier of comprehensive, interactive accounting solutions for more than 30,000 customers worldwide in 200 different types of businesses. Wholesalers... distributors... manufacturers... job shops... retailers... accounting firms... businesses like yours.



the industry. Our products include training disks and owner manuals that'll put even a computer novice at ease. And, whatever your accounting needs, we've got the most advanced software you can buy—one that's designed to become more powerful as your business grows.

Anyone familiar with book-keeping can get up and running with The SOFTWARE FITNESS PROGRAM. We run on more than 50 of the best known computers in

**If your bottom line is your top priority, today and tomorrow, we've got solutions.** Ask for a demonstration from your local computer dealer.

**Dealer inquiries are invited.**



**OPEN  
SYSTEMS INC**

430 Oak Grove Minneapolis, MN 55403  
(612) 870-3515 TWX 910 576 1743

Circle 288 on inquiry card.

The **SOFTWARE FITNESS PROGRAM™**



our product model and our user model and all the principles of design, but goes through all the usages and all the BITs. It also explains all of the functionality of Visi On, how to use it and why to use it, and the preferable and less preferable things to do with it. We're designing right to that guide. It's been an evolutionary document over two years.

**There could be a trade-off between consistency in the user interface and tailoring each program to a specific application. How have you resolved that?**

There absolutely is a conflict, and resolving it is an ongoing process. We have an evaluation lab set up and we try to mock up and evaluate things. Each product has a working team that includes marketing, technical writing, and development that works out the issues. Then we have a weekly meeting of what we call the Quasar product working group—Quasar was our original name for this product. There we actually confront issues as they become problems and attempt to come up with some solutions. Anything that can't be done at that level comes up to my level, and we work it out between the director of product marketing and me. And as I said, it is not something that is easy. Where you might find 80 percent of the things easy, the last 20 percent affect the other 80 percent anyway, so you end up having to revise it and revise it. And you have to have voices that speak all sides of the problem, and you have to be able to interact with that and evaluate it.

**So it's case by case... there's no other way?**

At this point it is. We set up our overall principles of design and we actually held hard and fast from January 1982 until the end of that year, trying to design as well as we could without any violations of the principles. We made one mid-course correction, an update of the guide in the fall of last year, and now that we're in the end throes of trying to interact with these products, to get them up, we're finding things that are bothersome, and so now we're at the point where it really is a case-by-case basis.

**Are you trying this out on naive users? How do you test it?**

Internally so far.

**On people you've hired?**

People we hire, but we brought in some naive users from the outside, and beyond that we do intend to do a significant beta testing of it, but that will be later on. We don't want to do it until enough things are stable that people can really... if the system gets in the way of using it, it doesn't matter whether it gets in the way because it's not complete or it has a bug or it isn't good.

**Can you say more about installing applications?**

As far as users are concerned, all they'll do is use this services window and select the Install button. This is how we install them today in our development environment. The window will prompt users to insert the floppy disk. Once users have done that and confirmed it, the code will actually be read onto the Winchester disk itself.

Basically, the loader will set up all the appropriate addresses in each seg-

ment. So all the segments are initialized and loaded on the disk. Then all of the appropriate indexes and overview pages are updated. An item is added to the services window indicating that this product is now installed; there is an overview table for what is available in the help files. The help files are loaded from this disk into the Winchester disk. The help window's overview will show that there's a new series of things here.

**Copy Protection in the Mouse**

Finally, the serial number of the machine is appropriately encrypted and stored on the floppy disk itself, so at that point you can use that program. You can load it on the Winchester disk as many times as you want or on as many Winchesters as you want. The program will run only for the appropriate serial number, which for us happens to be in the mouse. Anywhere you take your mouse, you can run that program. How will you adapt Visi On to run with different printers? How much of that are you going to do? Or will you let the computer manufacturers do

# BUY MONITORS DIRECT!!

**\$109<sup>95</sup>** plus \$4.75 shipping

**Model TM-12PC-GX**  
12" P31 GRAPHICS

- \* 1200 line resolution
- \* 18.9 MHz band width
- © Apple III is a registered trademark of Apple Computer.

Monitors by:



VISA, MasterCard & American Express accepted. No C.O.D.

**\$299<sup>95</sup>** plus \$9.50 shipping

**Model TM-1440**  
13" RGB COLOR

- \* 360/230 lines resolution
- \* Up to 80 characters
- \* Apple III and IBM customers please add \$29.50 for factory installed mod board and cable for 16 colors.

Call Toll Free 1-800-258-6370  
18 Bridge Street, Salem, NH 03079

## Coleman on the Future of Microcomputer Software

Looking at the next generation of software beyond Visi On, and I know that's very far to look ahead, when do you think voice will become a factor in the user interface? When do you expect to have to deal with that?

Voice input . . . in some ways I guess you can consider it a factor today.

**Because of TI's announcement of the Professional Computer?**

Well, because there are several things that can take very limited amounts of voice but not a general function. I think we're going to see much further integration over the next 10 years.

**Where will the integration increase?**

In the underlying data structures, so that you really do have common data. Each program understands all the context at some level or another of every other program's data.

**What stands in the way of that now?**

Basically a definition of the underlying data base. It's a broad subject, not just to understand that something is of a certain type, numeric and alpha and so on, but also to understand all the semantics and all the metadata that go with that type, that say, for example, that this program is a spreadsheet and therefore it has the following kinds of information as far as formulas and recalculation orders; or the program is a word processor and therefore it understands all the semantics about justification and margining and the rest.

If you look ahead somehow, if you could develop an underlying context that understood all of that, there's no reason why the tools that go on top of it can't be—boy, am I talking ahead—much smarter than such tools are today. Therefore you really can do what the 1-2-3s and Context MBAs are trying to do: make one product that does everything. What MBA and 1-2-3 do is integrate some functions very prob-

lematically and nonextensibly. But if you had something that could understand all of this kind of structure then, you really would approach Smalltalk's objective. You would have lots of classes and subclasses of data that understand all the manipulations that are done on them, and all you would have to do would be little processes to change that. Therefore you really could be just typing along and in the middle of your text have a spreadsheet, which will recalculate any time and will understand any time you make a change in this model over here that this document must be updated the next time you look at it or print it out. Those things are obviously an extension of where we are trying to go with Visi On, but they aren't here now.

Voice input and the next levels above that could be much more highly interactive. The problem with voice input is that you've got to deal with the office, and in many offices you can't do a lot of talking. The real technical problem, of course, is just getting the computer to understand voice.

That's sort of coupled with knowledge-based systems as well. If you start looking at the concepts of artificial intelligence, somewhere along the way we're going to start seeing voice input in inference processing, and use of artificial intelligence will work its way into these systems. But I see a highly usable system like that as about 10 years away. You are going to see special cases of that all the way along. After all, we've seen special cases of windowing systems for 15 years.

**When do you think the features of expert systems will begin to appear?**

You're just asking my personal opinion?

Yes.

In the next couple of years, you're going to see people coming out with ex-

pert systems that have some utility. I don't think you're going to see the Visicalc of expert systems for five to seven years—that is, an expert system that is so conceptually easy to use that it will be generally adapted by a large group of people. The expert systems that come out sooner will be special-purpose, will involve special training, and will do a very small segment of a problem. But we aren't close enough there in the technology. That's just my opinion.

**What about progress in languages? Do you think that we're going to see languages that incorporate features like the new applications? Is Smalltalk going to become popular? Do you think people will ever program with languages? Will languages reach the necessary stage of ease of use, or do you think that's just fantasy?**

I don't think that people will generally write programs in the sense we're talking about writing programs today because I don't think many people easily think at the level of logic it takes to do a program. Even concepts of iteration are hard for people to understand. I do think that people will be able to develop programs by interacting with systems that are being developed now, maybe inference processing systems.

But I don't think people will sit down and learn languages even as simple as BASIC or Smalltalk to do much programming on a general basis. The potential world market for the computer/personal computer/desktop workstation is an inverted pyramid—this is an Apple model, by the way—and we've seen only the first couple of percent of the tip of that pyramid. To get farther into the pyramid, you have to get farther and farther from the actual need for people to understand computers and programming.

that for the printers they sell?

The manufacturers can do them, and we'll have at least 10 printer drivers available when we first ship Visi On. You see, to develop a driver with enough capability to handle the GKS, we're talking about drivers that are about 8K to 15K bytes. The first year

we'll support probably three to four plotters and a whole line of printers.

But the idea is that these drivers are very sophisticated, because they have to interpret calls in context to what kind of device is attached to the other end and make the appropriate trade-off. If the device doesn't allow super-

scripting or subscripting, the driver won't do it. But we will be providing a lot of drivers and there will definitely be information to write drivers. Fortunately, it turns out that a lot of the manufacturers are already signing up to develop or have developed and will provide GKS drivers. Digital

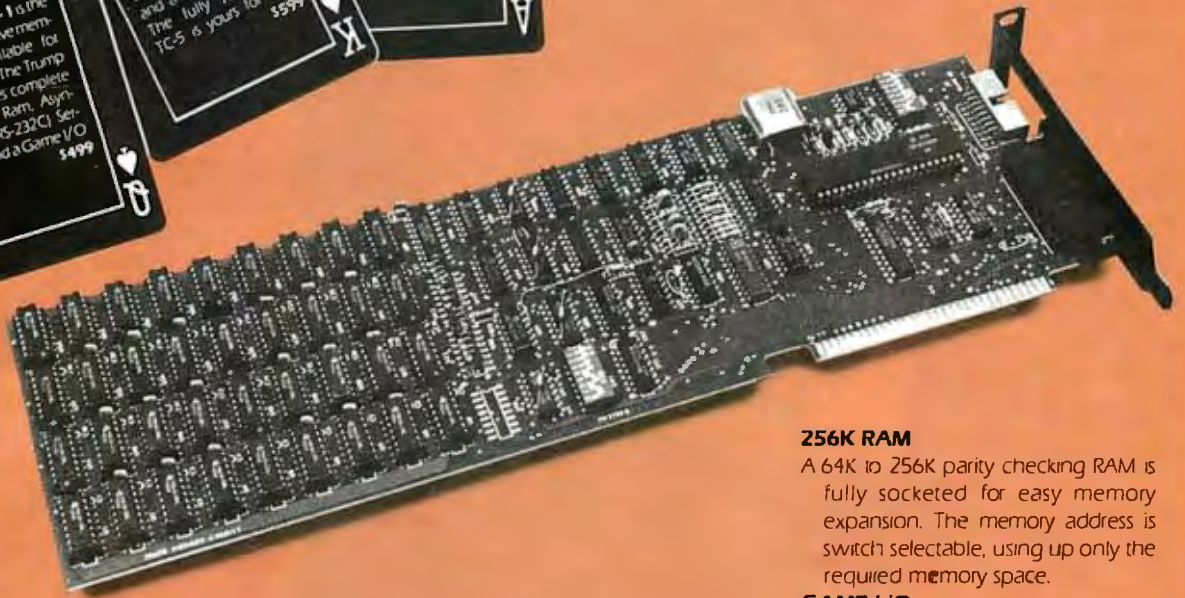
# TAVA CORP.



## INTRODUCES THE TRUMP CARD



**IBM® COMPATIBLE,  
FULLY POPULATED 256K RAM  
SERIAL I/O + GAME I/O. \$499**



**Available At  
CompuShack Stores  
OUTSTANDING  
QUALITY  
AT AFFORDABLE  
PRICES!**



For Further Information Contact:  
**Tava Corp.**  
1711 Corinthian Way Suite 1011  
Newport Beach, CA 92660  
**(714) 261-0200**

Headquarters Telex: 18-3511 Answer Back CSMA

### **256K RAM**

A 64K to 256K parity checking RAM is fully socketed for easy memory expansion. The memory address is switch selectable, using up only the required memory space.

### **GAME I/O**

Interface consisting of two joy-sticks and four switch inputs are IBM BASIC compatible. A standard GAME I/O DB 15 connector provides connection to the rear plate of the IBM computer.

### **GOLD IBM INTERFACE**

Gold connectors as well as glass epoxy PCB will provide years of reliable service, with all hardware interface meeting the IBM specification.

### **ASYNCHRONOUS COMMUNICATION**

A RS232 and 20Ma (TTY) interface supports software programmable baud rates, parity, stop bits, and character. Modem and serial printer are fully supported by the IBM communication software. A standard DB25 connector allows for the easy connection to serial devices.

\* TRUMP CARD is a registered trademark of TAVA Corporation.

\* IBM is a registered trademark of IBM Corporation.

# LABORATORY AUTOMATION

**(TAURUS LAB) + (YOUR PC) = (LAB COMPUTER SYSTEM)**

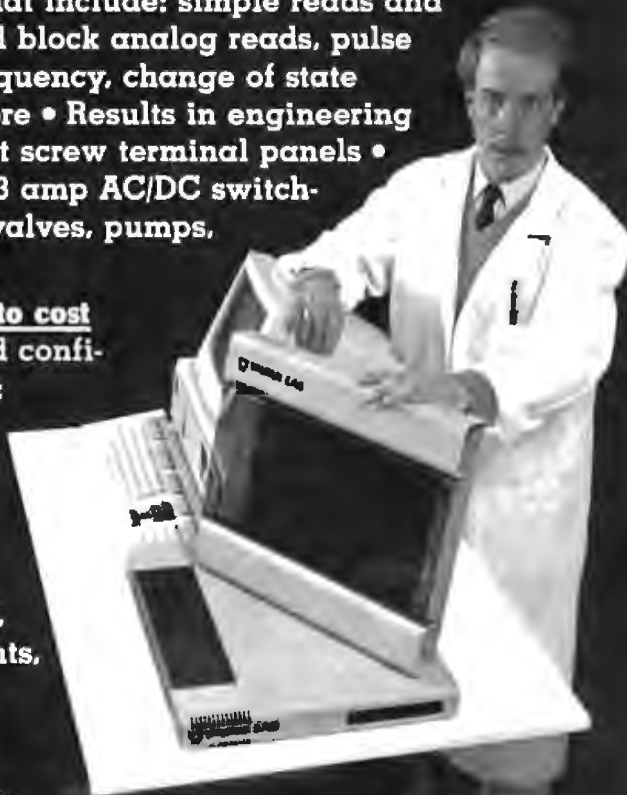
**Now a new micro computer based data acquisition and control front end that gives you:—**

**Power that's easy to use:—** Plugs into any RS232C, RS422, or IEEE port on your Personal Computer • Powerful Command functions that include: simple reads and writes, high speed block analog reads, pulse accumulation, frequency, change of state detection, and more • Results in engineering units • Convenient screw terminal panels • Compatible with 3 amp AC/DC switchers for control of valves, pumps, motors, etc. •

**Power that's easy to cost justify:—** Standard configuration includes:

64 twelve bit analog inputs with 4 programmable gains for inputs from  $\pm 10\text{mV}$  to  $\pm 10\text{V}$ , 64 digital I/O points, optional — seven 16 bit counters, 4 output pulsers, 4 analog outputs • Stand alone mode with direct terminal support • Communicates simultaneously to three computers • Low maintenance cost due to internal diagnostics •

**Power that's easy to expand:—** Plug in expansion to 1024 points of digital and analog I/O • User memory allows downline load of user written functions and programs • Rack mount hardware available for all options •



Research is already part of that.

One of the concepts of Visi On is to get people, once they've learned to use the system—which is very easy to learn to use—to a state of no longer having to pay attention to the use of the software tool, but only to solving the problem. The system should not distract people from the problem. No one is turning on the system in order to run Visi On or to run a spreadsheet under Visi On, or a word processor, graphics, whatever. People will turn the system on because they have a goal to get something done by the end of the day. Visi On is nothing more than a toolkit. We want to make sure that users can learn how to use it, not be afraid of it, get in and work quick, and get out. Users should not be concerned about where they're getting their data from. It should be possible in the future for users just to ask for some data and not worry about whether the data comes from a remote system over a telephone line, or from a local system, or from their buddy's personal computer.

The scripts capability is another important aspect of ease of use. It's a learn mode. It has a window that you can interact with. You can stop that learn mode at any time and tell the system to accept a variable. You open a scripts window and say, "learn." Then the system prompts you for a name, you type in the name, and that will be the name of a script. Maybe you go through a consolidation of three models and you combine data and you're loading models, etc. As you're going through that, you might tell the system—by reaching up and pointing into the middle of the scripts window—that something there is a variable.

When you replay that script, let's say once a month, you want to consolidate your East Coast, West Coast, and international sales plans. So once a month you can call up the script and go through it and it will stop at different points and you can type in specific items, and then the system will use the script to do the rest all by itself and print it out. The system has learned from you, and it has let you do what amounts to a form of rudimentary programming. ■

# TAURUS LAB®

Write for more information to:



**TAURUS  
COMPUTER  
PRODUCTS  
INC.**

IN U.S.A.:

C/O I.M.S.  
P.O. BOX 1663  
BUFFALO, N.Y.  
14203

IN CANADA:

P.O. BOX 911  
STATION "U"  
TORONTO, ONT.  
M8Z 5P9

Circle 375 on Inquiry card.



# The ultimate printing machines.

## Perfect business partners for IBM, Apple, Osborne, Eagle and other micros.



## One machine solutions to every application. Prices starting at \$775.

Meet the leading family in multi-functional micro printers. The 80-column Tally MT 160 for a small footprint; the 132-column Tally MT 180 for accounting and spreadsheet packages. (Print at 20 cpi and get 260 columns!)

A Word Processing package gives you letter quality text, proportional spacing, margin justification, auto centering. A resident Graphics package offers the versatility of two different dot densities. And you get high

speed report printing at 160 cps bi-directionally. Plus eight different resident character widths for condensed or double-wide printing.

There's more. 3-way paper handling lets you use fanfold forms, letterhead or roll stock. The control panel has a conversational program menu for easy "answer or question" push-button set-up. The dual interface has both a serial and parallel port for direct plug compatibility with your micro (no hidden interface costs!) And

one look at the solid machine construction lets you know that Tally builds printers to last!

Tally has the printers for today that you won't outgrow tomorrow.

Mannesmann Tally, 8301 South 180th Street, Kent, Washington 98032. Phone (206) 251-5524.

# MANNESMANN TALLY

Computer printers manufactured in the U.S. and Europe for worldwide markets.

Circle 230 on inquiry card.

### IN DISTRIBUTION NOW!

**WEST**  
Anacomp  
(206) 881-1113  
Byte Industries  
(415) 783-8272  
Paragon Sales  
(408) 263-9510

PGI Distribution  
(602) 967-1421  
Waybern  
(714) 554-4520  
Western Micro Systems  
(408) 725-1660

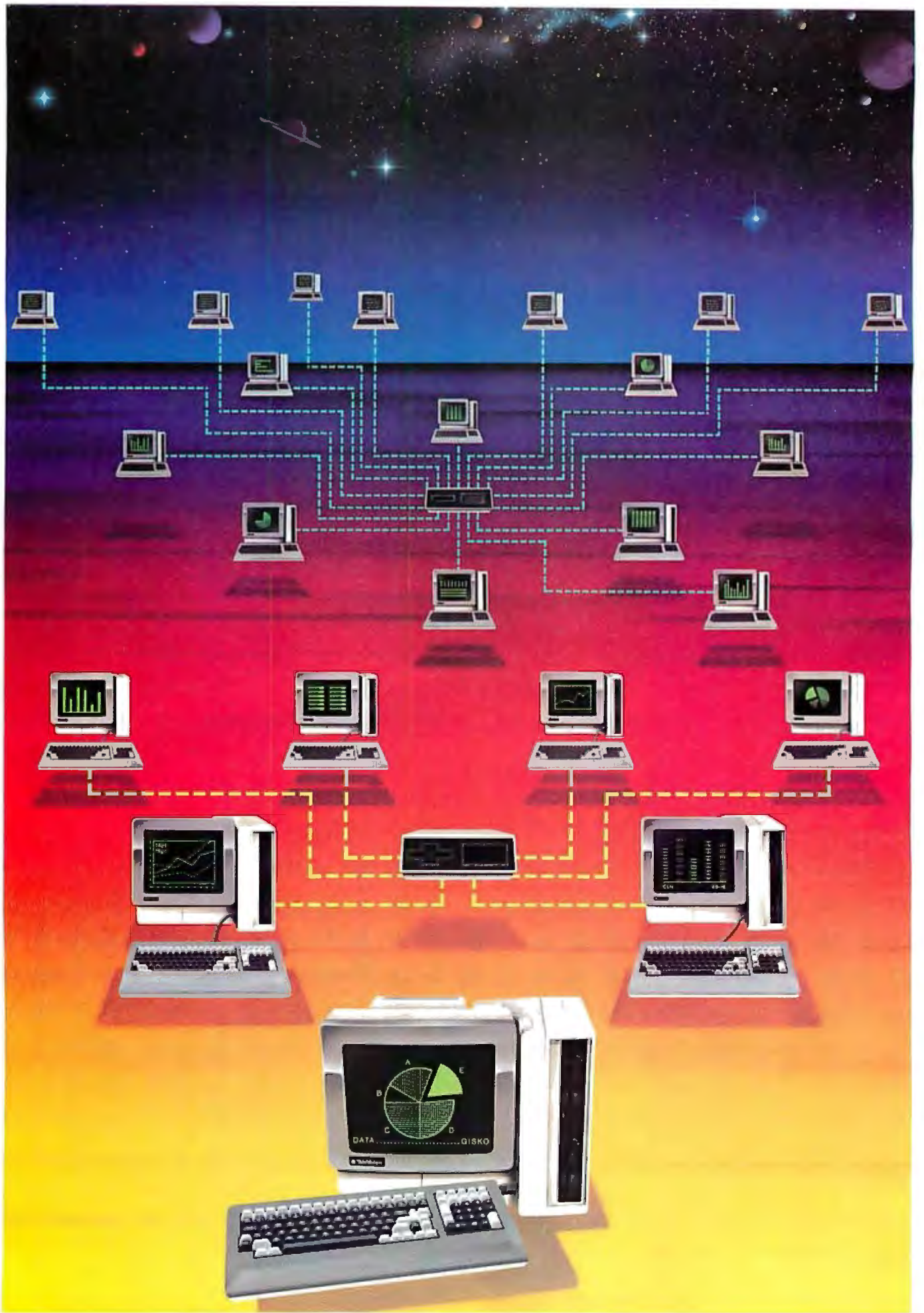
Acorn Data Products  
(303) 779-6644  
**CENTRAL**  
Information Systems  
(312) 228-5480  
D. L. MacNeil, Inc.  
(312) 952-8300

Sysprint  
(214) 669-3666  
Tek-Aids  
(312) 870-7400  
**EAST**  
Computermaxx  
(904) 878-4121

Digital Solutions  
(404) 955-4488  
Micro Distributors  
(301) 468-6450  
Hansen & Hughes  
(201) 652-7055

CPI  
(315) 476-6664  
Tech Data  
(813) 577-2794  
US Plus  
(203) 234-0444

Mannesmann Tally Canada  
(416) 661-9783  
**Nation-wide**  
Hall-Mark Electronics  
(214) 343-5000  
Kierulff Electronics  
(2213) 725-0325



# Of all the personal computers you can choose today, TeleVideo gives you more choices for tomorrow.

Any TeleVideo personal computer can be used as a single-user, stand-alone computer. Then, when you want to expand its professional performance capabilities, you have a choice of ways to grow into a network of up to sixteen TeleVideo personal computers. You can use our 8 or 16-bit computers, or any combination, starting with your original unit.

TeleVideo also gives you more choices of professional CP/M® and MS-DOS® software, including advanced graphics. And since our software works with all of our systems, it can run on one TeleVideo personal computer or a network of TeleVideo personal computers, without modification. So if you want a personal computer that gives you professional performance, it's

obvious that you have a lot of choices for today.

But there's only one with choices for tomorrow. TeleVideo.

For more information, write TeleVideo Systems, Inc., 1170 Morse Ave., Sunnyvale, CA 94086, call toll-free 800-538-1780 (in California call 800-672-3470 Ext. 945), call one of our authorized distributors or dealers, or contact one of our regional sales offices, listed below.

Northeast Region, 617-369-9370.  
Eastern Region, 703-556-7764.  
Southeast Region, 404-447-1231.  
Midwest Region, 312-969-0112.  
South Central Region, 214-258-6776.  
Northwest Region, 408-745-7760.  
Southwest Region, 714-752-9488.  
European Sales (Holland), (31) 075-28-7461.  
UK/Scandinavia Sales, (44) 0908-668-778.

TeleVideo Systems are fully serviced nationwide by TRW.

 **TeleVideo Systems, Inc.**

Circle 382 on inquiry card.

CP/M is a registered trademark of Digital Research, Inc.

MS-DOS is a registered trademark of MicroSoft, Inc.

## NEC PC-8201 Portable Computer

*A new contender with Tandy's Model 100*

---

Stan Wszola  
Technical Editor

---

With its PC-8201, Nippon Electric Company has introduced another contender in the fight for a place in the executive briefcase. Scheduled to be released in the U.S. this summer, the PC-8201 (see photo 1) is expected to compete directly with Tandy's new Model 100. Among other similarities, both machines use the 80C85 microprocessor, a low-power CMOS (complementary metal-oxide semiconductor) version of the 8085 running at 2.4576 MHz. But, and this is an important difference, the PC-8201's 16K bytes of CMOS RAM (random-access read/write memory) can be expanded to 64K bytes internally. And the machine can accept an optional 32K-byte CMOS RAM cartridge. The list price converted into U.S. dollars is about \$675 at the time of this writing.

The 8201's 32K bytes of CMOS ROM (read-only memory) contain the operating system, Microsoft BASIC, a simple text-editing program, and a telecommunications program. As with the RAM, the internal ROM can be expanded to 64K bytes, and NEC provides an optional 64K-byte ROM cartridge.

Looking at the rear of this machine (see photo 2), you can see that NEC tried to include connections for all necessary options. An interface for a cassette tape recorder, a Centronics-type parallel printer port, an RS-232C serial port, an interface for an optional bar-code reader, and connectors for as yet unannounced RAM modules and a floppy-disk drive are all there. Additionally, the reset switch, the memory-protection switch, and power input jack were squeezed in. On the right side of the case, you'll find the power on/off switch and an adjustment for the display's viewing angle.

Battery-powered and light (about 3.8 pounds), the 8201 uses four alkaline AA batteries, a rechargeable nickel-cadmium battery pack, or an AC adapter. It's housed in a red, white, or silver case that's 11.8 inches wide by 8.4 inches deep by 1.3 to 2.4 inches high, just slightly larger and approximately three times as thick as the copy of BYTE you're now holding.



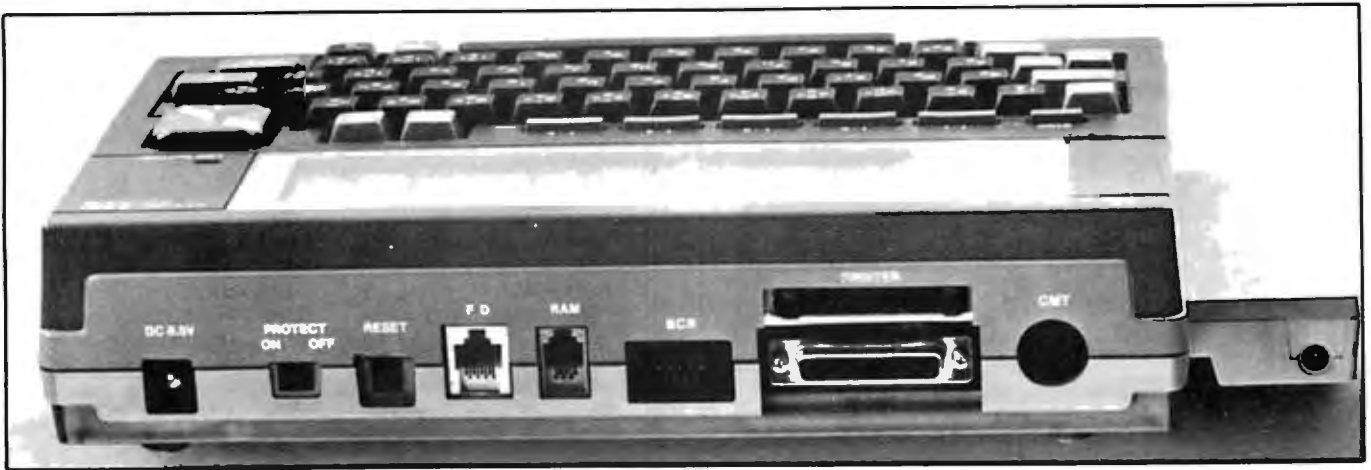
**Photo 1:** The NEC PC-8201 Portable Computer features a 40-character by 8-line LCD, software in ROM, and your choice of a red, white, or silver case.

### Display

The liquid-crystal display (LCD) has 8 lines of 40 characters with each character comprising a 6 by 8 matrix (see photo 1). The 8201 can display the full 128-character set of the American National Standard Code for Information Interchange (ASCII), the Japanese katakana character set, and 61 user-definable characters.

The 8201 display is the minimum practical size; anything smaller (e.g., Epson HX-20) becomes too difficult to work with. Even in the simplest writing task, you need to see a certain amount of text. This amount may vary, according to individual preferences or the type of material you are working on. While the 8 by 40 display is adequate for writing or programming, it is too small for use with tabular information or spreadsheet programs.

The display, suffering from the same faults that plague all devices using LCDs, is visible only at an ideal viewing angle of about 60 degrees. A bright light or sunlight obscures the display because of the reflections on the



**Photo 2:** Rear view of the NEC PC-8201. From left to right are the AC power input jack, memory-protection switch, reset switch, and connectors for the floppy-disk controller (not yet released), memory-expansion modules, and bar-code reader. The Centronics-type parallel printer port is located above the RS-232C serial port, which is next to the cassette tape input/output port. An optional RAM cartridge is shown plugged into the side of the computer.

cover. LCDs can't be easily used in low-light conditions because they function by reflecting ambient light rather than by producing a lighted display as does a standard video monitor. For most office use, however, the 8201's display is effective and poses no problems when used under average lighting conditions. If necessary, the contrast can be adjusted using a control on the right side of the case.

### Keyboard

Surprisingly, the 8201 has a very usable keyboard for such a small package. It has 55 keys in the popular Selectric-style layout (see photo 3) and five programmable function keys, initially defined for use with the text-editing and telecommunications programs. The four triangular-shaped cursor-control keys form a square on the right side of the keyboard, an excellent arrangement.

Two special keys, Paste/Insert and Delete/Backspace, provide text-editing functions. As its name implies, the first inserts characters in text or a program. A Shift-Paste inserts the contents of a Paste buffer (more on this later) into the text or program at the cursor location. The Delete key deletes the previously entered character and Shift-Delete deletes a character indicated by the cursor. A third special key, Stop, generates a Control-C and halts program operation.

Admittedly, the keyboard is a little cramped for my fingers, but the tactile response is fine. The only annoyance was with the confusing combination of English/katakana legends on the keytops. The American version of the computer will have only the English letters on the keytops.

### Memory

NEC provided the 8201 with an impressive capacity for memory expansion. The evaluation unit had 32K bytes of ROM (standard) and 32K bytes of RAM, both of which could be expanded with optional memory modules. With

the addition of both internal and external RAM, the 8201 gives you a total of 96K bytes. The ROM can also be increased internally to 64K bytes and, with plug-in cartridges, to 128K bytes.

Managing that amount of memory presents an interesting problem, which NEC solved by giving the 8201 a BANK command. A programmer can specify which 32K bank of both RAM and ROM the processor must look at. This method enables the 8201 to store very large programs in memory with enough memory left over to use other programs.

The plug-in cartridges offer you an alternative to program storage on floppy disks. Because the cartridges include battery power for the CMOS RAM, you could load a program into a cartridge, remove the cartridge, and plug in a different cartridge in order to use or store other programs. This is hardly an inexpensive solution, but it is convenient and portable.

Although the 8201 manual does not mention what programs will be available to fill 128K bytes of ROM, the needs of the market suggest a simple electronic spreadsheet and executive software such as a daily appointment record and phone/address records. Software developers have the opportunity to develop custom ROM cartridge programs.

### Software

A characteristic feature of most microcomputers is the required loading of software through cassette recorders and floppy-disk drives. The NEC PC-8201 is a true portable because it eliminates this dependence on peripherals by having programs in ROM or saved in RAM.

When the 8201 switches on, the operating system's main menu appears, showing the date, the time, a directory of all programs in memory, and which bank of memory is being accessed. In the directory, extensions indicate the type of information in the file. Text files use the extension DO for document, BASIC programs have the



**Photo 3:** Screen display and keyboard layout of the PC-8201. Note that the keytop legends show both English characters and Japanese katakana characters. The special-function keys are labeled by the last line of the display.

BA extension, and machine-language files use CO. You can identify applications programs such as BASIC, TEXT, and TELCOM by the lack of an extension. The bottom line of this initial display presents labels for the special-function keys and indicates the amount of free memory. (The similarity between the display of the 8201 in photo 3 and the Tandy Model 100's shouldn't be surprising because Microsoft designed the software for both systems.)

The user interface makes ease of use as strong an asset as portability with this computer. To choose a program to run or a file to edit, you simply position the cursor over the file name and press the return key. With a BA file extension, the system enters BASIC, and with DO, the text editor is invoked. Even machine-language programs with a specific execution address run automatically if selected from the menu. Another simplifying feature is available when you finish any application program or file. Just by typing "MENU," you close the files and

## At a Glance

**Name**  
NEC PC-8201 Portable  
Computer

**Use**  
Portable general-purpose  
computer

**Manufacturer**  
NEC Home Electronics  
(U.S.A.) Inc.  
Personal Computer Division  
1401 Estes Ave.  
Elk Grove, IL 60007  
(312) 228-5900

**Price**  
Approximately \$675 (de-  
pending on exchange rates)

**Dimensions**  
11.8 inches wide by 8.4  
inches deep by 1.3 to 2.4  
inches high

**Weight**  
3.8 pounds

**Software**  
Microsoft BASIC, telecom-  
munications program, and  
text-editing program in ROM

**Audience**  
Anyone needing a portable  
computer for telecommunica-  
tions, word processing, and  
general-purpose applications

return to the menu display.

One bundled application, TEXT, is a simple editing program for text or BASIC files and will probably be the most used program. To invoke the TEXT program, you choose the program from the main menu, select a document file that automatically invokes the editor, or use the EDIT command while in BASIC to edit a program.

The special-function keys make the TEXT program especially easy to use. For example, you search for text strings with FIND, locate the next occurrence of the string with NEXT, select text to be cut or copied with SELECT, and transfer copy to a Paste buffer with either CUT or COPY.

A safety feature prevents you from typing over previously entered copy. Whenever you want to insert text, you must first press the Insert key. The Paste buffer lets you put all or part of your text into a buffer with the COPY or CUT commands. Then, with the PASTE command, you reinsert that copy elsewhere in the text. An

## Like-new products



For free catalog,  
phone toll-free (800) 225-1008  
In Massachusetts (617) 938-0900  
**Genstar REI Sales Company**  
6307 DeSoto Ave., Ste. J / Woodland Hills, CA 91367

Circle 455 on Inquiry card.

## TELEVIDEO DEALERS & DIST.

Our general accounting programs  
operate on CP/M<sup>1</sup> & MP/M<sup>2</sup>  
compatible systems, including  
TurboDos<sup>3</sup> and MMost<sup>4</sup>.

1. **C.A.T.S.** (3 levels of User help —  
Computer Assisted Tutorial Software).
2. **OUTSTANDING DOCUMENTATION.**
3. **MULTI-USER** (w/file & record lock.)
4. **MULTI-COMPANY**  
(w/consolidation)
5. **FULLY INTEGRATED** w/single  
source entry (or stand alone)

### MONEY BACK GUARANTEE

**COUGAR MOUNTAIN SOFTWARE**  
10 S. Latah Box 6886  
Boise, Idaho 83707  
208-344-2540

TM: 1. & 2. Digital Research, 4. Software 2000;  
3. TeleVideo.

Circle 456 on Inquiry card.

## MicroScript™ \$99

State of the Art Text Formatter

- generic markup
- fully definable page with multiple columns
- multiline headers, footers, and footnotes
- automatic widow and orphan suppression
- automatic section numbering
- automatic table of contents and index
- automatic bullet, number, and definition lists
- floating figures
- text alignment to left, center, right, or justify
- left and right indentation with delay and duration
- bold, underscore, and proportional spacing
- macros and symbols
- multiple input files of unlimited size
- direct printer control
- IDS, Qume, Diablo, NEC, CJTOH, and all TTY

## MicroEd™ \$49

Customizable Full Screen Editor

- full cursor control by character, word, or line
- position to top or bottom of window or file
- scroll by line, half window, or full window
- global or selective find and replace
- delete by character, word, line, or block
- read external files into current file
- copy, move, and write blocks of text
- insert, overlay, or wordwrap text
- all cursor addressable VDTs

Postpaid within U.S., outside U.S. add \$10. CA residents add 6%  
8" SS/SD CP/M-80\*, and CP/M-86\*, 5.25" SS/DD PC-DOS

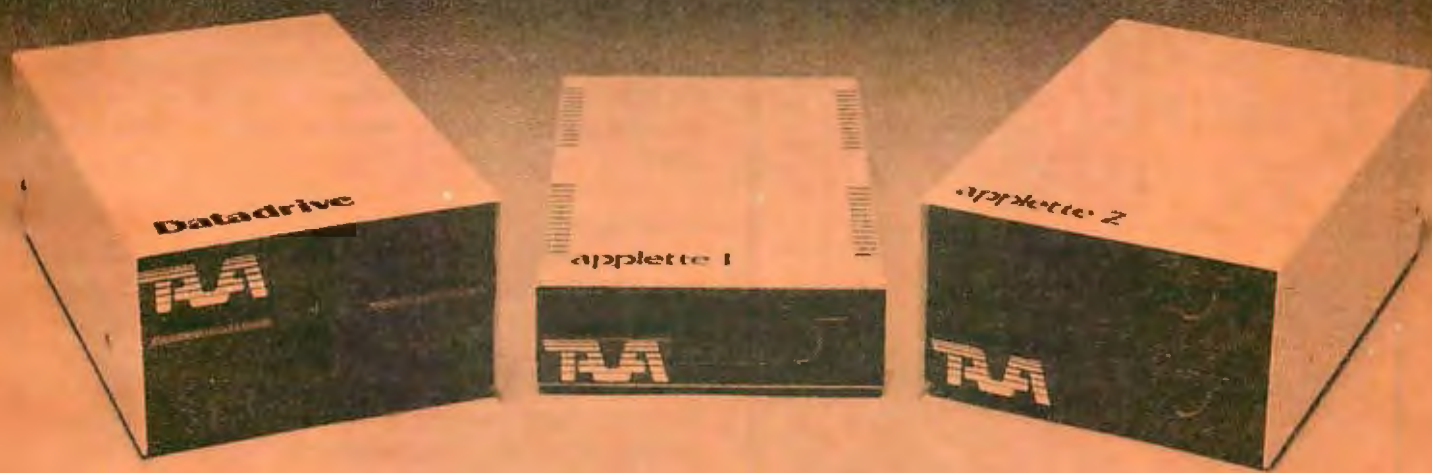
## MicroType™

6531 Crown Blvd., Suite 3A, San Jose, CA 95120  
(408) 997-5026

\* CP/M-80, CP/M-86 are trademarks of Digital Research. PC-DOS  
is a trademark of IBM Corporation.

Circle 255 on Inquiry card.

# FROM THE CREATORS OF THE DATA DRIVE® COMES APPLETTTE 1® AND APPLETTTE 2® SLIMLINE DRIVES



## Available At CompuShack Stores

**Applette 1® and Applette 2® are 100% Apple II compatible.** Halftracking, DOS, PASCAL, and CP/M®. 300% faster track to track speed with 15% greater storage capacity on a 40 track mode with enhancer diskette. TEAC® mechanism and read/write electronics. Direct shaft drive, metal band positioner, photo coupler write-protected sensor. 10,000 lifetime hours, and more.

**One year warranty on all parts and labor.**

TAVA  CORP.

HEADQUARTERS/TELEX: 181667—ANSWER BACK: COMPDShACK IRIN

**(714) 261-0200**

Circle 312 on inquiry card.

\*DATA DRIVE, APPLETTTE 1, APPLETTTE 2, and TRUMP CARD are registered trademarks of TAVA Corporation, respectively.

\*CP/M is a registered trademark of Digital Research, Inc.  
\*TEAC is a registered trademark of TEAC Corp.

# The Best In Price, Selection and Delivery

## Professional Quality

Call Now TOLL FREE

**800-368-3404**

(In VA, Call Collect 703-237-8695)

AMPEX • INTERTEC • TEXAS INSTRUMENTS • GENERAL DATA  
COMM. • ANDERSON JACOBSON • C. ITOH • QUME • BEEHIVE •  
DATASOUTH • DIABLO • CENTRONICS • NEC • PRENTICE

### MICROS

**INTERTEC SUPERBRAIN II**  
64K DD\* ..... ONLY \$1895  
64K QD\* ..... ONLY \$2295  
64K SD\* (96TPI) ..... ONLY \$2695  
\*(includes M/Soft BASIC)  
DDS-10 Meg  
(Hard Disk) ..... ONLY \$3195

**DYNABYTE** ..... Call

### PRINTERS

High Speed Line Printers..CALL

**NEC**  
7710 Ser ..... \$2089  
7715 ..... \$2099  
7730 Par ..... \$2099  
7720 ..... \$2449  
7725 ..... \$2496  
Std. Tractor 77xx ..... \$ 199  
3510 ..... \$1390  
3530 ..... \$1390  
3550 (IBM) ..... \$1869  
3515 ..... \$1395

**DATASOUTH** ..... Call

**DIABLO**  
620-SPI ..... \$ 949  
630-R102/147 ..... \$1949  
630 ECS ..... \$2389  
630-R155 ..... \$1745  
\*(for IBM P.C., Apple II, TRS-80)  
630-K104 (KSR) ..... \$2385

**QUME**

Sprint 9/45 FP ..... \$1794  
Sprint 9/55 FP ..... \$2119  
Sprint 9/55 FP/XMEM ..... \$2186  
Sprint 9/55 LP/XMEM ..... \$2094  
Sprint 11/40-PLUS ..... \$1449  
Bi-Dir. Forms Tractor ..... \$ 199  
**CENTRONICS:122 (P)** ..... \$ 689

### TERMINALS

**AMPEX**

D80 ..... \$ 699

**BEEHIVE (SMART DISPLAY)**

DM5 ..... Call

DM5A ..... Call

DM310 (3101 Emulator) ..... Call

DM 3270 (3270 Emulator) ..... Call

Protocol Converter ..... Call

**QUME**

QVT-102 ..... \$ 594

QVT-103 ..... \$ 739

**C. ITOH**

CIT 101 ..... \$1350

CIT 161 (64 Colors) ..... Call

**TEXAS INSTRUMENTS**

745 Standard ..... \$1172

In addition, we can make EIA RS 232 or RS 449 cables to your order, and supply you with ribbons, printer stands, print wheels, thimbles for all printers listed. And many, many more items. CALL NOW.

All items shipped freight collect either motor freight or UPS unless otherwise specified. All prices already include 3% cash discount. Purchase with credit card does not include discount. Virginia residents, add 4% Sales Tax. For fastest delivery send certified check, money order or bank-wire transfer. Sorry, no C.O.D. orders. All equipment is in factory cartons with manufacturers warranty (honored at our depot). Prices subject to change without notice. Most items in stock.



## TERMINALS TERRIFIC

Terminals Terrific, Inc., P.O. Box 216, Merrifield, VA 22116  
Phone: 800-368-3404 (In VA, Call Collect 703-237-8695)

added benefit of the Paste buffer is that it saves any entered text. With a little bit of effort, you can combine this benefit with the FIND and NEXT commands to perform operations similar to search and replace operations found in more powerful text-editing programs.

The same easy-to-use features of TEXT are in the TELCOM program, a fairly simple telecommunications program. Designed primarily to access online databases or information services (The Source, Compuserve, Dow Jones, etc.) or to exchange programs between two computers, it uses the special-function keys and Escape/character key sequences to control the program's operation. A two-page memory buffer, totaling 16 lines, lets you halt the display in order to refer to previously received information. You can set the program for half- or full-duplex operation and "echo" the screen display to a printer.

The UPLOAD and DOWNLOAD commands transfer files through the RS-232C port. The telecommunications program asks for the name of the file to send or receive, performs the operation, indicates the task's completion, and finally asks if you want to disconnect. With the STAT command, the 8201 provides a simple method of setting the data rate, parity, bit length, stop bits, and XON/XOFF sequence.

### BASIC

The implementation of Microsoft's BASIC ensures an easy transference of programs to the 8201 without costly translation. Additionally, this interpreted BASIC includes the statements and functions needed to write almost any type of program. By integrating BASIC with the TEXT program, you get two editing methods—a line-oriented program or the character-oriented TEXT program.

### Peripherals

Several related peripherals are due to be released with the computer. Of most interest are the floppy-disk controller (PC-8233) and disk drives. Apparently, the controller regulates several different types of drives (PC-8031-1W, PC-8031-2W, and PC-80S31), one of which is probably some version of the 3½-inch microfloppy. Another useful peripheral is the PC-8240 video monitor adapter, which enables you to connect the 8201 to a video monitor.

Peripherals in the planning stage include an intelligent telephone, an acoustic coupler modem, and a bar-code reader.

### Summary

With the portable computer market becoming crowded with contenders, more functions are being squeezed into smaller packages. The 8201 takes its place as a transition machine designed to determine just what features people want in a portable computer.

Overall, it looks as if NEC has developed an effective integrated package of hardware and software useful to anyone with a need for a computer to go. ■



# LET THE "ANGEL" DO THE WAITING .....

Two RS-232C Connectors for serial input and output

6 Leds to indicate power, transmission and reception status, buffer activities, page number, etc.

SKIP and REPRINT provide independent page controls to reprint portions of documentation.

40 Pin Expansion Bus available for future expansion

COPY provides convenient one key operation for single copy or multi-copy of text

3 externally accessible Dip Switches for baudrate, device type, and parallel and serial selections. Selections can be made without losing buffer



Function keys extend the useful commands to more than 10, including: hex-dump, memory test, remote loading, etc.

8 easy-to-operate membrane key switches.

Independent PAUSE and HOLD controls to suspend transmission and reception.

Two 20 Pin Edge Connectors for parallel input and output

"ANGEL" is compatible with almost all Micro-Computers, including IBM, Apple, TRS-80, Vector Graphic, NorthStar, Altos, Xerox, Heath, Zenith, NEC, DEC, etc., with RS-232 serial, Hardware Handshaking, or Centronics compatible parallel interface. The manufacturer reserves the right to change the product specification.

Connect an "ANGEL" between your computer and your printer, and let the "ANGEL" do the waiting ....

Your valuable computer spends 95% of its time waiting for the printer to catch up...and while the computer waits, the payroll continues.

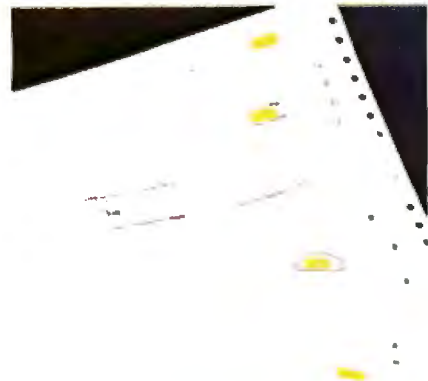
The computer sends data to the "ANGEL" at speeds up to 19.2K baud. The "ANGEL" stores data and sends it to the printer at a speed the printer can handle, and your computer is free to continue working without interruption.

#### A USER WRITES:

"I tried the "ANGEL" with my Altos system connected to an Epson MX-100, both set at 9600 baud. Without the "ANGEL" it takes 30 minutes to print 210 doctors' requisition forms. With the "ANGEL" installed, my computer is free after 90 seconds."

With "ANGEL'S" self diagnostics and memory test, the entire system thoroughly checks itself every time you power up.

PAGE REPRINT is another unique feature. EXAMPLE: You are printing a 32 page report, and the paper jams at page 11. Reset the printer to the top of the form, press PAGE REPRINT, and resume printing at the top of page 11. Want to restart two pages back? Press PAGE REPRINT twice, and you resume at page 10.



PAGE REPRINT

...And think of these other possibilities: HEX DUMP. Display or printout every bit of data your computer sends out to the printer in an easy-to-read Hexidecimal and ASCII format. A must for your programmer. Pause and Hold for real time programs. Page skip for selective printing. What a waste to print the entire documentation if you only need part of it.

Simple external switch settings, let the "ANGEL" accept either RS-232 serial or Centronics parallel data and can output either/or in any combination, (S-S,S-P,P-S,P-P). The "ANGEL" is compatible with almost all Micro-Computers, and can be installed by anyone in minutes. Switches are clearly marked for ease of operation, and a concise, USER FRIENDLY operator reference card is included with each unit.

The "ANGEL" has a full one year limited warranty.

**THE "ANGEL" WILL NEVER KEEP YOU WAITING!**



HEX DUMP

ANGEL, The Intelligent Buffer, features:

- 64K Byte Memory Size
- Four Interface Modes in one unit:
  - Serial to Serial
  - Parallel to Parallel
  - Serial to Parallel
  - Parallel to Serial
- Serial Baudrate from 110 to 19.2K Baud
- Single, Multiple and Continuous Copy
- Clear/Reset
- Pause/Hold
- Page Skip
- Page Re-print
- Page-Pause
- Hex-Dump
- Self-Diagnostics
- Space Compression to extend the effective buffer size to more than 128K
- Price - \$295.00

#### TO ORDER:

CALL TOLL FREE 1-800-323-3304  
OR SEND CHECK OR MONEY  
ORDER TO LIGO RESEARCH

Please rush me ( ) "ANGEL(S)" @  
\$295.00 each

Sub total

ILLINOIS ONLY Add 6% U.S. sales tax

Delivery charge

**TOTAL**

Charge my ( ) VISA ( ) MASTERCARD  
MY ACCT. # IS

EXPIRATION DATE

## HMS3264 EPROM Programmer

Marvin L. De Jong  
Department of Mathematics-Physics  
The School of the Ozarks  
Point Lookout, MO 65726

The HMS3264 EPROM (erasable programmable read-only memory) programmer package lets an Apple II computer handle the programming tasks for a broad range of software-development tasks. The Hollister Microsystems product (see photo 1) includes the peripheral card, a DOS 3.3 disk with the necessary software to program an EPROM, and a manual. This peripheral package lets you program Intel-compatible EPROMs, including the 2716, 2732, 2732A, 2764, and 27128. (Note that the Texas Instruments' TMS2716 is *not* compatible with the Intel 2716, whereas the TMS2516 is compatible with the Intel 2716.)

### The Hardware

Mounted on the HMS3264 EPROM programmer card are three Textool ZIF (zero insertion force) sockets with gold-plated contacts. Each socket, marked to indicate the type of EPROM device it is designed to hold, contains a lever that removes the force of its contacts on the pins of the installed EPROM, allowing an EPROM to be inserted in the socket with no effort. You push the lever down to hold the EPROM in place during programming. When you raise the lever, the EPROM can be easily removed without prying or damage to its pins.

Many EPROM programmers use plug-in "personality modules" to handle a variety of EPROM types, but the HMS3264 card has all the programming sockets on board. Software is used to identify the EPROM type and modify the programming parameters when necessary. These features eliminate the need for jumper wires and personality modules, which are easily misplaced or lost.

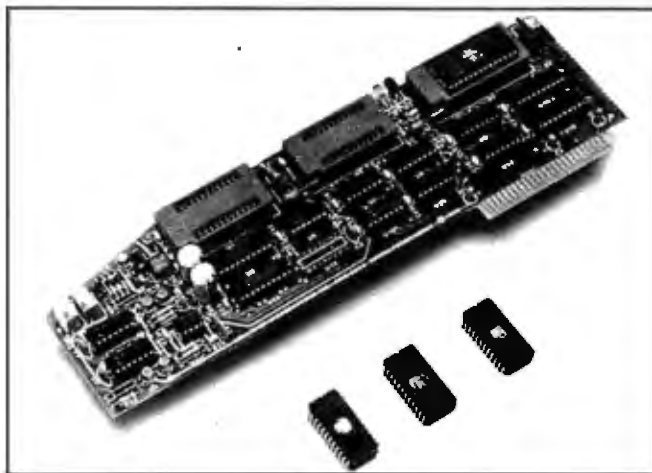


Photo 1: The HMS3264 programmer card for the Apple II.

EPROMs can be inserted or removed from the EPROM programmer while the HMS3264 card is installed in an Apple II peripheral-card slot and power to the Apple II is turned on. Two switches on the card control power to the Textool sockets. One switch controls the 5-V (volt) power supply that is required to read an EPROM. The other switch controls the programming voltage that is applied to the EPROM during the programming process. Setting the latter switch, called the

write switch, in its off or "protect" position prevents the occurrence of an undesirable Write. A red LED (light-emitting diode) indicates the status of the EPROM power switch; a yellow LED indicates a programming voltage being applied to an EPROM. Two on-board DC-to-DC converters provide the 21 V and 25 V required to program the EPROMs.

In order to insert or remove EPROMs, you must first remove the cover of the Apple II. Moreover, to prevent harm to your fingers, other circuit boards in the Apple II, or both, you must isolate the HMS3264 card with empty peripheral-card slots.

I found it convenient to install the EPROM programmer card in slot 3, leaving one blank slot on the left next to the printer-interface card and two blank slots between the EPROM programmer card and the disk-drive controller. Furthermore, be aware that a small but finite probability exists that you will drop an EPROM chip while attempting to insert or remove it from the EPROM programmer. In addition, a corresponding probability exists, guaranteed by Murphy's Law, that the EPROM will fall and produce a short circuit, smoke, and perhaps

# MICROHOUSE

## NEW LOWER PRICES!

We made business computing affordable.

### WORDPROCESSING

WORDSTAR .....	MICROPRO	\$279
MAILMERGE .....		149
SPELLSTAR .....		149
FINAL WORD .....		199
MATH* .....	FORCE II	\$89
	SORCIM	\$249
SUPERWRITER .....		129
SPELLGUARD .....	VISICORP	CALLI
VISWORD .....	CALLI	CALLI
VISISPELL .....	CALLI	CALLI
PERFECT WRITER .....	PERFECT SOFTWARE	\$199
PERFECT SPELLER .....		139
WORD HANDLER .....	SILICON VALLEY	\$139
LISTHANDLER .....		69
VOLKSWRITER .....	LIFETREE	\$155
T/MAKER III .....	T/MAKER	\$199

### LANGUAGES

APPLESOFT COMPILER .....	MICROSOFT	\$129
ALDS .....		99
BASIC COMPILER .....		289
BASIC INTERPRETER .....		259
EDIT 80 .....		89
FORTRAN 80 COMPILER .....		149
FORTRAN 80 COMPILER .....		349
COBOL COMPILER .....		549
COBOL COMPILER .....		529
MACRO ASSEMBLER .....		199
muLISP/muSTAR .....		149
muLISP/muSTAR .....		189
muMATH/muSIMP .....		189
	SUPERSOFT	\$189
ADA .....		159
C COMPILER .....		239
FORTRAN .....		129
LISP .....		99
RATFOR .....		69

### APPLE HARDWARE

MICROSOFT PREMIUM PACK .....	MICROSOFT	\$489
Z80 CARD .....		249
MICROSOFT Z80 CARD/VIDEX VIDEOTERM .....		499
MICROSOFT 16K RAM .....		74
MULTI I/O .....	MOUNTAIN	178
	M&R	39
SUPERFAN .....		39
	RANA	\$299
ELITE I .....		99
CONTROLLER FOR ELITE I .....		395
ELITE I PLUS .....		465
ELITE II .....		539
ELITE II PLUS .....		599
ELITE III .....		129
ENHANCER II .....	VIDEX	29
SOFTSWITCH .....		269
VIDEOTERM .....		68
FUNCTION STRIP .....		295
VIDEOTERM/SOFTSWITCH .....		299
VIDEOTERM/SOFTSWITCH/INVERSECHIP .....		

### COMPUTERS

IMS .....	CALLI
CALIFORNIA COMPUTER SYSTEM .....	CALLI
MORROW MICRODECISION .....	CALLI

### MEDIA

5" SINGLE SIDED .....	MAXELL	\$31
5" DOUBLE SIDED .....		48
3" SINGLE SIDED .....		39
3" DOUBLE SIDE .....		49
MAXELLS ARE BOTH SINGLE AND DOUBLE DENSITY AND COME WITH A LIFETIME WARRANTY.		
	ELEPHANT	\$22
5" SSSD .....		30
5" DSDD .....		

### FINANCIAL/BUSINESS

SUPERCALC .....	SORCIM	\$189
SUPERCALC II .....		219
	VISICORP	\$179
VISICALC .....		179
VISICALC APPLE IIE .....		89
VISICALC BUSINESS FORECASTING .....		CALLI
VISICALC ADVANCED .....		228
VISISCHEDULE .....		228
VISITREND/PLOT .....		179
DESKTOP PLAN .....		228
DESKTOP PLAN .....	ASHTON TATE	279
BOTTOM LINE STRATEGIST .....	CONTINENTAL	\$59
HOME ACCOUNTANT .....		109
HOME ACCOUNTANT PLUS .....		69
FILING CATALOGING AND MAILING .....	APPLE	99
FCM IBM .....		42
TAX ADVANTAGE .....		169
ACCOUNTS RECEIVABLE .....		169
ACCOUNTS PAYABLE .....		169
GENERAL LEDGER .....		169
PAYROLL .....		459
PROPERTY MANAGEMENT .....		
	PERFECT SOFTWARE	\$139
PERFECT CALC .....	SUPERSOFT	\$199
SCRATCHPAD .....	EAGLE	\$99
MONEY DECISIONS .....	PEACHTREE	CALLI
ACCOUNTING SERIES .....		CALLI

### PRINTERS, ETC.

PROWRITER (P) .....	C. ITOH	\$399
PROWRITER (S) .....		579
PROWRITER II (P) .....		689
PROWRITER II (S) .....		739
F-10 (P) .....		1379
F-10 (S) .....		1379
F-10 TRACTOR OPT. .....		229
GX-100P .....		250
6 MONTHS WARRANTY. MICROHOUSE IS AN AUTHORIZED C. ITOH REPAIR CENTER.		
	IDS	\$679
MICROPRISM .....		999
PRISM 80/SPRINT .....		1279
PRISM 132/SprInt .....		89
GRAPHICS OPTION .....		139
SHEET FEEDER .....		339
COLOR OPTION .....		
	GEMINI	\$399
GEMINI 10 .....		529
GEMINI 15 .....		
	QUADRAM	\$159
MICROFAZER 16K P-P .....		189
32K P-P .....		239
64K P-P .....		189
8K P-P .....		349
128K P-P .....		699
256K P-P .....		
MANY OTHERS AVAILABLE—CALL FOR PRICES		
	NEC	\$2499
77-10 SRO .....		2499
77-30 PRO .....		1595
35-10 SRO .....		2099
35-50 RO .....		989
35-50 SHEET FEEDER .....		239
35-50 TRACTOR .....		
	OKIDATA	\$359
MICROLINE 80 .....		439
MICROLINE 82A .....		679
MICROLINE 83A .....		1159
MICROLINE 84P .....		549
MICROLINE 92 .....		989
MICROLINE 93 .....		239
TRACTOR FOR 80 & 82 .....		
	SMITH-CORONA	\$599
TP-1 .....		139
TRACTOR FOR TP-1 .....		
	INTERACTIVE STRUCTURES	\$135
PKASSO .....		155
PKASSO PRISM COLOR .....		
	PRACTICAL PERIPHERALS	229
MICROBUFFER II (P) 32K .....		
	ORANGE MICRO	\$125
GRAPPLER PLUS .....		

### DATABASE/GRAPHICS

1-2-3 .....	LOTUS	CALLI
	MICROPRO	\$279
INFOSTAR .....		165
DATASTAR .....		219
REPORTSTAR .....		149
SUPERSORT .....	ASHTON TATE	\$489
DBASE II/ZIP .....	FOX & GELLER	\$219
QUICKCODE .....		68
DUTIL .....		219
D GRAPH .....	INNOVATIVE	\$359
TIM III .....		189
FAST GRAPHS .....	NORTH AMERICAN	\$229
THE ANSWER .....	PERFECT SOFTWARE	\$199
PERFECT FILER .....	ISM	\$69
MATHEMAGIC .....		69
GRAPHMAGIC .....		99
MATHEMAGIC/GRAPHMAGIC .....	SOFTWARE TECHNOLOGY	224
THE CREATOR FOR IBM .....		149
THE CREATOR FOR APPLE .....	VISICORP	\$179
VISIDEX .....		228
VISIFILE .....		159
VISIPILOT .....		184
VISILINK .....		

### COMMUNICATIONS

CROSSTALK .....	MICROSTUFF	\$119
	VISICORP	\$79
VISITERM .....	HAYES	214
SMARTMODEM .....		549
SMARTMODEM 1200 .....		279
MICROMODEM II .....		349
MICROMODEM II W/TERMINAL .....		329
SMARTMODEM/CROSSTALK .....		659
SMARTMODEM 1200/CROSSTALK .....	NOVATION	\$129
J-CAT .....		199
SMARTCAT 300 .....		489
SMARTCAT 1200 .....		

### MONITORS

COLOR I .....	AMDEK	\$320
COLOR II .....		730
COLOR III .....		429
APPLE RGB INT. .....		149
VIDEO 300 .....		149
VIDEO 300AMBER .....		169
VIDEO 310 .....		179
VIDEO 310 AMBER .....		1099
COLOR IV .....	NEC	149
12" GREEN .....		249
12" COLOR .....		174
12" GREEN HI RES. .....		859
12" RGB COLOR .....		

### IBM HARDWARE

QUADBOARD 64K .....	QUADRAM	\$459
QUADBOARD 128K .....		599
QUADBOARD 192L .....		699
QUADBOARD 256K .....		779
SERIAL ADAPTER .....		94
PARALLEL PRINTER INT. .....		119
64K MEMORY UPGRADE .....		129
	MICROSOFT	259
64K RAMCARD .....		389
128K RAMCARD .....		519
192K RAMCARD .....		599
256K RAMCARD .....		
	TANDON	195
SINGLE SIDED .....		249
DOUBLE SIDED .....		

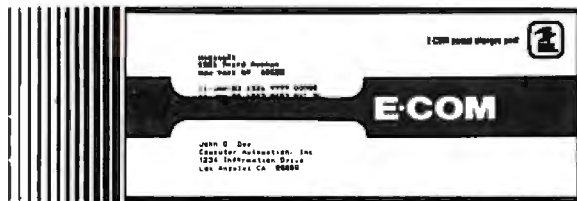
Call Toll-Free: 1-800-523-9511

In Pennsylvania: 1-215-868-8219

Circle 262 on inquiry card.

1444 Linden St./P.O. Box 499, Dept. 201, Bethlehem, PA 18016

# 2000 letters per hour via your personal computer



**delivered in 48 hours or sooner  
at 26¢ a piece.**

Whether it's credit and collection applications, announcements to your customers, or sales promotions for new services, our MAIL-COM software turns your personal computer into a one-button mailing house of enormous power. All you need is a modem, a personal computer, and our MAIL-COM software.

Our software allows you to link up with the U.S. Postal Service's new ECOM System. After receiving your letters via modem, the Postal Service will then print, stuff, seal and deliver the letters usually by the next day and guaranteed within 48 hours.

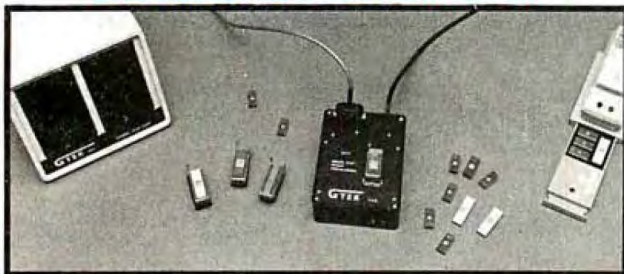
MAIL-COM is a complete, interactive package supporting all ECOM formats. Available now for the IBM PC (\$195.00), CP/M (\$195.00) and the Alpha Micro (\$495.00).

To order, call or write.

**Digisoft  
Computers**

1501 Third Avenue  
New York, NY 10028  
(212) 734-3875

## DEVELOPMENT HARDWARE/SOFTWARE GTEK MODEL 7128 EPROM PROGRAMMER



- Microprocessor based intelligence for ease of use and interface. You send the data, the 7128 takes care of the rest.
- RS-232 interface and ASCII data formats make the 7128 compatible with virtually any computer with an RS-232 serial interface port.
- Auto-select baud rate.
- Use with or without handshaking. Bidirectional Xon/Xoff supported. CTS/DTR supported.
- Devices supported as of DEC 82.
 

NMOS	NMOS	CMOS	EEPROM	MPU'S
2758	2508	27C16	5213	8748
2716	2516	27C32	5213H	8748H
2732	2532	C6716	X2816	8749
2732A	2564	27C64	48016	8741
2764	68766		12816A	8742
27128	8755			8751
27256				
- Read pin compatible ROMS also.
- Automatic use of proper program voltage based on type selected.
- Menu driven eprom type selection, no personality modules required. (40 pin devices require adapter)
- INTEL, Motorola and MCS-86, Hex formats. Split facility for 16 bit data paths. Read, program, and formatted list commands also.
- Interrupt driven type ahead, program and verify real time while sending data.
- Program single byte, block, or whole eprom.
- Intelligent diagnostics discern between eprom which is bad and one which merely needs erasing.
- Verify erasure and compare commands.
- Busy light indicates when power is being applied to program socket.
- Complete with TEXTTOOL zero insertion force socket and integral 120 VAC power supply. (240 VAC/50HZ available also)
- High Performance/Cost ratio.
  - Model 7128 PRICE \$389.00 •••

**MODEL 7128 SOCKET ADAPTERS**  
MODEL 481 allows programming of 8748, 8749, 8741, 8742 single chip processors. Price \$98.00

MODEL 511 allows programming the 8751, Intel's high powered single chip processor. Price \$174.00

MODEL 755 allows programming the 8755 EPROM/I/O chip. Price \$135.00

MODEL 7128/24 - budget version of the 7128. Supports 24 pin parts thru 32K only. Upgradable to full 7128 capacity. Price \$289.00

Non-expandable, very low cost models available for specific devices.  
MODEL 7128-L1 for 2716 only \$179.00  
MODEL 7128-L2 for 2732 only \$209.00

Also available from stock:  
Eprom Erasers UVP model DE-4 . . . \$78.00  
Avocet Systems Cross Assemblers . . . \$200.00  
RS-232 Cable Assemblies . . . . . \$25.00  
Programmable Devices . . . . . call  
Complete development systems . . \$3240.00

**GTEK INC.**

Post Office Box 289  
Waveland, Mississippi 39576  
(601) 467-8048

## At a Glance

**Name**  
HMS3264 EPROM programmer for the Apple II computer

**Manufacturer**  
Hollister Microsystems Inc.  
1455 Airport Blvd.  
San Jose, CA 95110  
(408) 293-3900

**Price**  
\$395

**Computer**  
Apple II or Apple II Plus with Applesoft BASIC, 48K bytes of user memory, and Apple II disk drive and controller

**Hardware**  
Single-circuit board for peripheral-card slots 1 through 7; no other circuits or personality modules are required; it programs Intel-compatible 2716, 2732, 2732A, 2764, and 27128 EPROMs

**Software**  
Single DOS 3.3 copyable disk handles all EPROM programming tasks, including editing, saving, and moving binary files before they are burned in the EPROM

**Documentation**  
A 25-page manual includes detailed instructions for using both the hardware and the software

**Audience**  
Apple II owners who use their computer as a development system, manufacturers of controllers who require a production EPROM programmer, and hobbyists who wish to program their own EPROMs

damage to components on the main logic board of the Apple II. However, a reasonably alert person can avoid these difficulties.

A third switch on the HMS3264 board is called the CFFF switch. The EPROM programmer uses the hexadecimal C800 through CFFF block of memory that the Apple II reserves for expansion ROM. The *Apple II Reference Manual* suggests that each peripheral card using this space should contain a flip-flop that disables its on-board ROM whenever location hexadecimal CFFF is referenced. This component prevents several ROMs from competing for the data bus with uncertain and undesirable side effects.

With the CFFF switch in its Norm position, the HMS3264 board becomes disabled when location hexadecimal CFFF is referenced with a read or write instruction. However, if you want to program all the locations in a 2716, you need to disable this feature in order to program location hexadecimal CFFF. In that case, place the CFFF switch in its Write position. Then make sure that other cards are not competing for control of the data bus by removing the cards that use the hexadecimal C800 through CFFF ROM space.

Of course, these details are mentioned in the manual. The intent here is to describe various aspects of the HMS3264 EPROM programmer so that you get a feeling for its features and qualities. For example, it is likely that an inexpensive programmer board would omit the CFFF feature. The HMS3264 is not an inexpensive board, and no shortcuts were taken in its design. All its ICs (in-

# Will this year's bells and whistles be next year's hoots and howls?

## NOT IF IT'S A GIFFORD.

Freedom from obsolescence now costs less than \$10,000 for 3 users. Because Gifford Multi-User Computer Systems, based on industry standard IEEE 696/S-100 with 20 bus slots, allow ample expandability and upgradability as new processors and peripherals are introduced. For example, up to four additional users can be added for only \$600 each, plus terminal costs. All while protecting your investment.

That's why Gifford computer systems, with their dual processor CompuPro CPUs, have proven themselves to be THE

SYSTEM for business and technical professionals requiring obsolescence-proof, hard-disk computers.

## GIFFORD GIVES YOU THE BEST OF TWO SOFTWARE WORLDS.

We were the first company to develop a system that runs any combination of 8 and 16 bit CP/M™ programs simultaneously. So, if you go with Gifford, you'll *know* you can use the thousands of 8 bit CP/M programs available, PLUS any of the more powerful 16 bit programs . . . at the same time.

And, in addition to compatibility with all the CP/M software that's out there, you also get Super-Calc-86™ dBase II™ and MP/M-86™ FREE.

## PRICELESS INFORMATION FOR THE PRICE OF A STAMP.

We invite you to cut out the coupon and mail it to us today. We'll send you a free brochure with detailed information regarding all the other advantages of going with Gifford. Such as, our exclusive networking and multi-tasking telecommunications packages, our two year warranty, complete service and support, system integration and custom application software. Plus all the benefits of selecting an IEEE 696/S-100 bus-based system.

MP/M 8-16 is a proprietary implementation of MP/M-86 and was configured for CompuPro by Gifford Computer Systems. CP/M and MP/M are registered trademarks of Digital Research. Super-Calc is a trademark of Sorcim. dBase II is a trademark of Ashton-Tate. CompuPro is a trademark of Godbout Electronics. Prices and specifications subject to change.



Other centers opening soon nationwide.

GIFFORD COMPUTER SYSTEMS CENTERS  SAN LEANDRO, CA 94577 (415) 895-0798  SAN FRANCISCO, CA 94104 (415) 391-4570  LOS ANGELES, CA 90064 (213) 477-3921  OKLAHOMA CITY, OK 73112 (405) 840-1175  HOUSTON, TX 77046 (713) 877-1212

**GIFFORD**  
COMPUTER SYSTEMS

1922 Republic Avenue, San Leandro, CA 94577  
(415) 895-0798 A division of C&G Engineering  
I'D LIKE THE WHOLE STORY.  
Please send me your brochure.

Name \_\_\_\_\_ Title \_\_\_\_\_

Organization \_\_\_\_\_ M/S \_\_\_\_\_

Address \_\_\_\_\_

City \_\_\_\_\_ State \_\_\_\_\_ Zip \_\_\_\_\_

Phone \_\_\_\_\_

Please have a representative call me.

```

***** HMS3264 EPROM SYSTEM *****V0.2
      (C) COPYRIGHT 1982
      HOLLISTER MICROSYSTEMS -- AMW
      ALL RIGHTS RESERVED

..NOW LOADING HMS3264 BINARY PROGRAM..

***** HMS3264 EPROM SYSTEM *****V0.2
      EPROM TYPE.. UNDEFINED
      EPROM START.0000
      EPROM END...????
      WORK START..0000

                               SLOT...

===== SELECT SLOT =====

ENTER SLOT NUMBER (1-7)

                               3

===== EPROM TYPE =====
      ENTER EPROM TYPE.... (1-5)

1)  2716 SINGLE VOLTAGE ONLY
2)  2732 INTEL COMPATIBLE
3)  2732A INTEL COMPATIBLE
4)  2764 INTEL COMPATIBLE
5)  27128 INTEL COMPATIBLE

                               2716 SINGLE VOLTAGE ONLY

```

Figure 1: Printed output from the software supplied with the HMS3264.

```

***** HMS3264 EPROM SYSTEM *****V0.2
      EPROM TYPE..2716 SINGLE VOLTAGE ONLY
      EPROM START.0000
      EPROM END...07FF
      WORK START..0000

                               SLOT...3

===== MAIN MENU =====

0.  LOAD & BURN SINGLE BINARY FILE
1.  BURN FROM WORKSPACE TO EPROM
2.  LOAD BINARY FILE TO WORKSPACE
3.  SAVE WORKSPACE TO FILE
4.  COPY EPROM TO WORKSPACE
5.  COMPUTE WORKSPACE CHECKSUM
6.  COMPARE WORKSPACE TO EPROM
7.  DISPLAY EPROM/WORKSPACE

8.  EDIT WORKSPACE  9.  EXIT

A.  EPROM TYPE      B.  SELECT SLOT
C.  CALIBRATE       D.  CLEAR WORKSPACE

      SELECT--

```

Figure 2: The main software menu of the HMS3264.

tegrated circuits) are socketed; you do not have to ruin the board in order to replace an IC.

The lack of unusual components in the analog circuitry, namely the DC-to-DC converters, means that a failure here is easy to correct. Each of the 11 74LS-series ICs has its own bypass capacitor. Obviously, careful attention was paid to the location of the power bus, ensuring noise-free and consistent operation. You are even provided with a location for a spare 16-pin DIP (dual-inline pin) socket, which might be used with jumper wires to program a special EPROM.

## The Software

The floppy disk provided with the HMS3264 contains software, partly in BASIC and partly in machine code, for performing the various functions. To illustrate some of the software, the output of the program was directed to a printer, and the results are reproduced in figure 1. Note that the first task is to select the slot number. Any peripheral-card slot number except 0 is acceptable. Next, you choose the type of EPROM you intend to program. In this application, I chose to program a 2716. The software confirms the choice, as shown in the last line of figure 1. After selecting the EPROM, you are presented with the main menu, as illustrated in figure 2.

The software uses a block of memory in the Apple II, called the *workspace*, to load, store, and edit the binary files that will be read from, or burned in, the EPROM.

The workspace starts at location hexadecimal 4000 in the RAM (random-access read/write memory) address space of the Apple II and extends upward as far as necessary for the particular EPROM being programmed. For instance, a type-2716 EPROM requires 2K bytes of RAM extending from location hexadecimal 4000 through 47FF; a type-27128 EPROM requires 16K bytes of memory extending from location 4000 through 7FFF. But to ease the translation to the EPROM, the workspace is *identified* by addresses hexadecimal 0000 and upward, even though the binary information is stored in locations 4000 and upward. For example, if you are dealing with a type-2716 EPROM, its 2K bytes of memory are identified both in the EPROM and in the workspace by addresses 0000 through 07FF. At the other extreme, the memory locations in a type-27128 EPROM are identified in the EPROM and in the workspace by addresses 0000 through 3FFF. Because a programmed type-2716 EPROM was available, I placed it in the 2716's socket on the EPROM programmer card and selected option four from the menu (copy EPROM to workspace).

After selecting an option, you are given a chance to return to the main menu before proceeding. The software then asks you to identify the starting address, default value = 0000, and the ending address, default value = 07FF, of the portion of the EPROM you wish to copy into the workspace. (I selected the default values because I wanted to copy the entire EPROM into the workspace.) You are next asked to identify the address in the workspace where you wish to begin copying the EPROM's contents. (I chose the default value, which is hexadecimal

0000.) The software then prompts you to turn on the EPROM power switch.

Upon switch activation, the EPROM's contents were copied into the workspace, but I received an error message. The software calculates a checksum for both the EPROM and the workspace to make sure that the copy program executed successfully. The error message puzzled me until I realized that the CFFF switch was in its Norm position; in this switch position, the software does not copy location hexadecimal CFFF in the EPROM into location hexadecimal 07FF in the workspace. Placing the CFFF switch in the Write position (no pun intended) allowed all the EPROM's contents to copy correctly into the workspace.

This procedure was the only one where a note in the documentation might have prevented a problem. Otherwise, the documentation is excellent. Each program in the menu is carefully explained in the manual, and the prompts on the video monitor make operation of the various programs idiot-proof.

After copying an EPROM to familiarize myself with the style of the software, I decided to do some programming. First, I selected item number two in the main menu. This program allows reading a binary file from a disk and storing the file anywhere in the workspace. You input the address in the workspace where you want the binary file to begin. After the file is loaded, you return to the main menu.

Next, I selected item number one in the menu. Here, you are asked to enter the EPROM addresses where you want to start and end programming. These addresses have default values, but you would probably want to enter the appropriate values for the binary file you are burning into the EPROM. You also input the workspace address where the binary file starts. This address would have a default value corresponding to the binary file just loaded into the workspace. Having done this, I was almost ready to operate.

Before starting, the Apple II will query whether you wish to suppress audio. During programming, the software causes the speaker to emit a series of audible clicks that can be eliminated by a positive response to this question. You are also reminded to set the switches properly. Finally, you have a last chance to abort and return to the main menu or to go ahead.

To keep going, you press the \* key. An estimate of the time needed to accomplish the task next appears on the screen, and then programming begins. Each EPROM address appears on the screen as the programming continues. After each byte is programmed, it is compared with the corresponding byte in the workspace. Programming stops if this test fails; otherwise, it proceeds until the entire binary file has been burned into the EPROM. Finally, programming returns to the main menu.

Item number zero in the menu is a combination of item numbers one and two. The other items in the menu are not covered in this discussion. Their functions are obvious from their names, and the manual describes the operation of each program in detail. With the exception

**You'll never have a better reason  
to begin shopping by mail:**

# IBM RAM BOARDS

## 256K

WITH AN RS-232C INTERFACE

### \$349

\$529 WITH SUPERCALC

## 512K

WITH AN RS-232C INTERFACE

### \$579

\$749 WITH SUPERCALC

Our fully-populated memory boards include parity checking and a standard RS-232C interface. They are compatible with all IBM software.

This is a rare opportunity to save a great deal of money without sacrificing quality. These boards meet the highest standards of design, materials and manufacturing available — at any price. They are completely guaranteed for two years.

Alpha Byte also carries the finest in IBM software, such as:

Lotus 1,2,3  
D BASE II  
Multiplan

Please call for our low prices.

**Alpha  
Byte**  
COMPUTER  
PRODUCTS

31245 LA BAYA DRIVE  
WESTLAKE VILLAGE, CA 91362

**To order or for  
information call**

**In Chicago:**

**(312) 454-1236**

**In New York:**

**(212) 509-1923**

**In Los Angeles:**

**(213) 706-0333\***

**In Dallas:**

**(214) 744-4251**

**By Modem:**

**(213) 991-1604**

CALL OUR MODEM LINE  
FOR WEEKLY SPECIALS.

\* For all your computer product needs, come visit us at our new California store.

Circle 15 on inquiry card. →

We accept VISA, MasterCard or C.O.D. (add \$3 for C.O.D.) Add a \$3 shipping charge to prepaid orders; actual shipping charges will be added to non-prepays. California residents, add appropriate sales tax.

A practical approach to constructing an operational compiler...

# Engineering a Compiler: VAX-11 Code Generation and Optimization



by Patricia Anklam, David Cutler, Roger Heinen, Jr., and M. Donald MacLaren, all of Digital Equipment Corporation

With an emphasis on authentic engineering processes, this book offers a step-by-step description of the development of a production-quality compiler with a code generator capable of highly optimized object code for **multiple** source languages. Specifically, it details the **practical** experiences of the programming team that developed a PL/I General Purpose subset compiler for Digital Equipment Corporation's VAX machines.

*Engineering a Compiler* focuses primarily on the lesser known aspect of compiler **design—the** back end code generation phases. More than **half** the book is devoted to optimization—global optimization, tree reductions, register allocation, and peephole optimization. The programming team's solutions to common problems of compiler design provide useful information to anyone undertaking a similar venture with other equipment.

The book begins by providing background information on the VAX code generator, the PL/I compiler, and the design team's approach to **bootstrapping** an existing PL/I compiler to produce code for VAX machines. Following chapters discuss specific **aspects** of the compiler design, such as the requirements for constructing Table-Building Language source programs, the symbol table and the structure of the trees, the Intermediate Language, Write Tree, the engineering and evolution of the optimizer, examples of VAX code generation, and the software engineering tools the team found most useful. Numerous PL/I and C program examples, a glossary, and over 80 figures and tables are included.

Return to: Digital Press Order Fulfillment  
Digital Equipment Corporation  
12-A Esquire Road, Billerica, MA 01862

Please send me \_\_\_\_\_ copies of *Engineering a Compiler* \*(\$24.00). Postage and handling free when your order is prepaid by check or charge card. Ten percent discount when ordering two or more copies. Prices subject to change without notice. Make checks payable to Digital Equipment Corporation.

- Check included.       VISA.  
 MasterCard.         Purchase Order (attach P.O.).

Charge Card Acc't No. \_\_\_\_\_

Expiration Date \_\_\_\_\_ Telephone \_\_\_\_\_

Authorized Signature \_\_\_\_\_

Name \_\_\_\_\_

Company/School \_\_\_\_\_

Address \_\_\_\_\_

City \_\_\_\_\_ State \_\_\_\_\_ Zip \_\_\_\_\_

**digital**

of item number nine (Exit), the successful completion of each routine returns you to the main menu. Programming an EPROM thus becomes a smooth operation with minimal chance for error. In fact, the software permits novice computer users to easily handle the EPROM programming tasks on a production-line basis.

You can tell from this review that I am favorably impressed with the hardware, software, and manual. I recommend this package to anyone who is programming EPROMs. If you want to change any features, you can easily modify the BASIC software for your own purposes by making a listing. The machine-language subroutine might be more difficult to modify, but it can be located, disassembled, studied, and modified if you wish. The EPROMs that can be programmed are all 5-V devices; that is, they can be used as ROM when powered by one 5-V supply. (The 2716 EPROM provides 16K bits of memory in a 2K by 8-bit format; that is, it has 2K bytes of memory. The 2732 stores 4K bytes of information, the 2764 stores 8K bytes, and the 27128 stores 16K bytes.)

One important criticism of the documentation is that it does not include a circuit diagram. For example, if you want to use the card as an EPROM card in the Apple II's hexadecimal C800 through CFFF ROM space, it might be possible to discover how the type-2716 EPROM is switched into this part of the address space. Also, it would be useful to know the bank-switching techniques used to access larger EPROMs. With additional documentation, the card could perform a secondary function as a regular EPROM card. However, this deficiency in the documentation should not be regarded as serious. ■

### About the Author

Marvin L. De Jong is the author of two microcomputer books, *Programming and Interfacing the 6502* and *Apple II Assembly Language*. He teaches mathematics and physics at The School of the Ozarks in Point Lookout, Missouri.

## BYTE's Bits

### New York to Host World Computer Chess Championship

New York will be the host city for the Fourth World Computer Chess Championship. This match, held during the annual conference of the Association for Computing Machinery (ACM), will pit the reigning champion, Belle, against challengers from England, Germany, the Soviet Union, and the United States. Belle will square off against Cray Blitz, Nuchess, and Chaos, which finished second, third, and fourth in

performance rating versus opponent's strength behind Belle last October at the ACM's Thirteenth North American Chess Championship. Play in this five-round tournament is expected to approach the master level.

The ACM's annual conference will be held in the Sheraton Center on October 22 to 25. Anyone interested in further information may write to Professor Monroe Newborn, School of Computer Science, McGill University, 805 Sherbrooke St. W, Montreal, Quebec H3A 2K6, Canada. ■



# IBM® + GENIE™ = Solution

## 5.25" Fixed/Removable Winchester Cartridge Drive Systems For The IBM Personal Computer/Compatibles



**5+5**

### • The Genie Cartridge Drive

A revolutionary new 10 Megabyte Hard Disk Drive that includes a 5 Megabyte removable hard disk cartridge. The cartridge drive system simply plugs into your computer, and includes all necessary software and hardware. Genie Drives are compatible with most popular software, and each cartridge replaces over 30 double-density floppy disks.

### • 5.25" Removable Cartridge

(Proposed ANSI Standard). Imagine, 5 Megabytes in the palm of your hand. These small Winchester cartridges are only .75 inches thick and 5.50 inches square. The disk itself is completely sealed from the outside and all its hazards by a sliding door that opens only once the cartridge is firmly seated inside the drive.

### • Genie's Solution To Personal Computer Mass Storage Problems

Up until now, people with serious mass storage applications have had no realistic means of conveniently maintaining their large data bases due to the cost of storage media and the expense and inefficiencies of doing back-ups. The Genie systems approach solves such typical storage problems by allowing both high capacity Fixed Drives and 5 Megabyte Removable Cartridge Drives to be intermixed on the same computer system. This provides the ultimate storage solution because of the new ease of doing back-ups, along with ability to maintain several large data bases on removable cartridges, eliminating the need to tie up expensive disk drives over a single data base application. With Genie Drives, the combinations are unlimited. Flexibility and versatility were key design considerations. A user can configure up to eight of our Drive Products in any combination to derive a storage solution for just about any application imaginable. With Genie, your personal computer can now take on tasks that had only been possible with mainframes.

- 10 MEGABYTES OF ON-LINE STORAGE
- FILE SIZES TO 5 MEGABYTES
- BACK-UP 5 MEGABYTES IN TWO MINUTES
- CARTRIDGE INTERCHANGEABILITY GUARANTEED



MODEL X5A

- 5 MEGABYTES OF ON-LINE STORAGE
- FILE SIZES TO 5 MEGABYTES

**X5**

Genie Systems Are Expandable Up To 160 Megabytes Using Any Combination Of Genie Drive Models



- USER CAN BACK-UP TO MODELS 5 + 5 OR X5 REMOVABLE CARTRIDGE DRIVES OR DISKETTES.

5 MEGABYTES  
10 MEGABYTES  
15 MEGABYTES  
20 MEGABYTES

Manufacturer's suggested retail price. Includes all required components.

CP/M-86 and Concurrent CP/M-86 is a registered trademark of Digital Research.

IBM is a registered trademark of IBM Corporation.

Dysan is a registered trademark of Dysan Corporation.

UCSD P System is a registered trademark of the Regents of the University of California San Diego.

QNX is a registered trademark of Quantum Software System, Inc.

Etherlink is a registered trademark of 3Com Corporation.

Ethernet is a registered trademark of Xerox Corporation.

- IBM XT Compatible
- Automatic Install (Genie Custom BIOS)
- Comprehensive menu driven utility package
- Intermix different operating systems on disk or cartridge
- Assign to any drive codes from A thru H
- Choice of volume sizes
- Give your virtual volumes 16 character names
- Assign command allows you to assign 8 virtual drives on line at any one time
- Show command allows instantaneous viewing of all virtual drives on line
- Help command displays syntax for all new commands
- User can back up to or from any model Genie Drive



5 MEGABYTES

SIMPLY PLUGS INTO YOUR I.B.M.

MODEL X5P

**5-10-15-20**

TALK ABOUT USER FRIENDLY . . . . .

3Com Ethershare™ Compatible (Ethernet Standard)

- File sizes 5-20 megabytes, dependent upon drive type.
- Automatic recovery system
- Easy back ups in minutes
- Cartridges can have 16 character names
- System status screen messages
- System expandable to eight drives using only one slot in your IBM PC
- Built-in error detection and correction
- No preventative maintenance required
- Power-on self test
- Create turnkey systems
- Ultra hi-speed DMA data transfers
- Comes complete with all necessary software and hardware
- Operating systems supported: IBM DOS 1.1, 2.0, CONCURRENT CP/M 86, CP/M 86, UCSD P SYSTEM, QNX™

AVAILABLE AT YOUR LOCAL COMPUTER DEALER

**GENIE COMPUTER CORPORATION**

31131 Via Colinas #607 • Westlake Village, CA 91362 • (213) 991-6210 • TLX 658233 (GENIE USA)

**“ADD UP TO 512K RAM, ASYNC AND SYNC COMMUNICATIONS, A CLOCK AND PRINTER SUPPORT-UP TO FOUR I/O PORTS IN JUST ONE SLOT?”**



# "YOU CAN WITH PERSYST."

## The Persyst Time Spectrum. It's the most powerful and expandable multi-function PC board you can buy.

A Persyst Time Spectrum™ multi-function board can make any personal computer work better.

Whether you own an IBM PC or XT. Or the IBM compatible Compaq or Columbia.

There's even a Time Spectrum board for the Texas Instruments PC.

With Time Spectrum, you can combine up to six powerful functions—plus two advanced software programs—on just one board. And get performance and features like nothing else.

## For the IBM PC, Compaq and Columbia, maximum capability in minimum space.

For example, Time Spectrum is the only multi-function board that lets you expand your IBM PC from 64K up to 512K RAM. Add a calendar clock. Add as many as two RS-232 asynchronous communications ports, or two synchronous and one asynchronous communications port. Plus print spooling and as much as 320K of RAM disk memory.

Up to four I/O ports—in just one slot.

How did we do it?

With the Cliffhanger™ A unique, RFI-shielded connector system that solves the problem of tying two or more I/O ports to peripheral equipment like a printer or modem, without consuming two or more slots.

And only Persyst has it.



The Time Spectrum Cliffhanger™. So ingenious, it's patented.

What's more, expansion functions can be plugged right onto the Time Spectrum board. Or added with Versapak™ piggyback modules. So you can add exactly the capability you need, when you need it.

## Extra flexible expansion for the IBM XT.

For the IBM XT, Time Spectrum not only delivers exceptional one-board expansion capability, but extra flexibility, too.

First, we designed Time Spectrum so you can add the RAM you want without having to fill the memory rows on the XT mother board.

And with Time Spectrum plug-in expandability, you can continue to add functions as you add requirements.

Start with basic memory and a calendar clock. Then add another asynchronous communications port. Parallel printer port. Additional memory. Or any combination of functions.

With Persyst, the choice is yours.

## And now, one-slot capability for your Texas Instruments PC.

Now there's even a Time Spectrum multi-function board for your TI PC. With it, you can add up to 512K RAM, two serial ports, calendar clock and light pen port—capability to handle even the most complex and difficult computing functions.

And still only consume one slot. The Persyst Time Spectrum board.

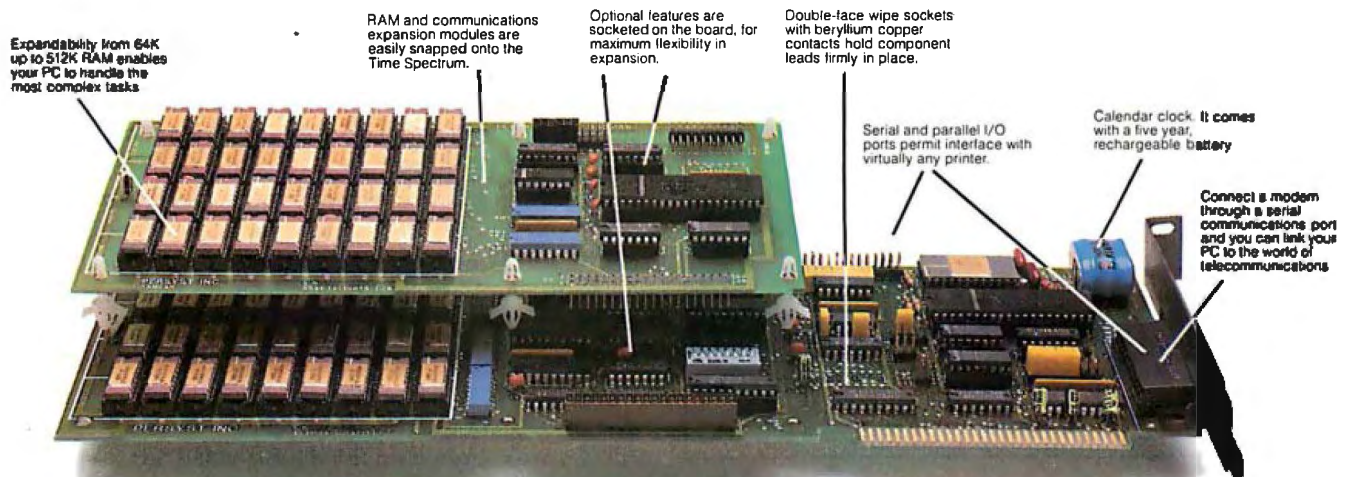
Maximum expandability now. And quality and versatility so you can keep on expanding later.

See your IBM or TI PC dealer and insist on Persyst.

# PERSYST™

Persyst Products, Personal Systems Technology, Inc., 15801 Rockfield Blvd., Suite A, Irvine, CA 92714. Telephone: (714) 859-8871. TWX: 467864.

Circle 300 on inquiry card.



# THE TIME SPECTRUM™ BY PERSYST.

## Electrohome Supercolor Board and Color Monitor

Jon N. Swanson  
Drafting Editor

Electrohome's Supercolor Board is a video interface that enables the Apple II to drive a professional color video monitor. The board sends three separate signals that directly control the amount of red, green, and blue seen on the monitor's screen. Without the board, the three signals would be combined with several others into a single *composite video* signal that a TV receiver must decode. The Supercolor Board eliminates these combin-

ing and decoding steps, thus producing an extremely clean high-resolution display.

### Background

The normal video signal output by the Apple II, referred to as composite video, is a mixture of image and "sync" (synchronization) signals. This signal is designed for use with a normal television set via an RF (radio-frequency) modulator (a device that converts the signal so that it may be received on a television channel) or with a composite-video monitor. Unfortunately, some signal components and resolution are lost in this process.

A conventional digital RGB (red-green-blue) video interface, which turns any or all of the three color guns in the monitor's picture tube fully on or fully off, offers some improvement over composite video. Only eight colors can be produced by a digital interface, however, because tints and shades require intermediate levels of the three colors. An analog interface like the Supercolor Board, on the other hand, can turn on the guns at varying intensities and produce many different colors.

### Hardware

The Supercolor Board uses 22 ICs (integrated circuits) that draw 365 mA from the Apple's +5-V power supply. All ICs are socketed on the double-sided, glass-epoxy circuit board, and the edge connector is gold-plated. Two cables are provided, one to connect to an RGB monitor,



Photo 1: The Electrohome high-resolution monitor and Supercolor Board.

# INTRODUCING 1-2-3.<sup>™</sup> IT'LL HAVE YOUR IBM/PC JUMPING THROUGH HOOPS.



Meet 1-2-3 – the remarkable new software package that puts more raw power at your finger tips than anything yet created for the IBM PC. 1-2-3 actually combines information management, spreadsheet, and graphing in one program that can perform all three functions interchangeably and instantly at the touch of a key. That's power.

To explain: since 1-2-3's information management, spreadsheet and graphing functions reside in memory simultaneously, you can go from retrieval to spreadsheet calculation to graphing instantly, just by pressing a few keys. So now you can experiment and recalculate and look at data in an endless variety of ways. As fast as your mind can think up new possibilities. There's no lag between you and the computer. And that's a new kind of power – power that's greater than the sum of its programs.

## The spreadsheet function.

If 1-2-3 were just a spreadsheet, you'd want it because it has the largest workspace on the market (2048 rows by 256 columns). To give you a quick idea of 1-2-3's spreadsheet capabilities: VisiCalc's spreadsheet for the IBM PC offers 15 arithmetic, logical and relational operators, 28 functions and 32 spreadsheet-related commands. 1-2-3 has 15 operators,

41 functions and 66 commands. And if you include data base and graphing commands, it actually has 110!

In addition, 1-2-3 is up to 50 times as fast as established spreadsheets. With all the features you've ever seen on spreadsheets. 1-2-3 also gives you the capability to develop customized applications (with 26 macro keys) and lets you perform repetitive tasks automatically with one keystroke. If 1-2-3 were just a spreadsheet, it would be a very powerful tool. But it's much, much more.

## The information management function.

Add to 1-2-3's spreadsheet a selective information management function, and the power curve rises at an awesome rate. Particularly since 1-2-3's information management capability reads files from other programs such as WordStar, VisiCalc and dBase II. So you can accumulate information on a limitless variety of topics and extract all or pieces of it for instant spreadsheet analysis. Unheard of before. Specific 1-2-3 information management features include sorting with primary and secondary keys. Retrieval using up to 32 criteria. 1-2-3 performs statistical functions such as mean, count, standard deviation and variance. It can produce histograms on part or all of the data base. 1-2-3 also

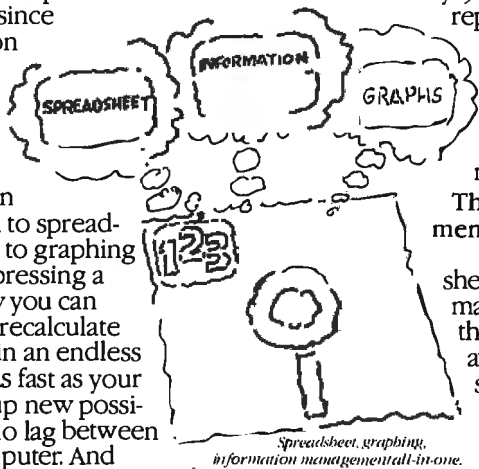
allows for the maintenance of multiple data bases and multiple criteria.

## The graphing function.

1-2-3 enables you to create graphs of up to six variables using information already on the spreadsheet. And have it on screen in less than two seconds! Once you've made a graph, three keystrokes will display it in a different form. If data on the spreadsheet changes, you can display a revised graph with one keystroke. This instant relationship of one format to another opens up a whole new application area. For the first time graphics can be used as a "what if" thinking tool!

For a full demonstration of 1-2-3's remarkable power, visit your nearby 1-2-3 dealer. For his name and address, call 1-800-343-5414 (in Mass. call 617-492-7171).

Lotus Development Corporation, 55 Wheeler Street, Cambridge, MA 02138.



1-2-3 and Lotus are trademarks of Lotus Development Corporation. All rights reserved. WordStar is a registered trademark of MicroPro Inc. VisiCalc is a registered trademark of VisiCorp. dBase II is a registered trademark of Ashton-Tate.



**NEW COMPUTER VIDEO TERMINALS!**  
**Hazeltine 1420**  
 List: \$1200  
 Our Price: \$450.00  
 (Dealer Inquires Welcome)

**Features.**

- 80 x 24 High Resolution Screen
- Upper/Lower Case Characters
- Reverse Video (Blink or Blank)
- Numeric Keypad with 9 Programmable Function Keys and Cursor Control Pad
- On Screen Editing with Wrap Around
- 75-9600 Baud Rate
- STD RS-232 Connector
- Lightweight/Compact/Single Unit
- **TWO Year Factory Warranty!!!**



**CENTRONICS HIGH SPEED DOT MATRIX PRINTERS**  
 List: \$4800  
 Our Price: \$199.00

**Features**

- 165 Characters per second (1920 words per minute)
- 2" to 15" Adjustable Tractor Feed
- 132 Columns Expanded Print & Multistrike Highlighting
- 9 x 7 Matrix with "End of Line" Seeking Carriage Return.
- Commercial Quality Heavy Duty Steel Construction
- 30 Day Money Back Guarantee
- Optional Lower Case Character Sets with Graphics Available
- Compatible with Centronics Parallel Outputs: (TRS-80, Apple, IBM-PC, Franklin Ace, Osborne, Atari, TI-99, Commodore 64, Vic-20, and More)
- Refurbished Units, with all Electronics Aligned.

C 110h Prowriter (120 Cps, Corresp. Mode, Graphics) - \$439.00  
 C 110h Starwriter F-10 (40 Cps Letter Quality) - \$1299.00  
 Seiko Dot Matrix Printers (80 Columns, 2" x 10" Width Graphics) - \$239.00  
 Franklin Ace 1200 (128K, Disk Drive, 80 Columns, CP/M) - \$1699.00

**Write For Free Price List.**

A.C.E. Systems, 106 E. Broad St. Bethlehem, Pa. 18018  
 (215) 348-8250 ● 867-5066  
 MC - ADD 3%

**At a Glance**

**Name**

Electrohome Supercolor Board and high-resolution RGB monitor

**Use**

RGB color monitor interface for the Apple II

**Manufacturer**

Electrohome Limited  
 809 Wellington St.  
 Kitchener, Ontario N2G 4J6  
 Canada  
 (519) 744-7111

Tech Plus Inc.  
 35 Marsh Rd.  
 Needham, MA 02192

**Price**

Low-resolution monitor, \$550; high-resolution, \$950; Supercolor Board, \$249

**Dimensions**

Supercolor Board: 7¾ by 2¾ inches; ECM Monitor: 18 by 13 by 1½ inches deep; screen: 13 inches (diagonal measure)

**Features**

Apple hardware board, RGB analog monitor, connecting cables, software contained on a 5¼-inch disk, users manual

**Capabilities**

Display of 256 colors or pure white text with color, compatible with existing and future Apple II software

**Hardware Required**

Apple II with 48K bytes of memory; must use slot 7

**Audience**

Any Apple II owner

**Warranty**

One year, limited, for board and monitor

**BYTEK'S SECOND GENERATION  
 UNIVERSAL (E)PROM  
 PROGRAMMER—SYSTEM 15**

**Features:**

- Bipolar PROMs.
- Micros - (8748 & 8749)
- I/O - 6 baud rates, 13 formats including Intellec, Texttronix and Motorola.
- EPROMs, (2708 - 27128)
- Gang option - programs eight at once.
- Remote control option.

**\$15-R  
 \$445**

**PROGRAMS  
 OVER 250  
 DEVICE TYPES**



**FUNCTIONS:**

- DISPLAY DEVICE DATA
- EDIT RAM DATA
- DEVICE PROGRAM
- TYPE SELECTION
- CRC-RAM
- LOAD DATA
- COMPARE FIELDS
- FILL MEMORY FIELD
- BLOCK MOVE
- DIAGNOSTICS and more.



**COMPUTER SYSTEMS CORP**

2283 S. Federal Hwy. Delray Beach, FL 33444 (305) 272-2051

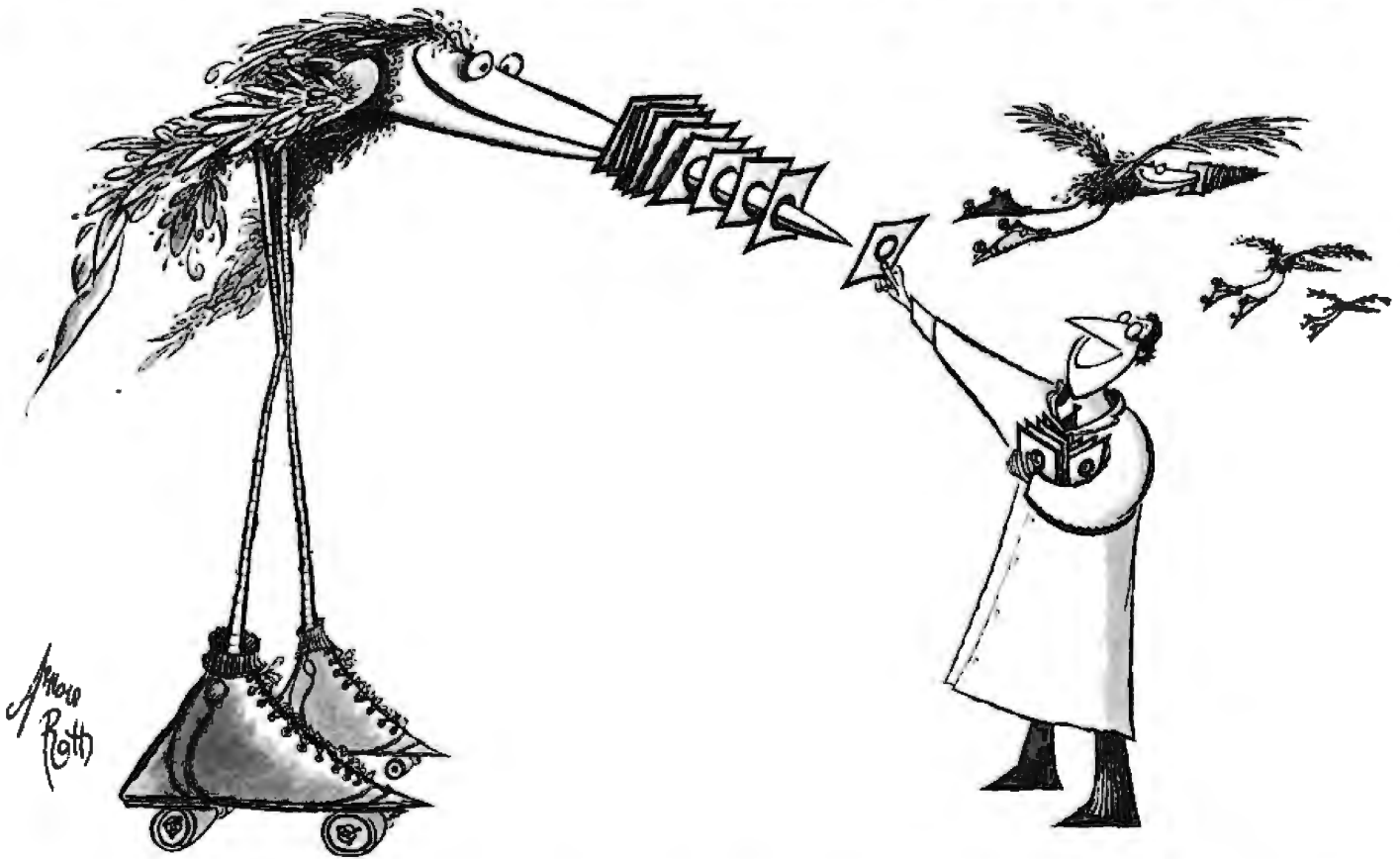
the other to obtain two signals from other parts of the Apple via a four-pin Molex plug and a component clip. The board must be installed in slot 7 on the Apple II motherboard because that is the only slot that provides the sync signal from the Apple's video circuitry.

Unlike some other video boards that use extra memory in the Apple, the Supercolor Board uses only the memory assigned to slot 7 and thus does not interfere with normal Apple II functions. The board adds 16 new memory locations to the Apple II, from decimal 50944 through 50959. The contents of these locations determine the values of low-resolution graphics colors 0 through 15 and high-resolution colors 0 through 7. These contents can be altered by using the Colorset program provided in the software package.

The Supercolor Board was developed in Canada by Electrohome. (Tech Plus Inc. is now licensed to sell Electrohome products in the United States.) The board comes with a seven-pin male DIN-type connector wired for use with Electrohome RGB analog monitors. Although the board will work with any RGB monitor, it offers 256 colors only on analog-input RGB monitors.

The Electrohome ECM 1302-2 high-resolution RGB monitor has a 13-inch black-matrix color CRT (cathode-

# Smallware™



## Our software is making a name for itself.

Smallware. That's what we've named our unique software designed for microcomputers. Smallware offers much more than ordinary software: high quality, customer support and a complete product line. You can buy software anywhere. But for the special features of Smallware, The Small Computer Company is your one and only source.

The Small Computer Company is known to many as the company who developed the filing system software Profile® II, Profile Plus and Profile III Plus for Radio Shack; and filePro™ our CP/M® version.

Now, whether you're a microcomputer end-user, dealer or manufacturer, you can order our Smallware directly from us.

Here are just some of the enhancements we offer to Model III users:

**PROSORT:** If you need to select records for a report by more than two criteria (income, zip code, purchases, etc.) Prosort lets you use up to sixteen. Once selected, the records can be sorted by up to five criteria (zip code, within state, by last name). Prosort also offers substantially greater sorting capacity. . . \$150

**FORMS:** If you prepare forms that require several lines of data, from invoices to shipping instructions, Forms is invaluable. It allows you to print individual forms (up to 13" x 11") with graphics, trademarks, logos, underlining, subscript and superscript functions. . . . . \$125

**ARCHIVE:** Lets you maintain up-to-the-minute, clean files by removing inactive records and transferring them to a pre-determined list or file; split an existing data base into any number of specialized files; free substantial disk storage space. . . . . \$150

**PROPACk™:** A tool that lets BASIC programmers more easily customize Profile systems. The resulting programs are shorter, easier to write and faster running. Propack also gives the BASIC program indexed access to Profile data. . . . . \$75

For Model II, 12 and 16 users, there's Quikback™ with Format, Display, Transfer, 8 Line Reports With Math, Math Upgrade for Profile Forms, Math 64, Propack and more.

The Small Computer Company does more than create award-winning Smallware. Our commitment to the customer extends to custom design as well as system consultation.

For further information, call (212) 398-9290. To order, ask for Ms. Price.



**The Small Computer Company, Inc.**

230 West 41st Street, Suite 1200, New York, New York 10036

Smallware, Propack, Quikback and filePro are trademarks of The Small Computer Company, Inc. CP/M is a registered trademark of Digital Research, Inc. Profile is a registered trademark of Radio Shack.

Circle 351 on inquiry card.



# Integrated Accounting System

Just plug it into your  PC  
and **RUN YOUR BUSINESS!**

THE BUSINESS MANAGER™:

Integrated Accounting System:

GENERAL LEDGER

ACCOUNTS RECEIVABLE

BILLING

INVENTORY

ACCOUNTS PAYABLE

PAYROLL

WORD PROCESSOR - WORDSTAR™

SPELLING CHECKER - SPELLSTAR™

FILE MANAGEMENT - MAILMERGE™

Electronic Spreadsheet - REPORT MANAGER™  
Application generator + 3-dimensional spreadsheet w/graphics

Relational Database Management System™  
MicroRIM™ (True mainframe capabilities)

APPOINTMENT MANAGER™  
Executive's Time Scheduler

PERSONNEL MANAGER™  
Human Resource Management

PROJECT MANAGER™ - Time Based Project Scheduler  
(Creates PERT & GANTT Charts)

The best and most complete business program package  
on the market . . . providing all the software and storage  
you ever wanted.

- ★ All software pre-installed on 10MB or 15MB hard disk and ready to run. No more diskettes and tedious paper work
- ★ High speed operation
- ★ All programs self-prompting and menu driven
- ★ Self-explanatory . . . easy to use
- ★ All software and hardware fully guaranteed and supported

## The Information Manager

includes:

Project Manager™  
Personnel Manager™  
Appointment Manager™  
Report Manager™  
MicroRIM™ RDMS  
Wordstar™  
Spellstar™  
Mailmerge™

CP/M® &  
APPLE®  
VERSIONS  
AVAILABLE  
SOON

Dealer  
Inquiries  
Invited

Contact your  
local dealer

# The Business Manager™

1420 E. Edinger Ave., Suite 115, Santa Ana, CA 92705

(714)836-3569

Circle 46 on inquiry card.

IBM is a Reg. trademark of IBM Corp. Apple is a Reg. trademark of Apple Computers. CP/M is a Reg. trademark of Digital Research. Wordstar, Spellstar and Mailmerge are Reg. trademarks of MicroPro International. Report Manager is a Reg. trademark of Datamension Corp. Prices and specifications subject to change without notice.



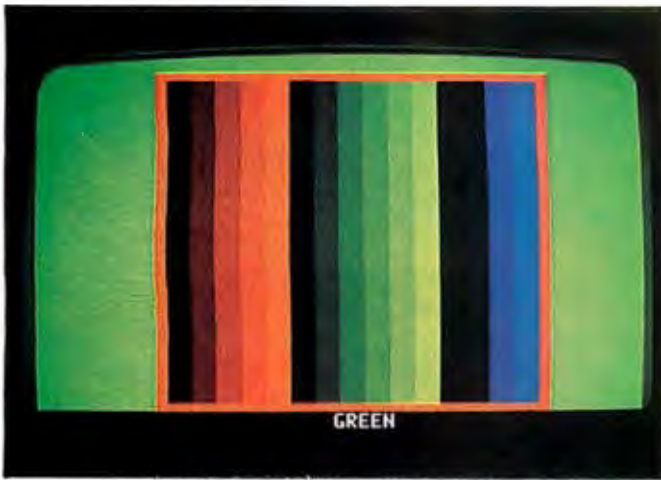


Photo 2: Red, green, and blue shades created with the Boardtest program.

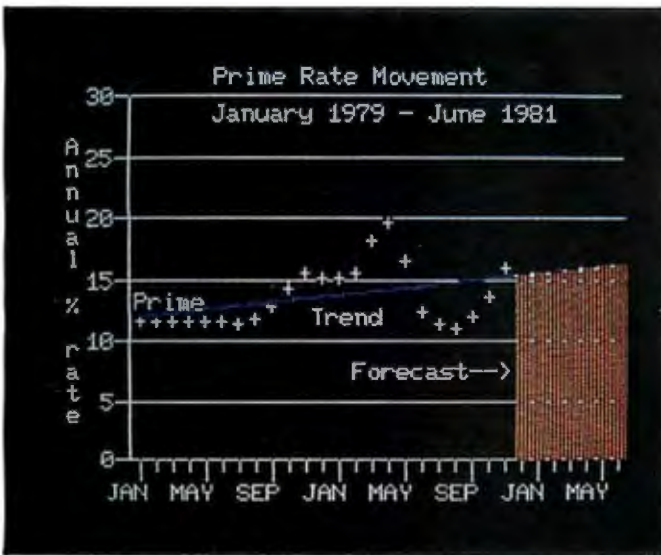


Photo 3: Pure white high-resolution text.

ray tube), RGB analog input at TTL (transistor-transistor logic) levels, 10 MHz bandwidth, 580- by 235-pixel resolution, and separate connectors that allow direct connection to the Supercolor Board or the Apple III computer (which has built-in provisions for digital RGB output). The monitor's Apple III input port is a 15-pin sub-miniature "D" connector that accepts RGB data. In another version (the ECM 1302-1 low-resolution monitor) Electrohome provides a bandwidth of 6 MHz and 370- by 235-pixel resolution. A 120/240 line voltage option is available for both versions, as well as a module that enables the monitor to accept composite video signals.

### Software

A 5¼-inch floppy disk with demonstration, testing, and color-programming software is included with the Supercolor Board. Because the disk is not copy-protected, the software is easily customized by the user. Of particular interest is the Colorset program. By blending varying amounts of red, green, and blue, this program

allows you to create with simple keystrokes a palette composed of any 16 of the 256 possible low-resolution colors or any 8 of the 256 possible high-resolution colors. Any set of colors you create can be stored on disk and accessed from a program.

A PROM (programmable read-only memory) on the Supercolor Board contains color settings for normal Apple II operation (default mode) and for an enhanced mode that offers pure white text in high-resolution mode. When creating text in high-resolution mode without the aid of the board, the locations on the screen where the six available colors can appear are restricted by whether an adjacent dot is on or off, whether the dot is in an odd or even column, and which color is selected. Any two adjacent dots produce white, but most letters require single, isolated dots. This is why text constructed dot-by-dot using high-resolution graphics is tinged with color.

When the enhanced PROM color set is entered, the Supercolor Board rewrites the tinged colors as white, producing pure white text. However, two of the six high-resolution colors are lost in this mode, so you may choose to put up with "confetti" text. Six-color mode is available with pure white text if you can fit all of your text into the four-line text window at the bottom of the screen. Letters in this window are always pure white, as is all text in TEXT mode.

### Installation

The Supercolor Board is advertised as being compatible with any version of the Apple II to date, but I could get it to work only on Apples that have the auxiliary four-pin connector between locations B and C on the motherboard. You should check with your Apple dealer to make sure the board will work with your version. The instructions are very straightforward and installation takes only about 15 minutes, reading included. One cautionary note—the board must be installed in slot 7 right next to the disk-drive interface, and it's a pretty tight fit for all of the various cables. Route your cables neatly, being careful not to puncture the disk-interface cable's insulation with the back of the circuit board. Inserting a thin piece of cardboard between the boards lessens this danger.

### Conclusions

My only complaint is the lack of a user-accessible contrast control on the monitor. When using high-resolution graphics, increased contrast is needed at times to brighten some of the thinner lines in the display. A spokesman for Electrohome said the firm will be adding a contrast control on its next model.

The hardware and software of the Supercolor Board and Electrohome RGB monitor are excellent, with all operations fully supported and documented.

The color output is very clean, and pure white text is definitely easier on the eyes than the rainbow-edged characters commonly seen on Apple IIs.

No modification to your Apple II is required, making this truly a "plug-and-go" interface. ■



## HOW TO GET COMPUTER FORMS MADE TO ORDER.

Most forms suppliers will print any quantity of customized computer forms you want.

As long as you want quantities of 2,500 or more.

But plenty of companies don't want to buy more than they can use in a reasonable time.

So Deluxe fills orders as small as 500.

And delivers them in a small amount of time.

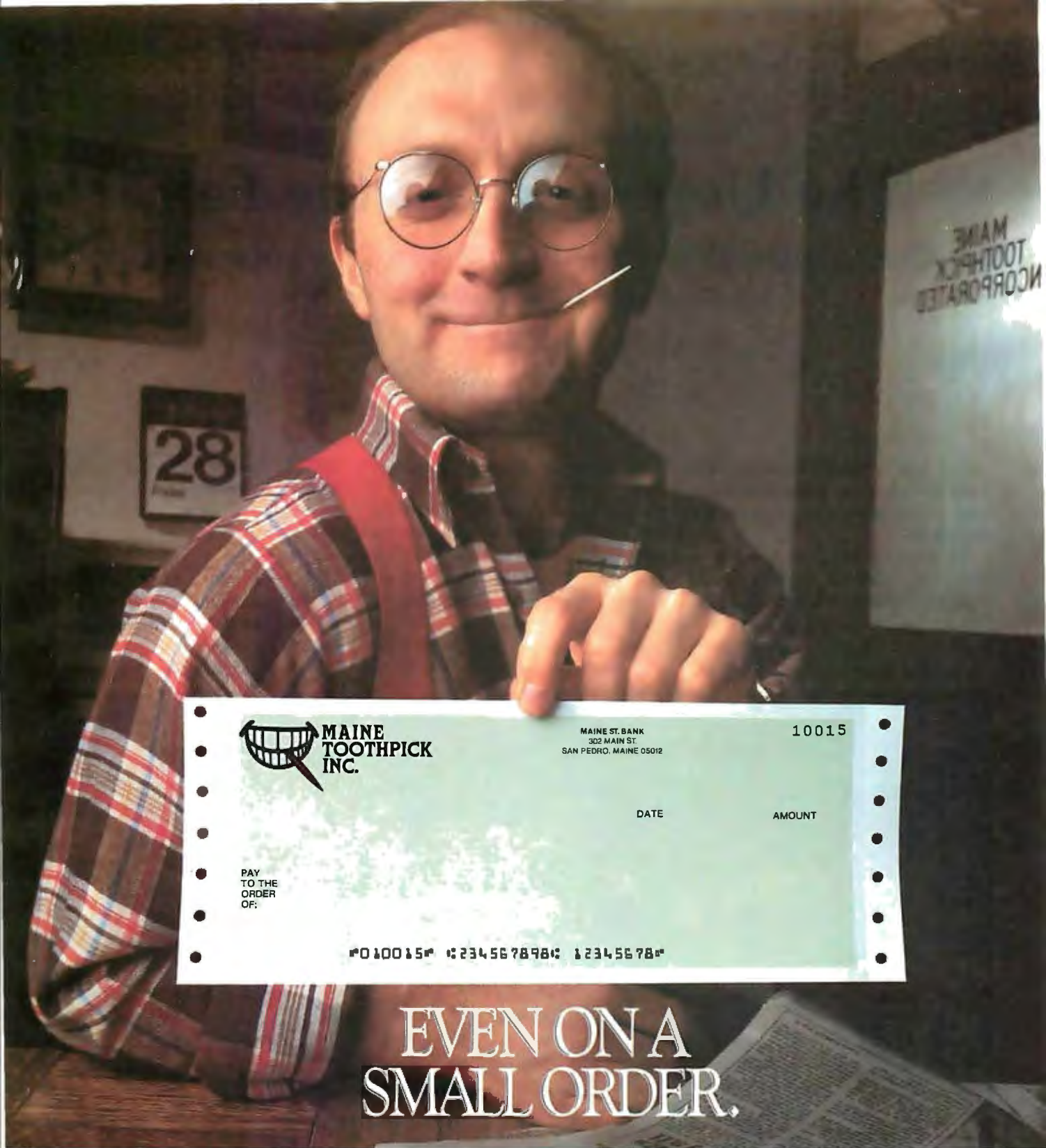
On standard computer forms, we give you three-day

in-plant turnaround. (Or 5 days on customized forms.)

Our major competitors can take up to 45 days, but still charge you just as much.

And even on a small batch, we can match all popular software formats.

We also customize forms for your own programs, with lots of ink colors and logo designs to choose from. But even our standard forms make a big impression.



**MAINE  
TOOTH PICK  
INC.**

MAINE ST. BANK  
302 MAIN ST  
SAN PEDRO, MAINE 05012

10015

DATE


AMOUNT

PAY  
TO THE  
ORDER  
OF:

⑆010015⑆ ⑆234567898⑆ ⑆2345678⑆

**EVEN ON A  
SMALL ORDER.**

Because as the name implies, Deluxe quality is unsurpassed. It's also **guaranteed**: If you're not satisfied with any Deluxe form, return it within 30 days and your money will be promptly refunded.

Call toll free for our free catalog,  featuring computer forms, supplies and accessories, **1-800-328-0304** (In Minnesota call : 612-483-7300.) Or mail the coupon. Or see your banker today.

**FREE COMPUTER STATIONERY.**

Deluxe Computer Forms, 530 North Wheeler, P.O. Box 43046, St. Paul, MN 55164-0046  
With your first order of Deluxe computer forms, we'll give you a free box of computer stationery (\$40.00 value). Just send this card for full details and our free catalog. Or call free: 1-800-328-0304. In Minnesota call 612-483-7300.)

Name \_\_\_\_\_  
Company \_\_\_\_\_  
Address \_\_\_\_\_  
City \_\_\_\_\_

**DELUXE**

# The User Goes to the Faire

*Our redoubtable critic journeys from Chaos Manor to the Eighth West Coast Computer Faire.*

---

Jerry Pournelle  
c/o BYTE Publications  
POB 372  
Hancock, NH 03449

---

This year's Faire report is different: I was there both as observer and participant. I'm afraid I can't separate the experiences . . .

The West Coast Computer Faire remains my personal favorite of the computer shows. There was a time when it was the most important show in the microcomputer industry, but I think that's no longer true. In the old

days many companies announced new products at the Faire; now that tends to happen more at Comdex and NCC. For users, though, the Faire remains one of the best shows of the year, and a lot of exciting things still happen there. You just have to dig for them.

For example: at this year's Faire you could (at last!) buy a copy of

WRITE, the text editor I'm using to write this report. I also saw the precursor to what I believe will replace both WRITE and my own computer.

I played with a copy of Niklaus Wirth's personal computer.

There's an APL interpreter for the Z80 microcomputer.

If that isn't enough of a teaser, I



*The main floor of the show—it was one of three floors the exhibitors occupied.*

# TCS Heart of TEXAS COMPUTER SYSTEMS

**LEADER in MAIL ORDER DISCOUNTS!**

**800 433-5184**

**Texas 817/274-5625**

## IBM Personal Computer

## APPLE

**INTERNAL DISKS FOR IBM**  
Tandon Internal Disk-160K ..... SCALL  
Tandon Internal Disk-320K ..... SCALL

**HARD DISKS FOR IBM**  
Complete 5 Meg. Systems from ... \$1550  
Multi-computer Network Systems.

**QUADBOARD FOR IBM**  
Includes 64K to 256K additional memory  
Serial & Parallel Port and Calendar Clock

**PRINTERS FOR IBM**  
STAR and EPSON ..... SCALL  
NEC 3550 Spinwriter ..... SCALL

**MONITORS**  
Med Hi Res-Green Comrex ..... \$89  
High Res-Green BMC from ..... \$89  
High Res-Color PGS ..... SCALL  
Matches IBM PC  
Low Res-Color-Taxon Vision 1 ..... SCALL  
High Res-Color-Taxon Vision 1 ..... SCALL  
High Res-Green-Taxon ..... SCALL

First DISK DRIVE includes controller, DOS 3.3, cables and manual ..... SCALL  
Second DISK DRIVE with cable ..... SCALL

APPLE to EPSON card and cable  
APPLE to GEMINI card and cable  
Z 80 CARD ..... SCALL  
RAM CARD ..... SCALL  
Printer Interface Cards ..... SCALL  
Graphic Printer Interface Card ..... SCALL  
Graphic Spooler Interface Card  
**available with 16K to 64K**



FOR IBM, APPLE II AND APPLE III  
SPECIFY INTERNAL/EXTERNAL  
5 megabyte hard drive ..... SCALL  
12 megabyte hard drive ..... SCALL

## TCS MODEL III 48K 2 DISK

Systems come with 180 day warranty.

**\$1444**

With standard 40 track  
double density drives  
Over 340,000 bytes  
includes TDOS

**\$1644**

With 2 dual headed 40  
track dbl. density drives  
Over 730,000 bytes  
Includes DOSPLUS 3.4  
(\$150 value)

Fully assembled and tested systems that are software compatible and functionally identical to Radio Shack units sold at computer stores for Shundreds more.

- CONTROLLER BOARDS are high quality double sided epoxy boards with gold plated contacts
- POWER SUPPLY is the finest switching type available.
- MOUNTING HARDWARE includes power and data cables.
- DISK DRIVES are Tandon, the same ones used by Radio Shack ..40 track, double density, with a 5 millisecond stepping rate.

## TCS MODEL III DISK EXPANSION KITS

- 1 Controller, Power Supply, Mounting Hardware & Instruction ..... \$279
- 2 Controller, Power Supply, Mounting Hardware & one 40 track Tandon Drive ..... \$475
- 3 Controller, Power Supply, Mounting Hardware & two 40 track Tandon Drive ..... \$677
- 3A Kit 3 but with two 80 track drives (dual 40's) ..... \$875
- 3B Kit 3 but with two 160 track drives (dual 80's) ..... \$1099

## TCS Model III and Color Computer

Ask about the Green or Amber CRT for your customized Model III

# TRS-80

## Model III and Color Computer

With Original 90 day Manufacturer's Limited Warranty  
Call for current pricing information on the

## Model II...Model 16...Model 12...Model 4

All Radio Shack Equipment shipped from our store in  
Brady, Texas.

# Tandon

TCS DRIVE CABINET is industrial grade heavy gauge metal, safely fused, and comes with gold plated external connector with extender cable

## 1 DRIVE in Cabinet

40 track single sided ..... \$249  
80 track (dual sided 40 track) ..... \$329  
160 track (dual sided 80 track) ..... \$449

## 1 DRIVE/Double Cabinet

40 track single sided ..... \$289  
80 track (dual sided 40 track) ..... \$389  
160 track (dual sided 80 track) ..... \$499

## 2 DRIVES/Double Cabinet

40 track single sided ..... \$489  
80 track (dual sided 40 track) ..... \$639  
160 track (dual sided 80 track) ..... \$849

Drives in cabinets come assembled/tested with power supply Order cable separately

## BARE DRIVES ONLY

40 track single sided ..... SCALL  
80 track (dual sided 40 track) ..... SCALL  
160 track (dual sided 80 track) ..... SCALL  
8 inch Slimline sgl/dbl sided ..... SCALL  
Winchester Hard Drives 5-30 Meg ..... SCALL

## Smith-Corona® TP-I

Parallel/Serial ..... \$535

## TEXAS COMPUTER SYSTEMS

P.O. Box 1327 Arlington, Texas 76004-1327

TECHNICAL ASSISTANCE 817/274-9221

ORDER STATUS 817/277-1913

TELEX/TWX/Easylink ELN 62100790

**★ 800 433-5184**

No tax out of state. Texans add 5%. Prices subject to change at any time.

# CORVUS

## HARD DISKS from \$1889

5 Megabyte Hard Drive ..... SCALL  
10 Megabyte Hard Drive ..... SCALL  
20 Megabyte Hard Drive ..... SCALL

Add 5, 10 or 20 Megabytes of storage to your TRS-80 Model 1, Model II, Model III, Model 12, IBM, Apple, Atari, Heath, Zenith, Intertec, S100, Osborne, Eagle Commodore 64, Xerox, Superbrain, Z89/90, DEC LSI-11, NEC PC-8001, and more

One or several computers can share A HARD DISK

Ask about OMNINET for your Apple or IBM PC.



Dedicated  
To Being No. 1!

## FEATURES

- 100 CPS
- 9X9 Dot Matrix
- True Decenders
- Super Script-Subscript-Underlining
- Friction and Tractor
- Programmable Line Spacing
- 99% Compatible with software written for No. 1 Printer.
- High Res. Bit Image Block Graphics
- Backspacing-Doublestrike-And More
- 5, 6, 8 1/2, 10, 12 and 17 Pitch
- Free 2.3K Buffer

Extended Six (6) Months Factory Warranty--FREE!

Gemini 10 (9 inch Carriage) Friction and Tractor ..... SCALL  
Gemini 15 (15 inch Carriage) Friction and Tractor ..... SCALL  
Serial Interface ..... SCALL  
Apple Card and Cable ..... SCALL  
Commodore Interface ..... SCALL

Call and ask about the new High Speed Printers By Star Micronics.

# COMMODORE 64

VIC 20--DISK DRIVES--MONITORS  
DATASETTES--SOFTWARE  
ACCESSORIES

Call For Current Pricing Information.

## PRINTERS

TCS has the LOWEST PRICES on IN-STOCK PRINTERS

### LETTER QUALITY PRINTERS

C ITOH F-10 (40 CPS)  
DAISY WHEEL II (RS)  
NEC 3510-3550  
NEC 7710/7730  
BROTHER/COMREX

### MATRIX PRINTERS

EPSON-MX & FX MODELS  
C.I.TOH 8510/TEC/PMC  
DMP 100  
DMP 200  
DMP 400  
DMP 500  
DMP 2100  
ANADEX 9501-A  
CENTRONICS 352/353  
OKIDATA PRINTERS

PRINTER CABLES AND INTERFACES AVAILABLE.  
CALL FOR CURRENT PRICING INFORMATION.

also saw the first computer with ventricles. Read on . . .

It's nearly impossible to write a brief overview of the West Coast Computer Faire. There's just too much going on. That in itself is significant; it means that the micro-computer field has gotten too big even for someone as frantically determined as I am to keep up. It used to be that I could follow the mainstream. Now, I'm not even sure there is a mainstream. That probably won't

last. Improved communications will bring the branches together again, but a lot of mistakes are going to be made first. Meanwhile, fair warning: given the number of panels, talks, and exhibits, no one could cover the whole Faire.

Second warning. I can't pretend total objectivity. My son and one of my closest friends had a booth at the Faire. They not only sold programs I've written, but also WRITE, which I've been using (and talking about)

for several years. While I have no financial interest in Workman and Associates, I can't divest myself of my friends and relations—nor would I if I could. Thus, this is the Faire as I saw it. Others probably saw a show that only partially overlaps mine.

First, let's set the scene. The Eighth West Coast Computer Faire was held the weekend of 18 through 20 March in the San Francisco Exposition Center. In previous years booths were set up on Wednesday, so that on Thursday the exhibitors had a chance to see each other's wares before the public arrived Friday morning. For some reason that didn't happen this year, and Thursday was setup day.

I had planned to fly up Thursday at noon and get a good night's sleep. It didn't work out that way. Wednesday afternoon there were big rainstorms. My son Alex and his friends had planned to use Barry Workman's Ford Escort to tow an overloaded trailer filled with computer equipment and Workman and Associates catalogs from Hollywood to San Francisco. The storms got worse. The weather reports got worse. Next thing I knew, I'd volunteered to drive with them in my International Harvester truck, and we were leaving well after midnight Wednesday.

### Dante's Ninth Circle

We arrived Thursday afternoon. It was raining in San Francisco. The Exposition Center was surrounded by cars, trucks, trailers, pushcarts, and every other conceivable means of transporting computer equipment. Dealers everywhere were bent on getting their stuff inside out of the rain.

Trailer unloading ought to be an Olympic event. Two men and one woman seemed to be the average team makeup. Some of the big companies cheated with professional help.

As the afternoon went on, the entire Exposition Center was covered with piles of rugs, boxes, boards, disassembled furniture, signs, computer components, and angry dealers trying to find out what happened to their electric power. *Compute!* magazine sponsored a very nice party in the exhibitors' lounge Thursday

ALL

# 1/3 off SOFTWARE

**Software Catalog. FREE.** Get the lowest price on every software program you need. 1/3 off list price *guaranteed*. And look what else you get from ITM:

**Unlimited Consultation!** ITM's consultants work with an amazing database indexed with over 300 software selection criteria—plus thousands of in-depth product reviews. You'll get the programs that are right for you. Quickly. Easily. It's the most sophisticated consultation service in the industry. Call toll free!

**Over 2,000 programs to choose from.** Hundreds added every month. All categories. All formats.

**See any program demonstrated.** Order any non-entertainment program for a *risk-free, thirty-day trial*. Full refund if not completely satisfied.

**No minimum order.** Buy just one program if you like. Quick shipments.

Call ITM now. Or, mail the coupon today and receive our FREE Software Catalog. Save hundreds—even thousands—of dollars on all of your software purchases with ITM.

American Express, Visa, or MasterCard honored.

Call toll-free today.

**(800) 334-3404**

In California (415) 284-7540

**Software Catalog. FREE.**

BYTE 6/83

YES. Send complete information for my review. Please include a free copy of ITM's Software Catalog.

NAME \_\_\_\_\_

COMPANY NAME \_\_\_\_\_

ADDRESS \_\_\_\_\_

CITY/STATE/ZIP \_\_\_\_\_

PHONE \_\_\_\_\_

Individual  Dealer  Consultant  Company

## ITM

Software Division

We make software buying simple.

Attn: Stevan Cloudfree  
936 Dewing Ave., Suite E  
Lafayette, CA 94549-4292  
(800) 334-3404 or  
(415) 284-7540

"It would be hard to find a more powerful or sophisticated desktop computer within the price range of the Sanyo"  
Infoworld - 11/29/82



# SANYO PLUS

A full feature, fast, Z-80, 64K computer with over \$2000 of software for \$1995.  
The Sanyo Plus hardware includes a Sanyo MBC-1000 computer with a built-in 12" high-res., green phosphor 25x80 display, a serial communications port and a parallel printer port. The detached keyboard is sculpt and tiered and includes a separate 10-key pad.

The Sanyo Plus has dual 5 1/4" double density drives and features a total formatted disk capacity of 624K.

The Sanyo Plus software includes CP/M® Basic and the unabashed, top-dog Micrapro application programs: Wordstar, with training guide, Mailmerge, Spellstar, Calcstar, and the new Infostar package including Darastar and Reportstar.

Plus we add a 300 baud direct connect modem with cable, modem software, and a games disk. Plus we integrate and test your system and include work copies generated on your system.

For more information call us at Scottsdale Systems. (No Dealers Please)

One year warranty \$99. Five module business software pack \$99. One drive system \$1649. Hard disks: 10Mb-\$1995/16Mb.\$2395.

# \$1995

### TELEVIDEO



Buy a Televideo multi-user system from us at discount and we'll arrange on-site installation via TRV. You can start with the single-user 803 and expand to a 16 user multi-tasking, multi-user network.

803	Call
1603	\$2769
802H	\$4529
806/20 Mb	\$5111
816/40 Mb	\$9210
800's	\$1299

### ALTOS



Our tech's favorite systems. From the lowest priced 3-user systems with either 2 or 6 MG. storage, to 40MG, 8-user 16 bit systems.

Add terminals, printers, and software and we can fully test and configure your system at low prices. Book nationwide by Moore Systems Service.

Series 5-1 5D	\$2195
Series 5-5D	\$3995
8000-10	call
8600-12	\$9465

Series 5, 8000, systems include MP/M

### ZENITH



New low prices on the systems that are 5-100, 16 bit/8 bit, MS DOS and CP/M compatible. Plus they're backed by Zenith service virtually everywhere. The Z-100's feature two built-in 5 1/4" drives, 128k RAM, and 225x640 graphics. Add a 13" RGB ZVM-134 monitor to your 110 for superior color display.

ZF-110-22	\$2699
110 w/green monitor	\$2799
ZF-120-22	\$2799
ZVM-134 (color)	\$555
Software Special (100-7)	\$489

### NORTHSTAR



Prices now include free burn and test. We warranty each unit for 90 days from the day you receive it (not 90 days from the day we receive it). Call for prices on compatible software and hardware.

Advantage 64K Quad	\$2769
Horizon 64K Quad	\$2695
Advantage w/5 Mb.	\$3795

### TERMINALS



#### Sanyo CRX 1000

Now a full feature terminal at a dumb terminal price. 8 Edit function keys. 8 programmable function keys. 256 characters in a 8x12 cell, graphics, detached keyboard with palm rest, printer port, 12" non-glare Sony display. \$549

Adds 3A+ Emulates the ADM-3A, detached keyboard, keypad, 12" green display, nationwide Adds service. \$469.

Wyse 100	\$699
Wyse 200	call
Televideo 910	\$579
Televideo 925	\$735
Televideo 950	\$927
Televideo 970	\$1044
Zenith Z-29	\$659
Zenith ZT-1	\$459
Hazeltine Espirits	call
Qume	call
Houston Instruments	Call

### Digital: Rainbows and Professional series ..... Call



## Scottsdale Systems Ltd.

617 N. Scottsdale Road, Suite B, Scottsdale, Arizona 85257

 **(602) 941-5856** 

Call 8-5 Mon.-Fri.

 We participate in arbitration for business and customers through the Better Business Bureau of Maricopa County.

### PRINTERS



Okidata 92	\$489
Okidata 93	\$835
Okidata 84	\$969
NEC 8023A	\$409
Epson FX-80	\$539
Tally 160L w/Trac	\$689
IDS Microprism	\$309

### HIGH SPEED

Prism 80 "Loaded"	\$1369
Prism 132 "Loaded"	\$1469
Anadex 9501A	\$1369
Qanrex 7030	\$1562
TI-810 Basic	\$1285

### LETTER QUALITY

Diablo 620	call
NEC 3510	\$1495
NEC 7710	\$2149
Transtor	call
DTC-380Z (48k)	Call

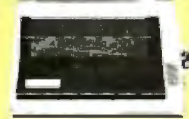
### SERVICE/ORDERING

**INTEGRATION:** Prices listed are for new equipment in factory sealed boxes with manufacturer's warranty. We will pretest your equipment, integrate your system, configure your software, provide special cables, etc., for an additional charge. Call for prices.

**ORDERING: MAIL ORDER ONLY.** Prices listed are for cash. No C.O.D.'s. We sell on a net 20 basis to Fortune 500 companies and Universities Charge cards add 2%. Prices subject to change, product subject to availability. AZ. residents add 5%. Personal checks take 3 weeks to clear. 0-20% restocking fee for returned merchandise. Shipping extra - products are F.O.B. point of shipment, CP/M and MP/M are registered trademarks of Digital Research.

**SOFTWARE:** We sell all popular CP/M® programs at discount. Software sold only with systems not warranted for suitability.

### GEMINI



The new best selling dot matrix printers. 100 c.p.s., friction, tractor and roll feed. Graphics, 180 day warranty, 2.5K std. buffer and much more.

Gemini 15	\$460
Gemini 10	\$304

### SANYO PR 5500

Finally - A full function, heavy duty, letter quality printer at a dot matrix price: Wide carriage, selectable 10, 12, or 15 pitch, 16 C.P.S. (Shannon text), bi-directional, std. parallel interface: bold, superscript, and subscript printing, std. comidge ribbons, and more.

**\$669**



afternoon, and I much enjoyed the hospitality. The party was largely attended by the press and the lucky few exhibitors who'd gotten their booths set up. Most hadn't, and when I left the Center Thursday evening, the scene resembled one of the less pleasant circles of Dante's Inferno.

Somehow by the time the show opened Friday morning, everything looked organized. Most of the dealers were exhausted, having worked all night under trying circumstances. That's not a big problem for large outfits with professional staffs, but it can be pretty serious for firms of owner and spouse, who have to work like donkeys all night and be charming the next day.

Friday morning the crowds came. Eventually there were 50,000 attendees. At least 25,000 were there Friday morning when I took my tape recorder and went racing past the exhibits while dictating notes. I always do this; the idea is to locate everyone. (I'm tempted to bring my roller skates. Jim Warren, who founded the Faire, always wears his.)

There were an astounding number of booths. Last year, the meeting rooms to each side of the main hall were devoted to convention conferences. This year they had become the Apple and IBM PC halls respectively. In addition, every corridor was jammed with booths. In past years booths have filled the corridor outside the rest rooms, but this year they extended into the chair storage area, a place more like the Black Hole of Calcutta than a computer exhibit site.

As usual, the halls are filled with 6 by 6 microbooths and the downstairs area contains innumerable 8 by 10 minibooths. You can't ignore them. They often have the most exciting stuff in the show.

### I Have Seen the Future . . .

One wants to be careful about bandwagons. In 1919, Lincoln Steffens, American writer and social critic, went to the newly created Soviet Union, and after a brief visit to what was then called Petrograd, cabled: "I have been over into the

future, and it works." He might have a different view today.

Similarly, at the tiny Logitech booth I saw Lilith, the computer used by Niklaus Wirth. This is a rather powerful machine capable of concurrent processing. That means that it can run a number of programs, or more important, a number of parts of the same program, at the same time. Lilith was operated by Brigham Young University professor Richard Ohran, who was there as one of the principals of the nonprofit Modula Research Institute, as well as vice-president of the commercial firm Diser Inc.

I saw graphics better than arcade games. There was a game of billiards, in which you could use a mouse to move the cue around. The balls had spin after being hit, and not only showed it by visibly "spinning" as they moved, but behaved accordingly as they bounced off each other and the "table."

More interesting, though, was a text editor that would format almost anything you wanted onto the screen,

*Continued on page 315*

## \$50 FACTORY REBATE

### Smith-Corona TP-1

Letter Quality  
Daisy Wheel Printer

- Serial Or  
Parallel Interface
- Microprocessor  
Electronics



# \$499

Free Shipping  
List Price \$895.00

Plus... \$50  
Factory Rebate

REBATE VALID  
IN JUNE & JULY ONLY



# CompuAdd Corp.

**ORDER TOLL FREE:**  
(800) 531-5475 (If Outside Of Texas)  
(512) 250-1523 (In Texas)  
13010 Research Blvd., No. 101  
Austin, Texas 78750



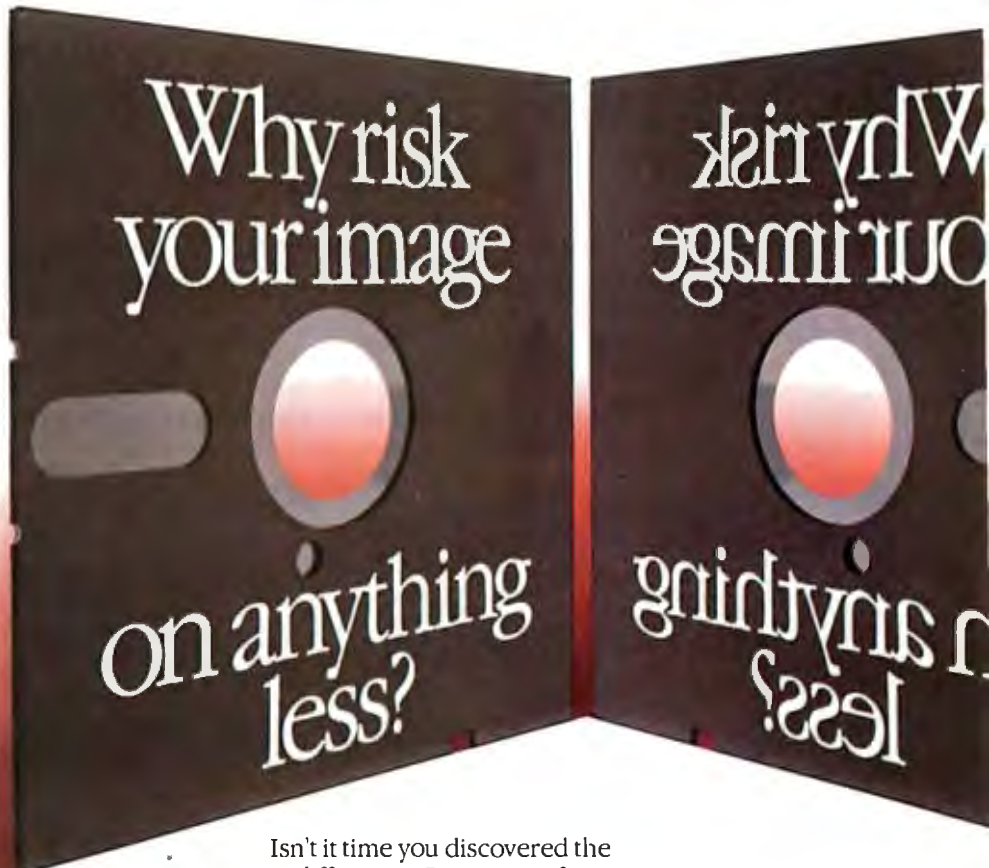
DISCOVER THE DYSAN DIFFERENCE

# Dysan Software Duplication:

It's your name on the package label. And your company's reputation on the line. Whether your program retails for \$40.00 or \$400.00, or is for company internal distribution, the cost of duplicating it on diskettes is just a fraction of the value of your product. Doesn't it make sense to protect the time, money and talent invested in your software with the finest and most complete software duplication services available?

## Quality Software Deserves the Quality Media.

Dysan's software duplication services are unsurpassed for fidelity of reproduction. Not only is your program copied unerringly onto the finest media made—the Dysan diskette—but it's also copied on proprietary equipment manufactured by Dysan, exclusively for Dysan. Plus Dysan offers you the widest variety of support services available—from software protection to serialization and packaging.



Isn't it time you discovered the Dysan difference? For more information on Dysan software duplication, fill out and return this coupon today, or call (800) 551-9000.

**dysan** **Dysan.**  
CORPORATION

Circle 133 on inquiry card.



### Dysan Software Duplication Division

5201 Patrick Henry Drive

Santa Clara, CA 95050

(800) 551-9000

(408) 988-3472

B 6

Please send me more details on  
Dysan's Software Duplication Services.

Name: \_\_\_\_\_

Company: \_\_\_\_\_

Address: \_\_\_\_\_

City: \_\_\_\_\_ State: \_\_\_\_\_ Zip: \_\_\_\_\_

Phone: (\_\_\_\_) \_\_\_\_\_

# More seat vs. more seats.



TWA's business class with bigger seats and fewer of them.



A typical widebody coach.

## TWA's Ambassador Class<sup>®</sup> is available on all widebodies everywhere we fly.

TWA is better for business.

Because unlike most airlines, TWA offers you Ambassador Class—our special business cabin with bigger, wider seats than coach. In fact, our seats are so big and roomy, we put four Ambassador Class seats where other airlines have five coach seats.

So now you can sit back and relax. Or even work if you want to. Either way, no one cramps you or your style.

And since there are fewer seats per row, you're never more than one seat from the aisle.

You'll find Ambassador Class on every widebody we fly. Every 747. Every L-1011. Every 767. Everywhere we fly.

### Special extras.

In Ambassador Class you get a lot more extras besides the extra room. You'll save extra

time, thanks to our special Ambassador Class Check-In at the airport.

And that's not all.

There are complimentary cocktails and fine wines in flight. Headsets when there's a movie. And on long flights, complimentary appetizers and a choice of three entrees served on china and linen.

### Much more for not much more.

You know a great deal when you see one. And Ambassador Class means a great deal more comfort than coach. Yet it costs a great deal less than First Class.

So call your travel agent, corporate travel department or TWA.

TWA's Ambassador Class.

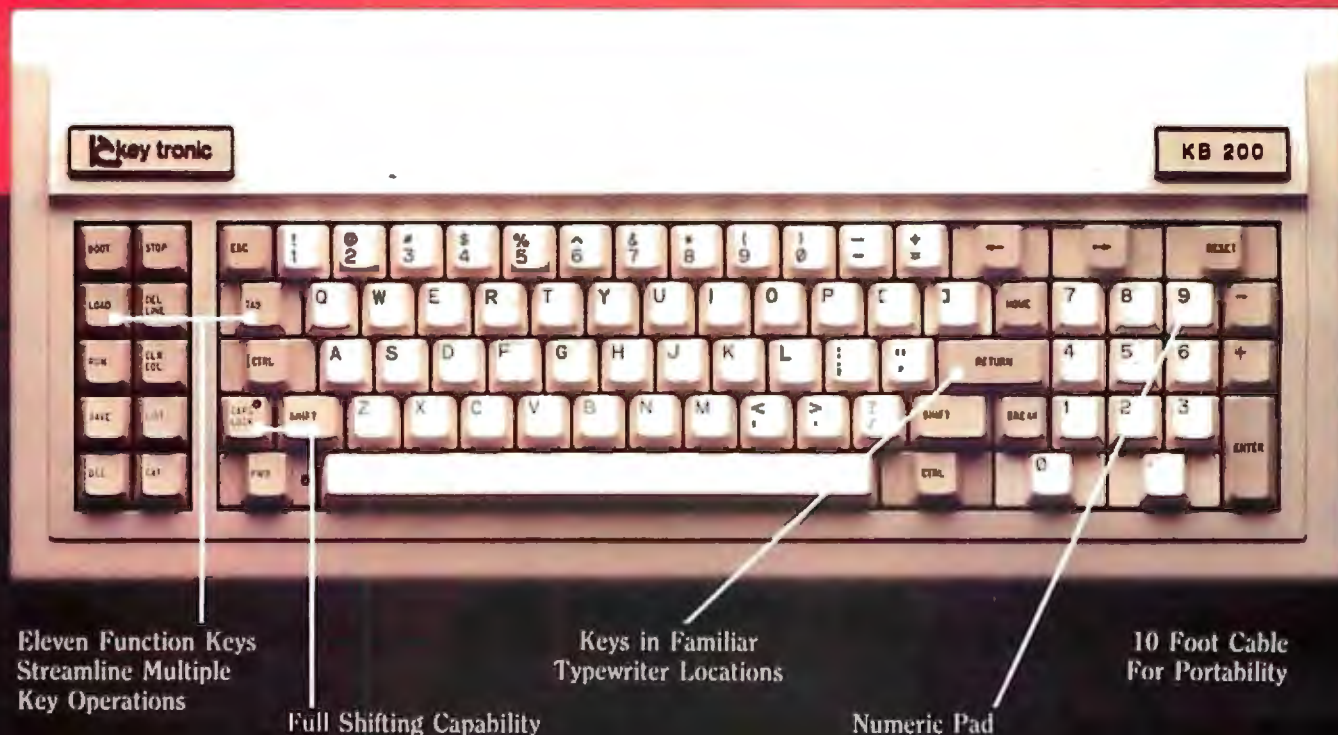
It's a more comfortable business environment.

You're going to like us





# KEY TRONIC POLISHES THE APPLE II\* KEYBOARD



Eleven Function Keys  
Streamline Multiple  
Key Operations

Full Shifting Capability

Keys in Familiar  
Typewriter Locations

Numeric Pad

10 Foot Cable  
For Portability

Enhance your APPLE II\* Computer System with a Key Tronic keyboard peripheral. This detached, low-profile keyboard is plug-compatible with the existing keyboard socket of the Apple II. It also features reliable microprocessor electronics, solid-state capacitance switches, and positive tactile feedback.

\*Apple II is a registered trademark of Apple Computer, Inc.

Price: \$298.00

To Order Model KB-200 Call Toll Free  
1-800-262-6006 (8am-4pm Pacific Standard Time).  
Warranty information may be obtained, free of  
charge, by writing to the address below.

 **key tronic**

THE RESPONSIVE KEYBOARD COMPANY

DEPT. E1 • P.O. BOX 14687 • SPOKANE, WASHINGTON 99214 USA

## AUTHORIZED DISTRIBUTORS:

C-J SALES  
San Francisco, CA (415) 941-6892  
DIGITAL ENTRY SYSTEMS, INC.  
Boston, MA (617) 899-6111  
COMPONENTS UNLIMITED  
Lynchburg, VA (804) 237-6286

J C SALES COMPANY  
Los Angeles, CA (213) 340-6136  
SSE PRODUCTS, INC.  
Elmont, NY (516) 827-9001  
PERIPHERAL SUPPORT, INC.  
Chicago, IL (312) 593-5900

BASIC TIME  
Los Angeles, CA (213) 538-9711  
QED ELECTRONICS, INC.  
Philadelphia, PA (215) 657-5600  
COMPUTER-MATE, INC.  
Dallas, TX (800) 442-4006 (Texas)  
(800) 527-3643 (Continental U.S.)

## CANADA:

FUTURE ELECTRONICS, INC.  
Montreal, Quebec (514) 694-7710  
Ottawa, Ontario (613) 820-8313  
Toronto, Ontario (416) 663-5563  
Calgary, Alberta (403) 259-6408  
Vancouver, B.C. (604) 438-5545

putting it in nearly any typeface and size you could imagine. It was also controlled by a mouse, and worked something like Apple's Lisa, but *much* faster.

The editor was coupled to the compiler and a debugger. A program could be written with the editor, compiled, and executed in the debugger. While the program was running, Ohran halted it. Then, using the mouse, he displayed the segment of source code corresponding to what the machine was doing when halted. Code could be altered quickly, and the program module could then be recompiled. (Modula uses very modular compilation, so you seldom need to recompile large parts of a program.)

I was impressed. This is the first editor I've seen that's probably better for text creation than WRITE, as well as certainly better for program writing. Moreover, it's written in a language I understand, or at least could understand, meaning that it can be changed, altered, and customized to fit my idiosyncrasies.

This whole system of editor, debugger, and compiler was written in Modula-2, Niklaus Wirth's new language. Modula-2 is sometimes described as "grown-up Pascal," and I'll be reporting on it frequently. I already have a version running on my Sage. The exciting news is that Logitech has a version of Modula-2 that compiles to 8086 native code.

This means that programmers can soon have Modula-2 for the IBM PC (and its work-alikes such as the Eagle and Victor), as well as for CP/M-86 machines such as the 8085/8088 dual processor and the new 10-MHz 8086 card Compupro had at the Faire.

There's even better news for PC owners. The Logitech mouse will plug into the IBM PC keyboard. It should also work with the Eagle and any other PC work-alike whose keyboard can be plugged unchanged into the IBM PC.

You can see why I was tempted to use Lincoln Steffens' line. This does look like the future, and it seems to work.

Alas, there may be more to the story.

# Will This Happen to You?

## NOT IF YOU BUY YOUR PRINTER FROM...

# THE PRINTER STORE

**SERVICE, COMPUTER AND SOFTWARE COMPATIBILITY, and LOW PRICE,** are among the many factors to consider when purchasing a printer. At the **PRINTER STORE** we specialize in printers, so our trained professional staff can help you choose the right printer for your personal and business needs. Every **Printer Purchase** includes:

- ★ **FULL FACTORY  
AUTHORIZED  
SERVICE**
- ★ **FREE  
TECHNICAL  
CONSULTATION**
- ★ **FULL  
AFTER SALE  
SUPPORT**

### DOT MATRIX PRINTERS

#### EPSON SERIES

FX 80 ..... \$ CALL  
MX 100 ..... \$ CALL

#### OKIDATA SERIES

82 A ..... \$ CALL  
83 A ..... \$685  
92 A ..... \$ CALL  
93 A ..... \$ CALL  
84 (parallel) ..... \$ CALL

#### C. ITOH SERIES

8510 Prowriter ..... \$395  
Prowriter II ..... \$ CALL

#### IDS SERIES

Microprism 480 ..... \$ CALL  
Prism 80 ..... \$ CALL  
Prism 132 ..... \$ CALL

#### GEMINI SERIES

Gemini 10 ..... \$339  
Gemini 15 ..... \$ CALL

#### NEC 8023

Toshiba P 1350 ..... \$1750

### LETTER QUALITY PRINTERS

#### BROTHER SERIES

HR-1 (parallel) ..... \$815  
HR-1 (serial) ..... \$ CALL

#### COMREX SERIES

CR-1 (parallel) ..... \$ CALL  
CR-1 (serial) ..... \$ CALL

Transtar 130 ..... \$785

Daisywriter ..... \$ CALL

#### NEC SERIES

3510 ..... \$1575  
3515 ..... \$2000  
3530 ..... \$1850  
3550 ..... \$ CALL  
7710 ..... \$2425  
7720 ..... \$2900  
7725 ..... \$3000  
7730 ..... \$2400

SCM-TPI ..... \$585

Grappler+ ..... \$ CALL

Apple Dumping ..... \$ CALL

Printer Sound Enclosure... \$ CALL

**We carry a full line of Cables and Accessories**

**Call (213) 470-1888 and ask us about...**

- 1) **LOW PRICES**
- 2) **FREE INTERFACING BOOKLET**
- 3) **FREE TECHNICAL SUPPORT**
- 4) **FULL SERVICE OPTION**

**HOW TO ORDER:** Our phone lines are open from 8 a.m. to 6 p.m. PST, Monday-Friday. We accept VISA, MASTERCARD (at no extra charge), personal checks take two weeks to clear. COD's accepted. Same-day shipment on orders placed before 1 p.m. Manufacturer's warranty applicable on all equipment. Prices subject to change.

# THE PRINTER STORE

2357 Westwood Blvd., L.A., CA 90064

© The Printer Store, 1983

**dBASE II™ made easy!**

# **QUICKCODE™**

**The dBASE II Program Generator**

Now dBASE II is made easy with Quickcode by Fox & Geller. QUICKCODE is a program generator, a computer program which writes computer programs.

**IBM  
VERSION  
NOW AVAILABLE**

## **FAST AND SIMPLE**

With QUICKCODE you can generate a customer database in 5 minutes. Its that fast. All you have to do is draw your data entry form on the screen. It's that simple!

## **NO PROGRAMMING REQUIRED**

QUICKCODE writes concise programs to set up and maintain any type of database. And the wide range of programs cover everything from printing mailing labels and form letters, to programs that let you select records based on your own requirements. There are even four new data types that are not available with dBASE II alone.

## **YOU CONTROL**

And since you work directly with your information at your own speed and your own style, you maintain complete control. Telling your computer what to do has never been so easy.

**Call us at (201) 794-8883**

**QUICKCODE, by Fox & Geller. Absolutely the most powerful program generator you've ever seen. Definitely the easiest to use.**

Ask your dealer for more information on QUICKCODE and all the other exciting new products from Fox & Geller. Circle 154 on inquiry card.



**FOX & GELLER**

Fox & Geller, Inc. Dept. BYT 001 604 Market Street Elmwood Park, N.J. 07407 (201) 794-8883

You've heard the good news. The not so good is that it's just not certain how much of this will work properly on the 8086-chip machines. Possibly a lot. Possibly not. Pierluigi Zappacosta, vice-president and spokesman for Logitech, didn't want to commit himself. Although Modula-2 is a transportable language—considerably more so than Pascal—there are some machine-dependent features of the editor/compiler/debugger system Ohran was demonstrating, and while Lilith isn't *that* much more powerful than the 8086 machines, it does have some unusual features.

According to Ohran, there are only about 75 copies of the Lilith machine in the world. You can buy the computer for something like \$15,000. And the laser printer needed to take advantage of the fancy graphics, print formats, and character fonts Lilith can generate costs another \$12-15,000.

We may not soon see those graphics and print formats on any existing PC or work-alike. They just don't have large bit-mapped screen systems like that. Lilith's display uses half a million bits of memory for screen mapping. I have seen similar bit-mapped graphics on the LISP machine at MIT, and Lisa has about two-thirds the resolution of the Lilith machine.

Zappacosta was a great deal more optimistic about transferring the debugger and many of the editing features to the IBM PC. The PC's 8086 chip can do concurrent processing, so the only real uncertainty is speed. Even that's not likely to be a problem for my 10-MHz Compupro 8086 board.

Beyond the 8086 is the 2-86, which most of us agree is as powerful as Lilith (although Ohran would argue the point). The 2-86 will accept 8086 instructions, meaning that the Modula-2 compiler will work instantly and can then be used to write a better compiler making more use of the 2-86's capabilities.

Meanwhile, a number of advanced firms, including Compupro, are looking at designs for the memory-mapped graphics board we'd need for that billiards game. Dennis Hunter of

the Swiss-backed firm Diser Inc. tells me that a commercial version of Lilith itself will be at the Atlanta Comdex show. That machine, complete with graphics and the software I've described, will be available as a package deal for around \$22,000.

There are some problems with Modula-2; it lacks features I'd have thought it should have. Even so, I *know* you can write nifty programs and operating systems with it, because I've seen them running. I guess the bottom line is that I've seen, if not *the* future, then a future I like, and I think I know how to make it work.

### APL

More good news. There's an APL for the Z80 machines. For those who don't know, APL (A Programming Language) is very strange. It makes use of about a zillion little special symbols, such as a "T" lying on its side, and squashed boxes, and diamonds, and stuff like that. Each symbol stands for something interesting, such as "take the natural logarithm" or "raise to a power." It's *interpreted*, like MBASIC, and works much like BASIC; and it has all the commands that a top-quality desk calculator has, including logs, trig, factorials, inverses, etc. In addition, there are matrix operations.

In fact, if the various APL keys had names like "Absolute value of Y" and "Pi times Y" instead of the symbols |Y and 0Y, APL probably wouldn't scare so many people because it works a lot like a fancy scientific desk calculator.

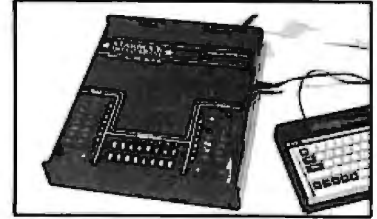
At least that's what my readers tell me. I don't get a lot of mail from APL enthusiasts, but every month there's one or two letters. The interesting part is that whereas enthusiasts of some languages are hostile, APL people *know* most people think their language is weird; instead of threatening, APL enthusiasts plead. "Just try it," they say.

Until now that's been irrelevant, because I had no machine on which I could try it. Now, though, Easi APL Systems Inc. has a real live APL running on Z80 machines. I saw it operate on an Osborne and a Victor. It is said to work with any CP/M

RS-232

DATA  
ACQUISITION

Control &  
Measurement



Starbuck Model 8232

A general purpose real-world interface: connects to ANY computer or terminal via RS-232

### TYPICAL APPLICATIONS:

- Use with printing terminal: create low-cost data logger
- Use with modem and phone for remote acquisition & control
- Capture data bursts for subsequent analysis/plotting
- Monitor experiments; transfer data daily to main computer

### FEATURES:

- 8 analog inputs, 0-5 VDC
- 8 digital input channels
- 8 opto-isolated outputs
- All inputs and outputs fully protected to withstand abuse
- 8 bit (0.4%) analog accuracy
- On-board 2000 point buffer
- Up to 5000 analog readings/s
- Triggered acquisition
- Units may be chained for extra channels
- Controlled by ASCII strings
- Application manual details interfaces for common sensors
- Applications engineer on call
- THRIFTY PRICE: \$540. complete! Applications manual only: \$5. TRS-80 version also available

★ STARBUCK ★  
DATA COMPANY

PO Box 24, Newton, MA 02162  
(617) 237-7695

Dealer and OEM inquiries welcome

Z80, but there's the problem of generating and displaying those strange APL symbols. According to David Saunders of Easi, I'll have this running on my Osborne in a few days, because they already have a ROM (read-only memory) chip that can plug directly into the Osborne to reprogram its keyboard and displays.

I know almost nothing about APL, but I confess I was impressed with Saunders' demonstration. He set up a 10 by 10 matrix with about three commands, inverted it with a single

command, and multiplied it by its inverse with one more. This took only a few seconds. Saunders thought that inverting a 50 by 50 matrix might take half an hour. When I get APL installed on one of my machines, I'll try the matrix multiplication benchmark I invented.

Meanwhile, I can't imagine writing large programs in APL, but as a quick calculator it has some really wonderful potential. If I could just learn it, and get it on the Osborne or the Otrona, I'd have a portable machine

with really powerful capabilities. I'll bet that within the year at least one portable machine will offer APL as a standard option.

### Ada, Now and Later

The booth next to Barry Workman's was run by R&R Software. They're the people who have implemented both 8080 and 8086 versions of Ada. They're honest to a fault, so they call their language Janus; but it's more nearly Ada than any other microcomputer implementation I know of.

The Department of Defense hopes Ada will save the government a lot of money. At the moment, though, there's no full Ada compiler for any machine in the world, and the "official" system compiles at tortuously slow rates. The R&R version compiles quite rapidly.

It's not a full Ada; but as Randy Brukhardt, one of the Rs in R&R, told me, it's certainly complete enough to write practical programs in. He knows, because it compiles itself. I watched some of the demonstrations, and it works. As I've said before: if you want an assured income, learn Ada. You don't have to like the language to profit from it, and the government will be hiring Ada programmers for a long time.

On that score, I can recommend a new book, Narain Gehani's *Ada: An Advanced Introduction*. It's just out in the Prentice-Hall Software series. I read part of it on the plane home (at least I didn't have to drive back). As the title says, it's an advanced introduction, meaning that it assumes the reader has some familiarity with computers and programs. It's fairly complete, and the writing isn't too obscure, although I have found myself reading some paragraphs more than once.

### Down with the Prices!

There were a number of bargains at the Faire. Priority One had 16-mega-byte Morrow hard-disk drives, with S-100 bus controller, for \$1595; the same disk drive without controller could be had for \$1295.

There were so many exhibits at the Faire that Priority One, along with

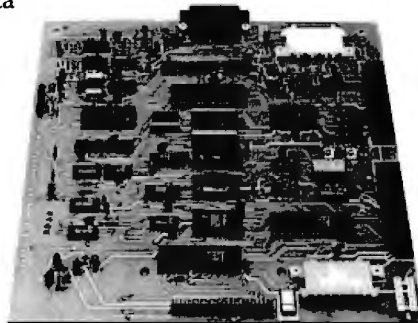


### The DS120 Terminal Controller makes your LA36 perform like a DECwriter® III.

The Datasouth DS120 gives your DECwriter® II the high speed printing and versatile performance features of the DECwriter® III at only a fraction of the cost. The DS120 is a plug compatible replacement for your LA36 logic board which can be installed in minutes. Standard features include:

- 165 cps bidirectional printing
- Horizontal & Vertical Tabs
- Page Length Selection
- 110-4800 baud operation
- 1000 character print buffer
- X-on, X-off protocol
- Self Test
- RS232 interface
- 20 mA Current Loop interface
- Top of Form
- Adjustable Margins
- Double wide characters
- Parity selection
- Optional APL character set

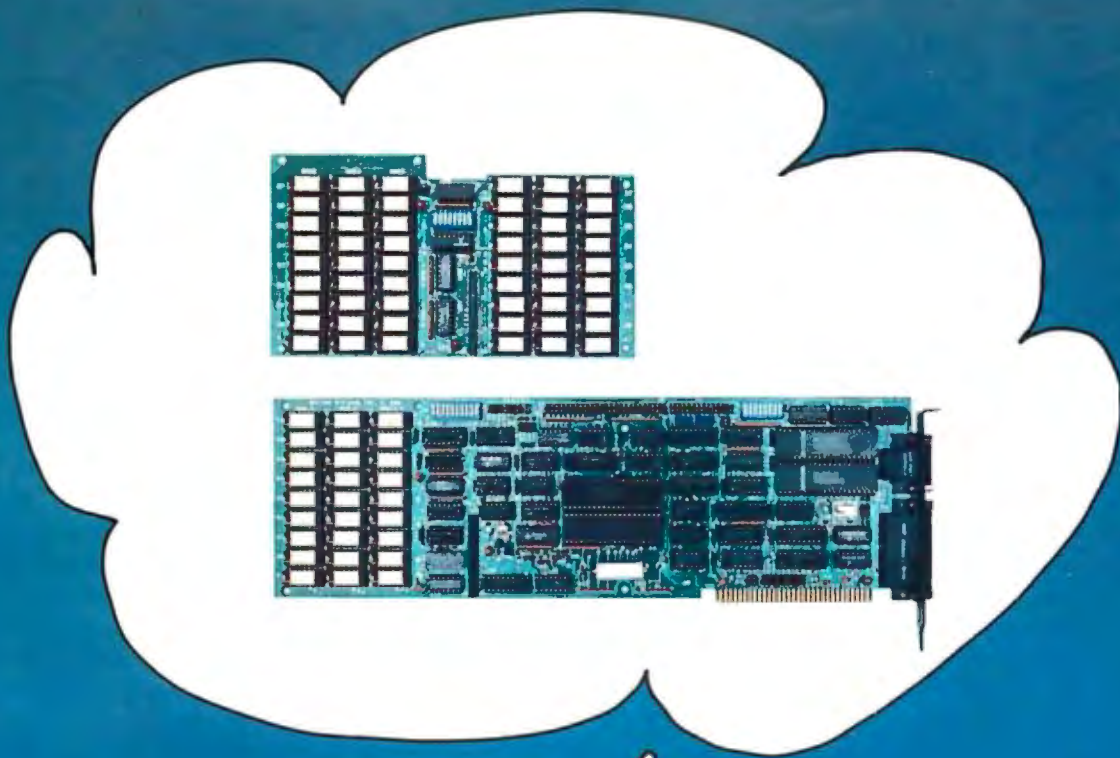
Over 5,000 DS120 units are now being used by customers ranging from the Fortune 500 to personal computing enthusiasts. In numerous installations, entire networks of terminals have been upgraded to take advantage of today's higher speed data communications services. LSI microprocessor electronics and strict quality control ensure dependable performance for years to come. When service is required, we will respond promptly and effectively. Best of all, we can deliver immediately through our nationwide network of distributors. Just give us a call for all the details.



**datasouth computer corporation**

4216 Stuart Andrew Blvd. • Charlotte, North Carolina 28210 • 704/523-8500





**HARDWARE FEATURES:**

64K-576K RAM  
Hard disk interface  
Parallel port  
2 serial ports  
Clock/calendar

**SOFTWARE:**

PSEUDO-DISK™ disk emulator  
PSUEDO-PRINT™ print spooler  
WHATIME™ clock support  
HARDISK™ hard disk support

**Titan** / **SATURN SYSTEMS**  
TECHNOLOGIES, INC. formerly of Michigan

P.O. Box 8050, Ann Arbor, MI 48107 (313) 973-8422

In Europe, Pete & Pam Computers, New Hall Hey Road, Rossendale, Lancashire, UK BB4 6JG  
Telephone (0706) 227011 Telex 635740 PETPAM G

Eagle Computers and Micropro, found themselves beyond the main building doors in a basement area that used to be a garbage collection area. It took Bill Godbout an hour to find the Priority One booth. When he finally did, he announced that his new Disk Three Controller will work with the Morrow hard-disk drive.

One hundred dollars a megabyte is a low price.

Meanwhile, down in the Black Hole of Calcutta, Micromate offered a full CP/M single-board system, with Z80 processor, disk controller, 64K bytes of memory, two input/output ports, and a single 8-inch disk drive, for \$695. Before you could use it you'd need a terminal, of course.

Lobo offers its Max-80 with keyboard but no screen—and no disk drives—for \$800. Matchless Systems, whose owner Mike Connor is a real disk whiz (a couple of years ago he solved several of the problems we had with our TRS-80 disk drives), has a two-drive full Z80 CP/M single-board system at a reasonable price, as

well as reliable add-on drives in single-sided and double-sided configurations.

Priority One will sell you a floppy-disk drive for \$255.

George Morrow's Decision One system was going for bargain prices.

These are just things I noticed. There are lots of others. Good CP/M components and full systems, capable of business-quality work, are now competitive with similarly configured "home computers." You still have to shop around, and note that this is a show report, not an evaluation column; except for Barry Workman's Lobo Max-80 (which he still loves after six weeks), I've had little to no experience with any of those systems.

Furthermore, I still recommend S-100 bus systems to those who can afford them: it remains true that "Iron is expensive, but silicon is cheap." You can update an S-100 bus system at reasonable costs. For the budget-minded though, there are some real bargains if you're careful. More on this in future issues.

## Ventricles in the Frammistan!

The Jonos computer is by all reports a good little machine. It makes use of the Sony-format vest-pocket (3¼-inch) disks. The Jonos is very portable, employs the STD bus, and has about the nicest keyboard I've seen on any portable computer. I've never worked with one myself, but people I respect who have them report great satisfaction, and I have no negative information about the machine itself.

I *do* wonder about the people demonstrating it.

When I first saw the Jonos last fall at the Mini/Micro show, Amos Jones, the company's owner, sat in a tiny booth personally explaining his machine. He answered all my questions patiently and sensibly.

I'm told he was present at the Faire, but I never saw him. When I went by the booth, there was a chap in a three-piece suit who seemed eager to answer questions. The Jonos has a key outboard of the Shift and below Control, which is in my judgment a terrible place for a key because it's so easy to strike it accidentally. On the Jonos it's inscribed "Funct," and I wanted to know what it does.

I asked the demonstrator. I should have waited for Amos Jones.

I don't mind when people don't know the answer to a question. I mind a lot when they give me an answer anyway. In this case I got a shine job about how wonderful that key was for programmers.

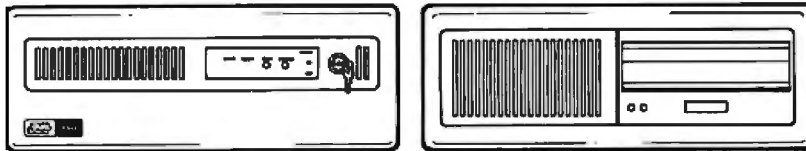
"Yes, but what does it do?" I asked patiently. There came more jargon. It made no sense to me. I asked a third time. I was told that the key sent special signals useful to programmers. Hmm, thought I. Could this be the equivalent of the "meta" key on some advanced machines? That really would be interesting.

"Does it set the eighth bit?" I asked.

"Yes, yes, these are 8-bit machines," came the answer.

Never mind if that makes no sense to you; it shouldn't. It makes no sense to *anyone*.

At this point I understood. I was going to get an answer to any question I asked, regardless of whether or not the question was rational. I must



## SYSTEM 83

### What's your problem?

Software development; color graphics; high speed communications; industrial control & robotics (FORTH); word processing/document formatting; computer time-sharing; timing of Hawaiian marathon; farm management; CAD/CAM, laboratory control; CAT scan, dermatology graphics; medical analysis; pattern recognition (music/speech); relational database; telecommunications; mobile geophysical studies; data copying; automatic typesetting; data processing security...

What is your need? Let DUAL SYSTEMS be the solution.

IEEE-696/S-100 based, 68000/UNIX,<sup>™</sup> multi-user/multi-tasking, 20/80M byte.

Call today for information!

# DUAL

\*UNIX is a trademark of Bell Laboratories

DUAL SYSTEMS CORPORATION

2530 San Pablo Avenue • Berkeley • CA 94702 (415) 549-3854 • 172029 SPX

# THE NEW DAS SERIES 500 FOR THE IBM PC:



## THE DATA ACQUISITION & CONTROL SYSTEM YOU SHOULD CONSIDER OVER A MINI. EVEN IF MONEY IS NO OBJECT.

Let's say you have enough money to buy nearly any data acquisition and control system you might want. What will you choose?

If sheer power is your main requirement, you might choose an expensive minicomputer system. But, then again, you might just as well choose the new DAS Series 500.

Simply plug the Series 500 into any off-the-shelf IBM Personal Computer and you'll have up to 336 channels of analog input, 60 channels of analog output and 192 channels of digital I/O (even AC/DC device control). And with measurement speeds as high as 25,000 analog data points per second, and true 12 or 14 bit precision, you'll have enough power and accuracy for the most demanding applications.

If you need flexibility, you'll want to compare other, more costly systems to the fully modular Series 500. It comes supported by an extensive library of integrated plug-in modules that let you custom tailor almost any

combination of inputs and outputs, digital or analog. And do so almost instantly.

So the Series 500 is ideal for hundreds of applications in product test, process control and energy management; in psychology, biology, analytical chemistry and neuroscience.

If ease of use is high on your list, consider this: Only the Series 500 comes equipped with the advanced, integrated Soft500 software package. With it, you can set up, collect, store, control, display and analyze, all with a few simple BASIC commands.

In fact, Soft500 makes programming so easy, you can be up and running with your Series 500 the same day you get it. Even if you're not a computer expert.

Now compare advanced features. Like exclusive foreground/background software architecture that lets you analyze data while you collect it. Like the real-time clock/calendar and precision interval timer.

Or the tremendous range of signal conditioning options, including software selected gain and offset, amplification from millivolt levels, and provision for direct connection of thermocouples, strain gauges and RTDs.

These are features you might not get elsewhere, no matter how much money you spend. But then, why spend all that money?

Because for less than \$6000 you get both the advanced capabilities of the DAS Series 500, plus an IBM PC\* (which incidentally, you can still use to do all the other things a PC does so well).

For complete information on the DAS Series 500 data acquisition and control system, write to us at Data Acquisition Systems, Inc., 349 Congress Street, Boston, Massachusetts 02210. Or call us at 617 423-7691.

**das**

IBM PC purchased separately. Also available for the Apple II. IBM PC & Apple II are registered trademarks.

TO ORDER CALL:  
1-800-451-2502  
617-641-1241

Technical Support  
617-641-1235

**SoftwareBanc**

661 Massachusetts Ave, Arlington, Ma. 02174

**TEACH YOUR COMPUTER WHO'S BOSS!  
ATTEND A dBASE II™ OR 1-2-3™ CLASS**

**Taught by ADAM B. GREEN  
Author of the dBASE II™ USER'S GUIDE**

*"Green's approach introduces dBASE II™ on a conceptual level, helping people learn to think about their information in a constructive way."*

*Jim Taylor, Product Manager, Ashton-Tate*

Monday	dBASE II™ Fundamentals
Tuesday	dBASE II™ Programming
Wednesday	Advanced dBASE II™ Techniques
Friday	Business Planning With 1-2-3™

Each day of instruction runs from 9:00 AM to 5:00 PM and costs \$175. Extensive notes and a buffet lunch are included. Call or write for a detailed description of each class, and a copy of our impressive client list.

*Register now for a class near you!*

**ANCHORAGE**  
August 11-12

**CHICAGO**  
October '83

**DALLAS**  
Nov. 14-18

**HONOLULU**  
January '84

**LOS ANGELES**  
July 18-22

**NEW YORK**  
September 19-23

**ORLANDO**  
February '84

**SAN DIEGO**  
Dec. 12-16

**WASHINGTON, D.C.**  
Aug. 29-Sept. 2

**dBASE II™ and 1-2-3™ classes are presented by SoftwareBanc Seminars**

™ - MANUFACTURER'S TRADEMARK

Circle 358 on inquiry card.

have been tired, for a wicked scheme came unwanted into my head.

"I've noticed," I said in my most puzzled voice, "that some of the competition has ventricles. Do you have them?"

"Yes, yes, we have the most features of any portable machine on the market."

"But," I continued, "do you have them in the frammistan where they belong?"

"Yes, yes," he began. Sudden comprehension flashed across his face. He realized he'd been had. The frammistan was just too much.

### Please, Fellows . . .

The moral of the story has nothing to do with Jonos computers, which remain good machines. (I've since learned what the Funct key does, and indeed it is very useful for programmers, because it allows you easily and simply to reprogram the special-function keys; this is a highly desirable feature.)

The moral of the story is, if you're

selling computers, make all your salespeople learn the words "I don't know." I'm told it's "good sales technique" for salespeople to act as if they know more than they do. Certainly it will work quite a bit of the time because the public doesn't know an awful lot about computers. Sooner or later, though, there'll come along someone like me.

I may never again catch anyone with ventricles in his frammistan, but I'll bet I can think of something equally absurd and not quite so obvious.

### Comes the Epson

Barry Workman's booth probably had as much new and different equipment and software as anyone at the show. One of his attractions was the Epson QX-10. If he'd been an Epson dealer, he could have sold a dozen of them. Everyone stopped to look at it.

What he had (with Epson's permission) was my beta-test machine. What made it really unusual was that Chris Rutkowski and Roger Amidon, respectively the president and soft-

ware development manager of Rising Star Industries, came by and updated our Epson software.

Rising Star is in charge of the Epson QX-10 software, and a couple of days before Faire time I called Roger Amidon for a quick conference on problems I was having with the test software. Roger worked on it overnight and brought the update to the Faire. That's *service*.

Alas, he didn't have the documentation completed in time, so I can't really report on the Epson QX-10. We did run some of the graphics package, and it's both very nice and quite easy to use. Some of the visitors to Barry's booth tried the Epson text editor and liked it, and a couple of them wouldn't accept that the machine wasn't for sale until Barry himself confirmed it. It wouldn't be fair to say more until I have the final version of the Epson software.

It was pleasant to meet Chris and Roger, but I didn't have long to talk with them, because they came just before my big speech.

# \*LASER™

micro systems inc.

Administrative Offices  
1321 N.W. 17th  
PORTLAND, OR 97209  
Telex: 3 0270  
Cable: WILL EXPT PTL

Sales Office  
1885 W. Commonwealth  
Suite G  
FULLERTON, CALIF 92623  
714-525-7474

OTHER PRODUCTS AVAILABLE NOW OR COMING	
• Disc Drive Interface Card	• Monitors
• Printer Interface Card	• Bare 55A Drive
• 16K Ram Card	• 5MB Hard Disc Drive
• 5¼ "floppy" disc	• IBM 55B Drive

DISTRIBUTOR INQUIRIES WELCOME



- \* Teac drive 55A  
48TPI, 163 KB formatted single side
- \* 40 Track
- \* Assembled and Tested in U.S.A.

## 5 1/4" SLIM LINE

## Call for MTI's lowest prices!

### "QED" DISCOUNTS. VISA & MASTERCARD.

#### VIDEO TERMINALS

ADM-3A Upper case only, direct cursor address.  
 ADM-5 Full ASCII, keypad, limited editing, etc.  
 MTI personal computing option for above, 800Kb.  
 Esprit Full ASCII, num. keypad, limited edit., etc.  
 Esprit II Full Esprit feat., Adds, ADM-3 & 5 emu.  
 Esprit III Full Esprit feat., Teletext 950 emula.  
 ADM-22 Ergonom. detached key, editing, etc.  
 ADM-23 Conversation & block mode, 2 page mem.  
 ADM-24 ADM-22 feat., 256 char buffer, graphics.  
 ADM-31 Full editing, 2 page buffer, protected fields.  
 ADM-32 Ergonom. ADM-31 with bus, graphics, etc.  
 ADM-36 DEC System terminal, 80 or 132 col., etc.  
 ADM-36 I IBM 3277 keyboard layout, use with p.c.  
 VT 100 DECscope, 80 or 132 col., upgradable, etc.  
 VT 18X Personal computing option, 360 Kb stor.  
 VT 101 Non-upgradable VT100.  
 VT 102 Non-up. VT100 with adv. video, print, port.  
 VT 131 Above with editing and block mode.  
 TI 940 80 or 132 col., ergonom., one page buff., etc.

#### GRAPHICS TERMINALS

VT 125 Full VT100 with DEC ReGIS firmware.  
 VT 100/Digital Eng. Retro-Graphics Tektronix comp.  
 VT 101/Digital Eng. Retro-Graphics Tektronix comp.  
 VT 102/Digital Eng. Retro-Graphics Tektronix comp.  
 VT 131/Digital Eng. Retro-Graphics Tektronix comp.  
 ADM-3A/Digital Eng. R-Graphics Tektronix comp.  
 ADM-5/Digital Eng. Retro-Graphics Tektronix comp.  
 Colorscan 10/D.E.R.G., VT 100/52 emu., Tektronix.  
 VT100 w/TI 810 plotter, Tektronix compatible.

#### TELEPRINTERS

LA 34-AA DECwriter IV 30 cps, variable char. widths  
 Diablo 620 RO letter quality 512-byte input buffer.  
 Diablo 630 RO API letter quality most pers. comps.  
 Diablo 630 KSR letter quality, 2688-byte buffer, etc.  
 TI 745 portable, thermal, built-in acoustic coupler.  
 TI 765 portable, above feat. with bubble memory.  
 Epson MX-80 80 cps serial impact printer, 80 CPL.  
 Epson MX-100 MX-80 plus 100 characters per line.  
 LA 120 RA receive only 180 cps, 132 col., multi. cop.  
 LA 120 AA KSR DECwriter III keyboard version.  
 LA 100 letterprinter, 240, 80 & 30 cps, graphics.  
 LA 50 personal printer, 100 cps, graphics capability.  
 LA 12 portable KSR, 150 cps on normal bond paper.  
 TI 783 portable, thermal, 120 cps bidirectional, etc.  
 TI 785 783 features plus acoustic coupler, etc.  
 TI 787 783 features plus internal modem, etc.  
 TI 810 RO impact, 150 cps, 132 cpl, multiple copies.  
 TI 820 RO 810 feat. plus full ASCII, 1280 char. buff.  
 TI 820 RO full features of RO plus full ASCII key.

#### DATAPRODUCTS LINE PRINTERS

M-200 2400 baud 200 lpm at 72 cpl dot matrix printer.  
 8-300 tabletop band printer, 300 lpm, 132 col., etc.  
 8-600 pedestal-mounted 600 lpm band printer.  
 8-1000 cabinet-enclosed 1000 lpm band printer.  
 BP-1500 cabinet-enclosed 1500 lpm band printer.

#### ACOUSTIC COUPLERS

Omnitec 715 300 baud orig./full duplex.  
 Omnitec 710 300 baud orig. /half & full duplex.  
 Vadic VA 3413 300/1200 orig. only.

#### MODEMS

VA 103 300 baud modemphone, rotary & tone.  
 VA 355 300 baud 103 orig./ans. full duplex.  
 VA 212LC low cost 1200 baud 212A orig./ans.  
 VA 212PA orig./ans. with auto dial.  
 DFO3AA DEC 212A.  
 VA 1250 202 dir. con. w/rev. chan.  
 VA 1255 202 dir. con. w/rev. chan.  
 VA 3212 212A/103 orig./ans.w & w/o auto dial.  
 VA 3451 triple modem w & w/o auto dial.  
 Vadic double modems VA & Bell comp.  
 VA 2450 Bell 201 comp. w & w/o rev. chan., etc.  
 MICOM modems up to 9600 bps.

#### LINE DRIVERS

MICOM asynch. & synch. line drivers.  
 MICOM 4 & 8-channel multiplexing line drivers.

#### MULTIPLEXORS

MICOM 4, 8 & 16-channel multiplexors.

#### PERSONAL COMPUTERS

DEC VT 180 64K, 360 Kb 5 1/4" dual floppy stor.  
 MTI Rooster 64K, 800 Kb 5 1/4" dual floppy stor.

#### CP/M APPLICATIONS SOFTWARE

MicroPro, Microsoft, Polygon & Select.



Applications Specialists & Distributors  
 Computer Terminals, Peripherals & Systems  
 New York:  
 516/621-6200, 212/767-0677, 518/449-5959  
 Outside N.Y.S.: 800/645-6530  
 New Jersey: 201/227-5552  
 Ohio: 216/464-6688

## The Pascal Project

Some time ago, weary of the limits of Pascal, I conceived a bright idea: if all the compiler writers would get together, maybe they could agree on a standard set of extensions to the language. That would make it much more useful.

Thus was born what I rather pretentiously labeled "The Pascal Prime Project." Since I hate to waste good ideas, I immediately telephoned a number of compiler people. "We all go to the West Coast Computer Faire," I said. "Let's get together and see what we can agree on." Most of those invited said they'd show up at the meeting, although few (other than me) thought there'd be much accomplished.

They were right, of course. Nothing specific was accomplished. On the other hand, we all agreed that the meeting had been worthwhile. Certainly I thought so. I learned a lot, most of which will have to be reported in another place.

The meeting was chaired by Carl Helmers, former editorial director of BYTE. Present were Bob Wallace, the Microsoft Pascal designer, Al Irvine of Softech Microsystems, Mike Lehman of Digital Research, James Tyson of JRT Systems, and Mike Haggarty, chairman of the IEEE Pascal Standards Committee. Conspicuously absent was Paul McQuesten of Sorcim. Everyone agreed that Pascal needs extensions, and there ought to be agreement on which ones and how to implement them.

McQuesten wasn't there because Sorcim didn't want to be committed to revisions; its resources are going into other work at the moment. He needn't have worried.

All the major companies except JRT stated their intention to implement "standard Pascal." There the agreement ended, and there, I fear, it will remain ended.

## A Ray of Hope

For a while I saw hope loom. Mike Haggarty announced publication of the IEEE Pascal Standard, and when I asked, plaintively, just what I should write programs in if I wanted some hope of both convenience and pro-

gram portability, he held up his standards book to universal laughter and applause.

Unfortunately, that was a better gesture than advice. No one uses "standard Pascal." You have to have *some* extensions or you'll never get any practical programs done.

Then Haggarty read the "proposed extensions" that have been "almost accepted" by the IEEE committee. They sounded like the answer to a prayer. An "otherwise" exception to the case statement. An exponentiation operator. An "open file" statement. Nonnumeric labels. Structured function results, with functions able to return any reasonable type. A whole mess of other stuff, all desirable.

There was also a list of proposed features that had been rejected, either because there was no agreement among the committee on how to accomplish them, or because a majority of the committee felt they weren't desirable anyway. Two of the rejected proposals, strings and separate compilations, were pretty important. Others weren't.

The list of "agreed" extensions was longer and far more important than the list of "rejected" ones.

Terrific, I thought. There is progress, and by the people who are supposed to be making it. I have foolishly set myself a task that I need not have begun.

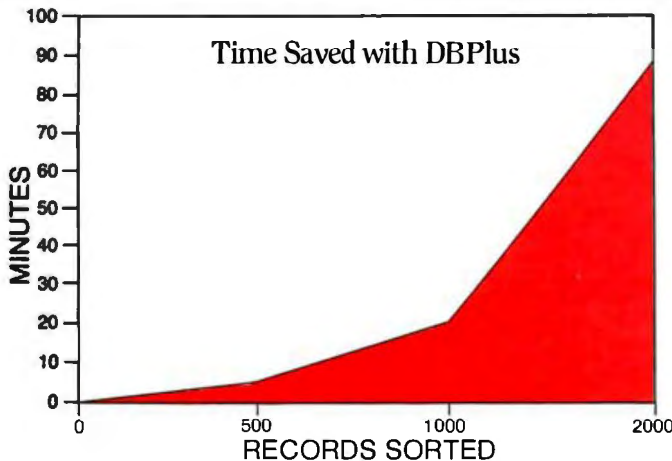
Then I had to ask: have these "standards" been published? No. They haven't even been adopted. They're merely proposed, "agreed" by some subset of the committee. Most of the compiler people present had implemented several of them, but no one had added all of them—and there had been no consultation about how they were implemented, either.

We're as far from portability as ever.

During the course of the discussion, I argued that Modula-2 will replace Pascal (and have a go at the C programming language as well). I may or may not believe that, but it did seem an interesting thing to say to a room full of Pascal enthusiasts. As expected, my view wasn't accepted by the panelists. Al Irvine of Softech

# DBPlus™

## ***SORT, COMPRESS, and TRANSFORM dBASE II™ DATA FILES***



If you are serious about dBASE II™ you need DBPlus. This program runs outside of dBASE II™ and performs the following important functions on dBASE II™ data files:

- **Sort**
- **Compress/Decompress**
- **Transform**

DBPlus™ is designed to free you from the chore of typing or memorizing a new language. In most cases all you have to do is move the cursor to the next menu item and press return!

### ***SORT***

DBPlus™ can sort a data file up to 15 times faster than dBASE II™ on a single field; 32 fields may be sorted in a single pass and each additional field requires 1% more sorting time.

### ***COMPRESS/DECOMPRESS***

A copy of any dBASE II™ data file can be produced which is only 30% to 40% of the original size.

The compressed file will save you transmission time and phone costs when you send a data file over a modem.

Making backup copies of large data files can use up many floppy disks. Compressed files will save you space in archival storage.

### ***TRANSFORM***

You can now modify the structure of any data file by adding, deleting, and modifying fields without any programming knowledge.

DBPlus™ can also create a new file which is compatible with WordStar/MailMerge.™

**Now retailing for \$125.**

Manual and demo disk may be purchased separately.

*Dealer and distributor inquiries invited!*

### **HumanSoft**

661 Massachusetts Avenue  
Arlington, Mass. 02174  
(617) 641-1880

dBASE II is a registered trademark of AshtonTate, Inc.  
WordStar/MailMerge is a registered trademark of MicroPro, Inc.  
DBPlus is a registered trademark of HumanSoft

Available from: Software Distributors 1-800-421-0814  
France: La Commande Electronique  
5 Villa Des Entrepreneurs  
75015 Paris, France  
Tel: (1) 577.31.82

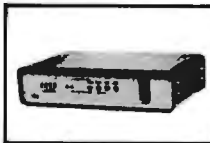
Software Wholesalers 1-800-633-2552  
Japan: JSE Int'l  
9F Toyo Bldg. 6-12-20 Jingmae  
Shibuya-ku Tokyo, Japan 150  
Tel: (03) 486-7151

Germany: Markt & Technik  
Hans-Pinsel-Strausse 2  
8013 Haar bei Munich, West Germany  
Tel: 089-4613-0

Available in popular formats (coming soon— IBM P.C.)

## Opt for Quality High-Reliability Design

### Model HS-2900

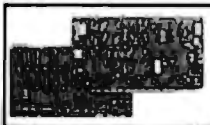


**Intelligent Buffer**

Standard \$348.00  
RS-232C Add \$120.00  
IEEE-488 Add \$160.00

•62KB STANDARD •Data compression/copy mode •Self test mode •Centronics I/F standard •RS-232C, IEEE-488 optional •Low price •AC 100/117/220/240V

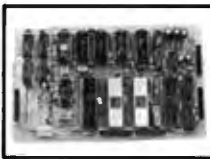
### Model SBC-696



**Single Board Computer meeting IEEE-696 (CP/M, SB-80) \$999.00**

•280A •64K ataic RAM (ROM replaceable) •RS-232C 2port Centronics 1port •Supports 5 1/4 floppy by DMA •Meets IEEE S-100 bus •+5V only •4layered PCB •Memory card piggy-back on main board •Include CP/M or SB-80

### Model SBC-488



**Single Board Computer (IEEE-488 etc)**

**\$488.00**

•280 •ROM/RAM total 10KB •IEEE-488 I/F (TMS9914) •RS-232C I/F (8251) •Parallel 5ports (8255) •+5V only

### Model GPIB-100



**S-100 bus Multifunction Board meeting IEEE-488 \$550.00**

•Supports IEEE-488 (TMS9914) •Universal interrupt controller (AM9519) •Programmed interval timer (8253) •Real-time clock, battery back-up (MSM5832) •IEEE-S-100 I/F •Software handler on 8" diskette (CP/M based)

### Model CAP-M20GP



**Intelligent Winchester Disk**

**\$6,200.00**

•8" Winchester disk, maintenance free •IEEE-488, RS-232C up to 38,400 baud •Intelligent functions •Supports CP/M based driver •430(W)X150(H)X450(D)mm •AC100/117/220/240V

### Model F2P/F2



**New 8" FD for CROMEMCO and general-purpose system**

F2P \$2,580.00  
F2 \$1,990.00

•Ultra-slim 8" drive •Signal compatible Perisc299 •No modification of the CDOS of your CROMEMCO is needed (F2P) •Fully compatible with Shugart SA801H and 850R(F2) •Cooling fan, noise filter included •160 (W)X225 (H)X500 (D)mm

ALL PRICES ARE FOB TOKYO AND SUBJECT TO CHANGE WITHOUT NOTICE (Dealer inquiries invited)

International Agent: **RENFUL COMPUTER LTD.**  
Rm.602, Hop Fat Commercial Centre, 490-492, Nathan Road, Kowloon, H.K. Tel: 3-820498(3lines)  
Telex: 37546 RENFUL HX Cable Address: RENFULCOMP

International Systems & Automation

**ISA CO., LTD.**

HEIAN BLDG.2-6-16 OKUBO, SHINJUKU-KU, TOKYO 160 JAPAN  
PHONE: 03-232-8570 TELEX: 2324466 ISATOK CABLE: ISAEIAN

was particularly lucid in his objections: too many people know Pascal, and there's too much invested in existing Pascal programs.

He's probably right. Still, Modula-2 does seem to offer some clear advantages, and it's very easy for Pascal programmers to learn it. It all depends really on just how good an implementation of Modula-2 we get, and when. Meanwhile, Pascal is alive, and if not well, at least not critically ill.

### Fun and Games

The most spectacular display at the show was Perfect Software's laser light show. It was in a room of undiscernible size. After you entered a black maw on a ramp, you were guided by lines of flashing lights on either side, with TV monitors at intervals. A breathless voice spoke in hushed tones about the future.

Once inside there was a Future-world atmosphere. Green laser beams flashed overhead. (I'm told it was one laser and lots of mirrors.)

As marketing hype it was awesome, at least to me. Alex's friend Jenny says it wasn't as effective as I thought: she went into the display and returned not knowing what it was Perfect Software sold.

Meanwhile, all over the Faire were arcade-style games. There weren't too many creatures eating dots, because Atari's lawyer was there to discourage that; he told H.A.L. Labs president Greg Autry that its game Taxman violates Atari trademarks. It seems that H.A.L. Labs uses a circle with a slice cut out of it, even though its Taxman creature doesn't eat dots. (It eats dollar signs and leaves a trail of cent signs.)

I wonder if this trade protection stuff hasn't gone too far. Eating dots was awfully popular last year, but I'd think the market is nearly saturated now. I certainly wouldn't want to be Atari's lawyer against H.A.L. Labs, which consists of a bunch of teenaged computer whizzes working out of their garage. Its games are nice, with excellent graphics. My kids prefer the Apple versions of Taxman to any of the other chase-in-a-maze games we have at the moment. I suspect any

jury would begin with considerable sympathy for H.A.L. Labs; I know I do, but then you must realize they're all science-fiction fans and like my books.

According to patent law, you can't patent an idea. Literary copyright law is a little more tricky. I served as an expert witness in the suit between *Star Wars* and *Battlestar Galactica*, and was given a fairly extensive briefing; but neither I nor anyone else could write a definitive statement of just what combination of common-knowledge elements constitutes an idea worthy of protection by the public authorities. Take any element: mazes, eating dots, creatures changing character after eating something special, and you can find many past precedents. How many must be put together before you can justify having the taxpayers pay the police and judges to protect your exclusive rights?

H.A.L. Labs has already had one bout with Atari, and as a result it changed its maze, changed dots to dollar signs, and made other changes in graphics. It's now being told that Atari has exclusive right to a circle with a wedge cut out.

Gosh, I'd swear CornNuts used to use circles with a slice cut out . . .

### Don't Lean on Shirley

For months now I've heard rumors that Compupro was going to build a machine that didn't use the S-100 bus. Compupro gave it the code name "Shirley."

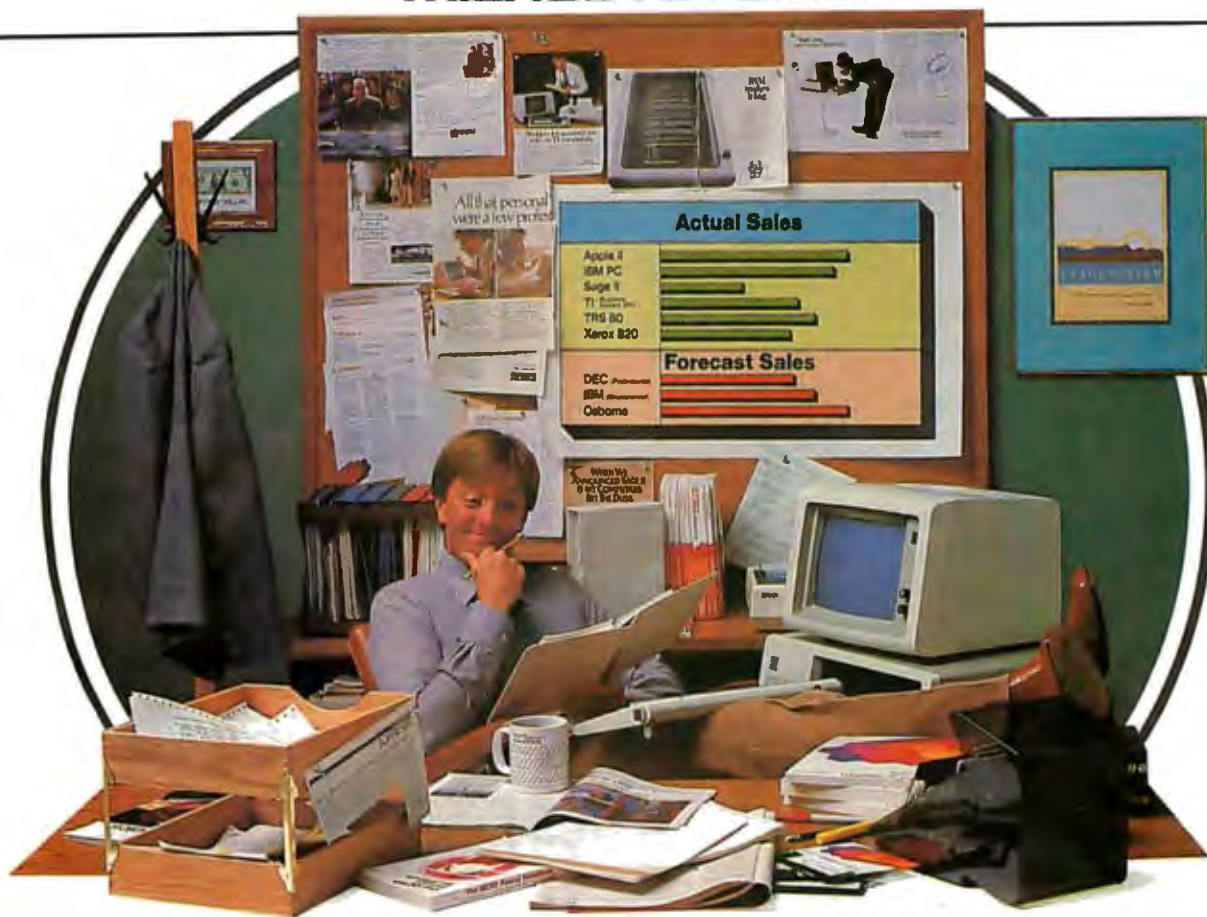
A model of Shirley was on display at the Compupro booth. It's certainly smaller than the usual Compupro machines: a low-profile box about the size of the electronics part of an IBM PC. It holds two half-height 5¼-inch floppies and a 5-inch Winchester hard-disk drive; the rumor is that there'll be about 20 formatted megabytes on the Winchester. Given that Bill Godbout started in this business by selling memory boards, and that he had hanging on his wall the new 64K-byte memory chips, you can expect plenty of memory aboard Shirley.

The display model was only a plastic case with drives in it. The real



# SOFTech

## MICROSYSTEMS



## The Universal Operating System.\* Finally, once and for all.

The UCSD p-System\* from SofTech Microsystems isn't like any other operating system you've ever used. Why?

Because the p-System is the *only* truly portable, universal operating system ever developed, that's why. It's equally at home with all popular personal computers. Such as an IBM PC or Displaywriter, an Apple, a DEC, an HP, an Osborne, a Philips, a Sage, a Tandy, a TI, you name it. It lets you develop applications that are portable to 8-bit as well as 16-bit micros.

**And we don't mean portable just at the source code level, either.**

We mean you can develop your program on virtually any micro, compile to object code, and it's totally transportable. So you can design programs once, and you've designed for the entire market.

The p-System then actually broadens your potential customer base. With no significant reinvestment in programming time. You can reuse program components

from one application to another, and even create your own library of utilities. What's more, the p-System's universality allows you to get your software up and running on new hardware as soon as it hits the market.

**It's about time.**

At SofTech Microsystems, we saw an industry-wide need for an efficient OS that could honestly call itself universal. So, in 1979, we delivered just that. The UCSD p-System. And we've been delivering ever since.

As an applications developer, we think you owe yourself an OS that lets you broaden your market base and develop higher quality applications faster, less expensively, more dependably and more efficiently than ever before.

All at the same time. All on one micro.

Thanks to the p-System, finally, once is enough.

For product information or information on how to get a copy of the p-System Application Catalog, call or write to us at SofTech Microsystems.

## Finally, Once and for All.

SofTech Microsystems • 16885 West Bernardo Drive • San Diego, Calif. 92127 • (714) 451-1230

\*Universal Operating System is a trademark of SofTech Microsystems Inc., UCSD p-System is a trademark of the Regents of the University of California

# IF YOU KNOW WHAT YOU WANT...

**EDIX/WORDIX**  
**\$149 (ea.)**  
**CROSSTALK**  
**\$119**

**SUPERCALC**  
**\$185**  
**EASYWRITER II**  
**\$259**

**CONDOR 3**  
**\$488**  
**PEACHPAK**  
**\$359**

**VOLKSWRITER**  
**\$147**  
**FINAL WORD**  
**\$223**

**VISICALC**  
**\$169**  
**DB MASTER**  
**\$148**

**IBM PC**

Advanced Operating Systems	List Now
The Programmer	200 150
American Training International, Inc.	
ATI-Power for PC	
DOS	75 56
Applied Software Technology	
Versaform	389 288
Ashton-Tate	
dBase II	[4] 700 429
Aspen Software	
Grammatik	75 56
Proofreader	50 38
Byrom Software	
BSTAM (Micro to micro comm.)	200 149
BSTMS (Micro to mainframe comm.)	200 149
Comshare	
Master Planner	325 253
Condor Computer Corp.	
Condor 1	195 147
Condor 3	650 488
Continental Software	
Home Accountant Plus	150 112
1st Class Mail	125 98
CP Aids	
Master Tax	16951371
Standard Tax	595 446
DataMost	
Write On	130 94
Real Estate Investment Program	130 95
Danver Software	
EASy (Executive Acctg. System)	750 562
Digital Research	
CBASIC 86	200 150
CIS COBOL 86	800 600
Concurrent CP/M-86	350 294
Level 2 COBOL 86	16001200
Pascal MT-86/w SSP	600 468
SID86	150 94
SPP86	200 168
Eagle Software	
Money Decisions	199 149
Emerging Technology	
Edix	195 149
Wordix	195 149
Howard	
Real Estate Analyzer II	250 187
Innovative Software	
T.J.M. III	495 357
Fast Graphs	295 221
ISM	
MatheMagic	100 75
Graphmagic	90 65
Combo Pack	160 120
IUS	
Easy Speller II	225 159
Easy Filer	400 281
Easywriter II	350 259
Easy Planner	250 188

AR/AP/GL (ea)	600 450
Financial Management Series (all 3)	1495 1121
Lexisoft	
Spellbinder	495 281
Lifeboat	
Lattice C Compiler	500 415
Lifefree	
Volkswriter	195 147
Lightning	
Master type	50 38
Mark of the Unicorn	
Mince	175 153
Final Word	300 223
Metasoft	
Benchmark Word Processor*	500 367
Benchmark Mail list	175 154
Microfocus	
CIS COBOL 8086	850 637
Micro Lab	
The Tax Manager	250 188
MicroPro	
Infostar	[5] 495 327
Report Star	350 231
Wordstar	[4] 495 327
Spellstar	250 165
MaiMerge	250 165
Wordstar/MaiMerge	[4] 695 426
Microsoft	
Flight Simulator	50 38
Multiplan	212
MicroStuf	
CrossTalk	195 119
North American Business Systems	
The Answer	250 188
Northwest Analytical	
Statpak	495 369
ODASIS	
The Word Plus	150 112
Organic Software	
Datebook	395 331
Milestone (CP/M 86)	395 331
Textwriter III (Text formatter)	125 97
PBL Corporation	
Personal Investor (128K)	145 105
Peachtree	
Series 4 Peachpak (GL/AR/AP)	[5] 595 359
Ryan-McFarland	
RM/COBOL	
• Full Dev. System	950 713
• Runtime only	250 188
Scrapps Data	
Job Cost Systems	495 371
Select Information Systems	
Select with SuperSpell (Word Proc.)	595 369
Software Publishing	
PFS File	109
PFS Report	99
Sorcim	
Spellguard	195 146
Supercalc	295 185
Superwriter	395 296

Southeastern	
Data Capture	120 90
Star	
Legal Timekeeping, Billing, & Accts	950 771
Structured Systems	
GL, AR, AP, Payroll, Inventory, OE (ea.)	1250 790
Analyst	250 188
Letterlight	200 150
NAD	100 75
OSORT	100 75
Supersoft	
Optimizer	200 149
Personal Data Base	125 93
Synergistic	
Data Reporter	250 188
Versa Computing	
Graphics Hardcopy System	25 19
VisiCorp	
VisiCalc (256K)	250 169
Desktop Plan I	300 229
VisiTrend/Plot	300 215
Visidex	250 189
VisiFile	300 229
Visischedule	300 234
Business Forecasting Models	100 78
Wool Software Systems	
Move It	150 99
<b>IBM PC HARDWARE</b>	
Kraft	List Now
Joystick	70 52
Microsoft	
RAM Card 64K	350 253
RAM Card 128K	525 381
RAM Card 192K	700 508
RAM Card 256K	875 634
QUADRAM	
Quadboard 64K	595 428
• 256K	995 670
TG Products	
Joystick	59 43
Versa Computing	
VersaWriter Graphics Tablet	299 249

**CP/M**

8" standard SSSD and Apple 5 1/4". Please call to confirm price & availability for other formats, available as special orders.

Adventure International	List Now
Adventures (#1-12)	129 97
American Training International, Inc.	
ATI-Power for CP/M	75 54
Anderson-Bell	
ABSTAT	359
Artificial Intelligence (Requires CBASIC 2)	
Medical	995 749
Dental	995 749
Ashton Tate	
dBase II	[4] 700 429
Aspen Software	
Grammatik	75 56
Proofreader	50 38
Balcones	
The Boss: Financial Accounting System	24951496
Byrom Software	
BSTAM (Micro to micro comm.)	200 144
BSTMS (Micro to mainframe comm.)	200 144
Caxton	
Cardbox	245 177
Centa Systems	
CP/M Northstar (Horizon only)	179 150
CP/M Micropolis	189 156
Computer Control	
FABS (B-TREE file access)	195 146
Ultrasort II	195 146

Computer Development, Inc.	
Image	495 356
Comshare Target Software	
Plannercat	50 38
Masterplanner	325 263
Condor Computer Corp.	
Condor 1	195 147
Condor 3	650 488
Designer Software	
Palantir	425 319
Dictronics	
Random House Electronic Thesaurus	150 113
Digital Research	
Access Manager	300 225
MAC (macro assembler)	90 75
SID (symbolic debugger for 8080)	75 63
ZSIO	100 88
CBASIC (language)	150 94
CB80	500 395
CIS COBOL	800 595
Display Manager	400 295
Pascal Mt+ w/SPP	500 395
DJR Associates	
FMS 80	995 625
FMS 80-1	495 312
FMS 80-2	495 312
Ecosoft	
MicroStat (stat package)	295 248
Epic Computer Corp.	
Supervyz	150 94
Faircom	
MICRO B+ (Keyed file accessing)	
For CBASIC 2	260 211
For MBASIC, COBOL, PL1/80, FORTRAN, Pascal MT+, CB 80	260 211
Fox and Geller	
dGRAPH	295 195
Quickscreen	149 125
Quickcode	295 195
dUTIL	99 59
FYI	
Superfile	195 129
Infocom	
Deadline	60 43
Zork I, II, III (ea.)	50 38
Star Cross	50 38
Human Soft	
D B Plus	125 95
ISM	
Mathemagic	99 72
Lexisoft	
Spellbinder	495 281
Lifeboat	
T-Maker II	275 215
Mark of the Unicorn	
Mince (text editor)	200 136
Final Word	300 229
Micro Pro	
Infostar	[5] 495 327
Report Star	350 231
Wordstar	[4] 495 327
MaiMerge	250 165
Wordstar/MaiMerge	[4] 695 426
Spellstar	[4] 250 165
Wordstar/Spellstar	[4] 695 426
Word/Spell/Mail	[4] 845 558
Calstar	145 96
Datatar	295 195
MicroSoft	
BASIC 80	350 252
BASIC Compiler	395 284
FORTRAN 80	500 360
COBOL 80	750 540
MACRO 80	200 156
EDIT 80	120 94
μ Math/μ Simp	250 194
μ LISP/μ Star	200 156
M-Sort	195 151
Multiplan	275 179
Microstuf	
CrossTalk	195 119
Northwest Analytical	

Statpak	495 369
<b>BASIS</b>	
The Word Plus	150 112
Organic Software	
Datebook	295 229
Milestone	295 229
Peachtree	
Series 4 Peach Pak (GL,AR,AP)	595 359
Pearlsort	
Personal Pearl	295 184
Pickles and Trout	
CP/M TRS 80 Mod II	185 89
Select Information Systems	
Select with SuperSpell	595 369
<b>Software Dimensions</b>	
Accounting Plus™	
GL, AR, AP, Inv each	645 402
All four	25801435
Sorcim	
Pascal/M (Z80 or 8080)	395 284
Pascal/M (8086, 8088)	495 356
ACT 80 (Z80, 8080, 8085)	175 126
ACT 86/88 (8086, 8088)	175 126
TRANS 86	125 90
Spellguard	195 166
SuperCalc	295 185
Superwriter	395 249
Supersoft	
C Compiler	250 188
Ada Compiler	300 225
Wool Software Systems	
Move it	100 66

Formats for CP/M 8", Apple 5 1/4" & others. Price the same in most cases.

HARDWARE	
Corona	List Now
5MB Hard Disk	[6] 2495 1895
Daisywriter	
Printer	[10] 1395 1235
Hayes Microcomputer Products	
Datacom Pascal Package	50 36
Hayes Stack Chronograph (RS-232)	[4] 249 199
Hayes Stack Smart-Modem (RS-232) 300 Baud	[4] 279 209
Hayes Stack Smart-Modem (RS-232) 1200 Baud	[4] 699 509
<b>NEC</b>	
12" Green Hi-Res CRT	[10] 285 167
7710 Printer	[10] 3085 2295
3530 Printer	[10] 2290 1735
8023 Printer	[10] 795 520
Novation	
J-Cat	[4] 149 119
Smart-Cat 103	[4] 259 207
Smart-Cat 103/212	[4] 595 476

\* = Manufacturer's trademark.

APPLE DOS	
Applied Software Technology	List Now
Versa Form:	
VS-1 Apple II/64K	389 249
VH-1 (Corvus)	495 360
VP-1 Versaform Pascal/Interface	245 180
<b>ARTSCI (Softape)</b>	
Magic Window II (40/70/80)	150 109
Magic Window	100 75
Magic Mailer	70 49
Magic Words	70 49
Magic Pack Combo (Contains all 3)	225 156

**dBASE Corner**

- dBASE II (relational DBMS) ..... \$429
- User's Guide ..... \$29
- Both ..... \$449
- Quickcode (program generator) ..... \$195
- dUTIL (programmer's utilities) ..... \$59
- ABSTAT (statistics package) ..... \$359
- D B Plus (short utility) ..... \$95

Technical questions, M-F/9-5 (415) 324-0311

Avant-Garde Creations	Metri-Vert	16 12	Adios $\mu$ Math/ $\mu$ Simp	250 194	Word Handler	199 145	VisiCorp (Personal Software)	
Ultra Plot/D.I.F./Data	Uni-Solve	25 19	M-Sort	195 151	List Handler	90 68	VisiCalc	250 169
Graph	PSAT Word Attack		$\mu$ Lisp/ $\mu$ Star	200 156	Dictionary	125 94	VisiFile	250 169
Beagle Brothers	Skills	49 37	Multiplan	275 179	Sirius		VisiLink	250 169
Alpha Plot	SAT Word Attack	49 37	MUSE		Pascal Graphics Editor		Desktop Plan II	250 194
DDS Boss	Hayden Software		Supertext 40/56/70	125 79	(48K II/III+)	100 69	VisiPlot	200 156
Utility City	Pie Writer/Standard	150 108	Supertext 40/80	175 126	Sol/Sys. Inc.		VisiTrend/Plot	300 234
Apple Mechanic	• Double Vision	150 108	Form Letter Module		Executive Secretary	250 169	VisiDex	250 194
Broderbund Software	• Multi 80-col	150 108	48K	100 72	Executive Speller	75 56	VisiTerm	100 65
General Ledger	(for Smartterm, Videoterm, & Superterm)		Data Plot 48K**	60 43	Softech Microsystems		VisiSchedule	300 234
(with A/P)			The Voice 48K	40 29	UCSD P-System Software Set	[4] 625 450	Business Forecasting Model (req. VisiCalc)	100 78
Payroll	Hayes		** Requires Applesoft, ROM or Apple II Plus		BASIC Compiler and Runtime Package	225 169		
Computer Enhanced	Terminal Pgm.	100 75	Omega		Xenofile	50 39		
Combined Enhanced	Highlands Computer Services		Locksmith	100 75	Inspector	125 90		
Graphics Software	E-Z Ledger	60 37	On-Line Systems		Software Dimensions			
Station Master	Howard Software		The General		Accounting Plus**			
Comshare Target Software	Creative Financing		Manager	230 168	GL, AR, AP, Inv ea	395 239		
Image Maker	1983	195 149	Screenwriter II	130 85	All four	1250 699		
Continental	Real Estate Analyzer		The Dictionary	100 70	Software Publishing			
Home Accountant	II	195 146	Expeditor II+ (Applesoft compiler)	135 94	PFS:File	140 99		
1st Class Mail	Information Unlimited Software (IUS)		LISA	80 56	PFS:Report	125 79		
CPA #1 — GL	Datadex	150 108	EPFIV (Extended Programming Facility IV)	80 56	PFS:Graph	140 99		
CPA #2 — AR	Datadex/Hard Disk	300 216	LISA Educational Package	120 83	Southeastern Software			
CPA #3 — AP	Professional		Optimized Systems Software, Inc.		Data Capture 4.0	65 45		
CPA #4 — PR	Easywriter	175 126	Speed Read Plus	60 43	Data Capture 4.0/Videx.			
All four	Professional		Peachtree		Smarterm, Superterm	90 65		
CPA #5 — Property Management	Easymailer	150 108	Series 40 GL, AR, AP, Inventory, Payroll (ea)	400 239	Southwestern Data			
Crane Software	Easy Mover	100 75	Penguin Software		Z-Term Professional	150 99		
Menu Generator	Tellstar Level I	40 30	Complete Graphics		ASCII Express	80 59		
Creative Curriculum, Inc.	Tellstar Level II	80 58	System	70 50	ASCII Express Professional	130 89		
Speed Reading Courseware	FORTH Development System	140 101	Special Effects	40 30	Professional Time and Billing	395 284		
Dakin 5/Level 10	Insolt		Graphics Magician	60 45	Language Reading Development Program	175 126		
Depreciation Planner	GraFORTH II	75 56	Additional Fonts and Character Sets	20 15	Apartment Manager	325 234		
Budget Planner	Electric Duet	30 23	Complete Graphics System II (Apple Tab Ver.)	120 86	Stoneware			
Business Bookkeeping System	TransFORTH II	125 94	Special Effects (Apple Tab Ver.)	70 50	DBMaster	229 148		
Datamost	ALD System II	75 56	Program Design, Inc.		Utility Pak #1	99 65		
Write On II	International Software Marketing Mathemagic (Advanced programmable calculator package)	90 65	The New Step-by-Step	80 58	Utility Pak #2	99 65		
Real Estate Analysis Program	Graphmagic	90 65	Quality Software		DBMaster/Hard Disk	499 359		
Tax Beater	Kensington Microware Ltd.		GBS-DB Apple Dev. Prog.	700 504	Stat Pac	99 71		
Datasoft, Inc.	Format II	250 169	Sensible Software		Micro Memo	40 30		
Micropainter (48K)	Lightning Software		Super Disk Copy III	30 23	Electronic Price Sheet	100 72		
BASIC Compiler (32K)	Mastertype	40 30	Multi Disk Catalog III	25 19	Compucube	30 22		
LISP Interpreter	Link Systems		Disk Recovery ("The Scanner")	30 23	Graphics Processing System (Standard)	60 45		
Decision Support	Datafax	199 149	Applesoft Plus Structured BASIC	25 19	Graphics Processing System (Professional)	179 129		
The Accountant	Datalink	100 75	Disk Organizer II	30 23	Synergistic Software			
• with DBCalc	Link Index	195 149	DOS Plus	25 19	The Linguist	40 30		
Delta Software	Link Video	55 41	Quickloader	25 19	The Directory Manager	25 19		
Bookkeeper Master Program	Link Disk	70 51	Image Printer-Letter Quality	40 30	The Star Gazer's Guide	30 22		
Bookkeeper Check Writer	LJK Enterprises		Image Printer-Epson	40 30	Higher Graphics II	35 26		
Denver Software	Letter Perfect with Mail Merge	150 112	Image Printer-NEC Dot Matrix	40 30	Mailing List Database	50 37		
Pascal Tutor	Data Perfect	100 78	The Bug	50 37	Program Line Editor	40 30		
Pascal Programmer	Lower Case Character Generator (accessory)	25 19	Build Using	30 23	Modifiable DataBase	80 59		
Financial Partner	Lotus		Edit Soft	30 23	The Data Reporter	220 158		
Eastside	Executive Briefing System	199 149	Quadrant 6112	35 26	Integer BASIC Compiler	150 108		
Wildcard	Micro Lab		Sensible Speller	125 94	Global Program Line Editor	65 49		
Eduware	The Invoice Factory	200 144	• for Supertext	125 94	Data Reporter—Hard Disk	220 158		
Compu-Read	The Merger	50 37	• for Apple CP/M	125 94	Versa Computing			
Statistics	The Learning System	150 108	• Pascal	125 94	VersaWriter Expansion Pac-I	40 30		
Spelling Bee with Reading Primer	Painter Power	40 30	BEST (Applesoft Program Optimizer)	40 30	VersaWriter Expansion Pac-II	40 30		
Compu-Math/ Fractions	US Constitution Tutor	30 22	Select Information Systems		VersaWriter Graphics Tablet (accessory)	299 252		
Compu-Math/ Decimals	English SAT #1	30 22	Select (with Super-spell)	595 356				
Compu-Math/Arithmetic Skills	VisiBlend	50 37	Silicon Valley					
Algebra 1	VisiFactory	75 54						
Fractions (New version)	The Asset Manager	200 144						
Decimals (New version)	The Tax Manager	180 129						
Algebra 2	Data Factory 5.0	300 216						
Counting Bee	Wall Streeter	300 216						
Compu-Spell/System	Payroll Manager	300 216						
Compu-Spell/Data Disk Levels 4 thru 8 (ea)	Microsoft							
	TASC (Applesoft compiler)	175 119						
	Typing Tutor II	25 19						
	Time Manager	150 116						
	Adios $\mu$ Math-80	125 97						

## TELEPHONE ORDERS

Outside Calif.: (800) 222-8811  
 Inside Calif.: (415) 324-3730

Order lines are manned 8:30-6 Monday thru Friday and 9-5 Saturday. Other lines are open 9-5 Monday thru Friday

**Technical Support** (415) 324-0311

**Order Status** (415) 324-0306

**Sales Manager** (415) 324-0305

MORE CP/M®, APPLE®, IBM PC®, UNIX®, UCSD p-System™ software, hardware, etc. call for quote.

## PROGRAMMING INTERNATIONAL

505 Hamilton Ave. • Suite 107  
 Palo Alto, CA 94301

**TERMS:** All prices subject to change without notice and availability. Cashier's check/MO/bank transfer. Allow time for company or personal checks to clear. Prices reflect cash prepaid discount. VISA/MASTER-CARD/COD/PO's + 3%. C.A. residents add sales tax. All sales final for games & special orders.

**SHIPPING:** \$2 per item for UPS surface (\$6 for Blue Label) within continental USA, except where shipping cost is specified in square brackets.

**RETURNS:** Must have authorization number, obtained at 415-324-0305. Unauthorized returns will be refused; damaged goods will be refused. All returns subject to 15% restocking fee. No return after 30 days.

# WHY PAY MORE?

## Products Mentioned

Caxton 10-14 Bedford St. Covent Garden London WC2E 9HE, England 01-379-6502	Cardbox	Logitech Corporation 165 University Ave. Palo Alto, CA 94301 (415) 326-3885	Modula-2 compiler
Compupro Systems Oakland Airport, CA 94614-0355 (415) 562-0636	Shirley	Matchless Systems 18444 South Broadway Gardena, CA 90248 (213) 327-1010	Add-on disks and small computers
Diser Inc. POB 70 Orem, UT 84057 (801) 224-7444	Lilith	Micro Peripherals Inc. 4426 South Century Dr. Salt Lake City, UT 84107 (801) 263-3081	Print-Mate 99
Eagle Computers 983 University Ave. Los Gatos, CA 95030 (408) 395-5005	Eagle	Rising Star Industries 24050 Madison St. #113 Torrance, CA 90505 (213) 378-3994	Epson QX-10
Easi APL Systems Inc. 10 Jackson St. #115 Los Gatos, CA 95030 (408) 354-3274	APL for Z80	R&R Software POB 1512 Madison, WI 53701 (608) 244-6436	Ada for 8085 and 8086
H.A.L. Labs Suite 23 4074 Midland Rd. Riverside, CA 92505 (714) 359-8480	Apple and Atari games	Sorcim 2310 Lundy Ave. San Jose, CA 95131 (408) 942-1727	Superwriter and Supercalc
Heath Company Benton Harbor, MI 49022 (616) 982-3200	Heath/Zenith Hero robot	Workman and Associates 112 Marion Ave. Pasadena, CA 91106 (213) 796-4401	WRITE

thing will be solid metal. It was amusing to watch the Compupro people nervously asking Faire-goers not to lean on the display model. They don't much care if you *stand* on the real machines.

They weren't saying much on the record about what Shirley's innards would be. Bill Godbout did tell me that it would have at least five CPU (central processing unit, or brain) chips for four users. Given that the Compupro team invented the dual processor and MPM-8/16, it's a good guess that it will have both 8- and 16-bit capabilities and will be able to take advantage of most existing software.

While I was at the Faire, I introduced Logitech's Pierluigi Zappacosta to Bill Godbout and Mark Garetz, his chief of research. Maybe something

will come of that, and they'll have some hardware to take advantage of Modula-2. I sure hope so.

All they'd tell me about Shirley, though, was that they've taken what amounts to an S-100 bus system and squashed out the bus idiosyncrasies, making the whole thing faster and more reliable. Given Bill Godbout's reputation for advancing the state of the art, I won't be the only one looking forward to Shirley.

### WRITE

On the Monday before the Faire, Tony Pietsch, my engineering genius friend who constructs and maintains my computers, made arrangements to release WRITE and have Workman sell copies at the Faire. I'm not certain precisely how that works, but Ashton-Tate isn't going to be selling

this version of WRITE. Tony will be, through Workman. I've written at least enough about this editor in the past, and I don't intend a full review here.

What's relevant is that I'd promised Tony I'd do the front end of his manual if he ever released WRITE. That hadn't been done. On Tuesday morning I was told about this. Tuesday afternoon was eaten by locusts: telephone calls, answering mail, and such like. Tuesday evening I sat down to write a manual.

Wednesday dawn saw 11,000 new words done and edited. There had already existed a "reference manual" about 10,000 words long; we went over that quickly and stuck it on the back end of what I'd done. By Wednesday noon there was an analytical table of contents. We for-

# Star Micronics GEMINI-10

Features Epson code compatibility



**\$339.88 UPS DELIVERED**

- 100 characters per second, bi-directional, logic-seeking, w/2.2K data buffer
- 5 fonts, w/italics, double width, emphasis & proportional spacing
- Subscripts, superscripts, underlining, backspace, emphasis, double strike, enhanced print, special characters
- 120 x 144 dots/inch hi-res graphics, 6 x 6 block graphics

Gemini 15 (132 column) ..... **\$499.88**

# Mannesmann Tally MT 160-L

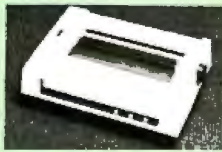


**\$789.88 UPS DELIVERED**

- 160 cps, bi-directional, logic-seeking printhead
- 4 sizes, 8 fonts, proportional print & graphics
- Subscripts, superscripts, underlining, backspace,
- Front panel install/control for maximum flexibility
- Parallel & RS-232C interface standard

## PRINTERS

### C. Itoh



- C. Itoh Prowriter ..... **\$399.88**
- C. Itoh Prowriter 2 ..... **\$734.88**
- C. Itoh F-10 Starwriter, 40 cps  
Parallel or RS-232C ..... **\$1379.88**
- C. Itoh F-10 Printmaster, 55 cps  
Parallel or RS-232C ..... **\$1679.88**
- F-10 Series Tractor ..... **\$289.88**

- Diablo**
- Diablo 620 ..... **\$1029.88**
- Diablo 630 ..... **\$1969.88**
- Diablo 630 Tractor ..... **\$289.88**

### Epson



- FX-80 ..... **SCALL**
- FX-80 F/T ..... **SCALL**
- MX-80 ..... **SCALL**
- MX-80 F/T ..... **SCALL**
- MX-100 ..... **SCALL**
- Com-Riter (Letter Quality)  
Parallel or RS-232C ..... **SCALL**

- IDS**
- IDS Prism 80 ..... **\$1079.88**
- above w/graphics ..... **\$1139.88**
- above w/sheetfeed ..... **\$1249.88**
- above w/4-color ..... **\$1539.88**
- ID 3 Prism 132 ..... **\$1229.88**
- above w/graphics ..... **\$1309.88**
- above w/sheetfeed ..... **\$1419.88**
- above w/4-color ..... **\$1699.88**
- IDS Microprism ..... **\$574.88**

- Mannesmann-Tally**
- MT-160-L ..... **\$789.88**

- NEC**
- NEC 3530 ..... **\$1759.88**
- NEC 7730 ..... **\$2399.88**

## PRINTERS

### Okidata

- Microline 82A ..... **\$419.88**
- 82A Okigraph ROM ..... **\$49.88**
- 82A Tractor ..... **\$59.88**
- 82A Roll Paper Holder ..... **\$49.88**
- Microline 83A ..... **\$679.88**
- 83A Okigraph ROM ..... **\$49.88**
- Apple Okigraph II ..... **\$59.88**
- Microline 84 w/graphics & tractor  
Parallel, 200 cps ..... **\$1024.88**



- Microline 92 ..... **\$524.88**
- Microline 93 ..... **\$684.88**

- Qume**
- Qume Sprint 11+ ..... **\$1539.88**

- Smith-Corona**
- Smith Corona TP-1 ..... **SCALL**
- Specify either 10 or 12 cpi,  
& parallel or RS-232C interface

- Accessories**
- 2-way Printer Switch  
Parallel or RS-232C ..... **\$119.88**
- Trace Soundtrap ..... **\$119.88**
- 8K Microfazer ..... **\$154.88**
- 64K Microfazer ..... **\$219.88**
- 128K Microfazer ..... **\$319.88**



## MODEMS

### DC Hayes

- Hayes 300 Baud ..... **\$224.88**
- Hayes 1200 Baud ..... **\$539.88**

### Novation

- A iToCat 300 ..... **\$319.88**
- AutoCat 1200 ..... **\$609.88**
- 103 SmartCat ..... **\$199.88**
- 103/12 SmartCat ..... **\$499.88**
- Novation D-Cat ..... **\$159.88**
- Novation J-Cat ..... **\$139.88**

### Anchor Automation

- Signalman Mark 1 ..... **\$89.88**

## Monitors

### Amdek

- 300G ..... **\$149.88**
- 300A ..... **\$159.88**
- Color 1 (Comp) ..... **\$319.88**
- Color 2 (Comp) ..... **\$649.88**
- Color 3 (Comp) ..... **\$379.88**

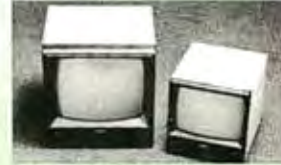
### Princeton Graphics

- HX-12 (RGB) ..... **\$529.88**

### Quadram

- Quadchrome (RGB) ..... **\$529.88**

### USI



- Pi-3 (12" Amber) ..... **\$189.88**
- Pi-4 (9" Amber) ..... **\$159.88**

## PC PERIPHERALS

### RAM Chips

- 16K (9/pkg) ..... **\$29.88**
- 64K (9/pkg) ..... **\$79.88**

### AST Research

- MegaPlus has a parallel port, two  
serial ports, a clock & software.
- MegaPlus 64K ..... **\$359.88**
- MegaPlus 256K ..... **\$609.88**
- MegaPack ..... **\$329.88**
- I/O Plus has a parallel port, serial  
port & clock—no memory.
- I/O Plus ..... **\$199.88**

### Maynard Controllers

- Floppy Disk ..... **\$159.88**
- w/Parallel Port ..... **\$219.88**
- w/RS-232C Port ..... **\$259.88**

### Quadram

- QuadLink lets you run Apple software  
in your PC. No file transfer, no down-  
loading, no reformatting. Plug Quad-  
Link in and run Apple II/III+ software  
with full PC capability.
- QuadLink ..... **\$549.88**

- Quadboards have parallel & serial  
ports, a clock, memory & software.
- 64K Quadboards ..... **\$279.88**
- 256K Quadboards ..... **\$429.88**

- Quad 512's have a serial  
port & memory on board.
- Quad 512 w/64K ..... **\$239.88**
- Quad 512 w/256K ..... **\$399.88**
- Quad 512 w/512K ..... **\$599.88**

- Single Function Cards for the IBM PC
- 64K Memory ..... **\$199.88**
- 192K Memory ..... **\$309.88**
- RS-232C Card ..... **\$89.88**
- Parallel Card & Cable ..... **\$89.88**
- Clock/Calendar ..... **\$89.88**

- microfazers are external print buffers  
for centronics parallel printers (parallel-  
parallel). Power is optional.
- 8K (p-p) ..... **\$159.88**
- 64K (p-p) ..... **\$219.88**
- 128K (p-p) ..... **\$319.88**
- 256K (p-p) ..... **\$629.88**
- 512K (p-p) ..... **\$979.88**
- 9V Power Supply ..... **\$9.88**

### QuCeS

- Big Blue ..... **\$479.88**
- 12mB Hard Disk ..... **\$2059.88**
- 20mB Hard Disk ..... **\$2479.88**
- 40mB Hard Disk ..... **\$3539.88**

### Tandon Drives

- Single-sided ..... **\$229.88**
- Double-sided ..... **\$279.88**

**Information & Orders  
(603) 881-9855**

**Orders Only: (800) 343-0726  
No Hidden Charges**

FREE UPS shipping on all orders—No extra charge to use credit cards—COD orders accepted (\$10 fee added)—All products shipped factory fresh with full warranty (we are authorized for warranty work on many products—just ask)—No purchase orders, foreign or APO orders accepted—Minimum \$50 per order—Personal checks take 3 weeks to clear—This ad prepared in April; prices are subject to change, but customers get lowest possible price at time of shipment.



HIGH TECHNOLOGY AT AFFORDABLE PRICES  
**THE BOTTOM LINE**



**FLOPPY DISK DRIVES - 8"****PRICE QTY. ONE****QUME**

242 - Half height DSDD 48TPI	450.00
842 - Full size DSDD 48TPI	465.00

**TANDON**

TM-848-2 - Half height DSDD 48TPI	385.00
-----------------------------------	--------

**MITSUBISHI**

M-2894 - Full height DSDD 48TPI	455.00
M-2896 - Half height DSDD 48TPI	455.00

**FLOPPY DISK DRIVES - 5 1/4"****QUME**

142 - Half height DSDD 48TPI	195.00
542 - Full size DSDD 48TPI	260.00
592 - Full size DSDD 96TPI	315.00

**REMAX**

RFD-480 - Two-thirds height DSDD 48TPI	245.00
RFD-960 - Two-thirds height DSDD 96TPI (IBM compatible; full-height face plate option available. N/C; 6-month warranty)	290.00

**TANDON**

TM-100-2 - Full size DSDD 48TPI	255.00
TM-100-4 - Full size DSDD 96TPI	365.00

(For the IBM PC)

**MITSUBISHI**

M-4853 - Half height DSDD 96TPI 1MB	335.00
M-4854 - Half height DSDD 96TPI 1.2MB	395.00

**WINCHESTER HARD DISKS****AMPEX**

Pyxis 7 - 5 1/4" 7MB capacity	650.00
Pyxis 13 - 5 1/4" 13MB capacity	795.00
Pyxis 27 - 5 1/4" 27MB capacity	1225.00

\*\*\* 1 year warranty \*\*\*

**WINCHESTER SUBSYSTEMS****MEDIA DISTRIBUTING**

MD-10 - 11MB capacity	2695.00
MD-20 - 22MB capacity	3595.00

(For Z-80, CP M, IBM PC systems)

**TERMINALS****ADDVIEWPOINT****Call for prices**

AMP	
D-125 Green phosphor	499.00
D-150 Green phosphor	610.00
D-175 Green phosphor	625.00

(Amber phosphor option available)

**QUME**

QVT-102 - Green phosphor	595.00
QVT-103 - Green phosphor	749.00
QVT-108 - Green phosphor	749.00

**PRINTERS****QUME**

Sprint 11 - 40 CPS Daisy wheel	1395.00
--------------------------------	---------

**OKI PRINTERS****Call for prices****MONITORS****TAXAN**

KG-12N-U 12" Green phosphor hi-res.	149.00
KG-12N-UY 12" Amber phosphor hi-res.	159.00
RGBVISION-I 12" RGB color medium-res.	359.00
RGBVISION-III 12" RGB color hi-res.	629.00

**(408) 438-5454****SUPPLIES AND ACCESSORIES ALSO AVAILABLE****DEALER INQUIRIES INVITED****TERMS: COD, CASH WITH ORDER, MASTERCARD, VISA****FREIGHT CHARGES WILL BE ADDED TO ALL ORDERS**

matted the whole mess and printed it on my NEC 7710. To salvage my pride, we stuck in a notice saying this was done in haste and guaranteeing a free copy of the revised version. Then it was off to the printer.

There's not enough money to have hired me to do that much work in so short a time. The interesting thing is that it was possible; that's probably the best testimonial WRITE will ever have.

Alas, WRITE was not well demonstrated at the Faire. One of the machines Barry Workman had with him was my Z-100; it has that big screen, making it an eye-catcher. They put it on a stand in front of the Workman booth.

That was a mistake. We didn't have a version of WRITE configured for the Z-100. We did have a version installed on the Z-19 terminal, and that worked on the Z-100, but just barely. For example, the special-function keys weren't implemented. These keys are one of the joys of WRITE, making it at least as powerful as any dedicated word processor I've seen. The editor will work without them—my first keyboard didn't have any—but if there are such keys and they don't do what they say they will, users tend to be confused.

The Z-100 when run in 8085 mode has slow disk access; at least it's slow compared to what I'm used to. We should have hooked up some 8-inch double-density disks to the machine, but there wasn't room, and Workman hadn't taken any extra drives along. Most of all, though, we should have configured WRITE for the machine it was running on.

Finally, I'd intended to put some text—say the WRITE manual itself—into the machine, so that people would have something to play with. I didn't do that, and in the frantic pace of the show it never got done. Thus, those who stopped to look at WRITE saw only a pale shadow. My fault, and my apologies to those who came by.

One last point: I have no financial stake in WRITE. The editor was originally written to suit Larry Niven and myself. Tony added a number of nifty features. Some new editorial

# It's True — We Did It!

We have met or have beaten most advertised prices.

Don't be foolish. Buy Direct!



## HORIZON

- Multi User System
  - Z80A Operating System
  - S-100 Bus
  - 5Mb-18Mb Hard Disc Available
- Super Super Super **\$2,495.00**

## NORTHSTAR

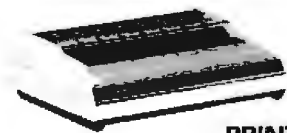
### ADVANTAGE

- 64K. Z80A Operating System
  - 2 Quad Capacity Floppy Drives
  - Business Graphics Software
  - 12" Green Phosphorus Screen
  - Bit Mapped Graphics
  - 6 I/O Business Slots
- Super Super Super **\$1,995.00**



## IDS

- Proportional Spacing
  - 200 CPS Bi Directional
  - Sheet Feed
  - 8 Character Styles
  - Color Optional
  - Graphics
- Prism 80 W/Sprint **\$899.00**  
 Prism 80 Loaded W/Color **\$1,239.00**  
 Prism 132 W/Sprint **\$1,039.00**  
 Prism 132 Loaded W/Color **\$1,395.00**  
 Colortext for IDS **\$104.00**



## PRINTEK

- Dot Graphics 144x144
  - Correspondence Quality
  - 8 Character Pitches
  - 1 Year Warranty
  - 8 Foreign Character Sets
  - Serial Interface Standard
- Model 910 200 Cps **\$1,329.00**  
 Model 920 **340 Cps \$1,889.00**



ALTOS  
ZENITH  
TELEVIDEO  
SANYO

FRANKLIN  
HAYES  
NOVATION  
UDS

OMNITEC  
VENTEL  
AMDEK  
BMC

TAXAN  
DIABLO  
NEC  
EPSON

OKIDATA  
OSBORNE  
COMREX  
DAISYWRIER

GTC  
ADDS  
DEC  
MANY OTHERS

For Price Quotes and Ordering Call:  
**1-800-328-8905**

For Technical Information and  
Arizona Orders Call:  
**602-949-8218**

411 South Madison  
Tempe, Arizona 85282  
(Mail Order Only)

**LIBERTY**  
**COMPUTER SALES**



Everything in  
computer related  
products:

- Computers
- Modems
- Printers
- Software
- Monitors
- Terminals
- Accessories
- Paper
- Ribbons
- Diskettes
- Office Furniture

Prices listed reflect a cash discount and are subject to change without notice. We welcome Certified and Cashiers Checks, Bank Wires and Money Orders. Allow 2 to 3 weeks for personal checks to clear. Product is subject to availability. Equipment is in factory sealed boxes with manufacturer's warranty. There will be a restocking charge for returned merchandise. Call first for an RMA number. Software not warranted for suitability. No return of Software which has been opened. Add 2% for shipping charges (minimum \$2.50). Z80A is a registered trademark of Zilog, Inc.

Circle 459 on Inquiry card.

features that Larry and I want will go into the next revision.

I've written my part of the WRITE document as "payment" for getting the text editor I want. I will do at least one more revision of that manual; probably two. I will not be paid for doing them. You couldn't pay me enough to do that much work, especially now when I'm up to my clavicle in assignments and contracts.

If I were marketing the program, I'd cut the price a lot. I understand there are some legal complications arising from the previous contract, and at the moment the price *can't* be cut. Anyone who buys the current version of WRITE will receive at least one free revision of both manual and program as part of the price. They'll also get an Install program that's already written, but which wasn't documented for the show. It should have been.

In other words, they weren't ready to sell WRITE, and I probably should have been more adamant about that.

Still in all: when, as, or if I find an

editor I like better for what I do—which is creative writing—I'll use it, and I'll tell my readers. Sol Libes tells me that there are better text-formatting editors. I believe him. Sol is one of the good guys. However, WRITE is the best thing I know (including dedicated word processors) for getting a lot of text written, edited, and polished, and it's pretty darned good for printing it, as I discovered when we formatted and printed the WRITE manual.

### Moving Right Along

There were more than 600 booths at the Faire. If I'd stopped 5 minutes at each one, it would have taken me more than 50 hours (and I'd have been even more of a nervous wreck than I was). I can only give quick impressions.

There are many good text editors. I'm fond of the Sorcim Superwriter, and I may change over to it for programming; but it has competition from Vedit, which was also on display here and there at the Faire (in-

cluding on my own Z-100). I've regained contact with Micropro, and Charles Stevenson, its chief research and development programmer, tells me it's doing a lot of interesting things, both with text editors and data management.

Micropro was out in the garbage area along with Priority One and Eagle. The Eagle computer looks very nice. It's a super-fast IBM PC work-alike, with (in my judgment) a better keyboard.

Texas Instruments was out in force, with some really excellent graphics. Its people were always busy with Faire-goers, so I'll have to find out details later.

John Matlock had a new small printer, the MPI Print-Mate 99, which we liked a lot. He handed one to Barry Workman for evaluation, and Barry's very happy with it. Everything I've seen of the MPI line is good stuff.

Matlock and MPI were in the Heath/Zenith area, as was Walt Bilofsky and his Software Toolworks. Zenith was drawing attention with the Z-100 and its dramatic color graphics, but its most spectacular exhibit was the Hero robot. Carl Helmers has a kit model; if Zenith wants an evaluation from me (and I hope it does), it will have to send a fully assembled and tested model. My kit-building days are long gone. I was quite impressed with the Hero demonstrations. I'd be even more interested in what my brilliant friend John McCarthy (of Stanford's Artificial Intelligence Laboratories) thinks. Maybe I'll know soon.

Caxton, a British firm, had a nice program called Cardbox, which impressed both Alex and Jennifer as well as me. It's what amounts to a computerized box of 3 by 5 cards. Caxton's sending me a copy, and we'll have more on it in an upcoming column.

The bottom line is that there's more to see at a Faire than any one person can manage. I'm happy, though: every week there's another interesting development in microcomputerland, and the big outfits haven't yet sewed up the market. I hope they never will. ■

## GET FULL VALUE FROM YOUR VICTOR 9000™

### with the UCSD p-SYSTEM™ IV.1

Get the most from your VICTOR 9000 as well as from your software development efforts. The power and portability of the UCSD p-System is available for the VICTOR 9000 from TDI.

#### The Standard Development System Includes:

- Full Screen Editor, Filer, Assembler and other Utilities
- The UCSD Pascal Compiler
- Native Code Generator
- Ram Disk Support Above 128K
- Turtlegraphics—full use of VICTOR screen (800 x 400)
- Complete documentation

#### Options:

- Fortran 77 and Basic compilers
- Hard disk support



TDI SYSTEMS, INC  
620 HUNGERFORD DR.  
ROCKVILLE, MD 20850  
(301) 340-8700

TDI LIMITED  
28 ALMA VALE RD.  
BRISTOL, U.K. BS8 2HL  
0272 742 796

VICTOR 9000 is a trademark of VICTOR TECHNOLOGIES, INC.  
UCSD p-SYSTEM and UCSD PASCAL are trademarks of the Regents of the University of California

NEW  
HARD  
DISK  
SUPPORT





# Recognizing all the advantages of a personal computer-controlled 80 channel logic analyzer isn't too difficult.

## It simply takes great vision.

If we could fully describe its features and functional advantages in 200 words or less, believe us, we would.

But what do you do when a product is this revolutionary? When it's the first logic analyzer controlled by a cost-effective Apple II personal computer. A system specifically designed to deal with

Real-time programmable outputs. And an easy-to-learn operating system designed to be a ready environment for co-resident post-processing software.

All of which combine to create a system that is a *true* analysis system. Not merely a powerful data storage unit, but a complete processing system designed to present the user with solutions configured in the most productive, familiar format.

### FIFTEEN INDEPENDENT STATES FOR TRIGGER/STORE CONTROL.

The Interactive State Analyzer eliminates much of the time spent defining your measurement task in the language of the logic analyzer. Fifteen independent states, each with a powerful set of word recognizers, are used to ensure that only the data you're really interested in is stored

in memory. Symbols are used not only to define word recognizer values, but the states themselves, thus avoiding much of the translation from source code to

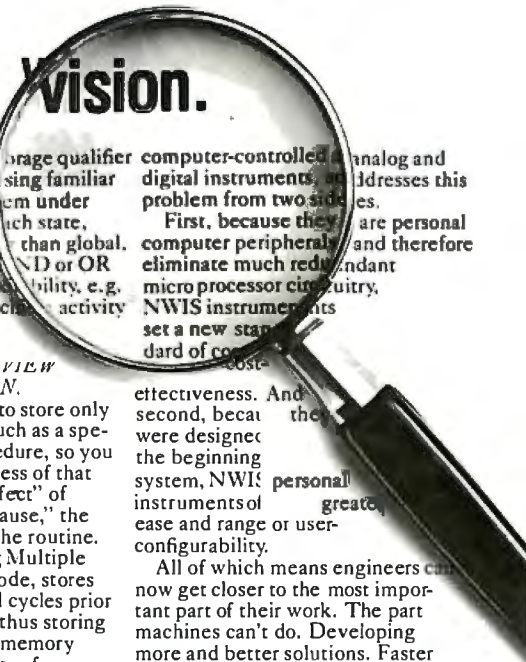
irrelevant data. Two storage qualifiers, words, programmed using familiar symbols from the system under test, are available in each state, permitting local, rather than global, control. Plus you can AND or OR the words for added flexibility, e.g. to store all but very specific activity at an I/O port.

### MULTIPLE PREVIEW ACQUISITION.

Often you may wish to store only a very specific event, such as a special subroutine or procedure, so you qualify on the first address of that routine. This is the "effect," of interest, but not the "cause," the instruction that called the routine. The Model 2100, using Multiple Preview Acquisition mode, stores up to seven unqualified cycles prior to every qualified one, thus storing the cause. With a 4096 memory depth, this gives 512 sets of "cause-effect" pairs.

### TRUE LOGIC ANALYSIS.

Tightly coupling a personal computer to a logic analyzer like the Model 2100 adds intelligent analysis to the picture. The system's operating software is written in Apple Pascal with enough memory left to accommodate co-resident programs written by the user to control instrument functions. For example, you might instruct the system to bin occurrences of a certain data value then format them in a histogram or other type of display.



Symbols are used to define the 15 available states in the TRIGGER-STORE menu.

modern software intensive micro-processor designs. Configurable from 16-80 channels. Priced from \$2,500 to \$6,500.

All you can do is rely on your readers' visionary nature and visual acuity.

### A FEW VITAL STATISTICS.

Residing in the  $\mu$ Analyst 2000 Personal Instrument Mainframe, Northwest Instrument Systems Model 2100 Interactive State



Analyzer offers 16-80 input channels, each with a 1024 or 4096 memory depth. Five Sample clocks create a master clock able to capture data from 8 and 16 bit micro-processors without special personality probes.

Additional key characteristics include: 60 word recognizers. Symbolic word recognizer definition. State labels for software trace.

Circle 284 on inquiry card.

trigger conditions. Symbolic IF-THEN-ELSE menus can be used to detect two-way software branches. This makes it easier to trace the procedures and subroutines used in structured programming. Since the states don't have to be sequentially linked, any state can jump to any other state.

### THIRTY STORAGE QUALIFIERS.

Storage qualifiers filter out unwanted data, avoiding the time-consuming search through

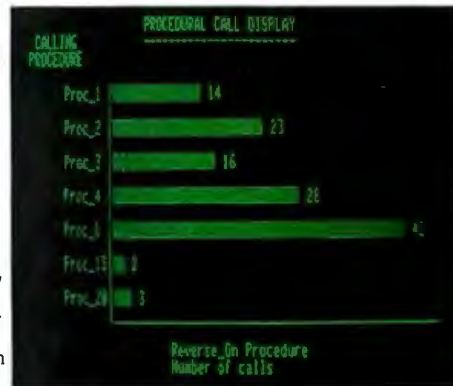
computer-controlled analog and digital instruments, addresses this problem from two sides.

First, because they are personal computer peripherals and therefore eliminate much redundant micro processor circuitry, NWIS instruments set a new standard of cost-

effectiveness. And second, because they were designed from the beginning system, NWIS personal instruments of greater ease and range or user-configurability.

All of which means engineers can now get closer to the most important part of their work. The part machines can't do. Developing more and better solutions. Faster than ever before.

For more information, including a demonstration disk or live demonstration, call for the name of the



Co-resident programs are used to format acquired data graphically.

### EASY TO LEARN, EFFICIENT TO USE.

The Interactive State Analyzer combines the best features of a menu-driven instrument with the strengths of a personal computer operating system. Command and Message lines prompt you with instructions and assistance. Single keystrokes on the ASCII keyboard make the system easy to learn and easy to use. And with a large personal computer CRT, data is clearly displayed in a readable size.

### HOW PERSONAL INSTRUMENTS BRING YOU CLOSER.

Engineers today face a serious dilemma. Too much time must be spent in the mechanical phases of problem-solving: setting up tests and wading through data. Leaving less and less time for the far more important creative phase: developing new solutions.

Personal instrumentation, NWIS's family of personal

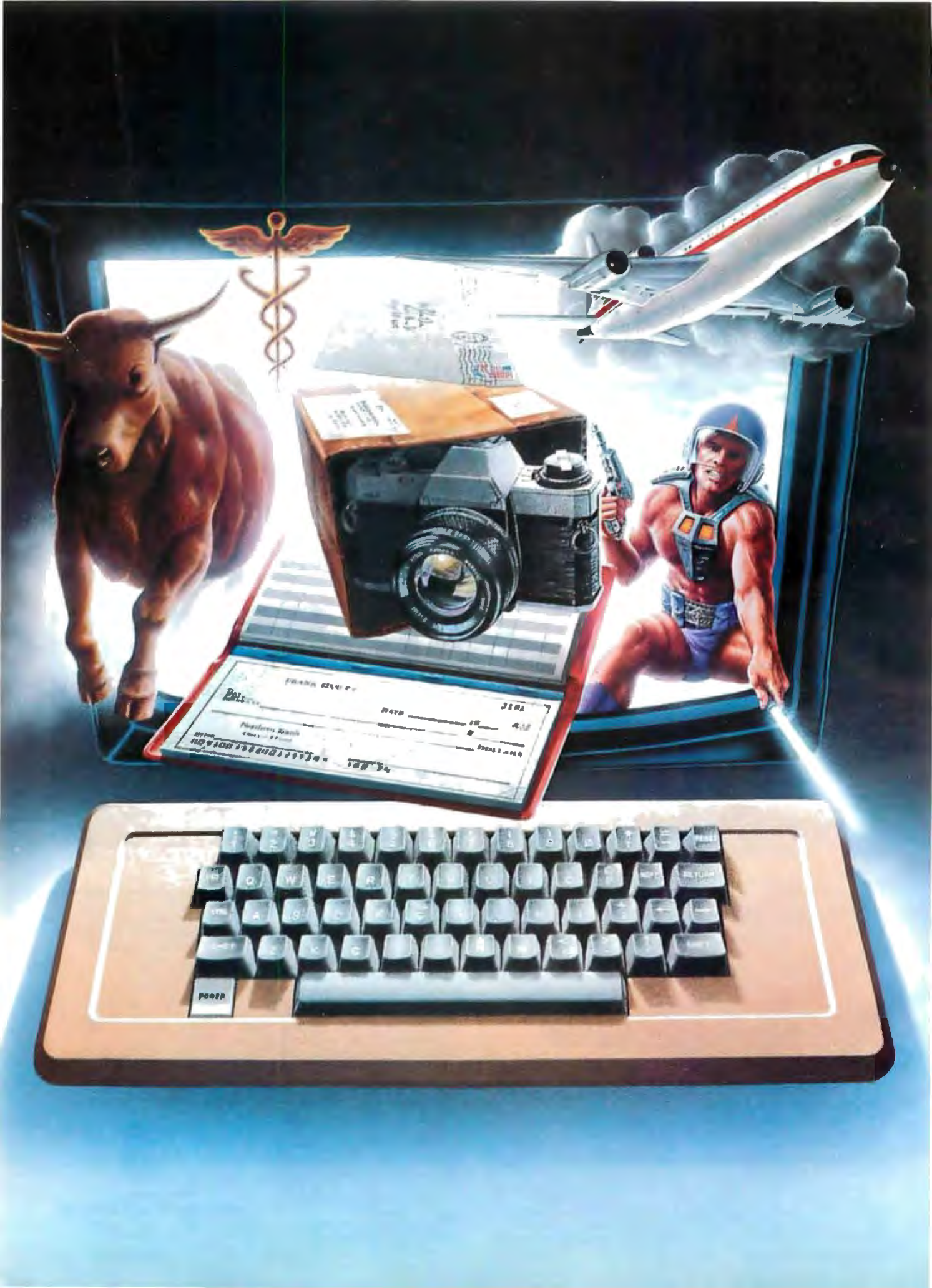
NWIS representative in your area: 800-547-4445.

NWIS personal instruments. If you think they look good on paper, you should see them in person.

PERSONAL INSTRUMENTS. BRINGING YOU CLOSER.



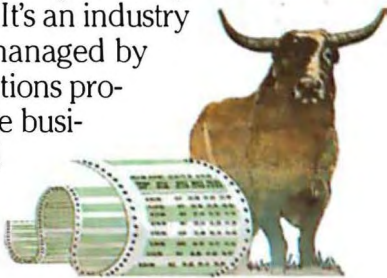
**NORTHWEST INSTRUMENT SYSTEMS, INC.**  
P. O. Box 1309, Beaverton, Oregon 97075  
(503) 297-1434



# We don't care which computer you own. We'll help you get the most out of it.

**CompuServe puts  
a world of information,  
communications, and  
entertainment at your  
fingertips.**

**CompuServe** is the versatile, easy to use interactive videotex service designed especially for the personal computer user. It's dynamic, growing and changing daily to satisfy its subscribers' needs. It's an industry leader, created and managed by the same communications professionals who provide business information and network services to over one fourth of the FORTUNE 500 companies.



**From current events to current assets,** CompuServe offers a wealth of useful, profitable or just plain interesting information.



Electronic magazines and national news wires plus worldwide weather, current movie reviews, electronic banking and shop at home services, and some of the most sophisticated financial information available are all offered to current subscribers.

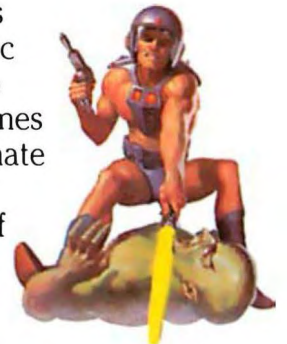
**From words to music.** CompuServe offers a communications network that gives special

interest groups from hardware enthusiasts to computer composers a chance to get together. There's a bulletin board for selling, swapping, and personal notices and a CB simulator for real-time communications between subscribers. There's electronic mail, the fastest, surest, way to communicate with other users across the street or across the country, plus file retention and editing, and lots, lots more.



**Fun and games** are expected whenever computer users interact, and CompuServe has the best. Games you can play alone or with other CompuServe subscribers anywhere in the country. Classic puzzlers, sports and adventure games, and fantastic space games featuring MegaWars, the "ultimate computer conflict."

But, that's just the tip of the chip. CompuServe offers a menu of thousands of items that make subscribing educational, fun and sometimes downright profitable. If you'd like to know more about CompuServe, call toll free, 800-848-8199 to receive an illustrated guide to the CompuServe Information Service. A videotex service for you no matter which computer you own.



## CompuServe

Consumer Information Service  
2180 Wilson Rd., Columbus, Ohio 43228

**800-848-8199**

In Ohio Call 614-457-8650

An H&R Block Company

# Before you bet your software business on an OS, look who's betting on MS-DOS and XENIX.

**A waiting market.** If you write and sell 16-bit software, MS-DOS and XENIX give you the largest installed base. In fact, over fifty 16-bit manufacturers offer their microcomputers with MS-DOS or XENIX. IBM, Victor, Altos, Wang, Radio Shack, Zenith and Intel, to name just a few. And the list is growing. That means there's a ready and expanding market for your 16-bit applications software.

**The UNIX™ connection.** XENIX is the multi-user, multi-tasking, UNIX-derived operating system for 16-bit microcomputers. MS-DOS 2.0 is Microsoft's single-user OS. MS-DOS and XENIX share hierarchical file structure and I/O redirection, including simple piping. MS-DOS 2.0 also provides XENIX-compatible system calls. That means there's a migration path for programs written to run under MS-DOS and XENIX. What's more, both MS-DOS and XENIX are supported by Microsoft® languages. That's your single-supplier advantage from Microsoft.

**Comprehensive support.** Microsoft offers you a full product support program. Excellent documentation. Plus continual enhancements to both languages and operating systems. Your applications programs can even be listed in Microsoft's growing Source Directory of 16-bit applications packages. Contact us for current software offerings and vendors.

**Leadership.** Microsoft led the world into the 8-bit microcomputer marketplace

with the first BASIC for microcomputers. Now, we're leading it into the 16-bit market with single and multi-user operating systems.

**Bet the winner.** If you're writing and marketing software in the 16-bit marketplace, MS-DOS and XENIX are setting the standard. In fact, they're the standard operating systems for the world's largest selling 16-bit microcomputer systems. Which means your market is already there... and growing. Contact us for complete information. Before you bet your software on an operating system, look where your market is betting.

BETTER TOOLS FOR MICROCOMPUTERS

## MICROSOFT™

MICROSOFT CORPORATION  
10700 NORTHUP WAY  
BELLEVUE, WASHINGTON 98004

Microsoft is a registered trademark, and MS, XENIX and the Microsoft logo are trademarks of Microsoft Corporation. UNIX is a trademark of Bell Laboratories



# Design Philosophy Behind Motorola's MC68000

## *Part 3: Advanced instructions*

---

Thomas W. Starnes  
Motorola Inc., Microprocessor Division  
3501 Ed Bluestein Blvd.  
Austin, TX 78721

---

Last month (May BYTE, page 342), I discussed the data-movement, arithmetic, and logic instructions of Motorola's MC68000 family of microprocessors (sometimes referred to as MACSS—Motorola's Advanced Computer System on Silicon). I examined a useful set of instructions based on a philosophy of *orthogonality*, which eliminates duplication of effort by similar instructions (thus making the microprocessor easier to understand and use). In this final part of the series, I will discuss branching, jumping, error-trapping, supervisor-mode, and other advanced instructions of the MC68000.

### **Branching and Jumping**

Data-movement, arithmetic, and logic instructions do most of the computational work in programs, but computers would be little more than adding machines without *program-control instructions*. These instructions give computers the capability to make decisions by executing nonsequential areas of code based on conditions tested at the time of execution. Branch instructions enable the microprocessor to transfer control to portions of code relative to the instruction being executed—that is, to transfer control to the effective address, which is the sum of the current

contents of the program counter and a given offset. You use branch instructions extensively when writing position-independent code. Jump instructions differ from branch instructions in that the jump instructions transfer control to absolute locations in memory, are unconditional, and can use any of the MC68000 addressing modes to specify the destination.

The MC68000 has a flexible conditional branching instruction, referred to as a *Bcc instruction*, in which the letters cc denote a variety of conditions that can be specified. There are 14 different conditions, including such things as greater than (BGT), less than or equal to (BLE), equal (BEQ), overflow (BVS), and low or same (BLS); a complete list is given in table 1. The BRA instruction is not conditional but always forces the branch to occur.

You cause branching by the addition of some value to the program counter (PC). Branch instructions include an 8- or 16-bit signed displacement value that you add to the program counter. Because the displacement is a signed number, it can cause either a forward or backward branch. If the condition being tested evaluates to "true," the MC68000 will take the branch; if it is not, it will execute the next instruction in sequence.

Even though all MC68000 instructions are multiples of 16 bits and must be aligned on word boundaries (i.e., start on even addresses), the MC68000 interprets the displacement in all branching operations to be a byte count, not a word count. This is done to give the machine maximum flexibility, while still providing the most opportunity for future growth. Limiting the machine to word offsets would have prevented any future MC68000-family processor from having instructions that could be misaligned (i.e., did not start on a word boundary) or be multiples of 8 bits. Since the flexibility to have misaligned instructions still exists, it makes sense to follow the natural byte-oriented addressing of the MC68000. A 16-bit offset gives an addressing range of  $-32,768$  bytes to  $+32,767$  bytes, not the puny 8-bit computer range of  $-128$  to  $+127$  bytes.

Versions of the jump and branch instructions also exist for subroutine calls. You can branch to a subroutine (BSR) with a displacement value, or you can jump to the subroutine (JSR) by specifying the absolute address. Subroutine calls save the return address (the current value of the program counter) on the system stack before transferring control to the subroutine; the return address is

Mnemonic	Condition Description	Flags Tested
T	true	1
F	false	0
HI	high	$\overline{C} \wedge \overline{Z}$
LS	low or same	$C + Z$
CC	carry clear	$\overline{C}$
CS	carry set	$C$
NE	not equal	$\overline{Z}$
EQ	equal	$Z$
VC	overflow clear	$\overline{V}$
VS	overflow set	$V$
PL	plus	$\overline{N}$
MI	minus	$N$
GE	greater or equal	$(N \wedge V) \vee \overline{(N \wedge \overline{V})}$
LT	less than	$(N \wedge \overline{V}) \vee \overline{(N \wedge V)}$
GT	greater than	$(N \wedge V \wedge \overline{Z}) \vee \overline{(N \wedge \overline{V} \wedge \overline{Z})}$
LE	less or equal	$Z \vee (N \wedge \overline{V}) \vee \overline{(N \wedge V)}$

**Table 1:** Conditional tests for the Bcc and DBcc groups of instructions. By substituting the letters in the first column for the letters cc, you can construct as many as 16 Bcc (branch on condition) and DBcc (test condition, decrement, and branch) instructions; for example, BHI branches if both the carry and zero bits in the status register are cleared. The third column indicates that the branch will take place if the expression evaluates to "true"; " $\wedge$ " indicates a logical AND operation, while " $\vee$ " indicates a logical OR operation. The same conditions are available to another instruction group, Scc, which sets or clears all the bits of a given byte based on the condition being evaluated.

removed from the stack and restored to the program counter when the MC68000 executes the RTS (return-from-subroutine) instruction.

Sometimes you will want to save and restore the condition codes that existed just before the subroutine was called. This is easy enough to do with the MOVE SR, -(A7) instruction, which pushes the status register onto the system stack (pointed to by register A7). You can also save selected registers with a single MOVEM instruction (discussed last month). At the close of the subroutine, you can use a MOVEM instruction to restore the saved registers and then use an RTR instruction (return and restore condition codes) to return and restore the saved condition codes in one operation.

### Looping and String Constructs

Many times, a backward branch is used to create a *programming loop*, which is a very important part of programming because it allows operations to be repeated until a desired

state or condition is reached. Although the looping constructs that most people are familiar with provide for a loop that ends with a given condition or one that ends after a certain number of iterations, a loop that can end by *either* means is often very useful. The double condition allows a loop to be performed until a given condition is met while ensuring that the loop does not process invalid data (in the case of, say, a string operation that reaches the end of the data without meeting the condition) or run forever (in the case of a numerical analysis algorithm that never converges to a given minimum tolerance).

The MC68000 has just the instruction for this kind of loop. The *decrement-counter-and-branch-conditionally* instruction (DBcc) uses any data register as a counter and branches based on both the evaluated condition and the data-register value. A DBcc instruction causes the following sequence of events. First, the MC68000 checks to see if the stated

condition is met; if so, execution continues with the *next* instruction, thus ending the loop. If the condition is not met, the specified register is decremented by 1. If the resulting value is -1, the loop is again ended by having the execution continue with the next instruction; otherwise, the branch to the top of the loop occurs.

Note that the DBcc instruction tests the register for a value of -1. At first, this might seem odd, but there is a very good reason for it. Most looping constructs require extra steps to ensure that the loop can execute zero times when needed *and* that the loop tests for the desired condition *before* executing a given iteration. By having the loop entered just before the DBcc instruction (at the end of the loop) and by designing the DBcc instructions so that they end the loop on a value of -1 instead of 0, you create a loop that meets both of the above conditions without being burdened by an explicit second test. As an added bonus, a simple conditional branch instruction (using the same condition as the DBcc instruction) enables you to determine whether the program exited the loop because of the iteration counter or the condition.

The DBcc instruction provides a huge set of string operations, especially in conjunction with the predecrement and postincrement addressing modes. By using the appropriate MOVE instruction, for example:

```
MOVE Dn, (An)+;
MOVE (An)+, (An)+;
MOVE -(An), -(An);
or MOVE (An)+, -(An)
```

followed by a DBRA instruction, you can have the MC68000 fill a block of memory, copy strings, and reverse strings. CMPM -(An), -(An) with DBNE compares two strings, while CMP Dn, -(An) with DBEQ searches a string for a pattern match. (See part 2, May BYTE, page 342, for an explanation of this address mode notation.) Multi-instruction loops can make very powerful string operations quite simple.

You can see the real beauty of the

## **WHY DEC AND INTEL CHOSE THE MARK WILLIAMS C-COMPILER.**

DEC and INTEL wanted the best C technology available, with excellent code density, supporting the full C language and their specific operating environments—all at a competitive price.

They found it all at Mark Williams.

## **WHY YOU SHOULD CHOOSE THE MARK WILLIAMS C-COMPILER.**

Our C-compiler supports the dominant 16-bit micro-computers—68000, PDP-11, Z8000, 8086—with a proven reliable, high-technology product. We are shipping versions of C for a large number of environments including CP/M and PC DOS. Both cross and native compilers are available.

Call us for the distributor nearest you. OEM's should contact us directly about their specific requirements.

Mark Williams Company,  
1430 West Wrightwood, Chicago, Illinois 60614,  
312/472-6659.



Circle 233 on inquiry card.

**Listing 1:** A string translation program that uses the DBEQ instruction to end a loop based on either of two conditions: end of string (as determined by the string length, given in register D3) or discovery of a termination character (stored in register D4). This program translates a string character by character according to the character values stored in TABLE. For a given character, its value (stored in register D0) is used as an index into TABLE (pointed to by register A2); the actual translation takes place at LOOP.

	MOVEQ	#\$13,D4	load termination character into register
	MOVE	#COUNT,D3	load string length
	MOVE.L	#STRING,A1	load string beginning
	LEA	*+TABLE,A2	offset to conversion table
	CLR	D0	prepare index for word
	BRA	POOL	start translation
LOOP	MOVE.B	0(A2,D0),(A1)+	translate and store result
POOL	MOVE.B	(A1),D0	load next character
	CMP.B	D4,D0	termination character found?
	DBEQ	D3,LOOP	if not and not end of string, branch

Execution time where n bytes are translated:

$72 + (40 \cdot n)$  clocks = 649  $\mu$ s for 128 bytes at 8 MHz

DBcc instruction in the assembly-language program of listing 1, which translates a string of characters until a terminating character shows up or the end of the string is reached. Register D3 has the string length in it, while register D4 contains the terminating character you're looking for. Register A1 points to the string, while the translation table (which is found some distance from this code) has its location placed in register A2. The routine in listing 1 runs very quickly and demonstrates the power that results from a combination of versatile instructions and various addressing modes.

### High-Level Language Aids

Many high-level languages, such as Pascal, use sophisticated programming concepts that can be enhanced by the use of reentrant and recursive programming and subroutines with local variable areas. The MC68000 has the facilities to support these techniques.

You can enter reentrant code at any time by several execution processes, and it will return correct results to all of them. This is very important for interrupt routines that may interrupt themselves before completion. Only reentrant code will correctly execute the interrupt routine the second time, then return to its interrupted version and correctly execute it. The MC68000 instruction set makes reentrant programming easy.

Recursive programs are those that

can call themselves. An example of such a program might draw a straight line between two points by repeatedly plotting the midpoint of the line, then calling itself to operate on the two line segments created by the new point. Recursive programs are created to solve complex algorithms with relatively small amounts of code. Their disadvantages include slow execution and heavy use of the stack (or some other area) for storing each level's set of temporary variables. Of course, the MC68000 designers included special instructions to make this task easier, LINK and UNLK (unlink).

LINK and UNLK allow subroutines to allocate part of the stack for the storage of local variables quickly and easily. Often, a programmer needing to refer to variables associated with a given subroutine call will decrement the stack pointer to reserve an area of memory for such use ("decrement" because stacks usually "grow" downward in memory) and save the address of the top edge of this area as a reference point; this address is called a *frame pointer* (FP) and is a value that, on the MC68000, is stored in one of the seven address registers A0 through A6. The stack pointer, of course, will move up and down during the execution of a subroutine as stack operations are performed. The stable frame pointer always gives a good reference point to the variables, while the stack pointer would give a wildly varying reference to those

same variables. Now let's look at a good method for going into a new routine.

To show how the LINK and UNLK instructions help give the programmer access to local variable areas, let's look at the example of figure 1. (Remember that the frame pointer is actually an address register that is designated by the programmer for this use.) Assume that you are in subroutine A, which has its own local variable area, pointed to by the frame pointer. Before subroutine A calls subroutine B, it first places parameters on top of the stack; see figure 1a. After the subroutine call to B, the return address to A is pushed onto the stack (figure 1b). The LINK instruction contains the name of an address register that is to be taken as the frame register and a displacement that indicates the amount of memory to be saved for local variables. When it is executed, three things happen (figures 1c-1e): the contents of the frame pointer (pointing to a stack location containing the previous frame pointer) are pushed onto the stack, the frame pointer itself is made identical to the stack pointer, and the stack pointer is changed by the displacement given in the instruction. (The displacement is a signed value and must be negative to save local variable space—if it is positive, you will lose information from the stack.) As shown in figure 1e, the stack pointer points to the top of the stack, and the frame pointer points to one word below the subroutine B local variable area. When the UNLK instruction is executed, the process is reversed (figure 1f), leaving subroutine B ready to execute an RTS instruction and return control to subroutine A.

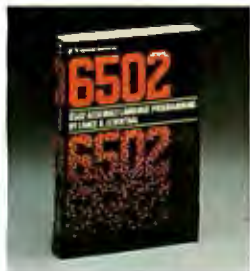
### Address Calculation in Hardware

Most microprocessor operations deal either with data or program control. Most also use memory addresses and, in the case of the MC68000, have some rather sophisticated means of generating those addresses. But the addresses are used by the instruction only to get to the data or program location; the address itself is never available to the programmer and is

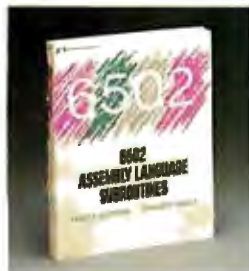


# Frustration Insurance.

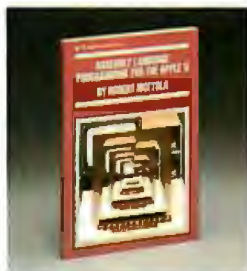
The Assembly Language Programming Series from Osborne/McGraw-Hill.



1) 6502 Assembly Language Programming  
Leventhal Order #27-6 \$16.99  
"The book that will probably get the reputation as being the 6502 Bible."  
INTERFACE AGE



2) 6502 Assembly Language Subroutines  
Leventhal, Saville Order #59-4 \$15.95  
Over 50 ready-to-use subroutines.



3) Assembly Language Programming for the Apple II.  
Mottola Order #51-9 \$12.95  
Run programs hundreds of times faster and use less memory space than with programs written in BASIC.



4) 6809 Assembly Language Programming  
Leventhal Order #35-7 \$16.99  
"Leventhal appears to have a formula for producing programming manuals. If so, it's a good formula... he has produced another clear and thorough manual for the serious programmer!"  
AMERICAN MATHEMATICAL MONTHLY



5) 6800 Assembly Language Programming  
Leventhal Order #12-8 \$15.99  
A complete reference to the 6800 instruction set and programming techniques.



6) 68000 Assembly Language Programming  
Leventhal Order #62-4 \$16.99  
Covers 68000 assembly language programming in the explicit detail needed to tap the full potential of this highly evolved microprocessor.



7) Z80 Assembly Language Programming  
Leventhal Order #21-7 \$16.99  
"There may never be a better book on the Z80 assembler than this one..."  
CREATIVE COMPUTING



8) Z80 Assembly Language Subroutines  
Leventhal, Saville Order #91-8 \$15.95 (Available 4/83)  
Over 50 useful subroutines to save you valuable programming time.



9) Z8000 Assembly Language Programming  
Leventhal, Osborne, Collins Order #36-5 \$19.99  
An excellent source reference for this powerful, 16-bit device. Filled with trouble-shooting hints and sample problems to guide the user to mastery of this "superchip."



10) 8080A/8085 Assembly Language Programming  
Leventhal Order #10-1 \$15.99  
"... an excellent encyclopedia of assembly language programming."  
BYTE



11) The 8086 Book  
Rector, Alexy Order #29-2 \$16.99  
"... far superior to any other book about the 8086."  
DR. DOBBS JOURNAL

Before you hit the Frustration Key, reach for an Osborne/McGraw-Hill book.



By phone, call TOLL FREE: 800-227-2895. In California, call 800-772-4077. VISA and MasterCard accepted.

By Mail, complete the coupon below and mail to Osborne/McGraw-Hill, 2600 Tenth Street, Berkeley, CA 94710. All orders must be pre-paid. Check, money order, VISA and MasterCard accepted. Add shipping fees per item: \$0.75 4th Class, \$1.50 UPS, \$3.00 1st class/UPS Blue Label. California residents, add local tax.

Allow 4-6 weeks for delivery. Prices subject to change without notice.

Z80 and Z8000 are registered trademarks of Zilog Inc.

©1983 Osborne/McGraw-Hill

 Osborne/McGraw-Hill

Circle 293 on inquiry card.

Dept C-1

\_\_\_\_ Please send me a free catalog.

Name \_\_\_\_\_

Address \_\_\_\_\_

City \_\_\_\_\_

State \_\_\_\_\_ Zip \_\_\_\_\_

Indicate method of payment: \_\_\_\_\_ Check/Money Order

\_\_\_\_\_ VISA/Exp. date \_\_\_\_\_ MasterCard/Exp. date \_\_\_\_\_

Card # \_\_\_\_\_


Signature \_\_\_\_\_

QTY	ORDER #	PRICE

Tax \_\_\_\_\_

Shipping \_\_\_\_\_

TOTAL \_\_\_\_\_

 Osborne/McGraw-Hill  
2600 Tenth Street  
Berkeley, CA 94710

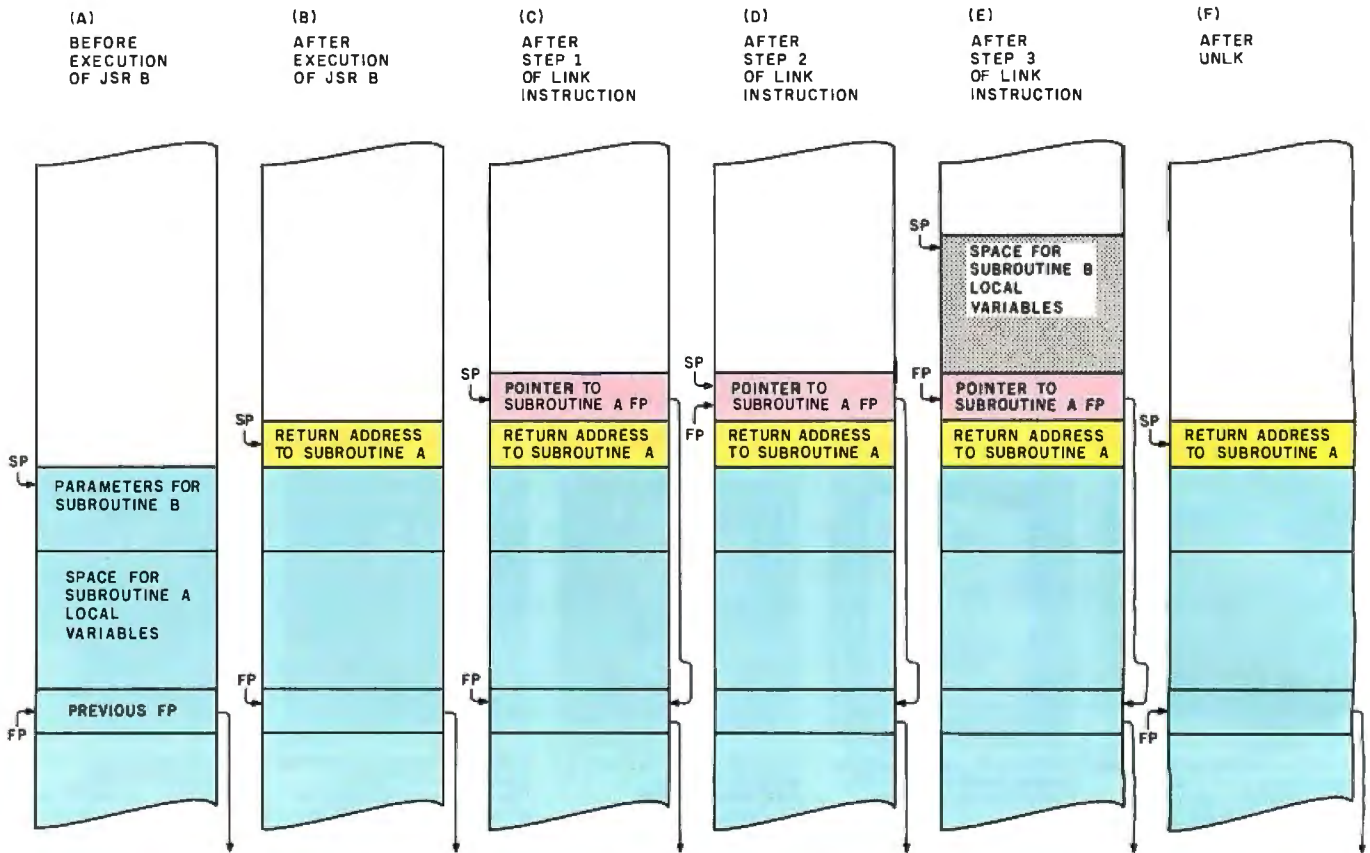


Figure 1: Use of the LINK and UNLK (unlink) instructions, both of which help the assembly-language programmer manage memory areas to be used for local variables in subroutines. See text for details.

often lost by the end of the instruction. However, it is sometimes the address itself that you need in your program. The MC68000 has two instructions that help you to get just the address, without using it to fetch any data. By having the MC68000 calculate the address itself (instead of writing a sequence of assembly-language instructions to do the same), you can do the calculation much faster without tying up either memory or registers.

The load-effective-address (LEA) and push-effective-address (PEA) instructions calculate a given effective address and place it either in any address register (LEA) or on the stack (PEA). You can calculate the effective address by using any available addressing mode with any of the appropriate registers. The LEA and PEA instructions can be useful when you are running position-independent code. Sometimes to take advantage of an addressing mode that runs more quickly than, say, the program-counter-relative addressing mode,

you may want to calculate the address using LEA and access that area of memory by addressing indirectly through the address register in which the LEA instruction left the calculated address. PEA and LEA are also useful for passing pointers of data to other routines or placing them in memory. Sometimes, it's helpful to verify that an effective address is correct or at least in range. Without these two instructions, it would be extremely difficult to use processor-generated addresses.

### Instructions for Shared Resources

Systems with more than one microprocessor running at a time are often designed to share some resources, e.g., memory, buffers, I/O, tasks, and so on. For this to happen, the programs running on the microprocessors must have a secure method of determining which processor has rights to a certain part of memory, a buffer, I/O, or a task. The MC68000 has an instruction, TAS (test and set), that makes such allocation of

resources between multiprocessors simple and secure.

The key to this instruction is that it is *indivisible*, i.e., it can lock out all accesses to the designated addressing location until work on the location is complete. The test-and-set instruction tests a given byte, sets the negative (N) and zero (Z) status register bits accordingly, and then sets the most significant bit of the byte to 1.

In most cases, the microprocessor uses the TAS instruction as follows: It chooses a given byte to represent the status of a shared resource (this byte is often called a *semaphore*). If the TAS instruction shows the byte to be negative (if its most significant bit is 1), the querying microprocessor knows that the resource is in use. The processor can then either retest the semaphore byte until it shows the resource is available, or it can go about some other task. If the TAS instruction shows the byte to be positive (most significant bit is 0), the microprocessor knows the resource is free. Because the TAS instruction im-

# Frustration Insurance.

The New DiskGuide™ Series from Osborne/McGraw-Hill.



- **IBM® PC DiskGuide**  
Order #94-2 \$8.95
- **Apple® II DiskGuide**  
(Including Apple II Plus and IIe)  
Order #96-9 \$7.95
- **ATARI® 400/800™ DiskGuide**  
Order #95-0 \$7.95
- **VisiCalc® DiskGuide**  
Order #98-5 \$6.95
- **CP/M™ DiskGuide**  
(Including CP/M-80 and CP/M-86)  
Order #97-7 \$8.95

The Computer Frustration Syndrome. It can hit anyone who uses a personal computer. We want to protect you from it. That's why we created **The DiskGuide Series**. Five easy-to-use, compact, computer reference guides chock full of vital commands, keys, summary tables and charts — information you need for frustration-free computing. No chitchat. Just clear-cut cues to help you master the Apple® II, IBM® PC, ATARI® 400/800™ plus VisiCalc® and CP/M®.

**TO ORDER:**  
**By phone,** call TOLL FREE 800-227-2895. In California, call 800-772-4077. VISA and MasterCard accepted.  
**By mail,** complete the coupon below and mail to Osborne/McGraw-Hill, 2600 Tenth Street, Berkeley, CA 94710. All orders must be prepaid. You can pay by check, money order, VISA or MasterCard. Be sure to add taxes and shipping fees. See schedule below. Taxes and Shipping Fees. Add per item: \$0.75 4th class, \$1.50 UPS, \$3.00 1st class/UPS Blue Label. California residents add local sales tax. Allow 4-6 weeks for delivery. Prices subject to change without notice.

Dept. B-1

YES, please send me a free catalog.

**Name** \_\_\_\_\_

**Address** \_\_\_\_\_ **City** \_\_\_\_\_

**State** \_\_\_\_\_

Indicate method of payment:

Check or money order       VISA/Exp. date \_\_\_\_\_

MasterCard/Exp. date \_\_\_\_\_       Card # \_\_\_\_\_

**Qty.** \_\_\_\_\_      **Order** \_\_\_\_\_

\_\_\_\_\_

\_\_\_\_\_

**Tax** \_\_\_\_\_

**Shipping** \_\_\_\_\_

**Total** \_\_\_\_\_

**Signature** \_\_\_\_\_

**Osborne/McGraw Hill**  
2600 Tenth Street, Berkeley, CA 94710



Look for **The DiskGuide Series** soon at a bookstore or computer store near you. Or order direct by phone or mail.



Escape The Computer Frustration Syndrome by reaching for our new **DiskGuide Series** or any one of 60 other Osborne/McGraw-Hill computer books.

© 1983 Osborne/McGraw-Hill



\* Apple and Apple II are registered trademarks of Apple Computer, Inc. • ATARI and ATARI 400/800 are registered trademarks of Atari, Inc. • CP/M and CP/M 86 are registered trademarks of Digital Research, Inc. • DiskGuide is a trademark of Osborne/McGraw-Hill • IBM is a registered trademark of IBM Corp. • VisiCalc is a registered trademark of Personal Software.

# North Star solutions are simple and powerful.

Not everyone needs a small business computer as powerful and fully-featured as a North Star. The North Star ADVANTAGE and HORIZON® micro-computer systems are built for those who demand a great deal more...of themselves as well as the vital tools they select for office automation.

## Powerful

Putting a North Star system through its paces is like high-speed driving in a luxury sports car: instant response to user commands, with a feeling of untapped resources within. Your North Star system has the power to get you through the fast curves of business and over towering peaks in workload. North Star outperforms the industry in single-user, multi-user and now in office network systems.

## Simple

Advanced software engineering has harnessed the power of the HORIZON and ADVANTAGE, so that achieving your results is as simple as a Sunday drive. Concise user commands instruct the computer to work the way you want it to.

And, we keep it simple everywhere: service, system expansion, and even custom software.

## Solutions

North Star systems are designed to get you from A to B as effectively as possible. The

designed-in harmony of our word processing, planning, accounting and other applications permits faster solutions and a broader range of possible accomplishments.

And no solution is complete until it is in presentation form. North Star graphics concisely present your results in charts, graphs and graphic figures.

Discover North Star's simply powerful solutions at one of over 1000 computer stores or systems houses. Call 800-447-4700 for the location nearest you, or write North Star Computers, Inc., 14440 Catalina Street, San Leandro, CA 94577.

**NorthStar**<sup>TM</sup>  
Simply powerful solutions.



The North Star logo, tagline and HORIZON are either trademarks or registered trademarks of North Star Computers, Inc. © 1983.

Systems serviced nationwide by MAI/Sorbus Service Division.

Circle 282 on inquiry card.

mediately sets the most significant bit to 1 (and because the instruction cannot be interrupted before completion), all the microprocessors with access to the semaphore byte have correct information about the shared resource. The microprocessor that has access to the shared resource has the responsibility of clearing the most significant bit when it is finished.

The only reason this process can work effectively is that the indivisible read-modify-write bus cycle (a special bus cycle) that accompanies the TAS instruction prevents, with hardware signals, any other device from accessing the semaphore byte between the time the TAS reads it and the time it is through setting the bit in it. This means that no two processors can read a semaphore byte and both be told that the resource is available. Thus, a secure way exists for software to determine the availability of shared resources in a multiprocessor MC68000 system.

### Supervisor and User Modes

The MC68000 executes instructions at one of two operating or privilege levels. The upper level, called the *supervisor level*, provides a protected environment for the operating system to run in, isolating it and its resources from the less trustworthy user code. After a reset operation, the MC68000 begins running in the supervisor mode, in which the operating system and all interrupt routines are also running. The lower level, called the *user level*, is where most application programs execute and, therefore, where the processor usually spends most of its time.

The only controlled way to get from the supervisor level to the user level is by changing the S/U (supervisor/user) status bit (bit 13) in the processor status register. This is how the operating system switches to begin a user-level program. Should an interrupt be handled in the middle of a user-level routine, the interrupt routine will run at the supervisor level, but upon return to the interrupted routine, the MC68000 will return to the user level.

User-level programs are guaranteed

to go to the operating system only through one of the 16 TRAP number  $n$  instructions. You can view these instructions as supervisor calls; they immediately transfer control to a specific routine. Upon completion of the TRAP routine, the processor will usually return to the original user-level routine to continue. Thus, there are 16 different supervisor trap instructions, which, along with other types of trap instructions, are listed in table 2.

Many other means of getting to the supervisor level of execution exist, but they are either conditional (like error traps) or asynchronous (like interrupts). Regardless, all traps are handled similarly by the supervisor. Any trap causes the processor to save the old program counter and status register on the supervisor stack. Then it will go to its external vector table and get a value, appropriate for the cause of the trap, to load into the program counter. This allows each type of trap to have a separate handling routine to correct the problem causing the trap and return to the original program.

Some of these other trap forms are intentionally conditional. Depending upon whether the overflow (V) condition bit is set, one instruction, TRAPV, either does nothing or causes a trap to occur, which forces the MC68000 into the supervisor state. This enables the program to handle all overflow conditions uniformly in a single operating-system-level routine. Another such instruction is the check (CHK) instruction, which verifies that the contents of any data register is greater than 0 but less than a specified bound. If it is within the limits, then nothing happens and the next instruction is run. If it is outside the bounds, then program control jumps indirectly through the vector table to a certain trap routine for handling. This gives the programmer an easy way to check whether an array index is within the proper bounds for that array. In addition, attempts to divide by 0 and access misaligned data (words or long words in memory on odd-byte addresses) will cause trap routines to be executed.

# LISP

For The  
IBM  
Personal Computer

THE PREMIER LANGUAGE  
OF ARTIFICIAL INTELLIGENCE  
AVAILABLE  
FOR YOUR IBM PC

#### ► DATA TYPES

Unlimited Precision Integers  
Floating Point Numbers  
Character Strings  
Multidimensional Arrays  
Files  
Machine Language Functions

#### ► MEMORY MANAGEMENT

Dynamic Allocation  
Compacting Garbage Collector  
Full Memory Space Supported

#### ► FUNCTION TYPES

Call-By-Name/Call-By-Value  
Fixed/Variable Number Of  
Arguments  
Macros  
Machine Language/Interpreted  
Over 150 Primitive Functions

#### ► IO SUPPORT

Multiple Display Windows  
Cursor Control  
All Function Keys Supported  
Read And Splice Macros  
Disk Files

#### ► POWERFUL ERROR RECOVERY

#### ► 8087 SUPPORT

#### ► LISP LIBRARY

Editor And Formatter  
Package Support  
Debugging Functions  
.OBJ File Loader

#### ► RUNS UNDER PC-DOS

## IQLISP

from

∫ q *Integral Quality*

P. O. Box 31970  
SEATTLE, WA 98103-0070  
(206) 527-2918

5¼ diskette and manual 125.00  
manual only 25.00

(Wash. State residents add sales tax)  
VISA and Mastercard Accepted

Type of Trap	Cause
address error illegal instruction	word or long-word access to an odd address no valid instruction exists for this op code (op codes starting with "1010..." and "1111..." generate other traps; see below)
zero divide CHK instruction TRAPV instruction privilege violation	attempt to divide by zero CHK instruction failed (operand out of bounds) overflow has occurred (V bit set) attempt to execute a privileged instruction while in the user mode
trace	an instruction has just ended and the T status register bit is set
line 1010 emulator line 1111 emulator TRAP n instruction	attempt to execute an op code that starts with "1010" attempt to execute an op code that starts with "1111" TRAP n instruction executed (n = 0,1, ..., 15)

**Table 2: Supervisor trap types and their causes.**

STOP
RESET
RTE
MOVE (when moving a word to the status register)
MOVE USP
AND, EOR, or OR (when combining an immediate value with the status register)

**Table 3: Privileged instructions in the MC68000.**

### Handling Illegal and Unimplemented Op Codes

To allow room for future expansion of the MC68000, designers did not use all of the possible bit patterns of the 16-bit op codes. Other microprocessors try to execute undefined op codes, often with disastrous results that cause you to lose control

of the computer or even lose valuable work. To assure a completely foolproof system in the face of undefined op codes, the MC68000 refuses to execute any illegal instruction and, instead, executes a specified trap routine for corrective action.

To enable programmers to add whole blocks of new instructions to MC68000 processors, designers left two subgroups of possible op codes unimplemented. Any 16-bit op code beginning with binary 1010 or 1111 was left without definition in the MC68000. Attempts to execute either of these categories of op codes, even though they could be considered illegal instructions, are trapped separately. They cause either a line-1010-emulator or a line-1111-emulator trap routine to execute, enabling the programmer to emulate in software functions that are not implemented in the processor chip of the


system. Currently, the 1111 op codes are defined mostly as floating-point instructions and so could be emulated on the MC68000. The 1010 op codes are still reserved for use in processors beyond the MC68020.

### Privileged Instructions

Privileged instructions have a special characteristic—they can be executed only while the processor is running at the supervisor level. Attempts to run them at the user level force privilege-violation traps to occur, allowing the supervisor to take whatever action it thinks suitable.

The privileged instructions are listed in table 3 and are mostly self-explanatory. These instructions are restricted because they modify or control resources or services that must be under the control of the operating system. Many of these instructions modify the upper portion of the status register (SR), which contains the S/U supervisor bit, the interrupt mask, and a trace-mode switch. Such resources are not meant to be in the hands of the users, but maintained by the supervisor; this is why they are restricted.

Another supervisor-privileged resource is the *supervisor stack pointer* (SSP). This pointer is visible (as address register A7) only when the MC68000 is running at the supervisor level, just as the *user stack pointer* (USP) is visible (as register A7) only when the MC68000 is running at the user mode. However, when the operating system is ready to pull in a new user-level task, it needs to be



**GRAPHIC SOFTWARE-**

A self-teaching guide of 61 BASIC programs that will show you how to write your own 2D and 3D graphics software: create 2D and 3D shapes, translate, rotate, scale, stretch, clip, remove hidden lines, shade, perspective views, surface intersections, animation, applications to science, business, engineering. Named 'The best book available for micro graphics' by Creative Computing. Special IBMpc version also covers separating text from graphics, hardware requirements and more.

Book 'Graphic Software for Micros'-\$21.95    IBMpc Graphics'- \$24  
 Apple Disk \$19.95    IBMpc Disk \$21.95

**DATA PLOTTING SOFTWARE-**

18 programs to process and display business and scientific data: Pie, bar, stock market charts, histograms, 3D views of surfaces, log plots, semi-log plots, curve fitting, regression, statistical analysis. Data management programs create disk data files, recall, update, list, refile. Special features- text over graphics, auto-scaling, auto-replot when data changes. All programs in BASIC, modular, menu driven, fully explained. Use as-is or modify and combine for custom applications.

Book 'Data Plotting Software for Micros'-\$28.50  
 Apple Disk \$19.95    IBMpc Disk \$19.95

**SOFTKITS™:** Our publications are called SOFTKITS. They contain ready-to-run programs written in BASIC listed alongside theory, equations and sample problems. This format allows you to learn how such programs are written, modify and combine them for custom applications, or use them as-is. Disks (Apple and IBMpc) contain the same programs in Applesoft BASIC or IBMpc BASICA..

able to access the hidden USP to initialize it. This is done with a special, privileged MOVE USP instruction.

The STOP instruction halts processor execution of further instructions, while waiting for an interrupt, a trace exception, or a reset to initiate new activity. The instruction also loads the status register with an immediate 16-bit value, allowing the programmer to enable certain interrupts before stopping the microprocessor. Only the supervisor can initiate this type of operation because, in a user's hands, the operation might throw off all sorts of operating-system timing integrity (such as time-slice clock signals) and generally brings the system to an irrecoverable halt. Also, the instruction must be restricted because it affects the entire status register.

The RESET instruction is a unique and powerful operation. Its execution pulses the reset line on the MC68000 without resetting the processor itself. You use this instruction typically after a catastrophic failure, from which the operating system is trying to recover on its own. It enables the operating system to initialize its external environment (i.e., reset the entire system except for the microprocessor) without forcing itself into a complete restart. Obviously, this instruction's power makes it inappropriate for the user level.

One final privileged instruction is the RTE (return-from-exception) instruction. An exception is anything that causes the microprocessor to perform an operation other than the next

normal instruction. Interrupts and traps, then, are exceptions. The RTE is similar to the return-from-interrupt instruction of most microprocessors. It basically reloads both the program counter and the status register with the values from the top of the stack. Because all exceptions force the processor to execution in the supervisor mode, the RTE instruction will be executed only in that mode; this makes it a privileged instruction.

Note, once again, that privileged instructions can be executed from only the supervisor level of operation, where the operating system usually resides. The two different levels of privilege and the restricted use of privileged instructions allow you to build systems that prevent user-level application programs from, inadvertently or otherwise, running rampant through operating-system code and data.

### Conclusion

As you have seen in previous installments of this article, the MC68000 architecture is really designed with the programmer in mind. The MC68000 branch and jump instructions give you complete control over program flow and simplify often-used looping and string-movement constructs. The link and unlink instructions make it easier for you to create modular programs that use local variables. Other instructions carry out complex address calculations quickly, help mediate the use of shared resources, provide for the data integrity of the operating

system, and allow recovery from errors under program control. In addition, planners designed the architecture and instruction set with far greater things in mind and made the set easy to expand to more powerful and more comprehensive functions. And all this has been done with a processor for which performance was a primary criterion.

Once you learn a few general concepts of programming the MC68000, coding an application comes easily. Pick up an MC68000 user's manual and a similar guide for any other 16-bit microprocessor. Then spend an hour or two learning each. Code a short program or two, and compare just how easy the MC68000 is to work with. And if you choose to write code for a larger program, you will find your task to be simple regardless of program size.

The MC68000 was designed to be a programmer's instrument through which programmers and system designers could use their creativity to engineer a system to fit the application instead of having to figure out some trick to get the microprocessor to perform the needed task. We at Motorola believe that using the right tool gets a job done faster with fewer mistakes, and the MC68000 is such a tool. ■

---

### About the Author

*Thomas Starnes is an electrical engineer who has spent the last five years helping to plan the direction of the MC68000 family of processor products for Motorola.*

---

### MAIL LIST SOFTWARE-

a series of ready-to-use mail list programs arranged in a tutorial sequence that show how to write mail list software: Create random access data files, store on disk, recall, update, sort by zip code, sort in alphabetical order, list, print mail labels. Programs progress step-by-step from elementary file handling concepts and build to ready-to-use mail list software. Perfect for small businesses who want to customize their own software. Programs listed in the book in IBMpc BASICA; disks available for Apple and IBMpc.

- Book 'Mail List Software for Micros'-\$32.50  
 Apple Disk \$19.95  IBMpc Disk \$19.95

### STRUCTURAL SOFTWARE-

11 programs combining structural analysis with graphics: Create a 3D mesh interactively, rotate in 3 dimensions, store on disk. Then recall, do linear and non-linear 3D truss analysis, linear 3D frame analysis using the 'direct stiffness' method. Also do combined stress analysis, calculate geometric properties of beam cross-sections. Truss programs graphically display deformed shape of structure. All programs in BASIC fully documented with theory, equations, sample problems.

- Book 'Structural Analysis Software for Micros'-\$42.50  
 Apple Disk \$42.50  IBMpc Disk \$42.50



**TO ORDER:** Send check on US bank, money order in US funds, VISA/MASTERCARD no with exp date to KERN PUBLICATIONS, PO Box 1029-BJ, Duxbury, MA 02332. Ad \$2 per book 4th cl mail in US and Canada; \$4 1st cl or UPS in US; \$4.50 1st cl Canada; \$12 air Europe and Central America; \$18 elsewhere. For faster delivery call (617)934-8445.

**KERN  
PUBLICATIONS**

computer mail order west

# computer mail order

### PRINTERS SMITH CORONA

Call on \$50.00 Factory Rebate!

TP-1 .....\$499.00  
Tractor Feed .....\$129.00  
Ultrasonic Typewriter .....\$439.00  
**C.I.TOH(TEC)**

**GX-100** .....\$209.00  
Prowriter 8510P .....\$379.00  
Prowriter 8510S .....\$579.00  
Prowriter 1550P .....\$699.00  
Prowriter 1550S .....\$749.00  
Starwriter F10-40 .....\$1259.00  
Printmaster F10-55 .....\$1849.00

### OKI/OATA

82A .....CALL  
83A .....CALL  
84 (Parallel) .....CALL  
84 (Serial) .....CALL  
92 .....CALL  
93 .....CALL

### IOB

MicroPram .....\$649.00  
132 (Fully Configured) .....\$1599.00  
80 (Fully Configured) .....\$1399.00  
Call for other configurations.

### STAR

Gemini 10 .....\$349.00  
Gemini 13 .....\$489.00  
Serial Board .....\$75.00

### DAIBYWRITER

2000 (Letter Quality) .....\$1049.00  
Tractor Feed .....\$109.00

### DIABLO

820 .....\$999.00  
830 .....\$1769.00



### TeleVideo

810 .....\$559.00  
812C .....\$689.00  
820C .....\$739.00  
825C .....\$719.00  
830 .....\$829.00

### COMPUTERS

800A .....\$1259.00  
801 .....\$2649.00  
802M .....\$4695.00  
806/20 .....\$4949.00  
816/40 .....\$8999.00  
803 .....\$1949.00  
1802G .....\$3399.00  
1803 .....CALL

### NEC

#### COMPUTERS

8000 .....CALL  
8001A .....\$719.00  
8031 .....\$719.00  
8032 .....\$549.00

#### PRINTERS

8023 .....\$419.00  
7710/7730 .....\$2249.00  
3510/3530 .....\$1549.00

#### MONITORS

JB-1260 .....\$119.00  
JB-1201 .....\$149.00  
JC-1212 .....\$299.00  
JC-12-202 .....\$299.00  
JC-1203 .....\$569.00

### EAGLE



Call on Eagle 8 Bit & 16 Bit Computers & Software

### MODEMS HAYES

Smart .....\$219.00  
Smart 1200 (1200 Baud) .....\$549.00  
Chronograph .....\$109.00  
Micromodem 100 .....\$309.00  
Micromodem II .....\$279.00  
Micromodem II (with term) .....\$299.00  
Smart Com II .....\$99.00

### NOVATION

J-Cat .....\$119.00  
Cat .....\$144.00  
D-Cat .....\$159.00  
103 Smart Cat .....\$189.00  
Apple Cat II .....\$279.00  
103/212 Smart Cat .....\$439.00  
212 Apple Cat II .....\$609.00  
AppleCat II 12 Upgrade .....\$309.00

### ANCHOR

Mark I (RS-232) .....\$79.00  
Mark II (Atari) .....\$79.00  
Mark III (T.J.-99) .....\$109.00  
Mark IV (CBM-PET) .....\$125.00  
Mark V (Osborne) .....\$95.00  
Mark VI (IBM-PC) .....\$179.00  
Mark VII (AutoAns/Auto Dial) .....\$119.00  
TRS-80 Color Computer .....\$99.00  
9 Volt Power Supply .....\$9.00  
Mark VIII .....CALL

### MONITORS AMOEK

300G .....\$159.00  
300A .....\$169.00  
310G .....\$179.00  
310A .....\$169.00  
Color I .....\$299.00  
Color II .....\$599.00  
Color III .....\$799.00  
Color III .....\$349.00

### BMC

12AU 12" Green .....\$79.99  
1401 13" Color (Mid-Res) .....\$369.00  
9191 U 13" Composite .....\$329.00

### TAXAN

RGB I (Hi-Res) .....\$299.00  
RGB III .....\$499.00  
12 N Green .....\$119.00  
12 A Amber .....\$125.00

### ZENITH

ZVM 121 .....\$95.00  
ZT-1 Terminal .....\$369.00

### U.S.I.

Pr 1, 9" Green .....\$99.00  
Pr 2, 12" Green .....\$119.00  
Pr 3, 12" Amber .....\$159.00  
Pr 4, 9" Amber .....\$139.00  
1400C 14" Color .....\$299.00

### PANASONIC

JR200U 32K Pers. Computer .....\$309.00

### MONITORS

TR-120 12" Hi-Res Green .....\$159.00  
CT-180 10" Dual Mode Color .....\$299.00  
DT-D1000 10" RGB .....\$349.00  
DT-D1300 13" RGB/Compos. ....\$429.00

### IBM

#### NEC

3850 PRINTER .....\$1549

#### PERCOM/TANDOM DRIVES

5 1/4" 180K Disk Drive .....\$249.00  
5 1/4" 320K Disk Drive .....\$289.00

#### AMOEK

310A Amber Monitor .....\$169.00  
310G Green Monitor .....\$179.00  
Amdisk (3 1/2" Drive) .....\$879.00  
XY Plotter .....\$649.00  
Color II .....\$599.00

#### ABT

Combo Card 64K .....\$429.00

#### QUBIE

PC Keyboard .....\$219.00

#### SOFTWARE

MicroPro WordStar/MailMerge .....\$349.00  
I.U.S. Easywriter II .....\$249.00  
I.U.S. EasySpeller .....\$129.00  
Peach Package (GL/AP/AR) .....\$419.00

#### PROFESSIONAL SOFTWARE

IBM-PC Word Processing .....\$319.00

#### CONTINENTAL SOFTWARE

1stClass Mail/Form Letter .....\$89.00  
The Home Accountant Plus .....\$109.00

#### SYNAPSE

File Manager .....\$119.00

### IMMS

Privacode Phone .....\$239.00

### READY FORMS

1" or 2" Address Labels (Tract. Feed) .....\$9.95  
15" Report Paper (Tract. Feed) .....\$24.95  
8 1/2" Blink Wrt Paper (Tract. Feed) .....\$19.95  
8 1/2" Blink Env (Tract. Feed) .....\$14.95

### SANYO

MB1000 Computer .....\$1599.00  
INCLUDES FREE SOFTWARE!  
MicroPro, WordStar, CalcStar, Mail Merge & Report Star.  
MB 180 Add on Drive .....\$539.00  
5500 Letter Quality Printer .....\$699.00

### TIMEX SINCLAIR 1000



\$39.95

16K Memory Module .....\$44.95  
Vu-Calc .....\$17.95  
Check Book Manager .....\$13.95  
The Organizer .....\$14.95  
The Budgeter .....\$13.95  
Stock Option .....\$14.95  
Loan & Mortgage Amortizer .....\$12.95  
Mindware Printer .....\$109.00

### ORBYTE SOFTWARE

Graphics .....\$12.99  
Home Budgeter .....\$12.99  
Home Inventory .....\$12.99  
Income Tax .....\$14.99  
Mega Mind .....\$15.99  
Selvo .....\$12.99  
The Quiz .....\$12.99  
Words .....\$12.99

### Commodore



### CALL ON CBM 64 \$100.00 REBATE!

### CBM 64 \$399

### VIC 20 \$99.

4064 .....\$569.00  
12840 .....\$649.00  
12880 .....\$749.00  
8032 .....\$1039.00  
4032 .....\$739.00  
8096 Upgrade Kit .....\$369.00  
9000 .....\$1499.00  
2031 .....\$449.00  
4040 .....\$949.00  
8050 .....\$1279.00  
8250 .....\$1639.00  
9060 (5 Meg. HD) .....\$1099.00  
9090 (7.5 Meg. HD) .....\$2199.00  
4022 .....\$389.00  
8023 .....\$569.00  
6400 Letter Quality Printer .....CALL  
Spell Master .....\$99.00  
Z Ram adds CP/M & 64K .....\$549.00  
Silicon Office .....\$749.00  
Calc Result .....\$159.00  
The Manager .....\$209.00  
The Soft Rom .....\$129.00  
Jinsem .....CALL  
ADA 1800 CBM to Parl. Int. ....\$89.00  
ADA 1450 CBM to Serial Int. ....\$99.00

### PROFESSIONAL SOFTWARE

Power .....\$79.00  
Info Pro .....\$219.00  
Word Pro 2 Plus .....\$159.00  
Word Pro 3 Plus .....\$199.00  
Word Pro 4 Plus .....\$269.00  
Word Pro 5 Plus .....\$299.00  
Administrator .....\$379.00  
Word Pro 64 .....\$79.95

### CAROCO

#### VIC 20/CBM 64

Light Pen .....\$39.00  
Cassette Interface .....\$29.00  
Parallel Printer Interface .....\$64.00  
3Slot Expans. Interface (20 only) .....\$32.00  
5Slot Expans. Interface (20 only) .....\$79.00

#### HEB

Shamus (ROM) .....\$29.00  
Protector (ROM) .....\$32.00  
Robot Panic (ROM) .....\$29.00  
Pirates (ROM) .....\$29.00  
HES Writer (ROM) .....\$29.00

### ART AND MUSIC

#### SERIES 64

Music Machine .....\$25.00  
Music Composer .....\$25.00  
Meta Music I .....\$79.00

#### COMMERCIAL DATA

Motor Mouse/20 .....\$23.00  
Centipede/20 .....\$23.00  
Froggie/20 .....\$23.00  
Froggie/64 .....\$23.00

#### CREATIVE SOFTWARE

Astro Blitz .....\$32.00  
Black Hole .....\$32.00  
Trashman .....\$32.00  
Home Finance .....\$27.00  
Home Inventory .....\$13.00

#### UMI

Amok .....\$30.00  
Meteor Run .....\$40.00  
Allen Blitz .....\$30.00  
Viterm A .....\$18.00  
The Alien .....\$18.00

Call on our Large Selection of VIC 20 & CBM 64 Software, such as: EPYX, Microspec and Kansas City Software.

### SHARP

### PC-1500 POCKET COMPUTER \$169.

### PC1250... \$89.00



CE150 Printer, Plotter and Cassette Interface Unit .....\$172.00  
CE152 Cassette Recorder .....\$62.00  
CE155 8K Ram Expans. Mod. ....\$94.00  
CE125 Printer/Micro Cass. ....\$129.00  
Statistics Pack .....\$49.00

## computer mail order west

# 800-648-3311

IN PA. CALL (717)327-8576  
DEPT. 601, 477 E. THIRD ST., WILLIAMSPORT, PA 17701

Circle 83 on Inquiry card.

No risk, no deposit on C.O.D. orders. Pre-paid orders receive free shipping within the UPS Continental United States with no waiting period for certified checks or money orders. Add 3% (minimum \$3.00) shipping and handling on all C.O.D. and credit card orders. Larger shipments may require additional charges. NV and PA residents add sales tax. All items subject to availability and price change. NOTE: We stock manufacturer's and third party software for most all computers on the market. Call today for our new catalog.



# computer mail order



Call for price and information on the NEW FRANKLIN Computers!  
Disk Drives, Software and System Specials ALSO AVAILABLE!

**MICRO-8CI**  
DISK DRIVES FOR APPLE & FRANKLIN  
A2 .....\$249.00  
A40 .....\$349.00  
A70 .....\$459.00  
C2 Controller .....\$79.00  
C47 Controller .....\$89.00

**RANA DISK DRIVES**  
Elite 1 plus (Apple/Franklin) ... CALL  
1000 (Atari) ..... CALL

**SYSCOM**  
48K Color Computer  
APPLE COMPATIBLE  
**\$599.**

**VISICORP**  
for Apple, IBM & Franklin  
Visidex .....\$189.00  
Visifile .....\$189.00  
Visiplot .....\$179.00  
VisiTerm .....\$89.00  
VisiTrans/Plot .....\$229.00  
VisiSchedule .....\$229.00  
Desktop Plan .....\$189.00  
Visicalc (Apple II, CBM, IBM) .....\$179.00  
Visicorp prices for IBM may vary slightly.

**BRODERBUND**  
Apple Panic .....\$23.00  
David's Magic .....\$27.00  
Star Blazer .....\$25.00  
Arcade Machine .....\$34.00  
Choplifter .....\$27.00  
Serpentine .....\$27.00

**INFOCOM**  
Deadline (Apple, IBM, Atari) .....\$35.00  
Star Cross .....\$29.00  
Zork I, II or III .....\$29.00

**MPC**  
Bubdisk (128K Non-Volatile) .....\$649.00

**AXLON**  
Apple/Franklin 128K Ram .....\$399.00  
Apple/Franklin Ram Disk .....\$999.00

**KRAFT**  
Apple Joystick .....\$44.00

**CONTINENTAL SOFTWARE**  
Tax Advantage (Apple/Atari) .....\$45.00  
Home Acct. (Apple/Atari) .....\$59.00  
1st Cl. Mail/Form Letter (Apple) .....\$79.00  
The Book of Apple .....\$14.95  
The Book of Atari .....\$14.95  
The Book of Apple Graphics .....\$14.95



**DISK DRIVES FOR ATARI**  
AT88-S1 .....\$399.00  
AT88-A1 .....\$299.00  
AT88-S2 .....\$649.00  
RFD 40-S1 .....\$549.00  
RFD 40-A1 .....\$349.00  
RFD 40-S2 .....\$889.00  
RFD 44-S1 .....\$679.00  
RFD 44-S2 .....\$999.00

**FLOPPY DISKS**  
MAXELL  
MD I (Box of 10) .....\$32.00  
MD II (Box of 10) .....\$44.00  
FD I (8") .....\$40.00  
FD II (8" DD) .....\$50.00

VERBATUM  
5 1/4" SS DD .....\$26.00  
5 1/4" DS DD .....\$36.00

ELEPHANT  
5 1/4" SS DD .....\$19.99  
5 1/4" SS DD .....\$24.99  
5 1/4" DS DD .....\$29.99

HEAD  
Disk Head Cleaner .....\$14.95

**BIRIUB**  
Bandits (Apple) .....\$26.00  
Bear Run (Apple) .....\$24.00  
Flea Fall (Apple) .....\$24.00  
Sneakers (Apple) .....\$24.00  
Snake Byte (Apple) .....\$24.00  
Fast Eddie (Atari) .....\$21.00  
Turmoil (Atari) .....\$21.00  
Deadly Duck (VIC) .....\$21.00

**INTERFACES & ACCESSORIES**  
80 Column Apple Card .....\$159.00  
Apple Paral. Printer Interface .....\$69.00  
Atari 850 to Paral. Printer Cable .....\$29.00  
RS232-RS232 Cables .....\$29.00  
Centronics Paral. Paral. Cables .....\$29.00  
Call on IBM, Osborne, Daisywriter, Atari, Commodore, Apple and Franklin Interface Cards, Cables and Accessories.

**HEWLETT PACKARD**  
   
**41CV**  
**\$209**

**HP75... \$749.**  
HP41C .....\$149.00  
HP10C .....\$59.00  
HP11C .....\$72.00  
HP12C .....\$99.00  
HP15C .....\$99.00  
HP18C .....\$99.00  
For NP41/41CV  
HPIL Module .....\$99.00  
HPIL Cassette or Printer .....\$359.00  
Card Reader .....\$144.00  
Extended Functions Module .....\$64.00  
Time Module .....\$84.00  
Mathematics Pac .....\$26.50  
Real Estate Pac .....\$40.00



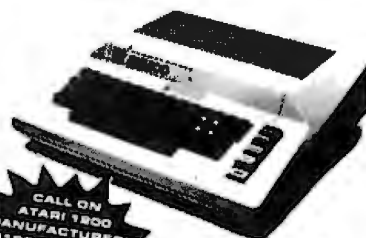
## HOME COMPUTERS

**ATARI 800**  
**48K**  
**\$289.\***

\*Reflects \$100.00 ATARI Rebate!

**ATARI 600-16K**  
**\$199.**

**ATARI 1200-64K**  
**NOW IN STOCK!**



CALL ON ATARI 1200 MANUFACTURER'S \$100.00 REBATE!

**ATARI 400**  
16K ..... CALL  
32K ..... CALL  
48K ..... CALL  
64K ..... CALL

810 Disk Drive .....\$429.00  
Inhome Keyboard/Atari400 .....\$89.00  
1010 Program Recorder .....\$74.00  
102040 Column Print/Plot .....\$269.00  
1025 80 Column Printer .....\$469.00  
1027 Letter Quality Printer .....\$299.00  
1050 Double Density Drive .....\$379.00  
830 Acoustic Modem .....\$159.00  
850 Interface Module .....\$169.00  
CX400 Pair Joysticks .....\$18.00  
CX418 Home Manager Kit .....\$69.00  
CX419 Bookkeeper Kit .....\$195.00  
CX482 Educator Kit .....\$129.00  
CX483 Programmer Kit .....\$54.00  
CX488 Communicator Kit .....\$229.00  
CX7101 Entertainer Kit .....\$89.00  
Invitation to Programming I .....\$18.00  
Invitation to Programming II .....\$20.00  
Invitation to Programming III .....\$20.00  
4002 Basic Language .....\$42.00  
4003 Assembler Editor .....\$47.00  
8121 Micro Assembler .....\$69.00  
8128 Micro Soft .....\$69.00  
405 Pilot (Educ.) .....\$105.00  
4018 Pilot (Home) .....\$72.00  
8036 Atari Writer .....\$79.00  
404 Word Processor .....\$119.00  
5059 Visicalc .....\$159.00

**ATARI**  
Pacman .....\$33.00  
Centipede .....\$33.00  
Defender .....\$33.00  
Galaxian .....\$33.00  
Missile Command .....\$29.00  
Star Raiders .....\$33.00  
Caverns of Mars .....\$32.00  
Dig Dug .....\$33.00  
Donkey Kong .....CALL  
E.T. Phone Home .....\$39.00  
Eastern Front (1941) .....\$39.00  
OJX .....\$33.00  
Superman III .....\$39.00  
Star Trek .....\$33.00  
Asteroids .....\$29.00  
Basketball .....\$29.00  
Computer Chess .....\$29.00  
Juggles House .....\$23.00  
My First Alphabet .....\$29.00

**APX**  
Text Formatter .....\$18.50  
Family Budgeter .....\$18.50  
Eastern Front .....\$24.00  
Family Cash .....\$18.50  
Jukebox .....\$13.50  
Downhill .....\$18.50  
Outlaw .....\$18.50  
Holy Grail .....\$24.00  
Player Piano .....\$18.50  
Keyboard Organ .....\$18.50  
Number Blast .....\$13.50  
Frogmaster .....\$18.50  
747 Land Simulator .....\$18.50  
Bumper Pool .....\$13.50

**ON-LINE**  
Jawbreaker .....\$27.00  
Softporn .....\$27.00  
Wizard and Princess .....\$29.00  
The Next Step .....\$34.00  
Mission Asteroid .....\$22.00  
Mowdown Attack .....\$31.00  
Frogger .....\$31.00  
Cross Fire (ROM) .....\$36.00  
Some ON-LINE Products are also available for Apple & IBM.  
Call for information!

**SYNAPSE**  
File Manager 800 plus .....\$69.00  
Chicken (ROM) .....\$34.00  
Picnic Paranoia (ROM) .....\$34.00  
Claim Jumper (ROM) .....\$34.00  
Slime (ROM) .....\$34.00  
Shamus (ROM) .....\$34.00  
Protector (ROM) .....\$34.00  
Dodge Racer (C/D) .....\$26.00  
Nautilus (C/D) .....\$26.00  
Shadow World (C/D) .....\$26.00  
Survivor (C/D) .....\$26.00  
Dreibe (C/D) .....\$26.00  
Necromancer (C/D) .....\$28.00  
Parah's Curse (C/D) .....\$26.00  
Fort Apocalypse (C/D) .....\$26.00  
Page 6 .....\$19.00  
Assembler .....\$30.00  
Disk Manager .....\$24.00

**OATBOFT**  
Pacific Coast Highway .....\$25.00  
Canyon Climber .....\$25.00  
Tumble Bugs .....\$25.00  
Shooting Arcade .....\$25.00  
Clowns and Balloons .....\$25.00  
Graphic Master .....\$30.00  
Graphic Generator .....\$13.00  
Micro Painter .....\$25.00  
Taxi Wizard .....\$79.00  
Spell Wizard .....\$84.00  
Bishop's Square .....\$25.00  
Sands of Egypt .....\$25.00  
Moon Shuttle .....\$25.00  
Zaxxon .....\$29.00

**ALIEN**  
Atari Voice Box .....\$119.00  
Apple Voice Box .....\$149.00

**MEMORY**  
Axiom 32K Ram .....\$89.00  
Axiom 48K Ram .....\$139.00  
Axiom 128K Ram .....\$399.00  
Intec 32K Board .....\$74.00  
Intec 48K Board .....\$99.00  
Intec 64K Board (400 only) .....\$149.00

**WICO**  
Joystick .....\$24.95  
Famous Red Ball .....\$26.95  
Apple Trackball .....\$59.00  
Atari/VIC Trackball .....\$55.00  
Apple Adapter .....\$16.00

**Non-Atari Ram**  
**CBS**  
Krazy Shoot Out .....\$32.00  
Krazy Kritters .....\$32.00  
Krazy Antics .....\$32.00  
K-star Patrol .....\$32.00  
Stick Stand .....\$6.99

**EPYX**  
Crash, Crumble & Chomp .....\$24.00  
Crypt of the Undead .....\$24.00  
Curse of Ra .....\$18.00  
Datestones & Ryn .....\$18.00  
Invasion Orion .....\$18.00  
King Arthur's Hair .....\$24.00  
Morloc's Tower .....\$18.00  
Rescue at Rigel .....\$24.00  
Ricochet .....\$18.00  
Star Warrior .....\$29.99  
Temple of Apsah .....\$28.00  
Upper Reaches of Apsah .....\$18.00

**SPINNAKER**  
Snooper Troops # 1 .....\$34.00  
Snooper Troops # 2 .....\$34.00  
Face Maker .....\$24.00  
Story Machine .....\$24.00  
Delta Drawing .....\$45.00  
Rhymes and Riddles .....\$21.00  
Kindercomp .....\$21.00

**ROKLAN**  
Wizard of War (ROM) .....\$34.00  
Deluxe Invader (ROM) .....\$26.00  
Gorf (ROM) .....\$34.00

**FIRST STAR**  
Astro Chase .....\$25.00

**BIG 6**  
Miner 49er .....\$25.00

**GAMESTAR**  
Baja Buggies .....\$24.99  
Football .....\$24.99

**BUOGECO**  
Reater Blaster .....\$24.95

**L.J.K.**  
Letter Perfect 40/80 Col. Disk .....\$109.00  
Letter Perfect 40 Col. ROM .....\$179.00  
Letter Perfect 160 Col. ROM .....\$179.00  
Data Perfect 40/80 Col. Disk .....\$99.00  
Mail Merge .....\$21.95  
CALL FOR APPLE/LJK PRODUCTS

**BIT 3**  
80 Col. Card for Atari 800 .....\$279.00

**INTEC**  
Real Time Clock .....\$39.00

We also stock software by:  
Adventure International,  
Eduware, Creative Software,  
Dorsett Educational,  
IDSI, Romox and Artworx.  
Call for details and prices

## computer mail order east

# 800-233-8950

IN NV. CALL (702)588-5854

DEPT. 601, P.O. BOX 8888, STATELINE, NV. 89448

INTERNATIONAL ORDERS: All shipments outside the Continental United States must be pre-paid by certified check only. Include 3% (minimum \$3.00) shipping and handling. EDUCATIONAL DISCOUNTS: Additional discounts are available from both Computer Mail Order locations to qualified Educational Institutions. APO & FPO: Add minimum \$5.00 shipping and handling.



computer mail order east

Circle 83 on inquiry card.

# The Bazeries Cylinder

## A Cryptographic Challenge

---

Rinaldo F. Prisco  
RD #7 Edgebrook  
Oswego, NY 13126

---

*In 1618, a French mathematician named Antoine Rossignol deciphered a secret message for the forces of the King of France. It enabled the King's forces to capture the city of Réalmont without resorting to battle. This feat was the beginning of Rossignol's long and outstanding career as court cryptanalyst to Louis XIII and later to Louis XIV. During his tenure, Rossignol created a complicated cipher system for the exclusive use of the King. When Louis XIV died in 1715, he left behind messages written in the Great Cipher—but not the process to decipher them. For more than a century, the Great Cipher stood against all assaults at its secrets. It was finally broken by Commandant Bazeries of the Black Chamber, the French Army's cryptographic department. Bazeries went on to create the cylindrical cipher system that became the de facto standard used throughout the world.*

The principles used in many of today's sophisticated cryptographic systems are based on the Bazeries cylinder. This article describes the cylinder, analyzes the security of the ciphertext produced, and illustrates its use with a computer simulation.

It is hoped that readers who must exchange private information over public facilities will find such a system useful. Needless to say, the Bazeries cylinder has survived the testing of several decades; during that time, it has been used worldwide by many security agencies.

### The Rubber Stamp Model

The easiest way to think of a Bazeries cylinder is to recall the familiar date stamp, where month, day, and year bands are separately rotated to set the correct date. The Bazeries cylinder uses the same principle. It consists of 20 sections, or disks, each of which can be separately

rotated. Each disk contains a permutation of letters on its rim. By rotating the disks, you can align any sequence of 20 letters, just as you set the date stamp to any date.

Figure 1 depicts how the Bazeries cylinder would look if it were slit lengthwise and laid flat. Note the alignment of the plaintext sequence SPEAKTOTHELADYINBLUE in the bottom row. Twenty-five other sequences are above it. Any one of them, say the top row, can be used as the corresponding ciphertext. To decipher text, simply align the scrambled disks of a cylinder to the ciphertext; the plaintext will set in one of its rows. If the text contains more than 20 characters, simply process it in blocks of 20.

For further security, the order in which the 20 disks are to be loaded in the cylinder can be specified by a key. For example, you can load the disks in the order

4-17-1-19-11-2-6-9-12-15-8-20-10-16-14-5-18-13-7-3

The key for this sequence is the phrase

BEWARETHEIDESOFMARCH

The numbers correspond to the position of the phrase's letters in alphabetical order.

### Analysis of Security

Each disk of the cylinder is the equivalent of a 26-cycle substitution cipher on 26 characters. More than  $1.55 \times 10^{25}$  (i.e., 155 followed by 23 zeros) possible settings exist. That works out to about  $7.75 \times 10^{25}$  settings for every man, woman, and child in the country! A 20-disk cylinder can thus be configured in approximately  $6.5 \times 10^{503}$  ways, an immensely large number. For example, the combined memory capacities,

# The Inmac Plus™ floppy is totally reliable, guaranteed for life, and you can get one free.

**A**LL YOU HAVE TO DO is ask, and we'll send you three Inmac Plus premium diskettes.

One—up to a \$9.90 value—is free.

The other two are for you to use for 45 days at no obligation. Test them out. Compare them to the diskettes you're now using.

We're convinced that once you try Inmac Plus, you'll buy Inmac Plus. And nothing else.

But if you're not completely satisfied, simply return the two diskettes and keep the third one with our compliments.

## Inmac Plus quality for error-free performance.

Do your floppy disks work the first time, every time you put them in your drive?

Ours will, and we're not just saying that. We back every Inmac Plus diskette with the strongest guarantee in the industry—a *lifetime guarantee*.

For as long as you own an Inmac Plus diskette it will read and write flawlessly. It will protect your data. It will perform to perfection—or we'll replace it free.\*



*With Inmac Plus diskettes, you're guaranteed 100% read/write accuracy and lifetime data protection.*

The problem with ordinary floppy disks is that they gradually wear down under the everyday stress of drive heads and pressure pads. This can result in everything from annoying read/write errors to complete data loss.

Inmac Plus diskettes don't have this problem. They're made with a durable oxide coating that "gives" not flakes as hard-coated disks do. So you don't wind up gambling with your data or wasting hours of valuable programming time.

Inmac Plus diskettes excel on all types of

\*Understandably, we cannot guarantee damage resulting from neglect or abuse. Nor do we assume responsibility for any consequential damages.



*Inmac Plus diskettes surpass every applicable performance standard in the industry. Trust them with your most critical programs and data.*

drives, even finicky ones. One reason for this is a special reinforced hub ring that protects against a major cause of data loss—warps, dents, and tears resulting from the drive's clamping hub.

In all, Inmac Plus diskettes go through 32 separate quality tests. And each is given an individual registration number to help us maintain the highest quality standards possible.

Due to this stringent quality assurance program, they surpass every applicable performance standard in the industry. You can trust them with your most critical programs and data.

## Nothing compares— at any price.

Add it all up.

Inmac Plus diskettes give you total reliability. 100% read/write accuracy. Lifetime protection for your data.

That's why they're your best buy—at any price.

## This exclusive Trial Offer ends August 31, 1983.

Here's how it works.

Simply mail the attached card or phone our toll-free number by August 31, and we'll send you three Inmac Plus diskettes—one of which is yours to keep, no matter what.

The other two are yours to use for 45 days at no obligation. Return them if not completely satisfied.

But we're expecting just the opposite. We think you'll be so utterly impressed, you'll want to keep the two diskettes.

That's why we're enclosing an invoice with



your order, so that by the end of the trial period, you can mail it back to us, along with your check or money order. Or if you prefer, use your credit card—whichever is most convenient for you.

Remember, send no money now. We want you to try Inmac Plus before you buy Inmac Plus, and we'll ship your diskettes within 24 hours so that you can get started as soon as possible.

Offer limited to one free diskette per customer. Offer void in Alaska and Hawaii.

## Get three diskettes for the price of two.

To be sure of getting the Inmac Plus diskette that's right for your system, specify its make and model. Below are some of the most popular systems and the corresponding Inmac Plus diskette. If yours is not listed, call us for assistance and pricing information.

System	Inmac Plus description	Price for 3 diskettes
Apple II, II Plus, III; IBM PC (single side); Osborne PC; Radio Shack TRS80-1 or 3	5 1/4" SSDD Soft Sector	\$11.80 (save \$5.90)
AB Dick Magna Writer; Cromemco Z2H; HP85/Series 9826A, 9836; IBM PC (Dual Side)	5 1/4" DSDD Soft Sector	\$16.80 (save \$8.40)
DEC RX01; IBM System 32, 3737, 3740, 3730, 3741, 3600, 3601, 3790, 3791	8" SSDD Soft Sector	\$15.80 (save \$7.90)
	IBM format 2305830	
CDC 9406; HP3000 Series 33; IBM Series I, diskette 2; IBM System 34, diskette 1	8" DSDD Soft Sector	\$19.80 (save \$9.90)

Double density diskettes can be used in single density applications.

**Send attached postage-free  
card or phone toll-free.**

**1 (800) 547-5444**

[1 (800) 547-5447 in California.]

When you call, ask for a free Inmac catalog. Inmac Plus diskettes are available only through the Inmac catalog or through special offers such as this.

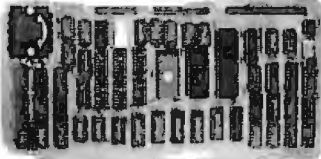
**inmac**

**World's leading source of computer  
supplies and accessories.**

Circle 189 on inquiry card.

107121

## S-100 Boards from S. C. Digital

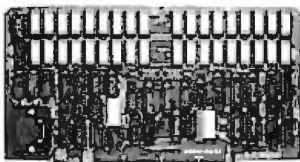


### FLOPPY DISK CONTROLLER

features: **Model FDC1**  
 ● Single or Double density, sides, in any combination of up to four 8" or 5.25" drives. ● Digital phase locked loop. ● DMA data transfer with cross 64K boundaries, 24B address, DMA arbitration. ● Monitor/boot EPROM accommodating two different processors. ● CPM Bios programs. ● Serial port to 19.2K baud.

### Z80B CPU BOARD

features: **Model Z80 CPU**  
 ● 2, 4 or 6 mhz clock. ● 22 bit Address by Memory Mapping in 16K blocks. ● 2 or 4Kbyte EPROM (not supplied) with Phantom generation. ● Jump on Reset. ● Provision to run two different CPU's on the same bus, such as forth coming 8086.



### NEW 256K DYNAMIC RAM

features: **Model 256KZ**  
 ● 8/16B Data, 24B Address. ● Parity bit per Byte ● Transparent refresh ● Unlimited DMA ● 180nsec. Access time ● Will run 8086, 8088, 68000 to 8mhz, Z80, Z8000 to 6mhz without wait states.



### NEW 64K STATIC RAM

features: **Model 64KS**  
 ● 8/16B Data 24B Address ● Disable in 2K increments ● 180nsec Access Time (with 64KB) from address on, runs 8086, 68000 to 10mhz, Z80, Z8000 to 8mhz without wait states ● Battery back up capable.

Board Sets: For Limited Time Only!  
 ● Z80B CPU, DMA Floppy Controller, CP/M 2.2, 64KB Static Ram \$1,000  
 ● Z80B CPU, DMA Floppy Controller, CP/M 2.2, 250KB Ram \$1,250  
 ● For CP/M Plus instead of 2.2 add \$50  
 Please call for latest prices.

All boards conform to IEEE696/S100 specifications, fully socketed, screened legends, masks, Gold contacts. Guaranteed One Full Year.

#### New Prices Effective May 1, 1983

Model	Prices	with
FDC1	\$395	Monitor EPROM
Z80 CPU	\$325	Memory Mapping, 6mhz
256KZ	\$695	256KB, Parity
256KZ-128	\$695	428KB, Parity
64KS	\$425	64KB, CMOS
32KUSM	\$295	32KB, CMOS
35PC	\$259	3 serial, 1 parallel, cassette
CP/M 2.2	\$55	Purchased with FDC1
CP/M Plus	\$105	Purchased with FDC1
Z80 Monitor	\$55	2K in EPROM, source code, for 35PC

All Boards come assembled and tested.

Delivery is within 3 to 5 working days. MC, Visa or COD orders accepted. (Add \$6 for COD orders) Illinois residents add 5 1/4% sales tax.

\*CP/M is a registered trademark of Digital Research, Inc.  
**O.E.M. & DEALER PRICE AVAILABLE**  
**S. C. DIGITAL**  
 1240 N. Highland Ave., Suite #4  
 P. D. Box 906, Aurora, Illinois 60507  
 Phone: (312) 897-7749

A F Y T Z X J N Y F O G U O R B D H Q V  
 O X R H S Q L W E K W N A G T Y A Z D Q  
 G I U N R P H X Q W V I X P H U N E Z X  
 R D F C A V G E P N E J T Z A M J D T Y  
 J L N Z B J A G G P P V O L Q Q T I A G  
 B E W X N C P S N A U O R T G X W P L C  
 U T A W O B T C B Z X H V A F A H G G D  
 Z V D U U N Z U R M S K W B D W M U N O  
 D Z L O P R R P T I K Y K U P V F O S Z  
 F Y Z G C A X Y F G D Z H N S G S S W W  
 M H J S Q D S A V H R C P E M L G M Y T  
 X U K V W S B D O U G L Z J L J U F J P  
 Y B M Y D K Q L W O J U N S Y S Z B M J  
 C Q Q B I H D Z S S Y X L F K I E R P R  
 V N S Q J I V Q C L Z E I V X K Y X H H  
 Q W C F V Y K J Z Y B S M K Z P X J V I  
 W A X P M O U K X C N F B R W O R C O B  
 E G H J G G N O D D Q W Q W J D V Y X K  
 I M V D H U Y I L J H T C M O T I W R A  
 T S P E X L E B M V C R J I N Z C N I M  
 H K T R L M W R I Q F P F H C C O V F S  
 N C G I E Z F M K X A Q G C B R L Q K U  
 P R I K T F M F U B M D E X U F Q K B N  
 L O B L Y W I H J T T B Y D V H K T E F  
 K J O M F E C V A R I M S Q E E P A C L  
 S P E A K T O T H E L A D Y I N B L U E

Figure 1: The Bazeries cylinder if it were slit lengthwise and laid flat.

whether disks, tapes, or RAMs, of all the computers in the world would not come close to it; neither would the number of electrons in the universe.

Furthermore, if one 20-character message were enciphered, using each of the possible cylindrical configurations, every 3 seconds, it would take  $2.3 \times 10^9$  centuries to do them all. Clearly, such a cryptographic system provides a great deal of security in sheer numbers alone.

However, the real world of cryptanalysis contains circumstances under which the best of cipher systems might be broken. To do this, an expert cryptanalyst would accumulate as much information about the cipher-system correspondence as possible, including prior plaintext messages. Analysis is also made using various frequency tables. Knowledge about the cipher system is another useful insight. The larger the body of ciphertext, the better the chances it can be deciphered. Two other important factors are doggedness and luck.

No matter how good the cryptanalyst, no matter how much computer power is used, no matter how much time is spent—in some situations the messages cannot be deciphered. Such systems are said to be *unconditionally* secure.

Even if a system is not unconditionally secure, it might still be *effectively* secure. Although such systems might possibly be broken, they usually entail such great expenditures of resources as to make them not worth the effort. Or even if worth the effort, it might require so much time to decipher them that their informational content is no longer of any value. In the seventeenth century, Rossignol put it more succinctly with his Law of Secret Writing: "A secret message must be safe enough so that by the time an enemy gets to solve it, it is too late to be of aid to him."

A Bazeries system is unconditionally secure in most instances over the short run. Even over the longer run, it can be made effectively secure if com-

# Keep your bottom line on the up and up and up.



The future never comes with any guarantees.

But there is a way to improve tomorrow's business performance today.

It's a microcomputer program called the Bottom Line Strategist.™

## The future is now.

With the Strategist and your microcomputer, you can explore *alternative* business decisions and get answers to the questions common to any business focused on growth:

How much money are we risking? Will the business be profitable? When? Is that soon enough? Can we improve this by changing the price? What's the impact of our assumptions on net worth, cash flow, market penetration and growth?

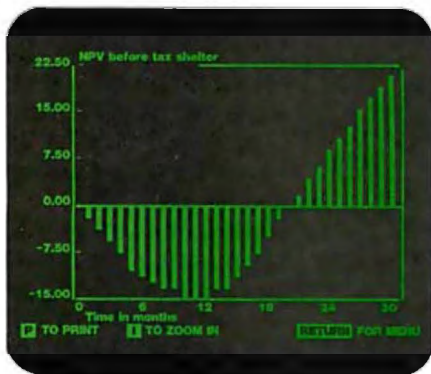
The Strategist uses seven sophisticated econometric models originally developed for companies on the Fortune 500 list.

But it's pre-programmed, so all you do is enter your current business assumptions, then sit back and watch the dynamics of your future unfold graphically.

The Strategist plots (and tabulates) your marketing and sales projections; anticipated cash flows; break-even point; Net Present Value; and more—a total of 11 production, financial and marketing forecasts.

If any area looks interesting, the unique "zoom" takes you in for a closer look at the picture. And if you don't like what you see, do it all over again.

Instantly. Without any programming. And do it as often as you need to get the results that you want.



## Tomorrow's answers today.

The Strategist is a unique short-cut to experience, without the hard knocks.

You can refine your pricing policies. Optimize your cash flows. And maximize your profits while minimizing your risks.

In today's business climate, how much is that worth? The Bottom Line Strategist is \$400.

## Our no risk offer.

You can check out the Bottom Line Strategist with no financial risk.

Drop by a dealer showroom and run through a hands-on demonstration. Then take home a package and use it for 30 days. It runs on 8-bit and 16-bit microcomputers (IBM PC, Apple II, CP/M, etc.) If you don't like it, return it and you'll get your money back.

For the name of your nearest dealer, contact Ashton-Tate at 10150 West Jefferson Boulevard, Culver City, CA 90230.

Better yet, call (213) 204-5570 today. Because if time is money, the Bottom Line Strategist is money in the bank.

**The Bottom Line Strategist™**

ASHTON-TATE ■

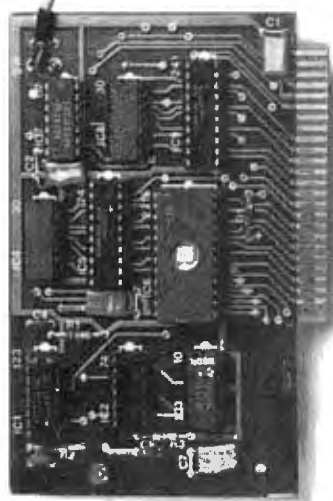
Circle 32 on Inquiry card.

NEW FOR APPLE II AND IIe

# WILDCARD™

New software locking schemes have rendered even the latest generation of copy programs virtually unusable. Locksmith™, Nibbles Away™ and other "Nibble copiers" require complicated parameter settings, much patience and great effort to use. More often than not, the results are disappointing. WILDCARD is different. Rather than copying disks track by track, WILDCARD ignores the disk and any copy protection encrypted on it. Instead, WILDCARD

...takes a snapshot of memory in your Apple® II. Now you can make back-up copies of protected software with the push of a button.



## FEATURES

- Hardware copying device... push button operation.
- Copies 48K memory resident software, most 64K software.
- No programming experience or parameters necessary.
- Backs up DOS 3.2 and DOS 3.3 disks.
- Creates DOS 3.3 unprotected and autobooting disks.
- WILDCARD lives in any slot. Undetectable by software.
- Produces autobooting disk in 2 minutes.
- Copies are DOS 3.3 compatible.
- Copies become accessible for alterations.
- Simple, easy-to-use software included.

WILDCARD *Utility Disk 1* also included, featuring:

- Automatic program compression and BRUN file maker.
- Multiple programs can be placed on the same disk.
- Recreates basic files to load and save.
- Files can be placed on a hard disk...and more.

Software is not copy protected. System requirements: Apple II Plus with 64K and DOS 3.3 or Apple IIe. Franklin Ace also supported.

\*Wildcard does not operate with CP/M\* or other microprocessor based software.

WILDCARD

\$139.95

Order direct from East Side Software Co., 344 E. 63 St., Suite 14-A, New York City 10021, 212-355-2860. Please include \$3.00 for shipping and handling. Orders outside continental U.S. please add \$10.00 for shipping and handling. Mail and phone orders may be charged to MasterCard and VISA. N.Y. State residents add sales tax. Dealer inquiries welcome.

**IMPORTANT NOTICE:** The WILDCARD is offered for the purpose of enabling you to make archival copies only. Under the Copyright Law you, as the owner of a copy of a computer program, are entitled to make a new copy for archival purposes only and the WILDCARD will enable you to do so. The WILDCARD is offered for no other purpose and you are not permitted to utilize it for any other use, other than that specified.

Apple and the Apple logo are registered trademarks of Apple Computer, Inc.—CP/M—trademark of Digital Research, Inc. Locksmith—trademark of Omega Microwave, Inc. Nibbles Away—trademark of Computer: applicatic

## Challenge to the Reader

### Challenge #1

To illustrate the security of the ciphertext produced by the Bazeries cylinder, the reader is invited to try to decipher the text below. To make it feasible, the text is enciphered using the program in listing 1 without any changes in the DATA statements. The use of the correct key when running this program will decipher the text.

A check for \$10 for a bottle of French wine will be sent to the person who sends the correct plaintext with the earliest postmark. Address correspondence to R. F. Prisco, RD #7 Edgebrook, Oswego, NY 13126.

```
OSUZKMTKLZYFYVTMDHKTQWWIBDMZJA
NZNTWDBVBHWGPDDHBPZCRJMDSWNZTH
FPBOVMVERUATTHCIYLNXYSDOYZKXU
YPSWBUHZXJKRYVYHANNQZVLMCRHIJ
VBZOIHVCEFP MCCOPISGXMBLCZMCTO
XTWDGYECVUUWYIQQFYHWMZPKAUURT
KSNZOCSSDZJBPMNDBPPWSCFFBLADXX
DPHOADEEBAGKNBGLLENDJBAZMOJUDO
```

### Challenge #2

A much more secure ciphertext is offered below. It is also enciphered by the program in listing 1. However, in this case, a completely new set of DATA statements are used, making the text effectively secure. No reward is specified for the corresponding plaintext in this case because it is anticipated that there will not be any need for one.

```
OJJPJMPUDAHDJXTUXNJUEDLGYQSIL
NUOESXFHUXJGODFBOTA OJZDLFHNNYC
KSJIXIKRUJECXGZBIQXMYFJIXUJMMQ
GZLYJOIMRMIMFSLTNAEHGBYUCODERP
QPEOIFYGZSABINADRSE RUXURAQJAWQ
MRBEWKKS YKCTELIXFSHMUZRFVOSAKU
JOB NBEGVTAGYHZKAUQXGGXZAXQHJKJG
RFHSCKCRWLJFXLZEFGLQND DDTSBIP
```

mon techniques of security are used. These techniques include frequent changes of the key and the set of disks.

For historical reasons, 26/20 Bazeries systems, consisting of 26-character disks and 20-disk cylinders, have been used as examples. With the computer power of today, however, 64/64 Bazeries systems are feasible. Such systems are much more secure than those previously discussed. In fact, a one-shot 64/64 Bazeries system could be used to send a 4032-character message with unconditional security as opposed to 500 characters for a 26/20 system. In addition, 64-character disks would be capable of including

numerals, punctuation marks, spaces, and control characters.

### Program Description

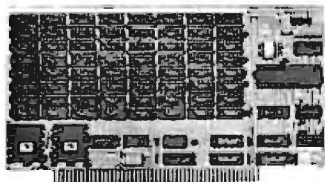
Listing 1 is a faithful simulation of the historic 26/20 Bazeries cylinder. (A run of this program is shown in listing 2.) Care has been taken to document it with the foregoing terminology.

It is written in the most commonly used dialect of BASIC. The only function that might not be allowed in some of the other common BASICs appears in line 1460. The instr function INSTR(*n*,A\$,B\$) returns the first position of the string B\$ in the string A\$ beyond the (*n*-1)st character of A\$. This function can be re-

placed by a loop in those BASICs that do not have it.

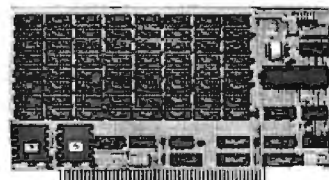
The program also uses specific rows of the cylinder when transforming text. The first row used is specified by the first character in the key (lines 1140 and 1390). Subsequent rows are used in cyclical numerical order where the direction depends on whether the text is to be enciphered or deciphered (line 1510).

The simple bubble sort (lines 1210-1320), which is used to load the cylinder as specified by the key, is not very fast but does load the cylinder as described above. The Shell-Metzner sort, although faster, is not consistent when the key contains several instances of the same character.



## Worldwide Computer Solutions

We sell SemiDisk  
for S-100 IBM PC,  
TRS-80 Mod. 2, Kaypro II,  
Osborne, Xerox 820 & Heath H-89



Computing has entered a new era: The SemiDisk era! No longer are you tied down by the speed of floppies or winchesters. Your computer can operate many times faster with a SemiDisk. And with our self installing software it couldn't be easier. Just plug in and hold on! No kidding! Special pricing: From \$995 to \$1595 for 512K Byte and \$2195 for 1 meg Byte.

Specifications:

TYPE: Semiconductor Disk Emulator—for Z80, 8080 (optional 8586)  
CAPACITY: 512K or 1Mb  
POWER REQUIREMENTS: 0.6A (512K) 0.9A (1Mb)  
BATTERY BACKUP: 10-12V Unreg. (optional)  
RAM available (500 piece min.) Call

**Dealers Wanted**

For information contact:  
Computer Solutions Worldwide  
Robert Pinkham  
P.O. Box 931  
Hillsboro, OR 97123  
(503) 640-5665

# CompuPro

SYSTEMS CENTER

- SYSTEM 8/16A \$4395.
- SYSTEM 8/168 \$5245.
- SYSTEM 8/16C \$6745.
- \* FULLY ASSEMBLED AND TESTED \*
- Lease-Purchase/Maintenance Avail.

## MORROW DESIGNS

- MICRODECISION 2** CALL
- with/Microsoft Basic, Basic, wordstar 3.0, Logical, Correct-it speller, Personal Pearl Data base manager, CP/M PILOT

**Cromemco** C-10 \$1525

**EAGLE II** \$2339

### PERIPHERALS — BOARDS:

- LIBERTY FREEDOM 100** CALL  
(emulates Televideo 925)
- PARA DYNAMICS** MAINFRAMES CALL
- VOTRAX** SPEECH SYSTEM \$ 275
- SSM** TRANSMODEM 1200 \$ 519  
(HAYES COMPATIBLE)
- CCS** ZBOCPU \$ 239
- FULCRUM** 64K Static Ram Bank Select/Ext. Address \$ 395
- SCION** Micro Angelo MA520 \$ 965

### PC MATE **TECMAR**

1st MATE 64K + Serial + \$295

- SO SYSTEMS** 3 BO SET w/1 yr warranty:
- SBC 200 W/MONITOR PROM
- VERSAFLOPPY II w/CP/M3.0
- 256 K EXPANDORAM III \$1295.00

- NOVATION J-CAT** \$125.00
- ADDS** VIEWPOINT 3A+ \$485.00
- TALLY** MT160L PRINTER \$775.00
- TARBELL** DO CONTROLLER \$396.00

### FLOPPY DISK DRIVES

**Tandon** 100-2 \$245.00

**Qume** 842 \$445.00

### FULL DEALER SUPPORT VISIT OUR SHOWROOM

Hrs. 9:00 A.M.-5:30 P.M. M-F

Subject to Available Quantities

Prices Quoted Include Cash Discounts

Shipping & Insurance Extra



14425 North 79th Street, Suite B  
Scottsdale, Arizona 85260  
TELEX 165025  
TECHNICAL 602-991-7870  
SALES 800-528-3138

### Extensions

As noted earlier, a 26-character disk is equivalent to a 26-cycle substitution cipher on 26 characters. Such ciphers contain only 1/26 of the substitution ciphers on 26 characters. For example, such ciphers do not include any that substitute B for A, C for B, and A for C. With virtually no additional overhead, general substitution ciphers can be used in place of the disk substitution ciphers.

If the disk ciphers are retained, the method of choosing the rows for the transformation of text could be specified by some permutation contained

in a DATA statement or key. Patterns should be avoided for added security.

Finally, routines for mass-storage devices can be added to buffer extensive amounts of text for future processing. ■

### About the Author

Rinaldo Prisco is an associate professor of mathematics at the State University of New York, College at Oswego. His interests include combinatorial group theory, discrete mathematics, and mathematical applications to computing. He has written several articles on microcomputing and is currently working on a mathematics text for computer programmers.

Listing 1: This program is a simulation of the 26/20 Bazeries cylinder.

```

1000 '      BAZERIES CRYPTOSYSTEM
1010 '
1020 '      Copyright (c) 8/1/81
1030 '
1040 '      Rinaldo F. Prisco
1050 '      Department of Mathematics
1060 '      SUNY at Oswego
1070 '      Oswego, NY 13126
1080 '
1090 CLEAR 1500
1100 DEFINT I,J,F,L,R,P,K,N
1110 DIM D$(20),P(20)
1120 FOR I=1 TO 20:READ D$(I):NEXT I
1130 PRINT "ENTER KEY: ";:LINE INPUT K$
1140 K=ASC(K$)
1150 ' ELIMINATE SPACES IF ANY
1160 S$=K$:GOSUB 1700 :K$=S$:PRINT
1170 ' RESTRICT KEY TO LENGTH <= 20
1180 IF LEN(K$)>20 THEN K$=LEFT$(K$,20)
1190 ' USE SORT ON KEY TO PERMUTE DISKS
1200 PRINT "Loading cylinder, ready shortly ..."
1210 FOR J=LEN(K$)-1 TO 2 STEP -1
1220   F=0
1230   FOR I=1 TO J
1240     L=I+1
1250     IF MID$(K$,I,1)<=MID$(K$,L,1) THEN 1300
1260     T$=MID$(K$,I,1):MID$(K$,I,1)=MID$(K$,L,1)
1270     MID$(K$,L,1)=T$
1280     T$=D$(I):D$(I)=D$(L):D$(L)=T$
1290     F=1
1300   NEXT I
1310   IF F=0 THEN 1330
1320 NEXT J
1330 ' CYLINDER IS NOW LOADED
1340 PRINT
1350 PRINT "ENTER TEXT: ";:LINE INPUT T$
1360 PRINT
1370 INPUT "<E>ncode or <D>ecode";Y$:Y$=Y$+" "
1380 IF LEFT$(Y$,1)="D" THEN F=1 ELSE F=0
1390 N=K-65
1400 ' ELIMINATE SPACES FROM T$
1410 S$=T$:GOSUB 1700 :T$=S$:PRINT:PRINT T$
1420 ' PROCESS AT MOST 20 CHARACTERS AT A TIME
1430 L=LEN(T$):IF L>20 THEN L=20
1440 ' ORIENT THE DISKS TO THE TEXT
1450 FOR I=1 TO L
1460   P(I)=INSTR(1,D$(I),MID$(T$,I,1))
1470 NEXT I
1480 ' SET R TO PROPER ROW NUMBER
1490 N=N+1:R=N-20*INT(N/20)
1500 IF R=0 THEN R=1
1510 IF F=1 THEN R=26-R
    
```

Listing 1 continued on page 360



# Disk Storage Needn't Double The Cost Of Your Apple III\*™



Expanding disk storage on your Apple III\*™ can be an expensive proposition.

But Micro-Sci has a better proposition for you, because our disk drives for the Apple III give you greater capacity and performance for every dollar spent.

And no compatibility problems. The A3 is a direct replacement for Disk III drives, and the 70-track A73 and 140-track A143 are supplied with a driver that is easily added to the SOS driver module, affording extra storage and fast seek rates for all of the programs that run under that operating system.

All three are the same 5 1/4" size as your built-in drive and use the same diskettes.

They also use your Apple III's controller and



power, saving an expansion slot and no AC power cord. And they can be mixed in any combination on the daisy-chain. At 572 KBytes, the A143 makes a truly viable backup device for the ProFile Hard Disk.

At 286 KBytes, the A73 gives you a lot more capacity than a Disk III drive.

The A3 offers identical capacity — and is an excellent choice for second drive compatibility in the Apple II emulation mode.

So see your Micro-Sci dealer today.

He'll show you how to up your Apple III's performance the affordable way.

**μ-SCI**

**MICRO-SCI**

Micro-Sci is a Division of Standun Controls, Inc.

2158 SOUTH HATHAWAY STREET • SANTA ANA, CALIFORNIA 92705 • 714/662-2801 • TELEX: 910-346-6739  
International Dealer Inquiries.... IMC International Markets Corp. Telephone: 714/730-0963 • Telex: 277782-ROBY UR

Circle 253 on inquiry card.

\*Registered Trademark of Apple Computers, Cupertino, California.

CALL TOLL FREE

**1-800-421-3135**  
**WAREHOUSE SOFTWARE**

**WE WILL TRY TO MEET OR BEAT  
 ANY LEGITIMATE ADVERTISED PRICE  
 FOR CP/M OR IBM PC SOFTWARE**

**MOST DISK FORMATS AVAILABLE—**  
 Program Names Prefaced With "#" Avail-  
 able For IBM PC

**DATA BASE MANAGEMENT SYSTEMS.**

**BUY OF THE YEAR!**

**DBASEII+EVERYMAN'S DATA BASE  
 PRIMER+EXTRA DISKETTE WITH DBASE  
 ACCOUNTING, MAIL LIST AND INVEN-  
 TORY PROGRAMS. IBM PC AND CP/M—  
 CALL FOR OUR SPECIAL PRICE.**

#Condor II ..... **\$475**  
 #NWA Statpack ..... **\$350**  
 #TIM ..... **\$350**  
 #Infostar ..... **Call**

**WORD-PROCESSING PACKAGES**

#Wordstar, Mail Merge, Spellstar ..... **\$445**  
 #Wordstar ..... **\$265**  
 #Mail Merge ..... **\$125**  
 #Wordstar, Mail Merge ..... **\$345**  
 #Spell Star ..... **\$145**  
 #Lexisoft Spellbinder ..... **\$270**  
 #Aspen Spellchecker ..... **\$36**  
 #Metasoft Benchmark ..... **\$285**  
 IBM PC Volkswriter ..... **\$145**  
 #Sorcim Spellguard ..... **\$135**

Peachtree Magic Wand, Spell  
 Check, Mail List ..... **\$325**

**SPREADSHEETS**

#Calcstar ..... **\$95**  
 #Supercalc ..... **\$185**  
 #Microsoft Multiplan ..... **\$185**

**ACCOUNTING**

#TCS Equivalent Of Peachtree Specially  
 Augmented By Warehouse Software Cus-  
 tomized For Your IBM Terminal And Printer-  
 GL, AR, PA, AP ..... Each Module **\$75**  
 For All Four **\$275**

#TCS Total Accounting ..... **Call**  
 #CYMA ..... **Call**  
 #Peachtree GL, AR, AP ..... **\$375**  
 Sail CP/M For North Star ..... **\$150**

**LANGUAGES**

C-Basic ..... **\$99**  
 CB-80 ..... **\$395**  
 Microsoft Basic 80 ..... **\$250**  
 Microsoft Basic Compiler ..... **\$315**

**TRANSFER PROGRAMS**

Move-It ..... **\$95**  
 IBM PC Move-It ..... **\$110**

**FOR THE IBM PC**

Five Function Board—Includes Async Adapt-  
 er, Parallel Adapter, Clock With Battery  
 Back-Up And Software, Game Port, 64K  
 Memory Expandable To 512K. 1 year  
 warranty ..... **Call**

Floppy Disk Controller ..... **\$235**  
 Tandon 100-2 Drives ..... **Call**  
 256K Ram Board W/Async Port ..... **\$365**  
 Hayes Smart-Modem 300B ..... **\$210**  
 Hayes Smart-Modem 1200B ..... **\$525**  
 Hayes Smartcom Program ..... **\$49**

**PC DOS**

PCII Copy Program ..... **\$34**  
 Datamost Write-On ..... **\$94**  
 Real Estate Investment Prog. .... **\$94**  
 Microsoft Flight Simulator ..... **\$38**  
 Howard Real Estate Analyzer II ..... **\$185**

**IBM CP/M-86**

CBasic86 ..... **\$145**  
 CIS Cobol86 ..... **\$595**  
 Pascal MT+86 W/Spp ..... **\$450**

TERMS: Prices include 3% cash discount. Add 3%  
 for charge orders. Shipping on most items  
 \$5.00. AZ orders + 5% sales tax.

**WAREHOUSE SOFTWARE**

4935 West Glendale Ave., Suite 12  
 Glendale AZ. 85301

(802) 842-1133 Technical Information  
 1-800-421-3135 Toll Free Order Line



Listing 1 continued:

```

1520 ' SET POINTERS TO ROW R
1530 FOR I=1 TO L
1540 P(I)=P(I)+R
1550 IF P(I)>26 THEN P(I)=P(I)-26
1560 NEXT I
1570 ' PRINT NEW TEXT
1580 FOR I=1 TO L
1590 PRINT MID$(D$(I),P(I),1);
1600 NEXT I
1610 ' IS THERE ANY MORE TEXT TO PROCESS?
1620 IF L=LEN(T$) THEN 1640
1630 T$=RIGHT$(T$,LEN(T$)-L):GOTO 1430
1640 PRINT
1650 PRINT
1660 INPUT "FURTHER TEXT";Y$:Y$=Y$+" "
1670 PRINT
1680 IF LEFT$(Y$,1)="Y" THEN 1350
1690 END
1700 ' REMOVES BLANKS FROM S$
1710 S$=" "+S$
1720 FOR I=2 TO LEN(S$)-2
1730 IF MID$(S$,I,1)<>" " THEN 1750
1740 S$=MID$(S$,1,I-1)+RIGHT$(S$,LEN(S$)-I)
1750 NEXT I
1760 S$=RIGHT$(S$,LEN(S$)-1)
1770 RETURN
1780 DATA FNWADLZJKMQSCXHVPTGIBOEYRU
1790 DATA ETXQPVJCBNRADSKHIYOGULMZFV
1800 DATA LEVQXYGCDOZWPJRHIBKAMSUNF
1810 DATA XYCVQWEITHNPLKSAOGRJBUZDFM
1820 DATA ODTZCRFHENBYUMQXAWVGLJSIKP
1830 DATA VKUNYEWFMICOJLHGAPTZRXSVD
1840 DATA JPHVOXRIFKBECUQDZTALGNSWY
1850 DATA RGJYZBNQHCFAAMILLOWVEPUXSKD
1860 DATA ZQJKOIBRMFHVNTNWXEGSCUPYADL
1870 DATA UAXTORVWKHPZNLIMVQCJFGEYS
1880 DATA MGHXLETYFKZSRABNOUPCQWDIJV
1890 DATA PGNBRTFVOWSCZXDLMIKUJAHYEQ
1900 DATA ZEDIPGUOSMFBRXJCYWNVQKTALH
1910 DATA FDPMSLYKXZJONCUBUVEIRTHAQQ
1920 DATA MIGHUOSLYCDJVQXBTRFEKWNPAZ
1930 DATA GPZLTABUNESJFVKRWMLHCXDQYO
1940 DATA XIDLETVZYHUBQNWAGMSKROJPF
1950 DATA WHMFSGUZYFYXRVICOLQKPB DANJT
1960 DATA IKLMATHNCZXWUOGSVYBQFPJDER
1970 DATA JVOHKY?ZCLUXESFWTRPQDBMAGNI
Ok
  
```

Listing 2: A run of the program in listing 1.

```

RUN
ENTER KEY: BEWARE THE IDES OF MARCH

Loading cylinder, ready shortly ...

ENTER TEXT: ANTICIPATE MERGER IN TWO WEEKS STOP PURCHASE SHARES

<E>ncode or <D>ecode? E

ANTICIPATEMERGERINTWOWEEKSSTOPPURCHASESHARES
GAILWOZLVKIFWZRHOQLPJMUKRIDXCMSKQGGZPJJKJFFQ

FURTHER TEXT? Y

ENTER TEXT: GAILWOZLVKIFWZRHOQLPJMUKRIDXCMSWKQGGZPJJKJFFQ

<E>ncode or <D>ecode? D

GAILWOZLVKIFWZRHOQLPJMUKRIDXCMSWKQGGZPJJKJFFQ
ANTICIPATEMERGERINTWOWEEKSSTOPPURCHASESHARES

FURTHER TEXT? N

Ok
  
```

# COMPUTER WAREHOUSE

CALL TOLL FREE **1-800-528-1054**

## ATARI

**Special 800 System**  
800 w/48K, recorder, Pac Man or  
Star Raiders, joysticks ..... **Call**

1200 ..... **Call**  
800 (48K) ..... **Call**  
400 ..... **\$225**  
810 Disk Drive ..... **\$440**  
850 Interface ..... **\$170**  
410 Recorder ..... **\$75**  
830 Modem ..... **\$155**

## COMMODORE

64 ..... **\$395**

## AXLON

Rampower 48 for Atari ..... **\$140**  
Rampower 128 for Atari ..... **\$355**  
Ramdisk 128 for Apple ..... **\$355**  
Ramdisk 320 for Apple ..... **\$1035**  
Data Link ..... **\$300**

## PRINTERS

**Anadex**  
9620A ..... **\$1445**

**C-Itch**  
F-10-Parallel ..... **\$1165**  
F-10-Serial ..... **\$1165**  
55 CPS-Series ..... **Call**  
8510 Parallel (Prowriter) ..... **Call**

**Computer International**  
Daisywriter 2000 w/16K ..... **Call**  
Daisywriter 2000 w/48K ..... **Call**

**Comrex**  
CR-1-S ..... **\$675**  
CR-1-P ..... **\$770**

**Datasouth**  
DS 180 ..... **\$1170**

**Diablo**  
620 RO wo/Tractors ..... **\$920**  
630 RO wo/Tractors ..... **\$1730**

**IDS**  
Microprism 480 ..... **\$515**

**Epson**  
All models ..... **Call**

**NEC**  
PC-8023A ..... **\$399**  
3510 ..... **\$1375**  
3550 ..... **\$1835**  
7710 ..... **\$2050**  
7720 ..... **\$2425**  
2050 ..... **Call**

**Okidata**  
All models ..... **Call**

**Smith-Corona**  
TP-1 ..... **\$650**

**Star Micronics**  
Gemini-10 ..... **Call**  
Gemini-15 ..... **Call**

**Tally**  
1805/1802 ..... **\$1455**  
MT 160I w/Tractors ..... **Call**  
MT 160L w/Tractors ..... **Call**  
MT 180 ..... **Call**

**Texas Instruments**  
810 Basic ..... **\$1260**  
850 ..... **\$650**

**Toshiba**  
P1350 ..... **\$1475**

## SPECIAL OF THE MONTH

**TS-802.....\$2525**

## DISK DRIVES

**Percom**  
Atari S/S S/D 1st Drive ..... **\$400**  
Atari S/S S/D 2nd Drive ..... **\$300**  
Atari S/S D/D 1st Drive ..... **\$525**  
Atari S/S D/D 2nd Drive ..... **\$330**

**Rana (Drives for Apple)**  
Elite 1 ..... **\$265**  
Elite 2 ..... **\$420**  
Elite 3 ..... **\$550**  
Controller (w/Drive only) ..... **\$75**  
1000 (For Atari) ..... **Call**

## MONITORS

**Zenith**  
12" Green Screen ..... **\$95**

**Amdex**  
Video 300 ..... **\$130**  
Video 300A ..... **\$145**  
Color I ..... **\$270**  
Color I Plus ..... **\$310**  
Color II ..... **\$450**  
Color III ..... **\$360**

**BMC**  
12" Green ..... **\$85**  
13" Color ..... **\$265**

**Comrex**  
13" Color Composite ..... **\$290**  
13" RGB ..... **\$455**

**NEC**  
JB 1201 ..... **\$155**  
JB 1260 ..... **\$115**

**Taxan**  
12" Amber ..... **\$125**

**USI**  
9" Amber ..... **\$130**  
12" Amber ..... **\$150**

## MODEMS

**Hayes**  
Smartmodem ..... **\$210**  
Smartmodem 1200 ..... **\$499**

**Novation**  
CAT ..... **\$140**  
D-CAT ..... **\$155**  
J-CAT ..... **\$110**

## VIDEO TERMINALS

**Qume**  
QVT 102 Green ..... **\$550**  
QVT 102 Amber ..... **\$560**

**Televideo**  
910 ..... **\$570**  
910 Plus ..... **\$570**  
920 ..... **\$735**  
925 ..... **\$730**  
950 ..... **\$915**  
970 ..... **\$1100**

**Wyse**  
Wyse 100 ..... **\$695**  
Wyse 300 ..... **\$1030**

**Zenith**  
Z-19 ..... **\$670**  
Z-29 ..... **\$640**  
ZT-1 Keyboard Only ..... **\$350**

## COMPUTERS

**Altos**  
ACS 8000-15 ..... **\$3550**  
Series 15D ..... **\$2125**  
Series 5-5D ..... **\$3900**  
580-10 ..... **Call**  
Eagle II ..... **\$2330**

**Northstar**  
Advantage ..... **\$1955**  
Advantage w/5MB ..... **\$3380**  
Horizon II 64K QD ..... **\$2625**

**Sanyo**  
MBC-1000 w/Micropro Software,  
S-Basic, CPM® ..... **Call**  
Above w/2 Drives ..... **Call**

**Syscom II 64K**  
Syscom II is an Apple  
look-alike with upper  
and lower case ..... **\$550**

**Televideo Systems**  
TS-802 ..... **\$2525**  
TS-802H ..... **\$4450**  
TS-803 ..... **Call**

**Zenith**  
Z-120 ..... **\$3100**  
Z-110 ..... **\$3025**

## DISKETTES

**Maxell**  
MD-1 (Qty. 100) ..... **\$250**

**Scotch**  
744-0 (Qty. 100) ..... **\$225**

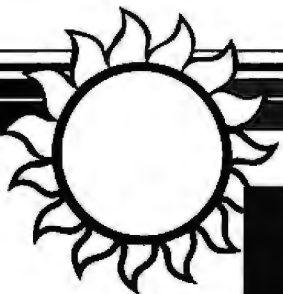
**Elephant**  
S/S S/D (Qty 100) ..... **\$180**

2222 E. Indian School Rd.  
Phoenix, Arizona 85016



Order Line: 1-800-528-1054 Other Information: 602-954-6109  
Order Line Hours: Mon.-Fri. 10-5 MST Saturday 9-1 MST

Prices reflect 3% to 5% cash discount. Product shipped in factory cartons with manufacturer's warranty. Please add \$8.00 per order for shipping. Prices & availability subject to change without notice. Send cashier's check or money order...all other checks will delay shipping two weeks. 6/83



# June Savings are bustin' out all over!



And we back every one with (1) expert technical advice, (2) fast response on orders, (3) in-house service repairs, (4) guaranteed satisfaction.



## COLOR MONITOR SPECIALS



### BMC 9191AU

13" Color Composite with Sound.  
350 x 350 lines. List \$429, NOW—  
**\$299<sup>00</sup>**

### USI 1400/C

14" Color Composite,  
260x300 lines. List \$399 NOW—  
**\$299<sup>00</sup>**

### BMC 9191MU

13" RGB Color Monitor, 640-line  
resolution (IBM only) with IBM  
Cable. List \$799, ..... NOW—  
**\$599<sup>00</sup>**

### PGS HX-12

12" RGB Color Monitor, 690 dots  
horizontal resolution for IBM PC.  
List \$795 ..... NOW—  
**\$675<sup>00</sup>**

## MONITORS

### ELECTROHOME

13" RGB . . . . .339.00  
13" Hi Res. RGB . . . . .589.00  
Apple II Interface . . . . .199.00

### TAXAN

KG 12N-12" Green . . . . .CALL  
KA 12N-12" Amber . . . . .CALL  
RGB Vision I-12" RGB . . . . .CALL  
RGB Vision III-12" RGB . . . . .CALL  
RGB Apple IIe Card . . . . .CALL  
RGB II Apple II Card with  
Text Color . . . . .CALL

### SANYO

9" Hi Res. Green . . . . .159.00  
12" Green Screen . . . . .135.00  
12" Hi Res. Green . . . . .209.00  
13" Color . . . . .419.00  
13" Hi Res. Color . . . . .899.00

### U.S.I.

9" Green Screen . . . . .119.00  
9" Amber Screen . . . . .155.00  
12" Green Screen . . . . .155.00  
12" Amber Screen . . . . .175.00  
Color Composite . . . . .335.00

## MODEMS

### HAYES

Micromodem II (Apple II) . . . . .289.00  
Micromodem II With Terminal  
Program . . . . .315.00  
Micromodem 100 (S-100) . . . . .339.00  
Smartmodem 1200 Baud . . . . .599.00  
Chronograph (RS-232) . . . . .195.00  
Terminal Program . . . . .75.00

### NOVATION

CAT (Acoustic) . . . . .145.00  
J-CAT . . . . .139.00  
Smart CAT 103 . . . . .205.00  
Smart CAT 103/212 . . . . .499.00  
Apple CAT II . . . . .299.00  
212 Apple CAT . . . . .609.00  
Expansion Module . . . . .35.00

## FURNITURE

### AMERICAN INNOVATIONS

Computer Stand . . . . .65.00  
Monitor Stand . . . . .25.00  
Printer Stand . . . . .40.00  
Super Printer Stand . . . . .75.00

### BMC

Monitor Stand . . . . .25.00

### GUSDORF

Printer Table . . . . .120.00  
Hutch . . . . .149.00  
Desk . . . . .205.00  
Expander 413S . . . . .49.00  
Expander 414S . . . . .75.00

Many items are not listed. Please call our 800 number if you don't see what you're looking for.

CALL FOR OUR FREE CATALOG!



## APPLE HARDWARE

ALS Z Card	235.00	Microtek Magnum 80—Column Card	209.00
ALS CP/M Card	379.00	Mountain Computer Romwriter	145.00
ALS CP/M Card with SuperCalc	595.00	Mountain Computer Ramplus (32K)	179.00
Apple II Plus	CALL	MPC Serial Printer Card	89.00
CCS IEEE Card	175.00	M & R Super Fan	40.00
CCS Analog/Digital Card	105.00	Nikrom Master Diagnostics	45.00
Computer Peripherals		Nikrom Master Diagnostics Plus	65.00
Octopus 16K Buffer	165.00	Novation Apple Cat	299.00
CPS Multifunction Card	179.00	Novation Expansion Module	35.00
Echo II Speech Synthesizer	125.00	Novation J-Cat	119.00
EPD AC Surge Protector	49.00	Novation Handset	27.00
EPD EMI-RFI Filter	39.00	Numeric Key Pad	150.00
Expandaport-6 Ports With Speaker	55.00	Paymar Lower Case Adapters:	
Hayes Micromodem II	299.00	Old (Rev. 1-6)	29.00
Microbuffer II 16K	219.00	New (Rev. 7)	19.00
Microbuffer II 32K	245.00	PCPI Z80A Appli-card, 4MHz	249.00
Microsoft Z80 Softcard with CP/M	265.00	PCPI Z80B Appli-card 6MHz	319.00
Microtek 16K Ram Card	79.00	PCPI Appli-card 4MHz, 64K RAM Extender,	
Microtek Parallel Printer Card	69.00	Appli-disc Software	335.00

Palomar features a complete selection of Apple and IBM Software. Call for details.

## IBM HARDWARE

Computer Peripherals 64K Ram	199.00	M & R SuperMod/5	59.00
Computer Peripherals 128K Ram	375.00	Micro Buffer In Line, (32K)	259.00
Computer Peripherals I/O Printer Interface (4 Ports)	159.00	Micro Buffer In Line (64K)	295.00
Computer Peripherals 64 I/O Memory Card	295.00	Micro Buffer In Line 64K Module	150.00
Computer Peripherals Octopus Printer Buffer	165.00	MPI 320K Drive	299.00
Computer Peripherals 64K Memory Card	199.00	PGS Hi-Res RGB 12" Monitor	759.00
Computer Peripherals 128K Memory Card	375.00	PMC Disk Drive	199.00
Computer Peripherals 192K Memory Card	499.00	Quadram 64K Quad Board	395.00
Computer Peripherals 256K Memory Card	635.00	Quadram 256K Quad Board	595.00
Computer Peripherals 64K Ram Kit, 9 chips	119.00	Super 5 Disk Drive, Thin-line, Bare (DS, DD)	289.00
Tech Adam & Eve Paddles	29.00	Raytronics RAM Plus Quad Board 64K	389.00
		Raytronics RAM Plus Quad Board 128K	455.00
		Raytronics RAM Plus Quad Board 192K	525.00
		Raytronics RAM Plus Quad Board 256K	589.00

## PRINTERS

<b>BMC</b>		<b>NOVELL</b>	
BM/PB101 Daisywheel, Parallel	825.00	Image 800	999.00
<b>FACIT</b>		<b>OLYMPIA</b>	
4510	635.00	COMPACT Serial Interface	849.00
<b>COMPUTER PERIPHERALS</b>		ES 100 KRO	949.00
Thermal Printer, 40 column/160 CPS	125.00	ES 100	699.00
<b>EPSON</b>		Serial/Parallel Interface	250.00
Microbuffer-16K Parallel	139.00	CCS Apple Serial Card	135.00
Microbuffer-8K Serial	139.00	<b>STAR MICRONICS</b>	
<b>SMITH CORONA</b>		Gemini 10	CALL
TP-1	599.00	Gemini 15	CALL
<b>TEC</b>		Thermal Printer	CALL
PMC 8510 Parallel	465.00	<b>OKIDATA</b>	
PMC 8510 Serial	585.00	Microline 82-A	489.00
ITOH 8510-A Parallel	469.00	Microline 83-A	689.00
ITOH 8510-A Serial	619.00	Microline 84-S	1199.00
ITOH 1550 Parallel	750.00	Microline 84-P	1059.00
ITOH 1550 Serial	789.00	Microline 92-P	549.00
ITOH F-10-40	1395.00	Microline 92 2K Serial interface	139.00
ITOH F-10-55	1795.00	Microline 93-P	949.00
		Microline 93 2K Serial Interface	139.00
		2K Parallel interface	129.00
		Forms Tractor (82-A)	55.00

## PERSONAL COMPUTERS

### OSBORNE

Osborne I Portable, Includes S200	
Extras	1795.00
With Double Density Drives	1995.00

### SANYO

MB1000	1795.00
--------	---------

### TELEVIDEO

TS 802	3119.00
TS 806	5735.00
TS 816	10365.00

### XEROX

820 with CP/M, Wordstar	1995.00
-------------------------	---------

### ALTOS

ACS 8000-2	3199.00
ACS 8000-15	4399.00

### APPLE

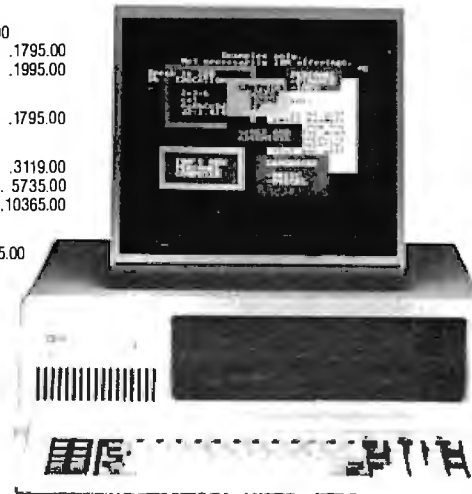
Apple II Plus	CALL
Disk II D.O.S. 3	CALL
Disk II	CALL

### BASIS

108-0003 (64K)	CALL
108-0004 (128K)	CALL

### MORROW

Micro Decision with 1 Drive (SS)	CALL
Micro Decision with Terminal & 1 Drive (SS)	CALL
Micro Decision with 2 Drives (SS)	CALL



### FRANKLIN

ACE 1000 (64K)	CALL
ACE 10, Disk Drive	CALL

## DISK DRIVES

Corona 5MB Winchester	CALL	Rana Controller	109.00
Corona 10MB Winchester	CALL	Super 5 for Apple II, SS Thin-line (TEAC)	275.00
Disk II With Controller Card	CALL	Super 5 for Apple II, SS Thin-line (ALPS)	249.00
Media Distributing 11 Mb Winchester Subsystem	2595.00	Super 5W for Apple II, DS Thin-line	405.00
Media Distributing 22 Mb Winchester Subsystem	3495.00	Super 5 for IBM, DS/DD Thin-line, Bare	289.00
Media Distributing 44 Mb Winchester Subsystem	4270.00	Super 5 Controller card for Apple II, SS	59.00
Microsci A35 With Controller Card	375.00	Super 5 Controller card for Apple II, DS	69.00
Microsci Controller Card	99.00		
Rana Disk Drive	319.00		



Palomar makes buying easy ...



# ORDER TOLL-FREE! Call 800-237-3333

In California call 800-338-5555

Telex 697120-150

Hours: Monday-Friday, 7:30 a.m.-6:30 p.m. (PST)

Saturday, 9:00 a.m.-2 p.m. (PST)

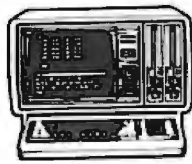
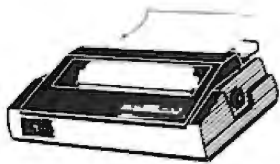
TERMS OF SALE: Cash, Check, money order, bank wire transfer, credit card, or purchase orders from qualified firms and institutions. Please include telephone number with order and expiration date on credit card orders. California residents add 6% sales tax. Advertised prices are for prepaid orders F.O.B. shipping point. Add 3% or \$3.00 minimum for shipping in the U.S. Pricing and availability subject to change without notice. Address written orders to:

910-105 W. San Marcos Blvd., San Marcos, CA 92069  
Telephone (619) 744-7314

# PALOMAR

## COMPUTER PRODUCTS

# RadioShack TRS-80's Full Line



**YOU CAN SAVE** money when you buy Radio Shack TRS-80 Computers from **Pan American Electronics**. Pan American Electronics went into business in 1976 and led the way in bringing consumers original Radio Shack TRS-80 Computers at reduced prices. **NO** other company has done it longer. **NO** other company has done it better and **NO** other company sells them for less.

## Pan American Electronics

**TOLL FREE NUMBER 800/531-7466**

1117 Conway Avenue • Department B  
Mission, Texas 78572  
Phone: 512/581-2766  
Telex Number 767339

TM — Trademark of Tandy Corporation

For Quality And Reliability  
Buy



Or

### VERBATIM DATALIFE

5 1/4" Mini Diskettes with Reinforced Hub Ring  
From

**NEW TECH ASSOCIATES, INC.**

Call **FREE**

**1-800-341-1144**

In PA Call Collect 215-446-0773



ACCEPTED

#### PRICES

**SINGLE SIDED DOUBLE DENSITY SOFT SECTOR**  
**5 1/4" MINI DISKETTE WITH REINFORCED HUB RING**  
**3M-744D-O VERBATIM DATALIFE MD 525-01**

10-40 ea. **2.39** ea. 10-40 ea. **2.90** ea.  
50 + **2.09** ea. 50 + **2.59** ea.

**DOUBLE SIDED DOUBLE DENSITY SOFT SECTOR**  
**5 1/4" MINI DISKETTE WITH REINFORCED HUB RING**  
**3M-745-0 VERBATIM DATALIFE MD 550-01**

10-40 ea. **3.39** ea. 10-40 ea. **3.89** ea.  
50 + **3.19** ea. 50 + **3.59** ea.

Verbatim Head Cleaning Kit **12.00**

Mail order to **NEW TECH ASSOCIATES P.O. BOX 2175 UPPER DARBY PA. 19082**. With check, Money Order, Or with VISA OR MASTERCARD CHARGE NUMBER AND EXPIRATION DATE. Authorized Purchase Order Accepted. Minimum Order 1 Box of 10 Diskettes. Shipping Charges and Handling add 5.00 Per Case or partial Case of 100 Diskettes. **NOTE:** If you Order 1 Box of 10 Diskettes or 1 Head Cleaning Kit Shipping and Handling charges will be only 2.00. Pa. Residents add 6% for state tax.

# Novel Methods of Integer Multiplication and Division

G. Reichborn-Kjennerud  
Tandberg Data A/S  
POB 9, Korsvoll, Oslo 8  
Norway

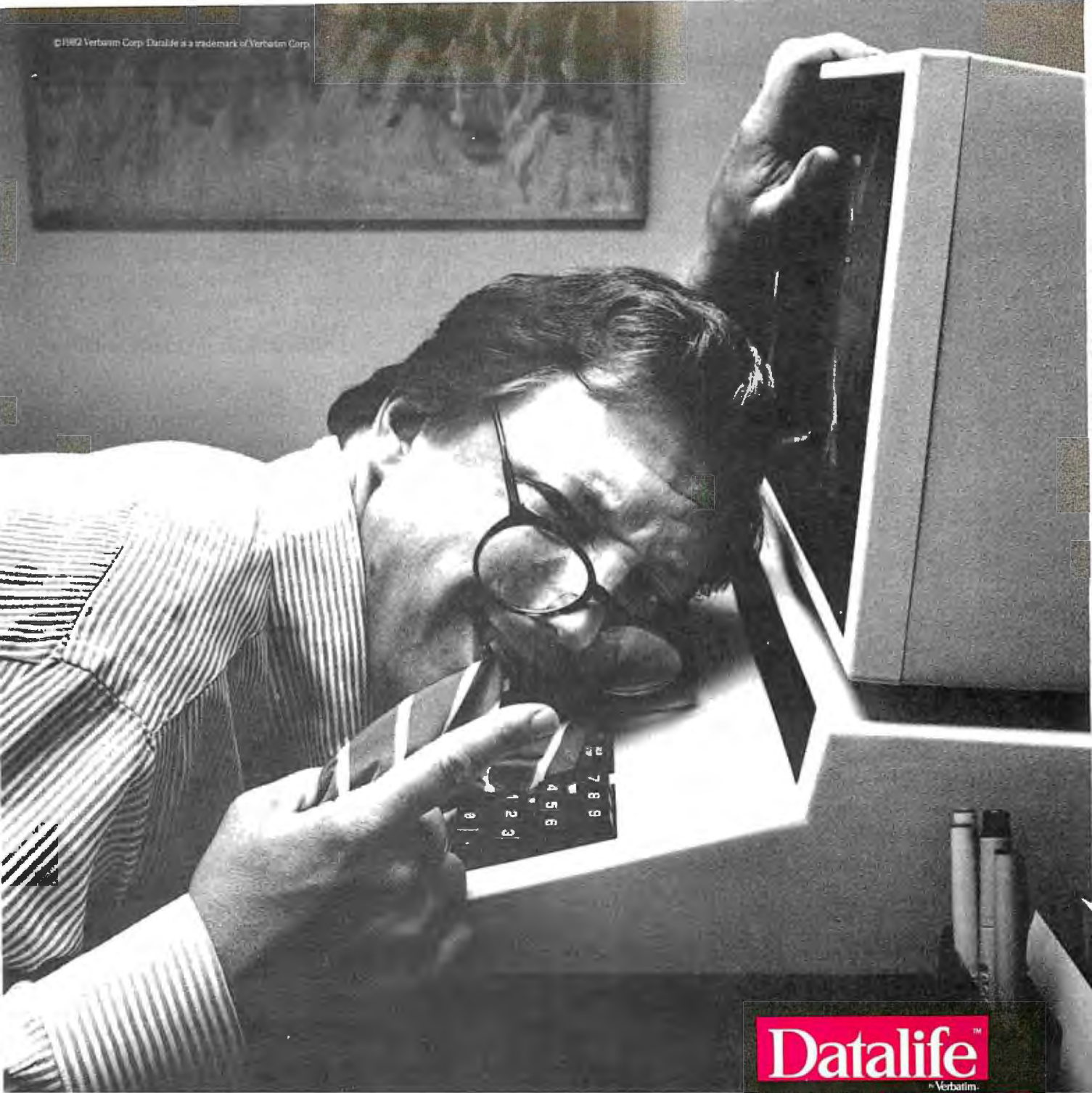
You may be familiar with the method of multiplication, variously alleged to be of Kenyan, Russian, or even Himalayan origin, in which you repeatedly halve the multiplicand and double the multiplier until the multiplier becomes 1. Then the sum of those multipliers that have a multiplicand counterpart of odd value becomes the product. This sounds complicated, but it's really not; table 1 shows an example.

Procedure: Repeatedly halve the multiplicand (discarding remainders) and double the multiplier until the former is 1. For every odd multiplicand, add the respective multiplier.

Example:  $44 \times 51$

Multiplicand (a)	Multiplier (b)	Partial Sum (c)	Column (c) Expressed in Terms of Original Multiplier (d)	Remainder of Division of Column (a) by 2 (e)
44	51	—	—	0
22	102	—	—	0
11	204	204	$4 \times 51$	1
5	408	408	$8 \times 51$	1
2	816	—	—	0
1	1632	<u>1 2</u>	<u><math>32 \times 51</math></u>	1
	Total	2244	$44 \times 51$	
	$44 \times 51 =$	2244		
	101100 is binary for 44			

**Table 1: An example of the Kenyan double-and-halve algorithm for integer multiplication.**



## How to avoid becoming a casualty of the computer revolution.

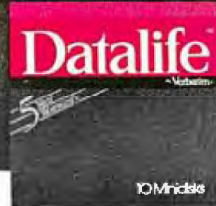
The computer revolution is eliminating lots of work for everybody. Unfortunately, it's often work you wanted to keep.

Because of inconsistent or weak magnetic properties, some flexible disks can "forget" some or all of your information. But not if you're using Datalife® flexible disks. They're certified 100% error free and backed by a 5-year warranty. This means what you put on them stays, ready for instant retrieval.

So enjoy all the benefits of the computer revolution without suffering the painful loss of your information. Use Datalife by Verbatim, the world's leading producer of flexible disks.

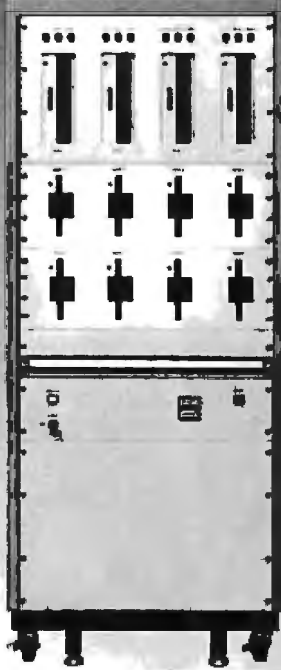
For your nearest Verbatim dealer, call toll-free 800-538-1793; in California or outside the U.S., call collect (408) 737-7771.

**Datalife**<sup>™</sup>  
by Verbatim



# Superhigh-Speed Floppy Disk Duplicator

8 inch : 5.25 inch & Micro disks



Easy Operation  
High Performance  
Error Free

TYPE SD85M



## ■ Distinguishing Features

The SD85M, a superhigh-speed floppy disk duplicator, reads all the data from a source disk mounted on a disk drive and stores them in a large capacity RAM (1.5 Megabytes) provided inside before output to destination disk drives. This "MEMORY to DISK" scheme has such distinguishing features over the conventional "DISK to DISK" as those described below.

- i) Extremely high data transfer rate can be obtained since the memory has no seek or settling time.
- ii) Multiple disks on destination disk drives can be written from the memory simultaneously with no effect on other operating disk drives even in the case of one disk drive failure.
- iii) Less deterioration of the source disk may be expected because duplicating requires only one reading.
- iv) High reliability is realized since data are transferred via the memory. A parity check feature is provided in the memory.

## ■ Throughput

The above processing can be performed on four disk drives at the same time. Individual disk drive can be managed using a CRT display

Size	Type	Initialize	Piece / Hour		
			INI & DUP	Duplicate	Verify
8 Inch	Diskette 1	380	284	568	568
	Diskette 2	188	140	284	380
	Diskette 2D	188	140	284	380
5 Inch	Mini Disk 1D 48	600	448	896	1792
	Mini Disk 2D 48	300	224	448	896
	Mini Disk 2DD 96	149	112	224	448

The SD85M can accommodate any special or customized format and also a precompensation initializing

**HOEI SANGYO CO., LTD.**

12-15, KOBUNACHO NIHONBASHI, CHUO-KU TOKYO 103, JAPAN  
TEL.(03)665-3431 TELEX NR. NAGASE J26480

## Programming Quirkles

This algorithm readily lends itself to coding, as exemplified by the sequence in 8080 code shown in listing 1. Halving is done by shifting to the right, and the odd/even test is performed by checking the carry. Doubling is done by adding to itself using the DAD instruction, which is also used for summing up the output terms.

Repeated halving of a number and then noting the odd/even results is a nice way of finding the binary form of the number (the last bit found being the most significant one). It also tells something of the binary nature of the Kenyan method.

Some time ago I became intrigued by the possibility of finding a procedure for division that was similar to the Kenyan method of multiplication. I came up with the

Procedure: Double the divisor until it is just less than the dividend. Then try to subtract the doubled divisors, starting with the largest, from the dividend. Note a 1 if the subtraction is possible; otherwise, note a zero and do not perform the subtraction.

The 1s and 0s constitute the binary form of the quotient. To obtain the decimal form, multiply the latter digits with the corresponding terms in a power of 2 series, arranged in reverse order. The quotient is the sum of the resultant terms.

To obtain decimal accuracy, multiply the dividend initially by an Nth power of 10. Then, after the division is complete, divide the quotient by the same power of 10 (moving the decimal point N places).

Example: 2246/51

				Counter
Double:	51			0
	102			1
	204			2
	408			3
	816			4
	1632			5
Subtract:	2246			
	<u>- 1632</u>			
	614	1	× 32 = 32	5
	<u>- 816</u>			
	614	0	× 16 = 0	4
	<u>- 408</u>			
	206	1	× 8 = 8	3
	<u>- 204</u>			
	2	1	× 4 = 4	2
	<u>- 102</u>			
	2	0	× 2 = 0	1
	<u>- 51</u>			
	0	0	× 1 = 0	0
Remainder:	2			
Quotient:			= 44	
			101100 = 44	
			(binary) (decimal)	


Table 2: An example of a new method of integer division suitable for implementation on microprocessors without a divide instruction.



# FRANKLIN'S BAKER'S DOZEN!

## 13 Good Reasons to Buy the **ACE1200**

1. **Apple® II-compatible**
2. **CP/M®-compatible**
3. **128K of RAM**
4. **Built-in floppy disk drive**
5. **Disk controller**
6. **80 column card**
7. **Serial interface**
8. **Parallel interface**
9. **Upper and lower case**
10. **VisiCalc® keys**
11. **Cursor control pad**
12. **Numeric pad**
13. **Auto repeat keys**

Extras can more than double the price of your personal computer. Not so with the Franklin ACE 1200. It's the professional computer system that includes the extras—and a  list of exclusive Franklin features that make it the most extraordinary value on the market today.

The ACE 1200 has everything you'll need to add a color or black and white monitor, modem, printer, back-up disk drive and other accessories. You can choose from the enormous selection of Apple programs and peripherals because the ACE 1200 is hardware- and software-compatible with

the Apple II. And, with the built-in CP/M card, you can run both Apple II and CP/M programs. Franklin's CP/M operates three times as fast as many competing systems, drastically reducing processing time for most business applications.

The Franklin ACE 1200—the most extraordinary value on the market today. Call or write today for the name of your local authorized Franklin dealer.

Franklin ACE is a trademark of Franklin Computer Corporation. Apple is a registered trademark of Apple Computer Inc. CP/M is a registered trademark of Digital Research Inc. VisiCalc is a registered trademark of Visi Corp.



**FRANKLIN**  
COMPUTER CORPORATION

2138 Route 38, Cherry Hill, NJ 08002 609-482-5900 Telex: 837-385

following scheme: The divisor is repeatedly doubled until just less than the dividend, then successively subtracted from the dividend. Every time the subtraction operation gives a positive result, a 1 is noted; otherwise a 0 is recorded. Remarkably enough, the resultant sequence of 0s and 1s constitutes the quotient directly in binary form, as shown in table 2.

Notice that the procedure is quite mechanical, with none of the trial-and-error search for the next correct quotient digit that is characteristic of the conventional method. Furthermore, it lends itself beautifully to coding (see listing 2). There need be no 8-bit restrictions on any of the numbers; the dividend, divisor, quotient, and remainder can all be entered as 16-bit numbers.

Procedure: Input multiplicand in both HL and DE register pairs. Constant K is the multiplier. Then perform a series of DAD D and DAD H instructions in the order given by the sequence of Ds and Hs under the given value of K. The final product will be in the HL register pair. If every DAD instruction is followed by a test of carry (JC or RC), carry will be set in case of overflow.

K =	2	3	4	5	6	7	8	9	10	11	12	13	14	15	16	17	18	19	20	21	22	23	24	25	26	27	28	29	30	31	32
DAD	H	H	H	H	H	H	H	H	H	H	H	H	H	H	H	H	H	H	H	H	H	H	H	H	H	H	H	H	H	H	H
DAD		D	H	H	D	D	H	H	H	H	D	D	D	D	H	H	H	H	H	H	H	D	D	D	D	D	D	D	D	H	H
DAD			D	H	H	H	H	D	D	H	H	H	H	H	H	H	H	D	D	D	D	D	D	H	H	H	H	H	H	H	H
DAD				D		D	H	H	H	H	D	D	H	H	D	D	H	H	H	H	H	H	H	H	H	H	D	D	D	D	H
DAD					D		D	H	H		D	H	H	H	H	D	D	H	H	D	D	H	H	D	D	H	H	H	H	H	H
DAD								D			D				D		D	H	H		D	H	H		D	H	H	H	D	D	D
DAD																					D				D		D	H	H		D
DAD																															D

Table 3: An algorithm for integer multiplication for 8080 microprocessors.

Listing 1: An implementation of the Kenyan algorithm for integer multiplication for the 8080 microprocessor.

```

;multiplication program MULT

;input multiplication factors in HL and DE, one of which must
;necessarily be an 8-bit number; if not, carry is set
;output product in DE, carry set if overflow.

;***** Initial test to find 8-bit factor
MULT:  xra      a           ;clear A
       ora      d           ;is D zero?
       jz       found      ;yes, DE number is 8-bit factor
       xra      a           ;no, DE number was not 8-bit factor
       ora      h           ;is H zero then?
       stc
       rnz
       xchg
found:  mov      a,e        ;transfer multiplicand to A

;***** Multiplication starts in earnest
       lxi      d,0        ;clear DE to receive output terms
next:  ana      a           ;8-bit factor now in A; clear carry.
       rar
       jnc      even       ;no, don't add multiplier term
       xchg
       dad      d           ;add multiplier (now in DE) to output.
       rc
       xchg
even:  ana      a           ;already reached 1 by halving?
       rz
       dad      h           ;yes, return with result, carry cleared
       jnc      next
       ret
       ;no, double the multiplier and
       ;continue the process.
       ;overflow, carry set on return

```

# A PICTURE'S WORTH:

U.S. SHIPMENTS (2 BILLIONS)



## \*\* GRAPHICS CAPABILITIES \*\*

- ◆ High Performance Graphics
- ◆ Tektronix 4010 Compatibility
- ◆ Automatic Scaling (1023x1023) with 250x512 resolution
- ◆ Alpha Mode (35 lines x 73 cols)
- ◆ Optional Joystick
- ◆ Connection to Low Cost Printer for Graphics Hardcopy
- ◆ ASCII and APL character sets
- ◆ Block Fill, Dotted/Dashed Lines

## \*\* DISPLAY TERMINAL CAPABILITIES \*\*

- ◆ ANSI Standard Conformance
- ◆ DEC Software Compatibility
- ◆ 80/132 Columns, Windowing
- ◆ 4 Pages of Memory Standard (up to 8)
- ◆ 43 Programmable Functions
- ◆ ASCII and APL models
- ◆ High Resolution Amber Phosphor
- ◆ Setup Mode



# \$1895.

Single quantity.

Whether used in video display mode or in its high-performance graphics mode, the concept GVT™ has more to offer at its price for terminal operators, interactive users, and applications developers than any other terminal available today.

Use the concept GVT graphics terminal for all its worth. Call 215-382-5000 or your local HDS sales/service office for a demonstration and free, no-obligation, trial in your office.

**HDS** human designed systems, Inc.  
3440 Market Street □ Philadelphia, PA 19104 □ 215-382-5000

Atlanta — (404) 391-9763; Boston — (617) 329-3510; Chicago — (312) 825-2960; Dallas — (214) 437-1888; Delaware — Infocon: (302) 239-2942; Hawaii — Gray Associates: (808) 261-3751; Los Angeles — (213) 410-9454; Northern New Jersey — Infocon: (201) 624-1372; New York City Area — Infocon: (212) 689-8833; New York State — Naco Electronics: Rochester: (716) 223-4490; Syracuse: (315) 699-2651; San Francisco — (415) 692-4184; Washington, DC — International Systems Marketing: (301) 279-5775; Australia — I. O. Peripherals Pty. Limited: (02) 427 3555; Belgium — BELCOMP: 091/25 22 88; Canada — CAIL Systems: Toronto: (416) 362-1063; Denmark — ADCOM Data Aps: 1-19 44 66; Finland — Modulsystem OY: 0-6926511; France — Walton: (1) 226.06.90; Singapore — DTS Singapore: (65) 33-88-566; Sweden — Allnovo Data AB: 08-37 25 15; Switzerland — Mitek ag: 02/461 22 52; United Kingdom — Shandell Systems Ltd.: 02407-2027; West Germany — COMKO Computersystemges, mbH: 0221-48 30 51.

Circle 176 on Inquiry card. DISTRIBUTORSHIP INQUIRIES INVITED.

GVT is a trademark of Human Designed Systems, Inc.

**More Apple II owners choose Hayes Micromodem II than any other modem in the world.** Compare these features before you buy. You should. It's your money. Thousands of other Apple II owners have already compared, considered, and are now communicating — all over the U.S.A. — with Micromodem II. The best modem for the Apple II. The most modem for your money.

**A complete data communication system.** Micromodem II is not "base priced" plus necessary "options." It's a complete, high-performance data communication system. The printed circuit board fits — quickly and easily — into your Apple II, eliminating the need for a serial interface card. And the Microcoupler™ (included) connects the Apple II directly to a standard modular telephone jack. Auto-dial and -answer features are built in. Operation can be full or half duplex,

with a transmission rate of 300 bps. And it's Bell 103 compatible and FCC approved.

**Now there's Hayes Terminal Program, too!** Developed by Hayes specifically for Micromodem II, this new

Terminal Program allows you to access all the great features of your modem in a matter of seconds.

With it, you can use your CP/M,<sup>®</sup> DOS

3.3 or Pascal formatted disks to create, send, receive, list and delete files. Hayes Terminal Program is a complete, stand-alone disk.

And because it's menu driven, you can choose from

a wide variety of options to set your communication parameters — as well as change hardware configuration — directly from the keyboard. It even allows you to generate ASCII characters that are normally not available from Apple

keyboards, further extending your capabilities. Incoming data can be printed (on serial or parallel printers) as it's displayed on your screen.

**Micromodem II is available with or without the Terminal Program.** Buy your modem by itself, or optionally packaged with the Terminal Program disk and user manual at extra cost. The software is also sold separately, for those who already own a Micromodem II.

**If you're ready to communicate with other computers,** to access information utilities, time-sharing systems, or use bulletin boards, then you're ready for Micromodem II. Come on. Compare. Consider. Then buy.

Micromodem II is already the best-selling modem for the Apple II. And Hayes' new Terminal Program



**Hayes**

makes it better than ever. Available at computer stores nationwide.

**Hayes Microcomputer Products, Inc.**  
5835 Peachtree Corners East  
Norcross, Georgia 30092 (404) 449-8791

Your Apple II  
just isn't the same without  
Hayes Micromodem II.™

**NEW!**  
Terminal Program  
from Hayes!

## Programming Quizzes

To handle 16-bit numbers, the add-to-itself DAD H instruction is used for doubling the divisor, and the necessary comparison with the dividend is accomplished by reverse-polarity addition, using the negative value of the dividend (in the DE register pair) and testing on the carry. Care is taken to restore the divisor before the next doubling by adding back the positive value (in the BC register pair). The doubled divisors are put in temporary storage by pushing them to the stack.

For the necessary subtraction of the doubled divisors from the dividend, reverse-polarity addition is used again. Luckily, the dividend is already present in negative form (in the DE register pair), and the divisors can be used in their existing positive form as they are popped from the stack for subtraction. The carry is then indicative of a positive or negative result, and for every subtraction, it is shifted into a register pair to form the final quotient. A counter sees to it that there are no more subtractions than there were doubling operations. The contents of the DE register pair constitute the remainder (in complemented form).

As we have seen, odd ways of multiplying and dividing can lead to useful code algorithms. But the reverse can also be true. Machine-code algorithms can lead to odd but perhaps not so useful manual methods.

First, consider a table used for multiplying by a fixed

Procedure: Repeatedly halve the multiplier (discarding remainders) until you reach 1. Ignore the 1 and arrange the resultant halved multipliers vertically in reverse order. For each halved multiplier, double the multiplicand. Add also the initial multiplicand if the halved multiplier is an odd number.

Example:  $44 \times 51$

Repeatedly halve the multiplier: 51 25 12 6 3 1		
Resultant	44	Double the multiplicand
odd/even halved	44	by adding to itself
multipliers:	3 + 44	Add initial multiplicand
	132	
	132	
	6 + 0	Don't add initial multiplicand
	264	
	264	
	12 + 0	
	528	
	528	
	25 + 44	
	1100	
	1100	
	51 + 44	
Final product:	2244	

Table 4: An example of manual implementation of the algorithm of table 3.

Listing 2: An implementation of the author's integer-division algorithm for the 8080 microprocessor.

```

;division program DIVIDE

;input dividend in BC and input divisor in HL.
;output quotient in HL and output remainder in DE.
;carry set if division by zero

;***** Test for division by zero and prepare
DIVIDE: mov     a,h      ;for reverse polarity subtraction
        ora     l
        stc
        rzc           ;division by zero; abort operation; carry set
        mov     a,b      ;put 2's complement of BC +1 into DE for
        cma           ;purposes of subtraction. (BC will be
        mov     d,a      ;incremented to enable subtraction when minuend
        mov     a,c      ;and subtrahend are having equal values).
        cma
        mov     e,a      ;dividend in negative form now in DE
        inx     b        ;BC +1; dividend incremented
        xra     a        ;reset counter A and
        sta     quot     ;clear the quotient buffer
        sta     quot+1   ;(high-order part of quotient buffer)
        jmp     double   ;start the division in earnest

;***** First phase: Doubling the divisor
restore:dad     b        ;add back
double:  inr     a        ;increment counter
        push    h        ;save divisor
        dad     h        ;double it, but go to second phase if
        jc     change   ;HL now is larger than dividend in BC
    
```

Listing 2 continued on page 372

## Programming Quickies

Listing 2 continued:

```
        dad      d      ;comparison with dividend by subtraction
        jnc      restore ;keep doubling unless HL now is larger than BC

;***** Second phase: Subtracting from the dividend
                        and accumulating quotient bits.
change: mov      b,a    ;transfer count to new counter
subtrct:pop      h     ;fetch halved divisor as positive subtrahend
        dad      d     ;subtract by using negative dividend as minuend
        jc       shiftc ;the carry bit becomes the quotient bit
        xchg     ;equivalent of adding back if subtraction fails
shiftc: cmc      ;invert quotient bit from reverse polarity
        lda     quot   ;shift quotient bits
        ral
        sta     quot   ;and place into temporary storage
        lda     quot+1
        ral
        sta     quot+1
        dcr     b     ;count-down finished?
        jnz     subtrct ;no, continue process
        lhld   quot   ;yes, place output quotient in HL.
        mov     a,e    ;change remainder in DE into proper polarity
        cma
        mov     e,a
        mov     a,d
        cma
        mov     d,a
        ret          ;division operation completed

quot:   ds      2     ;buffer for evolving quotient
```

Listing 3: An implementation in 8080 assembly language of the integer-multiplication algorithm given in tables 3 and 4.

```
;multiplication program DADDY

;input multiplicand in DE and input multiplier in A
;output product in HL, carry set if overflow

;***** Test for zero and leading zeroes, (8-bit
; factor already determined and placed in A)
DADDY: lxi      h,0    ;clear output product register
        mvi     b,8+1 ;set bit counter
        ora     a     ;is multiplier in A zero? (carry cleared)
skip:   dcr     b     ;yes, skip multiplication operation; 0 in HL
        ral     ;check multiplier bit
        ral     ;leading zero?
        jnc    skip   ;yes, ignore it and check next bit
        dad     d     ;no, load HL with multiplicand in DE; carry
                        ; cleared
;***** Multiplication starts in earnest
next:   dcr     b     ;more multiplier bits?
        rz     ;no, return with result in HL
        dad     h     ;yes, do a DAD H, doubling the multiplicand
        rc     ;overflow, carry set on return
        ral     ;is the multiplier bit a 1?
        jnc    next   ;no, check the next bit
        dad     d     ;yes, do a DAD D too, adding the initial
                        ; multiplicand
        jnc    next   ;check the next bit
        ret     ;overflow, carry set on return
```

# TRACK THE SPACE SHUTTLE ON AN APPLE? YES. WITH MICROSPEED!

At the Jet Propulsion Laboratory in Pasadena, NASA scientists have discovered the power of MicroSPEED. Using this remarkable hardware/software system with an Apple II, they produced a continuous graphic display of the Columbia's position relative to the earth during the second Shuttle mission. This enabled the JPL team to accurately follow the spacecraft in *real time*, and to precisely control its powerful sensors at critical points along the flight path. Surprised that such a demanding project is possible on the Apple? So were JPL's engineers, and many others who have discovered . . .

**THE MICROSPEED DIFFERENCE** This extraordinary Language System exploits the real potential of the microcomputer for the first time. The difference between MicroSPEED and other programming languages is that with MicroSPEED, there is virtually *no limit* to what you can achieve. It may well be the ultimate language for the Apple II and III (and soon the IBM Personal Computer). MicroSPEED literally combines the performance of a *minicomputer* with an

exhaustive set of user-friendly capabilities: hardware math processing, fast hi-res graphics and text, turtle graphics, print formatting, two text editors, unlimited data types, and incredible FORTH extensibility—all at speeds up to 100 times faster than Basic.

**USER-FRIENDLY, EASY-TO-LEARN** Starting with simple commands that are comfortable even for non-programmers, MicroSPEED extends and builds, allowing you to create your own tailored application languages. The capability of your computer will grow exponentially, as you work in an active partnership with the machine, exploring and developing new problem-solving facilities—creating, correcting, refining your increasingly powerful system.

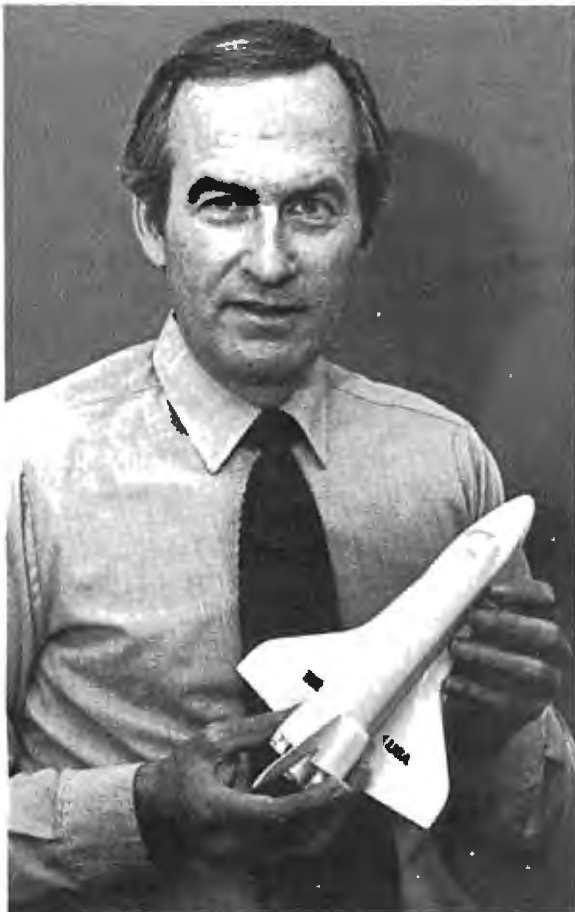
**DEMANDING JOBS AT LOW COST** MicroSPEED has been put to the test in fields as diverse as medicine, the stock market, oceanography, and the arts. In even the most challenging applications, MicroSPEED users have been unanimous in their praise of the System and manual. Typical comments are:

*"... we are more than pleased with MicroSPEED . . . I can't imagine using BASIC on any future applications."*  
Roger Guevremont, National Research Council of Canada.

*"I continue to marvel at its versatility and power."*  
Carl R. Schramm, USCG Base, Kodiak, Alaska.

*"Great! . . . A joy to use."*  
Henry Harris, Mission Design Manager  
Jet Propulsion Laboratory

*"If you plan to use a personal computer for any demanding task, then we built MicroSPEED for you."*  
Sam Cottrell, President of Applied Analytics.



MicroSPEED requires the Apple Computer with single disk. MicroSPEED II includes 2 MHz math processor. MicroSPEED II + includes 4 MHz math processor.

Applied Analytics Incorporated  
8235 Penn-Randall Place  
Upper Marlboro, Maryland 20772 (301) 420-0700

Please send me:

\_\_\_\_\_ MicroSPEED II, \$495.00 \_\_\_\_\_ 160 Page Manual, \$15.00  
\_\_\_\_\_ MicroSPEED II +, \$645.00 \_\_\_\_\_ Detailed Information

Name: \_\_\_\_\_

Company: \_\_\_\_\_

Address: \_\_\_\_\_



## Programming Quirks

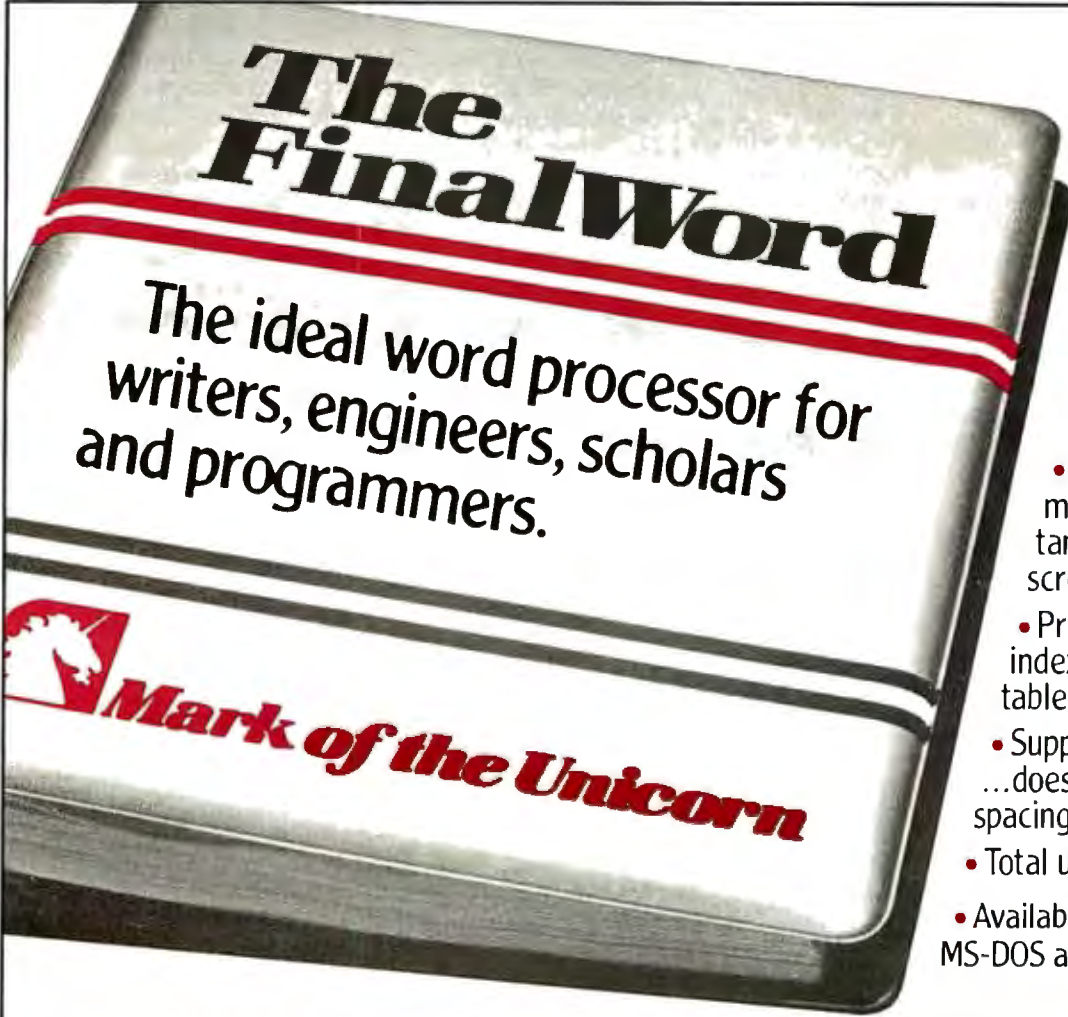
number K, based on using the 8080 DAD instruction (see table 3). The multiplicand is loaded into two register pairs (HL and DE), and the product is obtained by executing a sequence of DAD H and DAD D commands in the order given beneath each value of K (operand sequences for K=2 to K=32 have been included). DAD H doubles the accumulated multiplicand in the HL pair, and DAD D adds the original multiplicand to the HL pair.

It seems natural to look for a general algorithm based on DAD Hs and DAD Ds. If you look hard at table 3, you'll see a familiar pattern emerge: the Hs and Ds actually represent K in binary form. The 0s are represented by H, whereas the 1s are represented by H and D as a group. True, the most significant bit is missing, but that will always be a 1 anyway. As an example,

consider K=19. The sequence is H H (H D) (H D), which translates into (1) 0 0 1 1.

Thus, we can multiply by shifting the multiplier and examining the carry. When carry is cleared, we perform a DAD H operation, and when it is set, we do both a DAD H and a DAD D. This gives us the code in listing 3.

Now for the manual method that can be derived from this: Repeatedly halve the multiplier until it becomes 1 (in order to find the binary form). Reverse the sequence of halved multipliers and ignore the 1. Repeatedly double the multiplicand. Whenever the corresponding halved multiplier is odd, add also the original multiplicand to the accumulated doubled multiplicands; table 4 gives us an example of this method. Oh well, not everything is progress. But then, progress isn't everything. ■



- Display and edit multiple files simultaneously on a split screen
- Program-generated indexes, footnotes and table of contents
- Supports all printers ...does true proportional spacing
- Total user customization
- Available for IBM PC, MS-DOS and CP/M systems

**“Clearly one of the most powerful and versatile word processing programs available”**  
PC Magazine, January 1983

**“You’ll wonder how you ever got along without it”**  
Software Retailing, March 1983

Write or call Mark of the Unicorn P.O. Box 423, Arlington, MA 02174, (617) 489-1387





Dear Ma:

Racal-Vadic has the Ultimate 212A. It's like getting a Porsche at Volkswagen prices!



**The Auto-Dial VA212...  
For Those Who Want Everything**

Racal-Vadic has the ultimate 212A-compatible modem. It operates at 1200 and 0 to 300 bps and has a built-in automatic dialer with a non-volatile memory that can store as many as 15 phone numbers, up to 31 digits each. Non-volatile means the memory is retained even if you lose power.

This remarkable modem "talks" to the terminal operator using English words and phrases to indicate call progress, option status, and telephone numbers in memory. Calls can be originated or answered from the terminal keyboard or the modem front panel.

The front panel is really something, Ma. It has a 16-key tactile-touch keyboard and an eight character liquid crystal display. Twenty-six user programmable options are stored in the modem's memory, and can be keyed in from the front panel... eliminating the need to open the modem to change options.

**The VA212LC... For The Economy Minded**

For those who don't want auto-dial, Racal-Vadic has the perfect modem. It's called the VA212LC. LC means low cost... just \$550 in single quantity.

This is not a stripped down model. The VA212LC is a full-featured 212A-compatible modem with manual originate and automatic answer. It operates at 1200 and 0 to 300 bps full-duplex.

The VA212LC's extensive diagnostics include remote digital loopback and self test. Remote loopback allows end-to-end testing over the telephone from any of Racal-Vadic's regional diagnostic centers. The carrier indicator shows when you've established connection.



Now there is a real choice in the 212A market... A Porsche at a Volkswagen price... or the Volks itself at an even lower price.

Phone or write Racal-Vadic today!  
Your Independent Thinking Son,

*Alexander Graham Jr.*

PHONE: 800-543-3000, Operator 507

Circle 327 on inquiry card.

**Racal-Vadic** Member IDCMA

1525 McCarthy Blvd., Milpitas, CA 95035  
Tel: (408) 946-2227 • TWX: 910-339-9297

**RACAL**

# \$1590



Full size smart terminal with detachable keyboard

4Mhz Z80A CPU  
64K RAM Main Memory  
200Kbyte 5 1/4" floppy disk  
(Osborn, Xerox, IBM, CP/M-B6 formats)  
Two serial ports

Complete software package includes:  
WordStar word processing  
Correct-It spelling checker  
LogiCalc electronic spreadsheet  
Microsoft BASIC  
NorthStar compatible BAZIC  
CP/M 2.2 Operating System



# At \$1790, this computer was selling like hotcakes. So we dropped the price.

Crazy? No, not really. You see in order to meet the demand for the Micro Decision™ we increased our production. When we did that, our costs dropped. We're passing our savings on to you, because that's our philosophy.

More for less.

So now it only takes \$1590 to buy a Micro Decision with 64K of memory, a 200K double-density floppy drive and a full-size Morrow smart terminal with detachable keyboard. Not bad. But there's more.

The Micro Decision also includes a package of business and professional software worth well over \$2000. The WordStar® word processor. A 36,000 word spelling checker. The LogiCalc™ electronic spreadsheet. And both Microsoft BASIC-80® and NorthStar-compatible BAZIC®. Plus, the CP/M® 2.2 Operating System that gives you access to thousands of other software programs. And, we take the mystery out of CP/M with plain English commands and single-key operation.

If you have your own terminal, you can buy the complete computer and software package for \$995. That's the Micro Decision MD1™. The MD2™ includes another double-density disk drive, plus Personal PEARL™ the relational data base manager. Price? Only \$1395.

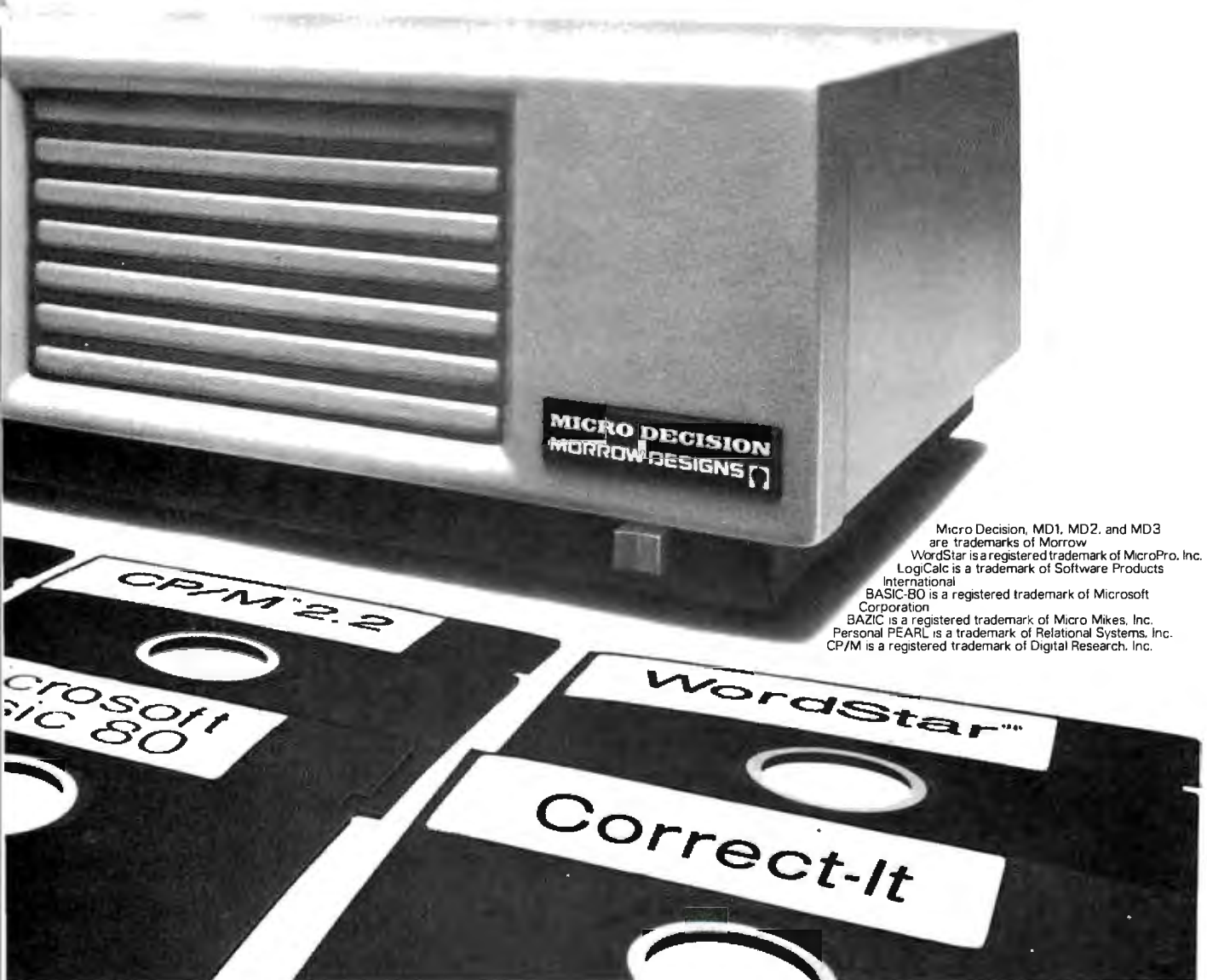
More memory? No problem. The Micro Decision MD3™ gives you two double-sided, double-density disk drives with 768K of storage and Personal PEARL for only \$2490. Without the terminal, \$1895.

Come in for a complete demonstration at your nearest Morrow dealer. If you don't know who that is, call us toll-free at (800) 521-3493. In California, call (415) 430-1970. At \$1790, the Micro Decision sold like hotcakes. At \$1590, we've just sweetened the deal.

## MORROW

MORROW, 600 McCormick Street, San Leandro, CA 94577  
(800) 521-3493, (415) 430-1970 In California

Circle 460 on inquiry card.



Micro Decision, MD1, MD2, and MD3 are trademarks of Morrow  
WordStar is a registered trademark of MicroPro, Inc.  
LogiCalc is a trademark of Software Products International  
BASIC-80 is a registered trademark of Microsoft Corporation  
BAZIC is a registered trademark of Micro Mikes, Inc.  
Personal PEARL is a trademark of Relational Systems, Inc.  
CP/M is a registered trademark of Digital Research, Inc.

**MDBS III™**

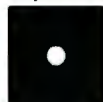
Mainframe-quality DBMS from  
Micro Data Base Systems, Inc.  
International Software Enterprises—USA  
(312) 981-9200

**ACCOUNTING PLUS™**

A comprehensive microcomputer  
business accounting system.  
SOFTWARE DIMENSIONS, INC.  
(916) 722-8000

**QUICK CHECK™**

Computer simplified bookkeeping  
and point of sale inventory.  
CHUCK ATKINSON PROGRAMS  
(817) 249-0166

**INMASS™**

Integrated Manufacturing and  
Accounting Software System  
MICROCOMPUTER CONSULTANTS  
(916) 756-8104

**DATA COMMUNICATIONS  
SOFTWARE**

ASYNCR, BISYNCR & SNA-SDLC protocol  
data communications software.  
IE Systems, Inc. & Micro-Integration, Inc.  
(603) 659-5891

**PC/FORTH™**

Program development systems for Z-80  
and 8086/88 microcomputers  
Laboratory Microsystems, Inc.  
(213) 306-7412

# WHEN YOU BUY THE RIGHT SOFTWARE, YOU CAN'T GO WRONG ON THE HARDWARE.

CP/M® compatible software — for maximum  
work power on more than 600 computer models.

All the computers in the world won't help you without smart software. That's why we're showing some of the best software products you can buy, from solid, innovative companies. They're shown here together because they're all CP/M compatible. CP/M is the universally accepted operating system created by Digital Research that allows software products like these to run on more than 600 different computer models including the biggest names in hardware. So, to get smart software for your system, call one of the fine Independent Software Vendors listed above or to find out how CP/M can increase productivity in your world, contact Digital Research at (408) 649-5500.

  
**DIGITAL  
RESEARCH™**  
The creators of CP/M™



Circle 127 on Inquiry card.

The logo, tagline and CP/M are either trademarks or  
registered trademarks of Digital Research Inc.  
©1982 Digital Research Inc.

# Random Numbers from an All-Digital Generator

*You don't need a complex and expensive analog generator to produce fast random numbers.*

---

Gary Finley  
Department of Psychology  
Biological Sciences Building  
University of Alberta  
Edmonton, Alberta, Canada T6G 2E9

---

A hardware source of random numbers, as discussed by Terry Mayhugh in the May 1981 BYTE Technical Forum column (page 452), is a useful addition to any computing system performing tasks that require a truly random selection of the values of some quantity. In some applications, the compelling attraction of hardware random-number generators over software routines is speed; when you simply cannot wait for the output of a software routine, a fast hardware source of random numbers becomes essential.

Such a requirement for high-speed random-number generation occurs in visual-perception experiments carried out at the University of Alberta. In this work, a minicomputer presents visual stimuli that consist of arrays of dots plotted rapidly on an oscilloscope screen. In some versions of these experiments the dot coordinates are chosen at random, and for maximum plotting speed, a new random coordinate must be available about every 3 microseconds ( $\mu\text{s}$ ). No software technique can provide this demanding performance, so an analog-based random-number generator, very much like the one described by Mr. Mayhugh, has been used in these

experiments for a number of years.

Recently, however, we have replaced this analog generator with a much simpler all-digital device, and the lower cost and reduced assembly time inherent in this design make it useful to microcomputer users who need fast random-number generation. As a result of the success of our first version, installed in a PDP-11/34 computer for laboratory experiments, we have since built several similar generators having clock speeds and word lengths suited to microcomputer applications. Two of these devices have been installed in portable video-display point plotters based on the Rockwell AIM-65 computer. We use these plotters in vision research studies conducted away from the laboratory.

Compared with traditional analog versions, the digital generator offers decreased sensitivity to external noise (which can induce periodic components into the output of analog designs) and decreased production of noise that may interfere with the host computer. An additional benefit of the digital generator is complete freedom from the logical asymmetry often found in analog generator outputs. Without very careful adjust-

ments made with the help of calibration programs, analog-based random-number generators tend to produce unequal totals of logic 1s and 0s—in a large sample of random binary outputs these totals should be exactly equal. Although careful calibration allows you to obtain equal 1 and 0 totals with analog-based generators, the 1s-to-0s ratio tends to wander with time, requiring the periodic recalibration typical of any sensitive open-loop analog device.

### Shift-Register-Based Circuit

The digital random-number generator (see figure 1, page 382) is a shift-register-based circuit more properly called a pseudorandom sequencer. This device, discussed by Don Lancaster in his excellent hobbyist reference *TTL Cookbook* (Howard W. Sams & Co., 1974), is essentially just a long shift register combined with additional logic circuitry. The outputs from two or more stages near the end of the register serve as the inputs to the logic circuit, which produces a bit that in turn feeds back to the register's first stage. This modified-ring shift register cycles through a number of states, each con-

# MICROXPRESS

DISK DRIVES FOR

IBM • apple • Zenith/HEATH®  
AND OTHER PERSONAL/MICROCOMPUTERS



- 8" THIN LINE FLEXIBLE DISK SUBSYSTEM  
(SHOWN ABOVE) FULLY ASSEMBLED & TESTED WITH  
COMPLETE DOCUMENTATION
- I-B480\* DUAL DRIVE, DOUBLE-SIDED, 2.4MB . . \$1,495
- I-B481\* SINGLE DRIVE, DOUBLE-SIDED, 1.2MB;  
INCL. FILLER PANEL - SECOND DRIVE  
CAN BE ADDED LATER . . . . . 995
- \*8" FLEXIBLE DISK CONTROLLERS FOR IBM  
PC & apple NO CONTROLLER NEEDED  
FOR Zenith/HEATH® Z-100 . . . . . Call
- 5 1/4" Tandon OR CONTROL DATA INTERNAL FLEXIBLE  
DISK DRIVES TM 100-2/CDC 9409  
DOUBLE-SIDED, 48TPI, 320KB . . . . . 235
- 5 1/4" Qume 1/2 HEIGHT INTERNAL FLEXIBLE DISK DRIVE  
QUMETRAK 142 DOUBLE-SIDED, 48TPI, 320KB . . 225
- 5 1/4" TEAC 1/2 HEIGHT INTERNAL FLEXIBLE DISK DRIVES
- FD 55-B DOUBLE-SIDED, 48TPI, 320KB . . . . . 295
- FD 55-F DOUBLE-SIDED, 96TPI, 640KB . . . . . 360
- IBM PC DOS SOFTWARE UTILITIES FROM TALL TREE  
SYSTEMS
- J FORMAT ENABLES USE OF 5 1/4", D/S, 96TPI  
& 8" FLEXIBLE DISK DRIVES PLUS  
OTHER FEATURES FOR IBM PC DOS  
1.10 VERSION 1.78 . . . . . 50
- J FORMAT-2 SAME AS J FORMAT ABOVE FOR  
IBM PC DOS 2.0 . . . . . 35
- WINDRIVE ENABLES USE OF WINCHESTER  
SUBSYSTEMS FOR IBM PC DOS 2.0 . . . . . 35
- JETDRIVE ENABLES IMPLEMENTATION OF  
ELECTRONIC DISK FOR IBM PC  
DOS 2.0 . . . . . 35
- J UTILITIES INCLUDES J FORMAT-2, WINDRIVE  
& JETDRIVE . . . . . 85
- apple DISK DRIVES
- DATA DRIVES 5 1/4" FLEXIBLE DISK EXTERNAL  
SUBSYSTEM . . . . . 275
- I-501/502 5 1/4" FLEXIBLE DISK EXTERNAL  
SUBSYSTEMS UTILIZING 1/2 HEIGHT  
DRIVES . . . . . Call

# MICROXPRESS

(714) 632-8512  
305 S. State College Blvd.

Suite 135  
Anaheim, CA 92806



sisting of a unique combination of binary bits present on the register outputs. The device assumes a new state each time a clock circuit causes the register to shift. When all possible states have appeared at the outputs, the first state reappears, and the cycle begins again.

As the device runs through its cycle of states, the outputs of eight arbitrarily chosen register stages can be used as the bits of a data byte. New bytes can be produced as rapidly as the register can be made to shift. For a register built from LSTTL (low-power Schottky transistor-transistor logic), this circuit can generate about 40 million random bytes per second, a rate far faster than that at which any microprocessor or minicomputer can operate on data.

This method of random-number generation is a close hardware equivalent of the multiplication and truncation technique used by many software random-number routines. Each register shift is equivalent to a multiplication by two, and the selection of 8 bits of the result as a data byte corresponds to the digit-truncation process.

The numerical values represented by the data bytes do not change at random; a precise logical function relates the value of each byte produced to the values preceding it. In the case of a single shift, the value of the new data is at most 1 bit different from one-half or twice the preceding value, depending on the direction of shift. The 1-bit variation arises from the way that the logical feedback circuit affects the bits of the current data. However, as successive shifts take place, the function relating the value of each new data byte to the starting value becomes extremely complex, and data bytes separated by a few shifts of the register have numerical values that appear to be completely unrelated, closely approximating the behavior of truly random values.

To avoid having any recognizable function relating one value of the data to the next, you need only to operate the circuit rapidly enough so that several shifts of the register take place between successive acquisitions

of the output data by the computer.

In our microcomputer applications, we use 6502-based computers that have a 1-MHz clock frequency. These machines can acquire a latched byte of data from the pseudorandom sequencer and store it in memory (using indexed addressing) in about 15µs. The 500-kHz clock frequency of the circuit in figure 1 results in seven shifts of the register separating the computer-acquired data bytes, and the resulting stored data approximates random data extremely well.

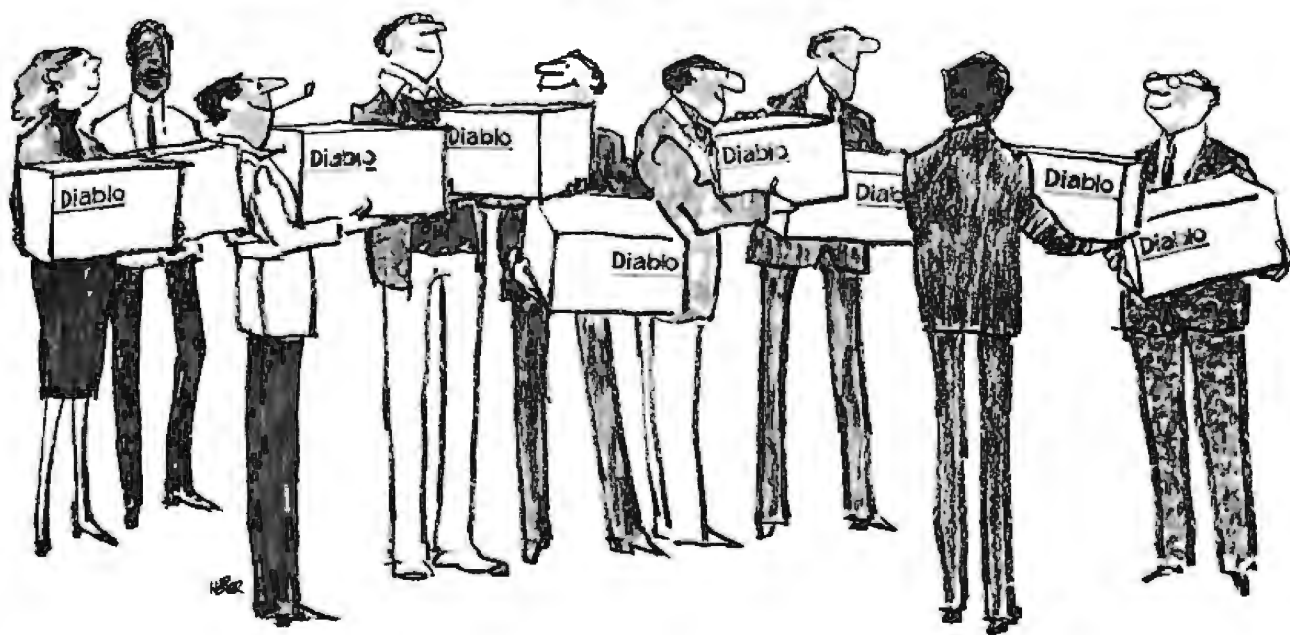
For use with faster computers you can sample the pseudorandom data more frequently (with some loss of "randomness"), or you can speed up the device by decreasing the value of the capacitor that controls the frequency of its clock (C1 in figure 1).

## The Number Series

At first glance, the finite size of the series of numbers produced by the pseudorandom sequencer may seem to be a serious drawback to this form of random-number generation, but a detailed look at the device shows why this is usually not so.

The length of the cycle of possible states in a shift register depends on the number of stages in the register and on the form of the logical feedback function used. For certain forms of this function, you can make the number of states as large as one less than the theoretical maximum of  $2^n$  states, where  $n$  is the number of stages in the register. The complexity of the feedback function required to give maximum cycle length depends on the number of stages involved. A register with 31 stages runs through a maximum-length cycle when the feedback is a simple two-input exclusive NOR function that takes its inputs from the outputs of register stages 28 and 31. A 31-stage shift register can be made with only four 74LS164 eight-stage TTL packages. With the addition of another package (74LS86) containing exclusive OR gates and a final one (74LS04) to act as the system clock, we can build a sequencer with  $2^{31} - 1$ , or 2,147,483,647, discrete output states. The circuit shown in figure 1 uses only six logic packages and a handful of resistors and

# DIABLO QUALITY COMES IN ALL SHAPES AND PRICES.



No matter what kind of computer you own, or what you use it for, Diablo can provide you with a perfect printing fit.

You'll find an impressive array of Diablo quality printers to fit any computer, from micro to mainframe. And Diablo accessories to make yours a complete printing system, customized to your needs.

Letter quality, matrix, inkjet or thermal, members of the Diablo family are easily recognized by their exceptional reliability, a trait all Diablo printers and products share. Diablo printers have few moving parts, and are modular in design for quick, easy maintenance and repair. And they're backed by a full warranty, plus the most comprehensive nationwide service network of any printer company.

At Diablo we understand it is not enough to be the leading printer manufacturer in the U.S., so we are constantly looking toward the future, developing new answers for the printer demands of tomorrow.

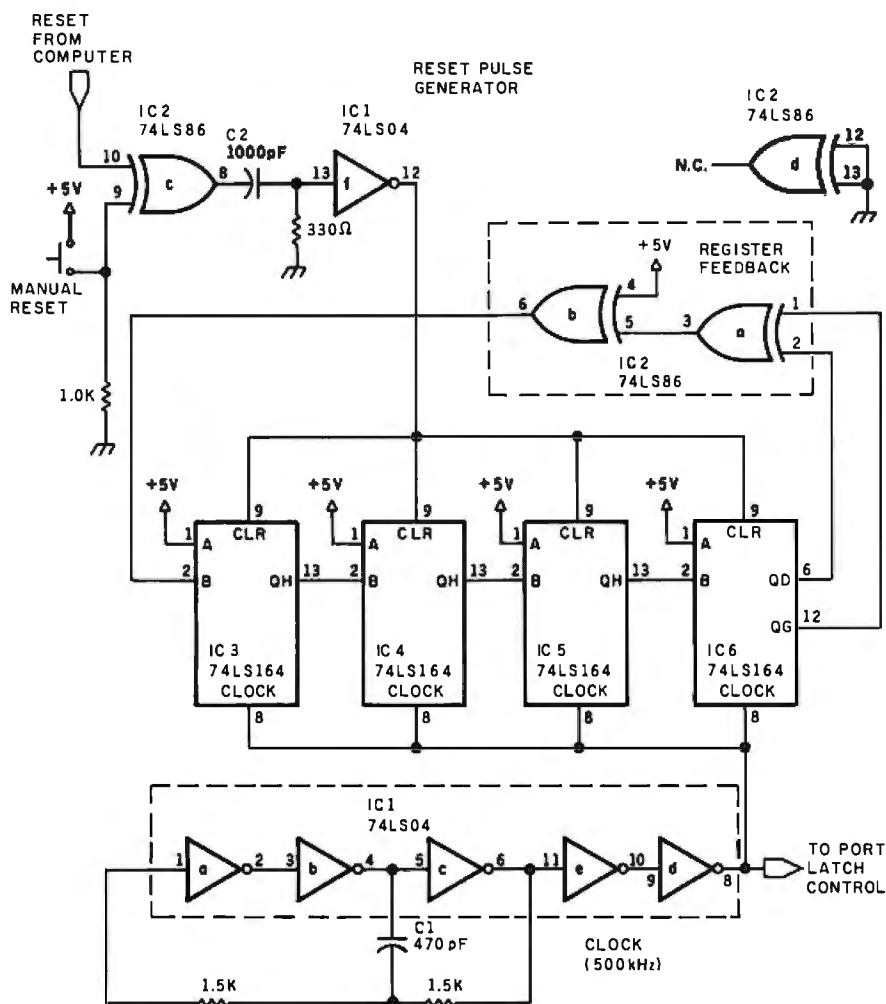
**The only printer company you'll ever need.**

## Diablo

a Xerox company

24500 Industrial Boulevard  
P.O. Box 5003  
Hayward, CA 94545

For the authorized Diablo distributor or dealer nearest you, call operator 606 at (800) 824-7888, in CA (800) 852-7777.



SEQUENCER OUTPUTS  
(CHOOSE ANY 8 FOR DATA OUTPUT TO COMPUTER)

IC3, 4, 5 - PINS 3, 4, 5, 6, 10, 11, 12, 13  
IC6 - PINS 3, 4, 5, 6, 10, 11, 12

N.C. = NO CONNECTION

Number	Type	+5V	GND
IC1	74LS04	14	7
IC2	74LS86	14	7
IC3	74LS164	14	7
IC4	74LS164	14	7
IC5	74LS164	14	7
IC6	74LS164	14	7

Figure 1: Six TTL packages form a random-number generator capable of producing 2,147,483,647 discrete output states.

capacitors, yet it produces a continuous stream of bytes of pseudo-random data at the rate of 500,000 bytes per second for more than an hour.

In applications not requiring such speeds, you could slow the clock enough to stretch the cycle time of the sequencer to several hours. However, in many applications the repetition of number sequences is extremely unlikely even if the generator cycles many times during a single computer-

program execution. This characteristic is due to the sequencer being clocked by its own oscillator, which is not synchronized to the clock of the computer. In most applications, the computer selects a number or set of numbers from the rapid continuous stream of numbers (half a million per second in this case) produced by the sequencer. The program then performs some calculations or manipulations using these numbers before reading in a new set of numbers for

the next series of operations. Frequently, these operations are separated by delays of several seconds during which the computer waits from some input, such as a keyboard entry.

If a small set of random numbers is read in once every few seconds on the average, then the chances of obtaining identical data during successive sequencer cycles is on the order of one in a million. Thus, in many cases, you will see no evidence of the cyclic nature of the device and can treat the pseudorandom sequencer as the source of a virtually infinite stream of random numbers.

### Demon State

I should clarify a few points concerning this design. First, sequencers of the form discussed here have one "demon state" that can trap them and halt operation. If all 31 stages of the register contain 1s, then no 0s can be produced by the feedback circuit, and the sequencer remains in this one state indefinitely. Fortunately, this state is not produced as a part of the cycle of usual sequencer outputs, but a remote danger exists that it may occur when the power is applied or through the chance action of some external event such as a glitch in the power-supply voltage. This frozen state can be escaped if you reset some or all of the stages of the shift register to 0 by applying a low pulse to the reset pins of one or more of the shift register packages.

In the figure 1 circuit, an unused inverter from IC1 is connected as a half-monostable circuit, which produces a suitable reset pulse in response to a positive transition at its input. A spare exclusive OR gate allows this reset transition to come from either a signal generated by the computer or the push of a button by the operator.

### Interfacing

The random data produced by the digital device described here is useful only if it can be accessed through the data bus of the computer on demand. You can most easily accomplish this by using an 8-bit parallel-input port that is able to latch its inputs on the transition of an external signal.



# WOW! LOOK WHAT XCOMP HAS ON SALE!

Don't be caught on the outside looking in!

XCOMP has 8MB and 16MB Hard Disk Subsystems available at incredible savings! Do what thousands of purchasers have done over the past 7 years with us . . . improve your computer's performance with a Hard Disk Subsystem from XCOMP at Corporate Prices!

If you have ever even thought of purchasing a Hard Disk Subsystem for your company's computer in order to drastically improve its performance, then think XCOMP. Not only will you look like a hero, but take a look at the reason's why:

- The savings in time alone will more than pay for your purchase within weeks!
- There is absolutely no maintenance required with XCOMP's Hard Disk Subsystem!
- The system can be used on many types of computers by simply changing adapters! (IBM, Apple, KAY-PRO, OSBORNE, NEC and others.)
- You'll continuously receive professional advice from XCOMP!
- You'll receive direct XCOMP service!
- Buy **without risk**, because you'll receive a full **One Year Warranty!**

To find out more how you can become the company hero, call or write XCOMP for

At XCOMP, we'll help you increase your company's potential by keeping your nose into new business technology.

This way, we also prevent your boss from getting his nose bent out of shape.

**\$1595..**

(8MB Hard Disk Subsystem, Quantity 2. \$1895. Quantity 1)

**\$1895..**

(16MB Hard Disk Subsystem, Quantity 2. \$2195. Quantity 1)



Circle 425 on inquiry card.

**XCOMP**

7566 Trade Street/San Diego, CA 92121 (619) 271-8730

**YES!** I want an XCOMP Fixed Hard Disk Subsystem, but I have a few questions first. Please call.  Please send \_\_\_\_\_ Fixed Hard Disk Subsystems at \$ \_\_\_\_\_ each. (See price.) I have a \_\_\_\_\_ Computer.  **8MB**  **16MB.**

Please send COD. I will pay COD with Cashier's Check.

Please charge my American Express Card.

# \_\_\_\_\_ Exp \_\_\_\_\_

Name \_\_\_\_\_

Company \_\_\_\_\_

Address \_\_\_\_\_

City \_\_\_\_\_ State \_\_\_\_\_ Zip \_\_\_\_\_ Phone \_\_\_\_\_

Calif. residents add 6% sales tax **American Express Card customers call : 1-(619) 271-8730.**

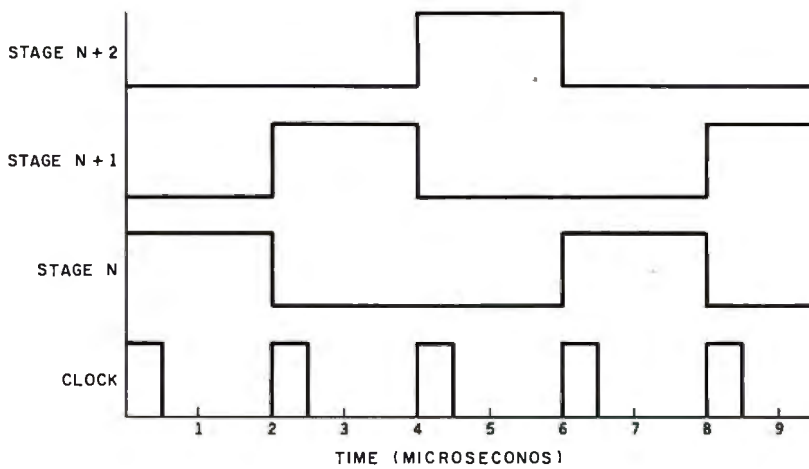


Figure 2: As illustrated in this timing diagram showing the figure 1 circuit's clock signal and three register-stage outputs, sequencer data remains stable for about 1.5  $\mu$ s following a negative-going clock transition.

Figure 2 shows the relationship between the waveform produced by the sequencer clock and the contents of a few stages of the shift register. The register shifts on every positive transition of the clock waveform. The positive pulses produced by the clock in figure 1 occur every 2  $\mu$ s and have a duty cycle of about 25 percent. Thus,

the data from the sequencer is stable for about 1.5  $\mu$ s following the clock pulse's negative transition. You use this transition as the signal that causes the latches in the input port to hold the current data. When the computer is finished with the byte of random data, the latches can be cleared in preparation for the latching of the

next available random byte upon the clock waveform's next negative transition.

### Conclusion

We have interfaced the output of the sequencer described here with a Rockwell AIM-65 microcomputer using one of the latchable ports in the 6522 VIA (versatile interface adapter) provided for user applications on the AIM-65 board. Frequency counts of the 256 possible outputs of the pseudorandom sequencer compiled with this computer showed a rectangular frequency distribution indicating that each of the possible numbers has equal probability of occurrence. No discernible patterns appeared in the frequency counts, even when the set of numbers tested reached 200 million samples. ■

### About the Author

Gary Finley designs custom peripheral hardware and assembly-language software for computers used as laboratory controllers in the academic research conducted at the University of Alberta psychology department.

# NO NONSENSE PRICES.

Find the best advertised price in this magazine on software, hardware, and peripherals then call TOLL FREE

## 1-800-922-9200\*

and we will beat it.

We carry all lines of software and hardware for APPLE, IBM, CP/M and other major brands.

### Mason Computers

Suite 1, 977 S. Santa Fe Ave. Vista, CA 92083

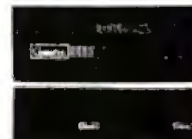
\*Outside CA Order line only HOURS 9 AM - 8 PM PST

1-619-726-7784 (Technical assistance) (CA orders subtract \$2.00 on orders over \$200.00)

TERMS: Cash/check (please include Drivers License No. & telephone no.), VISA, MASTER CHARGE. Call us for UPS shipping charge. ALL PRICES ARE MAIL ORDER ONLY, SHOWROOM PRICES DIFFER. CA residents add 6% sales tax. All prices and availability subject to change.

## SLUDER, THE COMPETITIVE EDGE

systems & subsystems since 1980  
20-27% off list on Godbout, Lomas, Teletex, and Seattle Components  
SPECIALS - GODBOUT 816 SYSTEMS-CALL



GODBOUT 816 A&T	\$8995.
Disk II A&T	695.
20MB HD	1.
TOTAL	\$9691.

COMPLETELY INTEGRATED, ASSEMBLED & TESTED  
COMPETITIVE EDGE BUDGET BOOT & RUN SYSTEMS  
TELETEK w/2 floppys . . . . . from \$1995.  
LOMAS 8086 w/2 floppys . . . . . from 3295.  
85/88 sys w/2 floppys . . . . . from 2995.  
Seattle w/2 floppys . . . . . from 3295.

OR, LET US CONFIGURE A SYSTEM TO YOUR NEEDS  
GODBOUT CPU Z 6MHz . . . \$199 20MB w/D-II & CP/M . . . . \$3495.  
SEATTLE GAZELLE . . . . . 4695. 2 DSD 8" Drs sub-sys . . . . . 1095.  
LOMAS 10MHz 8086 . . . . . 520. Godbout 10MHz 86 or 68K . . . . 621.  
DISK 1 w/CP/M . . . . . 445. LOMAS LDP72 w/CPM-86 . . . . 415.  
Teletext 925 . . . . . 689. Teletex SYSTEMASTER . . . . . 671.

DEALERS: GET THE COMPETITIVE EDGE, CALL OR WRITE  
UNIVERSITY PURCHASE ORDERS ADD 5%  
Prices subject to change. Tax & shipping extra.

CP/M is a trademark of Digital Research  
COMPETITIVE EDGE/SLUDER (714) 895-1746  
P.O. Box 951, Westminster, CA 92683-0951

This is a story about Al Roberts, a successful yet frustrated executive who wanted to take advantage of the computer revolution, but just didn't know where to start. In it, you'll follow Roberts' progress as he gains more and more knowledge and finally has the ultimate learning experience: a "hands-on" session in a computer store.

# HANDS-ON

By Donald M. Klein



Of all of the adjectives you could use to describe someone, "insecure" is probably the last word you would use to describe Al Roberts.

At 41, Roberts has the athletic good looks of a movie star. His financial situation is equally handsome: as the national sales manager of one of the country's largest sporting goods companies, Roberts' substantial annual

salary is augmented by a host of "perks" that include stock options, a car and access to the corporate jet. As if that weren't enough, Roberts is immensely likeable and very down to earth. In short, he has, as they say, "everything going for him." Yet up until about six months ago you could send shivers of fear down Al Roberts' spine by simply mentioning one word: computers.



## TI's new Compact Computer. It takes over your work, not your desk.

The ordinary personal computer occupies too much of the ordinary desk.

Now Texas Instruments brings you a cordless compact computer that puts much of the problem-solving power of Apple™ or IBM™ personal computers within your reach, wherever you go. You can expand its internal 6K RAM and 34K ROM with TI Solid State Software™ cartridges for an effective memory of up to 168K — more than enough for most personal computer tasks. Yet the Compact Computer 40™ is smaller than a magazine page.

TI Solid State Software cartridges, containing up to 128K bytes of ROM, let you plug in powerful, convenient, easy-to-use application programs. Sophisticated software is available right now for finance,

statistics and production planning. Graphics, spreadsheet and word processing are just around the corner.

The TI Compact Computer 40 has low-cost peripherals that make it even more useful: a TI Wafertape™ drive for convenient, reliable program or data storage; a 4-color printer/plotter; and an RS-232

interface for talking with other computers or running a larger printer.

Its built-in language is TI Enhanced BASIC, which allows you to write programs in everyday words. The integrated liquid crystal display shows 31 characters, which can be scrolled to show up to 80 per line. It operates on four AA alkaline batteries that give up to 200 hours of service.

The TI Compact Computer 40 offers solutions anywhere you go. Yet it retails for less than 1/3\* the price of Apple™ or IBM™ personal computers. The TI Compact Computer — compact in price and size, but not in power. See it soon at your Texas Instruments retailer.



\*Based on published manufacturer's suggested retail price.

Apple is a registered trademark of Apple Computer, Inc. IBM is a registered trademark of International Business Machines Corp.

Copyright © 1983 Texas Instruments

**TEXAS**  
**INSTRUMENTS**

Creating useful products  
and services for you.

"In retrospect, I suppose it was a simple matter of fear of the unknown," Roberts says. "Kind of silly, I suppose. But it was very real to me then."

Silly? Perhaps. But Al Roberts' "silly" fear is unfortunately...and increasingly...typical of the attitude of many of America's middle and upper managers today. These are intelligent, well-paid, often aggressive executives. And while their routine responsibilities may very likely include the approval of *purchasing* computers for their corporations, when it comes to their becoming personally involved with the equipment, they turn off.

As with Al Roberts, fear of the unknown (or fear of embarrassment) accounts for some managers' reluctance to use computers first hand. Others claim that computer implementation is a "clerical" task, and as such is beneath their station. Still others claim that they "don't have the time," or that computers are "fine for accountants and bookkeepers, but not applicable to what I do."

While it is true that computers are better suited for some tasks than for others, and that they do, indeed, require the somewhat "clerical" task of being manipulated by a keyboard, the truth of the matter is that most middle and upper managers would *like* to take advantage of the "computer revolution" if only they knew how.

As Al Roberts discovered, obtaining that knowledge was easier than he had feared.

"It all came to a head sometime around the holidays," Roberts recalls.

"It was just one of those days...you know, when nothing goes right? Anyway, it was about ten in the morning...my secretary had called in sick, and I was just about to call personnel and request some help from the typing pool when I was interrupted by a young marketing assistant who had been dispatched to find me. He told me he was new, that he worked for Robert Bradshaw, (our unbelievably humorless director of marketing), and that Bradshaw needed some important sales data as quickly as possible.

I invited the young man to sit down and asked him what the urgency was all about. He politely explained that the marketing department was planning the introduction of a new product...a quoit game called 'Hoity Quoit'...and that their research indi-

cated that there was a correlation between the sales of our archery and horseshoe sets and the projected sales of the new product. The information Bob Bradshaw wanted was nothing less than a complete breakdown by marketing area of the sales figures for what we call 'shoes' and 'arrows' for each of the last five years! What's more, he wanted it by the end of the day...preferably before lunch.

"Young man," I said to him, "what's your name?"

"Lathrop, do you realize what you've done?" I asked, my eyes burning with intensity.

"Me? What I've done?! N..no, Sir, I'm afraid, I don't, Sir." By this time I can assure you that young Lathrop was sorry he hadn't taken a job with PPG or General Motors.

"What you've done, young man, is manage to get yourself between a rock and a hard place. You've got Bob Bradshaw in back of you, expecting you to come back upstairs with a pile of sales numbers, and me



"Lathrop," he answered. "John Lathrop."

"Lathrop, how old are you?"

"Twenty-three," came the response.

"And I assume you're well educated? MBA and all that sort of thing?"

"Yessir." At this point the poor kid was starting to sweat, wondering desperately why I was giving him such a hard time. But there was a method to my madness, if not my meanness.

**“WOULDN'T IT  
MAKE MORE SENSE  
TO HAVE ALL  
OF THIS  
ON COMPUTER?”**

in front of you, telling you you're not going to have that data. Not today, anyway, and probably not tomorrow, either. There's just too much work involved...too much searching, too much reading, too much writing and too much calculating."

Young Lathrop looked like he was going to be sick. His first mission to the dreaded sales department, and he was failing.

"Unless," I said, "unless..."

The color returned to Lathrop's face as he started to realize that there might be an alternative to coming up empty-handed.

"Unless what, Sir?" he managed.

"Unless, of course, you were able to lend us a hand yourself. You see," I said, gesturing to the wall of file cabinets that lined the hall outside my office, "all of the information you want is in those files. It's getting it out of the files that's the problem."

"That's fine, Sir," he said with audi-

ble relief. "Just let me get my calculator, and I'll be right back."

"Take mine," I said, tossing it to him. "And make yourself at home at Julie's desk. She's out sick today anyway."

And so my method paid off: at the risk of feeling only slightly guilty I snaked one of Bradshaw's own boys to do my grunt work for me. The thing is, I knew in my heart there was a better way...a saner way...to get those statistics than chaining a budding young executive to a file cabinet and a calculator for five or six hours. I suspected that John Lathrop knew it too, and my suspicion was confirmed when he asked me the following question:

"Mr. Roberts...wouldn't it make more sense to have all of this on computer?"

He was, of course, right.

You know, I have to laugh when I think back on that day, but at the time it wasn't very funny. There was just too much for John to handle by himself, so I rounded up a couple of secretaries and pitched in myself to get the job done. It took the four of us seven hours of searching, writing, tabulating and typing. By the time we were finished I was exhausted. But what really bothered me was the comment that John had made earlier in the day...the one about having everything on computer.

That thought nagged at me all the way home.

The next morning, I ran into Bryce Deeter on the train. Bryce is the fleet manager for a huge manufacturing company. He's in charge of all their vehicles, ranging from the passenger cars used by their sales people, to the trucks they use for shipping and repairs. They even have their own limousine fleet! Anyway, Bryce is a friend, and I'm always glad to see him. I really don't know much about the details of his business, but I'm always teasing him about upgrading his fleet. When I saw him that morning I grabbed the seat next to him and asked him when he was going to buy a fleet of Ferraris.

"Not this week, pal," he said. "I just convinced the CEO to spend his money on something *really* classy...a bunch of desktop computers." Naturally, my ears perked up.

"Oh really? Tell me more. I've been thinking about taking the plunge myself."

"That's funny," he replied. "I would've thought that you guys were totally computerized over there by now."

"On a corporate level we are," I explained, "for things like payroll and manufacturing. But that's not what I'm interested in. I want something that can help *me*, you know, to get through my daily workload."

"Oh I know, alright!" Bryce exclaimed. "Why do you think I was so hot to get some units for us? Listen," he continued, moving closer so that I wouldn't miss an ounce of his enthusiasm, "those things are going to change my life. Here," he continued, taking a magazine article from his briefcase, "look at this."

The article was entitled "FROM ENGINEERS TO POETS, AMERICANS ARE LEARNING TO LIVE WITH COMPUTERS," and it detailed several case histories about people from all walks of life who got "computerized." The first example was a chief engineer of a large consumer appliance firm. The article told how he used very sophisticated computers to design three-dimensional schematics of new products. 'Computer-Aided Engineering' they called it, and while it was fascinating to read about, frankly, I couldn't see how it applied to me at all.

"Bryce, this is all very interesting, but why in the world do you need equipment like that in *your* job?"

"Keep reading," he said. "See what it says here? 'Although computer applications dominate high-tech industries, the advent of the personal computer has allowed previously non-technical people to benefit as well. And while it comes as no surprise that engineers are among the most likely to find ways to apply personal computers to their everyday lives (the chief engineer, for example, uses his personal computer for scheduling and planning), we are now seeing general businessmen growing increasingly dependent on their micros. For example, take the case of a chief financial officer of a major aircraft manufacturer who reports that 80 percent of his workload is now put on computer, including all of his charts and graphs... work previously done by hand with far less satisfactory results.'

"See," Bryce said. "I can't wait to get my hands on one!"

"Me neither," I said as the train pulled into the next station, "only I've got one small problem."

"What's that?"

"I don't know what to do with it when I get it!"

Although Bryce knew that I wasn't joking, he couldn't help laughing at my confession. He was still chuckling when the new passengers climbed aboard. Among them was Sally Peters. Sally is a purchasing agent with a metal refinishing outfit and both Bryce and I know her and her husband from when they used to live in town.



# Radio Shack Presents The Micro Executive Workstation

- Powerful Built-In Software
- Retains Memory Data When "Off"
- Self-Contained Telephone Modem
- 8K RAM—Expandable to 32K



Only  
**\$799**

Cat. No. 26-3801

## Introducing the TRS-80® Model 100 Portable Computer —User-Friendly Software Makes it Truly Revolutionary

Imagine a computer on your desk so small, it can fit in your in-basket. The second you turn it on, imagine seeing a menu of built-in executive management programs and your own files, ready for immediate use. All revealed on an eight-line by 40-character LCD display positioned just above a full-size keyboard. And when you leave the office, imagine a three-pound computer you can take along, because it works on AC or batteries.

Stop imagining. The new TRS-80 Model 100 is the computer you've been waiting for. As a desk organizer, it's a phone directory, address book, appointment calendar and telephone auto-dialer. It's a personal word processor, as well. There's even a built-in modem to access other computers by phone.

Come see the most revolutionary computer since the TRS-80 Model I at over 6500 Radio Shack stores and participating dealers, including over 400 Radio Shack Computer Centers nationwide.



Send me a free Model 100 brochure today!

Mail To: Radio Shack, Dept. 83-A-522  
300 One Tandy Center, Fort Worth, Texas 76102

NAME \_\_\_\_\_  
 COMPANY \_\_\_\_\_  
 ADDRESS \_\_\_\_\_  
 CITY \_\_\_\_\_ STATE \_\_\_\_\_ ZIP \_\_\_\_\_  
 TELEPHONE \_\_\_\_\_

**Radio Shack®**  
 The biggest name in little computers®  
 A DIVISION OF TANDY CORPORATION

Retail prices may vary at individual stores and dealers.





# RUGGED. COMPACT. PORTABLE.



STIEGMAN

The KAYPRO II, our powerful, inexpensive, professional little computer, will help you reach new heights of productivity and creativity. To make your ascent even easier, we throw in a strong package of software that includes word processing, statistical or financial modeling, list database, spelling checker, two high-level programming languages, and the popular CP/M operating system.

And if that weren't enough, the KAYPRO II is fully portable. Just flip up the keyboard, click the latches, grab the convenient carrying handle, and away you go. The KAYPRO II is at home on the most crowded desk, lab bench, library carrel, or kitchen table. It's perfect for field applications, and it even fits under the average airplane seat. Who says you can't take it with you?

At only \$1795 including software, though, the most impressive thing about our computer may be its down-to-earth price. You could throw away our software package and substitute your own, and you'd still be paying half of what a competitive machine would cost. Give it some thought, then ask your local computer dealer to give you the rest of the story. We think you'll find it rather interesting.



**KAYPRO**  
The personal portable

The KAYPRO II Portable Computer: 64 k RAM, 9" green phosphor monitor, 191 k storage on each of two double-density disk drives, CP/M 2.2 operating system, software: \$1795, complete.

CP/M is a registered trademark of Digital Research, Inc.

Kaypro, Div. of Non-Linear Systems, 533 Stevens Ave., Solana Beach, CA 92075, (619) 481-3424

# **EXXON** **Office Systems** **presents** **the future...** **without** **the shock.**

Guiding an office into the future can be a very shocking experience, especially in the ever evolving world of office automation.

But at Exxon Office Systems, we've worked hard to take the high anxiety out of high technology. You see, we've brought the high-tech office down to earth by designing it to grow the way you grow.

For instance, you can start an office automation system simply with just one of our remarkable EXXON 500 Series Information Processors.

Then as your needs grow you can expand, workstation by workstation, cluster by cluster, up to a fully functioned, shared resource office automation system ... The EXXON 8400 Series System. And that means you'll never face the shock of owning expensive word processing equipment that's obsolete because it can't expand.

The EXXON 8400 Series System's fully functioned capability is awesome. Operators can create, edit, reformat, file, share and retrieve documents, all with

# This is one information processor



## that really can be the start of something big.



simply the touch of a key.

There's a dictionary to check spelling automatically. An electronic mailbox for sending messages. A program for keeping calendars and scheduling meetings. A tickler file with an electronic signal to alert you to appointments, and more.

The EXXON 8400 System features an advanced central controller/microprocessor. Its upgradeable storage can hold up to 235,000 pages of typed material and supports up to sixteen systems, archiving or

stand-alone workstations.

Start automating your office now with one of our EXXON 500 Series Information Processors. And step into the future without the shock of unnecessary costs from expanding or upgrading inefficiently.

For more information on the EXXON 500 or our new upgradeable and expandable office automation system, just send in the coupon below.

Or call **800-327-6666**. Available now in the New York Metro area.

**EXXON** OFFICE  
SYSTEMS  
The future...without the shock.

Exxon Office Systems MHN 05 83  
P.O. Box 10184, Stamford, CT 06904

I'd like to know more about

- the EXXON 500 Series Information Processor  
 the EXXON 8400 Series System

Please have your representative call.

Name \_\_\_\_\_ Title \_\_\_\_\_

Company \_\_\_\_\_

Address \_\_\_\_\_

City \_\_\_\_\_ State \_\_\_\_\_ Zip \_\_\_\_\_

Telephone \_\_\_\_\_

**800-327-6666**  
IN CONNECTICUT, 800-942-2525.

if it's really important to you, you can learn the exact scientific explanation of what that means, but it really isn't necessary."

"Then how come you learned all that stuff?" I asked.

"Well, it's a funny thing," he said, "but I didn't consciously set out to learn it...I sort of acquired it. You'll see ...the same thing will happen to you."

As it turns out, Bryce was right: I *did* come to learn all about bits and bytes and everything else that seemed so mystical that morning on the train. But what I *really* wanted to know was how were all those bits and bytes going to help *me*? It's one thing to understand what a computer *is*, but it's something else again to understand what a computer *does*.

When I got to the office I asked Julie to get John Lathrop for me on the phone, and then to hold my calls. Today, I had decided, was 'Teach Al Roberts About Computers Day.'

Lathrop didn't sound too happy to hear from me, but I told him it was important that he come to my office as quickly as possible. He did.

"Lathrop," I said, "I need your help. Are you willing?"

"Sure," he replied. "As long as you clear it with Mr. Bradshaw."

"Oh, Bradshaw won't mind," I assured him. "In fact, by helping me, you'll be helping him too. The real question is are you *able* to help me?"

"That depends, Sir. What is it that you want help with?"

"Computers. Yesterday was a terrible waste of time, and I got the feeling that it was particularly frustrating for you because you, unlike me, knew exactly how a computer could have helped us."

"That's true," he admitted. "We could have knocked that project off in a matter of minutes. All we needed was a micro and a standard spreadsheet program. In fact, when I was in school we..."

"Wait a minute! Stop right there!" I exclaimed. "That's just the point, John. I don't know what a 'micro' is, let alone a 'standard spreadsheet program.' In fact, I just learned about RAM and ROM this morning. We're going to have to take this real slow."

"Okay," John smiled. "I get the picture. But if we're going to do this right, this is the wrong place to be doing it. We should go to one of those computer stores. There's one about ten blocks from here, and if we go over now, it'll probably be pretty empty."

"Julie," I said into the intercom, "Call Bob Bradshaw and tell him I've kidnapped Lathrop. Tell him I'll

return him unharmed by the end of the day."

"Yes Sir," she said, and we were off.

The place John took me was exactly as he described it: a computer "store." I had passed by it several times before, but I never actually looked inside. I guess I thought it was just a place to buy video games, but I got over that notion in a hurry. There must have been fifty computers on display, ranging from the kind you hook up to your own television set to little portable units that you can use anywhere ...even on airplanes.

John apparently knew Ted, the manager, from his previous visits, and he explained why we were there.

**“OK,” I SAID, TAKING MY SEAT IN FRONT OF THE MACHINE, “HOW DO I TURN IT ON?”**

"You've come at a perfect time," he said. "We get pretty busy around lunch time, but right now, I can give you all the help you want. For starters, why don't you tell me what you do for a living, and give me a couple of your 'typical days.'"

I spent about fifteen minutes describing my job, and then Ted made two observations: one, that every day was different from the day before, and the other, that most of the numbers work I did involved analyzing the same data (for example, sales of a particular inventory item) over and over again for each of the different sales areas. He also ascertained that the 'generation of the primary data' (for example, the sales figures themselves) were provided and reported for me by the appropriate sales reps.

"You," he finally said with a big smile, "are ripe for computerization."

"Great," I said. "So computerize me."

"First," he said, "I'm going to *software*-ize you. One of the biggest mistakes people make is to buy a computer...what we call the 'hardware'...first, only to find that the programs for the things they want to do aren't available for their machine.

"In your case," he continued, "the software you want is among the most popular made. For example, you'll

want something called an electronic spreadsheet program. These are sold under several different brand names."

"What do they do?" I asked.

"Rather than explain it," he said, "why don't I demonstrate it? In fact, why don't you demonstrate it to yourself?" With that he led me across the floor to a row of computers.

"Take your pick," he offered. "They're all equipped to handle spreadsheet programs."

I surveyed the machines and ultimately selected one that I had seen advertised before.

"Okay," I said, taking my seat in front of the machine. "Now what?"

"Turn it on."

"How?" I asked, and both Ted and John couldn't resist laughing.

"It's really tricky," Ted cautioned. "You push the 'on' button."

"Careful, Ted," I joked. "I can get your friend Lathrop fired in two seconds flat." I pushed the button.

"Now what?"

"Now you load the program."

I was beginning to feel like Luke Skywalker in "Star Wars." My pulse actually quickened.

"How?" I asked.

"Insert this diskette into the disk drive."

Now, I had heard the terms 'disk' and 'disk drive' before, but this was my first hands-on experience with them. The diskette, or 'floppy disk' as it is sometimes called, looked like one of those old viewmaster disks, only a diskette is a little bigger—about five inches square. I say 'square' even though it's a disk because the disk stays in its little paper cover...kind of like a miniature record album...even when you insert it into the disk drive housing. Inserting it is easy enough...you just push it through a slot, like mailing a letter. When you've pushed it in as far as it goes, you pull a little tab down over the slot to lock it in. The whole process takes about three seconds.

"Okay," I said, feeling rather proud of myself. "Is it loaded?"

"Almost," Ted said. "All you've got to do is push a few buttons."

Every computer has a different keyboard, but they're all basically the same. They look and feel very much like an electric typewriter keyboard, but there are a few extra keys. On the machine I had selected one of these extra keys is marked 'RESET,' and that's the key Ted told me to push first. Then he told me to push a key marked 'CTRL' (for control) while pressing the 'p' key. Finally, he had me push 'RETURN,'

# "Hyatt was a pioneer of local area networks. When Datapoint introduced the first one, we ordered."

—Bob Regan  
V.P. Management Information Systems  
Hyatt Hotels Corporation



"Local area networks are the hot topic in data processing these days. But they're nothing new to us," says Hyatt's Bob Regan. "Ours have been up and running for five years."

When Datapoint introduced the first local area network, the ARC® system, in 1977, Hyatt was among the first to install it. Today there are approximately 5,000 ARC local area networks in use, far more than any competing system.

"One reason the ARC network has been so effective for Hyatt is because it's easy to expand," says Regan. "Hyatt has had phenomenal growth, and the ARC has kept up. When more people needed the system to do more work, we simply added to the network."

The ARC local area network can be expanded virtually without limit by simply plugging in additional Datapoint processors, printers, storage disks, and terminals. Each new processor adds power to the

network so new users get the same fast response the original users were getting. Companies can closely match the power of an ARC system to their needs, expanding in small, inexpensive increments instead of buying "more computer than they need" in order to have room for growth.

What's more, Datapoint systems can be expanded or upgraded without replacing software. "We run some programs on ARC networks that were originally written for our first Datapoint computer more than ten years ago," says Regan. "That means we didn't lose any of the money we invested in programming and training. And it made the growth steps easy on our people. The changeover to the ARC network was accomplished in only two days."

No matter how far an ARC system is expanded, all the users can have access to all the data except where security precautions are installed. So even though more and more people are using more and more computers, there's never a

need to duplicate files.

"At present, Hyatt operates forty-five ARC systems," Regan says. "Others are in the planning stages right now. On the operations side we use them for accounting, reservations, and group sales. At Corporate we use them for accounting and for systems development. Obviously, we depend on them heavily. They're like the meters where we check our own financial performance. They simply have to work. And they do."

"Hyatt has stayed with the ARC system because it's been cost-effective. That's the bottom line. I can recommend a certain system to a hotel, but in the end, the system has to sell itself. And keep selling itself after it's installed. Our Datapoint ARC systems have done that."

For more about Datapoint, call (800) 531-5639. In Texas, call (800) 292-5099. Telex 767300 in the U.S.; 06986622 in Canada; or 923494 in Europe (UK). Or write Datapoint Corporation, Marketing Communications T41PM, 9725 Datapoint Drive, San Antonio, Texas 78284.



# DATAPOINT

and instantaneously the screen lit up. From left to right there were four columns, marked A, B, C and D. From top to bottom there were twenty lines, each appropriately numbered.

"Does that look familiar?" Ted asked.

"Sort of. It looks more or less like the format of one of my sales forecast worksheets."

"What would be required to make it look *exactly* like your sales forecast charts?"

"Well, for one thing, I need more than twenty rows. I've got fifty marketing areas that I do projections for."

"That's no problem," John volunteered, and by pushing a few buttons, an additional thirty lines appeared along the left hand side of the screen.

"You can add more columns, too," Ted said, "but obviously you're limited by the width of the paper that the computer will ultimately print out on."

"Okay. That makes sense. But how do I assign names to the rows and columns?"

"You just type them in. It'll take you all of about thirty seconds to learn," Ted said, and he was right. When you want to enter words or numbers into a computer, you have to place a little blinking light called a "cursor" in the position where you want to put your entry. You place the cursor into position by pushing certain keys on the keyboard: some make it go up and

down; some make it go left and right. Using these keys, you can position the cursor virtually anyplace on the screen in just a matter of seconds.

"Okay," Ted said when I had aligned the cursor with the first row. "What do you want to call that row?"

## **"FOR THE FIRST TIME, I WAS STARTING TO APPRECIATE THE PRACTICAL APPLICATION OF THE COMPUTER."**

"Well, all of our marketing areas have names and numbers. Unfortunately, the numbers don't coincide with the names alphabetically, which has always been sort of a pain in the neck, but usually I make my charts by market area name, in alphabetical order."

"In other words," Ted figured, "if you were to put your market areas in fifty rows in alphabetical order and then were to put the appropriate numbers next to each one, the numbers would read something like 12, 22, 45, 13 and so on, instead of 1, 2, 3, 4 and so on?"

"That's right. It's not really a big deal, but it is a nuisance since sometimes we do analyze the data by market area number."

"And don't you ever analyze the data by a sales rep's name, too?" he asked.

"Oh, sure," I replied, "But that's a whole other story."

"It doesn't have to be," Ted said, smiling. "That's one of the beauties of a program like this. You can enter your sales data under several different code names at once, so that you can analyze it any way you want to."

For the first time, I was starting to appreciate the practical application of the computer.

"In other words," I asked, "once I have this thing fed properly, I can find out sales either by market area name, market area number or sales rep's name just by pushing a few buttons?"

"That's the whole idea," Ted said. Now I was smiling, too. "But wait a minute," he continued. "As they say, you ain't seen nothin' yet."

"Go on," I encouraged.

"Let's go back to your sales fore-

casting example. I would imagine that in the sporting goods business your sales are variable by season, right?"

"Sure," I replied.

"Well, I'm just guessing, but I would imagine that it makes forecasting a bit difficult. I mean, don't you find that the percentage by which you anticipate sales varies by quarter, depending on the seasonality of the product in question?"

"Sure it does," I replied, "but we sort of fudge over that. It's hard enough to do projections on an annual basis, let alone do quarterly ones that are adjusted for seasonality."

"But would it be helpful to you if you could have that information?" he asked.

"Let's put it this way," I said. "It would be a luxury, not a necessity. I mean, it *would* allow me to forecast more reliably, and it *would* help the sales reps figure which products to put more time against..."

"So it's something you'd like to have, then?" he concluded. "Because it's something that the computer can figure out for you in just a few seconds. And it can figure it for you by market area, by sales rep, by sales district or by any other classification you want."

"That's unbelievable," I muttered.

"And that's still just the tip of the iceberg," he went on. "Suppose you do a dollar forecast for your entire product line for the year. Now, the computer will save you a lot of time and effort, but you still have to do *some* work, and doing that type of analysis *does* require a lot of input. Anyway, let's say that you've completed your analysis and you've got it all printed out, and then someone tells you the bad news that the prices on six of your items are going to be increased, each by a different percentage. Under your current method of forecasting, what would happen?"

"I'd get an instant migraine headache," I replied, "then I'd go back to the drawing board and recalculate everything. It would take days."

"Not anymore," Ted said, flashing that grin again. "With this program, it would take minutes."

"There are other ways you could manipulate the data, too," John offered. "For example, suppose that after you get the whole forecast completed you find out that marketing has increased the ad budget for several of the items and as a result we anticipate an x percent increase on those items. Obviously, that's going to change your entire forecast, not only for the items in question, but for the

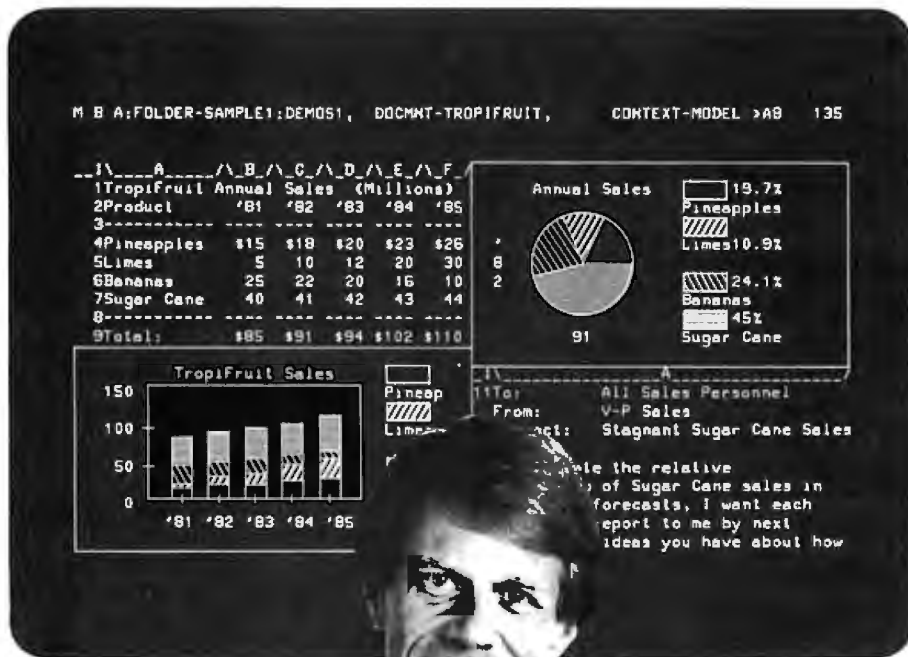


# IBM

2½ minutes

# HP

30 seconds



## Hewlett-Packard's new personal computer is up to 5 times faster than IBM's. And half the size.

Take two personal computers: Hewlett-Packard's new Series 200 Model 16 and the IBM PC. Run the same software—Context/MBA™—and solve the same problem.

You'll see one big difference. It takes the IBM minutes to do what the HP 200 can do in seconds\* And that's just the beginning.

With Context/MBA™ integrated software, the HP 200 can do word processing, spreadsheet projections, indexing, filing and graphics all at one time. Change one number in a projection... and the graphs change, automatically. It's that easy. And with the HP 200, it's just about that fast.

Because, with its super-powerful MC68000 micro-processor, the HP 200 can address 32 pieces of information at

one time. (Twice as much as the IBM.) And it's got the memory to handle big, complicated problems. (You can have as much as 768Kb.)

But for all its power, the HP 200 is surprisingly small. The whole computer, not including the keyboard, measures just 12" across by 13" deep. So, putting a personal computer on your desk doesn't mean taking everything else off.

If you'd like to see how the HP 200 measures up, call (800) 547-3400. (In Alaska, Hawaii and Oregon call (503) 758-1010 or TTY (503) 758-5566.) Ask operator #441 for more information and the name of the HP dealer or sales office nearest you.

 **HEWLETT  
PACKARD**

TC-02310

\*Recalculating and refreshing a screen with words, numbers and graphics. Both ran equivalent Context/MBA™ programs. Context/MBA™ is a trademark of Context Management Inc. IBM is a trademark of International Business Machines.

line in total. With this program, you can automatically calculate the effect that changing one variable will have on the entire forecast."

"In other words," I said, trying to grasp the full implications of this incredibly powerful device, "I can play 'what if' games all day long."

"That's right," Ted agreed. "And that's exactly what more and more executives are using p.c.'s for. They really let you explore options. And you can just imagine how these things have changed the lives of people in the financial community! Number crunching is a thing of the past."

**"I'VE HEARD ABOUT WORD PROCESSORS, BUT I THOUGHT THEY WERE COMPLETELY DIFFERENT MACHINES."**

"But they help you do more mundane things, too," John added. "For example, there's a program called a 'data base management system.' It allows you to manipulate or 'play with' huge collections of individual pieces of information."

"Like what?" I asked.

"Like your inventory. Or like your customer names and addresses. With a DBMS you can organize all of your accounts, say, alphabetically, or by volume, or by earned discount, or by terms, or by any other variable that would be useful to you."

"For what type of practical application?"

"Let's say that you have a certain type of promotion which you feel only customers doing a certain minimum volume would be interested in. Rather than culling through all of the accounts manually, or requesting each sales rep to file a report, you could simply ask the computer to do the work for you and present you with a list of qualifying accounts. You could then write each customer a personal letter, explaining the promotion in terms of their specific stores' sales, and even have the mailing labels printed up...all by computer."

"You're right...that *does* sound pretty exciting. My secretary would be happy to have one of these com-

puters, too!"

"Don't laugh," Ted said. "You would be amazed at how a computer can increase your secretary's efficiency, especially if you get a word processing program."

"I've heard about word processors, but I thought they were completely different machines."

"Those are called 'dedicated' word processors," Ted explained, "and those *are* completely different machines. In effect, a dedicated word processor is a computer that 'specializes' in word processing. The alternative is getting a word processing program. That's a diskette, just like a spreadsheet program, that allows your computer to function as a word processor when you want it to, but allows it to turn back into a computer when you need it to."

"So what's the advantage of a dedicated word processor, then?"

"The advantage is that they are customized to handle only word processing problems, so they are somewhat easier to operate and they can perform more word processing tasks than diskettes. In that sense, if you know that you'll never want to use your computer for anything other than word processing, a dedicated machine makes sense. But in your case, I'd recommend a conventional microcomputer with a couple of word processing programs."

"Why do I need a couple of word processing programs? Isn't one enough?"

"One is enough to perform basic word processing tasks," he advised, "but as with other applications programs, the software inventors weren't content to leave it at that, so they invented programs which automatically scan what you've written and point out the misspelled words."

"You're kidding!"

"Nope," he continued, "they've even got programs which point out trite phrases in your text and offer alternative ways to say the same thing."

"Now *that* I find scary," I said.

"If you think you find it scary, how do you think professional writers feel about it?" he said. But after we had our laugh, he went on to point out that word processors have done more, literally, to change the lives of people who write for a living than any invention since paper and pencil.

"A writer can edit, change words, even move whole paragraphs around in just seconds. And when he has everything just the way he wants

it, he just pushes a button and it prints itself automatically. Why, the storage implications alone are worth the price of the machine...volumes of words can be stored on a five-inch diskette."

"Well," I said, "I'm hardly what you would call a professional writer, but I certainly can see the advantage of having a word processing program. I mean, even for routine salesforce memos and inter-office communications I can see how one would be helpful. Are they expensive?"

"Not at all," said Ted. "In fact, depending on the machine, you might even get a word processing program included in your basic diskette set. Spelling correction programs, though, are sold separately and range from \$75 to \$200. Like anything else, if you use it, it's worth the price. But if it's just going to sit around, it's a waste of money."

"Speaking of money," I continued, "what's the price range on these beauties?"

"Well, let's see exactly what we've got. The prices on the microcomputers you've been looking at here are all in the same basic price range, anywhere from \$1,200 to \$6,500 depending on what we call the 'peripherals.' Peripherals include things like disk drive units, printers and graphics systems. For example, there are printers that can give you a wide range of type faces and sizes. Or graphics systems that allow you to print out multi-colored charts and graphs."

"But basically what you're telling me is that I can get a perfectly adequate computer set-up for somewhere in the \$5,000 price range."

"Easily," Ted said. "And remember, that's including the disk drives and the CRT as well as software."

"CRT? What's that?"

"It stands for cathode ray tube. It's simply the monitor that you use in conjunction with the micro. In many cases, you can just use a TV set instead. In fact, there's one little computer that costs less than \$100! It doesn't have much memory...only 1K...but it *is* expandable, and it's a great way to learn about computers at home."

"They even make a modem for it, making it a really inexpensive way to hook up to a data bank."

"Wait a minute," I protested, "Hold it! What's this about data banks and, what was that, modules?"

"Modems," Ted corrected. "Stands for 'modulate/demodulate.' A modem is a device that lets your computer talk to other computers



One more reason to buy your new personal computer at ComputerLand.

**FREE SOFTWARE!\***



©ComputerLand 1983

If you've been thinking about buying a personal computer, now's the time to do it. Because right now, when you buy a personal computer worth \$1500\*\* or more at a participating ComputerLand, we'll give you a valuable software package absolutely free. Select from a wide variety of programs, like word processing and financial planning. Including brand names like WordStar, VisiCalc, SuperCalc, EasyWriter II, Volkswriter, dBase II, T.I.M., Home

Accountant, CP/M, Concurrent CP/M 86, and VisiFile. The personal computer experts at ComputerLand will help you choose the computer that's best for your needs. And they'll back it up with all you need in the way of service, accessories, and support. Plus — for a limited time only — free software! So if you've been considering a personal computer, buy now at ComputerLand. And get free software to boot!

**ComputerLand®**

We know small computers.  
Let us introduce you.™

Over 400 stores worldwide.

For locations call (800) 227-1617, Ext. 118. In California call (800) 772-3545, Ext. 118. In Hawaii or Canada call collect (415) 930-0777.

\* Or its equivalent in value up to 10% of computer purchase price. Valid at time of purchase only. Not valid with any other discounts. Offer ends May 31, 1983. At participating stores.

\*\*\$3000 in Canada.

through the telephone. It 'modulates' ...or puts into sound frequencies... information from your computer so that the audible signals can be carried over the telephone lines. When it gets to the other computer's modem, the information gets demodulated so that the other computer can understand what it's being told. By using a modem, your computer can give you access to huge 'warehouses' of information which are too vast to be stored in a microcomputer, but which can be stored in what we call "mainframe" computers. Mainframe computers are the biggest computers made. They have incredibly gigantic memories. They also have gigantic price tags! Some manufacturers are now making desktop computer terminals which can be hooked up to their mainframes, thereby providing a relatively inexpensive way for companies to take advantage of mainframe capacity. Others are making the information stored in their mainframe computers available to the general public (via modems) for a fee, thereby providing themselves with an opportunity to make some money while at the same time providing a valuable service."

"What kind of information is available?" I asked.

"All sorts of good stuff," Ted enthused. "For example, there are several data banks which offer information of interest to the general public. If you subscribe to one of them, you get your own password. Whenever you want to use the service you simply call them on their WATS line, give your password, and as if by magic a "menu" appears on your CRT. The menu is like a table of contents. The headings are rather general: News, Business, Catalog Shopping, Home and Leisure, Entertainment, and so on. After your initial selection...say you pick Home and Leisure...another menu appears. This selection process goes on until you arrive at your 'destination'...in this case, maybe it's a game or recipe ideas for home entertainment. You then play the game, copy the recipe or do whatever else it is that you've accessed. You can even select one destination called 'chat' which enables you to talk to other computer operators via

your CRT."

"Sounds like fun."

"There's a lot more than fun and games," John pointed out. "For example, there are financial data banks that specialize in business news. In addition to up-to-the-minute stock quotes, you get special security analyses, world economic news, and so on. It's a pretty no-nonsense deal."



"How do they charge you?"

"You're charged only for the time you use, but usually there's an initial fee of about \$100 or so to get your password. Data banks generally charge only about \$5 an hour, but it can really add up, because as they say, time flies when you're having fun."

With that I glanced at my watch and noticed to my amazement it was already after noon.

"I'll say time flies when you're having fun!" I exclaimed. "We've really got to get going. Ted, I can guarantee that we'll do business. In fact, I'll be back to you at the beginning of the week. I can't tell you how much I appreciate the hands-on exposure...I learned more about computers in three hours than I would have learned in three days of reading articles and textbooks."

"I'm glad to help," Ted said. "If only more people would take the time to do what you did this morning, I'd be able to retire in a year. These things sell themselves once people get their hands on one."

With that, we were off.

The rest is history. I wound up getting the \$6,500 package Ted told me

about. Within three months I bought an additional four or five programs, including some graphics software that enabled me to do color graphs and charts. A basic word processing disc came with the computer and I do use it from time to time, but my secretary was so excited about it that we got her a dedicated word processor of her own. She swears she doesn't know how she existed without it.

John Lathrop gained with a bonus of his own, too. It seems that Bob Bradshaw was curious about Lathrop's sudden interest in the sales department, and looked into it. When he discovered that we bought a computer, his competitive instincts got the better of him and before you could say "Holy Central Processing Unit!" the marketing department had a micro of its own. Since Lathrop was the only one on the floor who knew how to drive it, it wound up on his desk. Ironically, he thanks me for getting it for him!

After that, microcomputers spread like wildfire throughout the entire company. Once the Executive Committee found out that the machines could be interconnected to "talk" to each other, we set up our own internal computer network with all of our regional offices...but that's another story for another time.

Al Roberts' story is not unique. In fact, if you're at all typical of American business management you probably noticed a number of parallels between Roberts' anxieties about computers and your own. If you have any interesting computer-related anecdotes, or any examples of how computers have made your life easier, please let us know. Correspondence should be addressed to:

Kathy Kirkland  
Professional/Managerial Network  
McGraw-Hill Publications Co.  
1221 Avenue of the Americas  
N.Y., N.Y. 10020

*Donald M. Klein, the author, is Executive Vice President, Creative Director of MacNamara, Ciapp & Klein, Inc., a New York City advertising agency.*

*Lou E. Frenzel, Senior Vice President, McGraw-Hill Continuing Education Center, served as technical advisor for this article.*

## Where to learn more

1. McGraw-Hill Microcomputer Literacy Program for Executives, Managers and Professionals. Audio cassette and print program covering all aspects of microcomputer operation application and selection. \$95 from McGraw-Hill Continuing Education Center, 3939 Wisconsin Avenue, Washington, D.C., 20016.

2. Crash Course in Microcomputers by L. E. Frenzel. An introductory programmed instruction book that discusses all aspects of microcomputers. \$19.95 available in most book stores or directly from the publisher Howard W. Sams & Co., Inc., 4300 West 62nd Street, Indianapolis, IN. 46206

If You Don't Have A Computer In Your Hands Soon, Your Career May Never Recover

## Save Time, Money, And Confusion With The New McGraw-Hill Cram Course In Microcomputers

You need no longer wait to put the power of a personal computer to work for you. In just 8 days—as little as 45 minutes a day—you can learn how to choose and use the personal computer that is right for pushing your paperwork, for crunching numbers, solving problems, even step up your creativity as you discover new ways to accumulate and look at information.

The Information Age is here! You can either drown, or turn its opportunities to tremendous personal advantage. McGraw-Hill's new Cram Course in Microcomputers is for engineers, executives, administrative managers, engineering assistants, technicians, and supervisors—who are looking for the competitive edge a personal computer will give them but are not exactly sure where to begin.

### Catch Up Fast

But the pressure's really on you to perform. You've got to catch up—fast. Personal computers are already sitting on thousands of desks . . . forecasting, analyzing, word processing. At this moment, nearly everything you are doing at your desk with pencil and paper can be done more efficiently if you use a computer.

With a computer on your desk, you're making an immediate, positive statement about yourself and your commitment to improving your professional efficiency (by as much as 30% according to some experts). You're placing yourself on the fast track for promotion. Your timing is perfect. If there is ever a time to jump into computing . . . a time to get ahead of the pack . . . that time is now!

Quickly, conveniently, and inexpensively, through audio cassette tapes and vivid texts, you'll get a clear understanding of the advantage of having a personal computer on your desk.

You learn just what a computer will do, how it does it, and what's required to make it happen. You'll know how to select the computer that's best for you, without paying too much for excess capacity or committing the probably greater mistake of paying too little for a computer inadequate for your needs.

### What Kind Of Computer To Pick

We'll show you how to identify your computing needs. Then we'll show you how to match your needs against such name brands like IBM, Osborne, Xerox, and Apple.

You do it all with the McGraw-Hill Cram Course in Microcomputers, the program that comes to you. We show you what to expect and what has to be done to perform with speed and efficiency functions like data base management, accessing economic and business information, inventory control, word processing, analyzing and forecasting.



### From The Leader In Explaining And Using Computer Technology

To McGraw-Hill's unique experience as the world's largest educational and business publishers has been added an extraordinary commitment to the field of data base publishing. Combining computers and communications technology with knowledge, data base publishing is the key product of the Information Age. From publishing Byte and Popular Computing magazines—to the recent announcement that McGraw-Hill and VisiCorp just plugged personal computer users into the world's largest library of business information—no one could have acquired better skills to create this immensely useful, timely, one-of-a-kind program.

### PROGRAM OUTLINE

What a personal computer can do for you • Matching a computer to the job you want it to do for you • Comparing personal computers • Identifying the best software for your job • Determining memory requirements • How to be certain that the operating system meets your jobs • Making a choice between floppies, micro-floppies, and hard disks • Strategies for getting started • Follow-up services • Insiders survey of off-the-shelf software • Looking ahead to your office of the future, today.

### PLUS YOU GET ALL THIS

- 7 subject modules
- 6 audio cassette tapes
- 200-page, illustrated accompanying text
- Handsome leather-grain vinyl binder
- Datapro's latest computer comparison report (\$29.95 retail)

The McGraw-Hill Cram Course in Microcomputers starts you at the beginning. No need for any experience with computers, no need to even own one.

### 15-Day Free, No-Risk Examination

This program is something you must see and experience for yourself to appreciate. And you can do it without risk or obligation. Just order by coupon or call toll free and we'll send the complete Cram Course in Microcomputers to you to examine free for 15 days. If you're not absolutely satisfied that this is exactly what you need, just pack everything back in the box and return it. We'll cancel your charge or return your payment immediately.

### TO ORDER CALL TOLL FREE

AND USE YOUR VISA, MASTERCARD, OR AMERICAN EXPRESS  
Call 1-800-323-1717 . . . Ask for Operator 51 . . . Order Program No. 3499-053  
(In Illinois, call 1-800-942-8881)

### McGraw-Hill's New Cram Course in Microcomputers NO RISK, FREE EXAMINATION ORDER FORM

McGraw-Hill Continuing Education Center  
3939 Wisconsin Avenue, NW  
Washington, DC 20016

YES, without risk or obligation, please send me the Cram Course in Microcomputers for a FREE, 15-DAY EXAMINATION. The cost is just \$95.00 plus \$4.75 for shipping and handling. I may return the program within 15 days for a full refund or cancellation of credit card charges.

Name \_\_\_\_\_ Title \_\_\_\_\_  
(Please Print)

Organization \_\_\_\_\_

Street Address \_\_\_\_\_

City/State/Zip \_\_\_\_\_

I've enclosed my check or money order payable to McGraw-Hill Continuing Education Center.

(DC residents add 6% sales tax.) Payable in U.S. funds only.

Charge to my:  VISA  MasterCard  American Express

Card No. \_\_\_\_\_ Expiration Date \_\_\_\_\_

Signature \_\_\_\_\_ Date \_\_\_\_\_

(Credit Card charges not valid unless signed)



# VR DATA ANNOUNCES: THE PRICE WAR IS OVER!!

**SMEG WINCHESTER  
HARD DISK \$995<sup>00</sup>**



**OPTIONAL:  
SMEG REMOVABLE DISK CARTRIDGE DRIVE \$595<sup>00</sup>**

10 MEG — \$1249.      15 MEG — \$1449.  
1 & 10 MEG — \$1999.      15 & 15 MEG — \$2299.  
5MEG DISK CARTRIDGE \$75.00

## ADAPTOR KIT

for IBM-PC/XT \$150.  
for TRS-80 MOD I 150.  
for TRS-80 MOD III 150.  
for LNW-80 150.  
Under Desk  
Mounting Bracket \$34<sup>95</sup>  
1 Year  
Ext. Warranty \$150.

As with our Winchester Hard Disk Drive, all our designs are tested, re-tested and "burned in." We're so proud of our quality control that we offer an unconditional extended warranty covering full costs of parts and labor on all VR Data products.

## INTRODUCTORY SPECIAL PACKAGE

**SAVE \$75.00**

5Meg Winchester  
fixed drive \$995.  
5Meg removable Disk  
Cartridge drive \$595.  
Adaptor  
(your choice) \$150.  
5Meg Disk  
Cartridge **FREE**  
**\$1740.**

# VR data

777 Henderson Boulevard N-6  
Folcroft, PA 19032 (215) 461-5300

Circle 412 on inquiry card.



Call Toll-Free  
**800-345-8102**

ALL VR DATA PRODUCTS CARRY A 120-DAY WARRANTY INCLUDING PARTS & LABOR. Published prices reflect cash discount. All prices are subject to change without notice. TRS-80 and TRSDOS are trademarks of Tandy Corp. DISK III is a trademark of VR Data Corp.  
8:30AM-7PM E.S.T. Mon.-Fri., Sat. 10AM-3PM  
CABLE "VRDATA" TELEX 845-124

# AVL Trees

## *Introducing a Russian-developed scheme for searching and updating sorted data efficiently*

---

W. D. Maurer  
Department of Electrical Engineering  
& Computer Science  
George Washington University  
Washington, DC 20052

---

In most sciences, Russian contributions are well known and respected. Russians, for example, invented the tokamak fusion reactor. Advances in computer science sometimes seem almost exclusively Western, but even in this field the Russians have made significant contributions. One is the so-called AVL tree, a data structure that allows sorted data to be handled efficiently.

Sorting data in alphabetic or numeric order allows a unit of data to be found quickly via a binary or logarithmic search (see figure 1). The computer compares the key to element  $x$ , the desired item, with the key to element  $y$ , an item located halfway between the beginning and end of the table. If the  $x$  key is larger than the  $y$  key,  $x$  is in the second half of the table; otherwise,  $x$  is in the first half of the table. In either case, the search space has been cut in half. Ultimately, this procedure narrows the search space down to two items. The total number of comparisons required to search a table containing  $n$  items is  $\log_2(n) + 1$ . Searching a table containing 1000 items, for example, requires at most 11 steps.

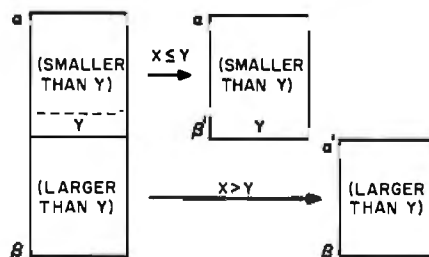


Figure 1: A simple comparison reduces the problem of searching for  $x$  in a sorted array (left) to searching for  $x$  in a sorted array half the size of the original (right).

The trouble with sorted tables comes when they have to be updated. On the average, inserting a new item in a table containing  $n$  elements requires shifting  $n/2$  elements. (It might take more or fewer steps, depending on where the newly inserted element fits in the table.)

Many programs that have to search and update large tables quickly use a hash function to assign table locations to items based on their keys. This technique allows both efficient searching and insertion. But it has a

drawback: data is scattered randomly around the table. This means that the data has to be sorted before it can be printed, a time-consuming process. Many applications require fast performance of three tasks: printing out data in sorted order, finding data, and adding new data. Neither a sorted array nor a hash table will suffice in such a case.

Enter the Russians—specifically, two Russians named G. M. Adelson-Velskii and Y. M. Landis. Writing in a mathematical journal called *Doklady Akademii Nauk* (Reports of the Academy of Sciences), they outlined a tree structure (figure 2) that permits these three operations to be carried out efficiently. The structure became known as an Adelson-Velskii-Landis tree, or an AVL tree for short.

A tree structure is a scheme for storing data in memory. It consists of interlinked nodes, each of which contains data plus one or more pointers to other nodes. A node that is not pointed to by any other node is called a root node; nodes that do not point to any other nodes are called leaf nodes. Each node occupies one or

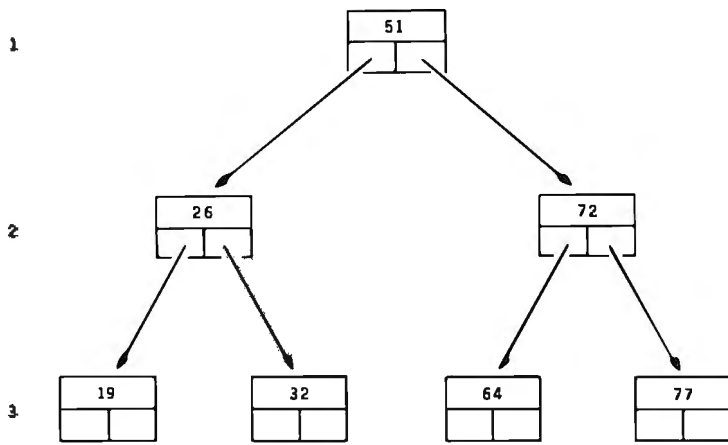


Figure 2: An AVL tree represents sorted data as interlinked nodes.

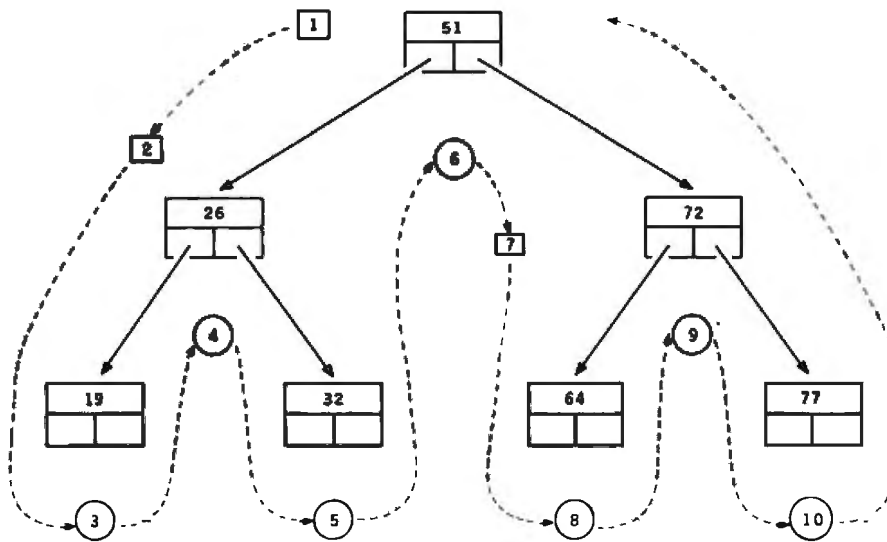


Figure 3: To print an AVL tree in sorted order the computer traverses the tree along the path shown. The circled numbers indicate points at which elements are printed.

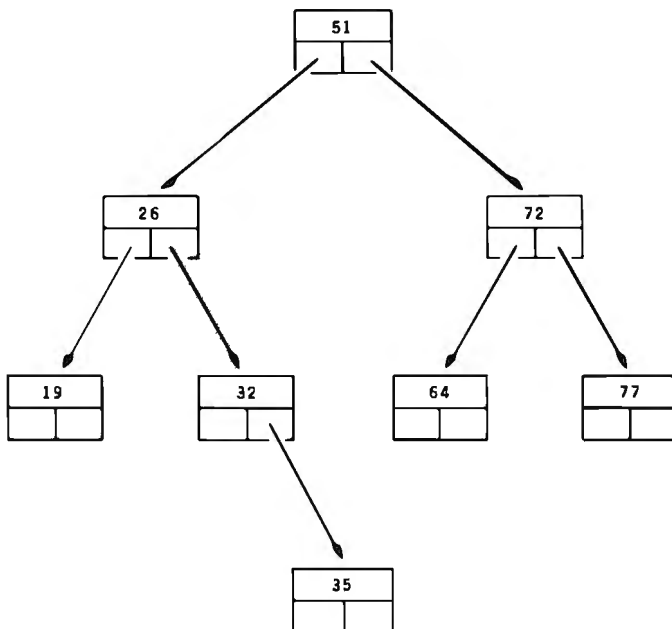


Figure 4: Inserting a new entry into a tree creates a new level.

more consecutive memory locations. A pointer is simply the memory address of a node.

An AVL tree represents the path taken by a computer through a sorted table during a binary search. The root node contains the middle item in the table and also contains two pointers, one to a subtree representing the lower half of the table and the other to a subtree representing the upper half. Each subtree similarly divides its half of the table into further subtree nodes. Searching the tree involves tracing through the branches from the root node to the leaves, comparing the key of the desired item to the contents of the nodes.

For example, to find item 19 in the AVL tree in figure 2, the computer would start with the root node. Because 19 is less than its contents, the computer would search the subtree pointed to by the left pointer. It would continue this process until it reached node 19, which happens to be a leaf node. The computer never searches the same level twice; therefore, the number of search steps is equal to the number of levels:  $1 + \log_2 n$  where  $n$  is the number of items in the tree. Thus, searching an AVL tree is as efficient as searching a sorted table.

Printing out the tree elements in order may be accomplished by tracing through the tree in the pattern shown in figure 3. This scheme entails visiting some nodes twice before printing them out. Hence, printing an AVL tree in order requires more operations than printing out a sorted table. However, it is more efficient than printing out a hash table.

Adding new elements to an AVL tree presents the problem of keeping the tree in balance—that is, with about the same number of levels in the left as the right branch of the tree. A balanced tree has a minimum number of levels and hence is the most quickly searched. A simple procedure would be to tack a new node immediately beneath two adjacent leaf nodes that are smaller and greater than the new node, respectively (figure 4). But this procedure quickly leads to a badly unbalanced tree (figure 5).

Fortunately, trees do not need to be perfectly balanced, as in figure 2; restoring a tree to perfect balance can require a large amount of time. The basic contribution of Adelson-Velskii and Landis was to devise a relaxed definition of a balanced tree that allows efficient rebalancing whenever a new element is added.

They defined a balanced tree as one in which the two subtrees governed by any node never differ in height by more than one level. Specifically, the subtrees may either be equal in height, or the left subtree may be one level higher than the right, or vice versa. In an AVL tree, each node is marked as to which case holds (see figure 6):

- L = left subtree higher
- E = equal heights
- R = right subtree higher

Only two bits are required at each node to hold this balance factor.

To insert a new piece of data into an AVL tree in such a way that it remains balanced, the computer first determines where to put the new datum. This is done by searching the tree for the two adjacent leaf nodes between which the new node fits in sorted order. The new node is then tacked onto the left leaf node, creating a new level, and the balance factors are adjusted appropriately (figure 7).

If the insertion violates the balance criterion, the computer must perform a balancing operation. There are six possible balancing operations, depending on the sequence of balance factors from the unbalanced node to the new node: LL, LRL, LRR, RLL, RLR, and RR (figure 8). For example, the insertion in figure 7 requires an RLR. In two cases, two node positions and three pointers are changed; in the other cases, three node positions and five pointers are changed. When a node position is changed, its balance factor is also changed. Once the balancing operation is completed, the insertion algorithm is finished.

How much time does this insertion algorithm take? It requires  $1 + \log_2 n$  steps to find the place to insert the

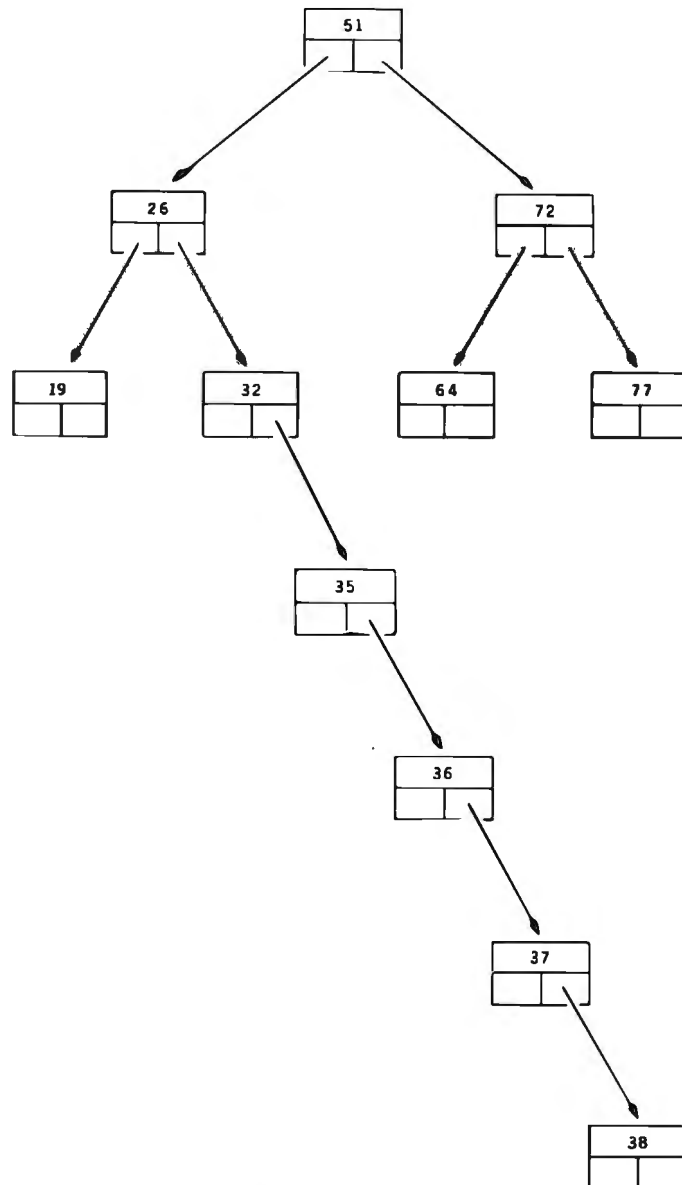


Figure 5: Insertion of new items can lead to an unbalanced tree, increasing the length of a search path.

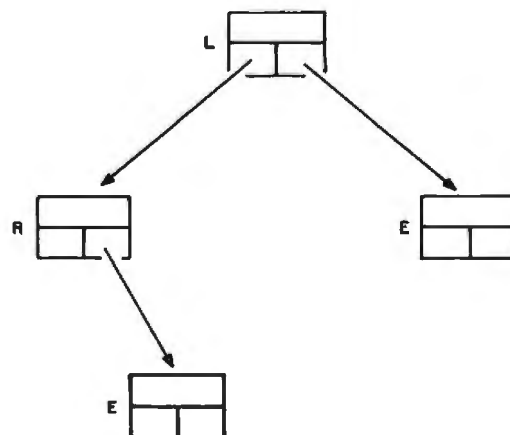
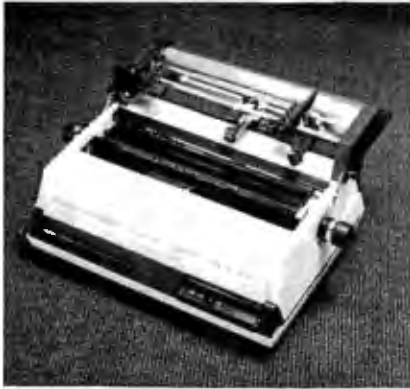


Figure 6: An AVL tree includes factors that enable re-balancing the tree when a new element is added.

# Smith Corona's

# TP-1

A Letter-Quality Text Printer



## \$489.88

With Smith Corona's Rebate  
FREE UPS Ground Shipping

### OUR LOW PRICES GO LOWER!

SCM's TP-1 List Price... **\$895.00**  
Our June Price... **\$539.88**  
Smith Corona's Rebate... **\$50.00**

**THE BOTTOM LINE... \$489.88**

This extraordinary offer is good through the month of June, from the 1st to the 30th *only*.

Specify 10 or 12 characters per inch, and Centronics parallel or RS-232C interfacing. Cables and interfaces available for most popular microcomputers. Call for prices on TP-1 forms tractor.

### QUESTIONS?

**(603) 881-9855**  
Orders: **(800) 343-0726**

All TP-1's sold factory fresh with Smith Corona's warranty (we are an authorized TP-1 service center). Free UPS shipping on all orders. Credit cards accepted *without* any surcharges. Orders are prepaid by certified check, money order or credit card—Purchase orders and/or terms not accepted. COD orders add \$10.

HIGH TECHNOLOGY AT AFFORDABLE PRICES

**THE BOTTOM LINE**

MILFORD, NH 03055-0423 □ (603) 881-9855

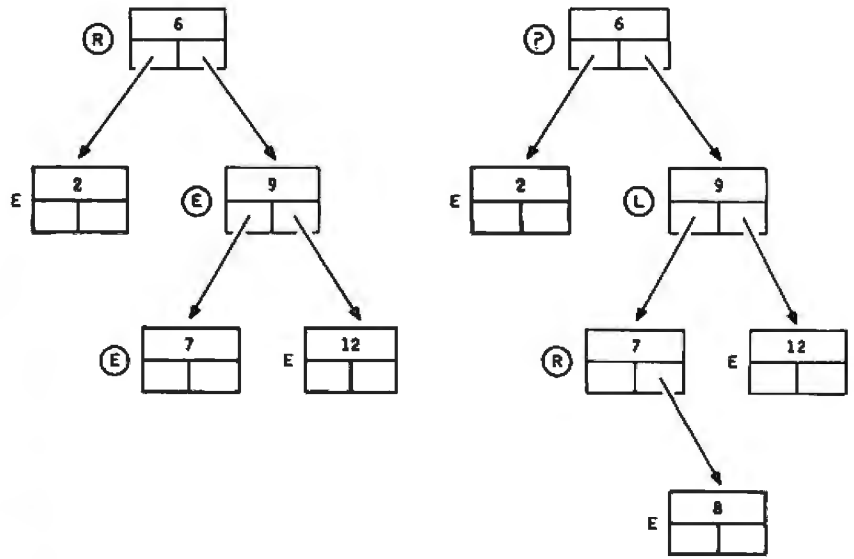


Figure 7: Inserting a new element in a tree (left) requires changing the balance factors.

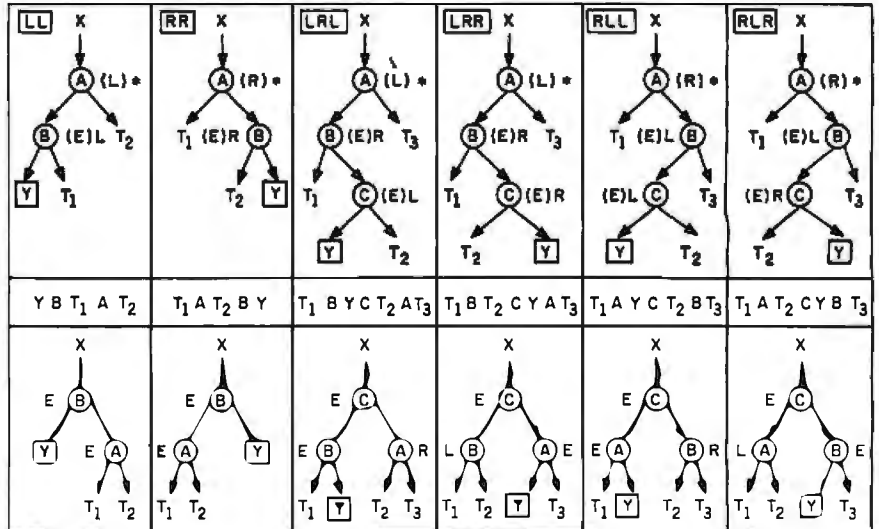


Figure 8: Six possible balancing operations exist, depending on the sequence of balance factors from the unbalanced node to the new node: LL, LRL, LRR, RLL, RLR, and RR.

new item plus a constant amount of time for the balancing operation, if necessary.

This is by no means the end of the study of balanced binary trees. The complete insertion algorithm for AVL trees is given in a high-level language in *Fundamentals of Data Structures* by Ellis Horowitz and Sartaj Sahni (Computer Science Press, 1976). There is a deletion algorithm for AVL trees, which allows one to take data out of an AVL tree in an amount of time that is also proportional to  $\log_2$

$n$ . Then there are bounded-balanced trees, B-trees, 2-3-trees, neighbor trees,  $k$ -trees, and brother trees; a guide to all this forestry is given in the bibliography of "Right Brother Trees" by Th. Ottmann, H. W. Six, and D. Wood, in the September 1978 issue of the *Communications of the ACM*. ■

#### About the Author

W. D. Maurer is a professor of computer science. His latest book, *Apple Assembly Language*, is soon to be published by Computer Science Press of Rockville, Maryland.



# UNLIKE MOST PERSONAL COMPUTERS, THE OLIVETTI M20 HASN'T FORGOTTEN THAT THE MIND HAS A BODY.

The Olivetti M20 personal computer is designed to meet the most demanding needs of your business. It's also intelligently designed to meet the needs of your body, as well.

Begin with the problem of eyestrain. The M20 offers extraordinarily high-resolution screens, both in color and black and white. Not only are the graphics more exacting, but the characters in word processing are more sharply defined.

The display screen can be tilted, swiveled or even removed and placed nearby. So the M20 accommodates itself to your height, posture and work habits.

Even the keyboard is ergonomically designed to have the optimum slant. And it's in the same configuration as your typewriter, so you need not readjust to it.

Or consider the simple matter of time. Waiting for a program to run can be vexing. So Olivetti designed the M20 to be a true 16-bit computer.

What's more, the M20's single-key programming feature can shorten the task of writing software by hours.

But of all the senses the M20 appeals to, it appeals



most strongly to your business sense. To begin with, it offers the flexibility you need in today's fast-changing business world.

It has 128K RAM, enough for most tasks. However, it can be easily expanded to 512K RAM. And, while it comes with a 320K floppy disk drive, an 11Mb hard disk is also available.

What's more, the M20 is flexible enough to run 8-bit software. So the choice of operating systems and storage is yours.

Equally important, the M20 is designed to be expandable in many

ways. It can be linked to

other Olivetti products. Like the revolutionary new PR2300 ink-jet matrix printer, which gives you ink-jet quiet and speed for the price of a matrix printer.

Or, for letter-quality word processing, link it with Olivetti's Praxis 41D portable electronic typewriter.

Yet, with all these exceptional features, the Olivetti M20 is priced in the same range as more ordinary personal computers.

Discover the computer that's intelligently designed to appeal to all your senses. Including your business sense. The M20 from Olivetti.

See your participating dealer for details on the M20 Challenge Sweepstakes

**DOCUTEL**  **olivetti**  
CORPORATION

CALL 1-800-447-4700 FOR THE DEALER NEAREST YOU. IN ALASKA AND HAWAII, CALL 1-800-447-0890.

PLEASE SEND MORE INFORMATION REGARDING:

- ELECTRONIC TYPEWRITERS
- PERSONAL COMPUTERS
- COPIERS  OTHER: \_\_\_\_\_

PLEASE HAVE MY LOCAL DEALER CONTACT ME.

NAME \_\_\_\_\_ TITLE \_\_\_\_\_

COMPANY NAME \_\_\_\_\_

ADDRESS \_\_\_\_\_ PHONE \_\_\_\_\_

CITY \_\_\_\_\_ STATE \_\_\_\_\_ ZIP \_\_\_\_\_

DETACH AND MAIL TO:  
DOCUTEL/OLIVETTI INFORMATION SERVICES,  
1909 E. CORNELL STREET, PEORIA, IL 61614.

**olivetti**  
THE INTELLIGENT CHOICE. BY DESIGN.

Until today, the world's most complete private collection of economic, financial, business, and industry data was accessible only through timesharing.

But now Data Resources, Inc., a McGraw-Hill company, has

# We just plugged personal computer users into the world's largest library of business information.



32. Project next quarter's costs for your business.



58. Track monthly pattern in oil wells drilled.



59. Access Platt's Oilgram data.



71. Evaluate DRI's forecast of government spending.



84. Analyze company model.



85. Analyze price indexes for key insurance costs.



86. Analyze trends in money markets.



97. Analyze critical line.



113. Forecast sales in 21 basic industries.

McGRAW-HILL PUBLICATIONS CO.  
McGRAW-HILL BOOK CO.  
McGRAW-HILL INTERNATIONAL BOOK CO.  
McGRAW-HILL BROADCASTING CO.  
McGRAW-HILL INFORMATION SYSTEMS CO.  
STANDARD & POOR'S CORP.  
DATA RESOURCES, INC.



joined forces with VisiCorp, a leading personal computer software company.

With the new VisiLink™ software, your personal computer can tap into DRI's mainframe computer over an ordinary telephone circuit. From the VisiLink electronic catalog, you

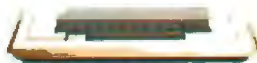
can order DataKits™—preformatted packages of historical and forecast data that you can manipulate in VisiCalc® worksheets—like the examples shown below.

With this new wealth of information available in offices and homes, the decision-making process in

America has just been changed for good—and for the better. For more details regarding the VisiLink program and DataKits, visit your local computer store, or write: Room 369-B, McGraw-Hill, Inc., 1221 Avenue of the Americas, New York, New York 10020.



6. Compare your business to U.S. economic trends.



7. Analyze DRI's forecast of inflation, unemployment.



8. Analyze DRI's forecast for housing starts.



9. Forecast various energy prices.



33. Monitor Dodge construction activity by region.



34. Examine monthly changes in paper prices by grades.



35. Track weekly rail shipments by traffic category.



36. Examine the impact of inflation on your business.



37. Evaluate...



61. Monitor activity for 8 agricultural commodities.



63. Compare yields of various money market instruments.



64. Calculate...



87. Evaluate arbitrage across foreign currencies.



88. Compare performance of over 5000 companies.



89. Compare performance of 180 industry aggregates.



90. Monitor changes in disposable income in Brazil.



91. Conduct analysis...



114. Analyze inflation rates in Mexico.



115. Measure daily portfolio performance.



116. Access Standard & Poor's Compustat® data.



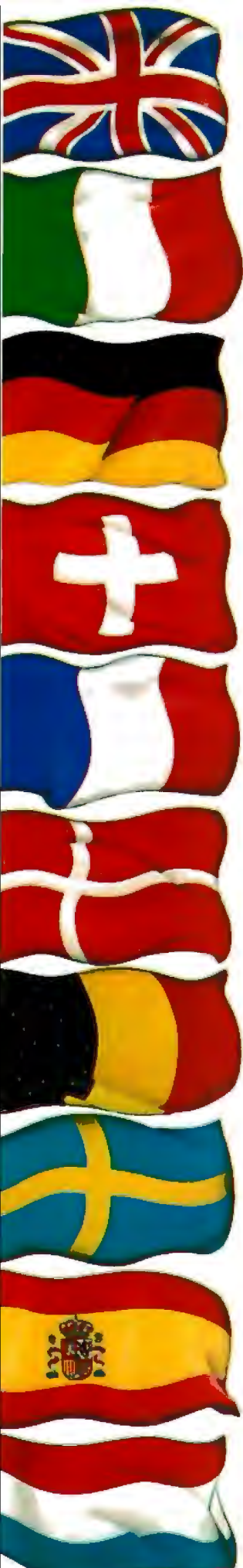
117. Compare your business to industry trends.



VisiLink™ and VisiCalc® are trademarks of VisiCorp./DataKits.™ Dodge® and Platt's Oilgram News® are trademarks of McGraw-Hill, Inc./Compustat® is a trademark of Standard & Poor's Corp.

# Information that leads to action.®

Circle 240 on inquiry card.



# Announcing the fastest door-to-door delivery service to and from Europe.

## Emery First Class International Service.

No matter what the value, size, or weight of your air shipments, Emery provides the fastest regularly scheduled door-to-door service available between most U.S. and major European cities. To most cities, we can deliver door-to-door in as little as 48 hours. From New York, we can deliver as quickly as overnight to major European cities. That includes everything from letters to packages to heavy cargo.

Emery offers you a total range of services from customs clearance to notifying your customer of the time of delivery, all for one basic price. For just a little more, you can even get proof-of-delivery and full documentation.

So the next time you want the fastest scheduled door-to-door service to most of Europe, ask for Emery First Class International Service. Call your local Emery office for details.

**Send for your free Emery  
First Class International Service  
Shipping Kit today.**

Mail coupon to:

Emery

P.O. Box 4036, Woburn, MA 01888

Name \_\_\_\_\_

Title \_\_\_\_\_ (Last) (First) (Middle Initial)

Company \_\_\_\_\_

Address \_\_\_\_\_

City \_\_\_\_\_ State \_\_\_\_\_ Zip \_\_\_\_\_

© Emery Worldwide 1983



**Time after time,  
no one delivers like Emery.**

Circle 143 on inquiry card.

# Build a Simple Light Pen for the Apple II

*Avoid complex hardware with the strategic use of software.*

---

David J. Lilja  
243 Acalanes Dr., #3  
Sunnyvale, CA 94086

---

You can use an inexpensive light pen instead of keyboard entry or an expensive digitizing tablet to control the Apple II's extensive graphics capabilities. In this article, you'll find a light pen design that relies on software to do most of the work, keeping the hardware simple.

The light pen in this design consists of a photodetector that senses light emitted from the video display screen. The hardware provides a logic-level input to the computer—an input at one level when no light is detected and another level when it is. To determine the location on the screen to which the light pen is pointed, the computer plots a bright block at a known location on an otherwise black screen. It then checks the light-pen input to see whether the pen detected the light. If it did, the computer then knows the pen's location (the location of the block). If the pen did not detect the block of light, the computer moves the block on to another location and checks again. It continues in this fashion until it finds the pen or has searched the entire screen.

## Uses of the Light Pen

The light pen serves two main purposes. The first is simple menu selection. When the display presents a list of possible alternatives, the user can merely point at one with the light pen rather than type in a choice. This capability eases selection for the inex-

perienced computer user and provides fewer opportunities for error than do other methods.

The second, and perhaps more important, task for the light pen is to input graphic information to the computer. The user can merely draw a figure on the screen to be stored in the computer's memory. This method is much easier than trying to define a complex figure by specifying coordinates via the keyboard.

## Operation of the Apple II

You must understand the way the Apple II displays graphics to successfully use the light pen. The system has two graphics modes: high resolution (high-res) and low resolution (low-res). Both are bit-mapped, generating video information from data in specific locations in memory. The low-res display shares 1K bytes of memory (from hexadecimal 400 to 7FF) with the standard text display. This configuration provides a 40 by 40 array of blocks with four lines of text at the bottom. The high-res display occupies an 8K-byte block of memory (from 2000 to 3FFF), which provides a display of 44,800 dots in a 280 by 160 dot array. A program can move between these two modes by referencing a certain memory location. When the light pen is used, the main display is the high-res screen, but the search for the light pen is done on the low-res screen.

The computer must search the en-

tire screen each time it looks for the light pen. This method allows you to place the pen at any point on the screen at any time as well as move the pen away from the screen without causing the computer to lose track of where the pen is pointed.

A program I wrote in Applesoft BASIC that can accomplish this entire screen search proved extremely slow, taking 10 to 15 seconds to locate the pen in the worst case—much too slow to be useful.

To speed up the search, I tried rewriting the program in 6502 assembly language. At first, the resulting program ran too fast. It would write data for a block to a memory location in the low-res buffer area, check the pen input, determine that it had not detected the block's light, and then erase the block and move on to the next location. The video display's update rate, nominally 1/60 of a second (16.7 milliseconds), proved to be the problem. The computer, running very fast, would write the block data, check the pen, and erase the block before it could be incorporated into the video stream and be actually displayed on the screen. The solution was to insert a delay between plotting the block and checking the pen to allow time for the block to be displayed. Unfortunately, the shortest delay time that seemed to work was about 4 ms, and therefore scanning the entire display took about 6 seconds.

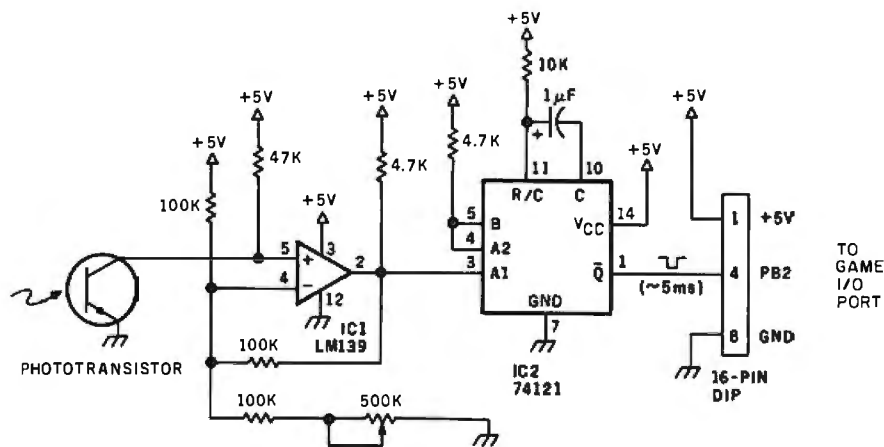


Figure 1: The circuit in the light pen's design uses a phototransistor, which serves as the device's sensing element.

Listing 1: The PEN subroutine.

```

PRESS ANY KEY TO CONTINUE

SOURCE FILE: PEN2
0000:      1 ;SUBROUTINE TO FIND LIGHTPEN IN
0000:      2 ; SMALL SQUARE
----- NEXT OBJECT FILE NAME IS PEN2.OBJO
0300:      3      DRG $300
0300:4C 09 03  4 FINDPEN JMP START
0303:      5 *****
0303:      6 * DEFINE STORAGE
0303:      7 *****
0303:00      8 VERT DFB 0 ;HORIZ POSITION
0304:00      9 HORIZ DFB 0 ;VERT POSITION
0305:00     10 SAVEA DFB 0 ;TEMP STORAGE FOR ACC
0306:00     11 HEND DFB 0 ;HORIZ END OF BLOCK
0307:00     12 VEND DFB 0 ;VERT END OF BLOCK
0308:00     13 HSTART DFB 0 ;HORIZ START OF BLOCK
0309:      14 ;
0309:      15 ;DEFINE EQUATES
0309:      16 ;
0002:      17 OFFSET EQU 2 ;"SIZE" OF SEARCH
000F:      18 WHITE EQU 15 ;COLOR WHITE
0000:      19 BLACK EQU 0 ;COLOR BLACK
F800:      20 PLOT EQU $F800 ;PLOT SUBROUTINE
F864:      21 SETCOL EQU $F864 ;SET COLOR SUB.
FCAB:      22 WAIT EQU $FCAB ;DELAY SUBROUTINE
0028:      23 DELAY EQU 40 ;LENGTH OF DELAY
C063:      24 PEN EQU $C063 ;ADDRESS OF PEN
C056:      25 LORES EQU $C056 ;SOFT SWITCHES
C057:      26 HIRES EQU $C057
C054:      27 PAGE1 EQU $C054
C050:      28 GRAPHIC EQU $C050
F836:      29 CLRSCR EQU $F836 ;CLEAR SCREEN
030F:      30 ;
0309:      31 *****
0309:      32 * MAIN PROGRAM
0309:      33 *****
0309:      34 ;
0309:20 36 F8 35 START JSR CLRSCR ;CLEAR THE SCREEN
030C:AD 54 C0 36 LDA PAGE1 ;SET LO-RES, P. 1
030F:      37 ;
030F:      38 ;INIT VARIABLES WITH LIMIT CHECKS
030F:      39 ;
030F:18     40 CLC ;HEND=HORIZ + OFFSET
0310:AD 04 03 41 LDA HORIZ
0313:69 02 42 ADC #OFFSET
0315:C9 28 43 CMP #40 ;A<40?
0317:90 02 44 BCC HOK ;YES
0319:A9 27 45 LDA #39 ;NO, LIMIT TO 39
031B:8D 05 03 46 HOK STA HEND
031E:18     47 CLC ;VEND=VERT + OFFSET
031F:AD 03 03 48 LDA VERT
0322:69 02 49 ADC #OFFSET
032: C9 28 50 CMP #40 ;A<40?
0326:90 02 51 BCC VOK ;YES
0328:A9 27 52 LDA #39 ;NO, LIMIT TO 39
032A:8D 07 03 53 VOK STA VEND

```

Listing 1 continued on page 398

To overcome the problem caused by this slow search time, I changed the program so that the computer instead scanned only a small portion of the screen, an area of 25 blocks in a 5 by 5 array centered at the last-known position of the pen. Because the computer then must scan only 25 locations instead of 1600, search time decreases from about 6 seconds to less than 100 ms. This rate causes noticeable flicker on the display; however, it is not objectionable. This drastic reduction in search time requires a trade-off with ease of use, however. When the computer is searching only a 25-block area, you must slide the pen across the screen so that the computer does not lose track of it. If the pen is not detected in this small area, the computer assumes that the pen is not pointing at the screen and that nothing is changed. The increase in speed outweighs the minor inconvenience of having to slide the pen.

Hardware

The light pen communicates with the Apple using a TTL-level (transistor-transistor logic) signal to the Apple's game I/O (input/output) port, the port through which the game paddles are connected to the machine. To keep hardware requirements to a minimum, the pen's signal is linked through the push-button 2 input (PB2), which connects directly to a 74LS251 data selector. The signal is checked by examining the most significant bit of location hexadecimal C063.

A phototransistor serves as the light pen's basic sensing element. The emitter is grounded, the collector is pulled up to +5V (volts) with a resistor, and light input is used as the base drive. The phototransistor alone doesn't provide the necessary logic levels to drive the input, however; nor is the light from the screen sufficiently bright to completely saturate the transistor and create a solid logic 0.

The complete circuitry needed to make the pen work is shown in figure 1; it can be installed in any appropriate cylindrical housing. The phototransistor's collector is pulled up to +5 V through the 47-k-ohm

# How to dress up your IBM.

Fred Molinari, President

## Low cost data acquisition and control for the IBM Personal Computer.™

Data Translation is fashioning a new look in the personal computer market.

Our new single board plug-ins bring complete analog and digital I/O capability to your IBM Personal Computer.

The complete DT2801 I/O system fits on just one board. It includes A/D with programmable gain, D/A, digital I/O, and a programmable clock and has direct memory access capabilities. The DT2805 features the same functionality, with provision for low level analog input.

With power and performance to match that of the IBM PC, either board provides 12-bits of resolution with over 14kHz throughput rates under BASIC.

And whether your application is in laboratory data acquisition or in industrial process control, you will find both boards highly reliable at a very low cost.

The DT2801 and DT2805 are easy to use. Just plug either one into an IBM Personal Computer expansion slot. No need for separate housing or cables. A screw terminal panel with optional thermocouple cold junction compensation is available for connecting analog and digital input signals.

And they're easy to program. More than 30 I/O functions are accessed with just 3 commands from BASIC. Programming instructions and sample routines are detailed in the comprehensive User Manual.

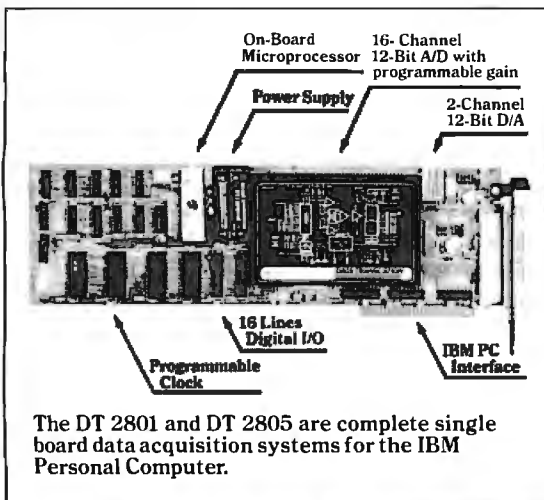
Plus, as with all Data Translation products, the DT2801 and

DT2805 are fully backed by our service and support team.

No other analog I/O system for the IBM Personal Computer offers such quality, power, and performance for such a reasonable price.

But, by now you probably expect that from Data Translation.

We don't just follow the latest trends. We set the style.



# DATA TRANSLATION

World Headquarters: Data Translation, Inc., 100 Locke Dr., Marlboro, MA 01752 (617) 481-3700 Tlx 951-646.

European Headquarters: Data Translation, Ltd., 430 Bath Rd., Slough, Berkshire SL1 6BB England (06286) 3412 Tlx 849-862.

IBM Personal Computer is a registered trademark of IBM.

Listing 1 continued:

```

0320:38      54      SEC          ;Y=HORIZ - OFFSET
032E:AD 04 03 55      LDA  HORIZ
0331:E7 02   56      SBC  #OFFSET
0333:10 02   57      BFL  H2OK      ;A>=0? YES
0335:A9 00   58      LDA  #0       ;NO, LIMIT TO 0
0337:80 08 03 59      STA  HSTART
033A:A8      60      TAY
033B:38      61      SEC          ;A = VERT - OFFSET
033C:AD 03 03 62      LDA  VERT
033F:E7 02   63      SBC  #OFFSET
0341:10 02   64      BFL  V2OK      ;A>=0? YES
0343:A9 00   65      LDA  #0       ;NO, SET TO 0
0345:80 05 03 66      STA  SAVEA
0348:      67      #
0348:      68      ;FIND LIGHTPEN
0348:      69      #
0348:AD 56 C0 70      AGAIN  LDA  LORES      ;PLOT ON LO-RES SCREEN
0348:A9 0F    71      LDA  #WHITE     ;SET COLOR
0340:20 64 F8 72      JSR  SETCOL
0350:AD 05 03 73      LDA  SAVEA      ;PLOT POINT
0353:20 00 F8 74      JSR  PLOT
0356:A9 28    75      LDA  #DELAY     ;FAUSE
0358:20 A8 FC 76      JSR  WAIT
035B:AD 63 C0 77      LDA  PEN        ;READ PEN (BIT-7)
035E:10 29    78      BPL  FOUND      ;LOW => FOUND
0360:A9 00    79      LDA  #BLACK     ;SET COLOR
0362:20 64 F8 80      JSR  SETCOL
0365:AD 05 03 81      LDA  SAVEA      ;ERASE POINT
0368:20 00 F8 82      JSR  PLOT
036B:AD 57 C0 83      LDA  HIRRES     ;SET TO HI-RES SCREEN
036E:CB      84      INY            ;NEXT HORIZ
036F:CC 06 03 85      CPY  HEND       ;Y>HEND?
0372:70 D4    86      BCC  AGAIN      ;NO,
0374:F0 02    87      BEQ  AGAIN      ;DO IT AGAIN
0376:AC 08 03 88      LDY  HSTART     ;YES, RESET Y
0379:EE 05 03 89      INC  SAVEA      ;NEXT VERT POSITION
037C:AD 05 03 90      LDA  SAVEA
037F:CD 07 03 91      CMP  VEND       ;A>VEND?
0382:70 C4    92      BCC  AGAIN      ;NO, DO IT
0384:F0 C2    93      BEQ  AGAIN      # AGAIN
0386:4C 9A 03 94      JMP  DONE       ;FINISHED, NOT FOUND
0389:A9 00    95      FOUND  LDA  #BLACK ;SET COLOR
038B:20 64 F8 96      JSR  SETCOL
038E:AD 05 03 97      LDA  SAVEA      ;SAVE NEW HORIZ
0391:80 03 03 98      STA  VERT
0394:8C 04 03 99      STY  HORIZ      ;SAVE NEW VERT
0397:20 00 F8 100     JSR  PLOT        ;ERASE POINT
039A:AD 57 C0 101     DONE  LDA  HIRRES     ;RESET HI-RES
039D:50      102     RTS            ;RETURN

```

\*\*\* SUCCESSFUL ASSEMBLY; NO ERRORS

resistor. This large resistor was used so that relatively small base currents would bring  $V_{CE}$  sufficiently low to trip the comparator. The comparator is linked (with hysteresis) to the 500 k-ohm potentiometer allowing adjustment of the overall sensitivity.

The comparator turns off too soon when the light pen is positioned on the edge of a block however, and the block drifts slightly on the screen, perhaps as a result of electromagnetic interference. When the block moves, the phototransistor is no longer saturated and thus turns off the comparator prematurely. To prevent the phototransistor from turning off too early, the comparator's output is connected to a monostable multivibrator that furnishes the actual signal output. The circuit provides a normally high signal on the PB2 input, but goes low for approximately 5 ms when the

phototransistor detects light. The computer detects this negative-going pulse.

### The PEN Subroutine

The PEN subroutine (listing 1) performs the search for the light pen on the screen. To ensure that the routine operates as quickly as possible, it is written in 6502 assembly language. The operating system resident in the Apple leaves page 3 of memory free from system use and available for user machine-language routines. For this reason, the subroutine was assembled at location hexadecimal 300 and is entered by a subroutine call to that location. As written, the routine is not relocatable object code. (Table 1 lists variables for the PEN subroutine.)

The routine does not require any parameters to be passed to it and

VERT	—the pen's last-known vertical coordinate
HORIZ	—the pen's last-known horizontal coordinate
SAVEA	—temporary storage location for the accumulator
HEND	—the horizontal coordinate of the end of the search block
VEND	—the vertical coordinate of the end of the search block
HSTART	—the horizontal coordinate of the start of the search block
OFFSET	—the plus and minus offset that determines the search block's size

Table 1: Variables for the PEN subroutine.

returns with the horizontal and vertical coordinates stored in memory. Both of these coordinates are in the range 0 to 39; (0,0) is the upper-left corner of the screen and (39,39) is the lower-right corner. The vertical coordinate is returned in memory location hexadecimal 303; the horizontal, in location 304. If the light pen is not pointing to the screen when the subroutine is called, the subroutine will return with the pen's last-known position, thus leaving these two locations unchanged.

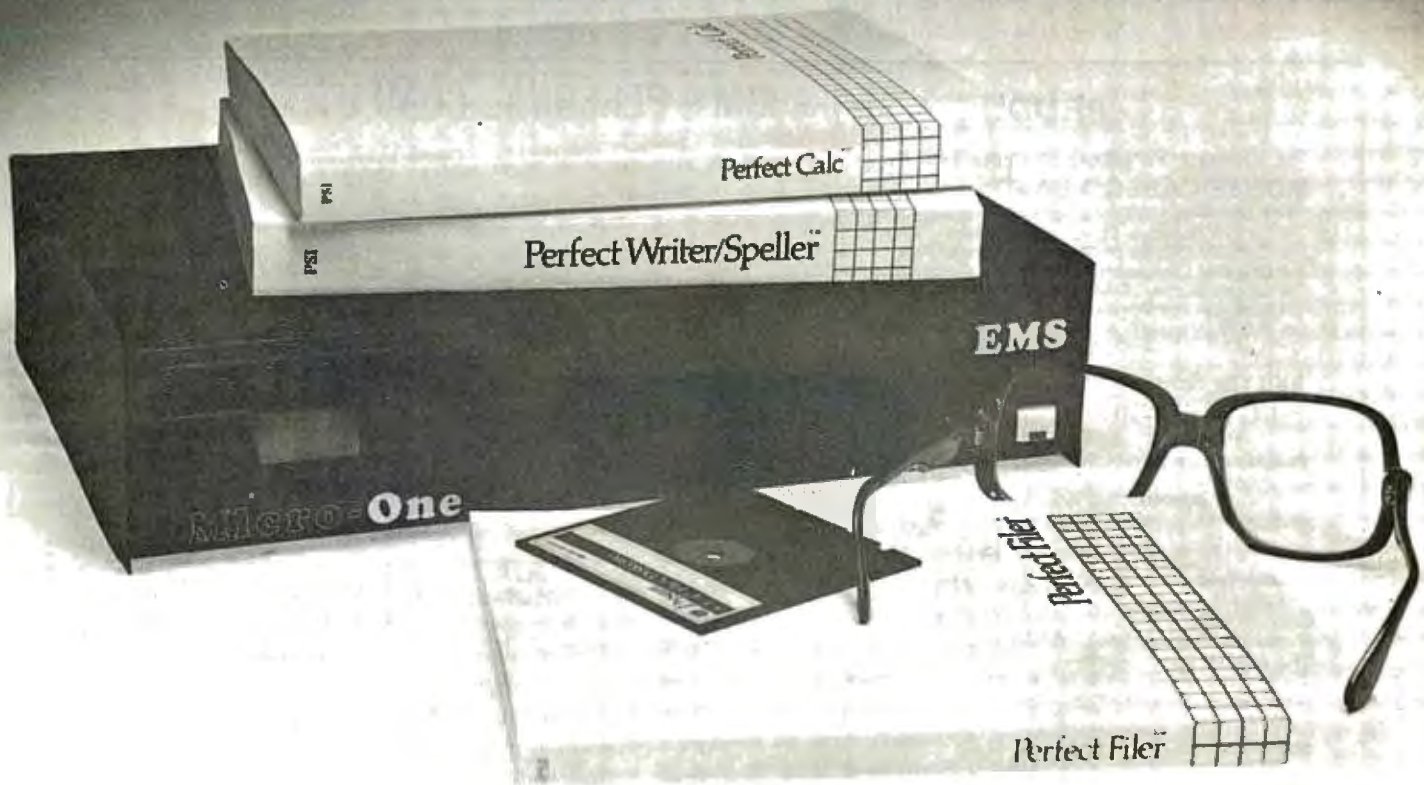
The PEN subroutine limits its search to a small area around the pen's last-known position, a 5 by 5 square that corresponds to an offset of  $\pm 2$  blocks in both the horizontal and vertical directions. In figure 2, you see that the subroutine first calculates the limits using an offset of 2. The limits are within a 0-to-39 range so that the search for the pen does not extend off the screen. As the program progresses, the current horizontal position is in the Y register, and the vertical position is in the accumulator, A.

After this initialization, the subroutine switches the display to the low-res mode by referencing memory location C056. It then plots the first block of the search square using a subroutine in the Apple's monitor (PLOT). After a delay of about 4 ms, the subroutine checks the light-pen input. If the pen has sensed the block, the program erases it, updates the horizontal- and vertical-position parameters to the new position, and



# NEW! 3¼" MICRO CP/M® SYSTEM

## \$1295



The **Micro-One** is a professional computer that takes advantage of the CP/M® 2.2 Operating System to give the user access to thousands of business programs. Its excellent hardware capabilities are matched only by its outstanding software package valued alone at more than \$1600.

All these features, coupled with its remarkable size of 2.75"x8"x12" and light weight of only 5 lbs., makes it an offer hard to beat.

### Micro-One Hardware Features

- 4MHZ Z80A® CPU
- 64K bytes RAM memory
- 500K bytes 3¼" disk drive
- Two RS-232 serial ports
- Centronics parallel printer port
- Hard disk interface port

### Micro-One Software Features

- CP/M® 2.2 DOS
- Perfect Writer™ word processor program
- Perfect Speller™ spelling checker program
- Perfect Calc™ spread sheet program
- Perfect Filer™ information filing program

### Optional Features

- Additional disk drives
- 6MHZ Z80B® CPU operation
- Additional serial port
- Additional modem port
- Additional software
- CRT Terminal (available soon)
- Hard disk drive (available soon)

**EMS** Educational  
Microcomputer  
Systems

P.O. Box 16115 • Irvine, CA 92713 • (714) 553-0133

Circle 139 on inquiry card.

CP/M Registered trademark of Digital Research, Inc.  
Z80 is a trademark of Zilog, Inc.  
Perfect Writer, Perfect Speller, Perfect Calc, Perfect Filer  
are trademarks of Perfect Software, Inc.

# CALL "THE COMPUTER-LINE" In Colorado.

"Committed to bringing computers within the reach of all Americans"™

The Computer-Line believes that it is important to be competitive by offering low prices; however, we regard service as the most important aspect of a mail-order organization. All our lines are available so that you, the customer, are able to talk to fully qualified computer specialists trained to answer all your questions pertaining to our line of microcomputers. We are renowned for our excellent after-sales support and our promptness for delivery. Peace of mind and excellence in service is our pledge to all our customers.

## PRODUCTS for the IBM® PERSONAL COMPUTER

### The Ultimate Peripheral for your IBM PC MONTE CARLO™ CARD

Five Functions — Memory/Serial/Parallel/Clock/Joystick

- Up to 1 Megabyte Expandable Memory
- One IBM Compatible Centronics Parallel Port
- One IBM Compatible Asynchronous Communication Port
- Clock/Calendar (Battery-backed) with Alarm
- Dual Port Joystick Interface
- Future Upgrade Options: Direct Connect Modem

..... SCALL

### AND The Sensational I

#### I-C — MAGIC

Prom Chip

#### Programmable Graphics Screen Dump

Print Spooling up to 64K

Terminal Emulation..... SCALL



### Hard Disk System for the IBM® Personal Computer

The Davong System's Hard Disk Drive fits conveniently inside or outside of the second floppy disk drive location of the IBM® Personal Computer chassis, providing more than 30 times the capacity of a floppy diskette, plus greater speed & reliability.

Available for internal or external installation, Please specify. SCALL



## SOFTWARE

#### Ashton-Tate:

D. Base II..... \$475.00

#### Continental:

Home Accountant Plus ..... \$99.00

#### The Business Manager™

A complete accounting/word processing/spread sheet/hard disk system for your IBM PC ..... SCALL

#### MicroPro

Wordstar. . . . . \$329.00

Mailmerge . . . . . \$159.00

#### Sorclm Software:

Supercalc..... \$199.00

Superwriter..... \$299.00

Spellguard..... \$149.00

#### Lifefree Systems:

Volkswriter..... \$149.00

#### Visicorp:

256K Visicalc..... \$185.00

Visidex..... \$185.00

#### Peachtree

Peachpak..... SCALL

## QUADRAM CORPORATION

Quadboard: The memory board for the IBM featuring:

- Fully Expandable from 64K - 256K
- Parallel Port
- Asynchronous (RS232) Serial Port
- Clock/Calendar
- RAM Disk Drive ..... SCALL

#### Microfazer:

- Buffering from 8K - 64K (4 - 32 pages of text)
- Printer & Computer Independent
- Parallel/Parallel; Parallel/Serial; Serial/Serial available
- Compute while you print! ..... SCALL

## Peripherals for all Computers

### PRINTERS

#### TEC / C-ITOH Printers

Prowriter I Parallel..... \$379<sup>00</sup>

Prowriter I Parallel/Serial ..... \$499<sup>00</sup>

Prowriter II Parallel ..... \$649<sup>00</sup>

Prowriter II Parallel/Serial..... \$699<sup>00</sup>

F10 Printmaster 55 CPS ..... SCALL

#### Okidata

Microline 92: 160 CPS bidirectional with 40 CPS correspondence. 80 column ..... \$575<sup>00</sup>

Microline 93: 160 CPS bidirectional with 40 CPS correspondence. 132 column ..... \$995<sup>00</sup>

Pacemark 2350: 350 CPS bidirectional/2 color printing/136 column.

Parallel ..... \$2195<sup>00</sup>

Serial ..... \$2295<sup>00</sup>

Pacemark 2410: 350 CPS bidirectional/2 color printing/85 CPS correspondence.

Parallel ..... \$2495<sup>00</sup>

Serial ..... \$2595<sup>00</sup>

ICALL FOR PRICES ON ALL OKI/OATA PRINTERS!

#### Star Micronics

Gemini 10 & 15 ..... Price Is Too Low To Publish!

#### IDS Prism

132 Color ..... \$1495<sup>00</sup>

#### Smith Corona

TP-I Parallel or Serial ..... \$569<sup>00</sup>

Call for prices on Epson's New FX Series



#### F10 Starwriter Letter Quality

40 CPS Printer, Diablo Standard Daisywheel

.....\$1195<sup>00</sup>

### MODEMS

#### D.C. Hayes:

Micromodem II (Apple) ..... \$259<sup>00</sup>

Smartmodem 300 Baud ..... \$209<sup>00</sup>

Smartmodem 1200 Baud ..... \$525<sup>00</sup>

#### Novation:

J-Cat RS232 Direct Connect ..... \$119<sup>00</sup>

Cat ..... \$149<sup>00</sup>

Smart Cat 1200 Baud..... \$455<sup>00</sup>

Applecat II (Apple)..... \$289<sup>00</sup>

Smartcom II ..... \$ 85<sup>00</sup>

#### U.S. Robotics:

D.C. Hayes Smart Modem compatible

300 Baud. .... \$179<sup>00</sup>

1200 Baud ..... \$479<sup>00</sup>

### Monitors

Amdek Color I..... \$299<sup>00</sup>

Color II ..... \$499<sup>00</sup>

300G Green..... \$145<sup>00</sup>

300A Amber ..... \$159<sup>00</sup>

310G Green ..... \$179<sup>00</sup>

310A Amber ..... \$179<sup>00</sup>

BMC 15MHZ Green ..... \$ 85<sup>00</sup>

20MHZ Green ..... \$149<sup>00</sup>

NEC 1201 Green ..... \$159<sup>00</sup>

1212 Color Composite ..... \$299<sup>00</sup>

1203 RGB Hi-Res Color ..... \$599<sup>00</sup>

Zenith ZVM-121 15MHZ..... \$109<sup>00</sup>

Taxan Amber ..... \$145<sup>00</sup>

### DISKETTES

#### \*\*Kangaroo:

The disks with the 'jump' on the competition. Outstanding value with library case and a ten year warranty.

#### \*Dysan—outstandingly low price

5¼" SS/DD (Box of 10) ..... \$31<sup>95</sup>

5¼" DS/DD (Box of 10) .. \$39<sup>95</sup>

5¼" SS/DD (Box of 10) ..... \$23<sup>95</sup>

5¼" DS/DD (Box of 10) ..... \$43<sup>95</sup>

#### Elephant Diskettes

5¼" SS/DD (Box of 10) ..... \$22<sup>95</sup>

5¼" DS/DD (Box of 10) ..... \$29<sup>95</sup>

### Apple IIe®

Provides these standard features:

- Typewriter-style, full ASCII keyboard, upper and lower case, and auto-repeat feature
- 6502A microprocessor (8-bit CPU)
- 64K bytes RAM memory
- 16K bytes ROM, which includes built-in Apple-soft BASIC language and sound capabilities



- color graphics and sound capabilities
- seven I/O expansion slots
- back panel designed for quick connect/disconnect, using D-style connectors

.....SCALL

### IBM® Personal Computer



Features:

- 64K Memory
  - 2 Tandon TM-100-2 320K Byte Drives
  - 1 floppy disk controller
  - 1 color graphics card
- SlimLine drives and hard disk drives configurations are available upon request.

Call for pricing on all IBM® Systems.

### ZENITH Z100 COMPUTERS

Z110-22 (Low Profile) \$3099<sup>00</sup>  
Z120-22 (All in one) \$3175<sup>00</sup>

★ TANDON ★  
★ DRIVE ★  
★ Special ★  
★ Double Side/ ★  
★ Double Density ★  
★ 320K Bytes ★  
★ of Storage. ★  
★ TM-100-2 ★  
★ \$249<sup>00</sup> ★

★ TANDON ★  
★ Thin-Line ★  
★ TM-55 ★  
★ \$245<sup>00</sup> ★

★ Special ★  
★ PRINCETON ★  
★ GRAPHICS ★  
★ SYSTEMS ★  
★ • 690 Dots Hor. ★  
★ • 16 Colors ★  
★ • Non-Glare Screen ★  
★ • Color at its finest ★  
★ \$CALL ★

### WORD PROCESSING SPECIALS

On Line Screenwriter \$85 Pro \$149  
Silicon Valley Word Handler \$119

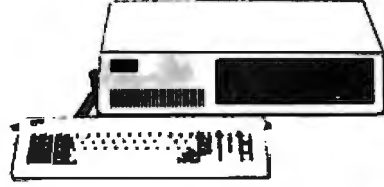
### NOW CARRYING:

PANASONIC JR-200 Personal computer \$299<sup>00</sup>  
Extremely Versatile  
Commodore 64 \$379<sup>00</sup>



See the NEC APC  
At Our Retail Stores.

### Columbia Data Products Personal Computer



- Featuring:
- IBM PC Compatibility
  - 16-Bit 8088 Processor
  - 8 Expansion Slots
  - Two RS232 Serial Ports
  - Centronics Printer Port
  - Double Density Floppy Disk Controller
  - 128K RAM Standard Memory
- CALL FOR PRICING AND INFORMATION ON THE EXTENSIVE SOFTWARE STANDARD WITH THE COMPUTER!

### Franklin Ace 1000

- Offers:
- 64K Memory
  - 40 column upper/lower case display
  - Apple IIe compatibility
  - more space between expansion slots and internal fan aid cooling ...
- .....SCALL
- Call for prices on Franklin Ace 1200!

## Products for the APPLE COMPUTER

We are smashing the prices on Apple Compatible Disk Drives!



FOURTH DIMENSION Drives \$225.<sup>00</sup>  
FOURTH DIMENSION Drive with Controller SCALL

We also carry: Rana Elite I, II, III ..... SCALL

Computer-Line is NOW OPEN Mon.-Fri. 7 a.m. to 8 p.m.  
7 Days a Week! Sat.-Sun. 8 a.m. to 6 p.m.

Product Information & Order Lines: (Mountain Standard Time)

### MBI APPLETIME CARD

Works with DB Master and Visidex Mountain Computer mode Basic and pascal operation complete with datebook software \$ 89<sup>00</sup>

### MBI VIP CARD

Dual Port Parallel/Serial Graphics Card Use ASCII Express The Professional 4 0 to simultaneously transfer data from modem to printer using the VIP Card \$129<sup>00</sup>

### ASCII EXPRESS (The Professional)

\$99<sup>00</sup>

### APPLE SOFTWARE

Continental:  
The Home Accountant \$ 54<sup>00</sup>  
Silicon Valley Systems:  
Word Handler \$119<sup>00</sup>  
List Handler \$ 59<sup>00</sup>  
Stoneware:  
DB Master \$159<sup>00</sup>  
DB Utility 1 2 3 \$69<sup>00</sup> ea  
Visicorp:  
Visicalc 33 \$185<sup>00</sup>  
Visibles \$185<sup>00</sup>  
Visidex \$185<sup>00</sup>  
Visitrend (PK) \$229<sup>00</sup>

### RAM CARDS

Microsoft 16K \$79<sup>00</sup>  
CP/M FOR APPLE \$269<sup>00</sup>  
Microsoft Z80 Card SCALL  
Advanced Logic SCALL  
Kensington System Saver \$69<sup>00</sup>  
T & G:  
Joysticks \$44<sup>00</sup>  
Select A Port \$44<sup>00</sup>  
Game Paddles \$29<sup>00</sup>  
Krafl:  
Joysticks \$49<sup>00</sup>  
Game Paddles \$33<sup>00</sup>  
80 Column Cards \$279<sup>00</sup>  
Videx with Softswitch \$279<sup>00</sup>

For 24-Hour/7 Days a Week Ordering & Product Information, Call "Info-Line™", our computer modem line. 1-303-279-4218.  
Operates at 300 Baud, Full Duplex

## Write or Call for Our Comprehensive Catalog. Call "THE COMPUTER-LINE"

Product Information & Order Lines: (303) 279-2848 or (800) 525-7877  
Customer Service & Order Inquiry Line: (303) 278-8321  
ORDER DEPARTMENT: COMPUTER-LINE, Inc. • 1019 8th Street • Golden, CO 80401  
COMPUTER-LINE of Denver • 1136 So Colorado Blvd • Denver CO 80222

We have leasing terms available on all our equipment.  
Look for our "Computer-Line" Stores opening throughout the U.S.  
Write for our Franchise Package.



TERMS: All prices reflect a 2.9% cash discount. All goods acknowledged faulty on receipt by the customer will be repaired or replaced at our discretion. Customers must call for a RMA number before returning any goods. This includes our quick attendance to faulty goods. We reserve the right to repair or return to the manufacturer for repair all goods becoming faulty within the specified warranty period. Any goods (hardware or software) returned for reworking are subject to a 15% reworking fee at our discretion. The charge for cancellation of orders is 20% of the purchase price. No returns on software. We accept no responsibility for any late claims made by manufacturers. Prices quoted for stock on hand and subject to change without notice. Specialists in APO and international deliveries. Please add 2% (minimum \$3.00) for shipping APO and add to all prices 5% for shipping (minimum \$5.00). Please allow 10 working days plus mail time for an order to materialize in the receipt of all UPS delivered goods. All goods shipped from APO or international delivered UPS ground.

ALL BRANDS ARE REGISTERED TRADEMARKS  
Circle 91 on inquiry card.

# AMX

## Real-Time Multitasking Executive

for  
**8080, Z80, 6809**  
and **8086**

# Gives your application a head start

Save time and money in the development of your product or system by using AMX, the software executive with proven, fault-free operation.

### **SIMPLE OPERATION**

You divide complex control programs into a number of separate, more manageable programs, called *tasks*, each designed to do one job. This allows tasks to be written and tested separately and then combined to form a reliable, finished system.

AMX supervises the orderly execution of these tasks, assuring that the most important jobs always get done first. Tasks appear to be executing simultaneously. It's almost like having a separate CPU for each task!

### **HARDWARE INDEPENDENCE**

AMX does not require a particular hardware configuration. *You* control your environment. *You* pick the I/O method. *You* decide the preferred interrupt service technique for your system. AMX will support you on the microprocessor of your choice.

AMX is fast, compact, and ROMable. The AMX nucleus, less than 1400 bytes in size, features multiple task priorities, intertask message passing with priority queuing, external event synchronization, and interval timing.

Support modules provide extended memory management, buffer control and resource allocation. Fast, re-entrant integer and floating point math libraries are also available.

AMX interfaces support programs written in C, PASCAL, PL/M, FORTRAN and assembler.

Access to CP/M® disk files in real time is possible using the AMX I/O Supervisor.

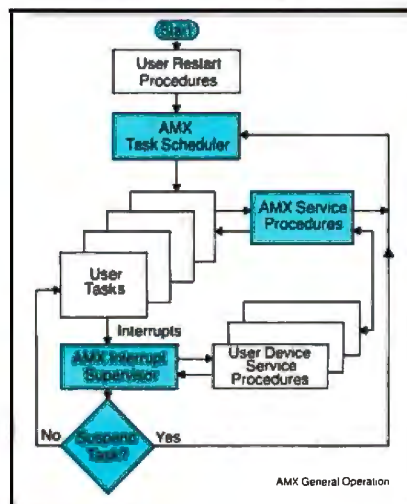
### **COMPLETE DOCUMENTATION**

We deliver AMX source on diskette to permit AMX to be moved to the software development system of your choice. Our liberal license agreement permits binary (object) distribution without royalties.

### **HOW TO ORDER**

A specification sheet and price list are available, free. Your check or money order for \$75 will purchase the AMX Reference Manual for immediate evaluation (specify 8080, Z80, 8086 or 6809 processor). Add \$25 for postage and handling outside USA and Canada. The standard 8080/Z80 AMX Multitasking Executive package, including source code, is **\$800**. Support modules and interfaces are available separately.

AMX is the choice of professionals the world over. Make it yours, today.



AMX is a trademark of KADAK Products Ltd.  
CP/M is a trademark of Digital Research Corp.  
Z80 is a trademark of Zilog Corp.



# KADAK Products Ltd.



206-1847 W. Broadway Ave., Vancouver, B.C., Canada V6J 1Y5/Phone: (604) 734-2796 Telex: 04-55670

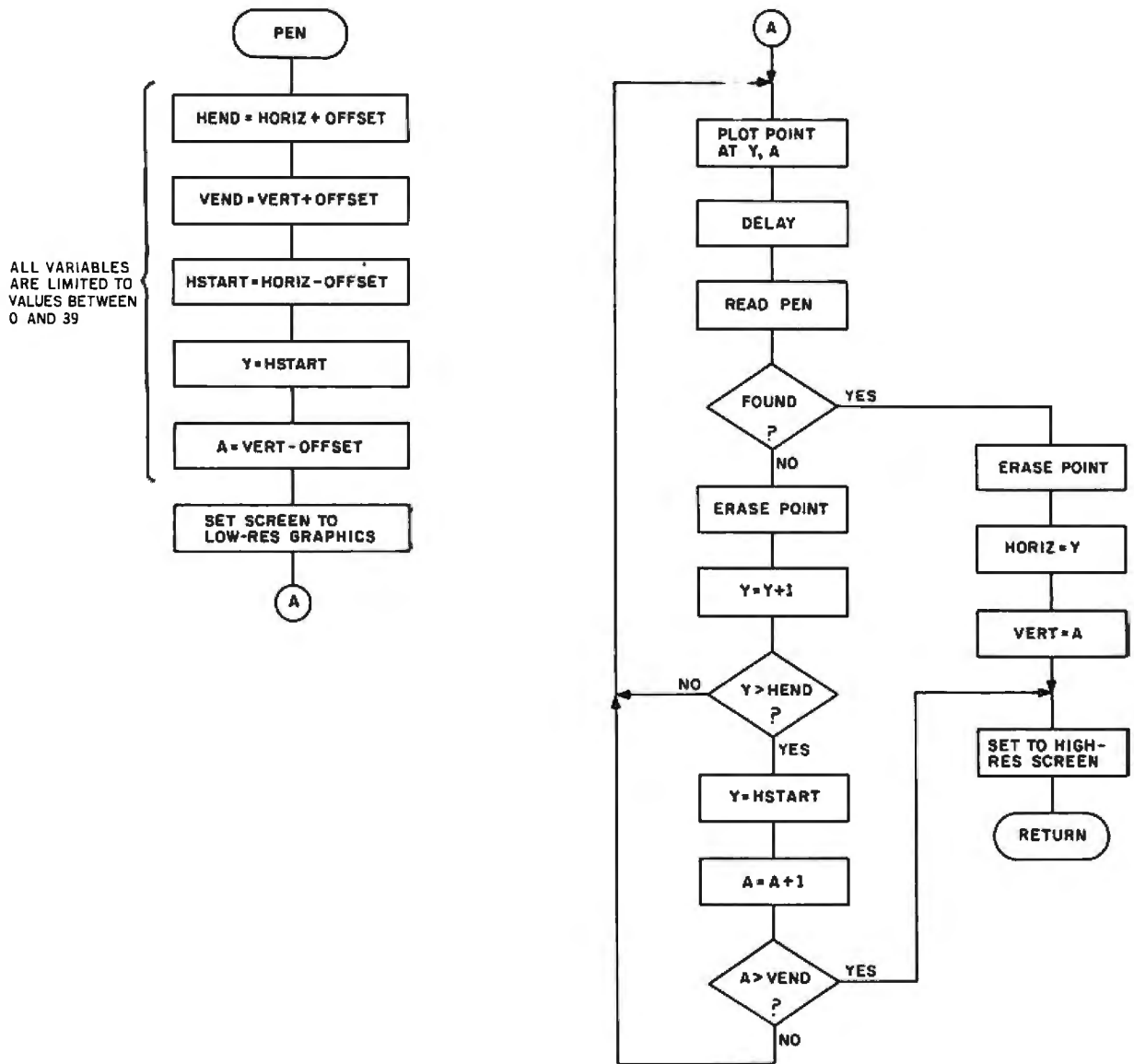


Figure 2: This flowchart plots the course of the PEN subroutine, which uses the top portion of the low-res display.

then returns to the calling program. If the pen does not sense the block, the program erases it and moves right to the next horizontal position, continuing until it reaches the end of the first line in the square. It then moves to the next line in the square and starts again. This process repeats until the pen is found or the entire square has been searched. The result of the process is a series of flashing blocks that seem to follow the pen around the screen. When the pen is not on the screen, the blocks remain stationary.

The PEN subroutine is very general and can be built into application programs to find the light pen's position on the screen. Note, however, that

the subroutine uses the top portion of the low-res display, the same display used by the normal text mode. Thus, a program that must use more than the bottom four lines of text will require modifications to use this subroutine.

### The LINES Program

The LINES program (listing 2), written in BASIC, enables you to draw shapes on the screen through the flashing square, termed the *cursor*, anywhere on the top portion of the screen. Error messages appear in the bottom four lines of text. You can mark the current position of the cur-

sor by pushing the space bar, which places a small cross on the screen and stores that point's location in an array. After marking a few points in this way, you can connect the points with lines by pushing another key and then move on to draw another figure. You can thus draw relatively complex figures simply by marking the vertices and using straight lines to connect them.

The first step the LINES program takes is to initialize all the variables (figure 3, page 405). This step includes loading a file from the disk that contains the PEN subroutine object code. The program then calls this subroutine to locate the light pen.

Listing 2: The LINES program.

```

JPR1#1
JLOAD LINES.REM
JLISTST

100 REM *****
110 REM
120 REM PROGRAM TO DRAW
130 REM WITH LIGHT-PEN
140 REM
150 REM *****
160 REM
170 PRINT CHR$(4);"BLOAD PEN2,
OBJO"
180 NMAX = 50
190 DIM FX(NMAX),PY(NMAX)
200 GOSUB 390: REM INITIALIZE
210 GOSUB 610: REM FIND PEN, S
ET X,Y
220 KEY = PEEK (KB): REM READ K
EYBOARD
230 IF KEY < 128 GOTO 210
240 HOME
250 I = PEEK (KS): REM CLEAR ST
ROBE
260 IF KEY = SPACE THEN GOSUB 7
10: GOTO 210
270 KEY = KEY - 192
280 IF KEY < 1 OR KEY > 17 THEN
GOSUB 2060: GOTO 210
290 ON KEY GOSUB 2060,2060,1400,
860,2060,2060,2060,1840,2060
,2060,2060,1240,2060,1600,20
60,1090,1690
300 T = PEEK (G): REM GRAPHICS
MODE
310 GOTO 210
320 REM
330 REM *****
340 REM
350 REM INITIALIZE
360 REM
370 REM *****
380 REM
390 KB = 49152:KS = 49168
400 PEN = 768
410 HZ = PEN + 4:VERT = PEN + 3
420 CL = 3
430 SPACE = 160:G = 49232
440 N = 0
450 POKE HZ,20: POKE VERT,20
460 TEXT : HOME : NORMAL : SPEED=
255
470 VTAB (12): PRINT TAB(7);"*
** WELCOME TO LINES ***"
480 PRINT : PRINT TAB(10);"DO
YOU WANT A MENU?";
490 GET Y$
500 IF Y$ = "Y" THEN GOSUB 1940

510 T = PEEK (KS)
520 HGR : HCOLOR= CL
530 RETURN
540 REM
550 REM *****
560 REM
570 REM FIND PEN, SET X,Y
580 REM
590 REM *****
600 REM
610 CALL PEN
620 X = 7 * PEEK (HZ):Y = 4 * PEEK
(VERT)
RETURN
630 REM
640 REM *****
650 REM
660 REM
670 REM "SPACE"--MARK POINT
680 REM
690 REM *****
700 REM
710 IF N < NMAX GOTO 750
720 GOSUB 2260
730 PRINT TAB(3);"TOO MANY POI
NTS."
740 RETURN
750 N = N + 1
760 FX(N) = X:PY(N) = Y
770 GOSUB 2160: REM DRAW CROSS
780 RETURN
790 REM

800 REM *****
810 REM
820 REM "D"--DELETE POINT
830 REM
840 REM *****
850 REM
860 I = 1
870 IF FX(I) = X AND PY(I) = Y GOTO
930
880 I = I + 1
890 IF I <= N GOTO 870
900 GOSUB 2260
910 PRINT TAB(3);"NO POINT TO
DELETE"
920 RETURN
930 IF I = N GOTO 970
940 FOR Z = I TO N - 1
950 PAX(Z) = FX(Z + 1):PY(Z) = PY
(Z + 1)
960 NEXT Z
970 N = N - 1
980 HCOLOR= 0
990 GOSUB 2160
1000 HCOLOR= CL
1010 RETURN
1020 REM
1030 REM *****
1040 REM
1050 REM "P"--MAKE A POLYGON
1060 REM
1070 REM *****
1080 REM
1090 IF N >= 3 GOTO 1130
1100 GOSUB 2260
1110 PRINT TAB(3);"NEED AT LEA
ST 3 POINTS"
1120 RETURN
1130 HPLLOT PX(N),PY(N) TO FX(1),
PY(1)
1140 GOSUB 1240
1150 N = 0
1160 RETURN
1170 REM
1180 REM *****
1190 REM
1200 REM "L"--DRAW LINES
1210 REM
1220 REM *****
1230 REM
1240 IF N >= 2 GOTO 1280
1250 GOSUB 2260
1260 PRINT TAB(3);"NEED AT LEA
ST 2 POINTS."
1270 RETURN
1280 FOR I = 1 TO N - 1
1290 HPLLOT FX(I),PY(I) TO FX(I +
1),PY(I + 1)
1300 NEXT I
1310 N = 0
1320 RETURN
1330 REM
1340 REM *****
1350 REM
1360 REM "C"--CHANGE COLOR
1370 REM
1380 REM *****
1390 REM
1400 TEXT : HOME
1410 VTAB (3): PRINT "THE POSSIB
LE COLORS ARE:"
1420 PRINT : PRINT " 0 = BLA
CK"
1430 PRINT : PRINT " 1 = GRE
EN"
1440 PRINT : PRINT " 2 = BLU
E"
1450 PRINT : PRINT " 3 = WHI
TE"
1460 PRINT : PRINT " 4 = BLA
CK"
1470 PRINT : PRINT " 5 = YEL
LOW"
1480 PRINT : PRINT " 6 = BLU
E"
1490 PRINT : PRINT : INPUT "WHAT
COLOR (0-6)? ";CL
1500 IF CL < 0 OR CL > 6 GOTO 14
90
1510 HCOLOR= CL
1520 RETURN
1530 REM

1540 REM *****
1550 REM
1560 REM "N"--NEW: CLEAR SCRIN
1570 REM
1580 REM *****
1590 REM
1600 N = 0: HGR
1610 RETURN
1620 REM
1630 REM *****
1640 REM
1650 REM "Q"--QUIT
1660 REM
1670 REM *****
1680 REM
1690 VTAB (23): PRINT "DO YOU WA
NT TO SAVE THIS? "
1700 GET Y$
1710 IF Y$ < > "Y" GOTO 1740
1720 INPUT "NAME OF FILE? ";Y$
1730 PRINT CHR$(4);"BSAVE ";Y$
;" .PIC,A8192,L8192"
1740 TEXT : HOME : NORMAL
1750 POP
1760 END
1770 REM
1780 REM *****
1790 REM
1800 REM "H"--HELP (MENU)
1810 REM
1820 REM *****
1830 REM
1840 TEXT : HOME : NORMAL
1850 PRINT : PRINT "HERE'S WHAT
YOU CAN DO--"
1860 PRINT : PRINT : PRINT
1870 PRINT : PRINT TAB(2);"SPA
CE--MARK CURRENT POINT"
1880 PRINT : PRINT TAB(6);"D--
DELETE CURRENT POINT"
1890 PRINT : PRINT TAB(6);"P--
CONNECT AS A POLYGON"
1900 PRINT : PRINT TAB(6);"L--
CONNECT FIRST TO LAST POINTS
"
1910 PRINT : PRINT TAB(6);"C--
CHANGE COLOR"
1920 PRINT : PRINT TAB(6);"N--
NEW: CLEAR SCREEN"
1930 PRINT : PRINT TAB(6);"Q--
QUIT"
1940 PRINT : PRINT TAB(6);"H--
HELP!!"
1950 PRINT : PRINT : PRINT TAB(
6);"PRESS ANY KEY TO CONTINU
E..."
1960 GET Y$
1970 T = PEEK (KS)
1980 RETURN
1990 REM
2000 REM *****
2010 REM
2020 REM COMMAND ERROR
2030 REM
2040 REM *****
2050 REM
2060 GOSUB 2260
2070 PRINT TAB(3);"UNRECOGNIZE
D COMMAND"
2080 RETURN
2090 REM
2100 REM *****
2110 REM
2120 REM PLOT CROSS
2130 REM
2140 REM *****
2150 REM
2160 HPLLOT X - 1,Y - 1 TO X + 1,
Y + 1
2170 HPLLOT X - 1,Y + 1 TO X + 1,
Y - 1
2180 RETURN
2190 REM
2200 REM *****
2210 REM
2220 REM ERROR MESSAGE
2230 REM
2240 REM *****
2250 REM
2260 VTAB (24): FLASH : PRINT "E
RROR!!": NORMAL : RETURN

```

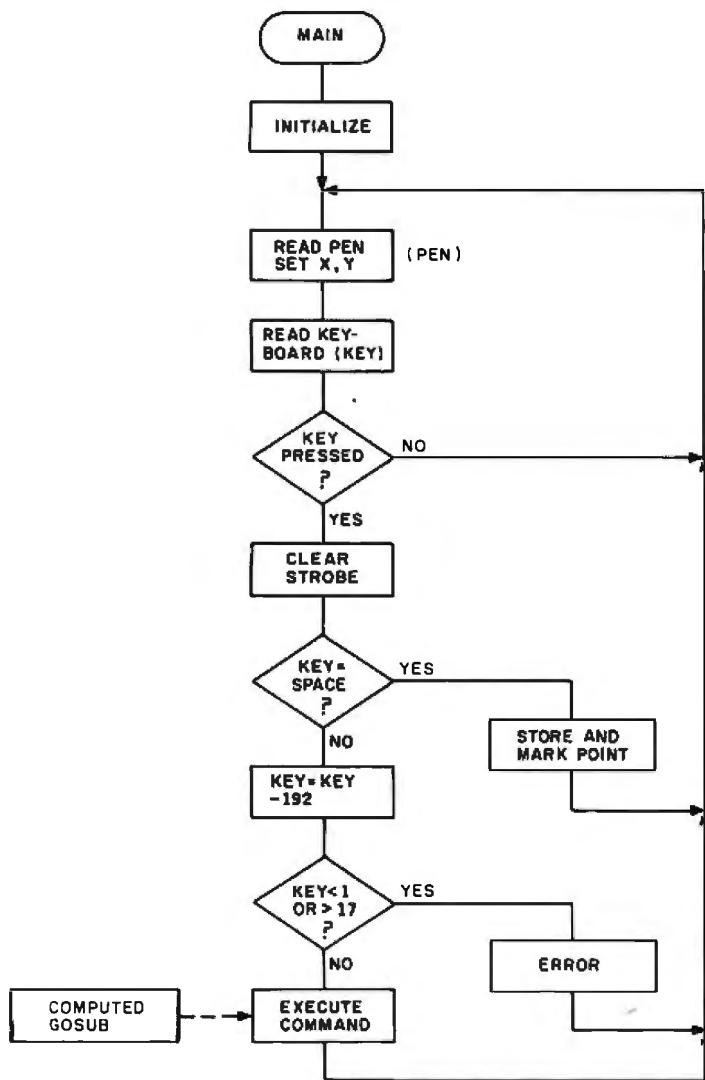


Figure 3: Outlining the course of the LINES program, this flowchart lists the steps you take to use the light pen to draw figures on the screen.

The LINES program plots in the high-res mode; the subroutine searches for the pen in the low-res mode. The value returned by PEN must, therefore, be scaled for the high-res screen. The horizontal position is thus multiplied by 7 and the vertical position by 4 in order to put these coordinates in the appropriate range to fit on the 280 by 160 dot high-res screen.

The program then reads the keyboard. If no key has been pressed, it goes to the top of the program to search again for the pen. If the space bar has been pushed, the program marks the point and saves the current pen position. If another key has been pressed, the program identifies it by first reducing the ASCII (American National Standard Code for Informa-

tion Interchange) value to the 1-to-17 range. If it cannot recognize the function, an error message is printed and the program returns to the beginning.

Recognized functions are called through an ON...GOSUB statement. Then the appropriate command is executed via a subroutine. As a result, you can continuously move the cursor around the screen. Any command is immediately executed when you press the appropriate key. (See table 2 for an annotated variable list for the LINES program.)

The following list describes the valid commands and explains their operation.

•Space: mark and save the current point. Pushing the space bar marks

X,Y	—current position of the cursor
KEY	—value read from the keyboard
KB	—address of the keyboard
KS	—address of the keyboard strobe
T	—temporary ("dummy") use
PEN	—address of the PEN subroutine
N	—number of points marked thus far
NMAX	—maximum number of points possible
PX(),PY()	—arrays of X,Y coordinates marked thus far
I	—index counter used in loops
Z	—index counter used in loops.
Y\$	—yes/no input variable
CL	—selected color
HZ	—address of horizontal coordinate parameter returned by PEN
VERT	—address of vertical coordinate parameter returned by PEN
SPACE	—value read from the keyboard if the space bar has been pressed (= 160)
G	—address of the soft switch to turn on the graphics mode

Table 2: Variables for the LINES program.

the cursor's current position with a small cross and saves the coordinates of that point. The x and y coordinates are saved, in order, in separate arrays. You can subsequently scan these arrays to connect the points with lines. If you try to mark too many points, however, an error message is printed and the command is ignored. The maximum number, NMAX, is initialized in line 180.

•D: delete the current point. This command causes the cross at the cursor's current position to be erased and the point to be removed from the arrays. You can delete points from the screen in any order; the arrays will be adjusted accordingly. If you don't accurately position the cursor over a point, however, an error message is printed and the command is ignored.

•P: connect the currently marked points as a polygon. When this command is executed, the program connects the last point in the array to the first one. To connect the rest of the

points with lines, it then calls the subroutine for the L command. The array is then cleared (actually, the point counter, N, is set to zero), and you can begin defining a new figure. If you do not define at least three points, an error message is printed and the command is ignored.

●L: connect all of the points with lines. This command is the same as the P (Polygon) command except that the first point is not connected to the last one. It thus allows you to draw lines between points without making a closed figure. An error message is printed and the command is ignored, however, if you do not mark at least two points.

●C: change color. A menu of seven possible colors for subsequent lines is displayed with this command. It doesn't affect any of the old lines. The choice of colors is black, green, blue, white, black2, yellow, and blue2. These colors can appear different, depending on the adjustments made on your television set or monitor and the Apple's color-trim potentiometer.

●N: new, or clear the screen. Use this command to clear the screen to black and reset the number of elements in the arrays to zero. You can then start again without rerunning the program.

●Q: quit. An orderly exit from the program is implemented with this command. It also offers the option of saving the contents of the high-res display on the disk. The POP instruction in line 1750 of listing 2 is needed to clean up the stack because the return from the subroutine is otherwise never completed by the Q command.

●H: help, or print a menu. Press H to display a list of all the commands.

### Conclusion

The light pen design presented in this article requires simple hardware and costs relatively little to implement because most of the processing is done in software rather than hardware. By limiting the search for the pen to a relatively small area, search time is kept short without much

sacrifice in performance. The light pen provides a convenient, efficient method to input graphics information to the Apple II and thus complements the computer's excellent graphics display capabilities. ■


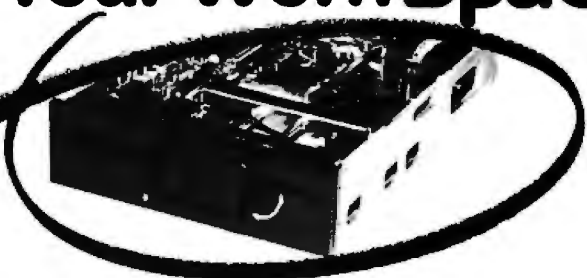
### About the Author

David Lilja is a hardware design engineer for a computer manufacturer in Cupertino, CA.

### References

1. Advanced Micro Devices. *Linear and Interface Data Book*. 1979.
2. Apple Computer Inc. *Applesoft II Basic Program Reference Manual*. Cupertino, CA, 1978.
3. Apple Computer Inc. *Apple II Reference Manual*. Cupertino, CA, 1979.
4. Apple Computer Inc. *Apple 6502 Assembler/Editor*. Cupertino, CA, 1980.
5. Camp, R. C., T. A. Smay, C. J. Triska. *Microprocessor Systems Engineering*. Portland, OR: Matrix Publishers, 1979.
6. Mims, Forrest M. "Experimenting with a Lightpen." *Popular Electronics*, December 1980 and January 1981.

# NEW! Double Your Work Space

## TEAC 5 1/4" Floppy Disk Drives


Double your work space with the new TEAC 5 1/4" Floppy Disk Drives. Because the TEAC FD-55 Series Drives are half the height of conventional drives, you can fit up to four TEAC drives in the same space where two conventional drives fit. Or, have room for two floppy disk drives and a hard disk drive.

Not only are the new TEAC drives half the height, they also consume half the power and generate half the heat. Design innovations using a low-noise brushless DC direct drive motor are responsible for this breakthrough. The result: a highly reliable drive with over 10,000 hours life backed by a one year parts and labor warranty.

	UNFORMATTED CAPACITY	TRACK DENSITY	TRACKS PER DISK
FD-55A (1 side)	250K Bytes	48	40
FD-55B (2 sides)	500K Bytes	48	80
FD-55E (1 side)	500K Bytes	96	80
FD-55F (2 sides)	1000K Bytes	96	160

*Maynard Electronics also manufactures a complete line of peripherals for the IBM PC and PCXT. They include: SandStar™ Series fully modular boards, Memory Expansion and 5 1/4" and 8" Floppy Drive Controller Boards, clock calendar and Parallel, Serial and Game Ports.*

**Maynard Electronics is an authorized distributor of TEAC Floppy Disk Drives. Call or write today for complete technical data and price.**



## MAYNARD ELECTRONICS

400 E. Semoran Blvd. • The Greater Mall • Suite 207 •  
Casselberry, FL 32707 • 305/331-6402

**We make modern times better.**



# COMPUTER SPECIALTIES

Where Service, Savings, & Selection Come Together



## Smith-Corona® TP-1™

Call For Free Catalog

DOT MATRIX		LETTER QUALITY	
Epson		Brother	
FX-80	Call	HR 1	799
FX-100	Call	HR-15	Call
<b>NEC</b>			
8023 Dot Mat	429	2000 w/16K	1029
OkiData		2000 w/48K	1489
Microline 82A	399	<b>NEC</b>	
Microline 92	499	3550 (for IBM)	1899
Microline 93	849	3510	1499
<b>Gemini</b>			
Gemini 10	299	Starwriter R-10	1289
Gemini 15	449	Printmaster F-10	1599



apple IIe

**SALE!**

## SYSCOM SYSTEMS

New Apple Compatible System



**Accessories**

Micro-Sci A-2	249	Z-Card by ALS	159
Micro-Sci A-40	279	The CP/M card	329
Micro-Sci A-70	339	Softcard Prem by MS	499
A-2 Controller	69	Softcard Plus by MS	449
A-40/70 Controller	69	Softcard Sys by MS	259

### New Special

The Power Pack by Micro-Sci includes: ● 1 A-2 Drive ● 1 80/64 e card ● 1 Magic Window II ● 1 MagicWord ● 1 Magic Calc Retail Value \$914 Sale Price \$599

5 Meg by Davong	599	The Grappler Plus	119
10 Meg by Davong	799	Applicard 4HZ	369
Elite One by Rana	299	Applicard 6HZ	458
Elite Two by Rana	508	Applicard w/80 col	369
Elite Three by Rana	699	Applicard w/WordStar	639
Rana Controller	84	Krait Joystick	44
Videx 80 col	219	Apple Dumping 32K	219
Parallel Int Cd	59	Apple Cat II by Nov	289
MB1 I(par-epson)32K	229	212 Apple Cat(1200bd)	599
System Saver Fan	64	Trackball by T.G.	47
MicroMo II by Hayes	279	Hayes 1200 baud	529

**Software**

Special sale on Micro-Pro ● Word Star . 279 ● Spell Star 129 ● Info Star 279 ● Mail Merge 129 ● Word Star Mail Merge and Spell Star . 499

Word Handler	147
Base II	529
Quick Screen	129
VisiCalc	189
Peachtree	call
Frogger	24
Chopfilter	24
Wizardry	34
PFS:Report	89
PFS:Graph	99

### DISK DRIVE SPECIAL!



CALL FOR CATALOG! Micro-Sci A-2 249!

**Taxan Amber 12"**  
\$119.00



Taxan	Price	USI	Price
KG 12" (green)	119	Green	119
KG 12" (amber)	119	Amber	119
RGB-I	329	<b>Zenith</b>	
RGB-II	459	121-Green	95
RGB-III	529	ZVM-134 Hi-Res RGB	589
<b>Amdek</b>			
V 300	139	13" Med-Res RGB	319
Color I	299	13" Hi-Res RGB	549
Color II	548	SuperColor Board	189

ORDER TOLL-FREE!! 1-800-854-2833



**IBM**  
CALL FOR COMPLETE CATALOG IT'S FREE!

<b>AST</b>	Combo Plus 64K(S/P)	349	<b>QUADRAM</b>	Quadboard II 64K	429
	Combo Plus 256K(S/P)	639		Quadboard II 256K	669
	Mega Plus 64K(S/P)	459		Quad 512+64K	389
	Mega Plus 256K(S/P)	749		Quad 512+512K	1049
<b>QUALITY COMP.</b>					
	Big Blue	449	<b>TECMAR</b>		
Complete Line . . . CALL					
<b>DAVONG</b>					
	5 MB Hard	1489	<b>MBI</b>		
	10 MB Hard	1899	Monte Carlo 64K		
	15 MB Hard	2249	Monte Carlo 256K		
	Slave 5 MB	1290	Baby Blue (64K&Z-80)		
Baby Blue Ramplus 659					

**SOFTWARE**

Visicalc (256K)	185	Vedit-86 by Cmpview	199
Word Star	249	The Programmer	369
Mail Merge	88	CP/M-86 by Digital	279
Peachtree Pkgs	CALL	Basic-80 by MSoft	297
Volks Writer	129	Fortran-80 by MSoft	419
Super Calc	217	M/Sort by MSoft	159
Easy Writer II	239	Easy by Denver	543
Home Acct. Plus	109	Mathemagic by ISM	69

ZENITH • KAYPRO • ALTOS • NEC • FRANKLIN  
And Others Available

FREE SHIPPING\*

**commodore NEW!**

C-128	Call		
B-128	Call		
<b>Vic Accessories</b>			
Dataset	64	24K Mem. Expander	139
Disk Drive	469	IEEE-488 Card	69
Graphic Printer	319	6 Slot Expand.	99
16K Mem. Expander	79	Afron Chassis	198
<b>C-64 Accessories</b>		<b>C-64 Software</b>	
Video Pak Z-80	259	Hesmon 64 (cart.)	29
Video Pak 80	159	Heswriter 64 (cart.)	34
IEEE Adapt. by MS	89	Home Journal (tape)	39
Viac (adapt any cass)	45	DataCalc (tape)	39

Call For Free Catalog

**COLUMBIA**  
The Columbia MPC is IBM® P/C Hardware & Software Compatible.  
The Price? Non - Comparable!  
Save Hundreds and Call



**EAGLE COMPUTER**

Free Brochure

<b>New 1630</b>	Call		
Eagle II	2395	Eagle IV	4595
Eagle III	3095	File 10	2395

**corona**

IBM® P/C Compatible

- Desktop with one 320K Drive 128K Ram, Ser. & Par. Ports, Hi-Res Monitor, MS DOS, Basic and Multiplan . . . \$2550
- Portable-same components as the "Desktop" but portable . . . \$1995

**TERMS AND CONDITIONS**

• Personal checks (allow 10 days to clear), Visa, Mastercard, American Express, Cashiers Checks, Wire Transfers, include 2% service charge • COD's minimum \$250.00 with \$25.00 deposit • All products factory sealed with manufacturers warranty • PO's accepted from qualified customers • Approval needed on all returns • Add 3% for UPS shipping (\$5.00 minimum) • Restocking fee for returned merchandise • Equipment subject to price change & availability • Foreign orders write for quotations • \$40.00 minimum purchase on all orders • Calif residents add 8% state tax • APO, FPO, Hawaii & Alaska call or write for shipping details \*with prepaid cash orders, includes certain printers, monitors & foreign orders.

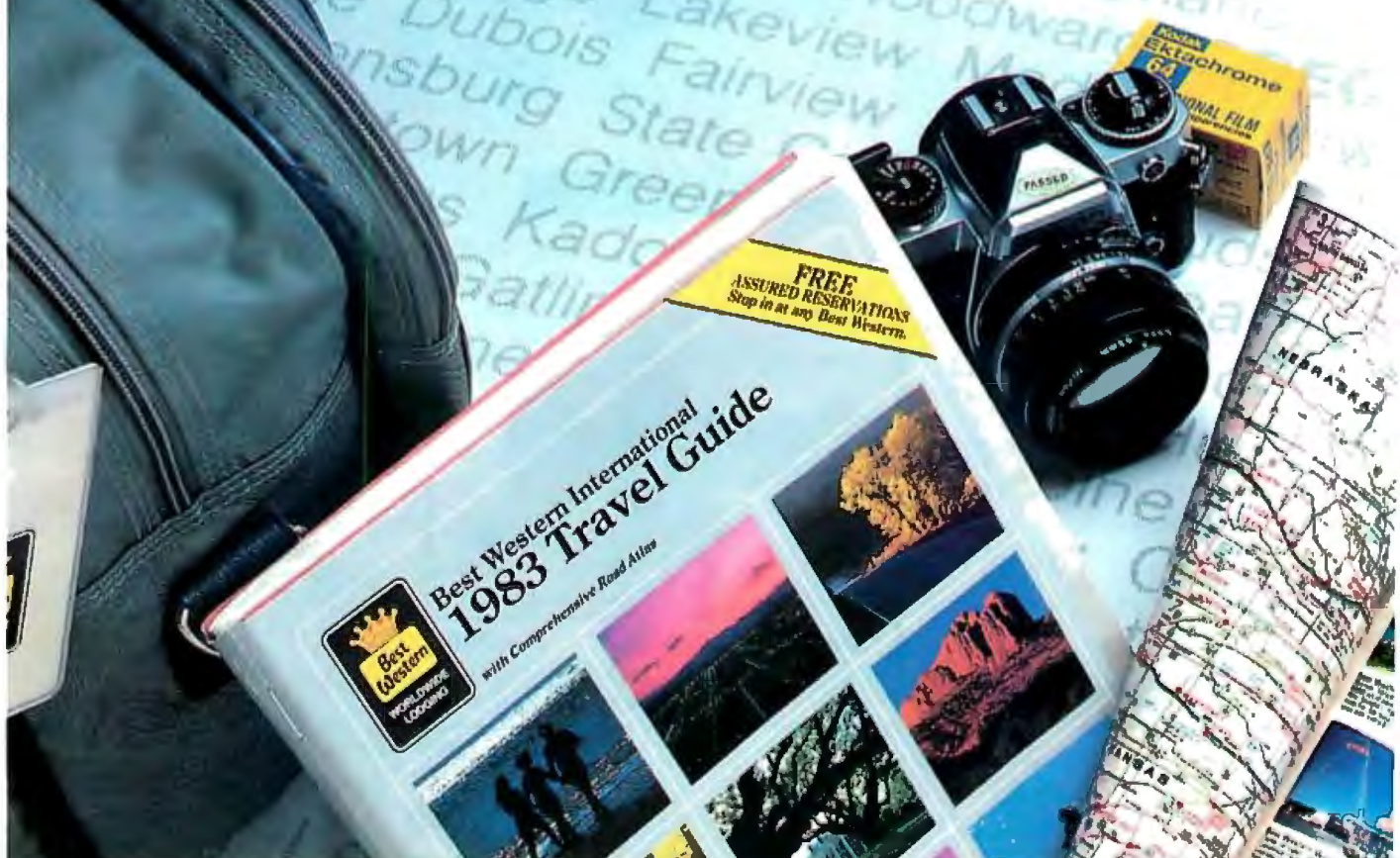
Apple®, CP/M®, IBM®, Smith-Corona® are all registered trademarks Circle 90 on Inquiry card.

**MAIL TO:**  
**Computer Specialties**  
1251 Broadway,  
El Cajon, CA 92021

**OR CALL: (619) 579-0330**

# Wherever you travel... the Best Western Crown. comfort and value for

Best Western has the right place to stay  
... at the right price. Visit any Best Western  
and ask for your free 300 page full-color  
1983 Travel Guide. It's loaded with road  
maps plus detailed listings and  
pictures of every Best Western  
in North America ... nearly 1,800 of them.



# we'll be there. Look for It's your assurance of your lodging dollar.

## Free Travel Guide... Free Instant Reservations.

For reservations, just ask the Best Western front desk person to "Make you a ST★R" on our instant, worldwide system... contact your travel agent... or call toll-free 1-800-528-1234.

*Rest Assured*<sup>SM</sup>  
2,800 places in 1,950 cities worldwide

Andorra, Aruba, Australia, Austria, Belgium, Canada, Denmark, Finland, France, Great Britain, Guadeloupe, Holland, Ireland, Italy, Liechtenstein, Luxembourg, Mexico, New Zealand, Puerto Rico, Sweden, Switzerland, United States, Virgin Islands, West Germany



Present this coupon at any Best Western for your free Travel Guide (or mail coupon with \$2 to cover postage and handling to Travel Guide, Box 10203, Phoenix, AZ 85064. Allow 8 weeks delivery time.)

PLEASE PRINT:

NAME \_\_\_\_\_

ADDRESS \_\_\_\_\_

CITY \_\_\_\_\_ STATE \_\_\_\_\_ ZIP \_\_\_\_\_

PM

# WE HAVE THE JUMP ON THE COMPETITION

10 YEAR WARRANTY



**Kangaroo™**

## in QUALITY and PRICE!

**Kangaroo**—the best disk at **any** price!

- CERTIFIED 100% ERROR FREE
- REINFORCED HUB RINGS
- ALL **KANGAROO** DISKS ARE PACKAGED IN A HARD LIBRARY CASE
- 10 YEAR WARRANTY

### Suggested List Price

5¼ inch Single Sided/Double Density **\$29.95**

5¼ inch Double Sided/Double Density **\$39.95**

### Try A Box Of Kangaroos On Us!

We are so convinced **Kangaroo** is the best disk you can buy that we make this offer. Buy a box of **Kangaroos**, if for any reason you are not satisfied with the quality of **Kangaroos**, return them within 30 days for a full refund—no questions asked.

EXCLUSIVE NORTH AMERICAN  
DISTRIBUTOR:

MICROCOMPUTER  
BUSINESS  
INDUSTRIES  
CORPORATION

ADMINISTRATIVE OFFICES: 1019 8TH STREET, GOLDEN, COLORADO 80401 (U.S.A.)  
TELEPHONE: (303) 279-1438

Circle 260 on inquiry card.

**MBE**

TWX: 910 934 019

# Zenith Z-100, Epson QX-10, Software Licensing, and the Software Piracy Problem

*Our intrepid columnist shoots from the hip and takes a little flak.*

---

Jerry Pournelle  
c/o BYTE Publications  
POB 372  
Hancock, NH 03449

---

The newest machine here at Chaos Manor is the Zenith Z-100. It's very colorful, so naturally it became known as Zorro.

The Z-100 has very nice features, and the best color graphics I've seen in a small machine. It's a dual-processor computer, with an 8-bit 8085 and a 16-bit 8088. In addition, there's a dedicated microprocessor chip that runs the elaborate keyboard. My system contains 128K bytes of memory, which is standard. There are sockets for more memory chips to bring it up to 192K bytes.

It's easy to add still more memory, because the Z-100 contains an IEEE-696 standard bus with five slots. This is better known as the S-100 bus. Thus you can add Zenith memory, or Compupro, or any other S-100 memory board you might have as long as it's bank selectable and can operate in a 5-MHz environment.

You can also add almost anything else you like. The Z-100 specification sheets specifically mention Compupro memory and I/O (input/output) boards, the Data Technology hard-disk controller, and the Tarbell disk

controller as being compatible; they also say that just about any IEEE-696 board (except CPU [central processing unit] boards, of course) should work fine.

There's an awful lot of good stuff made for the S-100 bus, and it's nearly all available to the Z-100.

Because the Z-100 has both 8085 (8-bit) and 8088 (16-bit) CPUs, it's very flexible regarding software. The Z-100 uses ZDOS (the Zenith disk operating system), which is operationally identical to the IBM PC-DOS; most programs for the IBM Personal Computer will run just fine on the Z-100. For example, IBM's Pascal native-code compiler and 8086 assembler run just as they come from the box. The Z-100 will not run software that contains graphics written for the IBM PC or that makes use of the ROM (read-only memory) monitor in the IBM.

The other operating system for the Z-100 is CP/M-85, which is Zenith's name for standard CP/M-80 version 2.2. The result is that not only can the Z-100 run programs written for the IBM PC, but also most of the soft-

ware written for 8-bit CP/M machines. Transfer of programs is no problem, either. The Z-100 comes with two built-in double-sided double-density 5¼-inch disk drives, but it also has a cable connector on the back for 8-inch disk drives. The nice part is that the Z-100 system expects the 8-inch disk drives to be jumpered as 0 and 1, meaning that I was able to plug my Compupro (Qume) disks from Zeke II (a Compupro Z80 computer) into the Z-100 and read disks as drives C and D immediately. I didn't have to change anything in either the Z-100 or in my Compupro disk drives. Just plug in the cable.

It won't read double-sided 8-inch disks unless I do something to the jumpers; but it reads single-sided double-density disks formatted by the Compupro Disk 1 controller just fine. That includes formats of 256, 512, and 1024 bytes/sector. I've just used PIP to copy XD.COM (an extended directory utility) from an 8-inch disk to Zorro's 5¼-inch disk, and it works. I was able to send over all kinds of stuff: a disk utility program

# 68000

## CROSS ASSEMBLER

FOR CP/M-80 \$ 260

MOTOROLA SYNTAX      MACROS

LINKAGE EDITOR      CONDITIONALS

STRUCTURED      WRITTEN IN C

Queto      (206)784-8018  
843 NW 54th      mornings  
Seattle, Wa. 98107      Dick Curless

IBM is a trademark of International Business Machines Corporation

Circle 324 on Inquiry card.

### -- PRINTERS --

**SMITH**      **\$489**  
**CORONA TP-1**

Prowriter 8510 AP      \$379  
Prowriter 1550 P      \$649  
Starwriter      \$1195  
Wordslinger 8600-180CPS      \$Call  
Okldata      \$Call

### -- MONITORS --

Amdek 300G \$149 Color I      \$298  
300A \$159 Color II      \$699

### -- MODEMS --

Hayes Smartmodem(300 Baud)      \$215  
Hayes Smartmodem(1200 Baud)      \$499

**-- DRIVES --      -- SOFTWARE --**  
IF YOU DO NOT SEE IT CALL



**1-800-421-8978**



CALL OR WRITE      (205)598-4047

**SUNBELT COMPUTER PRODUCTS**  
P.O. Box 142, Daleville, AL 36322  
ASK FOR FREE CATALOG

Circle 365 on Inquiry card.

### IN THE COMPUTER ROOM



no one can hear you  
**SCREAM**

T-shirt \$8.00 each. Brown on tan, yellow gold or white. Hanes 50-50 quality shirts. Catalog with order.

T-shirt HAUTE COUTURE for frobers, hackers & wizards. Technical T-shirts from the forefront (and backside) of science.

Extensive catalog of over 225 titillating topics and tantalizing tidbits to tickle your tastes and outrage your colleagues. Circle our number on the inquiry card or send 40¢ to address below for a fast catalog.

**SOFTWARE UNLIMITED**

Star Route Box 38, Winthrop, WA. 98862  
Phone (509) 996-2576

Circle 358 on Inquiry card.

called UNERASE, the program that checks for bad sectors (some outfits call it BADLIM), and SWEEP, which is a nifty utility that lets you go through a disk and copy, erase, rename, and otherwise muck about with the disk directory. All these programs, incidentally, are available from Workman and Associates for \$32.50 a disk. Most are in the public domain.

The best news is that WRITE, my favorite text editor, works fine. I used the old version I had for the Z-19 terminal. Tony Pietsch had set things up to use the Z-19's special-function keys, and also to make the Z-19 numeric keypad into a block of cursor-control keys. That all works exactly as it should on the Z-100. I conclude that although the Z-100 makes use of memory-mapped video, it thinks it's talking to a Z-19 terminal when it's running under CP/M-80 2.2. If WRITE, with all its special calls and scrolling and cursor controls, will work without modification—and it does—then it's fair to conclude that anything configured for the Z-19 terminal will work. That's good news.

I've also been playing about with ZDOS, which is Zenith's work-alike for the IBM PC-DOS. It's a bit cumbersome; I think I'd prefer CP/M-86. That may just be a matter of getting used to MS-DOS, of course. (One might as well call it MS-DOS, meaning Microsoft disk operating system; PC-DOS and ZDOS are simply versions of MS-DOS set up for their particular machines.)

My Z-100 has some of the most spectacular color graphics I've ever seen. The screen consists of a field of 225 (vertical) by 640 (horizontal) individual pixels (dots), each of which can take on any one of eight colors. This high resolution compares favorably to the IBM PC's 640- by 200-dot high-resolution mode with white on black only. A character-set generator makes nicely formed letters that are very easy to read on the big monitor screen.

A demonstration disk comes with the Z-100. The disk has BASIC routines to make all kinds of pretty pictures. There are also programs to do scads of business graphics: pie charts,

bar charts, wavy lines, etc., all in vivid color.

The only problem is that I have precious little applications software that runs under PC-DOS—and at the moment, the only language I have available (other than 8086 assembler, which I'm not ready to learn) is Zenith's version of Microsoft BASIC, ZBASIC. The color programs are all written in that. Microsoft has added a bunch of special commands, such as CIRCLE, LINE, and PAINT, to let you control the color.

I wanted to play with the color, and I didn't want to do any really serious work. Then I remembered that Epyx published the source code for Invasion Orion. This is a naval action game (well, it's supposed to take place in space, but it's rather two-dimensional, so that it's a lot like a wet navy battle). You have one fleet, and the computer has another, and the computer is a pretty good player. I liked that game on the Apple and the TRS-80; the only problem was that it was pretty slow. The Z-100 is a much faster machine, so that shouldn't be a problem. While I was at it, I modified the graphics to make use of the Z-100's color capabilities.

Alas, I never finished. I'd forgotten just how awful BASIC programs used to be. I've gotten used to CB-80, the CBASIC-II compiler, with its multiple line functions, and no line numbers, and local variables, and top-down structured code. After about three hours of trying to plow through a tangle of GOTO statements, and six or eight statements per line, and single-letter variables, I gave up.

I haven't given up completely, though; IBM Pascal works fine on the Z-100. Now all I have to do is figure out how to use the color graphics in something other than BASIC, and I can write my own space-war game. I have in mind The Moat Around Murcheson's Eye, in which the Moties are trying to escape. As the ships take more hits they change color, from red up the spectrum to violet (after which they explode).

**Games, Games . . .**

While I'm on the subject of games, I

# COM-STAR F/T

Tractor  
Friction  
Printer

only \$279



- Lowest price quality tractor friction printer in the U.S.A. • Fast 80 characters per second
- 40, 46, 66, 80, 96, or 132 characters per line spacing • Prints labels, letters, graphs, and tables
- List your programs • Print out data from modem services

**Deluxe  
COMSTAR F/T  
PRINTER — \$279.00**

The Comstar is an excellent addition to any micro-computer system. (Interfaces are available for Apple, VIC-20, Commodore-64, Pet, Atari 400 and 800, and Hewlett Packard) At only \$279, the Comstar gives you print quality and features found only on printers costing twice as much. Compare these features.

• **BI-DIRECTIONAL PRINTING** with a LOGIC SEEKING CARRIAGE CONTROL for higher through-put in actual text printing. 80 characters per second.

• **PRINTING VERSATILITY:** standard 96 ASCII character set plus block graphics and international scripts. An EPROM character generator includes up to 224 characters.

• **INTERFACE FLEXIBILITY:** Centronics is standard. Options include EIA RS232C, 20mA Current Loop. (Add \$20.00 for RS232)

• **LONG LIFE PRINT HEAD:** 100 million character life expectancy.

• **THREE SELECTABLE CHARACTER PITCHES:** • 10, 12 or 16.5 characters per inch. 132 columns maximum. Double-width font also is standard for each character pitch.

• **THREE SELECTABLE LINE SPACINGS:** 6, 8 or 12 lines per inch.

• **PROGRAMMABLE LINE FEED:** programmable length from 1/144 to 255/144 inches.

• **VERTICAL FORMAT CONTROL:** programmable form length up to 127 lines, useful for short or over-sized preprinted forms.

• **FRICTION AND TRACTOR FEED:** will accept single sheet paper.

• **224TOTAL CHARACTERS**

• **USES STANDARD SIZE PAPER**

If you want more try -

**Premium Quality  
COMSTAR F/T SUPER-10"  
PRINTER — \$369.00**

More Features Than MX-80  
For \$250 Less

For \$369.00 you get all of the features of the Comstar plus 10" carriage, 100 cps, 9 x 9 dot matrix with double strike capability for 18 x 18 dotmatrix. High resolution bit image (120 x 144 dot matrix), underlining, backspacing, 2.3K buffer, left and right margin settings, true lower descenders, with super and subscripts, and prints standard, Italic, Block Graphics, special characters, plus 2K of user definable characters. For the ultimate in price performance the Comstar F/T Super 10" leads the pack!

**80 COLUMN PRINTER \$199**

Super silent operation, 60 CPS, prints Hi-resolution graphics and block graphics, expanded character set, exceptionally clear characters, fantastic print quality, uses inexpensive thermal roll paper!

**Double  
Immediate Replacement  
Warranty**

We have doubled the normal 90 day warranty to 180 days. Therefore if your printer fails within "180 days" from the date of purchase you simply send your printer to us via United Parcel Service, prepaid. We will IMMEDIATELY send you a replacement printer at no charge via United Parcel Service, prepaid. This warranty, once again, proves that WE LOVE OUR CUSTOMERS!

**15 DAY FREE TRIAL**

**OTHER OPTIONS**

Extra Ribbons ..... \$ 5.95  
Roll Paper Holder ..... 32.95  
Roll Paper ..... 4.95  
5000 Labels ..... 19.95  
1100 Sheets Fan Fold Paper ..... 13.95

Add \$20.00 shipping, handling and insurance. Illinois residents please add 6% tax. Add \$40.00 for CANADA, PUERTO RICO, HAWAII, ALASKA orders. WE DO NOT EXPORT TO OTHER COUNTRIES. Enclose cashiers check, money order or personal check. Allow 14 days for delivery, 2 to 7 days for phone orders, 1 day express mail available!! Canada orders must be in U.S. dollars.

**PROTECTO**

**ENTERPRIZES** (WE LOVE OUR CUSTOMERS)

BOX 550, BARRINGTON, ILLINOIS 60010  
Phone 312/382-5244 to order

**COMSTAR F/T**

ABCDEFGHIJKLMN O P Q R S T U V W X Y Z abcdefghijkl  
lmnopqrstuvwxyz 1234567890  
ABCDEFGHIJKLMN O P Q R S T U V W X Y Z abcdefghijklmnopqrstuvwxyz 1234567890

**SUPER-10"**

**ABCDEFGHIJKLMN O P Q R S T U V W X Y Z  
ABCDEFGHIJKLMN O P Q R S T U V W X Y Z 1 2 3 4 5 6 7 8 9 0**

notice that whenever the boys play games on their Apple II, the games tend to be one or another by Epyx. They particularly like Rescue at Rigel, and they've nearly worn out the Dungeons of Apsai. The Epyx games tend to be intellectual. Because I have terrible eye-hand coordination, I greatly prefer that kind to the arcade games (I always get killed in arcade games). I'm particularly partial to Crush, Crumble, and Chomp, in which I get to play my favorite movie monster rampaging through Washington and burning down the Pentagon.

We also play Zork, the super adventure developed by the Gang of Four Implementers at MIT. If you liked Adventure and wanted more after you solved the Colossal Cave, I guarantee you'll love Zork. The people who wrote it also bring you Deadline, a very popular and fun game of detective logic complete with documentary evidence; and Starcross. This latter is a Zork-like game of exploring a large alien starship. I'm not as fond of it as I am of Zork, but a

number of science-fiction fans like it very much.

### Meanwhile, Back to Zorro

I'm still testing the Z-100. There's a lot to like about it. For one thing, I really like the keyboard, which is a dead ringer for the IBM Selectric. It's completely sculpted, with the home keys formed in such a way that you can find them easily. The keyboard feels good, with just the right amount of tactual feedback. All the keys are there, including arrows, numeric keypad, and a row of 15 user-programmable special-function keys across the top. The only thing missing is that shifted comma and period make < and >, which is standard enough, but I'm spoiled by my Archive keyboard.

The keyboard is completely reprogrammable, though, and there are complete documents on what it does and how it does it. I can, if I like, change the period and comma so that they put out the same characters shifted as unshifted. If Zorro becomes the system master here, I'll probably

do that.

The Z-100 is professional-quality equipment. I once said the real problems with the IBM PC were its non-standard bus and that awful keyboard. The Z-100 has fixed both those problems, and with its ability to run both CP/M-80 2.2 and MS-DOS, plus the spectacular color capability, it's going to be a strong contender for both business and development applications.

The machine has a couple of drawbacks. One, it's *big*. The keyboard, two disk drives, and the computer itself are all built into one box. (In some models, there's also a green screen built on top; that's *really* big.) In order to use the Z-100 properly, I'm going to have to build a special table that will get the keyboard low enough and have a place for the big 15-inch color monitor.

Most applications software available for the Z-100 is 8-bit stuff running under CP/M-80 2.2. That should change as more machines appear and people begin to take advantage of the 16-bit processor's capabilities. Meanwhile, there is an awful lot of CP/M-80 2.2 software. The Z-100 is a very good transition machine to go between 8-bit CP/M and 16-bit MS-DOS; and with the S-100 bus, it won't become obsolete for years.

A final problem is Zenith's documents. They range between good and excellent, but there are strange lacunae, and the indexes are just plain terrible. For example: the Z-100 has excellent tactile feel to the keyboard. There's no need for a keyclick, and certainly no need for the annoying squeak that Zenith has installed. Alas, the only index entry for "keyclick" refers you to the formal specifications for the machine, where it says, "Keyclick may be turned off." There's no hint as to *how* to turn it off.

I expect some of you are now wondering why I don't read through the entire set of documents, but if you could see them, you'd wonder no longer. The Zenith documents certainly *look* impressive: I have about five feet of them. They come in massive loose-leaf binders; two

## Can a Software Package Change the World?

### Spread Sheets First... QUESTEXT™ Next!



- A Revolutionary New Microcomputer Concept
- Store Information by Menu . . . • Not a WP
- Buy One General Purpose Package and save buying dozens of Specialized Programs
- ULTRA FRIENDLY • 100% Menu Driven
- LEARNABLE in one session • No Programming
- ALLOWS INSTANTANEOUS INNOVATION • Not a DBMS

QUESTEXT III is a mature general purpose system for organizing and communicating textual information. It organizes text into tree-like menu structures. It is the first electronic WordSheet, a generalized information analyzer.

**Unlimited uses:** Dealer Demo; Online help and documentation; Computer-aided instruction; On-line training; Top-down software documentation; Writer's outlines; Check teleprompting; Classroom phonebook; Public access queue; our database; Scheduling plan; and File cabinet indexing.

**Observation loggers:** Personnel and locator services; job commands; Customer New Product support and training; Technical information management; Diagnosis support; Quality control; Price; Product data; Electronic Publishing; Bulletin boarding; Tutorials

and quizzes for textbooks; a structured computing course; page numbering and note comment management; disk file inventory; amortization; system protocols; Proceedings; etc.; Home Computing insurance inventory; Records management; Survey and experiment control; Much more. . . . Detailed manual for contract consultants and systems developers.

**FEATURES:** Easy updating; Copy editing; Error handling; English prompting; No syntax; Fast machine-executable code; Simple commands (Help, Show, Add, Delete, Insert, Move, Edit, Print, New, Up, Top, Garbage free); Easy file control (Create, Delete, Back up, Modify); REQUIRES IBM PC or 286 or 386 CP/M or ASCII CP/M. WHO CAN USE QUESTEXT? ANYONE! CAN I? System Developers, Business People, Educators, Consultants, Scientists, Programmers and Nonprogrammers alike!

SEE BELOW FOR ADVANTAGES OF EARLY ORDER. MONEY BACK OFFER ON MINI VERSION. PHONE ORDERS 617-369-5719 • OEM AND DEALER INQUIRIES WELCOME.

Available from  
**iRr**

Mail to: iRr, 1538 Main Street, Concord, MA 01742

PLEASE SEND ME QUESTEXT III

Mini Version (6 lines menu, up to 40 screens, 500 records) (returnable for 14 days) (Mini Version is returned in good condition) \$ 4995

Full System (16 lines menu, up to 100 screens, 22,700 records) \$2995

Manual: Chk. \$ 295

Soft loading disk v. 3 applications \$ 295

Add \$30.00 Postage and Handling TOTAL COST: \$ 5995

\* Includes 21 days free home trial without charge. Add \$10.00

IBM PC  Xerox 820  Morrow MD (Others from dealer)

Personal  386  286  486  586

Name \_\_\_\_\_ Address \_\_\_\_\_



- ① Adjustable 4" to 10" snap-on tractor feed, 4" to 10" friction feed, and fixed 10" pin platen (all standard). Fan-fold paper, cut sheets, roll paper, label, and pin-feed paper can be used.
- ② Immediate tear-off. No more wasting valuable invoices and paper.
- ③ Clean, compact, reinkable black ribbon cassette. Low cost and easily replaceable.
- ④ User-replaceable 9 wire print head. 100 million character/life. Print head driven by steel wire.



## RITEMAN: The first 10" printer you can fit in your briefcase.

This new generation printer is half the size of an ordinary printer, measuring 2 7/8" (h) x 10 9/16" (d) x 14" (w) and weighing 11 lbs. Built solid and reliable, Riteman prints at a remarkable 120 cps, with bi-directional logic seeking, 63 lpm, 100 msec line feed for faster line spacing and forms control, to maximize throughput. True 1:1 dot ratio enables Riteman to draw perfect circles. And best of all, Riteman's advanced technology and manufacturing have resulted in exceptional cost savings.

For starters, Riteman has these features:

- 9 x 9 dot matrix • Bi-direction • Number of print modes • Underlining • Programmable line & forms feed • Parallel standard • Serial option
- 32 block graphics • 96 ASCII characters with true descenders • Italics • Skip over perf.
- Dot addressable graphics:
  - 480 dots—Low res. graphics
  - 960 dots—High res. graphics
  - 576 dots—1:1 graphics
- Compatible with most existing software

For more information, ask your local computer dealer, or contact Inforunner Corporation  
1621 Stanford Street  
Santa Monica, CA 90404  
(213) 453-6688



**:RITEMAN:**  
PERSONAL PRINTER

Circle 186 on inquiry card.

# Byte Book Club™

FORMERLY COMPUTER PROFESSIONALS' BOOK CLUB

**INTRODUCING THE UNIX SYSTEM.** By H. McGilton & R. Morgan. 256 pp., 50 illus. soft. This book helps you over the initial hurdles of learning this new and powerful computertool—even if you have never used the Unix system or penetrated any of its literature. 450/013 \$18.95

**OPERATING SYSTEMS** By H. Lorin & H. M. Dietel 582354-3 \$20.95

**MICROCOMPUTER GRAPHICS AND PROGRAMMING TECHNIQUES.** By H. Katzan, Jr. 240 pp., 100 illus. and tables. Here's a stimulating introduction to computer graphics for small computers. It covers all the advances to date in color coding and computer graphics technology and—best of all—it's written for information professionals who can't draw! Includes actual graphics programs worth hundreds of dollars! 582576-7 \$18.95

**MINICOMPUTER AND MICROPROCESSOR INTERFACING.** By J. C. Cluley. 266 pp., 73 illus. and tables. Unless you are content to have your information processing system simply talk to itself, you need the intense coverage of interfacing provided so brilliantly by this compact volume. In addition to discussing the logical design of interfaces assembled from small-scale integrated circuits, the book gives you a lucid picture of the interface packages designed for microprocessor systems and the way in which they are used. 582585-6B \$27.50 (Counts as 2 of your 3 books)

**ASSEMBLERS, COMPILERS, AND PROGRAM TRANSLATION** By P. Calingaert 582110-9 \$22.95

**THE SCIENCE OF PROGRAMMING** By D. Gries 582452-3 \$19.80

**PROGRAMMING WITH ADA: An Introduction By Means of Graded Examples** By P. Wegner 789/24X \$17.95

**AN INTRODUCTION TO VISICALC® MATRIXING FOR APPLE® AND IBM®.** By H. Anbarlian. 252 pp., illus., softcover. Enables you to use VisiCalc matrixes—also known as templates and models—to put your Apple or IBM personal computer to productive use almost immediately. It describes the actual process of developing matrixes for such applications as expense vouchers, price/earnings ratios, payrolls, stock portfolios, and more. 016/054 \$22.95

**SOFTWARE ENGINEERING: A Practitioner's Approach.** By R. S. Pressman. 576 pp., 180 illus. Gives you a concise but complete picture of each step in the software engineering process—a set of techniques that deal with software as an engineered product. Each step is discussed and illustrated—from planning, analysis, and design to implementation, testing, and maintenance. 507/813B \$32.95 (Counts as 2 of your 3 books)

**NETWORK SYSTEMS.** By R. L. Sharma, P. J. T. deSousa, and A. D. Ingle. 321 pp., illus. Here is the first book to describe—concisely and comprehensively—all current stored program-controlled (SPC) telecommunication network systems that use integrated modeling, analysis, and design techniques. 582557-0B \$29.95 (Counts as 2 of your 3 books)

# POWERFUL TOOLS! POWERFUL SAVINGS!

Take any 3 books for only **\$1.00** each\*

Values up to \$79.50



**BIT-SLICE MICROPROCESSOR DESIGN.** By J. Mick and J. Brick. 398 pp. All in one place—the crucial information you've been needing about the 2900 family of bit-slice microprocessor components. This remarkable "first" designs right before your eyes not just one but two complete 16-bit machines! 417/814B \$29.50 (Counts as 2 of your 3 books)

**MICROPROCESSOR APPLICATIONS HANDBOOK.** Edited by D. F. Stout. 472 pp., 284 illus. This BIG book on SMALL chips will help you make your systems timely, versatile, and cost-effective. The 16 expert contributors provide in-depth treatments of both hardware and software so you can completely analyze, design, construct, and program. 617/988B \$35.00 (Counts as 2 of your 3 books)

**COMPUTER PERIPHERALS FOR MINICOMPUTERS, MICROPROCESSORS, AND PERSONAL COMPUTERS** By C. L. Hohenstein 294/518 \$23.95

**THE SMALL COMPUTER CONNECTION: Networks for the Home and Office.** By N. L. Shapiro. 256 pp. Shows you how to use existing hardware and software to link your small computer to other computers—large and small—and to a vast universe of databases. 564/124 \$16.95

**ELECTRONICS ENGINEERS' HANDBOOK, 2/e** By D. G. Fink & D. Christiansen 209/812A \$75.00 (Counts as 3 of your 3 books)

**STRUCTURED PROGRAMMING: Theory and Practice** By R. C. Linger, H. D. Mills & B. I. Witt 788/537 \$22.95

**MICROPROCESSOR DEVELOPMENT AND DEVELOPMENT SYSTEMS.** Edited by V. Tseng. 170 pp., 90 illus. A panel of experts provides an overview of the development process, displays the different approaches taken by leading firms in the field, and covers existing systems and tools. You'll gain a better understanding of what is involved in microprocessor application development... and you'll be able to identify and decide what is important for you. 653/801B \$29.95 (Counts as 2 of your 3 books)

**Z80 USERS MANUAL.** By J. Carr. 326 pp., with diagrams, charts, and tables. Takes you through every opportunity the ZAP can offer! It covers Z80 pin definitions, CPU control signals, support chips, interfacing peripherals, and much more. 582336-5 \$21.95

**DATABASE DESIGN 2/e.** By G. Wiederhold. 704 pp. This expanded new edition offers 2 major sections: 1) a description and analysis of file systems and 2) a description and analysis of database systems. Plus additional updated information. 701/326B \$32.00 (Counts as 2 of your 3 books)

**SOFTWARE DEBUGGING FOR MICROCOMPUTERS** By R. Bruce 582075-7 \$18.95

**ELECTRONICS DICTIONARY, 4/e** By J. Markus 404/313B \$32.95 (Counts as 2 of your 3 books)

**MICROPROCESSOR DATA BOOK.** By S. A. Money. 350 pp., 220 illus. A truly awesome collection of data about virtually every chip available today! 427/062B \$38.00 (Counts as 2 of your 3 books)

# BYTE BOOK CLUB

## Membership Order Card

Please enroll me as a member and send me either the McGraw-Hill Computer Handbook, billing me only \$3.00, or any 3 other books, billing me only \$1.00 each, plus local tax, postage and handling. I agree to purchase a minimum of three additional books during my first year as outlined under the Club plan described in this ad. Membership in the club is cancellable by me any time after the three book purchase requirement has been fulfilled. A shipping and handling charge is added to all shipments.

- Check here if you want the McGraw-Hill Computer Handbook (279/721).
- Check here if you prefer three other volumes, and indicate below by number the books you want. A few expensive books (noted in the descriptions) count as more than one choice.

--	--	--

Name \_\_\_\_\_

Address/Apt. # \_\_\_\_\_

City, State, Zip \_\_\_\_\_

Corporate Affiliation \_\_\_\_\_

This order subject to acceptance by McGraw-Hill. All prices subject to change without notice. Offer good only to new members. Orders from outside the U.S. cannot be accepted.

# BYTE BOOK CLUB

## Membership Order Card

Please enroll me as a member and send me either the McGraw-Hill Computer Handbook, billing me only \$3.00, or any 3 other books, billing me only \$1.00 each, plus local tax, postage and handling. I agree to purchase a minimum of three additional books during my first year as outlined under the Club plan described in this ad. Membership in the club is cancellable by me any time after the three book purchase requirement has been fulfilled. A shipping and handling charge is added to all shipments.

- Check here if you want the McGraw-Hill Computer Handbook (279/721).
- Check here if you prefer three other volumes, and indicate below by number the books you want. A few expensive books (noted in the descriptions) count as more than one choice.

--	--	--

Name \_\_\_\_\_

Address/Apt. # \_\_\_\_\_

City, State, Zip \_\_\_\_\_

Corporate Affiliation \_\_\_\_\_

This order subject to acceptance by McGraw-Hill. All prices subject to change without notice. Offer good only to new members. Orders from outside the U.S. cannot be accepted.



NO POSTAGE  
NECESSARY  
IF MAILED  
IN THE  
UNITED STATES

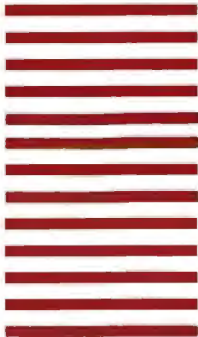
**BUSINESS REPLY CARD**

FIRST CLASS PERMIT NO. 42 HIGHTSTOWN, N.J. 08520

POSTAGE WILL BE PAID BY ADDRESSEE

**BYTE BOOK CLUB**

P.O. Box 582  
Hightstown, New Jersey 08520



NO POSTAGE  
NECESSARY  
IF MAILED  
IN THE  
UNITED STATES

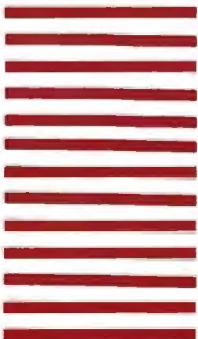
**BUSINESS REPLY CARD**

FIRST CLASS PERMIT NO. 42 HIGHTSTOWN, N.J. 08520

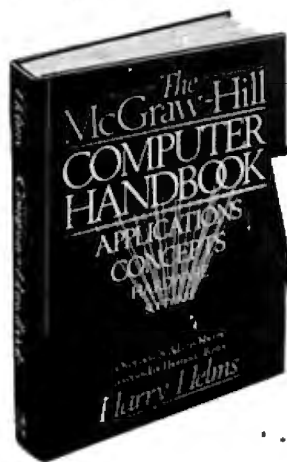
POSTAGE WILL BE PAID BY ADDRESSEE

**BYTE BOOK CLUB**

P.O. Box 582  
Hightstown, New Jersey 08520



# ANNOUNCING: The Most Important Computer Handbook Ever Published!



**This Remarkable  
New Reference  
—a \$79.50 value—  
Is Yours for only  
**\$3.00****

The McGRAW-HILL COMPUTER HANDBOOK, 992 pp., 475 illus., edited by Harry L. Helms, with over 24 world-reknown contributors, is by far the most useful and comprehensive reference yet designed for today's computer user. Crammed with easy to get at information, ranging from design concepts to programming techniques, from data bases to interfacing, networking, speech synthesis and recognition to mention just a few of hundreds of entries, this one volume reference does it all—in language and presentation everyone can understand. Invaluable for home, office, and school use, The Computer Handbook "can be helpful to users in solving many mysteries, while opening new doors for exploration and serving as a continuing reference," writes Thomas C. Bartee of Harvard University.

279/721A \$79.50

(Counts as 3 of your 3 books)

**\* If you join now for a trial period and agree to purchase three more books—at handsome discounts—during your first year of membership. (Publishers' prices shown)**

**PRINCIPLES OF INTERACTIVE COMPUTER GRAPHICS.** By W. M. Newman and R. Sproull. 2nd Ed., 544 pp., illus. Now in a revised, updated Second Edition, this volume has long been THE standard source of information for designers! Now, as before, it is utterly comprehensive and up to the minute in its coverage.

463/387B \$35.95  
(Counts as 2 of your 3 books)

**MICROPROCESSORS/MICROCOMPUTERS / SYSTEM DESIGN** By Texas Instruments, Inc. 637/58XB \$29.95  
(Counts as 2 of your 3 books)

**16-BIT MICROPROCESSOR SYSTEMS.** By the Engineering Staff of Texas Instruments, Inc. 576 pp., illus. This broad-based guide presents a comprehensive overview, from basic concepts to advanced design principles. Includes valuable discussions of programming methods, instruction sets, software features, high-level language programming, I/O design, and more.

637/601B \$45.00  
(Counts as 2 of your 3 books)

**WORD PROCESSING BUYER'S GUIDE.** By A. Naiman. 340 pp. illus. Here is a personal guide that leads you out of the jungle of competing word processors. Which one is best for you? Find out BEFORE you buy!

458/693 \$15.95

**INTRODUCTION TO WORDSTAR™.** By A. Naiman. 202 pp., with illus. and command displays. Get your hands on this guide to the most powerful word-processing program available. Well organized and clearly written, it surpasses the dry WordStar reference manual. You'll learn to edit copy • create and merge files • format on-screen • create special print effects • generate form letters • and more!

582594-5 \$21.95

**APPLE MACHINE LANGUAGE** By D. Inman & K. Inman 582398-5 \$19.95

**THE ADA PROGRAMMING LANGUAGE.** By I. C. Pyle. 293 pp., illus., softbound. Written primarily for practicing programmers of embedded computer systems, this book provides a full presentation of the power of ADA. It will also prove of great interest to other programmers as well as to managers of programming projects.

582447-7 \$15.95

**APPLE PASCAL: A Hands-On Approach.** By A. Luehrmann and H. Peckham. 426 pp., spiralbound. Finally—a how-to-use-PASCAL book for Apple computer users that makes a complete language as easy as (forgive us!) applesauce. Takes you from "total ignorance" all the way up to a very impressive competence in the use of that rather complex language, PASCAL.

491/712 \$18.95

**THE C PRIMER.** By L. Hancock & M. Kreider. 256 pp., 25 illus., softbound. This is the only book on the market that describes the C language clearly and simply from the novice's point of view.

259/81X \$14.95

**THE PASCAL HANDBOOK** By J. Tiberghien 582365-9B \$35.00  
(Counts as 2 of your 3 books)

**MICROCOMPUTER INTERFACING** By B. Artwick 789/436B \$28.00  
(Counts as 2 of your 3 books)

**CONVERSION OF COMPUTER SOFTWARE.** By J. R. Wolberg. 250 pp. illus. This book gives you practical and reassuring insights into the fundamental concepts of software conversion.

582588-0 \$19.95

## Consider these Byte Books as well!

**MICROCOMPUTER OPERATING SYSTEMS** By M. Dahmke 150/710 \$15.95

**TRS-80 GRAPHICS FOR THE MODEL I AND MODEL III** By D. Kater & S. Thomas 333/033 \$12.95

**THREADED INTERPRETIVE LANGUAGES** By R. G. Loeliger 383/60X \$20.75

**THE BRAINS OF MEN AND MACHINES** By E. W. Kent 341/230 \$20.95

**BASIC SCIENTIFIC SUBROUTINES, Vol. II** By Dr. F. R. Ruckdeschel 542/023B \$26.50  
(Counts as 2 of your 3 books)

**CIARCIA'S CIRCUIT CELLAR, Vol. 2** By S. Ciarcia 109/63X \$14.75

**BYTE BOOK OF PASCAL** By B. W. Liffick 789/673B \$25.00  
(Counts as 2 of your 3 books)

**BASIC SCIENTIFIC SUBROUTINES, Vol. I** By Dr. F. R. Ruckdeschel 542/015 \$24.50

**CIARCIA'S CIRCUIT CELLAR, Vol. III** By S. Ciarcia 109/656 \$12.95

**MICROCOMPUTER DISK TECHNIQUES** By P. Swanson 625/824 \$15.00

**BUILD YOUR OWN Z-80 COMPUTER** By S. Ciarcia 109/621 \$17.95

## Why YOU should join the Byte Book Club™ now!

- **Best and newest books from ALL publishers!** Books are selected from a wide range of publishers by expert editors and consultants to give you continuing access to the best and latest books in your field.
- **Big savings!** Build your library and save money too! Savings range up to 30% or more off publishers' list prices—usually 20% to 25%.
- **Bonus books!** You will immediately begin to participate in our Bonus Book Plan that allows you savings up to 80% off the publishers' prices of many professional and general interest books!
- **Convenience!** 14-16 times a year (about once every 3-4 weeks) you receive the Club Bulletin FREE. It fully describes the Main Selection

and alternate selections. A dated Reply Card is included. If you want the Main Selection, you simply do nothing—it will be shipped automatically. If you want an alternate selection—or no book at all—you simply indicate it on the Reply Card and return it by the date specified. You will have at least 10 days to decide. If, because of late delivery of the Bulletin you receive a Main Selection you do not want, you may return it for credit at the Club's expense.

As a Club member you agree only to the purchase of three additional books during your first year of membership. Membership may be discontinued by either you or the Club at any time after you have purchased the three additional books. Orders from outside the U.S. cannot be accepted.



Fill out the card and mail today! If the card is missing, write to:

**BYTE BOOK CLUB™, P.O. Box 582, Hightstown, New Jersey 08520**

## MOVE YOUR MICRO into the 3270 ENVIRONMENT



CLUSTER  
ENVIRONMENT  
OPERATOR

3270 Cluster Emulation Software, CLEO, allows asynchronous ASCII Terminals to communicate with a BSC port. These terminals may be CRTs and printers from various manufacturers. CLEO will handle up to eight ASCII terminals and may be multi-dropped with other cluster controllers from one port. The ASCII terminals may be on-site with CLEO or remote from it, over dedicated lines or dial-up.

DISTRIBUTED BY

**CYBER/SOURCE**

YOUR SOURCE FOR THINKING MACHINES

Call or Write for the Dealer Nearest You

2400 Telegraph Rd. 802 Burr Oak Dr.  
Southfield, MI 48034 Westmont, IL 60559  
(313) 353-8660 (312) 789-3366

DEALER INQUIRIES WELCOME

Circle 106 on Inquiry card.

## S-100 REAL TIME CLOCK/CALENDAR



### S-100 SYSTEM CLOCK FEATURING:

- 12/24 hour clock with hours, minutes, seconds
- 4 year calendar
- Port Address Switch selectable
- Polled or interrupt switch selectable
- Supports Vectored Interrupts
- Programmable interrupt on any future time/date
- Interrupt as fast as 1/1000 second
- Recharging battery backed up

**\$129.95 assembled and tested**

Plus \$5.00 shipping & handling

**\$15.00 full documentation with 8" CP/M Compatible Disk**

California residents add 6.5% sales tax

Send check or money order to:

**RONSAN ELECTRONICS**  
1491 Stubbins Way  
San Jose, CA 95132  
408-251-9279

Circle 334 on Inquiry card.

**5 Year Warranty**  
**SAVE 50% ON**  
**Verbatim Datalife**  
**Diskettes**

### DEALER INQUIRIES INVITED

**5 1/4"** Specify Soft  
10 or 16 Sectors prices/10

MD525	1 side/dbl dens.	\$24.90
MD550	2 sides/dbl dens.	35.00
MD577	1 side/quad 96tpi.	33.75
MD557	2 sides/quad 96tpi.	44.50

**8"** Specify Soft or 32 Sector

FD34-9000	1 side/sgl dens.	30.00
FD34-8000	1 side/dbl dens.	33.00
DD34-4001	2 sides/dbl dens.	41.00

Checks-VISA-MC-C.O.D./Add \$2 Shipping  
Call or write for our discount catalog.

**LYBEN COMPUTER SYSTEMS**  
27204 Harper Ave., St. Clair Shores, MI 48081  
Phone: (313) 777-7780

**DATALIFE • THE NAME IS THE PROMISE  
THE WARRANTY IS THE PROOF**

Circle 225 on Inquiry card.

volumes for CP/M-85, two volumes for ZDOS, two for ZBASIC, and one user's manual for the machine. In addition, there are two enormous volumes of a service manual that Zenith was kind enough to send me (the technical manuals are not available now, although they will be by the time you read this).

The result is more than you can read; indeed, more than you can find room for. It just isn't practical to hunt through page after page of stuff, and the table of contents is informative only to those who know what they're looking for.

Example: when you load ZBASIC, the program automagically configures the 13 special-function keys. One becomes LOAD, another SAVE, another is GOSUB, etc. If you do PRINT CHR\$(20) or type Control-T, a special twenty-fifth line on the screen lights up to show you what each function key does. However, once you've done that, it's not simple to turn off that twenty-fifth line, even if you want it for a program. You can write a program to put spaces on that line, but every time you clear the screen, there's that status line back again.

I searched through the ZBASIC index for some mention of the special-function keys. Nothing. Try user keys. Nothing. Now what? Eventually I stumbled across a command, KEY ON, and another, KEY OFF, that in fact turn on and off the status line; but unless you're reading alphabetically through every BASIC command, you're not likely to figure that one out.

There's other stuff like that. I strongly urge Zenith to get to work on its index and table of contents. The documentation is very clear, with lots of examples and good explanations; but the organization isn't optimum, and there's too much for anyone simply to read through. They need a better summary, and better indexes and tables of contents.

On the other hand, what Zenith has done, it has done well. Walt Bilofsky of the Software Toolworks told me he'd tried reading the IBM MS-DOS documents and eventually gave up. When he got the Zenith

ZDOS documents, though, he read through the section on using macros and discovered he could use them after all.

Heath designs good machines (and offers the H-100, a Heathkit version of the Z-100 for \$1000 less). It will be interesting to see whether Zenith knows how to market them.

## Dots . . .

I never had a dot-matrix printer before. Now we have the Print-Mate 150 from Micro Peripherals Inc., which is a highly sophisticated printer that does graphics. It will even do a screen dump from the Z-100. It even substitutes gray shades for color. Otherwise, it prints exactly what you see.

The Print-Mate 150 has an impressive array of features, most of which I don't suppose I'll ever use. However, Mrs. Pournelle is getting interested, since someone told her there are programs that will cause the printer to produce musical scores. I don't have any such programs yet, but I'm looking, and tips would be appreciated. I don't write music myself, but I can see how this could make life a lot easier for a composer.

The Print-Mate 150 has a lot of other impressive features. It comes with a keypad to let you program it, and some pretty fair documents on setting it up. The print quality isn't bad, and it's very fast. For manuscripts I'll stick to my NEC Spinwriter, but the 150 is plenty good enough for listings and other stuff I want in a hurry, and it can do fancy graphics that letter-quality printers can't touch.

## The Epson QX-10

I have a couple of good friends who believe in "synchronicity," which is a fancy way of saying that they don't believe there's such a thing as coincidence. If things happen together, there's a reason, and probably a lesson as well.

I don't have to believe that, but there are times when I wonder, as for instance a couple of weeks ago. Marvin Minsky, who cofounded the Massachusetts Institute of Technology's Artificial Intelligence Laboratory and

Circle 92 on Inquiry card. →

# stair<sup>★</sup>war



AN ASTRONOMICAL VALUE AND  
*THE LOWEST PRICES*  
*IN THE GALAXY ON*

stair<sup>★</sup>  
PRINTERS

CALL: (303) 279-2848 or (800) 525-7877



THE COMPUTER LINE, INC.

GOLDEN, COLORADO

Offer void outside the Milky Way

invented the LISP machine, was in town, and we'd made a dinner appointment. Marvin finished his conference early and came directly here to Chaos Manor. There are always a lot of small computers here, and we discussed what he ought to get for a home computer.

"What do you think of this new Epson QX-10?" he asked. He then showed me the eight-page advertisement Epson had in the January BYTE. I hadn't seen it yet.

At that exact moment, the doorbell rang. It was Federal Express with three big boxes. Prominently on the outside was stenciled "Epson America."

Unfortunately for synchronicity, that's the best part of the story. What had arrived was a beta-test machine. We had no trouble getting it set up, but the software and manuals were sent from a different place, and I didn't get them until Marvin had gone back to Boston. The software and

manuals that finally did arrive were incomplete—this is, after all, a system under development, and one reason they send these machines to people is to get their comments and reactions while there's still time to make changes.

The QX-10 is a very handsome and extremely well constructed single-board Z80 computer. Although the machine is single-board, there is a small (nonstandard; sigh) bus with five empty slots inside. I've no hint as to what Epson intends to put in there, but I'd bet a lot that by the time this is in print it will have a modem.

Physically this is an excellent machine. It comes with double-sided 5¼-inch thin drives, both parallel and serial ports, and a connector for a light pen. The computer itself is in one small box. There's a separate 9-inch (12-inch diagonal) green screen with a very pleasant character set, which, at the touch of a key, turns into italic and/or boldface right on the screen. That's impressive. There are also excellent monochrome graphics given the 640- by 400-dot resolution of the screen.

The detached keyboard is thin and sculpted, with a really nice key layout. That is, the layout is nice for those who intend to use the Epson for creating English text. Programmers might not care so much for it. It's missing a whack of a lot of keys—no tilde (~), no accent grave (`), no curly braces ({})—but it's said to be completely under software control, so that I presume it's possible to set it so that Control-Shift square bracket would be braces, and such like. To compensate for the missing keys, the Epson has one of my favorite features; the period and comma are doubled, so that you get them whether or not the key is shifted.

The QX-10 has a special pad of arrow keys placed conveniently between the Selectric-style letter keys and the number pad. There's also a row of special-function keys across the top. These latter have labels like Help, Index, Menu, Store, Retrieve, etc., all of which functions are tied into the Epson special software package, VALDOCS (short for valuable documents). Much of that works on

## DECADES OF SERVICE

### Washington Computer Services

97 Spring Street

New York, New York 10012

TO ORDER: CALL OUR TOLL-FREE NUMBER: (800)221-5416

In N.Y. State and for technical information: (212) 226-2121

HOURS: 9:30 AM—5:30 PM (EST) Monday-Friday

an affiliate of **WASHINGTON ELECTRIC COMPANY** est. 1912

CUSTOM COMPUTER ROOM WIRING SINCE 1960

TELEX: 12-5606

CABLE: WASHCOMP NYK

#### FULLY CONFIGURED BUSINESS SYSTEMS

The following are some examples of the fully assembled and tested business and scientific computer systems which we offer:

**IMS** The Premier Multi-User Computer System **CALL**  
 8000 SX, multi-processor, turbo DOS **FOF**  
 INTERNATIONAL CPM 2.2, FULL 2 YEAR WARRANTY\* **CONFIGURATION**  
 5000 IS, S-100 desk top mainframe  
 8000 S up to 16 user  
 3270 Software Available  
 On-Site Service Contracts Available

**NEC APC** 8086, 16 bit processor; Two 8" **II**  
 DSDD disk drives; 128K RAM (11)



- Word Processing
- CAD/CAM graphics (1024 x 1024 resolution)
- Database Management
- Accounting

• Chang Lab's Microplan • IBM emulations • CP/M-86, MSDOS, UCSD P.

NEC on N.Y.S. Contract #P-0720

#### ALSO PC-8000 Personal Computer

**EPSON** NEW QX-10 Micro with VALDOCS software: \$2995.



#### Systems Group

California Computer Systems  
 Under Systems

**GOBBOUT**  
 NorthStar

#### MORROW DESIGNS

8 & 16 BIT BOARDS & SYSTEMS

SCION MicroAngelo Hi Res Graphics Systems

Similar savings on SSM, DELTA, DYNABYTE, TELEVIDEO, DIGIAC, ADDS, DEC, DATA GEN., ATARI, TECHMAR, EPSON, ZENITH, MORROW, AND MANY OTHERS



olve Your Computer Puzzle?

#### TURN TO US!

We'll show you the easiest way to put the pieces together.

Matched, Compatible, Proven—Engineering to Supplement Yours.

Over 2000 business scientific, professional applications & educational packages are available. Call with your requirements for our advice or a quotation. We feature DBase II & Fox & Color.

#### 8" DISK DRIVE SALE

NOW!

8" SHUGART SABOR \$385 8" SHUGART 5A 851N \$540 2 for \$1025  
 QUME DATATRACK II or MITSUBISHI \$850 2 for \$1050  
 Enclosure, power supply for 2 8" drives A & T \$350  
 MORROW DISCU 20 + CP/M® MICROSOFT BASIC, CONT. \$950  
 VISTA SCALL

#### TERMINALS

AMPEX	QUME
TELETYPE	IBM 3101
TELEVIDEO	DIGITAL EQUIP. CORP.
LEAR SIEGLER	HAZELTINE

#### PRINTERS

pe 40, 300 LPM-typewriter quality, RS-232 from Only \$3200  
 interface. This quality printer is available in many configurations including forms access, quietized case, etc.

Teletype 43

ANADEX	DIABLO	MANNESMANN TALLY
CENTRONICS	EPSON	NEC AMERICA
C. ITOH	FACIT	QUME
DATA PRODUCTS	OKIDATA	TOSHIBA
DIGITAL EQUIP. CORP.	OLIVETTI	TELETYPE
INTERGRAL DATA SYS.	DANTEX	TEXAS INSTRUMENTS

**PLEASE!** Do not confuse us with mail order dealers. We are a full service distributor serving the data processing & installation needs of business & industry from micros to mainframes. System houses, educational institutions & governmental agencies given special consideration. Leasing available.

N. Y. State agencies, municipalities, and schools — call us for information on our O.G.S. term contracts on hardware & software.

For fast delivery, send certified check, money order or call to arrange direct bank wire transfer. Personal or company checks require two to three weeks to clear. Prices subject to change without notice; call for latest prices. Prices include 3% cash discount. N.Y. residents add sales tax. Dantex is a trademark of North Atlantic Industries, Inc. CP/M™ is a trademark of Digital Research. All sales subject to our standard sale conditions (available on request). Call for shipping charges. Above prices do not include customization or installation. DBase II is a trademark of Ashton Tate. P.O.'s accepted upon our credit approval; call for prices and terms.



# Space. Saver.

## The TTX-1014 Desktop Daisywheel. More Features. More Value. Less Space.

Presenting the TTX-1014 Desktop Daisywheel. The perfect letter-quality daisywheel printer for your home or office.

Your first look will tell you that the TTX-1014 Desktop Daisywheel is a different breed of printer. Sleek. Stylish. Compact. With a low-profile design and narrow footprint so it fits on any desktop...and leaves you plenty of room to work.

The TTX-1014 Desktop Daisywheel comes with an impressive array of standard features.

Bidirectional printing. Pin and friction feed. Full-size-form capability. Interchangeable, 100-character, ASCII printwheel. Built-in serial and parallel interface. Print speeds up to 140 words-per-minute. Plus switch- and program-selectable pitch, line spacing, and baud rates. All standard.

And all at a price that's irresistible. \$649! Complete.

The TTX-1014 Desktop Daisywheel. The best deal going for your home or office. Try it now at your dealer's showroom.



Conventional daisywheel printer footprint.

## TTX™

Teletex Communication Corporation  
3420 East Third Avenue  
Foster City, California 94404  
415/341-1300 TX: 349420

this early version I have, but it wouldn't be fair to write any kind of evaluation until I have the production version.

There's no Escape key on the Epson. I suspect that one of the top row of special-function keys—probably Undo—makes the Escape character, but I don't know this, because I don't yet have the documents. The operating system that came with the Epson is TPM-II, which is a lot like CP/M, but not quite; unlike CP/M, TPM-II

doesn't display control and other strange characters when in monitor mode. I could write a program that would do that, but this seems pointless because Epson promises complete technical documents for the machine.

I can't do a complete evaluation, but I am sufficiently impressed with the Epson to say this: before you buy an 8-bit small computer, be sure to look at the Epson QX-10. If its software ever gets done—it has been a

while since it was announced—and it's anywhere near as good as the hardware, this machine could be a real contender.

### The Love Affair Continues

I've had a Modula-2 compiler for more than a month now, and I'm still in love. I'll make a flat prediction: this language is going to be one of the most important of this century. It compiles tight, efficient code, code as compact as the C programming language, and was designed to be used for operating systems; but it's as easy to read and understand as Pascal.

At the moment I still don't have Modula-2 running on anything but the Sage 68000-based computer with the UCSD p-System (Pascal) operating system. That's been no problem, since the Sage remains a joy to use. I received a software update package that removes several minor annoyances, and I'm finally getting used to the UCSD p-System. The Sage with Modula-2 is a formidable combination for a development system. Compilations are very fast.

What's really exciting is Modula-2 itself, which is everything we hoped Pascal would be. I can't say Modula-2 doesn't have faults. I would have done a number of things differently than Niklaus Wirth. For example, in Modula-2 *every* loop is terminated by an END statement. This means WHILE loops and FOR loops as well as loops that start with BEGIN. In my judgment that makes the programs much harder to read.

Of course you can always fix that with comments, and I do. That is, when I write a Modula-2 program, I tend to do

```

WHILE n < N DO
  FOR I := 1 TO 5 DO
    WriteString ("Foo")
  END (* NEXT I *);
  WriteString("fiddle");
  DEC(N);
END (* WEND *);


```

I think it is clearer if the FOR loop ends with NEXT, and the WHILE ends with WEND. Note the statement DEC(N), which decrements; there is a corresponding INC that will incre-

**\*\* WE ARE BYTE MAGAZINE'S THIRD OLDEST ADVERTISER \*\***

**COMPLETE SYSTEMS FOR A WIDE RANGE OF APPLICATIONS, FOR VARIED LEVELS OF SOPHISTICATION. 8 & 16 BIT, S-100 AND NON S-100, SINGLE AND/OR MULTI USER, FLOPPY AND HARD DISK CAPABILITY, SOFTWARE, PERIPHERALS, SERVICE AND SUPPORT.**

**COMPUPRO/GODBOUT SPOKEN HERE:** We are proud of our recent designation as CompuPro Systems Center! We feature the high performance, versatile 8085/8088 dual processor 816 systems with unique version of MP/M that allows simultaneous use of both processors.

 **NEC APC:** The best 8086 system on the market! Gives you more for your money! For under \$4,000: 8086 processor, two double sided, double density 8" drives, 128K RAM, elegant keyboard and monochrome display (color optional), MS DOS and/or CP/M 86.

**EPSON QX 10:** Truly user friendly. Our entire staff loves this system. You can draw pie charts and bar graphs in two minutes with no prior computer experience! Incredibly easy and satisfying to work with. For under \$3,000: 256K RAM, complete VALDOCS software, HASCI keyboard. We also stock HX20, new FX80 printer.

**MASTER MAX:** Z80, S-100 with dual 8" drives (Winchester option). Uses Intercontinental Micro CPZ48000 single card computer. 4 DMA channels & universal interrupt controller give great versatility and speed. \$2740 includes CP/M. OPTIONS: double sided drives, TURBODOS, ICMS slave cards, 220v/50HZ operation.

**IMS MULTI USER SYSTEMS WITH TURBODOS:** Z80, S-100 CP/M compatible. Slave cards give each user Z80 CPU, 64K RAM, 2 I/O. No speed degradation as users are added! Nationwide service depots.

**GRAPHICS: MICROANGELO (S-100) OR MIRAGE (RS232).** Monochrome or color. AUTOCAD: Interactive graphics software for architects, engineers, others. HOUSTON INSTRUMENTS digitizer and plotters.

**ESQ 1:** Legal time and billing software implemented on our MASTERMAX, IMS or GODBOUT. On site training and complete software for NY quad state area.

**PERIPHERALS:** CRTS (Televideo, WYSE, Hazeltine); dot matrix and letter quality printers, S-100 boards & mainframes, floppy disk subsystems (Shugart, Qume, Tandon, Per Sci). Full line of RAM and accessories for IBM PC.

**SINGLE OR DUAL WINCHESTER SUBSYSTEMS:** Dual version solves back up problems! Implemented for CP/M, Turbodos, TRS 80, IBM PC, Osborne, Apple, many others. Very low prices.

**CROMEMCO DUAL PROCESSOR:** Z80/68000. Also Z80 C10 p.c.

**MODEMS:** US ROBOTICS DC Hayes compatible modems at lower prices.

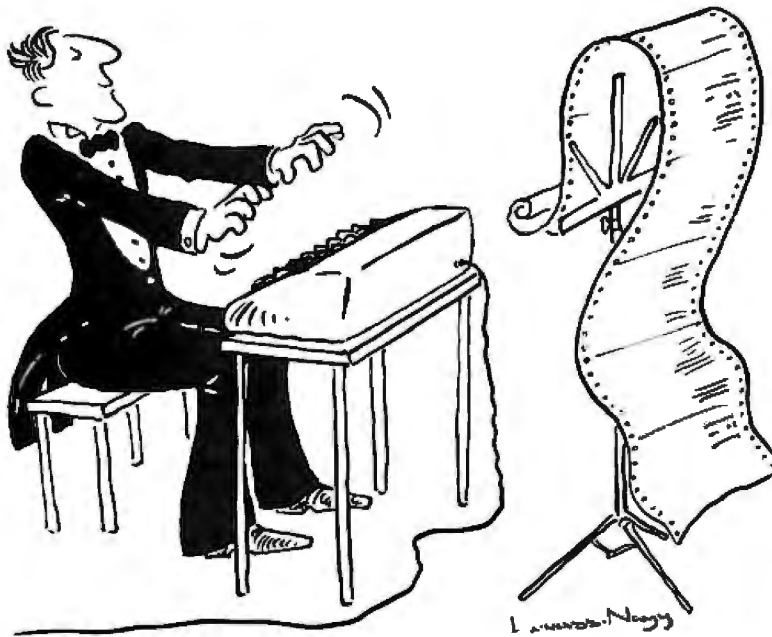
**HAZELTINE ESPRIT III:** \$795. Televideo 950 emulator, comparable performance for \$200 less! Quantity, OEM and dealer discounts.

**3270 NETWORK:** Teletype controllers, printers and terminals. Cost effective.

**CALL OR WRITE FOR FREE PRODUCT SPECS ON ANY ITEM WE CARRY**

**WE EXPORT** Overseas Callers: Phone (212) 448-6298  
TWX 710 588 2844 or Cable: OWENSASSOC

**JOHN D. OWENS Associates, Inc.**  
12 Schubert Street, Staten Island, New York 10305  
(212) 448-6283 (212) 448-2913 (212) 448-6298



# The Well-Tempered Cross-Assembler

Before Johann Sebastian Bach developed a new method of tuning, you had to change instruments practically every time you wanted to change keys. Very difficult.

Before Avocet introduced its family of cross-assemblers, developing micro-processor software was much the same. You needed a separate development system for practically every type of processor. Very difficult and very expensive.

But with Avocet's cross-assemblers, a single computer can develop software for virtually any microprocessor! Does that put us in a league with Bach? You decide

## Development Tools That Work

Avocet cross-assemblers are fast, reliable and user-proven in over 3 years of actual use. Ask NASA, IBM, XEROX or the hundreds of other organizations that use them. Every time you see a new microprocessor-based product, there's a good chance it was developed with Avocet cross-assemblers.

Avocet cross-assemblers are easy to use. They run on any computer with CP/M\* and process assembly language for the most popular microprocessor families.

XASMO5 .... 6805	\$200 each
XASMO9 .... 6809	
XASM18 .... 1802	
XASM48 .... 8048/8041	
XASM51 .... 8051	
XASM65 .... 6502	
XASM68 .... 6800/01	
XASMF8 .... F8/3870	
XASM28 .... Z8	\$500
XASM400... COP400	
XASM75 .... NEC 7500	
(Coming soon: XASM68K .... 68000)	

## Turn Your Computer Into A Complete Development System

Of course, there's more. Avocet has the tools you need from start to finish to enter, assemble and test your software and finally cast it in EPROM:

**Text Editor VEDIT** -- full-screen text editor by CompuView. Makes source code entry a snap. Full-screen text editing, plus TECO-like macro facility for repetitive tasks. Pre-configured for over 40 terminals and personal computers as well as in user-configurable form.

CP/M-80 version ..... \$150  
 CP/M-86 or MDOS version ..... \$195  
 (when ordered with any Avocet product)

**ROM Simulator** -- ROMSIM by Inner Access eliminates need to erase and reprogram EPROM. Installed in an S-100 host, ROMSIM substitutes RAM for EPROM in external target system. 16K memory can be configured to simulate the 2708, 2758, 2716, 2516, 2732, 2532, 2764, 2564 in either byte or word organization. Avocet's configurable driver makes loading of HEX or COM files fast and easy.

From \$495 depending on cabling and RAM installed.

**EPROM Programmer** -- Model 7128 EPROM Programmer by GTek programs most EPROMS without the need for personality modules. Self-contained power supply ... accepts ASCII commands and data from any computer through RS 232 serial interface. Cross-assembler hex object files can be down-loaded directly. Commands include verify and read, as well as partial programming.

PROM types supported: 2508, 2758, 2516, 2716, 2532, 2732, 2732A, 27C32, MCM8766, 2564, 2764, 27C64, 27128, 8748, 8741, 8749, 8742, 8751, 8755, plus Seeq and Xicor EEPROMS.

(Upgrade kits will be available for new PROM types as they are introduced.)

Programmer ..... \$389  
 Options include:  
 Software Driver Package ..... \$ 30  
 RS 232 Cable ..... \$ 30  
 8748 family socket adaptor ..... \$ 98  
 8751 family socket adaptor ..... \$174

## Call Us

If you're thinking about development systems, call us for some straight talk. If we don't have what you need, we'll help you find out who does. If you like, we'll even talk about Bach.

VISA and Mastercard accepted. All popular disc formats now available -- please specify. Prices do not include shipping and handling -- call for exact quotes. OEM INQUIRIES INVITED.

\*Trademark of Digital Research.



**AVOCET  
SYSTEMS INC.**

DEPT. 683-B  
 804 SOUTH STATE STREET  
 DOVER, DELAWARE 19901  
 302-734-0151 TLX 467210

ment a variable by 1. (You can also do  $INC(x,n)$ , which will produce the result  $x := x + n$ .) These are *standard procedures* that come with Modula-2.

Despite my quibbles, though, I have not seen a language I was more instantly attracted to than Modula-2. The only thing stopping it is getting implementations on enough machines. I would dearly love to have Modula-2 for the Z-100, with those magnificent color graphics. I'd like it for CP/M-86 and my big Compupro. What will really be interesting, though, is if Modula-2 catches on and they begin to write operating systems in it for, say, the 16032 systems that ought to be running on the S-100 bus in the next year or so. That could really produce a revolution.

### Again, the Piracy Problem

First a small apology. In the April column I reviewed a database-management program called Superfile from FYI Inc. There were a number of things to like about the program, as well as a few I thought needed im-

provement. As a courtesy, I sent a copy of my text to FYI.

In addition to my comments on Superfile itself, I used the review as a jump-off point for a complaint about user-threatening licensing agreements. This wasn't unfair; FYI's

**I wish software publishers would change their licensing agreements, because I hate 90 percent of the agreements I've seen.**

agreement really is bad. On the other hand, it's no worse than a lot of others, including agreement forms used by some of the biggest software publishers around.

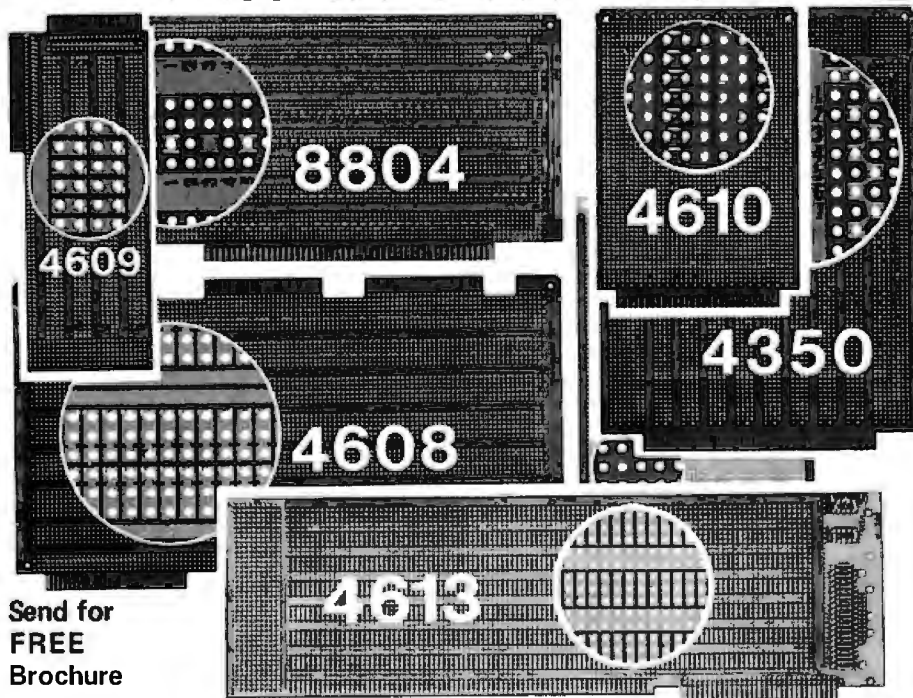
Back came a letter from FYI. It didn't much care for the review, but since FYI didn't show where I was wrong, or tell me something I hadn't known (other than to quote some people who really liked the program,

and heck, I'd said I like it myself), there seemed nothing to respond to, except one sentence: was it fair for me to condemn it for its licensing agreement, which was no worse than a lot of others?

I thought about that, and had just about concluded FYI was right, when the phone rang—a call from its lawyer. He, too, asked the same question, also in a reasonable manner. Okay, I thought. Maybe I should do something. Alas, he couldn't let well enough alone. There came a letter, on expensive legal stationery, from the lawyer, which began, "At the request of our clients we have been asked to review portions of your proposed column scheduled for publication — -"

I've been a journalist for some years, and I know a lot of other journalists, and we all seem to share one trait: if there's anything that will make a journalist see red, it's hinting at censorship. I may be a bit more irrational than some of my colleagues in what I see as a hint; but I do not at all care for lawyers informing me that

## BUILD YOUR COMPUTER BREADBOARDS & INTERFACES FASTER AND EASIER WITH NEW VECTOR PLUGBOARDS



Send for  
**FREE**  
Brochure



ALSO: Connectors • Enclosures • Mother Boards • Extenders 748209  
VECTOR ELECTRONIC COMPANY, Inc., 12460 Gladstone Ave., P.O. Box 4336, Sylmar, CA 91342-0336; (213) 365-9661

**New 4613 series** — for IBM Personal Computer. Three models available.

**New 4614, 4615 series** — for VME Bus. Six models available.

**4610 series** — for STD-Bus. Three models available.

**4608 series** — for Multibus solderable, or unpatterned.

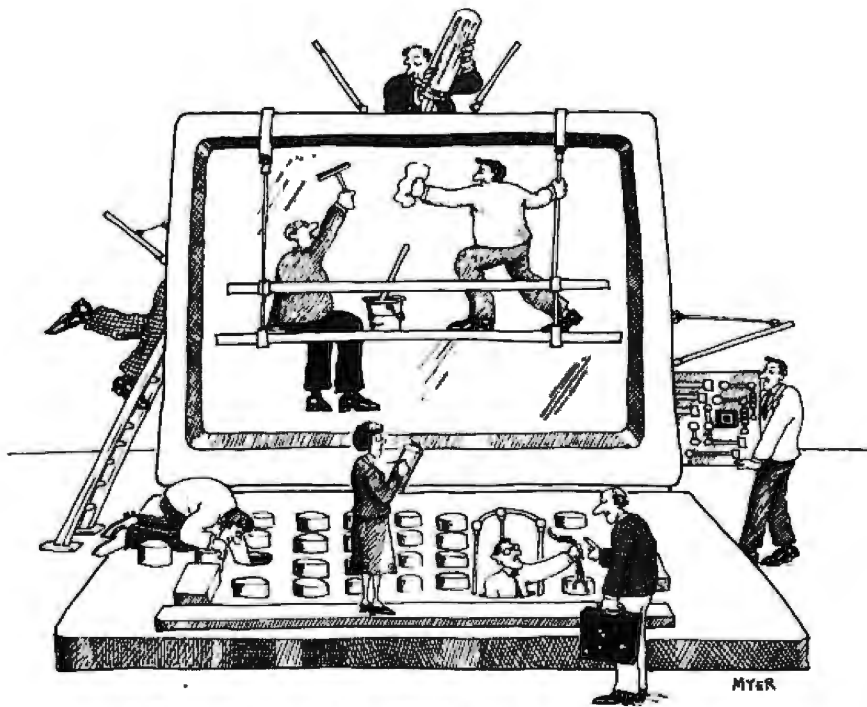
**8804 series** — for S-100. Seven models available.

**4607** — for DEC LSI-11/PDP8-11, Heath-11.

**4609** — for Apple II, Super-Kim, Pet Commodore with Expandamem.

**4350** — for TI 980

**4611 series** — for Motorola Exorciser



# UPTIME IN NO TIME. SORBUS FIXES COMPUTERS. FAST.

If you have a computer, there's a good chance Sorbus can fix it. Faster than the maker can.

MAI/Sorbus is the nation's largest independent computer maintenance service company, and we fix all kinds of computers in all kinds of places:

## BIG COMPUTERS. TINY COMPUTERS.

Big computer owners have voted us #1 in dozens of big-computer magazine surveys.

We're still big in big. But now that small is big, we're also big in micros.

We're making easy-to-use computers even easier for their owners, with innovative services. Like a phone-order data processing supplies catalog. And retail centers where small computers are usually fixed overnight.

## COMPUTERS IN NEW YORK. COMPUTERS IN NEW MEXICO.

Sorbus has built its reputation fixing computers anywhere in the country, from the urbs, to the suburbs, to the sub-suburbs.

And now, if your computer is small enough—like the IBM Personal Computer—and close enough, you can carry it in for 24-hour service or, we'll pick it up.

If it's not, we still have the tools, the experience, and will travel. Anywhere. Anytime.

Just call us.

## YOUR COMPUTER.

Whether you manage a mammoth operations center, or just a desktop micro, Sorbus can bring you back up when you're down.

Faster. Better. Almost always for less.

Of course, even we don't specialize in every computer ever made. But if you call us with a problem, we promise to do what we can.

Try Sorbus® service next time your memory gets foggy, or your printer suffers from terminal illness.

Where there's Sorbus, there's a way.

For more information, call (215) 296-6000, or fill out and mail coupon to:



Sorbus Service Division of Management Assistance, Inc.  
50 E. Swedesford Road  
Frazer, PA 19355

Please send me more information on Sorbus service for my \_\_\_\_\_

6-B-6

Please have a representative contact me.

Please send me the *Sorbus® Supplies Catalog*. 64-pages of quality printwheels, ribbons, diskettes, and other computer supplies.

Or, call toll-free: 800-523-0552.

In PA: 215-296-6200.

NAME \_\_\_\_\_

TITLE \_\_\_\_\_

COMPANY \_\_\_\_\_

ADDRESS \_\_\_\_\_

CITY \_\_\_\_\_ STATE \_\_\_\_\_ ZIP \_\_\_\_\_

PHONE \_\_\_\_\_

they are reviewing what I have written. I particularly don't like it when they're doing it prior to publication. Thus my immediate reaction was an explosion heard throughout much of Hollywood.

My own lawyer friends tell me that the letter I received wasn't a threat or even a hint, and that lawyers talk that way to impress their clients. I wouldn't know, but I have calmed down, although it took me past last month's deadline.

So much for the explanation. Now for the apology.

Superfile is a decent program, as I said in the April review. It needs some improvements, but it is certainly a useful addition to our software library and will probably be used here. Although the documents led me to expect that it did things in a manner rather different from what it really does, it wasn't hard to learn to use it.

Moreover, FYI is to be commended: unlike most software publishers, FYI will let you use Superfile for 30 days, and if you don't like it, it will give you your money back. This isn't a unique policy, but it's both commendable and rare, and I should have made a point of saying so.

Finally, FYI has a particularly lousy licensing agreement. It's nearly impossible to read, it's full of legalese terms, and it's printed in blue ink in tiny letters. I really did have to use the magnifying glass from my transistorized *Oxford English Dictionary* in order to read it. For all that, it is not the worst licensing agreement I've ever seen, and the company's policy of giving your money back makes up for a lot.

I wish FYI would change its licensing agreement, but then I hate 90 percent of the agreements I've seen.

### So What Should Agreements Look Like?

Mr. James Gallion, President of Engineering Technologies in North Carolina, asks a reasonable question: What kind of agreement is acceptable? He says, "Our licensing agreement is attached; unfortunately, it contains much of the Levitical documentation and fine print you would

like to eliminate. I would like to eliminate it, too, but . . ."

He continues, "Bear in mind your license agreement covers an easily

---

## Copyright law has some features, including "public interest" provisions, that may surprise you.

---

copied program selling for a hundred dollars or more, and your agreement must

*Protect the supplier against outright piracy of the program for resale and profit.*

*Protect the supplier against the "generous fellow" who runs copies for his mother, brother, and user's group.*

*Protect against the unqualified user who misuses the program and loses thousands of dollars' worth of time and information.*

*Apply equally for a one-person garage operation or a thousand-person corporation.*

*Stand up in a court of law.*

That's a reasonable statement of the publisher's wants. Unlike most publishers, Mr. Gallion goes on to look at the publisher's obligations:

*The software supplier has an obligation to provide bug-free programs, and to provide updates and corrections automatically to all his program users. We adhere to this and it is a part of our licensing agreement. But we also recognize that the user holds all the cards when he has our program—he can easily make copies for money, or for his friends; or he can just as easily sue us when the program gives him bad information from his bad input. The license agreement is our only protection.*

That is an excellent statement of the problem; and I presume that most ethical software publishers would agree with it. What, then, shall we do?

First, I will never agree with the FYI approach, which is to fill a sheet of paper with legalese. I'm not very happy with the approach used by Digital Research Inc., which puts out documents with a copyright notice, then adds at the bottom of each page: "All Information Presented Herein Is

Proprietary to Digital Research"; but at least DRI puts its agreement in legible print.

The DRI agreement in essence says that if you sell or give away this program you're in trouble, and you know that. It also tries to restrict the user to "a single computer"; if you're going to use its software on more than one machine, you're supposed to buy more than one copy.

Finally, DRI isn't obligated to do much. If it thinks you got a defective disk, it might replace it; and if it makes updates or fixes bugs, it will probably tell you how you can get your revisions. Otherwise, DRI is not liable for anything at all, and the company doesn't warrant that its product is useful, merchantable, or good for anything, unless state law forbids that kind of language, in which case DRI still doesn't claim its product is good for anything, and the most it will do is give you your money back.

You agree that you haven't bought "consumer goods," and that what you have isn't warranted.

It doesn't look like you get much for your money, does it? Here you're going to shell out a couple of hundred dollars, and in return you get the right to use a program on a single computer; if your computer dies, you should, strictly speaking, turn in your software, pay a transfer fee, and get a new license.

And that's silly. I doubt that has ever been done in the history of the microcomputer. No one does it, and no one expects it to be done.

Next, DRI seems a bit confused as to what's a trade secret, what's proprietary information, and what's protected by copyright. As a writer and officer of writers' associations, I've had to become reasonably familiar with copyright law. Writers' associations get involved in lobbying for copyright law changes. Sometimes we work with publishers. Sometimes we don't, because the interests of writers and publishers don't always coincide.

Copyright law has some interesting features. If you rely on copyright to protect your software, you can't possibly enforce the provision about

# These career opportunities are already yesterday's news.

Now there's a source of employment information as technically advanced as the job openings it offers.

It's called CLEO. It's Computer Listings of Employment Opportunities. A few minutes on your personal computer with CLEO and you've got the inside story on today's fast-changing technical career market.

CLEO is classified advertising that talks back. You're guided through every step by explicit on-line instructions. You tell CLEO what job categories, companies, or geographic locations interest you. Then CLEO calls up the appropriate ads right on your screen.

CLEO job listings are updated daily, and access to the system costs you nothing but the price of a phone call. You can even apply for positions right from your terminal. If you're looking, or just curious, don't reach for today's paper—it may already be out of date. Reach for your computer terminal. And CLEO.

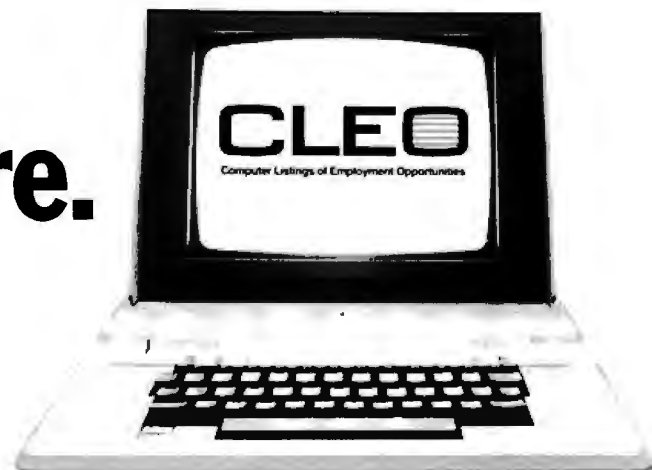
CLEO access: **(213) 618-8800**

300 BAUD, full duplex, 7 bit character, one stop bit, no parity. Access assistance phone number: (213) 618-1525. An electronic publishing activity of The Copley Press, Inc.

# Today's career news is right here.

Recruitment advertisers — call (213) 618-0200 collect to find out how you can place your ad on CLEO.

Circle 97 on inquiry card.



not transferring a program from one computer to another. Not only is it legal for you to lend copyrighted material to your friends, but the law requires authors to support public institutions whose business is to lend out their books. I refer, of course, to public libraries.

There are also copyright law provisions dealing with "fair use," use by the blind and handicapped, and use by nonprofit educational institutions and public radio and television: in a

word, there are "public interest" exceptions to the authors' and publishers' rights. Not all authors like all those exceptions; but they are part of the law.

Under copyright law, you cannot sell or give away *copies* of copyrighted material without permission of the copyright owner. Thus, if we stayed with *copyright* law, a fair interpretation might be that you couldn't run a program on more than one computer *at the same time*, and if

you wanted to lend, sell, or give away a program, you'd have to fork over the original copy.

This seems pretty fair to me. After all, I don't expect the FBI to go close down used book stores and libraries, even though both theoretically cost me money. If you lend my book to your friends, that's legal; if you make a copy for your mother, that isn't. In practice I'm not likely to do much about that, but if you make 100 copies and start selling them, my publisher and I are likely to cry "Foul!" and run to the police.

If we can agree that's what we mean, somebody ought to be able to put that into legal language that would stand up. I shouldn't think it would take more than a few sentences, and there needn't be a "whereas" or "witnesseth" anywhere in them.

Now for the other side of the question: the obligations of the publisher.

First, I sure don't see why publishers shouldn't have to replace defective media. In order to cut down on returns, Barry Workman distributes all his software on Dysan disks. It costs more to begin with, but saves in the long run, or so he says. Even so, once in a while he'll get a disk returned as unreadable. He replaces it. Why shouldn't he? If I buy a defective tape recorder by mail, I'm entitled to a replacement or my money back, and the electronics places I deal with don't argue. They even pay to have UPS come pick up my defective equipment.

Why should software publishers escape from the consumer protection laws? Why are they so bloody special?

On the other hand, if I buy a telephone from JS&A and use it to make threatening and obscene phone calls, JS&A isn't responsible and shouldn't be. I'll go further: if I buy a phone, expecting it to work, and when it doesn't I find I've missed an important call to my broker so that I've lost a lot of money, I can't see why JS&A should be liable. It's my own silly fault for not being more prudent.

Thus I can agree with publishers stating in big letters that they're not liable for secondary, incidental, in-

## 10 reasons why you should call DataSource® for software...

- 1. Free Systems Analysis** We have developed a variety of self-administered analysis tools to help you identify those products best suited to meet your needs.
- 2. Competitive Prices** Our volume enables us to offer you prices which are consistently competitive. Compare for yourself, then call us toll-free 800-328-2260.
- 3. Express Delivery** Time is money and we at DataSource understand that. Your order will be processed and shipped within 24 hours for all products in stock.
- 4. Discount Structures** We offer significant discounts to any individual, organization or user's group purchasing in quantity.
- 5. Key Account Program** For corporations and institutions, we offer a comprehensive program: volume discounts, complete maintenance packages, specially staffed technical support, a sales team experienced in micro applications, and several financing options.
- 6. Risk-Free Software** We stand behind every product we sell. All items are fully documented, backed by manufacturer's warranties, and are guaranteed by DataSource to be in perfect working condition.
- 7. Toll-Free Technical Support** We service what we sell. Our customers have direct access to our technical staff on a toll-free basis. 800-328-2260.
- 8. National Maintenance Network** We offer a variety of maintenance agreements tailored to the specific hardware items you select. Call for more information.
- 9. Flexible Payment Options** We accept most major credit cards, checks, and money orders, as well as purchase orders from approved corporate accounts.
- 10. State-of-the-Art Software and Hardware** We carry a broad range of what we believe to be the best in software plus carefully selected hardware products and accessories.

Always the current versions in stock.

Here's a small sampling of products available now from DataSource.®  
(If you don't see what you need, just call us at the number below.)

<b>Data Base Management</b>	
dBase II - Ashton Tate	5475.00
Condor III - Condor computer	495.00
Easy Filer - IUS	295.00
Visifile - Visicorp	189.00
Tim III - Innovative Software	325.00
Inostar - MicroPro	297.00

<b>Spreadsheets</b>	
Supercalc - Sorcim	125.00
Visicalc - Visicorp	189.00
Lotus 1-2-3 - Lotus	Call
Multiplan - Microsoft	225.00
Calcstar - MicroPro	95.00

<b>Communications</b>	
Crosstalk - Microstuf	135.00
Moveit - Woal software	99.00

<b>Word Processing</b>	
Wordstar - MicroPro	297.00
Spellbinder - Lexisoft	295.00
The Final Word - Mark of the Unicorn	245.00
Easy Writer II - IUS	265.00
Volkswriter - Lifetree	155.00
The Word Plus - Oasis	125.00
Spellguard - Sorcim	125.00
Grammatik - Aspen	60.00

<b>Languages</b>	
C Basic - Digital Research	125.00
CB 80 - Digital Research	420.00
M Basic - Microsoft	275.00
Basic Compiler - Microsoft	310.00
Pascal MT+ - Digital Research	425.00

<b>Miscellaneous</b>	
The Home Accountant - Continental	110.00
Milestone - Organic Software	245.00
Slatpak - NW Analytical	395.00
The Norton Utilities - Peter Norton	65.00

<b>Hardware</b>	
Hayes 300 Smartmodem	215.00
Hayes 1200 Smartmodem	525.00
Epson FX80	595.00
Okidata 82-A	439.00
NEC 3550	1915.00

### June Specials from DataSource

Supercalc - All Formats	<b>\$125.00</b>
Microsoft Basic Compiler - Osborne	<b>\$235.00</b>

**PLUS**

Sale prices on all Osborne Format software in stock!

FOR MORE INFORMATION CALL TOLL-FREE

**1-800-328-2260**

IN MINNESOTA, CALL 612-544-3615

Purchase orders accepted from corporate accounts. All orders are shipped UPS.  
\$3 shipping charge on software items, \$5 shipping charge on hardware items.

**DATASOURCE**

DATASOURCE SYSTEMS MARKETING CORP.

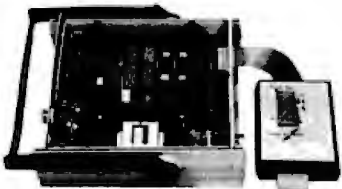
Your source for micro software and hardware®  
1660 South Highway 100, Minneapolis, MN 55416





# PORTASYS™ - A Low Cost, Versatile Expandable Development System OEM Dedicated Controller General Purpose Controller

**PROTOSYS  
MAINFRAME**



**EPROM ZAPPER**

**MAINFRAME**

- \*3 Cards Capacity
- \*AC power or Battery power (Battery not included)
- \*Comparator senses power dropout and switches to battery
- \*Output voltages: 5V, ± 12V
- \*Battery Voltage: 8V to 12V

Mainframe.... PR-1001 .... \$149.00

**EPROM ZAPPER (Programmer)**

- \*Programs 2716 or 2732 Eprom (not the A series, i.e. 2732A)
- \*Firmware included in an Eprom
- \*Connects to the Main CPU card parallel I/O ports

Eprom Zapper... PR-1002... \$ 79.00  
Zero Insertion Socket ... 10.00

**16K/32K CMOS  
RAM BOARD W/BATTERY  
BACK UP**



4.5 in. x 7.0 in.

**16K/32K BATTERY BACKED  
CMOS RAM/EPROM BOARD**

- \*16 Sockets for 6116 Low Power CMOS and/or 2716 Eprom - Total board capacity of 32K bytes
- \*On board battery holder for 3 AAA NiCad Batteries - trickle charged by the regular supply
- \*Very low power consumption for Data Retention - Can store program when power is turned off
- \*Bank selectable
- \*Other memory can occupy empty socket space location
- \*Gold plated edge finger for reliable contact

16K CMOS Ram Card.....  
PR-1005..... \$195.00  
(Batteries not included above)

**Z8/8741A CPU  
BOARD**



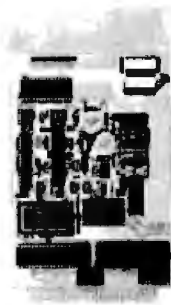
4.5 in. x 7.2 in.

**Z8671/8741A**

- \*Z8671 CPU with built in TINY BASIC INTERPRETER
- \*12K on board capacity CMOS Ram interchangeable with 2716 Eprom
- \*Data retention Battery backup capability
- \*Memory expandable to 60K - Bank selectable to greater than 480K
- \*All Buss Interface lines buffered and Tristatable for multiple CPU operation
- \*24 Fully programmable parallel I/O lines - uses 8255A IC
- \*14 additional I/O lines buffered and available at Main connector
- \*6 Interrupts
- \*RS232 Serial I/O switch selectable from 110 to 9600 Baud
- \*Optional Fully Programmable Real Time Clock - uses MM58167 IC with its own crystal controlled oscillator
- \*Optional 8741A Universal Peripheral Interface CPU or 8748 single chip processor, each with 1K of on board Eprom - Digital Cassette Interface software for the 8741A UPI available soon
- \*Fully Gold Plated edge fingers for reliable contact
- \*High quality Printed Circuit Boards

CPU Card with 4K Ram.....  
PR-1000CM..... \$195.00  
8741A UPI IC..... 29.00  
PR-8741A.....  
MM58167 Real Time Clock.....  
PR-58167..... 19.00

**12 BIT AD/DA AMP BOARD**



4.5 in. x 7.0 in.  
4.5 in. x 8.5 in. w/ Kluge Area

**12 BIT AD/DA AMP  
- CONTROL BOARD**

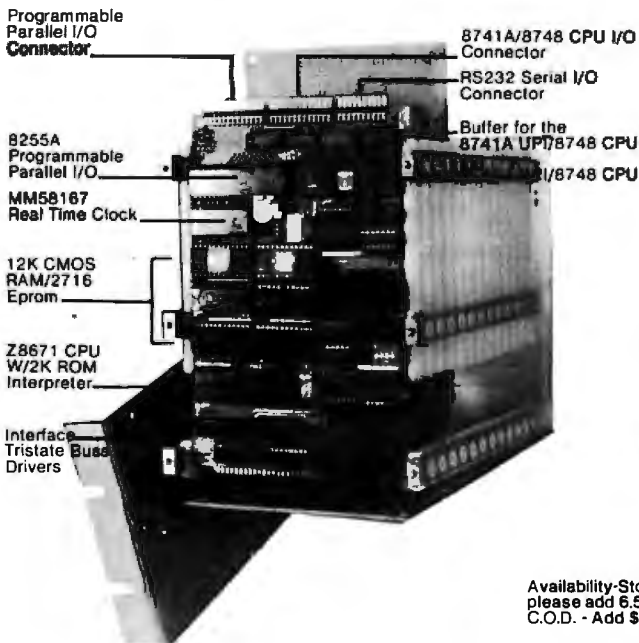
- A to D Section**
- \*12 Bit Analog to Digital Converter - uses AD ADC80 IC - 25 microsecond conversion time
  - \*Input Voltage ranges: 10V, 5V, ±2.5V, ±5V, ±10V
  - \*16 Lines Multiplexer single ended or 8 lines differential - differential pin out for twisted pair flat cable
  - \*Data latched and controlled by 8255A ICs
  - \*2 LM310 Buffers with balance control for differential nulling
  - \*2 LM318 inverted amplifiers with adjustable gain control
  - \*1 LM318 Differential to single ended converter
  - \*2 LM733 Video amplifiers with adjustable gain control

- D to A Section**
- \*12 Bit D to A converter - uses AD DAC80 IC - 3 microsecond conversion speed
  - \*Voltage ranges: 10V, 5V, ±2.5V, ±5V, ±10V
  - \*8 Analog switches for multiplexing output (or other applications)
  - \*DAC and Analog switches fully controlled by 8255A ICs

- GENERAL Section**
- \*3 optional double pole double throw relays
  - \*2 optional HI SPEED current amplifiers buffers - uses LH0033 - 1500 V/microsecond slew rate ±100 ma drive current - current limited - Very high input impedance - perfect for high speed peak detector, sample hold, etc.
  - \*6 additional parallel I/O lines
  - \*Kluge area available

12 Bit AD/DA Amp Control.....  
PR-1020..... \$299.00

8 Bit AD/DA-Other Circuits Same as Above..... PR-1021..... \$195.00



Availability-Stock to 2 weeks, California Residents- please add 6.5% Sales Tax. Shipping and Handling Charges: UPS - \$5.00 UPS Blue Label - \$8.00 C.O.D. - Add \$5.00 in addition to above

Send for detail information:



*ProtoSys*

830-4 Jury Court • San Jose, CA 95112 • (408) 998-4477  
P.O. Box 23698 • San Jose, CA 95123 • (408) 998-4478



direct, special, or consequential damages. You buy and use this at your own risk; if it doesn't do what you thought it would do, so that you lose all the time you've invested in keying in data, you've a right to tell the world that the software's no good, but I doubt you've much ethical standing to sue the publisher. Certainly you don't if you've been warned.

On the other hand, if the program's useless, or doesn't do what the manual says it will, why should the buyer be stuck for the price? Yet DRI's "agreement" says that it cannot be altered by advertising, meaning, presumably, that DRI could take out an ad promising that its software would find you gold and silver, and when it didn't, it wouldn't have to refund your money.

And yes, I know Digital Research wouldn't do that. Indeed, I'm using DRI as my example here precisely because they are good guys. I know for a fact that DRI spends a lot of time and money keeping its customers happy even when the customer makes quite unreasonable demands. Thus I wouldn't want anyone to think I dislike Digital Research or that I'm trying to lose it customers.

And yet, here's this agreement that says that if I buy a CB-80 compiler for Ezekial and later update to another computer, I'm in violation of the agreement and should destroy all copies of my software. Here's another, which says on the one hand that it's copyrighted software, and thus supposed to be published and made public (under the restrictions of the copyright law), while at the bottom of every page is the silly notation that everything in the book is proprietary. Yet I doubt anyone has brought suit against Rodnay Zaks or Thom Hogan for publishing books on how to use CP/M, even though their books are just *crammed* with that "proprietary" information.

When I carefully read my licensing agreement, I find that I'm supposed to put the serial number and copyright notice on all my work disks. I presume that's every darned one that has CP/M on it. Of course many work disks have a *lot* of copyrighted pro-

grams, from many different publishers, on them; after all, I can keep 1.2 megabytes on each floppy. There isn't *room* for all those copyright notices and serial numbers! And where, oh where, am I to put them on my *hard* disk?

Come on, fellows. No one expects those agreements to be kept, just as no one believes all that information is "proprietary," or that the customers will act as if it were.

---

### **I've seen no evidence to show that Levitical agreements—full of "Thou Shalt Nots"—have any effect on piracy.**

---

In fact, that's my point. In *practice*, many companies tend to act about the way I think they should. They refund people's money, they provide support, they don't get unduly excited when Aunt Minnie snaffles up a copy on the sly, and they fix bugs. Why, then, do they insist on making their customers sign "agreements" that the customer has no intention of keeping, and which the company *knows* won't be kept? Is it to give work to lawyers, is it pure inertia, or are we in the computer business sailing under a curse?

Must we continue making hypocrites out of both publishers and customers?

### **They Don't All Do It, You Know**

Although most publishers, including big ones like Microsoft and Digital Research, have legalistic licensing agreements, not all do. Walt Bilofsky's Software Toolworks places a copyright notice on its products, and reminds people in simple English that it tries to deal fairly with its customers, and "if you agree that we are dealing fairly with you, I hope you will be fair to us by respecting our copyrights on our material and not making copies for others."

I had much the same problem. When I began this column, I mentioned some programs I had written. There was an instant flood of mail requesting them. I'm not in the publishing business, nor can I afford the time

or the money to give away hundreds of copies of programs.

Eventually I solved the problem by asking Barry Workman to handle it. My agreement with Barry is simple. "If you get rich off these, I want something." So far he hasn't. Meanwhile, we had to face the problem of licensing agreements. We solved it by not having any. Like Software Toolworks, Workman and Associates prints a disclaimer of liability. Then there's a copyright notice. Workman invites customers to make as many backup copies as might be needed, and reminds them that they're not supposed to use more than one copy at a time. Workman also points out that distribution of copies by loan, sale, or gift is a violation of federal law.

Bilofsky and Workman are still in business. Indeed, some of Workman's customers are so conscientious that they buy multiple copies of his *public-domain* utilities, even though they know they're ethically and legally entitled to give away copies. "I know that," one customer said in a letter. "But I want to encourage you to keep collecting the best utilities possible." Walt Bilofsky has had similar experiences.

On the other hand, we all *know* there's piracy and theft going on in microcomputerland. (As I use the terms, piracy is selling someone else's property on a large scale. Giving away copies of copyrighted programs is theft. Selling one or two is petty theft.) We *know* that it costs publishers money.

We don't know what the real effect is. How many stolen copies represent lost sales, and how many went to someone who wouldn't, or couldn't, have bought it anyway?

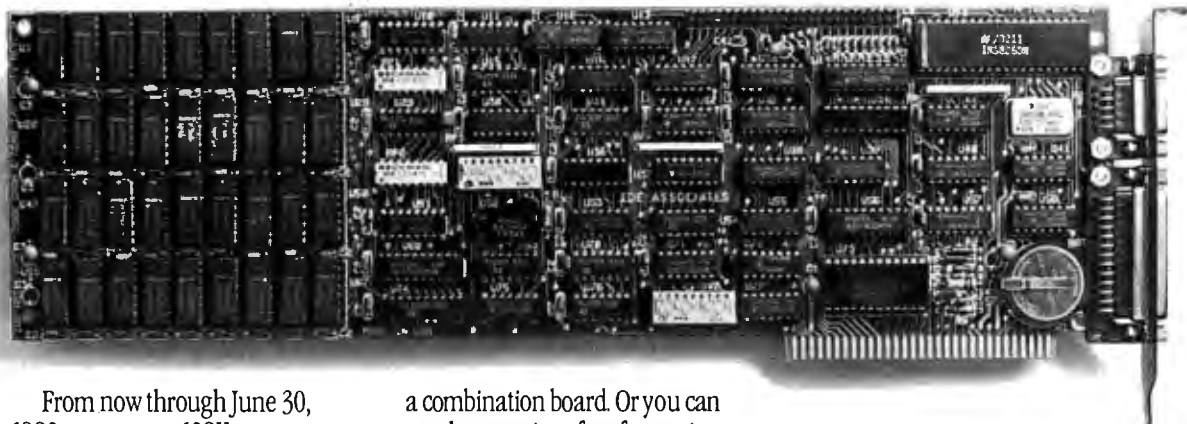
The question is complex. For example: suppose you have a program that you sell for \$200. Suppose you know that for every program you sell, one is stolen. Suppose further that you are absolutely certain that if you dropped the price to \$100, you would sell precisely *twice* as many programs and there'd be no theft at all.

Query: would you cut the price?

You probably wouldn't. You'd have twice as many legal customers.

# Introducing our best idea yet: Free memory.

Get free extra memory and RAMFloppy disk-emulation software when you buy IDE's 256K Combination Board for the IBM PC.



From now through June 30, 1983, you can get 128K extra memory absolutely free with the purchase of every 256K Combination Board from IDE.

And free memory isn't all. You also get free RAMFloppy disk-emulation software with each 256K Combination Board you order. Together, that's a savings of over \$300.

But wait...there's more. Buy any IDE board other than the 256K and you'll get 64K extra memory at half price. Plus free RAMFloppy disk-emulation software. For a combined savings of over \$100 per board.

This has to be the best idea from IDE since the Combination Board for the IBM PC.

## The Combination Board that beats the knockout problem.

IDE's new Combination Board allows you to cable both serial *and* parallel interfaces from the back of the board itself. So even if your IBM PC doesn't have a knockout, you can now interface printers, disks, or communications devices. Without any troublesome jury rigging, without wasting expansion slots, and with the unit's protective cover still in place.

## It's a technical knockout.

For the first time, you can get a Winchester disk drive interface on

a combination board. Or you can use the same interface for a printer. You can also add a serial interface (RS232C Cable Adapter included) and/or clock/calendar with battery backup.

And the IDE Combination Board gives you these capabilities for *both* the IBM PC and PC XT. Including DOS 2.0 software support.

## The winning combination: Price and support.

Look at our price structure.

You buy only the options you want, so you never have to pay for something you don't need.

And with IDE's helpful upgrade policy, you can trade up your board for one with more memory or options. For very little money.

Pricing table		
Memory:	Regular Price	Offer Price*
64K	\$275	\$275
128K	\$375	\$325
192K	\$475	\$425
256K	\$575	\$525
256K		
+ 128K	\$825	\$575

\*Includes free RAMFloppy software—a \$60 value. Offer good through 6/30/83.

One option: Add \$75  
Two options: Add \$120  
Three options: Add \$150

Plus, IDE backs up the Combination Board with a one-year warranty...not just 90 days.

It's available for immediate delivery, and installation is free in major metropolitan areas.

## Don't forget: Order now to get free extra memory and RAMFloppy software.

To get your free extra memory and RAMFloppy software, you must order your IDE Combination Boards by June 30. And the same is true for getting half-price extra memory and free RAMFloppy software with the other boards in our line.

So call us toll-free for the name and location of the nearest participating IDE dealer. (If there isn't one convenient to you, we'll be happy to take your order directly.)

Your IDE dealer will show you the whole line of IDE products: Combination Boards, memory boards, Winchester disk drives, printer spooler software, and disk-emulation software. He'll be glad to sell you the IDE Combination Boards or memory boards you need.

And help you take full advantage of the best free offer in memory.

**1-800-257-5027**  
(In MA call (617) 275-4430)

**IDE Associates, Inc.**  
Better ideas for personal computers.

7 Oak Park Drive, Bedford, MA 01730

You'd have to provide twice as much support.

Carry it further. How many copies of \$500 programs are stolen? At what price would that drop to half? A quarter?

I've seen no evidence to show that what my mad friend, Dan MacLean, used to call Levitical agreements—full of "Thou Shalt Nots"—have any effect on piracy. The evidence may exist, mind you; I just haven't seen any. It may be that people rip off Walt Bilofsky more than they do Digital Research, but I'd have to see it proved.

The bottom line, I think, is that we need to give a lot more thought to the whole problem. I can well understand software publishers' desire to keep software prices high. As a user, though, I've no desire to help them do it. I certainly won't concede their ethical right to discourage competition, nor will I cooperate in goofy schemes designed to protect publishers' rights to sell worthless junk and not refund the buyer's money.

There must be a fair way to "pro-

mote the progress of science and useful arts, by securing for limited times to authors and inventors the exclusive right to their respective writings and discoveries"—which is the *only* Constitutional authority for granting monopolies through copyright or patent. The one thing I'm certain of, though, is that it does no good to encourage disrespect for the law by having people sign agreements no one believes they'll keep.

### Snapshot

One thing that used to really enrage my mad friend was "uncopyable" software. He could concede that it made sense for games to be copy protected, but anything *useful* should be backed up. It's a sentiment I thoroughly agree with, and except for games I generally won't review software that has been copy protected.

However, for every ingenious copy protection scheme, there's an even more ingenious way to defeat it. It's probably impossible to make a disk thoroughly uncopyable, although

some publishers have come pretty close.

CP/M doesn't lend itself to copy protection. In fact, you can't even lock up BASIC programs; most experienced programmers know how to unlock execute-only BASIC programs so that you can get at their sources. CP/M users thus haven't been too worried about copy protection.

Apple users, though, have always had the problem. So have those who used TRS-DOS, and I understand that MS-DOS has copy protection features. There are a number of copy protection schemes. All involve mislabeling a disk sector. All of them I know of have the side effect of making the program a bit more fragile.

For every copy protection scheme there's a hacker ready to defeat it. Most involve so-called "nybble" copiers, which try to analyze the original disk and then make a copy. This involves in carefully chosen places on their original disk. The result is to make the program even more fragile,



Star Gemini 10 100 CPS, 9x9 1/2 in. res. graphics, friction/tractor feed, 80 column, Parallel interface. SCALL Gemini 15 15" carriage . . . SCALL



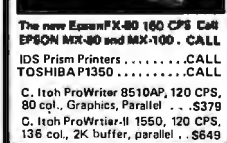
NEC SPINWRITER 3550  
NEC's new letter-quality printer especially designed for the IBM PC. 203 columns, auto proportional space, justification, bi-directional, 350 words per min. Serial. \$1,899



The new Epson FX-80 160 CPS Col. EPSON MX-80 and MX-100 . . . CALL



BROTHER HR-1  
Letter quality daisy-wheel printer 15 CPS, bi-directional, friction feed, parallel interface. Super value. \$759  
Serial interface . . . \$719  
Tractor . . . \$118



C. Itoh ProWriter 8510AP, 120 CPS, 80 col., Graphics, Parallel . . . \$379  
C. Itoh ProWriter-II 1550, 120 CPS, 136 col., 2K buffer, parallel . . . \$649



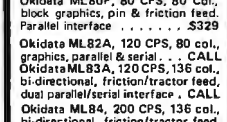
COMREX CR-1-C  
17 CPS daisy-wheel printer, bi-directional, Parallel . . . \$759  
CR-1-A Above but serial . . . \$769  
Tractor . . . \$119



Okidata ML80P, 80 CPS, 80 Col., block graphics, pin & friction feed, Parallel interface . . . \$329



TRANSTAR 130  
Letter quality daisy-wheel printer 15 CPS, bi-directional, proportional spacing, superscript and subscript, underlining, bold face. Amazingly quiet operation at 65dB. CALL



Okidata ML82A, 120 CPS, 80 col., graphics, parallel & serial. . . CALL  
Okidata ML83A, 120 CPS, 136 col., bi-directional, friction/tractor feed, dual parallel/serial interface . . . CALL  
Okidata ML84, 200 CPS, 136 col., bi-directional, friction/tractor feed, parallel interface . . . CALL  
Okidata ML84S, same as ML84 but serial interface. . . . . SCALL  
Okidata ML92, The newest! 80 col. 160 CPS, friction/tractor feed, graphics, parallel interface. . . . . SCALL  
Okidata ML93, The newest! 160 CPS, 136 col. tractor/friction feed, bi-directional, parallel . . . . . SCALL



C. Itoh F-10 StarWriter  
40 CPS daisy-wheel (parallel) SCALL  
Tractor for F-10 . . . \$225  
Cable—IBM to parallel printer—\$35

**AST**  
Multi-Function Cards for IBM PC and XT  
New Low Prices!  
(Each card now comes w/ SuperDrive & SuperSpool)

Amount of memory installed on card	64K	128K	192K	256K
w/ all options (serial, parallel ports & clock)	\$287	\$337	\$387	\$437

**ComboPlus Cards**

Amount of memory installed on card	64K	128K	192K	256K
w/ standard features of serial port No. 1 & clock	\$289	\$339	\$389	\$439
w/ either parallel or additional serial port No. 2	\$324	\$374	\$424	\$474
w/ both parallel and additional serial port No. 2	\$359	\$409	\$459	\$509
MegaPak — expands a fully populated MegaPlus card to 512K	...	...	...	\$335

**MegaPlus Cards**

Standard card w/ one serial port (S1) and clock/calendar	...	\$129
with ONE additional option: game(G) or parallel(P) or serial 2(S2) port	...	\$165
with TWO additional options (GP, GS2, or PS2)	...	\$199
with all THREE additional options (GPS2)	...	\$232

**I/O Plus Cards**

**HERCULES GRAPHICS CARD**  
This card will give high resolution bit mapped graphics (720H x 348V) on the IBM monochrome display. Complete with parallel printer port. Both text and graphics can be displayed simultaneously. Complete w/ HBASIC software to execute IBM's high resolution graphics commands. CALL

**the Graphics Card**  
This card will give high resolution bit mapped graphics (720H x 348V) on the IBM monochrome display. Complete with parallel printer port. Both text and graphics can be displayed simultaneously. Complete w/ HBASIC software to execute IBM's high resolution graphics commands. CALL

**Kaise**  
Autorangeing Digital Multimeter  
3.5 digit LCD w/ auto unit & sign indicators. Full auto ranging on Volt & Ohm w/ 10Amp AC/DC range.  
Model SK-6440  
Special \$99.50

**DATANAC HARD DISKS**  
DATANAC "Add-in" Winchester Disk System includes hard disk, disk controller card, cable, software, auxiliary power supply which mounts neatly behind IBM PC system unit, and all necessary documentation to insure ease of installation. System is fully buffered with automatic error correction code. All hard disks will fit neatly into the right-hand slot of the IBM PC.  
6 MB (5 MB formatted) . . . \$1,549  
12 MB (10 MB formatted) . . . \$1,949  
19 MB (15 MB formatted) . . . \$2,649

**MONITOR SALE**  
RGB COLOR  
BMC 8M-AU9191MU, 12" RGB color, w/ cabinet style to match IBM (as shown above) . . . \$645

Princeton HX-12, 12" RGB color, 590 dots 80 char x 25 lines. Identical IBM cabinet. Most pleasing & best price performance monitor for your IBM PC. List \$95 . . . Best Buy SCALL

**GREEN SCREEN**  
Dynac GM-120, 12" green, 600 lines 20 MHz. Made by JVC. Excellent! List \$200.00 . . . Sale \$109.00

**AMBER SCREEN**  
Dynac AM121, 12" amber, 600-dot 20 MHz. Made by JVC. Excellent! List \$250.00 . . . \$149.00  
Texan KA12N, 12" amber, 800-dot, List \$205.00 . . . \$150.00

**IBM PC & XT**  
IBM Personal Computers  
The new X T Model available now. Call for prices & configurations

**SOFTWARE FOR IBM PC**  
1-2-3 (Req. DS drive) . . . \$495 CALL  
dBASE II . . . \$700 \$469  
TKISolver . . . \$249  
T.I.M. III . . . \$495 \$349  
WordStar . . . \$495 \$339  
MailMerge . . . \$250 \$189  
SpellStar . . . \$250 \$179  
VisiCalc/256K . . . \$250 \$179  
VisiFile . . . \$300 \$219  
VisiDev . . . \$250 \$199  
Spellguard . . . \$195 \$149  
Versiform . . . \$389 \$259  
PeachPak (GL/AR/AP) . . . \$595 \$395  
The Tax Manager . . . \$250 \$179  
Home Accountant Plus . . . \$150 \$109  
1st Class Mail . . . \$125 \$99

**Hayes Smart Modem 300** — Call  
**1200** — Call

**5 1/4 TANDON DRIVES**  
The newest IBM PC compatible. Installation instruction included.  
TM100-1A, SSDD 160K . . . \$195  
TM100-2A, SSDD 320K . . . CALL

**EASTERN ENTERPRISES, INC.**  
2937 S. VAIL AVE., LOS ANGELES, CALIF. 90040  
TOLL-FREE ORDERS ONLY! (800)392-7081  
MasterCard VISA  
To order, please send money order or cashier's check. Personal or company checks require 2-3 weeks to clear. Prices reflect 3% cash discount. Visa/Mastercard accepted. Shipping, insurance & handling charges are 3% of total order value by UPS Surface, 5% by UPS Air or Parcel Post. COD's requires 20% deposit. California residents add sales tax. No sales tax on out-of-state orders. Prices & availability subject to change without notice. Send for catalog of other items at similar savings.

# THE FORTH SOURCE™

## MVP-FORTH - A Public Domain Product

MVP Forth is fig-FORTH updated to the FORTH-79 Standard Required Word Set. The source is public domain. Included are an editor, FORTH assembler, tools and utilities, making it compatible with the instructional book, *Starting FORTH*. Except for hardware dependencies, all high level FORTH is transportable between all systems. Modifications and extensions can be simplified through the use of MVP-FORTH Programming Aids and Meta and Cross Compilers.

## MVP FORTH Books - A Series

- Volume 1, All about FORTH** by Haydon. MVP-FORTH glossary with cross references to fig-FORTH, *Starting FORTH* and FORTH-79 Standard. 2nd Ed. \$25
- Volume 2, MVP-FORTH Assembly Source Code.** Includes CP/M®/IBM-PC®, and APPLE® listing for kernel \$20
- Volume 3, MVP-FORTH Math & Floating Point Extensions** by Koopman. \$25

**MORE COMING!**

## MVP-FORTH Software - A Transportable FORTH

- MVP-FORTH Programmer's Kit** including disk, documentation, Volumes 1 & 2 of MVP-FORTH Series (*All About FORTH*, 2nd Ed. & *Assembly Source Code*), and *Starting FORTH*. Specify CP/M, IBM-PC, TRS-80/1® or 3, TRS Color Computer or APPLE. \$150
- MVP-FORTH Cross Compiler** for CP/M Programmer's Kit. Can also generate headerless code for ROM or target CPU \$300

- MVP-FORTH Meta Compiler** for CP/M Programmer's kit. Use for applications on CP/M based computer. Includes public domain source \$150
- MVP-FORTH Fast Floating Point** for APPLE Programmer's Kit. Includes 9511 math chip on board with disk and documentation. \$400
- MVP-FORTH Programming Aids** for CP/M, IBM or APPLE Programmer's Kit. Extremely useful tool for decompiling, callfinding, and translating. \$150
- MVP-FORTH** by ECS Software for IBM-PC or ATARI® 400/800. Standalone with screen editor. License required. Upgradeable \$100
- MVP-FORTH** by ECS Software for IBM-PC or ATARI 400/800. Enhanced with color animation, multitasking sound, utilities, and unlimited run time license. \$175
- MVP-FORTH Professional Application Development System (PADS)** for CP/M, IBM-PC, or APPLE. A three level integrated system with complete documentation. Complete system for IBM, CP/M, or APPLE Includes 3 below \$400
- MVP-FORTH PADS** enhanced virtual system \$150
- MVP-FORTH PADS** Programming Aids \$150
- MVP-FORTH PADS** Meta Compiler \$150

\*\*\* MVP-FORTH operates under a variety of CPU's, computers, and operating systems. CP/M® disks can be supplied 8", SS/SD, 3740 format or 5 1/4 for Osborne® Northstar® Micro Decisions® Kaypro® or HB9/Z89®. Specify your computer and operating system. \*\*\*

## FORTH DISKS

FORTH with editor, assembler, and manual.

- |  |  |
|--|--|
| <input type="checkbox"/> <b>APPLE</b> by MM \$100    | <input type="checkbox"/> <b>NOVA</b> by CCI \$150                      |
| <input type="checkbox"/> <b>APPLE</b> by Kuntze \$90 | <input type="checkbox"/> <b>TRS-80/1®</b> by NS \$90                   |
| <input type="checkbox"/> <b>ATARI®</b> valFORTH \$60 | <input type="checkbox"/> <b>Z80</b> by LM \$50                         |
| <input type="checkbox"/> <b>CP/M®</b> by MM \$100    | <input type="checkbox"/> <b>8086/88</b> by LM \$100                    |
| <input type="checkbox"/> <b>HP-85</b> by Lange \$90  | <input type="checkbox"/> <b>VIC FORTH</b> by HES, VIC20 cartridge \$60 |
| <input type="checkbox"/> <b>IBM-PC®</b> by LM \$100  |  |

Enhanced FORTH with: F-Floating Point, G-Graphics, T-Tutorial, S-Stand Alone, M-Math Chip Support, MT-Multi-Tasking, X-Other Extras, 79-FORTH-79.

- |  |  |
|--|--|
| <input type="checkbox"/> <b>APPLE</b> by MM, F, G, & 79 \$140                      | <input type="checkbox"/> <b>TUTORIAL</b> by L & H, includes <i>Starting FORTH</i> 95 and 8086 \$95 |
| <input type="checkbox"/> <b>ATARI</b> by PNS, F,G, & X \$90                        | <input type="checkbox"/> <b>Extensions</b> for LM IBM,Z80, and 8086 \$100                          |
| <input type="checkbox"/> <b>CP/M</b> by MM, F & 79 \$140                           | <input type="checkbox"/> Software Floating Point \$100   |
| <input type="checkbox"/> <b>Apple, GraFORTH</b> by Insoft \$75                     | <input type="checkbox"/> 8087 Support (IBM-PC or 8086) \$100                                       |
| <input type="checkbox"/> <b>IBM-PC, PolyFORTH</b> by F I F, G, S, M, MT, & X \$300 | <input type="checkbox"/> 9511 Support (Z80 or 8086) \$100  |
| <input type="checkbox"/> <b>Multi-Tasking FORTH</b> by SL, CP/M, X & 79 \$395      | <input type="checkbox"/> Color Graphics (IBM-PC) \$100   |
| <input type="checkbox"/> <b>TRS-80/1 or 11</b> by MMS F, X, & 79 \$130             | <input type="checkbox"/> Data Base Management \$200  |
| <input type="checkbox"/> <b>Timex ZX81 &amp; TS1000</b> by FD, G,X, & 79 \$45      | <input type="checkbox"/> Requires LM FORTH disk, specify IBM, Z80, or 8086                         |
|  | <input type="checkbox"/> <b>Victor</b> by DE, G,X \$150  |

**CROSS COMPILERS** Allow extending, modifying and compiling for speed and memory savings, can also produce ROMable code. \*Requires FORTH disk.

- |   |   |
|---|---|
| <input type="checkbox"/> CP/M \$300       | <input type="checkbox"/> IBM• \$300         |
| <input type="checkbox"/> TRS-80/1 \$300   | <input type="checkbox"/> Z80• \$300         |
| <input type="checkbox"/> Northstar® \$300 | <input type="checkbox"/> Apple II/II+ \$300 |
| <input type="checkbox"/> 8086• \$300      |   |
- fig-FORTH Programming Aids** for decompiling, callfinding, and translating. Specify CP/M, IBM-PC, Z80, or Apple \$150
- Key to vendors:
- |                            |                                   |
|----------------------------|-----------------------------------|
| LM Laboratory Microsystems | MM MicroMotion                    |
| F I FORTH Inc.             | MMS Miller Microcomputer Services |
| DE Dai-E Systems           | FD Forth Dimension                |
| NS Nauti/us Systems        | L & H Laxen and Harris            |
| SL Shaw Labs               |                                   |

Jupiter Ace Computer - Z80 FORTH micro code \$150

## FORTH MANUALS, GUIDES & DOCUMENTS

- |  |  |
|--|--|
| <input type="checkbox"/> <b>ALL ABOUT FORTH</b> by Haydon. See above. \$25   | <input type="checkbox"/> <b>1982 Rochester FORTH Proc.</b> \$25                        |
| <input type="checkbox"/> <b>FORTH Encyclopedia</b> by Derick & Baker. A complete programmer's manual to fig-FORTH with FORTH-79 references. Flow charted, 2nd Ed. \$25 | <input type="checkbox"/> <b>A FORTH Primer</b> \$25                                    |
| <input type="checkbox"/> <b>FORTH Encyclopedia Pocket Guide</b> \$7  | <input type="checkbox"/> <b>Threaded Interpretive Languages</b> \$21                   |
| <input type="checkbox"/> <b>And So FORTH</b> by Huang. A college level text. \$25  | <input type="checkbox"/> <b>AIM FORTH User Man</b> \$12                                |
| <input type="checkbox"/> <b>FORTH Programming</b> by Scanlon \$17  | <input type="checkbox"/> <b>APPLE User's Manual MicroMotion</b> \$20                   |
| <input type="checkbox"/> <b>FORTH on the ATARI</b> by E. Floegel \$8   | <input type="checkbox"/> <b>META FORTH</b> by Cassidy. Meta compiler in 8080 code \$30 |
| <input type="checkbox"/> <b>Starting FORTH</b> by Brodie. Best instructional manual available. (soft cover) \$18   | <input type="checkbox"/> <b>Systems Guide to fig-FORTH</b> \$25                        |
| <input type="checkbox"/> <b>Starting FORTH</b> (hard cover) \$22   | <input type="checkbox"/> <b>Caltech FORTH Manual</b> \$12                              |
| <input type="checkbox"/> <b>1980 FORML Proc.</b> \$25  | <input type="checkbox"/> <b>Invitation to FORTH</b> \$20                               |
| <input type="checkbox"/> <b>1981 FORML Proc 2 Vol</b> \$40   | <input type="checkbox"/> <b>PDP-11 User Man.</b> \$20                                  |
| <input type="checkbox"/> <b>1982 FORML Proc.</b> \$25  | <input type="checkbox"/> <b>CP/M User's Manual, MicroMotion</b> \$20                   |
| <input type="checkbox"/> <b>1981 Rochester FORTH Proc.</b> \$25  | <input type="checkbox"/> <b>FORTH-79 Standard</b> \$15                                 |
|  | <input type="checkbox"/> <b>FORTH-79 Standard Conversion</b> \$10                      |
|  | <input type="checkbox"/> <b>Tiny Pascal fig-FORTH</b> \$10                             |
|  | <input type="checkbox"/> <b>NOVA fig-FORTH CCI</b> \$15                                |
|  | <input type="checkbox"/> <b>Installation Manual fig-FORTH,</b> \$15                    |

**Source Listings of fig-FORTH**, for specific CPU's and computers. The Installation Manual is required for implementation. Each \$15

- |                                |                                  |                               |  |
|--------------------------------|----------------------------------|-------------------------------|--|
| <input type="checkbox"/> 1802  | <input type="checkbox"/> 6502    | <input type="checkbox"/> 6800 | <input type="checkbox"/> AlphaMicro    |
| <input type="checkbox"/> 8080  | <input type="checkbox"/> 8086/88 | <input type="checkbox"/> 9900 | <input type="checkbox"/> APPLE II      |
| <input type="checkbox"/> PACE  | <input type="checkbox"/> 6809    | <input type="checkbox"/> NOVA | <input type="checkbox"/> PDP-11/LSI-11 |
| <input type="checkbox"/> 68000 | <input type="checkbox"/> Eclipse | <input type="checkbox"/> VAX  | <input type="checkbox"/> Z80           |

**Ordering Information:** Check, Money Order (payable to MOUNTAIN VIEW PRESS, INC.), VISA, MasterCard or COD's accepted. No billing or unpaid PO's. California residents add sales tax. Shipping costs in US included in price. Foreign orders, pay in US funds on US bank, include for handling and shipping by Air: \$5 for each item under \$25, \$10 for each item between \$25 and \$99 and \$20 for each item over \$100. Minimum order \$10. All prices and products subject to change or withdrawal without notice. Single system and/or single user license agreement required on some products.

**DEALER & AUTHOR INQUIRIES INVITED**

# MOUNTAIN VIEW PRESS, INC.

PO BOX 4656

MOUNTAIN VIEW, CA 94040

(415) 961-4103

as well as to make it harder to analyze the protection scheme.

I'm not sure who's ahead just now, protectors or unlockers. It doesn't really matter, because there's another and better approach to making copies.

Snapshot doesn't bother analyzing the disk. Instead, Snapshot is a *hardware* addition to the Apple II; through Snapshot you can interrupt the program and write out an exact copy of memory to disk. If you later load that image back to memory, the program has no way of knowing that it was ever interrupted. Thus Snapshot is a kind of ultimate "unlock" system.

It can't copy everything, of course. Programs that have to access the disk for information can't be copied that way, since Snapshot can get only what's currently in memory. On the other hand, often the data files *can* be copied, so that Snapshot plus transferring data files will do the job.

Snapshot is easy to install and simple to document. We don't use it much, because nearly all our Apple

programs are games, and I don't make backup copies of games. It does work, though, and there's a fallout benefit, since some games don't have a way for you to stop and save the game while you go have dinner. Snapshot makes that a cinch.

Snapshot requires an Apple II or II Plus with 48K bytes, one disk drive, and a 16K-byte memory card or language card. It is also said to work with the Franklin Ace computer. It's easy to install: a 16-year-old did ours from the Snapshot instructions.

### Softlock

Another truly horrible scheme that has surfaced recently is Softlock. This is a system for rendering software more or less useless until you enter a secret password.

The idea is that you go to the software store and look over the programs. You select a program that costs, say \$250, but you pay only \$49.95. You take the program home and play with it. It runs, but some crucial aspect of the program won't work. If it's a database, it won't ac-

cess more than five records. Something like that.

You send in your licensing agreement and the balance of the money, and when that's been received, you get the secret password that will "unlock" the program.

So far, so good; but what if you don't like the software? Suppose you've tried it and found it wanting? Ah, well, you're out \$49.95.

You're supposed to be grateful. After all, you could have been stuck for \$250 before finding out that you don't like the program.

The big advantage of this scheme is that dealers like it. The Softlock people have set it up so that the dealer's inventory cost is based on the \$49.95, rather than the full \$250 nominal value of the program; but when the dealer makes the sale, he gets the full \$250, less what Softlock takes for providing its service.

People who publish their software through outfits using Softlock tell me that dealers love this scheme, but "there's been considerable customer resistance." I'd hope to kiss a duck

# Microrubble

How long could your business survive if your computer were suddenly reduced to a smoldering pile of microrubble? If it were stolen? Or tampered with?

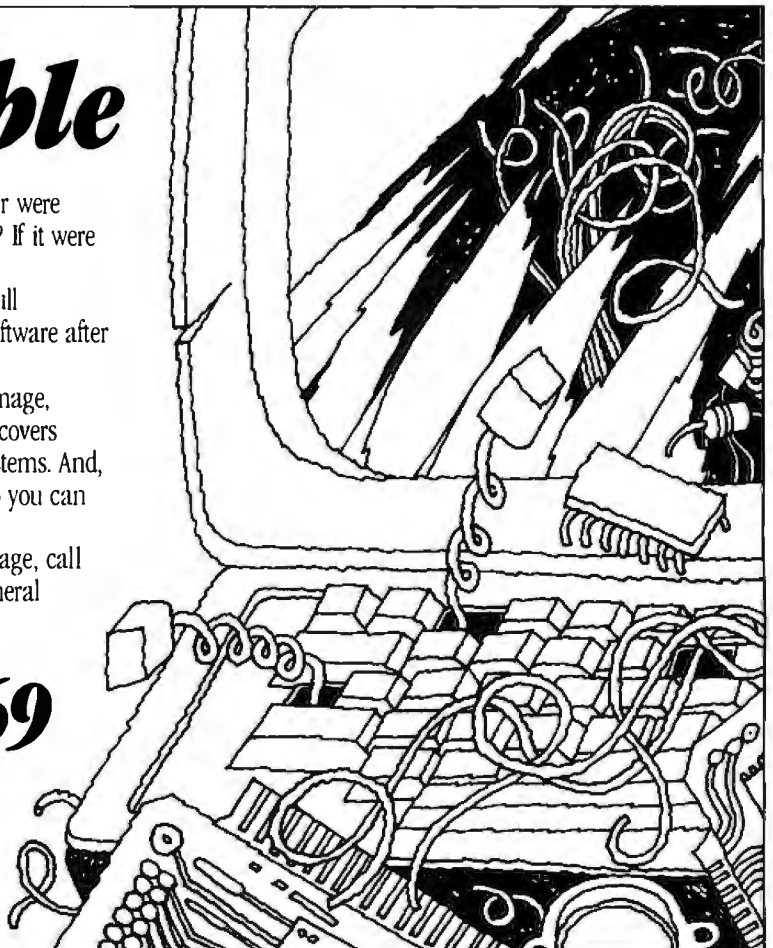
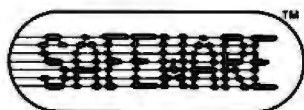
For as little as \$35/yr SAFEWARE provides for full replacement of all hardware, media and purchased software after a low \$50 deductible.

You're covered against fire, theft, accidental damage, earthquakes, and damage in transit. SAFEWARE even covers power surges, the second leading destroyer of microsystems. And, in the event of a claim, you'll get fast replacement. So you can be back in business almost before the smoke clears.

To find out more, or to obtain immediate coverage, call the toll free number. Or write: Columbia National General Agency, 88 E. Broad Street, Columbus, OH 43215.

## 1-800-848-3469

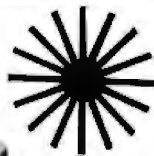
(In Ohio call toll free 1-800-848-2112)



# FORMULA INTERNATIONAL INC.

12603 Crenshaw Blvd., Dept. B, Hawthorne, CA 90250

For information (213) 973-1921 • Orders Only (outside Calif.) (800) 672-8758



## FORMULA II™

**The Alternative! The Compatible!  
The Affordable! 64K Color Computer Kit!**

### FEATURES:

- ★ Fully compatible with Apple® II+
- ★ Singleboard for easy assembly
- ★ Popular 6502 MPU for large amount of software
- ★ Game paddle connector on both sides of case
- ★ Built in 2-watt amplifier for realistic sound effect with volume control
- ★ 8 on board peripheral connectors for expansion
- ★ 14 key numeric key-pad
- ★ 5-amp switching power supply

**\$645.00**  
EACH

(please add 5% shipping and handling)



Easy to assemble! All components are clearly silk-screened on the high quality double-sided mother board. All integrated circuits, IC sockets, peripheral connectors, keyboard, switching power supply and the professional high impact plastic case are included.

### 5 1/4" DISC DRIVE FROM QUENTIN RESEARCH INC.

100% Made In USA 100% Apple and Pineapple™ Compatible  
50% Faster Seeking Time Than Apple Disk II Drive!



- 1 Year Full Warranty
- 40 Tracks
- One of the Most Quiet Drives
- Color and Shape same as the Disk II Drive

Disk Drive **\$285.00**

Controller Card **\$ 75.00**

Controller Card with 13 Sector, 16 Sector Auto Select **\$ 85.00**

### Big Savings On Peripheral Cards

Buy them in kit form.

All cards APPLE II and PINEAPPLE compatible.

80 column card kit . . . . .	<b>\$120.00</b>	EPROM writer card assembled (For 2708,2716,2732,2764,2532) . . . . .	<b>\$89.50</b>
Z80 CP/M card kit . . . . .	<b>\$110.00</b>	Printer interface card kit (For Epson or Oki)	<b>\$69.50</b>
16K RAM card kit . . . . .	<b>\$49.50</b>	New disk controller card kit (3.2, 3.3 auto select) . . . . .	<b>\$69.50</b>
Disk controller card kit . . . . .	<b>\$59.50</b>	PAL Color Encoder card (assembled) . . . . .	<b>\$88.50</b>
RS232 Interface card kit . . . . .	<b>\$95.00</b>		
16K RAM card (cable-less) kit	<b>\$59.50</b>		

### HEAVY DUTY SWITCHING POWER SUPPLY for Apple II, AP-II™ and Pineapple™ Computers

- +5V at 5.0 Amp
- +12V at 2.5 Amp
- 5V at 0.5 Amp
- 12V at 0.5 Amp



Model: THB-43H

Size and mounting holes are same as the ones used in the Apple II

**\$145.00 ea.**

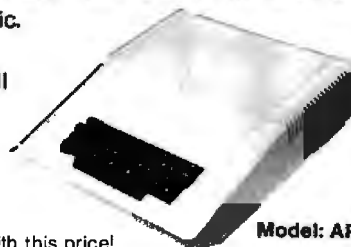
### The APPLE II LOOKALIKE COMPUTER CASE

Made with high impact plastic.  
Color and shape are compatible with the APPLE II



Special  
**\$99.95**

Keyboard not included with this price!



Model: APII

### APPLE II+ COMPATIBLE KEYBOARD

- LSI keyboard decoder
- Full ASCII code output
- Upper/lower case function
- N-key rollover function
- LED ON/OFF indicator



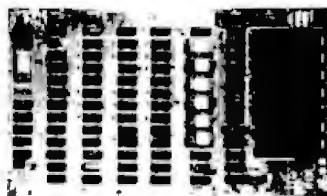
LKB-3600-N

Keyboard Case

Keyboard Only **\$99.00 EA.** Plastic Case **\$35.00 EA.**

### 6502 CPU MOTHER BOARD

- 48K on board RAM (4116)
- 12K on board ROM (2716)
- Upper/lower case
- Composite-video output
- Apple II alternative
- Size: 14 1/4" x 8 1/2"



P.C. Board Only **\$99.00 ea.**

Complete Component Pack (No ROMs) **\$175.00**

**GUARANTEED TO WORK! BUILD IT IN 2 HOURS!**

### 5 1/4" DISKETTE SALE

All diskettes soft sector single-side double density with hub rings.

		10 pcs.	100 pcs.
<b>wabash®</b>	#M43A	<b>\$21.50</b>	<b>\$195.00</b>
<b>Verbatim®</b>	#M525-01	<b>\$26.50</b>	<b>\$240.00</b>
<b>Sentinel</b>	#744D	<b>\$26.50</b>	<b>\$240.00</b>
<b>ATHANA</b>	#475001	<b>\$19.50</b>	<b>\$175.00</b>

Circle 152 on inquiry card.

Shipping & Handling Charges  
Under \$50.00 Under \$50.00

Purchase	10%	5%
Purchase	15%	10%
Purchase	25%	20%

Minimum Order \$10.00/Calif. Residents add 6.5% Sales Tax. Phone Orders Accepted on VISA or MC ONLY. NO C.O.D.'s. Prices subject to change without notice.



**STORE HOURS**  
MON-FRI—10-7  
SAT—10-6

Inside California  
Outside Calif. (incl. Mexico & Canada)  
Overseas

\*Apple and Apple II are the trademark of APPLE COMPUTERS, INC.

there'd be resistance. I hope the resistance looks like a boycott. I guarantee I'll never buy a program protected that way. Anyone else want to take the pledge?

### Nice Mice

One feature of Apple's new Lisa computer is a "mouse," a hand-held cursor controller. I'm pleased to say there is a mouse for the IBM Personal Computer. It is supposed to work with the IBM-compatible Zenith Z-100.

In fact, our mouse would work with just about any computer that has an RS-232C serial port; it's just that I don't have software for any machine other than the IBM PC.

The M-1 Optical Mouse from Mouse Systems Corporation is a pleasant-sized hand-fitting object with three buttons on it. Pressing a button from one to three times lets you use each button like three function keys. My friend Marvin Minsky tells me there's great controversy in the artificial intelligence community

over how many buttons a mouse ought to have.

This mouse sits on a specially scribed metal board. The board is thin and will sit on any table. The mouse has to be on this board, because it sees the myriad of lines on the board. When you move the mouse about, it knows how many lines it has crossed, and at what angle, and therefore is able to tell this to the computer. Proper software will make the computer cursor do whatever you have done with the mouse and the buttons act like function keys.

At MIT I have seen programs that use a mouse to "paint" the screen, not only with colors, but with strange patterns. You move the cursor to a set of "brush sizes," put the cursor over the size you want, and hit a mouse button. The cursor is now that size. Take the "brush" and move it to a "pot of paint," i.e., a pattern at the edge of the screen, and push the button again. Now, move the mouse about the screen; push a button to leave

"paint" on the screen, let go to "lift the brush." You can paint rather nice pictures that way.

I haven't seen any programs like that for microcomputers, but I'm sure it's only a question of time. If you like playing about with computers, you'll probably like having a mouse. I've noticed that almost all MIT hackers become addicted.

### New Kaypro II Software

The Kaypro II continues to improve. It now has the Perfect line of software. I certainly would prefer Perfect Writer to Select, which used to come with the Kaypro. There's also the speller, filer, and calculator from the Perfect line, plus another spreadsheet that has always come with the Kaypro. If all that isn't enough, you also get my favorite spelling checker, Wayne Holder's The Word Plus.

There's even more. You also get Microsoft BASIC with the Kaypro as well as S-BASIC, and the S-BASIC manual has been rewritten.

That's just as well. If I had to give an award for the most unreadable computer document I've ever seen, the original S-BASIC manual would win hands down. The new one has been worked over by Kaypro and is a great deal more sensible.

S-BASIC itself is quite nice. It's a structured and compiled BASIC that rivals CB-80. I'm more familiar with CB-80 than S-BASIC, but all my experiences with S-BASIC have been relatively pleasant. I suspect that those who buy the Kaypro machine will begin by using Microsoft MBASIC, then start translating their programs into S-BASIC and learn more about structured programming.

Meanwhile, our Kaypro II has been out on loan to a collaborator, Dr. Alan Trimpi. He's been using it mostly as a word processor, and he loves it. All other reports I've heard from Kaypro users have been positive, too, except for that awful squeaky key-click that is even worse than the Z-100's. Fortunately, it can be turned off.

The Kaypro II is a very good machine for those somewhat familiar with computers, and the company keeps upgrading the documents that

## dBASE II® Power from WordTech's INFORMATION MANAGEMENT SOFTWARE

### GENERAL APPLICATIONS

- **SALES SUPPORT SYSTEM** with high power stand alone order entry, invoicing, A/R, and shipping label printing. \$169
- **MAILING LIST SYSTEM** allows entry and maintenance with totally flexible sorting and label formatting capabilities. The last word in selective mailings. \$49
- **CALENDAR SYSTEM** controls important dates and appointments, lets you print reminders sorted by date, person and location. \$39

### LAW OFFICE APPLICATIONS

- **DOCUMENT FILING AND RETRIEVAL SYSTEM** allows cross indexing of thousands of documents with instantaneous reporting on location based on numerous search criterion. Keeps tabs on exactly where pertinent information is located. \$129
- **MASTER CALENDAR SYSTEM** accepts dates up to 48 months in advance. Reports show upcoming appointments, depositions, hearings, and trials sorted by date, time, person, place and event. \$89
- **CENTRAL MESSAGE SYSTEM** tracks messages for your entire office. Offers instantaneous and/or summary printout with excellent on line access to message records based on past dates, caller, subject, and person called. \$79

### CALIFORNIA LANDLORD FORMS

- **CALIFORNIA LANDLORD LEGAL FORMS** provides commercial and residential leases, rental agreements, unlawful detainers, actions and notice forms. Simply insert pertinent information then print out with your word processor. \$89

All packages include complete documentation. You can use these programs even if you don't have dBASE II\*. Phone for details.

**WordTech Systems**

953 Mountain View Drive  
(415) 254-7747

Lafayette, CA 94549  
DBASE II® ASHTON-TATE



Actually, we're being modest.

The truth is we won. Because 74% of consumers interviewed by Nationwide Consumer Testing Institute said the copies produced by the EP 300 were clearly superior to those from the Xerox® and IBM® copiers.

So, while the Xerox and IBM certainly do bigger jobs, they don't do better jobs than the compact Minolta EP 300 when it comes to copy quality.

The EP 300 has Minolta's exclusive micro-toning system for crisp, clear copies with blacker blacks. From top to bottom and edge to edge. On virtually any paper up to 10 x 14".

You also get an electronic troubleshooter to warn you of problems. And Minolta's world-renowned dependability.

**And there's the new Minolta EP 300RE. Superb Minolta copy quality plus enlarged and reduced copies.**

So now you can enlarge fine details in the original for greater legibility. Or reduce ledger, legal and computer printout-size originals to convenient letter-size copies. With all this extra versatility, the EP 300RE costs just \$3,295.

If you'd like the test results, send us the coupon.

If you'd like the name of your nearest authorized Minolta dealer, look under our trademark in the Yellow Pages. Or call toll-free 800-526-5256. In N.J., 201-797-7808.

The Minolta EP 300 Series. The small copiers that prove size isn't everything.

**The Minolta EP 300.**

**At up to 10 times the price, we'd still look good.**

# In a side-by-side-by-side test for crisp, clear copying



**IBM Series III  
Model 10 \$22,635**

**we**



**Minolta EP 300  
\$2,195**



**Xerox 5400  
\$16,095**



**MINOLTA**

©1982 Minolta Corporation. Product appearance, prices and/or specifications subject to change without notice. Copiers tested were the Xerox 5400, the IBM Series III Model 10, and the Minolta EP 300. Xerox and IBM prices are those in effect as of 7/1/82.

Xerox® and IBM® are registered trademarks of Xerox Corporation and International Business Machines Corporation, respectively.

Circle 268 on inquiry card.

- Please send me the copy test results.  
 I'd like more information. Please have my local dealer contact me.

Name \_\_\_\_\_

Title \_\_\_\_\_

Company \_\_\_\_\_

Address \_\_\_\_\_

City \_\_\_\_\_ State \_\_\_\_\_

Zip \_\_\_\_\_ Telephone \_\_\_\_\_

Mail to Minolta Corporation, Business Equipment Division,  
101 Williams Drive, Ramsey, NJ 07446

come with it. If you don't need true portability — the Kaypro II can be carried on an airplane, for I've done it, but it's pretty big and painfully heavy — then you ought to look at the Kaypro line. That's a *very* impressive list of software that comes with the machine; the list prices add up to more than the \$1795 charged for the Kaypro. Incidentally, by the time this is in print there will also be the Kaypro 10, which will have a 10-mega-byte hard disk and sell for less than \$3000. That sounds like an excellent package.

### Magic Keyboard

Regular readers of this column know that I've no love for the IBM PC's crazy European keyboard with its extra key between the "Z" and the Shift key, and the nearly unreachable Return key. I sympathize with the Europeans, who must have keys to make letters we don't have in English. People saddled with *umlauts* deserve sympathy. Sympathy or no, I don't intend to learn to type all over again;

let the Europeans learn, or, better yet, sell them one kind of keyboard and sell Americans another.

IBM, however, chose to try to ram its keyboard down U.S. throats, and indeed it appears to have been successful. A lot of people are buying the PC.

A lot of them are cursing their keyboards, too, if my mail is any sample.

Comes now Jim Baen with a solution. Jim Baen is arguably one of the best science-fiction editors in the world. Certainly Larry Niven and I regard him among the top two or three we've ever worked with.

I recall when I first got Ezekial, my poor late friend who happened to be a Cromemco Z-2. I began to tell Jim Baen about the joys of writing with a computer. He began to listen. One day he decided to do something about it. He went out to buy one.

What he got was an IBM PC. He hadn't noticed the keyboard until he got it home . . .

It nearly drove him crazy. Moreover, many of his authors refused to

work with that keyboard, so he wasn't getting one of the main advantages of having a computer, namely having manuscripts in a format readable by his computer. Something had to be done.

While others, including me, cursed, Jim did something. He got a programmer to write Magic Keyboard. Being an editor, Jim published it.

Magic Keyboard is a program that you run on your IBM PC. It immediately and invisibly reassigns the misplaced keys. The key between the "Z" and Shift becomes another Shift key. The key over there by Return becomes Return. And so forth. You can still get the characters those keys used to make: simply hit the Alt key and the changed key simultaneously.

Now that I have Magic Keyboard I wouldn't mind having an IBM PC, although now that we have Zorro I may not need one.

Incidentally, the Z-100 comes with what amounts to Magic Keyboard. That is, when you buy the machine and operating system, you get alter-

# Super 5



Super 5 has the following advantages compared to the normal floppy disk drive:

Characteristics	SUPER5-T40	Normal Type
Servo motor/Spindle connection	Direct shaft drive	Belt drive
Head positioning mechanism	Metal band positioner	Plastic CAM positioner
Track to track time	Approx. 3-6 msec.	Approx. 40 msec.
Write-protected sensor	Photo coupler	Mechanical switch
No. of tracks	40 tracks	35 tracks

SUPER5-T40 single sided, direct shaft drive.

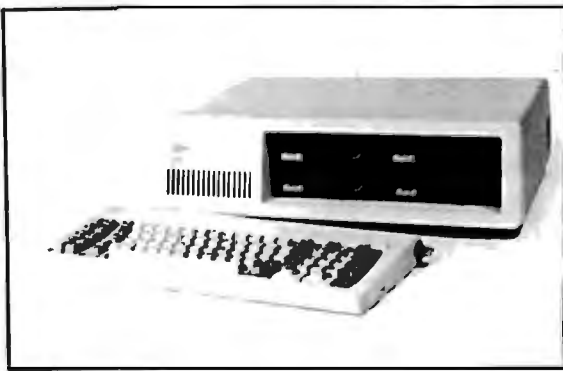
SUPER5-A40 single sided, belt drive.

SUPER5-T80 double sided, direct shaft drive.

DEALERS INVITED

## The Finest Quality Disk Drive for Apple® and IBM

The *Super 5* stands alone in fine quality and workmanship.



### Super 5 -IT80

- Slim, half-height
- Double sided

- Direct shaft drive
- 3-6 msec high speed access
- Low heat generation

E-EN ENT, JAPAN TLX: J23325  
LOS ANGELES BRANCH

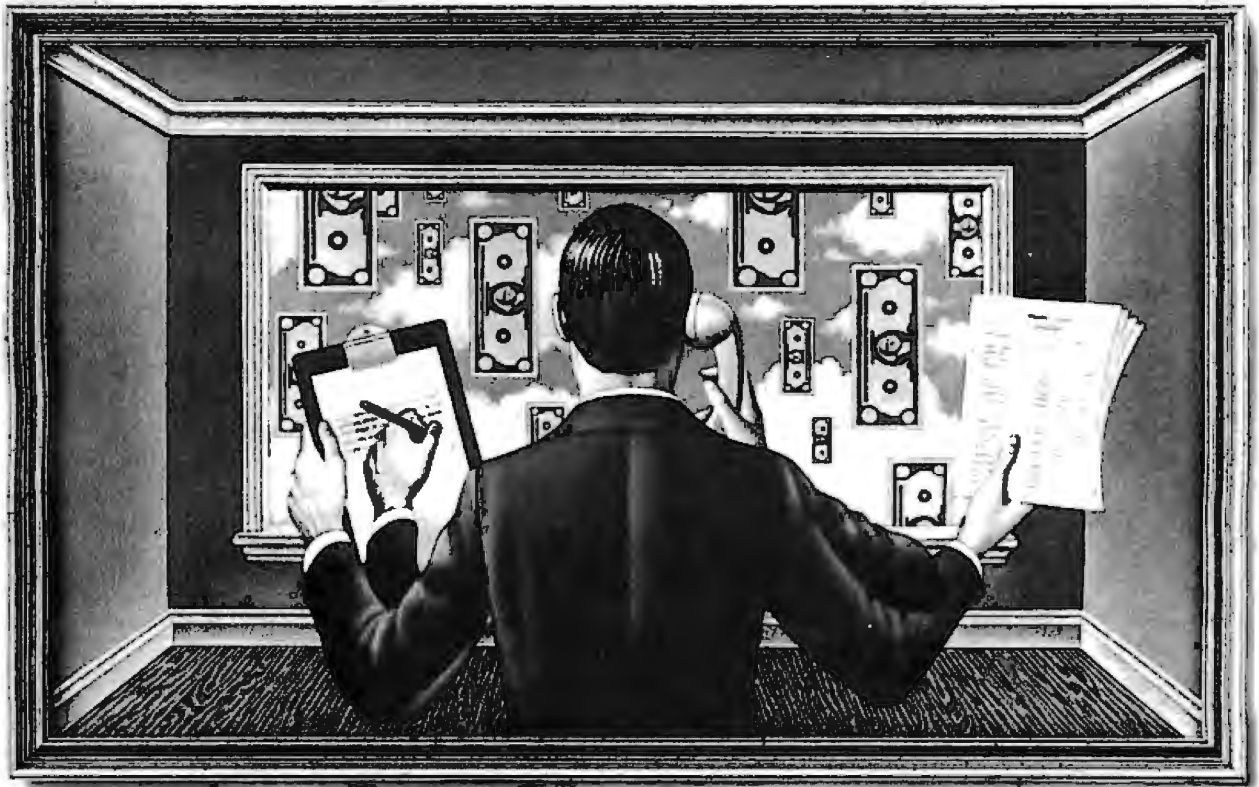
## Mitsuba Corporation

642 S. Second Ave.

Covina, CA 91723

Tel.: (213) 331-8434

# Are your company's out-of-pocket travel expenses getting out of hand? Introducing American Express Reimbursement Funds.



## How Reimbursement Funds can help reduce repayment costs—while enhancing control.

Handling the cash needs of your traveling employees can be a real managerial headache.

Reimbursement Funds, the newest corporate service from American Express®, can help you change that.

By minimizing paper work. By eliminating most cash advances. By streamlining your company's entire repayment process.

**Complete company control**  
With Reimbursement Funds, designated employees use special drafts imprinted with your company's name to reimburse themselves for out-of-pocket expenses.

You remain in control because you decide which employees receive the drafts. You set spend-

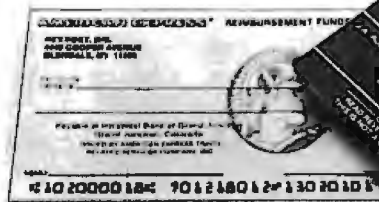
ing limits beforehand. You determine how and when the drafts are to be cashed.

And your employees will enjoy quick and easy repayment of cash expenses.

### A real breakthrough

Reimbursement Funds is just one part of our innovative new Travel Management Services—the first totally integrated system designed to meet every business travel need.

Hundreds of thousands of companies already benefit from the unmatched service and support of our Corporate Card



System and Business Travel Service. And now Reimbursement Funds.

For more information, just send in this coupon or call toll-free 1-800-847-4154.

©1983 American Express Travel Related Services Co., Inc.

A.M. Busquet  
Travel Management Services  
American Express Travel Related  
Services Co., Inc.  
P.O. Box 13816, Phoenix, Arizona 85002

I'd like to find out how Reimbursement Funds can benefit my company.

Name

Address

City

State  Zip

Phone  No. of Travelers

241-00-0000-48Y



## American Express® Travel Management Services

nate French, German, Danish, Swedish, English, and graphics character sets, plus a couple more. Any of those can be made the "standard" character set and keyboard layout; or, if you like, you can create your own.

I don't know why IBM didn't do something like that. Fortunately, Jim Baen has corrected IBM's deficiency. I cannot imagine anyone with a PC not wanting to have Magic Keyboard. Neither could Barry Workman, who distributes it.

### Hate Mail

Jeffrey Wade, of Liberty Mutual Insurance Company, writes to inform me that my "little diatribe against COBOL is pure poppycock," and he "thinks my readers ought to know it."

Mr. Wade calls as evidence the fact that "a recent estimate puts the inventory of COBOL programs in the world today at \$200 billion. In my shop alone, there are 20,000 active COBOL programs. Do you honestly think they'll go away in five years? In

your lifetime? In your son's?"

Moreover, COBOL is being updated. It will soon have, according to Wade, "structured programming constructs, Boolean operators, etc." He concludes, "If you're doing business applications which require lots of file processing, you'll be hard pressed to find a better language than my old friend, COBOL."

Perhaps Mr. Wade is right. It's almost certain that COBOL will be around for a while. The question is, is that a positive good or a regrettable evil?

If you want to write self-modifying code, COBOL has a statement that will do that for you. Whether you, and more importantly your successor, can understand what you've done is another matter entirely. Meanwhile, structured programming constructs and Boolean operators are coming Real Soon Now.

Perhaps, if what you need to do is process inputs from hundreds of terminals—say from a chain of department stores—or you must work with

tens of thousands of insurance policies, COBOL is the language of choice. I wouldn't have thought so, but I'm willing to be persuaded.

The one thing you won't persuade me of is that you've much chance of handling the records of 100,000 policy holders on any kind of micro-computer I'm going to see in the next few years.

To put the record straight: BYTE calls itself "The Small Systems Journal." I write the *User's Column*. Within that context, I cannot and do not recommend COBOL. For larger systems and larger businesses I would have thought there were better languages, but perhaps I'm wrong.

As to the \$200 billion value of all those COBOL programs, I'm reminded of the difference between price and value—or effort and work.

My other hate mail comes from Dr. Clyde Holsapple, whose brief introduction to database management I found incomprehensible.

Alas, I remain unrepentant. Dr. Holsapple informs me that I'm

## SuperBrain II™ - CompuStar™ Network Systems

- Excellent dealer & EOM discounts
- CMC's own national on-site service
- Toll-free Ordering & technical assistance
- Module replacement
- Advertising co-op
- After-sale support

### CMC ALSO OFFERS

- Six-month warranty
- High resolution graphics
- System support training in our facilities
- Optional green phosphor screen
- Enhanced DOS software with advanced files directory, diagnostics, disk editor, communications software and others

### SOFTWARE, PERIPHERALS FOR SUPERBRAIN COMPUSTAR

#### SOFTWARE

Accounting Plus	Microsoft
Wordstar	MBasic
dBase II	Fortran 80
Microplan	Cobol 80
Profitplan	M/T Pascal
Bisynch 80	P/L1 80
CBasic II	Spellguard
	Spellstar

#### PRINTERS

Datasouth  
Epson  
C. Itoh  
Okidata  
NEC  
Starwriter  
F10

#### MODEMS

Anderson-Jacobson  
CAT Novation

#### HARD DISKS

CMC Targa  
Corvus

#### MEDIA

Dysan  
Verbatim

MISC.  
Line Filters  
Power Supplies



## CMC INTERNATIONAL

1720 130th Ave. N.E.  
Bellevue, Washington 98005  
TELEX: 152558 SEATAC

For Information Call (206) 885-1600  
To Order, Call Toll-free 1-800-426-2963

DEALER INQUIRIES, GSA, GOVERNMENT, EDUCATIONAL BIDS INVITED

### CompuStar Hard Disk Systems

10mb, 32mb & 96mb

Control Data Corp.  
Phoenix Drives  
9448-96 CMD  
9448-32

**LOWEST PRICES  
ANYWHERE!**

# Introducing a sensible solution to the problems of dBASE II.™

	dBASE II	The Sensible Solution
Records Per File	65,535	999,999
Maximum Record Size	1,024 bytes	1,536 bytes
Fields Per Record	32	384
Key Fields Per File	7	10
Number of Files Simultaneously Accessible	2	10
Number of Screens Per Program	Limited by system memory	Limited only by system storage
Data Dictionary	No	Yes

We don't mean to debase dBASE II, but if you're looking for a data base manager that's long on features, dBASE II can come up a little short.

For instance, a single dBASE II record can only contain 32 fields. And when you need to share information between one file and another, you can only access two at a time.

So, as good as dBASE II is, its limitations can quickly paint you into an electronic corner.

And that's why we created *The Sensible Solution*.

## Finally A sensational relational.

Along with all the usual things you expect from a data base manager, *The Sensible Solution* lets you handle the kind of tough assignments that dBASE II can't.

You can design data files with more than 300 variables. You can create reports using 10 different files at once. You can even set up file locking for multi-user computers.

## Ready to get down to business.

A data base manager without ready-to-run application programs is hardly worth the disk it's copied on.

So, along with *The Sensible Solution*, you can also add *The Sensible Solution Bookkeeper*™ or *Sensible Management*™, our complete one-entry accounting and management system.

They're both affordable. Business-tested. And supplied with source code so you can make your own modifications.

## A sensible trial offer.

When you purchase *The Sensible Solution*, we'll send along a special trial disk that lets you create forms and enter a limited number of records. If, after 30 days, you're not satisfied, just return the unopened master system disk for a full refund.

So why not take us up on our trial offer? You've got nothing to lose.

Except the problems of dBASE II.

# The Sensible Solution™

To order, write or call: O'Hanlon Computer Systems, 11058 Main Street, Bellevue, WA 98004 USA, Phone (206) 454-2261. Prices: *The Sensible Solution*—\$695, *Sensible Solution Bookkeeper*—\$495, *Sensible Management*—\$895. In Washington, add 6.5% state tax. VISA, Mastercard and dealer inquiries welcome.

dBASE II is a registered trademark of Ashton-Tate. Sensible Solution, Sensible Solution Bookkeeper and Sensible Solution Management are trademarks of O'Hanlon Computer Systems, Inc.

## Items Reviewed

<b>Epson QX-10 Computer</b>	with 64K-byte RAM	\$2495
Epson America Inc.	with 128K-byte RAM	\$2995
Computer Products Division 3415 Kashiwa St. Torrance, CA 90505 (213) 539-9140		
<b>Invasion Orion</b>		\$24.95
<b>Crush, Crumble, and Chomp</b>		\$29.95
Epyx Automated Simulations Inc. 1043 Kiel Court Sunnyvale, CA 94086 (408) 745-0700		
<b>Kaypro II Computer</b>		\$1795
Non-Linear Systems Inc. 533 Stevens Ave. Solana Beach, CA 92075 (619) 755-1134		
<b>M-1 Optical Mouse</b>		\$312
Mouse Systems Corporation 2336-H Walsh Ave. Santa Clara, CA 95051 (408) 988-0211		
<b>Magic Keyboard</b>		\$32.50
<b>Utility Disk 4</b>		\$32.50
Workman and Associates 112 Marion Ave. Pasadena, CA 91106 (213) 796-4401		
<b>Modula-2 Compiler</b>	for UCSD p-System	\$495
Volition Systems Inc. POB 1236 Del Mar, CA 92014 (619) 481-2286		
<b>Print-Mate 150 Printer</b>	A1	\$1125
Micro Peripherals Inc.	B1	\$995
4426 South Century Dr. Salt Lake City, UT 84107 (800) 821-8848 or (801) 263-3081		
<b>Snapshot</b>		\$109.95
Dark Star Systems POB 140 Amherst, MA 01004 (413) 584-7600		
<b>Superfile</b>		\$195
FYI Inc. Suite 204 4202 Spicewood Springs Rd. Austin, TX 78759 (512) 346-0133		
<b>Zenith Z-100 Computer</b>	low-profile with two drives, color	\$3999
Zenith Data Systems	low-profile with one drive, monochrome	\$3249
1000 Milwaukee Ave.	all-in-one with two drives and monitor	\$4099
Glenview, IL 60025	RGB monitor	\$799
(312) 391-7000	monochrome green monitor	\$139
<b>Zork or Starcross</b>	8-inch disk for CP/M	\$49.95
<b>Deadline</b>	8-inch disk for CP/M	\$59.95
Infocom	(Apple, Atari, and	
55 Wheeler St.	IBM formats \$10 less)	
Cambridge, MA 02138		
(617) 492-1031		

thoroughly ignorant of the basic principles of database management. He's demonstrably right, although I plead that I did try to learn from his document.

My sin, I find, is that I have confused hierarchical database schemes with the more formally structured CODASYL systems. These aren't the same at all, and according to Dr. Holsapple, "It is unlikely that even a database dilettante would make such a glaring error."

Moreover, according to him, MDBS "is neither CODASYL nor hierarchical, but embodies much more powerful and flexible data modeling of a posthierarchical variety. For readers who are interested in genuine database management, as opposed to mere file management, these fundamental distinctions are important."

I'm sure they are. Moreover, since Dr. Holsapple's primer, which I found difficult to read, is apparently ideal for teaching (he uses it in his courses), I can only conclude that his primer, and MDBS, are able to tell me more about database management than I really wanted to know.

To be fair: I did consult with people who used MDBS for military applications in Portugal. I think I was fair when I said that MDBS is a tool for professional programmers and unlikely to be useful to users.

Those of you who wish to know more about database management—as opposed to mere file management—are invited to read Dr. Holsapple's primer. Of your charity, you might then explain to me what it says. I cheerfully admit that I am not a database-management expert; and I am apparently unable to become one by study. It seems to be one of my many failings, and I'll just have to live with it. ■

*Jerry Pournelle welcomes readers' comments and opinions. Send a self-addressed stamped envelope to Jerry Pournelle, c/o BYTE Publications, POB 372, Hancock, NH 03449. Please put your address on the letter as well as on the envelope. Due to the high volume of letters, Jerry cannot guarantee a personal reply.*

# HERE'S A ONE-TWO PUNCH



## WITH KNOCKOUT PRICES.

**1. EXP 550** fully electronic daisy wheel printer. Precision engineering is the key ingredient in Silver-Reed's rapid rise to prominence in the electronic office equipment field.

The EXP 550 is a good example. With features such as 17 cps (Shannon text-12 pitch); bi-directional letter-quality printing; subscript; superscript and bold typing; carrier feed in units of 1/120 inch and forward/reverse paper feed in unit of 1/48 inch. This computer compatible printer has a price tag that won't leave you hanging on the ropes.

Only **\$895.**

**2. EXP 500** — Coming your way soon — many of the same features as the EXP 550 in a smaller package. The EXP 500 is a fully electronic bi-directional daisy wheel printer. 14 cps (Shannon text-12 pitch); 10, 12, & 15 pitch; parallel and serial interface options; and lots more. And at a price that really packs a whollop.

Only **\$695.**

You'll find the Silver-Reed distributor nearest you listed below. Contact him today and get all the facts. Or, call (800) 421-4191 outside CA, or (800) 252-7760 within CA. Ask for the printer sales department.

### Midwest Region

Bohlig & Associates  
3440 Beltline Boulevard  
Minneapolis, Minnesota 55416  
(612) 922-7011

Comput Distributors  
500 Oliver  
Troy, Michigan 48084  
(313) 362-2740

Hollander & Company, Inc.  
600 James McDonnell  
Hazelwood, Missouri 63042  
(314) 731-4680

Zenith Distributing of Kansas  
12600 W. 93rd Street  
Lenexa, Kansas 66215  
(913) 888-4800

la/Mn/  
ND/SD  
W.Wi

NE.II/In  
Mi/Oh  
W.Pa/E.Wi

Ar/SW.II  
W.Ky/La  
E.Mo/Ms  
W.Tn

Ks/W.Mo  
Ne/Ok

### Northwest Region

Microware Distributors, Inc.  
20415 S.W. Blanton Avenue  
Aloha, Oregon 97007  
(503) 642-7692

Western Micro System  
10040 Bubb Road  
Cupertino, California 95014  
(408) 725-1660

### Southwest Region

Premier Source Distributing, Inc.  
18380 Enterprise Lane  
Huntington Bch., California 92648  
(714) 842-2208

Id/Mt  
Or/Wa

N.Ca/N.Nv

Az/S.Ca  
Hi/S.Nv

### South Region

The Stewart Company  
11000 N. Central Expressway  
Dallas, Texas 75243  
(214) 691-5555

### Southeast Region

Allison Erwin Company  
2920 No. Tryon Street  
Charlotte, N. Carolina 28232  
(704) 334-8621

Cain & Bullman  
2145 Dennis Street  
Jacksonville, Florida 32203  
(904) 356-4812

Tx  
NC/SC  
S.Va  
Al/FI  
Ga/E.Tn

### South Central Region

PLUS Distribution  
7330 S. Alton Way, Suite M  
Englewood, Colorado 80112  
(303) 850-7383

### Eastern Region

Erin Computer Distributing  
3 Grace Avenue  
Great Neck, New York 11021  
(516) 482-3202

Zamoiski  
1101 DeSoto Road  
Baltimore, Maryland 21223  
(301) 644-2900

### Northeast Region

Data Engineering, Sales  
375 Main Street, Suite 1  
Stoneham, Massachusetts 02180  
(617) 438-4700

Co/NM  
Ut/Wy

W.Ci/NJ  
NYC

De/Md  
E.Pa/Wa.DC

E.Ci/Ma  
Me/NH  
RI



**SILVER-REED**

**SILVER-REED AMERICA, INC.**

8665 Hayden Place, Culver City, California 90230/(213) 837-6104

# Book Reviews

## 6502 Assembly Language Subroutines

Lance Leventhal  
and Winthrop Saville  
Osborne/McGraw-Hill  
Berkeley, CA, 1982  
550 pages  
softcover, \$15.95

Reviewed by  
Paul E. Hoffman  
2109 Shattuck Ave.  
Berkeley, CA 94704

The title of this excellent book is misleading because it covers almost anything that a programmer would want to know about 6502 assembly language, not just subroutines. It does contain more than 50 well-documented subroutines that can

be used in many applications, but the 150 pages of programming methods, hints, and common errors alone are worth the price of the book.

The authors have written a book that both experienced programmers and relative novices can use. The subroutines they present are clear, concise, and filled with excellent comments. Those who own a computer that runs the 6502 chip (such as the Atari, Apple II, or PET) and an assembler program should find the book particularly valuable.

Leventhal and Saville make learning the 6502 fairly easy, especially for people who are familiar with assembly language on other computers. After describing all of the addressing modes and registers of the 6502, the authors offer

quick ways to implement common features that are found on many other chips. For instance, they present many three- and four-step examples of how to manipulate the registers in a manner similar to that used by many other machines. The discussion of I/O (input/output) handling is one of the best around, and it is relevant to many of the subroutines presented in the second part of the book.

The chapter on common programming errors in particular should be read by professional assembly-language programmers whether or not they use the 6502. The authors' comments on improper use of the bit flags, especially the carry bit, are particularly relevant to 6502 programmers because the 6502 handles flags differently than most processors.

Other interesting features of the first section of the book (we haven't even gotten to the subroutines!) are the discussion of stack handling and the clearest explanation of peripheral chips you're likely to find. The logical structure of the material and the profusion of hints make this section as relevant to experienced programmers as it is to novices.

The second section of the book presents subroutines that are useful whether you're writing a business system or a graphics-based game. Most of the common math functions, such as 16-bit multiplication and division, are covered, and all are supplemented by many multiple-precision routines. All of the standard bit manipulations and byte shifts are also shown.

The authors cover arrays in depth with some very easy-to-understand code. The subroutines they present, such as those for  $n$ -dimen-

sional indexing and total-array summation, could save a programmer hours of coding and testing. Like most of the subroutines, the one for array handling is given in both 8-bit and 16-bit versions.

Assembly-language programming books that deal with string handling are hard to find. *6502 Assembly Language Subroutines* contains six examples of string handling, all of which are general enough to cover many applications. Through examples, the authors stress ways to handle strings consistently; they do not fall into the usual trap of treating strings as grouped numbers.

Because many of the 6502 computers currently available were designed years ago, their I/O processing and interrupt handlers are often confusing and sometimes unwieldy. Once you get past the operating system, the ability to handle your own I/O is important. Leventhal and Saville offer many good examples of how to program using your own I/O handling.

The authors cover each subroutine extensively. Even though the code is well documented, the book also provides enough information for most programmers to modify any of the routines to suit their particular programs.

Before discussing each subroutine at length, the authors explain its purpose and how it accomplishes its goal—in plain English. In addition, they offer suggestions about other areas in which the subroutine might be useful and the type of data for which it was intended.

A wealth of other information is given along with the subroutines. The technical considerations that an experienced programmer might have—such as which registers

## Expand Your Networking Capabilities



### With ASCII - The Interface Experts

ASCII Switches can solve your RS-232 and Parallel networking problems

Other companies sell you boxes... ASCII has customized interfaces. For the same price as an off the shelf product, ASCII can provide the service you need to develop a network that works for you.

ASCII gives you the interfacing products that enable you to create...

- Office Automation Systems
- Peripheral Sharing Systems
- Scientific Equipment Mix/Matching
- Process Control Networks

Call ASCII today and receive our FREE brochure—Low Cost Local Area Networking...

**213-793-8971**



Advanced Systems Concepts, Inc.

435 N. LAKE AVENUE, DEPT. B  
PASADENA, CALIFORNIA 91101  
TELEX: 701 215



# Rutishauser

## The Feeder World of Quality

Portrait and landscape forms – Models for most letter quality printers – With or without interfaces – Electronically or mechanically controlled – No operator adjustments required – No reverse platen motion required – High precision registration – UL-recognitions – Multi-part forms – No paper cassettes – Field proven – Envelope attachment – Any paper size up to 12" x 15" – Clip-on mounting – Complete control of paper and its pathway to print-mechanism! – Lightweight – The Single Bin Cut Sheet Feeder most in use – Swiss-made quality



**RS 900**

Single Bin Sheet Feeder.

Self-controlled automatic feeder with internal electronics for universal application.

The most widely used single bin feeder in the world.

**RS 900**

1011 83 1

Maybe you didn't know we offer such a large Family of Devices!



**RT 200**  
Bi-directional Forms-Tractor.  
For precise continuous form feeding.

**RT 200**

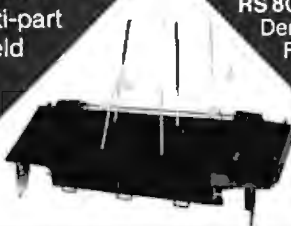


**RS 700**

Mechanical Sheet Feeder.

Automatic feeder with mechanical control mechanism. No electronics required. Driven forward by printer platen.

**RS 700**



**RS 800**

Demand Sheet Feeder.

Feeds sheets on command from an external interface. Compatible with RS 950.

**RS 800**

Rutishauser Products are available for a wide variety of popular types of Letter Quality Printers.

AES · Anadex · Binder · Brother · Centronics · Daisy Systems ·



**RS 950** Double Bin Sheet Feeder.

Feeds sheets from either of two supply bins upon command from an external interface. Direct control by printer electronics. OEM supplied interface or custom interface available for selected printers.

**RS 950**

Diablo · Data-Royal · Dataproducts · Facit · Fujitsu · HPI · IBM-System 6 · Mannesmann Tally · NEC · Olympia · Qume · Ricoh · T.A. · Santeo · SCM · TEC/C. Itoh · Toshiba · Walther · Wang · Xerox



**RS 1000**

Programmable Double Bin Sheet Feeder. Independent self-controlled feeding from two supply bins, with or without external electronic commands. Several modes of operation including user programmable sheet selection and programmed platen motion sheet selection.

**RS 1000**



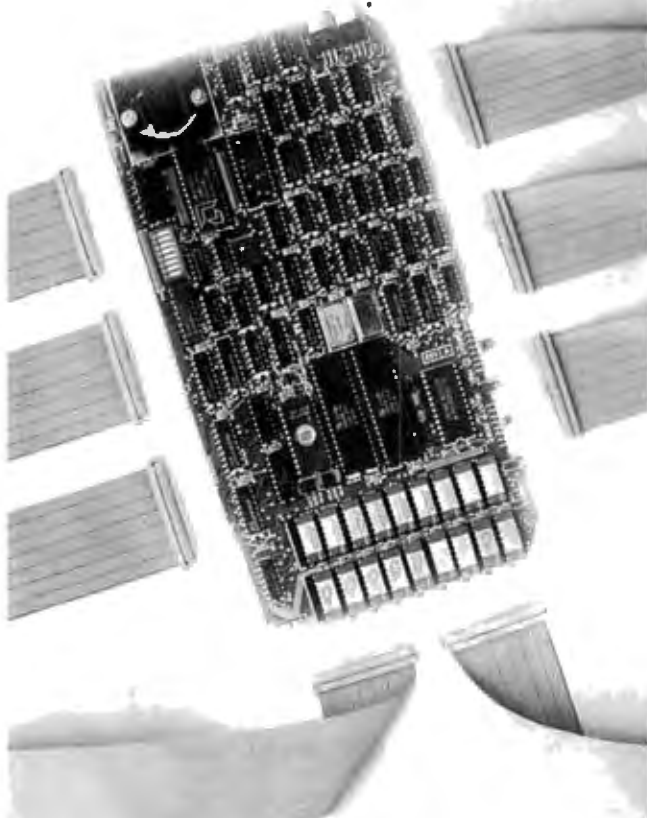
**RF 400** Front Feed Device. Programmed insertion of single or multipart forms for precisely registered applications – pre-printed forms, ledger cards, etc.

**RF 400**

# Rutishauser

Rutishauser Data AG, Rhynerstrasse 9, 8712 Stäfa, Switzerland  
Tel. (01) 926 43 00, Tx. 875171 ruti ch  
Rutishauser of America, Inc., 9677 Wendell Road, Dallas, TX 75243, U.S.A.,  
Tel. (214) 3439154, Tx. 730609 ruti dal – a subsidiary of Rutishauser Data AG  
Circle 432 on inquiry card.

# When one terminal is not enough



## Add a MuSYS Slave!

Expand your Z80A/S-100 based micros with MuSYS slaves and TurboDOS\*. Our NET/82 slave board has everything you need for another station: Z80A CPU, up to 128K bytes of RAM, two serial ports, a priority interrupt controller, memory parity checking, and many other features. There isn't a more cost-effective way to add complete, hardware-isolated network slaves to your system. And TurboDOS makes it even better. It's faster than CP/M\* for systems functions, supports larger files (134 MB) and disks (1048 MB), and unlike CP/NET\* it's compatible with nearly all 2.2 applications software. Many features which are optional, extra-cost, or not available at all in CP/M are standard with TurboDOS. Call today for all the details. Generous dealer/OEM discounts available.

\*TurboDOS is a trademark of Software 2000, Inc.; CP/M and CP/NET are trademarks of Digital Research, Inc.; NET/82 is a trademark of MuSYS Corp.

**MUSYS**  
CORP  
Specialists in Multi-user Microsystems

1752 B Langley  
Irvine, CA 92714  
(714) 662-7387  
TWX: 910-595-1967  
CABLE: MUSYSIRIN

## Book Reviews

are used—are covered concisely. These considerations include the size of the subroutine and the amount of data RAM needed.

The authors should be commended for their decision to include precise calculations for the execution times for each subroutine. Even though assembly-language programs on the 6502 are quite fast, programmers often forget that frequently called subroutines can slow a system down considerably. The authors give equations for determining the number of cycles for all of the given subroutines.

Most of the subroutines presented take all of their arguments from the stack, which makes the calling procedure much more general. An English description of the entry and exit conditions precedes the code. The authors also discuss special cases that you might encounter so that you can test for them before the subroutine is called.

In addition to offering thorough descriptions of everything in the code that they wrote, the authors documented the code completely. Variable names are surprisingly consistent throughout the book, and standard names for memory locations are used whenever possible.

The assembly pseudo-operations the authors use resemble those used on mainframe computers, so programmers shifting down to the microcomputer will feel at home. The authors define the variables on the first page of RAM memory at the beginning of the subroutine but wait until the end of the code to define the position-independent variables.

The authors stress good documentation for all of their code but also conserve space whenever possible. For example, the array-handling

programs do not attempt to make row and column computations if others are more appropriate. The emphasis is on clean code that is easy to understand.

The heavy use of the stack, both for passing the parameters of the subroutine and for processing, makes many of the subroutines easier to understand. Although the 6502's stack is underused by many programmers, the authors' structured style emphasizes saving memory and machine cycles by pushing and popping short-lived variables on the stack.

When handling strings, the authors assume that the programmer knows the length of the string before the subroutine is called. This is often true when you're writing assembly-language programs that interface with BASIC, but it may not always be true otherwise. The lack of routines for handling floating-point numbers is also unfortunate because most BASIC languages deal almost exclusively with them. Still, the general nature of the subroutines that are given lets programmers preformat the data that is being passed.

*6502 Assembly Language Subroutines* is exceptionally complete in its presentation of subroutines and should be an indispensable reference for programmers. The explanations that go along with the subroutines are clearly written and contain almost all of the information that could be relevant to modifying the authors' code to fit a particular need.

The first part of the book is one of the best references about the 6502 on the market. It shows how to easily overcome most of the weaknesses in assembly language and how to prevent programming mistakes. Together, the two sections form a superior programming manual. ■

We said we wouldn't say "We Have It" until we have it.  
We Have It!

## LMC Announces MegaMicro Systems 32-Bit Virtual Memory Microcomputers

LMC's MegaMicros are among the most powerful and expandable microcomputers ever offered. They provide mainframe or super-minicomputer performance at prices competitive with today's far less powerful 8- and 16-bit microcomputers. And, they are available for delivery now!

LMC Mega series computers incorporate: the NS16032 central processing unit which has true 32-bit internal logic and internal data path configured on the multibus (IEEE 796) 16-bit interface (making hundreds of peripheral boards and products available); demand-paged virtual memory implemented in hardware; and hardware 64-bit double-precision floating point arithmetic. These features give the Mega series remarkable performance.

In addition, the NS16032 instruction set architecture is symmetrical making the processor ideally suited to high-level languages such as FORTRAN, C, and PASCAL and to structured modular programming. Consequently, LMC's MegaMicros make efficient use of large operating systems and application software. LMC is pleased to offer HCR's UNITY\* version of UNIX\* with our MegaMicros. UNITY, an extremely powerful operating system that has been field-proven and used successfully on minicomputers and mainframes, is a full UNIX implementation and includes Berkeley 4.1 enhancements to take advantage of demand-paged virtual memory. Also included with UNITY are C and FORTRAN 77; PASCAL, PL/I, ADA and other high-level languages will be available soon as options.

Full technical specifications and prices of LMC's MegaMicros are available on request.

\*UNITY is a Trademark of Human Computing Researchers Corp., UNIX is a Trademark of Bell Laboratories

LMC MegaMicros *The Logical Alternative™*



The Logical MicroComputer Company  
140 South Dearborn, Chicago, IL 60603 USA (312) 580.0250 Telex: 270384 Cable: Lexcomp

# Victor has delivered more advanced 16-bit microcomputers than any other manufacturer save one.

## Here's why: Unsurpassed price/ performance value.

One look at the prices and capacities of these three popular Victor 9000 configurations and you'll understand why the Victor has quickly become the world's 2nd most popular advanced 16-bit microcomputer.

The Victor 9000 quite simply offers the best price/performance combination available on the market today.

The powerful memory and storage capacities of the Victor 9000 are only part of the Victor performance story.

Designed to be a hardworking, hands-on computer, the Victor 9000 gives new meaning to the term "user-friendly." From the human size, detached keyboard to the tilting, turning, high resolution display screen, the Victor 9000 makes complex business computing easy. And with scores of proven business application software packages available right now, plus networking, complete communications capabilities, and a complete line of high performance peripherals, the Victor 9000 is the class of its class.

To get the complete story on the powerful, friendly and very affordable Victor 9000, just call the Victor office nearest you or call 1-800-VIC-9000.



**\$3,995.00**

### The 16-bit Victor 9000 Personal Business Computer with two single-sided floppy disks.

Includes two single-sided floppy disks providing 1.2 megabytes storage; central processing unit, CRT and detached keyboard; communications and networking capabilities.

### The 16-bit Victor 9000 Personal Business Computer with two double-sided floppy disks.

Includes two double-sided floppy disks with 2.4 megabyte storage; central processing unit, CRT and detached keyboard; communications and networking capabilities.

**\$4,745.00**



**\$5,995.00**

### The 16-bit Victor 9000 Personal Business Computer with internal hard disk.

Includes fixed/removable storage device featuring 10.6 megabyte fixed/ and 1.2 megabyte removable storage; central processing unit, CRT and detached keyboard; communications and networking capabilities.

# VICTOR™

Victor Technologies, Inc. P.O. Box 1135 Glenview, Ill. 60025  
1-800-VIC-9000

# Victor has delivered more advanced 16-bit microcomputers than any other manufacturer save one.

## Here's how: Unsurpassed local distribution, support and service nationwide.

The Victor 9000 personal business computer system has the hardware and the software you need. But, equally important, Victor has the human ware. Our

new network of 8 districts, 50 branch offices and over 650 highly trained Victor dealers guarantees you superb day-in, day-out service and support. Locally, where you need it, when you need it. Which is what you should expect from a company with 66 years of experience in solving business application problems.

Here's how the Victor service/ support network works for you. As you can see, there's a Victor dealer near you.

### •DISTRICT 1: ATLANTA

District Office  
330 Research Court  
Technology Park  
Norcross, GA 30092  
(404) 449-7950

Includes 7 branches and  
70 dealers in 5 states.

#### Branch Offices

Alabama  
601 S. 37th Street  
Birmingham 35222  
(205) 252-2176

Florida  
5228 Beach Boulevard  
Jacksonville 32207  
(904) 396-7751

3000 W. Hallandale Bch. Blvd.  
Hallandale 33009 (Miami)  
(305) 458-3356  
(305) 949-4246 (Miami)  
(305) 421-8583 (Deerfield Bch.)

649 W. Vassar Street  
Orlando 32804  
(305) 841-9251

Georgia  
5801 Peachtree-Dunwoody Rd.  
Suite 102  
Atlanta 30342  
(404) 256-1044

Tennessee  
169 Racine Street, P.O. Box 11898  
Memphis 38111  
(901) 324-5554

702 Melpark Drive.  
P.O. Box 40644  
Nashville 37204-0644  
(615) 383-9151

### •DISTRICT 2: CHICAGO

District Office  
3 O'Hare Tower  
8420 W. Bryn Mawr Ave.  
Chicago, IL 60631  
(312) 399-1500

Includes 6 branches and  
93 dealers in 7 states.

#### Branch Offices

Illinois  
59 W. Grand Avenue  
Chicago 60610 (Central)  
(312) 527-0800

1331 Brummel  
Elk Grove Village 60007 (North)  
(312) 956-8190

### Indiana

1401 E. Riverside Drive  
Indianapolis 46202  
(317) 635-1336

### Minnesota

790 S. Plaza Dr., Mendota Hgts.  
55120-1572 (Minneapolis)  
(612) 454-8600

### Missouri

200 N. Leffingwell at Pine  
St. Louis 63103-2295  
(314) 535-9900

### Wisconsin

8028 W. Capitol Drive  
Milwaukee 53222  
(414) 438-0305

### •DISTRICT 3: CLEVELAND

District Office  
6133 Rockside Road, Suite 302  
Independence, OH 44134  
(216) 447-8890

Includes 7 branches and  
95 dealers in 5 states.

#### Branch Offices

Kentucky  
2460 Bardstown Road  
Louisville 40205  
(502) 458-5381

Michigan  
23200 Telegraph Road  
P.O. Box 2166 (48037)  
Southfield 48034 (Detroit)  
(313) 355-5330

New York  
3435 Harlem Road  
Cheektowaga 14225 (Buffalo)  
(716) 838-5100

Ohio  
5621 Creek Road  
Blue Ash Industrial Park  
Cincinnati 45242  
(513) 984-1060

3201 E. Royalton Road  
Broadview Hgts. 44147 (Cleve.)  
(216) 526-0200

3972 Indianola Avenue  
P.O. Box 14465  
Columbus 43214  
(614) 263-8806

Pennsylvania  
(Includes W. Virginia)  
108 Rosslyn Road  
Carnegie 15106 (Pittsburgh)  
(412) 279-5300

### •DISTRICT 4: DALLAS

District Office  
1404 Walnut Hill Lane  
Irving, TX 75062  
(214) 258-5000

Includes 7 branches and  
102 dealers in 7 states.

#### Branch Offices

Arkansas  
1900 W. 3rd Street  
Little Rock 72205  
(501) 376-0505

Missouri (Includes Nebraska)  
1535 Broadway  
Kansas City 64108  
(816) 842-7966

Louisiana  
1805 Dallas Drive  
Baton Rouge 70806  
(504) 927-4180

3230 Interstate 10 Service Rd.  
Metairie 70001 (New Orleans)  
(504) 831-2601

Texas  
3019 Diamond Park Drive  
P.O. Box 47746 Dallas 75247  
(214) 631-5430

5918 Southwest Freeway  
Houston 77057  
(713) 782-8964

2201 Cee Gee Street  
San Antonio 78217  
(512) 828-6471

### •DISTRICT 5: LOS ANGELES

District Office  
17744 Skypark Circle  
Suite 274  
Irvine, CA 92714  
(714) 850-9944

Includes 4 branches and  
61 dealers in 4 states.

#### Branch Offices

Arizona (Includes New Mexico)  
8126 N. 23rd Avenue  
Suite D Phoenix 85021  
(602) 249-4897

California (Includes  
Nevada)  
1202 Olympic Boulevard  
Santa Monica 90404 (L.A.)  
(213) 450-1559

17241 Murphy Avenue  
P.O. Box 18528  
Irvine 92713 (Orange County)  
(714) 660-0363

3661 Camino Del Rio S.  
San Diego 92108  
(714) 283-7001

### •DISTRICT 6: NEW YORK

#### District Office

2005 Rt. 22  
P.O. Box 1463  
Union, NJ 07083  
(201) 687-4700

Includes 7 branches and  
95 dealers in 8 states.

#### Branch Offices

Connecticut  
West Hill Center  
21 New Britain Avenue  
Rocky Hill 06067  
(203) 563-5388

581 W. Putnam Avenue  
Greenwich 06830  
(203) 629-9091

Massachusetts (Includes Maine,  
Vermont, New Hampshire)  
335 Bear Hill Road  
Waltham 02154 (Boston)  
(617) 890-3800

New Jersey  
2005 Route 22, P.O. Box 1463  
Union 07083  
(201) 687-4700

New York  
(Includes Rhode Island)  
Three Corporate Plaza  
Washington Ave. Extension  
Albany 12203  
(518) 869-8446

99 Jericho Turnpike  
Jericho 11753 (Long Island)  
(516) 334-7715

355 Lexington Avenue  
New York City 10017  
(212) 697-8900

### •DISTRICT 7: WASHINGTON

District Office  
8260 Greensboro Drive  
Suite 510, McLean, VA 22102  
(703) 448-1185

Includes 6 branches and  
88 dealers in 7 states  
and the District of Columbia.

Branch Offices  
Maryland (Includes Delaware)  
1031 Cromwell Bridge Road  
Towson 21204 (Baltimore)  
(301) 821-6710

North Carolina  
(Includes So. Carolina)  
1611 E. Seventh Street  
P.O. Box 9546 (28299)  
Charlotte 28204  
(704) 375-7708

Pennsylvania  
3559 Meadow Lane, P.O. Box 548  
Bensalem 19020 (Philadelphia)  
(215) 639-9510

Virginia (Includes Wash. D.C.)  
2116 Dabney Road, P.O. Box 6815  
Richmond 23230  
(804) 369-4091

7635 Sewells Point Road  
Norfolk 23513  
(804) 583-4511

8112 Gatehouse Road  
Falls Church 22042  
(703) 573-0550

•DISTRICT 8:  
SAN FRANCISCO  
District Office  
101 California St.  
San Francisco, CA 94111  
(415) 392-1991

Includes 6 branches and  
87 dealers in 9 states.

#### Branch Offices

California  
2718 J Street  
Sacramento 95816  
(916) 441-3156

5 Dorman Avenue  
San Francisco 94124  
(415) 826-8876

Colorado (Includes Nebraska,  
Montana, Wyoming)  
Watervleit Business Park  
7100 N. Broadway, Bldg. 4A  
Denver 80221  
(303) 426-4950

Oregon (Includes Idaho)  
14215 N.W. Science Park Dr.  
Portland 97229  
(503) 646-0535

Utah (Includes Idaho)  
537 E. Third, South  
Salt Lake City 84102  
(801) 363-0535

Washington (Includes Montana,  
Hawaii, and Alaska)  
13400 Northrup Way  
Bellevue 98005 (Seattle)  
(206) 624-7980

To get the complete story on the powerful, friendly and very affordable Victor 9000, just call the Victor office nearest you or call 1-800-VIC-9000.

# VICTOR

Victor Technologies, Inc., P.O. Box 1135, Glenview, Ill. 60025 1-800-VIC-9000

# The 8086—An Architecture for the Future

## Part 1: Introduction and Glossary

*The advanced 8086 microprocessor overcomes  
the limitations of previous designs.*

---

Stephen A. Heywood  
Intel Corporation  
27 Industrial Ave.  
Chelmsford, MA 01824

---

When the second-generation 8-bit microprocessors, such as the 8080, hit the market in the early 1970s, they were designed to meet the existing needs of the industry. Expensive memory made 64K bytes seem adequate.

In addition, the minicomputer architectures of the early 1970s favored assembly language with register-based data and linear-address programming. The second-generation microprocessors were also designed with this in mind.

As prices steadily dropped, however, microprocessors found their way into many applications they were not originally designed for. As a result, new performance demands revealed limitations that had to be sidestepped. For example:

- Overlays emerged as applications became increasingly memory-dependent and required more than 64K bytes of memory.
- Data types of greater than 8 bits proved difficult to manipulate and had to be divided into 8-bit parts, therefore increasing execution time.
- Programmers finding assembly lan-

guage cumbersome for large projects shifted program development to high-level languages, which use data in memory instead of in registers. Compiled code was inefficient because the microprocessor's architecture did not contain the complex addressing structure needed.

---

### **The 8086 can address 1 megabyte of memory and can process both 16-bit and 8-bit data.**

---

- Linear-address programming gave way to modular programming because large projects were frequently allocated among several programmers. Second-generation microprocessors found this type of program development difficult.
- Software routines for multiplication and division evolved because multiply and divide instructions weren't provided in the microprocessor's hardware.
- System applications incorporated multiple processors to perform specified functions. But the second-genera-

tion microprocessors were not designed to cooperate with other processors.

An advanced processor was needed to overcome these limitations. Therefore, Intel Corporation designed and produced the 8086, a 16-bit third-generation microprocessor.

This series of three articles takes a close look at how the 8086 meets the foregoing needs. Part 1 describes the architecture of the 8086, the programming model, the concept and use of segmentation, and the addressing modes. A glossary of terms associated with the 8086 is also included. Parts 2 and 3 will cover an introduction to the instruction set, advanced instructions, procedures, interrupt handling, modular programming, multiprocessing, coprocessing, and programming conventions.

Let's look first at how the 8086's physical architecture helps to satisfy users' requirements.

### **8086 Architecture**

The 8086 register set consists of general registers, the instruction pointer, flags, and segment registers,

as shown in figure 1. These registers are used to generate addresses, hold intermediate results, indicate the status of the machine, and fetch instructions.

Physically, the 8086 has 20 address lines that enable it to address 1,048,576 bytes (or 1 megabyte) of memory, or more than 16 times the memory capacity of an 8-bit microprocessor. Its internal and external data paths are 16 bits wide, giving the 8086 the ability to access and process both 16-bit (word) and 8-bit data. Support for multiprocessing (several processors using common resources over a common bus) and coprocessing (an extension that enhances the hardware capabilities of the processor) is also provided by the 8086 and its family of products.

To increase its speed of execution, the 8086 uses an instruction prefetch queue. While the 8086 executes an instruction, additional instructions are prefetched into the microprocessor and wait in line for execution. This method practically eliminates the fetch phase from the fetch, decode, and execute cycle of previous microprocessor designs.

To accommodate the wide range of available 8-bit devices, the 8086 has a close relative, the 8088 microprocessor. The 8088 possesses an 8-bit external data bus that interfaces with 8-bit devices. Internally, it's identical to the 8086 (same instructions, registers, etc.) but makes word (16-bit) transfers as two separate byte transfers instead of a one-word transfer as does the 8086.

## General Registers

The general registers encompass the data group and the pointer and index group. These registers contain the source and/or the destination operands for most operations, and the BX (Base), SP (Stack Pointer), BP (Base Pointer), SI (Source Index), and DI (Destination Index) registers can address memory. However, a few operations require the use of specific registers, as shown in table 1.

Because most programmers usually give certain registers fixed duties in a program, they will not mind 8086 in-

structions that do the same thing. For example, a programmer can dedicate one register as a counter, another register as a pointer into the stack, and still another register as a pointer to a string. In this way, the programmer can keep track of the values in the registers. Dedicating certain registers also makes the instruction set more compact, which decreases program size. For example, instead of several multibyte string instructions with operands specified in the instructions, the programmer inserts a few 1-byte instructions with implied operands.

The data group contains four 16-bit word registers: AX (Accumulator), BX (Base), CX (Count), and DX (Data). Alternately, the high half (AH, BH, CH, or DH) or the low half (AL, BL, CL, or DL) of each of these registers can be individually addressed for byte operations. The data-group registers are also so named because of their dedicated use. These registers hold operands or intermediate results to reduce memory-access times.

The pointer and index group of 16-bit general registers normally accesses memory operands. These registers, as well as the registers in the data group, can also handle arithmetic and logical instructions.

The BP and SP registers normally point to the stack. SP is obviously employed for stack operations, such as saving the return address when calling a subroutine; it is similar to the stack pointer in 8-bit machines. BP is not designated for its named purpose, but is used instead as an additional pointer into the stack. This register allows a convenient method for accessing parameters passed to subroutines on the stack. Reentrant procedures, subroutines that can be invoked while already in execution or that can invoke themselves, can thus set aside space in the stack for their variables. These subroutines can receive information (parameters) on the stack at each invocation using the BP register to access them. (I'll provide more information on this process when I later introduce the subject of procedures.)

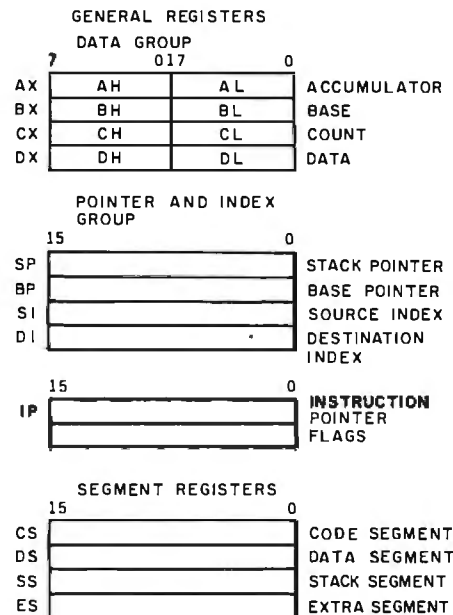


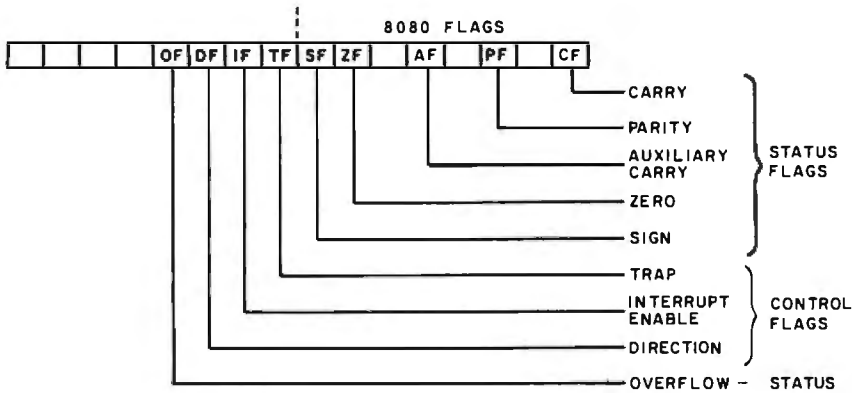
Figure 1: The register set of the 8086 is used to generate addresses, hold intermediate results, indicate status, and fetch instructions.

Register	Operations
AX	Word multiply, word divide, word I/O
AL	Byte multiply, byte divide, byte I/O, translate, decimal arithmetic
AH	Byte multiply, byte divide
BX	Translate
CX	String operations, loops
CL	Variable shift and rotate
DX	Word multiply, word divide, indirect I/O
SP	Stack operations
SI	String operations
DI	String operations

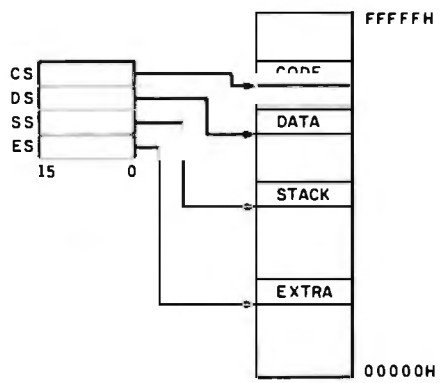
Table 1: General registers with dedicated uses. Some instructions require that specific registers be used.

The SI and DI registers access information in the normal data area of memory. Their names come from their explicit use in string instructions. But they can accomplish other tasks as well, such as accessing elements of an array. The full capabilities of these registers will become clear when I later present the subject of addressing modes.

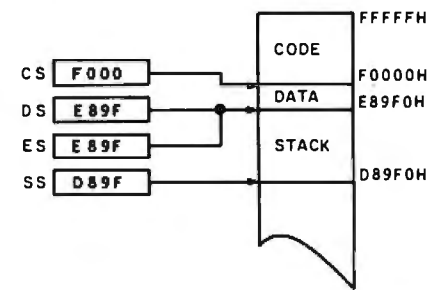
To fetch instructions, the 8086 uses a 16-bit IP (Instruction Pointer) register, which is similar to the program counter installed in 8-bit



**Figure 2:** The 8086 has six 1-bit status flags and three control flags in a 16-bit word register, with its low byte identical to the 8080 flag register.



**Figure 3:** The four segment registers contain the base address, or beginning location, of the current code, data, stack, and extra data segments.



**Figure 4:** The segment registers contain the most significant 16 bits of the 20-bit address, with the 4 least significant bits supplied by the 8086 equal to 0. Segments can be fully overlapped, partially overlapped, adjacent, or disjoint.

machines. Basically, it points to the next instruction to be fetched in order to fill the prefetch queue. The IP register cannot be directly accessed by the programmer, but can be manipulated by program jumps.

mode for debugging purposes. Later I will further explain the flags and their operations.

### Segmentation

The last four registers are the segment registers, CS (Code Segment), DS (Data Segment), SS (Stack Segment), and ES (Extra Segment), which are the basic building blocks for forming addresses in the 8086.

Memory stores three types of information: the code, or instructions, to inform the microprocessor what to do; data, numbers, and characters to be operated on; and the stack for saving return addresses. These three types normally reside in their own area of memory to avoid confusion. Otherwise, they would result in problems, such as the stack overwriting the code, data being executed as instructions, etc.

The 8086 views its memory as being divided into a group of logical units called *segments*. Each physical segment can be up to 64K bytes long. The processor has direct access to four segments at a time through the *segment registers*. The four segment registers contain the base address, or the beginning location, of each segment, as shown in figure 3. The CS register contains the base address of the current code segment; DS, the current data segment; SS, the current stack segment; and ES, the current extra or global data segment.

Only one restriction confines segment locations. A segment must begin on a memory boundary that is divisible by 16 (called a paragraph). The least significant 4 bits of the 8086's 20-bit address must thus all be 0s to fall on this paragraph boundary. For example, the first paragraph starts at address 00000 hexadecimal; the second paragraph, at address 00010 hexadecimal; the next one, at address 00020 hexadecimal; etc.

The 16-bit segment registers store the most significant 16 bits of the 20-bit address. The all-zero least significant 4 bits are appended to the end of the segment register to derive the full 20-bit address base. For example, figure 4 shows the SS register pointing to the segment of memory beginning at address D89F0 hexa-

### Flags

The 8086 has six 1-bit status flags and three control flags configured in a 16-bit register, as shown in figure 2. The lower byte of the flag register is a bit-for-bit copy of the 8080 flag register to accommodate conversion of 8080 programs to the 8086.

Microprocessor decisions are based on the condition of certain flags that indicate the status of an arithmetic or logical operation's result. The 8080-type status flags are the carry flag, CF, which indicates a carry out of, or a borrow into, the high-order bit of the result; the parity flag, PF, which is set if an even number of 1s are in the result; the auxiliary carry flag, AF, which is used by the decimal-adjustment instructions; the zero flag, ZF, which is set if the result is 0; and the sign flag, SF, which is set if the result is negative. The status flag added to the 8086 is the overflow flag, OF, which indicates that an operation incorrectly changed the sign bit of the result. An example is adding two positive numbers with the result being negative, i.e., +127 (7F hexadecimal) + 2 (02 hexadecimal) = -127 (81 hexadecimal) and an overflow for a byte arithmetic operation.

The control flags direct 8086 operations. These flags are the direction flag, DF, which is used to control the direction of string operations; the interrupt-enable flag, IF, which, if set, enables an external maskable interrupt; and the trap flag, TF, which places the 8086 in the single-step



decimal, which contains the value D89F hexadecimal. This figure also indicates that segment registers can be fully overlapped (as pointed to by ES and DS), partially overlapped (as shown by the code and the data segments), and adjacent (as displayed by the stack and the data segments). The segments might also be disjoint, as shown in figure 3.

To access a particular byte or word in a segment, the 8086 employs an offset, which is the distance in bytes from the beginning of a segment. The actual 20-bit physical address results from adding a segment register, with the zeroed least significant 4 bits appended, and a 16-bit offset, as shown in figure 5. Note that the segment register contains E89F hexadecimal and that the offset is 0003. The segment register is therefore pointing at address E89F0 hexadecimal. To this value, we add 0003 to obtain the final physical address, E89F3 hexadecimal.

Earlier, I mentioned that some 8086 registers can address data in memory. However, because they are 16-bit registers, they actually contain the offset and thus require a segment register to access this data. The segment register and the source of the offset depend on the type of memory reference the 8086 has to make, as shown in table 2. Instructions are always fetched using the contents of CS as the segment register and the contents of IP as the offset. Similarly, a stack operation always uses SS as the segment register and SP as the offset to the top of the stack. Variable data is typically accessed by the DS register, with the addressing modes supplying the offset. Note from table 2 that this condition can be overridden to exercise another segment register for most instructions. Exceptions are the string instruction's destination, which always employs the ES register as the base and the DI register as the offset, and the string source, which must use the SI register for the offset.

Notice that BP defaults to SS as its segment register. As I mentioned earlier, having BP default to the SS register yields an extra pointer into the stack. We will see later how to use this to advantage.

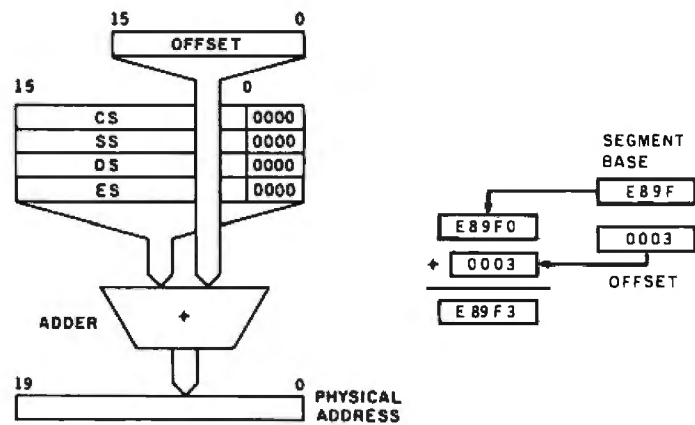


Figure 5: The 20-bit physical address is the result of the sum of a segment register, with appended zeros, plus an offset.

Type of Memory Reference	Default Segment Base	Alternate Segment Base	Offset
Instruction fetch	CS	None	IP
Stack operation	SS	None	SP
Variable (except the following)	DS	CS,ES,SS	Effective address
String source	DS	CS,ES,SS	SI
String destination	ES	None	DI
BP used as base register	SS	CS,ES,SS	Effective address

**Table 2:** Explicit segment and offset use. For access of different types of data items, most variables can be accessed using any segment register.

Allowing variable data to be accessed by any segment register permits the accessing of constants in the code area, the passing of parameters in the stack area, and the sharing of data between several programs in the extra data area. Figure 6 shows examples of segment and offset use.

### Addressing Modes

High-level languages utilize variables in memory as opposed to registers. These variables can be simple or complex, such as arrays and records. The 8086 addressing modes can access these variables by supplying the offset portion of the physical address.

As recorded in table 3, several methods exist for accessing variable data. The immediate and register addressing modes are listed with their instructions. These two addressing modes do not access operands in the data area of memory.

The direct addressing mode supplies the offset in the instruction itself as a 16-bit quantity. It can access simple variables.

The remaining addressing modes that can generate the offset use a base or an index (or the sum of both) with an optional displacement added. The register indirect addressing mode employs a base or index register's contents (BX, BP, SI, or DI) as the offset. Because these registers can be manipulated by arithmetic and logic instructions, they can be used to access buffers and blocks of data.

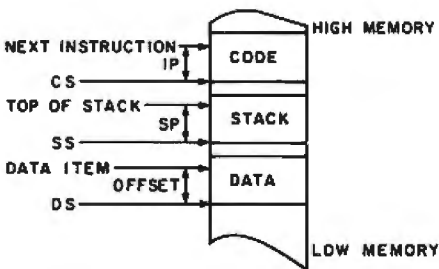
The based or indexed addressing mode utilizes the contents of either a base register, BX or BP, or an index register, SI or DI, with a displacement to generate the offset. These modes can support the array and record data types found in high-level languages.

In figure 7, the displacement field of the instruction points to the beginning of the array. The contents of the index register are then added to access the element needed. Furthermore, the index register can be manipulated to do operations such as adding a specific value to each element of the array.

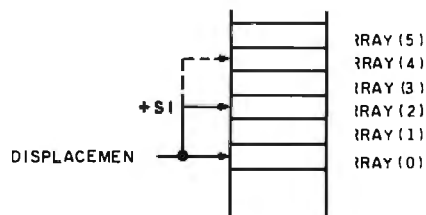
A record is made up of dissimilar

Mode	Location of Data
Immediate	Within instruction
Register	In register
Direct	At memory location pointed to by offset contained in instruction
Register indirect	At memory location pointed to by offset contained in register
Indexed or based	At memory location pointed to by sum of index or base register contents and displacement in instruction
Based and indexed with displacement	Memory address is sum of base register contents and index register contents and displacement

**Table 3: 8086 addressing modes.** To access variables for instructions, the 8086 uses its addressing modes to generate the offset for memory variables. The full address for memory variables consists of the contents of a segment register as modified by the addressing mode.

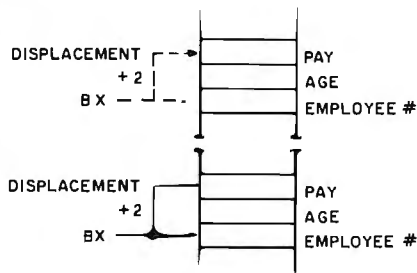


**Figure 6:** The segment register used and the source of the offset depend on the type of memory reference.



**Figure 7:** To access an array, the displacement points to the beginning of the array with the index register pointing to the element needed.

items, as opposed to an array, which is made up of similar items. In figure 8, the BX register points to the beginning of the record. The displacement can be added to this value to obtain the item from the record. What's more, the same item in a different



**Figure 8:** A record of dissimilar items uses a base register to point to the beginning of the record, with the displacement pointing to the item needed. The base can be re-adjusted to point to the base of a new record with the same displacement to access an item in the same position.

record can be accessed by changing BX to point to the beginning of the new record and by using the same displacement to obtain the item as shown.

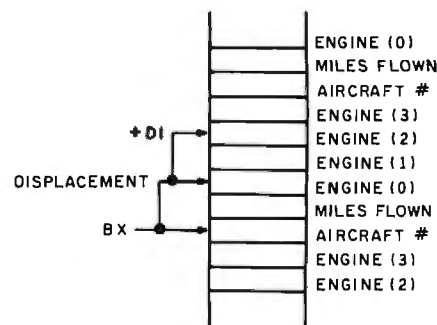
The based and indexed addressing mode is the sum of a base register, an index register, and a displacement. This powerful addressing mode can access an array in a record, as shown in figure 9. Note that the base register points to the beginning of the record, the displacement is added to point to the beginning of the array, and, lastly, the index is added to point to the element in the array.

The power of the addressing modes is revealed further when we introduce the instruction set.

### Advantages of Segmentation

Accessing memory using a segmented architecture holds many advantages over the earlier linear-addressing method.

Linear addressing must supply the entire address in one entity, as opposed to the 8086 two-part structure (segment and offset). For a register to hold a linear address, it must be at least 20 bits wide. In addition, instructions would have to supply a 20-bit address for direct addressing of operands. Moreover, arithmetic functions must be extended to 20 bits for manipulating registers containing addresses. Any future expansion in linear addressing would involve enlarging these capabilities (including arithmetic functions to manipulate indexing) to generate addresses.



**Figure 9:** The base register points to the beginning of the record containing the array, the displacement points to the beginning of the array, and the index points to the item needed.

Because the 8086 is designed for word accesses and word arithmetic, linear addressing is not an advantage. A 16-bit offset allows word registers to hold addresses and word arithmetic to manipulate these registers. Instructions have only to provide the offset, thereby minimizing their length. To expand these capabilities in future microprocessor designs for increasing the memory, only the base or segment registers need to be lengthened. And because only the offsets are manipulated, this would not involve any drastic changes to the 16-bit design.

Because all 8086 instructions are accessed as an offset from the code segment register, dynamic-code relocation is possible. Code and data can be loaded into a free memory area, with the CS and DS registers adjusted to point to the new base. This setup allows programs to be constructed without prior knowledge of their memory location. Additionally, multiple programs (or tasks) can also take advantage of this setup. When a task is not needed, it can be saved on disk, and a new task can be loaded in its place. When the original task is needed again, it can be loaded into whatever memory area is available.

This setup also encourages modular program development. Programs can be developed in small manageable pieces (modules) instead of one large one. Individual modules can then be debugged or updated as needed. Program libraries can be employed containing often-used utili-

ties such as terminal handling, disk accesses, and other such programs. Programs can be reconfigured for different hardware by changing to the modules for that particular machine.

Segmentation can easily be used for memory management and protection. For example, a program might be involved with handling employee records from several different departments. By changing the data segment register, the program can easily manage a different group of employees. It could also protect one department from looking at records from another department and changing those records. Future designs of microprocessors can take this segmentation one step further to include descriptor tables containing range checking and access rights without changing the architecture.

Being able to program in multitasking environments, using modular programming, and protecting and managing memory easily, segmentation takes away the heavy overhead previously needed with linear addressing. It also provides the base for future architectural growth in microprocessor development.

This article demonstrates how the 8086 handles the limitations that had arisen with earlier microprocessors. In sum, the 8086 addresses 1 megabyte of memory for increased memory capabilities and uses segmentation to generate addresses. The side benefits of segmentation fit in well with demands for modular programming, memory protection, memory management, multitasking, and future needs of programmers. The 8086 addressing modes support the high-level-language variable needs in memory. The 16-bit internal and external architectures and registers work well with the larger data types needed, but are still flexible enough to work with byte types.

Part 2 explores how the 8086's instruction set aids high-level compilers in their task. ■

#### About the Author

Stephen Heywood is an instructor with Intel Customer Training and is the course manager for the 8086 course.

## Glossary

**addressing mode:** the method used to access instruction operands, either from calculating the offset for variables in memory (using the 8086 segment and offset addressing), from the contents of a register, or from the instruction itself. The final memory address is called the effective address.

**assembler:** a program that takes a source file containing assembly-language instructions, which are symbolic representations of the machine language, and translates it to an object file consisting of machine code.

**compiler:** a program that converts high-level-language statements, such as those written in Pascal, to a sequence of machine instructions.

**coprocessor:** an extension of the processor that enhances the hardware capabilities. It does this by performing only the instructions pertaining to the coprocessor, while the processor ignores these same instructions. For example, the 8087, a coprocessor for the 8086, performs floating-point-math instructions.

**displacement:** the distance in bytes from a byte (or word) to another byte (or word) in memory.

**link:** a process that combines object files, consisting of machine code, from various sources, such as assemblers and compilers, into one final object file. Used in modular program development.

**modular programming:** a method of program development that allows a large programming task to be broken up into several small programs called modules. These modules can be assembled or compiled separately and then linked together. Updates and corrections are made only to the particular module instead of to the entire program.

**multiprocessing:** two or more coordinated processors in a system. Each processor performs its own program and shares system memory and I/O devices through a common bus with the other processors.

**offset:** the distance in bytes from the beginning of a segment. Used for calculating a memory address, which is the sum of a segment register with four 0s appended plus a 16-bit offset.

**overflow:** an indication that an

arithmetic result using signed numbers is out of range. It most often occurs when adding two positive numbers with a negative result or adding two negative numbers with a positive result.

**paragraph:** a byte address that is divisible by 16 (least significant 4 bits equal to 0).

**parameters:** data items passed to a procedure to be operated on. For example, a character being passed to a procedure that outputs it to a video display is a parameter.

**procedure:** another name for a subroutine.

**reentrant:** an attribute of a procedure that can be called upon while already in execution from a previous invocation. This action can occur if the procedure calls itself, the procedure invokes another procedure, which in turn invokes the original procedure, or the procedure is interrupted and the interrupted procedure invokes the original procedure.

**relocatable:** machine code that can be placed anywhere in memory and executed from that point.

**segment:** method for partitioning memory. In the 8086, each segment can be up to 64K bytes long, but must start on a paragraph boundary. A segment register contains the base address, and an offset accesses the information in the segment.

**stack frame:** an area of the stack containing the parameters and the return address given to a procedure. The procedure can then access its parameters from the stack frame, but it has to discard the entire stack frame when the procedure exits.

**string:** a set of sequential bytes or words in memory. An example is text data in ASCII (American National Standard Code for Information Interchange).

**word:** a 16-bit data type (2 consecutive bytes) used in the 8086.

**word aligned:** an alignment in memory. To be word aligned, a word must begin in an even memory location. The 8086 can thus access them in one memory transfer. It would need two memory transfers if the words were not aligned (i.e., started on an odd address).

# Some of our biggest ideas aren't very big.



Datamaster

## Small Systems from IBM.

In business, it's often the little things that count. And you can count on IBM for a lot of them.

That is, we make a wide range of low-cost, easy-to-use small computers to help businesses of all types and sizes solve big problems.

Like inventory control, for instance. IBM small systems can tell you what's what with your widgets: How many you have on hand. How many you need to fill existing orders. Where to ship and when.

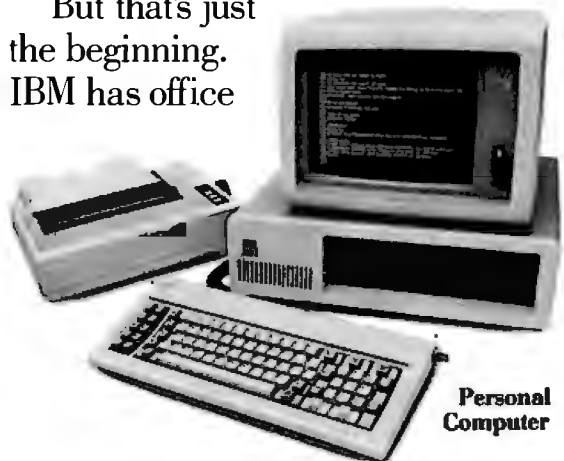
If you want to improve customer

service, we're at your service. With small systems that help your sales force match orders to inventory, figure a price and guarantee a delivery date. (All of which helps guarantee a sale.)

IBM small systems can help your marketing manager make price changes quickly. And your billing department improve cash flow by invoicing customers more efficiently.

When you write your customers, you can get letters and reports out faster.

But that's just the beginning. IBM has office



Personal  
Computer

administrative systems that take the work out of paperwork. As well as distributed systems that simplify and speed up the process of sending information back and forth between several locations.

The point is, whatever your problem—sales forecasting and analysis, billing, payroll, job estimating, order processing,



System/34

production control, and even energy management—it's no problem for IBM.

We have the right small system for the right job. And an IBM professional to recommend the one best for you.

What's more, our small systems are designed to be



Displaywriter



System/38

easy to learn and use. So you can put them to work quickly.

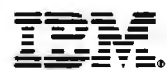
As your business grows, so can your IBM system with more storage capacity, work stations, printers and communication lines.

### **IBM Small Systems come with a special feature. IBM.**

IBM small systems come with a lot of excellent features. But the best feature of all is that they come from IBM. Which means you can get IBM education, service and support.

For further information on IBM small computers for your business, call your local representative or IBM's toll-free number below.

We'll show you that an idea doesn't have to be big to be great.



Call **IBM Direct** 1 800 631-5582 Ext. 104. In Hawaii/Alaska 1 800 526-2484 Ext. 104.

(Or write IBM 7AC/322, Dept. NQ-104, 400 Parson's Pond Drive, Franklin Lakes, N.J. 07417.)

# Clubs and Newsletters

## News from South Africa

The TRS-80 User Group in Johannesburg, South Africa, has a NEWDOS/80 version 2.0 CBBS (computerized bulletin-board service) up and running. Access is via a post-office-supplied modem; tone pairs comply with the European CCITT standard. The club holds open meetings regularly. For a free user code and further details, send a self-addressed envelope to the TRS-80 User Group, POB 35461, Northcliff 2115, Republic of South Africa.

## Computers In Construction

The *Construction Computer Applications Newsletter* (CCAN) is aimed toward contractors who use computers. It contains information on seminars, new products, and current issues such as software contracts and electronic mail. Annual subscriptions are \$60; \$80 overseas. For more information, write to Construction Industry Press, 1105-F Spring St., Silver Spring, MD 20910, or call (301) 589-4884.

## APL/AUG News from Johns Hopkins

The Applied Physics Laboratory/Apple User's Group (APL/AUG) is supported by Johns Hopkins University and the Applied Physics Laboratory. A monthly newsletter contains news, updates, and articles. Further information is available from Dr. E. A. Davis, APL/AUG, Johns Hopkins University/-Applied Physics Laboratory, Johns Hopkins Rd., Laurel, MD 20707, or call (301) 953-7100, ext. 3704.

## Meet On the Air

The Atari Microcomputer Network is a nonprofit amateur radio operator and users group that meets on the air every week via six regional networks. Membership dues are not required, but a \$10 annual donation is requested to cover expenses of the network's bimonthly journal *Ad Astra*. For more information, write to Jack McKirgan II, WD8BNG, The Atari Microcomputer Net Users Group, 4749 S.R. 207 NE, Washington C.H., OH 43160, or call (614) 869-3597.

## Attention: Political Scientists

The *Political Science Micro Review* focuses on programs, tutorials, and other items of interest to political scientists using microcomputers. This nonprofit newsletter is produced by the North Carolina State University Department of Political Science and Public Administration. Annual subscriptions are \$10. A disk-based version with hard-copy backup costs \$25. For details, write to *Micro Review*, PSPA Link 215, NCSU, Raleigh, NC 27511, or call David Garson at (919) 737-2481.

## First Year Free

*Stoneware Age*, a newsletter designed for users of Stoneware products, has updates on the DB Master Database File Management series, the Graphics Processing System, and information on other Stoneware-compatible products. The first year of subscription is free to registered owners of Stoneware products; \$6 per year thereafter. For further details,

contact Stoneware Inc., 50 Belvedere St., San Rafael, CA 94901, or call (415) 454-6500.

## Here's the Scoop

*H-Scoop*, the monthly newsletter of the H-8/H-89 User Exchange, has reports on new products, hardware, and software, and answers questions about Heath/Zenith computers. Annual subscriptions are \$20 a year in the U.S. and Canada; overseas airmail costs \$27. For information, write to *H-Scoop*, 2918 South 7th St., Sheboygan, WI 53081, or call (414) 452-4172 weekdays.

## For Vector Graphic Owners

Every two months the *Vector Letter* provides Vector Graphic owners with solutions to common problems, product reviews, articles of interest, and reference materials. A one-year subscription is \$29; in Canada and Mexico, \$35; elsewhere, \$40. Contact *Vector Letter*, POB 2403, Del Mar, CA 92014.

## For Engineers In All Fields

The *Engineering Software Exchange* contains technical tips for chemical, civil, mechanical, industrial, and electrical engineers. It serves as a forum to exchange, buy, or sell personal software. Manuscripts are welcome. An introductory issue is \$1; a yearly subscription (six issues) is \$6. For details, write to Lidia Lopinto, Engineering Software Exchange, 41 Travers Ave., Yonkers, NY 10705.

## Computer Language Newsletter

*NCUG News*, a monthly newsletter of the Nevada COBOL Users Group, disseminates information about the Nevada COBOL language. For further information, write to Nevada COBOL Users Group, 5536 Colbert Trail, Norcross, GA 30092, or call Bob Blum at (404) 449-8948.

## Keep Up with Technology

*Advanced Technology* is a technical bulletin that keeps its readers informed about new products, processors, and applications from Advanced Micro Devices. For further information, write to Advanced Micro Devices, 901 Thompson Place, POB 453, Sunnyvale, CA 94086, (800) 538-8450; in Massachusetts, call (617) 273-3970.

## Unofficially Yours

A bimonthly newsletter for owners of Texas Instruments' TI-99/4 and TI-99/4A computers, *Unofficial 99/4A* features programs, news, and a question-and-answer forum. Subscriptions are \$10 a year. For a free introductory issue, send a self-addressed, stamped envelope to *Unofficial 99/4A*, POB 651, Clute, TX 77351.

## Update Your Records

The new address of the Atari Computer Association of Orange County (ACAOC) is POB 9419, Fountain Valley, CA 92708, or call (714) 770-0372. (For a description of the club's activities, see the

# START YOUR OWN COMPUTER CO.

**HOW TO START YOUR OWN SYSTEMS HOUSE \$36.**

7th edition, November 1981  
Written by the founder of a successful systems house, this fact-filled 220-page manual covers virtually all aspects of starting and operating a small systems company. Contracts, proposals, agreements and a complete business plan are included in full, and may be used immediately. Proven, field-tested solutions to the many problems facing small turnkey vendors are presented.

**HOW TO BECOME A SUCCESSFUL COMPUTER CONSULTANT \$28.**

by Leslie Nelson, 4th revised edition, December 1981  
The rewards of the consultant can be high: freedom, more satisfying work and doubled or tripled income. This manual provides comprehensive background information and step-by-step directions for those interested to explore this lucrative field.

**HOW TO START YOUR OWN COMPUTER STORE \$145.**

1st printing, April 1983  
Computer store strategies. Optimum product mix. Brands to avoid. Working with distributors. Software selection. When to consider franchises. Where to find good personnel. Selecting the right location. The start-up plan. The seven best promotion strategies. Financial plan. Three low budget approaches.

**HOW TO START YOUR OWN WORD PROCESSING SERVICE \$48.**

by Leslie Nelson, 2nd edition, November 1982  
Turn a small investment into a steady, money making business that adds \$10,000, \$50,000 or \$100,000 to your income. Detailed start-up, marketing and operations plans are included.

**HOW TO SELL YOUR MICRO SOFTWARE \$19.95**

By B.J. Korites, Ph.D., May 1982  
The best practical guide for those with software to sell. Detailed discussion of the eight best marketing strategies. How to sell through distributors, brokers, computer manufacturers. Advertising techniques. Pricing. Software security.

Send check, money order, VISA, Master Charge or American Express # and exp. date. Publisher pays 4th class shipping. Add \$1.00 per book for UPS shipping (USA only). NJ residents add 6% sales tax. For faster shipment on credit card orders call (201) 783-6940.

**ESSEX PUBLISHING CO.** Dept. 2  
285 Bloomfield Avenue • Caldwell, N.J. 07006



## Protect your CRT with Specially Priced Dust Covers

An outstanding value at \$12.95, our Dust Covers fit all popular systems. These heavy gauge, anti-static Dust Covers protect sensitive electronic components, keep your CRT working at top efficiency. Tough-stitched for extra-strength, extra-long life. If you aren't completely satisfied, return the merchandise within 30 days and we'll return your money.

### PRYOR Computer Supplies Catalog

PHONE TOLL FREE 800-558-6866, or send coupon

Pryor Catalog Sales Corporation BT 683  
8785 North Port Washington Road  
P.O. Box 17829, Milwaukee, Wisconsin 53217

Please send the following Dust Covers: (specify manufacturer and system)

Manufacturer \_\_\_\_\_ System \_\_\_\_\_ No. ordered \_\_\_\_\_

Check enclosed  Bill me at \$12.95 ea. Total \$ \_\_\_\_\_

Send a FREE copy of the Pryor Computer and Word Processing Supplies Catalog

Name \_\_\_\_\_

Company \_\_\_\_\_

Address \_\_\_\_\_

City \_\_\_\_\_ State \_\_\_\_\_ Zip \_\_\_\_\_

Phone \_\_\_\_\_ Signature \_\_\_\_\_

# FREE SHIPPING

### IBM® Personal Computer Products

**Davong 5 MB Hard Disk System - \$1495.00** 12 MB - \$1995.00

**IBM PC-2 Drive System \$ CALL**  
3" DUAL DRIVE SUBSYSTEM \$725.00

#### Quadram - Quadboard with Parallel

Port, Serial Port, Clock/Calendar, Expandable to 256K

64K on brd. - \$340.00 128K on brd. - \$395.00

192K on brd. - \$439.00 256K on brd. - \$499.00

#### Quadram Memory Expansion

192K Maximum

64K on brd. - \$230.00 128K on brd. - \$290.00

192K on brd. - \$350.00

**AST & PERSYST MEMORY EXPANSION PRODUCTS \$ CALL**

#### Amdek Monitors

Mod 300 Phosphor - \$150.00 Composite Color III - \$345.00

IBM RGB Compatible Color II - \$599.00 Color I - \$300.00

#### IBM/TRS 80 Disk Drives/Cabinets

TM 100 Single 40 Track Drive - \$189.00

TM 100-2 Double 40 Track Drive - \$280.00

**TEAC 5 1/4" SLIM SINGLE & DOUBLE DRIVE SUBSYSTEMS \$ CALL**

### Apple II® Computer Products

**SYSCOM APPLE COMPATIBLE SYSTEM \$825.00**

Apple Compatible Controller Card..... \$ 79.95

Apple Compatible Disk Drive w/Cabinet & Cable..... 249.00

w/Controller..... 315.00

**TEAC SLIM LINE 5 1/4" DRIVE \$265.00 DUAL SLIM LINE \$525.00**

Printer/Graphics Interface..... 99.95

Davong 5 MB Hard Disk System - \$1495.00 — 12 MB - \$1995.00

Apple Compatible Joysticks ..... 29.95

### Epson/Smith-Corona Printers

MX80 \$425.00 FX80 \$550.00 MX100 \$875.00

TRS 80 / Parallel Printer Cable \$20.00

IBM Parallel Printer Cable \$35.00

**STAR MICRONICS GEMINI 10 \$ CALL**

**GEMINI 15 \$ CALL**

Smith Corona TP-1 Letter Quality Daisy Wheel..... \$575.00



**TRS-80 MOD III Disk Controller** incl: Disk Controller, Power-Supply, Mounting Hardware, Cables & Instruction Manuals **\$239.00**

**POWER SUPPLIES AND CABINETS** Dual 8" Slim Line - \$180.00 Dual 5 1/4" - \$ 99.00 Single 5 1/4" - \$ 89.00

**3" DUAL DRIVE SUBSYSTEM FOR IBM ..... \$725.00**

VISA, MASTERCARD (\$100 Min., Add 2%)

Or Certified Check

90 Day Warranty (Parts & Labor)

TRS 80 is a Registered Trademark, Tandy Corp.

Prices Subject to Change Without Notice

**DATA-MAIL**  
P.O. Box 818, Reseda, CA 91335  
1-800-635-5555

FREE SHIPPING IN CONTINENTAL U.S.

**(213) 993-4804**  
(IN CALIF.)





# In Less Than 3 Minutes

Your IBM Model 50, 60, 65, 75, or 85  
Electronic Typewriter  
can be an RS232C PRINTER or TERMINAL



CALIFORNIA MICRO COMPUTER Models 5060 and 5061 can be installed easily and require NO modifications to the typewriter.

For additional information contact:

CALIFORNIA MICRO COMPUTER  
17791 Jamestown Lane Huntington Beach, CA  
92647 (714) 847-4141

## HIDE-A-WAY COMPUTER DESK

BRAND NEW



MODEL 1500—size: 20 x 24 x 30 H, 70 lbs.

The ultimate work/storage unit for your computer. This beautiful two part desk closes to become a stunning piece of furniture. Open—it holds your computer and monitor in one side and a printer and auxiliary pieces in the other half. Equipped with casters for added convenience. Each unit features rich, durable, care free finish and solid core construction. Designed for quick n'easy assembly that will take just minutes. Only \$129.95 including shipping and handling. Send your check or money order to:

*EMC Distributors,*  
366 Fifth Avenue, New York, N.Y. 10001.  
(NY residents please add sales tax.)  
**Satisfaction guaranteed.**  
Dealer inquiries invited.

# BYTE back issues for sale

	1976	1977	1978	1979	1980	1981	1982	1983
Jan.		\$2.00		\$2.75	\$3.25	\$3.25		\$3.70
Feb.			\$2.75	\$2.75	\$3.25	\$3.25	\$3.70	\$3.70
March			\$2.75	\$2.75	\$3.25	\$3.25	\$3.70	\$3.70
April			\$2.75	\$2.75	\$3.25	\$3.25	\$3.70	\$3.70
May		\$2.00	\$2.75	\$2.75	\$3.25	\$3.25	\$3.70	\$3.70
June		\$2.00	\$2.75	\$2.75	\$3.25	\$3.25	\$3.70	\$3.70

	1976	1977	1978	1979	1980	1981	1982	1983
July	\$2.00	\$2.00	\$2.75	\$2.75	\$3.25	\$3.25	\$3.70	
Aug.		\$2.00	\$2.75	\$2.75	\$3.25	\$3.25	\$3.70	
Sept.		\$2.75	\$2.75	\$2.75	\$3.25	\$3.25	\$3.70	
Oct.			\$2.75	\$2.75	\$3.25	\$3.25		
Nov.		\$2.75		\$3.25	\$3.25	\$3.25	\$3.70	
Dec.	\$2.00	\$2.75	\$2.75	\$3.25	\$3.25	\$3.25	\$3.70	

Circle and send requests with payment to:  
**BYTE Back Issues**  
P.O. Box 328  
Hancock, NH 03449

Please allow 4 weeks for domestic delivery  
and 8 weeks for foreign delivery.

name \_\_\_\_\_  
address \_\_\_\_\_  
city \_\_\_\_\_  
state \_\_\_\_\_ zip \_\_\_\_\_

The above prices include postage in the US.  
Please add \$.50 per copy for Canada and  
Mexico; and \$2.00 per copy to foreign coun-  
tries.

Check enclosed

Payments from foreign countries must be  
made in US funds payable at a US bank.

VISA  Master Card  
Card # \_\_\_\_\_ Exp. \_\_\_\_\_

Signature \_\_\_\_\_

# Ask BYTE

Conducted by Steve Clarcla

## Comm-80 Adapted to ZX80

Dear Steve,

I read with interest your article on the Comm-80 Expansion interface for the TRS-80. (See "I/O Expansion for the Radio Shack TRS-80," Part 1, May 1980 BYTE, page 22; Part 2, June 1980 BYTE, page 42.) You mentioned that the Comm-80 could be adapted for other Z80-based computers. I would like to try it on my Sinclair ZX80 computer. Can you tell me what modifications I should make or refer me to other sources of information that I should have before I attempt this?

V. P. Subramanian  
Temple, TX

*The Comm-80 Expansion Interface for the TRS-80 can be easily adapted for use with the Sinclair ZX80. The only*

signals that are not compatible are the  $\overline{\text{MEMWR}}$ ,  $\overline{\text{MEMRD}}$ ,  $\overline{\text{TORQ}}$  and  $\overline{\text{IOWR}}$  required by the Comm-80. Their definitions are as follows:

$\overline{\text{MREQ}}$  Memory Request. Whenever a transaction occurs between the central processor

and memory, the  $\overline{\text{MREQ}}$  line goes to a logic 0.  $\overline{\text{IORQ}}$  Input/Output Request. Whenever a transaction occurs between the central processor and either an input port or an output port, the  $\overline{\text{IORQ}}$  line goes to a logic 0.  $\overline{\text{RD}}$  Read Request. Whenever the central processor

reads input data from either memory or an input port, the  $\overline{\text{RD}}$  line goes to a logic 0.  $\overline{\text{WR}}$  Write Request. Whenever the central processor is writing data to either memory or to an output port, the  $\overline{\text{WR}}$  line goes to a logic 0.

To differentiate between input and output ports during I/O instructions,  $\overline{\text{TORQ}}$ ,  $\overline{\text{RD}}$ , and  $\overline{\text{WR}}$  are gated together as shown in figure 1. In a similar manner,  $\overline{\text{MREQ}}$ ,  $\overline{\text{RD}}$ , and  $\overline{\text{WR}}$  are gated during memory transfers.

The resulting decoded strobes define the operations of Input Port Read ( $\overline{\text{IORD}}$ ), Output Port Write ( $\overline{\text{IOWR}}$ ), Memory Read ( $\overline{\text{MEMRD}}$ ), and Memory Write ( $\overline{\text{MEMWR}}$ ).

So you see, all that it takes is one chip to interface the Comm-80 to the ZX80.  
... Steve

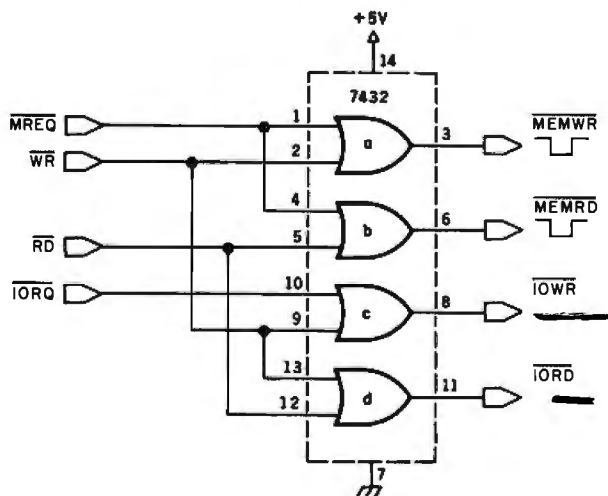


Figure 1

## Monitor Buffer Has Simple Solution

Dear Steve,

I have a Sinclair ZX81 with a Sanyo video monitor attached. The Syntax Newsletter suggested that the Sanyo could be hooked to the ZX81, but the monitor's 75-ohm input impedance doesn't match the ZX81's output. I'm told that I need to add a buffer. Can you tell me what circuits to use and how to build them? Any help would be appreciated.

Bruce Schalamon  
Manchester, CT

*The buffer you need requires source follower or emitter follower circuits, which are transistor circuits that are used to transform a*

high impedance to a low impedance. The source follower is used with field-effect transistors, while the emitter follower circuit is used with bipolar transistors.

Figure 2 is a simple circuit for an emitter follower that uses readily available parts

and will match your ZX81 to your Sanyo monitor. The circuit can be constructed on a small piece of perforated board and the required 5 volts and ground can be obtained from the expansion connector on the Sinclair.  
... Steve

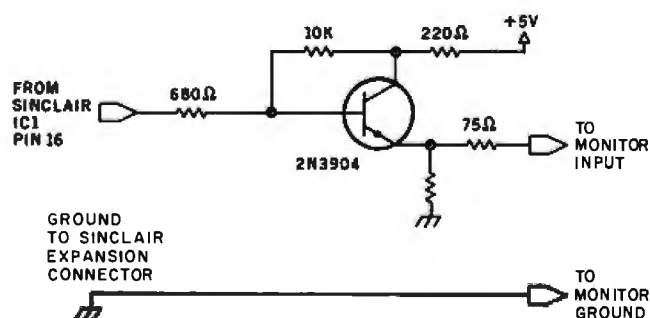


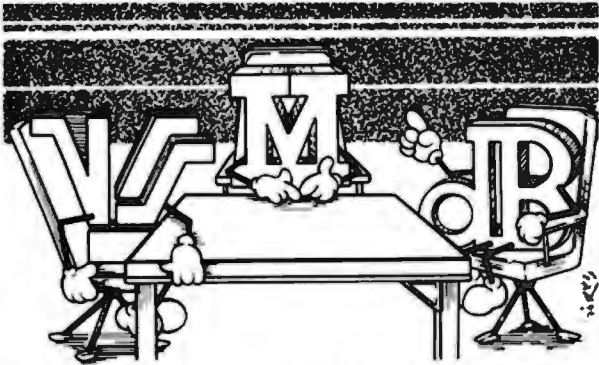
Figure 2

## Multiple Screens for Classrooms

Dear Steve,

We have several North Star systems with Zenith Z-19 terminals that we use in our microcomputer lab. Our problem is simple: we need some way for up to 50 students to see what is happening on the terminal screen. Using a computer to support teaching is rather useless if only a few students in the front row can see the screen; and even then, the instructor must have his or her back to the class.

We want to equip at least one classroom with display facilities, although a portable projection system would be better. We are not aware of any commercial equipment to



**"Microstat talks to dBase II,  
Wordstar, etc. . ."**

Microstat® Rel. 3.0 can now access external ASCII data files for statistical analysis. Virtually any comma-delimited ASCII file may be used.

Release 3.0 requires Micro Mikes baZic, a Z80 CPU and CP/M. The price is \$325.00 or the manual may be purchased for \$25.00 (credited towards purchase). If you need baZic, add \$100.00. For further information, call or write:



P.O. Box 68602  
Indianapolis, IN 46268  
(317) 255-6476

Trademarks: Digital Research (CP/M), Aston-Tate (dBase II), Micro Mike (baZic) and Micropro (Wordstar)

As Seen in **NEWSWEEK** Magazine

**The Most Personal Printers**



- Daisywheel Printer/Portable electronic typewriter
- Centronics and Wordstar™ compatible
- Olivetti approved
- ArkPrinter™ I w/portable carrying case \$599.00\*
- ArkPrinter II w/switch selectable pitch \$645.00\*
- ArkPrinter III durable office quality \$699.00\*
- Already own a PRAXIS typewriter? We offer an easy-to-install interface kit (no soldering) for just \$195.00\*\*

TO ORDER CONTACT:



**MICROSYSTEMS, INC.**  
P.O. BOX 4190  
ANN ARBOR, MI 48106 (313) 769-7253

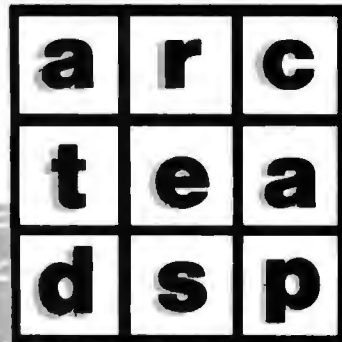
\*add \$10.00 for shipping

\*\*for an additional \$25.00 our factory trained technicians will install this for you.

VISA  
MASTERCARD

The intensity of Scrabble,<sup>®</sup>  
the excitement of Boggle,<sup>®</sup>  
the imagination of word search games...

**WORD CHALLENGE™**  
The Ultimate Word Game.



Ready for some mental gymnastics? Take on Word Challenge. You'll race the clock with LEX, an opponent of uncannily human intel-

ly find hidden words in a square of random letters. (The sample square has 142 words.) Longer words score better points, so while you might enter "cap," "ape" and "tea," LEX is picking out "aster," "repast" and "sacred," all part of his remarkable 90,000-word vocabulary. But don't give up. You can select from 26 different skill levels, choose the square size (3 x 3, 4 x 4 or 5 x 5), time limit and a variety of scoring methods.

Word Challenge. Only \$39.95 at your computer dealer. For Mastercard and Visa orders, call toll-free, 1-800-323-0023. In Florida, call collect, 305/566-3511. Or complete the coupon and send check or M.O. to: Word Challenge, Proximity Software, 3511 N.E. 22nd Avenue, Fort Lauderdale, Florida, 33308.

**PROXIMITY™**

Please send \_\_\_\_\_ Word Challenge Disk(s) for which I've enclosed \$39.95 each (plus \$2.00 shipping and handling). Florida residents please add 5% sales tax.

Check appropriate box.

- Apple II, II Plus or II Plus E (min 48k) w/disk
- IBM Personal Computer (min 64k) w/disk
- Osborne I (min 64k) w/disk

Name \_\_\_\_\_  
Address \_\_\_\_\_  
City \_\_\_\_\_ State \_\_\_\_\_ Zip \_\_\_\_\_

Apple, IBM and Osborne are registered trademarks of Apple Computer, Inc. International Business Machines Corp. and Osborne Computer Corp., respectively. Boggle and Scrabble are registered trademarks of Parker Brothers Division of CPG Products Corporation and Selchow and Richter, respectively.

do this, and no one has yet to suggest an acceptable setup. Ideally, the solution would require little, if any, hardware or software modification. Any ideas?

J. Burdeane Qrris  
Butler University  
Indianapolis, IN

*Yours is a classic problem. At various computer show demonstrations, I've seen multiple monitors placed around the room to provide visibility. This seems relatively effective and reminds me of the technique used to display camera shots to a live television audience.*

*I have used a Pioneer projection TV for displaying color graphics because it has a built-in video input jack. This works very well and would provide greater visibility because it has a 50-inch screen. Properly positioned, two of these units would be adequate for a 50-student class.*

*It should only be necessary to parallel the video inputs to provide the proper signal for the projection TVs. If the distances are excessive, or the drive signal is weak, an inline video amplifier can be used to boost the signal. This method offers three advantages: it's a relatively inexpensive way to provide the necessary visibility, no modifications to the computer are required, and it will allow the viewing of video tapes or TV programs as well.*

*At a recent convention, I saw an Electrohome Projection CRT that may do what you want. Contact Electrohome Ltd., 809 Wellington St. N, Kitchener, Ontario N2G 4J6, Canada, (519) 744-7111. . . . Steve*

### Guide's Contents Outlined

Dear Steve,

Can you supply a list of the

periodicals covered in the *Periodical Guide for Computerists*? What's its expected frequency of publication?

Thank you.  
David Ingham  
Edina, MN

*The Guide is published annually by Applegate Computer Enterprises, POB 288, Applegate, OR 97530. Here is a list of the periodicals it covers:*

"68" Micro Journal  
80 Microcomputing  
80 U. S. Journal  
BYTE  
Call-A. P. P. L. E.  
Compute  
Creative Computing  
Dr. Dobb's Journal  
Digital Design  
Infoworld  
Interface Age  
Kilobaud Microcomputing  
Lifelines  
Mechanix Illustrated  
Mini-Micro Systems  
OnComputing  
Personal Computing  
Popular Computing  
Popular Electronics  
Popular Mechanics  
Popular Science  
Radio Electronics  
Recreational Computing  
S-100 Microsystems  
Softalk

*Another guide that appears to be more comprehensive and includes abstracts of all articles it references is the Micro Computer Index. It's a quarterly publication available from Microcomputer Information Services, Suite 247, 2464 El Camino Real, Santa Clara, CA 95051. . . . Steve*

### Bell Rings for ASCII-to-Video Board Converter

Dear Steve,

Having read your Ask BYTE column, your books, and your Circuit Cellar ar-

ticles, I respect your ability to come up with answers. I hope that you can come up with one for me.

I have been asked to provide remote displays (approximately 20) of the screen from a Motorola 6800-based, multiplexed computer system that uses a serial port and Hazeltine 1500 as a console. Because this system is U. L. (Underwriters' Laboratories) listed, I do not want to enter it in any way that would void that status.

What I am looking for is an ASCII-to-video converter that would operate from the existing RS-232C port. The output of this converter would then be amplified and distributed to the required number of video monitors using commercially available video equipment. The key to the whole concept is the ASCII-to-video converter. I would appreciate any information you could furnish about a source.

Jerald Miskovsky  
Farmingdale, NY

*The ASCII-to-video converter that you are seeking is typical of the many computer video boards that are commercially available. In the early days of personal computing these devices were known as TV Typewriters, because they could display the output of an ASCII-encoded keyboard on the screen of a television. They usually were uppercase only and capable of only 32 or 64 characters per line.*

*With today's LSI (large-scale integration) integrated circuits, an entire TV Typewriter (now called a video-display controller) can be produced on one chip. This has led to very sophisticated video boards that are no longer stand-alone devices. They are designed to plug directly into the microcomputer bus.*

*One unit that will answer*

*your requirements is a video terminal board from John Bell Engineering, catalog number 82-018. It is available for \$199.95 assembled and tested, or for \$89.95 as a bare board (this may allow you to custom package it for your systems). The address is John Bell Engineering Inc., 1014 Center St., San Carlos, CA 94070, (415) 592-8411. . . . Steve*

### On 68000s and Operating Systems

Dear Steve,

I am currently putting together a 68000 system based on the IEEE-696 (S-100) bus. The 68000 uses memory-mapped I/O (which personally I detest but will tolerate for the sake of all the other 68000 features). Is there any standard location for the I/O ports in the address space? Would I be better off including a Z80 (or some other) coprocessor to handle I/O?

Also, what DOS should I use? Unix is very inviting, but much too expensive. Could I rewrite CP/M in 68000 code, or maybe use a Z80 to handle unmodified CP/M? I haven't seen much 68000 software around, but I want to choose a disk format and operating system that will give me access to software still to be written. Any suggestions would be greatly appreciated.  
Greg Trice  
Scarborough, Ontario,  
Canada

*The Motorola 68000 microprocessor is relatively new in the microcomputer field, and memory-mapping standards have not been suggested. Upon a reset, the microprocessor jumps to location 00000 and vectors to the initialization program called at this location. Hence, there should be some ROM (read-only memory) in low memory to accomplish this.*



What group of gifted folk has experienced a 304% population explosion over the past 6 years?



BYTE subscribers.  
Here's how to join them:

1. Within 6 to 8 weeks, your subscription will be processed. After receiving your first issue, you will receive our invoice. If not, just write "cancel" on the invoice and return it to us. You will not be charged for that issue.



2. Within 6 to 8 weeks, your subscription will be processed.  
3. Prior to receiving your first issue, you will receive our invoice. If not, just write "cancel" on the invoice and return it to us. You will not be charged for that issue.

4H63

Name Please print \_\_\_\_\_

Address \_\_\_\_\_

City State/Province/Country Code \_\_\_\_\_

**United States**

One year \$21 (12 issues)  2 years \$38  3 years \$55

**Canada or Mexico**

One year \$23 (12 issues)  2 years \$42  3 years \$61

**Foreign Rates** (to expedite service, remit in U.S. funds drawn on a U.S. bank)

- Europe, one year, air delivered, \$53
- All other countries, one year, surface delivered, \$37  
Air delivery available upon request
- Check enclosed** (entitles me to 13 issues for price of 12, North America only)
- Bill VISA  Bill Master Charge  Bill me (North America only)

Card Number \_\_\_\_\_ Expires \_\_\_\_\_

Signature \_\_\_\_\_

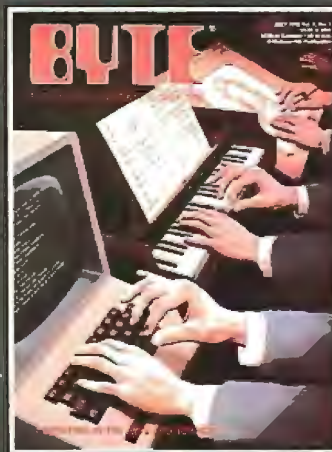


What group of gifted folk has experienced a 304% population explosion over the past 6 years?



BYTE subscribers.  
Here's how to join them:

1. Complete this post-paid reply card and mail.
2. Within 6 to 8 weeks, your subscription will be processed.
3. Prior to receiving your first issue, you will receive our invoice. After examining BYTE, honor the invoice if you're satisfied. If not, just write "cancel" on the invoice and return it to us. You will not be charged for that issue.



4H63

Name Please print \_\_\_\_\_

Address \_\_\_\_\_

City State/Province/Country Code \_\_\_\_\_

**United States**

One year \$21 (12 issues)  2 years \$38  3 years \$55

**Canada or Mexico**

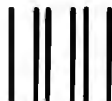
One year \$23 (12 issues)  2 years \$42  3 years \$61

**Foreign Rates** (to expedite service, remit in U.S. funds drawn on a U.S. bank)

- Europe, one year, air delivered, \$53
- All other countries, one year, surface delivered, \$37  
Air delivery available upon request
- Check enclosed** (entitles me to 13 issues for price of 12, North America only)
- Bill VISA  Bill Master Charge  Bill me (North America only)

Card Number \_\_\_\_\_ Expires \_\_\_\_\_

Signature \_\_\_\_\_



NO POSTAGE  
NECESSARY  
IF MAILED  
IN THE  
UNITED STATES

**BUSINESS REPLY CARD**

FIRST CLASS PERMIT NO. 39 MARTINSVILLE, NJ

POSTAGE WILL BE PAID BY ADDRESSEE

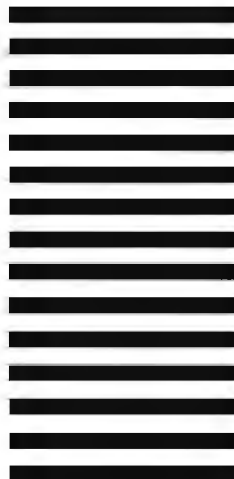
**BYTE**

the small systems journal

Subscription Dept.

P.O. Box 590

Martinsville, NJ 08836



NO POSTAGE  
NECESSARY  
IF MAILED  
IN THE  
UNITED STATES

**BUSINESS REPLY CARD**

FIRST CLASS PERMIT NO. 39 MARTINSVILLE, NJ

POSTAGE WILL BE PAID BY ADDRESSEE

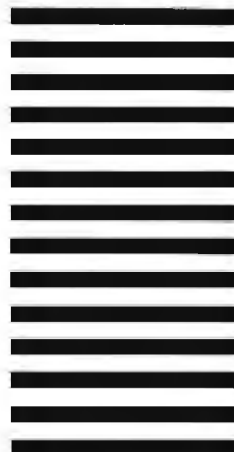
**BYTE**

the small systems journal

Subscription Dept.

P.O. Box 590

Martinsville, NJ 08836



The I/O ports do not have a standard location; they are a function of how the memory is configured. A 1K-byte block could be set aside to handle I/O, so it's not necessary to use a coprocessor for the task (I detect by your comments that you are a seasoned Z80 user). Memory-mapping I/O is convenient, fast, and easy to use.

The reason you haven't seen much 68000 software around is that the chip is just beginning to get popular. However, a listing of small-business computers in the June 1982 issue of *Mini-Micro Systems*, "Small-Business Systems Solve Big Problems," by David Simpson (page 201), indicated a preference for Unix or Unix-like operating systems (such as Microsoft's Xenix).

The thought of writing your own operating system is ambitious, and compatibility with other software is important. You might want to consider Digital Research's version of CP/M for the 68000. Most of this software is for the business and industrial markets and is quite expensive. . . . Steve

### Quick Printer Interface

Dear Steve,

I would like to interface a Radio Shack Quick Printer II to an Atari 400. I would appreciate any help that you could give me.

Thank you.  
Gary Greaser  
Silverdale, WA

The Radio Shack Quick Printer II requires serial data input at 600 bps (bits per second). It has a built-in microprocessor to convert the incoming data to a 7-bit ASCII code. Only three lines are needed: Data, Ground, and a Clear-to-Send signal for handshaking.

The interface to the Atari 400 is a little more difficult. While the Atari 400 does produce serial data, it is at a high rate (i.e., in excess of 19,000 bps), and it's not RS-232C-compatible. It is conceivable that you could build an adapter specifically for this project, but it is far more reasonable to buy Atari's Model 850 expansion box. This unit adds one parallel port and four serial ports to an Atari 400/800. It costs about \$150. . . . Steve

### Printer Drops Characters

Dear Steve,

I have an Explorer 85 computer and the Heath H14 printer. When I Run or List a program, the printer loses characters after several lines. Do you have a circuit of a printing buffer that would hold several K bytes' worth of characters and let the printer catch up with the flow of data?

I purchased a surplus memory board with sixty-four 2102-type static memories; could it be used in the circuit?  
Leroy W. Marshall  
Schaumburg, IL

If your printer loses data after printing several lines, it is an indication that handshaking between the printer and the computer is not occurring. Handshaking is the means of telling the computer to send data only when the printer is ready to accept it. Adding a buffer will only postpone the problem, since data loss will occur after the buffer is full.

The solution is to check the handshaking signals between the computer and the printer. For a serial port, the signals are Request-to-Send (RTS) and Clear-to-Send (CTS). For a parallel port, the signals are Acknowledge (ACK), Data Accepted, or something

similar. When these are properly connected, the flow of data from the computer will stop until the printer can catch up. This method is also much simpler than adding a buffer to the printer. For an idea of how RS-232C interfaces work, you may want to refer to Ian H. Witten's "Welcome to the Standards Jungle" (February 1983 BYTE, page 146). . . . Steve

### Parts Located

Dear Steve,

I want to build my own personal computer (perhaps several) from the ground up so that I can learn about computers. I have a book by Charles Adams that gives plans for a computer, but I cannot find two parts that he specifies: 7093-type integrated circuits and an 8½-by 16-inch Vector board. Do you know where I can find them?

R. C. Coakley  
Flandreau, SD

The 7093 chips referred to in Charles Adams's book, *How to Build Your Own Working Computer* (Blue Ridge Summit, PA: Tab Books, 1979), are known as Tri-State (three-state) Quad Buffers and are made by National Semiconductor. They are equivalent to the DM8093 or the more common 74LS125. The latter is a pin-compatible replacement and is available from any of the mail-order houses that advertise in BYTE, such as Advanced Computer Products, Jade Computer Products, and Jameco Electronics.

The Vector board is made by Vector Electronic Company (12460 Gladstone Ave., Sylmar, CA 91342) and is available in a variety of styles and materials (I prefer the epoxy glass). It consists of holes spaced at intervals of ½ inch on center in both direc-

tions. The model number for the 8½-by 17-inch board is 169P84. Vector boards can usually be obtained from the above mail-order sources.

. . . Steve

### Information on NASA's Videodiscs

Dear Steve,

I am most interested in your article "Build an Interactive-Videodisc Controller" (June 1982 BYTE, page 60). The text box accompanying it mentioned that NASA was producing videodiscs for distribution sometime in the near future. Do you have any further information?

Thank you.  
R. Teakes  
Toronto, Ontario, Canada

For further information, write to the Jet Propulsion Laboratory, Planetary Image Facility, 4800 Oak Grove Dr., Pasadena, CA 91103, Attn: Mr. Michael Martin, Planetary Data Management Team. . . . Steve ■

In "Ask BYTE," Steve Ciarcia answers questions on any area of microcomputing. The most representative questions received each month will be answered and published. Do you have a nagging problem? Send your inquiry to:

Ask BYTE  
c/o Steve Ciarcia  
POB 582  
Glastonbury CT 06033

If you are a subscriber to *The Source*, chat with Steve (TEC317) directly. Due to the high volume of inquiries, personal replies cannot be given. Be sure to include "Ask BYTE" in the address.

# Software Received

## Apple

**Concentrated Chemical Concepts.** This introductory chemistry course for high school students is available as a whole or in parts: general, organic, and biological chemistry. For the Apple II; floppy disk, \$550. Wiley Educational Software, John Wiley & Sons, 605 Third Ave., New York, NY 10158.

**Correlated Samples,** an educational program designed to teach difficult concepts in elementary statistics to high school and undergraduate students. For the Apple II; floppy disk, \$75. HMS Software, POB 49186, Austin, TX 78765.

**Dow Jones News and Quotes Reporter,** a database information service. You can access the Dow Jones online database to receive current information on stocks and securities from *The Wall Street Journal*, *Barron's*, and the Dow Jones News/Retrieval Service. For the Apple II Plus; floppy disk, \$135. Apple Computer Inc., 20525 Mariani Ave., Cupertino, CA 95014.

**Econalysys.** This economic-forecaster program helps you determine the best of several possible investments by comparing the costs of any energy- or maintenance-intensive purchase in six ways. For the Apple IIe; floppy disk, \$100. Energy Software, 1403 South 7th Ave., Kelso, WA 98626.

**Family Roots 1.2,** a set of programs that assist you in your search for family historical information. You can edit, search, file, chart, print, and further organize family data. For the Apple IIe; floppy disk, \$185.

Quinsept Inc., POB 216, Lexington, MA 02173.

**Health-Aide,** a nutritional, diet, and personal data system designed to provide a comprehensive analysis of your health. For the Apple II; floppy disk, \$79.95. Knossos Inc., 422 Redwood Ave., Corte Madera, CA 94925.

**Laser Bounce,** an arcade-type game. You must destroy enemy energy modules by bouncing laser beams off moving satellites and defend your own modules from the same attack. For the Apple II; floppy disk, \$34.95. Hayden Software Co., 600 Suffolk St., Lowell, MA 01853.

**Old Ironsides,** a naval-battle game. As animated ships fire at each other, two players can either shoot out each other's ammunition or hide in the fog and contend with the wind. For the Apple II; floppy disk, \$39.95. Xerox Education Publications, Computer Software Division, 245 Long Hill Rd., Middletown, CT 06457.

**Pick That Tune,** a musical-identification game. See if you can identify a song after hearing only a few notes. One to ten players can move through sixteen levels of difficulty. For the Apple II; floppy disk, \$29.95. Swearingen Software, Suite 197, 6312 West Little York, Houston, TX 77088.

**Pinball Construction Set,** a video-construction set. You can design and build your own high-resolution pinball games using video tools and parts to make borders and obstacles. For the Apple II; floppy disk, \$39.95. Budge Co. Inc., 428 Pala Ave., Piedmont, CA 94611.

**Stickybear ABC,** an educa-

tional program. Colorful animations help children between the ages of 3 and 6 to learn each letter of the alphabet. For the Apple II; floppy disk, \$39.95. Xerox Education Publications (see address above).

**Stickybear Bop,** a game for the whole family. In this animated shooting gallery see if you can knock ducks, planets, balloons, and Stickybears off the screen. For the Apple II; floppy disk, \$39.95. Xerox Education Publications (see address above).

**Stickybear Numbers,** an educational program. Colorful objects that move across the screen help children learn numbers and counting skills. For the Apple II; floppy disk, \$39.95. Xerox Education Publications (see address above).

**Zipscrip,** a word-processing system. This line-oriented text editor provides more than 65 editing and formatting commands. It is suitable for building data files and editing BASIC programs. For the Apple II Plus; floppy disk, \$49.95. Carter-mation, 3245 Pursell Dr., Pensacola, FL 32506.

## Atari

**Jumbo Jet Pilot,** a flight-simulation game. Put yourself in the pilot's seat, maneuver your way through the clouds to a safe landing, and receive a performance rating. Ten game variations; requires a joystick. For the Atari 400/800; cartridge, \$49.95. Thorn EMI, 1370 Avenue of the Americas, New York, NY 10019.

**The Magic Melody Box.** This educational program lets you

learn to create music simply by drawing a line. See and hear the computer harmonize your rhythm and melody in a song. Requires a joystick. For the Atari 400/800; floppy disk, \$15.95. Atari Program Exchange, 3281 Scott Blvd., POB 3705, Santa Clara, CA 95055.

**Soccer,** a soccer-animation game. Try to score a goal as you dribble the ball down the field. Features include goals, lines, a time clock, and 200 variations. Requires one to four joysticks. For the Atari 400/800; cartridge, \$49.95. Thorn EMI (see address above).

**Submarine Commander,** a submarine-patrol game. Your submarine must attack and destroy the enemy merchant-shipping boats in the Mediterranean. Requires one joystick. For the Atari 400/800; cartridge, \$49.95. Thorn EMI (see address above).

## CP/M

**TCS Simple.** This information-filing system allows you to store, query, and generate reports from database files. It can also create record types for logical organization of data. This utility package is designed to be used in conjunction with the TCS Total Accounting System. For CP/M 2.2-based systems, floppy disk. Price not available. TSC Software, 3209 Fondren Rd., Houston, TX 77063.

**Z80 DIS.** This disassembler package for Z80-based CP/M systems takes binary information from a disk file and converts it to either a source file or a listing file. For CP/M-based systems; floppy disk, \$69.95. SLR Systems,



200 Homewood Dr., Butler, PA 16001.

## Commodore

**Arcadia**, an arcade-type game. Defend your planet from multicolored aliens as they peel out of formation and attack your base. Eight skill levels; requires one joystick. For the Commodore VIC-20; cassette, \$24.95. Startech Inc., Suite 204, 13900 Northwest Passage, Marina del Rey, CA 90291.

**Bunny**, an arcade-type game. Guide the bunny across a crowded highway, dodging speeding cars and trucks, and finally cross a river to safety. Requires a joystick. For the Commodore VIC-20; cassette, \$24.95. Startech Inc. (see address above).

**Mailfile**, a mailing-list program. You can save up to 200 names and addresses per file. For the Commodore 64 and VIC-20; cassette, \$14.95. Step Industries, POB 52605, Houston, TX 77052.

**Ski-Run**, an arcade-type game. Three skiing-simulation games in one: slalom, downhill, and giant slalom. Each game has nine skill levels. For the Commodore VIC-20; cassette, \$24.95. Startech Inc. (see address above).

**Super 64 Music Maker**, a musical program that plays, saves, loads, and modifies music digitally with the Commodore Datasette. For the Commodore 64; cassette, \$19.95. Seyau-Kaun Loke, 1021-H West Bishop, Santa Ana, CA 92703.

## IBM Personal Computer

**APL\*Plus/PC**, a utility package that is an implementation

of the APL computer programming language. For the IBM Personal Computer; floppy disk, \$495. STSC Inc., 2115 East Jefferson St., Rockville, MD 20852.

**The Apartment House Manager**, a user-friendly accounting program that keeps track of accounts related to managing an apartment house: tenants, leases, deposits, payments, and expenses. For the IBM Personal Computer; floppy disk, \$395. User-Friendly Software Inc., POB 1192, Melville, NY 11747.

**Basic Programming Tools**. These five utility tools make programming in BASIC easy and efficient. For the IBM Personal Computer; floppy disk, \$120. Synergistic Software, Suite 201, 830 North Riverside Dr., Renton, WA 98055.

**The Chrome Ranger**, an arcade-type game. Score points by collecting gold nuggets, grabbing energy tablets, and capturing the bandits in the maze. For the IBM Personal Computer; floppy disk, \$29.95. Omniware, 8972 East Hampden Ave., POB 32, Denver, CO 80231.

**Disk Magic**. An easy-to-use utility program that allows you to access data on a disk at the sector level. Handy for locating control characters or repairing a damaged disk. For the IBM Personal Computer; floppy disk, \$49.95. Norell Data Systems Corp., 3400 Wilshire Blvd., POB 70127, Los Angeles, CA 90010.

**EZ\*Mailabel**, a mailing-list and label program. Records can be sorted by any field or fields with up to 64 total characters. For the IBM Personal Computer; floppy disk, \$85. Data Consulting Group, 877 Bounty Dr. #EE203, Foster City, CA 94404.

**EZ\*Retail Plus**. This sales and inventory-control program is a comprehensive method to control low-to-medium-volume retail or discount sales. For the IBM Personal Computer; floppy disk, \$245. Data Consulting Group (see address above).

**EZ\*Screenaid**. This screen-design generator works quickly and codes for data input efficiently. For the IBM Personal Computer; floppy disk, \$35. Data Consulting Group (see address above).

**E-Z—Tax**. This user-friendly program makes tax-preparation easy to do on a home computer with prompts. It automatically computes your lowest tax. For the IBM Personal Computer; floppy disk, \$69.95. E-Z—Tax, 2444 Moorpark Ave., San Jose, CA 95128.

**EZ\*Utilities**, basic programmer aids. You can improve your productivity in data processing by eliminating time-consuming tasks. For the IBM Personal Computer; floppy disk, \$65. Data Consulting Group (see address above).

**Easycalc**. This easy-to-use spreadsheet-calculator program computes budgets, projects investment returns, and figures taxes. For the IBM Personal Computer; floppy disk, \$99.95. Norell Data Systems Corp. (see address above).

**Easytext**. This utility program formats documents that are well-spaced, clearly typed, and indexed according to your specifications. For the IBM Personal Computer; floppy disk, \$79.95. Norell Data Systems Corp. (see address above).

**Eliza**, an educational game. Carry on a typed, two-way conversation with your com-

puter using this recreation of the artificial intelligence program developed at MIT. For the IBM Personal Computer; floppy disk, \$24.95. Norell Data Systems Corp. (see address above).

**Flip-ello**, a video game similar to the board game Othello that flips the pieces, keeps score, and offers advice and remarks. For one or two players. For the IBM Personal Computer; floppy disk, \$12.50. Resuba Digital Systems, POB 440, Department 7, Blackwood, NJ 08012.

**Fluidpak**, an engineering program that contains sub-routines to compute data on fluids-handling equipment such as turbines, compressors, fans, and cyclones. For the IBM Personal Computer; floppy disk, \$225. Physical Sciences Inc., Research Park, Andover, MA 01810.

**Graph 'n' Calc**. A utility program that lets you quickly prepare a variety of stacked and side-by-side bar, line, and pie charts in high-resolution color graphics. For the IBM Personal Computer; floppy disk, \$199. Desktop Computer Software Inc., 303 Potrero St., 29/303, Santa Cruz, CA 95060.

**HXpak**, an engineering program that provides analytical information on heat-exchangers: their general organization and the use of three modules used to model them. For the IBM Personal Computer; floppy disk, \$275. Physical Sciences Inc. (see address above).

**Hoser**, an interactive color game. Try to prevent a thirsty hose, seeking a faucet in a yard filled with obstacles, from turning against you. For the IBM Personal Computer; floppy disk, \$29.95. PC Connection, Mill St., Marlow, NH 03456.

**PopCom™**  
PERSONAL COMMUNICATIONS

© BRICKER ASSOCIATES 1982

## Enhance Your Computer

### Add A 5 1/4" Winchester Subsystem

- IMI 10MB formatted subsystem 2 yr. warranty .....\$1995.
  - AMPEX 20MB formatted subsystem 1 yr. warranty .....\$2695.
  - AMPEX 44MB formatted subsystem 1 yr. warranty .....\$3595.
- Compatible with: Apple with CP/M - IBM - PC - Northstar - Xerox 820 - TRS 80-Model II - Televideo 802 - Digital Group - Godbout Z80 CPU - Heath/Zenith - Kay Pro - Vectorgraphic - Any Z80, S-100 System.
- FUJITSU 21MB formatted for 8" Compupro-CP/M, CP/M86, MPM 8-16. Hard disk sub system. (requires Disk II) .....\$2895.

### Add Memory to Your IBM-PC New Lower Prices

- AST RESEARCH Mega-Plus II, with 64K clock
- (1) serial .....\$349. 256K clock (1) serial .....\$569.
- Add \$50. f d'I options. SEATTLE RAM & 192K
- (1) serial .....\$299. Baby blue .....\$499.
- PERSYT - STB - MONTE CARLO - QUADRAM
- PRINCETON color monitor - or - TAXAN
- RGB Vision III .....\$529

### Software:

- Spellbinder ....\$249. d Base II ....\$449. Supercalc ....\$169.
- LOTUS 1-2-3 - DIGITAL RESEARCH - MICROPRO
- MICROSOFT

### Printer:

- Epson FX 80 ...\$549. MX 80 ...\$349. C. Itoh 8510A ...\$399.
- Starwriter parallel or serial .....\$1225. Ribbons at discounts

Special department for universities and user groups. We accept purchase orders. All prices FOB El Toro, CA. and subject to change. If you don't see what you want...call...we carry most systems and all software.

In Europe contact McNeill, 138 University St., Belfast, Northern Ireland BT7 1 JH Telex 74351.



Suite #186 • 25422 Trabuco Ad., #105

El Toro, CA 92630 • (714) 768-8114



## Software Received

**Kaleida.** This interactive kaleidoscope generator is designed purely to provide a relaxing visual experience. For the IBM Personal Computer; floppy disk, \$24.95, Norell Data Systems (see address above).

**Mathpak,** a set of subroutines for solving engineering equations, algorithms, matrices, and more. For the IBM Personal Computer; floppy disk, \$75. Physical Sciences Inc. (see address above).

**Mechanical Engineering TKISolver Pack,** a mechanical-engineering program designed to run in conjunction with TKISolver. For the IBM Personal Computer; floppy disk, \$100. Software Arts Inc., 27 Mica Lane, Wellesley, MA 02181.

**Munchkin,** an arcade-type game. As you move your Munchkin through the maze eating dots, you must avoid getting eaten yourself. For the IBM Personal Computer; floppy disk, \$24.95. Norell Data Systems Corp. (see address above).

**1-2-3,** a program that integrates information management, spreadsheet, and graphing functions. For the IBM Personal Computer (Compaq Portable Computer-compatible), floppy disk, \$495. Lotus Development Corp., 55 Wheeler St., Cambridge, MA 02138.

**The Original Adventure,** an adventure-type game. In your exploration of Colossal Cave you can find a fortune in treasure and gold, solve puzzles, and become a wizard. For the IBM Personal Computer; floppy disk, \$24.95. Norell Data Systems Corp. (see address above).

**The Phantom's Revenge,** an adventure-type game. In this classic adventure game you

explore above and below ground for the treasure while avoiding **danger.** For the IBM Personal Computer; floppy disk, \$24.95, Norell Data Systems (see address above).

**S3Epak,** an engineering program for steady-state systems that includes a tutorial on power-plant and chemical-system analyses as well as information on a fuel-cell power plant. For the IBM Personal Computer; floppy disk, \$50. Physical Sciences Inc. (see address above).

**TE100-FT,** a utility package. This easy-to-use extension program allows your computer to function as a Digital Equipment Corporation VT100 series terminal emulator with ASCII file transfer. For the IBM Personal Computer; floppy disk, \$150. Perisoft Inc., 2186 U.S. Highway 51, Stoughton, WI 53589.

**TKISolver,** a program that allows you to solve simple or complicated equations without knowing how to program. Just enter the equations you need, supply the known values, and press a key. For the IBM Personal Computer; floppy disk, \$299. Software Arts Inc. (see address above).

**A TRS-80 to IBM Tape Loader/Converter.** This utility program will convert a TRS-80 BASIC program to run on an IBM Personal Computer. For the IBM Personal Computer; floppy disk, \$25. T. R. Coxon, 33 Parkland Dr., Elton, Chester, England.

**Thermopak,** an engineering program to calculate enthalpy, temperature, vapor pressure, thermal conductivity, and equilibrium constants for pure and mixed chemical turbines. For the IBM Personal Computer; floppy disk, \$100. Physical Sciences Inc. (see address above).

**Thermo3pak**, a high-precision version of Thermopak for dealing with water or ammonia in the evaluation of steam turbines. For the IBM Personal Computer; floppy disk, \$200. Physical Sciences Inc. (see address above).

## TRS-80

**Autogrammer**, a utility package. This automatic program-generation tool is for people who need to write customized microcomputer-based programs, but do not know programming languages. For the TRS-80 Model II; floppy disk, \$299.95. Roklan Corp., 3335 North Arlington Heights Rd., Arlington Heights, IL 60004.

**Copyart II**, a utility package. A word-graphics processor that allows you to edit, format, print, fix crashed disks, write mailing lists, and more. For the TRS-80 Model I and III; floppy disk, \$150. Simutek Computer Products Inc., 4897 East Speedway Blvd., Tucson, AZ 85712.

**Maxi Mail**, a utility package. This database-management system allows you to manage an extensive mailing list, generate labels and reports quickly, and merge text with most word processors. For the TRS-80 Model III; floppy disk, \$99.95. The Business Division, POB 3435, Longwood, FL 32750.

**Power Driver**, a utility program for use with SuperScripsit that allows you to use the special features of the Epson MX80/100 printers such as superscripts, subscripts, underlining, and proportional modes. For the TRS-80 Models I and III; floppy disk, \$29.95. Powersoft, Suite 125, 11500 Stemmons Expressway, Dallas, TX 75229.

**Profile III Plus**, a database-management program that allows you to organize files and manipulate data through storage and retrieval. It also performs math functions. For the TRS-80 Model III, floppy disk, \$199. Radio Shack, One Tandy Center, Fort Worth, TX 76102.

**64K Disk Utility Package**, three utility programs: Romcrack, Software Print Spooler, and a 40K relocater. For the TRS-80 Color Computer; floppy disk, \$23.95. Spectrum Projects, 93-15 86th Dr., Woodhaven, NY 11421.

**Speak Up!** a voice-synthesizer program that lets you type in words and sentences to be spoken or add speech statements to BASIC programs. For the TRS-80 Color Computer; cassette, \$29.95. Classical Computing Inc., POB 12247, Lexington, KY 40582.

**SuperScripsit**, a program that simplifies word processing by eliminating the need for retyping. It allows you to type, proofread, revise, and print letters formatted to your specifications. For the TRS-80 Model III; floppy disk, \$199. Radio Shack (see address above).

## Other Computers

**Datatre**, a utility package. A database-management system designed for use with mailing lists, student/teacher records, bibliographies, business accounts, and a variety of other applications. For the Sage II; floppy disk, \$150. Arizona Computer Systems Group Inc., POB 40878, Tucson, AZ 85717.

**Pedigree Manager**. This pedigree-documentation program is for breeders of pedi-

greed animals to keep records on the lineage of animals up to three or four generations. For the Heath/Zenith H-/Z-89 or Z-90, floppy disk, \$25. RCK Associates, 640 Trephanny Lane, Wayne, PA 19087.

**Xtal BASIC 3.1**, a utility

package. This updated version of the Xtal BASIC 2.2 enables you to write subroutines and insert owner-defined words in an auxiliary word table. For the Osborne 1; floppy disk. Price not available. Crystal Research Ltd., 40 Magdalene Rd., Torquay, Devon, England. ■

This is a list of software packages that have been received by BYTE Publications during the past month. The list is correct to the best of our knowledge, but it is not meant to be a full description of the product or the forms in which the product is available. In particular, some packages may be sold for several machines or in both cassette and floppy-disk format; the product listed here is the version received by BYTE Publications.

This is an all-inclusive list that makes no comment on the quality or usefulness of the software listed. We regret that we cannot review every software package we receive. Instead, this list is meant to be a monthly acknowledgment of these packages and the companies that sent them. All software received is considered to be on loan to BYTE and is returned to the manufacturer after a set period of time. Companies sending software packages should be sure to include the list price of the packages and (where appropriate) the alternate forms in which they are available.

**Buyer's Agent  
EXPORTING SERVICES**

Overseas dealers and distributors:  
You need the lowest prices, prompt  
delivery, exclusive territories and  
professional services. We've pro-  
vided these for three years. We've  
access to over 500 U.S. hardware  
and software manufacturers. Telex  
us NOW for more information or a  
quotation.

**American Buying and  
Exporting Services**  
1635 School St.  
Moraga, CA 94556  
(415) 376-9020  
Telex: 470851

# Event Queue

## June 1983

### June

**Continuing Engineering Education Courses**, George Washington University, Washington, DC. Among the courses available are "Computer Communications Systems and Networks," "A Phased Approach to Software Conversion," and "Microcomputer Applications Workshop." Course fees range from \$625 to \$855. For information, contact Douglas Green, Continuing Engineering Education, George Washington University, Washington, DC 20052, (800) 424-9773; in the District of Columbia, (202) 676-8512.

### June

**Courses from Ken Orr and Associates**, various sites throughout the U.S. Among the courses being offered are "Structured Requirements Definition" and "Structured Systems Design/Structured Program Design." Further details are available from Gayle Giesecke, Ken Orr and Associates Inc., 1725 Gage Blvd., Topeka, KS 66604, (800) 255-2459; in Kansas, (913) 273-0653.

### June

**Courses from Q.E.D. Information Sciences**, various sites throughout the U.S. Some of the courses listed are "Systems Analysis Workshop," "Project Management and Control," and "Data Analysis." Address inquiries to Priscilla Goudreault, Q.E.D. Information Sciences Inc., Q.E.D. Plaza, POB 181, Wellesley, MA 02181, (800) 343-4848; in Massachusetts, (617) 237-5656.

### June

**Data Processing Courses**, Hartford Graduate Center,

Hartford, CT. Among the courses being offered are "ANS COBOL Programming Workshop 1" and "CICS/VS Macro Level Coding Workshop." These data-processing courses are available for on-site presentation. For details, contact Don Florek, The Hartford Graduate Center, 275 Windsor St., Hartford, CT 06120, (203) 549-3600, ext. 252, 253, or 254.

### June

**Intel Microcomputer Workshops**, various sites throughout the U.S. Among the workshops to be held are "Introduction to Microprocessors" and "iAPX 86, 88, 186 Microprocessors." Intel Customer Training courses are available for on-site presentation. For details, contact Intel Corp., Mail Stop SV3-1, 3065 Bowers Ave., Santa Clara, CA 95051.

### June

**Intensive Seminars of Interest to Data Processing Professionals**, Boston metropolitan area. Among the two- to five-day seminars offered are "Project Management" and "Creative Problem Solving." Registration fees range from \$495 to \$975. For a seminar bulletin, contact Ms. Ginny Bazarian, Office of Continuing Education, Higgins House, Worcester Polytechnic Institute, Worcester, MA 01609, (617) 793-5517.

### June

**Management Development Programs**, Providence, RI, Boston, MA, and Hartford, CT. The Center for Management Development offers seminars on a variety of topics, including communications, industrial relations, and electronic data processing. Many of the Center's programs can be conducted on location for your organi-

zation. For details, contact The Center for Management Development, Bryant College, Smithfield, RI 02917, (401) 231-1200, ext. 314.

### June

**Microprocessor Seminars**, Rochester Institute of Technology, Rochester, NY. Five one-week seminars are offered: "Basic 8085," "Advanced 8085," "Basic 6800," "Advanced 6800," and "Advanced Digital Electronics." Hands-on experience is provided. The fee is \$480. Contact Jeanne Berry or Stacy Jordan, Rochester Institute of Technology, Rochester, NY 14627, (716) 475-2915.

### June

**Office Automation: Tee to Green**, various sites throughout the U.S. This three-day seminar for administrative and information-systems professionals addresses productivity issues and opportunities presented by automating the office workplace. Seminar objectives include establishing long-range office systems plans and developing integrated communications systems. The fee is \$385 for members of the Data Processing Management Association Education Foundation (DPMA/EF) or \$410 for non-members. For registration information, contact DPMA/EF Conferences, D. L. Hiller & Associates, 14536 Island Dr., Sterling Heights, MI 48078, (313) 247-8444.

### June

**Professional Development Seminars**, various sites throughout the U.S. Data communications, database management, software and systems, and computer-aided design/manufacturing are some of the areas investigated in seminars offered by the Institute for Advanced Tech-

nology. For a catalog, contact the Registrar, Institute for Advanced Technology, Control Data Corp., 6003 Executive Blvd., Rockville, MD 20852, (800) 638-6590; in Maryland, (301) 468-8576.

### June

**Seminars in Simulation, Management, Statistics, and Computer Science**, various sites throughout the U.S. "Simulation Modeling for Decision Making," "Database Design," and "Systems Analysis and Design" are some of the topics to be presented. For information, contact The Institute for Professional Education, POB 756, Arlington, VA 22216, (703) 527-8700.

### June-July

**Courses from Integrated Computer Systems**, various sites throughout the U.S. Course titles include "Computer Graphics," "Hands-On Pascal Workshop," "Defining Software Requirements, Specifications, and Tests," and "Computerized Robots." Fees range from \$695 to \$845. For information, contact Ruth Dordick, Integrated Computer Systems, 3304 Pico Blvd., POB 5339, Santa Monica, CA 90405, or call (213) 450-2060.

### June-July

**Productivity '83**, various sites throughout the U.S. and Canada. Hewlett-Packard's hands-on showcase of more than 32 computer products and 17 seminars is designed for both professionals and novices and aims to provide solutions to problems confronting the data processing industry. For details, call (800) 453-9500.

### June-July

**Software Workshops in MMSFORTH**, Boston metro-

politan area. These workshops are public versions of the professional training Miller Microcomputer Services (MMS) offers client companies in support of its MMSFORTH product line. A variety of topics and skill levels are covered. Full details are available from Miller Microcomputer Services, 61 Lake Shore Rd., Natick, MA 01760, (617) 653-6136.

*June-July*  
**Technical Courses from Zilog, Campbell, CA.** A wide variety of such courses as "Advanced Peripherals," "C Programming," and "ZEUS/System 8000 User Course" are offered. Fees range from \$175 to \$875. For a complete schedule, contact Zilog Inc., Training and Education Department, 1315 Dell Ave., Campbell, CA 95008, (408) 370-8092.

*June-August*  
**Courses in C Language and Unix,** various sites throughout the U.S. Three 5-day courses are offered by Plum Hall Inc. The "C Programming Workshop" is a hands-on course that covers all aspects of the C language for individuals able to program in another language. The "Advanced C Topics Seminar" covers efficiency, portability, readability, debugging, packaging, and interfacing. The "Unix Workshop" is an introductory course that focuses on software development. For further details, contact Joan Hall, Plum Hall Inc., 1 Spruce Ave., Cardiff, NJ 08232, (609) 927-3770.

*June-August*  
**Engineering Summer Conferences,** Chrysler Center for Continuing Engineering Education, North Campus, University of Michigan, Ann Arbor. More than 25 courses are offered in aerospace, chemi-

cal, civil, environmental, electrical, fluid, computer, information, and control engineering. One-week course fees range from \$500 to \$775; two-week courses are \$875. For course outlines and registration details, contact Engineering Summer Conferences, 200 Chrysler Center, North Campus, University of Michigan, Ann Arbor, MI 48109, (313) 764-8490.

*June-October*  
**Courses from the AMA,** various sites throughout the U.S. The American Management Associations (AMA) offers an on-going series of seminars in such areas as human resources, information systems, and manufacturing and technology management. In-house development and training seminars can be arranged. For information on AMA membership or seminar particulars, contact the American Management Associations, 135 West 50th St., New York, NY 10020, (212) 586-8100.

*June-December*  
**IEEE Conferences and Meetings,** various sites around the world. The Institute for Electrical and Electronics Engineers (IEEE) sponsors conferences, meetings, and workshops covering high-technology issues. For details, contact the IEEE Computer Society, Suite 300, 1109 Spring St., Silver Spring, MD 20910, (301) 589-8142.

*June-December*  
**Intensive Two-Day Seminars for Professional Development,** Worcester Polytechnic Institute, Boston metropolitan area and Hartford and Stamford, CT. Among the seminars being offered are "The Engineer as Manager," "Inventory Control: Using Computers," and "Fundamentals of Data Processing." For in-house seminar infor-



**COMPUTER**  
**THE SOFTWARE STORE**  
 2549 Cleveland ..... Granite City, IL 62040

CALL or WRITE FOR FREE CATALOG  
**Phone Toll Free 1-800-851-8791**  
 In Illinois Call (618) 876-2155  
 9 A.M.-9 P.M. WEEK DAYS - 9 A.M.-5 P.M. SATURDAYS

**15% - 35% DISCOUNTS**  
**GAMES - BUSINESS and HOME/PERSONAL SOFTWARE**  
**Apple, Atari, Commodore, Vic 20, TI, TRS, IBM, CP/M**

**SUPER JUNE SPECIAL**  
**Take ADDITIONAL 10% DISCOUNT**  
 On These Already Discounted Programs  
 If You Place Your Order By 6/30/83

ZAXXON.....	\$ 33.95	LIST HANDLER....	\$ 75.99
MYSTERY HOUSE..	\$ 19.99	WORD HANDLER..	\$169.00
WIZARDRY.....	\$ 19.99	PFS:REPORT.....	\$106.00

"Earn FREE Software with our Bonus Plan."  
 See Catalog!!

*We accept MasterCard or VISA*

Call 1-800-851-8791      Illinois Res. Call 1-618-876-2155

SOFTWARE FOR YOUR MICROCOMPUTER  
 SOFTWARE FOR YOUR MICROCOMPUTER  
 SOFTWARE FOR YOUR MICROCOMPUTER  
 SOFTWARE FOR YOUR MICROCOMPUTER  
 SOFTWARE FOR YOUR MICROCOMPUTER  
 SOFTWARE FOR YOUR MICROCOMPUTER  
 SOFTWARE FOR YOUR MICROCOMPUTER  
 SOFTWARE FOR YOUR MICROCOMPUTER  
 SOFTWARE FOR YOUR MICROCOMPUTER  
 SOFTWARE FOR YOUR MICROCOMPUTER

**25% DISCOUNT**

**WINTERHALTER, INC.**  
 SPECIALISTS IN DATA COMMUNICATIONS  
 3853 Research Park Dr., Ann Arbor, MI 48104  
 (313) 662-2002

## Event Queue

mation, call Robert J. Hall at (617) 793-5574. For a seminar bulletin and registration details, contact Ms. Ginny Bazarian, Office of Continuing Education, Higgins House, Worcester Polytechnic Institute, Worcester, MA 01609, (617) 793-5517.

*June-December*

**Systems Development Documentation: Forms Method**, various sites throughout the U.S. and Canada. This one-day seminar is designed for data-processing managers, project leaders, programmers, and technical writers. Topics to be covered include system design documentation, format and style guidelines, and options for end-document publication. The course fee is \$155, which includes all materials. In-company presentations are available for groups of 10 or more. For details, contact Technical Communications Associates Inc., 1250 Oakmead Parkway #210, Sunnyvale, CA 94086, (800) 227-3800, ext. 977; in California, (800) 792-0990, ext. 977, or (408) 737-2665.

*June 10-12*

**International Conference on Databases in the Humanities and Social Sciences-ICDBHSS/83**, Douglass College, Rutgers University, New Brunswick, NJ. Speakers from 24 countries will present papers on the structure, accessibility, and uses of databases in fields that include archaeology, religion, music, and law. The conference language is English. Registration fees are \$80. For information, contact Dr. Robert Allen, Bishop House, Room 306A, Rutgers University, New Brunswick, NJ 08903, (201) 932-7335 or (201) 932-7505.

*June 11-12*

**NJ-NY-CT Microcomputer Show and Flea Market**,

Meadowlands Hilton Hotel, New Jersey Sports Complex, East Rutherford, NJ. More than 75 commercial exhibitors and 200 flea-market booths will feature hardware, software, magazines, and accessories for all popular computing systems ranging from Apple to Zenith. Registration is \$5 for adults and \$2 for children under 12. Contact Kengore Corp., POB 13, Franklin Park, NJ 08823, (201) 297-2526.

*June 13-15*

**Analysis and Design-Oriented Techniques**, Los Angeles, CA. For details on this power-electronics course, contact Teslaco, Suite 6, 490 South Rosemead Blvd., Pasadena, CA 91107, (213) 795-1699.

*June 13-15*

**The Sixteenth Annual Association of Small Computer Users in Education Conference**, Taylor University, Upland, IN. This conference will feature formal papers and demonstrations of both the academic and administrative uses of computers. Topics on the agenda include "Artificial Intelligence in the Small College" and "How to Manage the Microkids." A one-day seminar on data communications will be held. Further information is available from Dr. Wally Roth, Department of Information Science, Taylor University, Upland, IN 46989, (317) 998-2751, ext. 269.

*June 13-15*

**Systematic Software Maintenance**, Chicago, IL. Topics to be addressed include structured methodologies, solutions for effective testing, resource allocation, and status determination. Full details are available from Eduteach Inc., Suite 907, 162 North State St., Chicago, IL 60601, (312) 641-1370.

*June 14-16*

**Introduction to Microprocessors**, University of Texas, Austin. This course will stress basic concepts with hands-on experience. Participants will write and run simple programs on a Z80-based Micro-Professor training system. Contact the College of Engineering, University of Texas, Austin, TX 78712, (512) 471-3396.

*June 14-16*

**Ohmcon/83, High Technology Electronics Exhibition and Convention**, Cobo Hall, Detroit, MI. For details, contact Electronic Conventions Inc., 999 North Sepulveda Blvd., El Segundo, CA 90245, (800) 421-6816; in California, (213) 772-2965.

*June 14-16*

**Technology Opportunity Conference**, Washington, DC. This conference will focus on the convergence of optical-storage, videodisc, and computer technologies. For full details, contact Technology Opportunity Conference, POB 14817, San Francisco, CA 94114, (415) 626-1133.

*June 14-18*

**Electronica**, Earls Court Exhibition Centre, London, England. This exhibition on laboratory technology aims to show the latest in instrumentation, equipment, and services for life and physical sciences. For details, contact Good Relations Ltd., 15 Adeline Place, London WC1B 3AJ, England; tel: (01) 636-6561; Telex: 265903.

*June 15-17*

**Basics of Power Electronics**, Los Angeles, CA. For information on this course, contact Teslaco, Suite 6, 490 South Rosemead Blvd., Pasadena, CA 91107, (213) 795-1699.

*June 15-17*

**The Twenty-first Annual Meeting of the Association for Computational Linguistics**, Massachusetts Institute of Technology, Cambridge, MA. Papers to be presented will address syntax, the representation of knowledge, machine and machine-aided translation, and other linguistically and computationally significant topics. Information is available from Don Walker, Artificial Intelligence Center, SRI International EJ278, Menlo Park, CA 94025, (415) 859-3071.

*June 16-17*

**Clinical Laboratory Computers: Symposium 1983**, Towsley Center for Continuing Medical Education, Ann Arbor, MI. Course credit will be offered. Contact the Office of Continuing Medical Education, Towsley Center Box 057, University of Michigan Medical School, Ann Arbor, MI 48109, (313) 763-1400.

*June 16-18*

**Personal Computer Interfacing and Scientific Instrument Automation**, Reston, VA. This workshop provides each participant with hands-on experience in wiring and testing interfaces. The fee is \$395. Call or write Dr. Linda Leffel, C.E.C., Virginia Polytechnic Institute and State University, Blacksburg, VA 24061, (703) 961-4848.

*June 17-19*

**PC '83/West**, Brooks Hall/Civic Center Complex, San Francisco, CA. This show will bring together users, developers, distributors, and retailers of products that are compatible with the IBM Personal Computer. Seminars, workshops, demonstrations, and a conference program will aim to educate users on product features and capabilities. Further details are available from Northeast Expositions, 826 Boylston St.,

Chestnut Hill, MA 02167, (800) 841-7000; in Massachusetts, (617) 739-2000.

June 19-23

**Conference on Computer Vision and Pattern Recognition-CVPR '83**, Crystal City Hyatt, Arlington, VA. This program, at one time called the Pattern Recognition and Image Processing Conference, provides a forum for the presentation of papers on vision, pattern recognition, and image processing. For full details, write to CVPR '83, POB 639, Silver Spring, MD 20901.

June 19-24

**Problem Solving Leadership**, Washington, DC. This workshop, designed to help managers and technical leaders enhance their problem-solving effectiveness, is sponsored by the Data Processing Management Association Ed-

ucation Foundation. Further information is available from Judy Cook, Weinberg & Weinberg, R R #2, Lincoln, NE 68505, (402) 781-2542.

June 20-24

**Physical Data Analysis**, Columbia Inn, Columbia, MD. For details, contact the Continuing Education Institute, Oliver's Carriage House, 5410 Leaf Treader Way, Columbia, MD 21044, (301) 596-0111; on the West Coast, (213) 824-9545.

June 20-July 15

**Computers in Education '83-CE '83**, Rutgers University, New Brunswick, NJ. The theme of this conference is "Necessary Direction for Computer Education: Navigational Aids for the 80s." The focus will be on the impact of microcomputers on elementary, secondary, and college-level education. Con-

ference highlights include presentations, special-interest sessions, a software exchange, film festival, and a variety of exhibits. The fee for the conference is \$145.

Running concurrently with CE '83, the Summer Institute for educators offers 40 short courses, ranging in length from one to twelve days. Topics include "The Turtle is the Teacher: An Introduction to Logo," "Using Computers in the Elementary School," and "Algorithm Design." These courses are \$95 per day; preregistration is required. For additional information, contact Dr. Mitchell E. Batoff, Director CE '83, Institute for Professional Development, Suite D, 245 Nassau St., Princeton, NJ 08540, (609) 924-8333.

June 21-23

**The Engineer as a Manager**, Quail Lodge, Carmel, CA.

For details, contact the Continuing Education Institute, Oliver's Carriage House, 5410 Leaf Treader Way, Columbia, MD 21044, (301) 596-0111; on the West Coast, (213) 824-9545.

June 22-24

**Machine Vision/Image Understanding**, Los Angeles, CA. For details, contact the Continuing Education Institute, Oliver's Carriage House, 5410 Leaf Treader Way, Columbia, MD 21044, (301) 596-0111; on the West Coast, (213) 824-9545.

June 23

**The Twenty-second Annual Technical Symposium of the Washington DC Chapter of the Association for Computing Machinery**, National Bureau of Standards, Gaithersburg, MD. The theme for this event is "Microcomputer Systems: Tools or Toys?" Topics

# Your customer gets a receipt.

## You get:

- |   |  |
|---|--|
| <input type="checkbox"/> On-line inventory control.     | <input type="checkbox"/> Printed price tags.   |
| <input type="checkbox"/> A 65,000 item inventory.       | <input type="checkbox"/> Sales by employee.    |
| <input type="checkbox"/> Data for 99 sales departments. | <input type="checkbox"/> Financial statements. |
| <input type="checkbox"/> Real-time price lookup.        | <input type="checkbox"/> Budget analysis.      |
| <input type="checkbox"/> Detailed daily reports.        |  |

With an ARBA Register on the sales counter and the point-of-sale software interfaced to virtually any computer, your business stays as up-to-the-minute as your last customer purchase.

# ARBA

ARBA Fine Business Computing Corporation  
890 E. Roosevelt Rd.  
Lombard, Illinois 60148  
(312) 620-8566



## WINCHESTER DISK SYSTEMS.



### A Complete Winchester/Floppy Disk System.

- S-100 (IEEE-696)
- Disk controller with 4 ports; supports 5 1/4" and 8" drives (floppy and/or Winchester) on same cable.
- Z80 CPU 4 or 6 MHz, 64KRAM, 2 serial I/O, 1 parallel, CTC.
- Supports 8MB Amlyn floppy. CP/M® and BIOS included.
- Package price: \$1,195.00 (OEM pricing upon request). May be purchased separately. Winchester and floppy drives available.

### SIGEN Corporation

1800 Wyatt Dr., #6, Santa Clara, CA 95054  
408/988-2527

CP/M is a trademark of Digital Research.



## Event Queue

of interest include systems software, human factors, and office systems. For further details, contact Howard Weeks Associates, 15201 Shady Grove Rd., Rockville, MD 20850.

June 23-24

**Computer Graphics in Design**, Chicago, IL. This seminar begins with the historical development of computer images and an introduction to graphics programming. It ends with participants using a digital-art system to create charts, graphs, and free-form art. It's sponsored by the Dynamic Graphics Educational Foundation (DGEF). For a catalog and registration details, contact DGEF, Department R, 6000 North Forest Park Dr., POB 1901, Peoria, IL 61656, (309) 688-8866, ext. 505.

June 23-24

**Shared Information Management Seminar**, Hyatt Regency, Chicago, IL. This seminar is designed for department heads, information-center managers, senior applications personnel, and data-processing support coordinators. It strives to explain how to manage the development of new systems with reduced risk and how to introduce new flexibility into data processing. The fee is \$455. Group discounts are available. For further information, contact Bob Mishler, Boeing Computer Services Co., Education and Training Division, POB 24346, Mail Stop 9A-90, Seattle, WA 98124, (800) 342-7700; in Washington, call collect, (206) 575-7700.

June 23-25

**The Executive Microcomputer Conference & Exposi-**

**tion**, Sheraton Centre, New York, NY. The main conference program will offer sessions ranging from how to buy a personal computer to new and future trends in personal computing. A special seminar for educators and administrators, "Microcomputers in Education," will highlight issues in educational computing. For details, contact CW Communications Inc., 375 Cochituate Rd., POB 880, Framingham, MA 01701, (800) 225-4698; in Massachusetts, (617) 879-0700.

June 27-28

**Computer Literacy for Lawyers**, San Francisco, CA. This seminar is intended to introduce attorneys to basic computer concepts and their application to the practice of law. Topics will include the specific uses, costs, and benefits of using computers in

legal practice. The fee is \$550, which includes reference materials. Group discounts are available. For further information, contact Kathryn Mann, Center for Legal Studies, 1926 Arch St., Philadelphia, PA 19103, (215) 732-6999.

June 27-30

**The World of CAD/CAM**, Marriott Resort, Newport Beach, CA. This seminar provides an overview of how manufacturing will change as the automated factory becomes a reality. It will consist of four one-day presentations in computer-aided engineering, design, manufacturing, and computer-integrated manufacturing. For a brochure, write or call the Center for Manufacturing Technology, 4170 Crossgate Dr., Cincinnati, OH 45236, (513) 791-8801.

# NEW!

## Aztec C II

• generates FAST 6502 code for APPLE, ATARI, and COMMODORE

## Aztec C86

• PC DOS, MSDOS, CP/M-86

## CROSS COMPILERS

• PDP 11, 8088/8086, 8080/Z80, 6502

## PORTABLE SOFTWARE APPLE CP/M IBM



# Leap into a new dimension with Aztec C!

### C COMPILERS — COMMON FEATURES:

• UNIX VER 7 compatibility • standard float, double, and long support • run time library with full I/O and source • fast compilation and execution • full language • cross compilers available

AZTEC C II CP/M (MP/M) \$199

• produces relocatable 8080 source code • assembler and linker supplied • M80 interface • SID/ZSID debugger interface • library utility • APPLE requires 280 and 16K card

AZTEC C II APPLE DOS \$199

• produces fast relocatable 6502 source code • relocating assembler supplied • APPLE SHELL • VED editor • library and other utilities • requires 16K card

AZTEC C86 IBM PC MSDOS CP/M-86 \$249

• produces relocatable 8088/8086 source code • assembler and linker supplied

ORDER BY PHONE OR BY MAIL — Specify products and disk format — Manuals only \$30

# MANX

software systems

Box 55, Shrewsbury, N.J. 07701 (201) 780-4004



CP/M FORMATS: 8" STD. HEATH, APPLE, OSBORNE, NORTHSTAR OUTSIDE USA — Add \$10  
In N.J. add 6% sales tax



June 27-July 1

**Auditing Integrity Controls in the Contemporary Computer Environment**, San Diego, CA. This program is designed to provide an overview of the computer environment, its controls, and its interrelationships. It combines theoretical and practical approaches for electronic data-processing auditing, with an emphasis on integrity controls and related operational concerns. Further details are available from Marge Umlor, EDP Auditors Foundation, 373 South Schmale Rd., Carol Stream, IL 60187, (312) 682-1200.

June 27-July 1

**Managing the Development and Introduction of New Products**, University of Wisconsin, Madison. The fee for this course is \$595. Contact William C. Dries, University of Wisconsin-Extension, Department of Engineering and Applied Science, 432 North Lake St., Madison, WI 53706, (608) 262-2061.

June 27-July 1

**Physical Data Analysis**, Miramar-Sheraton Hotel, Santa Monica, CA. For details, contact the Continuing Education Institute, Oliver's Carriage House, 5410 Leaf Treader Way, Columbia, MD 21044, (301) 596-0111; on the West Coast, (213) 824-9545.

June 28-30

**National Educational Computer Conference**, New York Statler Hotel, New York, NY. The theme of this conference is "Higher Instructional Techniques in Education." Seminars, exhibits, hands-on demonstrations, and workshops will highlight this event. Additional information is available from the National Educational Computer Library, POB 293, New Milford, CT 06776, (203) 354-7760.

June 29-July 1

**Microcomputers, Electronic Toys, and Genius Machines in Early Childhood Education**, Teachers College, Columbia University, New York, NY. This conference will examine the growing use of new technology in the entertainment and education of children. Events will include panel discussions, workshops, a computer fair, and a film festival. Participants can attend on a non-credit basis for \$125 or for graduate credit at \$240 per point. For further information, contact the Program in Early Childhood Education, Box 9, Teachers College, Columbia University, New York, NY 10027, (212) 678-3971.

June 29-July 1

**Tertiary Education for the Age of Communications**, Royal Melbourne Institute of Technology, Melbourne, Australia. Formal presentations will focus on the educational implications of new technologies on the needs of industry and the requirements of curriculum development. Areas of interest include telecommunications, engineering, and computer and information sciences. For details, contact the International Conference on Communications, Royal Melbourne Institute of Technology, G.P.O. Box 2476V, Melbourne, Victoria 3001, Australia; tel: 3452822; Telex: AA36406.

---

## July 1983

---

July

**Continuing Engineering Education Courses**, George Washington University, Washington, DC. Among the courses offered are "Hands-On Pascal Computer Programming," "Reliability of Computer Software and

# megabytes



The MARK SERIES WINCHESTER Disk Drive Unit

- CAPACITY - 20, 33 and 46 megabytes.
- SIZE - 5 1/4 floppy size (6x4x2).
- SPEED - Twice as fast as the competition (30 milliseconds).
- COMPATIBILITY - Hardware and Software interfaces for TRS-80, Apple II, IBM-PC, CP/M, Turbodus, S-100, any 8 bit parallel port, any Z-80, computer such as Osborne, Xerox, Televideo, Northstar Advantage, NEC, AVL-Eagle.
- EXCEPTIONAL WARRANTY - Comprehensive 1 year parts and labor.
- NOTHING ELSE TO BUY - Subsystems include disk, chassis with power supply, controller, cables, hardware adapter and software pkg.
- OEM quantity one prices start as low as \$2664.

**PH**  
ASSOCIATES

8720 Old Courthouse Road, Vienna, Virginia 22180  
703-281-5762

## CHANGE YOUR LETTER WRITING DRUDGERY INTO PUSHBUTTON LUXURY.

If you're still writing all your business letters yourself, you're spending a lot of time, energy and money on needless drudgery.

You need LetterBANK™.

The inexpensive word processing applications package designed to free you from all that - while making your essential day-to-day correspondence appear more businesslike and professional than ever.

LetterBANK is no ordinary form letter package. It's a sophisticated piece of applications software with over 200 professionally written letters you can use as is, expand, modify or even rewrite to exactly fit your needs.

There are letters for hiring and firing, sales promos, product introductions, collection of overdue accounts, information requests, internal memos, news releases - you name it and there's a LetterBANK letter to cover it.

Best of all, LetterBANK is a luxury you can afford. Because the entire package costs just \$99.

Ask for it wherever you buy business computer software. Or order direct by calling 1-800-972-5600 (in NH 431-4800). C.O.D., VISA, and MasterCard accepted.

# LetterBANK

If you're not using LetterBANK, you're not really using your word processor.

A product of The Wyndham Group, Ltd.  
Business Applications Software / 125 Mirona Road / Portsmouth, NH 03801 / (603) 431-4800

## Event Queue

Computing Networks," and "Computer Memory Systems." Fees range from \$625 to \$855. For details, contact Douglas Green, Continuing Engineering Education, George Washington University, Washington, DC 20052, (800) 424-9773; in the District of Columbia, (202) 676-8512.

*July-October*

**Repair of Microcomputer-based Equipment**, various sites throughout the U.S. and Canada. This seminar describes general servicing practices that are applied to the subsystems of any microprocessor family. This lecture/laboratory sequence is intended for field-service personnel, engineers, and technical writers. For details, contact the Registrar, Testek Consultants Inc., 1000 North Patton St., Arlington Heights, IL 60004, (312) 577-2134.

*July 5-7*

**Technology Opportunity Conference**, London, England. For details, see June 14-16.

*July 5-August 4*

**Laboratory Use of Microcomputers**, Brandeis University, Waltham, MA. This is an introductory, hands-on course in data-acquisition by microcomputer. Topics of interest include the use of the IEEE-488 parallel interface bus, handshaking, analog-to-digital and digital-to-analog conversion, and vectored interrupts. Participants will be expected to produce executable programs for each method. Some knowledge of BASIC is required. Tuition is \$495 and the course fee is \$15. For details, contact the Summer School Office, Brandeis University, Waltham, MA 02254.

*July 8-10*

**Computerfest '83: The Eighth Annual Midwest Affiliation**

**of Computer Clubs Computerfest**, Harbourfront, Toronto, Ontario, Canada. Seminars, exhibits, drawings, a computer flea market, and an auction will cover a broad range of topics, including computer languages and applications for the disabled. Carl Helmers, editor of *Robotics Age* magazine, is the featured speaker. Further information is available from the Toronto Region Association of Computer Enthusiasts, POB 6922, Toronto, Ontario M5W 1X6, Canada.

*July 10-11*

**The Role of Microcomputers in Music Education**, Triton College, River Grove, IL. Seminars, workshops, demonstrations, and manufacturer displays will highlight this event. Topics of interest include ear training, improvisation, computer basics for the teacher, choosing the right computer, and using computers in music for the disabled. The fee is \$25 a day; \$40 for both days. For details, contact Michael Ferrelli, Triton College, 2000 Fifth Ave., River Grove, IL 60171.

*July 11-13*

**The 1983 Summer Computer Simulation Conference**, Hyatt Regency, Vancouver, British Columbia, Canada. Full details are available from the Society for Computer Simulation, POB 2228, La Jolla, CA 92038, (714) 459-3888.

*July 11-15*

**Technology Opportunity Conference**, Los Angeles, CA. For details, see June 14-16.

*July 12-14*

**Audio-Visual America**, Hyatt Regency Hotel, Chicago, IL. The second annual Audio-Visual America will feature hardware and software exhibits, screenings of shows, and approximately 60

workshops on planning, production, and management. For more information, contact A-V America, IF Associates, 3150 Spring St., Fairfax, VA 22031, (703) 273-8272.

*July 14-15*

**Computer Graphics in Design**, Seattle, WA. For details, see June 23-24.

*July 14-16*

**Personal Computer Interfacing and Scientific Instrument Automation**, Charleston, SC. For details, see June 16-18.

*July 18-28*

**Microcomputer-based Instrumentation for Schools**, Middletown, OH. This workshop is designed for science and mathematics teachers in both secondary and undergraduate levels. Participants will learn how to construct and use simple, low-cost analog-to-digital and digital-to-analog converters for monitoring and controlling physical phenomena in classrooms and laboratories. Contact Bill Rouse, 301E McGuffey Hall, Miami University, Oxford, OH 45056, (513) 529-2141.

*July 20-21*

**Token-based Local Networks**, Washington, DC. This program is the second of four parts in the Architecture Technology Corporation's 1983 Forum Series. The series will bring together manufacturers and users of local network schemes to exchange information in an informal setting. The format includes presentations, panel discussions, and a technological summary. The fee is \$395 per person. For details, contact the Architecture Technology Corp., POB 24344, Minneapolis, MN 55424, (612) 935-2035.

*July 21-22*

**Shared Information Management Seminar**, Hyatt Re-

gency, Cambridge, MA. For details, see June 23-24.

*July 25-28*

**The World of CAD/CAM**, Dunfey's Resort, Hyannis, MA. For details, see June 27-30.

*July 25-29*

**Robot Manipulators, Computer Vision, and Automated Assembly**, Artificial Intelligence Laboratory, Massachusetts Institute of Technology, Cambridge, MA. The emphasis of this short course will be on developing strategies for the solution of problems that will arise in advanced automation: sensing, spatial reasoning, and manipulation. The use of current industrial robots and binary vision systems will be covered. For details, contact the Director of the Summer Session, Room E19-356, Massachusetts Institute of Technology, Cambridge, MA 02139.

*July 25-29*

**SIGGRAPH '83**, Detroit, MI. This is the tenth annual conference on computer graphics and interactive techniques sponsored by the Special-Interest Group on Computer Graphics of the Association for Computing Machinery (SIGGRAPH ACM). This show features tutorials, films and video tapes, exhibits of computing equipment, and a formal technical program. For full details, contact the SIGGRAPH '83 Conference Office, 111 East Wacker Dr., Chicago, IL 60601, (312) 644-6610.

---

## August 1983

---

*August 2-4*

**Microprocessor Background for Management Personnel**, University of California, Berkeley. The fee for this course is \$565. Full details are available from Continuing





# Books Received

*All About Chess and Computers*, David Levy and Monroe Newborn. Rockville, MD: Computer Science Press, 1982; 150 pages, 14 by 22 cm, hardcover, ISBN 0-914894-75-7, \$19.95.

*Assembly Language Graphics for the TRS-80 Color Computer*, Don Inman and Kurt Inman. Reston, VA: Reston Publishing Co., 1983; 280 pages, 37 by 51 cm, hardcover, ISBN 0-8359-0318-4, \$19.95.

*Celestial BASIC*, Eric Burgess. Berkeley, CA: Sybex, 1982; 300 pages, 42 by 54 cm, softcover, ISBN 0-89588-087-3, \$13.95.

*The Computer-The Business-The Staff*, Jack Bender. Princeton, NJ: Petrocelli Books, 1982; 123 pages, 16 by 24 cm, hardcover, ISBN 089433-196-5, \$17.50.

*Computer Peripherals That You Can Build*, Gordon W. Wolfe. Blue Ridge Summit, PA: Tab Books, 1982; 272 pages, 46.6 by 51 cm, softcover, ISBN 0-8306-1449-4, \$13.95.

*Controlling Software Projects: Management, Measurement & Estimation*, Tom DeMarco. New York: Yourdon Press, 1982; 296 pages, 42 by 58 cm, softcover, ISBN 0-917072-32-4, \$28.50.

*Crunchers: 21 Simple Games for the Timex/Sinclair 1000 2K*, Yin Chiu and Henry Mullish. New York: McGraw-Hill, 1983; 137 pages, 33 by 49 cm, softcover, ISBN 0-07-010831-5, \$8.95.

*Digital Computer Structure and Design*, 2nd ed., R. Townsend. Woburn, MA: Butterworths, 1982; 252 pages, 32 by 51 cm, softcover, ISBN 0-408-01155-6, \$24.95.

*Discrete Structures of Computer Science*, Leon S. Levy. New York: John Wiley & Sons, 1980; 310 pages, 40 by 55 cm, hardcover, ISBN 0-471-03208-5, \$25.95.

*Electrical Power Systems:*

*Design and Analysis*, Mohamed E. El-Hawary. Reston, VA: Reston Publishing Co., 1983; 785 pages, 44 by 58 cm, hardcover, ISBN 0-8359-1627-8, \$29.95.

*iAPX 88 Book*. Santa Clara, CA: Intel Corp., 1981; 80 pages, 42 by 54 cm, softcover, ISBN 0-8359-3016-5, \$12.95.

*Instructional Computing . . . Ten Case Studies*, Carol Hargan and Beverly Hunter. Arlington, VA: ERIC Document Reproduction Service (POB 190), 1978; 225 pages, 18 by 23 cm, softcover, ISBN none, \$17.90.

*Interactive Computer Graphics Systems*, William C. House, ed. Princeton, NJ: Petrocelli Books, 1982; 185 pages, 38 by 56 cm, hardcover, ISBN 089433-188-4, \$25.

*Interfacing to Microprocessors and Microcomputers*, Owen Bishop. Woburn, MA: Butterworths, 1982; 147 pages, 33 by 51 cm, softcover, ISBN 0-408-01129-7, \$12.50.

*Introduction to Digital Logic Techniques and Systems*, Matthew Mandl. Reston, VA: Reston Publishing Co., 1983; 201 pages, 37 by 51 cm, hardcover, ISBN 0-8359-3175-7, \$23.95.

*Japanese Manufacturing Techniques: Nine Hidden Lessons in Simplicity*, Richard J. Schonberger. New York: The Free Press/Macmillan Publishing Co., 1982; 244 pages, 15.8 by 24 cm, hardcover, ISBN 0-02-929100-3, \$14.95.

*Logic Circuits and Microcomputer Systems*, Claude A. Wiatrowski and Charles H. House. New York: McGraw-Hill, 1980; 413 pages, 41 by 57 cm, hardcover, ISBN 0-07-070090-7, \$33.95.

*Machine Language Disk I/O & Other Mysteries*, Michael J. Wagner. Upland, CA: IJG Inc., 1982; 272 pages, 21 by 27.5 cm, softcover, ISBN 0-936200-06-5, \$29.95.

*Making Money with your Microcomputer*, Robert J. Traister and Rich Ingram. Blue Ridge Summit, PA: Tab Books, 1982; 160 pages, 31 by 50 cm, softcover, ISBN 0-8306-1506-7, \$7.95.

*Mathematical Problem-Solving with the Microcomputer*, Stephen L. Snover and Mark A. Spikell. Englewood Cliffs, NJ: Prentice-Hall, 1982; 190 pages, 41 by 55 cm, softcover, ISBN 0-13-561811-8, \$8.95.

*Microprocessors and Logic Design*, Ronald L. Krutz. New York: John Wiley & Sons, 1980; 467 pages, 40 by 56 cm, hardcover, ISBN 0-471-02083-4, \$34.95.

*Microprocessors for Industry*, J.N.W. Baldwin. Woburn, MA: Butterworths, 1982; 149 pages, 33 by 52 cm, hardcover, ISBN 0-408-00517-3, \$19.95.

*Personal Graphics for Profit and Pleasure on the Apple II Plus Computer*, Michael P. Barnett and Graham K. Barnett. Boston, MA: Little, Brown and Co., 1983; 192 pages, 21.5 by 27.8 cm, softcover, ISBN 0-316-08164-7, \$14.50.

*The Physician's Guide to Desktop Computers*, Mark Harrison Spohr, M.D. Reston, VA: Reston Publishing Co., 1983; 222 pages, 37 by 51 cm, hardcover, ISBN 0-8359-5548-6, \$21.95.

*A Practical Guide to Computer Communications and Networking*, Richard Deasington. New York: John Wiley & Sons, 1982; 132 pages, 15.5 by 23.5 cm, hardcover, ISBN 0-470-27545-6, \$39.95.

*Professional Programming Techniques—Starting with the Basics*. Richard Galbraith.

## UV EPROM ERASER

- ★ Erases over 15 EPROMS - 15 minutes erase time
- ★ Element life 7700 hours
- ★ Intensity: 12W<sub>s</sub> 1/2 cm<sup>2</sup> at 1"
- ★ Erases all UV EPROMS (2716, 2732, 2516, 2532, etc.)

# \$49.95\*

\*HOBBY MODEL

### INDUSTRIAL MODEL

QUV-T8 / 2N

\$68.95

WITH TIMER AND SAFETY SWITCH

QUV-T8 / 2T

\$97.50

### INTELLIGENT PROGRAMMER STAND ALONE RS-232

- ★ RELIABLE
- ★ EASY COPY (No external equipment needed)
- ★ USER FRIENDLY

COMPATIBLE:  
IBM PC, TRS-80, APPLE, CPM  
FLEX, TEKTRONICS, MDS

**(MCS-48)**  
PROGRAMMING

PRICE INCLUDES PERSONALITY MODULE

**\$489.00**

ROGRAMS: 2508, 2516, 2532, 2716, 27C16, 27C32, 2732, 2732A, 2758, 8748, 8749H, 8748H

OPTIONAL MODULES: 2564, 2764, 8755A, 8741

- ★ STAND ALONE, CRT. OR COMPUTER CONTROL
- ★ UPLOAD/DOWNLOAD IN MOTOROLA OR INTEL HEX FORMAT
- ★ MICROPROCESSOR BASED - 4 K INTERNAL RAM
- ★ 90 DAY PARTS & LABOR WARRANTY ON ALL PRODUCTS

SOON TO BE RELEASED:

**PROMPRO-8 128K Version \$689.**

**MONEY BACK GUARANTEE**

**LOGICAL DEVICES INC.**

781 W. OAKLAND PARK BLVD. • FT. LAUDERDALE, FL 33311

Phone Orders (305) 974-0967 • TWX: 510-955-9496

Blue Ridge Summit, PA: Tab Books, 1982; 308 pages, 31 by 50 cm, softcover, ISBN 0-8306-0128-7, \$10.95.

*Programming the PL/I Way*, Dan Smedley. Blue Ridge Summit, PA: Tab Books, 1982; 300 pages, 31 by 50 cm, softcover, ISBN 0-8306-1414-1, \$9.95.

*Quick Pascal*, David L. Matuszek. New York: John Wiley & Sons, 1982; 179 pages, 15 by 23 cm, softcover, ISBN 0-471-86644-X, \$11.95.

*Raising Venture Capital*, Deloitte Haskins & Sells. New York: Entrepreneurs' Financial Advisory Group (1114 Avenue of the Americas), 1982; 104 pages, 14 by 23 cm, softcover, ISBN-none, \$5.

*A 60-Minute Guide to Microcomputers*, Lew Hollerbach. Englewood Cliffs, NJ: Prentice-Hall, 1982, 137 pages, 33 by 48 cm, softcover, ISBN 0-13-811422-6, \$6.95.

*So You Think You Need Your Own Business Computer*, William E. Perry. New York: John Wiley & Sons, 1982; 201 pages, 41 by 50 cm, softcover, ISBN 0-471-86196-0, \$14.95.

*Some Common BASIC Programs: IBM Personal Computer Edition*, Lon Poole, Mary Borchers, and Peter M. Burke. Berkeley, CA: Osborne/McGraw-Hill, 1982; 195 pages, 50 by 65 cm, softcover, ISBN 0-9311988-83-7, \$14.99.

*Successful Software for Small Computers*, Graham Beech. New York: John Wiley & Sons, 1982; 182 pages, 17 by 25.5 cm, softcover, ISBN 0-471-87458-2, \$14.95.

*TRS-80 Microcomputer Sourcebook for Educators*. Fort Worth, TX: Radio Shack Education Division, 1980; 27 pages, 18.5 by 24.3 cm, softcover, ISBN-none, \$1.

*The Telidon Book*, David Godfrey and Ernest Chang. Reston, VA: Reston Publishing Co., 1981; 309 pages, 38 by 55 cm, hardcover, ISBN 0-8359-7548-7, \$39.95.

*Understanding APL*, Susan M. Bryson. Sherman Oaks, CA: Alfred Publishing Co. Inc. (POB 5964), 1982; 45 pages, 25.6 by 66 cm, softcover, ISBN 0-88284-220-X, \$2.95.

*Understanding Artificial Intelligence*, Paul Y. Gloess. Sherman Oaks, CA: Alfred Publishing Co. Inc. (POB 5964), 1981; 47 pages, 25.6 by 66 cm, softcover, ISBN 0-88284-150-5, \$2.95.

*Understanding Atari Graphics*, Michael Boom. Sherman Oaks, CA: Alfred Publishing Co. Inc. (POB 5964), 1982; 48 pages, 10.8 by 28 cm, softcover, ISBN 0-88284-224-2, \$2.95.

*Understanding LISP*, Paul Y. Gloess. Sherman Oaks, CA: Alfred Publishing Co. Inc. (POB 5964), 1982; 64 pages, 25.6 by 66 cm, soft-

cover, ISBN 0-88284-219-6, \$2.95.

*User's Handbook to the IBM Personal Computer*, Jeffrey R. Weber. Cleveland, OH: Weber Systems Inc. (8437 Mayfield Rd.), 1982; 294 pages, 14 by 21.5 cm, softcover, ISBN 0-938862-13-8, \$13.95.

*Visicalc Book for the IBM Personal Computer*, Donald H. Beil. Reston, VA: Reston Publishing Co., 1983; 335 pages, 18 by 24 cm, hardcover, ISBN 0-8359-8396-X, \$20.

*What's Where in the Apple*, William F. Luebbert. Chelmsford, MA: Micro Ink (POB 6502), 1982; 256 pages, 22 by 28 cm, spiral bound, ISBN 0-938222-09-0, \$24.95.

*Word Processing Simulations for Text Editors, Information Processors and Personal Computers*, Carol Ann Wheeler and Marie Dalton. New York: John Wiley & Sons, 1983; 224 pages, 21.5 by 28 cm, looseleaf, ISBN 0-471-08159-0, \$12.95. ■

## OUR ISOLATORS FOR YOUR PROTECTION

### Prevents:

disk drive woes, printer interaction, memory loss and damage due to lightning or AC power line disturbances.



### Commercial Grade Isolators

ISO-1	3 Isolated Sockets	\$76.95
ISO-2	2 Isolated Socket Banks, 6 Sockets	76.95

### Industrial Grade Isolators

ISO-3	3 Double Isolated Sockets	115.95
ISO-11	2 Double Isolated Banks, 6 Sockets	115.95

### Laboratory Grade Isolators

ISO-17	4 Quad Isolated Sockets	200.95
ISO-18	2 Quad Isolated Banks, 6 Sockets	169.95

Circuit Breaker, any model (Add-CB)	Add 10.00
Remote Switch, any model (Add-RS)	Add 18.00

**ESP® Electronic Specialists, Inc.**

171 South Main Street, Box 389, Natick, Massachusetts 01760

Toll Free Order Desk 1-800-225-4876

MasterCard, VISA, American Express

This is a list of books received at BYTE Publications during this past month. Although the list is not meant to be exhaustive, its purpose is to acquaint BYTE readers with recently published titles in computer science and related fields. We regret that we cannot review or comment on all the books we receive; instead, this list is meant to be a monthly acknowledgment of these books and the publishers who sent them.

## BYTE's Bits

### Call for Papers

*Topic: A Journal of the Liberal Arts* seeks papers concerning the use of computers in education or research in the liberal arts. Two formats will be considered for publication: 1000-word papers describing specific experiments in the use of computers in collegiate instruction or research and 2500-word papers

on the educational value of computers and the philosophical issues involved in introducing the computer into the liberal arts environment. Preference will be given to those reports concerning fields not traditionally involved with computers. Contact Dr. Thomas W. Hart and Dr. Joseph Levenstein, Washington and Jefferson College, Washington, PA 15301. ■

## Personal Instruments Might Transform Labs

Today's sophisticated stand-alone laboratory equipment from industry giants such as Hewlett-Packard and Philips incorporates preprogrammed microprocessor systems. GPIB (general-purpose interface bus) controller boards or intelligent terminals make these devices user-programmable. Although this stringing together of stand-alone equipment works well enough, it is an expensive approach and often results in tasks being tailored to the tools at hand.

The two dozen employees of the Oregon-based Northwest Instrument Systems (NWIS) are out to change all that. Here's the idea: create a line of high-performance test instruments, make them peripherals for the Apple II/IIe rather than stand-alone units so that costly processors and displays can be omitted, and pass the savings on to your customers. It's a fetching idea, especially when company spokesmen point out that a complete waveform stimulus/acquisition system made up of an Apple IIe, video monitor, disk drive, a programmable oscilloscope, and a function or waveform generator can be purchased for less than \$4000.

### The Personal Instruments Approach

NWIS builds its products around a concept known as personal instruments. Personal instruments are easy-to-use, general-purpose computer peripherals that permit customized control over the instrument, analysis, and displayed results. Their architecture provides direct access to a computer, which enhances productivity because combinations of commands can be initiated with standard menu-driven software coupled with user-written programs. The overall system cost is said to be three to five times less than conventional units because of the elimination of redundant memories and other hardware that force prices skyward.

### The Product Line

Introduced early in 1982, the Model 85 aScope turns any Apple II into a fully programmable digital-memory oscilloscope. It features signal averaging, 50-MHz dual-channel configuration, and hard-copy capabilities. The Model 85 comes with disk-based oscilloscope setups and offers menu-driven commands, keyboard-controlled functions, and the ability to perform as a waveform digital voltmeter.

This past April, NWIS unveiled its Model 65 aGen Programmable Function Generator and the Model 75 aSource Arbitrary Waveform Generator. Both devices operate as programmable waveform generators and can be combined with the aScope and an Apple for a complete programmable waveform, stimulus/acquisition system. Generated signals can be automatically changed as a function of the acquired waveform via analysis performed by a program resident in the Apple.

The aGen generates sine, square, triangle, ramp, and pulse waveforms at frequencies ranging from 0.5 Hz (hertz) to 5 MHz (megahertz) and at amplitudes to 20 V (volts) peak-to-peak into an open circuit or 10 V peak-to-peak into 50 ohms. It operates in continuous, triggered, gated, or N-burst modes and has AM/FM inputs and self-prompting menus.

The aSource features a waveform editor that lets you define complex waveforms with mathematical expressions or construct waveforms from previously stored waveform segments. The editor also provides for file management, insertion and deletion of segments, and interpretation of mathematical equations. Waveform resolution is 12 bits. An enhanced version, the Model 76 aSource, offers waveform record lengths of up to 4K bytes. Both units operate in continuous, triggered, or arm modes. Triggered signals

can be initiated from the keyboard, software, or an external input.

The Model 2100 ISA (Interactive State Analyzer) offers 16 to 80 configurable channels of data input and memory depths of up to 4K bytes for each channel. It resides in the  $\mu$ Analyst Personal Instrument Mainframe, which holds the probes and memory cards. ISA can operate in 15 independent trigger/strobe states, with an event counter and word recognizers available in each state. ISA can label each state, store qualifiers for local control over data, and provide real-time programmable outputs. Its symbol control lets you define all the word recognizers in the trigger/strobe menu. Hexadecimal, octal, binary, or ASCII values are assigned in a symbol-table menu.

### Pricing

All NWIS's products are available factory-direct. The Model 85 aScope costs \$995, including manual and software. The aGen is priced at \$850. With the waveform editor, the Model 75 and Model 76 aSource generators are available for \$895 and \$995, respectively. The basic 1K-byte 16-channel Model 2100 with the  $\mu$ Analyst mainframe costs \$2495. With 4K-bytes of memory, it's \$2695. Probes are available optionally, and additional 16-channel memory cards can be purchased for the ISA.

NWIS, a venture-capital-funded firm, organized in mid-1981 by former Tektronix employees Jon Brick and Rick Cordray, plans to go public with a stock offering some time in the future. In addition to the Apple II and IIe, it plans to support other computers as laboratory acceptance grows. For complete details on this company and its products, contact Northwest Instrument Systems at POB 1309, Beaverton, OR 97075, (800) 547-4445; in Oregon, (503) 297-1434. ■

# What's New?

## 16-BIT COMPUTERS



### 16-Bit CEC8000S Suitable for Multitasking

Compac's 16-bit Model CEC8000S microcomputer is suitable for multiuser/multitasking environments. It's based on Zilog's Z8001 chip, which provides a 4-MHz clock, a 16-bit data bus, and a 24-bit address bus. The CEC8000S comes with 512K bytes of RAM (random-access read/write memory), a 20-megabyte Winchester drive, a 20-megabyte cartridge-tape unit, a parallel port, six serial ports, an MMU (memory-management unit), and Unix. Each of the CEC8000S's I/O controllers has a dedicated microprocessor, reducing central-processor overhead. Language support for program development includes the native C com-

piler, FORTRAN-77, COBOL, and BASIC.

Expansion options include up to 7.5 megabytes of RAM, a floating-point processor that combines 8086 and 8087 processors with up to 128K bytes of memory, as much as 160 megabytes of Winchester disk storage, one or two 1-megabyte floppy-disk drives, a 9-track tape drive, and up to eight additional serial ports. In OEM (original equipment manufacturer) quantities, the standard CEC8000S costs less than \$11,000. Contact Compac Microelectronics Inc., 3561 Ryder St., Santa Clara, CA 95051, (408) 773-0444.

Circle 550 on inquiry card.



### IBM PC-Compatible 16-Bit Computers

Corona Data Systems markets a line of 16-bit microcomputers that are compatible with the IBM Personal Computer. Available in both portable and desktop units, the Corona PC comes with a 320K-byte half-height floppy-disk drive, high-resolution green-phosphor monitor, 128K bytes of RAM (random-access read/write memory), serial and parallel ports, and high-resolution graphics capabilities. System software includes Microsoft's MS-DOS operating system, a version of BASIC with added graphics commands, CP/M-86, and Digital Research's GSX graphics package for CP/M. Both machines are built on Intel's 8088 microprocessor and can be equipped for 8087 floating-point mathematics coprocessor operation. The keyboard is fully detached and comes with a 6-foot cable. The standard monitor is a high-resolution, high-contrast monochrome display offering a resolution of 640 by 325 pixels and built-in graphics. Graphics can be intermingled with text on the screen. Characters have a

16- by 13-dot resolution.

These computers can be expanded with any IBM PC-compatible card. User memory can be increased to 512K bytes without the use of an expansion slot. Both systems have full-size card expansion slots and can carry a second half-height floppy-disk drive, and a 10-megabyte hard disk. In the portable unit, the hard disk is a separate attachment.

The desktop Corona PC costs \$2595, or \$2995 with a second disk drive. A unit with an internal 10-megabyte hard-disk drive and a single floppy-disk drive is available for \$4495. The base price for the portable PC is \$2395. With dual disk drives, it's \$2795. The 10-megabyte expansion unit for the portable computer costs \$2695. Both machines come with additional applications software. For complete information, contact Corona Data Systems Inc., Suite 110, 31324 Via Colinas, Westlake Village, CA 91361, (800) 621-6746; in California, (213) 991-1144. Circle 551 on inquiry card.



# What's New?



## 16-Bit Series 1000 Supports Large Software Library

Micro Five Corporation's 16-bit Series 1000 desktop computer supports a large library of applications software, including specialized programs for retail florists, beverage distributors, and insurance brokerages, and such operating systems as CP/M, MP/M, and MS-DOS, with the StarDOS operating system for multiuser applications provided as standard.

Series 1000 hardware features an 8-MHz 8088 microprocessor with no wait states and 16K bytes of onboard PROM (programmable read-only memory) containing self-test diagnostics for floppy- and hard-disk loaders, various utilities, and initialization bootstrap procedures. For local-area networking, the Series 1000 is equipped with multiprotocol serial chips for controlling asynchronous, byte-synchronous, or bit-synchronous communications. The Series 1000 can be configured with two to six I/O ports, which can be independently programmed for communications modes up to 19,200 bps (bits per second).

The Series 1000 is avail-

able in four standard configurations offering 128K bytes of RAM (random-access read/write memory), expandable to 512K bytes, up to 2 megabytes of floppy-disk storage, and two 5¼-inch Winchester hard-disk drives. Basic system prices range from \$4995 to \$8995. For complete details, contact Micro Five Corp., 17791 Sky Park Circle, Irvine, CA 92714, (714) 957-1517. Circle 552 on inquiry card.



## Rair Business Computer

The Rair Business Computer is a multiuser desktop system. The BC, capable of supporting four workstations, has 19 megabytes of integral Winchester storage, up to 1 megabyte of RAM (random-access read/write

memory), and 8- and 16-bit microprocessors. Its multitasking operating system is compatible with PC-DOS and 8- and 16-bit versions of CP/M and MP/M. An electronic spreadsheet, word processing, database management, and communications packages are supported, as are 16-bit implementations of BASIC, Pascal, and COBOL.

User workstations feature a high-resolution color monitor and an 83-key keyboard. The video display offers independent split-screen scrolling, foreground and background blink, and a display of 80 by 25 (each character can be displayed in one of eight colors). The keyboard connects to the monitor by means of a 6-foot coiled cable and has a 10-key numeric/editing keypad, shift and number locks, and 10 programmable function keys.

An entry-level, single-user system, configured with a 19-megabyte Winchester drive, 1-megabyte of floppy-disk storage, and 256K bytes of RAM (random-access read/write memory), costs \$8500. Memory upgrades in 256K-byte increments are \$1500. User workstations are priced at \$1500. Additional 19-megabyte Winchester drives are \$3500; workstation printers cost \$950. For OEM (original equipment manufacturer) prices or more information, contact Rair Computer Corp., 4101 Burton Dr., Santa Clara, CA 95050, (408) 988-1790. Circle 553 on inquiry card.



## Low-Profile Sage

Sage Computer Technology has incorporated half-height floppy-disk drives into its Sage II 16-bit microcomputer, reducing its dimensions to 3.9 inches high by 12.5 inches wide by 16.7 inches deep. The low-profile Sage II uses the 8-MHz Motorola 68000 microprocessor, which operates without wait states and is capable of executing 2 million instructions per second. The basic Sage II comes with 128K bytes of RAM (random-access read/write memory), a half-height 640K-byte floppy-disk drive, two RS-232C serial ports, a Centronics-type parallel port, an IEEE-488 port, and the Pascal p-System. When running CP/M, the Sage II supports the C language. Other languages available include FORTRAN, FORTH, APL, and Modula-2.

One or two floppy-disk drives, one- or two-user capabilities with multitasking, and up to 512K bytes of RAM are among the hardware options for the Sage II. Suggested retail prices range from \$3600 to \$5150. For more information, contact Sage Computer Technology, Suite 4, 35 North Edison Way, Reno, NV 89502, (702) 322-6868.

Circle 554 on inquiry card.

# What's New?

## FOREIGN



### 16-Bit Advance Compatible with IBM PC

For portability, the Advance 86's keyboard can tuck into the main computer unit. This 16-bit microcomputer, compatible with the IBM Personal Computer and running under MS-DOS, has 128K bytes of RAM (random-access read/write memory), 16K bytes of dedicated video memory, and 40K bytes of ROM (read-only memory) with diagnostics, BASIC, and a cassette operating system. The keyboard features 84 tactile keys and 10 programmable function keys. The Advanced 86 will support standard television, RGB (red/green/blue), composite color, or monochrome monitors while providing full-screen handling and resolutions of 40 or 80 by 25 (text) and 320 or 640 by 200 (graphics). Other video attributes include up to 16 colors, scroll, and reverse image. Built-in in-

terfaces for a cassette deck, light pen, control stick, and Centronics-type parallel printers are standard. It uses the 8086 microprocessor operating at 4.77 MHz.

Shugart 320K-byte 5¼ inch floppy-disk drives and a 10-megabyte Winchester-disk drive are available as options. The Advance 86 Model A costs \$599.95. With two floppy-disk drives and spreadsheet and word-processing software, the Model B costs \$1799.95. For \$3299.95, the Model B10W comes with the 10-megabyte Winchester hard-disk drive, one floppy-disk drive, and the software. Full details are available from Advance Products (U.K.) Ltd., 8a Hornsey St., London N7 8HR, England; tel: 01-609 0061; Telex 296701 JACK G. Circle 555 on inquiry card.

### After-Sales Service Center for Hire

Ferranti Computer Systems Ltd. is offering the services of its U.K. Electronic Support Centre to American companies seeking after-sales support for products sold in Europe. The Centre, located in Oldham, Lancashire, can provide a range of engineering resources for maintaining and servicing electronic equipment. Among the technologies supported are digital and analog circuitry, printed-circuit boards including multilayer, LSI- (large-scale integration) and microprocessor-based equipment, and germanium and silicon discrete component circuitry.

A descriptive brochure and information about available services can be obtained from Allan England or Stan Atkins, Electronics Support Centre, Ferranti Computer Systems Ltd., Waterhead, Oldham, Lancashire OL4 3JA, England; tel: 011 44 61 624 0281; Telex: 667645. Circle 556 on inquiry card.

### French Accounting Software Guide

The Practical Guide to Accounting Software Packages, written by Bernard Laur and Claude Salzman, contains up-to-date information on French computerized accounting systems and software. Designed for accountants and data-processing professionals, the

data in this book, based on a survey conducted last year, covers 188 accounting packages used in 5558 installations on microcomputers, minicomputers, and mainframes. Statistical analyses of the packages' characteristics and a comparative chart spanning 125 categories from price to hardware specifications are provided. A complete index classifies packages by supplier and computer. Other features include an overview of accounting software based on the AF-NOR (the French association for standardization) workshop specifications and a buying guide.

This 382-page book costs 450 francs, plus 50 francs postage. It's available from MLI-Editions D'Informatique, 54, rue de Bourgogne, 75007, Paris, France.

Circle 557 on inquiry card.

### Uninterruptible Power Supplies

The KD1-6 line of standard-range uninterruptible power-supply units are designed to protect electronic equipment. Produced by Avel-Lindberg Ltd., these devices are suitable for most environments where continuous spike- and transient-free stabilized power sources are essential, such as in computer and communication networks. They can be supplied in single units of 1, 2, or 3 kVA and in double units of 5 and 6 kVA. Standard hardware

# What's New?

includes a ferroresonant inverter, rectifier/battery charger, static or electro-mechanical transfer switches, and system-status monitoring alarm and control equipment.

With these power supplies, the degree of protection afforded to a power supply can be varied according to your level of priority by including a number of options. Battery

alternatives include lead/acid tubular cells, nickel cadmium, and maintenance-free cells. Depending on rated capacity, the cells can be installed in one or two lockable steel cabinets. Contact Avel-Lindberg Ltd., South Ockendon, Essex RM15 5TD, England; tel: 070 885 3444; Telex: 897106. Circle 558 on inquiry card.

## SOFTWARE



### Real Estate Package for Osborne

The Real Estate Investor Calcaid may be the first Supercalc spreadsheet enhancement for the Osborne computer. This package, configured by Simple Soft Inc., is marketed through authorized Osborne dealers. (Simple Soft's Real Estate Investor, parent program of Osborne Calcaid, runs on Xerox, IBM, and Apple computers.)

The Calcaid package for the Osborne provides in-depth financial analyses of both individual residences and income property purchases and sales. Designed for the novice, this program addresses com-

plex real-estate problems such as variable-rate mortgages, expense schedules, cash flows, tax benefits, and internal rate of return. Hard-copy reports can be produced.

For sales-support, Simple Soft is offering a videotaped presentation for dealers carrying the product. It's available in Beta or VHS formats for \$50. The Real Estate Investor Calcaid costs \$129.95. For complete details, contact Simple Soft Inc., Suite 101, 480 Eagle Dr., Elk Grove Village, IL 60007, (312) 364-0752.

Circle 559 on inquiry card.

### Free Classroom Programs

The Educational Computing Network has a number of free programs available for English and Social Studies teachers. For the English classroom, topics include vocabulary building and review, poetry, and the parts of speech. Social Studies teachers can pick from drill and review programs, simulations, and testing programs. All the programs are designed for the Apple II Plus. For more information, send a self-addressed, stamped envelope to Educational Computing Network, 12680 Hollyglen, Riverside, CA 92503.

CP/M- and HDOS-based systems and on an 8-inch CP/M disk for Z-19 terminals. Registered Zencalc owners may purchase it as an update for \$10, plus \$2 shipping. It's available at Heathkit Electronic Centers, Zenith Data Systems dealers, or factory-direct from The Software Toolworks, Suite 1118, 15233 Ventura Blvd., Sherman Oaks, CA 91403, (213) 986-4885.

Circle 560 on inquiry card.

### Low-Cost Graph Printing Program

West Bay Co. has unveiled a multipurpose graph program for the Radio Shack Color Computer. Kwikgraf works with the Color Computer and the Epson MX-80 printer to produce camera-ready bar graphs in approximately three minutes. This program, modular in nature, provides screened instructions and permits rapid keyboard changes of data and design. The program listing can be modified for printers other than Epson, and a screen print program is not required.

Kwikgraf requires Extended BASIC and 4K bytes of memory. It costs \$12.50, postage paid. For a sample graph produced with Kwikgraf, send a self-addressed, stamped envelope to West Bay, Route 1, Box 666, White Stone, VA 22578.

Circle 561 on inquiry card.

### Spreadsheet Has New Features

Zencalc 3.0, an enhanced version of the Zencalc spreadsheet program for Heath/Zenith computers, is available from The Software Toolworks for \$49.95. Zencalc 3.0 features a new table look-up function, a numeric keypad mode for rapid data entry, and a loan-amortization spreadsheet that automatically computes mortgage payments and schedules. Zencalc will run on Z-89 computers as well as Z-100 systems using the Z-89-compatible function keys.

Zencalc 3.0 comes on 5¼-inch hard and soft-sectored disks for Heath/Zenith

# What's New?



## Peek 'n Poke Around Your IBM

Peeks 'n Pokes for the IBM Personal Computer, a collection of programming techniques and programs, is distributed by Data Base Decisions. Made up of a floppy disk and a 38-page manual, this package shows you how to use BASIC PEEK, POKE, INP, and OUT functions to access and modify system information. General-purpose assembler routines that perform DOS and BIOS function calls, read the file directory, and determine the space used and remaining are provided. For Pascal programmers, assembly-language routines that perform the same operations are included.

The Peeks 'n Poke disk

contains more than 50 BASIC and Pascal programs that show you how to access the system's configuration, read and change the keyboard status, access the printer status, and generate sounds through the speaker. Also included are eight utility programs covering such functions as clearing the screen and swapping monitors.

Minimum system requirements are PC-DOS, 48K bytes of memory, a disk drive, and an 80-column monitor. It costs \$30, plus \$2.50 shipping, and is available from Data Base Decisions, 14 Bonnie Lane, Atlanta, GA 30328, (404) 256-3860.

Circle 562 on inquiry card.

## Terminal Program Waits for You

The Intelligent Terminal System-80 lets you operate your Apple II/IIe computer in a smart-terminal mode or in a dumb-terminal mode. ITS-80 is a menu-driven program that provides such full-screen capabilities as left and right cursor movements, clear-to-end-of-line or screen, and character insert and delete. When a typing error is made while in its smart-terminal mode, you merely go back and correct the error because ITS-80 will not transmit blocks and lines of characters until the Return key is pressed. Other features include an 18K-byte character buffer, text file send and receive, simultaneous printing with user-defined formats, and predefined configurations for the system being called.

ITS-80 requires an 80-column card, the Apple Pascal language, and the D. C. Hayes Micromodem II. It costs \$49.95. Contact Unisoft, 5520 12th Ave. S, Minneapolis, MN 55420, (612) 824-4131.

Circle 563 on inquiry card.

## Bids Generated for Contractors

Scripps Data Systems' Estimating System for the IBM Personal Computer rapidly and accurately generates bids for building contractors. This system, written in BASIC and running under MS-DOS 1.1, features a user-maintained

cost item database, with a retrieval time purported to be less than 1 second to any cost item. Major files are in ISAM (indexed sequential-access method) format, and all files are dynamically allocated. Estimates are structured by division, subdivision, sub-contract bids, and cost items. Burden rates for materials, labor, and other costs can be maintained by division for each estimate. Any cost item change on an estimate immediately updates all division and estimate totals. Reports can be generated in detail or summarized by subdivision or division. Summary information can be automatically interfaced to other Scripps products for greater accuracy.

Minimum hardware requirements for the Estimating System are 64K bytes of memory, two single-sided disk drives, and a 132-column printer. The suggested retail price is \$425. An Apple version is available. For full details, contact Scripps Data Systems Inc., Suite 202G, 9747 Businesspark Ave., San Diego, CA 92131, (619) 695-1540.

Circle 564 on inquiry card.

## Graphics Interpreter for Matrix Printers

Printer Graphist is a high-resolution graphics interpreter for dot-addressable matrix printers. This program, an extension of your Radio Shack TRS-80's

# What's New?

BASIC interpreter, provides 14 simple high-resolution graphics commands. It lets you define the physical size and location of the plot area (up to 32 feet wide by 32 feet long, using multiple sheets of paper), and you can define which type of logical scaling (linear or logarithmic at any base) must be used for both axes and their logical ranges. Other commands connect two pairs of points together with up to six line styles and eight colors, initiate and halt chaining processes, grid and graduate the x- or y-axis, and label

your plot in different character sets and colors.

Printer Graphist, available for the TRS-80 Models I and III, works with such printers as the IDS Prism 132, Epson MX-80 with Grafrax, Okidata with Okigraph, and Star Micronics. The price is approximately \$250. Contact Printer Graphist Ltd., POB 603, Newport, VT 05855. When ordering, please enclose complete information on your system, including processor number, disk-drive specifications, DOS, and printer.

Circle 565 on inquiry card.

bytes of RAM (random-access read/write memory) with bank-switching under CP/M Plus control. Built-in hardware is made up of two serial ports, an 8-bit parallel port suitable for Winchester-disk drives, a Centronics-compatible parallel printer port, and a connector for up to three external 5¼-inch floppy-disk drives for a total storage capacity of 1.5 megabytes.

System software comes in the form of a fully integrated package known as T/Maker III. This package provides spreadsheet, word processing, text editing, list processing, file management, and data transfer applications programs. It also has the ability to create bar charts from tabular data in the files.

A complete Micromate with a terminal, CP/M 3.0, and T/Maker costs \$1495. Without the terminal, the price is \$995. Dealer inquiries are invited. Contact Personal Micro Computers Inc., 475 Ellis St., Mountain View, CA 94043, (415) 962-0220.

Circle 566 on inquiry card.

and vector graphics capabilities. When used with an ordinary television set, it offers a 16-line by 32- or 64-character display format. The System 7000 uses the Zilog Z80 microprocessor and comes with an interactive BASIC interpreter, called IBI, which lets you load and run Radio Shack TRS-80 Model I and III programs. A standard cassette recorder is used for storage.

Options for this system include an internal expansion interface for a double-density floppy-disk controller, a parallel printer port, a real-time clock, and an RS-232C serial interface. A 5¼-inch floppy-disk drive, the CY-770, can store up to 160K bytes of data per disk; a total of four drives can be used with the 7000. Operating systems available include NEWDOS, NEWDOS 80 version 2.0, and TRSDOS. Languages such as BASIC, COBOL, FORTH, and Pascal are offered. Among the other options for the System 7000 are a music/speech synthesizer, a speech-recognition unit, 8- and 12-bit tracking A/D (analog-to-digital) converters, and a 16K-byte EPROM (erasable programmable read-only memory) firmware interface.

In kit form, the System 7000 costs \$199.95. A completely assembled 64K-byte unit is \$499. Options range in price from \$8.95 to \$599.95. For full details, contact Design Solution Inc., POB 1225, Fayetteville, AR 72701, (501) 521-0281.

Circle 567 on inquiry card.

## SYSTEMS



### Convert Terminal to CP/M Computer

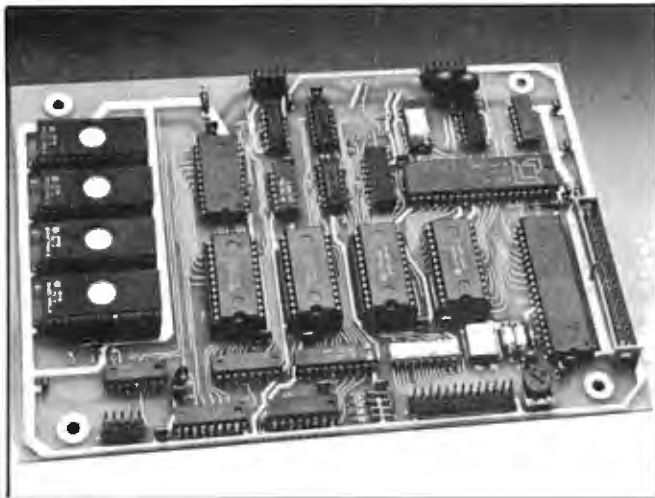
The Micromate converts any standard dumb or intelligent terminal into a CP/M-compatible computer. Produced by Per-

sonal Micro Computers, this portable computer, small enough to fit into a briefcase, has 390K bytes of disk storage and 128K

### Cyzern 7000 Grows with Your Needs

The Cyzern System 7000 can grow with your computing needs. This modular 16K-byte microcomputer features a 53-key keyboard with cursor-control keys, VHF/RF modulator and composite-video connectors, and an uppercase/lowercase character generator with block

# What's New?



## Single-Board 6809 Computer

The Hart-09 single-board, stand-alone computer is built on Motorola's 6809 microprocessor. It's designed for dedicated OEM (original equipment manufacturer) applications in data processing, instrumentation, and industrial automation. The Hart-09 carries an RS-232C port, five 16-bit timer/counters, an 8-bit D/A (digital-to-analog) converter, 1K bits of nonvolatile RAM (random-access read/write memory), 64K bytes of EPROM (erasable programmable read-only memory) and CMOS (complementary metal-oxide semiconductor) static RAM memory, hexadecimal keypad interface, and a general-purpose parallel port. The OS-9 multitasking operating system is standard, as is the BASIC 09 language. The serial RS-232C I/O channel permits data communication at programmable rates ranging from 110 to 4800 bits per second.

Hart Scientific offers full applications support for the Hart-09, as well as power supplies and dis-

plays. Prices range from \$800 to \$1200. For complete details, contact Hart Scientific, 54 North 400 W, Provo, UT 84601. Circle 568 on inquiry card.

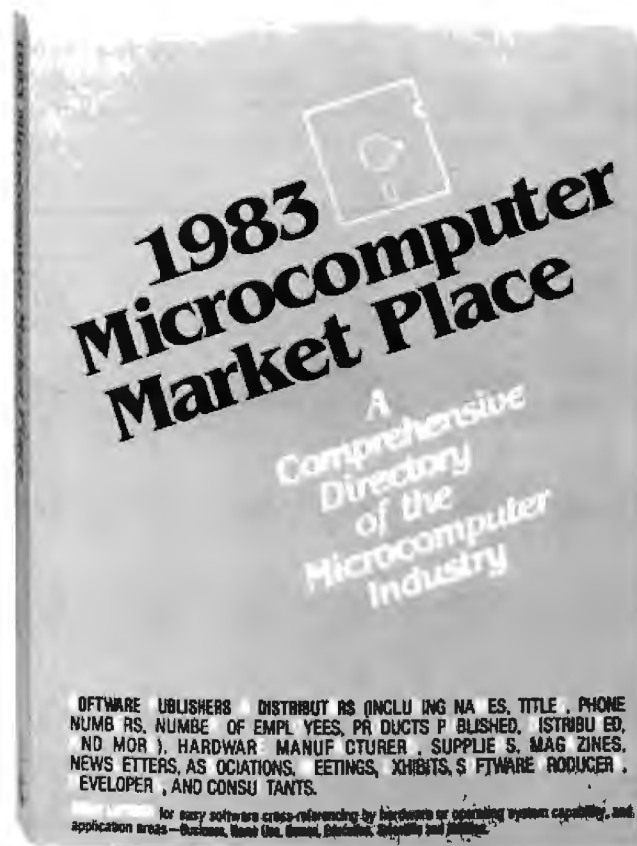
## 8- and 16-Bit S-100 Board

An IEEE S-100 standard central-processor board based on the Intel 80286/10 microprocessor and featuring code compatibility with 8- and 16-bit software, Compupro's CPU 286 has addressing capacity for multiuser/multitasking applications. Standard equipment includes sockets for an 80287 mathematics coprocessor and for up to 16K bytes of EPROM (erasable programmable read-only memory). The clock rate is 8 MHz, and a clock-switching circuit permits 8- or 16-bit slave processors to run on the same bus at various clock rates without timing conflicts. With a 24-bit address and 16-bit data bus, the CPU 286 can access as much as

16 megabytes of online system memory without segmentation. Its onboard logic can read or write 2 bytes serially to simulate 16-bit operation in the presence of 8-bit memory or I/O. A memory-management unit is incorporated into the CPU 286.

In single units, the CPU 286 costs \$1595. A 10-MHz high-reliability version is also available. For more information, contact Compupro, Oakland Airport, Oakland, CA 94614, (415) 562-0636. Circle 569 on inquiry card.

## PUBLICATIONS



## 1983 Computer Market Directory

The 1983 Microcomputer Market Place was compiled from a questionnaire survey of the industry. It covers software publishers and distributors, hardware manufacturers, suppliers, magazines, newsletters, software developers, and associations.

The information provided includes the company name and address, telephone numbers, number of employees, number of products produced or distributed, and the names of key executives in marketing, editorial, finance, and administration. Also

# What's New?

provided are 13 indices with information on 11 microcomputer systems, 16 supply categories, 35 special-interest categories, games and applications for business, home, education, and utilities.

The 1983 **Microcomputer Market Place** is available for \$75 from Dekotek Inc., POB 1863, Grand Central Station, New York, NY 10163, (212) 799-6602. Circle 570 on inquiry card.

## Telecommunications, Speech Synthesis Probed

**Talking Computers and Telecommunications** by John A. Kuecken examines this rapidly growing field. It deals with the use of talking-computer technology in telecommunications and provides a practical approach to the engineering problems encountered when computer speech is used in telephone systems. It discusses the concurrent social, economic, and technological forces that have produced the need for more advanced communications systems. The problems with such systems are explained and solutions are offered. Other features of this book include a rundown of the basic aspects of telephony and descriptions of pneumatic and mechanical vehicles for the production of sound. More than 100 illustrations are provided.

This 256-page hard-

cover book costs \$26.50. It's available from Van Nostrand Reinhold Co. Inc., 135 West 50th St., New York, NY 10020, (212) 265-8700. Circle 571 on inquiry card.

## Visicalc Applications

T. G. Lewis's 32 **Visicalc Worksheets**, a collection of ready-to-enter Visicalc programs, can be ordered from the Dilithium Press. The programs include games, business and household applications, and statistical analyses. Photographs of the programs as they appear on the computer screen are provided.

All the programs in this book are available on 5¼-inch floppy disks formatted for Apple or IBM Personal Computers. The book alone is \$19.95. With the disk, it's \$29.95. Contact the Dilithium Press, Suite E, 11000 Southwest 11th St., Beaverton, OR 97005, (503) 646-2713. Circle 572 on inquiry card.

## Modula-2 Manual Has Tutorials, Library Definitions

A 264-page **Modula-2 User's Manual** from Volition Systems is said to provide a complete description of the company's implementation of Modula-2. Written by Richard Gleaves, this manual is designed to be used with Niklaus

Wirth's 48-page monograph that defines Modula-2; the monograph is provided. A tutorial for Pascal programmers and standard library definitions highlight this work. It's divided into six sections that range from a system document that describes the implementation of Modula-2 for UCSD Pascal to a machine-specific implementation guide that has information on library modules, interrupt handling, and machine-level data representation.

The **Modula-2 User's Manual** costs \$35. It can be ordered directly from Volition Systems, POB 1236, Del Mar, CA 92014. Circle 573 on inquiry card.

## Ada Style Guide

A free six-page guide for Ada applications programmers is available from Intellimac. This guide illustrates proven techniques for efficient program structuring and provides examples of preferred methods for in-house standardization of program syntax. Style rules that help to enhance program maintainability and decrease software life-cycle costs are presented. The methods outlined in this guide were derived from more than 100,000 lines of Ada code developed and delivered over a 22-month period. For a copy, contact Intellimac Inc., 6001 Montrose Rd., Rockville, MD 20852. Circle 574 on inquiry card.

## Journal Covers Pascal and Ada

The **Journal of Pascal and Ada** features programs, algorithms, and procedures for many different applications. Produced bimonthly, this magazine covers the role of Pascal and Ada through articles, book and software reviews, reports on new developments, and a question-and-answer column. All the software published in the **Journal** is available to subscribers over the telephone.

Annual subscriptions to the **Journal of Pascal and Ada** are \$14. Foreign subscriptions are \$21. Single issues cost \$3 in the U.S. and \$4 elsewhere. For more details, write to the **Journal of Pascal and Ada**, POB 383, Orem, UT 84057.

Circle 575 on inquiry card.

## Access Your Computer

**Access: The Journal of Microcomputer Applications** is devoted to helping you make maximum use of your personal computer. It contains information on how to use your computer to solve traditional engineering and scientific problems and write reports, as well as giving you tips on how to keep track of technical papers and manage your time. Other topics of interest include mathematical modeling, process design, and economic and numerical analysis.

# What's New?

A year's subscription to **Access** costs \$16 (six issues). Foreign rates are \$21 in Canada and Mexico; \$34 elsewhere. Con-

tact Access, Leds Publishing Co. Inc., POB 12847, Research Triangle Park, NC 27709. Circle 576 on inquiry card.

## PERIPHERALS



### VT-100 Emulator

The Ergo 301 from Micro-Term fully emulates the VT-100, including its advanced video, 132-column display, and printer port features. The Ergo 301 has a detached keyboard with a coiled cable and seven LEDs (light-emitting diodes) to show terminal status. The monitor tilts 10 degrees and has a green nonglare display and a front panel on/off switch; it is equipped to accept up to four boards for expansion purposes. Standard features include two pages of memory, English-language setups, programmable function keys, transparency mode, and Xoff indication.

Options for the Ergo 301 include an amber screen and Plot 10/Regis-compatible graphics. The

Ergo 301 costs \$895. With the Plot 10 graphics option installed, it lists for \$1790. An add-on graphics capability costs \$1095. Nationwide service is available through more than 450 Western Union locations. For full details, contact Micro-Term Inc., 1314 Hanley Industrial Court, St. Louis, MO 63144, (314) 968-8151. Circle 577 on inquiry card.

### Videodisc Interface

Matrox Electronic Systems' VDI-1 videodisc graphics and data interface is a three-board, Multibus-compatible set designed for applications using NTSC (National Television Standard Code) laser video-

discs, including computer-aided instruction, mapping, simulation, and electronic publishing. The VDI-1 provides four operating modes that let you display a high-resolution image by combining a number of standard-resolution NTSC frames, retrieve large amounts of digital information, play an audio sound track while displaying a single television frame, and overlay computer graphics and alphanumerics on top of a video picture. This product allows four NTSC frames to be simultaneously stored in picture memory. For alphanumerics and graphics overlays, the system's central processor can read or write to any pixel or any bit of a pixel in the picture-memory space.

The VDI-1 costs \$7900 per set, which includes demonstration software. Contact Matrox Electronics Systems Ltd., 5800 Andover Ave., Town of Mount Royal, Quebec H4T 1H4, Canada, (514) 735-1182. Circle 578 on inquiry card.

### Switchable Memory for VIC Has Dual Connectors

RAMAX, a 28K-byte switchable memory and dual connector expander for the Commodore VIC-20, is available factory-direct from Apropos Technology. RAMAX has two extension connectors that are identical to the VIC's memory-expansion connector, except that the game cartridge signal, BLK

5, can be enabled or disabled. The memory is switchable in or out of use in one 3K- and three 8K-byte sections. Standard features include a Reset switch, a safety fuse, self-test program, and a display case.

RAMAX costs \$169, which includes an operating manual and shipping fees. A 19K-byte version, RAMAX Jr., costs \$139. Dealer inquiries are invited. Contact Apropos Technology, Suite 821, 350 Lantana Ave., Camarillo, CA 93010, (805) 482-3228.

Circle 579 on inquiry card.

### Sweet-P Plots Colorful Graphics

The Sweet-P Personal Plotter from Enter Computer draws hard-copy graphics such as colorful bar charts and illustrations. Sweet-P lets you create, edit, and store color graphics that can be recalled and instantly plotted in any scale. Graphics and engineering symbols may be programmed in memory and recalled with a single keystroke. Standard features include 19 programming commands, a plotting area of 7½ by 118 inches, a step size of 0.004 inch (i.e., 250 line segments per inch), and a programmable plotting speed of up to 6 inches per second. Alphanumeric character sizes can be as small as ⅛ inch or as large as 20 inches. Sweet-P draws on overhead transparency film or 8½-inch-wide



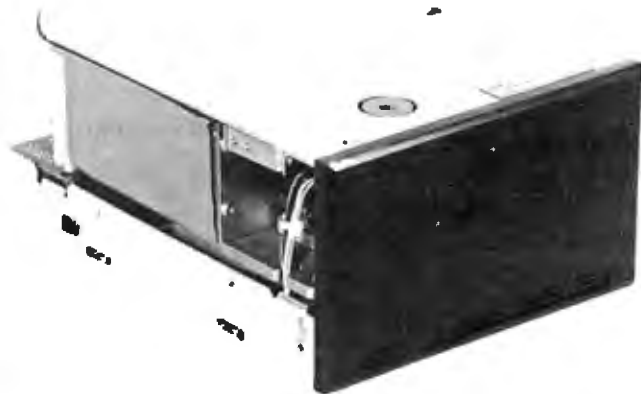
# What's New?

paper up to 120 inches long using specially made or commercial pens.

Optional accessories include an acetate-compatible pen set, advanced analytical and business graphics, and interface cables for Apple, Radic Shack TRS-80, IBM Personal Computer, and other popular microcomputers. Sweet-P costs \$795, which includes basic analytical engineer-

ing and business graphics software, a pen adapter, a pen set made up of red, green, blue, and black fiber-tip pens, plotting paper, and an operation manual with maintenance tips and programming instructions. It's available from Enter Computer Inc., 6867 Nancy Ridge Dr., San Diego, CA 92121, (619) 450-0601.

Circle 580 on inquiry card.



## XT Memory Expansion

Microdisk has unveiled a memory-system upgrade kit for the new IBM Personal Computer XT. With this kit, IBM dealers can expand the XT's integral Winchester hard-disk storage from 12 megabytes to 20, 27, or 54 megabytes (unformatted). The kit includes a new DOS with print spooling and a higher-capacity Winches-

ter disk. Also available is the IDOS operating system, which allows your XT to run CP/M-80 and CP/M-86 applications software under native PC-DOS. For the name of your nearest IBM dealer, contact Microdisk Inc., 1422 Industrial Way, POB 1377, Gardnerville, NV 89410, (702) 782-8105. Circle 582 on inquiry card.



## 248 Preprogrammed Keys Possible with Keywiz

An auxiliary keyboard with 31 user-programmable function keys, the Keywiz VIP is manufactured by Creative Computer Peripherals. Each programmable key can be set for as many as eight characters and reprogrammed once again using the shift key for a total of 62 user-defined keys. The Keywiz comes with four easy-to-access keyboard layouts in memory, which makes 248 preprogrammed keys available at any time. A 7-segment LED (light-emitting diode)

displays which keyboard mode you're using. Individual keys can be programmed any number of times, even while you're running a program.

The Keywiz VIP is software-independent and can be ordered for Apple II Plus, Apple IIe, Franklin Ace, and Radio Shack TRS-80 Model III systems. Contact Creative Computer Peripherals Inc., Aztec Environmental Center, 1044 Lacey Rd., Forked River, NJ 08731, (609) 693-0002.

Circle 581 on inquiry card.

## Add an Apple to IBM

Quadlink, a multifunction board designed to allow Apple software to be used with IBM PC and XT computers, is produced and marketed by Quadram Corporation. Quadlink is a simulated Apple computer on a single board that provides a means for translating DOS 3.3 software for use on an IBM. It works with most programs designed for the Apple II, II Plus, and IIe and permits the use of such IBM enhancements as printers and buffers while running Apple software.

Entering and exiting the Apple mode is accomplished with a single command. Disks do not require reformatting or converting. Quadlink connects to one IBM expansion slot.

Quadlink comes with 64K bytes of memory and game, parallel, and serial ports. The suggested retail price is \$680. Full information is available from Quadram Corp., 4357 Park Dr., Norcross, GA 30093, (404) 923-6666. Circle 583 on inquiry card.

# What's New?

## MISCELLANEOUS



### Software Modules Tailor Keyboard for Tasks

Executive Peripheral Systems markets a detachable keyboard upgrade for Apple II/III Plus computers that features plug-in PROM (programmable read-only memory) modules to configure it for popular software packages. When used with EPS PROMware modules, the board's 12 special function keys provide up to 48 commands tailored for the software package. Each module comes with a label strip identifying the commands programmed into the function keys. Current modules include Wordstar, Screenwriter II, Visicalc, and Apple Writer II.

The EPS keyboard connects directly to the Apple's keyboard socket. It has a complete word-processing layout with full-travel key switches, multi-function edit keys, shift and shift-lock keys, and cursor-control keys. Most keys are equipped with automatic repeat capabilities. A built-in 21-key numeric keypad, full ASCII characters, parallel output, and a 6-foot cord are standard.

The suggested retail price is \$399.95, which includes BASIC and DOS modules and an interface card. Additional PROMware modules cost \$32.95. This keyboard can be ordered from Executive Peripheral Systems Inc., 800 San Antonio Rd., Palo Alto, CA 94303, (415) 856-2822.

Circle 591 on inquiry card.

### 16-Bit Upgrade Upholds 8-Bit Software

Octagon Computer Systems' Board 8/16 lets you upgrade to a 16-bit system without making your 8-bit software obsolete. This board features IEEE-696 (S-100) compatibility, an 8-MHz, 16-bit 8088 processor, and an NSC-800 chip that operates at 4 MHz and executes the full Z80 instruction set. A built-in Intel 8272 floppy-disk controller provides 24-bit DMA (direct memory access), can handle four 5¼- or 8-inch floppy-disk drives, and allows file transfers between drives. The Board 8/16 has an 8K-byte

PROM (programmable read-only memory) monitor that boots the operating system and comes with such debugging features as memory test, dump, and search. Also standard are two serial ports with software-selectable data rates of up to 19,200 bits per second, an interrupt controller with eight vectored interrupts, and a fixed-frequency real-time clock interrupt for multiuser dispatching.

Options include an 8087 mathematics coprocessor and Concurrent CP/M-86 or MP/M-86 operating systems. The Board 8/16 costs \$895. Concurrent CP/M-86 and MP/M-86, sold only with the board, are \$195 and \$495, respectively. Full details are available from Octagon Computer Systems, Suite 5, 151 Bernal Ave., San Jose, CA 95119, (408) 225-2700.

Circle 592 on inquiry card.

### Nonvolatile Memory Module

The NVRD64, a 64K-byte nonvolatile memory module, can be used as all the memory in a conventional 8-bit system. Produced by the British firm Greenwich Instruments Ltd., this 4- by 2- by 1-inch plug-in unit can be paged into memory and used as data RAM (random-access read/write memory), emulating a high-speed disk. It features internal buffering, 150-nanosecond access time, 10-year data retention, an unlimited number of read/

write cycles without wait states or additional hardware, and 5-volt operation. Up to eight NVRD64s will fit on an S-100 card; four on a Eurocard. As a replacement for a ROM (read-only memory), this device permits immediate reconfiguration at any time while retaining the convenience of a ROM-based system.

The NVRD64 uses an industry-standard connector that's compatible with vertical- or horizontal-mount printed-circuit boards, backplanes, and IDC connectors. The NVRD64 costs \$875. It's distributed by LMS Electronics, 3401 Monroe Rd., Charlotte, NC 28205, (704) 376-7805.

Circle 593 on inquiry card.

### Where Do New Products Items Come From?

The information printed in the new products pages of BYTE is obtained from "new product" or "press release" copy sent by the promoters of new products. If in our judgment the information might be of interest to the personal computing experimenters and homebrewers who read BYTE, we print it in some form. We openly solicit releases and photos from manufacturers and suppliers to this marketplace. The information is printed more or less as a first-in first-out queue, subject to occasional priority modifications. While we would not knowingly print untrue or inaccurate data, or data from unreliable companies, our capacity to evaluate the products and companies appearing in the "What's New?" feature is necessarily limited. We therefore cannot be responsible for product quality or company performance.

# MAIL ORDER PRICES

Thousands of items to choose from. Call 800-752-1341

## DISK DRIVES

<b>MICRO SCI</b>	
A35 with Controller	\$377.
A40 with Controller	457.
A70 with Controller	577.
A35 without Controller	297.

## PRINTERS

<b>OKIDATA</b>	
Microline 82A	\$449.
Microline 83A	735.
Microline 92	578.
Microline 93	997.

## BROTHER

HR-1 Daisy Wheel - Parallel	910.
HR-1 Daisy Wheel - Serial	989.
Forms Tractor	147.

## STAR MICRONICS

Gemini 10	329.
Gemini 15	497.

<b>MANNMANN-TALLY MT 160L</b>	879.
-------------------------------	------

## MONITORS

<b>USI</b>	
12" Hi Res Green	\$154.
12" Amber	181.
9" Green	119.

## AMDEK

12" Green	167.
13" Color	363.
Color II Hi Res	819.
Color III RGB	468.

## NEC

JB 1260 12" Green Hi Res	126.
JB 1201 12" Green Hi Res w/Sound	174.
JC 1201 12" Color	348.
JC 1203 12" Hi Res Color/IBM PC	687.
Cable for IBM PC	22.

## TERMINALS

<b>TELEVIDEO</b>	
910	\$667.
925	849.
950	1,099.
<b>VISUAL 50</b>	
	719.

## ACCESSORIES

<b>SSM</b>	
ASIO Apple Serial I/O Card	\$132.
APIO Apple Parallel I/O Card	79.
AIO-II	169.
TG Game Paddle	29.
TG Joystick	43.
<b>ORANGE MICRO Grappler Plus</b>	137.

## MPC PERIPHERALS

Parallel Prt. Card Apple II	55.
RAMTEXT Extender Card	109.
Bubble Memory	657.
16K Memory Board Apple II	58.
32K Memory Board Apple II	110.
Upper & Lower Case ROM	14.
PROMIT Eprom	77.
Serial I/O Card Apple II	79.

## PRACTICAL PERIPHERALS

Microbuffer II 16K Apple II	229.
Microbuffer II 32K Apple II	244.
8K Serial Buffer/Epson	132.
16K Parallel Interface/Epson	132.

## MICROSOFT

Z-80 Keyboard for Apple	249.
-------------------------	------

## MOUNTECH COMPUTER

CPS Multifunction for Apple	149.
-----------------------------	------

## VIDEX

Videoterm	259.
Softvideo Switch	29.
Inverse Std. Character Set	24.
Enhancer	122.

## SOFTWARE FOR CP/M

Crosstalk	\$149.
Supercalc	222.
The Word Plus	119.
Spellbinder	288.
<b>ASHTON-TATE Data Base II</b>	529.

## MICROPRO

Wordstar	311.
Mailmerge	157.
Supersort	174.
Spellstar	174.
Infostar	347.
Reportstar	247.

## MICROSOFT

Fortran 80	388.
Macro 80	189.
Basic Compiler	299.
mu/Math/mu/SIMP 80	209.
Multiplan	209.

## SOFTWARE FOR IBM

<b>MICROLAB The Tax Manager</b>	\$188.
<b>ASHTON-TATE Data Base II</b>	479.
<b>SORCIM Supercalc</b>	227.
<b>VISICORP Visualc 256K</b>	209.

## MICROPRO

Infostar	377.
Wordstar	329.
Mailmerge	179.
Spellstar	179.

## I.U.S.

Easysspeller	\$127.
Easyfiler	277.
Easywriter II	249.

## CONTINENTAL SOFTWARE

The Home Accountant Plus	109.
--------------------------	------

## SOFTWARE FOR APPLE

<b>BRODERBUND Choplifter</b>	26.
------------------------------	-----

## MICROSOFT

Typing Tutor II	18.
Adventure	24.
Fortran	149.
A.L.D.S.	97.
Basic Compiler	297.
mu/Math/mu/SIMP 80	188.
Multiplan	188.

## VISICORP

Visualc	209.
Visiplot	169.
Visidex	209.
Visifile	209.

## MICROPRO

Wordstar	215.
Mailmerge	75.
Spellstar	115.
Infostar	375.

## MODEMS

### HAYES MICROCOMPUTER

Smartmodem	229.
Smartmodem 1200	579.
Micromodem II with Term. Prog.	359.

### NOVATION

Auto Cat	239.
Apple II Cat	309.
J-Cat	135.

Major credit cards accepted. All items shipped FOB San Diego. All Manufacturers' guarantees apply - plus our own 30 day guarantee, including freight on returns.



U.S. ORDERS: 800-752-1341  
CALIFORNIA ORDERS: 619-277-8002  
INFORMATION: 619-277-8006

**mail comp**

9434 Chesapeake Drive  
San Diego, CA 92123  
Circle 228 on Inquiry card.

**Dual AST Best Price • Good Quality • Swift Delivery • Export IDS**  
**Wicat Our Specialty: 68000, 6809 CPU, graphic, database, communication**

**Cromemco  
Zenith**

**North Star, Altos, Diablo, Qume, Houston Instrument, GTCO, Okidata, C.Itoh, Hayes, Epson, Tandon, SWTPC, Visual, NEC, Amdek, Hazeltine, Mitsubishi**

**COMPUTER**

**CROMEMCO**

Best Price  
Anywhere  
\$

CS1D2E	256K RAM, 68000 & Z80 two 5 1/4" floppy	4,396
CS1D2	no error correction	3,996
CS1HD5E	512K RAM, 68000 & Z80 20MB hard disk, 5 1/4" floppy	8,071
CS3D5E	512K RAM, 68000 & Z80 two 8" floppy	7,996
HD20	External disk drive for sys. 1, 2, & 3	3,596

**WICAT**

1 to 12 users, 68000 CPU, 266KB  
to 4.5 MB, 10MB to 474MB hard  
disk, graphic option

**DUAL**

68000 CPU, 512K RAM, 20 MB  
hard disk, intelligent I/O, 1MB  
floppy, UNIX, S100,  
32KB CMOS memory

SWTPC, HELIX ..... CALL

Z-110	dual drives, 128K RAM, color board, 225 x 640 graphic, IBM PC compatible	2,799
ZVM-134	RGB 640 x 480	550
ZW-110-32	192KB, 11MB hard disk	4,699

C-10	Z80, 64K, 12" monitor, 390K floppy, CP/M compatible O.S., word processing & spread sheet software	1,650
------	--	-------

NORTH STAR, MORROW, KAYPRO, DYNABYTE,  
DEC, TERAK, CORONA ..... CALL

LNW 801 280A, 65K, 480 x 192 graphic 1,100

**PRINTER**

**Integral Data System**

MICROPRISM	75 cps excellent print/110 cps 84 x 84 graphic, RS232/parallel pin & friction feed	498
PRISM 132	200 cps, 132 col. W/graphic, 84 x 84, graphic, color, friction	1,100 1,180 1,590
GEMINI 10	100 cps	345
15	15"	525
EPSON	FX-80 160 cps	555
TI	810 Superb	1,395
OKIDATA	ML 83A	650
	84 parallel	995
	92	560
	93	890
C.ITOH	Prowriter I parallel	410

**\*Letter Quality\***

C.ITOH	Starwriter F-10 40 cps	1,330
NEC	7710, 7730	2,250
	3510	1,500
	3530	1,650
	3553 for IBM	1,875
QUME	11+	1,400
Diablo	620	998
	630	1,875

**DISK DRIVE**

Tandon TM 100-2 5 1/4" DD, DS ..... \$260

**MITSUBISHI 8"**

DS, DD, Qume & Shugart compatible  
~~M2804-83 bare drive~~ ..... 410  
 2" subsystem 2 Mitsubishi bare drives,  
 cabinet w/power supply, fan ..... 1,099  
 assembled subsystem ..... 1,130  
 manual ..... 25  
 signal cable ..... 50  
 CORONA 5MB for IBM PC ..... 1,450

**DIGITIZER/PLOTTER**

Houston Instrument DMP29 ..... 1,795  
 DMP 40 ..... 795  
 HIPAD ..... 725  
 GTCO ..... CALL

**SOFTWARE**

dBASE II	Ashton-Tate	499
REDDING	Grafstalk business graphics	400
	Async micro to mainframe	100
	Alpaca micro to micro	450
CROSSTALK	Microstuf	160

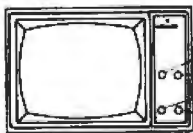
**CALL (212) 937-6363**  
free catalogue

Prices subject to change. American Express, Visa/Master-  
 card add 3% F.O.B. point of shipment. 20% restocking  
 fee for returned merchandise. Personal checks take 3  
 weeks to clear. COD on certified check only. N.Y.  
 residents add sales tax. Manufacturers' warranty only. In-  
 ternational customers, please confirm price before order.  
 Accept P.O. from Fortune 500 & schools.

Computer Channel  
21-55 44th Road  
Long Island City, NY 11101  
TELEX: 429418  
CSTNY

**Computer Channel**

**12" B&W MONITOR**



Contrast  
Power/Bright  
V-Hold  
H-Hold

VIDEO 100 by AMDEK

FULL  
FACTORY  
WARRANTY **\$79<sup>95</sup>**

for **APPLE**

**16K RAM CARD**

Language Transparent  
COEX FACTORY  
WARRANTY **\$59<sup>00</sup>**

**5 1/4" Floppy  
DISKETTES**

All Certified-100% Guaranteed

BOX of 100 ... **\$149<sup>00</sup>**  
 Above with  
 Hub Rings ..... **\$169.00**

**FLOPPY DISK DRIVE**

From Fourth Dimension Systems  
 with •Track Zero Micro Switch  
 •DOS 3.2.1 & DOS 3.3  
 •CP/M and PASCAL

DESIGNED  
 FOR YOUR **\$249<sup>00</sup>**  
 APPLE™ ..... **\$249<sup>00</sup>**

Controller Card  
 for above ..... **\$99.00**

**COEX 80-Ft DOT MATRIX  
PRINTER**

- Interface with Apple™, Centronics RS-232, IEEE-488
- 9x7 Dot Matrix, 80 CPS, Bi-Directional Printing
- 2K Buffered Memory
- 80, 96, 132 Columns, Graphics and Block Printing
- Selectable Char Pitch, Line Spacing and Feed



COEX Interface Card to APPLE **\$39<sup>95</sup>** **\$299<sup>00</sup>**

**VISION-80® \$249<sup>00</sup>**

80x24 Video Display Card  
 Vista Computer Company's new Vision-80 board is a sophisticated yet easy to use video display card for the Apple™ computer.

**PARALLEL INTERFACE  
EPSON TO APPLE**

New From **\$39<sup>95</sup>** CABLE  
 COEX INCLUDED

**PROTOTYPING CARDS**

for APPLE ... **\$19.95**  
 for I.B.M. .... **\$49.95**

**EXTENDER CARDS**

for APPLE ... **\$16.95**  
 for I.B.M. .... **\$19.95**

"Have You Kissed Your Computer Lately?"

**Components Express, Inc.**

VISA 1380 E. Edinger • Santa Ana, Calif. 92705 • 714/558-3972  
 MasterCard Terms of Sale: Cash, Checks, Credit Cards, M.O., C.O.D. Calif. residents add 6% sales tax.



# ORDER WITH CONFIDENCE FROM ONE OF THE NATION'S LARGEST CONSUMER ELECTRONIC PARTS DISTRIBUTORS

## APPLE COMPATIBLE KEYBOARD



Heavy duty error free switches, switchable N key rollover, last key repeat, upper/lower case capability, alpha lock. Complete with cable.

ORDER NO. 83-APL-KB-7 **\$79.95**

## ARCADE TYPE JOYSTICK



Atari, Commodore, Sears compatible. Heavy duty leaf switches. Long life.

ORDER NO. 83-ATR-JY-1 **\$15.00**

*Unbelievable Discount!*

## APPLE II® COMPATIBLE SLIM DISK DRIVE

**RUNS QUIETER THAN THE ORIGINAL!**

New - not surplus - guaranteed! Only 6" w x 1-7/8" h x 10" d. Complete with a 3' cable. Runs with Apple controller or our optional controller.



ORDER NO. 83-APL-DD-1 **\$299.95**



**CONTROLLER CARD**  
ORDER NO. 83-APL-CTL-1 **\$49.95**

**BONUS** Buy two disk drives and get a free controller card!

## REPLACEMENT POWER SUPPLY FOR APPLE II



Fully Apple compatible. 5A heavy duty switcher, 110V or 220V input, +5V/5A, +12V/3A, -5V -12V full load outputs. Fits in an Apple II case. AC cord included.

ORDER NO. 83-APL-PS-51 **\$79.95**

## REPLACEMENT POWER SUPPLY FOR ATARI® 800 AND 400 MODELS.



ORDER NO. 83-ATR-PS-800 **\$17.00**

## 12" AMBER MONITORS.



Call for details.

ORDER NO. 83-APL-MON-1 **\$140.00**

## REPLACEMENT PADDLE SET

FOR ATARI  
and OTHERS



ORDER NO. 83-ATR-PD-2 **\$12.00**

## REPLACEMENT RAM IC FOR ATARI 2600 VCS



ORDER NO. 83-ATR-IC-3 **\$11.95**

## REPLACEMENT CPU IC FOR ATARI 2600 VCS



ORDER NO. 83-ATR-IC-2 **\$9.95**

## APPLE COMPATIBLE JOYSTICK

Heavy duty.



ORDER NO. 83-APL-XY-10 **\$16.50**

## REPLACEMENT JOYSTICK

Fits Atari,  
Commodore,  
Sears others.



ORDER NO. 83-ATR-XY-4 **\$8.50**

## REPLACEMENT AC ADAPTOR FOR ATARI 2600 VCS

9V 500mA. UL listed.



ORDER NO. 83-ATR-PS-5 **\$5.00**

## REPLACEMENT R.F. MODULATOR FOR ATARI 2600 VCS

Also compatible with  
other video games.



ORDER NO. 83-ATR-RF-1 **\$5.00**

## JOYSTICK EXTENSION CORDS

Works with Atari, Coleco, Commodore and other 9 pin plugs. Two popular lengths: 6' and 12'.

ORDER NO. 83-ATR-EX-6 **\$5.00**  
83-ATR-EX-12 **6.50**



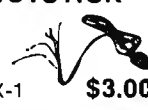
## REPLACEMENT APPLE JOYSTICK CABLE

ORDER NO. 83-APL-X-1 **\$4.50**



## REPLACEMENT ATARI JOYSTICK CABLE

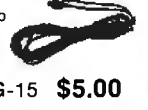
ORDER NO. 83-ATR-X-1 **\$3.00**



## RF EXTENSION CORD

15' RCA Male to  
RCA Female.

ORDER NO. 83-ATR-RG-15 **\$5.00**



MINIMUM ORDER \$25.00. VISA, MASTER CARD accepted. No surcharges. Exact UPS charges will be added. PREPAID: Certified checks and money orders, send exact amount. No shipping, handling or insurance charges in the continental USA. PERSONAL CHECKS: add 5% shipping charges, allow 3 weeks to clear. INTERNATIONAL BUYERS: US currency and 20% extra for shipping. CA Residents, add sales tax. OEM, DEALERS: send for special prices on your company letterhead. No purchase orders or open accounts-no exceptions.



A DIVISION OF ALLIANCE RESEARCH CORPORATION

18215 PARTHENIA ST. • NORTHRIDGE, CA 91325

Call toll free: (800) 423-5336  
In California: (800) 382-3663  
Local: (213) 701-5848

Telex 181011 ORAPARTS NTGE

## CB80\*

### Language Utilities

- † Directory display function, accepts CP/M\* ambiguous file references
- † Drive select error recovery
- † Disk read/write error recovery
- † Default drive finder function
- † All for only \$99

These professional utilities are powerful yet easy to use. Complete documentation with many examples on how to use them is included. Call or send for complete description. Visa, MasterCard, C.O.D. accepted.

**Elite Software**  
421 Hwy 30, Suite 121  
College Station, Texas 77840 409-696-3328

\*CP/M & CB80 TM of Digital Research

Circle 142 on inquiry card.

## TRANSMIT

### HEXMIT

A file transfer utility

- Error correction • Progress indication
- Error count • Link quality measurement
- Non-locking • Easy to modify
- Auto receive • Self instructing

HEXMIT for Micros ..... \$150.00  
Documentation ..... \$10.00

M, K, S P.O. Box 09558  
Columbus, Ohio 43209-0558  
614-460-5251

## RECEIVE

Circle 229 on inquiry card.

## Electronic Circuit Analysis

- DC and AC analysis
- Very fast, machine language
- Infinite circuits on multiple passes
- Worst case, sensitivity analysis
- Dynamic modification
- 64 Nodes, 127 branches
- Compare circuits
- Log or linear sweep
- Full file handling
- Frequency response, magnitude and phase
- Complete manual with examples
- TRS-80 (TRSDOS) \$90.00
- CP/M \$150.00

**Tatum Labs**  
P.O. Box 722  
Hawleyville, CT  
06440  
(203) 426-2184

Circle 373 on inquiry card.

## PERIPHERALS FOR APPLE/IBM(PC)

Quality Inexpensive Peripherals with a Full One Year Warranty

	EACH	BARE BOARD	KIT
IBM/TANDON DRIVE 160K 320K	\$189		
APPLE/SHUGART DRIVE (5¼")	219		
THINLINE	182		
DUAL THINLINE	339		
DISK CONTROLLER (DOS 3.2-3.3)	69	\$ 21	\$ 61
80 COLUMN CARD (VIDEX EQUIVALENT)	149	29	137
Z80 SOFTCARD (MICROSOFT EQUIVALENT)	119	29	109
PRINTER INTERFACE WITH 16K BUFFER AND GRAPHICS (APPLE DUMPLING EQUIV)	139	28	129
MULTI-FUNCTION CARD (PARALLEL, SERIAL, BSR, CLOCK) (VERSA CARD EQUIV)	136	29	126
USI GREEN SCREEN 9" MONITOR (90 DAY WARRANTY)	99		
APPLE IIe BARE BOARD			175

**COLORADO COMPUTER PERIPHERALS**  
R.R. 6, Box 7D  
Golden, Colorado 80401  
(303) 278-7172

Circle 64 on inquiry card.

## Y.E.S., we have the BEST prices available on I.C.'s.

2114	200ns	1.35
4116	200ns	1.25
4116	150ns	1.40
4164	200ns	4.65
4164	150ns	5.00
6116P-3	150ns	4.00
6116LP-3	150ns	4.75
2716	450ns	3.10
2732	450ns	3.85
2532	450ns	4.65
2764	250ns	9.00
Z80A CPU, CTC, PIO		3.30
Z80A SIO, DMA		11.50
8251A		3.00
8253-5		3.35
8255A-5		3.00

JUNE 1983

- MasterCard/VISA or UPS CASH COD.
- Allow up to 3 weeks for personal checks to clear, please include phone no.
- Prices subject to changes without notice.

**Yang Electronic Systems, Inc.**  
307 Compton Ave., Laurel, MD 20707  
(301) 776-0076

Circle 449 on inquiry card.

## 8 To 16 BIT UPGRADE

TRUE 16 BIT PROCESSING

- Z8001 Microprocessor (upgradable to Z8003)
- 2 Kx16 Eprom with Monitor Program (E'Rom optional)
- 16 Vectored Interrupts
- Full IEEE-696 (S100) Compliance
- All Z8001 Features available
- Battery backup time of day clock
- Requires ram capable of word transfers

\*Model M8000 CPU Board \$425<sup>00</sup>  
\*Model M8000 EE optional E'Rom 175<sup>00</sup>

\*5 year limited warranty (Memory Management Companion Card available 3rd Quarter 1983)

To order  
Call 1-800-821-8858, in New Mexico 1-505-523-0975  
or write  
Micro Solutions Inc  
Suite 191 B  
1608 El Paseo Rd  
Las Cruces, NM 88001

Include check or money order  
New Mexico residents add  
4.5% sales tax  
Visa and Master Card welcome

Circle 254 on inquiry card.

## S-100 EPROM PROGRAMMER

# EPROM - 32

- High quality S-100 board meets or exceeds IEEE-696
- Programs 1K through 32K (byte) EPROMs
- Textool zero-insertion-force programming socket
- EPROM is programmed through I/O ports and can be verified through I/O ports or located in memory space for verification
- Programming voltage generated on-board
- Personality Modules simplify adaptation of board to different EPROM types

PM-1-2508 2758	PM-3-2732 2732A	PM-6-68764
2516 2716	PM-4-2564	PM-8-27128
PM-2-2532	PM-5-2764	

**\$269.95\***

includes commands for programming verification, disk I/O and editing (assembled & tested)

**MicroDynamics Corporation**  
Suite 105 • 6363 Poplar Avenue • Memphis, TN 38119  
(901)-755-0619

\*Price includes EPROM-32, documentation and two Personality Modules (specify) Additional Modules—\$7.95 Control software on 8" SSSD diskette—\$9.95 Extension unit for EPROM and Personality Module—\$49.95 UPS ground—\$2.00 UPS air—\$400 CCB—\$1.50 foreign add \$15.00 TN add 6% sales tax VISA and MASTERCARD welcome

Circle 261 on inquiry card.

## 5¼" DISK DRIVES

### TANDON

- ★ **TM 100-1**  
Single Sided, 40 TRK.  
Single Or Double Density **\$189<sup>00</sup>**  
Free Shipping
- ★ **TM 100-2**  
Double Sided, 40 TRK/Side  
Single Or Double Density **\$259<sup>00</sup>**  
Free Shipping

### CDC

- ★ **9409**  
Double Sided, 40 TRK/Side  
Single Or Double Density **\$259<sup>00</sup>**  
Free Shipping

**Order Toll-Free**  
1-800-531-5475 (Outside Of Texas)  
(512) 250-1523 (In Texas)

"If We Can't Ship The Next Working Day,  
We Won't Take The Order"

MasterCard • VISA • Check  
Texas Residents Add 5% Sales Tax

**CompuAdd Corp**

13010 Research Blvd., Suite 101  
Austin, Texas 78750

Circle 74 on inquiry card.

## Smith-Corona TP-1 Daisy Wheel Printer

only **\$439<sup>00</sup>**

# UNBELIEVABLE!

- fully formed characters
- compatible with most micro-computers
- serial or parallel interface
- choice of 10 or 12 CPM models

Also for your TP-1 letter quality printer—the **Smith-Corona Tractor Feed**

**\$1349<sup>5</sup>**

- Adjustable tractor widths
- for continuous forms
- QUICK PAPER REMOVAL



**Call Collect:**  
(214) 826-6521

**FIGURE-LOGIC BUSINESS EQUIPMENT, INC.**  
6408 Gaston Avenue / Dallas, Texas 75214

Circle 151 on inquiry card.



# YOU'RE GONNA LOVE THESE ROCK BOTTOM PRICES!

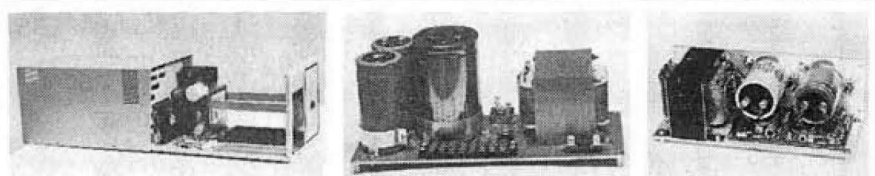
<b>IBM</b> 44K 2-DS/DRIVE COLOR CARD PC/DCE BASIC LOW!	<b>ATARI</b>	<b>EPSON</b> WITH ALL SOFTWARE LOW!	<b>SANYO</b> MC81000 SYSTEM W/SPTWR \$1580 PRC20 COMPUTER \$77 TWCS2 COMPUTER \$150	<b>PERCOM</b>	<b>HARD DISK !!!</b> LOW!	<b>Hyper</b> SMARTCOX II FOR IBM SMARTCOX 100 \$79 SMARTCOX 1200 \$499
<b>IBM</b> PC-LOOK-ALIKE COMPUTER LOW!	<b>TEXAS INSTRUMENTS</b> 99/4A COMPUTER \$270	<b>EPSON</b> FX-80 PRINTER LOW!	<b>EPSON</b> FX-80 PRINTER LOW!	<b>RanaSystems</b> ELITE 1, 2, & 3 FOR APPLE 1000 FOR ATARI LOW!	<b>ATARI DRIVE 55/50/10K 88K</b> ATARI DR. 05/05/20K 704K \$398 \$919	<b>APPLE-CAT II</b> 212 APPLE CAT \$264 \$584
<b>CORVUS SYSTEMS</b> CONCEPT MC8000 256K COMPUTER \$3900	<b>EPSON</b> 8510AP PRINTER \$365	<b>EPSON</b> FX-80 PRINTER LOW!	<b>EPSON</b> FX-80 PRINTER LOW!	<b>QUARANT</b> 64K (PC FAMILY) \$269	<b>ATARI DRIVE 55/50/10K 88K</b> ATARI DR. 05/05/20K 704K \$398 \$919	<b>APPLE-CAT II</b> 212 APPLE CAT \$264 \$584
<b>COMMODORE</b> 64 & PERIPHERALS APPLE EMULATOR \$75	<b>GENIUS</b> 10/15 PRINTERS LOW!	<b>PRISM</b> 80 PRINTER LOW!	<b>PRISM</b> 132 PRINTER LOW!	<b>MICROSOFT</b> Z-80 CARD FOR APPLE II \$225	<b>80 COL</b> \$225	<b>APPLE-CAT II</b> 212 APPLE CAT \$264 \$584
<b>CORONA</b> 128K IBM-COMPATIBLE DESK-TOP W/ MONOCHROME MONITOR 2-DS/00/DRIVES, MSDOS, CP/M 86 LOW!	<b>OKIDATA</b> 83 \$649	<b>PRISM</b> 80 PRINTER LOW!	<b>PRISM</b> 132 PRINTER LOW!	<b>ANDEK</b> COLOR I MONITOR \$295	<b>132 COL</b> \$225	<b>APPLE-CAT II</b> 212 APPLE CAT \$264 \$584
<b>RAFFORD II</b> WITH ALL SOFTWARE LOW!	<b>TRANSTAR</b> (COLOR PRINTER) LOW!	<b>PRISM</b> 80 PRINTER LOW!	<b>PRISM</b> 132 PRINTER LOW!	<b>ANDEK</b> AMBER (PC COMPATIBLE) \$259	<b>ANDEK</b> DUAL 3" DRIVES (10M) \$619	<b>APPLE-CAT II</b> 212 APPLE CAT \$264 \$584
<b>NEC</b> APC 801 MONOCHROME SYSTEM LTD. 8" DISK CP/M 86 OS/2 II WORD PROC. & SPREADSHEET PC801A \$2649 PC801A \$699	<b>WIZARD</b> 8FD 16K APPLE \$129	<b>PRISM</b> 80 PRINTER LOW!	<b>PRISM</b> 132 PRINTER LOW!	<b>NEC</b> EC800 GREEN SCREEN \$79	<b>PRINCETON</b> COLOR MONITOR (PC) LOW!	<b>APPLE-CAT II</b> 212 APPLE CAT \$264 \$584

FOR FASTEST DELIVERY: CASHIER'S CHECK OR VISA/MASTERCARD (NO EXTRA CHARGE FOR CARDS. INCLUDE NUMBER, EXPIRATION DATE, NAME, ADDRESS & PHONE). PERSONAL CHECK ALLOW 2 WEEKS TO CLEAR. PURCHASE ORDER MUST INCLUDE CHECK, SHIPPING & HANDLING; CONTINENTAL U.S. 5% (\$5 MIN), U.P.S. STREET ADDRESS REQUIRED; APO FPO ALASKA HAWAII & MONITORS \$A (\$10 MIN); FOREIGN 15% (\$15 MIN). INCLUDES PHONE NUMBER WITH ALL ORDERS. ALL ITEMS ARE NEW WITH MANUFACTURER'S WARRANTY. APPLE COUNTRY, LTD. CANNOT GUARANTEE THE MERCHANTABILITY OF ANY PRODUCT. PRICES ARE SUBJECT TO AVAILABILITY & CHANGE WITHOUT NOTICE. DUE TO OUR LOW PRICES, ALL SALES ARE FINAL. RETURNED MERCHANDISE IS SUBJECT TO A RESTOCKING FEE & MUST COME IN ORIGINAL UNDAMAGED CARTON WITH RMA NUMBER. NO SOFTWARE EXCHANGES. CALIFORNIA RESIDENTS ADD 6% TAX. SEND \$1 FOR NEW FALL CATALOG (GOOD TOWARD FIRST PURCHASE). APPLE COUNTRY, LTD. IS A DISCOUNT MAIL ORDER HOUSE FOR THE MICROCOMPUTER INDUSTRY & IS A CALIFORNIA CORPORATION NOT AFFILIATED WITH APPLE COMPUTER INC. APPLE IS TRADEMARK OF APPLE COMPUTER INC. 6-183

**Call us... we can help! (619) 765-0239** P.O. Box 1099, Julian, Calif. 92036

Apple Country, Ltd. is a DISCOUNT MAIL ORDER HOUSE for the micro computer industry and is a California corporation not affiliated with Apple Computer Inc. Apple is a trademark of Apple Computer Inc.

## SUNNY LOW LOW COST POWER SUPPLIES (LINEAR & SWITCHING) FOR S-100, DISK DRIVES



**S-100 & DISK POWER SUPPLIES:** OPEN FRAME, ASSY. & TESTED, 6 OUTPUTS, ADJU. & FUSES PROTECT. **No. 806 & No. 516 Mainframes** **Kit 1, 2 & 3 for S-100** **R2, R3 for 2 Drives (Floppy & Hard)**

ITEM	IDEAL FOR	+5V OVP	-5V	+24V(OR +12V)	+8V	±16V	SIZE W x D x H	PRICE
S <sub>3</sub>	12 SLOT & 2 FLOPPY (1 Floppy & 1 Hard Disk)	5A	1A	5-7A PEAK	13A	3A	10" x 6" x 5"	102.95
S <sub>4</sub>	6 SLOT & 2 FLOPPY	4A	1A	4-5A PEAK	8A	3A	8 3/8" x 5" x 4 3/4"	92.95

**DISK POWER SUPPLIES:** OPEN FRAME, ASSY. & TESTED, REGULATED, ADJUSTABLE & FUSES PROTECT.

ITEM	IDEAL FOR	+5V OVP	-5V	+24V (or +12V)	+8V Unreg.	±12V	SIZE W x D x H	PRICE
R <sub>0</sub>	2 x 8" SLIMLINE	2.5A		2.5A - 5A Peak			5" x 4" x 4"	49.95
R <sub>1</sub>	2 x 8" or 2 x 5 1/2" DISK	4A	1A	3A - 5A Peak	2A		8" x 4" x 3 3/4"	54.95
R <sub>2</sub>	3 x 8" (or 5 1/2") FLOPPY	6A	1A	6A - 8A Peak			10" x 4 7/8" x 3 3/4"	69.95
R <sub>3</sub>	or 1x Floppy & 1x Hard	6A	1A	6A - 8A Peak		1A	9" x 6 1/4" x 4 3/8"	81.95

AC & DC POWER CABLES WITH CONNECTOR FOR 2 DRIVES 8.00

**S-100 POWER SUPPLY KITS** (OPEN FRAME WITH BASE PLATE, 3 HRS. ASSY. TIME)

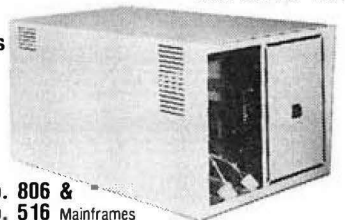
ITEM	(IDEAL FOR)	+8V	-8V	+16V	-16V	+28V	SIZE: WxDxH	PRICE
KIT 1	15 CARDS	15A	---	2.5A	2.5A	---	12" x 5" x 4 7/8"	54.95
KIT 2	20 CARDS	25A	---	3A	3A	---	12" x 5" x 4 7/8"	61.95
KIT 3	DISK SYSTEM	15A	1A	3A	3A	5A	13 1/2" x 5" x 4 7/8"	69.95

**6 SLOT MAINFRAME ASSY. & TESTED ONLY \$399.95 + SHIPPING \$18.00**

EACH MAINFRAME (ITEM NO. 806 OR 516) CONTAINS: EMI FILTER • FUSE HOLDER • AC POWER CORD • POWER SWITCH & INDICATOR • RESET SWITCH • 4 1/2" COOLING FAN • S-100 BUS 6 SLOT CARD CAGE • (110/220 VAC, 50/60 HZ) POWER SUPPLY FOR DISK DRIVES & S-100 SLOTS • 2 EA. DC POWER CABLES WITH CONNECTOR AND MOUNTING HARDWARE FOR DISK DRIVES • 9 EA. CUT-OUTS: 7 FOR DB25 CONNECTOR, 1 FOR 50 PIN CONNECTOR & 1 FOR CENTRONICS • CUSTOM FINISH & LOGO-LESS • COMPACT SIZE • LIGHTWEIGHT, 28 LBS. **ITEM #806** FOR 2 EA. 8" THINLINE FLOPPY (TANDON TM848-1 & 848-2 OR EQUIV.), OR ONE HARD DISK. POWER SUPPLY: +8V/8A, ±16V/3A, +5V/5A OVP, -5V/1A & 24V/5A. SIZE: 12"(W) x 19.5"(D) x 9.8"(H). **ITEM #516** FOR 2 EA. 5 1/2" FLOPPY (TANDON TM-100 - 1, 2, 3, 4 OR EQUIV.), OR ONE 5 1/4" FLOPPY & ONE 5 1/4" WINCHESTER HARD DISK (TANDON TM 600-2, 3 OR EQUIV.), POWER SUPPLY: +8V/8A, ±16V/3A OVP, +5V/6A OVP, +12V/6A, 8A PEAK. SIZE: 13.75"(W) x 19.5"(D) x 7"(H).

**SHIPPING** FOR EA. PWR SUPPLY: \$5.50 IN CALIF.; \$8.00 IN OTHER STATES; \$18.00 IN CANADA. FOR EA. TRANSFORMER: \$5.00 IN ALL STATES; \$12.00 IN CANADA. CALIF. RESIDENTS ADD 6.5% SALES TAX.

DEALER INQUIRIES INVITED



**No. 806 & No. 516 Mainframes**

MAILING ADDRESS:  
P.O. BOX 4296  
TORRANCE, CA 90510  
TELEX: 182558

**SUNNY INTERNATIONAL**  
(TRANSFORMERS MANUFACTURER)  
(213) 328-2425 MON-SAT 9-6

SHIPPING ADDRESS:  
22129 1/2 S. VERMONT AVE  
TORRANCE, CA 90502

# PROGRAMMABLE COMMUNICATIONS TRANSLATOR

THE PCT-100 IS A CONFIGURABLE IN-LINE RS-232 PROTOCOL AND DATA TRANSLATOR. THE PCT-100 CAN PROVIDE:

- \* TERMINAL OR PRINTER EMULATION
- \* DEC OR IBM SYSTEM COMPATIBILITY
- \* MACRO-FUNCTION KEYS
- \* "TYPE-AHEAD" AND DATA BUFFERING
- \* BAUD RATE CONVERSION
- \* HANDSHAKE PROTOCOL TRANSLATION (E.G. CTS/RTS, XON/XOFF)

THE PCT-100 IS CONFIGURED USING A BUILT-IN COMMUNICATIONS TRANSLATION LANGUAGE. PROGRAMS CAN BE EASILY ENTERED & EDITED FROM ANY ASCII DEVICE.

PCT-100-PCB (PCB ONLY) \$ 289  
PCT-100-ASM (PCB W/ CASE) \$ 339  
PCT-512-MOD (POWER SUPPLY) \$ 59



MSI



METHOD SYSTEMS INCORPORATED  
19751 SOUTH LAKESHORE BOULEVARD  
EUCLID, OHIO 44119  
(216) 531-0404

Circle 245 on inquiry card.

## Hayes Smartmodem 1200 BDRS232 \$489.

Rana Systems

Elite One \$265.00  
Elite Two \$395.00  
Elite Three \$495.00  
Rana Controller \$ 75.00

### COMMUNICATIONS PAK SALE

Micromodem II \$259.00  
Source Subscription \$ 89.95  
ASCII Express \$ 49.95  
ALL THREE PIECES \$375.00  
Verbatim 5 1/4" SSDD (10) \$ 25.50



WE CARRY A FULL LINE OF APPLE//E HARDWARE & SOFTWARE

GARDEN OF EDEN COMPUTERS

13147 Cedar Street, Westminister, CA 92683



714-894-9528

24 Hours - 7 Days

Ask for our Price List!



Circle 158 on inquiry card.

ONE KEYWORD PROCESSING on your **TELEVIDEO™** with **WORDSTAR™** and . . .

OVER 500 SOLD!



\$9995

MasterCard Visa

- NuKey™ Automates the 36 most commonly used word processing functions
- Reduces learning time while increasing operator speed
- For beginners and Wordstar experts
- Comes complete with 14 new matching keycaps

For your TELEVIDEO 950, TS-800, TS-800A, and TS 80Z PLEASE SEND WORDSTAR SERIAL NUMBER TO:

Business Solutions, Inc.  
91 W. Long Lake Rd., Suite 9  
Bloomfield Hills, MI 48013  
(313) 540-3360

CP/M™ OF DIGITAL RESEARCH TELEVIDEO™ TELE SOLUTION™ OF TELEVIDEO™ WORDSTAR™ OF MICROPRO INTERNATIONAL™ NUKEY & NUKEY KEY™ OF BUSINESS SOLUTIONS, INC.

Circle 47 on inquiry card.



Cost Plus 10% OR LESS!

We sell and lease **CompuPro** SYSTEMS

## MORROW DESIGNS DECISION 1

D2A WITH 1 MEG HD & 5 1/4" SSDD & CP/M \$8250 per mo  
only, 60-month lease with investment credit available

D3A WITH TERMINAL, 5 MEG HD & 5 1/4" SSDD, CP/M, Wordstar, Basic 80, Correct-It, Logscale, Basic, Pilot & Pearl \$10986 per mo.  
DBM: Shipment from factory with factory warranty.

We sell and lease all Morrow products. Airport-to-Airport Board Swap (Extra charge) Ask about bonus offer, Payroll, GL, AR, AP, Fixed Assets, Raw & Finished Inventory, Mail List, Transendental Pak, Loan Amortization, 6 Function Compound Interest, CPM Utilities, Lesser C and StarTrek. PRINTERS: OKI, Cihoh, NEC, Diablo, M/T, etc.

We cater to experienced users, state and federal agencies, corporate and small business customers. We have provisions for inexperienced users.

TERMS: Cash with order. Field tested and reliable. Add 2% for letter of credit or F.O.I. State P.G.

Cost Plus COMPUTERS

CALL US 9 AM to 10 PM 205 879-5976 P.O. Box 5114 Birmingham, AL 35259-5114  
205 879-4735 Our bank is 1st National of Birmingham, (205) 225-2120

Circle 99 on Inquiry card.

## 16 BIT 5100 SUPER MICRO

### EXPANDABILITY

18 SLOT 5-100  
128K-1M RAM  
1.2M PER 8" DISK  
640K PER 5 1/4" DISK  
15.8M PER HARD DISK

### FLEXIBILITY

IEEE 488  
A-TO-D AND D-TO-A  
OTHER IEEE 696 BOARDS

### GRAPHICS

512x480 SCION 95  
640x480 w/NEC 7220  
801 11x17" PLOTTERS

### SOFTWARE

MICROSOFT MSDOS  
BASIC, FORTRAN, PASCAL  
8087 SUPPORT

PLOTTING PACKAGE  
SCREEN DUMPING  
MATRIX ROUTINES  
DATA ACQUISITION

WILLIAM J. CLAFF  
(617)-235-9505

Circle 59 on inquiry card.

I WILL BEAT ANY COMPETITOR'S PRICE PROVIDED IT IS NOT BELOW MY COST. TRY TO BEAT THESE IC PRICES:

### DYNAMIC RAM

64K	200 ns	\$4.99
64K	150 ns	5.09
64K	120 ns	5.90
16K	200 ns	1.35

### EPROM

2764	300 ns	\$7.25
2732	450 ns	4.15
2716	450 ns	3.20
2532	450 ns	4.60

### STATIC RAM

6116P-3	150 ns	\$4.10
2016-LIKE	150 ns	4.40
2114	200 ns	1.45

### Z80A FAMILY

CPU, CTC, or PIO	\$3.39
DART	8.25
DMA or SIO.0	12.50

MasterCard VISA, or UPS CASH COD  
Factory New, Prime Parts

### MICROPROCESSORS UNLIMITED

24,000 South Peoria Ave.  
BEGGS, OK. 74421  
(918) 267-4961

Prices \$ 1.00

Prices subject to change. Call for volume prices. Subject to available quantities. Shipping & Insurance extra. Cash discount prices shown.

Circle 265 on inquiry card.

# Uniforth

One of the finest implementations of the FORTH language. Field tested and reliable. UNIFORTH is available for the IBM PC as well as most systems with 8" disks and the following processors:

8080 PDP-11  
Z80 6800  
8086/8 16032

As a task, UNIFORTH is compatible with and supports all features and file types of the CP/M, MSDOS, and DEC operating systems. As an operating system, UNIFORTH will function "stand-alone" on most commercial microcomputers.

The FORTH-79 Standard language has been extended with over 500 new words that provide full-screen and line-oriented editors, array and string handling, enhanced disk and terminal I/O, and an excellent assembler. Detailed reference manuals supply complete documentation for programming and system operation, in an easy-to-understand, conversational style using numerous examples.

Optional features include an excellent floating-point package with all transcendental functions (logs, tangents, etc.), the MetaFORTH cross-compiler, printer plotting and CP/M file transfer utilities; astronomical and amateur radio applications, word processing, etc.

Compare these features with any other FORTH on the market:

- Speed and efficiency
- Variety of options
- Ease of use
- Documentation quality

You'll find UNIFORTH is superior.

Prices start at \$35. Call or write for our free brochure.

Unified Software Systems

P.O. Box 2644, New Carrollton, MD 20784, (301) 552-1295

Circle 400 on inquiry card.

## PROGRAMMABLE APPLE™ II INTERFACE

The FLY BOARD is a digital interfacing system that is easily programmed through BASIC or assembly.

Fly Board's Hardware:

6522 VIA 2K bytes RAM

- 16 bidirectional I/O lines
- 4 control lines
- 2 - 16-bit timers
- Interrupt ability
- Accept PR# commands
- Replaceable with an EPROM
- Not used by monitor, BASIC, or DOS

2 - 36" DIP Jumper Cables

• Connect to your projects

Support Materials Included:

- User's Manual
- Engineer's Notebook
- Summary Card
- 6522 Data Sheet

only SNAVE SYSTEMS

\$12995 P.O. Box 957 Niles, IL 60448 (319) 966-4505

READY TO USE Add \$2 for shipping • VISA, M.C. or check

Circle 353 on inquiry card.

## ATM-RES THE PHCS

IEEE-696 S-100 MONOCHROME \$495

- 1 x 512 x 512 Pixel
- Single board system

IEEE-696 S-100 MONOCHROME / COLOR \$695

- 1 x 1024 x 1024 Pixel
- Expandable to 8 x 1024 x 1024 Pixel

IEEE-696 S-100 EIGHT COLOR \$1250

- 3 x 512 x 512 Pixel
- 8 Color RGB
- Two board system

MULTIBUS EIGHT COLOR \$2695

- 3 x 1024 x 1024 Pixel
- Eight color RGB
- Single board system

### IBM-PC

MONOCHROME	- 1 x 512 x 512 Pixel	\$495
	- 1 x 1024 x 1024 Pixel	\$695
COLOR	- 3 x 512 x 512	\$1295
	- 3 x 1024 x 1024 Pixel	\$1995

### FEATURES

Software drivers, Hardware zoom, Programmable Display Resolution, Windowing, Multi-Controller Capability, NEC UPD7220 Graphic Controller

ULTRA-RES Trademark CSD Incorporated Starting Prices

MULTIBUS Trademark INTC Corporation

C.S.D. Incorporated

P.O. Box 253 Suburb, Massachusetts 01776  
(617) 443-2750

Circle 52 on inquiry card.



# CHECK OUR NEW ★ LOW PRICES ★

## Apple Compatible Products



**AFDC-1 Floppy Disk Drive Controller** ... **\$89<sup>95</sup>**  
Runs DOS 3.3 with any standard Shugart compatible 5¼" Disk Drive. (2 Drives Each Card)

**APPLE ADD-ON DISK 1** **\$330<sup>00</sup>**  
AFDC-1, SA400, VDC-55S, Cables...

**APPLE ADD-ON DISK 2** **\$465<sup>00</sup>**  
AFDC-1, (2) SA400, VDC-55S, Cables



**ASCII KEYBOARD A&T** ... **\$99.00**  
Plug in compatible with Apple II, has shiftlock, underscore, [ ] and back slash characters.

**ALS Z80 CPU Card w/CP/M & Manuals** ... **\$135.00**

**Z80 CPU A&T, No manual or CPM** ... **95.00**

**Z80 CPU Card Kit, Instr only, no CPM** ... **85.00**

**ALS 80 Column Video Card, A&T**  
with manual ... **135.00**

**80 Column Video Card, A&T w/o manual.**  
Videx compatible ... **95.00**

**80 Column Video Card, Kit w/o manual.**  
Videx compatible ... **85.00**

**16K RAM Card, A&T** ... **44.00**

**16K RAM Card, Kit** ... **39.00**

**API Apple Parallel Printer Interface Card,**  
Centronics compatible, w/cable ... **45.00**

**EPROM Programmer A&T, Programs**  
2708-2764 w/o manuals ... **85.00**

**EPROM Programmer Kit, programs**  
2708-2764 w/o manuals ... **75.00**

**SUN-722 Apple Prototype Board** ... **13.75**  
Double Sided with gold contacts, holes drilled on .15" x .1" centers.

**PCM1 64K Memory Card, Expand. to 256K**  
with Parity Check ... **\$199.00**

**PCM2 256K Memory Card, Expand. to 512K**  
with Parity Check ... **469.00**

**PC-DUAL I/O (2) Serial RS232 Ports, (2) IBM**  
PC Compatible Ports and Real Time  
Clock w/Batt. Backup ... **189.00**

### ★SPECIAL★

**PCM1-DUAL I/O** Includes both PCM1 64K  
and PCM I/O Cards ... **359.00**

## Diskettes and Storage Cases

5¼" SS/DD Wabash 40 track w/hub rings ... **\$24.00**

8" SS/DD Soft with Library Case ... **26.00**

8" DS/DD Soft Memorex, Box of 10 ... **44.99**

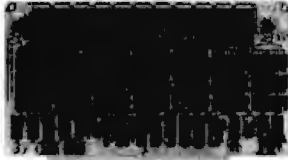
5¼" Case for 40 Disks ... **24.99**

8" Case for 40 Disks ... **36.99**

5¼" Case for 90 Disks ... **41.99**

8" Case for 90 Disks ... **54.99**

## 61K 6MHz Static RAM/EPROM



**64KSM A&T without RAM** ... **\$155<sup>00</sup>**

**64KSM A&T with 64k RAM (32-6116's)** ... **339.00**  
S-100 Board Uses 6MHz 6116's. ½A max. power, Bank Select plus Extended Addressing allow for multi-memory board set-up. 4 independent 16K Blocks make easy use with multi-user systems. Any 2K RAM may be replaced by 2716 EPROM.

## 256K/1M Byte Dynamic RAM

**256KDM A&T without RAM** ... **\$290<sup>00</sup>**

**256KDM A&T with 64K RAM (8-4164's)** ... **340.00**

**256KDM A&T w/256K RAM (32-4164's)** ... **489.00**  
S-100 Board, 4 Banks uses either 64Kx1 or 256Kx1 RAMs. Allows for 64K to 1M byte RAM on just one S-100 card. 24 Bit Addressing, Phantom Mode, Error Trap Opt., Parity Check, 4MHz Transparent Refresh, Front Panel Operation. Optional M1 Wait for 6MHz Operation.

## NEC Computers & Monitors

**We are an Authorized NEC Service Center**  
Call for Official Service Agreement

**PC8001A Keyboard Computer** ... **\$699.00**

**PC8012 I/O Expansion Unit** ... **499.00**

**PC8031 Disk Drive Subsystem** ... **699.00**

**JC1203RGB 13" Color Monitor** ... **666.00**  
This Monitor is excellent for use with IBM PC

**JC1203 13" Composite Color Monitor** ... **329.00**

**NEC CP/M V2.2 with manuals** ... **140.00**

**Select Word Processing Sys with Teach** ... **345.00**

**NEC Report Mgr for Database Mgmt** ... **135.00**



**SAMWOO GREEN 9" 18MHz** ... **121.00**

**SAMWOO AMBER 9" 18MHz** ... **125.00**

**SAMWOO GREEN 12" 12MHz** ... **130.00**

**SAMWOO AMBER 12" 12MHz** ... **134.00**

Composite video I/O. 750 lines resolution. 75/10K ohm impedance.



P/N	8 up	P/N	1-7	8 up
2716	\$3.95 \$3.95	6116P-3 (150nS)	\$6.10	\$5.75
2732	4.75 4.40	2114L-2(200nS)	1.62	1.62
2532	7.85 5.95	4164	6.25	5.95
2764	9.95 9.95	Z80A CPU	5.29	5.29

## S-100 Products

**SBC-880 Z80A CPU, A&T** ... **\$195.00**

**SBC-880 Z80A CPU, Kit** ... **175.00**  
4MHz Z80A CPU boards with Serial/Parallel Ports

**UFDC-1 Floppy Controller, A&T** ... **245.00**

**UFDC-1 Floppy Controller, Kit** ... **225.00**  
The UFDC-1 Floppy Controller uses the WD1795 chip which runs either and/or 8"/5¼" Disk Drives.

**CLOCK CALENDAR A&T** ... **115.00**

**CLOCK CALENDAR Kit** ... **95.00**  
This S-100 Clock Calendar Board has 4 interrupts, Time, Day of Week and Battery Backup.

**SUN-721 S-100 Prototype Board** ... **17.85**  
Double Sided with gold contacts and holes drilled on .15" x .1" spacing.

**S-100 Computer Systems**

**SYSTEM I** ... **\$2459.00**  
Z80A CPU with Serial/Parallel Ports, Floppy Disk Controller with Dual 8" SSDD Drives, 64K RAM, CPM, Clock and 1M Byte Storage.

**SYSTEM II** ... **2659.00**  
Z80A CPU with Serial/Parallel Ports, Floppy Disk Controller with Dual 8" DSDD Drives, 64K RAM, CPM, Clock and 2M Byte Storage.

**S-100 Mainframes 6-12 Slots**

**DMF8800T 6 Slot, Dual Thin 8" Drives** ... **\$699.00**

**DMF8800 6 Slot, Dual Std. 8" Drives** ... **699.00**

**DMF5550 6 Slot, Up to 3-5/4" Drives** ... **679.00**

**DMF2200 6, 8, 12, 18, 22 Slot MB** ... **Call**

All Mainframe Power Supplies rated at 8V @ 18A, ±16V @ 23A, 24V @ 5A, 12V @ 5A & 5V @ 5A.  
All cabinets made of strong steel with aluminum covers & inc EMI A/C power filter w/detachable power cord, quiet fan for pos. air pressure (blows dust out, not in), back panel has individual covers with (12) DB25 cutouts, (2) Centronics 36 pin cutouts, (1) 34 pin & (1) 50 pin flat ribbon cutout, (2) A/C convenience outlets (1 switched & 1 unswitched), keyed power, lighted reset switches, & tan cover with black face match most decours.

**Mother Boards & Card Cages**

**SLOTS Bare Bd KIT A & T w/CAGE**

SLOTS	Bare Bd	KIT	A & T	w/CAGE
6	\$12.00	\$34.00	\$49.00	\$74.00
8	16.00	45.00	70.00	105.00
12	22.00	65.00	100.00	140.00

\*10MHz, No termination Required



**Prowriter C. Itoh, 120cps, Parallel** ... **\$419.00**

**Starwriter C. Itoh, 40cps, Ser/Par** ... **1369.00**

**Printmaster C. Itoh, Serial/Parallel** ... **1529.00**

**NEC Spinwriters 3500, 5500, 7700** ... **Call**

## Disk Drives

**TM100-1 Tandon 5¼" SSDD, 40 track** ... **\$209.00**

**TM100-2 Tandon 5¼" DSDD, 40 track** ... **259.00**

**TM848-1 Tandon 8" Thin Line** ... **375.00**

**Mitsubishi 5¼" Thin DSDD, 40 track** ... **285.00**

**Mitsubishi 5¼" Thin DSDD, 80 track** ... **310.00**

**Mitsubishi 8" Thin DSDD, 77 track** ... **450.00**

## Subsystems

**VDC-55S Dual 5¼" Cabinet**  
w/5V @ 3A and 12V @ 3A Power Supply, and Fan ... **\$100<sup>00</sup>**

**SUNTRONICS CO., INC.**  
12621 Crenshaw Blvd., Hawthorne, CA 90250

STORE HOURS: MON.-FRI.  
SATURDAY

9:00am to 6:00pm  
10:00am to 5:00pm

CALIFORNIA **213-644-1149**  
(for Tech Info and Calif. orders)

OUTSIDE CALIFORNIA TOLL FREE **1-800-421-5775**  
(Order Desk Only)

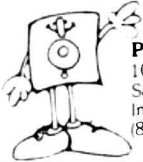
Mail Order—Minimum Order: \$10. Send Check or Money Order to: P.O. BOX 1957 Dept B, HAWTHORNE, CA 90250. Visa or MasterCard (please include expiration date). Add \$2.00 postage and handling for first 3 pounds plus .50 for each additional pound to your order. California residents add 6% sales tax.

# Maxell Floppy Disks

The Mini-Disks  
with maximum quality.



Dealer inquiries  
invited. C.O.D.'s  
accepted. Call  
FREE (800) 235-4137.



**PACIFIC EXCHANGES**  
100 Foothill Blvd., San Luis  
San Luis Obispo, CA 93401.  
In Cal call (800) 592-5935 or  
(805)543-1037

Circle 294 on Inquiry card.

# pc pipeline

Low, direct prices • Fast, direct service

2532-450.....	\$475
2716-450.....	369
2732-450.....	399
2764-250.....	979
2764-350.....	899
4164-200.....	475
6116-P3.....	430
6116-LP-3.....	548

Add \$2.95 shipping to all orders

OEM • Quantity discounts available • P.O.s on  
approval • C.O.D. OK • Credit cards • FL residents  
add 5% tax • All new, no surplus, no seconds  
(Prices subject to change.)

4920 Cypress St., Suite 100, Tampa, FL 33607

In FL, and for info., call 813-875-0299

**FOR ORDERS ONLY, 800-237-8910**

8AM-5PM EDT



Circle 149 on inquiry card.

# TYCOMP

## PRINTERS

Prowriter - 390<sup>00</sup> Par.  
Prowriter - 600<sup>00</sup> Ser.  
Prowriter II - 700<sup>00</sup> Par.  
Prowriter II - 775<sup>00</sup> Ser.  
Epson FX-80 - Call!!!  
OKIDATA - ML92 - 570<sup>00</sup>  
OKIDATA - ML93 - 999<sup>00</sup>  
Star-Gemini 10 and 15 - Call

## CALL FOR APPLE II E

& IBM-PC  
**LOW - LOW PRICES!!!**

**MBI - MONTE CARLO**  
CARD - CALL

**U.S. ROBOTICS -**  
1200 BAUD MODEMS  
CALL! CALL! CALL!

Plus a full line of letter  
quality and Dob Matrix  
Printers

## MONITORS

Princeton Graphics - Call  
AMDEK 300-179<sup>00</sup>  
AMDEK Color I - 289<sup>00</sup>  
AMDEK Color II - 875<sup>00</sup>

**A LARGE MAGAZINE AD  
DOES NOT ALWAYS INSURE  
YOU THE CUSTOMER WITH  
FAST SERVICE AND  
COMPETITIVE PRICING.  
WE OFFER LOW PRICES!  
SUPPORT AND EFFICIENT  
FRIENDLY SERVICE!!!**

**CALL (803) 877-2468**  
ORDERS - CALL COLLECT

**MASTERCARD AND  
VISA ACCEPTED**

## TYCOMP

700 W. Poinsett St.  
Greer, S.C. 29651

WRITE FOR FREE CATALOG



Circle 394 on Inquiry card.

# WE LOVE TO PASS THE BUCK!

We will do our  
best to beat any  
competitor's price.



## WE WANT YOUR BUSINESS!

<b>DYNAMIC RAM</b>	4164	200ns	\$4.75
	4164	150ns	5.10
	4116	200ns	1.50
	4116	150ns	1.75
<b>STATIC RAM</b>	6116P-3	150ns	\$4.10
	6116LP-3	150ns	4.60
	58725	150ns	4.10
	2114L	200ns	1.60
<b>EPROM</b>	2764	300ns	\$7.50
	2764	250ns	8.00
	2732	450ns	4.10
	2732	450ns	4.50
	2716	450ns	3.30
	2716-1	350ns	4.00
	2532	450ns	4.60
<b>Z80 FAMILY</b>	Z80A CPU, CTC, PIO		\$3.00
	DART		8.00
	DMA, SIO/O		12.00
	Z80B CPU, CTC, PIO		11.00

## NORTHWEST MICROCHIPS DISTRIBUTORS

1317 So. Woodlawn St./P.O. Box 1221 Tacoma, Washington 98401  
(206) 565-9331 (call anytime)

TERMS: \$10.00 Minimum Order. Money Order, Cashiers Check, UPS  
COD, Washington Residents add 7.8% tax. Shipping and Insurance  
extra. Quantity discounts available. Ask for our catalog.  
PRICES SUBJECT TO CHANGE.

Circle 285 on Inquiry card.

# The ACCOUNTER

for  
Apple II, 48K, One Disk Drive  
Double Entry, Menu-Driven  
GENERAL LEDGER

- Cash Journal
- Check Record
- Revenues
- Receivables
- Payables
- Payroll

- ▶ Flexible, simple to apply
- ▶ Sort, test, view, audit
- ▶ Current financial statement
- ▶ User-friendly
- ▶ Formatted printout
- ▶ 76 page manual
- ▶ Many more features

## GREAT FOR NON-ACCOUNTANTS

Limited-time special \$149.00

Add \$9.69 tax in California

Money-back guarantee

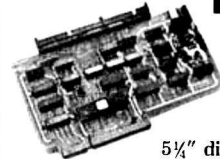


## CYCLONE SOFTWARE

10395 Flora Vista Ave.  
Cupertino, CA 95014

Circle 107 on inquiry card.

# ZENITH/Heath Users



Double Your  
5 1/4" disk storage  
capacity without adding a drive.

Get twice as much from your H88 or  
H89 microcomputer. Our FDC-880H  
floppy disk controller, in conjunction  
with your 5 1/4" drives, for example,  
expands memory capacity from 256  
bytes to 512 bytes per sector.

And it handles single and double-  
sided, single and double-density, 8" and  
5 1/4" drives — simultaneously.



C.D.R. Systems Inc.

Controlled Data Recording Systems Inc.  
7210 Clairmont Mesa Blvd., San Diego, CA 92111  
(619) 560-1272

Circle 55 on inquiry card.

# LSI C Compiler for 8080/Z80

LSI C compiler is designed for programs with  
a small memory and a shorter CPU time.

- ★ The object code is compact and is faster than  
leading "C" compilers (Eratosthenes: 13.4sec)
- ★ typedef, static, cast and initializers are available
- ★ The compiler and the generated code run  
under CP/M™, but also can be burnt into  
PROMs.

## Rational BASIC

a basic interpreter for Z80 CP/M

## TEDDY

a full screen editor for 8080/Z80 CP/M

CP/M is a trademark of Digital Research

for pamphlet write:  
P.O. Box 508 STA. CRUZ  
CA, USA 95062

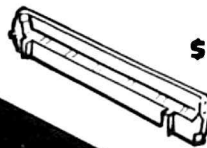
for further information contact:

**LSI JAPAN CO., LTD.**

2-24-9 YOYOGI SHIBUYA-KU TOKYO (151) PHONE (03)379-2427

Circle 223 on Inquiry card.

# EPSON® RIBBON CARTRIDGES



MX 70/80

**\$5.25 EA.**

\$60.00/DOZ.

MX 100

**\$9.95 EA.**

\$108.00/DOZ.

EPSON®  
MX100-ZIP  
PACK-RELOAD!

**\$6.50 EA.**  
**\$72.00/DOZ.**

PLUS OTHER MAJOR BRAND NAMES  
AVAILABLE

## DWIGHT COMPANY, INC.

15565 Northland Drive  
Suite 804 West  
Southfield, MI 48075  
(313) 569-3218

Circle 131 on inquiry card.



Peripherals a Generation Ahead

Voice Coil Actuated

Dual 8" Floppy Disk Drive

- FAST
- Apparent performance of a  
Hard Disc
- Equivalent of two standard  
drives

Model 299B (DS DD/SD)  
Model 270/277 (SS DD/SD)

## PERSci, Inc.



12624 Daphne Avenue  
Hawthorne, CA 90250  
(213) 777-7536  
TWP#910-321-4448

Circle 297 on Inquiry card.



ACE 1000  
**\$899<sup>00</sup>**

With Color \$949<sup>00</sup>



APPLE CAT II	295.00
APPLE CAT 212	295.00
J-CAT	149.00
AUTO CAT 212	599.00
D-CAT MODEM	179.00
CAT	169.00
SMART CAT 103/212	479.00



**TWO DRIVES**  
**128K; 3.0 CP/M**  
DIAGNOSTIC CONTROLLER  
**CALL FOR LOWEST PRICES**

## SOFTWARE

ASCII EXPRESS II	49 00
AZTEC	29 00
BANK STREET WRITER (AP, AT)	49 00
BEAGLE BROS	5Call
BPI GL, AR, INV	299 00
CP/M 3.0 (Basis)	189 00
CYDEX	49 00
D BASE II	499 00
FACEMAKER (AP, IBM)	25 00
FLIGHT SIMULATOR (IBM)	39 00
HOME ACCOUNTANT APPLE	49 00
IBM	109 00
INFOSTAR	289 00
LEARNING COMPANY	5Call
MAILMERGE (APPLE)	99 00
PEACHTREE	5Call
PASCAL/MT + 86 (IBM)	329 00
PFS (AP, IBM)	5Call
SUPERCALC	199 00
ULTAMA II	47 00
VOLKSWRITER (IBM)	149 00
WORDHANDLER II	129 00
WORDSTAR	279 00

## MONITORS

BMC 12" Green AU	86 00
BMC 12" Green EU	129 00
BMC 9191 Color	299 00
Quadchrom Hi-Res RGB	499 00
Taxan 12" Amber or Green	149 00
Taxan RGB III	549 00
USI Pi-3 12" Amber	189 00
USI Pi-1 9" Green	89 00

## PRINTERS

BMC	789 00
C-170H Prowriter 8510AP	459 00
DTC 380Z	1195 00
EPSON	5Call
GEMINI 10	329 00
GEMINI 15	499 00
OKIDATA	5Call
SEIKOSHA GP100	239 00

## HARDWARE

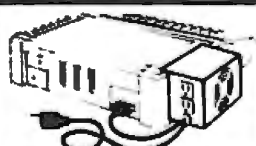
APPLESURANCE	99 00
DISPATCHER (SERIAL INTERFACE)	119 00
HAYES SMART MODEM 1200	529 00
MICROMODEM II	269 00
LEGEND 64K	299 00
LEGEND 128K w Software	359 00
MICROBUFFER II 16K	329 00
MICROSOFT 16K RAM CARD	59 00
SOFTCARD	239 00
MX PLUS (Finger Print)	45 00
PAYMAR L CASE Rev 7	20 00
RIBBONS EPSON MX 80	7 00
EPSON MX 100	11 00
OKI 82 83 GEMINI	3 95
SMARTERM II	149 00
SNAPSHOT	99 00
WIZARD RPO 16K	149 00
WILDCARD	119 00
Z-CARD II	149 00



A/D D/A	269 00
CPS CARD	159 00
CABLES	5Call
CLOCK	195 00
EXPANSION CHASSIS	599 00
MUSIC SYSTEM	299 00
RAMPLUS 32K	145 00
ROMWRITER	145 00
SUPERTALKER	149 00



80 COLUMN	199 00
ENHANCER II	119 00
FUNCTION STRIP	59 00
INVERSE VIDEO	19 00
ULTRATERM	5Call
PSIO	5Call
SOFTWARE	5Call



### SYSTEM SAVER

- Surge Suppression
- Dual Outlet
- U.L. Listed
- Fits Apple Stand

**\$65**



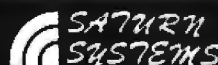
5 1/4" SS DD SS (100)	239 00
5 1/4" SS DD SS (10)	25 95
3" SS DD SS (10)	39 90
8" DS DD SS (10)	45 00

## DRIVES

4IN DIMENSION	249 00
MICRO SCI A2	249 00
MICRO SCI A3 A49 A70	5Call

## 16K RAM CARD

Compatible with  
DOS 3.3 CP/M  
Visicalc PASCAL  
**\$39<sup>00</sup>**  
2 YR WARRANTY



64K	\$319
128K	459
V-C Expand 80	99

## GAME I/O

TG JOYSTICK (IBM)	45 00
JOYSTICK II	40 00
JOYSTICK III	45 00
PADDLES	29 00
SELECT A-PORT	47 00
TRACKBALL	59 00
KRAFT JOYSTICK (AP, IBM, TRS)	47 00
JOYSTICK (AT COM)	15 00
PADDLES	35 00
PARADISE PORT	24 95
PADDLE APPLE	24 95



LETTER QUALITY  
DAISY WHEEL  
**\$569<sup>00</sup>**



QUADBOARD 64K	299 00
MICROFAZER	5Call
QUAD 512 (64K)	229 00
QUADBOARD II 64K	299 00

## POWER STRIP

W/SURGE  
PROTECTION  
**\$25<sup>00</sup>**



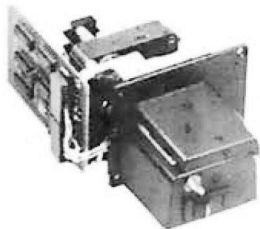
- No Charge for Credit Cards
- Min \$4.00 Shipping Charge
- Purchase Orders Welcome  
Call for Terms First



**COMPUTER  
DISCOUNT  
PRODUCTS**

MAIL ORDERS & RETAIL STORE  
860 S. Winchester Blvd.  
San Jose, CA 95128  
**(408) 985-0400**

HOURS: MON-FRI 8AM-5PM - SAT & SUN 10AM-4PM  
PRICES SUBJECT TO CHANGE-ALL ORDERS FOB SAN JOSE



**350 Char/Sec Low Cost Loader**

Solid state photoelectronic components read all standard 5, 6, 7 or 8-level tapes. Smooth, quiet AC drive. Reliable high-speed paper tape data entry. Data amplifiers and "character ready" output available for CMOS or TTL interfaces. Standard interface or to your interface specifications. Fanfold boxes available.

Addmaster Corporation, 416 Junipero Serra Drive, San Gabriel, CA 91776, Telephone: (213) 285-1121, Telex: 674770 Addmaster SGAB

Circle 6 on Inquiry card.

**DISKETTES**  
**3M Scotch BRAND**

**AT SUPER LOW PRICES**  
WE WILL SHIP YOUR  
ORDER WITHIN 24 HOURS  
AND WE PAY THE  
SHIPPING CHARGES



DEALER INQUIRIES INVITED



**CALL TOLL FREE**  
**800 922-8193**

IN CALIFORNIA  
800 468-1068



Tayco Business Forms  
Computer Supplies  
Post Office Box 605  
Newbury Park, CA 91320

Circle 376 on Inquiry card.

**ANALOG ↔ DIGITAL**  
**DIGITAL ↔ ANALOG**

CONVERSION MODULES

**SOFTWARE**  
**GAIN CONTROL**

high accuracy — programmable gain instrumentation amplifier — custom board test — \$100 — 2 to 15 kHz conversion time — mizable high and low inputs — gain from 1 to 1024 — 12-bit sample and hold amplifier 8-channel differential — 16-channel — analog to digital high accuracy — programmable gain instrumentation amplifier — custom board test — \$100 — 2 to 15 kHz conversion time — mizable high and low inputs — gain from 1 to 1024 — 12-bit sample and hold amplifier 8-channel differential — 16-channel — analog to digital high accuracy — programmable gain instrumentation amplifier — custom board test — \$100 — 2 to 15 kHz

For additional details about the AD-100-4 and other fine California Data Corporation 100% individually tested, high reliability products, circle the reader service card number below or for faster response write or call us.

**CALIFORNIA DATA CORPORATION**

3475 Old Conejo Road, Suite C-10  
Newbury Park, CA 91320

(805) 498-3651

Circle 53 on inquiry card.

**ScreenGen**  
**FULL SCREEN CONTROL**

An assembler subprogram you call from your programs to handle screen input/output as IBM mainframes do.

Define full screen format specifications outside your program, and call ScreenGen to retrieve the formats, and do all the I/O for you.

- One command input/displays a full screen
- Use all of your CRT video attributes
- Define up to 24 function keys
- Define templates for display and input
- Validate input while keying. Insert and delete characters to correct fields
- Tab fields forward and backward
- Draw figures using vertical field displays
- Save memory as only one format needs to be in memory at one time. Make the constants to display virtual, and they don't use any memory at all
- Build help screens. Call them with one function key then return to where you were

**Available now for most popular —**  
BASIC IBM PC and CP/M \$99  
COBOL Apple II CP/M \$75  
FORTRAN Shipping \$ 4  
PASCAL Source code included

Dealer inquiries welcome

**INTERDATA SYSTEMS INC.**

1051 Clinton Street, Buffalo, N.Y. 14206 Visa, M/C  
(416) 493-8675 (call collect to order) Am. Express

Circle 198 on inquiry card.

**DATAWARE**

tools for dBASEII  
application development



PREPAID/COD

DEVELOPING APPLICATIONS FOR MICRO-COMPUTER DATABASES: Concepts, Tools and Techniques. by Steve Patthen \$29/32

The DATAWARE MENU SYSTEM for dBASEII (with development and backup utilities) User's manual and 8"SD diskette \$65/69

dBASEII \$525/535

Look for our data dictionary system

DATAWARE SYSTEMS  
255 Chippewa  
Pontiac, Mich. 48053  
(313) 338-4358

Circle 115 on inquiry card.

**5 1/4" Floppy Disk Drives**

(Direct IBM® Plug-in)

TANDON Model TM 100-1 \$189\* ea.

TANDON Model TM 100-2 \$249\* ea.

12" Green Phosphor Zenith Monitor \$109\* ea.

**IBM EXPANSION BOARDS**

64K Memory ..... \$275\* ea.

128K Memory ..... \$375\* ea.

192K Memory ..... \$450\* ea.

256K Memory ..... \$510\* ea.

Floppy Controller ..... \$180\* ea.

16K System BD Memory . \$ 25\* ea.

MC / VISA or C.O.D. with certified check or money order. Arkansas residents add sales tax.

For information or orders, call

**501-777-9859**

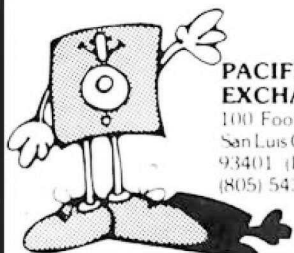
G-H Computer Systems, Inc.  
P.O. Box 871 • Hope, AR 71801

\* Plus Shipping.

Circle 157 on inquiry card.

**BASF**  
**DISKETTES**

BASF Diskettes at competitive price. Call TOLL FREE (800) 235-4137 for prices and information. Visa and Master Card accepted.



PACIFIC EXCHANGES  
100 Foothill Blvd  
San Luis Obispo, CA  
93401 (In Cal call  
(805) 543-1037)

Circle 294 on Inquiry card.

**SUPER-FAST!**  
**Z80**  
**DISASSEMBLER**  
**\$69.95**

Uses Zilog Mnemonics, allows user defined labels, strings, and data spaces. Source or listing-type output with Xref to any device. Available for Z80 CP/M or TRS-80.

SLR Systems  
200 Homewood Drive  
Butler, PA 16001  
(412) 282-0864

Add \$2.00 shipping. Specify format required. Check, money order, VISA, Master Card, C.O.D. PA residents add 6% sales tax. Dealer Inquiries Invited. CP/M, TRS-80 TM of Digital Research, Tandy Corp.

Circle 349 on Inquiry card.

**TeleVideo™ USERS!**

COGITATE Fast Dump/Restore System for TS 802H, 806.

- Back-up files twice as fast as PIP.
- Double the storage, up to 700K/diskette, with multiple diskette capability \$90.00

COGITATE Type Ahead With Print Screen

- Print key prints screen.
- 64 character type ahead buffer \$90.00

TurboDOS

- MULTI-USER \$750.00
- SEMINARS \$250.00

CP/M® is registered trademark of Digital Research, Inc. TurboDOS is a registered trademark of Software 2000, Inc.

PLUS OTHER GOOD TELEVIDEO STUFF!

**COGITATE, Inc.**

SPECIALISTS IN UNIQUE TELEVIDEO SOFTWARE  
24000 Telegraph Road, Southfield, MI 48034

(313) 352-2345

VISA/MASTER CARD Accepted

Circle 62 on inquiry card.

## Alspa Computer, Inc.

The price-performance leader. Includes Z80A, 1 or 2 full 8" drives (double density, double sided), 3 serial and 1 parallel port, and winchester port. Prices start at less than \$2000. Networking available. DEALER / OEM inquiries invited.

### SPECIALS on INTREGATED CIRCUITS

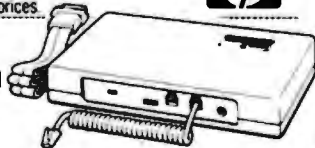
6502	7.45	10/6.95	50/6.55	100/6.15
6520 PIA	5.15	10/4.90	50/4.45	100/4.15
6522 VIA	6.45	10/6.10	50/5.75	100/5.45
6532	7.90	10/7.40	50/7.00	100/6.60
2114-L300	1.95	25/1.85	100/1.75	
2716 EPROM	5.90	5/5.75	10/5.35	
2532 EPROM	6.90	5/6.45	10/5.90	
6116 2Kx8 CMOS RAM	5.90	5/5.45	10/5.10	
4116 RAM		8 for 14		
Zero Insertion Force 24 pin Socket (Scanbe)				2.00

## Hewlett Packard



Write or call for prices

### Anchor Automation Signalman Modems



### FREE SOURCE MEMBERSHIP WITH SIGNALMAN

All Signalman Modems are Direct Connect, and include cables to connect to your computer and to the telephone. Signalman Modems provide the best price-performance values, and start at less than \$100. Dealer and OEM inquiries invited

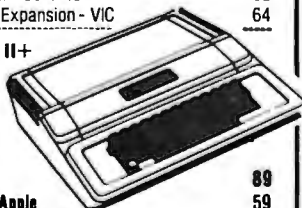
Mark I RS232	(99)	79
Mark II for Atari 850	(99)	79
Mark IV for CBM/PET with software	(169)	99
Mark V for Osborne (software available)	(129)	93
Mark VI for IBM Personal Computer	(250)	180
Mark VII Auto Dial/Auto Answer	(179)	119
Mark VIII Bell 212 Auto Dial/Answer	(399)	319

DC HAYES Smartmodem	219
DC Hayes Smartmodem 1200	545



Apple Emulator for Commodore 64	89
Screenmaker 80 COLUMN CARD for C64	149
FROGGER for C64 or VIC	25
Solid Oak 2 Level Stand for C64 or VIC	29
C64/VIC Switch (networking)	125
BACKUP V1.0 tape copier for C64 or VIC	20
CARDBOARD/6 Motherboard - VIC	79
CARDAPTER/1 Atari VCS Adapter - VIC	69
CARDPRINT Printer Interface - C64/VIC	64
CARDBOARD/3s Motherboard - VIC	32
CARDETTE/1 Cassette Interface - C64/VIC	32
CARDRITER Lightpen - C64/VIC	32
CARDRAM/16 RAM Expansion - VIC	64

We carry Apple II+ from Bell & Howell



Apple Emulator for Commodore 64	89
16K RAM Card for Apple	59
Solid Oak 2 Level Stand for Apple	29
Super Serial Card	149
MPC RAM/80 column card for IIE	139
Z80 Softcard and CP/M (Microsoft)	235
Parallel Printer Interface/Cable	79
Apple Dumping (Microtek) Printer Interface	115
Apple Dumping with 16K Buffer	160
Grappler + Interface	140
TG Products for Apple in stock	
DC Hayes Micromodem II	299
Videx 80 Column Card	239
Wayden Software for Apple 20% OFF	
PIE Writer Word Processor	120

## Commodore

See us for Personal, Business, and Educational requirements. Educational Discounts available.

### PETSCAN \$245 base price

Allows you to connect up to 30 CBM/PET Computers to shared disk drives and printers. Completely transparent to the user. Perfect for schools or multiple word processing configurations. Base configuration supports 2 computers. Additional computer hookups \$100 each.

### CBC / PET / C64 COMMUNICATIONS!

### COMPACT \$115

Intelligent Terminal Package  
ACIA Hardware / STCP Software

### VE-2 IEEE to Parallel Interface 110

Includes case, power supply, full 8-bit transmission, and switch selectable character conversion to ASCII.

### VIDEO ENHANCER for Commodore 64 89

Realize video quality equal or better than composite monitor using standard color TV.

### SCREENMAKER 80 Column Adpater for C64 149

Provides big screen capability for business applications.

VIC 20 Products	VIC Sargon II Chess	32
BACKUP V1.0	VIC GORF	32
VIC RAM Cards in stock	Meteor Run (UMI)	39
VIC SuperExpander	VIC Radar Rattrace	24
VIC 16K RAM	Amok (UMI)	20
Thorn EMI Software	Snakman	15
HES Software	Rubik's Cube	13
VIC Omega Race	Programmers Reference	15
Spiders of Mars (UMI)	FROGGER	25
Programmers Aid	VIC Adventure Series	

### VICTORY Software for VIC and C64

Street Sweepers	Maze in 3-D	12
Night Rider	Cosmic Debris	12
Treasures of Bat Cave	Grave Robbers Advent.	11
Games Pack I	Games Pack II	12
Victory Casino	Adventure Pack I	12
Adventure Pack II	Trek	11

Commodore 64 Programmers Reference Guide 16

MicroChess for C64 or PET 19

CompuTel's First Book of PET/CBM 11

C64 or VIC SWITCH 125

POWER ROM Utilities for PET/CBM 78

WordPro 3+/64 69

WordPro 4+ - 8032, disk, printer 295

SPELLMASTER spelling checker for WordPro 170

VISICALC for PET, ATARI, or Apple 189

PETRIX PET to Epson Graphics Software 40

SM-KIT enhanced PET/CBM ROM Utilities 40

Programmers Toolkit - PET ROM Utilities 35

CALC RESULT for C64 135

PET Spacemaker II ROM Switch 36

COPYWRITER Word Processor for C64 69

2 Meter PET to IEEE or IEEE to IEEE Cable 40

Dust Cover for PET, CBM, 4040, or 8050 8

CmC Interfaces (ADA1800, ADA1450, SADI) in stock

ZRAM - CBM 64K RAM, Z80, CP/M 550

Programming the PET/CBM (CompuTel) - R. West 20

CompuTel First Book of VIC 11

Whole PET Catalog (Midnight Gazette) 8

PET Fun and Games (Cursor) 11

Color Chart Video Board for PET 125

### FlexFile for PET CBM, C64 \$110

Database, Report Writer with calculations, Mailing Lists.

FORTH for PET full FIG model - Cargill/Riley \$50

Metacompiler for FORTH for independent object code 30

KMMM PASCAL for PET/CBM 85

EARL for PET/CBM Disk-based ASSEMBLER 65

Super Graphics - BASIC Language Extensions 45

Fast machine language graphics routines for PET/CBM

RAM/ROM for PET/CBM 4K \$75 8K \$90

DISK ICU - Recovery System for PET/CBM 40

## DISK SPECIALS



Scotch (3M) 5" ss/dd	10/2.25	50/2.10	100/2.05
Scotch (3M) 5" ds/dd	10/3.15	50/2.90	100/2.85
Scotch (3M) 8" ss/sd	10/2.40	50/2.20	100/2.15
Scotch (3M) 8" ss/dd	10/2.95	50/2.70	100/2.65

### We stock VERBATIM DISKS

Write for Dealer and DEM prices.

BASF 5" or 8"	10/2.00	20/1.95	100/1.85
NEW BASF Qualimetric Disks also in stock			
Wabash 5" ss/sd	10/1.80	50/1.75	100/1.70
Wabash 5" ss/dd	10/2.00	50/1.95	100/1.90
Wabash 8" ss/sd	10/2.00	50/1.95	100/1.90

### We stock MAXELL DISKS

Write for dealer and OEM prices.

Disk Storage Pages	10 for \$5	Hub Rings 50 for \$6
Disk Library Cases	8"—3.00	5"—2.25
Head Cleaning Kits	11	

### CASSETTES—AGFA PE-611 PREMIUM

C-10	10/.61	50/.58	100/.50
C-30	10/.85	50/.82	100/.70

### DATASHIELD BACKUP POWER SOURCE 225

Battery back up Uninterruptible Power Supply with surge and noise filtering. The answer to your power problems.

Zenith ZVM-121 Green Phosphor Monitor	100
BMC 12A 12" Green Monitor	80
VOTRAX Personal Speech System	280
VOTRAX Type-N-Talk	160
VOICE BOX Speech Synthesizer (Apple or Atari)	
CompuServe Subscription (5 hours free)	32
Prowriter Parallel Printer	389
USI Comp MOD 4 R F Modulator	39
Daisywriter 2000	1050
Many printers available (Star, Brpther, OKI, etc.)	

### We Stock AMDEK Monitors

Amdek DXY-100 Plotter	600
A P Products	15% OFF
Watanabe Intelligent Plotter 990	6-pen 1290
ISOBAR 4 Outlet Surge Suppressor/Noise Filter	49
We stock Electrohome Monitors	
dBASE II (8" format)	325

### ALL BOOK AND SOFTWARE PRICES DISCOUNTED

Panasonic TR-120M1P 12" Monitor (20 MHz)	149
Panasonic CT-160 Dual Mode Color Monitor	285

USI Video Monitors—Green or AMBER 20 MHz hi-res. Dealer and OEM inquiries invited

Synertek SYM-1 Microcomputer SALE 189  
KTM-2/80 Synertek Video and Keyboard 349

## ZENITH data systems

Z29 Terminal (new detached keyboard)	680
ZT-1 Intelligent Communications Terminal	369
Z100 16-bit/8-bit Systems in stock	CALL
We stock entire Zenith line.	



## ATARI SPECIALS

### WE STOCK ENTIRE LINE—write for prices.

Atari 1200	549	OIX	34
Voice Box	100	Anchor Modem—Atari	79
FROGGER	25	Atari Graphics (CompuTel)	11
Thorn EMI Software		First Book of Atari	11
EduFun Software		APX Software	

215-822-7727  
252 Bethlehem Pike  
Colmar, PA 18915

## A B Computers

WRITE FOR CATALOG. Add \$1.50 per order for United Parcel. We pay balance of UPS surface shipping charges on all prepaid orders (add extra for mail APO/FPO, air). Prices include cash discount. Regular prices slightly higher. Prices subject to change.

# maxell®

Floppy Discs

CALL NOW—TOLL FREE  
1-800-328-DISC

Dealer inquiries invited. C.O.D.'s and charge cards accepted.

All orders shipped from stock, within 24 hours. Call toll FREE.



North Hills Corporation

3564 Rolling View Dr.

White Bear Lake, MN 55110

1-800-328-DISC

MN Call Collect 1-612-770-0485

Circle 280 on Inquiry card.

## Full Size Keyboard Conversion

For Your ZX81/TS1000

SUN KD-81  
\$69<sup>95</sup>



Easy To Install  
No Soldering — No Modifications

41 Keys with Full Size Space Bar • Allows Touch Typing  
Same Key Layouts as Sinclair • Two Color Keypops  
Keyboard Case Holds Both Keyboard and Computer  
Commands and Graphics Spelled Out on Keypops

16K Piggyback RAM Module P/N MX-16 \$49.95



**SUNTRONICS CO., INC.**

In Calif Call 213-644-1149

Outside Calif Call 1-800-421-5775

Or send Check or M.O. to:

P.O. Box 1957 Hawthorne CA 90250

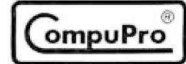
California residents add 6 1/2% sales tax

Add \$4.00 ship/handling VISA/Mastercard include expiration date

Circle 367 on Inquiry card.

# Bargain Boards™

Best prices around on



boards.



Include \$5.00 per board for shipping and handling.

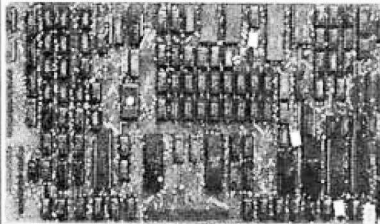
6331 Fairmount Ave. #701

El Cerrito, Ca. 94530

(415) 524-8352

CompuPro is a registered trademark of Godbout Electronics.

## NEW PRODUCT!



### CP/M Z80-A SINGLE BOARD COMPUTER

- On board video • Wide line and thin line graphics
- 128K of RAM • Sasi interface • Floppy disk controller for up to four 5-1/4 and four 8 inch drives, single/double density simultaneously • 4 serial ports • Full Centronics printer port • Expansion bus • Extended track buffer • 16K printer buffer
- DMA • Compact size (8-1/4 x 12-1/4)

\$750.00 3-6 weeks delivery

INSIGHT ENTERPRISES, CORPORATION  
373 N. Western Ave., Suite 12  
Los Angeles, CA 90004 (213) 461-3262  
Dealer, OEM, International Inquiries Welcome



Circle 190 on inquiry card.

## S-100 COLOR GRAPHICS \$199

256H-192V • IMAGER-I • 16 COLORS

- |  |   |                       |
|--|---|-----------------------|
| A<br>P<br>P<br>L<br>I<br>C<br>A<br>T<br>I<br>O<br>N<br>S | <ul style="list-style-type: none"> <li>• USES TMS 9918A FROM TEXAS INSTRUMENTS</li> <li>• 32 PRIORITIZED PLANES FOR 3D SIMULATION</li> <li>• 3 GRAPHIC MODES</li> <li>• TEXT MODE</li> <li>• 32 SIMULTANEOUS FAST MOVING SPRITES</li> <li>• SPRITE COINCIDENCE DETECTION</li> <li>• ON BOARD JOYSTICK &amp; PUSHBUTTON LOGIC</li> <li>• COMPOSITE VIDEO OUTPUT (INTSCI)</li> <li>• ON BOARD REF MOD CONVERSION INSTRUCTIONS</li> <li>• MEETS IEEE 696 SPECIFICATIONS</li> <li>• HIGH QUALITY PC CONSTRUCTION</li> <li>• SAMPLE PROGRAMS INCLUDED IN MANUAL</li> </ul> | G<br>A<br>M<br>E<br>S |
|--|---|-----------------------|

USER MANUAL ONLY — \$10  
DEALER INQUIRIES INVITED — CHECK OR MONEY ORDER OR C.O.D.  
MASTERCARD, VISA — ADD 4% — ADD \$2 SHIPPING & HANDLING  
MASSACHUSETTS RESIDENTS PLEASE ADD 5% SALES TAX.



CALL (800) 343-1292  
MASS (800) 322-0453



**TechniGraphic Designs**

P.O. BOX 239-GRAFTON, MASSACHUSETTS 01519

Circle 378 on inquiry card.

## DATA COMMUNICATIONS SPECIALISTS FOR IBM PC & SEATTLE COMPUTERS

Teleprocessing software available for above computers to time-sharing host or between two users (send binary files, also). Version 2 software, \$60. Version 3, IBM PC \$45, SEATTLE \$160. Write for details or \$4.00 for manuals.

### SEATTLE 8086 GAZELLE Computer system.

SPECIAL PRICE for SEATTLE SYSTEM (desktop) + 4-port serial board + cables. US ROBOTICS modems, TELEVIDEO BUSINESS SOFTWARE for IBM, SEATTLE. Write for literature and prices on above systems, or call for quote.

**CSCS**  
COMPUTER & STATISTICAL  
CONSULTING SERVICES

P O Box 5351  
Terre Haute, IN 47805  
(812) 466-4111

Circle 103 on inquiry card.

FREE! FREE! FREE! FREE! FREE!

SEND FOR OUR NEW  
1983  
PARTS CATALOG  
THOUSANDS OF  
SURPLUS ELECTRONIC  
PARTS, SUPPLIES AND  
DEVICES.  
**ALL ELECTRONICS CORP**  
905 S. Vermont Ave.  
P.O. Box 20406  
Los Angeles, Cal. 90006

Circle 13 on inquiry card.

## PConnection

Three functions in one card slot—  
Modem, Calendar clock, Serial port!

The PConnection is a premium telecommunications card for the IBM PC with a direct connect Bell 103/113 modem, a real time clock, and a serial I/O port for expanded communications capabilities. The PConnection gives you all three functions in a single card slot!

The PConnection has autodial (Touch Tone or pulse) and autoanswer, plus a built-in speaker for line status monitoring. Software selectable protocol and modes.

The real time clock can be used to auto-dial predetermined phone numbers at pre-set times. Excellent for polling and remote monitoring applications.

PConnection (plug-in modem) - \$275. Enhanced PConnection with real time clock and additional RS-232 - \$375. Another quality modem from

**the microperipheral corporation**

2565 152nd Avenue N.E.  
Redmond, WA 98052  
(206) 881-7544

IBM is a registered trademark of International Business Machine Corporation

Circle 263 on Inquiry card.

## APPLE®

### COMPATIBLE SYSTEM SALES

A W/P Package Incl:

- APPLE® COMPATIBLE W/64K
- RANA ELITE ONE W/CNTR
- 12" AMBER MONITOR
- SMITH/CORONA TP-I PRINTER
- WORD PROCESSING SOFT.

ON SALE \$1899

AND MORE—Savings & Selection

Apple IIe .....	CALL
KayPro II .....	\$1499
Franklin Ace 1000 .....	\$ 929
Colt mbia MPC .....	\$2295
Syscom 2 .....	\$ 649
IBM P/C .....	On Sale
Smith-Corona TP-I .....	\$ 559
Gemini 10 Dot Matrix .....	\$ 329

For Complete Selection and  
Lowest Prices — Free Catalog

## COMPUTERS and more

2420 University Ave., Suite 3, San Diego, Ca. 92104  
(619) 291-1442, Telex 697120, Datagram Attn: Dept. 322

Circle 93 on inquiry card.

**Retail Sales**  
123 East 200 South  
Salt Lake City, Utah 84102

**The Great Salt Lake  
Computer Company, Inc.**

**Mail Orders**  
P.O. Box 26816  
Salt Lake City, Utah 84126



**QT 5 1/2" MAINFRAME**



- Provisions for any 2 - 5 1/2" drives • 15 ea DB 25 cutout
  - 2 ea 50 pin • 2 ea 34 pin • 1 ea Centronic • EMI filter (fused)
  - 2 AC outlets • Avbl. with 6 - 8 or 12 slot motherbd •
  - Power supply (+8V16A/±16V3A/+12V5A)
- QTC-MF+MD8 (8 slot MB) ..... \$720.00  
QTC-MF+MD12 (12 slot MB) ..... \$765.00

**QT 8" MAINFRAME**



- Provision for any 2 - 8" drives (hard or floppy) • 15 ea DB25 cutout • 2 ea 50 pin • 2 ea 34 pin • 1 ea Centronic • EMI filter (fused) • 2 AC outlets • Avbl with 6 - 8 or 12 slot motherbd
  - Power supply (+8V16A/±16V3A/+5V6A/-5V1A/+24V6A)
- Desk Top Version  
QTC-MF+DD8 ..... \$800.00  
QTC-MF+DD12 ..... \$850.00
- Rack Mount Version  
QTC-RMF-DD8 ..... \$900.00  
QTC-RMF-DD12 ..... \$950.00

**QT STANDARD MAINFRAME**

- Provisions for any 2 - 5 1/2" drives
  - 15 ea DB 25 cutout • 2 ea 50 pin
  - 2 ea 34 pin • 1 ea Centronic
  - EMI filter (fused) • 2 AC outlets
  - Avbl with 6-8-12-18 or 22 slot MB
  - Power supply (+8V16A±16V3A)
- Desk Top Version  
QTC-MF+12 ..... \$675.00  
QTC-MF+18 ..... \$720.00  
QTC-MF+22 ..... \$800.00
- Rack Mount Version  
QTC-RMF-12 ..... \$775.00  
QTC-RMF-18 ..... \$820.00  
QTC-RMF+22 ..... \$900.00

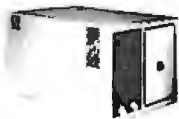
**QT S-100 CARD CAGES**

- Made of anodized steel • Card guides for ea. MB • 1 - Indicates w/MB
  - 2 - Indicates w/MB + 1 ea fan
  - 3 - Indicates w/MB + 2 ea fans
- QTC-CC4 ..... \$20.00 CC12 ..... \$60.00  
CC4-1 ..... \$75.00 CC12-1 ..... \$165.00  
CC6 ..... \$25.00 CC12-2 ..... \$200.00  
CC6-1 ..... \$90.00 CC12-3 ..... \$225.00  
CC6-2 ..... \$115.00 CC18 ..... \$75.00  
CC8 ..... \$35.00 CC18-1 ..... \$220.00  
CC8-1 ..... \$100.00 CC18-2 ..... \$250.00  
CC8-1 ..... \$135.00 CC18-3 ..... \$280.00

**QTS-100 MOTHERBOARDS**

- Silence Plus • Built in Termination • IEE696 • Terminal strip for easy power connection
- 4 Slot Motherboards  
QTC-MB4BB ..... \$20.00  
QTC-MB4K ..... \$35.00  
QTC-MB4A ..... \$45.00
- 6 Slot Motherboards  
QTC-MB6BB ..... \$30.00  
QTC-MB6K ..... \$50.00  
QTC-MB6A ..... \$65.00
- 8 Slot Motherboards  
QTC-MB8BB ..... \$35.00  
QTC-MB8K ..... \$65.00  
QTC-MB8A ..... \$95.00
- 12 Slot Motherboards  
QTC-MB12BB ..... \$40.00  
QTC-MB12K ..... \$95.00  
QTC-MB12A ..... \$135.00
- 18 Slot Motherboards  
QTC-MB18BB ..... \$65.00  
QTC-MB18K ..... \$135.00  
QTC-MB18A ..... \$185.00
- 22 Slot Motherboards  
QTC-MB22BB ..... \$75.00  
QTC-MB22K ..... \$150.00  
QTC-MB22A ..... \$200.00

**QT 8" THINLINE MAINFRAME**



- Provisions for 2 ea 8" thinline drives • 15 ea DB 25 cutout
  - 2 ea 50 pin • 2 ea 34 pin • 1 ea Centronic
  - EMI filter (fused) • 2 AC outlets
  - Power supply (+8V16A/-5V/+24V6A+5V6A)
- Cadillac Version  
QTC-IMF+DD6C (6 slot MB) ..... \$500.00
- Ford Version  
QTC-IMF+DD6F (6 slot MB) ..... \$389.00

**DISK DRIVES / DRIVE SUB ASSEMBLY**

- 8" Disk Drives**
- 801R Shugart SS/DD ..... \$355.00  
851R Shugart DS/DD ..... \$455.00  
DT8 (842) Oume DS/DD ..... \$465.00  
**BEST BUY (call for qty price)**  
M-2896-63 MIT DS/DD ..... \$409.00  
M-2896-63 MIT 8" thinline DS/DD ..... \$475.00
- 5 1/2" Disk Drives**
- TM100-1 or B-51 for IBM ..... \$200.00  
TM100-2 or B-52 for IBM (in stock) ..... \$270.00
- Vertical or horizontal disk cabinet - 11" h x 11" w x 20" d 5" h x 17" w x 20" d
- QTC-DDS+0 w/2 ea SS/DD Siemens drives ..... \$595.00  
QTC-DDS+1 w/1 ea DS/DD MIT 2894-63 ..... \$695.00  
QTC-DDS+2 w/2 ea DS/DD MIT 2894-63 ..... \$1150.00  
QTC-DDS+3 w/2 ea SS/DD 801R Shugart ..... \$975.00  
QTC-DDS+4 w/2 ea DS/DD 8" thinline drives ..... \$1150.00

**OUR SALTIER DEALS**

- Franklin Ace Computer ..... \$319.00  
"Thinline" Apple Compatible ..... \$235.00  
Disk Drive - 1/2 size/163 K/40 track  
Dumping CX/Grappier compatible ..... \$99.00  
C. ITOH 8600 (80 cps lr quality/  
18 pin printhead/180 cps reg. mode ..... CALL  
FX80FT Epson ..... \$389.00  
MX100FX Epson ..... CALL  
Cabinet for 2 ea. 5 1/2" disk drive w/p.s. ..... \$99.00  
Tohiba P-1350  
100 cps letter quality 200 cps reg. mode  
Par or serial - full graphics - 24 pin printhead ..... \$1575.00  
Bi-directional tractor ..... \$275.00  
Sheet feeder ..... \$1095.00

**QT DISK DRIVE CABINETS**



- "All in One" Vertical Disk Drive Cabinet**
- For 1) 2 ea or 4 ea 8" thinline drive  
2) 2 ea standard 8" drives  
3) 1 ea hard disk + 1 ea standard 8"
- Power supply (+5V6A/-5V1A/+24V6A)
  - Positive pressure fan w/filter • EMI filter
  - Power interface cable for any 8" drive
- QTC-DDC88V For 2 standard size 8" drives ..... \$325.00  
QTC-DDC88T For 2 thinline 8" drives ..... \$325.00  
QTC-DD8V For 1 ea 8" drive ..... \$275.00
- Horizontal Disk Drive Cabinet**
- For 2 ea 8" standard size drives
- Power supply (+5V6A/-5V1A/+24V6A)
  - Interface cable for any 8" drive
- QTC-DDC88H ..... \$300.00

**TERMINALS / MONITORS**

- Televideo 925C ..... \$700.00  
Televideo 970 ..... \$1095.00  
BMC12A (15 MHZ) ..... \$80.00  
BMC Color #9191 ..... \$299.00

**PARTS**

- TR1602B ..... \$2.50 ea. TMS2716(5+12V) ..... \$3.95 ea.  
2114L2 ..... \$1.50 ea. TMS2732 ..... \$4.95 ea.  
TMS2532 ..... \$5.95 ea. TMS4164(200NS) ..... 5.95 ea.  
2716 (SV) ..... \$3.95 ea. TMS6116-4(200NS) ..... \$4.75 ea.

MANY OTHERS IN STOCK

**SIERRA DATA S-100 BOARDS**

- SDS-SBC-100-Z80(4mhz)  
master 2 serial 2 par/floppy controller/64k ram ..... \$655.00  
SDS-SBC-100S-4mhz slave/2 serial  
2 par/64k ram ..... \$565.00  
SDS-ZSIO/4 - 4 serial port I/O bd ..... \$235.00  
SDS-MUX - RS232 multiplexer bd ..... \$235.00  
SDS-HDI-M - Hard disk bd for micropolis ..... \$129.00  
SDS-CPM/B105 - cp/m for SBC100 w/BIOS ..... \$150.00  
SDS-Turbodos - Multi-user for master & slaves ..... \$645.00

**PRINTERS**

- Star-Gemini 10 ..... \$335.00  
OK1-82A (120 cps) Serial + par ..... \$389.00  
OK1-83A (120 cps) Serial + par ..... \$85.00  
OK1-84A (200 cps) Serial ..... \$1079.00  
OK1-92A (160 cps) ..... \$519.00  
OK1-93A (160 cps) ..... \$899.00  
NEC-8023A ..... \$475.00

**BOARD SETS**

- Best Bare Board Set Available**
- QTC-SBC 2/4 CPU  
QTC-EXP+III 256K Memory bd.  
QTC-FDC 5/8 Floppy disk controller
- Bare Board Set** ..... \$150.00  
1) Includes manuals & assembly instructions  
2) Parts available 3) Monitor & B10S available

**QT CLOCK/CALENDAR**

- S-100 or Apple • Time in hrs. min. sec. • AM/PM or Military  
Format • Date in Mo., Day, Yr, Day of Week & Leap Year  
recognition • 4 hard interrupts (1024 Hz, 1Hz, 1 min, 1 hr)  
• On board battery (will last 14 mos. w/nopoweron)
- QTC-CCS-BB (S-100) ..... \$60.00  
QTC-CCS-K (kit) for S-100 ..... \$100.00  
QTC-CCS-A (A+T) for S-100 ..... \$125.00  
QTC-CCA-BB (for Apple) ..... \$40.00  
QTC-CCA-A (for Apple) ..... \$125.00

**CPU BOARDS / MEMORY BOARDS / I/O**

- QTC-SBC 2/4 BB ..... \$50.00  
QTC-SBC 2/4 A A+T ..... \$265.00  
QTC-Z+80 BB ..... \$28.00  
Teletek FDC-1 A+T ..... \$595.00  
Teletek Systemmaster A+T ..... \$695.00
- DYNAMIC (64K/256K or 1 MEG)**
- QTC-EXP+III Bare Bd. .... \$65.00  
QTC-EXP+III 64K A+T ..... \$450.00
- STATIC**
- S-RAM 64K BB ..... \$60.00  
S-RAM 64 A+T ..... \$349.00  
S-RAM 128K A+T (Fully IEEE696) ..... \$895.00
- QTC-I/O+BB 2 SER 3 PAR A+T ..... \$60.00  
QTC-I/O+A+T ..... \$340.00  
QTC-ADA ADA Converter A+T ..... \$375.00  
QTC-Dual GPIB-488 IEEE 488 interface bd. A+T ..... \$475.00

**APPLE CORNER / DISKETTES**

- Micro-SCI Drive ..... \$259.00  
w/controller ..... add \$79.00  
Rana Elite I ..... \$299.00  
Rana Elite II ..... \$439.00  
Rana Elite III ..... \$569.00  
Rana Controller ..... \$99.00  
QT Apple Compatible Drive ..... \$235.00  
5 1/4" soft sector (for Apple) ..... \$19.00 for 10  
1 yr warranty - with hub ring  
5 1/4" soft sector DS/DD ..... \$28.00 for 10  
5 1/4" plastic library case ..... \$2.50 ea, \$20.00 for 10  
Flip file storage case (stores 70 diskettes) ..... \$19.00 ea

In Continental U.S.  
**(800) 545-2633**

Inside Utah  
**(801) 363-3314**

We accept cash, checks, credit cards, or Purchase Orders from qualified firms and institutions. Minimum prepaid order \$15.00. For export customers outside the U.S. or Canada please add 10% to all prices. Prices and availability subject to change without notice. Shipping and handling charges via UPS Ground (reg. 10% Av \$1.00/lb) minimum charge \$3.00. Circle 163 on inquiry card.

**NEW! M-68000**  
**SINGLE BOARD COMPUTER**



**FEATURES:**  
16 bit Motorola 68000 CPU operating @ 10MHz, 20K bytes of onboard fast static RAM, 16K bytes of on board EPROM space, 7 levels of prioritized unvectored interrupts, 3 memory expansion buses (up to 256K), 2 serial communication ports (RS-232C), 16-bit bidirectional parallel port, 6800 peripheral accommodation bus, 5x16-bit counter/timers with vectored interrupts, on board real time clock, software compatible with Motorola MEX68KDM board.

**PRICE:**

Base board with documentation	\$99.95
MEX68KDM compatible monitor in 274 EPROM	\$120.00
M68000 CPU & memory map PROM	\$115.00
Shipping and handling (Domestic)	\$3.00
(Foreign)	\$15.99

**EMS** Electronic Mail Systems  
P.O. BOX 16115 IRVINE, CA 92713-1115

714-553-0133

Circle 140 on inquiry card.

**TIMEX-SINCLAIR**  
**ZX81 1000**



**1983 Directory**

- **Where to find:** Disk Drives, RAM Extensions, Printers, Modems, Keyboards, Game & Serious Software, Books, Periodicals, Programming Aids, and other Exciting Accessories!
- **Articles on:** Special applications like Control Circuitry, Enhanced Graphics, Voice Generation, Music Synthesis, Video Inversion, Light Pens, Joysticks, etc.
- **Complete Descriptions:** We'll tell you what it is, what it does, how much it costs, and where to buy it.
- **Jam-packed w/photographs:** We knew you'd want to see what these products look like. So, we got pictures and put them in!

**Only \$5.00 ... Postpaid!**

**To Order:** Send check, money order, or VISA/MC number and expiration date. MN residents add 6% sales tax.

**Dealer Inquiries Welcome.**

**E. Arthur Brown Company**  
Dept. BM-2 1702 Oak Knoll Drive  
Alexandria, MN 56308 Ph: 612/762-8847

Circle 134 on inquiry card.



**INDUSTRIAL CONTROL MICROCOMPUTERS**

We have six single board computers, two video boards and 20 other control products. You can use our products for security systems, heat control, light control, automated slide show, traffic lights, irrigation systems, home computer systems, automated process control, and robot control just to name a few. OEM prices available. For catalog call or write to:

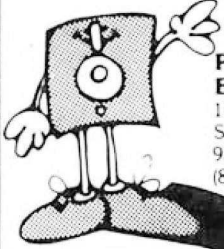
**JOHN BELL ENGINEERING, INC.**  
1014 CENTER STREET  
SAN CARLOS, CA. 94070  
(415) 592-8411

Circle 41 on Inquiry card.

**wabash**<sup>®</sup>

**When it comes to Flexible Disks, nobody does it better than Wabash.**

MasterCard. Visa Accepted.  
Call Free: (800) 235-4137



**PACIFIC EXCHANGES**  
100 Foothill Blvd  
San Luis Obispo, CA  
93401 (In Cal call  
(805) 543-1037)

Circle 294 on inquiry card.

**PC/FORTH**<sup>™</sup>

Complete FORTH program development systems for the IBM<sup>®</sup> Personal Computer. Packages include interpreter/compiler with virtual memory management, line editor, custom screen editor, assembler, decompiler, utilities, file and record access modules, and many demonstration programs. 150 page user manual. . . . \$100.00

Software floating point, Intel 8087 support, color graphics extensions, and target compiler available at additional cost.

Specify PC-DOS or CP/M-86<sup>®</sup>. One disk drive and 48 kbytes RAM required. Software supplied on 5 1/4 inch single sided soft sectored double density diskettes.

**Laboratory Microsystems**  
4147 Beethoven Street  
Los Angeles, CA 90066  
**(213) 306-7412**

IBM is a registered trademark of International Business Machines Corp  
CP/M is a registered trademark of Digital Research, Inc.

Circle 215 on inquiry card.

**Touch Tone Decoding Modem**

Convert Touch Tones to ASCII. The Touch Tone Decoder Modem offers a low cost solution to remote monitoring and data entry applications. It autoanswers and connects any host computer's asynchronous RS-232 port with the telephone system. Select 300, 600, or 1200 baud data rate or optional external audio input. \$500 single quantity. Touch Tone send/1200 baud receive terminal available.

**the microperipheral corporation**  
2565 152nd Avenue NE  
Redmond, WA 98052  
**(206) 881-7544**

Circle 264 on Inquiry card.

**Ray's Hollywood Hardware**

**Powerful — Economical — Professional**  
Peripherals for your Apple II<sup>®</sup>:

**A/D 12-Bit, 16 Channel \$450.00**  
AD 121602

- Simple CPU Selection of Channels
- Range ± 10, ± 5, ± 2.5, ± 1.0
- High-Speed 25 μ sec. Conversion
- Full Software Support — Disk or PROM
- Adjustable Bipolar Reference

**Ultra ROM Board/Editor \$190.00**  
ARB 102

- 32K of Bank-Switchable ROM Space
- Powerful GPLE (Global Program Line Editor) in Firmware
- Totally Transparent — Remove or reload with a few keystrokes — without Disk!
- Applesoft<sup>®</sup> Extensions including IF, THEN, ELSE.

6842 Valjean Ave.  
Van Nuys, CA 91406  
#213 908-1234

©1982 Ray's Hollywood Hardware, Inc.

Circle 20 on inquiry card.

**ELIZA IS HERE!**

AT LAST! A FULL IMPLEMENTATION of the original ELIZA program is now available to run on your microcomputer!

Created at MIT in 1966, ELIZA has become the world's most celebrated artificial intelligence demonstration program. ELIZA is a non-directive psychotherapist who analyzes each statement as you type it in and then responds with her own comment or question — and her remarks are often startlingly appropriate!

Designed to run on a large mainframe, ELIZA has hitherto been unavailable to personal computer users except in greatly stripped down versions lacking the sophistication which made the original program so fascinating.

Now, our new microcomputer version possessing the FULL power and range of expression of the original is being offered at the Introductory price of only \$25. And if you want to find out how she does it (or teach her to do more) we will include the complete Source Program for only \$20 additional.

Order your copy of ELIZA today and you'll never again wonder how to respond when you hear someone say "Okay, let's see what this computer of yours can actually do!"

**ELIZA IS AVAILABLE IN THE FOLLOWING DISK FORMATS:**

1. Standard 8 inch single density for all CP/M based computers \$25 for ELIZA.COM + add \$20 for Microsoft BASIC-80 Source
2. 5 1/4 inch CP/M for Apple II equipped with 2-80 SoftCard \$25 for ELIZA.COM + add \$20 for Microsoft BASIC-80 Source
3. 5 1/4 inch for 48K Apple II with Applesoft ROM and DOS 3.3 \$25 for Protected File + add \$20 for Applesoft Source
4. 5 1/4 inch for 64K IBM Personal Computer \$25 for Protected File + add \$20 for IBM Disk BASIC Source
5. 5 1/4 inch for Osborne I Microcomputer \$25 for Protected File + add \$20 for Microsoft BASIC-80 Source

**ARTIFICIAL INTELLIGENCE RESEARCH GROUP**  
921 NORTH LA JOLLA AVENUE  
LOS ANGELES, CALIFORNIA 90046  
(213) 656-7368 (213) 654-2214  
MC, VISA and CHECKS ACCEPTED

Circle 29 on inquiry card.

**SPECIAL OFFER!**



**TURBO-MICRO COMPUTER**  
Complete System With Networking Capability

- \* 1 to 16 Independent users
- \* 20 to 80 M.Byte hard disk
- \* CP/M or TurboDos Operating System
- \* 100% CP/M Compatible
- \* S-100 BUS Structure, master/slave concept

**3.2 M.Byte Desk Top Turbo-Micro Computer, 1 to 5 users. . . . . \$2995.00**

**20 M.Byte Hard Disk Desk Top Turbo-Micro Computer, 1 to 5 users. . . . . \$4995.00**

**20 M.Byte Hard Disk Stand-Alone Turbo-Micro Computer, 1 to 16 users. . . . . \$6895.00**

Write or call for complete information and price package.

**C.D.S.**  
**SAN DIEGO, CA 92111 (619) 571-5916**

Circle 9 on Inquiry card.



# ULTRA Diskettes

**Now...Diskettes you can swear by, not swear at.**

Lucky for you, the diskette buyer, there are many diskette brands to choose from. Some brands are good, some not as good, and some you wouldn't think of trusting with even one byte of your valuable data. Sadly, some manufacturers have put their profit motive ahead of creating quality products. This has resulted in an abundance of low quality but rather expensive diskettes in the marketplace.

## A NEW COMPANY WAS NEEDED AND STARTED

Fortunately, other people in the diskette industry recognized that making ultra-high quality diskettes required the best and newest manufacturing equipment as well as the best people to operate this equipment. Since most manufacturers seemed satisfied to give you only the everyday quality now available, an assemblage of quality conscious individuals decided to start a new company to give you a new and better diskette. They called this product the *Ultra* diskette, and you're going to love them. Now you have a product you can swear by, not swear at.

## HOW THEY MADE THE BEST DISKETTES EVEN BETTER

The management of *Ultra* Magnetics then hired all the top brains in the diskette industry to make the *Ultra* product. Then these top bananas (sometimes called floppy freaks) created a new standard of diskette quality and reliability. To learn the "manufacturing secrets" of the top diskette makers, they've also hired the remaining "magnetic media moguls" from competitors such as Verbatim, Memorex, Dyan and many more. Then all these top-dollar engineers, physicists, research scientists and production experts (if they've missed you, send in your resume to *Ultra*) were given one directive...to pool all their manufacturing know-how and create a new, better diskette.

## HOW ULTRA DISKETTES ARE MANUFACTURED

The *Ultra* Magnetics crew then assembled the newest, totally quality monitored, automated production line in the industry. We know that some of *Ultra's* competitors are still making magnetic media on equipment that is old enough to vote. Since all manufacturing equipment at *Ultra* is new, it's easy for *Ultra* to consistently make better diskettes. You can always be assured of ultra-tight tolerances and superb dependability when you use *Ultra*. If all this manufacturing mumbo-jumbo doesn't impress you, we're sure that at least one of these other benefits from using *Ultra* diskettes will:

- TOTAL SURFACE TESTING** - For maximum reliability, and to lessen the likelihood of disk errors, all diskettes must be totally surface tested. At *Ultra*, each diskette is 100% surface tested. *Ultra* is so picky in their testing, they even test the tracks that are in between the regular tracks.
- COMPLETE LINE OF PRODUCTS** - For a diskette to be useful to you and your computer, it must be compatible physically. *Ultra* Magnetics has an entire line of 5 1/4-inch and 8-inch diskettes.
- SPECIALLY LUBRICATED DISK** - *Ultra* uses a special oxide lubricant which is added to the base media in the production of their diskettes. This gives you a better disk drive head to media contact and longer head and disk life.
- HIGH TEMPERATURE/LOW-MARRING JACKET** - A unique high temperature and low-marring vinyl jacket allows use of their product where other diskettes won't work. This special jacket is more rigid than other diskettes and helps eliminate dust on the jacket.
- REINFORCED HUB RINGS** - Standard on all *Ultra* mini-discs, to strengthen the center hub hole. This increases the life of the disk to save you money and increase overall diskette reliability.
- DISK DURABILITY** - *Ultra* disks will beat all industry standards for reliability at well over millions and millions of revolutions. They are compatible with all industry specifications as established by ANSI, ECMA, ISO and JIS.
- CUSTOMER ORIENTED PACKAGING** - All *Ultra* disks are packaged 10 disks to a carton and 10 cartons to a case. The economy bulk pack is packaged 100 disks to a case without envelopes or labels.
- LIFETIME WARRANTY** - If all else fails, remember, all disks made by *Ultra* Magnetics, (except bulk pack) have a lifetime warranty. If your *Ultra* disks fail to meet factory specifications, *Ultra* Magnetics will replace them under the terms of their warranty.
- SUPERB VALUE** - With *Ultra's* automated production line, high-quality, error-free disks are yours without high cost.



## SAVE ON ULTRA DISKETTES

Product Description	Part #	CE quant. 100 price per disc (\$)
8" SSSD IBM Compatible (128 B/S, 26 Sectors)	81726	1.99
8" SSDD IBM Compatible (128 B/S, 26 Sectors)	81701	2.49
8" DSSD Soft Sector (Unformatted)	82701	3.19
8" DSSD Soft Sector (1024 B/S, 8 Sectors)	82708	3.19
5 1/4" SSSD Soft Sector w/Hub Ring	50001	1.79
5 1/4" Same as above, but bulk pack w/o envelope	00153	1.39
5 1/4" SSDD 10 Hard Sector w/Hub Ring	50010	1.79
5 1/4" SSSD 16 Hard Sector w/Hub Ring	50016	1.79
5 1/4" SSDD Soft Sector w/Hub Ring	51401	1.89
5 1/4" Same as above, but bulk pack w/o envelope	00096	1.49
5 1/4" SSDD 10 Hard Sector w/Hub Ring	51410	1.89
5 1/4" SSDD 16 Hard Sector w/Hub Ring	51416	1.89
5 1/4" DSDD Soft Sector w/Hub Ring	52401	2.79
5 1/4" Same as above, but bulk pack w/o envelope	00140	2.39
5 1/4" DSDD 10 Hard Sector w/Hub Ring	52410	2.79
5 1/4" DSDD 16 Hard Sector w/Hub Ring	52416	2.79
5 1/4" SSQD Soft Sector w/Hub Ring (96 TPI)	51801	2.49
5 1/4" DSQD Soft Sector w/Hub Ring (96 TPI)	52801	3.49

SSSD = Single Sided Single Density; SSDD = Single Sided Double Density; DSDD = Double Sided Double Density; SSQD = Single Sided Quad Density; DSQD = Double Sided Quad Density; TPI = Tracks per inch.  
For less than 100 diskettes, add 10% to our quantity 100 price.  
For additional compatibility info call *Ultra* Magnetics at 408-728-7777.

## The Small Print

To get the fastest delivery from CE of your *Ultra* computer products, send or phone your order directly to our Computer Products Division. Be sure to calculate your price using the CE prices in this ad. Michigan residents please add 4% sales tax or supply your tax I.D. number. Written purchase orders are accepted from approved government agencies and most well rated firms at a 30% surcharge for net 30 billing. All sales are subject to availability, acceptance and verification. All sales are final. Prices, terms and specifications are subject to change without notice. All prices are in U.S. dollars. Out of stock items will be placed on back order automatically unless CE is instructed differently. Minimum prepaid order \$50.00. Minimum purchase order \$200.00. International orders are invited with a \$20.00 surcharge for special handling in addition to shipping charges. All shipments are F.O.B. Ann Arbor, Michigan. No COD's please. Non-certified and foreign checks require bank clearance.

For shipping charges add \$8.00 per case or partial-case of 100 8-inch discs or \$6.00 per case or partial-case of 100 5 1/4-inch mini-discs for U.P.S. ground shipping and handling in the continental United States.

**Mail orders to:** Communications Electronics, Box 1002, Ann Arbor, Michigan 48106 U.S.A. If you have a Master Card or Visa card, you may call and place a credit card order. Order toll-free in the U.S. Dial 800-521-4414. In Canada, order toll-free by calling 800-265-4828. If you are outside the U.S. or in Michigan, dial 313-994-4444. Telex 810-223-2422. Order your *Ultra* diskettes from Communications Electronics today.

Copyright ©1983 Communications Electronics™

Ad #050583



**Order Toll-Free!**  
**800-521-4414**  
In Michigan 313-994-4444

**ULTRA**  
**MAGNETICS**  
**diskettes**

**COMMUNICATIONS**  
**ELECTRONICS™**

**Computer Products Division**

854 Phoenix □ Box 1002 □ Ann Arbor, Michigan 48106 U.S.A.  
Call TOLL-FREE (800) 521-4414 or outside U.S.A. (313) 994-4444

**IBM® Quality Printing for Your Computer**

Complete system with top-quality IBM Electronic typewriter is ready to plug into your computer. Or, you can convert your own IBM Electronic or Selectric®.

**IBM approved since 1978.**  
**For all popular computers.**  
**No special software required.**  
**Money back guarantee.**

\*\*\* **MORE SUPER SPECIALS!** \*\*\*

Smith-Corona TP-1	\$629	Teletype 925	\$788
Teletex Systemaster	\$792	Anadex DP9500A	\$1388

Software, other products **Call** Star Printers **Call!**

Call our professionals for best service and price.

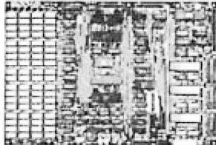
**IPEX**  
 IPEX INTERNATIONAL, INC.  
 5115 Douglas Fir Road  
 Calabasas, CA 91302 U.S.A.  
 Telex/TWX 910-494-2100

(213) 710-1444

IBM and SELECTRIC are trademarks of IBM Corp.

Circle 200 on Inquiry card.

**The Mega Super Computer**



**Free Computer with a Purchase of a RAM Disk**

- ★ 280B Running at 5mhz. ★ Versatile CPM. ★ Math chip 9511 or 9512 AMD. ★ 48 Plus Ports on Mega Expander BUS. ★ CTC, DMA. ★ 2 Parallel Ports—with hand shaking. ★ Serial Ports—with or without handshaking runs 150 to 19K2 Baud. Runs most terminals, printers, and modems.
- ★ NOW! CPM 3.0.
- ★ Hard Disk Interface hooks directly to Priam Drives
- ★ Floppy Disk Controller—Handles Single Density IBM compatible disks and Dual Density 1 or 2 sided supports 8" or 5 1/4" in various combinations—3 Drives equal over 4 Mega Bytes of Storage. WD2797.
- ★ 512K Bytes of 64K D-Rams with parity configurable as a HIGH SPEED ELECTRONIC DISK or 8 banks of 64K for multi-user or countless other applications.
- ★ All this on a state-of-the-art 4 layer card—with accurate documentation—10" x 15"
- ★ Prices: Bare Board with Documentation.....\$399  
 64K Base System A & T.....\$895  
 512K Base System A & T.....\$1595  
 CPM 2.2 System A & T.....\$125  
 512K Base Kit.....\$1299  
 Manual.....\$25  
 MPF.....\$325

**MEGA CO.**  
 2318 S. Park Street, Madison, WI 53713 (608)255-7400

Circle 243 on Inquiry card.

**RTL**

**Relocatable Threaded Language** **\$150**

RTL is a new language which retains the speed and extensibility of Forth but adds many additional advantages as a result of its more structured dictionary. Names, code, and variables are all stored in separate areas for easy generation of headerless, romable code. All code is relocatable. RTL supports local variables, multitasking, redirected I/O, and even allows definitions to be changed retroactively. All source code is included. Versions are currently available or under development for 68000, 6809, 8080, 280, 8086, 8088, and 6502.

RTL Programming Aids  
 10844 Deerwood SE  
 Lowell, MI 49331  
 (616) 897-5672

Circle 335 on Inquiry card.

**C LANGUAGE PROGRAMMERS**

**c-systems C COMPILER**

Now with: **c-window™**

The first c language source level program testing and debugging tool.

- Single step by c source line.
- Set breakpoints at line numbers.
- Display and alter variables by symbol name, using c expression syntax.
- No more printf or assembler level debugging!

**c-window™** is a support package for the **c-systems C COMPILER** for 8086/8088 based systems.

Contact:  
**c-systems** Fullerton, CA 92634  
 P.O. Box 3253 714-637-5362

TM c-systems

Circle 51 on Inquiry card.



**WEAR IT WITH PRIDE!**  
**Computer Jewelry**

Be identified as a micro professional  
 Lapel Pins • Tie Tacks • Stick Pins

Available in Sterling Silver or 18K over sterling  
 Size: 1/2" square Silver \$10 • Gold \$12  
 (Add \$2 for S/H) • (CA add sales tax)  
 Visa • Mastercard or check payable to MC/N, Inc.  
 Money Back Guarantee  
 Dealer & Corporate Discounts Available  
 Allow 2-3 weeks for delivery

MC/N, Inc.  
 SIMMS CENTER/Box 9393  
 San Rafael, CA 94912  
 (415) 453-7033

Circle 239 on Inquiry card.

**Scotch® Diskettes**

Rely on Scotch® diskettes to keep your valuable data safe. Dependable Scotch diskettes are tested and guaranteed error-free. The low abrasivity saves your read/write heads. They're compatible with most diskette drives.



**(800)235-4137**



PACIFIC EXCHANGES  
 1241 Franklin Blvd.  
 San Luis Obispo, CA  
 94901 In Cal. call  
 (805)542-5045 or  
 (805)541-1117

Dealer Inquiries Invited

Circle 294 on Inquiry card.

**DAISY WHEEL PRINTERS**  
 SMITH-CORONA TP-1



**\$529**

- BROTHER HR-15 (2 colors) **SAVE**
- BROTHER HR-1 (16 cps) **\$749**
- KAY-PRO-10 **\$CALL**
- KAY-PRO 11 **\$CALL**
- C-ITOH F-10 (40 cps) **\$1295**
- IBM PC **\$CALL**
- OSBORNE COMPUTER **\$CALL**
- SANYO MBC-1000 (incl. software) **\$1595**
- GEMINI-10 **\$289**
- GEMINI-15 **\$445**
- FRANKLIN-ACE **\$899**

**MICRO MART**  
 5375 Kearny Villa Rd #115, San Diego CA 92123  
 (619) 268-0169

Circle 250 on inquiry card.

**TOP QUALITY 5 1/4 DISKETTES**

SPECIFY SOFT, 10 or 16 SECTORS

• <b>wabash</b>	\$/10	\$/50	\$/100
SSDD (M13A411X)	23.45	112.00	218.00
DSDD (M14A411X)	30.43	146.00	286.00
• <b>control data</b>			
SSDD (CDG1242-00)	23.00	112.00	215.00
DSDD (CDC1244-00)	32.00	156.00	295.00
• <b>verbatim</b>			
SSDD (MD525-01-18158)	27.20	134.00	265.00
DSDD (MD550-01-18188)	40.00	196.00	385.00
• <b>3Mscotch</b>			
SSDD (3M 744D-0)	26.00	125.00	233.00
DSDD (3M 745-0)	36.00	175.00	309.00
• <b>dysan</b>			
SSDD (DYS 104-1D)	40.40	188.00	361.00
DSDD (DYS 104-2D)	47.30	231.00	426.50

**CALL TOLL FREE 800-824-7888**  
 OPERATOR 906

*Creativity Unlimited* **FREE CATALOG**

• CHECKS MD VISA M.C. P.O. BOX 1338  
 ADD \$2.00 SHIPPING SERRA TOGA, CA 95070  
 • CA RESIDENTS ADD (408) 252 4210  
 • SALES TAX

Circle 101 on inquiry card.

**NEW REPLACEMENT RIBBON CARTRIDGES**

**EPSON** MX 70-80 \$4.75 ea.  
 MX 100 10.75 ea.

Please add \$ .75 ea. shipping/handling

**WE HANDLE MOST POPULAR CARTRIDGES. SEND FOR PRICE LIST**

**LABELS \$12.00/5000**

STOCK #10350-1 15/16" x 3 1/2" x 1 wide.  
 White—pressure sensitive—pin feed—4 1/4" carrier, packed 5000 per box.  
 Add \$2.50 per box handling/shipping.

**COMPLETE LINE OF OTHER LABELS AVAILABLE. SEND FOR PRICE LIST**

**TERMS: MIN. ORDER \$12.00.**  
 VISA & MC (add 4%), check or money order.  
 C.O.D.'s add \$2.00. CA residents add Sales Tax.

**S&W COMPUTER SUPPLY CO.**  
 25422 TRABUCO RD. SUITE #200 A  
 EL TORO, CA. 92630 • (714) 768-0370

Circle 336 on Inquiry card.

# THE MOST VERSATILE MICROCOMPUTER YOU CAN BUY ISN'T SOLD IN ANY STORE.

Before you start hunting from store to store for the ideal microcomputer, consider this: you won't find it.

That's because the world's most versatile micro is available *only* from the manufacturer. It's Lobo's MAX-80™. And, dollar for dollar...feature for feature, there isn't another system that even comes close. Here's why.

## LOOK WHAT \$945 BUYS!

- 128k RAM standard.
- CP/M Plus included (CP/M 2.2 compatible). As a low-cost option you can get LDOS, and run most TRS-80 Model III software. The MAX-80 with CP/M and LDOS gives you access to more software than any other system!
- 5MHz Z-80B processor increases the speed of program execution by 250% over Model III or SoftCard/Apple.
- All disk interfaces built in. Plug in any combination of 5¼" floppies, 8" floppies, and Winchester disks.
- Software-selectable 24 x 80 (under CP/M), 16 x 64, and 16 x 32 (under LDOS) screen formats. For full compatibility with CP/M and TRS-80 applications.
- Two RS-232C serial ports for modems, printers, or what-have-you.
- Centronics-type parallel port. For any printer using this standard interface.
- Extra-rugged construction with heavy-duty case and sculptured full-stroke keyboard.
- Built-in numeric keypad with 4 programmable function keys.
- 1-year limited warranty on hardware.
- Plus: all characters (both text and graphics) are software definable; built-in clock/calendar with battery backup; and buffered I/O expansion port.

## HOW TO GET ONE...FAST!

At just \$945, the MAX-80 could be everything you've been looking for in a computer. Order yours today by calling Lobo's toll-free number. And, while you're at it, check the great prices on Lobo's superb peripherals.

Then, feel free to go window shopping again. You'll be amazed at how good you feel at having bought a MAX-80 in the first place.

### CPU and Accessories

MAX-80 computer with CP/M Plus	\$ 945
300102 12" (diag.) high-resolution anti-glare green phosphor monitor	\$ 175
300104 12" (diag.) high-resolution anti-glare amber screen monitor	\$ 195
LDOS operating system (version 5)	\$ 69

### Dual 5¼" Floppy Disk Systems

003120 single-sided, 40 track; 180kB per diskette	\$ 690
003420 double-sided, 80 track; 720kB per diskette	\$1,175

### Dual 8" Floppy Disk Systems

NOTE: Lobo CP/M permits reading and writing standard single-sided, single density CP/M disks with either of these systems.

Prices subject to change without notice.

004120 single-sided, double density; 577kB per diskette	\$1,185
004220 double-sided, double density; 1155kB per diskette	\$1,485

### Winchester Disk Systems

005020 5¼" system: 4.8MB hard disk plus 720kB floppy (double density only)	\$2,405
005520 8" system: 8MB hard disk plus 1155kB floppy (double density only)	\$3,085

© 1983 Lobo Systems

MAX-80 is a registered trademark of Lobo Systems Incorporated  
CP/M Plus and CP/M 2.2 trademarks of Digital Research Corp.

TRS-80 Model III trademark of Tandy Corp.  
SoftCard trademark of Microsoft Corp.  
Apple trademark of Apple Computer  
LDOS trademark of Logical Systems Inc.

ALL PRICES INCLUDE SHIPPING WITHIN THE U.S.A.  
California residents add 6% sales tax.  
Payable by credit card, check, money order, or certified C.O.D.

### The Lobo Warranty

All Lobo hardware products carry a limited 1-year parts and labor warranty. Call or write for complete warranty statement.



**ORDER NUMBERS:**  
(805) 683-1576 (800) 235-1245  
(800) 322-6103 (In Calif.)

**Telex 658482**

Hours: 7AM-5PM Pacific Time

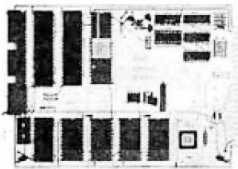
**LOBO**   
SYSTEMS INC.

Dept. B583  
358 S. Fairview Ave., Goleta, CA 93117



# \$73.80\*

## Single Board Computer



\*100 piece price, model MCL11

6800 MPU, serial I/O, parallel I/O, RAM, EROM, 44-pin 4 1/2" x 6 1/2" PCB

**EXPANSION MODULES**  
RAM, ROM, CMOS RAM/battery, analog I/O, serial I/O, parallel I/O, counter/timer, 488 GPIB, EROM programmer, power fail detect/power on reset

**WINTek**  
Wintek Corp.  
1801 South Street  
Lafayette, IN 47904  
317-742-8428

Circle 417 on inquiry card.

# GenderMate-25

Become a quick change artist with a pair of these Light-weight, compact

RS-232  
**GENDER CHANGERS**  
DOUBLE FEMALE      DOUBLE MALE

\$19.95 each      \$35/pair

- All 25 pins connected
- Gold plated contacts
- EMI shielded
- Hardware included
- Assembled & tested
- One year warranty

Personal Check/Cashier's Check/  
Money Order

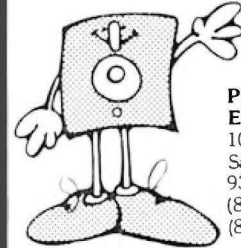
PREPAID includes shipping  
ID residents add sales tax.

**DATA CABLE Co., Inc.**  
P.O. Box 7392  
BOISE, IDAHO 83707  
208-385-0096

Circle 109 on inquiry card.

# Verbatim flexible disks

Call Free (800) 235-4137 for prices and information. Dealer inquiries invited. C.O.D. and charge cards accepted.



VISA

**PACIFIC EXCHANGES**  
100 Foothill Blvd.  
San Luis Obispo, CA  
93401. In Cal. call  
(800) 592-5935 or  
(805) 543-1037.

Circle 294 on inquiry card.

## Get Smart!



### Get Your Computer An Automatic Port Selector (ASU-3)

Our ASU-3 will connect your CPU or CRT to any one of 3 peripherals. Just enter a command from your keyboard and the desired peripheral is automatically connected. Also available for S and for T peripherals. The baud rate is set automatically. Many options are available. The only low cost, smart switch on the market.

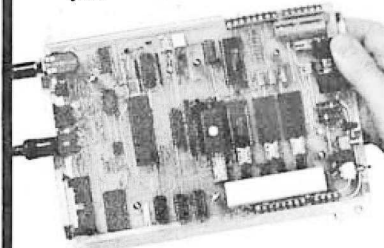
**SWITCH TO GILTRONIX.**

**GILTRONIX, INC**  
UNIVERSAL INTERFACE PRODUCTS

970 San Antonio Rd., Palo Alto, CA 94308. Call (415) 493-1300

Circle 161 on inquiry card.

## MICROCONTROL!



CONTROL THE REAL WORLD  
LIKE NEVER BEFORE!  
AND DO IT FOR AS LITTLE AS \$299\*

THE NEW RISE SYSTEM • Z8000 28011 MCU • 16 K MEMORY  
FRIENDLY BASIC INTERPRETER • PARALLEL AND SERIAL PORTS •  
110V AC POWER CONTROL PORTS • A TO D SENSOR INPUT PORTS •  
BATTERY RAM AND MUCH MORE • WRITE FOR INFO.

**HHS MICROCONTROLLERS**  
5876 OLD STATE  
EASTON, PA 18042  
(610) 734-4338

\*BASE PRICE

Circle 166 on inquiry card.

## DISK DRIVES

(For PC, Mod I & II)

TANDON TM100-1.....	\$189
TANDON TM100-2.....	\$249
TANDON TM100-4.....	\$339
Case and PS.....	\$ 45

## PC EXPANSIONS

<b>MAYNARD</b>	
DISK CONTROLLER.....	\$155
PP add \$50    SP add \$70	
<b>QUADRAM</b>	
Four Function 256K capacity with 64K installed.....	\$289
<b>AST</b>	
ComboPlus:	
64K+SPC+SuperDrive	
+SuperSpool.....	\$269
MegaPlus:	
64K+SC+SuperDrive	
+SuperSpool.....	\$269
I/O plus (SQ).....	\$114
User installed.	
2nd S or P or game.....	\$ 35

**VLM Computer Electronics**  
10 Park Place • Morristown, NJ 07960  
(201) 267-3268 Visa, MC, Check or COD.

Circle 242 on inquiry card.

## Verbatim® Diskettes



Top-quality Verbatim® Diskettes from **Tech•Data**, your complete supply and peripheral wholesaler. **Dealers only.**

Call Toll Free  
**1-800-237-8931.**  
In Florida, call  
**813-577-2794.**

**Tech•Data Corporation**  
3251 Tech Drive North  
St. Petersburg, FL 33702

Circle 377 on inquiry card.

## POWER PROTECTION FOR YOUR SYSTEM



The Datasaver™ AC Power Backup fits most desktop and portable microcomputer systems. Call **Cuesta Systems, Inc.** at (805) 541-4160 for product information and application literature.  
VISA/Mastercard orders call (800) 851-6055.

**INSTANT POWER**

Circle 104 on inquiry card.



**Scotch®**  
DISKETTES

3M

Call Toll-Free  
1-800-328-DISC for prices and information. Dealer inquiries invited. C.O.D. and charge cards accepted.  
**All orders shipped from stock, within 24 hours. Call toll FREE**



**North Hills Corporation**  
3564 Rolling View Dr.  
White Bear Lake, MN 55110  
1-800-328-DISC  
MN Call Collect 1-612-770-0485

Circle 281 on Inquiry card.

# True MAIL ORDER Prices

With so many so-called Mail Order establishments using "toll free" lines, and grandiose advertising, how can you, the customer, expect to receive true mail order savings? We have done away with large ads, and free phone lines to offer comparable service passing on the savings to you. Our reputation for low prices and satisfaction is outstanding.

DISKETTES	PRINTERS	MONITORS
<b>*Kangaroo:</b> (w/library case) SS/DD ..... \$19.35 DS/DD ..... \$28.00 — 10 yr. Warranty — <b>Elephant:</b> SS/DD ..... \$21.95 DS/DD ..... \$28.95 <b>Verbatim:</b> 5 1/4" SS/DD ..... \$22.95 5 1/4" DS/DD ..... \$38.95 8" SS/DD ..... \$38.95 8" DS/DD ..... \$43.95 — Available soft/hard sector — Library Case 5 1/4" ..... \$1.75	<b>Okidata:</b> Microline 92 ..... \$565.00 Microline 93 ..... \$985.00 <b>Pacemark 2350</b> Parallel ..... \$2100.00 Serial ..... \$2200.00 <b>Pacemark 2410</b> Parallel ..... \$2400.00 Serial ..... \$2500.00  <p style="text-align: center;">Call for prices on the entire line of Okidata Printers. Call for the New Epson FX Printers.</p> <b>TEC/C.I.TOH</b> Prowriter I Parallel ..... \$ 369.00 Prowriter II Parallel ..... \$ 639.00 F-10 Starwriter ..... \$1185.00 F-10 Printmaster ..... \$ CALL <b>Brother HRI:</b> ..... \$ 795.00 <b>Smith Corona TPI:</b> ..... \$ 539.00 <b>Star:</b> *Gemini 10 and 15 . Call for low prices!	<b>Amdek:</b> Color I ..... \$295.00 Color II ..... \$489.00 300G Green ..... \$145.00 300A Amber ..... \$155.00 310G Green ..... \$165.00 310A Amber ..... \$175.00 <b>Zenith:</b> 12" Green ..... \$ 99.00 <b>USI:</b> 12" Amber ..... \$159.00 12" Green ..... \$155.00 <b>*Taxan:</b> Amber ..... \$139.00 <b>PGS:</b> RGB Monitor ..... \$ CALL <b>BMC:</b> 12" Green ..... \$ 80.00 <b>NEC</b> 1203 Hi Res RGB ..... \$589.00

MODEMS
<b>Hayes:</b> MicroModem II with Terminal Program ..... \$285.00 without Terminal Program .. \$255.00 <b>Hayes Smartmodem:</b> 300 Baud ..... \$199.00 1200 Baud ..... \$505.00 <b>Novation:</b> J-Cat ..... \$104.00 Appecat II ..... \$285.00 Smartcat 1200 Baud ..... \$440.00 <b>Hayes Chronograph</b> ..... \$179.00

NEW PRODUCTS
<b>Commodore 64</b> ..... \$ 384.00 <b>Panasonic JR200</b> ..... \$ 299.00 <b>Percom Hard Disk Drives:</b> (Apple/IBM/TRS-80) 5 Megabyte ..... \$ 995.00 10 Megabyte ..... \$1295.00 15 Megabyte ..... \$1695.00 20 Megabyte ..... \$2095.00

DISK DRIVES
<b>Apple:</b> <b>Fourth Dimension:</b> w/o controller ..... \$250.00 w/ controller ..... \$319.00 <b>Rana Elite I:</b> w/o controller ..... \$270.00 w/ controller ..... \$339.00  <b>IBM:</b> *Tandon TM-55 The New Thin-Line ..... \$235.00

COMPUTER PRODUCTS FOR IBM
<b>The Ultimate Peripheral MONTE CARLO™ CARD</b> 64K ..... \$359.00 \$45 per 64K upgrade  <b>T &amp; G Products:</b> Joysticks ..... \$49.00 Trakball ..... \$49.00  <b>BUSINESS</b> <b>Visicorp:</b> Visidex ..... \$180.00 Visifiles ..... \$180.00 256K Visicalc ..... \$180.00 Visitrend/Plot ..... \$225.00  <b>ENTERTAINMENT:</b> <b>Infocom:</b> Zork I ..... \$27.00 Zork II ..... \$27.00 Zork III ..... \$27.00

TANDON DISK DRIVE SPECIAL
<b>TM-100-2 DS/DD 320K Bytes..... \$245.00</b> <b>TM-55 320K Bytes Half Height ..... \$239.00</b>

<b>QuadRam Quadboard</b> 64K ..... \$285.00 128K ..... \$330.00 192K ..... \$375.00 256K ..... \$415.00  <b>Kraft Products:</b> Joysticks ..... \$55.00 Game Paddle ..... \$29.00  <b>Davong Hard Disks</b> 5 Megabyte ..... \$1359.00 10 Megabyte ..... \$1759.00 15 Megabyte ..... \$2159.00  <b>Maynard Electronics</b> Floppy Controllers w/Parallel . \$209.00 Floppy Controllers w/Serial . . \$239.00
---

COMPUTER PRODUCTS FOR APPLE
<b>MBI:</b> VIP Graphics Card ..... \$119.00 Appletime ClockCard ..... \$ 85.00 <b>Silicon Valley Systems:</b> Final Analysis ..... \$149.00 Word Handler ..... \$115.00  <b>Continental:</b> Home Acct. .... \$ 49.00  <b>On-Line:</b> Screenwriter II Pro ..... \$139.00  <b>Visicorp:</b> Visidex ..... \$180.00 Visifiles ..... \$180.00 Visicalc ..... \$180.00 Visitrend/Plot ..... \$225.00  <b>Stoneware:</b> DB Master ..... \$149.00 DB Utility Pak ..... \$ 65.00  <b>T &amp; G Products:</b> Joysticks ..... \$42.00 Select-a-Port ..... \$42.00 Game Paddles ..... \$28.00  <b>Davong Hard Disks</b> 5 Megabytes ..... \$1450.00 10 Megabytes ..... \$1850.00 15 Megabytes ..... \$2250.00  <b>Ram Cards</b> Microsoft 16K ..... \$75.00 Generic 16K ..... \$60.00 CP/M Microsoft Z80 Card ..... \$259.00 80 Column Cards Videx w/soft .. \$269.00

Send orders and inquiries to:

## Computer Apparatus™

P. O. Box 32063 • Aurora, Colorado 80041

Telephone Inquiries: (303) 759-9251

Monday thru Friday — 9:00 a.m. to 5:00 p.m. (Mountain Standard Time)

**We built our reputation on low prices  
for the informed computer user.**

DELIVERIES: 2 - 4 weeks average.  
 PERSONAL CHECKS: Cashier's check and money order will receive shipping preference.  
 VISA & MASTERCARD: Add 4% to total.  
 CATALOG: Send for full pricing details.  
 Prices subject to change without notice.  
 SHIPPING: UPS add \$2.00 plus 2% of order total.

STOP LOSING MONEY ON TIME-SHARE SERVICES!

## LOGICSIM



CP/M based professional logic simulator

- \* For engineering work stations
- \* For gate-arrays, custom and all other IC designers
- \* For digital system engineers

Nine logic states, ability to simulate TTL, NMOS, CMOS, PMOS logic, ROM's and RAM's, three-state and transfer gates, word-of-ones, propagation delays, spike and race analysis, expandable pin-number based TTL macro library plus numerous other features make LOGICSIM comparable to industry standard simulators.

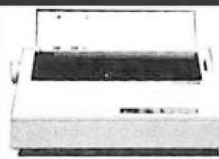
Try it now. Send us a \$30 check for LOGICSIM demo copy and User's Manual.

Please specify 8" IBM 3740/ 5" APPLE II (113/16 sector), CP/M based 56K to 64K systems (APPLE with CP/M card). Introductory price \$276.

For more information, call (408) 578-8096. Or write: E/Z ASSOCIATES, 5589 Starcrest Dr., San Jose, CA 95123

APPLE, CP/M, LOGICSIM are trademarks of Apple Computer, Digital Research and E/Z ASSOCIATES

Circle 135 on inquiry card.



## Brother HR-15

(Dynax DX-15)  
Daisy Wheel

\$495

Gemini 10 Printer.....CALL  
 Gemini 15 Printer.....CALL  
 C. Itoh 8510.....399  
 Epson FX 80.....CALL  
 Okidata Microline 92.....CALL  
 Transtar 130 Daisy Wheel.....CALL  
 Transtar 315 Color Printer.....499  
 Tandan 100-2 Drive.....295  
 Super 5 Apple Comp. Drive.....275

CALL FOR BEST PRICES

## MICRO MARKETING

Serving You Since 1979

4688 Convooy Street, Suite 109  
 San Diego, CA 92111 Tel. (619) 565-0158

Circle 77 on inquiry card.

## FAST Factory Floppy Disc Drive Repair

Specialists in the repair of:

Shugart  
 Tandon  
 PerSci

**PERSci, Inc.**



12624 Daphne Avenue  
 Hawthorne, CA 90250  
 (213) 777-7536  
 TWX 910-321-4448

Circle 298 on inquiry card.

## LOGICALLY THE ANALYZER



From \$475 (8 channel)

### 16 channel version (shown)—\$900

YES Logically...this is THE logic analyzer of industrial power at a personal price. As an addition to a S-100 system features are:

- 10 MHz sample rate
- 8 or 16 channels
- Data storage on disk (CP/M™ based version)
- Very user-friendly operation in software included being CP/M™ or EPROM based
- Sequencing, format conversions, searching
- And much more...

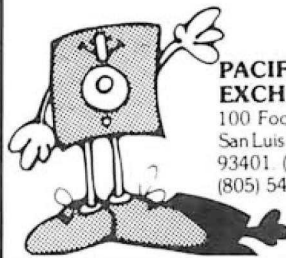
For user manual, only \$20  
 Compare and see the logical approach to logic analysis

**FORTE SYSTEMS**  
 Box 32627, San Jose, CA 95152  
 (408) 272-8772  
 CP/M is a trademark of Digital Research

Circle 153 on inquiry card.



Solve your disc problems, buy 100% surface tested Dysan diskettes. All orders shipped from stock, within 24 hours. Call toll FREE (800) 235-4137 for prices and information. Visa and Master Card accepted.



**PACIFIC EXCHANGES**  
 100 Foothill Blvd.  
 San Luis Obispo, CA  
 93401 (In Cal call  
 (805) 543-1037.)

Circle 294 on inquiry card.

## TeleVideo® Users!

TEACH YOUR TELEVIDEO® WORDSTAR®!

TV2000 PRICES SLASHED!! NOW \$179!!  
 (was \$220)

### FEATURES

- 92 WordStar® commands
- The Power of a dedicated word processor
- No loss of TeleVideo® attributes
- Soft switch activated
- Cuts WordStar® learning time to an hour

### INCLUDES

- microprocessor
- 46 Keycaps with WordStar® legends
- 45 Page WordStar® manual

### WordTechSystems

953 Mountain View Dr. Suite 114  
 Lafayette, California 94549  
 (415) 254-7747



SEE OUR SOFTWARE AD IN THIS ISSUE OF BYTE

Circle 420 on inquiry card.

## Printer Cables

— Parallel —

\$39.00\* ALTOS ATTACHE ATARI \$39.00\*

CENTRONICS COLUMBIA

EAGLE

IBM-PC

KAYPRO

OSBORNE

SANYO

TI-99

\$39.00\* \$39.00\*

— SERIAL —

ATTACHE COM.  
 RS232 (DB25P)  
 (9 conductor 1-8, 20)

### CABLES UNLIMITED

PO Box 93065  
 Pasadena, Calif.  
 91109

\*CA Residents Add 6% Sales Tax (\$2.44)

Circle 421 on inquiry card.

## \$\$ Printers \$\$

### EPSON

MX 80 ..... CALL  
 MX 80 FT III ..... CALL  
 MX 100 FT III ..... CALL  
 FX 80 ..... CALL

### STAR MICRONICS

Gemini 10 ..... 329  
 Gemini 15 ..... 509

### C. IOTH

8510 Prowriter Parallel ..... 419  
 8510 Prowriter Serial ..... 559  
 1550 Parallel ..... 659

Letter Quality  
 Smith Corona TP-1 ..... \$549  
 Comrex CRI ..... 825

"Other Printers Available"

Shipping and handling add 3%. CA residents add 6%.

### THE COMPUTER STORE

3941-B S. Bristol St. Dept. 345  
 Santa Ana, CA 92704

714-662-1425

Circle 84 on inquiry card.

## VOICE SYNTHESIZER Vocabulary Development system

Create custom vocabularies for TI-5220 or GI SP-250 Speech Synthesizers

INCLUDES HARDWARE AND SOFTWARE FOR:

- DMA Voice Digitizing and Playback
- Parameter extraction and coding
- Screen Oriented Parameter Editor
- Voice Synthesis

### USE YOUR S-100 SYSTEM, OR BUY OUR INTEGRATED SYSTEM BASED ON ZENITH Z-100

The Zenith Z-100 includes 8085/88 dual processor, 128K memory, two 5 1/4, 320K-byte drives, both CP/M80 and MS DOS and bit-mapped graphics, with CRT and keyboard in a convenient desktop model.

VPP-696: PC cards, software, speaker, cabling and documentation - \$4100

VPP-696Z: Includes VP-696 fully integrated to Z-100 with all cabling, software and documentation - \$8850

MULTIBUS VERSION FOR INTEL MDS AVAILABLE SOON

*adisa corporation*

APPLIED DIGITAL SIGNAL ANALYSIS  
 P.O. Box 1364 Palo Alto, CA 94301 (415) 326-7303

Circle 7 on inquiry card.

# MICROMAIL®

## MONITORS

### AMDEK

Color I .....	\$340
Color II .....	\$650
Color III .....	\$390

### PRINCETON GRAPHICS SYSTEMS

Hi-Res Color .....	\$550
--------------------	-------

### NEC, DYNAX

**ELECTROHOME ..... CALL**

## PRINTERS

### C-ITOH

GX-100 (50 CPS) Matrix .....	\$240
8510 .....	\$460
1550 (15") .....	\$690
F-10 (40 CPS) Letter Quality ..	\$1290
F-10 (55 CPS) Letter Quality ..	\$1690

### EPSON (W/GRAFTRAX PLUS)

MX 80 FT .....	\$490
FX 80 FT .....	\$575
MX 100 FT .....	\$690
FX 100 FT .....	\$790

### OKIDATA

82A .....	\$440
83A .....	\$690
84A .....	\$975
92A .....	\$575
93A .....	\$970

### BROTHER

HR-1 .....	\$750
------------	-------

### SMITH CORONA

TP-1 .....	\$520
------------	-------

### STAR MICRONICS

Gemini 10 .....	\$370
Gemini 15 .....	\$540

### NEC

#### SPINWRITER

7710-1 .....	\$1950	3510 .....	\$1350
7715-1 .....	\$2100	3515 .....	\$1350
7720-1 .....	\$2400	3530 .....	\$1550
7725-1 .....	\$2400	3550 .....	\$1850
7730-1 .....	\$1950	PC8023A ..	\$450

## MEMORY BOARDS

### AST

Combo Plus. 4 function card. Fully pop. 256K .....	\$490
Mega Plus. Fully pop. 512K ..	\$990



## MEMORY BOARDS

### QUADRAM

Quad Card. Fully pop. 256K \$500

**Big Blue .....** \$470

**Hercules graphics card .....** \$490

### IBM PC

PC System includes 64K IBM-PC with two 320KB Floppy Disk Drives, Controller, Color Graphics Card, Monochrome Monitor.

All for only ..... \$2490

### IBM PC/XT

Complete System with Floppy Disk Drive, Hard Disk, Color Graphics Card, Monitor .....

\$4990

**LOTUS 1-2-3 Software .....** \$390

### HARD DISKS FOR

#### APPLE AND IBM

### DAVONG

5 MB .....

10 MB .....

15 MB .....

### TAVA CORP.

#### TRUMPCARD 1

256K Ram .....

\$450

#### TRUMPCARD 2

512K RAM .....

\$650

### FDC

#### FOR IBM PC

W/Par. Port .....

\$220

W/Ser. Port .....

\$240

### DEC RAINBOW 100

Complete system 64K PC, Keyboard, Two Floppy Drives DS/DD, Monochrome Monitor .....

\$2990

### APPLE II+

Compatible Computer with 64K, Disk Drive, Controller, and Monitor .....

\$990

### APPLE IIe

64K System, W/Controller, Disk Drive, Monitor, 80 Column card, Stand \$1790

### DISK DRIVE FOR APPLE

Slimline, or Standard .....

\$250

### KAYPRO II COMPUTER

Complete System .....

\$1690

### EPSON QX-10

64K Ram, Z-80 CPU, Monitor, Etc. \$2200

**HX-20 Notebook Computer .** \$690

# MICROMAIL

## (714) 838-9100

631 E. First St., Tustin, CA 92680

Prices subject to change without notice.

APPLE is a trademark of Apple Computers, Inc.  
IBM is a trademark of IBM Corp.

# DISKETTES

maxell. VERBATIM

100% ERROR FREE

5 1/4 SS/DD 28.95 (BOX 10)

5 1/4 SS/DD 24.95 (BOX 10)

DATALIFE

CAPTAINS SPECIAL

BUY ONE BOX MAXELL GET 10% OFF 2nd BOX

VERBATIM HEAD CLEANING 8.95 KIT

WITH ORDER OF DISKS MX-80 CARTRIDGE 4.95 EA.

MEGA-BYTE

M.C. VISA C.O.D.

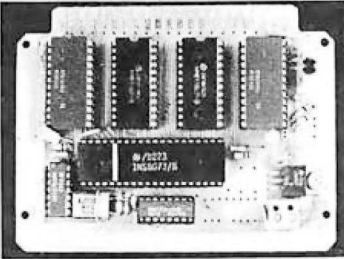
ADD 2.00 SHIP 5% TAX IN FLA. 800-327-1013

4699 S.W. 45th STREET FORT LAUD., FLA 33314 305-587-1130

Circle 244 on inquiry card.

## TIRED OF EPROM HASSELS?

WITH THE MICRO XCPU FORGET: 25 VOLT POWER, UV LAMPS, PULLING-ERASING, INSERTING EPROMS



BASIC ON  $\mu$ P — STRINGS, INTERRUPTS, MUCH MORE HARDWARE 16 BIT MULT AND DIVIDE 37  $\mu$ S, 42  $\mu$ S VOLTAGE REGULATOR, RS-232C FOR PROGRAMMING, 4K EEPROM (X2816A), 4K RAM, AUTO START PR UP :EXPANSION BOARDS AVAILABLE, MICRO XCPU — \$195 EPROM BURNER VERSION FOR DIE HARDS — \$125

MICRO APPLICATIONS — (305) 725-0944

515 ANDREWS DR, MELBOURNE BEACH, FL 32951

Circle 248 on inquiry card.

## NEW!!

The Apple users group software library bonanza at truly affordable prices. For the first time enjoy your Apple to its fullest capacity using specially packed disks with over 80 outstanding programs each. Not available from any other source!

• Applesoft • 3.3DOS

PROGRAMS \$1-EACH

APPLEWARE INC. offers An extensive variety of interesting, useful and entertaining programs indispensable to the serious computerist including:

Business • Educational • Graphics  
Games • Music • Science  
Utilities • Data Base • Finance

Library disks 1, 2 & 3 are mixed categories and new disks 4 (Games), 5 (Utilities), 6 (Graphics) & 7 (Integer) at \$59.95 each. Why pay more?

Order direct from this ad and Save up to \$136. Buy disk library package 1, 2 & 3 and get a special bonus disk FREE — over 260 programs for \$179.95 + shipping. For best value, get all 8 disks for \$349, postage prepaid, for over 530 of our best programs at 65¢ each! Call now toll free: 1-800-327-8664

Florida: 1-305-987-8665  
6400 Hayes St.  
Hollywood, FL 33024

Master Charge VISA

Circle 25 on Inquiry card.

## 8087 SUPPORT

For the IBM PC

8087 CHIP ... \$223  
64K RAM ... \$ 64  
64K QUADBOARD \$324

### APPLICATIONS

FFTs..... \$75  
MATRIXPAK..... \$100  
87/88 Guide Volume 1..... \$19.95

### LANGUAGE SUPPOR

87MACRO™ ..... \$150  
87BASIC™ ..... \$150  
87PASCAL™ ..... \$150  
87FORTRAN™ ..... \$150

IBM Personal Computer is a registered trademark of IBM Corp. CP/M 86 is a trademark of Digital Research, Inc. 8087 is a trademark of Intel Corp. 87/88GUIDE 87MACRO 87BASIC 87PASCAL 87FORTRAN and MicroWare are trademarks of MicroWare, Inc.

VISA MasterCard

MicroWare P.O. Box 79 Kingston, MA 02364 (617) 746-7341

Circle 267 on Inquiry card.

## Computer Sale

Franklin ACE 1000 w/Color ..... \$ CALL

1000 System w/Monitor ..... CALL

ACE 1200 w/Color ..... CALL

Drives for Apple and Franklin

Quentin 5 1/4 ..... 249  
Thin Line ..... 279  
Contr. Card ..... 65  
Contr. w/Diagnostics ..... 95

Franklin Color Kit ..... 39.95 (No Soldering)

Shipping and handling add 3%. CA residents add 6%.

THE COMPUTER STORE  
3941-B S. Bristol St. Dept. 345  
Santa Ana, CA 92704  
714-662-1425

Circle 85 on Inquiry card.

## LETTER QUALITY PRINTER KIT! LE

From \$200. Do It Yourself & SAVE!

FOR THE OLIVETTI PRAXIS® 30 & 35 ELECTRONIC OFFICE TYPEWRITERS Full KSR with RS-232 Serial/Parallel Comb. or Centronics Compatible Parallel Only.

COMPARE... THEN CALL

(615)727-6000

SYSTEMED CORPORATION  
Drawer 600, Mountain City, TN 37683

Master Charge VISA

Circle 439 on Inquiry card.

## MEMOREX FLEXIBLE DISCS

WE WILL NOT BE UNDER-SOLD!! Call Free (800)235-4137 for prices and information. Dealer inquiries invited and C.O.D.'s accepted.

VISA

PACIFIC EXCHANGES  
100 Foothill Blvd.  
San Luis Obispo, CA 93401 In Cal. call (800)592-5935 or (805)543-1037



Circle 294 on inquiry card.

## F.S.I. COMPUTER FURNITURE



- A full range of quality computer workstations for "do it yourself" assembly.
- Delivered well packed with assembly instructions.
- Manufactured from particle board with hard wearing melamine surface in oak, almond and walnut.
- Suggested retail price: \$294.00.
- Dealer inquiries welcome.
- For information, call F.S.I. (813-775-6984) or write to: F.S.I. Inc. 4227 Merchantile Ave. Naples, Fla. 33940

Circle 156 on Inquiry card.

## Floppy Disks

Scotch® MEMOREX

Dysan CORPORATION

BEST PRICES IN THE U.S.

Dealer Inquiries Invited. C.O.D. Accepted

TOLL FREE 800-652-8168 CALIF. 213-706-1626

VISA MasterCard

U.S. EXCHANGE

5015 Kanan Road  
Agoura Hills, CA 91301

Circle 398 on Inquiry card.





# WE WILL TRY TO BEAT ALL PRICES IN THIS MAGAZINE TO PLACE ORDER CALL (213) 219-0808 NOW!

Circle 70 on inquiry card.

## 48K APPLE COMPATIBLE COMPUTER

System 2 ..... \$649

### ALL COMPUTERS

Apple II E ..... \$ Call  
 Commodore 64 ..... 399  
 Kaypro II ..... 1649  
 Osborne ..... Call  
 Sanyo MBC 1000 ..... 1599  
 Apple Compatible Computer ..... 695  
 IBM PC ..... Call

### IBM PC PRODUCTS

#### Ast Research

Combo Plus 64K w/clock, Par. Port, Serial Port, Software ..... \$379  
 Mega Plus 64K Expandable to 512 ..... 430

#### Tandon

TM100-2 Dbl Side Dbl Density ..... \$ 259

### 5 1/4" & 8" DISK DRIVES

#### Shugart

SA400, 40 Track ..... \$ 195  
 SA801R, Sgl Side/Dbl Den ..... 369  
 SA851R, Dbl Side/Dbl Den ..... 479

#### Tandon

TM100-1, Sgl Side/Dbl Den ..... \$ 185  
 TM 100-2, Dbl Side/Dbl Den ..... 235  
 TM 848-1, Sgl Side/Dbl Den ..... 359  
 TM 848-2, Dbl Side/Dbl Den ..... 449

#### Qume

DT-8 Dbl Side/Dbl Den ..... \$ 465

#### Siemens 8"

FDD 100-8, Sgl Side/Dbl Den ..... \$ 195

#### Mitsubishi

8" Dbl Side/Dbl Den ..... \$ 409

### FOR FRANKLIN & APPLE

All Apple Products Not Seen in This Ad Are Available-Call for Guaranteed Lowest Price  
 Grappler + ..... \$121  
 Par. Inter Face Card & Cable ..... 49  
 TC Joystick ..... 39  
 16K Memory Card ..... 44  
 80 Column Card (Viewmax 80) ..... 169  
 RHF An ..... 69  
 RF Modulator ..... 25  
 System Saver ..... 69

### UNBEATABLE PRINTER PRICING

#### Star Micronics

Gemini 10 (100 cps) ..... \$ 310  
 Gemini 15 (15" carriage) ..... 465

#### C. Itoh

Prowriter 8510AP (120 cps) ..... \$ 375  
 Prowriter 8510ACD (Serial) ..... 549  
 Starwriter F-10 40pu ..... 1249

#### Okidata

Microline 82A ..... \$ 399  
 Microline 83A ..... 649  
 Microline 84P ..... 960  
 Microline 84S ..... 1075  
 Microline 92 ..... 505

#### Nec

Nec 8023 (price reduction) ..... \$ 439  
 Spinwriters ..... Call

#### Toshiba

P1350 ..... \$1650

## SUMMER SPECIALS

### PRINTER

#### Okidata

ML 92 ..... \$505

#### Star Micronics

Gemini 10 ..... \$310

### MODEM

#### Hayes

300 Baud ..... \$209

#### Novation

J-Cat ..... \$119

### MONITORS

#### BMC

12AU, 12" Green ..... \$ 79

#### USI

PI3, 20MHz Amber ..... 149

### DISK DRIVE FOR APPLE

#### Micro-Sci

A-2 ..... \$249

### ACCESSORIES

#### Gibson

Light Pen System ..... \$249

#### TC

Joystick ..... \$ 39

### DISK DRIVE

#### Tandon

TM100-2 (IBMPC) ..... \$259

All Products Carry at least a 90 Day Warranty

### MODEMS

#### Hayes

Smart Modem 300 ..... \$ 199  
 Smart Modem 1200 ..... 498

#### Novation

J-Cat 300 Baud ..... 119  
 Apple Cat ..... 259

### TERMINALS

#### Televideo

925C Green Screen ..... \$ 719  
 950 Detachable Keyboard ..... 949

### SOFTWARE

#### Micropro

Wordstar, IBM or Apple ..... \$ 299  
 Call for more Low Micropro Pricing

#### Ashton Tate

D-Base II ..... 429

### DISKETTES

All diskettes have reinforced hub and full 1 year warranty. Diskettes are packaged 10 per package, not bulk packed.

#### 5 1/4" Disks

Soft Sector ..... \$ 18.50/10  
 Soft Sector ..... 160.00/100

#### 8" Disks

Sgl Side/Sgl Density ..... \$ 25.00/10  
 Sgl Side/Sgl Den ..... 230.00/100

### CABINETS & MAINFRAMES

#### QT Computer Systems — 8" Cabs.

DDC-8 Cabinet w/pwr. supply & fan  
 ONLY \$209.00

DDC-88-H Dual Cabinet w/pwr. supply & fan  
 ONLY \$259.00

#### 5 1/4" Cabinets By JMR

Single Cabinet w/pwr. supply ..... \$ 59  
 Dual Cabinet w/pwr. supply ..... 89

### DISK DRIVES FOR FRANKLIN & APPLE

#### Rana Systems

Rana Elite I ..... \$ 285  
 Rana Elite II ..... 439  
 Rana Elite III ..... 569  
 Controller ..... 89

#### Micro Sci

A-2 (35 Track) ..... \$ 249  
 Controller ..... 75  
 Apple III Drives Available ..... Call

#### Quentin Research

Apple Mate ..... \$ 249  
 Controller ..... 60

### MONITORS

#### BMC

12A (15MHz) Composite ..... \$ 79  
 9191 Color Composite ..... 289

#### Zenith

ZVM 121, 12" Green (15MHz) ..... \$ 94

#### USI

9" Green (20MHz) ..... \$ 139  
 12" Green (20MHz) ..... 139  
 12" Amber (20MHz) ..... 149

### CABLES

IBM to Printer ..... \$ 32  
 Osborne to Printer ..... 32  
 Kaypro to Printer ..... 32  
 Call for all cable configurations

### DISKETTE STORAGE

Mini Files—Holds 50 Disks ..... \$16.50  
 Maxi Files—Holds 50 Disks ..... 24.00  
 5 1/4" Library Cases ..... 3.00  
 8" Library Cases ..... 4.00

### No Surcharge for Credit Cards



All merchandise new. We accept MC, Visa, Wire Transfer, COD Call, Certified Check, P.O.'s from qualified firms, APO accepted. Shipping: Minimum \$3.50 first 5 pounds. Tax: California Res. Only add 6 1/2% sales tax.

Mon.-Fri. 7 a.m. to 6 p.m.  
 Sat. & Sun. 11 a.m. to 4 p.m.

# Computer Components Unlimited

NEW RETAIL STORE:  
 11976 Aviation Blvd.  
 Inglewood, CA 90304

MAIL ORDER:  
 P.O. Box 1936  
 Hawthorne, CA 90250

ORDER DESK:  
 (213) 219-0808

# 5 1/4" Diskettes

## New Product Introduction

SK

1-9 boxes 1-2 cases 3-10 cases

SSDD \$20.50 per box \$195.00 per case \$190.00 per case

DSDD \$27.50 per box \$265.00 per case \$260.00 per case

### Soft Sectors - Hub Rings

- Highest Quality — thoroughly tested
- Satisfaction guaranteed
- We offer quotes for larger quantity users

Call TOLL FREE 800-982-2244

Checks, Money Order, Visa, Mastercard, — 5% shipping, California residents add 6 1/2% sales tax.

### Vidiom Media Supply

500 Airport Boulevard  
Suite #422  
Burlingame, CA 94010

Circle 409 on inquiry card.

# MediScript

MediScript I is a powerful word processor designed for the IBM-PC and newcomer to word processing. Simple to use yet has all common functions (such as word wrap and paragraph relocate). Additional functions in MediScript II include right justification, character graphics, fielded forms, and mailing list generation.

MediScript I — — — — — \$49.50  
MediScript II — — — — — \$99.50  
(plus 6% in CA) 30 day satisfaction guaranteed or your money back, minus \$4.00 for shipping and handling.

## MediSoft



Medical Professions Building  
1595 Soquel Drive, Suite 350  
Santa Cruz, CA 95065

Circle 54 on inquiry card.

# SAVE 50% on Scotch® Diskettes

Dealer Inquiries Invited

<b>5 1/4" Specify Soft</b>	prices/10
10 or 16 Sector	
744D 1 side/dbl dens. . . . .	<b>\$22.30</b>
745 2 sides/dbl dens. . . . .	<b>\$31.00</b>
746 1 side/quad 96 tpi . . . . .	<b>\$33.80</b>
747 2 sides/quad 96 tpi . . . . .	<b>\$45.50</b>
<b>8" Specify Soft or 32 Sector</b>	
740 1 side sgl/dens. . . . .	<b>\$23.60</b>
741 1 side/dbl dens. . . . .	<b>\$29.00</b>
743 2 sides/dbl dens. . . . .	<b>\$37.80</b>

Checks-VISA-MC-C.O.D./Add \$2 Shipping  
Call or write for our complete list.

**LYBEN COMPUTER SYSTEMS**  
27204 Harper Ave., St. Clair Shores, MI 48081  
Phone: (313) 777-7780

**Authorized Distributor**  
Information Processing Products **3M**

Circle 224 on inquiry card.

## SIGNALMAN MODEMS

300 BAUD **\$89**  
DIRECT CONNECT

300 BAUD **\$149**  
AUTO ANSWER/ORIGINATE  
HAYES COMPATIBLE

300/1200 BAUD **\$319**  
AUTO ANSWER/ORIGINATE  
HAYES COMPATIBLE

## GEMINI 10 PRINTER

GRAPHICS **\$329** 100 CPS

CALL (619) 436-8317  
IMAGE COMPUTER

\* VISA/MC ADD 3%

Circle 183 on inquiry card.

## DISKETTES



CONTROL  
DATA



Circle 36 on inquiry card.

## Wasting Money! We Have the World's Most Cost Effective Development System.

- Includes Hexkit 1.0, a powerful 100% machine code editor/debugger utility program that makes coding for 8-bit Micros a snap.
- Program from Commodore VIC-20 keyboard into built-in 4K ROM emulator
- Jumper to target ROM socket
- Test programs in circuit
- Built-in EPROM programmer and power supply
- Burns & runs EPROMS for the Commodore VIC-20, too
- Comprehensive manuals
- Fits EXPANSION PORT

**PROMQUEEN CARTRIDGE ONLY \$199**

Send for Free Brochure

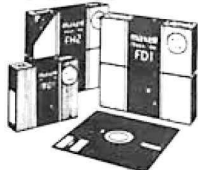
Distributed in U.S. by Arbutus Total Soft, Inc., 4202 Meridian, Suite 214, Bellingham, WA 98225. Phone 800-426-7253, in Washington 206-733-0494. Distributed in Canada by IIBC/Distribution Canada, 4047 Cambie St., Vancouver, BC V5Z2A9. Phone 604-879-7812

VISA AND MASTERCARD ACCEPTED

**commodore approved product**

Circle 28 on inquiry card.

# maxell Floppy Disks



## BEST PRICES IN THE U.S.

Call for our special dealer program C.O.D.'s accepted.  
TOLL FREE (800) 652-8168  
in California (213) 706-1626



U.S. EXCHANGE  
5015 Kanan Rd.  
Agoura Hills, CA 91301

Circle 399 on inquiry card.

## CHIPS & DALE

### THE INFLATION FIGHTERS!

- 4116 250ns 8/\$9.50 100+ 1.05 ea.
- 4116 200ns 8/\$10.00 100+ \$1.05 ea.
- 4116 150ns 8/\$11.50 100+ \$1.25 ea.
- 4116 120ns 8/\$14.50 100+ \$1.50 ea.
- 4116 120ns 8/\$15.50 100+ \$1.50 ea.
- 2114L 300ns 8/\$10.50
- 2114L 200ns 8/\$12.00
- \*4164 200ns \$4.65 ea.
- \*4164 150ns \$5.10 ea.
- \*6116 150ns \$4.00 ea.
- \*6116 200ns \$3.85 ea.
- \*6116LP 150ns \$4.75 ea.
- \*1791 Disk Controller \$20.00
- 1777 Disk Controller \$17.50
- Z80A, Z80ACTC, Z80A PIO \$3.00 ea.
- 8255 \$4.25
- 2716-1 5V 350ns 8/\$4.25 ea. \$5.00 ea.
- 2716 5V 450ns \$3.00 ea.
- \*2732 5V 450ns \$3.85 ea.
- \*2532 5V 450ns \$4.25 ea.
- \*2764 5V 300ns 28 pin \$9.00 ea.
- \*2764 5V 24 pin CALL
- \*2564 5V CALL
- \*8087 CALL
- 68000 CALL

Allow up to 3 wks. for personal checks to clear. Please include phone number. Prices subject to change without notice. Shipping & Handling for Chips \$3.50, FOB Bellevue, WA. for all else. Wash. residents add 6.5% Sales Tax.

CHIPS & DALE 1-206-451-9770  
10655 N.E. 4th St., Suite 400  
Bellevue, WA 98004

Circle 57 on inquiry card.

## A NO-COMPROMISE S-100 SYSTEM THAT YOU CAN AFFORD, STARTING AT \$2850

**Features:** Fully integrated S-100 system, with CP/M 2.2. 2 Thinline Mitsubishi 8" DS-DD drives. Integrand enclosure with 3 expansion slots. Teletek System-master single board computer. Freedom 100 terminal with 7 x 9 dot char, P-31 phosphor, detachable keyboard, 10 Func. keys. Mainframe has full 1 year warranty.

**\*\* All this for only \$2850 \*\***

**Options:** 7 or 10 slot full height enclosures. Hard disks 5 to 25 Mb. LQ Printer. \$ call

## TOTAL ACCESS

Suite 202, 2054 University Ave.  
Berkeley, CA 94704  
(415) 540-8066

Circle 389 on inquiry card.

# 10 MEGABYTE S-100 PACKAGE \$1295<sup>00</sup>



For Cabinet & Power Supply  
Please Add \_\_\_\_\_ \$200.00

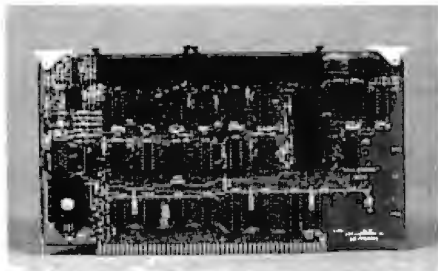
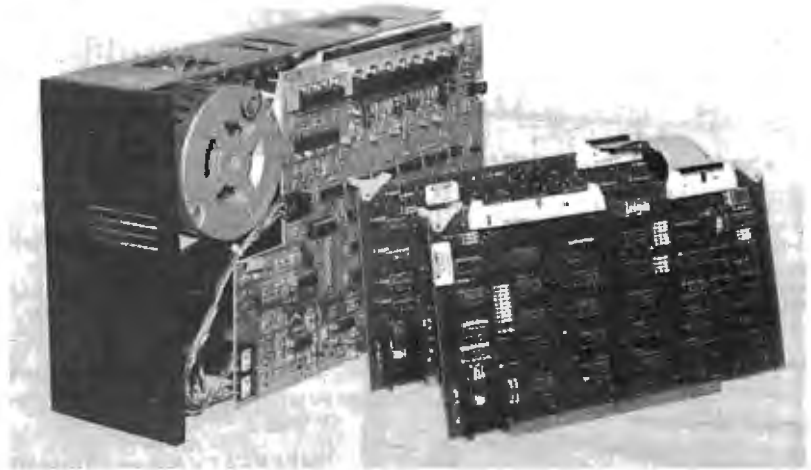
## "The Winchester Deal Of The Year"

If your data storage needs have outgrown your floppy-based S-100 system, Jade now gives you the opportunity to add a fast, reliable hard disk package to your system at a bargain price.

If purchased separately, the components of this package would cost you well over \$3000.00; our special purchase now allows us to give you a special price of only \$1295.00 CALL NOW... These units will not be on the shelf for long at this price!

- Shugart SA1004 8-inch 10MB Winchester
- X Comp S-100 Controller For SA1004
- Your Choice of X Comp CP/M Auto-Attach Software (for most S-100 Systems) or "WD BOOT" PROM (for SD Systems board sets)
- Cables and Manuals Included
- Limited Quantity

MSH-991000 with SD Boot Prom \_\_\_\_\_ \$1295.00  
MSH-991002 with Auto Attach Software — \$1295.00

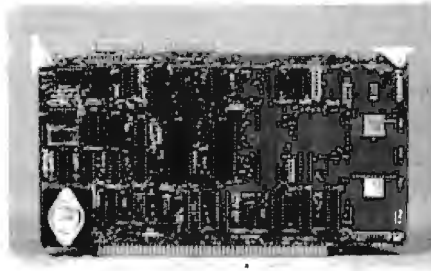


### VERSAFLOPPY II

SD Systems' Versafloppy II is a reliable field-proven S-100 double-density floppy disk controller. For full software compatibility it can also read and write standard IBM 3740 single density format. The Versafloppy II controls single or double sided drives in single or double density format. 5 1/4" 8" in any combination and up to 4 drives simultaneously. The Versafloppy II is faster, more stable and more tolerant of bit shift and "jitter" than most other controllers. All control and diagnostic firmware included  
IOD-1160A Versafloppy II \_\_\_\_\_ \$359.95

### FREE!\* CP/M 3.0

S-100 board set with 4 MHz Z-80A, 64K of RAM expandable to 256K, serial and parallel I/O ports, double density disk controller for 5 1/4" and 8" disk drives, new and improved CP/M 3.0, manual set, system monitor, control and diagnostic software. Includes SD Systems SBC-200, 64K ExpandoRAM III, Versafloppy II, and FREE CP/M All boards are assembled and tested.  
\*64K Board Set with FREE CP/M 3.0 \_\_\_\_\_ \$1195.00  
\*256K Board Set with FREE CP/M 3.0 \_\_\_\_\_ \$1395.00



### SBC 200

SD System's SBC-200 is an S-100 bus compatible single board computer based on the 4 MHz Z80A CPU. It contains a synchronous/asynchronous serial port with software programmable baud rates, a parallel I/O port, a four channel counter timer and 1K on-board RAM. Up to 8K of firmware may be added to the board's 4 EPROM sockets. The SBC 200 is the ideal heart of a system composed of the other boards in the SD product line, or can stand alone in process control applications.  
CPC-30200A SBC-200 \_\_\_\_\_ \$399.95

### CP/M 3.0 PLUS

SD Systems' implementation of Digital Research's CP/M 3.0 Plus is a unique combination of hardware and software that optimizes the powerful new features of CP/M Plus. CP/M Plus requires 192K of memory for optimum performance, making it an ideal match for the 256K ExpandoRAM III  
SFC-55009059F Unbanked, RS232 \_\_\_\_\_ \$250.00  
SFC-66009058F Unbanked, VDB80 \_\_\_\_\_ \$250.00  
SFC-55009057F Banked, RS232 \_\_\_\_\_ \$250.00  
SFC-55009056F Banked, VDB80z \_\_\_\_\_ \$250.00  
SFC-55009057D Manual \_\_\_\_\_ \$50.00

### RAM DISC

The RAM Disc from SD Systems is a "solid-state disc drive" for IEEE696/S-100 systems. It allows programs to execute from high speed RAM, circumventing the mechanical problems and speed limitations of floppy disk drives. RAM Disc increases system performance substantially in disk intensive applications. 256K storage per board, "install" programs available for CP/M & MP/M  
MEM-66256A RAM DISC \_\_\_\_\_ \$799.95

### ROM DISC

SD Systems ROM Disc is a 128K EPROM/ROM board which is similar in concept to the RAM Disc. Like the RAM Disc it allows execution of software at high speed directly from memory, without the use of disk drives. The ROM Disc is non volatile memory ideally suited for use with the new CP/M Plus, now available in EPROM  
MEM-12850A ROM DISC Board \_\_\_\_\_ \$295.00  
CP/M Plus On EPROM:  
SFC-55009059E Unbanked RS232 \_\_\_\_\_ \$400.00  
SFC-55009057E Banked RS232 \_\_\_\_\_ \$400.00

### EXPANDORAM III

SD Systems new ExpandoRAM III is a high density S-100 memory board utilizing the new 64K x 1 dynamic RAM chips. It allows memory sizes of 64K, 128K or 256K all on a single S-100 board.

The ExpandoRAM III marks a new generation of highly reliable and versatile dynamic RAM boards suitable for expanding current S-100 systems, or for use in new multi-user systems.

MEM-65064A 64K \_\_\_\_\_ \$495.00  
MEM-65128A 128K \_\_\_\_\_ \$595.00  
MEM-65192A 192K \_\_\_\_\_ \$675.00  
MEM-65256A 256K \_\_\_\_\_ \$755.00

## Place Orders

### Toll Free:

Continental U.S.  
800-421-5500

Inside California  
800-262-1710

For Technical Inquires  
or Customer Service Call:  
213-973-7707

# JADIE

## Computer Products

4901 West Rosecrans, Hawthorne, California 90250

## S-100 MEMORY BOARDS

### 64K STATIC RAM - Jade

Uses new 2K x 8 static RAMs, fully supports IEEE69624 bit extended addressing, 200ns RAMs, lower 32K or entire board phantomable, 2716 EPROMs may be subbed for RAMs, any 2K segment of upper 8K may be disabled, low power typically less than 500ma.

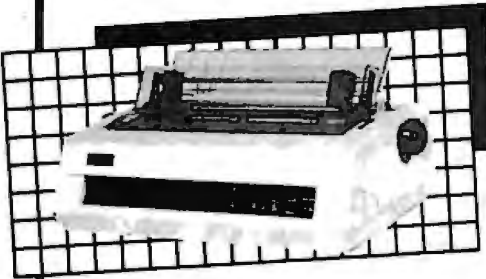
MEM-99152B Bare board	\$49.95
MEM-99152K Kit less RAM	\$99.95
MEM-32152K 32 kit	\$199.95
MEM-56152K 56K kit	\$289.95
MEM-64152K 64K kit	\$299.95
Assembled & Tested	add \$50.00

## LETTER QUALITY PRINTERS

### Letter Quality Printer - COMREX

Uses standard daisy wheels and ribbon cartridges, 16 CPS bi-directional printing, semi-automatic paper loader (single sheet or fan fold), 10/12/15 pitch, up to 16" paper, built-in noise suppression cover.

PRD-11001 Centronics parallel	\$899.95
PRD-11002 RS-232C serial model	\$969.95
PRA-11000 Tractor Option	\$119.95



### 380Z by D.T.C.

Based on the same quality mechanism as the Comrex printer, the 380Z contains electronic enhancements that allow it to print at speeds up to 32 CPS. Other features include a 48K buffer, proportional spacing, and Diablo 1640/1650/630 compatible protocol. Comes with printwheel, ribbon and users manual. Serial, parallel, and IEEE 488 interfaces standard.

PRD-11300 380Z printer	\$1295.00
PRA-11000 Tractor option	\$169.95
PRA-1200 Cut sheet feeder	\$699.95
Cable Please specify	\$49.95

### Printers From Jade

OKIDATA 82 10" 120 CPS	CALL
OKIDATA 92 10" 160 CPS with Graphics	CALL
OKIDATA 93 15" 160 CPS with Graphics	CALL
OKIDATA 83 15" 120 CPS with Tractor	CALL
OKIDATA 84 15" 200 CPS with Graphics	CALL
OKIDATA 2350 15" 350 CPS	CALL
OKIDATA 2410 15" 350 CPS, Two color	CALL
DAISYWHEELER 2000 48K Daisywheel	\$1395.00
GEMINI 10 100 CPS 10" with Graphics	\$349.95
GEMINI 15 100 CPS 15" with Graphics	\$499.95

### PRINTER PALS - FMJ

Desk top printer stand and paper rack. Fits all printers.	
PRA-99080 10" Printer pal	\$29.95
PRA-99100 15" Printer pal	\$39.95
PRA-99700 for Letter Quality	\$49.95

## S-100 I/O BOARDS

### The BUS PROBE - Jade

Inexpensive S-100 Diagnostic Analyzer

TSX-200B Bare board	\$59.95
TSX-200K Kit	\$129.95
TSX-200A A & T	\$159.95

### I/O-4 - SSM Microcomputer

2 serial I/O ports plus 2 parallel I/O ports

IOI-1010B Bare board w/manual	\$35.95
IOI-1010K Kit with Manual	\$179.95
IOI-1010A A & T	\$249.95

### I/O-5 - SSM Microcomputer

Two serial & 3 parallel ports, 110-19.2K Baud

IOI-1015A A & T	\$289.95
-----------------	----------

### INTERFACER 4 - CompuPro

3 serial, 1 parallel, 1 Centronics parallel

IOI-1840A A & T	\$314.95
IOI-1830C CSC	\$414.95

## S-100 EPROM BOARDS

### PB-1 - SSM Microcomputer

2708, 2716 EPROM board with on-board programmer

MEM-99510K Kit with manual	\$154.95
MEM-99510A A & T with manual	\$219.95

### PROM-100 - SD Systems

2708, 2716, 2732 EPROM programmer with software

MEM-99520K Kit with software	\$189.95
MEM-99520A A & T with software	\$249.95

## VIDEO MONITORS

### VIDEO MONITOR - Jade

1000 lines ultra-high resolution, 20 MHz ultra-high band width, 9" or 12", Amber or Green phosphor, the finest monitors we sell.

VDM-750920 9" Green	\$99.95
VDM-750910 9" Amber	\$129.95
VDM-751220 12" Green	\$129.95
VDM-751210 12" Amber	\$139.95

### 12" GREEN SCREEN - Zenith

15MHz, 40 or 80 column	
VDM-201201 12" Green	\$114.95

## DUAL DISK SUB-SYSTEMS

### DISK Sub-Systems - Jade

Handsome metal cabinet with proportionally balanced air flow system, rugged dual drive power supply power cable kit, power switch, line cord, fuse holder, cooling fan, neevermar rubber feet, all necessary hardware to mount 2-8" disk drives, power supply, and fan, does not include signal cable.

#### Dual 8" Sub-Assembly Cabinet

END-000420 Bare cabinet	\$49.95
END-000421 Cabinet kit	\$199.95
END-000431 A & T	\$249.95

#### 8" Sub-Systems - Single Sided, Double Density

END-000423 Kit w/2 Siemens FD100-8Ds	\$650.00
END-000424 A & T w/2 Siemens FD100-8Ds	\$695.00
END-000433 Kit w/2 Shugart SA-801Rs	\$999.95
END-000434 A & T w/2 Shugart SA-801Rs	\$1195.00

#### 8" Sub-Systems - Double Sided, Double Density

END-000426 Kit w/2 Qume DT-8s	\$1224.95
END-000427 A & T w/2 Qume D-8s	\$1424.95
END-000436 Kit w/2 Shugart SA-851Rs	\$1274.95
END-000434 A & T w/2 Shugart SA-801Rs	\$1195.00

## S-100 MOTHERBOARDS

### ISO-BUS - Jade

Silent, simple and on sale - a better motherboard

#### 8 Slot (5 1/4" x 8 3/4")

MBS-061B Bare board	\$22.95
MBS-061K Kit	\$39.95
MBS-061A A & T	\$69.95

#### 12 Slot (9 3/4" x 8 3/4")

MBS-121B Bare board	\$34.95
MBS-121K Kit	\$69.95
MBS-121A A & T	\$109.95

#### 18 Slot (14 1/2" x 8 3/4")

MBS-181B Bare board	\$54.95
MBS-181K Kit	\$99.95
MBS-181A A & T	\$149.95

## S-100 CPU BOARDS

### The BIG Z - Jade

2 or 4 MHz switachable Z-80 CPU board with serial I/O accommodates 2708, 2716, or 2732 EPROM, baud rates from 75 to 9600.

CPU-30201B Bare board w/manual	\$35.00
CPU-30201K Kit with Manual	\$149.95
CPU-30201A A & T with Manual	\$199.95

### 2810 Z-80 CPU - C.C.S.

2 or 4 MHz Z-80 CPU with serial I/O port & on board monitor PROM, front panel compatible

CPU-30400A A & T with PROM	\$289.95
----------------------------	----------

### CPU-Z CompuPro

2 or 4 MHz Z80A CPU, 24 bit addressing

CPU-30500A 2/4 MHz A & T	\$279.95
CPU-30500C 3/6 MHz CSC	\$374.95

### 8085/8088 - CompuPro

Both 8 & 16 bit CPUs, standard 8 bit S-100 bus, up to 8 MHz, accesses 16 Megabytes of memory

CPU-20510A 6 MHz A & T	\$398.95
CPU-20510C 6/8 MHz CSC	\$497.95

## PLACE ORDERS TOLL FREE

Continental U.S.  
**800-421-5500**

Inside California  
**800-262-1710**

For Technical Inquires  
or Customer Service call:  
**213-973-7707**

We accept cash, checks, credit cards, or Purchase Orders from qualified firms and institutions.  
Minimum prepaid order \$15.00 California residents add 6 1/2% tax. Export customers outside the US or Canada please add 10% to all prices. Prices and availability subject to change without notice. Shipping and handling charges via UPS Ground 50¢/lb. UPS Air \$1.00/lb. minimum charge \$3.00

## 5 1/4" DISK DRIVES

Tandon TM100-1 single-sided double-density 48 TPI  
 MSM-551001 \$219.95 ea 2 for \$199.95 ea  
 Shugart SA400L single-sided double-density 40 track  
 MSM-104000 \$234.95 ea 2 for \$224.95 ea  
 Tandon TM100-2 double-sided double-density 48 TPI  
 MSM-551002 \$294.95 ea 2 for \$269.95  
 TEAC FD55A single-sided double-density 40 track  
 MSM-660551 \$299.95 ea 2 for \$239.95

### 5 1/4" Cabinets With Power Supply

END-000216 Single cab w/power supply \$69.95  
 END-000226 Dual cab w/power supply \$94.95

## 8" SLIMLINE SUB-SYSTEMS

### Dual Slimline Sub-Systems — Jade

Handsome vertical cabinet with scratch resistant baked enamel finish, proportionally balanced air flow system, quiet cooling fan, rugged dual drive power supply, power cables, power switch, line cord, fuse holder, cooling fan, all necessary hardware to mount 2-8" slimline disk drives. Does not include signal cable.

#### Dual 8" Slimline Cabinet

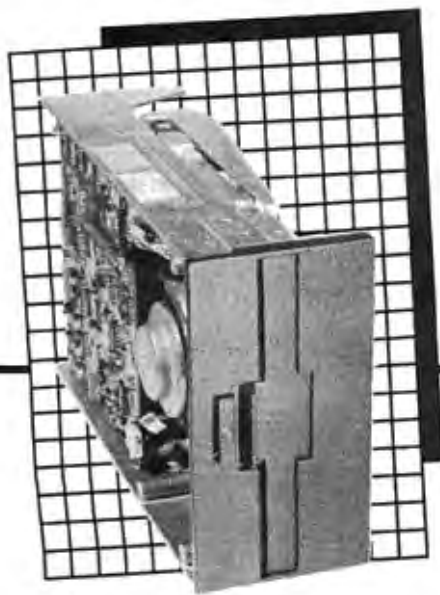
END-000820 Bare cabinet \$59.95  
 END-000822 A & T w/o drives \$179.95

#### Dual 8" Slimline Sub-Systems

END-000823 Kit w/2 SS DD Drives \$919.95  
 END-000824 A & T w/2 SS DD Drives \$949.95  
 END-000833 Kit w/2 DS DD Drives \$1149.95  
 END-000834 A & T w/2 DS DD Drives \$1179.95

## 8" DISK DRIVES

Siemens FDD 100-8 single-sided double-density  
 MSF-201120 \$274.95 ea 2 for \$249.95 ea  
 Shugart SA801R single-sided double-density  
 MSF-10801R \$394.95 ea 2 for \$389.95 ea  
 Shugart SA851R double-sided double density  
 MSF-10851R \$554.95 ea 2 for \$529.95 ea  
 Qume DT-8 double-sided double-density  
 MSF-750080 \$524.95 ea 2 for \$498.95 ea  
 Tandon TM8481 single-sided double-den thin-line  
 MSF-558481 \$379.96 ea 2 for \$369.95 ea  
 Tandon TM848-2 double-sided double-den thin-line  
 MSF-558482 \$494.95 ea 2 for \$484.95  
 NEC FD1165 double-sided double-den thin-line  
 MSF-851165 \$484.95 ea 2 for \$449.95



## MODEMS

### Smart Buy In MODEMS — Signalman

1200 and/or 300 baud, direct connect, automatic answer or originate selection, auto-answer/auto-dial on deluxe models. 9v battery allows total portability, full one year warranty.

IOM-5600A 300 baud direct connect \$89.95  
 IOM-5610A 300 baud Deluxe \$149.95  
 IOM-5620A 1200/300 baud Deluxe \$369.95  
 IOM-5650A 300 baud for Osborne \$119.95  
 IOM-5630A 300 baud card for IBM \$269.95  
 IOM-5690A 1200 baud option for IBM \$129.95

### SMARTMODEM — Hayes

Sophisticated direct-connect auto-answer/auto-dial modem, touch-tone or pulse dialing. RS-232C interface programmable

IOM-5500A Smartmodem 1200 \$574.95  
 IOM-5400A Smartmodem 300 \$224.95  
 IOK-1500A Hayes Chronograph \$218.95  
 IOM-1100A Micromodem 100 \$368.95  
 IOM-2010A Micromodem II w/Term prgm \$329.95  
 IOM-2012A Terminal program for MMII \$89.95

### 1200 BAUD SMART CAT — Novation

103/212 Smart Cat & 103 Smart Cat, 1200 & 300 baud, built-in dialer, auto re-dial if busy, auto answer/disconnect, direct connect, LCD readout displays mode analog/digital loopback self tests, usable with multi-line phones.

IOM-5241A 300 baud 103 Smart Cat \$229.95  
 IOM-5251A 1200 baud 212/103 Smart Cat \$549.95

### J-CAT™ MODEM — Novation

1/5 the size of ordinary modems, Bell 103, manual or auto-answer, automatic answer/originate, direct connect, built-in self-test, two LEDs and audio beeps provide status information.

IOM-5261A Novation \$149.95

## S-100 DISK CONTROLLERS

### DISK 1 — CompuPro

8" or 5 1/4" DMA disk controller, single or double density, single or double sided, 10MHz

IOD-1810A A & T \$449.95  
 IOD-1810C CSC \$554.95

### 2422 DISK CONTROLLER — C.C.S.

5 1/4" or 8" double density disk controller with on-board boot loader ROM, free CP/M 2.2 & manual set

IOD-1300A A & T with CP/M 2.2 \$399.95

### DOUBLE D — Jade

High reliability double density disk controller with on-board Z-80A, auxiliary printer port, IEEE S-100 can function in multi-user interrupt driven bus.

IOD-1200B Bare board & hw man \$59.95  
 IOD-1200K Kit w/hdwr & stwr man \$299.95  
 IOD-1200A A & T w/hdwr & stwr man \$325.00  
 SFC-59002001F CP/M 2.2 with Double D \$99.95

## DISK TUBS

### DISKETTE STORAGE BOXES

Clear Plexiglass storage boxes for up to 75 Diskettes  
 MMA-505 Holds 75 5 1/4" \$19.95  
 MMA-508 Holds 50 8" \$24.95

## SINGLE BOARD COMPUTER

### SUPERQUAD — Adv. Micro Digital

Single board, standard size S-100 computer system 4MHz Z-80A, single or double density disk controller for 5 1/4" or 8" drives, 64K RAM, extended addressing up to 4K of EPROM, 2 serial & 2 parallel I/O ports, real time interrupt clock, CP/M compatible

CPC-30800A A & T \$724.95  
 IOX-4232A Serial I/O adapter \$29.95

## EPROM ERASERS

### ULTRA-VIOLET EPROM ERASERS

Inexpensive erasers for industry or home.

XME-3100A Spectronics w/o timer \$69.50  
 XME-3101A Spectronics with timer \$94.95  
 XME-3200A Logical Devices \$49.95

## APPLE II ACCESSORIES

### DISK DRIVE — Apple Compatible

Totally Apple compatible, 143,360 bytes per drive on DOS 3.3 full one year factory warranty, half-track capability reads all Apple software, plugs right into Apple controller as second drive, DOS 3.3, 3.2.1 Pascal, & CP/M compatible.

MSM-123200 Add on Apple Drive \$249.95  
 MSM-123100 Controller \$99.95  
 IOD-2250A Half height Teac \$299.95

### CP/M 3.0 CARD for Apple — A.L.S.

The most powerful card available for your Apple! 6MHz Z-80B, additional 64K of RAM, CP/M plus 30 100% CP/M 2.2 compatibility, C basic, CP/M Graphics, 300% faster than any other CP/M for Apple. One year warranty.

CPX-62810A A.L.S. CP/M Card \$349.95

### Z-CARD for Apple II — A.L.S.

Two computers in one, Z-80 & 6502, more than doubles the power and potential of your Apple, includes Z-80 CPU card CP/M 2.2 and complete manual set, Pascal compatible utilities are menu-driven, one year warranty.

CPX-62800A A & T with CP/M 2.2 \$159.95

### 80 COLUMN APPLE CARD

80 column x 24 line video card for Apple II, addressable 25th status line, normal/inverse or high/low video, 128 ASCII characters, upper and lower case, 7 x 9 dot matrix with true descenders, CP/M, Pascal & Fortran compatible, 50/60 Hz, 40/80 column selection from keyboard. Best 80 column card!

IOV-2500A 80 column card \$149.95

### 16K RAM Card — for Apple II

Expand your Apple II 64K, use as language card, full 1 year warranty. Why spend \$175.00?

MEX-16700A Save over \$115.00 \$49.95

### SERIAL I/O CARD — A.L.S.

Full feature serial card for modems & printers, baud rates from 110 to 19,200, CTS/RTS & X-on/X-off protocols auto line feed, RS-232C cable interface included:

IOI-1000A A & T Dispatcher Card \$129.95

# JADE

## Computer Products

4901 West Rosecrans, Hawthorne, California 90250

# DoKay Computer Products, Inc.

VISIT OUR RETAIL STORE

3250 KELLER STREET, #9 SANTA CLARA, CA 95050

## 16K APPLE II RAM CARD

**BARE BOARD KIT** 14.00  
**ASSEMBLED** 42.50

\*Apple is a trademark of Apple Computer, Inc.

INTERFACE	
BT26	1.65
BT28	1.95
BT95	.95
BT96	.95
BT97	.95
BT98	.95
DM8131	2.90
DP8304	2.25
DS8835	1.89
DS8836	.99

EPROMS		STATIC RAMS			
1702	1ns	2.95	2101	450ns	1.80
2708	450ns	2.98	5101	450ns	3.89
2758	450ns	5.89	2102-1	450ns	.78
2716	450ns	3.25	2102L-2	250nsLP	1.44
2716-1	350ns	4.69	2111	450ns	2.48
TMS2516	450ns	5.49	2112	450ns	2.58
TMS2716	450ns	7.89	2114	450ns	1.74
2532	450ns	4.69	2114L-4	450nsLP	1.84
2732	450ns	4.15	2114L-3	300nsLP	1.84
2764	450ns	CALL	2114L-2	200nsLP	1.94
MC68764	450ns	34.95	2147	55ns	4.89
DYNAMIC RAMS		TMS4044-4	450ns	3.15	
TMS 4027	250ns	.79	TMS4044-3	300ns	3.45
UPD 411	300ns	2.89	TMS4044-2	200ns	3.89
MM 5280	300ns	2.89	MK4118	250ns	9.69
MK4108	200ns	1.74	TMM2016	200ns	4.15
MM 5298	250ns	1.74	TMM2016	150ns	4.89
4027	250ns	2.00	HM6116-4	200ns	CALL
4116	200ns	CALL	HM6116-3	150ns	CALL
4116	150ns	CALL	HM6116-2	120ns	CALL
4164	200ns	CALL	Z6132	300ns	32.95
4164	150ns	CALL			

RESISTORS	
1/4 WATT 5% CARBON FILM	
ALL STANDARD VALUES	
FROM 1 OHM TO 10 MGE OHM	
50 PCS. SAME VALUE	.0200
100 PCS. SAME VALUE	.0150
1000 PCS. SAME VALUE	.0125

6500 1 MHz	
8502	5.25
6504	6.85
6505	7.60
6507	9.85
6520	3.95
6522	4.95
6532	5.95
6545	16.95
6551	10.95
2 MHz	
6502A	8.95
6522A	9.95
6532A	11.90
6545A	27.90
6551A	11.90
3 MHz	
6502B	11.90

**We Will Beat Any Competitors' Prices!**

74LS00	.23	74LS123	.49	74LS253	.58
74LS01	.23	74LS124	1.24	74LS257	.58
74LS02	.23	74LS125	.44	74LS258	.58
74LS03	.23	74LS126	.44	74LS259	1.19
74LS04	.23	74LS132	.54	74LS260	.58
74LS05	.23	74LS136	.54	74LS266	.58
74LS08	.23	74LS137	.89	74LS273	1.48
74LS10	.23	74LS138	.49	74LS275	3.20
74LS11	.25	74LS139	.49	74LS279	.48
74LS12	.25	74LS145	1.19	74LS280	1.79
74LS13	.39	74LS147	2.39	74LS283	.68
74LS14	.39	74LS148	1.29	74LS290	.74
74LS15	.29	74LS151	.39	74LS293	.78
74LS20	.23	74LS153	.39	74LS295	.98
74LS21	.23	74LS154	1.89	74LS298	.88
74LS22	.23	74LS155	.59	74LS324	1.74
74LS26	.29	74LS156	.69	74LS352	1.28
74LS27	.23	74LS157	.44	74LS353	1.28
74LS28	.29	74LS158	.49	74LS363	1.34
74LS30	.23	74LS160	.68	74LS364	1.89
74LS32	.25	74LS161	.64	74LS365	.48
74LS33	.49	74LS162	.68	74LS366	.48
74LS37	.29	74LS163	.64	74LS367	.44
74LS38	.29	74LS164	.68	74LS368	.44
74LS40	.23	74LS165	.79	74LS373	.98
74LS42	.43	74LS166	1.69	74LS374	.98
74LS47	.49	74LS168	1.69	74LS377	1.24
74LS48	.74	74LS169	1.74	74LS378	1.15
74LS49	.74	74LS170	1.45	74LS379	1.34
74LS51	.23	74LS173	.68	74LS385	1.89
74LS54	.23	74LS174	.44	74LS386	.44
74LS55	.28	74LS175	.39	74LS390	1.15
74LS63	1.19	74LS181	1.89	74LS393	1.15
74LS73	.34	74LS189	8.79	74LS395	1.15
74LS74	.34	74LS190	.79	74LS399	1.48
74LS75	.34	74LS191	.79	74LS424	.37
74LS76	.34	74LS192	.64	74LS447	.37
74LS78	.45	74LS193	.64	74LS490	1.94
74LS83	.59	74LS194	.68	74LS668	1.69
74LS85	.65	74LS195	.68	74LS669	1.89
74LS86	.35	74LS196	.78	74LS670	1.48
74LS90	.35	74LS197	.78	74LS674	9.45
74LS91	.79	74LS221	.74	74LS682	2.99
74LS92	54	74LS240	.89	74LS683	2.99
74LS93	54	74LS251	.89	74LS684	2.99
74LS95	74	74LS242	.98	74LS685	2.99
74LS96	69	74LS243	.98	74LS688	2.39
74LS107	.35	74LS244	.79	74LS689	2.99
74LS109	.35	74LS245	1.48		
74LS112	.35	74LS247	.74	81LS95	1.48
74LS113	.35	74LS248	.89	81LS96	1.48
74LS114	.35	74LS249	.89	81LS97	1.48
74LS122	.39	74LS251	.58	81LS98	1.48

UARTS	
AY3-1014	5.85
AY5-1013	3.90
AY5-1015	6.90
TR1602	3.90
IM6402	7.85
IM6403	8.85
INS8250	10.49

LEDS	
Jumbo Red	10/1.00
Jumbo Green	6/1.00
Jumbo Yellow	6/1.00

DIP SWITCHES	
4 Position	.85
5 Position	.90
6 Position	.90
7 Position	.90
8 Position	.95

EXAR	
XR 2206	3.75
XR 2207	3.75
XR 2208	3.90
XR 2211	5.25
XR 2240	3.25

RCA	
CA3010	.95
CA3013	1.99
CA 3023	2.75
CA 3035	2.49
CA 3039	1.25
CA 3046	1.25
CA 3053	1.45
CA 3059	2.90
CA3060	2.90
CA 3065	1.75
CA 3080	1.10
CA3081	1.65
CA3082	1.65
CA 3083	1.65
CA 3086	.80
CA 3089	2.10
CA3130	1.25
CA3140	1.15
CA3148	1.75
CA3160	1.15
CA3401	.59
CA 3600	3.45

**APPLE\* II COMPATIBLE DISK DRIVE**  
**225.95**  
**CONTROLLER CARD**  
**79.95**

**5 1/4" FLOPPY DISKS**  
**FLIP FILE**  
 CAPACITY 75 EA  
**19.95**

**APPLE SUPER COOLING FANS**  
**49.95**  
 WITH SURG PROTECH  
**69.95**

**APPLE PADDLES**  
**9.95**

**APPLE UPGRADE TRS-80**  
**4116 - 200ns**  
**8/10.00**

## DoKay Computer Products, Inc.

3250 Keller Street, #9 Santa Clara, CA 95050

(800) 538-8800

Calif. Residents (800) 848-8008 Local Phone (408) 988-0697

STORE HOURS:  
 MON-FRI 8:30 A.M.-5:30 P.M.  
 SAT 10:00 A.M.-3:00 P.M.



TERMS: For shipping include \$2.00 for UPS Ground. \$3.00 for UPS Blue Label Air. \$10.00 minimum order. Bay Area residents add 6 1/2% Sales Tax. California residents add 6% Sales Tax. We reserve the right to limit quantities and substitute manufacturer. Prices subject to change without notice. Send SASE for complete list.

# APPLE\* II USERS DISK DRIVE!

- Includes metal cabinet
- Color matches Apple
- 35 tracks/single side
- Includes cable
- Use with Apple II controller

## 225.95

CONTROLLER CARD . . . . . 79.95

# DoKay Computer Products, Inc.

VISIT OUR RETAIL STORE

3250 KELLER STREET, #9 • SANTA CLARA, CA 95050

## EPROM ERASERS

HOLDS 15 EPROMS  
ERASES IN 20 MINUTES

### 59.95

**2.5 MHz**

Z80-CPU	3.35
Z80-PIO	3.35
Z80-CTC	3.35
Z80-DMA	12.49
Z80-DART	14.98
Z80-SIO/O	16.95
Z80-SIO/1	16.95
Z80-SIO/2	16.95
Z80-SIO/9	16.95

## Z80 SERIES

**Z80A-DMA** 21.95  
**Z80A-DART** 15.95  
**Z80A-SIO/O** 20.95  
**Z80A-SIO/1** 20.95  
**Z80A-SIO/2** 20.95  
**Z80A-SIO/9** 20.95

**4.0 MHz**

Z80A-CPU	4.90
Z80A-PIO	4.90
Z80A-CTC	4.90

**6.0 MHz**

Z80B-CPU	14.95
Z80B-PIO	12.95
Z80B-CTC	12.95

**ZILOG**

Z6132	32.95
Z6671	38.95

## 5 1/4" DISKETTES ATHANA OR NASHUA

SSSD . . . . . 18.95  
 SSDD . . . . . 22.95  
 DSDD . . . . . 27.95

**BULK  
SSDD SOFT  
\$1.65 EA**

### LINEAR

LM301	.32	LM741	.29
LM308	.75	LM747	.75
LM309K	1.25	LM748	.49
LM311	.64	LM1310	2.45
M317T	1.65	MC1330	1.69
LM317K	1.70	MC1350	1.25
LM318	1.49	MC1358	1.69
LM323K	3.75	LM1414	1.49
LM324	.59	LM1458	.55
LM337K	3.90	LM1488	.65
LM339	.79	LM1489	.65
LM377	2.25	LM1800	2.45
LM380	1.25	LM1889	2.45
LM386	1.00	LM3900	.59
LM555	.38	LM3909	.95
LM556	.65	LM3914	3.70
LM565	.95	LM3915	3.70
LM566	1.45	LM3916	3.70
LM567	.99	75451	.35
LM723	.49	75452	.35
LM733	.95	75453	.35

## ORDER TOLL FREE

# (800) 538-8800 (800) 848-8008

(CALIFORNIA RESIDENTS)

ALL MERCHANDISE IS 100% GUARANTEED

### CLOCK CIRCUITS

MM 5314	4.90
MM 5369	3.90
MM 5375	4.90
MM 5375	8.90
MM 58167	10.95
MM 58174	10.95
MSM 5832	6.90

### 9000 SERIES

9316	.95
9334	2.39
9368	3.69
9401	8.95
9601	.69
9602	1.39
96502	1.79

### MISC.

11 C 90	12.95
3242	6.95
MC 3470	7.95
MC 3480	8.95
ULN 2003	5.95
CA 3146	1.75
2513-001 up	9.69
2513-002 low	9.69

### VOLTAGE REGULATORS

7805T	.75	7908T	.85
7808T	.75	7912T	.85
7812T	.75	7915T	.85
7815T	.75	7924T	.95
7824T	.85		
7805K	1.29	7905K	1.39
7812K	1.29	7912K	1.39
7815K	1.29	7915K	1.39
7824K	1.29	7924K	1.39
7905T	.85		

T = TO-220  
K = TO-3

### CONNECTORS

RS232 Male	3.00
RS232 Female	3.50
RS232 Female Right Angle	4.95
RS232 Hood	1.20
30 pin Edge	2.49
44 pin Edge	2.49
50 pin Edge	2.69
86 pin Edge	3.90
100 pin ST	3.90
100 pin WW	4.90

### CRYSTALS

32.768 KHz	1.90	6.144	2.69
1.00Hz	4.50	65536	2.69
1.8432	4.50	8.0	2.69
2.0	3.90	10.0	2.69
2.097152	3.90	12.0	2.69
2.4576	2.69	14.31818	2.69
3.2768	2.69	15.0	2.69
3.579545	2.69	16.0	2.69
4.0	2.69	17.430	2.69
5.0	2.69	18.0	2.69
5.0688	2.69	18.432	2.69
5.185	2.69	20.0	2.69
5.7143	2.69	22.1184	2.69
6.0	2.69		

### 8000

8035	4.95	8251	4.39
8039	5.95	8253	6.89
8080A	3.89	8253.5	7.89
8085A	5.89	8255	4.39
8086	24.95	8255.5	5.19
8088	34.95	8257	7.89
8155	7.75	8259	6.85
8156	8.75	8272	39.00
8185	29.00	8275	29.00
8202	27.95	8279	8.89
8205	3.45	8279.5	9.89
8212	1.79	8282	6.49
8214	3.75	8283	6.49
8216	1.69	8284	5.49
8224	2.19	8286	6.49
8226	1.79	8287	6.49
8228	3.34	8268	24.95
8237	19.00	8289	39.00
8238	4.39	8741	34.95
8243	4.39	8748	14.95
8250	10.49	8755	29.95

## Disc Controllers

1771	15.95
1791	27.95
1793	29.95
1795	49.95
1797	49.95
6843	32.95
8272	39.00
UPD765	34.95
1691	17.95

### 6800

#### 1 MHz

6800	4.75
6802	7.89
6808	8.45
6809	11.95
6809E	17.95
6810	2.89
6820	3.50
6821	2.95
6828	13.95
6840	7.95
6843	32.95
6844	24.95
6845	13.95
6847	11.95
6850	3.20
6852	3.50
6860	9.89
6862	11.90
6875	6.89
6880	1.80
6883	22.95

### 2 MHz

68B00	9.95
68B02	21.95
68B09	28.95
68B09E	28.95
6810	7.89
6810	11.95
68B45	33.95
68B50	11.95

### 3 MHz

68000	57.95
-------	-------

## IC Sockets

### IC SOCKETS

	ST	W/W
8 PIN	.10	.49
14 PIN	.12	.50
16 PIN	.15	.57
18 PIN	.20	.85
20 PIN	.25	.99
22 PIN	.25	1.30
24 PIN	.25	1.40
28 PIN	.35	1.50
40 PIN	.40	1.80

ST = Soldertail  
W/W = Wirewrap

## Power Supplies

MOUNTED ON PC BOARD  
MANUFACTURED BY CONVER  
+5 VOLT 4 AMP  
±12 VOLT 1 AMP



### 34.95



## DoKay Computer Products, Inc.

3250 Keller Street, #9  
Santa Clara, CA 95050

(800) 538-8800

### STORE HOURS:

MON-FRI 8:30 A.M.-5:30 P.M.  
SAT 10:00 A.M.-3:00 P.M.



TERMS: For shipping include \$2.00 for UPS Ground, \$3.00 for UPS Blue Label Air, \$10.00 minimum order. Bay Area residents add 6 1/2% Sales Tax. California residents add 6% Sales Tax. We reserve the right to limit quantities and substitute manufacturer. Prices subject to change without notice. Send SASE for complete list.

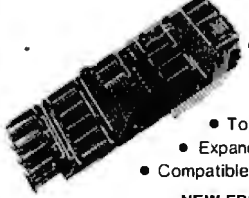
Calif. Residents  
(800) 848 8008

Local Phone  
(408) 988-0697

# ADVANCED COMPUTER PRODUCTS

SEND \$2.00 for 1983 CATALOG

## 16K Apple™ Ramcard



LIST 195  
ACP  
\$59.95

- Full 1 year warranty
- Top quality — gold fingers
- Expand Apple II 48K to 64K
- Compatible with Z-80 Softcard™

NEW FROM COEX  
Apple IIe Compatible Extended 80 Column TEXT Card  
List \$199.00 ACP \$149.00

## 32K STATIC RAM

2 or 4 MHz  
Expandable  
Uses  
2114's

19K 4 MHz KR \$159.95  
19K 4 MHz AAT 217.95  
32K 4 MHz KR \$129.95  
32K 4 MHz AAT 269.95  
SAFE BOARD 339.00  
Data Sheet/Parts list \$9.95

## 64K CMOS RAMCARD

IEEE Compatible  
Low Power  
6116 IC's  
8Volt  
Single Supply  
Assembled and Tested

\$299.00

## REPEAT OF SELL-OUT

58 Key Unencoded Keyboard  
\$19.95

This is a new 58 key terminal Keyboard manufactured by a major manufacturer. It is unencoded with SPST keys unattached to any PC board. Solid molded plastic 11" x 4" base.

## INTEL 4K STATIC RAMS

Super Fast!  
Super Low Power!

Part No 2147 ..... \$1.95 ea.

## Unencoded Key Pad

15 Key Keypad with 1-10 keys and tab, return, (←, →) and (↑, ↓)

Only \$9.95 ea.

## STEPPER MOTOR

Operates by applying 12VDC in one direction and then reversing polarity for square wave.

Clock Wise Rotation, Rated 3 RPM at 4 P.P.S. with a 5 degree stepping angle

ACP PRICE \$3.95 ea. 10 for \$34.95

## Only "EPROM" ERASER

Model DE-4  
\$89.95  
Holds 4 EPROM's at a time \$325.00

## RS232 SIGNAL TESTER

COEX RS232 Line Tester  
(7) LED Indicators

only \$24.95  
Other Styles Also Available

## 16K Memory Expansion Kits for Apple/TRS-80

8 pcs 4116 16K 200/250's \$12.95  
Specify computer  
CALL FOR VOLUME PRICING

## INTEL CODEC IC

P/N 2910A For Digital Voice \$9.95 ea.

## CORCOM FILTER

Popular CORCOM Filter \$4.95  
6 amps  
Compatible Line Cord Add \$3.50

## SURGE SUPPRESSOR "Surgeonics"

Power Sentry 15 Amps 250 Volts Transient suppression ACP Low Price \$39.95

## Astec RF Modulator

for COLOR & B/W  
P/N 1082 Channel 3 or 4 \$6.95

## CONNECTORS

DB25P (RS232) \$3.25  
DB25S Female 3.75  
Hood 1.25  
Sole with Hood, Sale 7.50  
2244 S/T, MOT 2.85  
4306 S/T, MOT 6.50  
80/100 3-100 Connector W/W 4.85  
50/100 3-100 Connector S/T 3.95

## AMD MODEM IC

P/N AM7910 1200Baud 5 Volts  
Special ACP Price \$9.90

## PARALLEL ALPHA NUMERIC PRINTER

19 Column Printer prints 16 numerical columns plus 3 columns which have math, alpha and other notations. Each wheel has 12 positions with position 12 blank. Position 11 on numerical columns have decimal point or ". Utilizes 2.75" wide adding machine tape and a dual color ink ribbon. Input data parallel with four bit BCD compare to circuit (schematic provided). Print rate, 3 lines per second. Operating voltage 22-28VDC with typical cycle time of 340mS. Size 6 1/2" W x 3 1/4" H x 5 1/2" Dp. New. \$9.95 ea. 3/\$37

## MICROPROCESSORS

2801	598.00	6008-1	\$14.95	8002P	14.95
2802	69.00	2801	6.90	8003	14.95
2803	8.95	2801A	14.95	8009	12.95
2804	11.95	8003L	46.95	8013	34.95
F-8 (3550)	16.95	6802	9.95	8786	46.95
2650	16.95	6802A	16.95	8746	46.95
1602	9.75	80100	29.95	8829	30.00
6802A	4.75	8011	11.75	8830	30.00
8085	14.95	6800B	19.95	6800	129.95

## RAMS CALL FOR QTY PRICING

8118/2016	\$7.95	2147	\$5.99	2900	\$1.99
8264-64K	\$ 95	411	5.99	5298	14.49
4118-2	1.00	414	4.69	6508	4.50
4118-2	8/12	1101	9.99	6518	6.79
2101	3.90	1103	9.99	6561	3.79
2102	7.9	4027	4.69	6604	3.99
21102-2	1.49	4039	3.99	6605	7.99
21102-4	1.29	4050	6.95	9130	8.99
2111	3.49	4060	4.69	9140	6.99
2112	3.49	4096	3.99	93415	6.99
2114	1.99	4115	1.49	94245	6.99
2114L-2	3.25	4200	7.95		
2114L-4	2.29	4402	1.99		
2125	6.99	5280	4.60		

## SUPPORT

8155	90.95	8259	88.95	88047	822.95
8158	9.95	8275	18.95	88488	18.95
8202	28.95	8279	8.50	48505	22.95
8205	2.99	8910	4.75	88230	6.95
8212	2.78	8920	6.50	88232	8.25
8214	4.95	8921	8.95	8830X	24.85
8216	2.75	8926	10.50	8832	17.95
8224	2.95	8934	18.95	8851	18.05
8228	2.95	8945	22.95	Z80-PD	0.50
8229	3.95	8947	27.95	Z80-PD	0.50
8232	2.78	8950	6.25	Z80-CTC	0.50
8250	14.95	8952	5.25	Z80-CTC	0.50
8251	6.90	8960	10.95	Z80-DMA	18.25
8253	11.95	8982	10.85	Z80-DMA	27.95
8295	4.50	8976	5.95	Z80-SIO	24.85
8297	8.50	8980	2.49	Z80-SIO	29.95

## MOS PROMS

2784 (8Kx4) TS	680.95	2708 (450nS)	\$5.75
2732 (16Kx8) TS	12.95	2764 (650nS)	5.25
2716 (2516) 5V (2Kx8) TS	7.99	MM5203AO	14.50
2764 (5V, 160nS)	17.95	MM5204O	9.95

## HI-TECH

2512-681 (5V) Loper	59.90	CMC90	89.95
2512-908 (5V) Loper	10.95	CMC100	4.95
2513-9083 (5V) Loper	14.95	CMC101 Function Generator	4.95
MC164616 (450nS) 2Kx8	12.95	CMC121 CO	9.95
MC164616 (450nS) 2Kx8	13.95	CMC122 CO	1.95
MC164616 (450nS) 2Kx8	13.95	CMC123 CO	1.95
1171-01 "1" & 2-Address	24.95	SR7675 Function Generator	3.25
1781 Dual Flipflop	29.95	AY51013 (5V) 1791	3.95
1791-01 Dual Flipflop	36.95	AY51014A (1625-1691)	6.95
1791-02 Dual Flipflop	44.95	AY51015A (1683-691)	7.95
1791-03 38 Flipflop	44.95	CMC130	1.95
1791-04 58 Flipflop	64.95	CMC135	1.95
1791-05 88 Flipflop	84.95	CMC138	1.95
1791-06 128 Flipflop	104.95	CMC138S	1.75
1791-07 168 Flipflop	124.95		
1791-08 208 Flipflop	144.95		
1791-09 248 Flipflop	164.95		
1791-10 288 Flipflop	184.95		
1791-11 328 Flipflop	204.95		
1791-12 368 Flipflop	224.95		
1791-13 408 Flipflop	244.95		
1791-14 448 Flipflop	264.95		
1791-15 488 Flipflop	284.95		
1791-16 528 Flipflop	304.95		
1791-17 568 Flipflop	324.95		
1791-18 608 Flipflop	344.95		
1791-19 648 Flipflop	364.95		
1791-20 688 Flipflop	384.95		
1791-21 728 Flipflop	404.95		
1791-22 768 Flipflop	424.95		
1791-23 808 Flipflop	444.95		
1791-24 848 Flipflop	464.95		
1791-25 888 Flipflop	484.95		
1791-26 928 Flipflop	504.95		
1791-27 968 Flipflop	524.95		
1791-28 1008 Flipflop	544.95		
1791-29 1048 Flipflop	564.95		
1791-30 1088 Flipflop	584.95		
1791-31 1128 Flipflop	604.95		
1791-32 1168 Flipflop	624.95		
1791-33 1208 Flipflop	644.95		
1791-34 1248 Flipflop	664.95		
1791-35 1288 Flipflop	684.95		
1791-36 1328 Flipflop	704.95		
1791-37 1368 Flipflop	724.95		
1791-38 1408 Flipflop	744.95		
1791-39 1448 Flipflop	764.95		
1791-40 1488 Flipflop	784.95		
1791-41 1528 Flipflop	804.95		
1791-42 1568 Flipflop	824.95		
1791-43 1608 Flipflop	844.95		
1791-44 1648 Flipflop	864.95		
1791-45 1688 Flipflop	884.95		
1791-46 1728 Flipflop	904.95		
1791-47 1768 Flipflop	924.95		
1791-48 1808 Flipflop	944.95		
1791-49 1848 Flipflop	964.95		
1791-50 1888 Flipflop	984.95		
1791-51 1928 Flipflop	1004.95		
1791-52 1968 Flipflop	1024.95		
1791-53 2008 Flipflop	1044.95		
1791-54 2048 Flipflop	1064.95		
1791-55 2088 Flipflop	1084.95		
1791-56 2128 Flipflop	1104.95		
1791-57 2168 Flipflop	1124.95		
1791-58 2208 Flipflop	1144.95		
1791-59 2248 Flipflop	1164.95		
1791-60 2288 Flipflop	1184.95		
1791-61 2328 Flipflop	1204.95		
1791-62 2368 Flipflop	1224.95		
1791-63 2408 Flipflop	1244.95		
1791-64 2448 Flipflop	1264.95		
1791-65 2488 Flipflop	1284.95		
1791-66 2528 Flipflop	1304.95		
1791-67 2568 Flipflop	1324.95		
1791-68 2608 Flipflop	1344.95		
1791-69 2648 Flipflop	1364.95		
1791-70 2688 Flipflop	1384.95		
1791-71 2728 Flipflop	1404.95		
1791-72 2768 Flipflop	1424.95		
1791-73 2808 Flipflop	1444.95		
1791-74 2848 Flipflop	1464.95		
1791-75 2888 Flipflop	1484.95		
1791-76 2928 Flipflop	1504.95		
1791-77 2968 Flipflop	1524.95		
1791-78 3008 Flipflop	1544.95		
1791-79 3048 Flipflop	1564.95		
1791-80 3088 Flipflop	1584.95		
1791-81 3128 Flipflop	1604.95		
1791-82 3168 Flipflop	1624.95		
1791-83 3208 Flipflop	1644.95		
1791-84 3248 Flipflop	1664.95		
1791-85 3288 Flipflop	1684.95		
1791-86 3328 Flipflop	1704.95		
1791-87 3368 Flipflop	1724.95		
1791-88 3408 Flipflop	1744.95		
1791-89 3448 Flipflop	1764.95		
1791-90 3488 Flipflop	1784.95		
1791-91 3528 Flipflop	1804.95		
1791-92 3568 Flipflop	1824.95		
1791-93 3608 Flipflop	1844.95		
1791-94 3648 Flipflop	1864.95		
1791-95 3688 Flipflop	1884.95		
1791-96 3728 Flipflop	1904.95		
1791-97 3768 Flipflop	1924.95		
1791-98 3808 Flipflop	1944.95		
1791-99 3848 Flipflop	1964.95		
1791-100 3888 Flipflop	1984.95		

## SOCKETS

LOW PROFILE SOCKETS (TIN)	
1-24	25-49 50-100
8 pin LP	16 15 14
14 pin LP	20 19 18
16 pin LP	22 21 20
16 pin LP	29 28 27
20 pin LP	34 32 30
22 pin LP	29 27 24
24 pin LP	38 37 36
28 pin LP	45 44 43
40 pin LP	60 59 58

## 3L WIREWRAP SOCKETS (GOLD)

8 pin W/W	55	54	48
10 pin W/W (TIN)	85	83	58
14 pin W/W	75	73	87
16 pin W/W	90	77	70
18 pin W/W	95	90	81
20 pin W/W	115	108	98
22 pin W/W	145	135	123
24 pin W/W	135</		



# ADVANCED COMPUTER PRODUCTS

SEND \$2.00 for 1983 CATALOG

Vista Computer Company

Apple Computer Authorized Dealer

## SIEMEN'S SALE

You can now purchase Shugart compatible 8" Disk Drives below your existing factory direct pricing!



These Prices are the lowest ever published.

\*Siemens's \$300 FD0100-8 ... \$199.00

Also, with purchase of Disk Drives you can buy the Vista V-1000 Dual Case with Power Supply and Cable for only \$375.00. Regular Price \$495.00

See Special Offer on this page for additional disk savings!

OFFER LIMITED! FACTORY WARRANTY 90 DAYS!

SHIPPED IMMEDIATELY FROM STOCK! \*Cable Quantities

## S-100 64K "CMOS" RAMCARD

Unbelievable Price! **\$299.00**  
Assembled and Tested

ACP has sold over 1000 of these IEEE compatible, low-priced, high-reliability 64K Static RAM Cards.  
Single 5-Volt operation.

### LPS II

Light Pen System for Apple II Computers

ACP **\$299.00**  
Price

### COEX 80-FT

Best of all, the price... **\$299.00**  
only

Optional COEX Interface Card to Apple ..... \$49.95  
Apple System Saver Fan

Surge Suppressor Fan. Double Outlet Receptacle ... \$79.95

## IBM LOW COST MEMORY

MEMORY PLUS AT LOW PRICES!

Now! "MultiCard" expandable from 64 - 256K with  
(1) PARALLEL (1) SERIAL  
(1) CLOCK/CALENDAR  
COEX 256 SPC with 64K **\$199.00**  
COEX 64 SPC with 256K **\$335.00**

### FLOPPY DISK DRIVES

SINGLE-SIDED 8"				DOUBLE-SIDED 8"			
MFG	P/N	1	2	MFG	P/N	1	2
Shugart	SA851R	\$385	\$375	Shugart	FD0100-8	\$350	\$362
Seagate	FD0120-8	199	189	Seagate	FD0120-8	199	189
Shugart	SA851R	519	495	Seagate	FD0120-8	399	389
Shugart	SA851R	515	490	Seagate	FD0120-8	479	479
Shugart	SA851R	559	539	Seagate	FD0120-8	479	479
SINGLE-SIDED 5 1/4"				DOUBLE-SIDED 5 1/4"			
Shugart	SA400	210	208	Shugart	FD0120-8	205	198
Shugart	SA400	310	298	Shugart	FD0120-8	149	149
Shugart	SA450	345	325	Shugart	FD0120-8	209	205
Shugart	SA450	189	159	Shugart	FD0120-8	209	205
DOUBLE-SIDED 5 1/4" Thinline				DOUBLE-SIDED 3"			
TEAC	5 1/4" Thinline	375	385	TEAC	5 1/4" Thinline	375	365
WINCHESTER 5 1/4"				WINCHESTER 5 1/4"			
Seagate	ST312(12Mb)	880	870	Seagate	ST312(12Mb)	800	875
Seagate	ST312(12Mb)	885	850	Seagate	ST312(12Mb)	1068	1070
Seagate	ST312(12Mb)	1313	1299	Seagate	ST312(12Mb)	1068	1070

SPECIAL LIQUIDATION - SMALL QTY SHUGART 4004

14" WINCHESTER  
Only 10 Available - So Hurry!  
14.5 MEGABYTES  
List 2495.00

Special Sale Price ... **\$995.00**

## HARDWARE

Item	List	ACP
ABR BSR X10 Interface	395	385
Color Mono I/O Module	95	85
Telephone Receptionist adapt	95	85
PS3276/Bisyn Emulator	1295	1150
AMDEK Dual3+ Amdisk	899	649
(2) Hitachi DS (256K)		
AST MegaPlus+ Card	595	449
P/N MG-064, 64K, Ser. Clk	595	449
P/N MG-064SP, ad01 Ser. Par	695	499
P/N MG-256, 256K, Ser. Clk	995	695
P/N MG-256SP ad1 Ser. Par	1095	749
AST I/O Plus+ Card	265	199
P/N I/O-SP, Clk. (2) Ser. Par		
AST Combo Plus+ Card	695	499
P/N MG-256SP, Clk. P/S 995		
AST PC Disk++ Card	655	495
P/N MD-064, 64K, Host. Par		
CACTUS TECHNOLOGY	349	299
3001 Baud Direct Modem		
COEX	40	19
Extender Card	69	42
Prototype Card	19	6
37 Pin "D" Connector	19	6
Snap-In Card Guides (5)		
CORONA Hard Disk System	Call	Call
CORVUS Hard Disk System	Call	Call
DAVONG	1995	1495
5Mb Hard Disk	2495	1995
12Mb Hard Disk		
MAYMARD Disk Drive Card	295	249
Floppy Card w/Parallel	325	280
Floppy Card w/Serial		
MOUSE SYSTEMS	332	279
Mouse w/Mousepad	40	30
Mouse RS232 I/O		
ORCHID	495	429
Hi-Res Graphics Adapter		
PERYSST Spectrum (64-256K)	499	375
P/N SP64-CCP, 64K, S. S. P	499	375
P/N SP64, 64K	130	50
64K Upgrade Kit (9 chips)		
QUADRANT Quadboard (64-256K)	595	429
P/N O64, 64K w/4 functions	295	195
TANDON TM 100-1 (160K)	395	289
TM 100-2 (320K)	395	289
TEAC FD55B (320K) Disk	695	499
TEG PRODUCTS Joystick	65	52
TEG TRACK Ball		
VISTA	529	369
MULTICARD w/64K SPC	829	599
MULTICARD w/256K SPC	929	50
64K Upgrade Kit (9 chips)		
"MAXICARD" w/64K	376	299
"MAXICARD" w/256K	676	449
"MAXICARD" w/576K	1176	699
"PC MASTER" 7 Functions	590	549
DISKMASTER (5 1/4", 8")	379	299
ECONOCARD-SPC only	299	159

## PRINTERS

Item	List	ACP
COEX 80F/T 80cps	\$499	\$299
STAR MICRONICS - NEW!		
Gemini 10 100cps	399	349
Gemini 15 15" 100cps	649	479
EPSON MX80 w/Graffrax	494	419
MX100 w/Graffrax	749	669
FX80 w/Graffrax	699	629
INTEGRAL DATA	799	689
Micronline 480	1795	1495
Prism 80 Color (all)	1995	1685
Prism 132 Color (all)	1195	895
BROTHER HR-1	1425	1095
Daisywriter	60	45
IBM PC to EPSON Cable	599	469
OKIDATA Microline 82A	599	469
Microline 83A	599	469
Microline 84AP	1399	1099
Okidata 92	699	549

## MONITORS

Item	List	ACP
AMDEK CORP.	\$199	\$155
30" Green 12"	210	175
310 Amber 12"	399	299
Color I Composite	899	790
Color II RGB Hi-Res	1060	699
Color II RGB Comm1	1299	1059
Color IV RGB Analog	199	155
NEC 12" Green - NEW	895	799
12" RGB (690 x 230)		
PRINCETON GRAPHICS	700	599
RGB IBM LOOK style		

## DISKETTES

Item	List	ACP
DYSAN 5 1/4" SS SD	10/555	538
DYSAN 5 1/4" DS SD	10/615	48
IBM 5 1/4" SS DD	10/615	43
IBM 5 1/4" SS DD	10/615	43
VERBATIM 5 1/4" SS	10/415	23
VERBATIM 5 1/4" DS	10/515	34
MAXELL MD1 SS	10/615	43
MAXELL MD2 DS	10/615	43
AMDEK HiRes 3 1/2" DS Micro 5.99	10/715	49
BULK SPECIAL 5 1/4"	100/195	149

## MORE IBM GOODIES

Item	List	ACP
CURTIS PC Pedestal	\$80	\$66
IBM 220 Extension Cable	50	44
INTEL 8087 IC	85	69
RAM EXPANSION	17	10
16K Motherboard (16 Kbit)	19	10
64K Memory Exp 19 IC's	70	49
KRAFT IBM Joystick	70	49
IBM Padlock	50	40

## MODEMS

Item	List	ACP
SIGNALMAN Mark I (RS232)	\$99	\$75
HAYES Smartmodem (RS232)	299	225
Smartmodem 1200	499	349
IBM PC to Modem Cable	40	30
SSM	299	249
AMC 300 300 Baud	695	549
AMC 2200 2200 Baud	299	249
TRANSPAK I	348	299
TRANSPAK II	348	299
TRANSPAK III	569	499
NOVATION CAT	199	169
DCAT	199	169
AUTO CAT	249	199
212 AUTO CAT	249	199

## "SOLO"

Apple II/IIe Compatible Disk Drive

Totally compatible to Apple Drives.

only **\$249.00**

Controller ..... \$99.00  
Just plug in and run.

## Vista Quartet

Equivalent to 4 Apple Drives

only . . . **\$799.00**

## Special Offer

Up To 2.4 Megabyte!

Now "TRIMLINE V1100" with Tandem Thinline DS DD Drives.

Tandem Dual DS DD . . . \$1895.00  
Qume Dual DS DD . . . \$1699.00  
Shugart Dual 801R . . . \$1295.00

## SPECIAL OFFER

(2) Siemens's 8" Disk Drives  
(1) Vista V-1000 Enclosure  
(1) Power Supply w/Fan, w/Cable

ACP Low Price **\$699.00**

## SAVE UP TO 40%

Apple Compatible Software

BUSINESS	HOBBY
Screen Writer \$29	Bag of Tricks \$32
Word Handler \$49	Graphics Magic'n \$45
80 Master \$155	DOS Boss \$19
Vozicak 3.3 \$185	Zoom Graphics \$32
Master Type \$29	Utility City \$22
Desk Top Plan II \$179	Locksmith 4.0 \$90
Desk Top Plan III \$225	Compl Graph Sys \$55
Valpilot \$159	Apple Mechanic \$41
PFS, File II \$115	Nibbles Away II \$35
PFS, File III \$155	GAMES \$29
Valpilot/Personal \$25	The Missing Ring \$29
PFS, Graph II \$115	Choptifer \$26
PFS, Graph III \$155	Frogger \$39
Multiplan \$199	Wizardy \$29
Versafont \$279	Snack Attack \$24
Wordstar \$365	Castle Wolfenstein \$24
Format II \$175	Arcade Machine \$44
MS-DOS II \$439	Canyon Climber \$24
Supercalc \$169	Aztec \$29
PFS, Report II \$95	Mask of the Sun \$29
PFS, Report III \$115	Cannonball Blitz \$26
Acct Plus Q/L \$299	Knight Diamonds \$29
Q/L, A/P, A/R \$599	Zork III \$29
AboveInventory \$799	Zork III \$29
Magic Window \$115	Starcross \$29
HOME	Serpentine \$25
Home Accountant \$59	Star Blazer \$29
Transend I \$119	Deadline \$39
Transend II \$119	Tubeaway \$25
Data Capture 4.0 \$49	Flight Simulator \$25
Visiterm \$89	Space Vikings \$25
Per. Finance Mgr \$85	Sargon II \$29
ASCI Express, Prof. \$99	Spillfire Simulator \$29
Electronic Duet \$25	Apple Panic \$22
Tax Prep. 1983 \$149	Olympic Death \$22

## Apple II/IIe Compatible Disk Drive

Item	LIST	ACP
Apple IIe w/64K	\$1395.00	\$1195.00
Apple IIe System	1995.00	1695.00
Apple IIe Sys w/Ext Text	2195.00	1895.00
Disk II w/Controller	545.00	449.00
Disk II w/Controller	395.00	359.00
Monitor II Green	249.00	169.00
Super Serial Card	195.00	169.00
Parallel Interface Card	165.00	139.00
80 Column Text Card	125.00	109.00
Extended 30 Column Text	295.00	249.00
Dot Matrix Printer	695.00	529.00

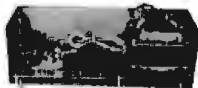
\*Apple Products Available In-store Only!

## MORE HARDWARE

Item	LIST	ACP
MICROSOFT 280 Softcard	\$395.00	\$249.00
16K Ramcard	195.00	89.00
The Premium Package	685.00	654.00
SSM		
AIO-II 4 Function Serial/Parallel	225.00	179.00
AIO Serial/Parallel	195.00	165.00
EASTIDE Wildcard Apple II	149.00	115.00
KENSINGTON System Saver	89.95	74.95
KEYBOARD COMPANY Numeric Keypad	149.95	124.95
Apple II Joystick	49.95	44.50
Apple II Handcontrollers	29.95	25.95
KRAFT (IBM also) Joystick		49.00
Hand Controller		40.00
MPC 128K Bubble Memory	875.00	699.00
PROMETHEUS VERSABox Spool/Buf'r	249.00	199.00
VERSAcard Four-in-1	199.00	166.00
AUTO-DOC diagnostics	99.00	82.00
VISTA COMPUTER CO. Vision 80 80x24 Card	395.00	219.00
80 Visicac 80 Col Pad	69.00	49.00
AB008" Disk Contr	379.95	349.00
Quartet Disk Drive 5 1/4"	849.00	799.00
Solo Disk Drive w/Contr	249.00	249.00
Solo Drive w/o Contr	379.00	319.00
Vista 5 1/4" Disk Contr	92.00	79.00
Typeahead Buffer	49.95	35.00
VIDEX Videoterm 80x24 Card	345.00	279.00
Keyboard Enhancer II	149.00	129.00
Soft Switch	35.00	30.00
Function Strip Keys	7900	69.00
PRACTICAL PERIPHERALS 16K Microbuffer	259.00	220.00
32K Microbuffer	299.00	253.00
Snapshot Option	149.00	109.00
VOTRAX Type n Talk Speech Personal System	249.00	219.00
395.00	339.00	
VNYE Apple II Voice Syn. Apple II Telephone I/O	395.00	349.00
295.00	249.00	
SCOTT INSTRUMENTS Voice Recognit'n VET80	799.00	675.00
COEX 16K RAM Card	99.00	59.95
Parallel Card w/cable	99.00	49.95
Apple Protocard	29.00	19.95
Apple Extendercard	29.00	19.95
Apple II Ext RAM Card	199.00	149.00
CORVUS 5 Mb Hard Disk	3750.00	Call
10 Mb Hard Disk	8350.00	Call
20 Mb Hard Disk	645	

**U.S. MICRO SALES**  
★ MADE IN U.S.A. BY AMERICANS ★

**UNIVERSAL POWER SUPPLY**



For Big Board, Apple or Aim 65  
+5VDC @ 3 Amps  
+12VDC @ .750 Amps  
-12VDC @ .750 Amps  
-5VDC @ .500 Amps  
Dimensions: 4" x 4" x 11"

**\$69.95**

**DISK DRIVE POWER SUPPLY**

For 2 - 8" or 5" Drives  
+ 5VDC @ 4 Amps  
+24VDC @ 3 Amps  
- 5VDC @ 1 Amp



AC Cables for 2 Drives \$7.50

Dimensions: 4" x 4" x 11"

**\$59.95**

**S-100 POWER SUPPLY**



+8VDC @ 30 Amps  
+16VDC @ 6 Amps  
-16VDC @ 6 Amps  
PC Board Design

Dimensions: 5" x 6" x 11"

**\$89.50**

**S-100 MOD KIT**  
by XOR

For test or systems applications.  
Complete S-100 12 Slot Mainframe with Disk Drive Power Supply for 4 Drives.



**SPECIFICATIONS**

Unregulated	Regulated
+8V @ 30A	+5V @ 5A
±16V @ 6A	+24V @ 3A
	-5V @ 1A

\$225.00 Kit with 12 S-100 Bus Connectors  
\$255.00 Assem. and Tested with 12 Bus Connectors  
\$15.00 AC/DC Drive Cable Set for 2 Drives  
Dimensions 6" x 10" x 18" — Shipping Weight 25 lbs.

**Cooling Power**  
**4 1/8"**

Low Velocity  
Whisper® Fans  
Only \$18.00 ea.  
Finger Guards  
\$2.50 each.



**XOR**  
**S-100 MOD**

**California Computer Systems SPECIAL!**



**CCS SYSTEM 2410 . . \$1995.00**

- Includes CP/M® 2.2
- 2-Serial/1-Parallel Port
- DMA Disk Controller
- Hardware Vectored Interrupts
- 2-Real Time Clocks
- Supports CP/M®, MP/M®, DASIS

**CCS 2300 System, A & T . . 1695.00**

- 2810 CPU . . . . . Only-255.00
- 2422 Disk Controller . . . . . Only-330.00
- 2066 64K. . . . . Only-360.00
- 2300A Mainframe NEW! . . . . . Only-399.00
- CCS Apple Boards. . . . . Call Toll Free For Prices

**CUSTOMER SERVICE HOTLINE 1 - (714) 898-5525**

**DUAL DRIVE SUBSYSTEMS**



**HORIZONTAL OR VERTICAL**

Fully Assembled and Tested Units

**ONE YEAR P + L WARRANTY**

On Shugart and Mitsubishi Subsystems

- w/two Mitsubishi DS/DD . . . . . \$1170.00
- w/two Shugart 801R SS/DD . . . . . 975.00
- w/two Shugart 851R DS/DD . . . . . 1225.00
- w/two Siemens 120-8 SS/DD . . . . . 675.00
- w/two Qume DT-8 DS/DD . . . . . 1250.00
- Cabinet A & T w/Power Supply and Accs. . . . . 235.00
- Cabinet Top and Bottom . . . . . Only 60.50

All cabinets A & T and subsystems include all AC/DC wiring and 50 pin data cable except the horizontal model which includes the internal 50 pin cable and requires an external 50 pin cable part # C-6000-01 . . . . . \$ 25.00

**5 1/4" Subsystems**

- w/two 48TPI SS/DD. . . . . 495.00
- w/two 48TPI DS/DD. . . . . 595.00
- w/two 96TPI DS/DD. . . . . 695.00

**★ SPECIAL ★**

**OF THE MONTH ON MITSUBISHI DS/DD SUBSYSTEM\***



**2.4 MEGABYTES . . . ONLY \$1095.00**

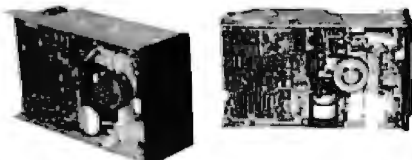
Fully assembled and tested horizontal drive cabinet including fused power supply, fused AC input, fan, all AC and DC cables, 50 pin data cable and ONE FULL YEAR PARTS AND LABOR WARRANTY on the complete subsystem including the Mitsubishi 2894 double sided double density drives.

Add \$15.00 for shipping material.

\*OFFER EXPIRES JULY 31st 1983

**FLOPPY DRIVES**

Buy a set at these reduced prices



- 8" Shugart 801R SS/DD . . . . . \$369.00
- 8" Shugart 851R DS/DD . . . . . 495.00
- 8" Qume DT-8 DS/DD . . . . . 519.00
- 8" Mitsubishi 2894 DS/DD . . . . . 465.00
- 8" Mitsubishi Slimline DS/DD . . . . . 465.00
- 8" Tandon 848-1 Thinline SS/DD . . . . . 370.00
- 8" Tandon 848-2 Thinline DS/DD . . . . . 470.00
- 8" Siemens 120-8 SS/DD . . . . . 235.00
- 5 1/4" Mitsubishi 96 DS/DD Full . . . . . 315.00
- 5 1/4" Mitsubishi 96 DS/DD 1/2 Height . . . . . 315.00

All Shugart and Mitsubishi drives will have a 1 year parts and labor warranty. Qume drives — Full 6 months — All others 90 days.

**★★★**

**SUBSYSTEM SPECTACULAR**

**★★★**

**HARD DISK ADD-ON**

**INTERFACE TO ANY S-100 SYSTEM!!!**

**CARTRIDGE ADD-ON**

NOW U.S. Micro Sales offering mass storage subsystem add-ons for your XOR S-100-4, S-100-12, or any S-100 computer systems. Choose from five to 15 megabytes of hard disk storage or invest in a 10 or 20 megabyte removeable cartridge subsystem and never worry about storage problems again! The 20 megabyte cartridge add-on includes two cartridge drives which means 10 meg to 10 meg back-up and storage in under 3 minutes! All subsystems include chassis, cabinet, power supply, all necessary cables, and all required software. All non-XOR S-100 systems will require an S-100 Interface board for the 5, 10 and 15 megabyte hard disk units at an additional \$199<sup>00</sup>. The Iomega™ cartridge subsystems include this interface at no extra cost.



**ONLY 6" x 6" x 11!"** Save \$150 on our 5 megabyte hard disk add-on. Reg \$1295

- 5 megabyte . . #S-1000-52 . . \$1145<sup>00</sup>
- 10 megabyte . . #S-1000-53 . . \$1495<sup>00</sup>
- 15 megabyte . . #S-1000-54 . . \$1695<sup>00</sup>



XOR Data Sciences S-100 interface board is included with the above cartridge subsystems to interface the hard disk controller to the S-100 bus.

- 10 megabytes of removeable cartridge add-on. #S-100-55 . . . . . \$1995<sup>00</sup>
- 20 megabytes 2 drive add-on backup cartridge to cartridge a full 10 meg. in less than 3 minutes. #S-1000-56 . . . . . \$2950<sup>00</sup>
- Extra cartridges. #M-2000-51 . . . . . \$50<sup>00</sup>



Visit Our Retail Stores

**ORDER TOLL FREE**

☆ EAST ☆ ☆ WEST ☆

1 (800) 435-9357 1 (800) 854-8174

In Ill. (815) 485-4002

In Calif. 1 (714) 898-1492

**TERMS:** We accept VISA/MC, prepay, check or money order. Please allow personal check two weeks to clear before shipment. \$5.00 handling charge on all orders under \$50.00. 15% Restocking Fee. All orders shipped via U.P.S. unless otherwise specified. All U.P.S. C.O.D. orders over \$100.00 require a Cashiers Check. \*Our products carry a full 6 months parts and labor warranty excluding drives, printers and terminals which carry the full O.E.M. factory warranty. PRICES SUBJECT TO CHANGE WITHOUT NOTICE.



**MICRO SALES**

★ MADE IN U.S.A. BY AMERICANS ★

★ EAST ★ 11 Edison Drive, New Lenox, Illinois 60451  
★ WEST ★ 15392 Assembly Lane, Huntington Beach, CA 92649

**TERMINALS**



**Adds Viewpoint 3A+:** A low cost high performance terminal w/green screen and detachable keyboard. Features include ★ Reverse video ★ 1/2 intensity ★ Visual highlighting ★ Full auxiliary port use ★ 150 — 19.2K baud rate.

#T-1000-04 ..... \$519.00



**Televideo 910+:** Save your eyes on a great green screen w/features like ★ Built-in self test ★ Full editing ★ Tab options ★ cursor control ★ 16 visual attributes like, reverse video, monitor mode and 1/2 intensity.

#T-1000-05 ..... \$569.00



**Televideo 925:** From the hobbyist to the basic professional this popular terminal will fit your needs. ★ Detachable keyboard ★ Numeric keypad ★ Green screen ★ Self test ★ Time of day display ★ Programmable function keys ★ 912/920 emulation hardware/software programmable configurations.

#T-1000-08 ..... \$739.00

Televideo 950 #T-1000-09 ..... \$939.00

**PRINTERS**



**C-Itoh Starwriter F-10:** The best you can get in a daisy-wheel letter quality printer with removable print head and speed to 45 C.P.S. Order serial or parallel models — same price. No extra charge for the quiet-low profile design.

F-10 Starwriter Parallel #M-2000-47 ..... \$1475.00

F-10 Starwriter Serial #M-2000-31 ..... \$1475.00



**Okidata Microline:** New versatility, correspondence quality printing and speed make the ML92 and ML93 the best printer values in their categories. Both printers provide multi-speed print modes; bi-directional high speed mode with short line seeking logic at 160cps, emphasized and enhanced mode printing at 80cps, and high resolution correspondence quality printing at 40cps. **Dot-addressable** graphics is standard. Both serial and parallel interfaces are standard and BOTH prices include full tractor assembly at no extra charge.

ML92 #M-2000-10 ..... \$ 629.00

ML93 #M-2000-11 ..... \$ 965.00



**Epson FX-80:** This is the latest entry from the manufacturer that has taken the printer market by storm by offering the highest quality at very reasonable prices.

One quick glance at the features below should convince you that Epson has created a real winner with the new FX80:

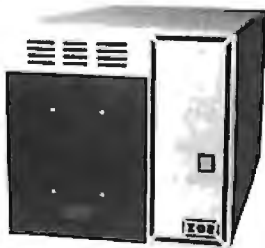
- Burst print speed of 160 cps; continuous speed of 110cps • 11x9 character matrix; 18x18 in emphasized and doublesize modes • User definable characters
- Internal RAM can function as either 2K print buffer or user-definable character set storage area • Standard Centronics parallel interface • Programmable left margin; 32 horizontal tab stops and 8 sets of 16 vertical tabs.

Introductory offer #M-2000-70 ..... \$599.00

Above w/Serial/Int #M-2000-71 ..... \$699.00

The 4 slot S-100 systems below are equipped with the XOR Z-80 4MHZ three board set. Each can run 8" or 5" disk simultaneously. In addition to the high speed XOR mini format, they can read KPRO, IBM and Morrow 5" disk formats. Each has a modular dual power supply sub chassis. They are fan cooled. Standard IO is 2 serial ports and one centronics parallel. Expansion IO is available.

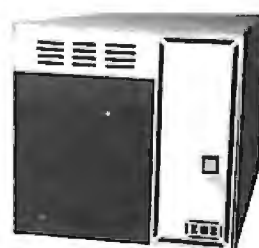
**TWIN 5 1/4" MINI**



- ★ System less boards and drives ..... \$ 425.00
- ★ Mini 48TPI SS/DD ..... \$1395.00
- ★ Mini 48TPI DS/DD ..... \$1495.00
- ★ Mini 96TPI DS/DD ..... \$1650.00

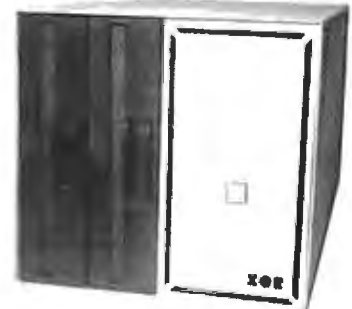
**5 1/4" HARD DISK**

★ NEW PRODUCT SPECIAL ★



- ★ w/1 48TPI + 5 Meg ..... \$2395.00!
- ★ w/1 96TPI + 5 Meg ..... \$2495.00
- ★ w/2 96TPI + 5 Meg ..... \$2750.00
- ★ w/2 96TPI + 10 Meg ..... \$2995.00
- ★ w/2 96TPI + 20 Meg ..... \$3445.00

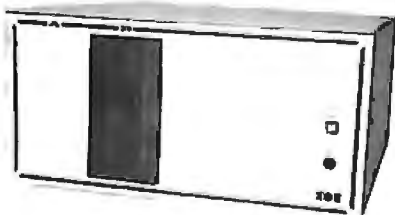
**8" MITSUBISHI/TANDON**



- ★ System less boards + drives ..... \$ 395.00
- ★ w/2 Mitsubishi DS/DD ..... \$1895.00
- ★ w/2 Tandon SS/DD ..... \$1725.00

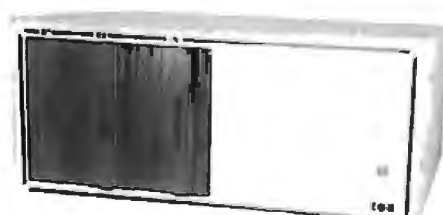
The 12 slot commercial grade S-100 systems below have all of the features listed above plus a massive 30 amp power supply capable of the expansion we expect you will do. All units are cooled by four inch fans. Each system must pass 2 days of constant read and write disk testing without a single error before shipment. **One year complete system warranty is included.**

**BASIC PROFESSIONAL**



- ★ w/no drives (full board set) ..... \$1350.00
- ★ w/2 Mitsubishi ..... \$2295.00
- ★ w/2 Shugart 801R ..... \$2125.00
- ★ w/2 Shugart 851R ..... \$2425.00
- ★ w/2 Qume ..... \$2450.00
- ★ w/2 Mitsubishi/wide ..... \$2295.00

**IOMEGA S-100-12+**



- ★ w/1 iomega + 1 Floppy ..... \$3395.00
- ★ w/1 iomega + 2 Floppies ..... \$3715.00
- ★ w/2 iomega + 1 Floppy ..... \$3995.00

**PROFESSIONAL 8" HARD DISK TO MP/M**



- ★ w/20 Meg + 1 Floppy ..... \$4395.00
- ★ w/40 Meg + 1 Floppy ..... \$4950.00
- ★ w/85 Meg + 1 Floppy ..... \$5395.00
- ★ Add Tape Backup ..... \$1495.00
- ★ Add MP/M ..... \$ 695.00
- ★ Add per User ..... \$ 250.00



**LIBERTY FREEDOM 50 \$475**

The Liberty Freedom 50 terminal features detachable keyboard with 33 keys including 10 function keys, 15 graphic symbols, and DSP switch-selectable character set for 7 foreign languages. The 12 inch high resolution green phosphor screen displays 34 rows by 80 characters in full matrix with true descenders. Soft feel and 25hz data display row also includes detachable head reads from 110 characters per second memory, allowing operator to display a full 1000 characters. Simulates 1 popular CRT terminals for easy software configuration. Switch selectable between 119 and 230 wpt. We have never seen a terminal with all these features for the incredibly low price of only \$475. LFB-750 40 lbs.

**DIABLO ECLIPSE 100 \$995**  
Word Processing Printer

Now from the originator of the daisy wheel printer, the Diablo 620 Print speeds to 24 char/sec., user selectable bi-directional printing, superscripts, subscripts, graphics and more. Plus standard RS-232C interfacing. Communication speed 1200 baud with a 500 character printer buffer. Software programmable absolute horizontal tabs makes report formatting easy. Over 20 different print wheels are currently available. The 620 automatically selects the print spacing for 10, 12, 15 char/each print wheels. Onsite service available worldwide. DBL-620 50 lbs.

**ECLIPSE 100 \$695**

The Eclipse 100 is an industrially rated IEEE 488 S-100 18 pin modular. Equipped with a 600 watt forced modular power supply to assure operation in the most severe environments. Processor for internally mounting a 3 1/2" Winchester disk drive. All cast components receive proper cooling from a bladed 65 cm fan. Constructed from 304 brushed stainless steel is suitable for medical and process control applications. Use of the highest grade materials and state of the art construction techniques has made Eclipse Data Products the industry standard for quality and versatility in computer mainframes. EDP-100 10 lbs.

**MORROW DESIGNS Micro Decision MD1 \$995**

The Morrow Micro Decision offers one of the best values in small business computers. Standard features include 64K of RAM, iRMZ 2.80 CPU, two RS232C serial ports, dual density floppy disk controller capable of supporting four disk drives, and a 200 Kbytes 5 1/4" disk drive. The Micro Decision is delivered complete with CP/M 2.2 as well as Basic 80, Wordstar and other software packages. MDS-MD1 18 lbs. Also available priced above, the Micro Decision MD2 with two 5 1/4" disk drives at only \$1195. MDS-MD2 22 lbs.

**Houston Instruments PLOTTERS \$995**

The DMP-20 is the latest in a long line of high reliability plotters from Houston Instruments. Software selectable 8 pens allows the operator to plot color illustrations, with dot resolution of 001". The DMP-20 can create graphs up to a maximum plot size of 10 by 15 inches. Easily interfaced to most computers through an RS-232C serial port. This unique plotter is also capable of functioning in a multiplexing mode electronically opening and closing a back into the computer's printer port. \$1995.00 35 lbs. Also available, the single pen HCU-DMP 21 \$995.00.

**U.S. ROBOTICS 1200 BAUD MODEM \$419**

The U.S. Robotics 212A/1020 modem represents a major advance in 1200/300 baud modem technology. Proprietary 1200 baud LSI integrated circuits allow the U.S. Robotics 212A modem to maintain higher reliability over marginal phone lines. The U.S. Robotics 212A features auto dial, auto answer, command repeat and auto intelligent baud selection. USR-212A \$419.00 2 lbs. Other excellent values in direct connect modems: Signalman Mark 1 at \$74.95 and the Universal Data 1200 baud at only \$69.00.

**STAR GEMINI \$319**

Star Gemini-10 tractor and tractor 100 char/sec parallel STR-G10 319.00  
Star Gemini-15, 100 char/sec, 15" paper STR-G15 559.00  
StarCoax80F17 tractor tractor VST-CR0FT 259.00  
Okidata 82A serial & parallel 9" paper OKI-82A 159.00  
Okidata 92A serial & parallel 11" paper OKI-92A 679.00  
Okidata83A parallel 15" paper OKI-83A 695.00  
Okidata84A parallel 15" paper OKI-84A 1079.00  
Okidata 8500 serial 2350 OKI-8500 1959.00  
Epson FX80, 180 char./sec. with graphics, inc. & tractor EPS-FX80 575.00  
Epson MX100 with graphics, 15" paper EPS-MX100 695.00  
NEC CB23A parallel 9" paper, graphics NEC-CB23A 439.00  
Anadex 9500A high speed 15" paper ADX-9500A 1279.00  
Anadex 9501A high speed with graphics ADX-9501A 1279.00  
Dataseq 180 high speed 180 cps 15 DS-180 1295.00  
Quantix 7000 correspondence quality 180 char/sec QTX-7000 1959.00  
Prowriter 8510 parallel 9" paper PRO-8510P 495.00  
Prowriter 8510 serial 9" paper PRO-8510S 839.00  
Prowriter II parallel 15" paper, graphics PRO-8511 750.00  
Prowriter 8510 high speed printer 300 lines per minute PTX-P300 4500.00  
Prowriter 1600 ultra high speed 300 lines per minute PTX-P800 6150.00  
Mansmann Tally 1065 200 char/sec serial MAN-1065 1850.00

**64K DYNAMIC MEMORY BOARD \$495**

The Wyse WY-100 features die cast aluminum case, 102 key keyboard and non-glare 26 line green phosphor video display. Split screen both horizontal and vertical makes the WY-100 unusually user friendly. This unique terminal is perfect to enhance your next business system.

**APPLE BRAND PRODUCTS \$1595**

Apple IIe Starter System includes Disk Drive, Green Phosphor Monitor, and 80 Column Card. APL-DSK1 5600.00  
Apple disk without controller card APL-DSK2 495.00  
XITEN XITEN 1995.00  
XIN-G10 16K RAM card for Apple II 69.00  
XIN-16K 16K RAM card for Apple II 69.00

**S-100 BOARDS**

**16 BIT MICROPROCESSORS**  
Godbout 8086/8087 microcomputer 16bit GB-8687 495.00  
Godbout dual processor 8086/8088, 8 bit bus GB-8588 359.00  
Lomas Data Systems 16bit microcomputer DSI-8086 429.00

**SINGLE BOARD COMPUTERS**  
Wentworth Computers 16bit with CRT WAC-280 295.00  
Advanced Digital, floppy 3.6k ADI-280 795.00  
Teletype System master, NEC765 floppy, 6k TEL-SM 850.00  
Teletype FDC-1 single board without memory TEL-FDC1 675.00

**8 BIT MICROPROCESSORS**  
Godbout 680, 24 pin extended GB1-780 260.00  
California Computer 28k microcomputer CCS-100 339.00  
Talley 280 with RS232 ports TAR-280 339.00

**FLOPPY DISK CONTROLLERS**  
Godbout 680, 24 pin extended GB1-680 395.00  
California Computer Systems 2424 with CPU CCS-2422 339.00  
Memp. Disk Access with CPU 2.1 MDS-D2 3500.00  
Marlow Disk Jockey with CPU, single density HDS-DJ1 275.00  
Talley Electronics flexible density controller TAR-200 119.00  
Talley Electronics single density controller TAR-SDC 229.00  
Fulcrum DMA Demods, 10 to 10 hard disk FDA 369.00

**STATIC MEMORY BOARDS**  
Godbout 16K, 16K 16 bit data transfer GB1-R16 499.00  
Godbout Ram 21, 64K Ram 24 bitwired add GB1-R24 899.00  
Godbout Ram 72, 128K Ram 64 bitwired add GB1-R72 2999.00  
Fulcrum Demods 16, 16 bitwired select FDR-R16 249.00  
California Computer 2128, 8 bit only 16k bus CCS-2128 249.00

**DYNAMIC MEMORY BOARDS**  
California 06m 256k type extended 1Mcp CAL-0256 4550.00  
California Computer 68K 64k bus add CCS-68K 299.00

**INTERFACE BOARDS**  
Godbout Interface I, 3 serial GB1-I3A 499.00  
Godbout Interface II, 1 serial 3 parallel ports GB1-I3SA 499.00  
Godbout Interface III, 4 serial 3 parallel GB1-I3SA 499.00  
Godbout Interface IV, 3 serial 2 parallel GB1-I3PA 379.00  
Godbout Computer 1728 4 serial ports CCS-1728 279.00  
California Computer 2773 2 serial 8 parallel CCS-2773 579.00  
California Computer 2773 4 serial ports CCS-2773 579.00  
California Computer 2773 8 serial 8 parallel CCS-2773 579.00  
California Computer 2773 16 serial 8 parallel CCS-2773 579.00  
California Computer 2773 32 serial 8 parallel CCS-2773 579.00

**SPECIAL FUNCTION BOARDS**  
Hayes S-100 Micromodem, 3000 baud FCC req. HYS-M100 325.00  
D-1 Computer clock calendar, bat. back up DIC-CCD10 190.00  
Godbout System support board, 4K EPROM GB1-SYS1 3300.00  
Godbout System support board with 8 K EPROM GB1-SYS11 3300.00  
Dual Systems, 4 channel 12 bit A/D converter DSC-ADM12 619.00  
Dual System 12 bit serial, 32 channel A/D DSC-ADM12 619.00  
Mullins-Dunn interface controller boards IAU-42510 279.00  
Mullins-Dunn interface controller boards IAU-42510 279.00  
I/O Technology wire-wrap prototype board IOT-WR100 250.00  
Aries Electronics wire-wrap prototype board ARIE-WR100 250.00  
Aries Electronics system purpose controller board ARIE-CP100 250.00

**MAINFRAMES & MOTHER BOARDS**  
Colson Data modular system serial 18 pin EDP-100 899.00  
Colson Data modular system serial 18 pin EDP-100 899.00  
California Computer 2200, 12 slot wireframe CAL-CC200 479.00  
California Digital 18 slot wireframe CAL-DM18 399.00  
California Digital 18 slot wireframe assembled CAL-DM18E 399.00

**WORD PROCESSING PRINTERS**

NEC7710 55 char./sec, serial interface NEC-7710 2379.00  
NEC7720 same as above only parallel interface NEC-7720 2379.00  
NEC3510 15 serial interface, 35 char./sec. NEC-3510 1729.00  
Dataseq 40 char./sec. serial DNL-830 2250.00  
Dataseq 100 high speed, 180 cps 15 DS-100 1295.00  
Brother H711 daisy wheel, parallel interface BTH-H711 895.00  
Starwriter F10 serial 40 char./sec PRO-F10S 1475.00  
Starwriter F10 parallel 40 char./sec PRO-F10P 1475.00

**EPSON MX80 RIBBONS \$6.95**

**MONITORS**

BMC 12A green phosphor 15 MHz composite video BMC-12 89.00  
BMC 12 highest resolution 20MHz BMC-12 129.00  
Zenith VM121 green phosphor 12 40/80 column BMC-121 109.00  
NEC-JB1201 green phosphor 18 MHz composite video NEC-JB1201 169.00  
NEC-JB1200 commercial grade composite NEC-JB1200 129.00  
USI Amers screen 12" composite monitor USI-A12 169.00  
Motorola 21" open frame bit white composite video MCT-BW23 159.00  
Motorola 12" open frame requires horz sync, and power MCT-BW12 279.00  
Conrac 21" open frame requires horz sync & 12v. supply. Conrac 21" composite video COM-6600 399.00  
Amrad Color 1 composite video AMR-100 399.00

**MODEMS DIRECT CONNECT \$75.00**

Hayes Smart Modem 1200 baud auto answer auto dial HYS-212AD 575.00  
Hayes Smartmodem, 300 baud only, auto answer, auto dial HYS-102AD 229.00  
Hayes Micro Modem II, 103 Apple II direct connect HYS-MM2 279.00  
Hayes Micro Modem 100, S-100 auto answer, auto dial HYS-100 319.00  
Hayes Chronograph time & date HYS-CHR202 199.00  
Universal Data 103L P.I. Auto answer HYS-103L 279.00  
Pencil 300/1200 auto dial auto dial HYS-PEN-1200 695.00  
Universal Data 103LP, line power answer & originate HYS-103LP 169.00  
Universal Data 103L P.I. Auto answer HYS-103L 279.00  
Universal Data 202, 1200 baud, half duplex only UDS-202LP 209.00  
Universal Data 212LP, 103 baud duplex, 1 line power UDS-212LP 399.00  
Universal Data 212A, 300/1200 baud auto answer UDS-212A 599.00  
Novation J Cat direct connect, auto duplex NOV-CAT 119.00  
Novation Cat automatic connect NOV-CAT 159.00  
Novation SmartCat 103, auto answer auto dial NOV-SM103 219.00  
Novation SmartCat 103-212 1200 baud auto dial NOV-SC212 529.00  
Signalman Mark 1 direct connect with terminal cable SGL-MK1 75.00

**APPLE BRAND PRODUCTS**

Apple IIe Starter System includes Disk Drive, Green Phosphor Monitor, and 80 Column Card. APL-DSK1 5600.00  
Apple disk without controller card APL-DSK2 495.00  
XITEN XITEN 1995.00  
XIN-G10 16K RAM card for Apple II 69.00  
XIN-16K 16K RAM card for Apple II 69.00

**RAMA SYSTEMS**

RAM-APL1 Apple add on disk drive with controller 5250.00  
RAM-APL2 Apple add on drive without controller 3950.00

**CALIFORNIA COMPUTER SYSTEMS**

CCS-7710 Asynchronous Serial Interface 925.00  
CCS-7720 Centronics Parallel Interface 925.00  
CCS-7720 Apple Parallel Interface 950.00  
CCS-7710 12K Rom/Prm Module 115.00  
CCS-7424 Caterpillar/Clark Module 95.00  
CCS-7440 Programmable Timer 95.00  
CCS-7811 Arithmetic Processor for Apple II plus 319.00

**MOUNTAIN COMPUTERS, INC.**

MTC-CPS MTC-CPS 169.00  
MTC-TCK MTC-TCK 169.00  
MTC-SLK MTC-SLK 149.00  
MTC-MSK MTC-MSK 169.00  
MTC-MSK1 MTC-MSK1 149.00  
MTC-MSK2 MTC-MSK2 149.00  
MTC-MSK3 MTC-MSK3 149.00

**MICRO SOFT**

MSF-SETR0 Microsoft 1.80 CPU card 249.00  
MSF-16KRAM Microsoft 16K RAM card 125.00

**VISTA**

VSA-A800 Vista 8" controller card 469.00  
VSA-V800 Vista 8" video board 289.00  
MCI-CTRL Micro Scidisk drive controller 89.00

**FOURTH DIMENSION**

FDM-SPDRV Super Drive 35 track Apple add on 329.00

**SORRENTO VALLEY ASSOC**

SVA-221 Single add-on serial density controller 360.00  
SVA-222 Dual add-on serial density controller 360.00  
SVA-223 Single add-on double density controller 475.00

**16 BIT MICROPROCESSORS**

Godbout 8086/8087 microcomputer 16bit GB-8687 495.00  
Godbout dual processor 8086/8088, 8 bit bus GB-8588 359.00  
Lomas Data Systems 16bit microcomputer DSI-8086 429.00

**SINGLE BOARD COMPUTERS**

Wentworth Computers 16bit with CRT WAC-280 295.00  
Advanced Digital, floppy 3.6k ADI-280 795.00  
Teletype System master, NEC765 floppy, 6k TEL-SM 850.00  
Teletype FDC-1 single board without memory TEL-FDC1 675.00

**8 BIT MICROPROCESSORS**

Godbout 680, 24 pin extended GB1-780 260.00  
California Computer 28k microcomputer CCS-100 339.00  
Talley 280 with RS232 ports TAR-280 339.00

**FLOPPY DISK CONTROLLERS**

Godbout 680, 24 pin extended GB1-680 395.00  
California Computer Systems 2424 with CPU CCS-2422 339.00  
Memp. Disk Access with CPU 2.1 MDS-D2 3500.00  
Marlow Disk Jockey with CPU, single density HDS-DJ1 275.00  
Talley Electronics flexible density controller TAR-200 119.00  
Talley Electronics single density controller TAR-SDC 229.00  
Fulcrum DMA Demods, 10 to 10 hard disk FDA 369.00

**HARD DISK CONTROLLERS**

Godbout 8k, 8 1/4" hard disk GB1-OS42 5600.00  
Godbout Disk 3 for 5 1/4" Winchester GB1-OS43 495.00  
Marlow Design 8 controller for 5 1/4" Winchester MDS-V026 195.00  
Western Digital new HD-100, (10 to 10) 100-1001 195.00

**EPROM BOARDS**

Ingel Research EPROM 80 programs 21728s IAC-PR02 469.00  
Ingel Research 16k program 21728s IAC-PR12 469.00

**SYSTEMS**

Apple II-E System 64K bytes, includes disk drive, Apple green monitor & 80 column card 1595.00  
Franklyn 1000 48K bytes of memory, ten key pad, Apple II look-a-like 989.00  
System II 48K bytes of memory, Apple II look-a-like 789.00  
Columbia Two 5 1/4" floppies, IBM look-a-like keyboard & video card extra 2395.00  
Compaq PC Portable with graphics controller CRT, IBM look-a-like 1639.00  
Kaypro II Portable with two drives and 9" display, bundled with lots of software 1679.00  
Aos 586-10 10 meg. harddisk & 5 1/4" floppy, up to five users, 16 bit 8086 CPU 6250.00  
Eagle II Two 5 1/4" disk drives, 12" green phosphor monitor with Perfect Software 1795.00  
Morrow MD2 Two 5 1/4" disk drives, bundled with six software packages, CFM 2.2 1195.00  
CCS Calstar 128K bytes, two Quad density disk drives with CFM and Perfect Software 3150.00  
CCS 2210 CPU Complete 2.20 based S-100 system, 64K byte, floppy disk with CFM 2.2 1639.00  
Northstar 15-MB System includes 15 Megabyte Winchester, 5 1/4" floppy, 64K byte 4995.00  
Northstar 20 Two quad density disk drives, 64K dynamic memory 2595.00



Shipping: First five pounds \$3.00. Each additional \$3.50. Foreign orders: 10% shipping. Excess will be refunded. California residents add 6 1/2% sales tax. COD's discouraged. Open accounts extended to state supported educational institutions and companies with a "strong" Dun & Bradstreet. Warehouse: 15608 Inglewood Blvd.

TOLL FREE ORDER LINE 800-421-5041 TECHNICAL & CALIFORNIA 213-649-9001





**THERE ARE NO BETTER BOARDS — THERE ARE NO BETTER PRICES!**

**CompuPro FROM PRIORITY ONE ELECTRONICS**



**CPU BOARDS**

**CO-PROCESSOR 8086/8087**

16 bit 8 or 10 MHz 8086 CPU with sockets for 8087 and 80130

Part No.	Description	List Price	Our Price
BRGBT106A	A&T 8MHz 8086 only	\$750.00	<b>\$669.00</b>
BRGBT106C	CSC 10MHz 8086 only	\$850.00	<b>\$764.89</b>
BRGBT106A87	A&T with 8087 option	\$1050.00	<b>\$938.00</b>
BRGBT106C87	CSC with 8087 option*	\$1150.00	<b>\$1065.00</b>

\*8087 Limits clock speed to 5MHz

**(816) DUAL PROCESSOR 8085-8088**

6 or 8 MHz provides true 16 Bit Power with a standard 8 bit S-100 bus

BRGBT1012A	A&T 6MHz	\$495.00	<b>\$439.00</b>
BRGBT1012C	CSC 6/8 MHz	\$595.00	<b>\$529.00</b>

**68K - 68000 16 BIT CPU**

16 bit 8 or 10 MHz on-board sockets for 2716, 2732, or 2764 EPROMs for up to 8K x 16 of memory

BRGBT104A	A&T 8MHz	\$695.00	<b>\$625.00</b>
BRGBT104C	CSC 10MHz	\$850.00	<b>\$765.00</b>

**FORTH OPERATING SYSTEM FOR 68K CPU**

Requires a DISK 1, 64K of CompuPro memory, and an INTERFACER 3 or 4.

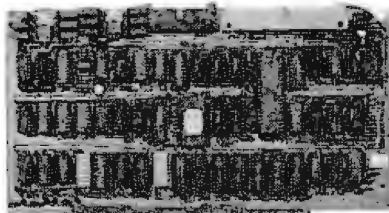
BRGBT68KOS	FORTH operating system		<b>\$200.00</b>
------------	------------------------	--	-----------------

**CPUZ - Z80B CPU NOW 6MHz!**

3/6 MHz Z80B CPU with 24 Bit Addressing. FASTEST Z80 CPU AVAILABLE!

BRGBT10DA	3/6 MHz A&T	\$325.00	<b>\$289.00</b>
BRGBT10DC	3/6 MHz CSC	\$425.00	<b>\$379.00</b>

**DMA DISC CONTROLLER CP/M 2.2 FOR FREE!\***



\*When 2 or more 8" disk drives are purchased with Disk 1 Controller.

**DISK CONTROLLERS**

**DISK 1 FLOPPY CONTROLLER - OUR BEST!**

Fast DMA, Soft Sector, Controls Up to Four 8" or 5 1/4" Single or Double Density Drives.

BRPDB171ACP	A&T w/CPM 2.2 & BIOS	\$670.00	<b>\$495.00</b>
	*When purchased with two 8" disk drives only.		<b>\$450.00</b>

BRPDB171CCPM	CSC w/CP/M 2.2 & BIOS	\$770.00	<b>\$595.00</b>
BRGBT171A	Disk 1 Controller A&T	\$495.00	<b>\$449.89</b>
BRGBT171C	Disk 1 Controller CSC	\$595.00	<b>\$550.00</b>
BRGBTCPMB0	CP/M 2.2 for Z80/8085 w/manual & BIOS 8" S/D disk		<b>\$174.89</b>
BRGBTCPMB6	CP/M 2.2 for 8086 w/manuals & BIOS 8" S/D disk.		<b>\$289.89</b>

**DISK 2/SELECTOR CHANNEL HARD DISK CONTROLLER**

Fast DMA 2 board set. controls 4 Shugart 4000 series or Fujitsu 2300 type drives. Includes CP/M 2.2

BRGBT177A	Assembled & Tested	\$795.00	<b>\$750.00</b>
BRGBT177C	CSC	\$895.00	<b>\$850.00</b>



**CMOS RAM SALE!**

**RAM 17 - 64K CMOS STATIC RAM**

12 MHz, RAM 17, 2 Watt, DMA Compatible 24 Bit Addressing

Part No.	Description	List Price	Our Price
BRBBT175A84	64K A&T 12MHz	\$499.00	<b>\$480.00</b>
BRBBT175C84	64K CSC 12MHz	\$599.00	<b>\$550.00</b>

**RAM 16 - 32K x 16 BIT CMOS STATIC RAM**

8 and/or 16 Bit

**(816)** 12 MHz, RAM 16, 32K x 16 or 64K x 8 IEEE/696 16 Bit 2 Watt, 24 Bit Addressing

BRBBT16DA	64K A&T 12MHz	\$550.00	<b>\$510.00</b>
BRBBT16DC	64K CSC 12MHz	\$650.00	<b>\$610.00</b>



**NEW! RAM 21 - 128K STATIC RAM**

816 RAM 21 12MHz, 128K x 8 or 64K x 16 IEEE/696 8 or 16 Bit, 1.2 Amps, 24 Bit Addressing

BRBBT190A	128K A&T	\$1095.00	<b>\$995.00</b>
BRBBT190C	128K CSC	\$1245.00	<b>\$1125.00</b>

**M-DRIVE SOLID STATE DISK DRIVE, 3500% FASTER!!**

Not really, but the next best thing for CompuPro 8085/88 Users. Call for Details on M-Drive.

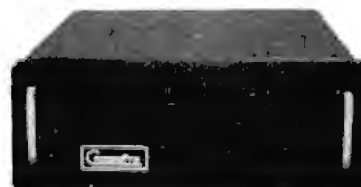
M-Drive requires a 6MHz CPU 8085/88 dual processor, Disk 1 DMA disk controller and System Support 1 Multifunction Board.

BRGBTM0120KA	128K of A&T memory & M-Drive Software	\$1180.00	
BRGBTM0120KC	128K of CSC memory & M-Drive Software	\$1390.00	
BRGBTM0256KA	256K of A&T memory & M-Drive Software	\$2395.00	
BRGBTM0256KC	256K of CSC memory & M-Drive Software	\$2795.00	

**M-DRIVE/H HARDWARE LOGICAL DISK SYSTEM**

Interfaces through two I/O ports, and runs at 10MHz. IEEE 696 compatible. Requires any CompuPro CPU and a Disk 1. Each board contains 512K of fast, low power (900mA) RAM, with parity checking.

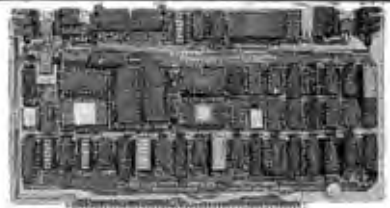
BRGBT197A	M-DRIVE/H w/software, A&T	\$1895.00	<b>\$1295.00</b>
BRGBT197C	M-DRIVE/H w/software, CSC	\$2095.00	<b>\$1495.00</b>



**S-100 MAINFRAME**

110V 60Hz CVT Mainframe uses 1amous 20 slot CompuPro Motherboard (55 lbs.)

BRGBTENC20RM	20 Slot Rackmount	\$895.00	<b>\$825.00</b>
BRGBTENC20DK	20 Slot Desk Top	\$825.00	<b>\$780.00</b>



**I/O BOARDS**

**SYSTEM SUPPORT 1 MULTIFUNCTION BOARD**

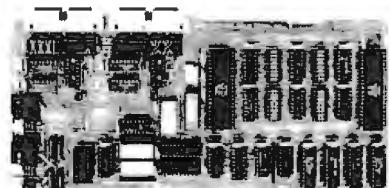
Serial port (software prog. baud), 4K RAM included, 15 levels of interrupt, real time clock, optional math processor

Part No.	Description	List Price	Our Price
BRGBT162A	Assembled & Tested	\$450.00	<b>\$395.00</b>
BRGBT162C	CSC	\$550.00	<b>\$495.00</b>
BRGBT8231	Math Chip		<b>\$105.00</b>
BRGBT8232	Math Chip		<b>\$195.00</b>
BRGBT162AM1	A&T w/8231 Math Chip		<b>\$570.00</b>
BRGBT162CM1	CSC w/8231 Math Chip		<b>\$870.00</b>
BRGBT162AM2	A&T w/8232 Math Chip		<b>\$570.00</b>
BRGBT162CM2	CSC w/8232 Math Chip		<b>\$870.89</b>

**MPX CHANNEL BOARDS**

I/O Multiplexer, using 8085A-2 CPU on board w/16K RAM

BRGBT166A16	Assembled & Tested	\$649.00	<b>\$584.89</b>
BRGBT166C16	CSC	\$749.00	<b>\$674.89</b>



**INTERFACER 1**

Two Serial I/O

BRGBT133A	Assembled & Tested	\$295.00	<b>\$259.00</b>
BRGBT133C	CSC	\$370.00	<b>\$329.00</b>

**INTERFACER 2**

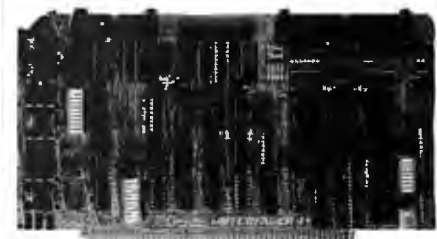
Three parallel, one serial I/O board

BRGBT150A	Assembled & Tested	\$325.00	<b>\$289.00</b>
BRGBT150C	CSC	\$399.00	<b>\$359.00</b>

**INTERFACER 3**

Eight-channel multi-user serial I/O board

BRGBT1748A	Assembled & Tested	\$699.00	<b>\$628.89</b>
BRGBT1748C	CSC 200 hr: 8 port	\$849.00	<b>\$748.89</b>
BRGBT1745A	Assembled & Tested	\$599.00	<b>\$558.89</b>
BRGBT1745C	CSC 200 hr: 5 port	\$699.00	<b>\$628.89</b>



**INTERFACER 4**

Three Serial, 1 Parallel, 1 Centronics Parallel

BRGBT187A	Assembled & Tested	\$450.00	<b>\$399.00</b>
BRGBT187C	CSC	\$540.00	<b>\$479.00</b>

**S-100 MOTHERBOARDS**

Active termination, 6-12-20 Slot

BRGBT153A	A&T 6 slot, 2 lbs.	\$140.00	<b>\$125.00</b>
BRGBT153C	CSC 6 slot, 2 lbs.	\$190.00	<b>\$155.00</b>
BRGBT154A	A&T 12 slot, 3 lbs.	\$175.00	<b>\$155.00</b>
BRGBT154C	CSC 12 slot, 3 lbs.	\$240.00	<b>\$220.00</b>
BRGBT155A	A&T 20 slot, 4 lbs.	\$265.00	<b>\$235.00</b>
BRGBT155C	CSC 20 slot, 4 lbs.	\$340.00	<b>\$310.00</b>





**S-100 STATIC RAM  
128K RAM 21**



• Meets or exceeds all IEEE 696/S-100 standards • Uses less power than dynamics (12 amps typical) • 24 bit extending addressing • 8 bit (128K) or 16 bit (64K) operation • Addressable as one block • 16K window deselect: DIP switch selectable • Switch selectable PHANTOM disable • 16K x 1 static RAM • Capable of DMA processing • Assembled and Tested • 1 year warranty  
BRGBTRAM21 Catalog Price: \$1225.00

**BUY IT NOW FOR ONLY:**

**\$695**

**FREEDOM 50**

- 9 cursor control keys
- 7 editing function keys
- Programmable protection
- Multi-emulations
- Green screen 12"
- Tilt Base
- 5 function keys

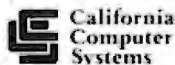
BR LIBF50 (Sh. Wt. 34 lbs.)  
List Price: \$599.00

**SALE PRICE:  
\$475**

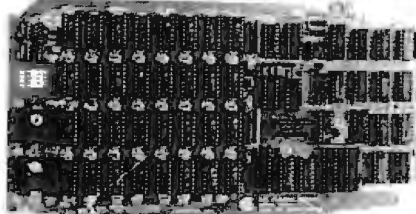
**FREEDOM 100**

Contains all of the above features of the FREEDOM 50 plus 5 additional function keys, 7 character sets, 15 special graphics symbols, and block mode transmission. (Sh. Wt. 34 lbs.)

BR LIBF100  
List Price \$649.00  
**SALE PRICE: \$525.00**



**64K - 4MHz  
IEEE/S-100  
DYNAMIC RAM**



• Operates with either an 8080 or Z-80, providing processor transparent refreshes • Bank-select system • Any 16K block can be made bank-independent • Phantom input • Assembled & Tested  
REGULAR LIST PRICE IS \$375.00

**\$175.00 ea.  
4/\$640.00**

BRCCS20653 (Sh. Wt. 2 lbs.)

**RAM BOARD DISK DRIVE BONUS!**

As an added bonus, PRIORITY ONE ELECTRONICS is giving away software developed by Micro Resources that will allow 4 CCS20653 boards to be used as an in-memory disk drive. This allows for an incredible speed increase in speed in your computer. This software is only available with the purchase of 4 CCS20653 memory boards. Use part number BRMRSRDSK. (Sh. Wt. 1 lb.)

**DUAL QUME 8" FLOPPY DRIVE,  
CABINET, DMA S-100  
CONTROLLER,  
AND CP/M®**

**\$1595.00**

BR P066DTYS206

**FROM  
CompuPro**



**YOU SAVE  
\$1419.77!!**

**ABSOLUTELY THE MOST COST EFFECTIVE  
DISK SUBSYSTEM EVER OFFERED  
BY PRIORITY ONE ELECTRONICS!!**

- 2 Double sided 8" QUME DT8 disk drives
  - DMA Floppy Controller (controls up to 4 drives)
  - CP/M® 2.2 software written for the Disk 1 Controller
  - Cabinet includes power supply & internal data cable
  - External data cable included
- ⓧ Shipped freight collect!
- |            |                  |
|------------|------------------|
| 1 6BT2065P | \$235.00         |
| 1 6BT171A  | \$455.00         |
| 1 6BTCP060 | \$175.00         |
| 1 PCCS0500 | \$ 18.77         |
|            | <b>\$3014.77</b> |

**CABINET AND 2 QUME DT8 DOUBLE SIDED DRIVES \$1295.00**  
PROVIDE 2.4 MBYTES OF MASS STORAGE!!  
List \$2325.00 SAVE \$1030.00! BR 6BT2065P

**CompuPro™ UN-SYSTEM 816**

**FOR THOSE WHO DEMAND  
EXCELLENCE!**



Each CompuPro system contains the same nucleus of common hardware and software. This insures compatibility between systems as well as allowing you to expand as your needs grow. The following is a list of the basic hardware components as well as software.

- HARDWARE:**
- Desk top Enclosure 20 slots
  - Floppy disk enclosure with 2 Qume DT8 drives
  - DMA Floppy Controller
  - 8085/8088 CPU operates 8 or 16 software
  - Memory in the form of RAM 17s
  - System support 1 (Clock calendar, RAM/ROM/math processor options, RS-232 Serial port, dual interrupt controllers, triple interval timers, and more!)
  - All internal cables

- SOFTWARE:**
- CP/M 2.2™ and CP/M 86™
  - M Drive Software - allows the use of memory as another disk drive
  - Sorcim's SUPERCALC 86™
  - Ashton Tate's DBase II

**DIG DEEP!! Now is the time to buy  
the CompuPro UN-SYSTEM 816!!**

SAVE MONEY, and have a UN-SYSTEM 816 for your very own! All UN-SYSTEMS contain the very same components as the SYSTEM 816s listed in our Winter 1983 Engineering Selection Guide, but are not installed or configured. All it takes is your professional computer experience and knowledge to have the highest performing S-100 computer system on the market today. BEWARE! This is not for the novice and inexperienced user, as it requires a well-matured knowledge in system integration procedures.

**So, WHY WAIT!? Don't Pass Up This  
Incredible Deal!!**

Each component of the UN-SYSTEM 816 has been assembled and individually tested. Final installation and configuration are the sole responsibility of the purchaser.

**UN-SYSTEM 816/A  
ENTRY LEVEL - SINGLE USER**

Disk storage: 2.4 Megabytes. Expandable to 4.8 Megabytes.  
Main memory: 128K - expandable to 1 Megabyte  
Serial Ports: 4 / Parallel Ports: 1  
Centronics/Epson ports: 1  
Software: CP/M 2.2™, CP/M-86™, M-Drive, SuperCalc-86, dBase.

Component List Price: \$6705.00  
**OUR SALE PRICE: \$4795.00**  
SAVE \$1910.00!!

**UN-SYSTEM 816/B  
ENHANCED HIGH PERFORMANCE  
SINGLE USER SYSTEM**

Disk Storage: 2.4 Megabytes. Expandable to 4.8 Megabytes.  
Main memory: 256K - expandable to 1 Megabyte  
Serial ports: 6  
Software: CP/M 2.2™, CP/M-86™, M-Drive, SuperCalc-86™, dBase II™

Component List Price: \$8497.00  
**OUR SALE PRICE: \$5795.00**  
SAVE \$2702.00!!

**UN-SYSTEM 816/C  
HIGH PERFORMANCE MULTI-USER SYSTEM**

Disk storage: 2.4 Megabytes. Expandable to 4.8 Megabytes.  
Main memory: 384K - expandable to 1 Megabyte  
Serial ports: 9  
Software: CP/M 2.2™, CP/M-86™, MP/M 8-16™, M-Drive, SuperCalc-86™, dBase II™

Component List Price: \$10,636.00  
**OUR SALE PRICE: \$7595.00**  
SAVE \$3041.00!!



**PRIORITY ONE ELECTRONICS**



**ORDER TOLL FREE (800) 423-5922 - CA, AK, HI CALL (213) 709-5111**

Terms: U.S. VISA, MC, BAC, Check, Money Order, U.S. Funds Only. CA residents add 6 1/2% Sales Tax. MINIMUM PREPAID ORDER \$15.00. Include MINIMUM SHIPPING & HANDLING of \$3.00 for the first 3 lbs. plus 40¢ for each additional pound. Orders over 50 lbs. sent freight collect. Just in case, please include your phone number. Prices subject to change without notice. We will do our best to maintain prices through June, 1983. Credit Card orders will be charged appropriate freight. If you haven't received your Winter '83 Engineering Selection guide, send \$1.00 for your copy today! Sale prices for prepaid orders only.

**RETAIL STORE PHONE NUMBERS: (Chatsworth:) (213) 709-5464 - (Irvine:) (714) 660-1411**

Circle 309 on inquiry card.

**SIEMENS FDD100-8**

## 8" FLOPPY DISK DRIVE

**SINGLE SIDED, DOUBLE DENSITY  
SHUGART 801R COMPATIBLE**

**90 DAY WARRANTY!**

**ONCE AGAIN YOU RECEIVE THE BENEFIT OF OUR UNEQUALLED PURCHASING POWER!**



Ea. **\$225.00**  
2-9 **\$199.00**  
10+ **CALL**

**ORDER NOW AND SAVE!**

DEM INQUIRIES INVITED  
(Include \$7.00 per drive for shipping)  
BR SIEFDD1008

**NEW LOW PRICES!**



### 5 1/4" DISK DRIVES

BRMPI51*	Single-Sided Double-Density 48 TPI	\$200.00
BRMPI52*	Double-Sided Double-Density 48 TPI	\$270.00
BRMPI91*	Single-Sided Double-Density 96 TPI	\$275.00
BRMPI92*	Double-Sided Double-Density 96 TPI	\$400.00

\*Replace "\*" when ordering, with "m" for MPI style bezel, or "S" for Shugart style bezel. (Shipping Weight 5 lbs.)

**NEW! NEW! NEW! NEW! NEW!**

### 5 1/4" HALF HEIGHT DRIVES!

BRMPI501	1 side, 48 tpi 6ms access	\$260.00
BRMPI502	2 side, 48 tpi 6 ms access	\$300.00
BRMPI901	1 side, 96 tpi 3ms access	\$300.00
BRMPI902	2 side, 96 tpi 3ms access	\$355.00

(Shipping Weight: 4 lbs.)

### 2" HIGH 8" DISK DRIVES

The first 2" high 8" disk drive allows for mounting under the keyboard on CRT, etc.  
NO AC Required +5V +24VDC only  
FAST 3 msec track-to-track!

BRMP41M	1/2 High 1 side double-density	\$380.00
BRMP42M	1/2 High 2 side double-density	\$460.00
BRMP41S	Full height 1 side single drive, dble.-density	\$380.00
BRMP42S	Full height 2 sided single drive, dble.-density	\$480.00
BRMP41D	Full height 1 side dual drive, dble.-density	\$780.00
BRMP42D	Full height 2 side dual drive, dble.-density	\$920.00

(Shipping Weight 11 lbs. per drive)

## S-100 DUAL 8" SUBSYSTEM

BRCCS2422A	S-100 Disk Controller with CP/M 2.2	1 \$399.00
BR SIEFDD1008	Siemens Double Density 8" drive	2 \$398.00
BR IHFD002	Dual Horizontal Cabinet with Power Supply and Data Cable	1 \$295.00

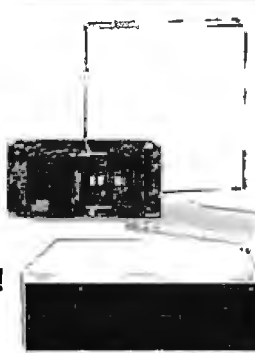
**\$1127.00**

**SAVE \$132.00!!**

# \$995.00

(Include \$30.00 for shipping)

**DON'T MISS OUT!**  
Order No. BR PDBSIESUB1



## Tandon



**8-INCH THIN LINE**

Exactly one-half the height of any other model  
Proprietary, high-resolution, read-write heads patented by Tandon  
D.C. only operation - no A.C. required  
Industry standard interface  
Three millisecond track-to-track access time (9 lbs.)

## BUY DRIVE AND CABINET TOGETHER AND SAVE!

**DUAL 8" SIEMENS FDD1008,  
DUAL 8" CABINET POWER SUPPLY  
AND INTERNAL POWER CABLES**

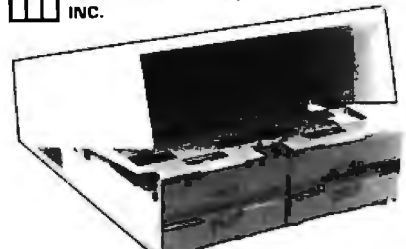
IF BOUGHT SEPARATELY: \$890.00

PRICED AT: **\$675.00**

BR PDBHSIE  
**ENVIRONMENT MONITOR PANEL**  
Temperature and voltage monitor with visual and audible alarm for overtemp condition. Direct Digital Readout of Internal Temperature in C° on standard DVM

BR IHFD002	CABINET ONLY (Sh. Wt. 38 lbs.)	\$295.00
BR PDBHSIEM	2-Drives, Cabinet & disk environment monitor	\$775.00
BR IHFD002EM	Cabinet only with disk environment monitor	\$375.00
BR PDBSOM1BE1BE	Dual Data Cable	\$ 31.15
BR PDBSOS80S	External Data Cable	\$ 19.77

INTERNATIONAL INSTRUMENTATION, INC.



- Positive Pressure Filter Cooling
- Power Supply 4A @ +5V, 3A @ +24V 1A @ -5V
- Each output is individually fused
- Hinged top for easy access
- Heavy non-flex 090 aluminum base
- Modular power connectors

### TANDON 8" DRIVES

BR TNDTM8481	Single Sided:	\$380.00	2 or more:	\$370.00 ea.
BR TNDTM8482	Double Sided:	\$495.00	2 or more:	\$485.00 ea.

### TANDON 5 1/4" DRIVES

BR TNDTM1001	Single Sided, 250KB (5 lbs.)	\$220.00 ea.
		<b>2 or More: \$200.00 each</b>
BR TNDTM1002	Double Sided, 500KB	\$295.00 ea.
		<b>2 or More: \$270.00 each</b>
BR TNDTM1003	Single Sided, 500KB	\$295.00 ea.
		<b>2 or More: \$270.00 each</b>
BR TNDTM1004	Double Sided, 1000KB	\$395.00 ea.
		<b>2 or More: \$375.00 each</b>

## OUR FINEST 8" DUAL DISK DRIVE CABINET

International Instrumentation Incorporated



**Compare these features listed and you'll see why this cabinet is our FINEST DISK CABINET**

**FEATURES**

- Positive pressure forced air cooling for reliable disk drive operation
- AC input via 3 wire 7 foot international cord/socket set
- AC input EMI filtered to six amps to help prevent disk crashes due to power spikes and line noise
- 14 gauge main chassis
- Integral power supply with 5V @ 6A/-5V @ 1A/24V @ 6A
- Double-sided custom PC power board and supply
- Each DC supply and AC separately fused

**STANDARD UNIVERSAL DISK ENCLOSURE**

BR IHUEDD04	List Price	OUR Price
	\$495.00	\$425.00

With augmented power supply to handle Tandon Slimline, or Winchester disk drives. Includes the disk environment monitor.

BR IHUEDD04AUG	\$733.00	\$625.00
----------------	----------	----------

With Disk Environment Monitor for cool, reliable operation.

BR IHUEDD04EM	\$584.95	\$495.00
---------------	----------	----------

## DUAL 8" HALF HEIGHT FLOPPY CABINET

- 24V @ 4A 5V @ 3A -5V @ 800ma
- Fan cooled
- Socketed power connections
- All supplies regulated

INTERNATIONAL INSTRUMENTATION, INC.

BR IHOTL002	Dual Thin Line Cabinet (12 lbs.)	\$225.00	<b>\$165.00</b>
-------------	----------------------------------	----------	-----------------

**BUY THE CABINET & DRIVES AND SAVE!**  
With 2 Tandon ThinLines

BR PDBHSITN01	Cabinet w/2 TNDTM8481 - 1 sided (30 lbs.)	\$885.00
BR PDBHSITN02	Cabinet w/2 TNDTM8482 - 2 sided (30 lbs.)	\$1115.00

**With 2 MPI Slimlines**

BR PDBHSIMP11	Cabinet w/2 MPI41M - 1 sided (30 lbs.)	\$920.00
BR PDBHSIMP12	Cabinet w/2 MPI42M - 2 sided (30 lbs.)	\$1080.00

**Options**

BR IHOTLMPKIT	MPI drive adaptor mounting kit (2 lbs.)	\$24.95
BR IHOCSSHU	Shugart / AC/DC power connector kit (2 lbs.)	\$14.95

(For full size single SA801 or compatible drives)

**APPLE II 5 1/4" DISK DRIVES**

FULLY  
APPLE II  
COMPATIBLE



**APPLE ADD-ON DISK DRIVE**

BRVIS3101 (Sh. Wt. 6 lbs) List Price: \$299.95

**SPECIAL SALE PRICE: \$229.00**

**DISK DRIVE WITH CONTROLLER**

BRVIS3111 (Sh. Wt. 7 lbs) List Price: \$379.00

**SPECIAL SALE PRICE: \$289.00**

BRVISAFDC Apple II Drive Controller **ON SALE NOW FOR ONLY \$79.00**

**LOWEST COST PRINTERS AVAILABLE \$299.00 !!**



**COEX 80 F/T**  
by  
**star**  
MICRONICS INC.

- 80 cps • 10, 12 or 16.5 cpi • 3 selectable line spacing • Vertical format control • Centronics parallel interface • Uses a standard Underwood spooled ribbon • Friction and tractor feed (Shipping Weight 21 lbs.)

BRCOX80FT Parallel int. **\$399.00 \$299.00**

BRCOXAPLINTP Apple parallel interface w/cable **\$49.95**

**IBM MULTICARD**

**Vista™ MEMORY & I/O CARD**



- 64K RAM Expandable to 256K
- One RS232 Serial Port
- One Parallel Printer Port
- Real Time Clock Calendar with Battery Backup (Sh. Wt. 1 lb.)

BRVIS025665 List Price: \$595.00

**SALE PRICE:**

**\$329.00**

**IBM MAXICARD**

**Vista PERSONAL COMPUTER RAM CARD**  
POPULATED IN 64K, 256K, or 576K



- Runs at full speed with no wait states
- Parity can be disabled at User's option
- On board parity bit on each Byte
- Fully expanded, a full 576KB on one card
- One board fills entire primary RAM address space available
- Full Vista 120 Day Warranty

**64K \$219.00**  
BRVIS057884 List Price: \$379.00  
**SAVE \$160.00**

**256K \$489.00**  
BRVIS0578258 List Price: \$789.00  
**SAVE \$320.00**

**576K \$849.00**  
BRVIS0578576 List Price: \$1299.00  
**SAVE \$450.00**

\*Available with 256K & 576K boards only (Sh. Wt. 6 lbs.) (IBM is a trademark of International Business Machines)

**EIA/RS232 WALL PLATES**

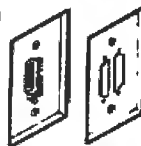
(Does not include connectors)

BR11WPDB251 Single punched

**4/\$10.00**

BR11WPDB252 Dual Punched

**4/\$12.00**



**RS-232 "D" SUB-MINIATURE CONNECTORS**

1-8 10-24 25-99 100-UP

BRCN00B25P	25 Pin Male	\$2.75	\$2.50	\$2.25	\$1.95
BRCN00B25S	25 Pin Female	\$4.00	\$3.50	\$3.25	\$3.00
BRCN00B51212	1 Pc. Grey Hood	\$1.85	\$1.40	\$1.25	\$1.15
BRCN0P25H	2 Pc. Grey Hood	\$1.50	\$1.25	\$1.10	\$1.00
BRCN00B51226	2 Pc. Black Hood	\$1.75	\$1.50	\$1.35	\$1.20
BRCN00Z041B	Hardware set 2/Pr.	\$1.00	\$.80	\$.70	\$.80

**TEXAS INSTRUMENTS**

**16 PIN GOLD AND TIN DIP SOLDER TAIL SOCKETS**



	TIN	GOLD
QTY	BRTIS16LP	BRTIG16LP
50	\$ 8.00	\$ 10.00
(Sh. Wt. 4 oz)	\$ 60.00	\$ 80.00
1000	\$225.00	\$315.00
(Sh. Wt. 4 lbs.)		
4500		
(Sh. Wt. 15 lbs.)		

**DIRECT CONNECT MODEM**

**\$79.00**

**0 - 300 BAUD MURA MM-100**

**MURA**



- 0 - 300 baud
- RS232C interface
- Full duplex
- Carrier detect indicator
- Bell 103 compatible
- Low voltage
- Original Answer switch selectable

	List Price	SALE
BRMURMM100 0 - 300 baud modem (Shipping Weight: 2 lbs.)	\$99.95	<b>\$79.00</b>
BRCNDRS2328F RS232 cable		<b>\$19.95</b>

**\$229.00**

**AXIOM**  
AXIOM CORPORATION



**SAVE \$160.00!!**

- 5 x 7 Dot Matrix • Parallel Interface (Centronics) • Tractor Feed
- Dot Addressable Graphics • Up to 3-Part Paper • Self Test • One Year Warranty • 30 CPS 80 Column Unidirectional • Uses Regular Paper

BRAXIOMP100A Dot Matrix Printer **\$389.00 \$229.00**

**ULTRA MAGNETICS**

**5 1/4" FLOPPY DISKETTES**

**LIFETIME WARRANTY!**

**DOUBLE DENSITY!**

- FEATURES:**
- Includes reinforcement ring
  - Write protect with tabs
  - 100% Surface tested
  - Lifetime warranty



**SALE!**

**SINGLE SIDED**

<b>40 TRACKS —</b>	<b>BOX OF</b>	<b>\$25.00</b>
<b>DOUBLE DENSITY</b>	<b>10</b>	
<b>ORDER INFORMATION:</b>	<b>2</b>	<b>\$40.00</b>
BRPULT51401 Soft Sector	<b>BOXES:</b>	
BRPULT51410 10 Sector	<b>10</b>	<b>\$180.00</b>
BRPULT51416 16 Sector	<b>BOXES:</b>	

Description	Box of 10	2 Boxes	10 Boxes
BR ULTS2401 Soft sector, 40 track, 2 side	<b>\$35.00</b>	<b>\$60.00</b>	<b>\$280.00</b>
BR ULTS2410 10 sector, 40 track, 2 side			
BR ULTS2416 16 sector, 40 track, 2 side			
BR ULT51801 Soft sector, 80 track, 1 side	<b>\$30.00</b>	<b>\$50.00</b>	<b>\$220.00</b>
BR ULT51810 10 sector, 80 track, 1 side			
BR ULT51816 16 sector, 80 track, 1 side			
BR ULT52801 Soft sector, 80 track, 2 sided	<b>\$40.00</b>	<b>\$70.00</b>	<b>\$320.00</b>
BR ULT52810 10 sector, 80 track, 2 sided			
BR ULT52816 16 Sector, 80 track, 2 sided			

**star**  
MICRONICS INC.

**gemini**



**100CPS DOT MATRIX PRINTER**

- Centronics parallel interface • 9 x 9 character matrix • 6 x 6 block graphic matrix • Bit Image (7 or 8) x 480 dot matrix (single density) (7 or 8) x 960 dot matrix • Bi-directional printing with logic seeking • 40, 48, 66, 80, 96, or 132 characters per line • 96 ASCII characters • 5, 6, 8, 5, 10, 12, or 17 characters per inch • 1/6, 1/8, n/72, n/144 Line pitch • Sprocket or friction feed • Uses a standard underwood ribbon

BRGEM10 80 Column\* Printer List Price: \$399.00

**SALE PRICE: \$359.00**  
(Shipping Weight: 20 lbs.)

BRGEM15 132 Column\* Printer List Price: \$649.00

**SALE PRICE: \$489.00**  
(Shipping Weight: 26 lbs.)

\*Based on 10 characters per inch

**SERIAL INTERFACE CARD FOR GEMINI 10 & 15**  
BRGEMSERINT Serial Interface Module (Sh. Wt. 1 lb.) **\$85.00**

**RETAIL STORE PHONE NUMBERS: (Chatsworth:) (213) 709-5464 - (Irvine:) (714) 660-1411**

Circle 309 on inquiry card.

# COMPLETE 8 BIT ENTRY LEVEL CP/M® BASED COMPUTER SYSTEM



- Z80B 6MHz CPU • 2.4 Mbytes of floppy disk storage using the best QUME DATATRAK 8 drives • Fast DMA disk controller • 64K low power static RAM • 3 serial RS-232 ports • 1 parallel port • 1 centronics printer port • 20 slot S-100 IEEE mainframe • Constant voltage transformer • CP/M 2.2® included • I/O and disk drive cables included

LOOK AT WHAT YOU GET!

		List Price
BRGBT160A	6 MHz Z80 CPU	\$325.00
BRGBT171A	DMA Disk Controller	\$495.00
BRGBT206SP	Dual QUME Drives and Cabinet	\$2395.00
BRGBT187A	3 Serial, 1 Parallel, 1 Centronics I/O	\$399.00
BRGBTAM17	64K Static RAM	\$499.00
BRGBTENC200K	20 Slot S-100 Mainframe	\$825.00
BRGBTCPM80	CP/M 2.2® with BIOS	\$175.00
BRGBTCL4	3 Port Serial Cable to Cabinet	\$ 44.00
BRGBTCL9	Centronics Cable to Cabinet	\$ 29.50
BRPGC50S6DS	5' Drive Cable	\$ 19.77

TOTAL PURCHASE VALUE: **\$5206.27**

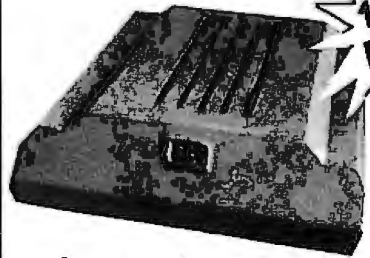
**BUY IT NOW FOR ONLY:**

# \$3495

BRPDBGBT8BT

**SAVE \$1711.27!**

**NEW!! PASSWORD**  
by  U.S. ROBOTICS  
**BELL 212A AUTO/DIAL MODEM HAYES SMARTMODEM COMPATIBLE**



**1200 BAUD**

# \$425.00

PASSWORD puts any micro computer into a telecommuting network with 300/1200 baud speed, programmable auto dial and auto answer capability, auto mode and auto speed select, audio phone line monitor, and other advanced features. So simple, one button operates it. So compact it mounts on the back of a computer with Velcro®. The PASSWORD features all of the same operating specifications as the AUTO DIAL 212A modem at only a fraction of the cost!

Part No.	List Price	SALE
BRUSRPPASSWORD (sh. wt. 4 lbs.)	\$449.00	<b>\$425.00</b>

## TELPAC SOFTWARE PACKAGE

TELPAC, the USR software package, programs computers to exploit all the automatic dialing features of the USRPASSWORD and USRDIAL212A modems, including timed calls, login-logout, custom phone directories, access passwords, and much more!

BRUSRTELPAC5A on APPLE II soft sector	\$79.00
BRUSRTELPAC8 on 8" single density (Shipping Weight 1 lb)	\$79.00

# SUPER DMM SALE



**HITACHI**  
Hitachi Denshi America, Ltd.

## AUTO RANGING 3 1/2 DIGIT LCD

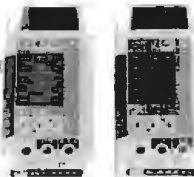
- Eight measurement functions with auto ranging • Data hold feature • Continuity beeper • Temperature measurements (except HITVR3550) • .5 to 1% accuracy • 10 M input impedance • 250V overload protection on all resistance functions • 1100 VDC or 850 VAC overload protection on volt scales

List Price: **SALE**

BR HITVR3550 5% Autoranging DMM	\$127.00	<b>\$105</b>
BR HITVR3525 25% with temp	\$157.00	<b>\$130</b>
BR HITVR3510 1% with temp	\$187.00	<b>\$160</b>
BR HIT6703 Soft carrying case		<b>\$ 15</b>

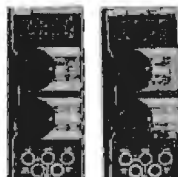


**FLUKE**  
**DMMs**



BRFLU8022B	Handheld DMM 25% Accuracy	\$144.00
BRFLU8021B	Handheld DMM 5% Accuracy w/cond.	\$159.00
BRFLU8028B	Handheld DMM 1% Accuracy	\$194.00
BRFLU8024B	Handheld DMM 1% Accuracy, Pk & Hold	\$249.00
BRFLU8010A	10A Tru RMS Bench DMM	\$259.00
BRFLU8010AD1	FLU8010A w/battery	\$299.00
BRFLU8012A	Low Ohms Tru-RMS Bench	\$339.00
BRFLU8012AD1	FLU8012A w/battery	\$379.00
BRFLU8060A	4 1/2 Digit DMM w/Frequency Counter	\$349.00
BRFLU8062A	4.5 digit Handheld DMM	\$279.00
BRFLU8050A	4.5 digit tru-RMS Bench	\$389.00
BRFLU8050AD1	FLU8050A w/battery	\$439.00
BRFLUC90	Soft carrying case	(\$10.00) <b>1¢</b>

**KEITHLEY**  
**DMMs**



BRKTH130	3.5 digit 5% Acc handheld OMM	\$129.00
BRKTH131	3.5 digit 25% Acc handheld DMM	\$139.00
BRKTH128	3.5 digit handheld DMM w/beeper	\$139.00
BRKTH132C	3.5 digit handheld DMM/thermometer Cent.	\$199.00
BRKTH132F	3.5 digit handheld DMM/thermometer Far.	\$209.00
BRKTH135	4 1/2 digit handheld DMM	\$239.00
BRKTH169	3.5 digit bench LCD DMM	\$189.00
BRKTH176	4.5 digit bench LCD DMM	\$299.00
BRKTH179A	4.5 digit bench LED DMM	\$359.00
BRKTH1911910	5 digit bench	\$870.00
BRKTH1911920	5.5 digit bench true RMS	\$940.00
BRKTH1304	Soft carrying case	(10.00) <b>1¢</b>

## BUY A SOFT CARRYING CASE FOR 1¢

\*WITH THE PURCHASE OF ANY FLUKE OR KEITHLY HANDHELD DMM!

## 1200 BAUD AUTO DIAL DIRECT CONNECT MODEMS WITH 10 NUMBER MEMORY RIXON INC.



### STANDALONE OR IBM PC CARD

- 0-300 baud or 1200 baud operation • Auto dial • Tone or pulse dial • Redial last number • Auto answer • 5 second dial delay • link to another number • wait for dial tone • 10 number memory of up to 60 characters in length - 60 character field can include ID code, password, and a description of the called station - single keystroke actuates a number • PC COM™ modem operating software package for IBM PC™ optional • Shipping weight 2 lbs.

List Price SALE Price

BRRIXR212A Standalone Unit	\$495.00	\$475.00
----------------------------	----------	----------

### IBM PC™ COMPATIBLE MODEM CARD

- Features all the same specifications as standalone unit.
- |                                       |          |          |
|---------------------------------------|----------|----------|
| BRRIXPC212A IBM PC™ modem (2 lbs)     | \$495.00 | \$475.00 |
| BRRIXPCCOM1 IBM modem software (1 lb) |          | \$ 89.00 |

**BUY THE CARD AND SOFTWARE TOGETHER AND SAVE!!**

BRPDBRIXIBM Card and Software (3 lbs)	\$539.00
---------------------------------------	----------

(SEE PAGE 431 IN MAY ISSUE OF BYTE)

## 1200 BAUD AUTO-DIAL HAYES SMARTMODEM COMPATIBLE



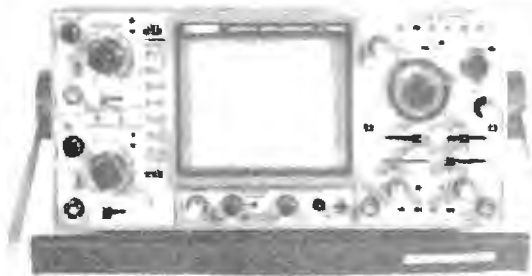
### MODEMS

# \$495.00

The AUTO DIAL 212A Modem is a direct connect 0-300 or 1200 baud modem capable of dialing and calling for you. The AUTO DIAL 212A is compatible in function to the DC Hayes SMARTMODEM™.

Part No.	Description	List Price	SALE Price
BR USRDIAL212A	0-300 1200 baud dialing modem	\$599.00	<b>\$495.00</b>

# LAST CHANCE FOR SCOPE REBATE!!



**DUAL TIME BASE!  
CALIBRATED DELAYED SWEEP!**

**100 MHz**  
8 TRACE - 4 CHANNEL  
BRBKP1590 List Price: \$1995.00  
**\$1449.00**  
(Shipping Weight 18 lbs.)  
**SAVE \$546.00!!**

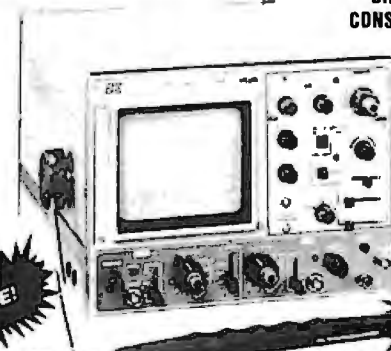
**70 MHz**  
8 TRACE - 4 CHANNEL  
BRBKP1570 List Price: \$1395.00  
**\$995.00**  
(Shipping Weight 18 lbs.)  
**SAVE \$400.00!!**

**NO ONE ELSE HAS LOWER SCOPE PRICES!!**



**\$75.00 REBATE!**

**35 MHz**  
DUAL TRACE - TRIGGERED  
BRBKP1535 List Price: \$950.00  
**\$695.00**  
(Shipping Weight 20 lbs.)  
**SAVE \$430.00!!**  
**INCLUDING REBATE**



**DIRECT FACTORY CONSUMER REBATE CERTIFICATE INCLUDED!**  
(Valid through June 30, 1983)

**\$50.00 REBATE!**

**30 MHz**  
DUAL TRACE - DELAYED SWEEP  
BRBKP1530 List Price: \$875.00  
**\$599.00**  
(Shipping Weight 20 lbs.)  
**SAVE \$326.00!!**  
**INCLUDING REBATE**

2 Probes Included With Each Scope!



**12" RGB COLOR MONITOR**  
380 HORIZONTAL LINE RESOLUTION

BQTAXRGB1  
List Price: \$399.00  
(Sh. Wt. 29 lbs)

**\$329**

BQTAXIBMRGB  
Interface cable to IBM \$19.00

BQTAXRGBAPL  
Apple IIe & III cable \$19.00

**WITH APPLE II RGB INTERFACE**

BQPD8TAXRGBAPL  
List Price: \$528.00 **\$359.00**

**12" RGB SUPER HIGH RESOLUTION MONITOR**  
630 HORIZONTAL LINE RESOLUTION

• 18MHz bandwidth  
• Linear RGB input provides unlimited color combinations  
• Compatible with APPLE III and IBM P/C

BQTAXRGB3  
LIST PRICE: \$699.00  
(Sh. Wt. 29 lbs.)

**SALE PRICE: \$595.00**

**SUPER HIGH RESOLUTION RGB MONITOR WITH AN APPLE INTERFACE CARD**  
BQPD8RGB3APL **\$695.00**

**RGB VIDEO INTERFACE WITH 80 CHARACTER ALPHANUMERIC FORMAT FOR THE APPLE IIe**  
BRTAX41080 APPLE IIe RGB Int. List: \$199.00 SALE: \$189.00

**HIGH RESOLUTION 12" GREEN OR AMBER VIDEO MONITOR**



• >18 MHz bandwidth  
• 800 line horizontal resolution  
• Composite video input  
BQTAXKG12N Green  
BQTAXKG12NUY Amber  
LIST PRICE: \$179.00  
(Shipping Weight 19 lbs.)

**SALE PRICE: \$129.00**

THE LEMON™ SOURS SURGES



NEW!  
FROM EPD  
The LEMON, LIME, ORANGE, and PEACH are solid state and EMI-RFI noise filters designed to protect all mini and micro computers, word processors, printers, disc drives, and other computer-controlled equipment that is plugged into an AC power line. There may be nothing more terrifying than to lose all of your software or data files due to a high voltage spike or noise from an adjacent elevator, air conditioner, or any other high powered equipment being operated in the nearby area. With a LEMON, LIME, ORANGE, or PEACH, you can be sure that the FRUITS of your computer will be protected from most voltage spikes and EMI-RFI interferences.

**AC SURGE PROTECTORS**

Part No.	Description	List Price	SALE PRICE
BREP0LEMON	6 outlet wall mount	\$59.95	\$44.95
BREP0LIME	6 outlet 4 1/2' cord w/power switch	\$89.50	\$69.95

(Shipping Weight: 4 lbs. each)

**EMI-RFI FILTERED AC SURGE PROTECTOR**

BREP0ORANGE	6 outlet 4 1/2' cord w/power switch	\$139.95	\$104.95
BREP0PEACH	6 outlet wall mount	\$97.50	\$74.95

(Shipping Weight: 4 lbs. each)

COLOR IS INDICATED BY PART NUMBER

**MURAPHONE CORDLESS CORDLESS TELEPHONE**

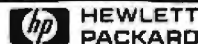
**\$95**

**600' RANGE!!**

• 12 button dial pad • last number called auto redial • hide-away base unit • battery charger plugs into AC outlet • includes carry case  
BRMUR600/601 (Sh. Wt. 3 lbs.) List Price: \$129.95

**ON SALE NOW FOR ONLY \$95**

**H-P QUALITY & PERFORMANCE AT OUR LOW PRICES!!**



**SERIES 10 PROGRAMMABLE CALCULATORS**

Model	Description	List Price	SALE
BR HP-10C	Scientific	\$70.00	\$59.00
BR HP-11C	Adv. scientific	\$90.00	\$79.00
BR HP-12C	Adv. financial	\$120.00	\$99.00
BR HP-15C	Adv. sci. w/matrix	\$120.00	\$99.00
BR HP-16C	Digital & Computer science	\$120.00	\$99.00

(Shipping Weight: 3 lbs.)

**HP-41C/CV HANDHELD COMPUTER SYSTEM**

Part No.	Description	List Price	SALE
BR HP-41C	Handheld computer	\$195.00	\$159.00
BR HP-41CV	Handheld computer w/5x the memory	\$275.00	\$219.00
BR HP82104A	Card reader	\$195.00	\$159.00
BR HP82153A	Optical Wand	\$125.00	\$99.00
BR HP82161A	Cassette drive	\$450.00	\$349.00
BR HP82162A	Thermal Printer	\$450.00	\$349.00
BR HP82163A	Video interface	\$225.00	\$179.00

(Shipping Weights: 5 lbs. for each item above)

**ENHANCEMENT MODULES:**

BR HP82160A	HP-IL module	\$125.00	\$95.00
BR HP82170A	Quad RAM module	\$75.00	\$59.00
BR HP82180A	Extended functions/memory module	475.00	\$59.00
BR HP82181A	Ext. memory module	\$75.00	\$59.00
BR HP82182A	Time module	\$75.00	\$59.00

(Shipping Weights: 1 lb. for each item above)

**HP-75C PORTABLE COMPUTER**

BR HP-75C	Portable computer	\$995.00	\$795.00
-----------	-------------------	----------	----------

• Accepts 48K of applications ROM  
• Touch type typewriter like keyboard  
• Powerful BASIC language  
• Expandable using the Series 41 peripherals and modules

**ON SALE NOW FOR ONLY**

**\$795.00**



**PRIORITY ONE ELECTRONICS**

9161 DEERING AVE. CHATSWORTH, CA 91311

**ORDER TOLL FREE (800) 423-5922 - CA, AK, HI CALL (213) 709-5111**

Terms: U.S. VISA, MC, BAC, Check, Money Order, U.S. Funds Only. CA resident add 6 1/2% Sales Tax. MINIMUM PREPAID ORDER \$15.00. Include MINIMUM SHIPPING & HANDLING of \$3.00 for the first 3 lbs. plus 40¢ for each additional pound. Orders over 50 lbs. sent freight collect. Just in case, please include your phone number. Prices subject to change without notice. We will do our best to maintain prices through June, 1983. Credit Card orders will be charged appropriate freight. If you haven't received your Winter '83 Engineering Selection guide, send \$1.00 for your copy today! Sale prices for prepaid orders only.



RETAIL STORE PHONE NUMBERS: (Chatsworth:) (213) 709-5464 - (Irvine:) (714) 660-1411

**4164** 64K DYNAMIC \$595  
200 NS

**TMM2016** 2KX8 STATIC \$415  
200 NS

**STATIC RAMS**

2101	256 x 4 (450ns)	1.95
5101	256 x 4 (450ns) (cmos)	3.95
2102-1	1024 x 1 (450ns)	.89
2102L-4	1024 x 1 (450ns) (LP)	.99
2102L-2	1024 x 1 (250ns) (LP)	1.49
2111	256 x 4 (450ns)	2.49
2112	256 x 4 (450ns)	2.99
2114	1024 x 4 (450ns)	8/9.95
2114L-4	1024 x 4 (450ns) (LP)	8/12.95
2114L-3	1024 x 4 (300ns) (LP)	8/13.45
2114L-2	1024 x 4 (200ns) (LP)	8/13.95
2147	4096 x 1 (55ns)	4.95
TMS4044-4	4096 x 1 (450ns)	3.49
TMS4044-3	4096 x 1 (300ns)	3.99
TMS4044-2	4096 x 1 (200ns)	4.49
MK4118	1024 x 8 (250ns)	9.95
TMM2016-200	2048 x 8 (200ns)	4.15
TMM2016-150	2048 x 8 (150ns)	4.95
TMM2016-100	2048 x 8 (100ns)	6.15
HM6116-4	2048 x 8 (200ns) (cmos)	4.75
HM6116-3	2048 x 8 (150ns) (cmos)	4.95
HM6116-2	2048 x 8 (120ns) (cmos)	8.95
HM6116LP-4	2048 x 8 (200ns) (cmos)(LP)	5.95
HM6116LP-3	2048 x 8 (150ns) (cmos)(LP)	6.95
HM6116LP-2	2048 x 8 (120ns) (cmos)(LP)	10.95
Z-6132	4096 x 8 (300ns) (Qstat)	34.95

LP = Low Power Qstat = Quasi-Static

**DYNAMIC RAMS**

TMS4027	4096 x 1 (250ns)	1.99
UPD411	4096 x 1 (300ns)	3.00
MMS280	4096 x 1 (300ns)	3.00
MK4108	8192 x 1 (200ns)	1.95
MMS298	8192 x 1 (250ns)	1.85
4116-300	16384 x 1 (300ns)	8/11.75
4116-250	16384 x 1 (250ns)	8/11.95
4116-200	16384 x 1 (200ns)	8/12.95
4116-150	16384 x 1 (150ns)	8/14.95
4116-120	16384 x 1 (120ns)	8/29.95
2118	16384 x 1 (150ns) (5v)	4.95
4164-200	65536 x 1 (200ns) (5v)	5.95
4164-150	65536 x 1 (150ns) (5v)	6.95

5V = single 5 volt supply

**EPROMS**

1702	256 x 8 (1us)	4.50
.2708	1024 x 8 (450ns)	3.95
2758	1024 x 8 (450ns) (5v)	6.95
2716	2048 x 8 (450ns) (5v)	3.95
2716-1	2048 x 8 (350ns) (5v)	5.95
TMS2516	2048 x 8 (450ns) (5v)	5.50
TMS2716	2048 x 8 (450ns)	7.95
TMS2532	4096 x 8 (450ns) (5v)	5.95
2732	4096 x 8 (450ns) (5v)	4.95
2732-250	4096 x 8 (250ns) (5v)	6.95
2732-200	4096 x 8 (200ns) (5v)	11.95
2764	8192 x 8 (450ns) (5v)	8.95
2764-250	8192 x 8 (250ns) (5v)	14.95
2764-200	8192 x 8 (200ns) (5v)	24.95
TMS2564	8192 x 8 (450ns) (5v)	17.95
MC68764	8192 x 8 (450ns) (5v)(24 pin)	38.95

5v = Single 5 Volt Supply

**EPROM ERASERS**

	Timer	Capacity Chip	Intensity (uW/Cm <sup>2</sup> )	
PE-14		6	5,200	83.00
PE-14T	X	6	5,200	119.00
PE-24T	X	9	6,700	175.00
PL-265T	X	20	6,700	255.00
PR-125T	X	16	15,000	349.00
PR-320	X	32	15,000	595.00

**Z-80**

**2.5 Mhz**

Z80-CPU	3.95
Z80-CTC	4.49
Z80-DART	10.95
Z80-DMA	14.95
Z80-PIO	4.49
Z80-SIO/0	16.95
Z80-SIO/1	16.95
Z80-SIO/2	16.95
Z80-SIO/9	16.95

**4.0 Mhz**

Z80A-CPU	4.95
Z80A-CTC	4.95
Z80A-DART	11.95
Z80A-DMA	16.95
Z80A-PIO	4.95
Z80A-SIO/0	16.95
Z80A-SIO/1	16.95
Z80A-SIO/2	16.95
Z80A-SIO/9	16.95

**6.0 Mhz**

Z80B-CPU	11.95
Z80B-CTC	13.95
Z80B-PIO	13.95
Z80B-DART	19.95

**ZILOG**

Z6132	34.95
Z8671	39.95

**CRYSTALS**

32.768 khz	1.95
1.0 mhz	4.95
1.8432	4.95
2.0	3.95
2.097152	3.95
2.4576	3.95
3.2768	3.95
3.579535	3.95
4.0	3.95
5.0	3.95
5.0688	3.95
5.185	3.95
5.7143	3.95
6.0	3.95
6.144	3.95
6.5536	3.95
8.0	3.95
10.738635	3.95
14.31818	3.95
15.0	3.95
16.0	3.95
17.430	3.95
18.0	3.95
18.432	3.95
20.0	3.95
22.1184	3.95
32.0	3.95

**CRT**

**CONTROLLERS**

6845	14.95
68B45	35.95
HD46505SP	16.95
6847	12.25
MC1372	6.95
68047	24.95
8275	20.95
7220	99.95
CRT5027	39.95
CRT5037	49.95
TMS9918A	39.95
DP8350	49.95

**KEYBOARD CHIPS**

AY5-2376	11.95
AY5-3600	11.95

**8000**

8035	5.95
8039	6.95
INS-8060	17.95
INS-8073	24.95
8080	3.95
8085	5.95
8085A-2	11.95
8086	29.95
8087	CALL
8088	39.95
8089	89.95
8155	6.95
8155-2	7.95
8156	6.95
8185	29.95
8185-2	39.95
8741	39.95
8748	24.95
8755	24.95

**8200**

8202	24.95
8203	39.95
8205	3.50
8212	1.80
8214	3.85
8216	1.75
8224	2.25
8226	1.80
8228	3.45
8231	call
8237	19.95
8237-5	21.95
8238	4.49
8243	4.45
8250	10.95
8251	4.49
8253	6.95
8253-5	7.95
8255	4.49
8255-5	5.25
8257	7.95
8257-5	8.95
8259	6.90
8259-5	7.50
8271	39.95
8272	39.95
8275	29.95
8279	8.95
8279-5	10.00
8282	6.50
8283	6.50
8284	5.50
8286	6.50
8287	6.50
8288	25.00
8289	49.95

**DISC CONTROLLERS**

1771	18.95
1791	24.95
1793	26.95
1795	49.95
1797	49.95
2791	54.95
2793	54.95
2795	59.95
2797	59.95
6843	34.95
8272	39.95
UPD765	39.95
1691	17.95
2143	18.95

**CONNECTORS**

RS232 MALE	2.50
RS232 FEMALE	3.25
RS232 HOOD	1.25
S-100 ST	3.95

**6800**

68000	59.95
6800	3.95
6802	7.95
6808	13.90
6809E	19.95
6809	11.95
6810	2.95
6820	4.35
6821	3.25
6828	14.95
6840	12.95
6843	34.95
6844	25.95
6845	14.95
6847	11.95
6850	3.25
6852	5.75
6860	9.95
6862	11.95
6875	6.95
6880	2.25
6883	22.95
68047	24.95
68488	19.95

**6800 = 1MHZ**

68B00	10.95
68B02	22.25
68B09E	29.95
68B09	29.95
68B10	6.95
68B21	6.95
68B45	19.95
68B50	5.95

**6800 = 2 MHZ**

6500	4.95
6504	6.95
6505	8.95
6507	9.95
6520	4.35
6522	7.95
6532	9.95
6545	22.50
6551	11.85

**6500 2 MHZ**

6502A	6.95
6522A	9.95
6532A	11.95
6545A	27.95
6551A	11.95

**6500 3 MHZ**

6502B	14.95
-------	-------

**6500**

**1 MHZ**

6502	6.95
6522	9.95
6532	11.95
6545	27.95
6551	11.95

**2 MHZ**

6502A	6.95
6522A	9.95
6532A	11.95
6545A	27.95
6551A	11.95

**3 MHZ**

6502B	14.95
-------	-------

**UARTS**

AY3-1014	6.95
AY5-1013	3.95
AY3-1015	6.95
PT1472	9.95
TR1602	3.95
2350	9.95
2651	8.95
TMS6011	5.95
IM6402	7.95
IM6403	8.95
INS8250	10.95

**GENERATORS**

**BIT-RATE**

MC14411	11.95
BR1941	11.95
4702	12.95
COM5016	16.95
COM8116	10.95
MMS307	10.95

**FUNCTION**

MC4024	3.95
LM566	1.49
XR2206	3.75
8038	3.95

**74LS00**

74LS00	.24	74LS173	.6
74LS01	.25	74LS174	.5
74LS02	.25	74LS175	.5
74LS03	.25	74LS181	2.1
74LS04	.24	74LS189	8.9
74LS05	.25	74LS190	.8
74LS08	.28	74LS191	.8
74LS09	.29	74LS192	.7
74LS10	.25	74LS193	.7
74LS11	.35	74LS194	.6
74LS12	.35	74LS195	.6
74LS13	.45	74LS196	.7
74LS14	.59	74LS197	.7
74LS15	.35	74LS221	.8
74LS20	.25	74LS240	.9
74LS21	.29	74LS241	.9
74LS22	.25	74LS242	.9
74LS26	.29	74LS243	.9
74LS27	.29	74LS244	.9
74LS28	.35	74LS245	1.4
74LS30	.25	74LS247	.9
74LS32	.29	74LS248	.9
74LS33	.55	74LS249	.9
74LS37	.35	74LS251	.5
74LS38	.35	74LS253	.5
74LS40	.25	74LS257	.5
74LS42	.49	74LS258	.5
74LS47	.75	74LS259	2.7
74LS48	.75	74LS260	.5
74LS49	.75	74LS266	.5
74LS51	.25	74LS273	1.4
74LS54	.29	74LS275	3.3
74LS55	.29	74LS279	.4
74LS63	1.25	74LS280	1.9
74LS73	.39	74LS283	.6
74LS74	.35	74LS290	.8
74LS75	.39	74LS293	.8
74LS76	.39	74LS295	.9
74LS78	.49	74LS298	.8
74LS83	.60	74LS299	1.7
74LS85	.69	74LS323	3.5
74LS86	.39	74LS324	1.7
74LS90</			



**2732** 32K EPROM

**\$495**

**2764** 64K EPROM

**\$995**

**CAPACITORS**

**TANTALUM**

	6V	10V	15V	20V	25V	35V	50V
.22uf						.40	
.27						.40	
.33						.40	.45
.47				.35		.50	
.68					.45	.50	
1.0		.40	.40	.45	.45		
1.5			.45		.50	.60	
1.8						.75	
2.2		.35	.40	.45		.65	.85
2.7		.40	.45			.90	
3.3		.45	.50	.55	.60	.65	.90
3.9		.45					
4.7	.45	.55		.60	.65	.85	.90
6.0		.60					
6.8		.70	.75				
8.2							1.00
10	.55	.65	.80	.85	.90	1.00	
12	.65		.85	.90			
15	.75	.85	.90				
18			1.25				
22		1.00	1.35				
27			2.25				
39		1.50					
47		1.35					
56		1.75					
100			3.25				
270		3.75					

**DISC**

	50V	.05	470	50V	.05
22	50V	.05	560	50V	.05
25	50V	.05	680	50V	.05
27	50V	.05	820	50V	.05
33	50V	.05	.001uf	50V	.05
47	50V	.05	.0015	50V	.05
56	50V	.05	.0022	50V	.05
68	50V	.05	.005	50V	.05
82	50V	.05	.01	50V	.07
100	50V	.05	.02	50V	.07
220	50V	.05	.05	50V	.07
330	50V	.05	.1	12V	.10
			.1	50V	.12

**MONOLITHIC**

.1uf-mono 50V	.18	.47uf-mono 50V	.25
---------------	-----	----------------	-----

**ELECTROLYTIC**

RADIAL		AXIAL	
.47uf	50V .14	1uf	50V .14
1	25V .14	4.7	16V .14
2.2	35V .15	10	16V .14
4.7	50V .15	10	50V .16
10	50V .15	22	16V .14
47	35V .18	47	50V .20
100	16V .18	100	15V .20
220	35V .20	100	35V .25
470	25V .30	150	25V .25
2200	16V .60	220	25V .30
		330	16V .40
		500	16V .42
		1000	16V .60
		1500	16V .70
		6000	16V .85

**COMPUTER GRADE**

26,000uf 30V	3.95
6000	16V .85

**WIREWRAP CARDS**

FR-4 Epoxy Glass Laminate  
With Gold-Plated Contact Fingers

**S-100 BUSS**

<b>P100-1</b>	Bare — No Foil Pads	15.95
<b>P100-2</b>	Horizontal BUSS	22.95
<b>P100-3</b>	Vertical BUSS	22.95
<b>P100-4</b>	Single Foil Pads Per Hole	23.95

**APPLE**

<b>P500-1</b>	Bare — No Foil Pads	15.95
<b>P500-3</b>	Horizontal BUSS	22.95
<b>P500-4</b>	Single Foil Pads Per Hole	23.95

**IBM**

<b>IBM-PR</b>	BUSS Lines + Pads	55.00
---------------	-------------------	-------

**GENERAL PURPOSE**

22/44 PIN (.156" SPACING)

<b>P441-3</b>	Vertical BUSS, 4.5" x 6"	13.95
<b>P442-3</b>	Vertical BUSS, 4.5" x 9"	14.95

36/72 PIN (.1" SPACING)

<b>P721-3</b>	Vertical BUSS, 4.5" x 6"	13.95
<b>P722-3</b>	Vertical BUSS, 4.5" x 9"	14.95

**IF YOU CAN FIND A PRICE LOWER ELSEWHERE LET US KNOW AND WE WILL MEET OR BEAT THEIR PRICE! (SEE TERMS BELOW)**

**OPTO-ISOLATORS**

4N26	1.00	MCA-7	1.50
4N27	1.10	MCA-255	1.75
4N28	.69	IL-1	1.25
4N33	1.75	ILA-30	1.25
4N35	1.25	ILQ-74	2.75
4N37	1.25	H11C5	1.25
MCT-2	1.00	TIL-111	1.00
MCT-6	1.50	TIL-113	1.75

**DIODES**

1N751	5.1 volt zener	.25
1N759	12.0 volt zener	.25
1N4148	(1N914) switching	25/1.00
1N4004	400PIV rectifier	10/1.00
KBP02	200PIV 1.5amp bridge	.45
KBP04	400PIV 1.5amp bridge	.55

**MUFFIN FANS NEW UN-USED**

4.85" Square	14.95
3.125" Square	14.95

**SWITCHES**

SPDT mini-toggle	1.25
DPDT mini-toggle	1.50
SPDT push-button	1.49

**TRANSISTORS**

2N918	.50	MPS3706	.15
MPS918	.25	2N3772	1.85
2N2102	.50	2N3903	.25
2N2218	.50	2N3904	.10
2N2218A	.50	2N3906	.10
2N2219	.50	2N4122	.25
2N2219A	.50	2N4123	.25
2N2222	.25	2N4249	.25
PN2222	.10	2N4304	.75
MPS2388	.25	2N4401	.25
2N2404	.25	2N4402	.25
2N2905	.50	2N4403	.25
2N2907	.25	2N4857	1.00
PN2907	.125	PN4916	.25
2N3055	.79	2N5086	.25
3055T	.69	PN5129	.25
2N3393	.30	PN5139	.25
2N3414	.25	2N5209	.25
2N3543	.40	2N5028	.35
2N3585	.40	2N6043	1.75
PN3585	.25	2N6045	1.75
MPS3638	.25	MPS-A05	.25
MPS3640	.25	MPS-A06	.25
PN3643	.25	MPS-A55	.25
PN3644	.25	TIP29	.65
MPS3704	.15	TIP31	.75
		TIP32	.79

**HEAT-SINKS**

TQ-3 style	.95
TQ-220 style	.35

**IC SOCKETS**

8 pin ST	1.99	100
14 pin ST	.13	.11
16 pin ST	.15	.12
18 pin ST	.17	.08
20 pin ST	.20	.16
22 pin ST	.29	.27
24 pin ST	.30	.27
28 pin ST	.40	.32
40 pin ST	.49	.39
64 pin ST	4.25	call
ST = SOLDER TAIL		
8 pin WW	.59	.49
14 pin WW	.69	.52
16 pin WW	.49	.49
18 pin WW	.99	.90
20 pin WW	1.09	.98
22 pin WW	1.39	1.28
24 pin WW	1.49	1.35
28 pin WW	1.69	1.49
40 pin WW	1.99	1.80
WW = WIREWAP		
16 pin ZIF	6.75	call
24 pin ZIF	9.95	call
28 pin ZIF	10.95	call
ZIF = TEXT TOOL (Zero Insertion Force)		

**DIP SWITCHES**

4 POSITION	.85
5 POSITION	.90
6 POSITION	.90
7 POSITION	.95
8 POSITION	.95



**LED LAMPS**

Jumbo Red	.10	.09
Jumbo Green	.18	.15
Jumbo Yellow	.18	.15

**LED DISPLAYS**

HP 5082-7760	.6"	CC	1.29
MAN 72	.3"	CA	.99
MAN 74	.3"	CC	.99
FND-357 (359)	.375"	CC	1.25
FND-500 (503)	.5"	CC	1.49
FND-507 (510)	.5"	CA	1.49

**BYPASS CAPS**

.01 UF DISC	100/6.00
.1 UF DISC	100/8.00
.1 UF MONOLITHIC	100/15.00

**RESISTORS**

1/4 WATT 5% CARBON FILM ALL STANDARD VALUES	
FROM 1 OHM TO 10 MEG OHM	
50 PCS. SAME VALUE	.025
100 PCS. SAME VALUE	.02
1000 PCS. SAME VALUE	.015

**VISIT OUR RETAIL STORE**

HOURS: M-W-F, 9-5 T-Th., 9-9 Sat. 11-3

PLEASE USE YOUR CUSTOMER NUMBER WHEN ORDERING  
TERMS: For shipping include \$2 for UPS Ground or \$3 for UPS Blue Label Air. Items over 5 pounds require additional shipping charges. Foreign orders, include sufficient amount for shipping. There is a \$10 minimum order. Bay Area and Los Angeles Counties add 6% Sales Tax. Other California residents add 5% Sales Tax. We reserve the right to substitute manufacturer. Not responsible for typographical errors. Prices are subject to change without notice. We will match or beat any competitor's price provided it is not below our cost.



**JDR Microdevices**

1224 S. Bascom Avenue  
San Jose, CA 95128  
800-538-5000 • 800-662-6279 (CA)  
(408) 995-5430 • Telex 171-110

© 1983 JDR MICRODEVICES, INC.



**2716** 16K EPROM

**\$395**

**TMS2532** 32K EPROM

**\$595**

**MICROCOMPUTER  
HARDWARE HANDBOOK**

FROM ELCOMP — \$14.95

Over 800 pages of manufacturers data sheets on most commonly used IC's.

Includes:

- \* TTL — 74/74LS and 74F
- \* CMOS
- \* Voltage Regulators
- \* Memory — RAM, ROM, EPROM
- \* CPU's — 6800, 6500, Z80, 8080, 8085, 8086/8
- \* MPU support & interface — 6800, 6500, Z80, 8200, etc.

**BEST SELLING  
BOOKS**

**OSBORNE/MC GRAW-HILL**

- Apple II User's Guide . . . . . 16.95
- CRT Controller's Handbook . . . . . 9.95
- 68000 Assembly Language Programming . . . . . 16.99
- CBASIC User Guide . . . . . 15.00

**SYBEX**

- Your First Computer . . . . . 8.95
- The CPM Handbook . . . . . 14.95
- The PASCAL Handbook . . . . . 18.95
- Microprocessor Interfacing Techniques . . . . . 17.95

**TRANSFORMERS**

**FRAME STYLE**

12.6VAC	2amp	4.95
12.6VAC CT	2amp	5.95
12.6VAC CT	4amp	7.95
12.6VAC CT	8amp	10.95
25.2VAC CT	2amp	7.95

**PLUG CASE STYLE**

12VAC	250ma	3.95
12VAC	500ma	4.95
12VAC	1amp	5.95
12VAC	2amp	6.95

**DC ADAPTER**

6, 9, 12 VDC selectable with universal adapter 8.95

NOTE: Please include sufficient amount for shipping on above items.

**DISK DRIVES  
TANDON**

**TM100-1** 5 1/4" (FOR IBM) SS/DD 229.00

**TM100-2** 5 1/4" (FOR IBM) DS/DD 295.00

**SHUGART**

**SA 400L** 5 1/4" (40 TRACK) SS/DD 199.95

**SA 400** 5 1/4" (35 TRACK) SS/DD 189.95

**SIEMENS**

**FD100-8** 8" SS/DD (801 REPLACEMENT) 259.00

**PERTEC**

**FD-200** 5 1/4" SS/DD 179.95

**FD-250** 5 1/4" DS/DD 199.95

**MPI**

**MP-52** 5 1/4" (FOR IBM) DS/DD 295.00

NOTE: Please include sufficient amount for shipping on above items.

**CABINETS FOR 5 1/4"  
DISK DRIVES**

**CABINET #1 \$29.95**

- \* DIMENSIONS 8 3/8 x 5 15/16 x 3 15/16"
- \* COLOR MATCHES APPLE
- \* FITS STANDARD 5 1/4" DRIVES, INCL. SHUGART
- \* INCLUDES MOUNTING HARDWARE AND FEET

**CABINET #2 \$79.00**

- \* COMPLETE WITH POWER SUPPLY, SWITCH, LINE CORD, FUSE & STANDARD POWER CONNECTOR
- \* DIMENSIONS: 11 1/2 x 5 3/4 x 3 15/16"
- \* +5V @ 1 AMP, +12V @ 1.5 AMP
- \* FITS STANDARD 5 1/4" DRIVES
- \* PLEASE SPECIFY GRAY OR TAN

NOTE: Please include sufficient amount for shipping on above items.

**JDR SPRING SPECIALS**

**SA400 \$189.95**

- \* 35 TRACKS
  - \* REPEAT OF A SELLOUT
  - \* LIMITED SUPPLY (AGAIN)
  - \* MODIFY FOR USE IN APPLE (EXPERIENCED TECHNICIANS)
  - \* USE WITH CABINET #1 TO MAKE A BEAUTIFUL APPLE COMPATIBLE DRIVE
- MODIFICATION INSTRUCTIONS \$1.00  
34 PIN EDGE CARD CONNECTOR MATES TO RIBBON CABLE \$3.25

**MEMORY SALE**

2114 450NS (TMS4045)	8/9.95	100 FOR .99 ea.
2114 250NS (TMS4045)	8/10.95	100 FOR 1.99 ea.
2102L-4 LOW POWER 450NS	.55 ea.	100 FOR .49 ea.

4164 200NS	5.95	Z80A-CPU 4MHZ	4.95
HM6116-4 200NS	4.75	8080 2MHZ	3.95
TMM2016 200NS	4.15	8085 3MHZ	5.95
2732 450NS	4.95	8086 5MHZ	29.95
TMS2532 450NS	5.95	6800 1MHZ	3.95
2764 450NS	9.95	68000 8MHZ	59.95

**COMPONENTS**

LM1488 or LM1489	.69 ea.	7805T or 7812T	.75 ea.
16 PIN LOW PROFILE ST IC SOCKETS	100/8.00		
16 PIN TOOLED WIRE WRAP IC SOCKETS	.49 EA.		

SPRING SPECIALS ARE GOOD ONLY UNTIL MAY 31, 1983

**POWER SUPPLY**

**MODEL 2 \$39.95**

MOUNTED ON PC BOARD  
MANUFACTURED BY CONVER

- +5 VOLT 4 AMP
- ±12 VOLT 1 AMP

NOTE: Please include sufficient amount for shipping on above items.

**CONNECTORS**

RS232 MALE	2.50
RS232 FEMALE	3.25
RS232 FEMALE RIGHT ANGLE	5.25
RS232 HOOD	1.25
8-100 ST	3.85
8-100 WW	4.85
44 pin ST	2.95
44 pin WW	4.95
72 pin ST	6.95
72 pin WW	7.95

**RIBBON CABLE**

CONTACTS	SINGLE COLOR		COLOR CODED	
	1'	10'	1'	10'
10	.50	4.40	.83	7.30
20	.65	5.70	1.25	11.00
26	.75	6.60	1.32	11.60
34	.98	8.60	1.65	14.50
40	1.32	11.60	1.92	16.80
50	1.38	12.10	2.50	22.00

**D-SUBMINIATURE**

DESCRIPTION	SOLDER		RIGHT ANGLE SOLDER		RIBBON CABLE		HOODS	
	MALE	FEMALE	MALE	FEMALE	MALE	FEMALE	BLACK	GREY
	DBxxP	DBxxS	DBxxPR	DBxxSR	IDBxxP	IDBxxS	HOOD-B	HOOD
CONTACTS 9	2.08	2.66	1.65	2.18	3.37	3.69	—	1.60
15	2.69	3.63	2.20	3.03	4.70	5.13	—	1.60
25	2.50	3.25	3.00	4.42	6.23	6.84	1.25	1.25
37	4.80	7.11	4.83	6.19	9.22	10.08	—	2.95
50	6.06	9.24	—	—	—	—	—	3.50

For order instructions see "IDC Connectors" below.

**IDC CONNECTORS**

DESCRIPTION	SOLDER HEADER	RIGHT ANGLE SOLDER HEADER	WW HEADER	RIGHT ANGLE WW HEADER	RIBBON HEADER SOCKET	RIBBON HEADER	RIBBON EDGE CARD
ORDER BY	IDHxxS	IDHxxSR	IDHxxW	IDHxxWR	IDSxx	IDMxx	IDExx
CONTACTS 10	.82	.85	1.86	2.05	1.15	—	2.25
20	1.29	1.35	2.98	3.28	1.86	5.50	2.36
26	1.68	1.76	3.84	4.22	2.43	6.25	2.65
34	2.20	2.31	4.50	4.45	3.15	7.00	3.25
40	2.58	2.72	5.28	4.80	3.73	7.50	3.80
50	3.24	3.39	6.63	7.30	4.65	8.50	4.74

ORDERING INSTRUCTIONS: Insert the number of contacts in the position marked "xx" of the "order by" part number listed. Example: A 10 pin right angle solder style header would be IDH10SR.

# SPRING APPLE SALE!

## FD-35 DISK DRIVE

By MA Systems

- ★ Direct Replacement for Apple Disk II
- ★ Compatible with Apple Controller or other Apple compatible controllers
- ★ Specially designed electronics with **low power consumption**
- ★ DOS 3.3 and 3.2 compatible
- ★ Owner's Manual and Warranty Card included
- ★ 90-day Warranty

**NEW INTRODUCTORY OFFER** **\$229<sup>95</sup>**  
CONTROLLER CARD \$89.95

## APPLE II KEYBOARD \$99.95

From the Keyboard Co.

- ★ Brand New Rev. 7 keyboard — NOT an imitation
- ★ Special Purchase — Supply very limited
- ★ Includes Encoder Board and Cable

## APPLE COMPATIBLE POWER SUPPLY \$99.95

- ★ Compact Switching Design
- ★ All Outputs regulated
- ★ Short Circuit and Overload Protection
- ★ Complete with Apple-type plug-in power cord
- ★ Apple Compatible — Yet higher output allows more disk drives and cards without overheating
- ★ +5V @ 5A, +12V @ 3A, -5V @ .5A, -12V @ .5A
- ★ Shielded enclosure: 10 3/4" x 3 1/2" x 2 3/8"

## VIEWMAX 80

A Full Function 80 column card for Apple II\*

2 YEAR WARRANTY

**\$199<sup>95</sup>**

## NEW IMPROVED JDR COOLING FAN FOR YOUR APPLE II

- ★ Easy modification — no modification of Apple required
- ★ Eliminates overheating problems
- ★ Switch on front controls fan, Apple, and extra outlet
- ★ Rotron whisper fan is the quietest, most reliable on the market

**NOW WITH SURGE SUPPRESSION**  
**\$69.95**

WITHOUT SURGE SUPPRESSION \$59.95

## INTERFACE CARDS

By Perisoft

### PRINTERLINK \$79.00

- ★ Centronics Standard Parallel Interface for Apple II
  - ★ Simple to use — Yet supports custom driver applications from ROM or Disk
  - ★ Includes card, cable and user's manual
  - ★ 1 Year Warranty
- ### MESSENGER \$119.00
- ★ Serial I/O for Apple II
  - ★ Connects virtually any RS-232 serial device
  - ★ 6 switch selectable drivers:
    - 4 printer drivers
    - Terminal Driver — 40 or 80 driver
  - ★ Includes card, cable and user's manual
  - ★ 1 Year Warranty

## OKIDATA PRINTERS

- ★ 120 cps, 9x9 Dot Matrix
- ★ 50% faster than EPSON
- ★ Parallel and Serial interfaces are standard

**ML-82A** . . . . . \$479<sup>50</sup>

**ML-83A** . . . . . \$699<sup>95</sup>

**ML-84** PARALLEL . . . \$1059<sup>00</sup>

CALL FOR PRICES ON 82A TRACTOR OPTION AND 82A, 83A GRAPHICS OPTION. CABLES AND INTERFACE CARDS AVAILABLE

## JDR 16K RAMCARD

For Apple II\*

- ★ Expand your 48K Apple to 64K
- ★ Fully compatible with Apple Language System — Use in place of Apple Language card
- ★ Provides extra memory for Visicalc™
- ★ Run PASCAL, FORTRAN, Integer Basic with appropriate software
- ★ Highest quality card features: gold edge connector, sockets for all IC's

**NOW WITH 2 YEAR WARRANTY**

ASSEMBLED & TESTED WITH WARRANTY . . . . . **\$44<sup>95</sup>**

KIT — INCLUDES ALL PARTS & INSTRUCTIONS . . . **\$40<sup>95</sup>**

BARE PC CARD WITH INSTRUCTIONS . . . . . **\$14<sup>95</sup>**

## MONITORS

GREEN PHOSPHOR

**NEC** JB1201M **\$169<sup>00</sup>**

**ZENITH** ZVM-121 **\$119<sup>00</sup>**

COLOR

**AMDEK** COLOR 1 **\$335<sup>00</sup>**

## ORDER TOLL FREE

**800-538-5000**

**800-662-6279**

(CALIFORNIA RESIDENTS)

## 5 1/4" DISKETTES

**ATHANA** SS SD SOFT . . . 24.95

**MEMOREX** SS SD SOFT 26.95

**VERBATIM** SS DD SOFT 29.95

**VERBATIM** 10 SECT. HARD 29.95

## NASHUA

TOP QUALITY — LOW PRICE!

Single Sided, Single Density

Soft Sector with Hub Ring

**\$19.95 BOX OF 10**

## VISIT OUR RETAIL STORE

HOURS: M-W-F, 9-5 T-Th., 9-9 Sat. 11-3

**PLEASE USE YOUR CUSTOMER NUMBER WHEN ORDERING**  
TERMS: For shipping include \$2 for UPS Ground or \$3 for UPS Blue Label Air. Items over 5 pounds require additional shipping charges. Foreign orders, include sufficient amount for shipping. There is a \$10 minimum order. Bay Area and Los Angeles Counties add 6% Sales Tax. Other California residents add 6% Sales Tax. We reserve the right to substitute manufacturer. Not responsible for typographical errors. Prices are subject to change without notice. We will match or beat any competitor's price provided it is not below our cost.

\* APPLE IS A TRADEMARK OF APPLE COMPUTER CO.



## JDR Microdevices

1224 S. Bascom Avenue

San Jose, CA 95128

800-538-5000 • 800-662-6279 (CA)

(408) 995-5430 • Telex 171-110

© 1983 JDR MICRODEVICES, INC.

# Unclassified Ads

**NEEDED:** Would greatly appreciate any unprotected science, math, engineering, or utility programs for use by a blind student studying engineering with an Apple II Plus and an Echo II voice synthesizer who cannot use protected software. Also, would like to correspond with anyone knowledgeable about synthesizers, unprotecting software, and/or altering programs to work with voice. Willing to pay for altered programs that work. Lawrence Silvermintz, 148 Waverly Ave., East Rockaway, NY 11518, [516] 887-2638.

**WANTED:** An Apple II Plus club is forming in Sarajevo, Yugoslavia, city of the XIV Winter Olympic games. All donations in software and optional hardware will be greatly welcomed. In return will send Olympic games memorabilia. A. Salihbegovic, Mlade Bosne 1C, 71210 Iidza, Yugoslavia.

**WANTED:** Church youth group needs computers, printers, monitors, or firmware cards for education program; particularly Apple-compatible equipment. All donations are tax deductible. Mike Yard, Westchester Christian Church, 8740 La Tijera Blvd., Los Angeles, CA 90045, [213] 645-4344.

**WANTED:** Christian organization seeks TRS-80 Model III as donation. Gifts are completely tax deductible. Rev. Wallace Schultz, RR#5, Box 65, Pacific, MO 63069, [314] 257-4444.

**WANTED:** A progressive high school needs small personal computers (Apple, Commodore, Franklin, IBM, etc.) for teaching literacy and programming. Your donations are fully tax deductible. Wm Martin, Department of Math and Science, Naples Academy, Naples, FL 33999, [813] 455-1087.

**WANTED:** A nonprofit public TV station is seeking tax-deductible donations of computer systems, modems, terminals, and Datapoint-compatible peripherals. Certified receipts will be furnished. KBDI-TV 12, POB 427, Broomfield, CO 80020, or ask for Jane or Paul at [303] 469-5234.

**ATTENTION:** System operators, bulletin-board owners, and modem users: I am compiling a list of nationwide public bulletin-board and time-sharing systems as a research project that will be published later this year. To have your favorite systems listed, send all updated lists and descriptions. (Sysops and owners: include details about your hardware, software, operating system, and hours, etc.) Thomas Baird, 6592 South Steele, Littleton, CO 80121, [303] 795-7363.

**WANTED:** Young, creative individual. Must be a mathematician, computer specialist, and a logical systems analyst. Familiarity with all aspects of ring theory and advanced theory of logic. Willing to spend two to three years in original analysis in a three-way partnership to develop new, diagnostic programs that learn by experience. Algebraic aspect has been partially developed by a former research mathematician and businessman. E.D. Goodrich, 1744 Lamont NW, Washington, DC 20010.

**WANTED:** Anyone interested in contributing or subscribing to a new newsletter. Languages, devoted to the improvement of existing microcomputer languages and the development of better ones. The first issue should be published soon, depending on the response received. Send a SASE. Ronnie Hunter, Harrington Hall, Saint Thomas University, POB 77, Fredericton, New Brunswick, E3B 5G3 Canada.

**WANTED:** A Timex-Sinclair users group is forming in the Cincinnati, Ohio, area. Anyone interested, please call Richard Johnson, [513] 825-1449.

**WANTED:** Information for a new users group forming for the Commodore VIC-20. Tips, programming, articles, etc. all welcome. J.M. Mott Jr., 800 Lea Crest, Memphis, TN 38109.

**WANTED:** Information concerning LITTON ABS Model 30 Printer. Need circuit diagram, service manual, data rate, etc. I am trying to interface it with a Sinclair ZX81. Wayne Finger, POB 16422, Jacksonville, FL 32245.

**FOR SALE:** 48K Apple II Plus, Apple Silentype printer with controller, and M & R fan. Manuals included: \$1000. Jerry Kozak, 55 Van Sicken Ave., Brooklyn, NY 11207, [212] 227-3251 before noon.

**FOR SALE:** NSC800 evaluation board. Won in contest, never used. New \$495, sell \$250. Jim Peter, 16012 Falls Rd., Sparks, MD 21152, [301] 771-4062.

**FOR SALE:** Heath H-19 with anti-glare white screen. Fully assembled, in excellent condition. All manuals included: \$500. William E. Severance Jr., Center Lovell, ME 04016, [207] 925-1515.

**FOR SALE:** TRS-80 Model II, CP/M software, and some hardware, unused. Upgrading my systems. Send SASE for list. Rob Lee, 25 Amayillis Ave., Waterbury, CT 06710.

**FOR SALE:** TRS-80 software: nearly 50% off on original cassette tapes for TRS-80 Models I and III. These are all new originals mostly of arcade-type games, also some utilities and educational programs. Will consider trading. Send a SASE for a free list. Dr. Michael W. Ecker, Luzerne B, Viewmont Village, Scranton, PA 18508.

**FOR SALE:** TRS-80 Model I, Level 2, all original equipment with keypad and lowercase driver. 48K system with expansion interface. Vista V-80 40-track disk drive, NEC PC-8023-AC printer with 8.5 by 11-inch tractor-feed paper (about 1500 forms). Excellent software library includes BIG 5, Scripsit, Deathmaze, and others; \$1625 or best offer; shipping included, cashier's check or cleared bank check. Karl Ryan, 16408 Mount Ararat Cr., Fountain Valley, CA 92708, [916] 752-4744.

**FOR SALE:** Atari 400 personal computer with 32K of memory, BASIC cartridge, 11 games and programs on cassette. Almost new, \$350 firm. Also, 21 games on cassette for Atari computers: \$10 each. Rick Bloom, 100 Dehaven Dr., Yonkers, NY 10703, [212] 986-9666 between 9 and 5.

**FOR SALE:** SSB 6809 microcomputer with OS9. 32K, DCB 4A, dual 8-inch disks, four serial and two parallel ports. Software includes OS9 Level 1, Basicomne, ASMX, editor, super debugger. A little over a year old, \$4200 retail value; \$3000 or best offer. Harry Fair, 1952 South Holland, Lakewood, CO 80227, [303] 773-1313 or 985-7419.

**FOR SALE:** Altair 8800 with 48K, Pro Tech VDM board, video modulator, one serial and four parallel ports. North Star disk and controller, keyboard, PR-40 printer, 4K and 8K cassette BASIC, North Star BASIC, FORTH, Allen Astley Macro Assembler, all manuals, extra 4K board, cassette interface, and hardware: \$1200 plus shipping. Damian Bonicatto, 13401 Morgan Ave. S #108, Burnsville, MN 55337, [612] 894-2794.

**FOR SALE:** Televideo Model 950 video terminal and Teletype Model 43/20 with tractor-feed attachment. Both in mint condition: \$750 each. Ricki B. Rovner, 944 Robin Rd., West Amherst, NY 14228, [716] 688-8974.

**WANTED:** Used Sorcerer S-100 expansion unit or Exidy S-100 interface card. Yvon Mayo, 930 Pembridge Cr., Kingston, Ontario K7M 6C5, Canada, [613] 384-3081 evenings.

**WANTED:** College student needs surplus, used, or damaged computers, parts, or other related equipment. I will pay shipping for reasonably priced equipment. Scott R. Gagnan, Box 2232, APO, NY 09130.

**FOR SALE:** Used printed circuit boards from an IBM computer system. 20 to 30 components per board (transistors, resistors, diodes, etc.); minimum 20 boards; 10¢ per board. Check or money order. Stephen Grot, RD #1, Chadds Ford, PA 19317.

**WANTED:** Data (articles, books, etc.) relating to floppy-disk directories and disk layout to recreate a blown disk. Interest is in personal computers, word processors, etc. Bill Ott, ADC, 14272 Chambers Rd., Tustin, CA 92680, [714] 731-9000.

**FOR SALE:** Brand new Microdasys System 2 kit: 6-slot S-100 with enclosure, 64-key keyboard, processor board with both 6802 and 6809, V818 video board, 32K (8K populated) 2114-RAM board, power supply, BASIC, assembler, disassembler, and games. Still in box, was \$729. Asking \$350, best offer, or swap for AIM65. Used Dynatyper IBM Selectric interface for TRS-80 Model I with software: \$220 or best offer. I'll pay shipping. Joseph Lo, 9215 Benchley, Houston, TX 77099, [713] 495-4359.

**WANTED:** Existing package to convert civil calendar dates to their equivalent Jewish calendar dates. Harry Edwards, POB 403, West Hartford, CT 06107.

**FOR SALE:** Commodore PET 4032 with graphic keyboard, 3.0 and 4.0 BASIC, 40-40 dual-disk drive unit, and two cassette drives. Software and other accessories available. Bruce Loe, 322 South Bonner, Hope, AR 71801, (800) 643-1577 ext. 126 days and [501] 777-5080 evenings and weekends.

**WANTED:** Motorola user manual and documentation for MEK 6802 D3, MEK 68MM32, MEK 68RR, MEK 6810. Scott Tillman, 4910 West Mossman Rd., Tucson, AZ 85746.

**FOR SALE OR TRADE:** New Osborne I with all software and manuals. Will consider Apple II or Commodore including VIC-20 or 64. R. C. Nicklin, Physics Dept., Appalachian State Univ., Boone, NC 28608, [704] 262-3091 or 264-2921.

**WANTED:** I have a growing and diverse collection of programs for the TRS-80 Model I, Level II. Am interested in swapping or trading games, utilities, and home programs. Send listing of your programs along with name and address. Clifford Albury, 6252 North Lee St. #41, Morrow, GA 30260.

**FOR SALE:** Texas Instruments editor/assembler for the TI 99/4A home computer on 5 1/4-inch disk with 470-page manual and Tombstone City on 5 1/4-inch disk with the Command Module cartridge. Never used, best offer over \$85. Wm del Solar, [212] 797-7239 weekdays 1-4 p.m. ET.

**FOR SALE:** H-11A 128K total: one parallel and two serial ports, LTC, KEV11, H-27 controller, boxes of documentation, extra backplane, wire-wrap cards, and software: \$2500 or best offer. Warren Burwell, 1171 Boylston St. #33, Boston, MA 02116, [617] 266-4822.

**WANTED:** Netronics Explorer-85 Level A terminal and FASTER-64 terminal or the special Microsoft BASIC pak. Robert W. Schu, 8304 West Summerdale Ave., Chicago, IL 60656, [312] 631-5286.

**FOR SALE OR TRADE:** F-10 Star Writer, 40 cps, letter-quality printer, with optional tractor-feed. Can support either parallel or serial interface. Owned almost a year, hardly used, perfect condition: \$1100 (50% off list price). Lionel Getman, 63 Radtke Rd., Randolph, NJ 07869, [201] 328-0719 after 7 p.m.

**WANTED:** Owner of new Epson HX-20 computer would like to correspond and exchange programs and ideas with other Epson owners. James Phillips Jr., 14226 Woodland Ridge, Baton Rouge, LA 70816.

**FOR SALE:** Printer terminal with full keyboard and DEC writer 2 (LA-36) with RS-232C. Up to 14-inch-wide paper tractor feed: 110, 150, and 300 data rates. Upgradable to 1200+ bits per second. In mint condition with original user manual: a real workhorse. First offer over \$1000 (plus shipping). Abbott Rhoades, POB 5551, Santa Monica, CA 90405.

**WANTED:** Used Apple II Plus computer. Advise on age, condition, accessories (if any), and price. M. Amani, 2355 Corona Court., Berkeley, CA 94708, [415] 548-2228.

**FOR SALE:** IMSAI 8080 microcomputer with 40K-byte high-speed RAM (4MHz), and one parallel and two serial I/O ports: \$800. Micropolis 1053 Model II dual floppy-disk drives with controller: \$800. Hazeltine 1500 display terminal: \$600. Mint condition, willing to sell separately. Dale Pischke, 2194 Rising Star Dr., Diamond Bar, CA 91765, [714] 598-9401.

**WANTED:** Quest Super ELF owners to form an "ELFnet" and exchange ideas and experiences by mail. I have a Super ELF Version 4.0 with 32K dynamic memory, 256 by 192 Super Color Graphics board, serial and parallel I/O, Quest Super Monitor V2.1, and Super BASIC V5.0. I am eager to hear from people who run this version of BASIC, or later: ELFnet, Bob Margolis, 11357 Columbia Pike #D-6, Silver Spring, MD 20904.

**FOR SALE:** IMSAI 8080 computer with 10-slot S-100 bus, 64K dynabyte RAM, MPU-A 8080 processor board, ZPU Z80 processor board, 216, SMB, SID, MIO, Godbout terminator: \$900. R. Pollock, 2315 Lee Ave., Melbourne, FL 32901.

**FOR SALE:** Cromemco System III, 64K, two 8-inch disk drives, Tuart board: \$1900. SOROC IQ 120 terminal: \$200 with above. OUME Sprint 5 printer (cost \$3400): \$2000. All in excellent condition. Will ship UPS on receipt of certified check. J. Maley, 7625 Northwest McDonald Place, Corvallis, OR 97330.

**WANTED:** Time Zone player needs help through the mazes. Will assist through or purchase master solutions. Ben Bennett M.D., 2809 Plum Court, Kokomo, IN 46902.

**WANTED:** Schematic for TRS-80 Model I computer and expansion interface. Also, want inoperative Model I computers and equipment for parts. Send details and prices. Michael Ulik, #12 Mar Wey, St. Peter, MN 56082.

**FOR SALE:** Hewlett-Packard 85A desktop computer: includes 32K RAM, ROM drawer, Advanced Programming ROM, documentation programs, and cartridges. Excellent condition, about a year and a half old, reasonable offers only. R. H. Sekaly, Apt. 7-1179, Esquimalt Rd., Victoria, BC V9A 3N6, Canada, (604) 382-0978.

**FOR SALE:** Carrying cases for the TRS-80 Model I: one case holds the keyboard with a power plug and cassette; the other is for the TRS-80 video monitor: \$50. Also, I would like a copy of the JPC TC B cassette. Ben Leff, 2134 Mountain Vista Dr., Encinitas, CA 92024, [619] 436-1990.

**FOR SALE:** Texas Instruments 810 RO dot-matrix printer. RS-232C serial interface, 150 cps, full options including vertical-forms control and compressed print. Factory maintained and in mint condition. Asking \$900 or best offer. John Mulligan, POB 3461, Van Nuys, CA 91407, [213] 486-2304.

**WANTED:** Apple II programs to swap: games, home, and business. Send tape or disk with your name and address. Also looking for people interested in corresponding. Gil Nedjari, Via Mauro Rota, 8 Milan, Italy, Tel. 02/6880387; Telex 333504 KIN MI 1.

**FOR TRADE:** I would like to swap TRS-80 Models I and III games or utilities. Send a cassette with some of your programs, and I will return it with the best of mine. Gary Harper, POB 371, Fuquay-Varina, NC 27526.

**FOR SALE:** Complete microprocessor training computer. Heathkit ET3400, ETA3400 with 4K RAM plus H-9 video terminal: \$500. Pick-up only. John Siegel, 181 Columbia Ave., North Plainfield, NJ 07060, [201] 753-6507.

**WANTED:** Processor Tech software and/or documentation for use on SOL-20 computer. Also, software and/or documentation for Explorer-85 which uses Exatron Stringy floppy. Will buy or trade. F. Iomo, 22 Midship Lane, Patchogue, NY 11772, [516] 758-6625 evenings.

**UNCLASSIFIED POLICY:** Readers who have computer equipment to buy, sell, or trade or who are requesting or giving advice may send a notice to BYTE for inclusion in the Unclassified Ads section. To be considered for publication, an advertisement must be non-commercial (individuals or bona fide computer clubs only), typed double-spaced on plain white paper, contain 75 words or fewer, and include complete name and address. This service is free of charge; notices are printed once only as space permits. Your confirmation of placement is appearance in an issue of BYTE as we engage in no correspondence. Please allow at least three months for your ad to appear. Send your notices to Unclassified Ads, BYTE/McGraw-Hill, POB 372, Hancock, NH 03449.

# Unclassified Ads

**FOR SALE:** H-89 with 48K, disk drive, anti-glare screen, HDOS, and HUG subscription. Hardly used: \$1400. Heath H-14 printer, never used: \$350. Steve Ha, 10855 Meadowglen #710, Houston, TX 77042, [713] 977-6539.

**FOR SALE:** 5868b09 system in excellent condition, 56K, DCB4aFDC, two DSDD[760K] drives, 2S/2P I/O, clock, OS9L1 multitasking, MWBASIC09, ED, ASM, Debug, Screeneditor, and Database software. H-19 terminal with utilities. Complete system less printer: \$3800. Doug Ramers, 245 Cambridge Rd, Camden, DE 19934, [302] 674-6386 or 697-3444.

**FOR SALE:** TRS-80 16K Level 2. Includes all original equipment, lots of books and software, three editor-assemblers, and eight instruction cassettes. Joe Smith, 296 Spanish Dr., Las Vegas, NV 89110.

**FOR SALE OR TRADE:** Tektronix 4013 graphics terminal, RS-232C, hi-res green storage display, with maintenance and user manuals. Scope communicates but will not display characters — can be repaired by Tektronix or fix yourself. Price new, over \$7800; asking \$995 or agreeable trade. Send SASE for copy of description from catalog. If I fix it before it's sold, the price will increase. Brent Carter, 3906 Sedgewood Rd., Greensboro, NC 27407, [919] 854-2764.

**FOR SALE:** BYTE issues #1, #5, and #7. Mint condition, make an offer. Robert A. Martin, 32 Orlea St., Westville, IL 61883, [217] 267-2484 after 5 p.m.

**FOR SALE:** Sorcerer 48K Model II, Amdex 12-inch monitor, Exidy floppy-disk subsystem, two Exidy floppy-disk add-on units, C. Itoh dot-matrix printer, C. Itoh daisy-wheel printer, and CPM 2.2. In original boxes, never used. All for \$3000 or best offer. R. L. Mouser, Trinity University, 715 Stadium Drive, Box 2079, San Antonio, TX 78212, [512] 828-0583 or 546-7111

**FOR SALE:** AIM-65 Memory-Mate expansion board by Forethought Products 16K; new, still in box. Complete with manual: \$250. R. C. Ester, 1825 Florida Rd., Durango, CO 81301, [303] 247-1963 after 7 p.m.

**FOR SALE:** ExpandaPET memory-expansion board with installation instructions. Adds 24K to Commodore PET or CBM computers: \$140. John Wilcox, 10051 Boyce Rd., Chelsea, MI 48118, [313] 475-1224.

**FOR SALE:** Two MITS/Altair 8800b systems. System #1 with 64K, 3 disks and controller, Lear-Seigler ADM3A, OJME Sprint 3/35 and interface, Auto-start, DOS, and BASIC: \$3750. System #2 with 32K, cassette interface, BASIC in ROM, OJME interface, 2-SIO serial card, Lear-Seigler ADM3: \$2750. Also, 16K 2716 PROM card, BK Program Saver PROM programmer card, and diagnostic card. Claude Hill, 820 Redwood Dr., Nashville, TN 37220, [615] 331-4743 evenings and weekends.

**FOR SALE:** Back issues of BYTE in good condition beginning with #1: 9/75 to 5/76 and 1/76 to 3/77. Asking \$5 per issue. Prefer to sell all issues at once. Robert Erickson, 1426 Boulevard Ave., Havre, MT 59501.

**WANTED:** Does anyone know of a company that sells disk controller boards for the TRS-80 Model III? Also, controllers that will handle 8-inch disks (and/or hard drives). Need information on what RAM location DOS (LDOS, NEWDOS, TRSDOS, etc.) loads. Scott Hamilton, 225 Grandview St., Bennington, VT 05201, [802] 447-7994.

**FOR SALE:** Altair 8800b, 32K RAM, two active parallel ports, SSM video card, and Selectric terminal with special parallel interface: all with complete schematics. Also, modified 12-inch black-and-white TV, keyboard, and two 5 1/4-inch floppy-disk drives. Disk software includes DOS, extended BASIC, user-developed word processing, and disk read/write in hexadecimal or text, disk editing, and others. All original documentation plus program instruction for \$3500. Earl Sanders, 519 Oxford Court, Orlando, FL 32803, [305] 894-4917.

**FOR SALE:** BYTE 9/76 to present. Microcomputing 2/80 to present, 73 Magazine 5/79 to 4/82. Also, Motorola Micor X83RTA3404AA 110W hi-band with preamp, wide-spaced exciter and receiver, all accessories, Multi-PL control head, and six reeds. Main receiver: 142-105.8, 2nd receiver: 150.8-162, exciters: 140-155, and three channel elements: T143.9, T148.15, and R148.15. Good working condition, but sold as is. Manual available. Make an offer. K. Varley, 1740 Chew St., Allentown, PA 18104, [215] 433-8696.

**FOR SALE:** DEC VT-132 with RS-232 printer-port option. Excellent condition: \$1500. Mitch Che, Suite 201, 5221 Central Ave., Richmond, CA 94804, [415] 527-9876.

**FOR SALE:** Motorola display XM701-10A in good shape with an 8B processor board. The board could be easily repaired. Display and board contained in a video-game cabinet. You pay shipping. First \$250 takes. Also, TRS-80 Model I disk-editor, assembler, Macro-80, Edit-80, Link-80, Cref-80, and FORTRAN library: \$50. Barry Nicholson, Rt. 1, Box 78, Ingalls, KS 67853

**FOR SALE:** Extended BASIC TRS-80 Color Computer 32K [64K with modification] with disk drive, two disks [one with homebrew utilities], dust covers, disk-storage box, and cassette cable: \$900. Also, Joysticks: \$15, Space Assault: \$20, Skiing: \$20, Chess: \$30, Editor/Assembler: \$35, and printer cable: \$4. About a year and a half old, in new condition, with original boxes and manuals. N. T. Schneck, 221 Fancher Ave., Buffalo, NY 14223, [716] 835-9075.

**FOR SALE:** Microsoft BASIC in ROM: four 2716s for Netronics Explorer-85 computer. All documentation included; only a few months old. Paid \$99, asking \$45; check or money order. I will pay postage. Ken Hoffman, 2112 110th Lane NW, Coon Rapids, MN 55433, [612] 451-5600 days and 757-3404 evenings.

**FOR SALE:** S-100 boards: Polymorphic video interface with graphics, 128 by 48: \$50, modified TV monitor: \$30, Tarbell cassette interface: \$45, cassette recorder: \$15, SSM BK static RAM: \$65, Godbout 8K static RAM: \$65, Vector Graphic PROMRAM: \$25, IMSAI 4K static RAM (less RAMs): \$20. Documentation included. Dan Golowka, [213] 705-6631 evenings.

**FOR SALE:** Heath H-8, serial I/O, cassette interface, 32K RAM, 3-port parallel board, disk controller and drive, H-9 terminal, complete software package, cassette and DOS. Asking \$1100. G. Arsenau, 19 Zwicks Farm Rd., Plantsville, CT 06479, [203] 621-4109 after 5 p.m.

**FOR SALE:** The following back issues of BYTE: July, September, October, November, and December of 1976; all but August of 1977; all of 1978; and January through June and December of 1979. In excellent condition, will sell all or part. Best offer plus shipping. Ronnie Powell, 2306 South 126 E Ave., Tulsa, OK 74129.

**WANTED:** BIOS to run CP/M on Spacebyte processor. J. Weldon Bellville, 926 Malcolm Ave., Los Angeles, CA 90024.

## March BOMB Winners

"Build the ECM-103, an Originate/Answer Modem" by Steve Ciarcia is the first-place winner in the March BOMB contest. He'll receive the \$100 kitty. Second place and the \$50 award goes to Tom Moran for his article "New Developments in Floppy Disks." Larry Sarisky earned third place for his discussion of improved data-storage technologies in "Will Removable Hard Disks Replace the Floppy?"

## Correspondence

Address all editorial correspondence to the editor at BYTE, POB 372, Hancock NH 03449. Unacceptable manuscripts will be returned if accompanied by sufficient first class postage. Not responsible for lost manuscripts or photos. Opinions expressed by the authors are not necessarily those of BYTE. Entire contents copyright © 1983 by BYTE Publications Inc. All rights reserved. Where necessary, permission is granted by the copyright owner for libraries and others registered with the Copyright Clearance Center (CCC) to photocopy any article herein for the base fee of \$1.50 per copy of the article. Payment should be sent directly to the CCC, 21 Congress St, Salem MA 01970. Copying done for other than personal or internal reference use without the permission of McGraw-Hill is prohibited. Requests for special permission or bulk orders should be addressed to the publisher. BYTE® is available in microform from University Microfilms International, 300 N Zeeb Rd, Dept PR, Ann Arbor MI 48106 USA or 18 Bedford Row, Dept PR, London WC1R 4EJ England.

# BOMB

## BYTE's Ongoing Monitor Box

Article #	Page	Article	Author(s)
1	35	Use ADPCM for Highly Intelligible Speech Synthesis	Ciarcia
2	54	Sunrise Systems	Roberts
3	74	The Gavilan Mobile Computer	Lemmons
4	96	Digital's Professional 300 Series	Melling
5	104	A DEC On Every Desk?	Snyder
6	110	Tight Squeeze: The HP Series 200 Model 16	Monahan
7	128	Texas Instruments' 99/2 Basic Computer	Littlejohn, Jander
8	138	Implementing Minicomputer Capabilities in a Desktop Microcomputer	Naylor
9	150	A Machine for All Processors: The Fujitsu Model 16s	Clingingsmith
10	168	The Pronto Series 16	Hansen
11	188	A Sleek Import: The Docutel/Olivetti M20	Mello-Grand
12	194	Modular Architecture	Kavuru
13	208	Digital Research's DR Logo	Kildall, Thornburg
	230	An Inside Look at MS-DOS	Paterson
15	256	BYTE West Coast: A Guided Tour of Visi On	Lemmons
16	282	NEC PC-8201	Wszola
17	288	HMS3264 EPROM Programmer	De Jong
18	298	Electrohome Supercolor Board and Color Monitor	Swanson
19	306	The User Goes to the Faire	Pournelle
20	339	Design Philosophy Behind Motorola's MC68000, Part 3: Advanced Instructions	Starnes
21	352	The Bazerics Cylinder	Prisco
22	387	AVL Trees	Maurer
23	395	Build a Simple Light Pen for the Apple II	Lijja
24	411	User's Column: Zenith Z-100, Epson QX 10 Software Licensing, and the Software Piracy Problem	Pournelle
25	450	The 8086—An Architecture for the Future, Part 1: Introduction and Glossary	Heywood

# Reader Service

Inquiry No.	Page No.	Inquiry No.	Page No.	Inquiry No.	Page No.	Inquiry No.	Page No.
1	1st NATIONAL COMPUTER 197	83	COMPUTER MAIL ORDER 350, 351	172	HDL RESEARCH LAB. INC. 460	259	MICROCOMP.BUSN.IND. 67
433	1 SUPER WAREHOUSE 158	86	COMPUTER PERIPH. INC. 113	173	HEWLETT-PACKARD 115	280	MICROCOMP.BUSN.IND. 410
2	800 SOFTWARE 155	67	COMPUTER PLUS 477	174	HITACHI 79	281	MICRODYNAMICS 496
5	A.C.E SYSTEMS 300	86	COMPUTER SFTW. STORE 471	20	HOEI SANGYO. LTD. 368	282	MICROHOUSE 286
3	A.S.T. RESEARCH 103	89	COMPUTER SOLUTIONS 357	175	HOLLYWOOD HARDWARE 508	283	MICROPERIPH. CORP. THE 504
434	A.S.T. RESEARCH 188, 187	80	COMPUTER SPCLTIES. 407	176	HUMAN DESIGNED SYSTEMS 369	284	MICROPERIPH. CORP. THE 508
4	AB COMPUTERS 503	64	COMPUTER STORE, THE 512	177	HUMAN SOFT 325	285	MICROPROCESSORS UNLTD. 498
6	ADDMASTER CORP. 502	85	COMPUTER STORE, THE 514	178	I-BUS SYSTEMS 125	*	MICROSOFT (CPD) 71
7	ADISA CORP. 512	*	COMPUTER WAREHOUSE 381	179	I.T.M. 308	286	MICROSOFT (CPD) 185
8	ADV. COMP. PROD. 522, 523	91	COMPUTERLINE INT'L-A 400, 401	180	IBM CORP. 240, 241	*	MICROSOFT (CPD) 271
11	ADV. SYS. CONCEPTS 444	92	COMPUTERLINE INT'L-B 419	181	IBM/SMALL SYS. DIV. 458, 457	*	MICROSOFT (CPD) 338
*	ALF PRODUCTS, INC. 184	93	COMPUTERS AND MORE 504	182	IDE CORP. 431	386	MICROTECH EXPORTS 118
13	ALL ELECTRONICS CORP. 504	96	COMPUVIEW PROD. INC. 63	183	IMAGE COMP. PROD. 518	287	MICROWARE 514
14	ALPHA BYTE COMP. PROD. 50, 51	95	CONSOLINK 171	184	IMS INTERNATIONAL 34	288	MINOLTA CORP. 437
15	ALPHA BYTE COMP. PROD. 293	98	CORONA DATA SYS. 188, 187	185	INFO. REDUCTION RESEARCH 414	289	MITSUBA 438
18	ALPHA SOFTWARE 25	99	COST PLUS COMP. 498	186	INFORUNNER CORP. 415	480	MORROW DESIGNS 378, 377
17	ALTOS COMP. SYS. 203	456	COUGAR MOUNTAIN SOFT. 264	187	INFOCOM, INC. 138, 137	271	MOUNTAIN VIEW PRESS 433
352	AMDEK 107	101	CREATIVITY UNLTD. 508	188	INFOSCRIBE 16	272	MTI SYSTEMS CORP. 324
18	AMER. SQUARE COMP. 147	102	CROMEMCO 5	189	INMAC 353	273	MUSYS 448
19	AMER. BUYING & EXPORT 469	103	CSCS 504	190	INSIGHT ENTERPRISES 504	274	NEBS 80
*	AMERICAN EXPRESS 439	104	CUESTA SYSTEMS 510	191	INSTITUTE -SCTF. ANALYSIS 131	275	NEC HOME ELECTR. USA 179
22	APPLE COMPUTER INC. CII, 1	105	CUSTOM COMP. TECH. 148	192	INTEGRAL QUALITY 347	278	NEC HOME ELECTR. USA 181
24	APPLE COUNTRY LTD. 497	*	CYBERNETICS INC. 75	193	INTEGRAND 98	277	NEC HOME ELECTR. USA 183
25	APPLEWARE, INC. 514	106	CYBERSOURCE 418	195	INTERACTIVE MICROWRE. 174	*	NETRONICS 184
28	APPLIED ANALYTICS 373	107	CYCLONE SOFTWARE 500	196	INTERACTIVE STRUCT. 172	278	NETWORK CONSLTNG CORP. 61
*	APPLIED CREATIVE TECH 14	108	DATA ACQUISITIONS 321	197	INTERCONTN. MICROSYS. 30	279	NEW TECH ASSOC. INC. 384
27	ARBA 473	109	DATA CABLE CO. 510	198	INTERDATA SYSTEMS INC. 502	280	NORTH HILLS CORP. 504
28	ARBUS TOTALSOFT INC. 518	194	DATA MAIL 459	199	INTERTEC DATA SYS. 11	281	NORTH HILLS CORP. 510
331	ARK MICROSYSTEMS 483	111	DATA TRANSLATION INC. 397	200	IPEX INT'L. 508	282	NORTH STAR COMPUTERS 348
29	ARTIFICIAL INT'L. RESRCH. 508	112	DATA-ED 275	201	IRONSIDES COMP. CORP. 211	283	NORTHWEST DIGITAL SYS. 88
30	ASHTON-TATE 77	110	DATASOURCE SYS. CORP. 428	202	ISA CO. LTD. 328	284	NORTHWEST INSTR. SYS. 335
31	ASHTON-TATE 288	113	DATASOUTH COMP. CORP. 145	203	J.C. SYSTEMS 192	285	NORTHWEST MICROCHIP DIST. 500
32	ASHTON-TATE 355	114	DATASOUTH COMP. CORP. 318	204	JADE COMP. PROD. 517	286	NOVATION 108, 109
34	ASPEN SFTW. CO. 122	115	DATAWARE SYSTEMS 502	205	JADE COMP. PROD. 518, 519	287	NOVELL INC. 33
35	ATARI 175	117	DELUXE COMP. FORMS 304, 305	206	JAMECO ELECTR. 528, 529	441	O'HANLON COMP. SYS. 441
36	ATLANTIS ELECTR. CORP. 518	118	DENNISON KYBE CORP. 83	207	JDR MICRODEVICES 538, 537	450	OLYMPIC SALES 139
*	AUTOMATED EQUIPMNT. 219	119	DIABLO DISTRIBUTION 381	208	JDR MICRODEVICES 538, 539	288	OPEN SYSTEMS INC. 274
37	AVOCET 423	120	DIAMOND SOFTWARE 282	209	JDR MICRODEVICES 540	*	ORA ELECTRONICS 495
*	BARGAIN BOARDS 504	121	DIGISOFT COMPUTER 290	210	KADAK PRODUCTS, LTD. 402	289	ORANGE MICRO 228
38	BASF SYSTEMS 153	431	DIGITAL DIMENSIONS 180	211	KENSINGTON MICROWARE 227	290	ORANGE MICRO 229
39	BASIS, INC. 209	122	DIGITAL EQUIPMNT. CORP. 231	212	KERN PUBLISHING 348	291	ORANGE MICRO 195
40	BAUSCH & LOMB INSTR. SYS. 239	123	DIGITAL LABORATORIES 178	213	KERN PUBLISHING 349	292	ORYX SOFTWARE 213
41	BELL, JOHN ENGR. 506	124	DIGITAL MARKETING 10	214	KEYTRONICS CORP. 314	293	OSBORN/MCGRAW-HILL 343, 345
*	BEST WESTERN INT'L. 408, 409	125	DIGITAL PRESS 294	215	LABORATORY MICROSYS. 508	*	OWENS ASSOC. 422
42	BHRT 148, 149	126	DIGITAL RESEARCH 85	437	LANGLEY ST. CLAIR 283	294	PACIFIC EXCHANGES 500, 502,
43	BIBLE RESEARCH SYS. 242	127	DIGITAL RESEARCH 378	216	LASER MICRO 323	508, 508, 510, 512, 514	
44	BLAT RESRCH & DEVELOP. 250	*	DISCOUNT SOFTWARE 220, 221	217	LEADING EDGE PROD. CIII	295	PALANAM COMP. EQUIP. 382, 383
45	BOTTOM LINE, THE 331	128	DOCUTEL OLIVETTI 391	459	LIBERTY COMP. SALES 333	296	PAN AMERICAN ELEC. INC. 384
454	BOTTOM LINE, THE 390	129	DOKAY COMP. PROD. INC. 520, 521	218	LIGO RESEARCH INC. 287	297	PER SCI INC. 500
46	BUSINESS MANAGER 302	130	DUAL SYS. CONTROL CORP. 320	219	LOBO DRIVES INT'L. 509	298	PER SCI INC. 512
47	BUSINESS SOLUTIONS 496	131	DWIGHT CO. INC. 500	220	LOGICAL DEVICES 479	299	PERCOM DATA 9
*	BYTE BOOK CLUB 416, 417	132	DYNALOGIC INFOTECH 183	443	LOGICAL MICROCOMPUTER 447	300	PERSONAL SYS. TECHN. 296, 297
46	BYTE INDUSTRIES 134	133	DYSAN CORP. 311	221	LOMAS DATA PRODUCTS 261	301	PH ASSOCIATES 475
*	BYTE BACK ISSUES 481	134	E. ARTHUR BROWN CO. 508	222	LOTUS DEVELOPMENT 299	302	PHASER 180
49	BYTEK COMP. SYS. 300	135	EZ ASSOC. 512	223	LSI JAPAN CO. 500	303	PHYSICAL DATA 148
50	BYTEWRITER 18	136	EAST SIDE SOFTWARE 358	224	LYBEN COMP. SYS. 518	440	PICKLES & TROUT 252
51	C-SYSTEMS 508	137	EASTERN ENTERPRISES 432	225	LYBEN COMP. SYS. 418	304	PION INC. 238
52	C.S.D. INC. 498	138	ECSOFT 483	227	MACROTECH INT'L. 117	305	POPCOMP 468
421	CABLES UNLTD. 512	141	ELECTRONIC SPCLISTS 480	228	MAI SORBUS 425	306	PRACTICAL PERIPH. 28, 29
53	CALIF. DATA CORP. 502	142	ELITE SOFTWARE 498	228	MAILCOMP 493	307	PRINCETON GRAPHIC SYS. 177
*	CALIF. DIGITAL 528, 527	*	ELLIS COMPUTING 237	229	MAIN KANNING INC. 498	308	PRINTER STORE, THE 315
*	CALIF. MICRO. COMP. 481	481	EMC DISTRIBUTORS 481	230	MANNESMANN TALLY 279	309	PRIORITY ONE 530, 531, 532,
55	CDR SYSTEMS 500	143	EMERY AIR FREIGHT 394	231	MANX SOFTWARE 474	533, 534, 535	
9	CDS 506	*	EMPIRICAL RESRCH. GRP. 27	232	MARK OF THE UNICORN 374	314	PROGRAMMERS SFTW. EX. 90
56	CHECK-MATE 242	139	EMS 399	233	MARK WILLIAMS CO. 341	315	PROGRAMMING INT'L. 328, 329
57	CHIPS & DALE 518	140	EMS 506	235	MARYAM INDUSTRIES 70	318	PROPTDOC, INC. 178
56	CHRISLIN INDUSTRIES 251	144	ENGINEERING SPECIALTIES 212	236	MASON COMPUTERS 384	317	PROMPTO ENTERPR. 198
59	CLAFF, WILLIAM J. 498	145	ENTER COMPUTER 233	238	MAXTEK 284	456	PROMPTO ENTERPR. 413
97	CLEO 427	146	EPSON AMERICA 85	237	MAYNARD ELECTRONICS 408	318	PROTOSYS 429
60	CMC INT'L. 135	147	ESSEX PUBLISHING 459	238	MC NEILL 486	319	PROXIMITY DEVICES CORP. 483
61	CMC INT'L. 440	148	EXPOTEK 133	239	MC/N INC. 508	320	PRYOR COMP. 459
82	COGITATE 502	149	EXXON OFFICE SYSTEMS 500	240	MCGRAW-HILL CORP. 392, 393	321	QUADRAM CORP. 57
83	COLONIAL DATA SERV. 82	150	FACIT DATAROYAL 273	*	MCGRAW-HILL CEC 385	322	QUADRAM CORP. 12, 13
64	COLORADO COMP. PERIPH. 498	151	FIGURE LOGIC BUS. EQUIP. 496	*	MCGRAW-HILL PROF. MANAG.	323	QUARK ENGINEERING 73
65	COLUMBIA DATA PROD. 248, 249	152	FORMULA INT'L. 435	242	NETWORK 384 A-P	422	QUIBE DISTRIBUTING 173
66	COMMUNICAL, INC. 106	153	FORTE 512	241	MEDIA DISTRIBUTING 332	324	QUELO 412
69	COMMUNICATIONS ELECTR. 507	154	FOX & GELLER INC. 318	54	MEDISOFT 518	325	QUICK-N-EASI PROD. INC. 478
70	COMP. COMPNTS. UNLTD. 515	21	FRANKLIN COMP. CORP. 387	243	MEGA CO. 508	326	QUICK TAX 84
71	COMPAQ COMPUTER CORP. 265	391	FROBCO 200	244	MEGABYTE INDUSTRIES 514	327	RACAL-VADIC 375
72	COMPONENTS EXPRESS 494	156	FURNITURE SYS. INT'L. INC. 514	245	MEMORY MERCHANT 119	328	RADIO SHACK CIV
73	COMPUADD 310	157	G-H COMPUTER SYS. 502	*	MEMOTECH 91	329	RED BARON COMP. PROD. 157
74	COMPUADD 498	158	GARDEN OF EDEN COMP. 498	248	METHOD SYSTEMS 498	332	ROCKY MT. MICRO INC. 205
75	COMPUPRO/GODBOUNT 20, 21	159	GENIE COMP. CORP. 295	248	MICRO APPLICATIONS 514	333	ROKLAN SOFTWARE 193
*	COMPUPRO/GODBOUNT 22, 23, 24	455	GENSTAR REI SALES CO. 264	435	MICRO BUSINESS WORLD 313	334	RONSAN ELECTRONICS 418
76	COMPUERVE 336, 337	180	GIFFORD COMP. SYS. 291	313	MICRO MAIL 513	335	RTL PROGRAMMING AIDS 508
310	COMPUSHACK 268, 269	451	GLADSTONE ELECTRONICS 232	249	MICRO MANAGEMENT SYS. 253	432	RUTISHAUSER 445
77	COMPUTER AGE 512	181	GILTRONIX INC. 510	250	MICRO MART 508	336	S&W COMPUTER SUPPLY 508
78	COMPUTER APPARATUS 511	183	GREAT SALT LAKE COMP. 505	252	MICRO PRO. INT'L. 254, 255	337	S-100 DIV. 698 CORP. 358
79	COMPUTER CHANNEL 484	184	GREENWOOD MFG. 250	253	MICRO-SCI 359	67	SAFEWARE 434
80	COMPUTER DISCOUNT PROD. 501	185	GTEK INC. 290	254	MICRO SOLUTIONS 496	338	SAGE COMP. TECH. 143
448	COMPUTER EXCHANGE 208, 207	186	H.H.S. MICROCONTROLLERS 510	255	MICRO TYPE 284	340	SAKATA 31
447	COMPUTER EXCHANGE 208, 207	188	HAYES MICROCOMP. PROD. 94, 95	256	MICRO WEST 204	341	SATURN SYSTEMS INC. 67
448	COMPUTER EXCHANGE 208, 207	189	HAYES MICROCOMP. PROD. 88, 89	257	MICRO WORKS, THE 199	342	SATURN SYSTEMS INC. 319
82	COMPUTER INNOVATIONS 26	171	HAYES MICROCOMP. PROD. 370	258	MICRO XPRESS 380	438	S.C. DIGITAL 354

To get further information on the products advertised in BYTE, fill out the reader service card with your name and address. Then circle the appropriate numbers for the advertiser's you select from the list. Add a 20-cent stamp to the card, then drop it in the mail. Not only do you gain information, but our advertisers are encouraged to use the marketplace provided by BYTE. This helps us bring you a bigger BYTE. The index is provided as an additional service by the publisher, who assumes no liability for errors or omissions. \*Correspond directly with company.

# Reader Service

Inquiry No.	Page No.	Inquiry No.	Page No.	Inquiry No.	Page No.	Inquiry No.	Page No.
353	* SMITH CORONA 245	371	TALLGRASS TECH. 81	452	TOUMAYAN & ASSOC. 232	242	VLM COMPUTER ELEC. 510
354	SNAVE SYSTEMS 498	372	TARBELL ELECTR. 267		* TRANS WORLD AIRLINES 312	412	VR DATA 388
355	SOFTTECH MICROSYS 327	373	TATUM LABS 496	380	TRANSTAR 185		* WAREHOUSE SOFTWARE 380
356	SOFTWARE BANC 89	374	TAURUS COMP.PROD.INC. 32	382	TRISTAR DATA SYS. 178	414	WASHINGTON COMP.SERV. 420
357	SOFTWARE BANC SEMINARS 322	375	TAURUS COMP.PROD.INC. 278	383	TSK ELECTR.CORP. 181	415	WASHINGTON COMP.SERV. 477
358	SOFTWARE SUPPORT INC. 478	311	TAVA CORP. 277	384	TYCOMP COMPANY 500		* WESTICO INC. 121
359	SOFTWARE UNLTD. 412	312	TAVA CORP. 285	386	U.S. EXCHANGE 514		* WHITESMITHS LTD. 93
359	SOLID STATE SALES 280	378	TAYCO BUSINESS FORMS 502	389	U.S. EXCHANGE 518	417	WINTEX CORP. 510
	* SORCIM 128, 127	377	TECH-DATA CORP. 510	395	U.S. MICRO SALES 524, 525	418	WINTERHALTER, INC. 471
360	STAR MICRONICS 223		* TECHNICAL SYS.CONSLTNS. 235	397	U.S. ROBOTICS 92	419	WORDTECH SYSTEMS 438
361	STARBUCK DATA CO. 317	378	TECHNIGRAPHIC DESIGNS 504	400	UNIFIED SOFTWARE SYS. 498	420	WORDTECH SYSTEMS 512
362	STEMMOS LTD. 264	379	TEKTRONIX INC. 123	401	UNITED COMPUTER 17	423	WYNDHAM GROUP 475
363	STIRSMAN CORP. 460	360	TELETEK 15	402	UNIVERSAL DATA SYS. 45	424	WYSE TECHNOLOGY 58, 59
364	STREET ELECTR. CORP. 158	361	TELETEX COMMUNICATIONS 421	404	VECTOR ELECTR. 424	425	X COMP 383
365	SUNBELT COMP. PROD. 412	362	TELEVIDEO INC. 280, 281	405	VECTRIX 247	428	YANG ELECTR. SYS. 174
366	SUNNY INT'L 497	363	TERMINALS TERRIFIC 288		* VERBATIM CORP. 385	449	YANG ELECTR. SYS. 496
367	SUNTRONICS 504	364	TEXAS COMP.SYS. 307		* VICTOR TECHNOLOGIES 448, 449	427	ZOBEX 215
368	SUNTRONICS 499		* TEXAS INSTRUMENTS 225	408	VIDEX 19		
369	SUPERSOFT 243	368	TDI 334	409	VIDIOM 518		
370	SUPERSOFT 141	365	THINKERS SOFT INC. 259	410	VISTA COMPUTER CO. 202		
439	SYSTEMED 514	369	TOTAL ACCESS SYS. 518	411	VISUAL TECH,INC. 201		

\*Correspond directly with company.

## NATIONAL ADVERTISING SALES REPRESENTATIVES:

### NEW ENGLAND

ME, NH, VT, MA, RI

Paul McPherson, Jr. (617) 262-1160

McGraw-Hill Publications

607 Boylston Street

Boston, MA 02116

### ATLANTIC

NJ (NORTH), NY, NYC, CT

Eugene Duncan (212) 997-2096

McGraw-Hill Publications

1221 Ave of the Americas - 39th Floor

New York, NY 10020

Dick McGurk (212) 997-3588

McGraw-Hill Publications

1221 Ave of the Americas - 39th Floor

New York, NY 10020

### EAST

PA (EAST), NJ (SOUTH), MD, VA, W. VA,

DE, D.C.

Daniel Ferro (215) 496-3833

McGraw-Hill Publications

Three Parkway

Philadelphia, PA 19102

### SOUTHEAST

NC, SC, GA, FL, AL, TN,

Maggie McClelland (404) 252-0626

McGraw-Hill Publications

4170 Ashford Dunwoody Road - Suite 420

Atlanta, GA 30319

### MIDWEST

IL, MO, KS, IA, ND, SD, MN, WI, NB

Jack Anderson (312) 751-3740

McGraw-Hill Publications

Blair Building

645 N. Michigan Ave

Chicago, IL 60611

### GREAT LAKES, OHIO REGION

MI, OH, PA (ALLEGHENY), KY, IN,

EASTERN CANADA

Dennis Riley (313) 352-9760

McGraw-Hill Publications

4000 Town Center - Suite 770

Southfield, MI 48075

### SOUTHWEST, ROCKY MOUNTAIN

UT, CO, WY, OK, TX, AR, MS, LA

Alan Morris (214) 458-2400

McGraw-Hill Publications

Prestonwood Tower - Suite 907

5151 Beltline

Dallas, TX 75240

### SOUTH PACIFIC

Southern CA, AZ, NM, LAS VEGAS

Page Goodrich (714) 557-6292

McGraw-Hill Publications

3301 Red Hill Ave

Building #1, Suite 222

Costa Mesa, CA 92626

Karen Niles (213) 480-5243, 487-1160

McGraw-Hill Publications

3333 Wilshire Boulevard #407

Los Angeles, CA 90010

### NORTH PACIFIC

HI, WA, OR, ID, MT, NORTHERN CALIF,

NV (EXCEPT LAS VEGAS) W. CANADA

David Jern (415) 362-4600

McGraw-Hill Publications

425 Battery St.

San Francisco, CA 94111

Bill McAfee (415) 964-0624

McGraw-Hill Publications

1000 Elwell Court - Suite 225

Palo Alto, CA 94303

### WEST COAST SURPLUS AND RETAIL ACCOUNTS

Tom Harvey (805) 964-8577

3463 State St. - Suite 256

Santa Barbara, CA 93105

## International Advertising Sales Representatives:

Mrs. Maria Sarmiento  
Pedro Telxelra 8, Off. 320  
Iberia Mart 1  
Madrid 4, Spain  
45 52 891

Mr. Andrew Karnig  
Andrew Karnig & Associates  
Kungsholmsgatan 10  
112 27 Stockholm, Sweden  
08 51 68 70

Mr. Hans Csokor  
Publimedia  
Relsnerstrasse 61  
A-1037 Vienna, Austria

Mrs. Gurit Gepner  
McGraw-Hill Publishing Co.  
115 Yosephthal St.  
Bat Yam, Israel  
866 561 321 39

Mr. Fritz Krusebecker  
McGraw-Hill Publishing Co.  
Llebigstrasse 27C  
D-6000 Frankfurt/Main 1  
West Germany  
72 01 81

Mr. Michael Sales  
McGraw-Hill Publishing Co.  
17 rue Georges Bizet  
F 75116 Paris  
France  
720 33 42

Mr. Simon Smith  
McGraw-Hill Publishing Co.  
34 Dover St.  
London W1X 3RA  
England  
01 493 1451

Mr. Ello Gonzaga  
McGraw-Hill Publishing Co.  
Via Baracchini 1  
20123 Milan, Italy  
86 90 617

Seavex Ltd.  
05-49/50 Tanglin Shopping Center  
19 Tanglin Rd. Singapore 1024  
Republic of Singapore

Seavex, Ltd.  
Room 102, Yu Yuet Lal Bldg.  
43-55 Wyndham St. Central  
Hong Kong

Nikkel/McGraw-Hill Publishing Co  
Nikkel Annex Bldg  
2-1-2 Uchikanda  
Chiyoda-Ku  
Tokyo, Japan

# BYTE READER SERVICE



For fastest service transfer mailer label from wrapper to coupon provided at the right. Requests cannot be honored unless zip code is given. This card valid for 90 days only. **NOTE**—If label is missing or defaced fill out coupon carefully—**PLEASE PRINT**—this is the only way to get requested material to you.

Name \_\_\_\_\_  
 (Title) \_\_\_\_\_ (Company) \_\_\_\_\_  
 Address \_\_\_\_\_  
 City \_\_\_\_\_ State \_\_\_\_\_ Zip \_\_\_\_\_

1	21	41	61	81	101	121	141	161	181	201	221	241	261	281	301	321	341	361	381	401	421	441	461	481	501	521	541	561	581	601	621	641	661	681
2	22	42	62	82	102	122	142	162	182	202	222	242	262	282	302	322	342	362	382	402	422	442	462	482	502	522	542	562	582	602	622	642	662	682
3	23	43	63	83	103	123	143	163	183	203	223	243	263	283	303	323	343	363	383	403	423	443	463	483	503	523	543	563	583	603	623	643	663	683
4	24	44	64	84	104	124	144	164	184	204	224	244	264	284	304	324	344	364	384	404	424	444	464	484	504	524	544	564	584	604	624	644	664	684
5	25	45	65	85	105	125	145	165	185	205	225	245	265	285	305	325	345	365	385	405	425	445	465	485	505	525	545	565	585	605	625	645	665	685
6	26	46	66	86	106	126	146	166	186	206	226	246	266	286	306	326	346	366	386	406	426	446	466	486	506	526	546	566	586	606	626	646	666	686
7	27	47	67	87	107	127	147	167	187	207	227	247	267	287	307	327	347	367	387	407	427	447	467	487	507	527	547	567	587	607	627	647	667	687
8	28	48	68	88	108	128	148	168	188	208	228	248	268	288	308	328	348	368	388	408	428	448	468	488	508	528	548	568	588	608	628	648	668	688
9	29	49	69	89	109	129	149	169	189	209	229	249	269	289	309	329	349	369	389	409	429	449	469	489	509	529	549	569	589	609	629	649	669	689
10	30	50	70	90	110	130	150	170	190	210	230	250	270	290	310	330	350	370	390	410	430	450	470	490	510	530	550	570	590	610	630	650	670	690
11	31	51	71	91	111	131	151	171	191	211	231	251	271	291	311	331	351	371	391	411	431	451	471	491	511	531	551	571	591	611	631	651	671	691
12	32	52	72	92	112	132	152	172	192	212	232	252	272	292	312	332	352	372	392	412	432	452	472	492	512	532	552	572	592	612	632	652	672	692
13	33	53	73	93	113	133	153	173	193	213	233	253	273	293	313	333	353	373	393	413	433	453	473	493	513	533	553	573	593	613	633	653	673	693
14	34	54	74	94	114	134	154	174	194	214	234	254	274	294	314	334	354	374	394	414	434	454	474	494	514	534	554	574	594	614	634	654	674	694
15	35	55	75	95	115	135	155	175	195	215	235	255	275	295	315	335	355	375	395	415	435	455	475	495	515	535	555	575	595	615	635	655	675	695
16	36	56	76	96	116	136	156	176	196	216	236	256	276	296	316	336	356	376	396	416	436	456	476	496	516	536	556	576	596	616	636	656	676	696
17	37	57	77	97	117	137	157	177	197	217	237	257	277	297	317	337	357	377	397	417	437	457	477	497	517	537	557	577	597	617	637	657	677	697
18	38	58	78	98	118	138	158	178	198	218	238	258	278	298	318	338	358	378	398	418	438	458	478	498	518	538	558	578	598	618	638	658	678	698
19	39	59	79	99	119	139	159	179	199	219	239	259	279	299	319	339	359	379	399	419	439	459	479	499	519	539	559	579	599	619	639	659	679	699
20	40	60	80	100	120	140	160	180	200	220	240	260	280	300	320	340	360	380	400	420	440	460	480	500	520	540	560	580	600	620	640	660	680	700

## BYTE'S BOMB

is your direct line to the editor's desk. Each month, the authors of the two top-rated articles receive bonuses based on your evaluation. First look at the list of this month's articles and corresponding article numbers (located in the unclassified ads section on the page preceding the Reader Service list), then rate each article you've read as **Excellent**, **Good**, **Fair**, or **Poor**, based on your overall impression of the article, by circling the appropriate number in each column below. Your feedback helps to produce the best possible magazine each month.

Article No.	1	2	3	4	5	6	7	8	9	10	11	12	13	14	15	16	17	18	19	20	21	22	23	24	25
<b>Excellent</b>	801	805	809	813	817	821	825	829	833	837	841	845	849	853	857	861	865	869	873	877	881	885	889	893	897
<b>Good</b>	802	806	810	814	818	822	826	830	834	838	842	846	850	854	858	862	866	870	874	878	882	886	890	894	898
<b>Fair</b>	803	807	811	815	819	823	827	831	835	839	843	847	851	855	859	863	867	871	875	879	883	887	891	895	899
<b>Poor</b>	804	808	812	816	820	824	828	832	836	840	844	848	852	856	860	864	868	872	876	880	884	888	892	896	900
<b>Comments</b>																									

# BYTE READER SERVICE



For fastest service transfer mailer label from wrapper to coupon provided at the right. Requests cannot be honored unless zip code is given. This card valid for 90 days only. **NOTE**—if label is missing or defaced fill out coupon carefully—**PLEASE PRINT**—this is the only way to get requested material to you.

Name \_\_\_\_\_  
 (Title) \_\_\_\_\_ (Company) \_\_\_\_\_  
 Address \_\_\_\_\_  
 City \_\_\_\_\_ State \_\_\_\_\_ Zip \_\_\_\_\_

1	21	41	61	81	101	121	141	161	181	201	221	241	261	281	301	321	341	361	381	401	421	441	461	481	501	521	541	561	581	601	621	641	661	681
2	22	42	62	82	102	122	142	162	182	202	222	242	262	282	302	322	342	362	382	402	422	442	462	482	502	522	542	562	582	602	622	642	662	682
3	23	43	63	83	103	123	143	163	183	203	223	243	263	283	303	323	343	363	383	403	423	443	463	483	503	523	543	563	583	603	623	643	663	683
4	24	44	64	84	104	124	144	164	184	204	224	244	264	284	304	324	344	364	384	404	424	444	464	484	504	524	544	564	584	604	624	644	664	684
5	25	45	65	85	105	125	145	165	185	205	225	245	265	285	305	325	345	365	385	405	425	445	465	485	505	525	545	565	585	605	625	645	665	685
6	26	46	66	86	106	126	146	166	186	206	226	246	266	286	306	326	346	366	386	406	426	446	466	486	506	526	546	566	586	606	626	646	666	686
7	27	47	67	87	107	127	147	167	187	207	227	247	267	287	307	327	347	367	387	407	427	447	467	487	507	527	547	567	587	607	627	647	667	687
8	28	48	68	88	108	128	148	168	188	208	228	248	268	288	308	328	348	368	388	408	428	448	468	488	508	528	548	568	588	608	628	648	668	688
9	29	49	69	89	109	129	149	169	189	209	229	249	269	289	309	329	349	369	389	409	429	449	469	489	509	529	549	569	589	609	629	649	669	689
10	30	50	70	90	110	130	150	170	190	210	230	250	270	290	310	330	350	370	390	410	430	450	470	490	510	530	550	570	590	610	630	650	670	690
11	31	51	71	91	111	131	151	171	191	211	231	251	271	291	311	331	351	371	391	411	431	451	471	491	511	531	551	571	591	611	631	651	671	691
12	32	52	72	92	112	132	152	172	192	212	232	252	272	292	312	332	352	372	392	412	432	452	472	492	512	532	552	572	592	612	632	652	672	692
13	33	53	73	93	113	133	153	173	193	213	233	253	273	293	313	333	353	373	393	413	433	453	473	493	513	533	553	573	593	613	633	653	673	693
14	34	54	74	94	114	134	154	174	194	214	234	254	274	294	314	334	354	374	394	414	434	454	474	494	514	534	554	574	594	614	634	654	674	694
15	35	55	75	95	115	135	155	175	195	215	235	255	275	295	315	335	355	375	395	415	435	455	475	495	515	535	555	575	595	615	635	655	675	695
16	36	56	76	96	116	136	156	176	196	216	236	256	276	296	316	336	356	376	396	416	436	456	476	496	516	536	556	576	596	616	636	656	676	696
17	37	57	77	97	117	137	157	177	197	217	237	257	277	297	317	337	357	377	397	417	437	457	477	497	517	537	557	577	597	617	6			

PLACE  
STAMP  
HERE

**BYTE**

READER SERVICE  
PO BOX 298  
DALTON, MA 01226  
USA

PLACE  
STAMP  
HERE

**BYTE**

READER SERVICE  
PO BOX 298  
DALTON, MA 01226  
USA



# BYTE

## SUBSCRIPTIONS



4163

For a subscription to BYTE, please complete this card.

Name \_\_\_\_\_

Address \_\_\_\_\_

City \_\_\_\_\_

State \_\_\_\_\_ Zip \_\_\_\_\_ Country \_\_\_\_\_

Card No. \_\_\_\_\_

Expiration date \_\_\_\_\_

Four digits above name—Master Charge only \_\_\_\_\_

Signature \_\_\_\_\_ Date \_\_\_\_\_

Please allow eight weeks for processing. Thank you.

USA

Canada  
Mexico

- |                                  |                               |                               |
|----------------------------------|-------------------------------|-------------------------------|
| <input type="checkbox"/> 1 year  | <input type="checkbox"/> \$21 | <input type="checkbox"/> \$23 |
| <input type="checkbox"/> 2 years | <input type="checkbox"/> \$38 | <input type="checkbox"/> \$42 |
| <input type="checkbox"/> 3 years | <input type="checkbox"/> \$55 | <input type="checkbox"/> \$61 |

- \$53 Europe (air delivery) payment enclosed  
 \$37 Elsewhere (surface mail) payment enclosed

(Air mail rates available upon request)

**Please remit in US funds drawn on a US bank. Thank you.**

- Check enclosed (**Bonus:** [North America only] one EXTRA issue—receive 13 issues for the price of 12)

- Bill me (North America only)

# BYTE

## SUBSCRIPTIONS



4163

For a subscription to BYTE, please complete this card.

Name \_\_\_\_\_

Address \_\_\_\_\_

City \_\_\_\_\_

State \_\_\_\_\_ Zip \_\_\_\_\_ Country \_\_\_\_\_

Card No. \_\_\_\_\_

Expiration date \_\_\_\_\_

Four digits above name—Master Charge only \_\_\_\_\_

Signature \_\_\_\_\_ Date \_\_\_\_\_

Please allow eight weeks for processing. Thank you.

USA

Canada  
Mexico

- |                                  |                               |                               |
|----------------------------------|-------------------------------|-------------------------------|
| <input type="checkbox"/> 1 year  | <input type="checkbox"/> \$21 | <input type="checkbox"/> \$23 |
| <input type="checkbox"/> 2 years | <input type="checkbox"/> \$38 | <input type="checkbox"/> \$42 |
| <input type="checkbox"/> 3 years | <input type="checkbox"/> \$55 | <input type="checkbox"/> \$61 |

- \$53 Europe (air delivery) payment enclosed  
 \$37 Elsewhere (surface mail) payment enclosed

(Air mail rates available upon request)

**Please remit in US funds drawn on a US bank. Thank you.**

- Check enclosed (**Bonus:** [North America only] one EXTRA issue—receive 13 issues for the price of 12)

- Bill me (North America only)

*Note our special offer!  
 Send cash with your order  
 and receive 13 issues  
 for the price of 12 for  
 each year you subscribe.  
 (North America only, please.)*

## Don't Miss An Issue!

### Have BYTE delivered to your door.

Each month BYTE will bring you the latest in microcomputer technology.

DISCOVER and IMPLEMENT new ideas. Don't miss the original information presented in the pages of BYTE.

With BYTE you'll always be among the first to know about the important breakthroughs, worthwhile new equipment, and innovative projects in the world of computing.

CHALLENGE US to deliver the very best ideas in microcomputers and advanced technology to you. Return the attached card today!

Subscribe to BYTE—the world's leading computer magazine.

PLACE  
STAMP  
HERE

**BYTE** SUBSCRIPTIONS  
PO Box 590  
Martinsville NJ 08836  
USA

PLACE  
STAMP  
HERE

**BYTE** SUBSCRIPTIONS  
PO Box 590  
Martinsville NJ 08836  
USA

**BUY A BANANA.  
SAVE A BUNCH.  
MORE TO COME.**



Leading Edge Products, Inc., 225 Turnpike Street, Canton, Massachusetts 02021.  
Call: toll-free 1-800-343-6833; or in Massachusetts call collect (617) 828-8150. Telex 951-624.

Circle 217 on Inquiry card.

# Radio Shack Presents The Micro Executive Workstation

- Powerful Built-In Software
- Retains Memory Data When "Off"
- Self-Contained Telephone Modem
- 8K RAM—Expandable to 32K

Only  
**\$799**

Cat. No. 26-3801

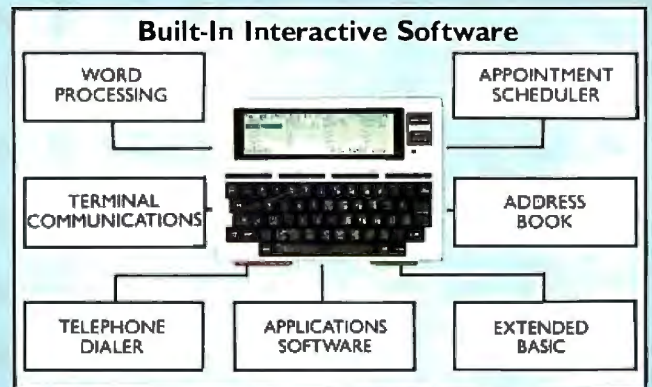


## Introducing the TRS-80® Model 100 Portable Computer —User-Friendly Software Makes it Truly Revolutionary

Imagine a computer on your desk so small, it can fit in your in-basket. The second you turn it on, imagine seeing a menu of built-in executive management programs and your own files, ready for immediate use. All revealed on an eight-line by 40-character LCD display positioned just above a full-size keyboard. And when you leave the office, imagine a three-pound computer you can take along, because it works on AC or batteries.

Stop imagining. The new TRS-80 Model 100 is the computer you've been waiting for. As a desk organizer, it's a phone directory, address book, appointment calendar and telephone auto-dialer. It's a personal word processor, as well. There's even a built-in modem to access other computers by phone.

Come see the most revolutionary computer since the TRS-80 Model I at over 6500 Radio Shack stores and participating dealers, including over 400 Radio Shack Computer Centers nationwide.



**Send me a free Model 100 brochure today!**

Mail To: Radio Shack, Dept. 83-A-165  
300 One Tandy Center, Fort Worth, Texas 76102

NAME \_\_\_\_\_  
 COMPANY \_\_\_\_\_  
 ADDRESS \_\_\_\_\_  
 CITY \_\_\_\_\_ STATE \_\_\_\_\_ ZIP \_\_\_\_\_  
 TELEPHONE \_\_\_\_\_

Retail prices may vary at individual stores and dealers.

**Radio Shack®**  
 The biggest name in little computers®  
 A DIVISION OF TANDY CORPORATION

Circle 328 on inquiry card.