

12490

®

BYTE

the small systems journal

MARCH 1984 Vol. 9, No. 3
\$3.50 in USA
\$5.95 in Canada/\$2.10 in U.K.
A McGraw-Hill Publication
0895-5229/84

ROBERT
83 TINNEY



SIMULATION



Inside Apple

Vol. 1, No. 4

A dot matrix printer that will improve your image.

Meet the Apple® Imagewriter, the newest dot matrix printer for your Apple Personal Computer.

And with all that it has going for it, just maybe the best dot matrix printer on the market.

Take legibility, for instance.

The Imagewriter crams 140 x 160 dots into each square inch. So you get text that's highly readable and high resolution graphics, besides.

And is it fast.

The Imagewriter cruises at an unbelievable 120 characters per second. And that's just in the text mode. It's even faster printing graphics. 180 characters per second, to be exact.

What's more, the graphics dump is up to 60% faster than other comparably priced dot matrix printers. And that makes the Imagewriter fast enough to handle the Lisa.™

Yet it's just as at home with an Apple III or Apple IIe. Thanks to Apple software experts who designed the control electronics to give the Imagewriter perfect compatibility. Not to mention some special capabilities

like superscript and subscript, to name just two.

Now, with all this high-speed performance, you'd expect the Imagewriter to make the Devil's Own Noise. It doesn't. In fact, the Imagewriter is specially constructed — with overlaid seams and special sound-deadening materials — to achieve a remarkable 53 dB. How loud is a remarkable 53 dB? You'd make more noise if you read this aloud.

The Imagewriter even has quiet good looks, since we designed it to look like the rest of the Apple Family.

Yet even with all its improvements, the Imagewriter is a better deal than any other dot matrix printer with comparable performance. And you can print that.

**APPLE PRESENTS THE
EIMAGewriter APPLE PR
ESENTS THE IMAGewriter APPLE PRESENT
S THE IMAGewriter APPLE PRESENTS THE IMAGewriter APPLI**

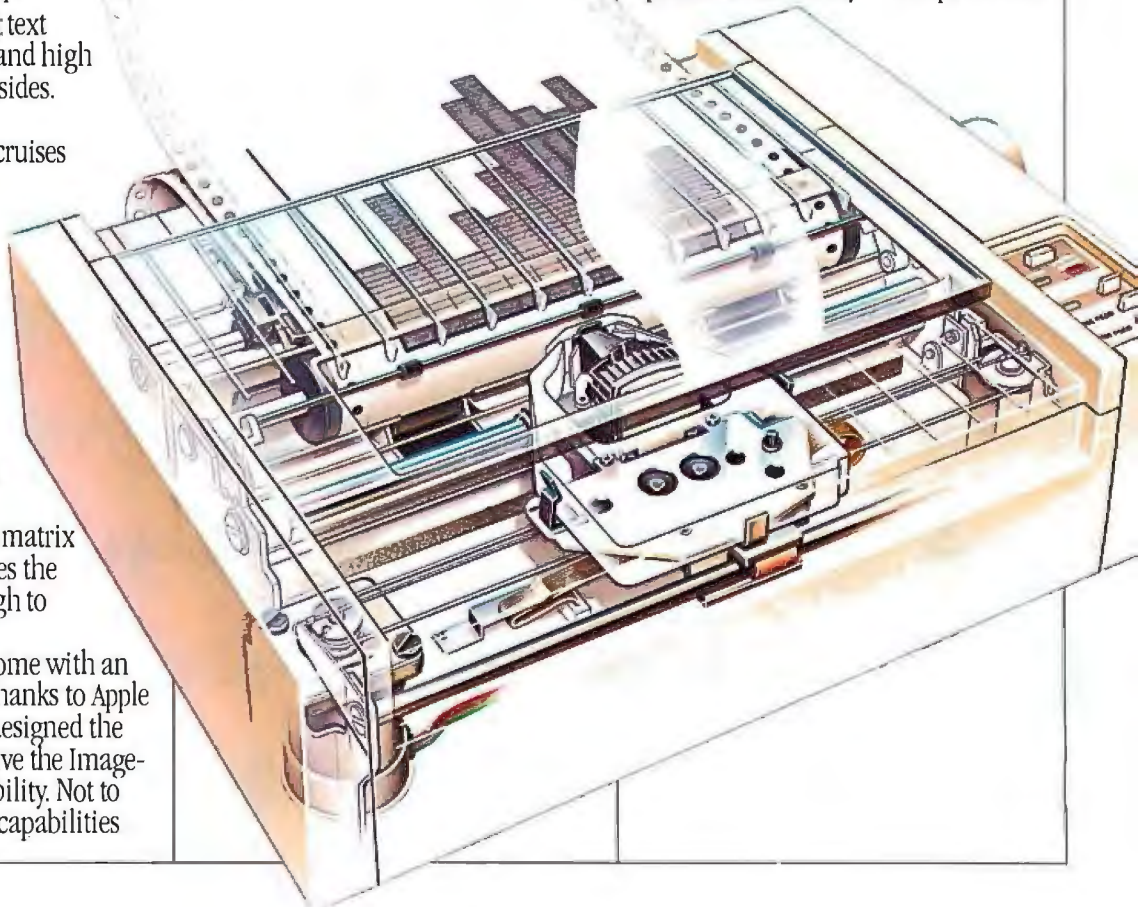



Charge!

Go out there and get the Apple Personal Computer System you really want. Now. Without laying out your extra cash. Without **tying up** your other lines of credit. **With the Apple Card.** The only consumer credit card reserved **exclusively** for the purchase of **Apple Computers**, peripherals and **software**.

Like all our products, it works simply:

Fill out an application (short, to the point and annotated in English) at an authorized **Apple dealer** honoring the **Card**. Your salesperson will call in the application and in most cases get an approval for you right on the spot.

You can then take your **Apple** system home. You don't even **have** to wait for the **Card**; we'll mail it out to you. And by the time you get it, you'll probably be well into doing whatever you bought your Apple system to do.

There is no annual fee for the **Card**, **although** a couple of restrictions do **apply**. The first purchase must include an **Apple Personal Computer** and you **have** to **put** 10% down. And subsequent **purchases** need to be at least \$100 if made with the **Card**. Oh, yes — you'll also have a credit limit.

When you use the **Apple Card** to make additional purchases, all you have to do is show the **Card** and sign the invoice. **As long** as it's within your credit limit, of course. Our dealers get a little nervous when someone signs for half their **inventory**. You understand.

You'll also receive monthly statements that include the latest purchases, credit available, and the minimum payment due. You'll also be happy to know **Apple Card** credit terms are affordable and the payments can be spread out. It's all

spelled out for you at the time your **Card** is approved.

So **stop** by a participating **authorized Apple dealer** and get an **Apple Card**. **Just** think of it as credit where credit is due.

Give your floppy disks the boot.

We call it the "floppy disk shuffle." It happens when you have two or more software programs on floppies and you need to work with both. What do you do? You put one disk in, boot it, do your work, take it out, put the other disk in, boot it, do your work — you get the idea.

Well, you can stop shuffling any time now.

Thanks to a unique new software program called **Catalyst™** from Quark, Inc. Specially designed for your **Apple III** and **ProFile™** hard disk.

Catalyst allows you to take a wide variety of software programs and store them on your **ProFile**. Once they're on your **ProFile**, you just select the program you want from the **Catalyst** menu that **appears** on your monitor — then **Catalyst** does the rest. You'll never have to boot those programs again.

What kinds of programs will work with **ProFile** and **Catalyst**?

Almost anything written for the **Apple III** including copy-protected programs like **VisiCalc®**, **Quick File™** and **Apple Writer III**. Or languages like **Pascal**, **BASIC**, or **COBOL**.

And once you've loaded these programs into your **ProFile**, the only diskette you may ever need is the **Catalyst**.

So if you have an **Apple III** and a **ProFile** and more floppies than you care to flip through, get **yourself** a **Catalyst**. And boot those disks for good.

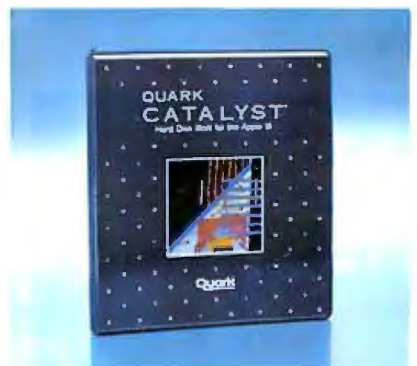

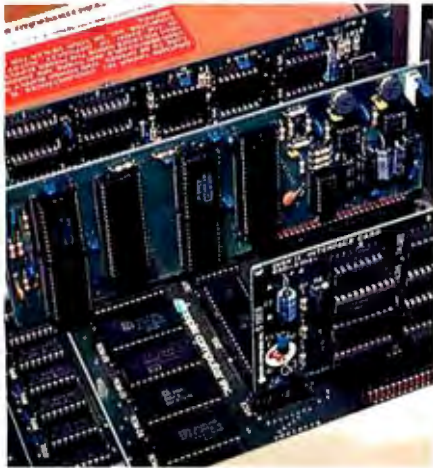

Page 28



Page 106



Page 224

Columns

28 Build a Third-Generation Phonetic Speech Synthesizer by Steve Ciarcia / The latest development in phonetic speech synthesis is the Silicon Systems SSI263 chip.

47 User's Column: New Machines, Networks, and Sundry Software by Jerry Pournelle / Chaos Manor is inundated with new computers.

81 BYTE West Coast: A First Look at Dayflo by Ezra Shapiro / A free-form database gets you closer to your ideas.

Themes

93 Feigning Reality by Art Little / This month's theme articles explore the use of software models to solve real-world problems.

95 Computer Simulation: What It Is and How It's Done by Richard Bronson / An introduction to modeling and computer simulation as they apply to microcomputers.

106 Simulating Reality with Computer Graphics by Peter R. Sørensen / One of the most intriguing branches of computer science promises to get even more exciting in the future.

138 Simulation of Weighted Voting: The Banzhaf Index by Philip A. Schrodt / In choosing and electing candidates, sometimes a small political party has the greatest influence.

157 Queue Simulation by E. Hart Rasmussen / A microcomputer can help you manage waiting lines.

179 A Risky Business—An Introduction to Monte Carlo Venture Analysis by Pat Macaluso / The author explains a simple method for analyzing business risks.

194 Simulation and Graphics on Microcomputers by Ronald R. Miller / Some graphic examples may be worth a thousand words.

204 Going Further by Charles A. Pratt / A compendium of conferences, organizations, books, and software for microcomputer simulationists.

Reviews

213 Reviewer's Notebook by Rich Malloy / BYTE's product-review editor comments briefly on the Wang Professional Computer, DEC's Rainbow, and other systems.

214 Compupro's System 816/C and System 68K—the Two and Only by Ed Teja / Compupro's new reversibles are 8085/8088 on one side and 68000 on the other.

224 Microsoft Flight Simulator by Stan Miastkowski / Even experienced pilots should find this program useful and challenging.

236 The Eagle PC by Tom Wadlow / A clone with a few improvements and a few mistakes.

246 STSC APL* Plus and IBM PC APL: Two APLs for the IBM PC by Jacques Bensimon / The IBM version of APL is simpler and more conservatively designed; the STSC version is more powerful and more expensive.

268 Chalk Board's Powerpad and Leonardo's Library by Elaine Holden / A new large touch panel for the Atari 400/800, the Commodore 64, and the Apple II comes with a wide selection of software.

BYTE is published monthly by McGraw-Hill Inc., with offices at 70 Main St., Peterborough, NH 03458, phone (603) 924-9281. Office hours: Mon—Thur 8:30 AM — 4:30 PM, Friday 8:30 AM — Noon, Eastern Time. Address subscriptions to BYTE Subscriptions, POB 590, Martinsville, NJ 08836. Address changes of address, USPS Form 3579, and fulfillment questions to BYTE Subscriptions, POB 596, Martinsville, NJ 08836. Second-class postage paid at Peterborough, NH 03458 and additional mailing offices. USPS Publication No. 528890 (ISSN 0360-5280). Postage paid at Winnipeg, Manitoba. Registration number 9321. Subscriptions are \$21 for one year, \$38 for two years, and \$55 for three years in the USA and its possessions. In Canada and Mexico, \$23 for one year, \$4



274 Simulated Computer II by Richard Grehan / A graphic demonstration of how a microprocessor operates is also an easy introduction to assembly language.

282 Bank Street Writer by Mario Pagnoni / This word processor is simple enough for children but powerful enough for many adult writers.

288 SPOC: The Chess Master by Emil Flock and Jonathan Silverman / A close look at a significant chess program for the IBM PC.

296 M.U.L.E. by Gene Smarte / Beneath its clever packaging lies a fascinating economic simulation.

301 The Witness by Dennis Barker / A murder-mystery game for detectives whose business is trouble.

Features

306 The Tandy TRS-80 Model 2000: A Powerful New MS-DOS Machine by Rich Malloy / Performance advantages and an attractive price will make this 80186-based machine the new Tandy standard-bearer.

320 A Closer Look at the IBM PCjr by G. Michael Vose and Richard S. Shuford / Two BYTE editors compare the PCjr to the PC and evaluate its performance and expandability.

336 The Japan Shows: An Update on the Japanese Computing Scene by Richard Willis / NEC introduces an impressive 16-bit computer, and Canon shows a remarkable, inexpensive laser printer.

352 The User Goes to COMDEX, 1983 by Jerry Pournelle / Sorting through a plethora of booths and products, Jerry manages to find some worthwhile merchandise.

371 Pascal's Design Flaws: Modula-2 Solutions and Pascal Patches by Mark C. Johnson and Allen Munro / The authors look at seven subtle problems with Pascal and how Modula-2 avoids them.

393 Trademarking Software Packages by Robert Greene Sterne and Perry J. Saidman / Trademark clearance can prevent litigation and loss of hard-earned goodwill.

400 An EPROM Simulator by Albert S. Woodhull / This versatile project includes battery backup.

411 Simulation with Electronic Spreadsheets by Art Matheny / Spreadsheet programs make a career change.

Nucleus

- | | |
|---|---|
| 4 Editorial: Where BYTE Is Going | 462 Software Received |
| 9 MICROBYTES | 470 Books Received |
| 15 Letters | 473 Book Reviews |
| 418 BYTE's User to User | 474 What's New? |
| 430 Ask BYTE | 541 Unclassified |
| 438 Event Queue | 542 BYTE's Ongoing Monitor Box, BOMB Results |
| 458 Clubs and Newsletters | 543 Reader Service |

Cover painting by Robert Tinney



Page 268

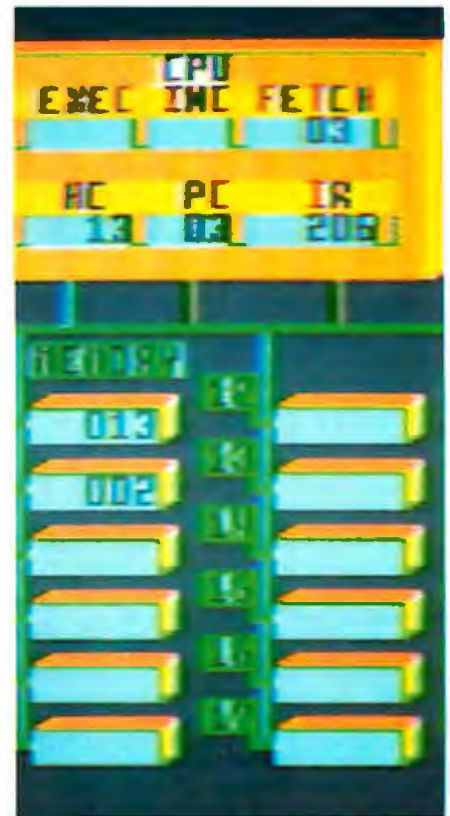

Page 274



Page 336

for two years, \$61 for three years. \$53 for one year air delivery to Europe, 17,100 yen for one year surface delivery to Japan, \$37 surface delivery elsewhere. Air delivery to selected areas at additional rates upon request. Single copy price is \$3.50 in the USA and its possessions, \$3.95 in Canada and Mexico, \$4.50 in Europe, and \$5.00 elsewhere. Foreign subscriptions and sales should be remitted in United States funds drawn on a US bank. Printed in the United States of America.

Subscription questions or problems should be addressed to:
 BYTE Subscriber Service, POB 328, Hancock, NH 03449



Managing Editor: Philip Lemmons

Senior Technical Editors: Gregg Williams, Richard Malloy, G. Michael Vose

Technical Editors: Richard S. Shuford, Arthur A. Little, Stanley Wszola, Bruce Roberts, Gene Smarte, Richard Krajewski, Jane Morrill Tazelaar, Anthony J. Lockwood, New Products Editor; Steve Ciarcia, Consulting Editor; Mark Welch, Staff Writer; Alan Easton, Drafting Editor

West Coast Editors: John Markoff, Senior Technical Editor; Ezra Shapiro, Technical Editor; Donna Osgood, Assistant Editor. McGraw-Hill, 425 Battery Street, 4th Floor, San Francisco, CA 94111, (415) 362-4600

Copy Editors: Elizabeth R. Cooper, Chief; Warren Williamson, Nancy Hayes, Joan V. Roy, Dennis E. Barker, Anne L. Fischer, Bud Sadler, Margaret Cook, Paula Noonan

Assistants: Faith Kluntz, Beverly Jackson, Lisa Jo Steiner, Peggy Dunham

Production: David R. Anderson, Assoc. Director; Virginia Reardon, Production Manager; Jan Muller, Michael J. Lonsky; Sherry McCarthy, Chief Typographer; Donna Sweeney, Valerie Horn, Len Lorette

Advertising: Deborah Porter, Supervisor; Marion Carlson, Rob Hannings, Cathy A. R. Drew, Lisa Wozmak, Jeanne Cille, Jeanna Reenstierna; Wai Chiu Li, Quality Control Manager; Linda J. Sweeney, Advertising/Production Coordinator; Julie Nelson

Advertising Sales: J. Peter Huestis, Sales Manager; Sandra Foster, Administrative Assistant
Circulation: Gregory Spitzfaden, Director; Andrew Jackson, Subscriptions Manager; Barbara Varnum, Asst. Manager; Agnes E. Perry, Louise Menegus, Jennifer Price, Jane Varnum, Phil Dechert, Mary Emerson; James Bingham, Single-Copy Sales Manager; Linda Turner, Assistant Manager; Carol Aho, Edson Ware

Marketing Communications: Horace T. Howland, Director; Doug Webster, Director of Public Relations; Vicki Reynolds, Coordinator; Stephanie Warnesky, Graphics Design Manager; Michele P. Verville, Research Manager; Patricia Akerley, Market Research Analyst; Cynthia Damato, Reader Service Coordinator

Business Manager: Daniel Rodrigues

Controller's Office: Kenneth A. King, Assistant Controller, Mary E. Fluhr, Acct. & D/P Manager; Karen Burgess, Linda Short, Vicki Bennett, Vern Rockwell, Lyda Clark, Janet Pritchard, JoAnn Walter, Julie Ferry, Patricia Burke

Traffic: N. Scott Gagnon, Manager; Brian Higgins
Receptionist: L. Ryan McCombs

Personnel/Office Manager: Cheryl A. Hurd

Associate Publisher/Production Director: John E. Hayes

Publisher: Gene W. Simpson;
Doris R. Gamble, Publisher's Assistant

Editorial and Business Office: 70 Main Street, Peterborough, New Hampshire 0345B, (603) 924-9281

Officers of McGraw-Hill Publications Company:
President: John G. Wrede; Executive Vice Presidents: Paul F. McPherson, Operations; Walter D. Serwatka, Finance & Services. Senior Vice President-Editorial: Ralph R. Schulz. Senior Vice President Publishers: Harry L. Brown, David J. McGrath, James R. Pierce, Gene W. Simpson, John E. Slater. Vice President Publishers: Charlton H. Calhoun III, Richard H. Larsen, John W. Patten. Vice Presidents: Kemp Anderson, Business Systems Development; Shel F. Asen, Manufacturing; John A. Bunyan, Electronic Information Services; George R. Eisinger, Circulation; Michael K. Hehir, Controller; Eric B. Herr, Planning and Development; H. John Sweger, Jr., Marketing.

Officers of the Corporation: Harold W. McGraw, Jr., Chairman; Joseph L. Dionne, President and Chief Executive Officer; Robert N. Landes, Senior Vice President and Secretary; Ralph J. Webb, Treasurer.

Where BYTE Is Going

We want to clear up some confusion about different kinds of articles in BYTE that have sometimes been mistaken for one another, to explain how we intend to avoid the same problem in the future, and to reaffirm BYTE's editorial direction as a magazine for personal computer users.

BYTE publishes *reviews* in order to help readers make purchasing decisions on personal computers, peripherals, and software. A review passes judgment on a product. Every review in BYTE appears in the Reviews section and carries a banner that includes the word "review." Although staff members sometimes write reviews, we more often solicit them from personal computer users who are not on staff. We try to ensure that reviews are thorough, frank, and fair. Fairness requires that all reviews be performed on actual shipping products rather than prototypes or beta-test machines and software. To do otherwise is unfair to the reader, the reviewer, and the manufacturer. In a few cases, we have mistakenly published reviews of prerelease products. (We owe an apology to Supersoft for holding a prerelease version of its C compiler up to the standard of a shipping product in our August 1983 issue.)

BYTE publishes *product descriptions* to give readers an early look at forthcoming products that are innovative and important. BYTE staff members write almost all product descriptions because of the absolute confidentiality required in gaining access to prototypes and beta-test products months before product announcements. Because product descriptions are written at such an early stage of a product's development, they cannot pass judgment on the final product. Rather, the goal of a product description is to give the reader as much technical information as possible at the time and also a detailed impression of how it feels to use the product, how the product works, and how it breaks new ground.

When we see a prototype or test system at an even earlier stage of development, we call the resulting article a *product preview* rather than a product description. Again we try to give our readers an early look at something new and interesting, and an impression of the product-to-be, but we also recognize that the manufacturer may make significant changes before going into production. A product preview usually has less detail than a product description.

To review a prerelease product would be unfair, but product descriptions and previews do point out design limitations that cannot be changed by shipping date (for example, the HP 150's lack of provision for an 8087 coprocessor, or Macintosh's lack of an inboard second disk drive). At this writing, BYTE has done product previews of both the HP 150 and the Macintosh, but has not yet received review machines of these products. As soon as machines arrive, we will assign them to reviewers. We will publish the reviews as quickly as possible after their completion, but bear in mind that a good review requires the writer to use a product for four to eight weeks and then spend another two weeks or more in the writing. It takes another three to four months to turn a completed manuscript into a printed article in BYTE.

Those readers who have recently suggested that BYTE publishes too many favorable reviews have typically mistaken product previews and product descriptions for reviews. The editors of BYTE are under no pressure to review any product favorably. We enjoy complete editorial

How Cromemco plugs you into the state of the art.

Cromemco offers you the most complete line of S-100 boards and peripherals in the business. These boards use the new IEEE-696 state-of-the-art standard. One-stop shopping can satisfy your design needs the easy way.

You can build one system, or a hundred, exactly the way you want, and upgrade existing systems with a simple board swap or addition. And since we design our own boards for our own systems, we always take advantage of the latest developments in IC technology.

68000 microprocessor performance. Cromemco's Dual Processor Unit gives you the best of both worlds: the

68000 and the Z-80A microprocessors on the same board. It's the easiest way to move into 68000 performance and still use your existing 8-bit software. Or use Cromemco's Z-80A CPU board or our Z-80A-based single board computer.

For selection, Cromemco can't be matched. From the well-known SDI High Resolution Color Graphics board to the new 512MSU, 512K byte RAM board. From our highly reliable Local Area Network interface (C-NET) to our wide variety of general purpose interface boards. And you can put them in one of our 8-, 12-, or 21-slot card cages with our 12 amp PS-8 power supply to get your system into operation fast.

We have over 30 S-100 boards to fill your needs. And all are supported by a broad line of software. Our Board Products Catalog has the latest information. Call today for your copy, or to get the name of our nearest dealer or distributor. Or, write Cromemco, Inc., 280 Bernardo Avenue, P.O. Box 7400, Mountain View, CA 94039. Tel: (415) 964-7400. In Europe: Cromemco A/S, Vesterbrogade 1C, 1620 Copenhagen, Denmark.

In the U.S., contact your local Hall-Mark or Kierulff distributor.

Cromemco

Circle 106 on inquiry card.



freedom, which remains unabridged even when advertisers have canceled ads because they disliked a review.

BYTE does sometimes accept articles from the designers or developers of some interesting new product or technology but never asks or permits them to review their own creations. We publish design and development articles because they can appear months earlier than reviews, can contain insights into technical creativity, and can provide a glimpse of the state of the art or the future direction of personal computing.

In some recent cases, BYTE has been guilty of insufficient editorial zeal in purging promotional material from certain articles. We deeply regret these errors, are correcting the circumstances that led to them, and will redouble our efforts to see that no expressions of self-interest appear in these pages. We definitely erred in moving the affiliations of authors

from the beginning of the article to the end. The change was made for purely graphical reasons, not to mislead the reader, and is reversed in the April issue. In upcoming issues we will also provide distinctive graphics to make reviews, product descriptions, product previews, and design articles look markedly different from one another.

We try our best to present independent reviews of all products covered in design articles, product descriptions, and product previews. This has been the case with the June 1983 issue on "16-Bit Designs," which attempted to show the great variety of systems becoming available despite the tide of PC compatibles and to stimulate dialogue between designers and users. In a few instances, circumstances prevented our publishing in-depth reviews of products featured in that issue. Four of the systems described—Gavilan, Sunrise, Pronto, and TI 99/2—had hardly been an-

nounced and could not have been reviewed then. Unfortunately, we are still awaiting review machines of the Gavilan, the Sunrise (Xerox 1800), and the Pronto. The TI 99/2 died aborning but was of interest as an under-\$100 16-bit computer. Despite these exceptions, most of the systems presented in the June issue have been reviewed or are scheduled for review in the near future. Berry Kercheval's independent review of the HP Series 200 Model 16 appeared in November. (Generally he liked the machine, but he found serious fault with the documentation, the keyboard, and the Pascal compiler. David Colver, in turn, found Kercheval's review wanting, and we publish Colver's letter on page 15 in this issue.) Reviews of the DEC Professional 350, the Altos 586, the Fujitsu Model 16s, and the Sritek 68000 board for the IBM PC are in progress. A review of the DEC Rainbow is scheduled to appear in April.

This issue contains product descriptions of the Tandy 2000 and the IBM PCjr. Reviews will follow as soon as possible; we would be delighted to receive reviews from any readers who get one of the first production machines from Tandy or IBM.

In some areas of advanced technology, such as perpendicular magnetics, there is not yet a product to describe, preview, or hand over to an independent reviewer. Furthermore, it is extremely difficult to find an expert author who is not working for one of the few companies active in that field.

BYTE is committed both to covering new technology in depth and to providing independent, well-informed, frank, and fair product reviews. Although we will seek technical expertise in academe, industry, and private life, BYTE is and will remain a magazine for personal computer users. The sophisticated user is both our most common reader and our best writer. We believe that users should shape the future of personal computing, and we invite you once again to do so through the pages of this magazine.

—Phil Lemmons, *Managing Editor*

New!

BYTEWRITER®

**DAISY WHEEL
PRINTER/TYPEWRITERS**



- Full Olivetti typewriter warranty when purchased complete

Complete BYTEWRITER using:

Olivetti Praxis 30 portable	\$495
Olivetti Praxis 35 portable	\$545
Olivetti Praxis 40 office machine	\$645
Interface only-wired and tested	\$165

The parallel interface mounts entirely internally interconnecting cables available for most computers.

BYTEWRITER

125 NORTHVIEW RD., ITHACA, N.Y. 14850
(607) 272-1132

HOW TO GET AN IBM PC FOR JUST \$1995.

BUY A CHAMELEON.



The Chameleon by Seequa does everything an IBM PC does. For about \$2000 less than an IBM.

The Chameleon lets you run popular IBM software like Lotus® 1-2-3™ and Wordstar.® It has a full 83 key keyboard just like an IBM. Disk drives like an IBM. And a bright 80 × 25 character screen just like an IBM.

But it's not just the Chameleon's similarities to the IBM that should interest you. Its advantages should, too. The Chameleon also has an 8 bit microprocessor that

lets you run any of the thousands of CP/M-80® programs available. It comes complete with two of the best programs around, Perfect Writer™ and Perfect Calc.™ It's portable. And you can plug it in and start computing the moment you unwrap it.

So if you've been interested in an IBM personal computer, now you know where you can get one for \$1995. Wherever they sell Chameleons.

The Chameleon by



For the location of the Seequa dealer nearest you, call (800) 638-6066 or (301) 672-3600.

Get A HeadStart[™] On The Other Guys.



HeadStart Features:

Size: 15" wide, 11" deep, 10½" high.

Weight: 25 lbs.

Processors: 280A (8 bit) and 8086 (16 bit).

Memory: 128K to 1MB depending on model. All models are expandable.

Disk Storage: 500K to 1MB (unformatted) on a 3½" Micro-Disk.

Display: 12" (diagonal) P31 phosphor, non-glare screen, 25 lines x 80 or 132 columns.

Keyboard: Detachable with 105 total keys. Also an optional portable version straps onto the front screen area for easy transportability.

Disk Operating Software: *CP/M 80 for 8 bit
**MS DOS for 16 bit. LAN DOS for multi-user 8 or 16 bit operation.

Networking: Up to 255 HeadStart VPUs may be connected via coaxial interface into one of 2 optional data storage systems.

Interfaces: One RS449/RS232 compatible serial port. One Centronics compatible parallel printer port. External data bus. Coaxial communications interface. External disk I/O interface.

Optional Data Storage Systems: 2 models available. A 10MB, 5¼" system is expandable to 20MB. A 50MB, 8" system (25MB fixed, 25MB removable) is expandable to 200MB.

*CP/M is a registered trademark of Digital Research.

**MS DOS is a registered trademark of Microsoft.

Intertec's HeadStart is the smallest, smartest, fastest, most powerful business computer money can buy. And the most expandable (it's networkable up to 255 user stations.)

Great Ideas Come In Small Packages.

Instead of three bulky components, HeadStart needs only two—the keyboard and CRT. There's no need for a cumbersome disk and processor cabinet. With HeadStart, it's all in the CRT enclosure.

HeadStart's small but powerful 3½" disk drive offers as much storage as larger 5¼" disks. Its 8 and 16 bit processors make software availability no problem.

And HeadStart's small size permits easy transportability with no sacrifice in performance. Each Video Processing Unit (VPU) comes with its

own easy-carrying handle. A portable keyboard option is also available.

How Fast Is Fast?

HeadStart's RAM Disk, an electronic emulation of the typical second internal drive, responds up to fifty times faster than conventional microcomputers.

Depress a key and you get a response within a split second. Literally before your finger leaves the key.

And HeadStart is incredibly powerful, too. Up to one megabyte of internal memory can tackle even the most sophisticated applications.

Some Ideas Are Bigger Than Others.

Because HeadStart is designed to be both a single *and* multi-user computer, you buy only as much computer as you need today.

But as your business grows, it grows with you.

Each HeadStart Video Processing Unit comes with its own memory, processors, disk and multi-user interfaces.

Just add a 10 or 50 megabyte Data Storage System and up to 255 users can share a common data base in an incredibly powerful, multi-user network.

HeadStart is available in three different models. All offer full performance, transportability, and are easily expandable.

Unlike conventional, single-user-only computers, HeadStart is here today with the designed-in technology to be here tomorrow.

So get a HeadStart on the other guys. For more information, call (803) 798-9100 or write: Intertec, 2300 Broad River Road, Columbia, SC 29210.

intertec[™]

Staff-written highlights of late developments in the microcomputer industry.

SINCLAIR ANNOUNCES 68008-BASED BUSINESS COMPUTER

Sinclair Research Ltd. introduced in England a low-priced computer using a 68008 processor. The 68008 is an 8-bit data bus version of Motorola's 16-bit 68000. The QL (for "quantum leap") computer will include 128K bytes of RAM, two 100K-byte tape drives, two local-area network ports, two RS-232C serial ports, SuperBASIC, and a multitasking concurrent operating system. It will sell for £399 (about \$570) through mail order in England.

Bundled with the machine will be QL Abacus, a spreadsheet package; Archive, a database manager; Easel, graphics software; and Quill, a word processor. While the company may add a hard-disk interface, it has no plans for a floppy-disk drive. Sinclair hopes to bring the QL to the U.S. late this year.

LOTUS ANNOUNCES NEW INTEGRATED SOFTWARE PACKAGE

Lotus Development Corp. has introduced an integrated software package including word processing, database management, telecommunications, spreadsheet, and graphics capabilities. Lotus says the spreadsheet portion is compatible with 1-2-3 and has enhanced graphics and macro capabilities. The program lets you display multiple windows simultaneously, even into a single document. Lotus says the new product will be available in the summer.

SEIKO OFFERS WRISTWATCH-DISPLAY COMPUTER

Seiko Electronics and Instruments Co. of Tokyo has developed a microcomputer that uses a 4-line by 10-character LCD display on a wristwatch. In addition to normal watch and alarm functions, the \$85 watch includes 2K bytes of CMOS RAM and 6K bytes of ROM and has four cursor and function keys. A separate 62-key keyboard, which will cost about \$26, uses wireless electromagnetic induction to transmit information to the watch.

A \$127 Z80-based controller can be used with the keyboard and watch to program in BASIC, to interface with a printer, and to use ROM cartridges that Seiko plans to offer. The controller's Microsoft BASIC is not compatible with MSX or any other version of BASIC. With an optional interface adapter, not yet released, the computer can use an RS-232C interface for communications. Seiko began selling the UC-2000 series products in Japan last month and may offer them in the U.S. later this year.

KOALA PAD MAKER ADDS LIGHT PEN TO LINE

Koala Technologies Corp. announced at the Winter Consumer Electronics Show (CES) that it will manufacture and distribute the Gibson Light Pen for Apple, IBM, and Commodore microcomputers. The \$300 pen can be used to draw high-resolution color animation, shapes, and graphs directly on a CRT screen using the Pentrack Language System and Penpainter software, which are included.

RADIO SHACK MODEL 100 GETS DISK DRIVE, MONITOR

Radio Shack has introduced a disk drive and video interface for its Model 100 notebook-size computer. The Disk/Video Interface includes one 184K-byte 5¼-inch floppy-disk drive, with room for an optional second drive, as well as an interface for a standard video monitor or television set. Model 100 disks will not be compatible with other disk formats. The video interface displays 25 lines by 80 characters on a monitor (25 by 40 on a television display) and supports the full Model 100 character set, but it cannot use Model 100 dot graphics. The Disk/Video Interface will sell for \$799; an optional second disk drive is \$239.95.

COLECO'S ADAM TO GET DISK DRIVE, MODEM, AND OTHER ADD-ONS

Coleco Industries Inc. announced a variety of add-on products for its Adam computer system at CES. The products, which should all be available by late summer, include a 300/1200-bps modem for less than \$250, a second digital data-pack (cassette) drive for under \$200, a 64K memory expander for under \$200, and a tractor-feed option for the Adam's printer for about \$125.

Coleco also announced a 5¼-inch double-sided, double-density disk drive with a 360K-byte capacity for less than \$400. Included with the disk drive—or available separately on a digital data pack—will be Digital Research's Personal CP/M operating system, making Coleco the first U.S. manufacturer to use this home computer version of CP/M.

A TOUCHSCREEN AND NEW COMPUTERS FROM COMMODORE

Commodore Business Machines Inc. showed a touch-sensitive screen and supporting software at CES, similar to the Hewlett-Packard Model 150's touchscreen. The screen should be available in late spring at a "not very high" price.

Commodore also showed its new 264 series of computers. Features include 64K bytes of RAM, windowing, 128 colors, two tone generators, and a machine-language monitor. The 264 will be available in several versions, each with different ROM-based applications software. Available software includes 264 Magic Desk, a combination calculation and filing program using icons for mode selection; 264 Word Processor; and 264 3-Plus-1, an integrated package including a spreadsheet, word processor, file manager, and graphics. Prices for the 264, which will be available in early summer, were not announced.

NEW ADD-ONS FOR APPLE II AND MACINTOSH

Apple Computer Corp. is shipping its new ProDOS operating system with all Apple II disk-drive packages; it is available separately for \$40. Apple also unveiled a \$700 protocol card to allow Apple II computers to emulate IBM 3270 and 2780 terminals. A \$300 terminal-emulation package is also required.

Apple is selling modems that connect to the RS-232C serial port of any Apple product except the original Apple II: a 300-bps modem is \$225; a 1200-bps version is \$495.

A number of third-party vendors unveiled products for Apple's new Macintosh computer. Most are translations of software available for the Apple II or IBM PC, including IBM terminal emulation, accounting, game, and business-productivity software. Included are Microsoft's Multiplan, Word, Chart, and File programs, and Lotus Development Corporation's popular 1-2-3 spreadsheet program. As for hardware products, Tecmar Inc. has announced a 5-megabyte removable cartridge hard-disk drive, and Davong Systems Inc. has introduced a line of 5- to 32-megabyte hard-disk systems for the Macintosh.

UNIX PRODUCTS ANNOUNCED AT UNIFORM SHOW

The peak of February's Uniform show in Washington, D.C. was an agreement between AT&T and Digital Research Inc. to publish a library of applications software for UNIX System V in an effort to make that version of UNIX a standard. Software approved by DRI and AT&T will be sold by both companies. According to AT&T, over 90 companies have published over 300 programs for UNIX so far.

AT&T also announced enhancements to UNIX System V and demonstrated its Documentors Workbench and a version of BASIC for software developers to run under UNIX.

Whitesmiths Ltd. showed a \$550 version of IDRIS, its UNIX-like operating system, for the IBM Personal Computer.

NANOBYTES

Despite strong efforts by a number of microcomputer-based chess programs, this year's World Computer Chess Championship was led by mainframe-based programs. In winning the title, Cray Blitz, a program running on a Cray supercomputer, defeated AT&T Bell Labs' Belle, which is classified as a "master" chess player, and Northwestern University's Nuchess. . . . **Harris Semiconductor** is sampling the 80C88, a CMOS version of Intel's 8088 microprocessor to be available late this year. Harris already is producing the 80C86. CMOS microprocessors use far less power than NMOS versions, allowing use in portable computers and industrial and military applications. . . . **Sony Corp.** is reportedly developing a version of its double-sided 3½-inch disk drive that can store 5 megabytes of information. . . . **Hitachi** has reportedly developed a one-megabit memory chip. . . . **Select Software** has introduced Select Bilingual, a \$395 word processor able to give prompts and display text in both Spanish and English. . . . **Microsoft** and **National Semiconductor** announced that Microsoft's XENIX, an implementation of UNIX, will be available for National Semiconductor's 16032 processor. . . . **Commodore**, **Coleco**, and **Epson** have signed agreements with CompuServe, which will provide special information services for owners of those computers. . . . **Epson America Inc.** will sell a \$795 MS-DOS expansion card for its Z80-based QX-10 computer, with 256K bytes of RAM and an 8088 processor. . . . **Creative Software** has announced three integrated software packages for the Commodore 64 and the IBM PC and PCjr. Priced at \$49.95 each are: Joe's Writer, a word processor; Fred's Filer, an index card file; and Jack's Calc, a spreadsheet package. . . . **IBM** is now selling PC/IX, a \$900 version of UNIX System III, through its National Accounts and National Marketing divisions.

Net Results ...



Net results are what you get with **PerComNet™** ... the sophisticated, user-installable Local Area Network from PERCOM DATA CORPORATION.

PerComNet IBM® interface cards are available now to provide true networking capabilities for IBM and most IBM compatible personal computers. This includes the sharing of peripheral devices such as printers, modems, floppy disk drives, and all PERCOM DATA High Performance PHD™ Hard Disk Drives.

PerComNet provides these net results:

- Token passing reliability.
- Built-in 64K FIFO buffer, to speed data transmissions.
- Signal regeneration at each node to eliminate noise, regardless of network size.
- User installation simplicity.
- Optional NBS encryption for data security.
- Support for simultaneous voice/data transmissions.
- Operating system compatibility for MS-DOS™, CP/M®, UNIX™, and uNETix®. uNETix for PerComNet is distributed by Percom Data.

If you want net results ... PerComNet is the logical, economical and reliable choice. PERCOM DATA has a PerComNet OEM Evaluation Package* ready for your immediate use. The package includes all the hardware, and communications and file transfer utilities you need for configuring a network of three IBM PC computers. Package price is only \$1695.

To order your evaluation package or to get more information contact us today!

PERCOM DATA CORPORATION
11220 Pagemill Road · Dallas, Texas 75243

Name: _____ Title: _____

Company: _____

Address: _____

City: _____ State: _____ ZIP: _____

- I'd like you to send me more information.
 I'm very interested, please have your rep call me at _____
 I'd like to know more about your PHD Hard Disk.

PERCOM DATA
CORPORATION

Expanding Your Peripheral Vision

DRIVES • NETWORKS • SOFTWARE

11220 Pagemill Road, Dallas, Texas 75243 (214) 340-5800
1-800-527-1222

*Does not include operating system or application software.

PerComNet and PHD are trademarks of Percom Data Corporation. IBM is a registered trademark of International Business Machines. MS-DOS is a trademark of Microsoft, Inc. CP/M is a registered trademark of Digital Research. UNIX is a trademark of Bell Laboratories. uNETix is a registered trademark of Lantech Systems Incorporated.

COPYRIGHT Percom Data Corporation 1983 - All prices, and descriptions subject to change with notice.

Introducing COMPAQ PLUS, the first high-performance portable personal computer.

The makers of the COMPAQ™ Portable Computer, the industry standard, announce another breakthrough—the COMPAQ PLUS™ Portable Personal Computer. No other personal computer can handle so much information in so many places.

The new COMPAQ PLUS offers the power of an integrated ten-megabyte fixed disk drive in a portable. You get problem-solving power that no other personal computer can match.

Plus a bigger payload

How much is ten megabytes?

Enough to tackle jobs that can't be conveniently handled on most personal computers.

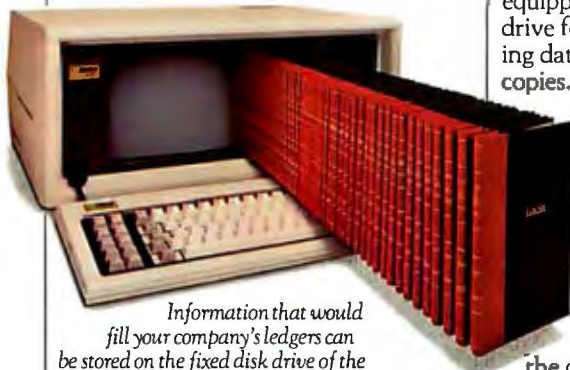

Information that would fill your company's ledgers can be stored on the fixed disk drive of the COMPAQ PLUS.

A mailing list of 100,000 names, addresses, cities, states, and Zip codes.

A full year of daily prices for every stock on the New York exchange.

Inventory records on a quarter million items.

The entire San Francisco phone book. And room left over for Peoria.

The fixed disk drive keeps all the information seconds away, ready to be searched, sorted, retrieved, analyzed or updated.

Plus better use of your time

The integrated fixed disk drive will store programs. That means your most

used programs and data can be permanently kept in the COMPAQ PLUS, ready to call up and run.

With programs permanently stored, the COMPAQ PLUS becomes a well-informed traveling companion, a tool to help you apply your best thinking anytime, anywhere.

You could store a complete library of accounting programs on the disk—payables, receivables, general ledger, and payroll—with the company's books.

You could store an inventory control program with your inventory records and a list management program with your mailing list and a filing program with your personnel files.

The COMPAQ PLUS is also equipped with a 360K byte diskette drive for entering new programs, copying data files, and making backup copies.

Plus more programs

More programs means more versatility. And the COMPAQ PLUS is impressively versatile because it runs all the popular programs written for the IBM® Personal Computer XT, available in computer stores all over the country. And they run as is, with no modification whatsoever.

And the high-capacity portable multiplies the productivity of every program it runs. Your inventory and its



The COMPAQ PLUS runs all the popular programs written for the IBM Personal Computer XT.

control programs can go with you to the factory. Your books and your accounting programs can go with you to a board meeting. Your building specs and your project management programs can go with you to the construction site.

You're buying a computer to solve problems. Why not have more problem-solving programs to choose from?

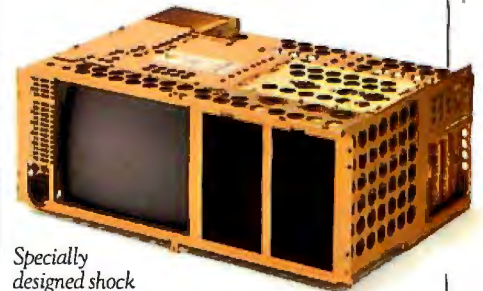

Specially designed shock isolation system protects the fixed disk from jolts.

Plus a traveler's toughness

Life can be tough on the road. A true portable has got to be tougher. The COMPAQ PLUS is.

Its integrated fixed disk drive is unique, designed specifically to travel. Rough roads and hard landings don't bother it because of a specially designed shock isolation system that protects the disk from jolts and vibration.

All the working components are surrounded by a uniquely cross-membered aluminum frame. This structure, common in race car design technology, strengthens it side-to-side, front-to-back, and top-to-bottom.

The outer case is made of LEXAN®, the same high-impact polycarbonate plastic used to make bulletproof windows and faceplates for space suit helmets.

Does a portable personal computer really have to be this tough? Take a good look at your briefcase and then decide.

Plus ease of use

The COMPAQ PLUS is big where it counts.

The display screen is big. Nine inches diagonally. Big enough to show a full 25-line-by-80-character page that's easy to read even if you're leaning back in your chair.

The keyboard is full-sized and typewriter-style for easy control.

With its built-in display, the COMPAQ PLUS makes a smooth, low profile on your desk, not an obstacle that you have to talk around.

Plus an easy way to get started

If you're buying your first personal computer and you're not sure how much capacity you need, your choice is easier now.

Start with the COMPAQ Portable with single or double 320K byte diskette drives. If you need more capacity later, upgrade to the COMPAQ PLUS. A conversion kit is available that turns the COMPAQ Portable into a COMPAQ PLUS, complete in every detail and capability.

Plus a lot more

The COMPAQ PLUS also works with optional printers, plotters, and communications devices designed for IBM's personal computer family.

It has two IBM-compatible slots for adding optional expansion boards. With companion programs, they'll let you share information with a network of personal computers in your office, communicate with your headquarters computer files while you're away, or add memory capacity if your needs grow.

The COMPAQ Portable, the industry standard in portable personal computers. ▼

The problem-solving power of a high-performance desktop personal computer can now go where you need it.



It's got high-resolution graphics and text on the same screen. A detached keyboard. Programmable function keys. Expandable memory. Dozens of other features that simply make it do a better job of personal computing.

And when you see all that the COMPAQ PLUS has to offer, you'll be pleasantly surprised by the price. The fact is, it costs hundreds less than comparably equipped desktop personal computers.

See the first high-performance portable personal computer. The COMPAQ PLUS—performance, programs, productivity. Plus problem-solving power.

The new COMPAQ PLUS, the first high-performance portable personal computer. ▼

COMPAQ PLUS Specifications

Storage

- One integrated 10-megabyte fixed disk drive
- One 360K byte diskette drive.

Software

- Runs all the popular programs written for the IBM XT.

Memory

- 128K bytes RAM, expandable to 640K bytes

Display

- 9-inch diagonal monochrome screen
- 25 lines by 80 characters
- Upper- and lowercase high-resolution text characters
- High-resolution graphics

Interfaces

- Parallel printer interface
- RGB color monitor interface
- Composite video monitor interface
- RF modulator interface

Expansion board slots

- Two IBM-compatible slots

Physical specifications

- Totally self-contained and portable
- 20" W × 8½" H × 16" D

For the name of the Authorized Dealer nearest you, call 1-800-231-0900.

©1983 COMPAQ Computer Corporation. COMPAQ™ and COMPAQ PLUS™ are trademarks of COMPAQ Computer Corporation. IBM® is a registered trademark of International Business Machines Corporation. LEXAN® is a registered trademark of General Electric Company.



COMPAQ

PLUS™

In the Hard Disk Jungle Tallgrass Clears A Path



In today's hard disk jungle, Tallgrass clears a path by offering high performance, integrated mass storage solutions for the IBM® PC/XT, the T.I. Professional and related computers.

TALLGRASS INNOVATIVE FEATURES

MASS STORAGE SYSTEMS with formatted HardFile™ capacities of 6, 12, 20, 35 and 70 Mb, all with built-in tape backup.

CONVENIENT INTEGRAL TAPE BACKUP SYSTEM allows rapid tape "image" streaming, or incremental file-by-file backup and restore on ANSI standard inexpensive data cartridges, instead of the usual floppies, video cassettes, or low-capacity removable Winchester devices.

NETWORK READY and fully compatible with networks such as PCnet® and EtherShare™.

HIGH RELIABILITY with dual directory and read-after-write verify options. A dedicated landing zone, where the read/write heads reside when the disk is idle, provides data protection during powerdowns and transportation.

EtherShare™ is a registered trademark of 3Com Corp.

PCnet® is a trademark of Orchid Technology

IBM® is a registered trademark of International Business Machines Corp.

Follow the Tallgrass path to your local computer dealer and watch your personal computer transform into a powerful data processing system. From \$2,995.00 U.S. including integral tape backup.

Available from COMPUTERLAND® Entré® Computer Centers, MicroAge® Computer Stores and other participating computer dealers.

New! IBM-XT Cartridge Tape Backup

World Headquarters: Tallgrass Technologies Corp. / 11100 West 82nd St. Overland Park, KS 66214 / 913-492-6002 / Telex: Z15406 TBYT-OR

Canadian Distributors: Micro-Ware / 440 Phillip St. Waterloo, Ontario N2L 5R9 / 519-884-4541

European Distributor: CPS Computer Group, LTD Birmingham, England B276BH / (021) 7073866

Australian Headquarters: Tallgrass Technologies (Australia) / Five Dock Plaza, Suite 12 / 50 Great North Road / Five Dock / Sydney, N.S.W. 2046 / (02) 712-2010



**Tallgrass
Technologies**
Corporation

Common Concern

I share the doubts and concerns of your correspondents (Letters, page 12, November 1983) about your use of articles describing new products contributed by employees of the manufacturer involved. I was particularly disappointed by the June 1983 issue on 16-bit designs, which seemed largely composed of such material. However, there are deeper and more disturbing aspects involved than your correspondents have noted.

In this country, Hewlett-Packard has been promoting its 68000-based model 9816 computer with mail shots and advertisements in trade publications using the slogan "a lion packaged as a housecat," attributing the phrase to BYTE. These words begin and conclude the description of the 9816 authored by an HP employee ("Tight Squeeze: The HP Series 200 Model 16," June 1983, page 110).

I telephoned the HP representative in charge of the sales campaign and told him of my misgivings about the use of wording that gave the impression that an independent BYTE review had drawn this favorable conclusion. His answers were surprising.

He told me that the article was too professionally written to have been the work of an HP engineer, so that a staff writer must have ghost-written it, and it was thereby a BYTE article regardless of the attribution to HP; that BYTE would not have published it if they had disbelieved it; and that BYTE had been contacted by HP and had given consent for the promotion in question. Nevertheless, he apologized if HP had unintentionally appeared to mislead.

I would like to see your version of this story in print. If HP, one of the most reputable firms in the business, can manipulate BYTE in this way, then you owe it to your readers to prevent less-scrupulous operators from doing the same.

You might argue that the independent review of the 9816 ("A Look at the HP Series 200 Model 16" by Berry Kercheval, November 1983, page 328) should tend to verify or counterbalance the manufacturer-submitted descriptions. I use the HP machines professionally, and I can only remark how disappointing this review is.

HP BASIC is one of the best BASICS

around and is unusual in having separate subroutines and functions. How can a serious review illustrate this language with a three-page listing of a game program, written as one large routine? Should not potential purchasers be warned of a significant shortcoming in the system, that the file-handling software can be very slow unless used with care and understanding? Why are independently compiled modules that borrow much syntax, power, and elegance from Modula-2 and are the core concept of the Pascal implementation, mentioned in just a few lines, whereas several paragraphs are devoted to explaining that you can't play a tune on the bleeper?

Perhaps publishing the maker's description is not such a bad idea after all.

David Colver
29 Chepstow Place
London, England W2 4TT

Mr. Colver's letter is representative of several BYTE has received in the past few months. This month's editorial (see page 4) addresses in detail the issues raised by these letters.

As to the specifics of Mr. Colver's letter, no BYTE editor had any role in the authorship of the June article on the HP 200-16. John Monahan of Hewlett-Packard wrote the article, as indicated when the article was published. The purpose of the theme articles in the "16-Bit Designs" issue was to show the views and intentions of people who are designing today's personal computers, in the hope of starting more direct communication between computer designers and computer users. None of the articles on 16-bit designs was a review or was labeled as a review. (This is not to disclaim BYTE's responsibility; see the editorial for more on this.)

Permission for HP's use of the quotation from Mr. Monahan's article was granted by telephone. BYTE is now developing new procedures to prevent the misleading use of quotations.

Praise for Objectivity

I bought my first computer in November 1982 and am still pleased with it. I am a writer, not a computer expert. I read everything I can find on computers. My friends, with whom I compare notes

frequently, own IBM PC, PC-compatible, Kaypro, Apple, and Zenith computers. We do not put each other down, and we are not fooled by magazine authors who haughtily demean products they consider to be inferior.

Almost every article we read in computer publications is biased. The author has a prejudice from his or her long experience in computers and selects facts to prove the prejudice. I don't believe that the proponents of Apple, IBM, Kaypro, etc., intentionally misuse their vast knowledge to confuse us. I think, however, that they are lazy about objectivity—almost all of them.

BYTE is far and away the best of the computer magazines I have read, and I now subscribe to 10. After today, I will subscribe to only three, BYTE included.

On such subjects as what computer companies are going to do, magazines should stick with excellent interviews with corporate executives who know what they're talking about, such as your interview with Philip D. Estridge of IBM (November 1983, page 88).

Magazines enjoy predicting that many of the hundreds of computer companies are going to go out of business. How many magazines are going to fold as a result of sloppy editing, shallow reporting, and childish biases?

Maintain your dignity. Continue to avoid the prejudicial comparisons that make other magazines look foolish. We all know that all of our computers have good points and weak points. We didn't buy mainframes.

Robert R. Jann
3320 Selwyn Ave.
Charlotte, NC 28209

Software Design Resources

Martin Dean laments the dearth of articles on "how to design software" ("Simplify, Simplify, Simplify," December 1983, page 161). I'd like to point out some papers that may be helpful:

- A case study of how a design evolved iteratively in response to user feedback is described in "A Communications Package for the IBM PC" by R. Moore and M. Geary (November

CARD TRICKS.



(Or how to add six functions to your IBM PC/XT with just one multifunction card)

It's not magic. And it isn't sleight of hand. It's ConsoCard from Consolink... the multifunction card for your IBM PC OR PC/XT that performs six tricks from a single slot space.

- Up to 384K expansion memory for larger in-memory data bases.
- Printer spooling for computing even when the printer is printing.
- RAM disk emulator for fast access to frequently used files.
- TWO asynchronous RS-232 ports for communication with other computers.
- Battery powered chronograph for accurate time keeping.

One Card. Six Tricks.



ConsoCard
Without it, your IBM
isn't playing with a full deck.

Circle 88 on Inquiry card.

IBM and the IBM logo are a registered trademark of International Business Machines Corporation

CONSOLINK
CORPORATION

1840 Industrial Circle • Longmont, CO 80501
(303) 651-2014 • Toll Free 800-525-6705

Subsidiary of Consolidated Packaging Corporation

Letters

- 1983 BYTE, page 199).
- The design principles for an office-system user interface are described in "Designing the Star User Interface" by D. Smith et al. (April 1982 BYTE, page 242).
 - A pattern-directed approach to database query language similar to Dean's is described in the paper "Query by Example" by M. Zloof (*Proceedings of the National Computer Conference, 1975*, page 431).
 - A general scheme of "filtering templates," with the specific example of an information retrieval program called Findit, is described in the paper "A Metaphor for User Interface Design" by A. Goldberg and D. Robson (*Proceedings of the 12th Hawaii International Conference on Systems Sciences, 1979*, page 148).

I agree with Dean that finding useful descriptions of the design process is hard (even harder than finding papers on good designs themselves), but I don't think this is due to a "plot." Many commercial software developers carefully guard their designs, but there is still a tremendous amount of published literature from academia, research labs, and "enlightened" commercial developers. Thorough research of this literature pays off: one ends up either with a body of existing ideas on which to build, or with knowledge of the existence of an area in which few have thought (or written).

Paul McJones
Tandem Computers Inc.
2116 Kramer Ln.
Austin, TX 78758

A Scalpel Icon?

I must commend Tom Houston for his article entitled "The Allegory of Software" (December 1983, page 210). He brought up a point that is all too frequently glossed over by "user-friendly" software enthusiasts. I believe the main point of his article was that it is better to train people to use software than to write sophisticated software that condescends to the level of a 10-year-old.

I will agree that much of the software that has been written is not very good from the user's point of view. This is usually because the input and output sections of the program were written by

people whose major skill was programming and not what is now called human-factors engineering. As a result, the program could be cumbersome to use. The answer to this problem, however, is programs that are efficient to use, not programs that are easy to use.

Systems based on the idea of metaphors run more slowly and use more memory than systems designed by a standard approach such as menus or commands. Moreover, they are only useful for inexperienced users. A person who has had enough experience with any particular program will be able to use it as efficiently as a novice with a user-friendly system.

No computer system can do the real work that a professional is paid to do. Anyone who spends a good proportion of his life learning what to do with a computer should be willing to spend about one-thousandth of that time learning how to use the computer itself. If a program is well designed, learning how to use it will pay off more in the long run than using "metaphorical" software that is almost a type of crutch.

One might say that the development of user-friendly software was predicted as early as 1950 in a science-fiction story by Cyril Kornbluth, entitled *The Little Black Bag*, in which the author described a futuristic surgical kit with which a complete idiot can practice medicine (trick: the scalpels do all the work). I would recommend this story to those involved in developing easy-to-use systems because it gives a frightening glimpse at what can happen if the development of technology takes precedence over the development of intelligence in people, a.k.a. "education."

Paul B. Callahan
701 Stuart Hall
University Park, PA 16802

IBM Drive Door Fixes

Had I authored "Buddy, Can You Spare a Door Latch?" (by Jerry Pournelle, December 1983, page 59) about the elusive door latch for the Tandon drive, the article would have been subtitled, "Whence Cometh the Door Latch?"

My experience with the doors on the drives in my IBM PC has been that the plastic guide pins shift, causing malpositioning and jamming of the doors.

This 3 hour coffee break is brought to you by your printer.



Wait-less Computing™ is brought to you by MicroSpooler.™

In the business world, time means money. So you want your computer to make the most of every minute. But while your printer is busy printing, your computer is busy... **waiting.**

MicroSpooler™ from Consolink keeps your computer free for use even when your printer is operating. It stores data, then sends it at the fastest rate your printer will accept. There's no down time, so there are no needless coffee breaks. And your computer is back on the job in seconds... **working** instead of waiting.

Because MicroSpooler™ is a stand-alone buffer, it can be easily

installed in-line between almost any printer and computer, as well as communications and peripheral devices. And its attractive case and compact size allow it to fit comfortably in any office environment.

Standard features include:

- 16K memory—expandable to 64K
- Status readout—displays amount of data stored or number of copies left to run (up to 99)
- Internal power supply—eliminates extra cost and bulky adaptors

MicroSpooler™ from Consolink. When you want your computer to **wait** less... and **work** more.



CONSOLINK CORPORATION

We've always said SuperCalc® is the world's most useable spreadsheet.

At first, all spreadsheets seem to give you about the same things. Until you put them to work. Then you'll find out if they do everything you expected. Or make you do everything the hard way.

You know what makes the difference? It's not just having the newest, whizziest features, but what those features actually do for you in the real world. And that's the whole idea behind SuperCalc and SuperCalc2. Because they've been designed to work with you in a natural, intuitive way.

What we're really talking about here is useability. When you get right down to it, it's not any one big thing, but a combination of little things. Like the number of key-strokes it takes to get a job done. Or the effort it takes to switch from one function to another. Maybe a few keystrokes here and there doesn't seem like much of a difference. Or having to change disks to plot a graph. But when you multiply those little things by the thousands of times you do them, they make all the difference in the world.

Even the size of the spreadsheet is important. Some programs promise you a huge area to work with. Unfortunately, they can use so much of the computer's available memory just keeping track of all the blank cells that you're left with only a handful. But we've designed SuperCalc to give you the largest useable spreadsheet.

If you look at the printout below, you'll see a lot more examples of what we mean. And we think you'll realize why this is the most useable spreadsheet in the world.

Text can "spill over" into next column

Calendar/Date calculations

Dictionary sort order (not ASCII)

Two key sort

User-set decimal places

Floating \$ signs

Data management capability

Individually variable column widths

Negatives shown in ()

Level	Name	Rate	Util	Hours	Total	Rate	Util	Hours	Total	Rate	Util	Hours	Total			
PARTNER	1-11 Super	\$120	85	1,680	201,600	97	34	88,400	84	50	84,000	125	72	824,800	525	85%
	1-12 Fuller	\$90	80	1,680	151,200	100	36	8,750	94	50	81,000	125	74	35,552	316	84%
	1-13	800	75	1,680	134,400	100	36	8,750	94	50	81,000	125	74	35,552	316	84%
MANAGER	2-85 Dean	\$60	85	1,680	100,800	122	70	19,480	118	70	29,840	125	72	824,800	525	85%
	2-86	500	75	1,680	126,000	122	70	19,480	118	70	29,840	125	72	824,800	525	85%
SENIOR	3-102 Baraback	\$30	85	1,680	50,400	125	85	17,150	145	85	27,500	120	85	424,150	443	94%
	3-115 Callahan	\$30	85	1,680	50,400	125	85	17,150	145	85	27,500	141	85	24,310	442	94%
STAFF	4-91 Ray	\$10	80	1,680	16,800	140	90	6,860	143	80	6,760	141	80	20,640	430	114%
	4-92 Smith	\$10	80	1,680	16,800	140	90	6,860	143	80	6,760	141	80	20,640	430	114%
4-104	Mallinson	\$10	80	1,680	16,800	140	90	6,860	143	80	6,760	141	80	20,640	430	114%
OFFICE TOTAL		\$0	80	191,167	1401	78	389,317	1309	75	189,744	1,318	77	626,423	4020		

OFFICE SUMMARY STATISTICS:

Lowest Utilization	55%	90%	90%	5%
Highest Utilization	99%	99%	99%	98%

Staff Complement & Average Rates:

Partner	2	\$97,500
Manager	3	\$84,667
Senior	3	\$51,000
Staff	2	\$42,000

Now you can draw your own conclusions. SuperCalc³

Now we're introducing our newest version, SuperCalc3, which comes complete with the kind of graphics you'd expect to find in a program that does everything else so well. We give you full color. And presentation quality. Plus eight different type styles to choose from. And new financial features like internal rate of return. We've even integrated all these functions onto one single disk. Which means you don't have to change disks all the time. Or settle for a weak spreadsheet and low-resolution graphics just for the sake of getting

both in the same package.

As you might expect, we've made SuperCalc3 100% compatible with SuperCalc and SuperCalc2. So you can move up to it whenever you're ready. You can even convert your VisiCalc files. The SuperCalc family is available for CP/M, CP/M-86, Concurrent CP/M-86, MP/M, MS-DOS and PC-DOS operating systems. Right now, SuperCalc3 is available for the IBM PC, PC XT and IBM PC compatibles. It's only \$395. And soon it'll be available for a lot more personal computers.

SuperCalc3. When you're really serious about spreadsheets, this is the one you'll wind up using. But don't take our word for it. Go try SuperCalc3 at your computer store today. And draw your own conclusions.

CP/M[®] CP/M-86[®] Concurrent CP/M-86, and MP/M[®] are trademarks of Digital Research. MS-DOS is a trademark of Microsoft Corporation. IBM[®] is a trademark of International Business Machines Corporation. VisiCalc[®] is a trademark of VisiCorp. © 1983 Sorcim Corporation.

SuperCalc³

SORCIM[®]

2310 Lundy Avenue San Jose, CA 95131
(408) 942-1727

Integrated presentation-quality graphics

Prints up to four charts on the same page

Prints all available plotter colors

Eight font types

Labels print horizontally or vertically, for best fit

Components of graph resize to match size of text

Full color graphics

Exploding pie charts

Billings - Top 3 Employees

Employee 1	\$35,513
Employee 2	\$30,032
Employee 3	\$29,040

SMITH & CO., CPAs
Employee Billing by Month

Month	Johnson	Wain	Adams
January	\$100,000	\$120,000	\$150,000
February	\$80,000	\$100,000	\$130,000
March	\$90,000	\$110,000	\$140,000

New York Office
Billings - Top 3 Employees

Employee	Billings
Johnson	\$35,513
Wain	\$30,032
Adams	\$29,040

Lowest/Highest Billings

Employee	Lowest	Highest
Johnson	\$100,000	\$150,000
Wain	\$80,000	\$130,000
Adams	\$90,000	\$140,000

Billings by Management Level

Management Level	January	February	March
Staff	\$20,000	\$25,000	\$30,000
Senior	\$30,000	\$35,000	\$40,000
Manager	\$40,000	\$45,000	\$50,000
Partner	\$50,000	\$55,000	\$60,000

My first "fix" was to reposition the pins and doors and everything worked fine until the next slippage/jam. My second fix mimicked the first with the addition of a carefully applied drop of a superglue penetrating adhesive where the plastic pins are held in two slots on either side of the door.

Eventually one door itself broke, not the pins. My first try at a replacement part was successful. A visit to my local Computerland store, a short discussion with their "Mr. Fixit," a brief rummaging through a box marked "Parts for Tandon Drives" and, voilà, a small box marked "IBM Office Products Division, 8529260, 1PCLC 2 83" had just the right part in it.

My total investment of time and effort was about 1.5 hours: 10 minutes for the initial phone call to determine the likelihood of success if I visited Computerland, a 1-hour round-trip drive to pick up the part, 20 minutes or so to get into the PC, remove one or two screws, and change the pesky door.

I hope that this note will help those with similar problems to (a) try doing it yourself, it's an easy replacement job, and (b) have an easy time getting the part

through (I presume) any IBM dealer or Product Center. In a call to the IBM Product Center in Stamford, Connecticut (just before mailing this note), I learned that the part is indeed available, although not in stock at the center. Delivery would be less than two weeks and the company representative with whom I spoke implied that IBM could expedite and foreshorten that delivery if the part is critical to the customer.

Donald P. Relyea
Hoffrel Instruments Inc.
POB 825
South Norwalk, CT 06854

Looking Over the Rainbow

A note on Rich Malloy's "Reviewer's Notebook" (December 1983, page 282). I was for a brief time a distressed owner of a DEC Rainbow 100. My impression of this machine, after about 50 hours of intensive use, was quite the opposite of Mr. Malloy's. It struck me as the handsomest, most expensive smart terminal ever

made. I ended up returning the unit for a refund after a DEC support person agreed with my criticisms:

- 1) The documentation is wretched, though slickly produced. In some instances, two documents contradict each other on the same point. No useful information is provided on screen formatting or using the function keys. An additional set of documents is available for about \$250 extra. DEC informed me that there was no way I could get a look at these documents without purchasing them.
- 2) There is no high-level language support of screen formatting or function keys. By trial and error I figured out how to simulate PRINT AT and so forth. But why should I have to? Why is there no LOCATE statement in the Microsoft BASIC? I could not figure how to use the function keys at all. DEC's advice was to buy the \$250 documents and program the softkeys in machine code. Again, after spending nearly \$4000 on a "system," why should I have to code

PLOTWARE-Z This ad was drawn entirely by PLOTWARE-z.

interfaces to most devices: CRT'S, PLOTTERS, DOT MATRIX PRINTERS (at maximum dot resolution), & with "do-it-yourself" custom attachments. Use with PCDOS, MSDOS, CPM/86, CPM/80, CDOS, etc. (and UNIX in MAY!) Makes all charts with FONTS (several text styles), Greek, italic, Russian, Old English, or different shaded, very stylish ones. Even Hebrew and math or special symbols - or "Do-it-yourself" fonts. Include LOGO'S and digitized figures. Plus - all pictures can be TRANSMITTED to remote stations. Use with electronic "cut-and-paste", for camera ready copy.

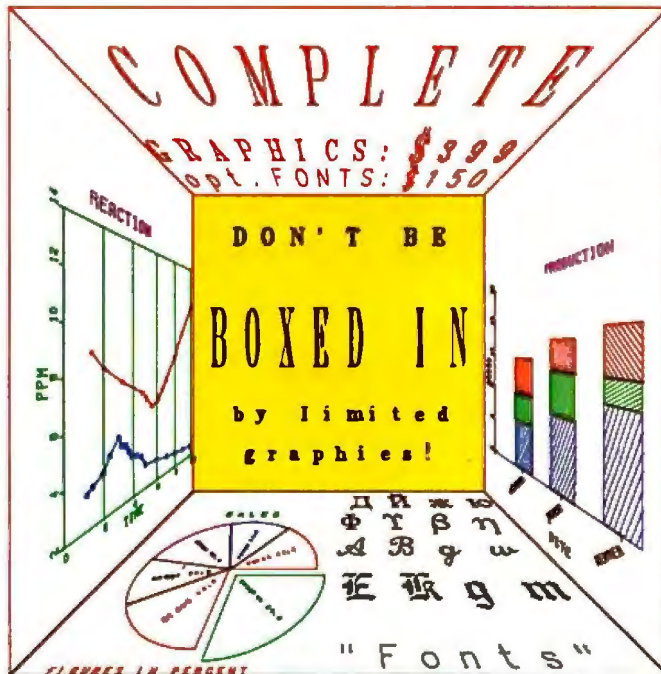

GET PLOTWARE-Z : A reliable system with over 3 years of proven usage. Complete with comprehensive manual now with user-written application notes & extensive "walk-thru" help

DIRECT ACCESS to your data from

1. Word Processors (like WORDSTAR)
2. DATA BASE files (like dBASE II)
3. SPREAD SHEETS (Super Calc 2)
4. Compilers, and

Assemblers -even interpretive BASIC 5 easy ways to use, from: menu driven to command files to direct library use. try the DEMO at your dealer or contact:

THE ENERCOMP CO.
1978 S. Garrison #7
Lakewood, CO. 80226
(303) 987-0125
telex: 499-8325

CPM/80, CPM/86 to Digital Research
PCDOS to IBM, MSDOS to MICROSOFT
dBASE II to Ashton TATE
SuperCalc 2 to BORIS
Supercalc 2 to BORIS

FIRST CLASS SOFTWARE

TAKES YOU SOMEWHERE AND GIVES YOU SOMETHING SPECIAL

AGENT 2.0

AGENT 2.0 A crisis, real or imagined? A spy, ours or theirs? A file, fact or fiction? You must decide.



Portfolio Manager

BLU CHIP PORTFOLIO MANAGER Your broker on a disk. Tracks your portfolio. A data base for investors--with spread-sheet capabilities.

THOTH

Action List Data Base Manager

THOTH Advisor to the gods of Ancient Egypt can now be yours. The easy action list data base manager to increase your productivity.

C TOOLS

C TOOLS A collection of our most useful C routines. Add flavor to your C programming and save time too.

All Xor products are designed for the IBM® PC and compatibles.

IBM is a registered trademark of International Business Machines Corporation.

易動 EDO

EDO The game of many strategies where no strategy is sacred. Think fast and remember -- danger often wears a smile.

ST. HIPPOLYTE'S WALL

ST. HIPPOLYTE'S WALL The challenge of the wall. Colorful. Ever-changing. Complex. How will YOU do when you're up against THE WALL?

XOR CORPORATION

Ask for Xor products at fine Computer Stores.

5421 OPPORTUNITY COURT

MINNETONKA, MN 55343

(612) 938-0005

Circle 388 on inquiry card.

my own routines for such a rudimentary function? Obviously, DEC expects the end user *only* to buy packaged software.

- 3) DEC advertises that its dual processors can run "thousands" of extant CP/M and CP/M-86 disks. Not so. Because DEC has chosen a perverse disk format (single-sided quadr-density, 98 tpi) and has shut out third-party vendors by an "authorization" program, the *only* software available for the Rainbow is what DEC approves and sells. This amounts to dozens, not thousands, of programs.

When BYTE does a full-bore review of the Rainbow, I hope you will address these points. I am convinced that my criticisms are valid, by my experience, by the concurrence of the DEC support person, and by the sudden plummet of DEC's stock after the Rainbow was introduced—attributed by a DEC spokesperson (in *The New York Times*) almost wholly to the personal computer division.

I think DEC rushed into the market

with a handsome but immature product. In a year or two the Rainbow may be a good, solid, general-purpose microcomputer. At the moment it's a collage of impressive features with limited utility.

Carter Scholz
2110 Acton, #2
Berkeley, CA 94702

A review of the Rainbow is scheduled for April.

IBM Screen Displays

Many thanks to Tim Field for supplying the screen listing (the program for switching of monitors on the IBM PC). Other than some minor comment errors, the listing was bug-free and worked great the first time around ("Enhancing Screen Displays for the IBM PC," November 1983, page 99). This was my first try at assembly-language programming and I found this program useful in developing a feel for the power and flexibility this method

of programming offers for functional control.

As pointed out by Mr. Field, the default values for initial conditions can be modified to suit the individual user. I find that starting with the monochrome screen rather than the color monitor, and white characters on a black background are more natural initial states. This start-up condition can be achieved by modifying three lines in the listing as follows:

```
LINE 0112: CUR__MODE
           DW MONO__AREA
LINE 011A: COL80__AREA S
           < 5019H,000FH,20H,3 >
LINE 0122: COL40__AREA S
           < 2819H,000FH,10H,1 >
```

Line 012A remains unchanged; although the comment indicates the attribute to be reverse video, this is not the case. For reverse video the 0007h value should be 0070h.

Again, due to its ability to remain active under all operating modes, and its ease of implementation, this program is far superior to any of the other monitor-switching programs I have seen.

Sig Hansen Jr.
6530 Happy Canyon Rd.
POB 125
Santa Ynez, CA 93460

Thanks to Tim Field for his article "Enhancing Screen Displays for the IBM PC" (November 1983, page 99).

One small detail should be pointed out to readers: the file, after assembling, should be converted to .COM by using the Exe2bin program. I spent a whole day trying to get it to work, and because the last paragraph of the article states that you can buy an installation program, I thought I was ripped off.

Many thanks again for an "It's just what we needed" program.

Marvin Konopik
American Embassy
APO San Francisco, CA 96356

Address Correction

The International Association of Computer Crime Investigators was mentioned several times in "Computer Crime: A

Powerful Z80 emulation, priced well within your grasp. That's NICE.™

NICE may be only 3" square and 1/2" thick, but it hands you full speed, real-time emulation for the Z80—over 50 emulation functions, software breakpoints, all memory addresses and all I/O ports.

Just plug NICE directly into the target Z80 socket and any RS232 terminal for system development, troubleshooting, debugging or testing . . . at home, in the lab or in the field.

And NICE hands you all this performance, portability and versatility for only \$498* . . . the best emulator price/performance ratio on the market, hands down.

Call in your order today using

your VISA or Mastercard number: (800) NICOLET outside CA, or (415) 490-8300 in CA.

Or send your

check or money order to NICE, Nicolet Paratronics Corporation, 201 Fourier Avenue, Fremont, CA 94539.

*Payment by check, money order, VISA or MasterCard.
NICE is a trademark of Nicolet Paratronics Corporation.
Z80 is a trademark of Zilog, Inc.



Nicolet

Three ways to Speed up your Apple II & Apple IIe for \$295



The SpeedDemon™ from McT.

- SpeedDemon™ ● Makes any Apple II, II+, or IIe run 3½ times faster.
- SpeedDemon™ ● Makes your Applesoft, Apple Fortran, Word Processing, D.B. Master, Pascal, or Visicalc programs run up to 3½ times faster.
- SpeedDemon™ ● Costs less than any other speed up card.
- SpeedDemon™ ● Costs only \$295.

Please send me _____ SpeedDemons™ by return mail at \$295 each. I have enclosed \$ _____
 I have an: Apple II Apple II plus Apple IIe This is for: Business Use
 Or charge my: Visa Mastercard American Express Personal Use
 My Acct.# is _____ Expires _____
 Name _____
 Address _____
 City _____ State _____ Zip _____
 Signature _____ Calif. Res. Add 6½% Sales Tax.
 Mail to: McT • 1745 21st Street • Santa Monica • CA • 90404 • Telephone (213) 829-3643

 A PROJECT OF
 MICRO COMPUTER TECHNOLOGIES

Circle 225 on inquiry card.

Dealer Inquiries Invited

Apple is a registered trademark of Apple Computers, Inc. VisiCalc is a registered trademark of VisiCorp, Inc. DB Master is a registered trademark of Stoneware, Inc.

only \$1995⁰⁰



How Sweet it is!

"What a feeling!"
That's just how you'll feel knowing you've purchased an IBM-compatible Personal Computer with full color graphics capability at a price far, far below anyone else.

STANDARD FEATURES

- Full Graphics capabilities • 128K Ram (expandable to 256K) • Two RS232 Serial Ports • One parallel printer port • Color Display Card • Fully detachable, IBM-compatible Keyboard • 8 Expansion Slots • MS-DOS Operating System • Real Time Clock and Calendar

*IBM is a registered trademark of International Business Machines
*CP/M is a registered trademark of Digital Research, Inc.
*MS-DOS is a registered trademark of MicroSoft, Inc.



**For further information call
800-821-3628**

Handwell Corp.

4962 El Camino Real
Los Altos, CA 94022
415 962-9265

*Dealer and OEM
inquiries invited*

Letters

Growing Threat" by Collen Gillard and Jim Smith (October 1983, page 398). We are a newly formed nonprofit public-benefit corporation created to professionalize and educate the data-processing, legal, and criminal-justice communities in computer-crime investigation. Our address was incorrectly listed as Burlingame, California. Our correct address for anyone who may be interested in more information is:

International Association
of Computer Crime Investigators
1100 Gough St., Ste. 8F
San Francisco, CA 94109

As we indicated in the article, we also collect data on computer crime cases. This type of information is made available to our members on a periodic basis. We are an international organization with members covering several continents.

Bruce Goldstein
1100 Gough St., Suite 8F
San Francisco, CA 94109

Computer Crime Giving Hackers a Bad Name

As a hacker, I feel that the term "hacker" has received a new, derogatory connotation implying illegal computer use. I have been using computers for about 10 years, and the term has always meant "one who is a computer hobbyist." I feel that those who access a computer without permission using false passwords should be accused of forgery!

Granted, it's sometimes easy to hit (access) a system, but saying "There's no security; it's so easy" does not erase the fact that access was granted under false pretense. It's also easy to write someone else's signature on checks or documents, but that doesn't make it right. Because computers cannot read a person's signature, the password became the computer equivalent of a signature. Those who use a false or forged password should be treated as forgers.

The recent article "Computer Crime: A Growing Threat" (October 1983, page 398) that referenced this problem was far from complete and a little misleading. The Los Alamos computer that was accessed was specially designed for easy public access.

(See *Electronics*, September 8, 1983, page 52.) And the last half of the article reads like an ad for the Secure Access Unit (SAU) hardware. The author failed to acknowledge that the same protection can be obtained with a simple software addition. In fact, all the SAU is is a computer and autodial modem. Why use two computers when you already have one that will easily handle the job?

As a hacker, I feel that the articles about computer theft are giving us a bad name. How about some positive articles on remote bulletin boards, remote systems, and public-domain software?

Mike Woodward
606 Kinglet St.
Suisun, CA 94585

Kudos to Steve

Again, Steve Ciarcia has another excellent construction article, "Build the H-COM Handicapped Communicator," (November 1983, page 36). Although I have no use for the communicator described, the article provided a wealth of information on single-chip microcomputer solutions to seemingly complex problems. I look forward to more projects like this, especially the well-documented, fun-to-read assembly-language listing. Keep up the good work.

Chris Brown
FEI/AMSF-EUR
APO New York, NY 09086

A Clarification

I would like to comment on Mark Haas's review of the TI Professional in the December 1983 issue. On page 320, while comparing the TI and the IBM PC, he claims that the TI "also has a PSET STEP variation" which, in the context, implies that the IBM PC does not. In fact, IBM PC graphics coordinates can be used in the STEP format. There is a description of this in Chapter 3 of the IBM PC BASIC manual, beginning on page 38.

Daniel Bernstein
5 Brewster Ln.
Bellport, NY 11713

When You Turn
this Page
You'll be Leaving
the World of
Ordinary
Microcomputers

TECH

A \$

5%

g
12

A World Apart from the Ordinary.

It begins with the sense of touch.

With the sleek black metal housing. Cool to the touch. Cool to the advanced circuitry and components contained within.

And the solid feel of people-sized keys set up in a field that gives you room to work and space in which to think.

But the difference only begins with what you see and feel. Where it ends...well, that's really up to you.

In a very practical sense, the only limits you'll experience with the MTX512 are those you choose to accept.

64K To 512K RAM – A Look On The Inside

Take a close look at the MTX512.

We could tell you it offers the greatest performance and versatility of any micro in its price range, but we think you're smart enough to draw your own conclusions.

The design is elegant in its simplicity. Remarkable for the power and complexity it represents. 64K RAM built in, with total expansion to 512K. And that doesn't include 16K of video RAM controlled by its own processor.

Speaking of video, keep in mind this is no ordinary monochromatic, single screen system. The MTX starts off where other micros end up. Delivering vivid screen capabilities with 256 x 192 pixels that crisply define interference-free high resolution graphics. 16 brilliant colors that can be displayed simultaneously. In a format powered by 32 easily movable, user-defined graphics characters. Graphics capabilities you'd find impressive in a system that gives you a single screen to work in. With the MTX, you have eight.

Yes, eight.

Eight definable windows to operate independently or in tandem. And still maintain full screen capabilities. Thus, you can manipulate spread sheets on the MTX and see the impact of changing variables in graphics at the same time. Eight separate windows on the world. We call them Virtual Screens. You'll call them extraordinary.

Far from ordinary as well are the built-in system outputs that come standard on the MTX. The Centronics parallel printer port. The two industry-standard joystick ports. The uncommitted parallel I/O port. The Cassette port with 2400 baud. Separate TV and Video Monitor Ports. The 4-channel sound hifi output. We've even installed a ROM cartridge port for word processing and other dedicated programs.

Interactive Languages And Routines – A Look At The Way All Micros Will One Day Perform

Forget the way all other micros perform. This is the way they should.

Interactively.

With the MTX, you can create and manipulate programs using four different languages in dynamic interaction, all coordinated through the FRONT PANEL DISPLAY. Interweaving elements as you would in creating a symphony.

And take a serious look at the languages housed in the MTX's 24K ROM. MTX BASIC, a more powerful form of BASIC that allows you to use all standard BASIC programs. MTX GRAPHICS, with straight forward commands, eliminates the tedium and difficulty of creating complex graphics programs. NODDY, an 11-command "easy learn" language that can transform real world programming into a child-friendly activity. And MTX ASSEMBLER, which enables sophisticated programming in assembly language. Something else the advanced programmer will appreciate is our ASSEMBLER/DISASSEMBLER, tied to BASIC, which provides unprecedented display and keyboard access to Z80 CPU storage locations, memory and program.

If you're hungry for more, PASCAL and FORTH are also available as add-on ROM packs.

On the keyboard side of things, you'll find a number of operator-oriented features that speed up and ease up the operation of the MTX. The separate numeric pad with quadri-directional cursor control and full editing functions. The eight dual function keys.





The auto repeat function on all alpha-numeric keys. Add to this such programmer-saving features as the use of abbreviated BASIC commands, a built-in syntax verifier, automatic cursor-honing to errors, auto-line numbering and automatic scrolling, and you begin to see the MTX not only opens a lot of doors that other micros leave closed, but speeds you through them as well.

The 160 Megabyte Connection – A Look At The System

To build a good system, quality must be designed in at every level.

We designed the MTX and its complete line of system peripherals using proven, standard components. Striking a strategic balance between power, versatility and dependability. Our Z80A processor, running at 4MHz, gave us the high performance characteristics we were striving for, plus the ability to expand into the MTX Hard Disc, MTX Silicon and Floppy Disc CP/M operated systems. Systems that could provide up to 160 megabyte storage capacity. More power than you'll probably ever need, unless you take full advantage of the MTX's impressive system capabilities.

Systems hookup is as simple as every other MTX procedure. By merely plugging in the twin RS232C Serial interfaces and the Node software, sold optionally, you're ready to create a disc-driven interactive communications network (OXFORD RING®) that can link up to 255 units.

Software? You'll never worry about software availability with the MTX. Dozens of MTX-dedicated programs have already been created, supplementing the vast landscape of CP/M applications software currently available. And advance word of the MTX's technical capabilities has precipitated an MTX software "push" on the part of many leading software manufacturers.

Word Processing For \$999 – A Look At A Great Deal

Look first at the capabilities, then at the price.

This is word processing the way it should be. Quick. Easy. Professional. A package that includes the MTX512; the powerful New Word™ word processing ROM cartridge; and the Memotech DMX80 correspondence quality printer.* An exceptional value!

And that brings us to the bottom line.



A Look At The Price

There's a very simple equation that covers the pricing of the MTX512.

The more engineering you put in a system, the less it will cost to produce. As you've already seen, the MTX is a pure product of advanced, innovative engineering.

Which is why we can sell it for \$595.**

And why we can confidently back it up with a full one-year warranty.

Make no mistake. When you turn this page, you'll be returning to a world very different from this one.

A world in which all microcomputers will suddenly seem very different.

Suddenly very ordinary.

For more information about the MTX512, or to find out the location of the MTX dealer nearest you, contact Memotech Corporation, 99 Cabot Street, Needham, MA 02194; or phone (617) 449-6614

MEMOTECH CORPORATION

CP/M is a trademark of Digital Research, Inc.
New Word™ is a trademark of New Star Software, Inc.
*DMX80 correspondence quality printer suggested retail price \$395.
**Suggested retail price.

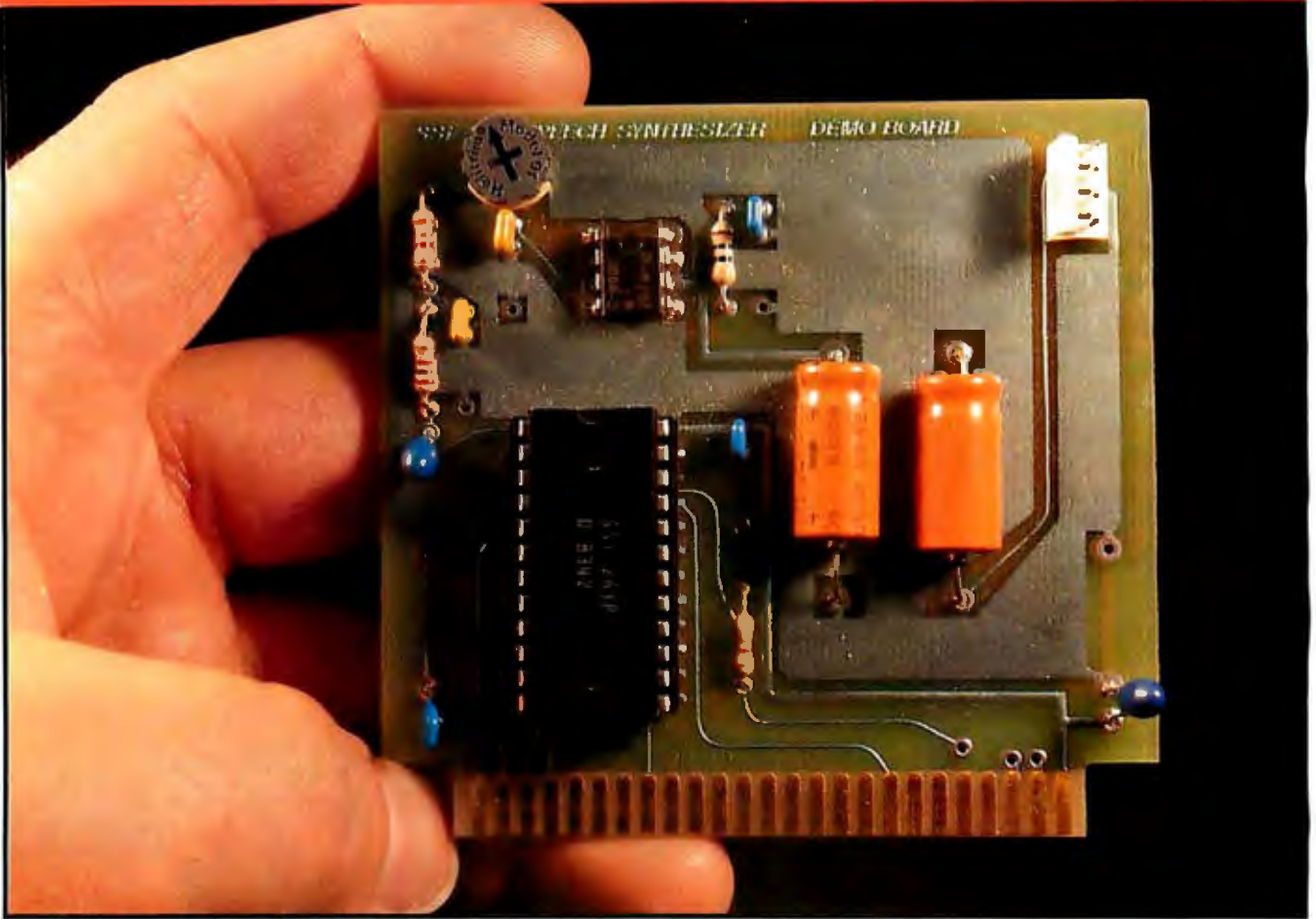

Build a Third-Generation Phonetic Speech Synthesizer

by Steve Ciarcia

The idea for this month's project may seem familiar to many of you, and with good reason: I've done projects on building speech synthesizers five times before. Why? The integrated-circuit technology for doing it keeps getting better and better, and I like nothing more than experimenting with new chips.

The Shadow of the Past

The most successful of the past speech-synthesis projects were the Sweet Talker, presented in September 1981 (see reference 3), and the Micro-

vox, presented in August and September 1982 (see reference 4). Many of you have built and used these as peripheral devices on your personal computers.

The original Sweet Talker was a simple, parallel-port-driven phoneme-based synthesizer. To make it talk, you just sent 6-bit phoneme codes to it. It's still useful; I've used it for broadcasting weather reports, among other things (see reference 1). The Microvox was an enhancement of the same basic design. Both these devices were built around the Votrax SC-01A chip, a member of the second generation of commercial speech-synthesis products. (The first genera-

tion consisted of hybrid modules containing many discrete components.)

Latest Technology

I suppose I would continue to tinker with improving the sound quality from this foundation if I had not been beaten to the punch by the appearance of an enhanced speech-synthesis chip. This month we'll look at the latest development in phonetic speech synthesis: the SSI263 integrated circuit from Silicon Systems Inc.

Speech-synthesis chips of the new third generation, such as the SSI263, produce much more intelligible

The latest development in phonetic speech synthesis is the Silicon Systems SSI263 chip

speech than did older devices, such as the SC-01A. The new chips achieve this through more flexible intonation, inflection, and filtration. With the SSI263, it is possible to vary these three effects on the fly as well as load new speech phonemes dynamically. When synthesizing in this way from sufficiently detailed data (at about 400 bits per second), the SSI263 generates the most human-sounding synthesized voice I've heard to date. (Systems that reproduce a digitized human voice can still sound better, however.) In its minimal operating mode, which requires data at about 50 to 70 bits per second, the quality of sound is comparable to that produced by the Votrax SC-01A.

Sweet Talker II

Seeing that the SSI263 could be easily interfaced to many different microprocessor-based systems, I decided to use an Apple II Plus as its host because the Apple's allocation of a separate address space for each expansion slot would eliminate address decoding on the speech card. The board, which contains only two chips, can be adapted for use with many other computers if you don't mind a little extra wiring. Out of sentiment for my earlier project, I decided to call the new package the "Sweet Talker II." It's shown in photo 1.

Programming the Sweet Talker II can be simple, if you'll settle for a monotonic, uninflected voice, or complicated, if you need the highest quality speech. Unlike its predecessor, the SC-01A, which used only a 6-bit phoneme input, the SSI263 contains five registers (totalling 40 bits) that influence the emitted sound. With the constant updating of all the registers (at a higher data rate and controlled by a more complex program), the SSI263 can even sing with vibrato.

Because the SSI263 is just out on the market, very little has been published on it. After a review of the

basic techniques of computer speech, we'll go through some specific information about the device. Following that, we'll look at the simplicity of interfacing the SSI263 to a personal computer and discuss the software needed to support it.

Review of Computer Speech

There are three major techniques presently employed to allow computers to speak: formant synthesis, linear-predictive coding (LPC), and waveform digitization. The most noticeable difference between these three methods is the amount of data required to construct a word.

In *formant synthesis*, an electronic model of the human vocal tract is constructed. Driven with signals from frequency and noise generators, the model mimics the natural resonances of the vocal tract. The output spectrum contains bands of resonant frequencies called formants.

The most common variant of the formant technique is called *phoneme synthesis*, in which the spectral parameters are derived from basic word sounds—the phonemes. In such a circuit, each phoneme is assigned a digital code; the synthesizer circuit utters phoneme sounds corresponding to the codes it receives. Therefore, speech is produced simply by stringing the phoneme codes together.

The original electronic voices of this type were intelligible but had a slightly mechanical quality. The latest phoneme synthesizers, on the other hand, combine control of pitch, rate, amplitude, and filtration to achieve quite lifelike speech. Continuous speech using phoneme synthesis can generally be obtained with data at a rate of less than 100 bps (bits per second), using no extra control attributes. Even with all the embellishments, it never requires a data rate of more than 400 bps.

Linear-predictive coding (LPC) is similar to formant synthesis in that both techniques are based on the fre-

quencies found in speech and use similar hardware to model the vocal tract. Instead of encoding phonemes, however, LPC uses stored filter coefficients, amplifier-gain settings, and excitation frequencies; the name of the method is derived from the programmed activities of the multistage lattice filters that produce the desired formants. Continuous speech can generally be achieved with data rates of 1200 to 2400 bps. LPC has been used in products from Texas Instruments (the Speak & Spell and the now-discontinued TI 99/4 Text-to-Speech Translator) and General Instrument (the VSM2032 Voice Synthesis Module).

The third technique of computerized speech is *waveform digitization*, which reproduces a voice waveform from its stored amplitude characteristics. The simplest form is uncompressed digital data recording by pulse-code modulation (PCM). A more complex method involving data compression is called adaptive differential pulse-code modulation (ADPCM).

In digital recording by PCM, the analog waveform from a real human voice is sampled at a frequency twice that of the highest frequency to be preserved from the voice; the samples are sent through an analog-to-digital (A/D) converter and stored. The digital signal is played back through a digital-to-analog (D/A) converter and a low-pass filter. Since it's essentially a recorded voice, the reproduced speech retains the original inflections and accents. Unfortunately, waveform digitization requires very high data rates, so the vocabulary is usually limited by the amount of data that can be stored.

For more detail on speech digitization, you can refer to some of my previous articles in BYTE. In June 1978 I published a simple project for digitizing and reproducing speech from uncompressed data; you might call it "brute-force digitization" (see reference 5). The second project,

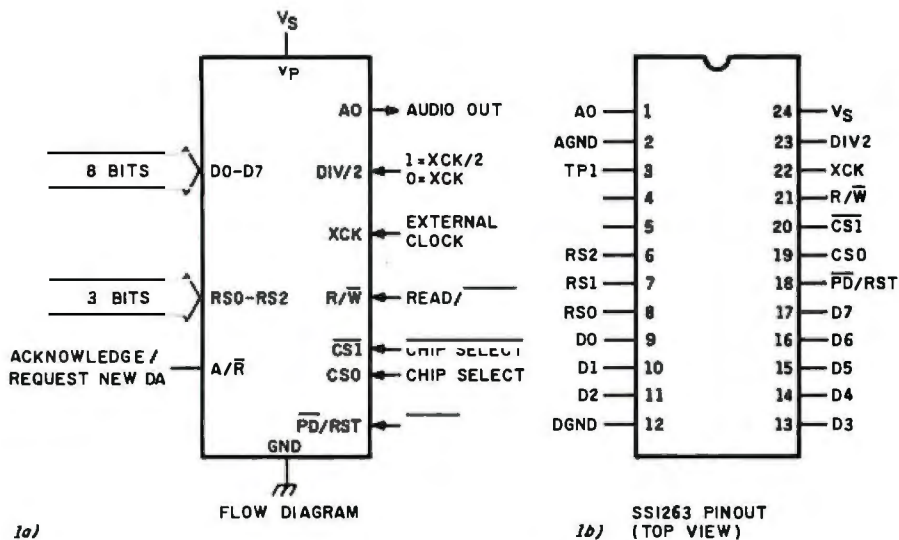

Figure 1: Pinouts of the Silicon Systems SSI263 speech-synthesizer integrated circuit.

1. appropriate control inputs ($\overline{R/W}$, $\overline{CS0}$, and $\overline{CS1}$) for address mapping with several buses
2. provision for resetting at power-down
3. five 8-bit internal registers
4. 256 phoneme equivalents (64 different phonemes each with four different duration settings)
5. four modes of handshaking
6. 4096 pitch variations (32 absolute levels with eight different speeds of inflection)
7. 16 speed settings
8. 16 amplitude levels
9. eight rates of articulation
10. 255 settings of the vocal-tract filter frequency response

Table 1: Operational characteristics of the SSI263.

Support for the SSI263

As with many Circuit Cellar projects, the Sweet Talker II is available with the text-to-speech software from a source listed at the end of the article. In true Circuit Cellar tradition, however, many of you will hard-wire the unit as I've detailed. Unfortunately, since the program is owned by Silicon Systems Inc., royalties are involved and it cannot be published. In an effort to reward rather than diminish your handiwork, I will pay the royalty and provide the Apple II software to anyone sending me a photograph of his or her custom-assembled Sweet Talker II. This offer extends to noncommercial applications and individual experimenters until June 1, 1984.

In the long term, the SSI263 will be supported by Sweet Micro Systems, the company that makes the Mockingboard music-synthesis system for the Apple II. Sweet Micro Systems' latest version of the Mockingboard can use two optional SSI263s to provide synthesized voices that can sing along in stereo with the synthesized two-channel music; the chips are plugged right into sockets on the circuit board. Photo 3 on page 40 shows the new Mockingboard, containing one SSI263, plugged into an Apple II Plus.

I've made sure that the Sweet Talker II will be software-compatible with the voice software intended for the Mockingboard, and it should be compatible with other SSI263-based products for the Apple II as well.

published in June 1981, was for reproducing digitized speech from compressed data (reference 2), and the third article, appearing in June 1983, was a project that used ADPCM (see reference 6.)

SSI263 Integrated Circuit

The Silicon Systems SSI263 is a self-contained phoneme-based speech synthesizer. It consists of a single 24-pin CMOS (complementary metal-oxide semiconductor) integrated circuit that runs from a 5-V (volt) power source. It provides an analog output for music, sound effects, and continuous speech of unlimited vocabulary at low data rates. The SSI263 is easy to interface with any microprocessor; its principal characteristics are listed in table 1. Figure 1 contains a pinout diagram; a description of each pin's function is shown in table 2. The SSI263 can use a 3.59-MHz color-burst crystal divided by 2 or 4 as a timebase, or it can run off an external 1- or 2-MHz clock signal.

The SSI263 contains five 8-bit internal registers, which allow 256 phoneme-equivalents; 4096 pitch variations; and control of amplitude, rate of articulation, and vocal-tract filter frequency response (useful for sound effects). The individual registers are described in the text box on page 38.

A Simple Circuit

Connecting the SSI263 to any microcomputer system is not hard, but with the Apple II family of computers (II, II Plus, and IIe) the connection is simplicity itself (due largely to the address decoding provided on the Apple's motherboard). As you can see in figure 2 on page 32, the entire Sweet Talker II circuitry consists of only two integrated circuits and a few passive components.

In figure 2, IC1 is the SSI263, which can be directly connected to the Apple's data and address buses, operating on interrupts generated on the \overline{IRQ} (normal interrupt request) line. The chip is selected when the A6 address line and the $\overline{R/W}$ and I/O-select status lines are active. Address lines A0, A1, and A2 select the proper register for data to be entered through the eight data-bus lines D0 through D7. The three low-order address lines are individually asserted to trigger one of three mutually exclusive register-select inputs on the voice-synthesis chip: RS0, RS1, or RS2.

When plugged into expansion slot 4 of any Apple II-series computer, the registers are addressed at hexadecimal C400 through C404 (decimal addresses 50240 through 50244).

The remaining components on the speech-synthesizer board constitute the amplifier and filter sections.

Capacitors C4 and C5 and resistors R2 and R3 form a simple low-pass filter. The audio signal is then amplified by an LM386 1-watt operational amplifier (IC2) to directly drive an 8-ohm speaker. Potentiometer R4 controls the volume on the external speaker (connected to the header provided). In addition to the +5-V supply needed by the SSI263, the board requires a +12-V supply to power the op amp.

Speaking in Phonemes

All the words in the English language can be written using only 26 alphabetic characters, but the language contains far more than 26 sounds—most letters of the alphabet (or combinations) can represent more than one sound. As a practical matter, English can be considered to contain 50 or so distinct sounds, called *phonemes*. These are listed in table 3 on page 33.

It's not as hard to use the phoneme list as it first appears. For example, the phonemes in the word "disk" are written as follows:

D I S K

Simple enough. From the table, the corresponding digital codes (in hexadecimal) are

25 07 30 29

These are the values fed into the speech synthesizer.

Few words are quite that easy, though. For instance, the five distinct phonemes in "hello" are

H F E H L O W

These are translated into the hexadecimal codes

2C 0A 20 11 23

It isn't necessary for you to become a linguist to use a phonetic speech synthesizer because many lists of words and their phoneme equivalents are available (see reference 3).

Programming for Phoneme Synthesis

The speech-synthesizer board speaks a word when it receives, in se-

Pin	Function
1	AO (Audio)—analog output, DC-biased at $V_{DD}/2$. Requires an external audio amplifier to drive speaker.
2	AG (Analog Ground)—must be connected to a good ground potential to eliminate noise in the output signal.
3	TP1 (Test Point 1)
4	A/\bar{R} (Acknowledge/Request—Not)—digital open-collector output. When forced low it requests new data. It can respond on a frame or phoneme boundary condition or be deactivated (see DR0, DR1—page 38—and \overline{PD}/RST). This signal can also be read on D7 in an inverted state.
5	TP2 (Test Point 2)—normally not used.
6	RS2 (Register Select 2)—used in conjunction with RS1 and RS0, these three register select lines are used to select and write to one of five internal registers.
7	RS1 (Register Select 1)
8	RS0 (Register Select 0)
9	D0—first of data lines, listed in order of increasing significance
10	D1
11	D2
12	V_{SS} (ground)
13	D3
14	D4
15	D5
16	D6
17	D7—most significant bit of 8-bit data bus. D7 is bidirectional. When read, high is an active request for new data and low is an acknowledgment that data has been received (A/\bar{R}).
18	\overline{PD}/RST (Power Down—Not/Reset)—this input is active in the low state. When active, it powers down the SSI263 and silences the audio output and retains its DC bias without disturbing the internal registers. It also puts the SSI263 in a disabled- A/\bar{R} mode.
19	CS0 (Chip Select 0)—control input that selects the SSI263 on a microprocessor control/mapping bus, active high.
20	$\overline{CS1}$ (Chip Select 1—Not)—active-low state.
21	R/\bar{W} (Read/Write—Not)—control input, write is an active-low state (writes into D0 through D7), read is an active-high state (reads D7 only).
22	XCLK (External Clock Input)—input for externally supplied clock. Normal frequency input is in two ranges: 2.0 MHz/1.79 MHz or 1.0 MHz/895 kHz dependent upon level of DIV2 input.
23	DIV2 (External Clock Divide-by-2 Input)—when this input is high, $XCLK = 2$ or 1.79 MHz. When this input is low, $XCLK = 1$ or 0.895 MHz.
24	V_{DD} (Positive Voltage Supply)— V_{DD} operating range is +4.5 V DC to 6.6 V DC.

Table 2: Pin functions of the SSI263.

quence, the codes for the constituent phonemes. The programming for this can be simple: POKE statements in BASIC suffice. If the synthesizer were plugged into slot 4 of an Apple II, the program of listing 1 would cause it to say "hello" in a monotonic voice. Observe that the program loads the stop phoneme (hexadecimal 0) after the end of the word; this makes the synthesizer stop sounding the last phoneme.

You'll also note that the first six executable statements in listing 1 load

constant values into the registers in the speech-synthesis chip; the five attribute registers in the SSI263 must be properly initialized; once they have been, a program using this method can cause the chip to emit the sounds of essentially any word or series of words. But an interpreted BASIC program is not fast enough to operate in an interrupt mode or dynamically change the attribute registers with each phoneme.

So a program in BASIC can only scratch the surface of the SSI263's

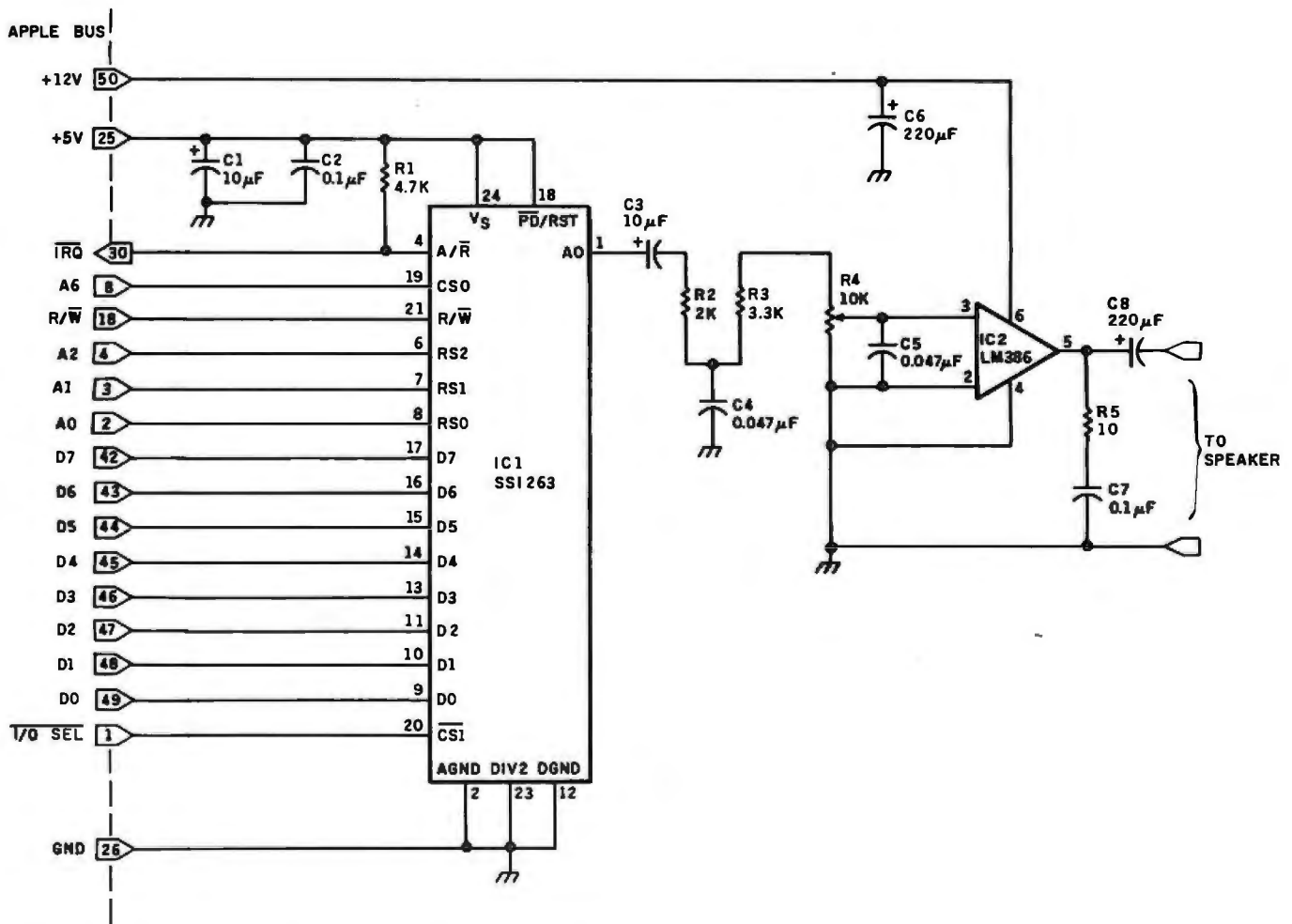

Figure 2: Schematic diagram of the Sweet Talker II circuitry.

Listing 1: This BASIC program causes the Sweet Talker II to pronounce the word "hello" by sending it the minimal set of phoneme codes.

```

10 REM SET UP SSI263 FOR TRANSITIONED INFLECTION
20 POKE 50243,255 :REM CONTROL BIT EQUALS 1
30 POKE 50240,192 :REM SET PHONEME DURATION
40 POKE 50243,116 :REM CONTROL BIT EQUALS 0 AND SET AMPLITUDE
50 POKE 50244,231 :REM SET FILTER FREQUENCY TO NORMAL
60 POKE 50242,168 :REM SET SPEECH RATE TO NORMAL
70 POKE 50241,127 :REM SET INFLECTION LEVEL
100 HOME
110 PRINT "HELLO"
120 DATA 44,10,32,17,35,0 :REM PHONEMES FOR WORD HELLO
130 FOR X=1 TO 6
140 READ A
150 POKE 50240,A :REM LOAD PHONEME INTO INPUT REGISTER
160 FOR T=0 TO 50 :NEXT T :REM DELAY TIL NEXT PHONEME TIME
170 NEXT X
180 END

```

capabilities. To really appreciate what it can do, you have to exercise the chip with an assembly-language program that adds inflection and intonation. The program in listing 2 on pages 34 and 35 also causes the system to say "hello" but with

superior results. For speech applications requiring the most reliable intelligibility, an assembly-language word-list-to-phoneme output program is required.

But many applications require an essentially unlimited vocabulary, for

instance, if you wanted your computer to read aloud the stories on the Associated Press newswire. (By the way, that's an acid test for intelligibility of synthesized speech.) In such cases, you'll need a program that can perform its own translation from normal spelling to phoneme codes using a text-to-speech algorithm.

Text-to-Speech Algorithm

A text-to-speech algorithm is a program that takes words spelled out in letters encoded in ASCII (American National Standard Code for Information Interchange) and analyzes them. It determines which characters are silent and which should produce sounds, and what kind of sounds, by following a set of general pronunciation rules. Most research in such synthesis by rule has been on English, but text-to-speech algorithms have been written for other languages as well.

The amount of program code

(3a)

Table 3: Elementary speech sounds, or phonemes, that occur in English and a few other languages. Consonants are shown in 3a; vowels are listed in 3b. The four code columns for each phoneme represent spoken sounds of different length. You can choose the length that provides the best intelligibility or most pleasing sound. From left to right, the lengths decrease by about 25 percent in each column from the previous one. The code in column 1 can usually be used as the default value.

Phoneme	Code				Examples
	1	2	3	4	
B	24	64	A4	E4	bat, tab
D	25	65	A5	E5	dub, bud
F	34	74	B4	F4	fat, ruff, photo, laugh
HV	2A	6A	AA	EA	eh
HVC	2B	6B	AB	EB	(post-B aspiration as in "tab")
HF	2C	6C	AC	EC	hat, home
HFC	2D	6D	AD	ED	(post-P aspiration as in "pad")
HN	2E	6E	AE	EE	ba-ba black sheep (voiceless glottal stop)
J	31	71	B1	F1	job, rage
K	29	69	A9	E9	kit, tick
KV	26	66	A6	E6	big, gag
L	20	60	A0	E0	lab, ball
L1	21	61	A1	E1	plan, club, slam
LB	3F	7F	BF	FF	il (French)
LF	22	62	A2	E2	bottle
M	37	77	B7	F7	mad, dam
N	38	78	B8	F8	not, ton
NG	39	79	B9	F9	ring, rang, drink, drank
P	27	67	A7	E7	pat, tap
R	1D	5D	9D	DD	rat
R1	1E	5E	9E	DE	(French)
R2	1F	5F	9F	DF	(German)
S	30	70	B0	F0	sat, lass
SCH	32	72	B2	F2	shop, push
T	28	68	A8	E8	tap, pat, baked
THV	35	75	B5	F5	bathe, the
TH	36	76	B6	F6	bath, theory
V	33	73	B3	F3	vow, pave
W	23	63	A3	E3	why, quake
Y	03	43	83	C3	(French)
Y	04	44	84	C4	you
Z	2F	64	A4	E4	zap, maze
(space)	00	40	80	C0	(pause)

(3b)

needed to implement a text-to-speech algorithm varies, with longer programs usually performing better. Typical microprocessor routines are in the 4K- to 8K-byte range, but some of the more sophisticated programs take up to 80K bytes. The main difference between the most common algorithms is the number of pronunciation exceptions and the length of word tables. An 80K-byte routine, for example, is often 90 percent look-up tables of words that are pronounced in unpredictable ways.

The Sweet Talker II speech synthesizer outlined in this article can be made to speak by direct input of individually selected phonemes, as demonstrated above, or through use of a text-to-speech algorithm. While two of my previous Circuit Cellar speech-synthesis projects, the Sweet Talker I and the Microvox, had some form of text-to-speech capability, they were built around the Votrax SC-01A; the software is not compatible with the SSI263 in the Sweet Talker II.

At first, I thought I would have to

Phoneme	Codes				Examples	Comments
	1	2	3	4		
A	08	48	88	C8	day	
A1	09	49	89	C9	care	
AE	0C	4C	8C	CC	dad, plaid	
AE1	0D	4D	8D	CD	ask	
AH	0E	4E	8E	CE	top, father	
AH1	0F	4F	8F	CF	about	
AW	10	50	90	D0	saw, caught	
E	01	41	81	C1	beet, be	
E1	02	42	82	C2	advent	
EH	0A	4A	8A	CA	leg, said	
EH1	0B	4B	8B	CB	silent	
ER	1C	5C	9C	DC	third, urn, heard	
I	07	47	87	C7	sit, bid	
O	11	51	91	D1	boat	
OO	13	53	93	D3	put, pull, look	
OU	12	52	92	D2	orb	
U	16	56	96	D6	boot, you	
U1	17	57	97	D7	poor	
UH	18	58	98	D8	cup	
UH1	19	59	99	D9	nation, circus	
UH2	1A	5A	9A	DA	nation, circus	
UH3	1B	5B	9B	DB	nation, circus	
Foreign Sounds						
AY	05	45	85	C5	français	French
A	3A	7A	BA	FA	être	French, or unlauded a (ä) in German
E2	3E	7E	BE	FE	schön	German
IE	06	46	86	C6	il	French
IU	14	54	94	D4	peut	French
IU1	15	55	95	D5	Goethe	German
OH	3B	7B	BB	FB	menu, tu	French
U	3C	7C	BC	FC	Fühlen	German
UH	3D	7D	BD	FD	menu, tu	French

Listing 2: An assembly-language program for the 6502 microprocessor that causes the synthesizer to say "hello" with better inflection and intonation by sending more data than the BASIC program.

```

1      * SSI-263 COMPOSITE DATA DRIVER
2      *
3      *
4      *          ORG   $8000
5      *
6      *
7      *  OUTPTR   EQU   $FB           ; POINTER TO START OF DATA
8      *  ENDPTR   EQU   $FD           ; POINTER TO END OF DATA
9      *  BUSY     EQU   $FF           ; BUSY FLAG
10     *  IRQL     EQU   $03FE        ; IRQ VECTOR, LOW BYTE
11     *  IRQH     EQU   $03FF        ; IRQ VECTOR, HIGH BYTE
12     *  BASE     EQU   $C440        ; REGISTER 0 OF SSI-263
13     *  DURPHON  EQU   BASE
14     *  INFLECT  EQU   BASE+$01     ; REGISTER 1 OF SSI-263
15     *  RATEINF  EQU   BASE+$02     ; REGISTER 2 OF SSI-263
16     *  CTTRAMP  EQU   BASE+$03     ; REGISTER 3 OF SSI-263
17     *  FILFREQ  EQU   BASE+$04     ; REGISTER 4 OF SSI-263
18     *
19     *
20     * SET-UP ROUTINE *
21     *
22     *
8000: 78      23      *          SEI           ; DISABLE INTERRUPTS
8001: A9 2E   24      *          LDA   #<INTERR ; INT SERVICE ROUTINE, LOW ADDRESS
8003: 8D FE 03 25      *          STA   IRQL
8006: A9 80   26      *          LDA   #>INTERR ; INT SERVICE ROUTINE, HIGH ADDRESS
8008: 8D FF 03 27      *          STA   IRQH
28     *
800B: A9 80   29      *          LDA   #>TABLE ; DATA TABLE, HIGH ADDRESS
800D: 85 FC   30      *          STA   OUTPTR+1
800F: 85 FE   31      *          STA   ENDPTR+1
8011: A9 69   32      *          LDA   #<TABLE ; DATA TABLE, LOW ADDRESS
8013: 85 FB   33      *          STA   OUTPTR
8015: A9 9B   34      *          LDA   #<TABLE+$32
8017: 85 FD   35      *          STA   ENDPTR
36     *
37     *
8019: A9 FF   38      *          LDA   #$FF     ; SET BUSY FLAG
801B: 85 FF   39      *          STA   BUSY
801D: A9 80   40      *          LDA   #$80     ; SET SSI-263 TO
801F: 8D 43 C4 41      *          STA   CTTRAMP ; TRANSITIONED INFLECTION MODE
8022: A9 C0   42      *          LDA   #$C0
8024: 8D 40 C4 43      *          STA   DURPHON
8027: A9 70   44      *          LDA   #$70
8029: 8D 43 C4 45      *          STA   CTTRAMP
802C: 58      46      *          CLI           ; CLEAR INTERRUPT MASK
802D: 60      47      *          RTS          ; RETURN TO CALLER
48     *
49     *
50     * INTERRUPT SERVICE ROUTINE *
51     *
52     *
802E: 8A      53      *  INTERR   TXA           ; SAVE X REGISTER
802F: 48      54      *          PHA
8030: 98      55      *          TYA           ; SAVE Y REGISTER
8031: 48      56      *          PHA
8032: A0 00   57      *          LDY   #$00     ; INIT Y REGISTER
8034: A2 04   58      *          LDX   #$04     ; INIT X REGISTER
8036: A5 FB   59      *          LDA   OUTPTR   ; CHECK FOR END OF DATA
8038: C5 FD   60      *          CMP   ENDPTR
803A: D0 1B   61      *          BNE   CONT     ; NO, SO CONTINUE
803C: A5 FC   62      *          LDA   OUTPTR+1

```

Listing 2 continued on page 35

Listing 2 continued:

```

803E: C5 FE      63      CMP   ENDPTR+1
8040: D0 15      64      BNE   CONT           ;NO, SO CONTINUE
8042: A9 00      65      LDA   #$00          ;END, SO TURN OFF SSI-263
8044: 8D 40 C4    66      STA   DURPHQN
8047: A9 70      67      LDA   #$70
8049: 8D 43 C4    68      STA   CTTRAMP
804C: A9 00      69      LDA   #$00          ;RESTORE BUSY FLAG
804E: 85 FF      70      STA   BUSY
8050: 68          71      RET
8051: A8          72      PLA           ;RESTORE Y REGISTER
8052: 68          73      TAY
8053: AA          74      PLA           ;RESTORE X REGISTER
8054: A5 45      75      TAX
8056: 40          76      LDA   $45          ;RESTORE ACCUMULATOR
8057: B1 FB      77      RTI             ;RETURN FROM INTERRUPT
8058:          78      *
8059:          79      *
8059: B1 FB      79      CONT   LDA   (OUTPTR),Y ;GET DATA
8059: 9D 40 C4    80      STA   BASE,X       ;AND PASS IT TO SSI-263
805C: E6 FB      81      INC   OUTPTR       ;INCREMENT POINTER
805E: D0 02      82      BNE   CONT1
8060: E6 FC      83      INC   OUTPTR+1
8061:          84      *
8062: CA          85      CONT1  DEX           ;NEXT REGISTER
8063: E0 FF      86      CPX   #$FF        ;LAST REGISTER?
8065: D0 F0      87      BNE   CONT        ;NO, SO CONTINUE
8067: F0 E7      88      BEQ   RET         ;EXIT INTERRUPT
8068:          89      *
8069:          90      *
8069:          91      *
8069:          92      *
8069: E7 3B AB    93      TABLE  HEX   E73BA87AAC
806C: 7A AC      94      HEX   E84DA87BCA
806E: E8 4D AB    95      HEX   E85DA874CA
8071: 7B CA      96      HEX   E76CA864E0
8073: E8 5D AB    97      HEX   E77BA853A0
8076: 74 CA      98      HEX   E77AA85A11
8078: E7 6C AB    99      HEX   E779A86163
807B: 64 E0      100     HEX   E770A86000
807D: E7 7B AB    101     HEX   E770A85800
8080: 53 A0      102     HEX   E770A85000
8082: E7 7A AB    103     *
8085: 5A 11      104     *

```

find a new text-to-speech program. Fortunately, Silicon Systems had foreseen the demand for a text-to-speech routine for the SSI263 and arranged for the necessary software to be available under license.

Customizing Software

The Sweet Talker II's text-to-speech routine was produced by Sweet

Micro Systems of Cranston, Rhode Island. It was derived from an algorithm originally developed at the Naval Research Laboratory and uses a similar rule-definition format. But it's much more versatile, and it nicely uses the talents of the SSI263. (At this writing, the software has been implemented only for the Apple II computer family.)

One problem of text-to-speech translation is of personal interest to me. There isn't an algorithm written that can digest and properly pronounce "Ciarcia" (it should sound like "see-ARE-see-uh") unless there is a specific rule for that character string that outputs a predetermined set of phonemes when the string is detected.

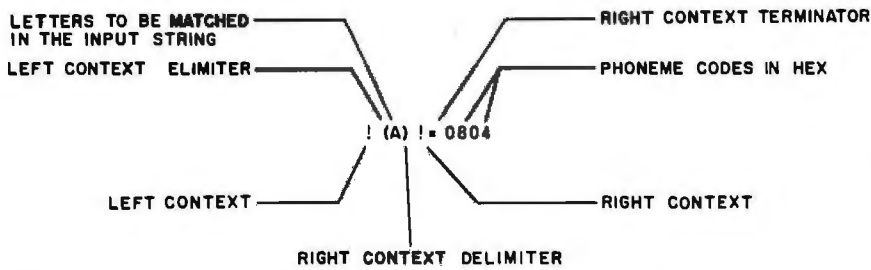

Figure 3: Format of the rules in the text-to-speech algorithm.

Symbol	Function
!	represents any nonalphabetic character in the input string
#	represents one or more vowels
:	represents zero or more consonants
+	represents a front vowel (E, I, Y)
\$	represents one consonant
.	represents a voiced consonant (B, D, G, J, L, M, N, R, V, W, Z)

Table 4: Context symbols used in the rules of the text-to-speech algorithm.

Most text-to-speech routines don't let you modify the rule tables or expand the number of exceptions. The Sweet Micro Systems program employs a rule-based method that encompasses whole-word, morpheme, and letter rules in character-specific subtables. Furthermore, this new program also comes with a utility routine for changing, editing, or redefining those rules. The utility can even adjust the size of the main routine depending on whether rules or characters in the rules have been inserted or deleted. This flexibility in design allows you to totally redefine the rule table for foreign languages and dialects, to prepare for certain proper names, or simply to improve pronunciation of a specific frequent word.

The original Naval Research Laboratory algorithm did not include any facility for varying intonation and stress, but the software for the SSI263 uses a simple yet effective system of stress markers to allow intonation and stress to be specified. (In addition, a more extensive utility program is available that provides total control

over parametric changes on an individual phoneme basis. This utility routine allows you to create high-quality words or phrases that can be easily used in any application, without the need for the text-to-speech algorithm and rule table to be resident in memory at the time of execution.)

How the Algorithm Works

Before I describe the rule-based text-to-speech algorithm, an explanation of the rule format is in order. Figure 3 shows that each rule consists of several different components. The letter or letters contained within the parenthetic delimiters are the characters to be matched in the input string. The symbols to the left of the delimiters define the left context (what comes before the characters to be matched), and the symbols to the right define the right context. The context symbols' meanings are listed in table 4. The equals symbol ("=") denotes the end of the rule definition, and the numbers to the right are the phoneme codes in hexadecimal. Most rules have a left or right context for the matched characters, but some situations do not require either.

The routine begins by converting the entire input string to uppercase characters to maintain uniformity in conversion. During this period, all characters in the input string are categorized and marked according to the symbol groupings described in table 4, and corresponding rule symbols are stored for later use. Also, stress markers are found and marked for use in the determination of intonation and stress characteristics.

The first input character is then compared to the first applicable rule

in the subtable for that character. Since all rules in a single subtable begin with the same character, the algorithm attempts to match the left context first, then if the match succeeds, it attempts to match the second and following characters, if any, remaining in the parenthetic string. If that match succeeds, the algorithm attempts to match the right context. Should any match attempt fail, the algorithm proceeds to the next rule in the subtable and attempts to match that rule.

The last rule in every rule subtable for a given letter contains a parenthetic string of just that letter with no left or right context, thus guaranteeing a match for any letter in the input string. Once a match has been achieved, the algorithm then places the phoneme codes designated in the rule (to the right of the equals sign) into a phoneme buffer.

The rule table also allows the definition of punctuation marks and numbers. This allows a description of those characters to be pronounced. Some rules, for silent letters, are defined with no phoneme codes. The algorithm simply places nothing in the phoneme buffer and proceeds to the next character in the input string.

When the routine attempts a match on either the left or right context, it may encounter special symbols in the rule, those shown in table 4. These symbols cause the algorithm to compare each context symbol in the rule to the categorical symbols assigned earlier to the characters in the input string. Again, should the algorithm encounter a failure in a match attempt, it will proceed to the next rule.

When the phoneme conversion is complete, the routine collects values for intonation and stress characteristics in other buffers. The parameters involved are those for pitch inflection, output amplitude, speech rate, filter frequency, rate of inflection transition (slope), and rate of articulation transition (slope). These last two parameters are not stored in separate buffers but as one nybble of parameters in the speech-rate and amplitude parameter buffers, respectively. A detailed explanation of these parameters appears in table 5.

Interpreting the Rules

Let's look at a few sample cases of the phoneme rules. For instance:

!(A)! = 0804

This rule states that a letter A preceded and followed by a nonalphabetic character (the "!" context) is to be pronounced by the phonemes A and Y1.

The exclamation points indicate that on both sides of the A are one or more nonalphabetic characters, which can be a space, punctuation mark, number, or any symbol other than an alphabetic letter. For example, the A in the string "1A " would be pronounced according to the above rule since it meets the conditions indicated. The strings " A ", "A%", and "\$A?" would all match the above pattern.

When putting another rule into a subtable, you must carefully consider the exact position of that rule because the algorithm takes the rules in sequence. If the conditional parameters of two rules were similar, it would be possible for sequential preference to cause the wrong rule to be selected for a given input string.

For example, it is possible that "YOUR" would be pronounced like "you-are" if the rule for "YOU" preceded a specific rule for "YOUR", because the rule for "YOU" would be accepted before the rule for "YOUR" was even considered, so the rule for "YOUR" would never be evaluated. (After accepting "YOU", the algorithm would next search the "R" subtable for a rule to satisfy "R" in the last position.)

To avoid such errors, clearly the rule for "YOUR" must precede the rule for "YOU"; "YOU" would not be mispronounced by the first rule since the trailing "R" would cause a no-match situation. The algorithm would continue to search the subtable until it reached the rule for "YOU".

The example given above for the letter A is tightly defined, and the pronunciation appears to be an exception to a rule that is more generally applicable, which comes next in the table:

Duration/Phoneme

This parameter contains the actual phoneme code. The upper 2 bits of this value designate the duration of the phoneme. The real-time duration varies depending on the value of the speech-rate parameter.

Inflection

Of the several modes of inflection that could be used, only the transitioned inflection mode is used by the text-to-speech algorithm. In this mode, there are 32 target values for the pitch of the spoken output. The output signal moves smoothly from one target value to the next.

Speech-Rate Inflection Slope

This controls the rate at which speech is produced. The lower 3 bits control the rate of inflection transition.

Control Articulation Amplitude

The upper bit controls the mode of operation of the chip. The next 3 bits control the rate of articulation transition. The lower 4 bits control amplitude.

Filter Frequency

Controls the vocal-tract filters. Different values will instantaneously shift the frequency of all formant filters.

Table 5: A detailed explanation of the parameter bytes used by the text-to-speech routine for pitch inflection, output amplitude, speech rate, filter frequency, rate of inflection transition, and rate of articulation transition.

1!(A)! = 0804

2(A)! = 1A

The second rule states that "A" in the input string followed by a nonalphabetic character is to be pronounced as the phoneme UH (hexadecimal 1A represents UH). The second rule does not specify anything in particular to the left of "A". Therefore, as long as "A" is merely followed by a nonalphabetic character, this pronunciation will be used. Note that if the rules were reversed, the rule !(A)! would never be reached because the (A)! rule would match its patterns.

Although rule 1 above is rather narrow in scope, the class of nonalphabetic characters comprises a number of different symbols, and even more specific rules might sometimes be needed. For example, if you found that the pronunciation for the input string "A?" was too short, a rule could be created to deal with this, as follows:

!(A?) = 080404

This rule would have to be placed before !(A)! in the table because having a question mark following the "A" is an exceptional condition. Any other nonalphabetic symbol would not match the question mark, and

the algorithm would proceed to the next rule.

In addition to adding new rules, you may delete any rule within the range of the subtable, with the exception of the last rule. (Each subtable must have at least one rule, even if its input character is to produce no sound.) All rules following the deleted rule will move up one position, reducing the rule count and number of bytes accordingly.

The text-to-speech software provides a convenient test mode as part of the rule editor to let you evaluate any changes made to the rule tables.

The Rule Editor

The rule-table editor provided with the text-to-speech algorithm allows complete control over the rules that govern the conversion of input text into phonemes.

The rule table contains all alphabetic characters, all numbers, all punctuation marks, and all printable special-purpose symbols. (Control characters are not included.) Although the number of rules in a table is unlimited (insofar as the disk storage and memory capacity will allow), extremely large tables will cause the conversion process and the output of speech to slow down.

When the rule editor is in use, the

(6a)	Key	Function	Key	Function
	D	delete an entry	S	select new subtable
	E	edit an entry	T	test mode
	H	help menu	U	update main rule table
	I	insert a new rule	Control-P	print current subtable
	Q	quit or exit program	Control-S	save rule table to disk
	(space)	advance to next page of current subtable (if any)		

(6b)	Keys	Command	Function
	Control-A	(amplitude)	set amplitude level (0-11)
	Control-F	(filter frequency)	set filter frequency (0-253)
	Control-I	(inflection)	set inflection level (0-25)
	Control-R	(speech rate)	set speech rate (0-13)
	Control-X	(help)	display brief introductions
	Control-Z	(return to editor)	exit test mode

Table 6: The rule editor provides a set of editing functions (6a) and a test mode with several commands (6b) consisting of control characters.

screen shows up to 10 of the rules in the current subtable (see photo 2). If the subtable contains more than 10 rules, the program lets you scroll through the rules 10 at a time, wrapping around to the first set when the end of the rule list is reached. A list of rule-table editing functions is shown in table 6a.

The test mode allows you to enter any word or phrase up to 239 characters long, including punctuation marks. The algorithm then converts the input phrase into phoneme codes, based on the rules currently in the rule table, and instructs the Sweet Talker II to speak the codes. Commands available in the test mode

are control characters as shown in table 6b. To make the rule-table changes permanent, the rule table must be saved to disk after an editing session.

Intonation

Perhaps the best way to see how the text-to-speech routine deals with indications of varying intonation and stress is to provide examples of usage. When entering text to be spoken, you can indicate what words or syllables are to differ in stress by setting them off with slash marks ("/").

For example, the string of characters

HELLO

would be pronounced with monotone inflection. But the string

/HE/LLO

would produce stress on the first syllable, while the string

SSI263 Registers

The registers discussed below are listed with their bits in order of decreasing significance.

Duration/Phoneme Register 0

DR1 DR0 P5 P4 P3 P2 P1 P0
The duration/phoneme register, D/P, is an 8-bit register where the 6 low-order bits (D5 through D0) designate one of 64 phonemes (P5 through P0). Table 3 on page 33 lists the 64 phonemes produced by the SSI263. The 2 high-order bits of the D/P register (DR1 and DR0) control the duration (timing) of the phoneme called out by the 6 low-order bits (P5 through P0).

Inflection Pitch Register 1

I10 I9 I8 I7 I6 I5 I4 I3
The inflection register is an 8-bit register (D7 through D0) where all 8 bits (I10 through I3) set or determine the rate of movement of inflection pitch. There are two modes of implementing inflection: transitioned inflection and immediate or instantaneous inflection. Immediate inflection causes the current output to instant-

ly take on the value corresponding to the 8-bit code in the inflection register and the 4-bit code in the R/I register. The total of 12 bits in these two inflection registers gives a range of seven octaves on an even-tempered scale. The immediate mode is useful for singing, musical sound effects, and for fine-tuning a duplication of human inflection.

Rate/Inflection Register 2

R3 R2 R1 R0 I11 I2 I1 I0
The rate/inflection register, R/I, is an 8-bit register where the 4 high-order bits (D7 through D4) designate one of 16 (R3 through R0) overall settings of speech/sound-effects rates and A/R timing response. The 4 low-order bits (D3 through D0) of the R/I register (I11, I2, I1 and I0) are 4 bits of inflection that are always in the immediate mode. In combination with the 8 bits of inflection from the I inflection register, I2, I1 and I0 are the 3 low-order bits of the 12-bit counter-inflection chain, and I11 is the MSB (most significant bit).

Control/Articulation/Amplitude Register 3

CTL TR2 TR1 TR0 A3 A2 A1 A0
This 8-bit register, C/A/A, has three

functions. The 4 low-order bits (D3 through D0) designate one of 16 (A3 through A0) amplitude levels of the analog audio output (AO, pin 1). The MSB (D7) of this register (C/A/A) is the control (CTL) bit. When this bit is found to be high, the SSI263 is powered down. The remaining 3 bits (D6, D5, and D4) of the C/A/A register (TR2, TR1, and TR0) determine the rate of movement of the formant position for articulation.

Filter-Frequency Register 4

FF7 FF6 FF5 FF4 FF3 FF2 FF1 FF0
The file-frequency register is an 8-bit register (D7 through D0) in which all 8 bits (FF7 through FF0) instantaneously set or shift the frequency of all the vocal-tract filters (formants), which can produce an effect similar to slowing down or speeding up a record player, but with a greater range and without affecting inflection (pitch) or other SSI263 timing. With a setting other than the normal one for speech, the filter-frequency register can raise or lower the vocal-tract filter frequencies to create sound effects.

HELL/O/

would put stress on the final "O". The program is smart enough to consider punctuation in setting inflection. The text string

HELLO?

would be pronounced with a rise in pitch at the end, and the string

HELLO.

would be sounded with a drop in pitch at the end.

The algorithm looks for pairs of stress markers; it can ordinarily be overridden only by proper terminating punctuation, such as a period or question mark. The type of terminator determines the slope of pitch inflection at the end of a phrase or sentence. Multiple pairs of stress markers can be used to set the starting level of inflection and to specially emphasize any subsequent stressed portions of the remaining phrase or sentence.

Figure 4 depicts the inflection pattern for a single pair of stress markers. The inflection level begins at the default of level 2; it continues at this level until the program encounters the first stress marker, where it raises the pitch to level 3. The inflection level remains at level 3 until the program finds the second marker. After the second marker is found, the program looks for the terminator at the end of the clause. The inflection level will be raised or lowered at the end depending on the type of terminator. If no terminator exists, then the algorithm assumes that it should glide the pitch down (as in a declarative statement), but the glide will begin at a later point than otherwise. The maximum value of the up or down glide is predetermined; if the limit is reached prior to the end of the phrase or sentence, it will continue at that level.

Let's take a look at some real examples:

/HOW/ ARE YOU?

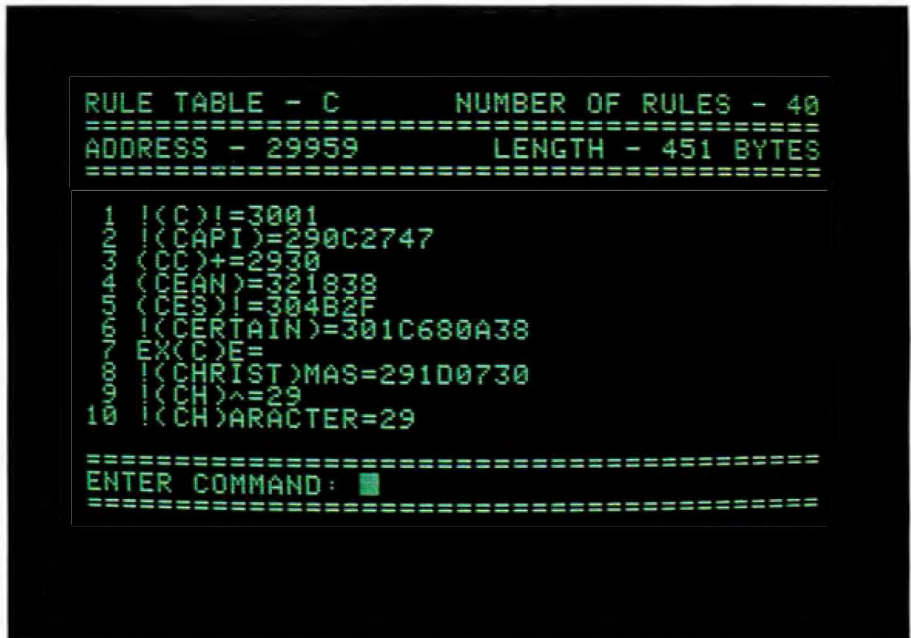

Photo 2: The rule editor for the text-to-speech software displays the phoneme-translation rules for each letter in groups of 10.

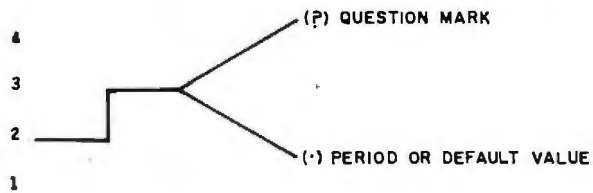

Figure 4: The inflection pattern for a single pair of stress markers, as used by the text-to-speech routine to identify where to change pitch.

"HOW" is stressed; its pitch glides up to the fourth level until the limit is reached or the terminator is encountered.

HOW ARE /YOU?

A simple system of stress markers allows specification of intonation and stress.

The word "YOU" is stressed in this case; the pitch then continues to glide up until the end of the sentence. Since the algorithm finds the interrogative terminator before anything else happens, the glide also stops at that point. In this case, the

sound produced for the word "YOU" is very short. It is so short that the algorithm may not have time to react to the stress marker and initiate a glide before it encounters the terminator. The result may be an abrupt rise in pitch. Greater and more significant differences may be seen in the following example:

DID YOU /SEE/ THAT?

The effect of the stress markers and question mark works extremely well in this particular case.

The question-mark terminator has two possible effects on a sentence. In general, the question mark causes the pitch inflection to glide up at the end of a sentence, with one exception. The algorithm looks for questions whose first word begins with

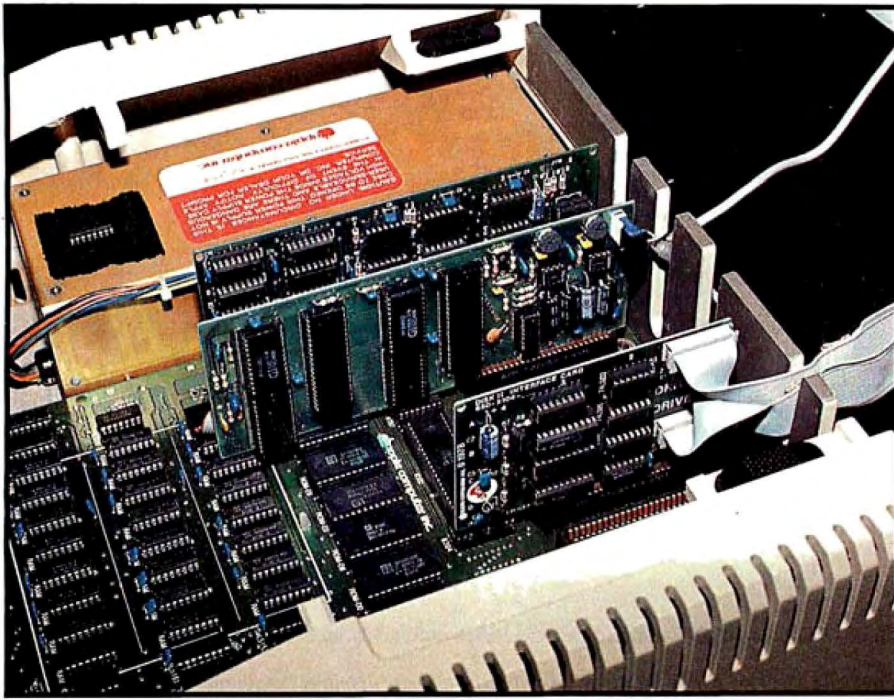

Photo 3: The latest version of the Mockingboard music-synthesis system has two sockets into which SSI263s can be plugged. The speech synthesizers can then sing along in stereo. The Mockingboard is a product of Sweet Micro Systems, 50 Freeway Dr., Cranston, RI 02920, (401) 461-0530.

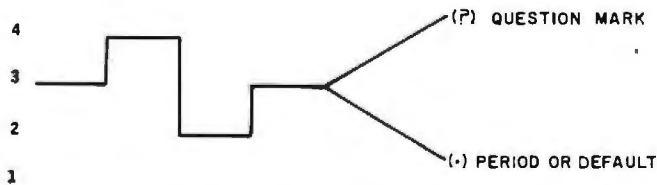

Figure 5: The pitch inflection follows the pattern shown here when the algorithm encounters multiple pairs of stress markers.

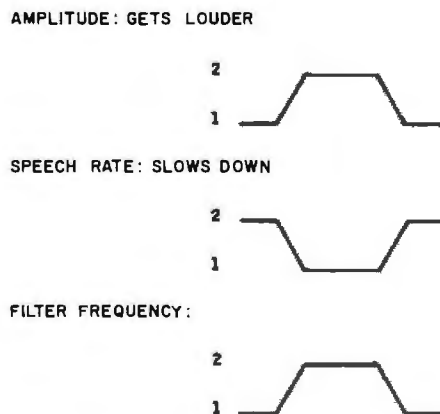

Figure 6: Not only is the pitch raised for stressed syllables, but the other speech parameters are altered as well.

“WH”. In such cases, the glide at the end of the sentence should be down. For example:

WHAT /WAS/ THAT?

When the algorithm encounters multiple pairs of stress markers, the inflection follows the pattern in figure 5. In figure 5, we can see the inflection pattern beginning at level 3 and continuing until the text-to-speech routine finds the first stress marker. The level then goes to level 4 until the routine finds the second marker. At that point, the inflection level drops to 2, where it stays until the third marker is reached. The inflection level then goes up to level 3 again and remains until another marker or the terminator comes along.

As a general rule, the first syllable in a clause is stressed to a greater degree than subsequent syllables. This inflection pattern does not take effect if a compound sentence contains multiple pairs of stress markers or clauses separated by commas. Commas are also considered terminators, so the clause preceding the comma will be treated separately.

The other speech parameters besides pitch are also altered, in a rather consistent and straightforward manner, when a syllable is being stressed. Their changes are shown in figure 6.

In Conclusion

I haven't mentioned many uses for speech synthesis, but I'm sure you have a few ideas for what you could do with a speech synthesizer. I hope you now appreciate the amount of vocal power currently available at a relatively low price. The SSI263's highly intelligible speech promises new applications for computers, and the Sweet Talker II will likely enjoy a lot of indirect software support because of its compatibility with other SSI263-based speech synthesizers.

The invention of SSI263 does not mean the demise of other approaches to computer speech. But it introduces low-cost speech output into fields that could never previously have justified the expense.

Bored Waiting? Here's The Board You've Been Waiting For.

Now
Available!

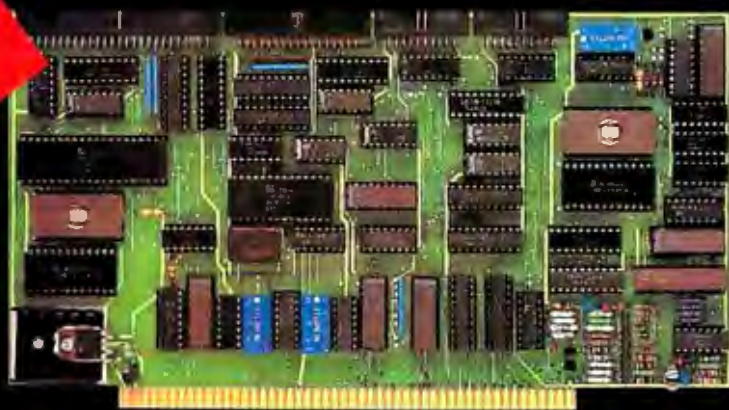

A hard disk and cartridge tape controller together on one board? Magic? Not really. It's Teletek's HD/CTC. The hard disk and cartridge tape drive controller provide the support necessary to interface both rigid-disk drives and a cartridge tape deck to the S-100 bus.

- A Z-80A CPU (optionally Z-80B) providing intelligent control of the rigid-disk and cartridge tape drives.
- Support of 5¼" rigid-disk drives with transfer rates of

5 megabits per second. Minor changes of the on-board components allow the support of other drive types/sizes and transfer rates up to 15 megabits per second. (Interface to disk drive is defined by software/firmware on-board.)

- Controller communications with the host processor via 2K FIFO at any speed desirable (limited only by RAM access time) for a data block transfer. Thus the controller does not

constrain the host processor in any manner.

- Two 28-pin sockets allowing the use of up to 16K bytes of on-board EPROM and up to 8K bytes of on-board RAM.
- Individual software reset capability.
- Conforms to the proposed IEEE-696 S-100 standard.
- Controller can accommodate two rigid-disk drives and one cartridge tape drive. Expansion is made possible with an external card.

Teletek's HD/CTC Offers A Hard Disk
Controller, Plus Cartridge Tape Controller,
All On One Board.

TELETEK

Next Month:

The IBM Personal Computer can run BASIC programs as much as 100 times faster than normal using a coprocessor board. ■

References

1. Ciarcia, Steve. "Build a Computerized Weather Station." BYTE, February 1982, page 38.
2. Ciarcia, Steve. "Build a Low-Cost Speech-Synthesizer Interface." BYTE, June 1981, page 46.

3. Ciarcia, Steve. "Build an Unlimited Vocabulary Speech Synthesizer." BYTE, September 1981, page 38.
4. Ciarcia, Steve. "Build the Microvox Text-to-Speech Synthesizer." Part 1, BYTE, September 1982, page 64. Part 2, BYTE, October 1982, page 40.
5. Ciarcia, Steve. "Talk to Me: Add a Voice to Your Computer for \$35." BYTE, June 1978, page 142.
6. Ciarcia, Steve. "Use ADPCM for Highly Intelligent Speech Synthesis." BYTE, June 1983, page 35.
7. Ciarcia, Steve. "Use Voiceprints to Analyze Speech." BYTE, March 1982, page 50.
8. Elovitz, Honey Sue, Rodney W. Johnson,

Astrid McHugh, and John E. Shore. "Automatic Translation of English Text to Phonetics by Means of Letter to Sound Rules." *United States Naval Research Laboratory Report 7948*, 1976.

9. Kuecken, John A. *Talking Computers and Telecommunications*. New York: Van Nostrand Reinhold, 1983.

Steve Ciarcia is an electronics engineer and computer consultant with experience in process control, digital design, nuclear instrumentation, product development, and marketing. In addition to writing for BYTE, he has published several books. He can be contacted at POB 582, Glastonbury, CT 06033.

Special thanks to Rod Nakamoto for his contributions to this project. Technical data on the SSI263 speech synthesizer reprinted by permission of Silicon Systems Inc., 14351 Myford Rd., Tustin, CA 92680, (714) 731-7110.

To receive a complete list of Ciarcia's Circuit Cellar project kits available from the Micromint, circle 100 on the reader service inquiry card at the back of the magazine.

Editor's Note: Steve often refers to previous Circuit Cellar articles; most of these past articles are available in reprint books from BYTE Books, McGraw-Hill Book Company, POB 400, Hightstown, NJ 08250.

Ciarcia's Circuit Cellar, Volume I covers articles that appeared in BYTE from September 1977 through November 1978. Ciarcia's Circuit Cellar, Volume II contains articles from December 1978 through June 1980. Ciarcia's Circuit Cellar, Volume III contains articles from July 1980 through December 1981. Ciarcia's Circuit Cellar, Volume IV, soon to appear, will contain articles from January 1982 through June 1983.

The following item is available from:

The Micromint Inc.
561 Willow Ave.
Cedarhurst, NY 11596
(516) 374-6793 (for information)
(800) 645-3479 (for orders)

Sweet Talker II: Apple-II-compatible synthesizer board. Assembled and tested with SSI263 speech-synthesis chip, demonstration software, user's manual, and text-to-speech algorithm on DOS 3.3 floppy disk \$100

Please include \$4 for shipping and handling in the continental United States, \$12 elsewhere. Residents of New York state please include 7 percent sales tax.



Touch-Tone® In...ASCII Out.

Turn any Touch-Tone® phone into a remote data entry terminal

By combining the capabilities of an intelligent modem with a DTMF to ASCII converter, Telnet has unlocked countless opportunities for you. With a Teleport 300 on your computer, you can use any Touch-Tone® phone in the country as a remote data entry terminal, or, if you wish, a control panel.

Imagine the possibilities: Branch office order entry, Inventory control, Remote control of environmental systems, Data logging, Emergency access to process control systems, Credit card authorizations, etc. The list goes on and on.

It's a full-featured smart modem

The Teleport 300 is a fully equipped intelligent modem: Bell 103J compatible, auto answer and originate, with tone and pulse repertory dialing and call progress indications. It's menu driven and user programmable. An internal buffer lets the

Teleport handle DTE speeds from 75 to 9600 baud.

Teleport delivers front end hardware security

You can program the Teleport 300 to respond only to a pre-determined series of DTMF signals. Unless the correct DTMF tones are detected, callers are not connected to your computer. It's an effective hardware barrier in front of any software security scheme you may be using to protect valuable programs and data.

List price is \$399.95.

To get all the Teleport details, call:

1-800-227-3800 ext 1130

Dealer inquiries are invited. Call the Telnet Telcom Components Division: (206) 827-9626 ext 220.

Telnet Corporation
10801 120th Avenue NE
P.O. Box 657, Kirkland, WA 98033
TWX 910 449-2862

Touch-Tone® is a registered trademark of AT&T.

TELNET

WAREHOUSE SHOP AND SAVE...

COLUMBIA MPC 1600



The enhanced IBM Alternative
TRULY IBM COMPATIBLE

IBM Hardware & Software compatibility in a Multi-User 16 BK computer. 128K two serial ports, one parallel port and 8 expansion slots.

Plus free software. Macro-Assembler. Diagnostics. Basic w/ colorgraphics PLUS Perfect Writer, Speller, Calc and Files, Fast Graphs, Space Commanders and Home Accountant.

CALL FOR FANTASTIC PRICE

- COLUMBIA VP PORTABLE CALL
- NEC APC CALL
- NEC 8201 A 699.00

PRODUCTS FOR YOUR IBM PC/XT AND COLUMBIA

QUADRAM CORP.

Quadboard Multifunction Board	
Full Expandability From 64K to 256K	
Par. Printer Port, Ser. Port, c/c	
Ram Disk Drive	\$ Call
Quadlink-Apple On A Card	\$ Call
Microfazer Printer Spooler	
Print Buffering From 8K to 512K	
Why Wait For Your Printer	\$ Call

APPARAT

Ram Card 64K-512K	\$ Call
Prom Blaster	\$ Call

AMDEK

Multiple Adaptor Interface	\$ Call
----------------------------	---------

USI

Multidisplay Card	
IBM Mono And Colorgraphics And Par. Port	\$ Call

PLANTRONICS

Color Plus	\$ Call
------------	---------

KEYTRONICS

Enhanced Word Processing Keyboard	
Model KB5150	\$ Call

KRAFT

Joystick	\$ 46.00
Paddles	\$ 35.00

T & G

Joystick	\$ 43.00
Paddles	\$ 29.00

KOALA

Tablet	\$ 109.00
--------	-----------

AST

6-Pack Plus 64K-364K	
One Ser., One Par., c/c	\$ Call
I/O Plus	
Clock Cal, 1 Ser. Port	\$ Call

STB

"Super-Rio" Card 64K-256K,	
Two Serial, One Par Port, Clock Cal,	
Ram Disk, Cables Included	\$ Call

TECMAR

1st Mate	\$ Call
Graphics Master	\$ Call
2nd Mate	\$ Call

CALL FOR FANTASTIC PRICES ON ALL PRODUCTS FOR YOUR IBM.

PRODUCTS FOR YOUR APPLE/FRANKLIN COMPUTER

ORANGE MICRO

Grappler +	\$ 119.00
Buffered Grappler	\$ 189.00

MICROTEK

RV-611C Par. Interface	\$ 63.00
SV-622C Ser. Interface	\$ Call
Apple Dumping 16K	\$ Call
BAM 16K Ram Expandable	\$ 73.00

MICROSOFT

16K Ram Expandable	\$ 75.00
Softcard	\$ 228.00
Softcard Premium Pak	\$ 459.00

ALS

Smarterm II 80 Col Card	\$ 129.00
-------------------------	-----------

VIDEX

Ultraterm	\$ 251.00
Videoterm 80 Col Card	\$ 185.00
PS/O Card	\$ 152.00

KENSINGTON

System Saver	\$ 72.00
--------------	----------

KRAFT

Joystick	\$ 48.00
Game Paddles	\$ 35.00

T & G

Joystick	\$ 43.00
Game Paddles	\$ 28.50
Select-A-Port	\$ 43.00
Trak-Ball	\$ 47.00

PRACTICAL PERIPHERALS

Micro-Buffer II 16K	\$ 159.00
---------------------	-----------

INTERACTIVE STRUCTURES

Pkaso Printer Interface	\$ 145.00
-------------------------	-----------

KOALA

Tablet	\$ 89.00
--------	----------

STORAGE

Library case, 5 1/4"	\$ 2.50
Disk Bank, 5 1/4" Interlock & enamel	\$ 5.50
Flip n File 50	\$ 21.95

- ★ Minuteman Madness
- ★ Wabash Diskettes
- ★ 5 1/4" SS/DD \$18.95
- ★ 5 1/4" DS/DD \$25.95
- ★ 6 Year Guarantee - 100% error free
- ★★★★★★★★★★★★★

MONITORS

Princeton Graphics HX-12 RGB	\$ 499.00
NEC	
JB-1201 12" Green-Hi Res	\$ 185.00
JB-1260 12" Green	\$ 119.00
JC-1203 RGB	\$ 519.00
JB-1205 12" Amber	\$ 169.00
JC-1215 12" Composite Color	\$ 329.00
AMDEK	
300G 12" Green	\$ 139.00
300A 12" Amber	\$ 149.00
310A IBM Compatible	\$ 175.00
Color I Composite	\$ 299.00
Color I Plus	\$ 339.00
Color II RGB (IBM Compatible)	\$ 449.00
BMC	
12" Green	\$ 89.00
13" Color Composite	\$ 249.00

FLOPPY DISK DRIVES

Amdek-Amdisk I 3" (Apple)	\$ 259.00
Amdek-Amdisk III	\$ 475.00
Amdek-Amdisk V 5 1/4" Half Height	\$ 249.00
Vista-V1200 6MB Disk Pack System (Apple)	\$ 1298.00
CDC-5 1/4" DS/DD 320K	\$ 249.00
Tandon-TM 100-2 5 1/4" DS/DD 320K	\$ 235.00
Tandon-TM 55-2 5 1/4" DS/DD Half Height	\$ 235.00
Qume-142/6MS 5 1/4" Half Height	\$ 199.00
Rana-Elite I	\$ 289.00
Rana-Elite II	\$ 449.00
Rana-Elite III	\$ 589.00
Rana-Elite Controller	\$ 99.00
Rana-1000 (Atari)	\$ 349.00
Micro SC1-A2	\$ 219.00
Micro SC1-Controller	\$ 75.00
Fourth Dimension-Drive	\$ 219.00
Fourth Dimension-Controller	\$ 50.00

HARD DISK DRIVES

Davong-Complete Line	\$ Call
Corvus-Complete Line	\$ Call

DISKETTES

Memorex	
10 per box 5 1/4" SS/DD	\$ 25.95
10 per box 5 1/4" DS/DD	\$ 35.95
Elephant	
10 per box 5 1/4" SS/DD	\$ 19.95
10 per box 5 1/4" DS/DD	\$ 26.95
Verbatim	
10 per box 5 1/4" SS/DD	\$ 25.95
10 per box 5 1/4" DS/DD	\$ 36.95
Wabash	
10 per box SS/DD	\$ 19.95
10 per box DS/DD	\$ 26.95

NO CREDIT CARD FEE

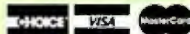

Apple is a registered trademark of Apple Computer Inc.
CPM is a registered trademark of Digital Research
IBM is a registered trademark of International Business Machines Corp.

NATIONAL ORDER DESKS

WEST 1-800-862-7819 ORDERS ONLY

EAST 1-800-672-7277 ORDERS ONLY

TECHNICAL
ASSISTANCE
&
CUSTOMER
SERVICE

Discount
on Disk
Case Lots
(Buy
with a
group)

IN COLORADO CALL (303) 371-2430
10890 E. 47th Ave. (Near I-70 & HAVANA)
DENVER, COLORADO 80239

VISIT OUR
WAREHOUSE
SHOWROOMS

OPEN
9 am - 6 pm M-F
10 am - 4 pm SAT.

IN NEW HAMPSHIRE CALL (603) 623-1010
699 E. INDUSTRIAL DRIVE (Near MALL OF NEW HAMP.)
MANCHESTER, NEW HAMPSHIRE 03103

THE FORTH SOURCE™

MVP-FORTH

Stable - Transportable - Public Domain - Tools
 You need two primary features in a software development package . . . a stable operating system and the ability to move programs easily and quickly to a variety of computers. MVP-FORTH gives you both these features and many extras. This public domain product includes an editor, FORTH assembler, tools, utilities and the vocabulary for the best selling book "Starting FORTH". The Programmer's Kit provides a complete FORTH for a number of computers. Other MVP-FORTH products will simplify the development of your applications.

MVP Books - A Series

- Volume 1, All about FORTH** by Haydon. MVP-FORTH glossary with cross references to fig-FORTH, Starting FORTH and FORTH-79 Standard. 2nd Ed. \$25
- Volume 2, MVP-FORTH Assembly Source Code.** Includes CP/M®, IBM-PC®, and APPLE® listing for kernel \$20
- Volume 3, Floating Point Glossary** by Springer \$10
- Volume 4, Expert System** with source code by Park \$25
- Volume 5, File Management System** with interrupt security by Moreton \$25

MVP-FORTH Software - A Transportable FORTH

- MVP-FORTH Programmer's Kit** including disk, documentation, Volumes 1 & 2 of MVP-FORTH Series (All About FORTH, 2nd Ed. & Assembly Source Code), and Starting FORTH. Specify CP/M, CP/M 86, CP/M+, APPLE, IBM PC, MS-DOS, Osborne, Kaypro, H89/Z89, Z100, TI-PC, MicroDecisions, Northstar, Compupro, Cromenco, DEC Rainbow \$150

FORTH DISKS

FORTH with editor, assembler, and manual.

- APPLE** by MM \$100
- APPLE** by Kuntze \$90
- ATARI®** valFORTH \$60
- CP/M®** by MM \$100
- HP-85** by Lange \$90
- HP-75** by Cassidy \$150
- IBM-PC®** by LM \$100
- NOVA** by CCI 8" DS/DD \$175
- Z80** by LM \$100
- 8086/88** by LM \$100
- 68000** by LM \$250
- VIC FORTH** by HES, VIC20 cartridge \$50
- C64** by HES Commodore 64 cartridge \$60
- Timex** by HW \$25

Enhanced FORTH with: F-Floating Point, G-Graphics, T-Tutorial, S-Stand Alone, M-Math Chip Support, MT-Multi-Tasking, X-Other Extras, 79-FORTH-79, 83-FORTH-83.

- APPLE** by MM, F, G, & 83 \$160
- ATARI** by PNS, F,G, & X. \$90
- CP/M** by MM, F & 83 \$160
- Apple, GraFORTH** by I \$75
- Multi-Tasking FORTH** by SL, CP/M, X & 79 \$395
- TRS-80/II or III** by MMS, F, X, & 79 \$130
- Timex** by FD, tape G,X, & 79 \$45
- Victor 9000** by DE,G,X \$150
- fig-FORTH Programming Aids** for decompiling, callfinding, and translating. CP/M, IBM-PC, Z80, or Apple \$150
- Extensions for LM** Specify IBM, Z80, or 8086
 - Software Floating Point \$100
 - 8087 Support (IBM-PC or 8086) \$100
 - 9511 Support (Z80 or 8086) \$100
 - Color Graphics (IBM-PC) \$100
 - Data Base Management \$200 Requires LM FORTH disk.

CROSS COMPILERS Allow extending, modifying and compiling for speed and memory savings, can also produce ROMable code. •Requires FORTH disk.

- CP/M \$300
- 8086• \$300
- 68000• \$300
- IBM• \$300
- Z80• \$300
- Apple II/II+ \$300

FORTH COMPUTER

- Jupiter Ace** \$150
- 16K RAM Pack \$50
- 48K RAM Pack \$125

Key to vendors:

- CCI Capstone Computing Inc.
- DE Dai-E Systems
- FD Forth Dimension
- HW Hawg Wild Software
- I Insoft
- LM Laboratory Microsystems
- MM MicroMotion
- MMS Miller Microcomputer Services
- PNS Pink Noise Studio
- SL Shaw Labs

- MVP-FORTH Cross Compiler** for CP/M Programmer's Kit. Generates headerless code for ROM or target CPU \$300
- MVP-FORTH Meta Compiler** for CP/M Programmer's kit. Use for applications on CP/M based computer. Includes public domain source \$150
- MVP-FORTH Fast Floating Point** includes 9511 math chip on board with disks, documentation and enhanced virtual MVP-FORTH for Apple II, II+, and IIE. \$450
- MVP-FORTH Programming Aids** for CP/M, IBM or APPLE Programmer's Kit. Extremely useful tool for decompiling, callfinding, and translating. \$150
- MVP-FORTH** by ECS for IBM-PC or ATARI®. Standalone with screen editor. License required. \$100
- MVP-FORTH** by ECS for IBM-PC or ATARI. With color animation, multitasking sound, utilities, and license. \$175
- MVP-FORTH Professional Application Development System (PADS)** for IBM-PC, or APPLE. A three level integrated development system with complete documentation. \$500
- MVP-FORTH Expert System** for development of knowledge-based programs for Apple, IBM, or CP/M. \$80
- MVP-FORTH File Management System (FMS)** with interrupt security for IBM, Victor 9000, or CP/M \$200

FORTH MANUALS, GUIDES & DOCUMENTS

- ALL ABOUT FORTH** by Haydon. See above. \$25
- FORTH Encyclopedia** by Derick & Baker \$25
- The Complete FORTH** by Winfield \$16
- Understanding FORTH** by Reymann \$3
- FORTH Fundamentals, Vol. I** by McCabe \$16
- FORTH Fundamentals, Vol. II** by McCabe \$13
- Beginning FORTH** by Chirlian \$17
- FORTH Encyclopedia Pocket Guide** \$7
- And So FORTH** by Huang. A college level text. \$25
- FORTH Programming** by Scanlon \$17
- FORTH on the ATARI** by E. Floegel \$8
- Starting FORTH** by Brodie. Best instructional manual available. (soft cover) \$18
- Starting FORTH** (hard cover) \$23
- 68000 fig-Forth** with assembler \$25
- 1980 FORML Proc.** \$25
- 1981 FORML Proc 2 Vol** \$40
- 1982 FORML Proc.** \$25
- 1981 Rochester FORTH Proc.** \$25
- 1982 Rochester FORTH Proc.** \$25
- 1983 Rochester FORTH Proc.** \$25
- A FORTH Primer** \$25
- Threaded Interpretive Languages** \$23
- META-FORTH** by Cassidy \$30
- Systems Guide to fig-FORTH** \$25
- Invitation to FORTH** \$20
- PDP-11 User Man.** \$20
- FORTH-83 Standard** \$15
- FORTH-79 Standard** \$15
- FORTH-79 Standard Conversion** \$10
- Tiny Pascal fig-FORTH** \$10
- NOVA fig-FORTH** by CCI Source Listing \$25
- NOVA** by CCI User's Manual \$25
- Jupiter ACE Manual** by Vickers \$15
- Installation Manual for fig-FORTH,** \$15

Source Listings of fig-FORTH, for specific CPU's and computers. The Installation Manual is required for implementation. Each \$15

- 1802
- 8080
- PACE
- 68000
- 6502
- 8086/88
- 6809
- Eclipse
- 6800
- 9900
- NOVA
- VAX
- AlphaMicro
- APPLE II
- PDP-11/LSI-11
- Z80

Ordering Information: Check, Money Order (payable to MOUNTAIN VIEW PRESS, INC.), VISA, MasterCard, American Express. COD's \$5 extra. Minimum order \$15. No billing or unpaid PO's. California residents add sales tax. Shipping costs in US included in price. Foreign orders, pay in US funds on US bank, include for handling and shipping by Air: \$5 for each item under \$25, \$10 for each item between \$25 and \$99 and \$20 for each item over \$100. All prices and products subject to change or withdrawal without notice. Single system and/or single user license agreement required on some products.

MOUNTAIN VIEW PRESS, INC.

PO BOX 4656

MOUNTAIN VIEW, CA 94040

(415) 961-4103

New Machines, Networks, and Sundry Software

Chaos Manor is inundated with new computers

by Jerry Pournelle

We've got three new machines—four if you count the IBM PC, which arrived only a month ago. Alas, the work load at Chaos Manor has come in a flood that threatens to drown us, and we haven't yet been able to get a new editorial assistant on board, so there's not been as much hacking about with the machines as I'd like.

Meanwhile, things are happening in micro land. The winds of change are blowing again, and it's a bit hard to look far ahead. Even so, we can spot some trends.

First, though, the Corvus.

Corvus

The Corvus Concept is a fairly revolutionary piece of equipment. Corvus calls it a "workstation," which is to say that not only is it a full computer based on the Motorola 68000 chip, but the company has also paid a lot of attention to making it communicate with other equipment.

The Concept is an 8-MHz machine with 512K bytes of memory, a 720 by 560 bit-mapped display, a well laid out Keytronics keyboard that looks an awful lot like an IBM Selectric, a hard disk, and a bunch of communications ports. The screen is unusual: it's taller than it is wide, or it can be laid on its side so that it's wider than tall. The monitor is a big Ball Brothers that

feels like it weighs a ton; you want hefty furniture, and don't expect to carry a Concept around very much.

I'm very fond of the detached keyboard, and I like the character set used on the screen. Being bit-mapped, it can show **boldface** and *italics*. The machine comes with a text editor called "Edword." The name is a horrid pun, but the editor itself is quite nice, sort of a well-tamed EMACS with lots of dedicated keys. The editor continuously updates the disk file every 30 seconds or so. That takes less than a second to write to the hard disk; it's not particularly distracting. This means that power failures, or playful kittens, can't lose you more than a few seconds' worth of work. Edword (ye gods I hate that name!) keeps a complete disk file of everything you've done, so that there's a full Undo function; enough presses of Undo will get you right back to a blank screen.

The operating system and disk formats are Corvus's own, of course, and are going to require more study. So far, I've used UCSD p-System and CP/M-68K on the Sage and CP/M-68K on the Compupro 68000. I think I prefer Corvus's own operating system to the other two, but that view is based on far too little experience to put any confidence in.

One feature I like in the Corvus is a Suspend key; pressing it will let you do other tasks, such as communications through the modem, after which you can resume editing or whatever.

We're always concerned about hard-disk systems. Some, like the Kaypro 10, must be shut down in a particular sequence that retracts the disk head to what's called a "landing position." There wasn't any obvious shutdown procedure for the Corvus, so Alex called David Ramsey of Corvus to ask how to turn the machine off.

"Set all switches to the 'off' position," was the reply.

While we were on the phone the wind came up, and we had two short power failures, with power restoration too quick to allow us to turn off the machine, so that the Corvus disk powered down and back up unattended. The Corvus never lost a single byte of data and is unharmed.

By contrast, there seems to be a newly developed bad area on the Kaypro 10's hard disk; we don't know if this is related to the spate of storms and power failures we've had this month, but it might be.

There's a lot to like about the Corvus, and you'll certainly be hearing more about it in future columns.

I confess that until I began playing with its new machinery, I wasn't much impressed with the company; but the Concept has completely changed my view.

Alex has done more with the Corvus than I have. His notes open with, "I think the Concept is great!" He's also anxious to see Corvus's Unix for the 68000 Concept, which it claims will be available Real Soon Now. At COMDEX, Corvus showed off its new "gateway" to the IBM SNA (System Network Architecture); that plugs into the Corvus Unix engine, which is a 68000 box something like the Concept but not quite. The company will also be adding an interface to Ethernet.

Networking

Computer networks are the coming thing. Individual micros are powerful enough to do most of the work needed by small businesses, but not *all* of it. In particular, micros can't store and easily retrieve huge gobs of data, and of course they're limited in the number of data sources that can be active.

The obvious solution is to connect a bunch of micros together. Networking has long been done with big mainframe machines and minicomputers; it's harder to accomplish for micros than it sounds. Of course, one might use the same kind of network interface for micros that is used on minicomputers. One of the most popular is Ethernet, developed by Xerox. The problem is that an interface board to couple any machine to Ethernet will cost about \$1000, which is trivial compared to the cost of a big mini but is no small sum for micro users.

One of the Concept's strongest features is communications. The machine comes with an Omninet interface; we also have Omninet interface boards for the IBM PC, the Apple, and our S-100 system. Omninet uses a twisted pair of wires and will run up to 2000 feet between workstations. Alex is even now stringing wires through the house. With luck, we'll soon have all the major machines in Chaos Manor connected to the Corvus hard disk.

Corvus believes in Omninet. Its new headquarters in Silicon Gulch is wired for communications: coaxial cable between buildings, Omninet inside each. Corvus will use its "SNA gateway" box as an interface between other kinds of computer networks. The "gateway" looks a lot like the bottom part of a Concept. It has big slots for an Ethernet board and small slots for Apple boards. For that matter, the Concept has four Apple-type slots in back. We're told that most Apple boards, including 5¼- and 8-inch disk controllers, will run in those.

If you listened in the right places at COMDEX, you could hear rumors of an IBM multiuser machine that would be the big brother of the IBM PC. If that's truly in the works—and it makes sense—then a network officially supported by IBM wouldn't be far behind.

With luck, we'll soon have all the major machines in Chaos Manor connected to the Corvus hard disk.

An IBM "big micro" would surely be built around a larger chip than the 8088 used in the PC and PCjr. Since IBM owns some 15+ percent of Intel, it's likely to be one of the new Intel family, possibly the iAPX286, or even the 486, unless the production problems Intel has had lately persist longer than I think they will. Whatever IBM uses, I suspect the "Super PC" will connect downhill to the PC and uphill to IBM mainframes.

What net might IBM use? It has several choices.

(1) It can go with the fast but relatively expensive Ethernet. If Big Blue does that, Ethernet will be "legitimized," with some drop in prices as a result of increased volume of sales. The most popular IBM PC Ethernet interface is based on one very complicated chip, so hardware prices have the potential to drop.

On the other hand, the low-cost net designers won't give up. Omninet will get a fair amount of business, because Omninet can hook into

Apple and other machines incompatible with Ethernet. Besides, if Ethernet can be put on one (expensive) chip, the less expensive nets can be put on a single (cheaper) chip as well. There'll also be a scramble to build gateways to the IBM network.

(2) It can go with an existing low-cost net system like Omninet, Arcnet, or some other RS-232C-type network. This doesn't seem likely: IBM would be just another competitor in an already crowded market.

(3) It can go with its own expensive network. This is certainly consistent with IBM's past actions. It wouldn't be a popular choice among users, but that hasn't concerned IBM in the past.

(4) It can devise its own cheap networking system. This is a nontrivial R&D task even for IBM; but it would certainly have a major effect on the market, causing a big shakeout and cleanup. Alex doesn't think this alternative is likely, and I'm inclined to agree.

Networking Really Is Important

Why worry about networks? Businesses and hackers alike will want them. There's so much appeal for business in a network that links incompatible machinery—such as Apple, IBM, Kaypro, Eagle, Corvus, etc.—that "independent" networks will flourish no matter what IBM does. For example: once we have Omninet set up, I'll be able to transfer files among the Apple, Corvus, Compupro, Z-100, and IBM PC machines, neatly solving a number of the disk-format problems that have plagued us for months.

Networks will be forced upon the bigger companies just to increase productivity. Some businesses may resist, but that will stop the day the managers of Company A find that all of Company B's employees know of A's newest developments before all of A's people know.

In fact, there's going to be a thriving business in building gateways between various popular networks, and outfits like Corvus are getting a head start. A black box that interconverts all networking protocols will be mandatory when a business wants to con-

How can your microcomputer talk to an IBM mainframe?

CLEO.



The communications features of the CLEO-3270 Software package allows your microprocessor to emulate a cluster of IBM terminal devices.

You don't even need to change software on your mainframe computer, because for all it knows, it's communicating with a 3271-12, 3275-12, or 3276-XX cluster. And the program will accommodate up to 8 terminals.

The CLEO software provides the cluster emulation and makes the ASCII devices look like an IBM 3278 CRT and 3287 printer.

If your IBM mainframe doesn't support remote 3270 clusters, you need remote batch communications. CLEO-3780 Software is your answer.

For full details contact Phone 1, Inc., 461 North Mulford Road, Rockford, IL 61107; phone (815) 397-8110.

Circle 286 on inquiry card.

Standard Features-CLEO 3270

- Bisynchronous 3276-2 protocol to 9600 baud
- SDLC 3271-12 and 3275-12 protocol
- Up to eight line cluster activity
- Selectable control unit address
- User install program for various CRTs
- 3278 emulation for ASCII CRTs
- Available for CP/M™, MP/M™, MsDOS™, TurboDOS™, Unix™, and Xenix™.
- Coded in C language
- 3276-12 protocol, coming soon

Standard Features-CLEO 3780

- Point-to-point and multipoint communications
- Available for CP/M™, MP/M™, MsDOS™, TurboDOS™, Unix™, and Xenix™.
- Supports transparent mode
- Coded in C language

CLEO



nect several "unfriendly" networks.

Some years ago, Digital Research sold something called "CP/Net" that allowed CP/M machines to talk to each other. We had a copy here at Chaos Manor, but we never had it running. CP/Net languished within Digital Research, getting little support or sales, and in early 1983 Digital Research quietly removed it from the market, neatly stranding several outfits who'd signed up for the 16-bit version. In theory, Digital Research will support CP/Net, although the company no longer sells it. In practice, that support is minimal.

At this fall's COMDEX, DR announced "Soft/Net," its new network. Unlike hardware manufacturers who sponsor networks built around one particular kind of network hardware, DR plans to support *all* the major networks, including Omninet, Arcnet, and Ethernet. (In fact, DR had TI Professionals, IBM PCs, and Compupros talking to each other in its booth at COMDEX.) This is a clever move, since there's no clear-cut network leader. If IBM announces a micro network, DR can quickly add it to its stable—always assuming that Digital Research doesn't already know what Big Blue plans. There's some evidence that it does, as we'll see later.

Soft/Net is supposed to connect to both 8-bit and 16-bit micros running CP/M, CP/M+, CP/M-86, and Concurrent CP/M. The network is supposed to look just like any other disk or printer to the computer; current software should run without changes. In theory, that will end disk-format incompatibilities: put your files on the central disk drive and use PIP to move them to another machine. Soft/Net should also be a big boon to bulletin-board operators.

DR promises all the usual trimmings to go with Soft/Net: file sharing, password protection, record locking, and file locking. (File locking means that no one else can write to a particular file while you're using it; record locking write-protects only specified records within a file.) If DR can make this work, it will be tremendously popular and successful. I believe that Concurrent CP/M will

replace PC-DOS in the IBM PC world; add Soft/Net, and DR will have given the micro world a new de facto standard. The computer world desperately needs a software network that works with *all* the other popular networks; we wish Digital Research well in this effort.

Operating Systems, Past and Future

When microcomputers first came out, there were oodles of different operating systems, and the only way our computers could talk to each other was by (ugh!) paper tape. Then came the CP/M revolution, and suddenly hackers with machines made by different companies could communicate simply by swapping disks. CP/M quickly became the de facto standard.

For a while, few doubted that CP/M with upgrades to 16-bit systems would continue to be the standard; then came IBM. For some reason, Digital Research didn't sign up IBM, and Microsoft's PC-DOS became the standard for IBM PC systems. CP/M-86 was available, but few bought it.

The original PC-DOS had remarkable similarities to CP/M 1.4. However, the commands for PC-DOS were quite different from CP/M's, in some cases being precisely backward. PC-DOS also suffered from CP/M 1.4's major limitations, and many programmers muttered that it wasn't truly an operating system; it was merely a job-control language. It was obvious to most that vanilla PC-DOS wasn't long for this world. Changes would be made.

The inevitable was delayed a bit by embellishments to PC-DOS; incidentally, that made PC-DOS less and less like MS-DOS, increasing the babel in 16-bit land. Even so, PC-DOS has too many limits. Something's going to give.

There are several possibilities.

Unix

Unix, for the tiny few who don't know, is a multiuser, multitasking operating system developed at Bell Laboratories. Multitasking means that one user can do several jobs at the same time, with some intercon-

nection between the jobs; multiuser allows more than one person to use the computer, not all that useful for a micro: better, I'd think, to have "one user, one computer." Multitasking, though, is *very* useful.

It seems that Unix System 5 is going to be very different from Xenix. As a result, Microsoft will not be writing a version of System 5 for Intel for the iAPX286. Instead, Intel has contracted for a version of System 5 from Digital Research. Xenix's position in the marketplace may now be somewhat less secure than it once seemed.

Unix probably would have become commercially popular, but Bell had some legal problems involving anti-trust, so the price tag was kept very high—except for nonprofit users. These latter could buy Unix for trivial bucks, and did, so that a number of computer science students learned to use Unix, and many came to love it.

We've heard rumors of Unix for micros since the late 70s. The rumor-mongers are usually very positive. "I can't wait," and "Wow, will you love Unix!" are typical. A few detractors mutter that users had better be prepared to know more than they want to about their computers; Unix lets you do a lot more than CP/M does, but before you can do *anything* you must learn more about Unix than you'll ever need to know about CP/M.

I won't get into that debate here.

For one or another reason, a series of "almost Unix" systems were developed, the best known of which was Xenix.

Meanwhile, a few outfits, such as Charles River Data, have a real live Unix clone (called Unos) on their MC68000 systems. After the first of the year, when, for reasons never clear to me, we're going to dismantle the world's best-run telephone company (have you ever tried to make a phone call in Paris?), Unix will, we are told, be a lot cheaper for ordinary businesses; some predict a rush to Unix. Others are more skeptical.

At the moment, there's no clear "standard" operating system for MC68000 microcomputers. Unix may take over that spot.

computers wholesale

315-472-3055

Box 150 Brewerton, N.Y. 13029

Circle 94 on inquiry card.

We pay UPS shipping charges on prepaid orders.

-TERMINALS-

ESPRIT

Esprit \$489
Esprit II 499
Esprit III 649

LEAR SEIGLER

ADM 3A \$529
ADM II 539
ADM 36 979

New!

Televideo Personal Terminal

Personal Terminal \$399
Personal Terminal 529
w/300 band modem

Personal Terminal 849
w/1200 band modem

TELEVIDEO

910 \$439
914 579
924 695
925 699
950 865
970 929

TEXAS INSTRUMENTS

TI 703 Printing Terminal Call
TI 707 Print Term. w/modem Call

WYSE

50 Call
75 (Color) Call

ZENITH

Z-29 \$659
ZTX-10 319
ZTX-11 389

-MODEMS-

HAYES

Micro Modem 100 \$299
Micro Modem II 249
Smartmodem 300 199
Smartmodem 1200 498
Smartmodem 1200B Call

NOVATION

D-Cat \$149
J-Cat 99
Apple Cat II 269
103 SmartCat 179
103/212 Smart Cat 399
212 AutoCat 549
Access 1-2-3 449

SIGNALMAN

Mk I \$79 Mk VII \$109
Mk III 99 Mk II 79
Mk V 89 Mk VI Call

U.S. ROBOTICS

Auto Dial 212A \$439
Password 339

Advertised prices reflect a cash discount on prepaid orders only. Most items are in stock for immediate delivery in factory sealed cartons with full factory warranties.

IBM PC BOARDS

Amdel MAI Graphics Board \$479
AST Sixpak plus 64k 299
AST Megaplus 256k 569
CCS 132 Column Board 589
Microsoft 256k RAM Board 399
Plantronics Color + Board 399
Quadram New Quadboard Call
Quadram Quadlink Board Call
Tecmar 1st MATE Board 229
Tecmar Graphics Master Board 569
64K Chip Kit (9 chips) Call

-SYSTEMS-

COLUMBIA

VP Portable Call
MPC Call
MPC w/Hard Disk Call

CROMEMCO

C-10 Super Pak \$1429
C-10MP w/MicroPro software 1819
CS-1 3195
CS-2 3755
CS-3 5595
64 FDC 475
TUART 255

EAGLE

II E Series PC Series
II E-1 II E-2 PC-2 PC-1+
II E-3 II E-4 PC-2+ PC-XL+

1600 Series SPIRIT
1620 1630 Portable

—Call us today for the best prices—

INTERTEC Call

MORROW

New Portable w/2 Drives & Software Call
MD-11 w/Hard Disk + Software Call

NEC

PC-8201 Portable Call
PC-8801 A Computer Call
PC-8831A Dual 5 1/4" disk drive Call

NORTHSTAR

New! Dimension Call

SANYO

MBC 1100 \$1349
MBC 1200 1599
MBC 550 Call
MBC 555 Call

TELEVIDEO

TS-803 \$1989
Portable Call

ZENITH

ZF-100-21 \$2319
ZF-120-22 2869
ZF-120-32 4479

-PRINTERS-

ANADEX

DP-9501 \$1099
DP-9620 1199
DP-9625 1299
DP-6500 2399
WP-6000 2159

CENTRONICS

730-1 Parallel \$199
739-3 Serial 449

COEX 80 FT parallel

..... \$219

CITOH

Prowriter 8510A Par. \$369
Prowriter 8510A Ser. 569
Prowriter II Par. 669
Prowriter II Ser. 739

DIABLO

620 RO 25 CPS \$919
630 RO 40 CPS 1769

EPSON

RX-80 Call
RX-80FT Call
FX-80 Call
FX-100 Call

GEMINI

10X \$295
15X 435

MANNESMAN TALLEY

MT-160 I \$529
MT-160 L 579
MT-180 L 859
SPIRIT Call

NEC NEWNEC 2050

3510 \$1399 3530 \$1490
3550 1849 7710 1899
7715 1949 8023 399

OKIDATA

ML-82A \$299
ML-83A 569
ML-92 Par. 449
ML-92 Ser. 529
ML-93 Par. 709
Pacemark 2350 Call
Pacemark 2410 Call

PANASONIC

KX-P1090 \$319

QUME

Sprint 11/40 \$1299
Sprint 11/55 1499

SILVER REED

EXP 500 Par. \$459
EXP 550 Par. 659
EXP 550 Ser. 689

TEXAS INSTRUMENTS

TI 810 Basic \$1199
TI 810 LQ 1919
TI 850 Par. 499
TI 855 Call

-MONITORS-

AMDEK

Color I \$275
Color I+ 319
Color II (RGB) 399
Color III (RGB) 349
300 G (12" green) 135
300 A (12" amber) 145
310 A (IBM PC) 169

BMC

15 MHZ (12" green) \$79

NEC

JB-1260 (12" amber) \$109
JB-1201 (12" green) 135
JC-1212 (12" color) 339
JC-1203 (12" RGB) 549

PANASONIC

12" Green Monochrome \$169
12" Amber Monochrome 179
13" RGB 389

TAXAN

KG 12N (12" green) \$129
RGB Vision I (12" color) 299

ZENITH

Z-122 (12" amber) \$139
Z-123 (12" green) 109

-HARD DISKS-

CORVUS

Model 6 \$1869
Model 11 2549
Model 20 3399
Omnet 6 1695
Omnet 11 2375
Omnet 20 3225
Mirror Back-up 670

-DISKETTES-

Maxell

5 1/4" MD1 \$22.95
5 1/4" MD2 32.95

3M/Scotch

5 1/4" SSDD \$21.95
5 1/4" DSDD 30.95

Educator

Lifetime Warranty
5 1/4" SSDD \$17.50
5 1/4" DSDD 23.50
Flip 'n' File/holds 50 Disks 17.95

N.Y. residents, add appropriate sales tax. We accept VISA and MasterCard. Personal and company checks, allow 2 weeks to clear. C.O.D.'s require a 25% deposit. All prices and offers may be withdrawn without notice.

Graphics for Zenith Terminals



Graphics-Plus transforms Z19 into super terminal

The GRAPHICS-PLUS enhancement board installs easily into your Zenith Z19 terminal to give you powerful graphics capability as well as expanded user features. For a small investment, your Z19 now rivals the horsepower of very expensive terminals.

You get Tektronix 4010 compatibility to run industry standard graphics software. In the text mode, you get DEC VT100 compatible 80 and 132 column formats and 24/49 line

displays. Plus seven pages of off-screen scrolling memory. A "plain English" Set-up mode. Sixteen programmable function keys. And many more convenience features.

Printer Port Option

To capture your graphs and text on hardcopy, you will also want our printer interface board for popular dot matrix printers. Specify if you need serial or parallel compatibility.

* Ask about GRAPHICS-PLUS for the Z-29

Northwest Digital Systems

P.O. Box 15288
Seattle, WA 98115
(206) 524-0014

<input type="checkbox"/> Enter my Order		Quantity
<input type="checkbox"/> Send literature only		
<input type="checkbox"/> GRAPHICS-PLUS (GP-19) board	\$ 849	
<input type="checkbox"/> Z19 Terminal with GP-19 installed	1495	
<input type="checkbox"/> Printer I/O board	195	
<input type="checkbox"/> Serial I/O <input type="checkbox"/> Parallel I/O		
		Total \$ _____
Name _____		
Company _____		
Address _____		
City _____ State _____ Zip _____		
Telephone _____		

One prediction I can make with confidence: you won't see "vanilla Unix" anywhere a business user can get at it. Straight from the box, Unix is user-threatening. Unix is very adaptable, though, and can be surrounded with a very friendly command structure "shell."

Concurrent CP/M 3.1

A major contender for supremacy in the PC-compatible world is Digital Research's Concurrent CP/M-86, which I'll call CCPM.

CCPM has a lot going for it. For one thing, it's file compatible with CP/M 2.2, meaning that it's possible, if nontrivial, to transfer files written on 8-bit machines up to your PC-compatible 16-bit equipment. This is important for companies planning an upgrade from 8-bit equipment.

Second, CCPM is multitasking. That is, you can be working with your text editor, go do some calculations, drop that to start printing a file, let that be printing and start a long compilation, and leave the compiler going while you return to your text editor as if you'd never left it. This is such a nifty feature that anyone who uses it will never understand how he got along without it.

Even so, CCPM hasn't quite caught on, largely because so much PC-DOS software is out there, and there were a few difficulties with early versions of CCPM.

Have no fear. Concurrent CP/M-86 3.1 is here.

The new CCPM is not only multitasking, it is also multiuser, which means it looks an awful lot like Unix. Indeed, you can recompile most CCPM programs and they'll run under the Unix operating systems that are being developed in various skunk works in Silicon Valley.

More important, CCPM 3.1 emulates PC-DOS: that is, along with CCPM you can get an enhancement that will let you, as one (or more) of the multiple tasks CCPM is capable of, run PC-DOS programs right out of the box. Now there are limits, of course: programs that are hardware specific to the IBM PC aren't going to run on anything but a PC. However, all the PC-compatible software will

ETI's Four Ways To Better Management

Project Control System

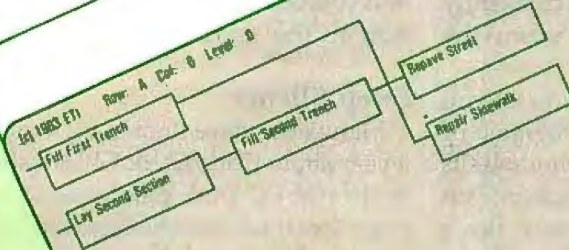

The ETI Project Control System is a visual project management tool. It allows the user to divide large, complex projects into individual tasks and operations. Based on the proven CPM and PERT methodologies, the ETI Project Control System offers uncluttered "what you see is what you get" displays and extensive user flexibility. With a few keystrokes, the ETI Project Control System user can draw a task chart to fit nearly any project, overhead cost, include name, duration, manpower requirements or manpower mix, person(s) responsible, starting and ending dates (including early and late dates) and a narrative description. Better understanding and control of complex projects is only one result of using the ETI Project Control System. It can also help find schedule threats and test alternatives, or seek the best cost/time tradeoffs. In addition, there are management-aiding displays such as schedule charts, personal schedules, assignment lists and charts that show either budgeted or actual costs.

Personnel System

The ETI Personnel System is a visual personnel management tool. It allows the user to organize a firm's most important resource—its personnel. With only a few keystrokes, the Personnel System can draw an organization chart to fit nearly any company or department. Persons are displayed in boxes, with lines showing the hierarchical relationships. Each personnel record may include the person's name, department, job title and salary, address, work schedule, holiday and vacation schedule, and a narrative position description. The user has complete freedom in creating the organization chart. People may be added, removed, or moved anywhere on the organization chart. No additional graphics hardware is required. If you have a printer, "what you see is what you get" reporting of all charts and personal information transfers your organization chart does not fit on a single page it will be printed on multiple pages which may be taped together to form a complete chart.

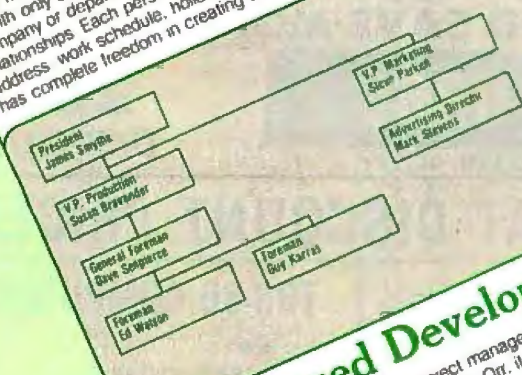

Structured Development System

The Structured Development System is a visual project management tool. Based on the structured methodologies of Jean-Dominique Warner and Kenneth Orr, it allows the user to divide large complex projects into individual tasks and operations. With only a few keystrokes, the Structured Development System can draw a Warner chart to fit nearly any project. Task names are displayed, with brackets showing the dependencies and sequence. Each task may include a narrative description in addition to the task name. The user has complete freedom in creating the Warner chart. Tasks may be added, removed, or moved anywhere on the Warner chart. No additional graphics hardware is required. If you have a printer, "what you see is what you get" reporting of all charts and narratives transfers your ideas to paper. If the Warner chart does not fit on a single page it will be printed on multiple pages which may be taped together to form a complete chart.

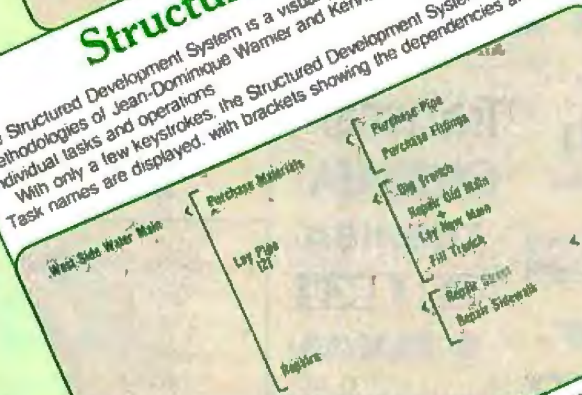

All programs require an IBM Personal Computer with monochrome display running PC-DOS. A memory of 128K or more bytes of RAM and one disk drive with at least 256K byte capacity. No printer is required, but any printer with at least 80 columns may be used. IBM and PC-DOS are trademarks of International Business Machines.

Micro-Reminder

Micro-Reminder is an important tool for anyone who wants to use the computer to organize their time. Even if you have never used a computer you will feel at ease with Micro-Reminder and quickly learn to use all of its powerful features. With Micro-Reminder, you can use the computer's memory to help remember all the details which make up your day. Micro-Reminder acts as a desk calendar to keep you abreast of your appointments. You can also use Micro-Reminder to write yourself short reminders, and keep track of the tasks facing you by keeping a "Things To-Do" list. Lastly, Micro-Reminder allows you to store names, addresses and phone numbers for easy reference. Micro-Reminder separates these functions by dividing the screen into three windows: Calendar, Appointments, Reminders, Things To-Do, and Addresses. By typing just a few keystrokes you can see any of the information change it, or enter new items.

ETI

ETI • 5848 EXECUTIVE DRIVE
LANSING, MI 48910 • (517) 887-2480

run with any machine with CCPM. In particular, we're getting it going on our Compupro Dual Processor, as well as on the Compupro 8086/8087 and the Eagle 1600. Also, Compupro is developing a PC-compatible video board for the S-100 bus; this will let us use even more PC-DOS software without modification. (That board should be available sometime in the spring of 1984.)

CCPM 3.1 will also support the Digital Research GSX graphics package, Soft/Net network communications, the 8087 math chip, and a print spooler. Test versions are being delivered to beta test sites as I write this. CCPM 3.1 is not yet released, and is an OEM product, but it should be released not long after you read this. I expect to like it a lot.

Windows, Too

One of the big themes of this fall's COMDEX was "windows." Window is a generic term for displaying more than one job (task) on a computer screen at once. Until recently, windows were available only on very ex-

pensive computers like the Xerox Star; then the Apple Lisa showed up. Since then, many companies have raced to put windows on the IBM PC.

There's a difference between windows and concurrency. The original Concurrent CP/M will run more than one task at a time, but you can watch only one at a time. This is like a television: you have a number of channels, but you can watch only one at a time. You have to constantly switch channels to see when the commercial is over.

With computers, windows let you watch more than one program, or channel if you will. Each window sits on its own portion of the screen; you can move freely between them (usually with a mouse). If, say, you are processing words and get a sudden urge to draw a graph, you can see both with windows.

You can also have windows without concurrency: that is, windows can be a screen feature to let you watch different displays, but they're all generated by the same program. Some of the most widely advertised

"window" systems are that kind.

The newest version of Concurrent CP/M has both: you can start a long assembly, and while that's running, open a new window to start an entirely different program, while leaving a window open on the assembly. You could then open another window and use it to watch a program running under PC-DOS. CCPM 3.1 supports up to four concurrent tasks, and you can watch them all in operation on the same screen.

Deep Silence

Many of us have known for almost a year about Concurrent CP/M's ability to run PC-DOS programs. Why, then, has it taken Digital Research so long to announce it?

I don't know, but I have a guess.

Digital made a serious mistake when IBM brought out the PC. There are a number of rumors about why the PC didn't come out with CP/M-86. No matter which is true, it was a very serious situation for Digital Research. It had been the de facto standard, and suddenly it was only a far-

Text continued on page 58

IT'S SIMPLE. . .CALL AND SAVE MONEY! UP TO		
Since 1978	1-800-841-0860	20% DISCOUNT
GA. INFO 912-377-7120		
NAME BRAND PRODUCTS AT DISCOUNT PRICES		
<p>WE SELL IBM-PC COMPATIBLES CALL FOR YOUR CHOICE EAGLE PC COLUMBIA PC TRS-80 MODEL 2000 \$CALL</p>	<p>TRS-80 COMPUTERS <small>PURE RADIO SHACK EQUIPMENT</small></p> <p>EPSON <small>SMITH CORONA</small></p> <p>C. Itoh <small>MANNESMANN TALLY</small></p> <p>Novation</p> <p>Hayes</p> <p>SANYO</p> <p>QUADRAM <small>COMPUTER</small></p>	<p>TRS-80 COMPUTERS</p> <p>MODEL 100.....CALL MODEL 4 TRANSPORTABLE.....CALL MODEL 2000.....CALL</p> <p>WE CARRY THE COMPLETE LINE OF TRS-80 COMPUTERS PURE RADIO SHACK EQUIPMENT \$CALL</p>
<p>DIRECT MARKETING COMPUTERS AND EQUIPMENT TO SAVE YOU MONEY!</p> <p>FREE UPON REQUEST</p> <p><small>*PRICE LIST AND INFORMATION KIT *COPY OF MFR'S WARRANTY PRICES AND PRODUCTS ARE SUBJECT TO CHANGE WITHOUT NOTICE.</small></p>	<p>stair <small>MICROSYSTEMS</small></p> <p>COLUMBIA <small>DATA PRODUCTS, INC.</small></p> <p>Transtar</p> <p>OKIDATA</p> <p>TOSHIBA</p> <p>JUKI</p> <p>TAXAN</p> <p>FRANKLIN</p> <p>EAGLE COMPUTER</p>	<p style="text-align: center;"></p> <p style="text-align: center;">Micro Management Systems, Inc. 2803 Thomasville Road East Cairo, Georgia 31728 TELEMARKET DEPT #1</p>

NOW AVAILABLE
Only \$275.00 Suggested Retail



QUADCOLOR™ BY QUADRAM™

The first and only color graphics adapter board your IBM PC or XT will ever need.

- Most advanced color graphics board you can buy.
- 136 different colors, and expandable memory.
- No additional board or modification needed to run existing software—completely PC-compatible.
- Serves your graphics needs today... ready to meet your expanded needs tomorrow.

Start with Quadcolor I

Quadcolor I adapts to any color monitor and starts you off with 32K of memory. That means that in text mode you get 16 active video pages with a 40 column format or 8 pages with 80 column. Twice as many as IBM's Color Graphics Adapter offers.

When you switch to the graphics mode, Quadcolor I's 32K memory lets you create two complete pages. You can even modify one page while the other is being displayed, for special effects like animation.

Choose 2 true colors for high-resolution displays on RGB monitors. With Quadcolor, there's no reason to limit yourself to black-and-white.

Display shown on screen produced with Quadcolor II.

IBM is a registered trademark of International Business Machines Corporation.



Quadcolor I also offers support for a light pen and an RF modulator connector for use with a home television set.

Grow with Quadcolor II

As your needs change, plug Quadcolor II into Quadcolor I and get a total of 96K of memory combined with higher resolution bit-mapped graphics. Quadcolor II also includes BASICQ, a software package that

enhances the IBM's own BASIC capabilities.

Display graphics like a bar chart, and text like graph labels, together on the same screen. Now that's Quadcolor teamwork.

When you're in the mood for fun and games, Quadcolor II has a game port available for your use.

The choice is clear

Quadcolor is the only graphics board that can offer you all these features and the solid tradition of Quadram Quality. Nobody even comes close. So be sure you choose tomorrow's color graphics board today—Quadcolor by Quadram.

With Quadcolor, looking good never looked so good.



4355 International Blvd./Norcross, Ga. 30093
(404) 923-6666/TWX 810-766-4915 (QUADRAM NCRS)

Circle 296 on inquiry card.

© Copyright 1983 Quadram Corporation
All rights reserved

Software for Writers

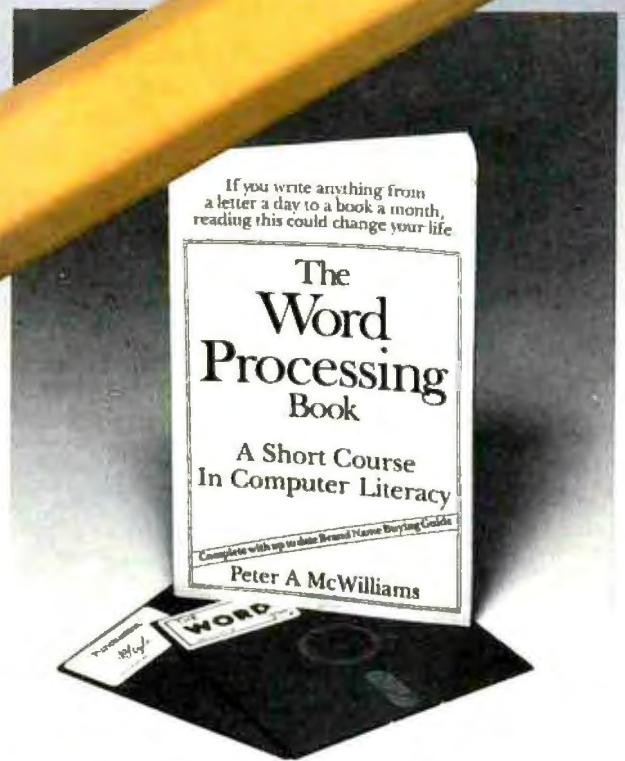
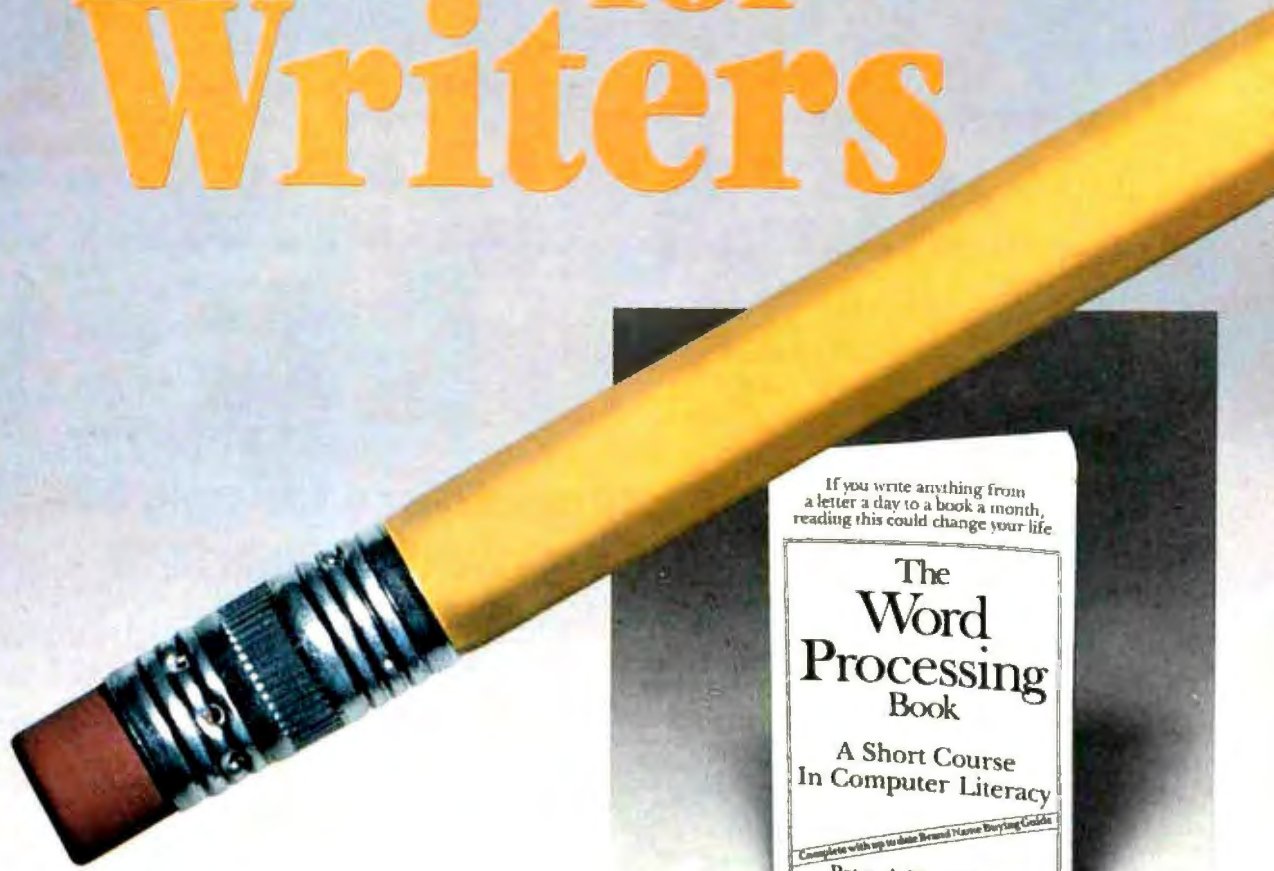

"Oasis Systems' software - unquestionably the best" . . . Peter McWilliams, author of the #1 best-selling book on word processing.

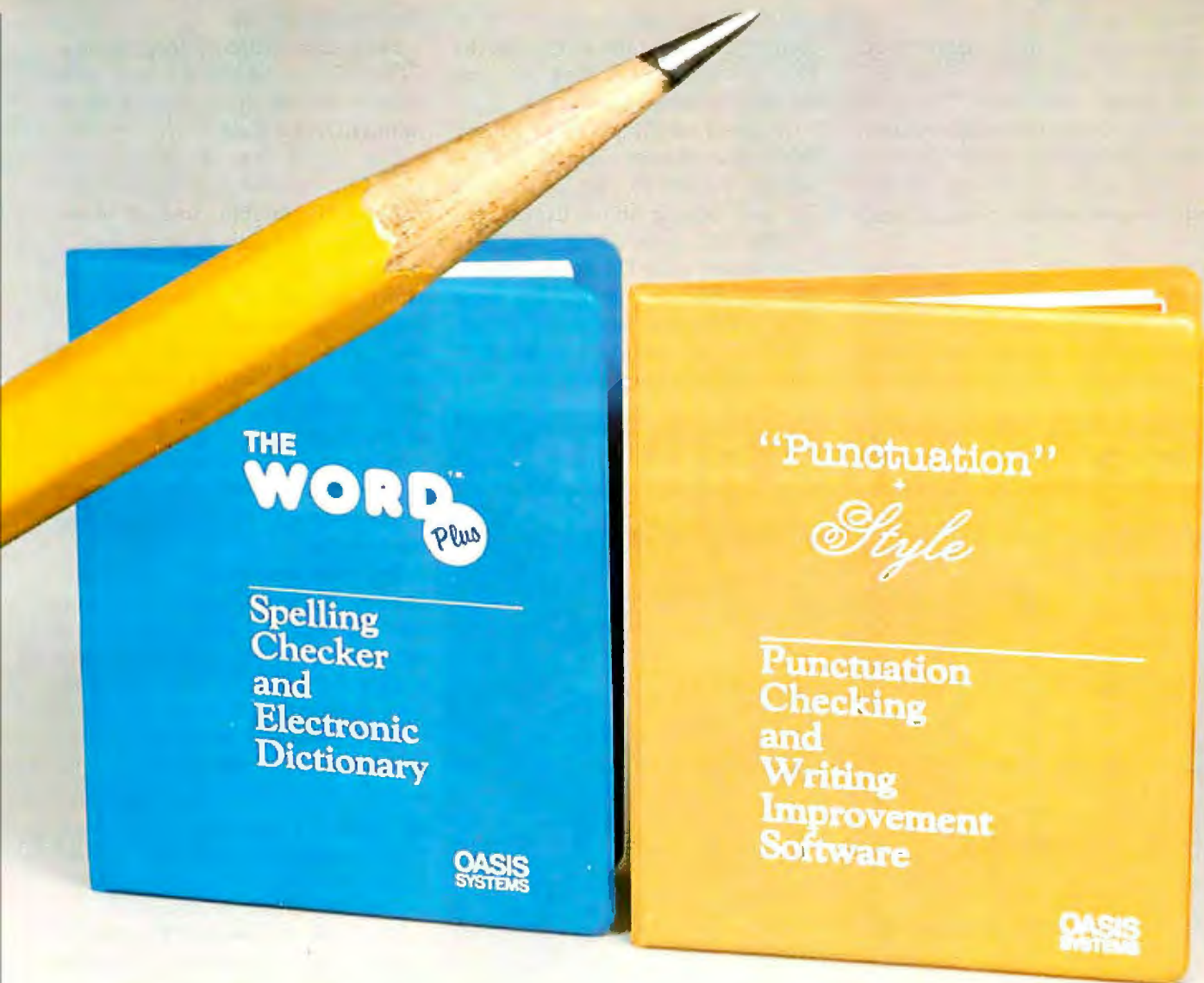

The WORD Plus is the standard by which other spelling checkers are measured. Here's why:

- *Real* 45,000 word dictionary.
- Shows errors "in-context."
- Interactive word look-up finds correct spelling for you and corrects at the push of a button.
- Hyphenates words automatically.
- Solves crosswords, puzzles, and anagrams.
- Works with almost any CP/M®, CP/M-86® or MS/DOS (1.0, 1.1 and 2.0) compatible word processing program (WordStar, Magic Wand (PeachText), Spellbinder, Perfect Writer, Select, Final Word, Volkswriter, . . . and more!).

Punctuation & Style takes the worry out of writing by automatically catching dozens of different punctuation errors, both common and obscure. In addition, P&S catches unpaired format commands (underline, boldface, etc.), doubled words, and more.

P&S gives you a "critique" of your writing, suggesting alternatives for commonly misused or over-worked phrases. It also shows where active voice can replace passive voice to add clarity and precision.

Punctuation & Style is the perfect companion to The WORD Plus. It works easily with most CP/M word processors. (Available also for CP/M-86 and MS/DOS.)

Call or write for
complete information:

619-222-1153

**OASIS
SYSTEMS**

2765 Reynard Way
San Diego, CA 92103

Circle 271 on inquiry card.

Dealers contact:

SOFTWARE DISTRIBUTORS

1-800-252-4024 (in California)

1-800-421-0814 (outside California)

Text continued from page 54:
behind Number Two.

Concurrent CP/M is a genuine advance over both CP/M+ and PC-DOS. When users try it, they don't want to go back to the older systems. Digital got its concurrent system in operation well before anyone else, and I've seen nothing that can touch it.

One suspects that IBM recognizes just how valuable Concurrent is; certainly, there are many signs of impending IBM support for Concurrent. However, Concurrent 3.1 isn't

out of testing yet. It takes a lot of memory, pushing the limits that the PCjr can support. There's still time for IBM to make some sales. It's a pure guess on my part, but I think IBM will announce support of Concurrent, but not for a while, and that DR isn't talking about Concurrent CP/M's PC compatibility because IBM doesn't want DR to do that yet. DR isn't about to give IBM any more trouble. If it cooperates with Big Blue, it will be the standard again. If it doesn't, it will have problems.

Eagle's Spirit XL

I saw a lot of IBM PC look-alikes at COMDEX. None of them were as attractive as our Spirit, which we've named Denny Colt.

The Spirit has a 10-megabyte plated-media hard disk. Since it folds up into a portable, use of plated media on the disk is important: it makes the disk a lot more resistant to shock. At Spirit demonstrations, the Eagle people will pick up the front of the Eagle, raise it about 6 inches off the table, and drop it while the machine is running. Nothing happens to the disk.

We haven't had the nerve to do that to ours, but we did carry it to Las Vegas and back, with nary a glitch to the hard disk.

The Eagle people have worked very hard to make the Spirit PC compatible. All the PC software—quite a lot—they worked with runs as it comes out of the box. Next month I'll have a more detailed report on that.

There are minor differences. For example, Rogue, the game of the month, runs fine on the Spirit, but some of the graphics symbols it displays are slightly different. One little gizmo blinks on the Spirit but not on the PC, which is absurd.

The Spirit comes with PC-DOS 2.0, so that you can get some real value out of that hard disk. You may remember we had the Eagle 1600 with hard disk running under DOS 1.1, and since 1.1 has no user numbers or tree structure, it made it very hard to find anything on a 10-megabyte disk.

Hope at Last!

DOS 2.0 is also available for the Eagle 1600, and indeed you can be sure it runs on it, because the company used an Eagle 1600 as the development machine to get 2.0 running for the Spirit. Eagle has some brand-new ROMs and new operating-system software for the 1600; the machine improves constantly. The Spirit documents are incomparably better than the 1600's documents were; and since the 1600 was the development machine for the Spirit, it should be simple work to revise the Spirit documents to reflect the pecu-

GET UP THE RAMP WITH OUR EE/EEPROM PROGRAMMERS & UV ERASERS

- R**eliability
- A**ffordability
- M**aintainability
- P**rogram

NOW AVAILABLE: PAL PROGRAMMERS (call)

GANGPRO-8™ MULTIPROGRAMMER \$995.00

GANGPRO-8™ allows user to program up to 8 EE/EPROMS simultaneously using the latest state of the art programming algorithms. It can test and duplicate a wide variety of devices from 16K to 256K. There are no personality modules to buy. 8 digit alphanumeric display prompts user with messages. This unit is extremely easy to operate and is ideally suited for a production environment.

QUV-T8™ series UV EPROM ERASERS

QUV-T8/2T (\$97.50) is an industrial quality eraser designed in a steel enclosure with a 5" wide tray UV indicator lens, antistatic pad, 60 minute rugged timer and safety interlock switch are standard. Capacity is 24 EPROMS. 15-20 minutes erase time for 16 EPROMS.

QUV-T8 / Z (\$124.95) Similar to QUV-T8/2T (with 40% faster Erase Time)

QUV-T8/2N (\$68.95) Same as the QUV-T8/2T version without the timer and safety interlock switch.

QUV-T8/1 (\$49.95) Economy model in a molded two part plastic case. Erases 16 EPROMS in 15 minutes.

*MCS-48 is a registered trademark of Intel Co.

PROMPRO-7™ SERIAL RS-232 STAND-ALONE \$489.00

MCS-48™ FAMILY PROGRAMMING WITH PROMPRO-7™ PROMPRO-7™ is an intelligent self-contained unit, ideally suited for engineering development, or for field service & production. It can program and verify a wide variety of 8K to 128K EPROMS. This unit has a 32K (4K BYTES) internal RAM Buffer that could be accessed by the user through a computer or terminal. This unit can also program the micro chips such as the 8478, 8749, 8751, 8741, 8742, 8755. The price includes all modules up to 32K EPROMS & The 8748 & 8749H Micros Upload/download is done by either Motorola or Intel Hex format.

PROMPRO-8™ SERIAL RS-232 STAND-ALONE \$689.00

This extremely versatile programmer has as much as 128K (16Kx8) of internal RAM dedicated to the EE/EPROMS. This RAM buffer can be accessed either through a computer terminal, or by user target system (EPROM emulation). PROMPRO-8 8 digit alphanumeric display prompts user with the system messages. A keypad option is available for standalone editing. An impressive range of devices are programmed (as standard feature).

SEE US AT COMDEX
SPRING ATLANTA

ORDER TOLL FREE 1-800-EEL-PROM (331-7766)

AVAILABLE SOFTWARE DRIVERS

- | | | | |
|--------------------|-----------------|-----------------|---------|
| 1. IBM PC | 2. APPLE II | 3. MDS-ISIS | 4. CPM |
| 5. TEKTRONICS 8002 | 6. COMMODORE 64 | 7. TRS-80 COLOR | 8. FLEX |

LOGICAL DEVICES, INC.

DEPT 6, 1321-E N.W. 65th PLACE, FORT LAUDERDALE, FLORIDA 33309
INFO. TEL. (305) 974-0967
DISTRIBUTORS WELCOME FOR QUALIFICATIONS



BHART-NEVADA (800) 845-5555

NATIONWIDE LEASING

To get our FREE monthly bargain flyer with specially priced items and advertised specials, circle reader response card or drop us a note (sorry absolutely no telephone request!)

SHARP PC-5000

Revolutionary Portable Computer 12 lb. Internal re-chargeable batteries. — no power cord! 80 char x 8 line liq. crystal display! 16-bit 8088 MS-DOS 192K ROM + 128K RAM 128K bubble 'Disk' runs most pc software graphics, optional built-in printer & modem. **SPECIAL \$1,895**
LIST \$1995



Limited Time Offer IBM-PC

\$2449
SAME DAY SHIPPING

256K.
2 thinline floppies (room for hard disk!)

keyboard \$125 IBM color card \$249
Plantronics Color Plus \$379
shipped factory cartons 90-day warranty

IBM — XT in stock!!! \$ CALL



NEC PC-8800 SYSTEM

64K 2 Floppies 5" BASIC, CP/M WordStar MultiPlan 16-bit card. 128K MS-DOS . . . \$499
LIST . . . \$1995 **\$1,799**



SPECIAL BMC Color Computer/Printer

Built-in printer hires color graphics screen dump to printer 2 floppies CP/M BAS-IC WordStar SpellStar MailMerge. CalcStar

~~\$1,895~~ **\$1,795**



SPECIAL! COLUMBIA 1600

\$3000 FREE Software
Nationwide Service by Bell & Howell.

MP/M-86 Multi-user operating system \$595

Columbia VP Portable LIST \$2995... **SCALL**
NOW YOU CAN LEASE A COLUMBIA 1600 I FOR ONLY \$83/MO



NEC PC-8201

List \$799
\$609

Immediate hit! Weighs only 3.8 lbs! 40 char x 8 line display; 32K ROM + 16K RAM Interlaces printers, bar-code reader, cassette & floppies



LASER 3000 ONLY \$659

APPLE compatibility. Fully legal. BASIC in ROM, hi-res. /color (560 x 192) 4 channel sound, parallel interface 40/80 column, 8 function keys, cassette input opt. Floppy run APPLE software!

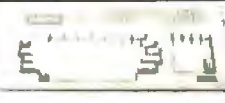

16-BIT POWER For Your KAYPRO \$499 FREE SHIPPING!

(or Osborne Zorba Xerox 820) with 8088 CoProcessor Board. Use MS-DOS to read/wr IBM-PC diskettes and execute PC Software! PLUS 256K RAMDISK speeds CP/M up to 10 times! 90-day warranty! IMMEDIATE AVAILABILITY! SPECIAL INTRODUCTORY OFFER 256K CoProcessor Board



FOR APPLE II

DISK CONTROLLER	59	EPROM WRITER CARD	79
2-80 CARD	65	POWER SUPPLY 5 amp	69
80 COLUMN CARD	79	COOLING FAN & surge protector	59
80 COL CARD w/softswitch & reverse	79		
16K RAM CARD	65		
PRINTER CARD w/cable	69		

Highest quality. ceramic chips throughout!
90 Day Unconditional Warranty!

For complete information on any of the products featured above, send a self-addressed stamped envelope (2 letters = 1 oz. postage)

NASHUA FLOPPY DISKETTES

First quality individual envelopes original factory boxes of 10 5 1/4" diskettes have reinforced hubs LIFE TIME WARRANTY! Minimum Order 3 boxes

5 1/4" s.s. d.	1.49
5 1/4" s.s. d.d.	1.84
5 1/4" d.s. d.d.	2.15
8" s.d. s.d.	1.84
8" d.s. d.d.	2.69

SIGNALMAN XII MODEM. 300-1200 BAUD. Auto-dial. Auto-answer.

List \$399 **ONLY \$299**

(All features of other smart modems) PLUS: features you won't find in the competition: Dial-tone detect. Busy detect!

ROMAR-II Apple-compatible, ideal second computer 469

NEW: BROTHER Electronic Typewriters for Office and Home!

COMPUTERS

TAVA fully IBM compatible 2 drives.	1699
CORONA-PC LIST 2995	2299
CORONA-PC portable	\$ CALL
EAGLE PC-XL Hard disk	3395
EAGLE SPIRIT-XL	3995
EAGLE 1620	3995
EAGLE 1630	4995
ZENITH Z-100. FREE Lotus 1-2-3 Hard disk optional.	2239

SOFTWARE COMPARE OUR PRICES

★ WORDSTAR PROPAG (W/S, SpellStar, MailMerge, StarIndex)	479	★
★ FRIDAY	189	★
★ BOTTOM LINE STRATEGIST	288	★
★ PFS-FILE	99	★
★ CONDOR III w/ReportWriter	SCALL	★
★ IUS G/L, A/R, A/P (per module)	369	★

PRINTERS

Mannesman-Talley MT-160L	559
MT-160L NEW	779
GEMINI-10X List \$499	279
Gemini Delta 10, 160 CPS	\$ CALL
Epson FX-80	549
Epson RX-80	\$ CALL
Okidata 92	439
NEC 8023	339
NEC 8025	\$ CALL

MODEMS

HAYES 1200	384
HAYES 1200B w SmartCom II	439
HAYES MicroModem IIe	239
US ROBOTICS Password	349

SOFTWARE COMPARE OUR PRICES (continued)

YOUR PRICE	UTILITIES	
300	Disk Doctor (Supersoft)	100
228	Fancy Font (SoftCraft)	180
125	Smart Key I	90
85	Smart Key II	90
500	Super Sort (MicroPro)	250
330	Supervyz (Epic)	90
286		
286	LANGUAGES	
90	Basic Compiler	395
264	Basic Interpreter 80	350
105	Cobol Compiler (MicroSoft)	750
	Fortran 80 Compiler	500
	Level II Cobol (D/R)	1600
	Pascal MT/MT-85	500
	PL/I (D/R)	500
	RM/Cobol full devel sys	750
		540
	RECREATIONAL	
	Zork	49 95
	Deadline, Starcross.	
	Planetfall, Witness.	
	Suspended	59
	[KAYPRO, OSBORNE, DU, MORROW, etc., add \$20]	
	DATA COMMUNICATIONS	
	Crosstalk (MicroSoft)	195
	Move-It (Woolf)	125
	Smartcom II (Hayes)	119
	APPLICATIONS SOFTWARE (Cyma, MBA, Star, Peachtree Artificial Intelligence, etc.)	\$ CALL

TERMINALS MONITORS

HAZELTINE Espn III	539	DYNAX 12 Amber	135
HAZELTINE Espn III	719	TAXAN RGB	315
QUME QVT-102	529	TAXAN 460 hi-res	499
QUME QVT-108	729	ZENITH RGB	524
WYSE 50	\$ CALL	PRINCETON PGS	495
TELEVIDEO 914	\$ CALL	NEC 1216	419

MODEMS (continued)

TOLL FREE LINE BUSY? Hard as we try, the heavy demand sometimes results in all our toll-free lines being engaged. To place an order call (702) 451-1361; we will take your order promptly and Credit you double the cost of your call!!!

SOFTWARE COMPARE OUR PRICES (continued)

YOUR PRICE	TRAINING	
300	AT-I-All	75
228		54
125	SPREADSHEET/FINANCIAL PLANNING	
85	MultiPlan (Microsoft)	275
500	ProfitPlan (Chang Labs)	195
330	SuperCalc II (Sorcim)	295
286	VisiCalc (VisiCorp)	250
286	SuperCalc III	SCALL
90	DATA BASE MANAGEMENT	
264	1-2-3 (Lotus)	499
105	dBase-II (AshTon-Tate)	700
	GRAPH (Fox & Geller)	295
	DU/IL (Fox & Geller)	99
	InfoStar (MicroPro)	495
	Notebook (Dig Mktg)	150
	PFS FILE (Soft Pub)	140
	PFS GRAPH (Soft Pub)	125
	PFS REPORT (Soft Pub)	125
	Q-PRO-4 (Quick n' Easy)	395
	Quickcode (Fox & Geller)	295

TELEX ORDERS: Hardware under \$1,000 and all Software. Please Telex re larger hardware items only if you are eligible for U.S. Export License! All export orders add 10% TELEX 472-0127 Att: EMD

TAKE THE CATALOG

CHALLENGE

- For Savings
- For Selection
- For Service

Other companies waste time and overhead producing expensive catalogs. Computers and More doesn't. Putting the latest products and best prices in our customers' hands, not catalogs, is our goal. We challenge any catalog company to match our pricing, selection and service.

Take the catalog challenge and save! • New Product or Price.

COMPUTERS

Desk Top	Portable
IBM P/C 2-320K 2195	Columbia YP 2349
IBM XT ON SALE!	Corona 1-320K 1989
Columbia 1600-1 2289	Panasonic Sr. Partner 1995
Columbia 1600-4 3494	Kaypro II CALL
Corona 2-320K 2389	Kaypro 4 1669
Eagle 1620 3995	Teletek 1289
Eagle PC XL 3395	Televideo TPC-2 1759
NEC All Models	Eagle Spirit XL 3495
Epson 0X-10 ON SALE!	The Computer by Sharp NEW!
Dec Rainbow 100 CAEL	NEC 8201A 639
Leading Edge P/C 2199	Compaq I drive CALL
Televideo 803 or 1605 H. CALL	Apple Compatible CALL
Franklin OMS CALL	Epson HX-20 CALL
Apple Computers CALL	Zorba 9 in. 1778

PRINTERS

Letter Quality	Dot Matrix
NEC 3550 (IBM) 1695	C. Itoh 8510 339
Canon Ink Jet 534	C. Itoh 1550 845
Juki 6100 489	Epson FX-80 CALL
Silver-Reed 550 599	Epson RX-80 CALL
Silver-Reed 770 CALL	OKI 82A 319
Transar 130 699	OKI 83A 589
Transar 140 1089	OKI 80 319
NEC 2010 859	OKI 92A 449
NEC 2015 859	OKI 93 739
NEC 2050 (IBM) CALL	Rieman 80 Col 349
F-10 Starwriter 1099	Gemini Delta 10 549
F-10 Printmaster 1349	Gemini Delta 10 or 15 CALL
Powertype by Star CALL	Gemini 10K 259
HR-15 ON SALE!	Toshiba P-11350 SALE
Dialo 630 CALL	NEC 8025 699
Daisywriter 48K 1089	IDS Prism 132 1165
DTC 380-2 1049	Mann-Tally 160L 619
Brother HR-25 769	Mann-Tally 180L 849
	Transar 315 CALL

ACCESSORIES

IBM	Apple
Supervision by CCS 679	Rana 8088 CPU CALL
Paradise Multi display 419	Dual Interface (Par & Ser) 159
Graphics Card by Hercules 367	80 Col/64K for file 118
STB Video Board 349	PKASO Card 127
Baby Blue by Microlog 459	Par. Interface 59
AST Sx Pak 289	Koala Touch Tablet 84
AST PC Net 1279	Wildcat Computer ON SALE!
Smartdm 1200 B(w/soft) 429	Premium Slt Cd II 349
Password Modem 339	Sup R Mod 49
Tandon TM 100-2 219	Disk Drive 199
CDC Disk Drive DS/DD 227	Drive Controller 59
Disk Controller by Maynard 157	Disk Emulator 294K 519
Hall High 320K 199	Ultraterm 289
Quaddisk 6 meg. Fixed 1589	MicroModem II 269
Keytronic New 5150 198	Smart Modem 1200 529
Kraft Joystick 34	D-Cat 149
USI Color/Graphics 1/2 & Para 359	Kraft Joystick 29
Concus+Pegasus+Corona 469	Davong 5 Meg 1359
Quadram Quadlink 469	Microbuffer II 209
Quadram New Quad Bnd 64K 299	80 Col cd 99
Teclar 1st Mate 259	BUF Wizard+ CALL
Teclar Graphics Master 559	Wigard 16K 53
Orchid Technologies CALL	Keytronic KB200 217

MONITORS

Color	Monochrome
Princeton HX 12 \$469	Taan Amber 129
Princeton SR-12 649	Taan Green 129
New Max-12 199	Zemith 122 A 125
NEC JC 1203 (IBM) 519	Zemith 123 G 97
Taan RGB-3 449	Amdek 310 A 169
Quadram Quadchrome 497	Amdek 300 159
Zemith - New CALL	New Max 12 199

SOFTWARE

IBM	Apple
R Base CALL	Tax Preparer 147
Missionare 39	Home Accountant 49
Wizardry 39	Great Plains CALL
Wordsair 239	Peachtree CALL
Easywriter II 259	PFS: Solutions CALL
Volkswriter 189	PFS: File 84
Vesicalc (256K) 179	PFS: Report 84
Multiplan 189	PFS: Graph 84
Lotus 1-2-3 319	dBase II 397
PFS File 89	Visible 169
PFS: Report 83	Versalform 264
PRS Solutions CALL	T I M CALL
dBase II 384	List Handler 59
CDEX Any Program 49	Wordstar 249
Tax Preparer 169	Bank Street Writer 47
OZ by F & G CALL	Screenwriter II CALL
Infolast 259	Magic Window 97
Personal Pearl 199	Magic Call 99
Home Acct Plus 112	Zork I 27
Peachtree CALL	Zaxxon 27
Property Management 329	Chopitter 26
Digital Research SALE!	Frogger 24
DESO NEW!	Wizardry 39
Select 299	Jumpman 29

Printer Accessories

Sooper Spooler 283	Microbuffer (in line 32 K P) 219
Micro Spooler (P to P 16K) 189	Microbuffer (in line 32 K S) 219
Micro Spooler (P to P 64K) 229	64 K for MB 139
Soundtrap 89	Optimizer by ACT CALL

Terminals	Plotters
Wyse 300 1019	Mann-Tally Poy 3 689
Wyse 200 1019	Sweet-P 528
Adds - AR Models CALL	Six-Shooter CALL
T.V. 910+ 569	Amdek X-Y 569
T.V. 925 C 749	Amdek 6 Pen Auto 995
T.V. 950 C 969	Quadjet by Quadram CALL
Dume 102 A 549	C. Itoh CX (Par) 549
Dume 102 G 548	C. Itoh CS (Ser) 549
Dume 106 A 679	Strobe & Pen 799
Zemith CALL	Houston Ins HI-Pad 759

liarities of the older machine. I expect Eagle to send some new 1600 documents Real Soon Now, and I'll certainly be glad to get them.

One defense Eagle has about the 1600 documentation: it advertised the machine as good for word processing and spreadsheets, both of which it does faster and neater than the IBM PC can do them; and those tasks are well documented. It was only the system features that it didn't tell us about.

The argument is valid, I suppose, but it doesn't impress me much. The 1600 is too good a machine to have been put out with those lousy documents. Indeed, with proper documentation, the Eagle might be the best PC-compatible software-development system on the market. Fortunately, Eagle is, at last, getting out manuals worthy of the machines they describe.

Rogue

Rogue is an Adventure-like computer game for the IBM PC. Unlike the original Adventure, the Rogue dungeons are randomly generated each time you play, so that no two games are ever alike.

It isn't played entirely like Adventure, either. For one thing, you move your character around on the screen with the cursor arrows (or with a mouse; the Logimouse works fine). Commands are menu driven; there are an awful lot of them, things like "q" for quaff a magic potion you may have found, "w" for wield a particular weapon, and such. You can read scrolls, put on rings of power, change weapons, change armor, and like that.

I hate to confess it, but the game is a real time trap. I found myself thinking "just one more try" far too often. The object of the game is to retrieve the Amulet of Yendor, but I haven't the faintest clue how one does that; I was killed every time, although once I got down to the fifteenth level and accumulated nearly 4000 gold pieces before a combination of trolls and quaggas got me.

Rogue is advertised as the most popular game running on Unix, and Alex says that's probably true. The

← Circle 92 on inquiry card.

COMPUTERS



and More

The Catalog Challengers!

3620 - 30th Street
SAN DIEGO, CA 92104

TO ORDER
(619) 291-1442

Artificial Intelligence Design Systems company has put it onto the IBM PC (requires 128K bytes of memory and a disk drive). It's also added a command called "S," for "Supervisor"; when you press that, the dungeon map vanishes, and a dummy of the PC-DOS operating system appears on the screen. This is intended to fool your boss into thinking you're working.

At one time, there were simultaneous Rogue games going on every PC-compatible machine in this house. It certainly was the game of the month. Recommended, but I won't be responsible if you get fired for wasting too much time with it.

Copy Protection

Longtime readers of this column will know that I don't much approve of copy-protection schemes. They're all right for games, but businesses *must* have backups of important software.

The argument for copy protection usually goes: "We have a \$700 product here that can be copied in half a

minute for five bucks. Of course we protect it." Which is all very well—until you ask the justification for charging \$700 for something that can be produced for less than five bucks. The answer to that one often goes, "We put all that effort into software development, and when we sell it, people make illegal copies. We have to get a lot from each sale."

Fortunately, competition plus the expanding market base will drive the price of software down to something reasonable, say a small multiple of the price of a good book. Meanwhile, copy protection continues.

It's an evil practice. It's also futile. Let me give an example.

A number of programs designed to defeat copy protection are available. About the best I know of for the IBM PC is System Backup from Norell Data Systems. System Backup was written by a good friend who thoroughly understands the IBM PC; the program is revised as new and more clever protection schemes are devised.

I had a new version of System

Backup at hand when Rogue arrived. I don't usually run master disks, so we routinely tried to make a copy. Wouldn't work. Rogue is copy protected. It's a game, so that's not so important; but I wanted to test the new System Backup, and Rogue was right there, so why not?

System Backup made a copy, but it reported a CRC error. We tested the copy on the IBM PC, and it seemed to work properly. Then we tried it on the Eagle Spirit. It worked there, but it wouldn't save the game. That was interesting enough that we tried the original disk on the Spirit; it worked fine, and indeed the copy can *read* a saved game; it just won't save one. On the IBM, though, the copy saves and reads and runs fine.

I gathered all the data and called System Backup's author. We agreed this was an interesting case. What, for instance, was the CRC error?

The problem, you see, is that copy protection involves putting carefully engineered errors into the system. A copy-protected disk has garbaged sectors, improperly formatted sectors, and such like; it also has a means for reprogramming the disk controller to allow it to find all, and only, the good sectors on the disk.

It's therefore impossible to tell whether an error on a copy-protected disk is a *real* error, caused by stray magnetic fields or spilled coffee, or a *contrived* error that's part of the copy-protection scheme.

Another problem: have the copy protectors thought everything through? They've reprogrammed your disk controller; do they undo that when you exit the program? If not, you'll have to reset the machine, or perhaps even turn it off and back on again.

Every time a publisher devises a new copy-protection scheme, a systems engineer will find a way to defeat it. That's inevitable: if the software can be made to load into the machine, then it can be copied. There is a class of systems engineer who *enjoys* defeating copy-protection schemes, much as Yardley enjoyed breaking codes. Any copy-protection scheme, no matter how elaborate, will be defeated—unless, in the effort

Text continued on page 66



List Wize

ORGANIZED... SYSTEMIZED... LIST WIZE! The "wise" choice in List Information Management.

LIST WIZE lets you keep the information you need most in a highly organized system for handy and efficient access to names, addresses, telephone numbers, appointments, clients, business prospects... and more!

Large data capacity. User-designed files and fields. Flexible file-availability. Complete sorting

DEC Rainbow 100 is a registered trademark of Digital Equipment Corp. IBM PC is a registered trademark of International Business Machines.

control. Alphabetical and numerical listings. Fast and easy printing. Full printer options. File merge capability. Versatile filing uses.

The one program "custom-designed" for YOUR business needs!

For more detailed information and the retailer nearest you write or give us a call:

ORBYTE
SOFTWARE

P.O. Box 948, Waterbury, CT 06720
203-621-9361

Get "Wize" to DEC Rainbow 100 & IBM PC

The best ... for peanuts!

Get the most computing power from your IBM/PC Jr. with these exciting Amdek monitors.

The COLOR-I accepts composite video input for complete compatibility ... and it has a built-in speaker and quality resolution. It's the most popular color monitor in the entire world!

The VIDEO-300 with amber or green screen provides 80 column text or graphics display capability ... and its nylon mesh, non-glare screen eliminates distracting reflections.

Both monitors are backed with the best warranty in the business (2 years!) ... and you won't have to shell out a lot of money to own one.

2201 Lively Blvd. • Elk Grove Village, IL 60007
(312) 364-1180 TLX. 25-4786

AMDEK

REGIONAL OFFICES: Southern Calif. (714) 662-3949 • Texas (817) 498-2334
Northern Calif. (408) 370-9370 • Denver (303) 794-1497



Epson. For those who need it, simplicity.

One computer.
Two points of view.

The Epson QX-10 personal computer. To many, the Epson represents the ultimate in simplicity.

Just press a single key for the function you require: word processing, scheduling, business graphics, address book or file management. One key-stroke produces your program. There are no rigamaroles to remember. No disks to change.

The result: you start to work immediately. And you start being productive, immediately. With step-by-step prompts. In plain English, not computerese.

Simplicity itself.
Or is it?

The plain fact is that the ease of operation the Epson offers today is accomplished with a degree of technological sophistication most other computers can only promise for tomorrow—specifically, fully integrated software, operating in an interactive environment.

The few other computers offering such "simplicity" cost \$5,000 to \$15,000 more. And most other computers can't offer it at any price. Which makes one wonder exactly what they do offer, in terms of either simplicity, or performance.

HOW MUCH CAN YOU DO ON THE EPSON? HOW MUCH ARE YOU READY TO DO?

The Epson's ease of operation may spoil you, but it certainly won't limit you.

Case in point: every Epson comes complete with an integrated software system—*Valdocs*®—to effortlessly provide the basic functions for which most people buy computers. The Epson also comes with *CP/M*®-80 2.2, so you can choose from the hundreds of programs in the *CP/M* library. And only Epson offers an exciting new collection of seven best-selling programs now specially enhanced to give you every powerful feature, plus Epson one-button simplicity. Included are

dBase II®, *Friday!*™, *Microplan*®, *Graphplan*™, *WordStar*®, *SpellStar*®, and *MailMerge*®. And the Epson also allows you to add *MS*™-DOS compatibility, so you have access to best-sellers like *Lotus*® 1-2-3.®

Best of all, you will run the software of your choice on the computer of choice. The high-performance Epson. With 256K RAM. 128K dedicated video memory. The breathtakingly sensible *HASCI*™ keyboard. Dual 380K double density disk drives.

Graphics capabilities unequalled in its price range. A high resolution monitor, 640 by 400 pixels, for clarity few computers in any price range can offer. Plus, an RS-232C interface, a parallel printer interface, and internal space for up to five peripheral cards so you can expand your Epson as your needs require.

One further point: all these features, and quite a few more, are included in the Epson's \$2,995 price. Some com-

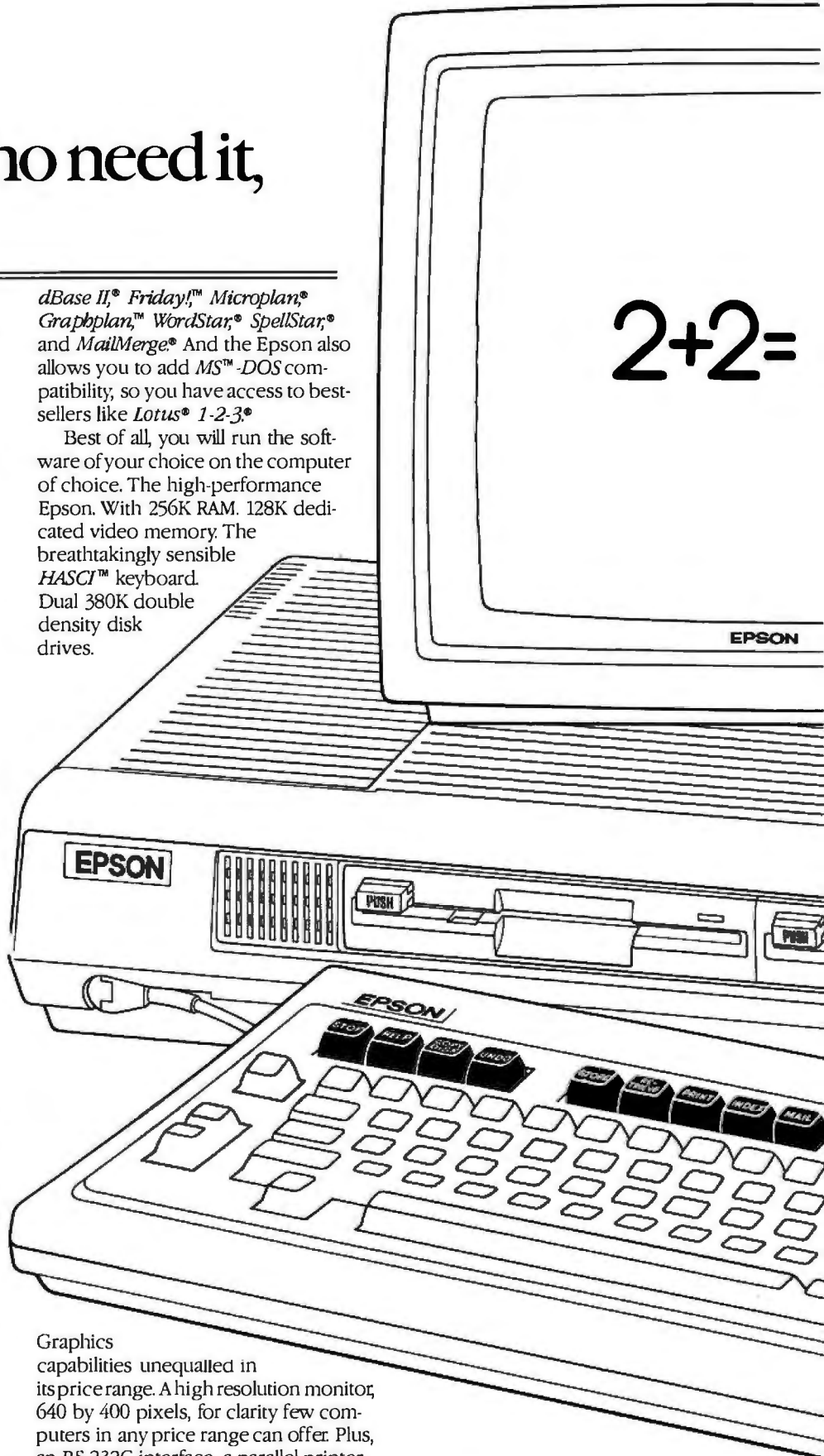

Epson. For those who can handle it, performance.

puter companies ask you to pay extra for features like these. Most can not offer them at any price.

That, too, is performance. The kind of performance that can make choosing a personal computer very simple, indeed.

**EPSON QUALITY. OR, WHY
WONDER WHAT TERRIBLE
KLUDGES LURK IN WHICH
SLEEK BOXES.**

If you know computers, you know Epson. Epson printers set the industry standard for quality, reliability and value. Rest assured, the same can be said for the Epson personal computer.

The satisfying silence of the slim, Epson-designed disk-drives is one way for you to judge or, for an inside-out perspective, here is an excerpt from a review by Jim Hanson in the April, 1983 issue of *Microcomputing**

"The Epson QX-10 is soundly designed and executed. I looked hard and found no evidence of kludging or shorting out anything in the name of economy. All the connectors have gold on them and are of quality manufacture. The printed circuit boards are heavy, with soldermarks on both sides of double-sided boards. The circuit boards are completely silk-screened with component labels, and the layout is as professional and clean as you will find anywhere."

Isn't this what you expect? After all, it's an Epson.

**A WORD TO THE WISE:
GET YOUR HANDS ON
THE EPSON.**

Is the Epson a simple, easy-to-use computer for beginners? Or a sophisticated high-performance computer for the experienced? The answer is "yes." And when you think about it, aren't those two computers the one you need now.

For technical specifications, and the complete, 3-part *Microcomputing* review, along with the name of your nearby Epson dealer, call toll-free (800) 421-5426. California residents, call (213) 539-9140.

*Excerpt reprinted by permission of *Microcomputing Magazine*. All rights reserved. CP/M, dBase II, Microplan, WordStar, SpellStar, MailMerge, Lotus, 1-2-3 are registered trademarks of Digital Research, Ashton-Tate, Chang Labs, MicroPro (3), and Lotus Development (2). Valdocs, Graphplan, MS, and HASCI are trademarks of Rising Star, Chang Labs, Microsoft, and Rising Star, respectively.

EPSON

STATE-OF-THE-ART...SIMPLICITY.



Richard Innes

Text continued from page 62:

to make the software uncopyable, it's made so fragile that it's no longer reliable. That, alas, is all too common.

Programs like System Backup are revised each time a new copy-protection scheme comes out. They're one remedy for the copy-protection disease. Another is simply to stay away from publishers who are more concerned with their own protection than their customers' requirements.

Does That Suit You?

As I'm writing this, the radio tells

me that the space shuttle *Columbia* will miss her morning landing, due to a glitch in one of the IBM general-purpose computers aboard the spacecraft.

I wonder what that will do to IBM's stock?

In any event, it reminded me of another computer aboard the ship.

I was, many and many a year ago, involved in full pressure suit design and testing, and indeed my Experimental Stress Laboratory at the Boeing Company did some of the crucial

simulations that led to choosing the Goodyear suit for the Apollo mission.

Suit design is tricky. One doesn't want too much pressure in them, lest they blow up like balloons and become so stiff that the astronaut can't move. On the other hand, there has to be *enough* pressure to keep the astronaut alive. Finally, you can't have your astronaut go too quickly from 14.7 psi (pounds per square inch), which is standard atmospheric pressure, down to, say, 3.8 psi, which is about the minimum needed to keep the occupant healthy in a pure oxygen environment. Sudden pressure drops can cause lots of problems, including what divers know as "the bends," which is caused by nitrogen bubbles forming in the bloodstream.

That's another story. In any event, NASA sponsored several suit design efforts, but eventually the shuttle suits were produced by the Hamilton Standard Company. Before it was over, it had put a couple of hundred million dollars into building fewer than 50 suits. The cost overrun for pressure suits was a significant fraction of the total overrun for the shuttle program.

One of the features of the shuttle suit is a computer, which is supposed to monitor how well the suit is working. NASA is quite proud of it. In fact, though, it's very primitive compared to anything you're likely to be using; it has about 1K bytes of program ROM. Even a Timex has more memory and processing ability. Moreover, it isn't as if the environment is particularly harsh: after all, the astronaut has to endure it as well as the computer. Alas, as far as I can tell, NASA didn't bother with modular design, so that upgrading that computer is going to be hideously expensive.

NASA doesn't have the money, so the upgrade probably won't happen.

The micro revolution was originally driven by the need for on-board computers in missile and space-booster guidance systems; it's a darned shame that the suits are designed in a way that makes it tough to retrofit newer technology. With

Professional Graphics at Practical Prices

Add our Imaginator™ graphics upgrade card to your H/Z-19 terminal or H/Z-89 computer. It's quick and easy. You gain intelligent, highly efficient graphic display capabilities proven in countless Heath/Zenith terminal and computer updates.

Check Imaginator's special features:

- High resolution 504 x 247
- Accessible through any high level language FORTRAN, Pascal, BASIC, etc.
- Onboard microcomputer eliminates processing load on host
- Source code available
- Rich graphics instruction set
- Mix text and graphics
- Tektronix® 4010-4014 compatibility option with GIN mode
- Comprehensive documentation includes numerous examples
- Fully buffered for asynchronous operation
- All original H/Z features remain intact

Now check Imaginator's low cost:

- Assembled complete \$445.
- Kits from \$215.

Also ask us about our Imaginator 2 upgrade for H/Z-29 terminals.

Call or write us today for additional information.

**CLEVELAND
CODONICS, INC.**

18001 Englewood • Cleveland, OH 44130 (216) 243-1198

Your H-19 Can Do This...

IMAGINATOR



Tektronix® Registered trademark of Tektronix, Inc.
Codonics and Imaginator are trademarks of Cleveland Codonics, Inc.

How to make your Apple run 3½ times faster.



Just plug in the Accelerator II[™] and watch your Apple[®] II, II Plus or IIe take off.

Imagine running VisiCalc[®], DB Master[®], Applesoft, Apple Fortran or Pascal without long delays. With the Titan Accelerator IIe, your Apple II, II Plus or IIe runs these programs a true 3½ times faster. The Accelerator IIe also runs your Franklin, Basis and other Apple II compatibles 3½ times faster. This faster computer response time means less waiting for you and an increase in your productivity.

This Titan exclusive has its own fast 6502 processor, 64K of high-speed memory, and built-in fast language card. It is transparent to your software and is hardware compatible with most standard peripherals. And you can turn it off from the keyboard to run your Apple at regular speed.

Find out how to run faster and increase your productivity without breathing hard. For information on the Accelerator IIe and other Titan products, see your computer dealer or contact:

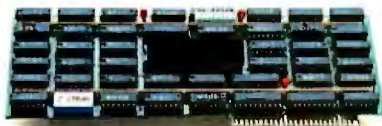

 **Titan**
TECHNOLOGIES, INC.

310 West Ann Street, Ann Arbor, MI 48104
Telephone (313) 662-8542

Apple is a registered trademark of Apple Computer Inc.
VisiCalc is a registered trademark of VisiCorp.

DB Master is a registered trademark of Stoneware, Inc.
Accelerator IIe is a trademark of Titan Technologies, Inc.

Sales and Marketing by The MARKETING RESOURCE GROUP, Fountain Valley, CA.

proper design, the astronaut could have an in-suit computer that would not only monitor suit performance but also be a general-purpose computer and alarm clock. Instead, kids have better machines stored unused in their bedroom closet. Sigh.

Thanks for the Memory . . .

One feature of the IBM PC is memory checking. For each block of eight memory chips in the PC, there's a ninth chip whose purpose is to store the parity bits for the other eight. A parity bit is the logical sum of the 1s and 0s in a memory cell; if there are an odd number of 1s in a "word" of memory, parity is odd; if an even number, it's even.

The IBM, along with many other PC-compatible machines like the Zenith Z-100, looks at the parity bit when it accesses a memory cell; if the parity isn't what it should have been, the PC reports a memory error.

It also dumps the program. Moreover, if there's any memory error on power-up, the IBM PC renders itself useless. This may not be optimum if

the flaky memory chip is in an area your program won't be using.

The Eagle 1600 doesn't do parity checking, as I found out when I stuffed my Eagle full of memory chips. The Eagle has on-board sockets for 512K bytes of memory. This is eight blocks of 64K bytes, and thus I'd expected it to take eight additional memory chips for parity checking; but it didn't. The Eagle's chips are arranged in blocks of *eight*, not nine.

I was curious enough about this to ask the Eagle people, who referred me to Gary Kappenman, Eagle's vice-president for R&D.

Eagle had considered doing parity checking, he said; but it decided against it. First, parity checking introduces new chances for error. There are 12 percent more chips in the system, and each of those is as likely to fail as is any other memory chip; if it does, it will have the same effect as a real memory error.

Second, there's no software to take advantage of parity checking. The parity check doesn't *restore* your data;

it merely notes that there's been some kind of error and dumps your program. Now if the error was in a program instruction, that's probably what you wanted; but if it were merely in a data area, so that the effect would be to spell the word "data" as "datq," I think I'd rather not be told if being informed dumps my text and renders my computer useless.

If there were software to tell you about memory errors and ask you what to do, Eagle might consider designing parity checks into its machine; until then, Eagle thinks it causes more problems than it's worth.

Incidentally, the Eagle 1600 has yet another undocumented feature, a memory test on power-up; one merely holds down the "t" key while the system comes up. Thus you can, if you like, test memory each time as the IBM does; but it's your choice. This will hopefully be documented in Eagle's revised systems manuals for the 1600. I wish the IBM PC offered a way of doing without the memory checks. It takes Lucy (for Lucy Van Pelt because she's a fussybudget) one

FREE SHIPPING

Order line: 800-354-7330

SANYO SUPER SYSTEMS

SYSTEM #1 \$1195

SANYO MBC-550

- SANYO GREEN MONITOR
- GEMINI 10 X • SOFTWARE •

Sanyo MBC-550 Single Drive Computer • Sanyo CRT-36 Monitor • Star Micronics Gemini 10X • Cabling • WordStar • CalcStar • Easywriter • MS-DOS • Sanyo Basic •

SYSTEM #2 \$1525

SANYO MBC-555

- SANYO GREEN MONITOR
- GEMINI 10X • SOFTWARE •

Sanyo MBC-555 Dual Drive Computer • Sanyo CRT-36 Monitor • Star Micronics Gemini 10X • Cabling • WordStar • CalcStar • SpellStar • InfoStar • Mail Merge • Easywriter • MS-DOS • Sanyo Basic •

PRINTERS

C. ITOH

Prowriter 8510 **\$335**

A10-20 **\$503**

F-10 Serial or Parallel **\$940**

8510SP (Prowriter SP) **\$565**

COMREX

CR-2 **SAVE**

DIABLO

620 RO **\$860**

630 RO **\$1715**

S-11 **\$560**

P-11 **\$560**

EPSON

RX-80 **SAVE**

RX-80 F/T **SAVE**

FX-80 **SAVE**

FX-100 **SAVE**

LQ1500 **SAVE**

JUKI

6100 **\$480**

NEC

2010 **\$780**

2050 **\$905**

8023A **\$385**

3510 **\$1370**

3550 **\$1715**

OKIDATA

82A **SAVE**

83A **SAVE**

84P **SAVE**

84S **SAVE**

92 **SAVE**

93 **SAVE**

QUME

11/40 w/Interface **\$1370**

11/55 w/Interface **\$1570**

Letter Pro 20P **\$609**

Letter Pro 20S **\$609**

SILVER REED

EXP 500 **\$390**

EXP 550P **\$580**

EXP 550S **\$610**

EXP400 **\$329**

STAR MICRONICS

Gemini 10X & 15X **SAVE**

Delta 10 **SAVE**

TALLY

MT 160L w/tractors **SAVE**

MT 180L w/tractors **SAVE**

Spirit 80 **SAVE**

TOSHIBA

1350 Serial or Parallel **\$1450**

TRANSTAR

130P **\$675**

120P **\$450**

T315 **\$450**

TERMINALS

TELEVIDEO

910 + **\$555**

914 **\$540**

924 **\$670**

925 **\$705**

950 **\$905**

970 **\$980**

ZENITH

Z-29 **\$649**

COMPUTERS

SANYO

MBC-550 System **\$1195**

MBC-555 System **\$1525**

TELEVIDEO

803 **\$1799**

ZENITH

Z-100 Low Profile **\$2635**

Z-100 All-In-One **\$2815**

MODEMS

HAYES

1200 **\$490**

1200B **\$435**

300 **\$205**

DISK DRIVES

RANA

Elite 1 **\$215**

Elite 2 **\$345**

Elite 3 **\$410**

1000 w/DOS (for Atari) **\$305**

MONITORS

BMC

12" Green **\$89**

13" Color **\$210**

TAXAN

12" Amber **\$125**

ZENITH

12" Green **\$95**

12" Amber **\$120**

Prices reflect 3% to 5% cash discount. Product shipped in factory cartons with manufacturer's warranty. Free shipping is on UPS ground only. Prices & availability subject to change without notice. Send cashier's check or money order...all other checks will delay shipping two weeks.

SILICON SPECIALTIES
2034 WEST SOUTHERN
MESA, ARIZONA 85202
602-969-0909

68 BYTE March 1984

How to make your IBM run 2½ to 4 times faster.



Just plug in the Accelerator PC™ and watch your IBM* PC or XT take off.

Yes, Titan's done it again. The innovators who speeded up the Apple® now bring similar performance advantages to IBM users. Imagine running Lotus® 1-2-3™, VisiCalc®, or Multiplan™ without long delays. With the Titan Accelerator PC, your IBM PC or XT can run all your software faster. Data bases, word processors, spreadsheets, graphics, and much more will speed up by a factor of 2½ to 4 (average around 3).

The Accelerator PC has a 10 MHz 8086 processor and 128K of high-speed RAM, expandable to 640K with the memory upgrade piggyback option. It's compatible with your present hardware and software, and designed to be ready for future enhancements.

Get your work done in a third of the usual time.

See your computer dealer today or contact: Titan Technologies, Inc., P.O. Box 8050, Ann Arbor, MI 48107; Telephone (313) 662-8542.

 **Titan**
TECHNOLOGIES, INC.
FORMERLY SATURN SYSTEMS OF MICHIGAN

Sales and Marketing by The MARKETING RESOURCE GROUP, Fountain Valley, CA.

IBM is a registered trademark of International Business Machines Corporation. Lotus and 1-2-3 are trademarks of Lotus Development Corporation. Multiplan is a trademark of Microsoft Corporation. Apple is a registered trademark of Apple Computer Inc. VisiCalc is a registered trademark of VisiCorp, Inc. Accelerator PC is a trademark of Titan Technologies, Inc.



NEW FOR '84!		Quick C	Uni-Tools	C Tutor	Z	Phact DB
C Grafz		COMMODORE C64 Cross Compilers				
AZTEC C86 8086/8088 new release 2.0		<input type="checkbox"/> Full C	<input type="checkbox"/> Fast object code	<input type="checkbox"/> Basic graphics		
PC DOS/MS DOS	\$249	<input type="checkbox"/> 8087 support	<input type="checkbox"/> Large memory model	<input type="checkbox"/> Fast I/O		
CP/M-86	\$249	<input type="checkbox"/> Overlays	<input type="checkbox"/> Relocating assembler	<input type="checkbox"/> Linker & library		
BOTH	\$399	<input type="checkbox"/> Library has I/O, screen I/O, graphics, PC DOS-CP/M/86				
		<input type="checkbox"/> Interfaces with DRI and MICROSOFT assemblers				
		<input type="checkbox"/> Compatible with AZTEC C for CP/M, APPLE, C64, & TRS-80				
/PRO extension	\$249	/PRO includes optimizer, C86 debugger, and other tools				
C Grafz	call	Comprehensive color graphics for use with C or stand alone				
Uni-Tools I	\$ 99	Tools I has make, diff, grep, & other UNIX inspired tools				
PHACT database	call	Phact is a comprehensive set of C database functions				
Z	\$125	Z is a full screen C editor much like the UNIX Vi editor				
Quick C	\$125	Quick C compiles C source into interpreted code in a flash				
AZTEC C II	8080/Z80	Full C compiler, assembler, linker, library utility, . . . PRO extensions include library source, utilities, ROM libraries, M-80 and RMAC interface				
CP/M-80	\$199					
/PRO extensions	\$150					
AZTEC C80	TRS-80	The Model 4 system is full AZTEC C II and runs under TRSDOS or DOSPLUS, the Model III system does not support float. /PRO has float for III, Z, library source, . . .				
MODEL III or 4	\$199					
/PRO III and 4	\$349					
AZTEC C65	6502	A complete C development system for the APPLE II and IIE with assembler, linker, editor, SHELL, library, and library source. Binary files execute under DOS or SHELL				
APPLE DOS	\$199					
ProDOS	call					
C CROSS DEVELOPMENT SYSTEMS		Cross systems generate modules on a HOST system that are downloaded for execution on a target system. HOSTS include PDP-11 UNIX, 8086 UNIX ports, PC DOS, CP/M-86, CP/M, and APPLE. TARGETS include CP/M, APPLE, COMMODORE C64, & TRS-80.				
C cross compiler, assembler, & linker						
PDP-11 \$2000 other \$750						
AZTEC C TUTOR		PRENTICE-HALL and MANX SOFTWARE SYSTEMS joined forces to produce an unmatched "hands on" C tutorial. Includes lessons, text, fast compiling student C compiler, and . . .				
APPLE or IBM	\$99					
other systems	call					
Quick C		Quick C compiles C code into extremely compact interpreted code at blinding speed. Run time system has UNIX functions.				
APPLE, CP/M, T-80	\$125					

MANX [®] Order phone 800-221-0440 (outside NJ)
201-780-4004 (NJ and outside USA)

Telex (ITT): 4995812
Information: 201-530-7997
Tech support: 201-780-8374

Shipping: per compiler
next day USA \$20, 2 days
USA \$5, 2 days worldwide \$75,
Canada \$10, airmail outside
USA & Canada \$20

SOFTWARE SYSTEMS
P.O. Box 55
Shrewsbury, N.J. 07701

whack of a long time to warm up and be useful now that we have big memory boards in her.

Don't Use Function 37

Time out for some technical advice to hackers and programmers. Others can listen in, but no apologies if you don't understand.

If you're writing software for CP/M 2.2x systems and you use BDOS (basic disk operating system) calls, do *not* use Function 37, "Reset Drive." Tony has tried to use that "feature" in several programs, and each time he's got into terrible trouble. There's an unrecoverable and undocumented bug in CP/M 2.2; the result is that attempts to use Function 37 to tell the program you have changed disks can cause ungodly horrible results.

As an example, you can write garbage into the directory of a hard disk, losing all the programs on it. (This is one reason that we do not and will not have a hard disk on our experimental system: we test a lot of software from many sources, and some of that software tries to use Function 37. This would be a disaster for us.)

You can also with Function 37 dump the user's program and scramble up his disk directories. There is no foolproof way to get around the bugs in Function 37. Don't use it. Instead, use Function 13, "Reset System." That's more work, and takes longer, because 13 recomputes the bit maps for all the logical disk devices, then sets logical disk "A" as the logged-on disk; if you started with something else logged on, you'll have to write code to take care of that.

Tony says this may not be fixed in CP/M-86, so be very careful about using it there, too.

Incidentally, there's no mention of this bug in Andy Johnson-Laird's otherwise excellent *The Programmer's CP/M Handbook* (Osborne/McGraw-Hill), which I recommend to anyone trying to write programs involving the CP/M operating system.

Public Benefactors

I like the new IBM and Digital Research manuals. They're of a good size to fit onto bookshelves, and the box they come in is a good place-

UNIX is a trademark of Bell Labs. CP/M, CP/M-80 and CP/M-86 are trademarks of DRI. PC DOS is a trademark of IBM. MS DOS is a trademark of MICROSOFT. N.J. residents add 6% sales tax.

The fascinating tale behind the world's first* laser video disc player with a semiconductor laser by Hitachi.



The advantages of the laser video disc are considerable. The same size as an LP record, the laser video disc can hold more information in less space than any other medium today. And that information is rapidly and selectively accessible. Combined with computer programmability, the varieties of interaction between the viewer and the machine are a distinguishing feature of the disc and player.

Until now, large bulky gas lasers were used to track the discs. The advantages of semiconductor lasers were not unknown but they had serious problems.

When the temperature fluctuated, so did the output power of the semiconductor laser. This resulted in noise and seriously interfered with quality laser disc reproduction. Hitachi's research team began a series of experiments to see if the problems could be solved.

Changes in the heat sink temperature resulted in considerable noise [see fig. 2 (a)]. Mirror feedback increased the noise (mode hopping noise) and is represented by the clearly visible peaks.

Fig. 2 RIN (Relative Intensity Noise) at various temperatures

(a) Without HF superimposition

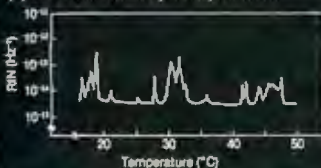

(b) With HF superimposition

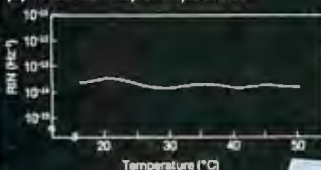

The line in fig. 2 (b), however, is remarkably straight. It represents measurements under the same conditions as for fig. 2 (a) but with a superimposed HF (high frequency) sinusoidal current. These experiments clearly show that noise can be virtually totally suppressed by HF current superimposition.

Fig. 1 Measuring Laser Noise

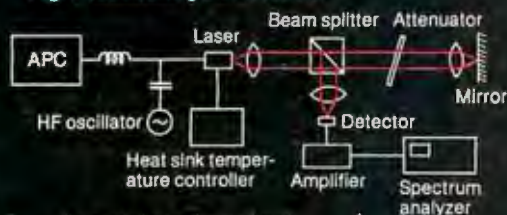

A special configuration to measure laser noise was used. [see fig. 1] An automatic power control circuit maintained a constant power output. A beam splitter deflected part of the output which was focused on a detector. Another part was focused on a mirror and an attenuator controlled the feedback light intensity.

This important breakthrough made a laser video disc player a practical possibility. And Hitachi's technological expertise has made such a high-quality, ultra-compact and light player a reality. Other special features include an exceptionally durable motor, unusual design for rapid servicing, ultra-high speed random access and accurate tracking with a Hitachi-developed 3-directional actuator.

Hitachi's 3-Directional Actuator

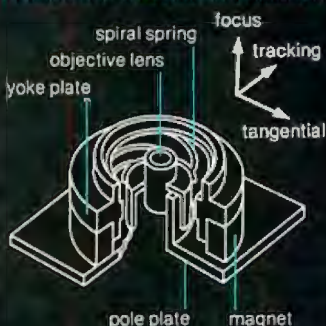

Application of this unique and powerful medium is barely beginning. For education, for training, for "living catalogues," and for computer visual programming of amazing speed and flexibility, the laser video disc is unique. And Hitachi's laser video disc player is, perhaps, the first to realize the medium's full potential with greater ease and convenience than has ever been possible before.

* Specifically, the world's first mass-produced laser video disc player with a semiconductor laser. (Production began September, 1982.)



A World Leader in Technology

For details: Hitachi Sales Corp. of America

Eastern Regional office: Mr. D. Fukuda, 1290 Wall Street West, Lyndhurst, N.J. 07071 Phone: (201) 935-8980
Western Regional office: Mr. J. Ohl, 401 West Artesia Blvd., Compton, Calif. 90220 Phone: (213) 537-8383

**Semiconductor
Laser Video Disc Player**

FOR PROFESSIONAL USE

Circle 175 on inquiry card.

Your computer's telephone. Hayes™



What will counteract NDC
74-0054-60?



Gary: The pedigrees for next week's
auction are as follows...



Sold 1000 shares at 33 for net profit
of 6000. Richard.

Wouldn't it be great if you could use your IBM®PC to tap into vast resource libraries across the country? To transfer files to your partner, upstate? Or from your broker, down the street?

It's possible. All you need is a modem, to connect your computer to others. Down the hall. Or thousands of miles away.



Hayes Smartmodem. Think of it as your computer's telephone. Hayes Smartmodem 300™ and the faster Smartmodem 1200™ allow you to communicate over ordinary phone lines.

But any modem will send and receive data. Smartmodems also

dial, answer and disconnect calls. Automatically. And without going through the telephone receiver, making them far superior to acoustic coupler modems.

Choose your speed; choose your price. The lower-priced Smartmodem 300 is ideal for local data swaps and communicates at 300 bps. For longer distance and larger volumes, Smartmodem 1200 operates at baud rates of 300 or 1200, with a built-in selector that automatically detects transmission speeds.

Both work with rotary dials, Touch-Tone® and key-set systems; connect to most time-sharing systems; and feature an audio speaker.

Smartmodem 1200B™ is also available as a plug-in board. Developed specifically for the PC, it comes packaged with Hayes' own communications software, Smartcom II™

Smartcom II. We spent a lot of time developing it, so you can spend less time using it. Smartcom II prompts you in the

simple steps required to create, send, receive, display, list, name and re-name files. It even receives data completely unattended—especially helpful when you're sending work from home to the office, or vice versa.

If you need it, there's always "help." This feature explains prompts, messages, etc. to make communicating extra easy.

With Smartcom II, it is. Case in point: Before you communicate with another system, you need to "set up" your computer to match the way the remote system transmits data. With Smartcom II, you do this only once. After that, parameters for 25 different remote systems are stored in a directory on Smartcom II.

Calling or answering a system listed in the directory requires just a few quick keystrokes.

You can store lengthy log-on sequences the same way. Press one key, and Smartcom II automatically connects you to a utility or information service.



Hayes®

Smartmodem 300, 1200 and 1200B are FCC approved in the U.S. and DOC approved in Canada. All require an IBM PC with minimum 96K bytes of memory; IBM DOS 1.10 or 1.00; one disk drive; and 80-column display.

Smartmodem 1200B. (Includes telephone cable. No serial card or separate power source is needed.)



Smartcom II communications software.

NOTE: Smartmodem 1200B may also be installed in the IBM Personal Computer XT or the Expansion Unit.

In those units, another board installed in the slot to the immediate right of the Smartmodem 1200B may not clear the modem; also, the brackets may not fit properly. If this occurs, the slot to the right of the modem should be left empty.

And, in addition to the IBM PC, Smartcom II is also available for the DEC Rainbow™ 100, Xerox 820-II™ and Kaypro II™ personal computers.

Backed by the experience and reputation of Hayes. A solid leader in the microcomputer industry, Hayes provides excellent documentation for all products. A limited two-year warranty on all hardware. And full support from us to your dealer.

So see him today. Break out of isolation. Get a telephone for your personal computer. From Hayes.

Hayes Microcomputer Products, Inc., 5923 Peachtree Industrial Blvd., Norcross, GA 30092. 404/441-1617.

Smartmodem 300, Smartmodem 1200, Smartmodem 1200B and Smartcom II are trademarks of Hayes Microcomputer Products, Inc. IBM is a registered trademark of International Business Machines, Corp. Touch-Tone is a registered service mark of American Telephone and Telegraph. Rainbow is a trademark of Digital Equipment Corporation. Xerox 820-II is a trademark of Xerox Corporation. Kaypro II is a registered trademark of Non-Linear Systems, Inc.

©1983 Hayes Microcomputer Products, Inc.

Circle 174 on inquiry card.

holder to remind you where to put the manual away when you're finished using it.

However, there's a problem. Much of Digital Research's software comes with a READ.ME file of errata and additions. It's formatted so that any simpleminded line printer can make a hard copy, and the line sizes are right for inserting the corrections into your document.

Alas, how do you do that? You need tractor-feed fanfold paper, and I've not found anyone who'll sell it in the proper size. The result is a long bout with scissors or paper cutter if you use formfeed, or standing there pretending to be a sheet-feeding machine if you use prepunched notebook paper (assuming you can find the proper size and hole arrangement of that).

Worry no more. William Simmonds of Anthropomorphic Systems has sent me a box of paper of proper size. He says, "I couldn't find anyone who made or carried this paper, so I simply had a large supply made up."

He'll sell you a carton of 1000 for \$20 or a case of 2500 for \$40. May be a stiff price, but he's not getting rich on it—and Lord knows it's a needed service.

Thanks, Mr. Simmonds.

One Way Out

Another public benefactor is Microsolutions and its Uniform program.

Regular readers will know that we've had our problems with disk formats. A few have written to ask why we don't use some kind of transfer program. The answer to that is simple: it's blooming slow. As a last resort we can always use serial transfer, but consider the situation where the machines are in locations separated by several miles, and both are in constant use. Much better to transfer disks. As my late mad friend MacLean used to say, "Parallel is faster than serial."

Microsolutions has a program called Uniform that reads many and many a 5¼-inch format; about 40 so far. There's also a MS-DOS/PC-DOS < -- > CP/M bidirectional file-copy program. The company's added the Epson QX-10 and is coming up with

a version to run on the Otrona Attache.

If there's ever the slightest chance that you'll have to deal with several different kinds of micros, get Uniform; the savings in nervous energy and frustration are more than worth the price of the program. Microsolutions keeps revising it, too.

Strongly recommended.

Graphics and the Z-29

My son Alex is very interested in graphics, and I ought to have him work on this, but he's delivering the new WRITE manual to Compupro in Hayward. There's a story that goes with that, but this isn't the place to tell it.

One graphics product that impressed him mightily was the Imaginator 2 from Cleveland Codonics. This is an add-on board for the Heath/Zenith Z-29 terminals; with that add-on, the Z-29 becomes one heck of a bargain graphics terminal. The monochrome add-on board is about \$900, with 672 by 500 pixels (dots) shown on the screen.

The upgraded Z-29 keeps all its old features, and the graphics mode can be commanded either from the terminal keyboard or from the computer. The graphics mode emulates the popular Tektronix 4010/4014 terminal, with a number of additional commands that can be called in from BASIC or Pascal, etc. The Imaginator 2 uses the NEC 7220 graphics chip for some of its functions, but for speed reasons it doesn't rely on it alone.

There's also a color Imaginator that requires more modification to the Z-29.

The Imaginator 2 plus a Z-29 terminal costs less than many dedicated graphics terminals, and still it acts as a superb text terminal. Alex thinks Zenith ought to offer the terminal with this board in it and won't be surprised if it decides to do this.

Alex asked a lot of questions at COMDEX and is satisfied. (That's an understatement; he was impressed.) Still, fair warning: I haven't actually installed one of these boards in our Z-29, so I don't know how easy that is to do, or how good the documents are. Maybe in the future.

“Thoughtware, How Good A Manager Am I?”



Thoughtware is new, easy-to-use software that will help you see and understand how to become a better manager. It's a unique series of personal, computer-based management diagnostic and training programs.

© Thoughtware is a registered trademark of the Institute for Management Improvement.

How good a manager are you? Thoughtware Module 1.1 “Assessing Personal Management Skills” will tell you. This program is a three-part, comprehensive self-assessment of your personal attitudes, behavior and understanding as they relate to your effectiveness as a manager.

Unit 1 assesses your leadership style by examining the degree to which you are task- or people-oriented and how you use communication, teamwork, participation, initiative and support to get results. It also assesses your understanding of what motivates employees, promotes teamwork, and the extent to which you provide feedback.

Unit 2 assesses your attitudes about setting goals and objectives, clarifying roles and responsibilities, and delegating. It also assesses the methods you use to improve employee performance and the ways you conduct performance evaluations.

Unit 3 assesses your personal effectiveness by looking at how you manage time and stress, how you conduct meetings and solve problems. The programs conclude with specific recommendations designed to address the weaknesses identified.

To introduce you to Thoughtware, we'll send you “Assessing Personal Management Skills” (which normally sells for \$350), for only \$150. (See adjacent column for details.) Offer expires April 30, 1984.

Thoughtware programs run on the following: IBM® PC, PC XT, PC jr and compatible PC's. Apple® II Plus and IIe.



Thoughtware®

Expanding The Universe Of Learning.

Thoughtware Is The Future.

It's a new way to learn, a logical and innovative approach to management training. It will revolutionize management training now, and in the future.

Thoughtware utilizes the latest research in management development from leaders in the field, and has been tested nationally. The benefits of Thoughtware's computer-based Learning Programs are enormous.

Educationally, Thoughtware is self-paced and continuously interactive. Real situations are simulated. The animation and color graphics motivate and hold your interest. Skills are practiced until they're mastered. There's consistent quality of instruction and increased training effectiveness. And even the capability to test yourself.

Economically, Thoughtware reduces training time and cuts the cost of training dramatically. And the more it is used by you and those who work with you, the more cost-effective it becomes. It also eliminates travel, living and instructor costs.

Operationally, training fits the schedule of the student, not the trainer, thus facilitating increased usage. There's minimal job interruption as training can take place on or off site, during or after regular hours.

Other Thoughtware Programs include:

- 1.2 *Evaluating Organizational Effectiveness*
- 2.1 *Leading Effectively*
- 2.2 *Motivating To Achieve Results*
- 2.3 *Defining Goals And Objectives*

Become a better manager by visiting your local computer dealer or call us at our toll-free number, 1-800-THT-WARE, or write:

Thoughtware Inc.
Suite S, 2699 So. Bayshore Dr.
Coconut Grove, Florida 33133.

Zorro's Hidden Capabilities

Computer companies have a long tradition of hiding features of their new products. Zenith, for example; has yet to send me updates to its software to tell me how to format single-sided disks on Zorro the Z-100. It claims it will do that Real Soon Now. We'll see.

Zenith has also brought out CP/M-86 for the Z-100. It has been through beta testing and is out in the marketplace. We don't have our own copy yet, but Jim Ransom has had problems getting Logitech's Modula-2 compiler for CP/M-86 running with his Z-100. I don't know the details; perhaps when I get a copy of CP/M-86 here I can find out.

I find among my notes another: CP/M-85 cannot find a directory on the CP/M-86 disks that came from Logitech, but the IBM PC reads them fine under Concurrent CP/M-86. I suspect some format problems. More when I know more.

Meanwhile, there's a hidden feature to Zenith's CP/M-86: it can run CP/M-80 software without modification. Bringing up the Z-100 under CP/M-86 and then running normal CP/M-80 software with it gives you a much larger temporary program area (TPA: the "usable" memory for a program). At COMDEX Alex was unable to find any Zenith employees or dealers who knew about this feature. It ought to trumpet it, though, because it's an important selling point. Currently, DEC's Rainbow, the Compupro CP/M-8/16 systems, and the Fujitsu Micro 16 are the only machines I can think of that can do this.

With WRITE, for example, our text memory area is about 35K bytes under CP/M-85; but under CP/M-86 it's well over 40K bytes. WRITE works fine, and since Tony used some very complex BIOS (basic input/output system) calls in that program, it's a pretty good test.

Upgrading Zorro

Don't buy Zenith 8-inch drives. They're overpriced, and they don't work any better than anyone else's. Zenith's current software supports only two 5¼-inch and two 8-inch drives anyway, and it has no plans to

upgrade to more. For that matter, there isn't enough power in the Z-100 case to run four full-power 5¼-inch drives anyway.

We've been using our Compupro 8-inch drives disconnected from the experimental box as a way to transfer files from the Zenith to our Compupro systems. Alas, for reasons I haven't had time to analyze, the only completely reliable way to do that is to use old-fashioned single-sided single-density IBM 3740/1-format disks. Sometimes the Z-100 will read double-density and sometimes it won't, and sometimes the Compupro doesn't seem to understand the Zenith's double-density disks. One day I'll do a systematic investigation; until then, we use Old Reliable slow 241K SSSD.

HELP!

I love to get mail. As I've said before, it's as if I have my own intelligence network out there; it makes writing this column no end easier, and obviously I can't do the User to User column at all without reader letters.

However.

Please help simplify my life. For example: there's no point in sending me long press releases about promotions within your company. Most of those are accompanied by photographs of nervous people with strange smiles. Sometimes we use the photos: we tack them to the walls with captions like "Hi! I'm not wearing any underwear!" or "I know a secret! I'm nude from the waist down!," which is what those grins suggest they're thinking.

We also use them as targets for our Beeman Hurricane air pistol. (I can recommend air pistol shooting at pictures of computer company presidents as a means for computer columnists to relax.)

Second, before you write asking me how to make contact with some company whose products I have reviewed, *please* look at the *big box* that *always* accompanies the column. If you read the October BYTE and want to make contact with Larry Weed's Problem-Knowledge Coupler company, look in the box in the Oc-

Items Reviewed

Concept	\$3995	Imaginator 2	\$895
Corvus Systems 2029 O'Toole Ave. San Jose, CA 95131 (408) 946-7700		Cleveland Codonics 18001 Englewood Dr. Cleveland, OH 44130 (216) 243-1198	
Concurrent CP/M-86 Soft/Net	\$350 Not yet released	Rogue	Not available
Digital Research POB 579 Pacific Grove, CA 93950 (408) 649-3896		Artificial Intelligence Design Systems POB 3685 Santa Clara, CA 95055	
DR Manual-Sized Paper	1000 sheets \$20 2500 sheets \$40	System Backup	\$49.95
Anthropomorphic Systems Ltd. POB 819 Addison, IL 80101 (312) 629-5160		Norell Data Systems POB 70127 Los Angeles, CA 90010 (213) 257-2026	
Eagle Spirit XL	\$4795	Uniform	\$49.95
Eagle 1600 Series	1620 \$4495	Microsolutions 125 South Fourth St. DeKalb, IL 60115 (815) 756-3421	
Eagle Computer	1630 \$6995	Zenith Z-100 Computer	\$2899
983 University Ave. Los Gatos, CA 95030 (408) 395-5005	1640 \$8995	Zenith Data Systems 1000 Milwaukee Ave. Glenview, IL 60025 (312) 391-8865	

tober issue rather than writing me to ask for the address.

Third, please do not send me form letters. If you're a dealer for products I've reviewed favorably, God bless you; but I don't need flyers describing stuff I've already written about, and I particularly don't need solicitations to buy a Sage computer. I already have one, for Heaven's sake!

Finally, there's a letter from Jonathan Sachs of Sand River Software to the managing editor of BYTE.

Sachs says, "Several weeks ago I wrote to Jerry Pournelle asking how I could get a copy of a program he mentioned. To date he has not replied."

Mr. Sachs says he is upset because "I pay money to read Jerry's column because I think I can profit from the information in it. Now it appears that he's got a program that would make my business more efficient—but I can't get it, or even find out for sure what it is, because he doesn't answer mail.

"From my point of view, this is no different from the behavior of a software producer that refuses to support the product it sells. Jerry regular-

ly (and justifiably) rails against such practices. Does he realize he's guilty of them himself?"

Both the original letter inquiring about some of Tony Pietsch's experimental work and this letter to BYTE's managing editor were unaccompanied by a self-addressed stamped envelope.

I try to answer mail. I really do, and I apologize to all those whose letters I just can't get to; but darn it all, I don't like addressing envelopes and while I'm willing to pay postage if someone forgets, I don't like having it *demand*ed of me.

No, Mr. Sachs; I do not believe a columnist has the same obligations to provide individual support as does a software company, nor do I believe BYTE's managing editor has the obligation to drop what he's doing and answer your letter. I'm sorry you're going to cancel your subscription, but I guess I'm just going to have to live with the situation.

In other words: I'll try to answer letters. I can't guarantee an individual reply even if you send a self-addressed stamped envelope, although I'll do my best. I certainly am not ac-

cepting heavy guilt trips because one or another letter didn't get answered.

I do feel pretty bad when someone sends me a really neat program and I don't get to it quickly.

I'm Really Trying ...

As I write this, Dr. Allan Trimpi, who's *way* overqualified for the job, is off in the next room cataloging about seven cubic feet of software. We'll then assign the most promising stuff to assistants. Maybe we'll get caught up. It isn't likely, but we can try.

Micro land expands at a frantic pace. Trying to stay current can wear you to a frazzle. I love it. ■

Jerry Pournelle welcomes readers' comments and opinions. Send a self-addressed, stamped envelope to Jerry Pournelle, c/o BYTE Publications, POB 372, Hancock, VT 05448.

Jerry Pournelle is a former aerospace engineer and current science-fiction writer who loves to play with computers.

THE COLUMBIA IBM-PC COMPATIBLES. THEY REWARD TWO BUSINESS VIRTUES: FORESIGHT AND CUNNING.



Trust your instincts.

While others rushed out to buy an IBM®PC, you waited and watched. You knew prices would come down and software would get better.

Now we have a reward for your patience: the Columbia family of IBM-PC compatible computers. It's a choice of systems and software no one else can match.

The Columbia line includes the VP Portable which lets you work anywhere, any time. There's also the MPC, our desktop model, available in dual floppy disk or 10MB hard disk drive. Compatible with each other and the IBM-PC, as well.

Foresight led you to our IBM-PC compatibility.

We start you with more operating systems than IBM, even more than other IBM-PC compatibles (MS-DOS® and CP/M®86). Which means you have immediate access to all the latest business and financial software.

Free software that's a steal.

Thousands of dollars worth of free software come with every Columbia computer. Columbia Tutor gives you a fast, comfortable start. Perfect Software™ covers your word processing, spreadsheeting, and filing needs. Fast Graphs® turns facts and figures into graphs and charts. And asynchronous communications lets you share information with other computers.

For your sense of self, we give you Home Accountant Plus™, games, and two programming languages so you'll feel like an eleven year old genius.

Responsive service. Above and beyond.

175 local Bell & Howell service centers stand ready to maintain your Columbia computer at a moment's notice.

Prices start at \$2995. The phone call is free.

Now, while you're feeling shrewd, call toll free for the Columbia dealer nearest you. Then, see for yourself how the Columbia Compatibles can reward your business virtues.

800-638-7866

COLUMBIA

DATA PRODUCTS, INC.

Columbia Data Products, Inc.
9150 Rumsey Road, Columbia, MD 21045
(301) 992-3400, TWX 710-862-1891.

Trademarks: IBM—International Business Machines Corp.; MS-DOS—Microsoft, Inc.; CP/M 86—Digital Research, Inc.; Perfect Software—Perfect Software, Inc.; Fast Graphs—Innovative Software; Home Accountant Plus—Continental Software Company.
Software on screens not included.

Circle 70 on inquiry card.

BYTE March 1984 77

The new 384K Quadboard by Quadram is the most comprehensive board you can buy for the IBM PC or XT. Now with added hardware features and advanced software. But at a very low price.

NEW EXPANDED QUADBOARD
Quadboard now delivers 9 of the most needed PC functions/features. To let you get the most out of your Personal Computer. And help you work better and faster.

THE WORLD'S BEST SELLING MULTIFUNCTION BOARD IS NOW EVEN BETTER

All of these features are standard on the new Quadboard:

- **Parallel Port:** With the new Quadboard, you get a Parallel Port. Perfect for operating most printers and other parallel devices.
- **Serial Port:** There's

a Serial Port, too. Fully programmable, use it to connect to plotters, modems, and other serial devices.

- **Chronograph:** And Quadboard's Chronograph (Real-time clock/calendar) keeps your system's clock up-to-date.

- **Game Port:** The new Quadboard has an IBM compatible Game Port. Plug in a joystick or game paddles, and fire away.

- **I/O Bracket:** Quadboard now comes with a special I/O bracket. Use it to organize your expansion port connectors. Snaps right onto the back of the PC.

EXPANDABLE TO
384K

NEW

QUADBOARD®



• **Expandable to 384K:**

The new Quadboard is expandable in 64K increments for up to 384K additional RAM. With full parity checking standard. With the new Quadboard and a fully populated system board, you can take your PC's memory up to the 640K limit.

• **QuadRAM Drive:** Plus, with Quadboard you get advanced QuadMaster Software. Including the QuadRAM Drive program. Use it to set up multiple RAM Drives in Quadboard memory. Solid state drives that let you store and retrieve data quickly and easily. Or take advantage of QuadMaster disk caching. To access frequently

used data whenever you need it.

• **MasterSpool:** QuadMaster Software also includes MasterSpool. Use it to set up a software print buffer quickly and easily. This advanced spooler lets you pause at any time, back up or move forward in a file. Choose just the amount of buffer space you need and stop waiting on your printer.

• **Qswap:** Another feature of QuadMaster Software is Qswap. With Qswap change line printers 1 and 2 back and forth, with just a few keystrokes, as often as you like.

QUADBOARD STANDS OUT FROM THE PACK

Now more than ever Quadboard is the first and only board your IBM PC or XT may ever need. No other board even comes close. Because Quadboard is designed for performance. Engineered for dependability.

And built in the continuing tradition of Quadram Quality.



There are many imitators, but only one leader. So make sure you ask for Quadboard by Quadram, the leader in micro-computer enhancement products.

Compare. See why more Quadboards are bought than any other multifunction board...

Features/Functions	Quadboard	SixPakPlus
Memory Available	0-384K	0-384K
Parallel & Serial Port	Yes	Yes
Clock/Calendar	Yes	Yes
I/O Bracket	Standard	Optional
Game Port	Standard	Optional
Diagnostic Testing	Yes	Yes
Advanced Spooler	Yes	No
Simple Menu Setup	Yes	No
Disk Cache	Yes	No

SixPakPlus is a trademark of AST Research Inc.



4355 International Blvd./Norcross, Ga. 30093
(404) 923-6666/TWX 810-766-4915 (QUADRAM NCRS)

Circle 297 on inquiry card.

BY QUADRAM™

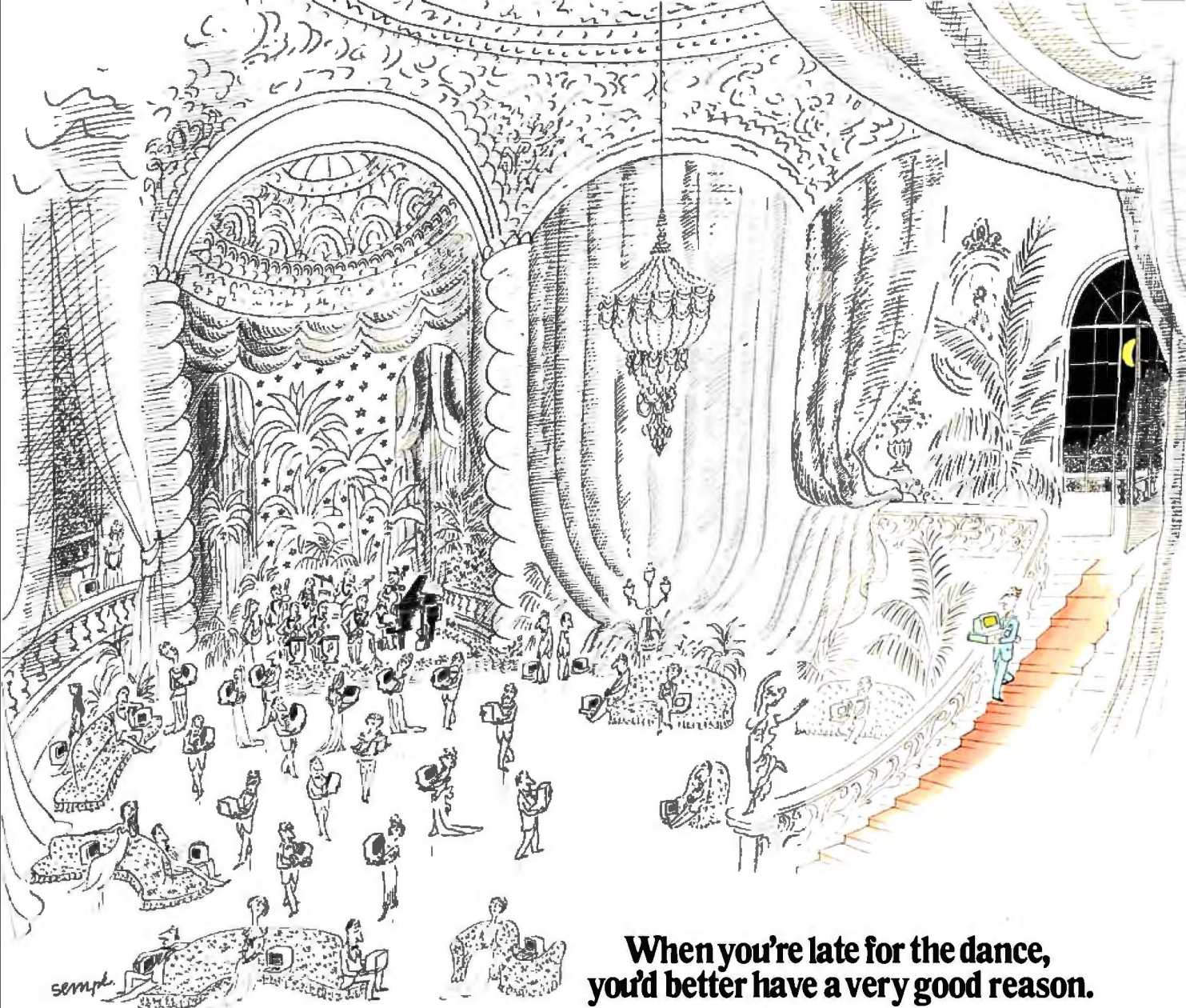

**When you're late for the dance,
you'd better have a very good reason.**

The party started about three years ago for the personal computer.

And there was dancing.

But there wasn't much talking. Because as more and more computer companies arrived, there were some very real compatibility problems.

Until one latecomer arrived. Sperry.

With a remarkably simple solution. The Sperry PC.

It was able to run all IBM compatible software.

It was able to run all this software with stunningly more

dramatic graphics and from a substantially more comfortable keyboard than IBM's.

And, with the flick of a special "turbo" switch, the Sperry PC could even run 50% faster than IBM.

Enough for one night? Not for the people from Sperry.

For the Sperry PC had the additional ability to plug into the real brains of an organization — the main computer. Whether that system was IBM or Sperry.

Or both. The Sperry PC. An admittedly attractive arrival.

But when you get there late, you'd better have something important to bring to the party.

To see how the Sperry PC can work for you and for your free copy of the Micro Software Catalogue, write Sperry Corporation, Computer Systems, Dept. 100, P.O. Box 500, Blue Bell, PA 19424. Or call 800-547-8362.

© SPERRY Corporation, 1983

SPERRY PERSONAL COMPUTER SPECIFICATIONS

OPERATING SYSTEM	AUXILIARY MEMORY
MS DOS Version 1.25 or 2.0 with G.W. BASIC	Up to two internal 5 1/4" diskettes
MICROPROCESSOR	10MB internal fixed disk when configured with single diskette
High-Speed 16-bit 8088	USER MEMORY
DISPLAY SCREENS	Standard 128K bytes, expandable to 640K
High Definition monochrome display.	DIAGNOSTICS
High resolution color display. IBM compatible graphics.	Power-on self test
COMMUNICATIONS	CLOCK
Built-in Asynchronous	Time-of-day with battery back-up
KEYBOARD	
84 keys, 6 ft. cord	

SPERRY



**The Sperry PC.
What the personal computer
should have been in the first place.**

A First Look at Dayflo

A free-form database gets you closer to your ideas

by Ezra Shapiro

Dayflo, a program announced at COMDEX in November and released during the first quarter of 1984, is representative of the new wave of "idea processing" software. Dubbed "a personal information-management system" by its creators, the program is a free-form, text-oriented database-management package, designed—at least initially—to run on the IBM PC XT.

The central principle behind the structure of Dayflo stems from the realization that note scrawling and the constant organization and reorganization of small scraps of paper into larger documents are a major part of what goes on in the world. A program that answers the demands of a typical office environment would have to be able to move quickly from one kind of note to another and allow for the impulsive entry or retrieval of information at the time of thought, without the traditional delays of program start-up and data entry.

Dayflo Software of Irvine, California, states that the average office personal computer is used only half an hour a day. Dayflo represents an attempt to create a flexible tool that can be used throughout the day. It allows variable-length text records to be tagged and recalled in much the same way that a standard database manager handles fixed-length records. However, Dayflo's form design is only as structured as the user wants it to be. The program seeks to accommodate itself to the ebb and flow of the workplace, hence its name and guiding philosophy. For a look at Dayflo in use, see the sequence of operations in photos 1 through 15.

The Metaphor

Dayflo is structured around the metaphor of the executive desktop—a fairly standard theme these days—but this version adds a number of perceptive twists. The program begins by assuming that you have an open file folder on your desk, one containing a collection of information that relates to your current project. Up to 19 other folders are piled off to one side, as if they had been gathered from a nearby filing cabinet. These folders may or may not pertain to the task at hand.

You're also equipped with a trash basket, a pair of scissors, a tray in

Dayflo adjusts to the ebb and flow of the workplace.

which to drop pieces of paper, and a scratch pad, all of which are constantly available. During the course of the day, you pull the scraps in your folder into presentable form, sometimes using items from the other folders on the desk, sometimes digging new material out of the filing cabinet. If you're interrupted, simply jot a note on your pad—even if you happen to be in the middle of a paragraph. When the opportunity presents itself, you can make a copy of the note and file it in the appropriate location. When a task is completed, you close the folder and move on to the next, or you refile it in the filing cabinet and begin gathering material for the next job. At the end of the day, you can leave your folders as they are or stuff them back into the cabinet.

With a few additional permutations, this is Dayflo.

An Evolutionary Step

Text management has always been a primary concern of software developers. From the earliest line editors to the sophisticated screen-oriented word-processing systems of today, programmers have struggled to accomplish two goals: to apply the power of the computer to the relatively straightforward tasks involved in word-by-word data entry; and to aid the writer by easing the creative process of transferring ideas to paper. While the first goal has largely been met, the second has proved more elusive.

For obvious reasons, the focus in the computer industry has been on tailoring features to the needs of the business world. The first true word processors were aimed at the secretarial arena—a major selling point was (and still is, in many cases) not how much easier a program could make the process of creating a rough draft, but how much easier it could make the final presentation of an error-free business letter.

Recent efforts have concentrated on a more advanced problem, the business report. Spreadsheet-based text processors are good examples of the current approach, as are many of the integrated business packages now appearing on the market—programs that incorporate ledger computation, graphics, and data retrieval with text handling. But until the past year or so, very little has been done to expedite the storage, retrieval, and manipulation of *ideas* as opposed to data.

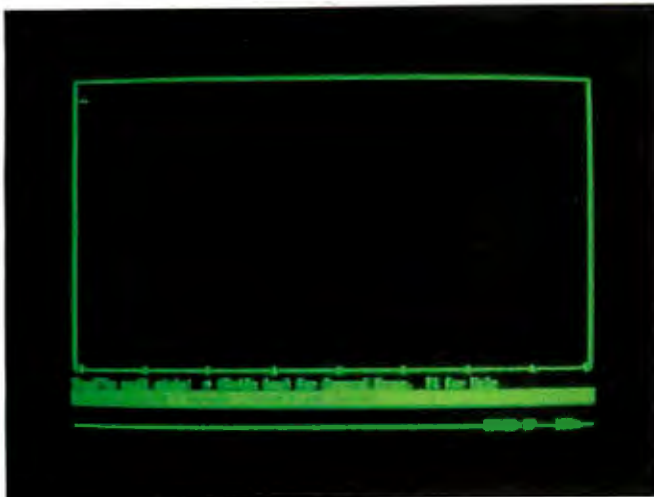

Photo 1: Dayflo's basic entry mode, the "wait state." Text is entered and forms are designed much as they are with any word-processing program. Just press the F1 function key for a screen full of guidance.

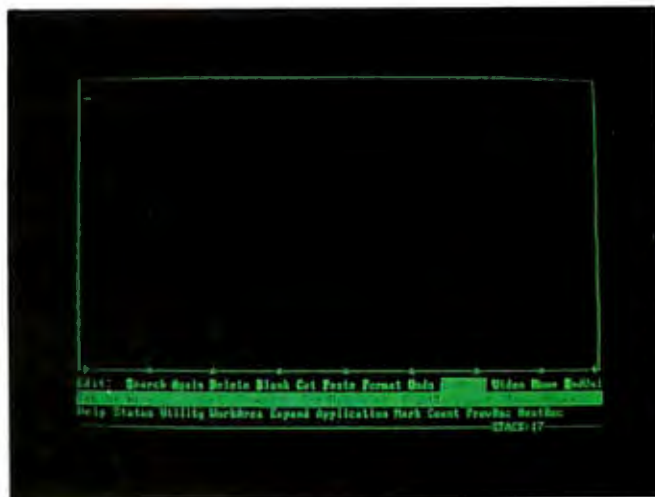

Photo 2: A touch of the *(PrtSc) key puts you in command mode. Single-key choices let you select from a menu of word-processing options; moving the cursor to the bottom line gives access to overall Dayflo instructions.



Photo 5: The Status command provides a means to check the configuration of any aspect of Dayflo, and it's a good way to keep track of what you're doing.



Photo 6: The Work Area Status screen—a map of the Dayflo desktop. Only one record has been entered in the first stack; although some of the other stacks have been named, they're empty until records are either created or pulled from the main database.

Most word-processing programs provide relatively simple block moves; they transfer chunks of text within an individual document or among a small group of documents stored in on-line buffers. When data transfers must occur *outside* the limits of a work in progress, things become unpleasant. The mechanisms provided by the typical text processor for, first, labeling and storing, and second, locating and recalling blocks of information, are cumbersome at best. In most cases, the writer must

both name the block and remember the name in order to have a prayer of finding and reusing the information.

On the other hand, most database-management software, while adept at storage and retrieval of punch card-style chunks of data, is miserable at text processing, and the restrictions of fixed entry forms and precisely limited entry length would drive a creative writer up the walls. And it's almost impossible to combine a mixture of data types and formats into a cohesive whole without retreating to

the use of a word processor.

Dayflo is a philosophical combination of text manager and database manager intended to provide the user with a quick method of linking labels to idea units, thus adding a degree of control and organization to a normally haphazard process.

How It Works

When you first enter the Dayflo environment, you are presented with an almost blank screen, representing the Dayflo "wait state." You can begin

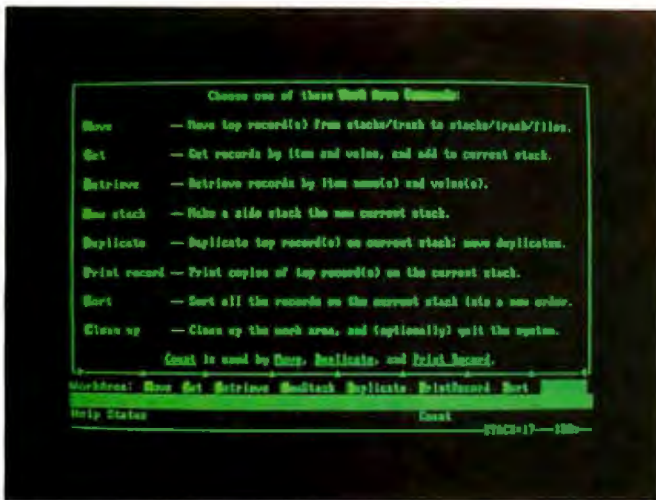

Photo 3: The Work Area menu manipulates individual records and whole stacks; it's the route you take to move around on your "desktop." Once you tire of rereading the menu, commands can be activated by pressing a function key followed by a single letter.

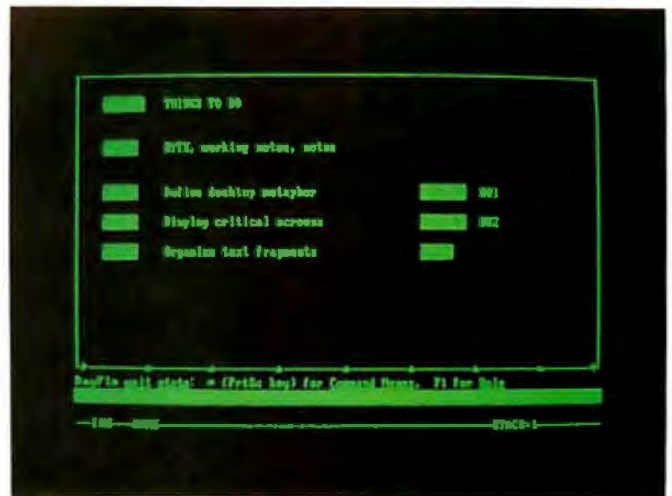

Photo 4: A database-style form under construction. The INS and NAME flags appearing on the status line at the lower left of the screen indicate that you're in insert mode and that a field name is being entered. Once this record has been completed, it can be retrieved by searching for the contents of any single field name (or group of names).



Photo 7: The Profile Status screen shows how the system has been set to respond to errors and dangerous commands. You can change the response settings and some of the major video attributes.

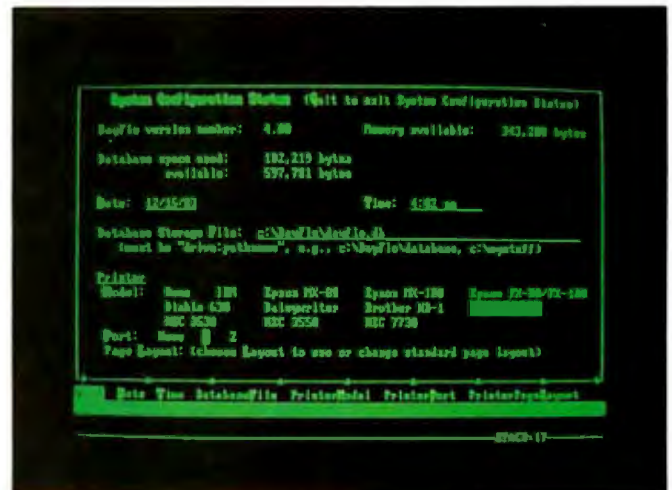

Photo 8: The System Configuration Status screen allows changes to major system features. Dayflo can be used with more than one database—to switch to a different database, simply overtype the Database Storage File name with the new information.

typing immediately, as the blank screen is essentially a word processor. You are working on the equivalent of a sheet of paper on a scratch pad resting in an open folder on your desk. (In Dayflo terminology, this "folder" is called a "stack," and that term will be used from here on.)

Pressing the *(PrtSc) key displays a line of menu options close to the bottom of the screen; these provide such standard functions as format changes, search and replace, block moves, and toggling between insert-

ing and overwriting. A second list of menu choices, accessed by punching the down cursor key, shows the possibilities for accomplishing functions that deal with overall Dayflo operations.

The document you're creating is a single record in a text database. It and other records like it have been organized into 20 stacks. The current stack can contain a large number of records, which can be flipped through one by one. When you begin work in a new stack, the "bottom" of the stack is

always the scratch-pad area, but as you flip through your records, you tuck them under the scratch pad; thus, while each stack contains a scratch pad, it won't always be the bottom record. A status line indicates your position in the stack as you move around.

Block moves of text can be performed by marking the beginning and the end of the section and pressing one of the PC's function keys. Selecting the "Cut" option moves the block into a buffer called the "cutout



Photo 9: Page layout options are limited but sufficiently complete to generate professional reports. More sophisticated layouts can be produced using Reportflo, an optional companion program.

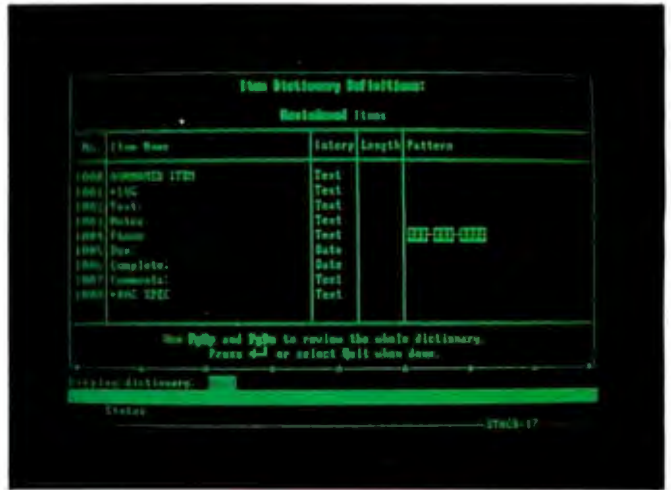

Photo 10: The Item Dictionary lists all field names that Dayflo “knows” and their attributes. If you enter data that does not conform to the dictionary specifications, the program will request verification before accepting the information. Nonindexed items can be retrieved only as part of entire records; indexed items can be retrieved independently.



Photo 13: Blocks are stored in the Dayflo “cutout holder” and pasted in where needed. Once a block has been placed in the holder, it remains available for reuse until an active decision is made to throw it away.

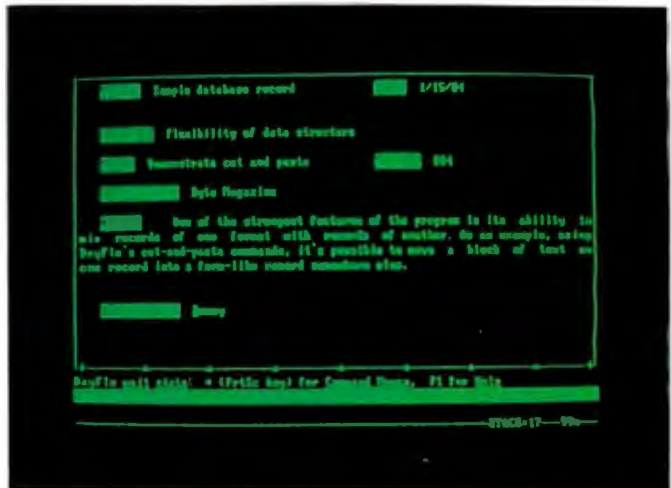

Photo 14: The holder itself is much like a stack; blocks can be stored as if they were scraps of paper. The only real difference is that the cutout holder cannot be used to update the main database.

holder.” Positioning the cursor at the new location and choosing “Paste” completes the transfer. The holder itself is much like a stack, although the fragments it contains can neither be edited nor stored until reunited with actual stack records. It will accumulate snippets of text until it is told to clear itself, which is ideal for gathering a series of segments and then relocating them. Moves can be accomplished within a record or from one record to another, regardless of stack boundaries.

However, Dayflo is more than a text editor with advanced buffering capa-

bilities: it is a full-fledged database manager. Once a record has been completed, it can be stored in a central database for future use. Although stacks can be created entirely from scratch, a more typical event would be to extract the contents of a stack from the database by searching for single or multiple relationships.

In a finished record, all entries must be tagged with a field name, or “item name,” as defined in a user-generated name dictionary. A one- or two-stroke toggle command activates the switch from text entry to name entry. “Indexed” names can be

used for eventual retrieval of the item or its record; “nonindexed” names merely identify items and cannot be used as keys for searching.

Free-form blocks of text can be entered on the scratch pad or in the middle of a preexisting document, as with any simple word processor. However, Dayflo will not allow you to end an editing session until you have included at least one indexed field name (the default is “&RECORD NAME”). Such a precaution is designed to save the unwitting from themselves; if it were possible to store raw text in the main database

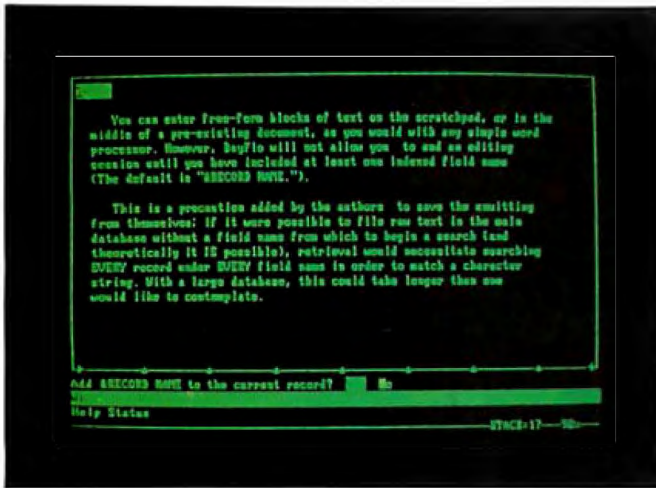

Photo 11: Dayflo demands at least one indexed item name per record before it will allow the record to be saved. This is not a frivolous restriction.

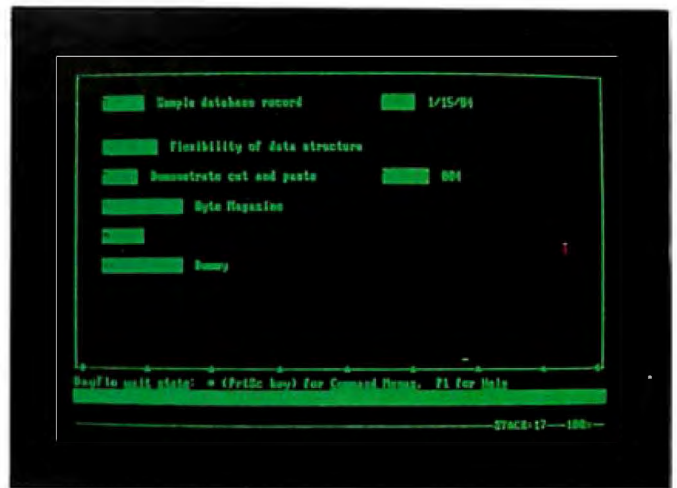

Photo 12: Using Dayflo's Cut and Paste commands, a block of text can be moved from one record to another.

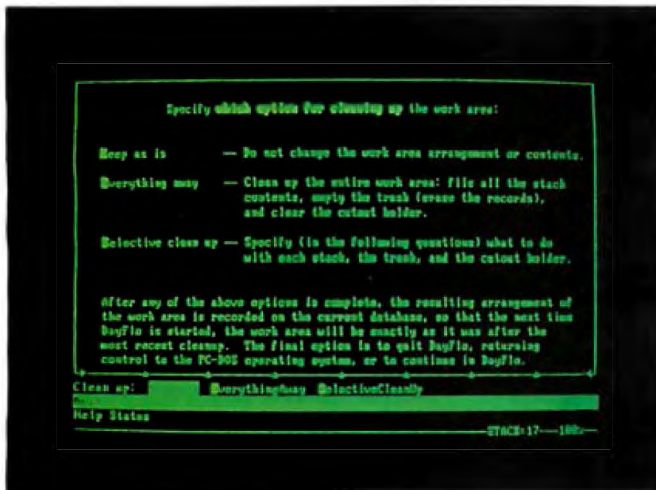

Photo 15: Cleanup time. You can either leave your metaphorical desk as it is or put everything back in the main database. If you elect to refill materials, remember that you'll have to rebuild all your stacks when you begin working again.

without a field name from which to begin a search (and theoretically it is possible), retrieval would necessitate searching every record under every field name in order to match a character string. With a large database, this could take a disturbingly long time.

Maneuvering on the Desktop

The Dayflo "Status" command provides access to a number of screens of configuration information that can be altered to suit the needs of the moment, including database in use, printer assignment, page layout,

video attributes, warning messages, and text format. The most frequently consulted status screen is probably that for Work Area Status.

The Work Area is your desktop. The status screen shows the titles of all the stacks in use, the number of records in each stack, the number of records in the trash, the number of blocks in the cutout holder, the current stack, and your position within the current stack as measured in distance from the scratch pad.

Work Area commands let you build new stacks, move between stacks, print records, sort records within the

stack, extract new records from the database, duplicate records, and initiate cleanup procedures. You can access command mode either by moving to the Work Area command menu and making your choice or by typing one function key followed by a mnemonic initial. In either case, maneuvers rarely require more than two or three keystrokes.

Weak Points

As is the case with all new programs, Dayflo is not without its weaknesses. To Dayflo Software's credit, however, it does not view the initial release as an end to the development process. Dayflo will be enhanced as the product evolves.

At the time this report was written, Dayflo had some drawbacks, particularly in the user-interface portions of the program. Shortly before its release to the buying public, Dayflo staff members were still debating whether the program should come up showing the Work Area Status screen (to provide an overview of work in progress) or return to the point at which the user had been working. The general opinion was that the latter solution would be best for users who had learned the system, and that opening with the status screen was an interim step in the training process that would prove annoying within several days of use.

Accounting Business Systems
EASYTABS

NEW

If your
Computer
Store doesn't
have this ...

Software
for the
small
business
& first
time
user

only
\$189⁰⁰
per
module



ask them where
you can get it!

Accounting Business Systems
EASYTABS

Back on all
SOFTWARE
issues Call us
800-367-1870

further dealer/distributor
enquiries welcome.

- **EASY TABS** family consists of Accounts Receivable, Accounts Payable, General Ledger, Word Processor and Data Manager.
- **EASY TO USE** simply insert your disks and switch on!
- **SELF INSTALLING** no need for expensive professional installation fees.
- **TUTORIAL MANUALS** ensure an easy introduction to running your system.
- **HELP** facilities in the program to prompt the user.
- **LOW COST** economic entry into office automation.



SI

SILICOM INTERNATIONAL SOFTWARE INC.
990 Hillside Ave. Unit 1, 2521 Palma Drive,
Victoria, B.C. V8T 2A1 Ventura, CA., 93003

Telex 049-7102

However, as the prerelease versions lacked both provisions for field configurability and any sort of macro-key command capacity, either option would be irritating to a certain percentage of users. The problem was solved at Dayflo offices by the widespread use of Pro-Key, a keyboard reconfiguration program for the IBM PC—the solution is an admitted patch, well below the overall high standards of the operation.

A conscious effort has been made to imitate the Wordstar approach to menus and help screens (the experienced user can circumvent these screens with quick function-key commands), but a number of the screens could easily entrap and confuse a novice, and the language used, while concise, is intimidating. For example, the initial Dayflo work screen is labeled "wait state"—terse and to the point, but useless to the uninitiated.

Dayflo does not interact well with other software packages on the market. Although it can accommodate text output from other packages, Dayflo can't handle raw data files. The user must wait until the other packages spit out information in a form that Dayflo can digest. Although designers are working on a solution, it's not a simple problem; building in all the translation algorithms for the varied universe of available data structures is no small task.

Finally, Dayflo may suffer as a result of its massive size. The basic program is more than 75,000 lines of program code written in C, which compiles down to 1 megabyte. And that's without the object database or databases, Reportflo (a companion program for fancier output), or spreadsheeting capabilities (one of the first of a projected series of enhancement packages). To say that Dayflo is designed for a hard-disk environment is something of an understatement; it absolutely requires a hard disk.

Conclusions

The more you work with Dayflo and become accustomed to its idiosyncrasies, the more you become conscious of its power. It is possible to design simulated fixed-length

← Circle 322 on inquiry card.

WATCH THE BIG GUYS

When you are going to expand a thousand IBM PC's you want to get it right. Fact is, if you are going to expand one PC you want to get it right. That's why world leaders in computers, energy, manufacturing, research and education as well as tens of thousands of individual computer owners have picked Qubie' for their PC or XT expansion products.

THE PEOPLES CHOICE

You can't gather an impressive list of customers without great products. You just have to be impressed with **MegaPlus II™**, **SixPakPlus™**, and the **Qubie' PC212A/1200**

modem card. **MegaPlus II™** is the most flexible expansion product available for the PC. It's companion, the **SixPakPlus™**, has quickly become the number one selling multifunction board for IBM PC's. The Qubie' modem card utilizes four digital microprocessors to provide flawless performance at 300 or 1200 baud. It even comes with **PC-TALK III™** software, the program PC WORLD magazine called, "The benchmark that other PC communications packages are measured against". All this for under \$300.

No wonder the Fortune 500 is impressed!

THE RIGHT PRICE

Our prices don't just look good, they are. No extra charges for shipping, testing, insurance, credit cards, or COD fees. If you are in a hurry, 2 day air service is available for just \$5 extra. We also offer a Qubie' exclusive, our **PREFERRED CUSTOMER PLAN**. For \$50 we will extend your warranty a second year, perform warranty repairs within 24 hours, and return your board by UPS blue label air service.

DON'T FORGET SERVICE

We will be there when you need us. Knowledgeable people to answer your questions before and after you buy. Warranty repairs are performed within 48 hours or we replace your board. All products are guaranteed for one year on parts and labor. If not completely satisfied within 30 days of purchase, return your board for a complete refund including the postage. Join our list of impressive customers. You'll be glad you did.

TO ORDER BY PHONE:

In CA (805) 987-9741
Outside CA (800) 821-4479

TO ORDER BY MAIL:

Send a complete description of products, and your daytime phone number. Include check or credit card with expiration date. (Personal checks take 14 days to clear). California residents add 6% sales tax.

CORPORATIONS & INSTITUTIONS

Call for details on terms and delivery before mailing your purchase order. If your organization needs large quantities we have the prices and quick delivery you need.

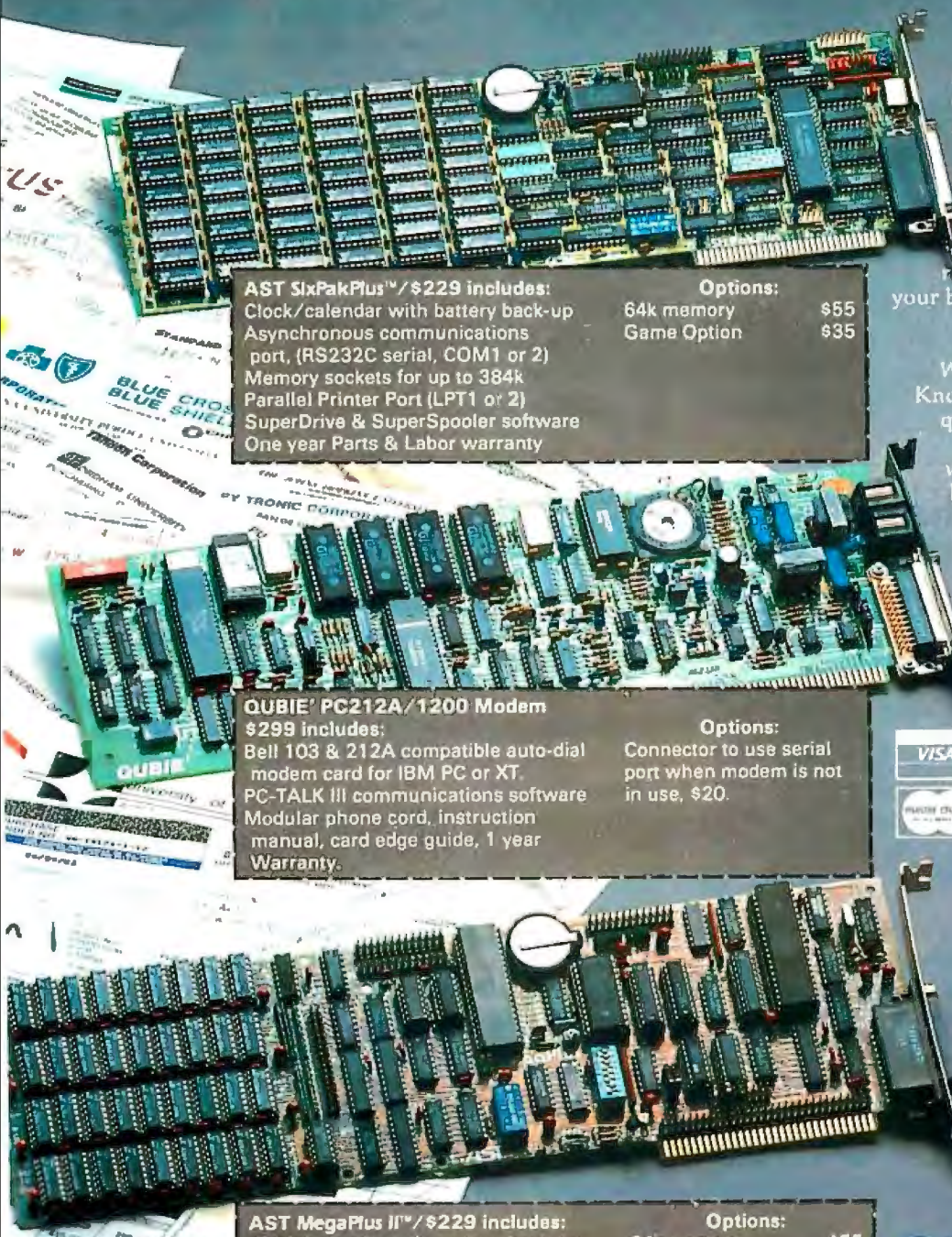

AST SixPakPlus™ / \$229 includes:
 Clock/calendar with battery back-up
 Asynchronous communications port, (RS232C serial, COM1 or 2)
 Memory sockets for up to 384k
 Parallel Printer Port (LPT1 or 2)
 SuperDrive & SuperSpooler software
 One year Parts & Labor warranty

Options:
 64k memory \$55
 Game Option \$35

QUBIE' PC212A/1200 Modem \$299 includes:
 Bell 103 & 212A compatible auto-dial modem card for IBM PC or XT.
 PC-TALK III communications software
 Modular phone cord, instruction manual, card edge guide, 1 year Warranty.

Options:
 Connector to use serial port when modem is not in use, \$20.

AST MegaPlus II™ / \$229 includes:
 Clock/calendar with battery back-up
 Asynchronous communications port, (RS232C serial, COM1 or 2)
 Memory sockets for up to 256k
 SuperDrive & SuperSpooler software
 One year Parts & Labor warranty

Options:
 64k memory \$55
 2nd async port \$35
 Printer port \$35
 GamePak \$40
 MegaPak 256k \$299
 MegaPak 128k \$199

Circle 300 on inquiry card.

QUBIE'

4809 Calle Alto, Camarillo, CA 93010

Tempo House, 15 Falcon Road,
London SW11, United Kingdom

IBS IBM® COMPATIBLE

\$649 In large dealer or OEM quantities

MAXIMUM IBM® COMPATIBILITY

CARDS N DRIVES for OEM



STANDARD FEATURES:

- Multi-Layered Board
- 8088 Processor
- 64K RAM Expandable to 256K
- Power Supply
- Cooling Fan
- Metal Casing
- Detachable Keyboard
- Two RS-232 Serial Ports
- One Parallel Printer Port

PC-2000 BIOS is designed to give maximum compatibility with IBM approved software, under MS DOS 1.1, 2.0, CP/M-86, and Unix.

CALL NOW FOR EVALUATION UNIT



CORP.

714-630-6361

630-6362

990-4662

TELEX: 755197

2732 E. MIRALOMA AVE. • ANAHEIM, CA. 92806

IBM is a trademark of IBM Corporation. Unix is a trademark of Quantum Software. MS DOS is a trademark of Microsoft Corporation. CPM is Digital Research's trademark.

databases (e.g., phone directories) that coexist quite peacefully with pure text records within the context of the overall structure of the program. Diverse records can be combined within the same stack or the same record, and data can be transferred between them at will. Command logs can be constructed to perform extremely complex search and retrieval operations; records can be copied, split, combined, and mutilated, as freely as you please, as long as you remember to include at least one indexed field name within a given record. True, the package demands a bit of learning, but its flexibility more than compensates for the effort.

Dayflo demonstrates the advantages of applying lateral thinking to an old problem. Its architects claim that the theory behind Dayflo is nothing revolutionary, but the program allows text entry with an uncommon ease and spontaneity. With a little practice, users find Dayflo procedures quite natural, and a return to older programs can be frustrating.

Dayflo's open logic *can* encourage you to develop a terrible mess, certainly as bad as any on a real desktop, and unless you perform regular cleanup, order in the stacks can fall apart. But, all things considered, it's pleasant to have that much control. Freedom is not without its price.

Whether or not Dayflo will dramatically increase the use of personal computers in the office is another question entirely. It's certainly a wonderful program for writers of all types, and executives who are used to working with software will be pleased by the speed with which they can pirouette through all that data. For them, the program is a major step in the right direction. But new users will have to be induced to learn the program before they can appreciate it. It may well be that Dayflo's shot at revolutionizing the workplace will depend more on marketing and training than on its outstanding potential as a tool. ■

Don't let the competition sneak up on you.



© 1983 Art Ciokey

Be up and running with The Assistant Controller™
Flexible Accounting Systems from Lake Avenue Software

Written entirely in dBASE II by CPAs. Source Code and Modifications Available. Fully integrated or stand-alone. Accounts for up to 999 departments. Automatically consolidates reports. Complete Audit Trail. Detects out-of-balance transactions. For PC-DOS, MS-DOS and CP/M Systems. \$475 per module.

- General Ledger
- Financial Reporting
- Accounts Receivable
- Accounts Payable
- Payroll
- Professional Time & Invoicing
- Job Costing

The Assistant Controller™ Series

LAKE AVENUE SOFTWARE

77 North Oak Knoll, Suite 105 • Pasadena, CA 91101 • (818) 792-1844

dBASE II is a registered trademark of Ashton-Tate.

Ezra Shapiro is a technical editor at BYTE's West Coast bureau. He can be reached at McGraw-Hill, 425 Battery St., San Francisco, CA 94111.

New!

Three Winchester Internal Hard Disc Drive Systems!

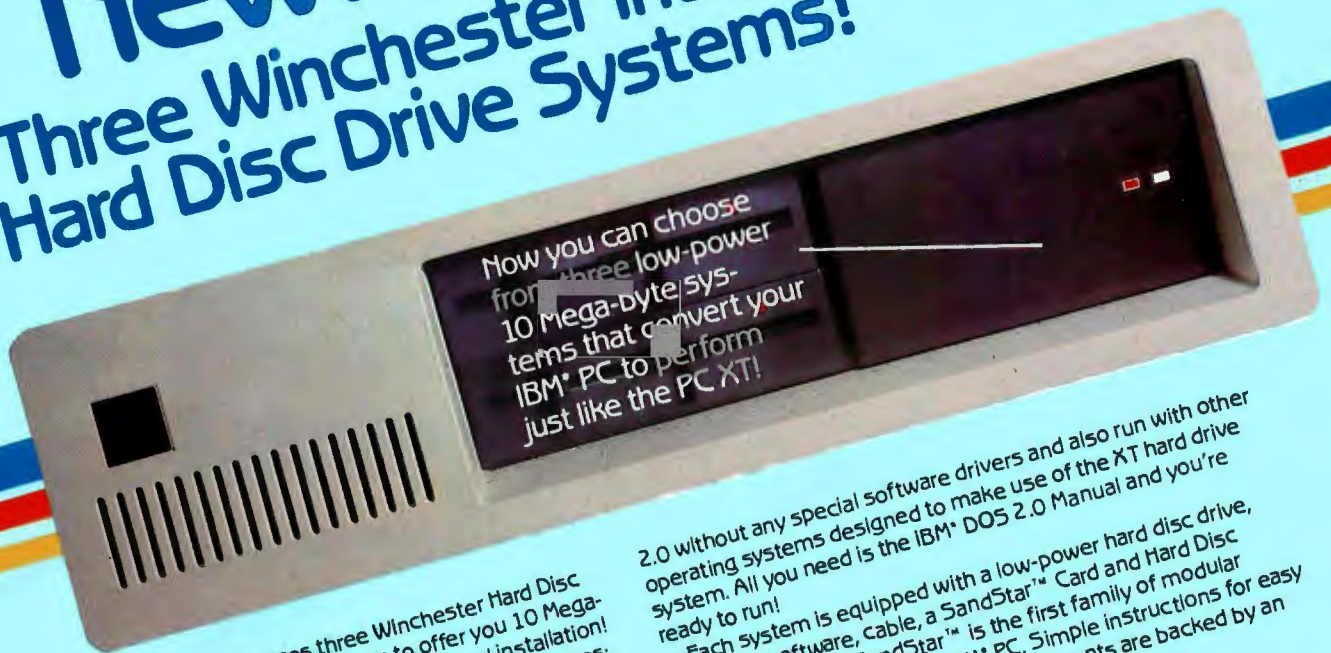

Maynard Electronics introduces three Winchester Hard Disc Drive Systems — the only drive systems to offer you 10 Mega-bytes of formatted capacity with complete internal installation! These systems offer the user countless benefits and features: capability of booting off the hard disc; additional functions while requiring only one card slot in your PC; and, use of available power, thereby preventing overheating problems which have affected other drives. Handling heavyweight data was never easier.

All three systems are quality engineered and work with DOS

2.0 without any special software drivers and also run with other operating systems designed to make use of the XT hard drive system. All you need is the IBM® DOS 2.0 Manual and you're ready to run!

Each system is equipped with a low-power hard disc drive, complete software, cable, a SandStar™ Card and Hard Disc Controller Module. SandStar™ is the first family of modular peripherals created for the IBM® PC. Simple instructions for easy installation are included and all components are backed by an Unconditional One Year Parts and Labor Guarantee.

WS 1

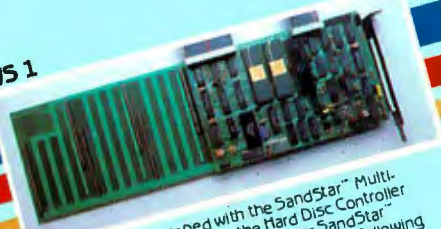

This System is equipped with the SandStar™ Multi-function Card. In addition to the Hard Disc Controller Module, you can add up to three other SandStar™ Modules while using only one Card slot. The following modules are available: Serial Port, Parallel Port, Clock Calendar, Game Adaptor, SASI Host Adaptor and Prototyping Module.

WS 2

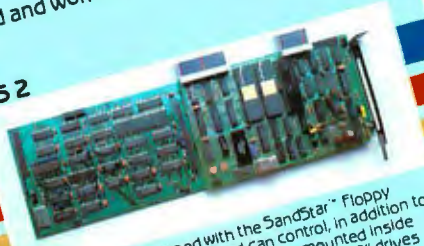

This System is equipped with the SandStar™ Floppy Drive Controller Card. The Card can control, in addition to the Hard Disc Drive, two floppy drives mounted inside your PC and optionally two additional 5¼" or 8" drives mounted externally. This leaves three system slots for other expansion boards.

WS 3

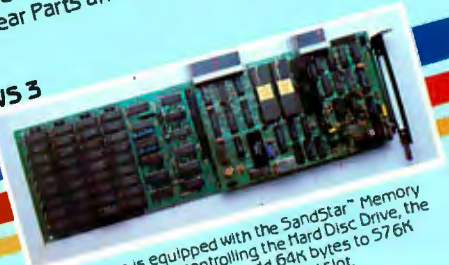

This System is equipped with the SandStar™ Memory Card. In addition to controlling the Hard Disc Drive, the Memory Card allows you to add 64K bytes to 576K bytes of memory using only one card slot.

NOW!
Compatible
with
COMPAQ!™

To expand your PC to perform like the PC XT, one of our Winchester Hard Disc Drive Systems is right for you. And if you have already made the wise decision to install any of Maynard's SandStar™ Cards, the SandStar™ Hard Disc Controller Module may be purchased separately.

TO ORDER, CONTACT YOUR LOCAL DEALER OR DISTRIBUTOR.



MAYNARD ELECTRONICS
400 East Semoran Blvd. • Suite 207
Casselberry, Florida 32707
305/331-6402

We make modern times better.

Circle 224 on inquiry card.

IBM is a trademark of the International Business Machines Corporation.
COMPAQ is a trademark of Compaq International, Inc.



StorageMaster™
Is Here.



Now you can buy the flexible disk drives preferred by major computer manufacturers.

Introducing the perfect partner to the IBM PC—StorageMaster 400 Series 5.25 inch flexible disk drives. They're completely compatible with IBM PCs.

Now, for the first time you can own the whisper quiet flexible disk drive that's only been available to computer manufacturers: From Control Data, the leading independent supplier of peripherals. Which means that StorageMaster drives come to you user-tested in the toughest laboratory around—on the job, in hundreds

of thousands of computer systems worldwide.

That's one good reason to buy StorageMaster products. There are others. Control Data's been in the computer business for over 25 years. We've earned a solid reputation for quality and reliability—at prices that mean real value.

Look to StorageMaster diskettes for the best in flexible media too!

Control Data StorageMaster brand diskettes are known for their high quality and consistency. Each diskette is 100% certified and backed with a full

5-year warranty. Now with StorageMaster, you can use the top of the Control Data line in flexible diskettes—made to the same exacting standards as the StorageMaster disk drives. Look for StorageMaster products in your local computer store or for more information call toll-free **1-800/232-6789**. In Minnesota call **612/921-4400 ext. 41**.





ROBERT
& TINNEY

Feigning Reality

The term *simulation* is suspect at best. In the minds of many, this word connotes a *counterfeit* or *sham*: a rhinestone masquerading as a diamond. In the context of computers, however, simulation has no negative meanings and we hope that our March theme issue helps this beleaguered word to regain its standing in the lexical community.

Simulation is the process of representing or modeling the behaviors of a system on a computer. This software model attempts to mimic the processes of the original system as nearly as possible. Data enters the model, is acted upon, and then the "system's" responses are recorded. Until quite recently, the field of computer simulation was exclusively the province of mainframe systems, but as microcomputers have become more powerful and capable, they have become increasingly important to the would-be simulationist.

Our lead article by Richard Bronson is an overview of microcomputer simulation; it covers the two basic types of computer simulation and surveys some of the simulation languages available for microcomputers. Articles by E. Hart Rasmussen and Pat Macaluso investigate the mathematical underpinnings of simulations. These articles contain source-code listings so that interested readers can try their hand at modeling.

In terms of applications, we explore computer-generated graphics with Peter Sørensen—simulations of things that never were. Philip Schrodtt takes a look at using microcomputer simulations in the social sciences. Ronald Miller gives us a view of simulation and graphics on microcomputers. To round out the issue, Charles Pratt of the Society for Computer Simulation offers us a "going further" article for those who want to get more information about the field.

Even three of our software reviews are related to the theme of simulation and modeling. Stan Miastkowski checks out the Microsoft Flight Simulator for airworthiness on page 224, Dennis Barker reviews a mystery adventure game (page 301), and on page 274 Richard Grehan explores a software package that makes a computer simulate the internal workings of a computer—a novel twist indeed.

To discover some of the whys and hows of microcomputer simulation, please join us . . . in the queue.
—Art Little

95 Computer Simulation: What It Is and How It's Done by Richard Bronson

106 Simulating Reality with Computer Graphics by Peter R. Sørensen

138 Simulation of Weighted Voting: The Banzhaf Index by Philip A. Schrodtt

157 Queue Simulation by E. Hart Rasmussen

179 A Risky Business—An Introduction to Monte Carlo Venture Analysis by Pat Macaluso

194 Simulation and Graphics on Microcomputers by Ronald R. Miller

204 Going Further by Charles A. Pratt

Now you can move your Z80[®] designs from 8- to 16- to 32-bit performance and never lose your software investment.



All you need is a Z80-to-Z8000™ source code translator. And, it's available without charge to readers of this ad!

This new source code translator was developed by 2500 A.D. Software, Inc. to provide Z80 CPU users with ready-made software compatibility between the Z80 device and the Z8000 CPU. In just a few days, you can translate and debug complex programs that previously took years to write.

And once you've got the Z8000 chip on board and running, you can upgrade easily, with total software compatibility, to Zilog's new 32-bit Z80,000™ CPU. But that's not all!

When you need assembly language tools to help achieve smooth-working Z8000 programs, no problem. 2500 A.D. Software has also developed a complete line of macro-assemblers, cross-assemblers, and linkers.

- Please send me a free Z80 Source Code Translator, documentation and Zilog's new Winter Software Directory.
- I don't need the Translator at this time, but please send your Software Directory.
- Please have a salesperson call.

Name _____ Title _____
Company _____
Address _____ City _____
State _____ Zip _____ Phone _____
scr BY 3/84

For a free translator with complete documentation mail the coupon to: Zilog, Inc., Components Tech. Publications, 1315 Dell Avenue, MS C2-6, Campbell, CA 95008. Or call our Tech. Publications TOLL FREE line: 800-272-6560. We'll also include Zilog's Winter Software Directory for other software support products that you may require.

Zilog
an affiliate of
EXON Corporation

Pioneering the Microworld

Z80 is a registered trademark of Zilog, Inc.
Z8000, Z80,000 are trademarks of Zilog, Inc.

Computer Simulation

What It Is and How It's Done

An introduction to modeling and computer simulation as they apply to microcomputers

by Richard Bronson

According to Robert Shannon in *Systems Simulation: The Art and Science*, "Simulation is the process of designing a model of a real system and conducting experiments with this model for the purpose either of understanding the behavior of the system or of evaluating various strategies for the operation of the system." This description emphasizes both facets of an exciting and expanding field. The *art* is the creative process of constructing a simple model that adequately replicates the dynamic behavior of a system; the *science* involves transferring a model into computer code and then analyzing its behavior to predict the responses of a real system.

Computer simulation is a child of the computer age. Without computers there could be no computer simulation, and without computer simulation we would be without one of our most powerful and versatile methods for problem solving. Simulation techniques are currently used in over 70 fields spanning ambulance dispatching, consumer-behavior patterning, financial forecasting, harbor design, manpower planning, water-resource management, educational funding, aircraft design, and urban development. In each, simulation is a tool for solving problems.

Simulation is a unique discipline in that there are relatively few people engaged in the "pure science" aspects of the field; those who are develop

simulation languages and statistical tests. The bulk of practitioners apply simulation to problem analysis and solution in other fields. They use simulation techniques to provide structure and definition to imprecisely worded verbal descriptions, to identify key components, to quantify interactions, and then to code, experiment, and recommend.

Two Types of Simulation

Simulation, as practiced today, falls into one of two types: discrete or continuous. Each has its own set of procedures for model conceptualization, each is based on a different area of mathematics, each uses its own set of computer languages, and each solves different sets of problems.

Discrete simulation deals primarily with queuing systems in which customers arrive at a service facility, then wait in a line (queue) if all servers are busy, eventually receive service, and finally depart from the facility when service is completed. Air traffic control problems are often embedded in such systems. Here, the aircraft seeking permission to land becomes the customers and the runway assumes the role of servers. With scheduling problems involving court cases in the judicial system, judges are modeled as servers, and the cases become customers.

Of prime interest in all queuing systems is the expeditious processing of customers. Since customer arrival

times and the times required to service individual customers are generally random events, mathematical models for queuing systems are anchored in probability and statistics. Questions regarding the average time a customer spends in the system and the length of a queue can be answered only when the probability distributions governing arrival and service patterns are known (or can be assumed). For almost all probability distributions, the *only* technique available for answering these questions is computer simulation.

Large blocks of time in which the state of the underlying system does not change are a defining characteristic of discrete simulation. Another characteristic is that units moving through the system are measured as integers. Queuing systems have these properties, which is why their problems are so amenable to solution by discrete simulation. Customer arrivals and customer departures occur in unit amounts; the number of customers in a service facility at all times can be represented as an integer. Arrivals and departures occur at discrete instances and, in between, nothing of importance to the state of the system transpires—the same customers receive service and the same customers wait.

Continuous simulation, in contrast, deals with systems that change continuously with respect to time and with measurements that are not re-

stricted to integers. A simple example is the trajectory of a rocket in flight; there is no instant of time when the system as measured by the rocket's position in space does not change. Less obvious examples are provided by Levin and Roberts in their book *The Dynamics of Human Service Delivery* (see bibliography). For example, one case study assesses the effects on student performance from student-teacher interaction at the elementary school level.

Of prime interest in all continuous systems is the time-varying behavior of all quantities in the system. Since behavior patterns are governed generally by rates of change, mathematical models for continuous systems are based on differential equations. And the *only* technique available for solving most sets of differential equations is numerical integration, which is the core of all continuous-simulation languages.

It's not always clear whether it is better to use discrete or continuous simulation in solving a particular problem. Population growth problems seem ideal candidates for discrete simulation. They can be modeled easily as self-service queuing systems with people as customers (and their own servers), births as customer arrivals, and deaths as customer departures. Yet population problems often are analyzed with continuous simulation primarily because the time between successive births and deaths is small (seconds) compared to the time span of interest (years). It is more economical in both computational time and memory requirements to approximate the system as a continuous one rather than having the computer update its queue files every few seconds. The problem of using nonintegral values is obviated by the magnitude of the items being measured; a population of 60.38 is perfectly acceptable when the unit of measure is millions of people.

The choice between simulation branches is further obscured by systems that possess both types of behavior. Pritsker and Pegden offer a good example in their book *Introduction to Simulation and SLAM* (see bib-

liography) of such a hybrid system, part continuous and part discrete, based on a simulation study by Ashour and Bindingnavle. Ingots of warm steel arrive at a soaking pit of hot liquid where they are immersed and heated to high temperatures for further processing. If the soaking pit is full, ingots must wait for space in a holding tank. The random arrival pattern and subsequent queuing are vintage discrete simulation. The service pattern, raising the temperature of the ingots as they soak in the hot bath, is continuous based on the temperature of the pit, the temperature of the arriving ingots, and Newton's law of heating. To simulate such a system, elements of both types of simulation are needed.

Models

Models are often classified as either *iconic*, *analog*, or *abstract*. An iconic model looks identical to the system it represents; one example is a wood and paint mock-up of an automobile shell. From a distance the mock-up appears to be an automobile, but since it contains no engine or interior, it is an incomplete one. Nonetheless, if the purpose of the model is to determine the aerodynamic characteristics of the car it represents, then it may be all that is needed to achieve the objective. An analog model acts like the system it represents even though it may appear quite different. Engineers often build electrical systems to model mechanical spring systems and then predict the motion of the mass at the end of the spring by measuring the current in the electrical model. Abstract models are sets of mathematical equations for quantities in the systems being modeled. The solutions of the equations are used to predict the behavior of the systems.

Discrete simulations employ analog models with computer files representing most components in a system. Each customer is a file, every queue is a file, and there is even a calendar file for storing service completion times and arrival times. These files are then manipulated according to patterns established by the modeler to mimic the behavior of the

underlying system. Only servers are spared the indignity of being reduced to files; instead they become variables assigned either the value 1 when they are busy, or the value 0 when they are free.

Abstract models of differential equations are the bases of all continuous simulations. For technological systems, such equations are consequences of physical principles, such as Newton's laws of motion, governing changes in the states of the systems. Unfortunately, no such principles currently exist in the social sciences, but in the late 1950s and early 1960s Jay Forrester and his associates at MIT developed system dynamics as an approach for generating differential equations in these areas. Prior to 1960, continuous simulation was practiced almost exclusively by electrical and aerospace engineers. As a result of Forrester's work, abstract models now exist in economics, sociology, management science, and ecology.

Once constructed, nearly all simulation models must be coded for a computer and then run before any inferences are possible. Mathematical solutions are preferred but almost never obtainable, given the complexity of interactions between components in models, even reasonably simple models. Mental inferences are dangerous. Forrester, in a 1971 article for *Technology Review* (see bibliography), cited the following experience:

Time after time we have gone into a corporation that is having severe and well-known difficulties. The difficulties can be major and obvious, such as a falling market share, low profitability, or instability of employment. Such difficulties are known throughout the company and by anyone outside who reads the management press. One can enter such a company and discuss with people in key decision points what they are doing to solve the problem. . . . In a troubled company, people are usually trying in good conscience and to the best of their abilities to solve the major difficulties. Policies are being followed at various points in the organization on the presumption that they will alleviate the difficulties. One can combine these



Go on line in the world's fastest growing technology.

NEW! DATA COMMUNICATIONS TRAINING FROM NRI

Practical training includes computer, modem, test instruments, and access to exclusive NRI communications network

Satellites... microwave... fiber optics... dedicated land lines. Suddenly the world is communicating in a new and different way, via digital data systems. People talking to computers... computers to computers... information is stored, retrieved, and relayed in nanoseconds. And an entirely new kind of communications is born.

Industry, opportunities to triple

Data and telecommunications is already a \$150 billion industry and is expected to triple over the next five years. One typical company has grown from \$85 million to \$650 million... a 765% growth since 1978 alone. The need for qualified technicians to install, maintain, and service this enormous investment in high-tech equipment is tremendous even now. Opportunities and salaries can go nowhere but up and up.

NRI will train you at home

You can learn at home in your spare time to become a data communications technician with NRI at-home training. NRI will start you with the basics, build upon your knowledge with easy-to-follow, bite size lessons to take you into the world of digital data communications. You'll learn what it takes to work on satellite, microwave, fiber optic, and telephone data links.

And you'll learn at your own comfortable pace, without classroom pressures or evenings away from your family. Over the past 70 years, NRI has taught the latest high-tech skills to almost 2 million students to become the world's largest and most successful school of its kind.

Hands-on training includes computer, modem, breakout box and much more

NRI takes you far beyond "book learning." As part of your course, you receive plenty of practical hands-on training that gives you real-world skills. You get the Radio Shack Color Computer, with 16K memory to teach you the systems and language of data communications plus you get an operating modem to let you tie in with world-wide communications networks.

You build your own RS-232C interface breakout box, an indispensable installation and trouble-shooting instrument you'll use throughout your career. You receive a professional digital multimeter and the NRI Discovery Lab, where

you construct solid-state circuits and demonstrate practical applications of the theory you've learned.

Learn on-line with the exclusive NRI data network

You'll learn what data communications is all about by actually becoming part of an operating network. Using your computer, modem, and terminal software, you'll go on line to "talk" to your instructor, take your

exam by computer link, communicate with other NRI students and leave messages on the NRI "bulletin board."

As part of your course, you'll also receive membership in THE SOURCESM, a regular \$100 value. A phone call ties you into computers loaded with instant news, stock quotes, electronic mail, educational programs, games, even discount shopping and travel reservations.

Move into the future, send for Free Catalog

You can't find training like this anywhere else... only NRI trains you at home for an exciting and rewarding career in the brilliant new world of Data Communications. Mail the postage paid card right now for our big catalog of high-tech electronic careers showing all the equipment you get, detailed lesson descriptions, and career opportunities. Look it over and decide where you want your future to grow. Act now. There's a real need for trained

data communications technicians.

Training includes all this equipment you keep... 16K computer, modem, breakout box, digital multimeter and the exclusive NRI Discovery Lab.



NRI NRI SCHOOLS
McGraw-Hill Continuing Education Center
3939 Wisconsin Avenue
Washington, D.C. 20016



WE GIVE YOU TOMORROW.

TRS-80 is a trademark of the Radio Shack division of Tandy Corp. SM a service mark of Source Telecomputing Corp., a subsidiary of the Reader's Digest Association, Inc.

policies into a computer model to show the consequences of how the policies interact with one another. In many instances it then emerges that the known policies describe a system that actually causes the troubles. In other words, the known and intended practices of the organization are fully sufficient to create the difficulty, regardless of what happens outside the company or in the marketplace.

In Forrester's experience, individuals perceive a problem, develop a conceptual model of the system in which the problem exists, mentally run the model, and develop strategies for alleviating the problem based on these runs. The net result is often the opposite of that intended because the mental inferences were faulty.

Lave and March, in their book *An Introduction to Models in the Social Sciences* (see bibliography), present a more striking example of the pitfalls awaiting those who would bypass the computer in favor of mental deductions. The example is credited to Bertrand de Jouvenal and features the thoughts of the philosopher Jean

Jacques Rousseau. Rousseau built a population model for eighteenth-century England based on three assumptions: (1) the birth rate in London is lower than the birth rate in rural England; (2) the death rate in London is higher than the death rate in rural England; (3) as England industrializes, people leave the countryside in increasing numbers and move to London. Rousseau concluded that, since London's birth rate was lower and its death rate higher than rural England and since people moved from rural England to London, the population of England must decline eventually to zero. Had Rousseau coded his model for a computer he would have reached just the opposite conclusion. In quantifying the rates for computer input, he would have seen that as long as London's birth rate was greater than its death rate, regardless of how they compared to similar rates elsewhere, the population of London must grow.

If a scholar of Rousseau's stature can err on such a simple model, then Forrester's experiences with twen-

tieth-century man and complex models are not surprising.

When a computer is used to run a model, a computer language is a necessity. Although some experienced practitioners prefer a general-purpose language such as FORTRAN, most opt for specially designed computer-simulation languages that also fall into two classes: discrete and continuous. Both types are easy to program and possess special features of value to simulationists. Both permit the modeler to focus attention on the system rather than the details of programming.

Discrete Simulation Languages

There are hosts of discrete simulation languages available: SIMPAS, CAPS, SIMULA, and DEMOS to name but a few, with new ones introduced yearly, but the overwhelming majority of simulation studies that utilize such languages are written in GPSS, SIMSCRIPT, GASP, or SLAM. GPSS was introduced first by IBM and its latest version, GPSS V, is still supported by them. A faster

THE SENSIBLE SPELLER™ IV CORRECTS SPELLING MISTAKES IMMEDIATELY.

The most popular new word-processing product introduced for the Apple computer in 1982 was not a word processor—it was the SENSIBLE SPELLER IV proofreading program. A perfect complement to your current Apple word-processing program, the SENSIBLE SPELLER IV is fast, friendly, and gives you the features you need in a spelling checker.

First in features**

It only takes a minute or two for the SENSIBLE SPELLER to scan through a ten-page document and compare each word against its 80,000-word dictionary. Each misspelled word is shown to you in the middle of a small excerpt from your document, so you won't waste time trying to remember how you used the word.

You can immediately correct the misspelled word by replacing it with the proper spelling. The SENSIBLE SPELLER even suggests the correct spelling for your misspelled words!

First in dictionaries

The SENSIBLE SPELLER includes the largest, most authoritative dictionary available for the Apple computer. Over 80,000 words are supplied, direct from the official Random House Dictionary. And there is unlimited room to add your own special words. The official Black's Law Dictionary is available separately.

First in word-processor compatibility

The SENSIBLE SPELLER works with more Apple word processors than any other spelling program, including: DOS 3.2, DOS 3.3 (Apple Writer—all versions, Bank Street Writer, Magic Window, Screen Writer, etc.), SuperText, Word Handler, CP/M (Wordstar, etc.), and Pascal word processors.

The SENSIBLE SPELLER is available for \$125 and runs on all Apple //e, II+, and Apple-compatible computers with one or two disk drives.



**Sensible®
Software, Inc.**

24011 Seneca
Oak Park, MI 48237
(313) 399-8877

Please add \$1.25 for shipping.
Visa/Mastercard/Check/COD welcome!

*April 1983, Softalk magazine reader survey
**Not all features are available with CP/M, Pascal, and Word Handler.

Apple, Apple Pascal and Apple Writer are trademarks of Apple Computer, Inc.; Bank Street Writer — Brodebund; Black's Law Dictionary — West Publishing; CP/M — Digital Research Corp.; Screen Writer — Sierra On-Line, Inc.; SuperText — Muse Software; Word Handler — Silicon Valley Systems; WordStar — Micropro International

VISUAL 1050 Personal Computer System



... the complete professional solution at an unbeatable price.

Complete Solution The VISUAL 1050 is an advanced personal computer system designed especially for managers and professionals. It comes complete with top-rated software and high-performance hardware ... all fully configured for easy set-up and simple operation. The VISUAL 1050 costs much less than other full-feature personal computers and comes with everything you need to tackle important professional jobs, right out of the box.

Words, Numbers and Graphics The VISUAL 1050 solves more professional problems than any other computer in its class. Whether you work with words, numbers, or graphics, the VISUAL 1050 speaks your language. You get *WordStar*,[™] *MailMerge*,[™] *Multiplan*[™] and Digital Research's *DR Graph*[™] ... leading software packages for word processing, spreadsheet and graphics. And all have been specially adapted to share data and perform as an integrated software family.

Communications, BASIC and More ... You get *Terminal Emulation* software which turns your VISUAL 1050 into a powerful ASCII terminal for dial-up access to remote computer resources. And you get *CBASIC*[™] for custom programming applications. *CP/M Plus*,[®] a new and improved release of CP/M, allows your VISUAL 1050 to support hundreds of popular third-party packages.

Unbeatable Value \$2,695 is the total retail price for the VISUAL 1050. You get the best and most popular software packages, ready to run on hardware which offers the features and quality you should demand. Two high capacity disc drives. 128K memory standard. Fast, bit-mapped graphics. Full size green screen.

Circle 373 on inquiry card.

	VISUAL 1050	IBM PC	Apple IIe	TRS-80 Model 12	DEC Rainbow
Base System Price ¹	\$2,695	\$2,750	\$2,390	\$3,999	\$3,495
Serial Port (RS232)	STANDARD	\$119	\$195	2 STANDARD	2 STANDARD
Parallel Port	2 STANDARD	\$119	\$180	2 STANDARD	STANDARD
Bit-Mapped Graphics	STANDARD	\$240	STANDARD	\$499	\$845
Word Processing Software	STANDARD	\$200-\$500	\$200-\$500	\$399	\$200-\$500
Spreadsheet Software	STANDARD	\$200-\$300	\$200-\$300	\$299	\$200-\$300
Business Graphics Software	STANDARD	\$200-\$400	\$200-\$400	\$200	\$200-\$400
Communications Software	STANDARD	\$100-\$200	\$100-\$200	\$100	STANDARD
COMPLETE SOLUTION PRICE	\$2,695	\$3,928-\$4,628	\$3,465-\$4,165	\$5,496	\$4,940-\$5,540
Dual Drive Capacity	800 KB	640 KB	280 KB	2.5 MB	800KB
Graphics Resolution	640 x 300	640 x 200	280 x 192	640 x 240	800 x 240
Keys on Keyboard	93	83	63	82	105
Expandable Memory	YES	YES	YES	YES	YES
Optional Winchester	YES	YES	YES	YES	YES
Tilt and Swivel Display	YES	NO	NO	NO	NO

1--Includes CPU, 64K User Memory, Keyboard, Display, Two Disc Drives, and Operating System
Based on manufacturers' information available August, 1983. VISUAL 1050 includes 128K User Memory standard

Standard printer and communication ports. Rugged 93-key keyboard with special *WordStar* engravings. You can't buy a more complete hardware and software solution at anywhere near the price.

See for yourself[®]

Visual Technology Incorporated
540 Main Street, Tewksbury, MA 01876
Telephone (617) 851-5000. Telex 951-539

®Registered trademark of Visual Technology Incorporated

version, GPSS/H, which runs on a wider variety of mainframes and minicomputers, is supported by Wolverine Software of Annandale, Virginia. SIMSCRIPT is a product of CACI of Los Angeles, California, and requires its own compiler. Both GASP and SLAM are supported by Pritsker & Associates of West Lafayette, Indiana, and are compatible with many FORTRAN compilers.

SIMSCRIPT and GASP are event-oriented simulation languages, which means that they are a set of subroutines for file creation, file manipulation, scheduling, and statistical analysis that the modeler combines in the way that best replicates the system under study. A completely coded model consists essentially of calls to subroutines and assignment statements for updating files associated with individual customers.

GPSS is a process-oriented simulation language in which the modeler stipulates the processes involved in the system, such as creating customers, seizing servers, queuing in lines, and collecting statistics. Once this delineation is complete, the simulation language automatically creates, manipulates, and updates the necessary files. Process-oriented languages are conceptually easier to understand and easier to code than event-oriented languages, but the latter are more flexible and give modelers a wider range of options for representing systems.

SLAM is a relatively new language and potentially the most versatile of all. It allows for both event-oriented and process-oriented simulations as well as continuous simulation for those segments of a model requiring it. Figure 1 is the main portion of a SLAM program in its process-oriented mode for a one-person barber shop. The first and last lines simply frame the process being modeled. Line 2 creates customers with times between arrivals governed by an exponential distribution having mean 25. Line 3 directs each arriving customer into queue #1 to await the barber. Line 4 of the code states there is only one barber whose service times are normally distributed with a mean of 20 and a standard deviation

```
NETWORK;
CREATE,EXPON(25);
QUEUE(1);
ACTIVITY#1,RNORM(20,5);
TERMINATE,100;
END;
```

Figure 1: *The main portion of a queuing-system simulation written in the language SLAM.*

```
$D1
BAL = 0.05*BAL
$M10
END
BAL = 1000
TMAX = 25
END
LIST BAL
PLOT BAL
END
```

Figure 2: *The main portion of a bank balance simulation written in the continuous-simulation language DARE.*

of 5. This activity is designated as activity #1. Line 5 instructs SLAM to terminate a customer upon completion of service and to terminate the simulation after 100 customers have been processed. SLAM does the rest including taking the first customer in the queue and placing that person in service when the barber is free, reporting statistics on each queue and each activity designated by a number, and sampling from stipulated probability distributions. SLAM automatically creates and updates a calendar of service completion times for all customers in service coupled with the time of the next customer arrival, and at each time in chronological order, SLAM creates, manipulates, and terminates all necessary files for replicating the queuing system as stipulated in the code.

Continuous-Simulation Languages

All continuous-simulation languages are based on numerical-integration routines for solving sets of first-order differential equations, both linear and nonlinear. Many adhere to standards established by the Society for Computer Simulation (SCS) of La Jolla, California. Such languages provide modelers with a choice of inte-

gration algorithms including variable-step Runge-Kutte routines and routines for solving stiff differential equations, they allow inclusion of user-written subroutines in the host language of the source code, and they provide options for graphic output with internal scaling of axes. A continuous-simulation language can be mastered in under five hours.

The forerunner of most continuous-simulation languages is the IBM product CSMP, but there are now many others that run on a greater variety of computers. Some of these languages include CSSL-IV from Simulation Services of Chatsworth, California, ACSL from Mitchell and Gauthier Associates of Concord, Massachusetts, EASY5 from Boeing Computer Services of Tukwila, Washington, and DARE from the Department of Electrical Engineering at the University of Arizona.

Figure 2 is the main portion of a DARE program for solving a bank balance problem modeled by the differential equation:

$$dBAL/dt = 0.05BAL; BAL(0) = 1000$$

The code is separated into sections, each terminating with an END statement. First, derivatives are denoted by periods following variable labels. The first section headed by \$D1 is the operational segment and contains all the differential equations in the model. It also includes the \$Mnn line that instructs DARE as to which of ten different integration routines it should employ. The second section is the specification segment including both the initial conditions and TMAX, the length of time the simulation should run. The last section specifies output, LIST for a table, PLOT for a graph. DARE does the rest, including solving the differential equations (here there is only one), and providing appropriately scaled graphs for all output variables.

DYNAMO, supported by Pugh Roberts Inc. of Cambridge, Massachusetts, differs from other continuous-simulation languages in that it is designed expressly for social scientists using the system-dynamics approach to modeling. DYNAMO con-

Number One Add-On Products for IBM PC



The Multifunction Cards that let you get the most out of your IBM PC.

AST Research Number One Add-Ons let you realize the full potential of your IBM PC or PC-XT without wasting valuable slot space. By combining your memory and input/output requirements on a single card, you can take advantage of more of the capabilities IBM designed into the PC, while leaving space for future enhancements as they are introduced. AST Research multifunction boards can add user memory from 64K to 512K to your PC bringing your PC memory to its maximum of 640K. You also receive the added features of serial ports, parallel ports, a clock/calendar, game adapter port, and SuperPak™ — the utility diskette with the most powerful disk emulator and print spooler software available.

SixPakPlus™ — Up to 384K memory, serial port, printer port, optional game port, and clock/calendar on a single card.

I/O Plus II™ — Up to 2 serial ports, optional printer port, optional game port, clock/calendar on a single card. No memory.

MegaPlus II™ — Up to 512K memory, up to 2 serial ports, optional printer port, optional game port, and clock/calendar on a single card.

ComboPlus™ — Up to 256K memory, serial port, printer port, and clock/calendar on a single card.

Communication Products — Other AST Research Number One products include system enhancements and mainframe communications products such as 3270 SNA and 5251 terminal emulation, 3780 RJE support and AST-PCnet™ — the Local Area Network specifically designed for the IBM PC.

AST Quality

All AST Research multifunction boards come with the **AST "Plus"** — our unsurpassed reputation for quality, reliability, after-the-sales support, and overall design excellence — which give our products the best price/performance ratio in the industry.

AST Research Number One Add-On Products are available at Computerland, Entré, Businessland and other computer stores worldwide. Contact AST Research, Inc. for the dealer nearest you. (714) 540-1333/863-1333 TELEX: 295370ASTR UR

PCnet is a registered trademark of Orchid Technology, Inc.

Circle 4 on inquiry card.



AST
RESEARCH INC.

tains simple integration algorithms rendering it unsuitable for engineering simulations and does not allow easy inclusion of user-written sub-routines. Its main appeal is that modelers need not know calculus or differential equations to use the language. DYNAMO only requires modelers to code rates of change, and then it composes and solves the resulting differential equations internally. The language, therefore, is particularly attractive to modelers of social systems.

Simulation and the Personal Computer

The exciting news in computer simulation is the same story sweeping the entire computer world: microprocessors. Some languages are already available, including micro-DYNAMO for both the Apple II and the IBM PC from Addison-Wesley; SIMAN, a discrete-simulation language for the IBM PC from System Modeling Corporation of State College, Pennsylvania; MicroNET, a discrete-simulation language for a variety of personal

computers from Pritsker & Associates; ACES, a continuous-simulation language for the Apple II from Modulo 2 Company of Tukwila, Washington; and SIMSCRIPT for the IBM PC, and many others are sure to follow. Conferences, such as the 1982 Modeling and Simulation on Microcomputers Conference (sponsored by SCS), have encouraged further participation. ■

Richard Bronson is a professor of computer science at Fairleigh-Dickenson University in Teaneck, NJ 07666.

Bibliography

- For in-depth discussions of the various topics covered in this article, consult the following:
- Emshoff, J.R. and R.L. Sisson. *Design and Use of Computer Simulation Models*. New York: The Macmillan Company, 1970.
- Forrester, J.W. *Industrial Dynamics*. Cambridge, MA: Wright-Allen Press Inc., 1961.
- Forrester, J.W. *Urban Dynamics*. Cambridge, MA: The MIT Press, 1969.
- Forrester, J.W. *World Dynamics*. Cambridge, MA: Wright-Allen Press Inc., 1971.
- Forrester, J.W. "Counterintuitive Behavior of Social Systems." *Technology Review*, 1971.
- Gordon, G. *The Application of GPSS V to Discrete System Simulation*. Englewood Cliffs, NJ: Prentice-Hall Inc., 1975.
- Korn, G.A. and J.V. Wait. *Digital Continuous-System Simulation*. Englewood Cliffs, NJ: Prentice-Hall Inc., 1975.
- Lave, C.A. and J.G. March. *An Introduction to Models in the Social Sciences*. New York: Harper & Row, 1975.
- Levin, G. and E.B. Roberts. *The Dynamics of Human Service Delivery*. Cambridge, MA: Baling Publishing Co., 1976.
- Meadows, D.L. and D.H. Meadows. *Toward Global Equilibrium: Collected Papers*. Cambridge, MA: Wright-Allen Press Inc., 1973.
- Pritsker, A.A.B. *The GASP IV Simulation Language*. New York: John Wiley & Sons, 1974.
- Pritsker, A.A.B. and C.D. Pegden. *Introduction to Simulation and SLAM*. New York: John Wiley & Sons, 1979.
- Richardson, G.P. and A.L. Pugh III. *Introduction to System Dynamics Modeling with DYNAMO*. Cambridge, MA: The MIT Press, 1981.
- Roberts, N., D. Andersen, et al. *Introduction to Computer Simulation*. Reading, MA: Addison-Wesley Publishing Co., 1983.
- Schriber, T.J. *Simulation Using GPSS*. New York: John Wiley & Sons, 1974.
- Shannon, R.E. *Systems Simulation: The Art and Science*. Englewood Cliffs, NJ: Prentice-Hall Inc., 1975.
- Speckhart, F.H. and W.L. Green. *A Guide to Using CSMP*. Englewood Cliffs, NJ: Prentice-Hall Inc., 1976.

GET REAL 16 BIT POWER

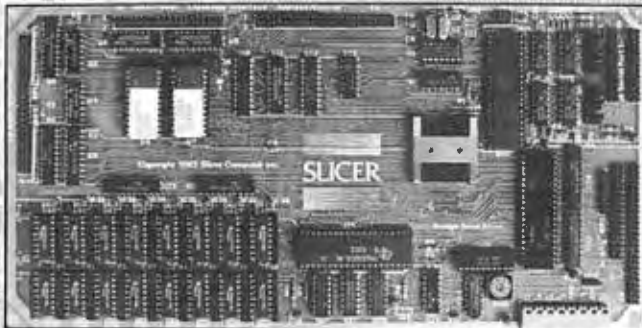

A SINGLE BOARD COMPUTER FEATURING THE INTEL 80186 (see Byte magazine April '83) THE SLICER

- Full 8MHz 16-bit microprocessor having complete software compatibility with the 8086 and 8088
- 256K Bytes of RAM plus 32K Bytes of EPROM memory capacity on board
- Floppy disk controller can run the combination of 8", 5-1/4", 3-1/2" drives simultaneously
- SASI port for hard disk controller
- Two full function RS232C serial ports with individually controlled baud rates from 60 to 38.4K baud
- BK of EPROM contains drivers for peripherals, commands for hardware checkout and software testing
- Source for monitor and bios included on disk
- Bios for CP/M 86™ supports 8", 5-1/4", 3-1/2" drives and the Xebec 1410 controller for hard disks
- Board size 6" x 12" power requirements +5 @ 3A, +12V @ 80mA, -12V @ 50mA
- Complete documentation included.

Sold in various forms:
 Assembled and tested \$1,075.00
 Full Kit 895.00
 Easy Kit (hard to get parts) 450.00
 Bare Kit (board, Rom, doc, and disk) ... 150.00
 CP/M 86™ available 85.00
 Regular U.P.S. shipping within continental U.S. is included.

THE NEW SLICER EXPANSION BOARD

- 256K bytes dynamic RAM using the TMS4500 DRAM controller
- 2 RS232C serial asynchronous ports using the Signetics SC2681 serial communications circuit with baud rates selectable from 38.4K baud to 50 baud
- 2 RS232C serial asynchronous ports using the Zilog 8530 SCC with header connectors for synchronous communications personality cards
- Real Time Clock with battery back-up using the CDP6818 RTC circuit, on-board or off-board battery
- Parallel printer port for Centronics-type printers
- Same size as the SLICER, Power: 5V @ 1.5A, +12 @ 200 mA - 12V @ 100 mA

Sold in various forms:
 Assembled and tested \$850.00
 Full Kit 650.00
 Memory Board 450.00
 3 Port Board and Clock 225.00
 Bare Board and Doc 85.00
 Regular U.P.S. shipping within continental U.S. is included.

Choose 8 MHz CPU for speed
 6 MHz CPU for speedy delivery
**SLICER COMPUTERS INC. 2543 Marshall St. N.E.
 Minneapolis, MN 55418 (612) 788-9481**

Mastercard, Visa,
 check, money order or
 C.O.D. orders accepted.
 Please allow 4 weeks for delivery.

CP/M is a trademark of Digital Research, Inc.



SAFT STANDBY POWER SYSTEMS FOR SMALL BUSINESS COMPUTERS AT A SMALL BUSINESS PRICE.

Now there's a standby power system designed especially for the small business computer. At a price the small businessman can deal with.

It's from SAFT, the hottest name in the battery business today. And although it can provide emergency power for almost anything, it was designed specifically to protect personal and small business computers from data loss in the event of a blackout or brownout.

As soon as the power drops, a Saft Standby Power System cuts in within one-

half cycle. There are two systems available. The 200VA, which provides standby power up to 20 minutes. And the 400VA with standby power up to 10 minutes. That gives an operator plenty of time to get off the computer safely. And during normal operation it acts as a line filter to protect against harmful spikes.

We can give you more reasons for depending on the Saft Standby Power System. Call us at (602) 894-9564. Or write SAFT Electronic Systems Division, 2414 14th St., Tempe, Arizona 85281.



SAFT

MORE POWER TO YOU.

Others say, "The Sky's the Limit."
We go one step beyond.

Add up to 256K of memory
in 64K increments to your
IBM PC or XT

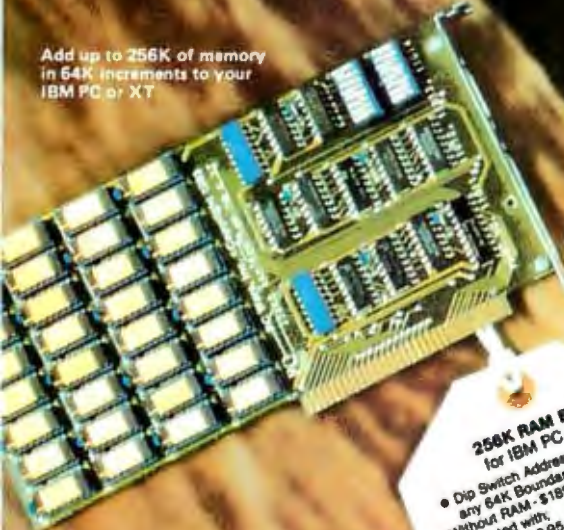

256K RAM Board
for IBM PC or XT

- Dip Switch Address Selectable on any 64K Boundaries
- Without RAM - \$189.95, Part No. 11010
- Populated with:
 - 64K \$229.95 Part No. 11012
 - 128K \$309.95 Part No. 11013
 - 256K \$349.95 Part No. 11014

This board maintains the time and date for your IBM PC or XT when you don't have to enter it when you turn the computer on. Features slots in battery holder. Battery and software included.



CLOCK CALENDAR
for IBM PC or XT

- DOS compatible
- Comes with software driver
- Will fit in any slot including the small slot in back corner
- 3 yr. Lithium battery backup

Part No. 21050 \$74.95

Connect any parallel device such as printer to your IBM PC or XT.



PARALLEL PRINTER ADAPTOR
for IBM PC or XT

- Fully IBM Compatible
- May be used as a general purpose I/O port
- 12 buffered TTL Latched outputs
- 5 buffered TTL inputs
- Fully software programmable
- Software controlled interrupts
- Reset of target peripheral device with system
- Industry standard D-shell connector

Part No. 21020 \$89.95



SERIAL COMMUNICATIONS ADAPTOR
for IBM PC or XT

- Fully IBM compatible
- Asynchronous EIA RS-232C I/O mapping (Jumper)
- Fully software programmable transmit, receive, error, line status and data set interrupts
- Diagnostic capability to provide loopback capability to provide receive and input/output signals (or equivalent)
- Powerful Intel INS8250 UART (or equivalent)
- Supports full or half duplex header
- Simple DCE/DTE configuration
- Crystal controlled baud rates, software programmable from 50 to 19200 including 134.5
- Programmable control register error checks
- Data is double-buffered
- External receiver clock input available
- Modem control functions supported (e.g. CTS, RTS, DTR, RI and carrier detect)
- False-start bit detection
- Line-break generation and detection
- Choice of 4 handshake signals (Jumper)
- DSR* and/or CTS* hardware override (Jumper)

Part No. 21010 \$94.95

Connect any serial device such as a printer, modem, plotter, mouse, terminal, etc. to your IBM PC or XT.

PC
PERSONAL COMPUTER
WARE

PC Ware, Inc.
Dept. 2
4883 Tonino Dr.
San Jose, CA 95136
(408) 978-8626

TO ORDER
In USA shipping paid by us for orders pre-paid. We accept C.O.D. orders (U.S. only). For VISA or MASTERCARD shipping charges will be added. CA residents add 6.5% for tax. Outside USA add 15% for shipping and handling. Payment must be in U.S. funds. Dealer inquiries invited. One year warranty.



Display 80 characters across and add 64K of memory. This board is for the Apple IIe only.



EXTENDED 80 COLUMN CARD for Apple IIe

- 64K RAM
- Functionally identical to the Apple version
- Part No. 22070 \$159.95



Same as the Serial Interface with many more features such as intelligent firmware.



ENHANCED SERIAL INTERFACE for Apple II and IIe

- Same features as the SERIAL INTERFACE plus:
- Powerful 8K intelligent communications and control: baud rate, interrupts, data format, parity, screen return, break, flow, parity, screen return, auto, linefeed (line mode), pass through, XOFF, XON, baud rate, parity, linefeed after (CTRL) card, data software controls: carriage return, reset (line mode), printer return, video stop, soft format, parity, linefeed after carriage return, and video stop.
- Part No. 22050 \$186.95

Connect your Apple II or IIe to a parallel printer.



CENTRONICS PRINTER INTERFACE for Apple II and IIe

- Multiple drivers onboard in EPROM (Interchangeable 2K RAM)
- Applesoft, Pascal, & CP/M Compatible
- 2 handshake lines (ACK* and strobe*)
- 4 status lines (select*, Busy, Paper out, and Prime*)
- Centronics data bit 8 may be jumpered low
- Conveniently located ribbon connector
- Part No. 22010 \$59.95
- With cable included
- Part No. 22011 \$79.95



HI-RES GRAPHIC PRINTER INTERFACE for Apple II and IIe

- Keyboard controlled screen dumps
- 23 different commands for text and graphics
- Color graphic screen dumps
- Interfaces to any dot matrix printer
- On-board printer selection
- Two page side by side printout
- Cable included
- Part No. 22080 \$149.95

Use your dot matrix printer to print high resolution graphics with your Apple II or IIe.

SERIAL INTERFACE for Apple II and IIe

- Asynchronous EIA RS-232C I/O
- Multiple drivers (up to 8) resident in EPROM optional 2K RAM
- Apple soft, Pascal, and CP/M compatible
- Full or Half Duplex
- Separate DCE and DTE Connectors
- Crystal controlled baud rate, software programmable from 50 to 19200
- Choice of 4 handshake signals
- Programmable control register
- Parity, overrun, and framing error checks
- Software programmable interrupts
- Data is double-buffered
- Choice of 4 handshake signals (Jumper)
- DCD*, DSR* and/or CTS* hardware override (Jumper)
- DMA and interrupt daisy-chain supported
- RS-232 cable included
- Part No. 22040 \$129.95

Connect any serial device such as a printer, mouse, plotter, modem, etc. to your Apple II or IIe



PARALLEL I/O INTERFACE for Apple II and IIe

- Multiple drivers onboard in EPROM (Interchangeable 2K RAM)
- Applesoft, Pascal, & CP/M Compatible
- Dual 8-bit bi-directional parallel ports
- Four handshake lines
- Conveniently located ribbon connector
- Part No. 22020 \$89.95

Connect any parallel device to your Apple II or IIe. This is a general purpose I/O port.

See us in California at the **NORTH-WEST COMPUTER SWAP** JANUARY 28, 29, 1984 San Mateo Fairgrounds MAY 5, 6, 1984 Oakland Convention Center

Simulating Reality with Computer Graphics

by Peter R. Sørensen

Since daguerreotypes became popular in the last century, we have assumed that "the camera doesn't lie." We still assume that the photos we see are accurate representations of reality. But before the invention of the camera, pictures were not taken at face value because they were hand-drawn and subject to the artist's interpretation.

The trust we place in photographs has had a profound impact on communications. It is already possible to create the appearance of metal, plastic, and glass so effectively with computers that the average viewer can't tell if the image is real or not. If techniques continue to improve at the current rate, by the 1990s it will be possible to conjure up almost any kind of scene from a digital description. The implications for entertainment, education, art, and even propaganda are worthy of note. Computer graphics is already one of the most exciting branches of computer science, and it promises to get only more exciting in the future.

Image Generation

You must accomplish two essential tasks very accurately to create believable pictures: perfect perspective and smooth, uniform shading. There are many other factors, of course, but if either one of these two is incorrect, nothing else matters. Any artist trying to paint realistically can attest to the accuracy required to fool the human eye. Although it's extremely difficult to execute flawless perspective with shadows and highlights by hand, the task can be done efficiently by computer.

To generate a picture, you must give the computer the measurements, colors, and reflective properties of the objects in the environment, the point of view of the imaginary camera, the type of imaginary lens (close-up, wide-angle, etc.), and the locations of any light sources. You give the locations in terms of X, Y, and Z coordinates, with X being the width (horizontal), Y the height (vertical), and Z the depth. Many people refer to this process and its products as 3-D because this is a three-dimensional description of the scene. In reality the images are two-dimensional, which is confusing because you can also create true three-dimensional stereo image pairs with parallax on a computer. If you want to animate the scene, you must also specify the motions of the camera and the objects. There are still two quite different software approaches to creating an image: boundary representation (B-rep), the most popular, and *ray tracing*.

With B-rep, the computer needs to determine first the distance of all the objects from the viewpoint and their orientation. Knowing where and how big the objects are (things appear smaller the farther away they are), the system projects a frame of view out into the scene and ignores everything else (called *clipping*). Next, the computer needs to decide which surfaces are



Photo 1: *Jumping Skeleton*, created by David Zeltzer of Ohio State University and done at Cranston/Csuri Productions. An artificial-intelligence program automatically animates the skeleton with realistic motion.



The line between fantasy and reality disappears

visible and which are hidden behind other objects. This is necessary because the computer has an x-ray view, seeing everything at once. To discover how brightly lit the visible surfaces are, the computer must determine their orientation toward the light source. The computer then creates the picture with lines (like a television picture) made up of dots called pixels.

Ray tracing is less frequently used but is currently gaining in popularity. In ray tracing, the computer calculates the paths taken by the light rays. This is a more natural process, except that the computer performs the process backwards: from camera to object to light source. The imaginary film plane is divided like a pixel grid—each pixel is the origin of a ray. The ray emanates into the scene until it strikes an object while the computer traces its path. The angle at which the ray strikes the object determines the angle at which it bounces off and continues on its way. The ray may go on to strike another object or go off into space.

The system can now determine pixel color and brightness from how close the ray came to the light source and how many and what other objects it struck. Everything is calculated strictly according to the rules of physics—how light reflects off different materials or passes through transparent ones—except that things are figured in reverse. If you started tracing the rays from the light source, you'd find that very, very few of them wind up going into the camera, and a lot of effort would be wasted.

A major advantage of ray tracing is that it takes care of hidden surfaces and clipping automatically, just as in real life: you see only what's in your line of sight. This technique saves a lot of computer time; however, ray tracing is still generally slower than B-rep. It's faster to find out which surfaces you can see, calculate their color and intensity, and assign that color/intensity to the appropriate pixels (perhaps hundreds at a time) than it is to calculate each pixel separately with the ray-tracing method. For this reason, most computer-graphics people shy away from ray tracing. How-

Computer Graphics in Japan

As with all things technical and artistic, the Japanese have become passionate developers of computer graphics. Just a few years ago, their first hesitant steps into scene simulation reached the West and appeared rather naïve. At second glance, however, it became obvious that they were making progress at an astounding rate. Indeed, at this year's SIGGRAPH, some of Japan's animation was among the best, in terms of both technical innovation and haunting beauty. What follows is a brief overview of some of the major people and companies involved.

Yoichiro Kawaguchi, a programmer and professor of art at Nippon Electronics College, is perhaps best known in the West. His fascination with plant-growth patterns has led him to develop a "morphological foundation algorithm" that literally grows bizarre and beautiful computer-graphics patterns, branching and spiralling with astonishing complexity. His short film, Growth, Mysterious Galaxy, brings his art to life. He points out that Dr. James Blinn (see the interview on page 120) helped him with the animation software.

Another important force, Seibu Digital Communications (SEDIC), used a Cray computer to generate the ultimate (for the moment) ray-tracing film, Mandala 1983 (see the photo at right). It represents the hierarchy of cosmic forces as a pattern of crystal spheres in a traditional meditation design, changing colors and rotating in space. Richard Hampton, an American programmer working at SEDIC, reports, "With computers coming of age, the heads of SEDIC realized that information would

soon become a tangible product. They were interested in the new media. The Buddhists created the Mandala as a means of visually communicating the true essence of the spiritual world to their followers. In the same way we are trying to communicate through the visual."

Another force in computer graphics is NHK, the huge and progressive state-run television network, responsible for several developments in computer animation including real-time video. The network's talented producer/director, Mayumi Yoshinari, has created several lovely animations, including Origami, which simulates folding an elegant paper bird in space.

Dr. Kouichi Ohmura of Osaka University assembled a remarkable experimental parallel-processing computer, LINKS, that in many ways outperforms the Cray. LINKS uses dozens of Z8000 microprocessors, each working on a different aspect of the image, producing all kinds of computer graphics including cartoon animation and ray tracing. LINKS was recently used for some special effects in a movie called Gogol 13. Keep your fingers crossed that it is shown in the United States.

The Japanese Computer Graphics Lab is mainly a cartoon-animation facility using several New York Institute of Technology systems for painting hand-drawn characters, but they are becoming involved in simulation. Texnai, a design firm, specializes in computer graphics. Far East Labs uses a system built in Dallas by Acme cartoon as well as a trusty old Scanimate analog computer.

ever, if you want the superb realism of reflection and transparency, you'll have to spend a little extra time. (This article is *not* an exhaustive comparison of software; there are exceptions to all the rules, and the intent here is to present only an overview.)

Picture generation with a computer is extremely time-consuming, no matter what method you use. Most of the animation in *Tron* took an average of 15 minutes per frame; some took considerably longer. The degree of resolution (the clarity) that you want a picture to have, determined by the number of lines and pixels used to make it, is an impor-

tant factor in computation time. If you double the number of lines used to get a higher-quality picture, you quadruple the number of pixels used and the amount of time needed. Video pictures have 512 lines, or a quarter of a million pixels. That's very low resolution by the standards of motion pictures; the lowest resolution used in *Tron* was 1,200 lines. When the resolution is very low, you can see the pixels as little squares, which result in diagonal and curved lines having a stair-stepping appearance that's technically known as *aliasing*, commonly called the jaggies. Even at rather high resolutions where



Mandala 1983, a remarkable ray-tracing image done on a Cray in Japan by SEDIC Inc. Musaki Fujihata was the creative director; Kenetsu Hanabusa and Masataka Ohta were the technical directors. With reflections of reflections clearly visible, the picture took the Cray eight minutes to compute at 1024 by 1024 resolution.

the pixels aren't obvious, aliasing can cause edges to "crawl" as objects move, and very small details to flicker on and off.

There are two approaches to the aliasing problem: use very high resolution (tests show, however, that even at 6000 lines there is room for improvement) or try *anti-aliasing* (average the pixels out with their neighbors so the jaggies are blurred and less noticeable). Anti-aliasing tends to soften the whole picture, so you should attack only the offending pixels, which is a pretty tricky process. This smoothing process can save time but it requires some time

itself. The decision to use anti-aliasing or high resolution is another point of disagreement among people involved in computer graphics.

Another graphics aspect that is far from being standardized is how a computer models objects. The approach usually used with B-rep is to describe objects in terms of polygons or patches, with front, side, top, and other views. This concept is relatively straightforward and makes even the oddest shapes definable. There are also more sophisticated methods of defining surfaces that rely on higher orders of mathematics, such as *quadratics*.

Another approach, *combinatorial geometry*, is like building with blocks—"primitive" geometric shapes such as cubes and spheres that are known to a computer—that you can add to or subtract from each other to make compound shapes. You can stretch and distort these shapes (creating an egg from a sphere, for example). You enter the instructions on the keyboard after you sketch the desired shape and think through the construction process. It's not nearly as natural a process as the B-rep method; in fact, you may need to input additional information on a data tablet to create complicated shapes such as type fonts. However, it has advantages: it requires very little memory space, and you get perfectly smooth surfaces without having to take a step to blend the edges of polygons. A sphere is defined by its center point and radius; the B-rep method requires a great many polygons to define a sphere.

Computing the way light reflects off things or passes through them is a subject in itself. The methods have been evolving and becoming more like a study of physics every year. It is now routine to define the subtle differences between the optical properties of plastic and glass, chrome and pewter, ceramic and plastic, and many subtleties in between. In the early days, all surfaces were considered mirrors, bouncing light off themselves and diffusing it equally in all directions according to Lambert's Law. Then Bui-Thong Phong created a more realistic formula that introduced more light-control variables. Now we have the Torrance-Sparrow model, which considers the object's surface to be covered with randomly oriented microscopic mirrors; this comes remarkably close to approximating real life.

What if you want to create a wooden or patterned object? You can scan a photograph or painting with a digital TV camera and project the image onto the surface of your object. This process is called *mapping*; it's the reverse of making a flat world map from the earth's curved surface. With a curved surface like a planet's, the



Photo 2: *Point Reyes*, perhaps the most complex simulated picture to date, was done by the digital magicians at Lucasfilm. "The piece is very much a team effort, a one-frame movie," with mountains, rocks, and lake created using fractal programs written by Loren Carpenter, plants by Alvy Ray Smith and Bill Reeves, and textures by Tom Porter. All of the art was directed by Rob Cook, who created many of the details, including the rainbow.

picture wraps around the object and gives it a natural-looking perspective as it moves about. You can also map certain kinds of textures onto surfaces, like the bumpiness of an orange, with each bump having its own shadow (a process known as *perturbed normal texture mapping*, developed by Dr. James Blinn of the Jet Propulsion Laboratory).

So far I have focused on generating a single realistic image. There are a few additional considerations if you want to animate a scene. You must choreograph the motion desired and describe it to the computer. You can trace it out on a data tablet or type in commands, like a movie director telling the actors what to do: "Go from point A to point B taking three seconds and accelerating as you move." Directions must be given in

the language of the software. The motion becomes rather complicated when you have moving parts on moving objects in a scene observed by a moving camera. A classic example is a flea walking around on an elephant's head while the elephant nervously paces back and forth on a raft floating down a river. The camera's view is called the world space, the raft is a parent space, the elephant is a daughter space of the raft, and all the elephant's appendages, to say nothing of the flea, are daughter spaces of the elephant. All this is handled by a tree structure showing these various relationships.

Motion is an important element in making or breaking the believability of an image. When a ball bounces, its acceleration and trajectory tell a lot about it; a Super-Ball behaves one

way, a Nurf Ball another. To more precisely portray motion, some computer-graphics designers are beginning to incorporate artificial-intelligence routines into their software.

The last step involves turning the millions of bytes into a picture on a monitor or a piece of film. Essentially it's a straightforward process of converting digital data to analog form. You can then record the signal on videotape or display it on a monitor. In the case of movie film, the signal paints the picture on a high-resolution monochrome video display mounted beneath a movie camera that shoots one frame at a time. The camera's shutter stays open while the computer generates three consecutive images, using color filters for each of the three primaries.

Some people ask, "Why bother?"

Gifford has a lock on multiuser CP/M[®] 8-16.

It's 11:00 P.M. Do you know where your files are?

It's great when multiple local and off site users can run any 8- or 16-bit CP/M or MP/M™ program. It's even better when they can share expensive resources like printers, hard disks, and tape drives. Best of all is when they can share your most precious resource— data. Gifford has been delivering systems with all these features for over two years.

But sometimes data is sensitive. How do you keep people from taking more than their fair share?

Gifford adds a new dimension to CP/M security.

With our new security features, you can control what resources and data are shared.

Gifford's proprietary security enhancements include user login with encrypted passwords, control over access rights of modem users, secure electronic mail, and the ability to restrict users to specified terminals, programs, and directory areas. Plus, an audit log utility that keeps a permanent record of system activity. And you also get all the standard security features of Digital Research's MP/M-86™

You select the level of security needed to get the best balance between file sharing and file safety.

Unleash productivity with Gifford's Virtual Terminals.

With our Virtual Terminals, each terminal on your system can monitor up to four different programs running concurrently. And at the touch of a key you can switch screens instantly from one program to another.

You could look up an address in dBASE II™, jump over to SuperCalc™ to make some projections, then switch instantly to WordStar® to use this information to update a letter. If you forget what's on a screen, just touch a key to refresh your memory. You won't need to go through the distracting process of loading and unloading programs.

And since your Virtual Terminal can run any 8- or 16-bit CP/M or MP/M program, you can choose the best programs for your job from the biggest software library in the world. It's easier than 1, 2, 3!

The Gifford Security Blanket: Total Solutions.

Gifford delivers solutions. This means professional pre-sale consultation, expert system integration with 200 hour system burn-in, complete training, and full after sale support.

For example, our three user CompuPro® based system with a 21-megabyte hard disk costs just \$9,990, and can be easily expanded for \$500 per

user. This includes MP/M 8-16, SuperCalc, and dBASE II.

Other Gifford solutions include systems with hard disks that range from 5 to 300 megabytes, 4 and 9 track tape backup, printers, plotters, and modems. Single- and multiuser 8086, 68000, and Z-80 based systems are available for immediate delivery, with 80286 and 16032 systems on the way.

Two year warranty protection.

In the unlikely event that you encounter a hardware related problem, we'll replace any defective S-100 part within 24 hours FREE for two full years. But chances are, it can be solved on the Gifford service hotline or diagnosed via modem. All at no cost to you.

Lock in on Gifford Security today.

If total support, training, on site service, obsolescence-proof upgradeable S-100 bus architecture, and complete system security sound appealing, cut the coupon or give us a call. We'll send you a free brochure that tells the whole story. Once you get it you'll see why Gifford has a lock on multiuser CP/M 8-16.

Gifford Computer Systems is a Full Service CompuPro® Systems Center.

The powerful Gifford System 321 shown with optional GCS-80 Virtual Terminals.



GIFFORD
COMPUTER SYSTEMS

2446 Verna Court, San Leandro, CA 94577
(415) 895-0798 A division of G&G Engineering
I'D LIKE THE WHOLE STORY.
Please send me your brochure.

Name _____ Title _____
Organization _____ M/S _____
Address _____
City _____ State _____ Zip _____
Phone _____
 Please have a representative call me. **BY-S**

GIFFORD COMPUTER SYSTEMS San Leandro, CA (415) 895-0798 Los Angeles, CA (213) 477-3921 Houston, TX (713) 680-1944
Amherst, NY (716) 833-4758 Telex: 704521



Photo 3: Alvy Ray Smith, with the help of colleagues at Lucasfilm, created this deceptively simple-looking work of art entitled *White Sands*. The flowering plants are grown in three dimensions from a single "cell" using an algorithm written by the artist, based upon mathematics by Paulien Hogeweg. The grass is done with a procedural modeling technique developed by Bill Reeves. The oriental characters form the artist's name.

Why not just take a camera and film the real thing?" Obviously, if you *can* film the real thing, you should. But if you want to film a Model T turning into a Thunderbird, in an improbable but believable organic metamorphosis, scene simulation is the only answer. Or, if you want impossible camera angles, like an atom's-eye view of a molecule, or a tour around the inside of a computer chip (anything that defies the physically possible), image synthesis is often the only way to go. Frequently used in TV commercials, this technique promises to become in the near future an economical alternative to constructing movie sets and to some kinds of location shooting. Image synthesis is important in other fields too, such as medical CAT-scan imagery, product design, and flight simulation. As miniaturization progresses, we can look forward to many of the capabilities now available on mainframes becoming possible on microcomputers.

There are obviously a great many doors opening in computer graphics today. I interviewed several major figures in the field, including John Whitney Sr., generally regarded as the "Father of Computer Animation," and Dr. Alvy Ray Smith, who is

working on George Lucas's remarkable computer-graphics research and development project. The insights and advice from these experts cover all aspects of the field. They occasionally even contradict one another, which doesn't mean one is right and the other wrong, but rather indicates that this business is still very much in its formative years.

Alvy Ray Smith (Lucasfilm)

The work being done at Lucasfilm is revolutionary and almost certain to have a profound impact on the entire entertainment industry. George Lucas, creator of the *Star Wars* saga, became interested in the possibilities of computers several years ago, hired a team of the best software and hardware people he could get, and gave them a mandate to develop a system that would bring motion-picture special effects into the 21st century. He actually wanted several different systems to provide different capabilities: computer imagery, digital matting, sound synthesis and mixing, a laser scanner to print the final product onto film with first-generation quality, and a totally computerized editing studio called EditDroid, with all the footage shot for a film on video-

discs, enabling totally interactive editing.

The team developing the Pixar image generator included Rodney Stock, Adam Levinthal, Mark Leather, Glenn Sharp, and Tom Porter on hardware; Alvy Ray Smith, Rob Cook, Bill Reeves, Sam Leffler, and Loren Carpenter on software; both groups were directed by Dr. Ed Catmull. They set a three-year goal and put their noses to the grindstone, pausing only briefly to create film footage—the "Genesis Demo" for *Star Trek II* and the display of the force field around the moon of Endor in *Return of the Jedi*. The work progressed on schedule despite the inevitable difficulties, but rumors of failure began to circulate among the competition.

My first question to Smith concerned whether the project was doomed. "These rumors probably came about because people have been expecting us to do all this in three weeks. All prototype devices have difficulties—that's normal. We said it would take about three years; the three years are just about up, and the system is just about to roll out the door. We're very pleased. The boards for our Pixar are starting to come in, our laser scanner is now making color moving pictures, software systems are up, and we're doing a little in-house film with motion blur and all to demonstrate the system's capabilities." (Motion blur, sometimes called temporal anti-aliasing, is very difficult to simulate, but it adds a great deal to the natural quality of an object's motion.)

Why did Lucasfilm decide to build their own hardware from scratch, with all the time and risk involved, instead of buying a system off the shelf? "You can't just buy something like that," Smith said. "True, there are supercomputers that we would be glad to use, but even they are a little slow for what we want to do. So while we are waiting for the price of these machines to drop, we are building a machine especially designed to implement graphics algorithms—one that costs significantly less.

"You know, we are *not* limited to scene simulation, so I much prefer

WORDS FOR THE WHY'S.

When you're ready to learn more about computers, you're ready for Ashton-Tate books.

We've assembled a rapidly-growing library of micro-computer-related books that cover the why's and wherefores of computing, not just the how-to's.

Whether you're a novice or a techie, you'll find that Ashton-Tate books are a quick, economical way to help you get the most from your computer.



Through The Micromaze, by Wayne Creekmore
Micros made simple. 64 pages of colorful and helpful illustrations, diagrams and visual aids, all designed to make computers less intimidating. Suggested retail price \$9.95.

Reference Encyclopedia for the IBM® Personal Computer, by Gary and Karen Phillips
Now in its second edition, this 2-volume set gives PC owners the meaning behind the manuals. Plus current information on compatible hardware and software for the IBM PC and XT.™ 1,000 pages. Suggested retail price \$69.95.

Data Management for Professionals, by Bryan Lewis
How data management can be applied to different fields—medicine, law, dentistry, pharmacy. Suggested retail price \$15.95.

Everyman's Database Primer, by Robert A. Byers
Concise. Witty. Ranges from how to turn on a computer to how to design a relational database system. Suggested retail price \$19.95.

dBASE II® for Every Business, by Robert A. Byers
Information-filled follow-up to "Everyman's Database Primer." Includes dBASE II applications development, debugging, documentation. Suggested retail price \$19.95.

Application Junction
A unique reference guide to specialized dBASE II applications—14 different fields, including insurance, legal, medical and financial. Suggested retail price \$19.95.

dBASE II for the First Time User,* by Alan Freedman
A highly visual introduction to data management for computer novices. Suggested retail price \$19.95.

System Design Guide, Featuring dBASE II*, by Ron Freshman
Provides a step-by-step approach to the design of data management systems. Suggested retail price \$18.50.

dBASE II Guide for Small Business*, by Robert T. Schadewald
A host of practical dBASE II programs to help run a small business. Hints on customizing particular applications. Suggested retail price \$24.95.

IBM PC Public Domain Software, Vol. I*, by Gary Phillips
Guide to public domain software currently available for the IBM PC. Selected program reviews. Suggested retail price \$24.95.

Advanced Programmer's Guide*, by Jay Hanson, Thomas Rettig and Luis Castro
Culmination of problem-solving experiences as well as latest developments in dBASE II language. Suggested retail price \$28.95.

Ashton-Tate books are available at computer and software stores and at many bookstores. For the name and location of your nearest Ashton-Tate dealer, contact Ashton-Tate, 10150 West Jefferson Boulevard, Culver City, CA 90230. (213) 204-5570.

ASHTON · TATE ™

*Early 1984 release. Ask your dealer or Ashton-Tate for details on availability. dBASE II is a registered trademark of Ashton-Tate. IBM and XT are trademarks of International Business Machines. © Ashton-Tate 1984



Photo 4: Using the manufacturer's blueprints, the Cray at Digital Productions simulated this Pontiac Fiero, which assembles itself from pieces that fly in from all directions. Mario Kamberg and Jim Rygiel were the creative and technical directors, respectively. (Digital Scene Simulation (sm) by Digital Productions, Los Angeles, CA. ©1983, all rights reserved.)

the term *computer imagery*. Reality is only a measure, not a goal."

Advice? "It's not easy to get into computer graphics, but I suspect it's going to get easier. People will be making pictures with computers from now on, and anyone who knows how will be in demand. Go to school and learn how to program; find out how graphics algorithms work."

Photos 2 and 3 are examples of Lucasfilm's work.

Patricia Cole (Atari)

The people at Atari's advanced graphics research and development division are interested in both games and motion-picture special effects and work at times with Lucasfilm. Pat Cole is in charge of the division and was previously with Lucasfilm, the Jet Propulsion Laboratory, and NASA.

The creation of the computer-generated visuals for *Superman III* in 1982 was one of her first jobs. "*Superman* needed the immediate visual impact of a video game, but with better than current game technology. We decided to do a two-and-one-half-dimension

computer animation. [Flat images with some spatial aspects are called 2½-D.] We built a software system for this on top of an existing system we use to develop our games, programming in LISP on a Symbolics LM2 under Paul Hughett's leadership. In the meantime we have also been establishing a full-blown three-dimension image synthesis animation facility—technology which is literally right around the corner for us. This is primarily oriented toward developing videodisc games, but we aren't drawing too many boundaries. As the facility grows and develops a personality of its own, we want to be able to do other types of projects."

Cole offered some advice. "The first decision a person has to make is whether they're more interested in the creation aspect or the technical aspect. This isn't necessarily an either/or situation, but the ideal is to have some people who are primarily creative and others who are primarily technical, knowing that talents overlap and merge. I don't encourage artists to go back to school and get a degree in math, but you should get as much experience, even working on

a home computer, and exposure—going to conferences and seminars, like SIGGRAPH—as you can. Become familiar with the jargon and with the capabilities and boundaries of the technology. Similarly, people with a technical background would benefit greatly from a basic course in design and from visiting art museums and getting an appreciation of the artistic world. The ideal goal is a common visual vocabulary, a common communication, so that this overlapping knowledge can increase."

John Whitney Jr. (Digital Productions)

The world's most powerful production computer, according to *The Guinness Book of World Records*, is the Cray XMP. The first of these magnificent beasts belongs to Digital Productions, a company founded by John Whitney Jr. and his associate Gary Demos. (Photo 4 was created by Digital Productions.)

Growing up immersed in state-of-the-art movie technology, Whitney did the first computer graphics for Hollywood movies, *WestWorld* and *FutureWorld*, at Information International Inc. (Triple-I), working with Demos. They coined the term Digital Scene Simulation*. In 1982, Whitney and Demos got the funding they needed to lease their first Cray 1/S. It had about one-third the power of the current model, but it was the most powerful machine available at the time. Soon after they opened shop, Lorimar Productions brought them their first job: to do about 40 minutes worth of simulation for *The Last Starfighter*.

"Getting the XMP is a major development. The combination of the new hardware and continued improvements in software will give Digital Productions a major thrust forward. Databases of 1 million polygons on the 1/S computer began to require an unacceptable amount of time per frame. We hope to compute scenes with the XMP on the order of 1 million polygons plus and still maintain a speed of 200 seconds per

*Digital Scene Simulation is a service mark (sm) of Digital Productions.

Taxan monitors - engineered for style and performance

Styled to compliment Apple, IBM and most other personal computers, and designed to fit in any office or home.

☉ **TAXAN** offers a complete line of monitors including green and amber, ultra-high resolution monochrome, plus medium and high resolution RGB monitors

☉ **TAXAN** features the 410-80, 80 column and RGB Card to interface with the Apple IIe.

☉ **TAXAN** monitors stand alone

Circle 390 for Dealer inquiries.
Circle 391 for End-User inquiries.

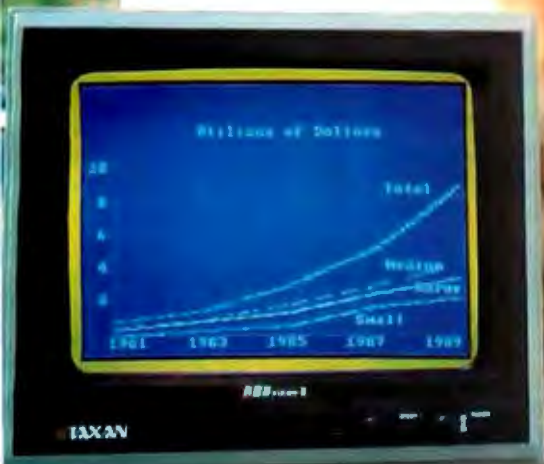

See your local ☉ **TAXAN** dealer, or call us for details

TSK Electronics Corporation
18005 Cortney Court
City of Industry, CA 91748
(213) 810-1291



Photo 5: *Low Tide*, by Peter Oppenheimer. These seashells with the patterns mapped onto their surfaces were generated by a spiral growth-simulating algorithm. (© New York Institute of Technology Computer Graphics Lab.)

frame, where we like to be. Even so, our appetite for greater scene complexity never seems to end."

To talk to the Cray, Whitney explained, "Digital Productions uses a VAX 11/782, which is a user-friendly, interactive front-end processor. The VAX provides a programming environment for software development and handles front-end operations for productions that are not practical on the Cray. We also have the Cray I/O [input/output] subsystem (a buffer memory and multiple-processor computer that provides access to the XMP high-speed channel) in operation at this time. The high-speed channel is required to optimize high-bandwidth data transfer, desirable for film recording and scanning operations, and to more efficiently utilize color-monitor workstations.

"Many organizations today claim to use computers for special effects, but the claims are often exaggerated. Using an Apple, for example, in a process- or numerical-control installation [i.e., a small computer running a mechanical process such as a motion-control rig] hardly constitutes computer graphics. Also, many creative and talented art directors are working with computer graphics

where the computer output is only a small part of the end product. I would advise art directors not to become used to this sort of interim, transition-level computer graphics. Simulation implies an ability to create live action with a high-performance computer. In special-effects production, this means that the struggle to combine a half-dozen different techniques is as passé as a turn-of-the-century sweatshop. The challenge to the art director who wants to create something unique and refreshing is to remain open-minded in exploring mature simulation opportunities."

Whitney's advice: "A background in computer science oriented toward graphics is certainly a basic requirement. Beyond that, if someone is serious about pioneering in the field, then numerical analysis and very high-level mathematics are mandatory. There are a few institutions, MIT, Cornell, and the University of Utah, that offer graduate educational opportunities in computer graphics."

Howard Gutstadt (General Electronic Systems Inc.)

Of course, graphics can be done on microcomputers. General Electronic Systems Inc. (GESI) is doing that

very intensively. The company is building systems for industrial video applications capable of doing two-dimensional and some three-dimensional animation with the new Sony microcomputer. The system is a natural for a videodisc arcade game that overlays real-time graphics on top of the disc images.

I asked Howard Gutstadt, GESI's vice president, why the company uses the Sony instead of a more popular machine. He responded, "One strong rationale is that the Sony is designed to interface more effectively with video-type applications than other micros. It combines an inexpensive approach to computer graphics with a reasonable color palette and a sophisticated approach to machine control of videodiscs. It contains all the necessary I/O to control the associated machines. In addition it has two other very important features: genlockable input for video (the computer can be on line between the source materials and resulting video materials and still give you video that meets the standards of the National Television System Committee; for microcomputers that's a real pain to achieve) and specialized circuits (you can integrate the graphics you generate with the disc material, avoiding the need to buy a post-production switcher). In addition, you can write any interactive scenario in software and run it with graphics from a floppy. And it's all relatively inexpensive—the central processor is less than a thousand dollars."

Lance Williams (New York Institute of Technology)

People in the field consider the New York Institute of Technology (NYIT) to be one of the foremost centers for computer-graphics research and development. (See photo 5.) NYIT is also a hardware producer and a production facility for all kinds of state-of-the-art animation. The Computer Graphics Lab was founded in 1974 with Ed Catmull (now with Lucasfilm) in charge. Many greats in computer graphics, including Jim Blinn and Alvy Ray Smith, have passed through its doors and contributed to the evolution of

People are going for Friday!™ like there's no tomorrow.

Friday! is the new electronic file handling system that has become an instant best-seller because it's so revolutionary.

Within two weeks, it broke into the Top 20 on the sales chart of Softsel, one of the country's leading computer software distributors.

And it's now well on its way to the top.

The Friday! phenomenon is simple.

Friday! uses simple menus and talks to you in plain English, so almost anybody can use it.

It's great for sales and commissions, clients and portfolios, mailing lists and labels, invoices, inventories, paychecks, reports and more. And it works with other microcomputer software like 1-2-3™ and dBASE II® (our own advanced database management system).

It comes with a complete, step-by-step tutorial, but you can set up an "electronic file" without even looking at the manual, then use it at the touch of a few keys.

Friday! finds any filed information in seconds. Computes totals, subtotals, commissions, etc. Prints form letters and mailing labels. Gives you quick reports from all or part of a file with a few key-strokes. Or if you need a special report for



your bank or board of directors, just "paint" the format on your screen, then have Friday! do all the work.

And while Friday! does more than file handling systems selling for as much as \$495, it's yours for just \$295 (suggested retail price)!

For more information, contact Ashton-Tate, 10150 West Jefferson Boulevard, Culver City, CA 90230. (800) 437-4329 ext. 202. In Colorado, (303) 799-4900. In the U.K., call (0908) 568866.

Or for the name of your nearest dealer, just call 1-800-4-FRIDAY, ext. 202.

ASHTON · TATE

©Ashton-Tate 1983. Friday! is a trademark and dBASE II is a registered trademark of Ashton-Tate. 1-2-3 is a trademark of Lotus Development Corp.



Photo 6: An X-Wing fighter done by Art Durinski at Information International Inc.'s now closed motion-picture division. (This image was created for the cover of IEEE Computer.) The successful simulation of the Star Wars spacecraft convinced George Lucas that scene simulation is an important special-effects tool.

the systems there. Today, Lance Williams spearheads development. He is working on, among other things, a system called 3-DV. It will be composed of off-the-shelf components including a 68000 microprocessor and an Adage high-performance bit-slice processor, running scene-simulation software. Williams said he expects the system "to be two or three times as fast as a VAX."

At the time of this writing NYIT has eight VAXes, two DeAnza array processors, two floating-point array processors, many frame buffers, and three Ikonas processors with a lot of frame-buffer memory on them. Much of the Institute's work is done on video, both 2-inch and 1-inch, and film recording is done with a Dicommed or one of two Dunn Boxes.

NYIT has a computer-graphics course taught by Robert McDermott. In addition, there are computer painting facilities in the design department, computer special-effects facilities in the TV department, and an Evans & Sutherland Picture System with three-dimensional modeling capabilities in the architecture department. NYIT's main facility, however, is an independent research and development department that is not part of the school proper. "We have hired students here to work as computer operators," said Williams, "but there are not enough people involved to recommend this as an entry into a career.

"Usually I recommend that you get a technical background; even if your major interest is design, it will help

a lot to have technical skills. You'll be able to do more with the machine and to get jobs. You have to acquire some technical expertise. The first thing is to learn a trade, a basis you can build a career on, developing some sound, expensive skill. You want to become a good programmer and a good animator. Animation is a dying art. There aren't many places that teach it anymore. [Exceptions include the California Institute for the Arts and the Rhode Island School of Design.] Also learn as much as you can about photography. Computer graphics is an exploding field. The opportunities are springing up everywhere, although the competition is stiff."

Art Durinski (Freelance Designer)

Tron, unfortunately, wasn't a blockbuster movie. Consequently, the moguls of motion pictures threw the baby out with the bath water and assumed that the public wasn't interested in computer graphics. That was very unfortunate for many computer-animation companies. The firms were expecting a lot of business after *Tron* and some of them went out of business instead. Triple-I, which had done the Solar Sailer and the MCP for *Tron*, closed its motion-picture division within a year of the movie's release, putting some of the most talented engineers and designers out on the street. This included designer/director Art Durinski. For a while he worked with Digital Productions, but eventually he decided to go independent as a freelance consultant.

"The popularity of computer graphics in entertainment," he said, "isn't rising as quickly as expected. It's going to take a major successful movie. Hopefully, *Starfighter* or *Gogol 13* will be nicely stylized and have a good story. That could do it. In four or five years, people will accept the computer look as a new kind of reality. (See photo 6.) I don't agree with the philosophy that everything must look photographically real. Computer graphics should have its own unique and exciting look, and not necessarily try to pass itself off as real. *Tron* and *Fantasia* were never

PIECE OF MIND

CompuPro's System 816.

The fastest, most cooperative computer you can buy.

OEMs and systems integrators are busy people. Too busy to waste time with an uncooperative computer system. That's why every System 816 from CompuPro is built to work long and hard without a whine or a whimper.

More Dependable.

With ten years of pioneering successes built into it, the System 816 is backed by the industry's longest warranty coverage. Depending on your needs, our warranties range from 12 to 36 months. Most other computer manufacturers expect you to be satisfied with 90 days, which typically covers parts only.

You can also depend on complete hardware and software support, flexible configurations and upgrades, and system training.

More Powerful.

The System 816 squeezes more performance out of the IEEE-696/S-100 bus than any other system you can buy. A choice of CPUs—and up to 4 Mbytes of our exclusive M-Drive/H™ RAM disk—give multiple workstations all the speed and power they can ask for. Standard RAM memory is expandable to one megabyte or more.

Disk storage capacity ranges up to 4.8 Mbytes on floppy drives and as much as 320 Mbytes per controller on hard disk.

CompuPro®

A GODBOUT COMPANY

3506 Breakwater Court, Hayward, CA 94545

CP/M and CP/M-86 are registered trademarks and CP/M-68K, MP/M-86, Concurrent CP/M-86 and FORTRAN 77 are trademarks of Digital Research Inc. CP/M 8-16 and MP/M 8-16 are compound trademarks of Digital Research Inc. and CompuPro.

Circle 78 on inquiry card.

More Versatile.

All family members share a common modular architecture. So it's a simple matter to upgrade or reconfigure any of them to keep up with your needs. All the while maintaining complete software compatibility up and down the line.

And the S-100 bus allows you the flexibility to plug in any compatible board to add graphics capabilities or boards for your own unique applications.

You also get your choice of operating environments, including CP/M®, CP/M-86®, Concurrent CP/M-86™, MP/M-86™ and CP/M-68K™, and our own CP/M®8-16™ and MP/M™8-16™.

At the programming level, the System 816 family supports Pascal, C, FORTH, BASIC, COBOL, PL/1, FORTRAN 77™ and more.

More Information.

Your customer's satisfaction is important to both of us, so don't get stuck with a system that's more of a hindrance than a help. Send in the coupon and find out what peace of mind is all about.

For business, scientific and industrial computing solutions, call (415) 786-0909 ext. 506 for the location of our dealers worldwide, or the Full Service CompuPro System Center nearest you.

- Send me your OEM/Systems Integrator information package.
- Send me your free catalog with warranty information.

NAME _____

TITLE _____

ADDRESS _____

CITY _____ STATE _____ ZIP _____

TELEPHONE _____

Mail to: CompuPro, Attn: Sales Dept.

3506 Breakwater Court, Hayward, CA 94545

Prices and specifications subject to change without notice.

System 816 front panel design shown is available from Full Service CompuPro System Centers only.

©1983 COMPUPRO

For dealer locations see page 461.

BYTE March 1984 119

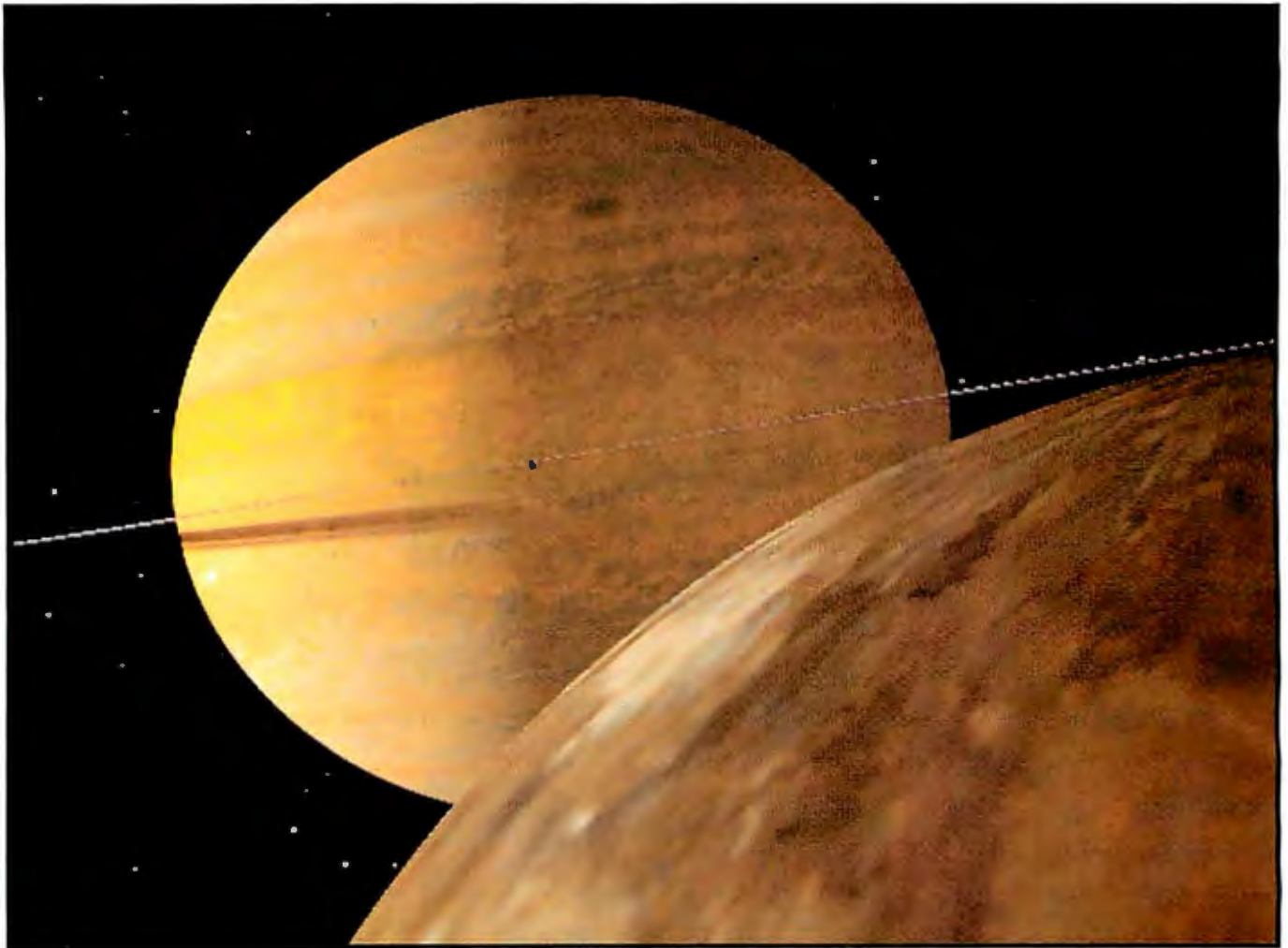

Photo 7: Saturn seen from her moon, Rhea, as rendered by James F. Blinn at Cal Tech's Jet Propulsion Laboratory for NASA's computer-generated film about the flight of the Voyager spacecraft. The surfaces are painted flat and mapped onto the spheres.

meant to look real, but they hold together beautifully."

Durinski's advice: "If you are excited about this field, just coming out of school, changing careers or whatever, I don't think that there is an easy way into three-dimensional computer graphics in entertainment yet. You might get a job at an analog house first and then migrate into three-dimensional animation when a job opens up. The situation in TV is much better than in films right now, but the opportunities are not really there yet."

James F. Blinn (Jet Propulsion Laboratory)

One of the foremost innovators in scene-simulation software, Dr. James F. Blinn, studied at the University of Utah in the early 1970s. Dr. Ivan Sutherland was teaching there then and it was a mecca at the time for

people interested in computer graphics. Since then, Blinn has worked at a number of places including NYIT, Triple-I, and Lucasfilm, but mostly at the Jet Propulsion Laboratory at Cal Tech. There he combines his three loves: computer graphics, astronomy, and teaching. His animations of the Voyager missions to Jupiter and Saturn are very well known, having been broadcast by all the national networks when the spacecraft was passing those planets (see photo 7). The imagery was so realistic that many people were puzzled as to which were the synthesized pictures and which were the real ones sent back by the ship's cameras.

Blinn is currently doing animations illustrating the laws of physics for Community College Television's series, "The Mechanical Universe." He is working with Cal Tech professor David Goodstein, the writer/de-

signer of the series. One program, for instance, shows how the movement of the planets is a natural consequence of Newton's laws of motion, and why the planets have elliptical orbits. The animation is done on a VAX 11/780 with a DeAnza frame buffer and is recorded on 1-inch tape using a Lyon/Lamb controller.

When asked about the poor performance of *Tron* at the box office despite the beautiful special effects, Blinn pointed out, "A human being makes a good movie—not a committee. Powerful figures like a George Lucas or an Alfred Hitchcock make a good movie because it's their movie, their creative energy. They don't have a group of bankers telling them what to do."

Although many people in computer graphics demand state-of-the-art systems, Blinn's reaction to that approach was, "State-of-the-art

PRO-MODEM 1200



It's about time.

Time for your computer to make the telephone connection – with an intelligent, full 212A 300/1200 baud modem – with a real time clock/calendar – and with the capability to expand into a complete telecommunications system. It's time for PRO-MODEM 1200. Much more than just a phone modem.

When you're on-line, time is money. PRO-MODEM telecommunication systems help you save. By monitoring the duration and cost of your phone calls. And by sending and receiving messages, unattended, at preset times when the rates are lower. . .with or without your computer.

Compare the \$495 PRO-MODEM 1200 with any other modem on the market. For example, you'd have to buy both the Hayes Smartmodem 1200 plus their Chronograph for about \$950 to get a modem with time base.

PRO-MODEM 1200 is easy to use. A convenient "Help" command displays the Menu of operating command choices for quick reference whenever there's a question about what to do next. Extensive internal and remote self-diagnostics assure that the system is operating properly. Some of the other standard features include Auto Answer, Touch Tone and Pulse Dialing, and Programmable Intelligent Dialing.

PRO-MODEM does more. It lets you build a full telecommunications system with features like Auto Dialer, Incoming and Outgoing Message Buffering, Business/Personal Phone Directory, Programmable Operating Instructions, a 12-Character Alpha-Numeric Time and Message Display, and versatile PRO-COM Software. PRO-MODEM commands are Hayes compatible so you can use most existing telecommunications software without modification.

There's much more to the PRO-MODEM story. See your local dealer for complete details. He'll show you how to save time. And money.

Prometheus Products, Inc., 45277 Fremont Blvd., Fremont CA 94538, (415) 490-2370

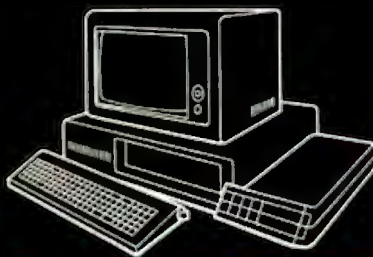

PROMETHEUS

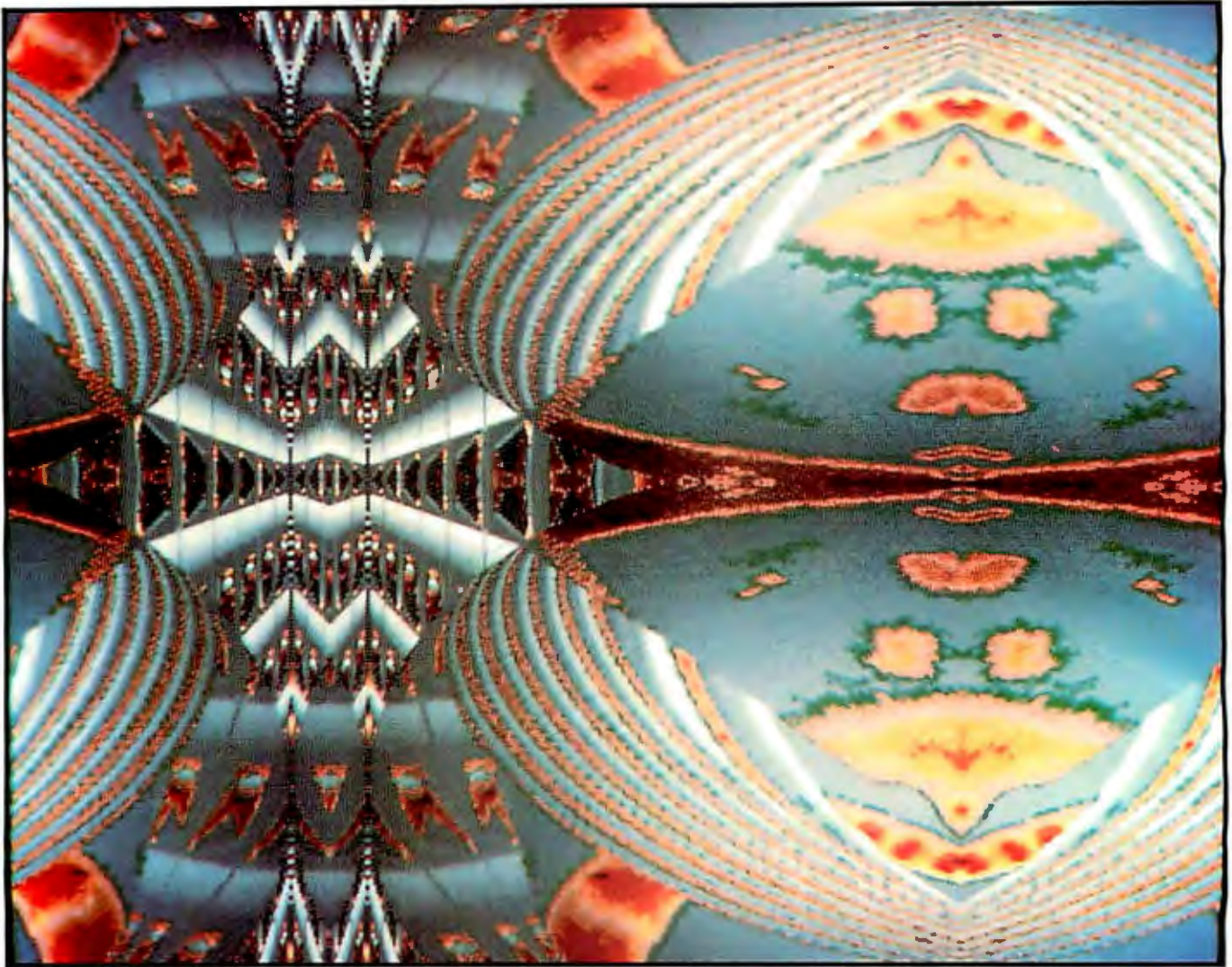

Photo 8: *Suma*, a digital creation by David Em, was done at the Jet Propulsion Laboratory using software written by James F. Blinn. The artist uses the computer so that much of his art is like painted sculpture. This is a result of the mapping technique that permits him to take an image, distort it, and use images inside of images, resulting in a staggering complexity. (© David Em, 1979, artist.)

means that it doesn't work 90 percent of the time! You can use state-of-the-art equipment and do pictures very quickly for half an hour, and then your computer is down for the rest of the day. I'm not interested in using exotic hardware. I want absolutely plain-vanilla, off-the-shelf hardware that works consistently and is readily serviced."

Blinn recommended a formal education as the best way to get into the field. "I went to school and studied computer science."

David Em (Artist)

Probably the foremost computer-graphics artist in the world today is David Em, an eclectic whose interests include painting, theater, and dance.

His fantastically complex digital creations (see photo 8) rely heavily on the computer's capability to take an existing image and work with it, making it three-dimensional, mapping it onto a cylinder or some other complex geometrical shape. Much of his work has been done at the Jet Propulsion Laboratory, using James Blinn's software. He builds gem-like environments of staggering complexity with a technique of repetition (pictures inside of pictures inside of pictures).

Em's artistic talent first bloomed as a child in Colombia. He gained a reputation as a painter and sculptor many years before becoming involved in electronic media. "It's been 10 years since I decided to go into the

electronic side of things. But before I had even heard of computers I was making sculptures in factory environments. To do that I had to work with complex machines and establish relationships with the company president, the supervisor, and the worker who operated the machine. I didn't realize at the time that I was learning the skills that would enable me to work with programmers, managers, and high-tech scientists later on.

"You must learn to interface with personalities as well as with machines. There are three fronts that all have to be kept up: you have to have your machine act, your people act, and your creative act all working in parallel.

It Meets Your Needs... Whatever They Are

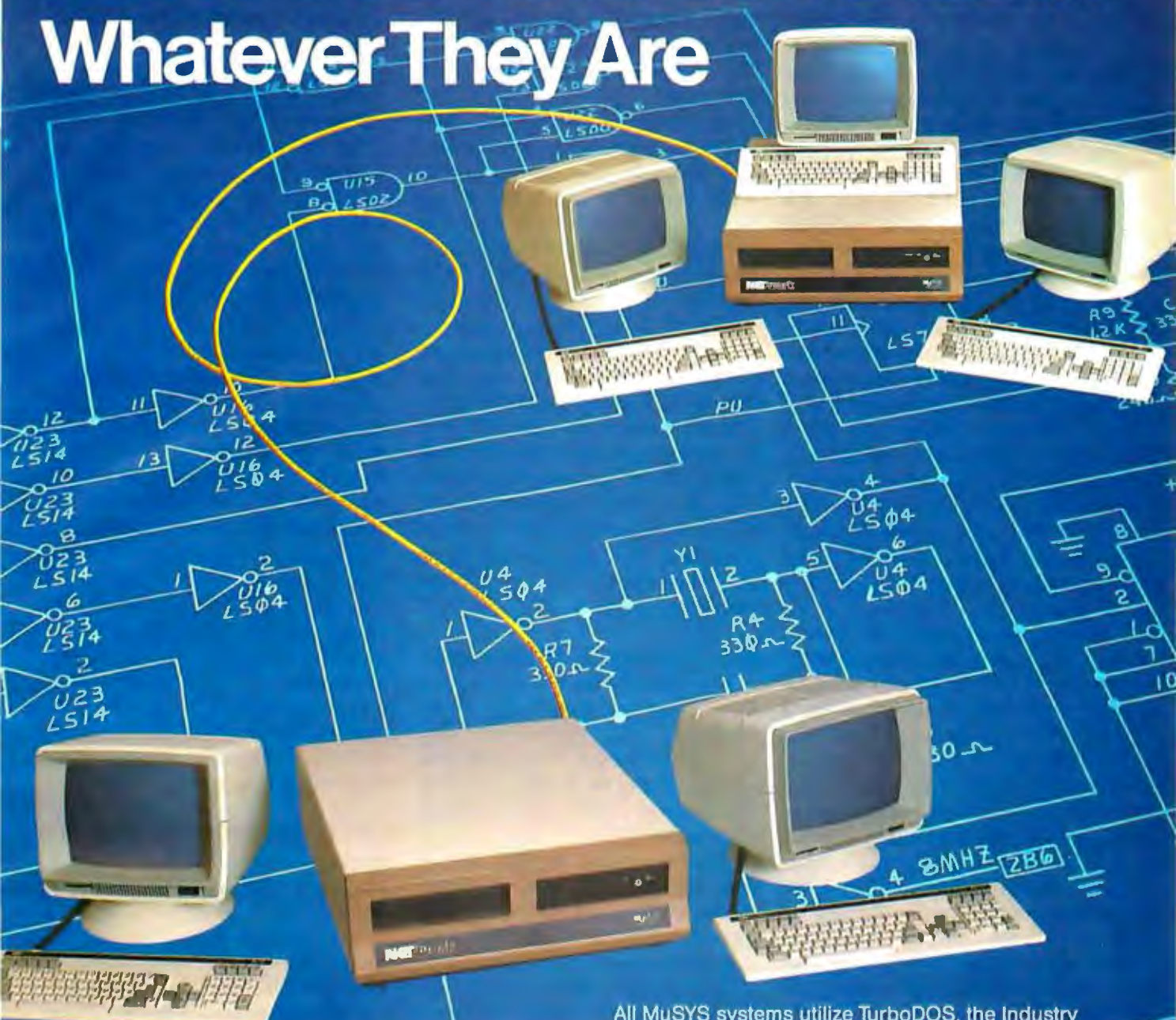

Large Multi-user Capability

A truly professional, reliable solution—the NET/work 8816 has been specifically designed for installation in demanding multi-user applications. The low starting price allows you to start with two users and grow later to many thousands without the expense of replacing existing equipment or software as you grow. We offer three types of Local Area Networking, including Ethernet, with full shared multi-system resources. **AND IT WORKS.** Gone are the bottlenecks that make shared-processor multi-user systems too sluggish for real time applications. What's more, we offer an unbeatable combination in a video terminal with our NET/worker. You get styling, operating comfort, value and reliability.

All MuSYS systems utilize TurboDOS, the Industry Standard Multi-user Operating System. Mainframe capability at microcomputer prices, and compatible with virtually all CP/M Software. NET/work systems give you advanced features such as 8MHz processors, high speed hard disk drives with storage capacities up to 280MB, and 16 bit future upgrade path.

This system meets your needs...WHATEVER THEY ARE. Call or write, MuSYS Corporation, 1752-B Langley, Irvine, California 92714. (714) 662-7387 toll free outside California 1-800-852-5362. TWX 910-595-1967. Cable MUSYSIRIN.

Dealer and OEM inquiries welcome.

MUSYS
CORP

We design the future.

NET/work is a trademark of MuSYS Corporation. TurboDOS is a trademark of Software 2000, Inc. CP/M is a trademark of Digital Research, Inc. Ethernet is a trademark of Xerox Corporation.

"The first computer I actually worked with was at the Xerox Palo Alto Research Center in January of 1975. It had that first frame buffer that Dick Shoup got up and running. At that time Alvy Ray Smith was there with David DiFrancisco, and they had written one of the early Super Paint programs. I made my first picture about an hour after my introduction to the computer system. You don't need two years of technical study to make a picture. True, the more you know about the medium, the better off you are, but since the programs were fairly interactive, I was able to create a picture practically from scratch. I kind of discovered this new medium that I knew had to exist. The frame buffer was like a mystical revelation—I'd actually been looking for this specific instrument. Everyone said it didn't exist but there it was! Then the whole operation there shut down later in 1975 and eventually I came back to Los Angeles.

"Then I was at Triple-I for about a year after they did their historic simulation of Peter Fonda's head for the movie *FutureWorld*. That was a very different experience than I had with Xerox. The Triple-I system wasn't interactive at all. Even though it was a much more powerful system (high resolution and all), it was not a viable creative tool for me. I didn't know what a picture would look like until it came back from the film lab three days later. A frame buffer gives you instant, interactive control over what you're doing. When you make a picture, whether you're a designer or a filmmaker, you make millions of little decisions that you don't think about until you have to start specifying them."

During this time Em established a relationship with the Jet Propulsion Laboratory. Working late at night when the equipment was available, Em began using digital paint, texture mapping, and other leading-edge processes that had synthesized the solar system for NASA, to create his own fanciful universe.

"If you're pushing the state of the art, the process is more important than the parts. You have to get every-

thing working and talking together. Some of these processes are as old as the hills, like storyboarding, and some of them are the latest capabilities that civilization has brought us. The computer is just one of these elements."

Em offered some advice. "You might be surprised at how quickly you can apply your existing knowledge, expand it, and do the things that are peculiar to the high-tech medium. You don't need five years of programming or math. Those fears that creative people have are a psychological block more than anything. Just start doing computer graphics on any level, whether it's in a class or on your own. The actual action of doing it is very important even if it's in a very rough way. Once you start, one thing leads to another. Oddly enough, computer graphics is a *scene*, so go to things like SIGGRAPH in your town. Find out what's going on and who's doing it. Find out who the personalities are."

John Whitney Sr. (Filmmaker)

John Whitney Sr., with his brother James, and his three sons, Mark, Michael, and John, literally pioneered the craft of computer animation. Today he teaches at UCLA and lectures widely on the subject. (See photo 9.)

Whitney recalled the early days. "I started in the 1950s using the high-quality analog computer systems that came out of World War II. They were designed to solve the complex ballistics equations of fire control for the anti-aircraft gun batteries, and here I was making design machines out of them! I didn't have any engineering background at all when I began to adapt this kind of equipment. I didn't realize how significant it was that they represented the beginnings of the advanced problem-solving computers. In a sense, I stepped backward into computer graphics. Only after I became competent with the equipment did I begin to realize that I was really trying to build my own computer. By the 1960s, industrial computer graphics was underway and being used extensively in scientific circles. I applied to IBM for a re-

search grant in 1965 and benefited from it until 1970.

"I would never claim to have foreseen the coming of computer graphics as it is now. It was the other way around—I could see that my vision of abstract design and color, in completely pure, fluid motion, was going to be quite possible with computer systems. In fact, a year or two after I started, I made a film showing the tedium involved in making computer-graphics films! But I expected that the systems would become smaller, cheaper, and faster, and that one day I would have one, the size of a television set, in my home. Ten years later, that's exactly what I have.

"I am confident that we will be able, in a single system, to compose music and color design, bringing a brand new world of rhythm and action ready for a brand new breed of artists and composers. There's no question that it will start the same kind of cultural and social phenomena that has always been true in music. The only reason we have outstanding rock singers and pop-music composers is because for every one that makes it to the top, there are hundreds of thousands of youngsters teaching themselves to play musical instruments and to sing, aspiring to succeed in music. It's important to have in the composer's hands the power to compose both sound and image in a totally interwoven and integrated relationship."

Carl Rosendahl (Pacific Data Images)

If you have a difficult time getting a job in computer graphics, you might consider Carl Rosendahl's approach. Fresh from school with a degree in electrical engineering, he started his own company on a shoestring. In a short time his company has grown to where it is doing work for national and international clients, including the opening animation for "Entertainment Tonight" (see photo 10).

"I started the company three years ago, and the first year and a half I was alone, trying to figure out computer graphics. I knew computers pretty well, and I knew film, because I grew

THE BUFFER DID IT.

Who Stole The 1500 Letters From The Computer?

Let's just say you've got to send a letter to 1500 different people. Would you like to spend 22.5 hours* or 60 seconds of computer time?

With a garden-variety buffer, the computer has to mix, merge and send 1500 addresses and 1500 letters to the buffer. Trouble is, most buffers only store about 32 letters. So after 32 letters, the computer's down until the printer's done. Altogether, you're talking 22.5 hours.

In the case of our new (not to mention amazing) ShuffleBuffer, computer time is 60 seconds flat. Just give

ShuffleBuffer one form letter and your address list, and it takes care of the mixing, the merging, and the printing. But that's not all ShuffleBuffer's stolen from the computer. Oh, no.

Who Changed and Rearranged The Facts?

Again, ShuffleBuffer's the culprit. You want to move paragraph #1 down where #3 is? Want to add a chart or picture? No problem. No mystery, either. Any buffer can give you FIFO, basic first-in, first-out printing. And some

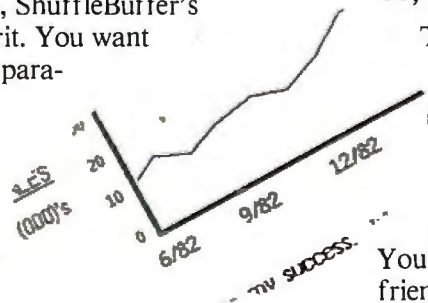

buffers offer By-Pass; the ability to interrupt long jobs for short ones. But only ShuffleBuffer has what we call Random Access Printing — the brains to move stored information around on its way to the printer. Something only a computer could do before. Comes in especially handy if you do lots of printing. Or lengthy manuscripts. Or voluminous green and white spread sheets. And by the way, ShuffleBuffer does store up to 128K of information and gives you a By-Pass mode, too.

And Who Spilled The Beans 239 Times?

Most buffers can't tell the printer to duplicate. If they can, they only offer a start/stop switch, which means you're the one who has to count to 239. Turn your back on your buffer, and your printer might shoot out a room full of copies. ShuffleBuffer, however, *does* control quantity. Tell it the amount, and it counts the copies. By itself.

So, What's The Catch?

There isn't any. Sleuth around. You won't find another buffer that's as slick a character as this one. You also won't find one that's friendly with any parallel or serial computer/printer combination. This is the world's only universal buffer. With a brain.

Who Wants You To Catch A ShuffleBuffer In Action?

You guessed it. We do. Just go to your local computer dealer and ask him to show you a ShuffleBuffer at work. Or, you can call us at (215) 667-1713, and we'll clue you in on all the facts directly.

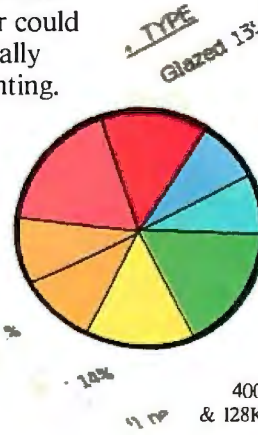

* Based on an average 4000 character letter & 128K buffer.

Mr. Harold Burns
P.O. Box 1111
Toledo, Ohio 48420

Dear Harold:

Let's just say you've got to send a letter to 1500 different people. Would you like to spend 22.5 hours* or 60 seconds of computer time?

With a garden-variety buffer, the computer has to mix, merge and send 1500 addresses and 1500 letters to the buffer. Trouble is, most buffers only store about 32 letters. So after 32 letters, the computer's down until the printer's done. Altogether, you're talking 22.5 hours.

In the case of our new (not to mention amazing) ShuffleBuffer, computer time is 60 seconds flat. Just give

ShuffleBuffer one form letter and your address list, and it takes care of the mixing, the merging, and the printing. But that's not all ShuffleBuffer's stolen from the computer. Oh, no.

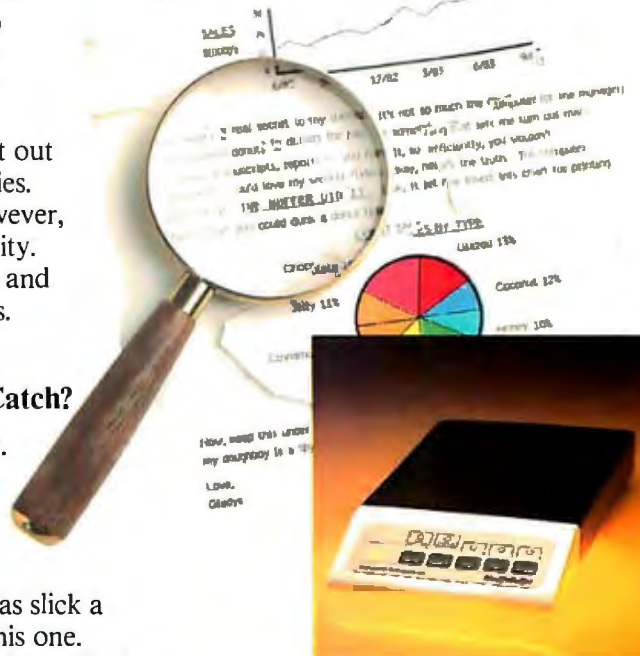

ShuffleBuffer
The Buffer with a Brain

Interactive Structures Inc.
146 Montgomery Avenue
Bala Cynwyd, PA 19004

up in Los Angeles and made movies all through high school. I spent that first year with a little Cromemco computer, reading the SIGGRAPH proceedings and figuring things out. Then I got a PDP 1134. That's when Glenn Estes and Richard Chong joined me, and we spent the next year developing software. Six months later we got the VAX 11/750, and although it took three weeks to get the VAX running, it only took about 36 hours to load all the software and

have it up and running. Then in May of 1983 we opened our doors for production."

"We do everything in video resolution, 512 by 486, 24 bits per pixel, so it's full color and it's all anti-aliased so you don't get any jaggies. Each picture takes a quarter of a megabyte, so a 10-second spot generates about 225 megabytes of picture data. When you get into 60-second commercials, there are gigabytes of data. All our machines are running Unix, and all our

code is written in C. There is no assembly language or microcode that allows us to develop code on one machine and run it on all the others."

Rosendahl's advice: "An understanding of the geometry and math involved and good three-dimensional visualization are really important because the modeling and motion design must happen in your head before they can happen in the computer. Being able to visualize what you're building is very necessary. If you want to work closely with the clients on production, you have to be able to communicate with them artistically rather than technically. There is also a big need for people doing development—creating the tools to use in production—where artistic ability isn't as necessary."

Bill Kovacs (Robert Abel & Associates)

Bill Kovacs is a software designer and vice president of Robert Abel & Associates. He came to Hollywood to work with Robert Abel on the special effects for *Star Trek*, *The Motion Picture*. He devised a way to use an Evans & Sutherland Picture System to preview choreography that would ultimately be filmed with models on a motion-control rig. Although politics and production problems eventually took the *Star Trek* work elsewhere, the computer-graphics work proved so successful that it became a mainstay of Abel's special-effects business.

Recently, Kovacs used the new IRIS computer from Silicon Graphics to assemble a raster system capable of scene previewing, which is a formidable tool in the hands of the company's designers. "It's the first unit shipped in the U.S.," he said, "and it's wonderful. It can do real-time shaded graphics of limited complexity, or it can do nonreal-time graphics of very high complexity. And it's totally compatible with our Unix system. It runs on Ethernet, the *in* way to connect one computer to another."

In addition to commercials for Corvette, 7-Up, and TRW, Kovacs and the Abel team recently did the animation for a videodisc arcade game, *Cube*



Photo 9: Pioneer computer animator John Whitney Sr. in 1959, operating one of the first computer-graphics engines, a mechanical analog computer built largely from surplus World War II anti-aircraft guidance hardware. The camera is in the upper left, aiming down through the apparatus that "paints" the film with light. (Photo by Charles Eames.)

A PC for PEANUTS

NOW 256K

Why settle for a limited home system when Scottsdale Systems will sell you a complete business system for less? Our PC Plus features an 8088 CPU, one 160K drive, 256K RAM with Romdisk and Spooler software, MS-DOS, Wordstar, Calcstar, Color Graphics Basic, a printer port, and your choice of an amber or green 12" monitor for \$1099.

The PC Deluxe has 2 160K drives plus Mailmerge, Spellstar and Infostar.

Both systems run many programs written for the IBM-PC®, and the computer boards are warranted for a full year by over 70 nationwide Sanyo Service Centers. Don't settle for less, give us a call.

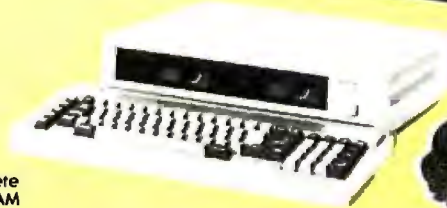

PC PLUS™ \$1099
PC DELUXE™ Call

Hard disks, networking systems - Call

TELEVIDEO



Single user systems now include Word processing, spreadsheet and graphics software (along with CP/M or CP/M-86). Local installation of multi-user systems available via TRW.

TPC Call
 803 \$1849
 1603 \$2289
 802H \$4319
 806/20 mb. \$4859
 816/40 mb. \$9275

ALTOS



From the lowest-priced dual-floppy multi-user systems to true 16-bit 10 Mhz. multi user systems. Local service available via TRW. We will configure, test and install your systems for an additional charge (call for prices).

5-80-2 \$1998
 5-80-10 \$3629
 5-86-10 \$5795
 5-86-40 \$7995
 8000-10 \$4679
 8000-14 \$8118

ZENITH



Low prices on the systems that are 5-100, 16 bit/8 bit, MS-DOS and CP/M compatible. Plus, they're backed by Zenith service virtually everywhere. The Z-100's feature two built-in 5 1/4 drives, 128K RAM, graphics and 3 ports. Free software and specials on additional software.

ZF-110-22 \$2699
 ZF-120-22 \$2799
 ZV-110-32 \$4249

COLUMBIA



Each Columbia now comes with MS-DOS, CP/M-86, Basic (with IBM-PC compatible color graphics), Perfect Writer™, Perfect Speller™, Perfect Calc™, Perfect Filer™, Fast Graphs, Home Acct. Plus, Space Commanders, Diagnostics, and The Columbia Tutor. The VP is 36 lbs. portable with a built-in 9" monitor. The 1601 is the desktop unit. Both computers come with dual 320K drives, and are backed by Dell and Howell.

VP \$2349
 1600-1 \$2589
 1600-4 (10mb) \$3545

TERMINALS



Adds Viewpoint 3A+ Emulates the ADM-3A, detached keyboard, keypad, 12" green display, nationwide Adds service.

Viewpoint 60 \$457
 Wyse 50 \$589
 Wyse 100 \$508
 Televideo 914 \$694
 Televideo 924 Call
 Televideo 970 \$689
 Altos II \$1044
 Zenith Z-29 \$724
 Zenith ZT-1 \$656
 Qume 102 \$469
 Qume 102 \$544

HOUSTON INSTRUMENTS

DMP-29 \$1795
 DMP-40 \$745
 DMP-41 \$2340

Sanyo 8-bit Systems new lower prices.



Scottsdale Systems Ltd.

617 N. Scottsdale Road, Suite B, Scottsdale, Arizona 85257

VISA (602) 941-5856 MasterCard

Call 8-5 Mon.-Fri.



We participate in arbitration for business and customers through the Better Business Bureau of Maricopa County.

SERVICE/ORDERING

INTEGRATION: Prices listed are for new equipment in factory sealed boxes with manufacturer's warranty. We will pretest your equipment, integrate your system, configure your software, provide special cables, etc. for an additional charge. Call for prices.

ORDERING: MAIL ORDER ONLY. Prices listed are for cash. No C.O.D.'s. We sell on a Net 30 basis to Fortune 1000 companies and Universities with good credit. P.O.'s add 2% charge cards add 3%. Az. residents add 6%. Prices subject to change, product subject to availability. Personal checks take 3 weeks to clear. 0-20% restocking fee for returned merchandise. Shipping extra - products are F.O.B. point of shipment. CP/M and MP/M are registered trademarks of Digital Research. Wordstar is a registered trademark of MicroPro International. IBM and IBM PC are registered trademarks of International Business Machines Corporation. TeleVideo® is a registered trademark of TeleVideo Systems, Inc.™ SOFTWARE: Sold only w/systems, not warranted for suitability.

PRINTERS



Gemini 10X \$115 off
 Gemini 15, 15X Call
 Delta 10's Call
 Tolly 160L/trac \$584
 Tolly 180L/trac \$799
 Tolly Spirit \$298
 Anodex Call
 IDS Prisms Call



LETTER QUALITY

Silver Reed 500 \$409
 Silver Reed 550 \$619
 Sanyo PR5500 Less
 Silver Reed 770 Call
 NEC 7710 \$1965
 NEC 2000's Call

OKIDATA



The new Micraline 92's and 93's feature 160 C.P.S. draft mode, 40 C.P.S. correspondence mode. Standard parallel, serial card add \$95.

Micraline 92 \$175 off
 Micraline 93 \$290 off
 Micraline 82 \$134 off
 Pacemark 2350P Call

DTC-380Z

Replaces the Daisywriter 2000. Uses the same printhead, ribbons, and tractor feed. Will run serial, parallel, or IEEE 488. 48K buffer standard, uses Diablo codes.

\$1044





Photo 10: The opening title animation for the television show "Entertainment Tonight," done by Carl Rosendahl of Pacific Data Images. The sequence is created using smooth-shaded polygons and anti-aliasing.

Quest, for Simutrek. Kovacs explained, "The game uses laser video-disc technology overlaid with—and this is the key—very sophisticated, real-time, three-dimensional, shaded computer graphics. This is new for the industry.

"Business people still don't appreciate the value of software. They go out and buy expensive hardware but don't hire a good software person to go with it. It's so stupid! It's like racing formula cars when you can afford the cars but not the high-priced mechanics. If you can't afford both, you shouldn't be in the racing game. Some companies are so intimidated by the computer that when it arrives, they step around it, always staying five feet away. They're afraid that it might break if they touch it and they might have to pay a couple hundred dollars for maintenance."

Vibeke Sørensen (Artist and Educator)

Director of the computer-graphics program at the Pasadena Art Center College of Design, Vibeke Sørensen (not related to the author) teaches a computer-graphics course for graphic designers, industrial designers, and illustrators.

"The concept is to give them access to sophisticated programs that will teach them the fundamentals of two- and three-dimensional computer image generation. We are using software especially designed for this course and written for the school's Atari computers by Jim Blinn and Bob Schaff. The students are not learning programming, they are learning use. Until now, most computer-graphics courses have been in engineering schools because that's where the tools were. As a result, most people in computer graphics tend to be engineers. But computers have been liberated from the domain of the engineers and put in the hands of all kinds of people, including artists, with the advent of the personal computer.

"I believe that you should have an education in the process; you should learn about elementary programming—even if you're an artist. That doesn't mean you're going to be a programmer; it means you should be able to talk to programmers. Whatever industry you want to work in, people want to hire trained people. It's much more expensive to train people on the job, so it makes sense to go to a school where you can learn

computer graphics. The question is, what is your background, and what do you want to do?

"The other way to get into the business (if you're not going to go through an organized program or the course doesn't exist) is to beg, borrow, or buy a small computer (an Apple or Atari being the low end) and teach yourself. There are a lot of books and tutorials on how to do it. Basically, it's a question of technique. That's the way to get started and find out if it's for you—because it's not for everybody."

Charles Csuri (Cranston/Csuri)

For over a decade, Charles Csuri has taught computer graphics at Ohio State University. He and his students wrote a lot of highly interactive software that has advanced the state of the art. Recently he formed a company, Cranston/Csuri, that quickly caught everyone's attention for its attractive ray tracing and sophisticated medical imagery. The firm's demo reel won several prizes, including grand prizes at the Tokyo International Computer Animation Competition and the London Competition. Cranston/Csuri is talking with several personal computer manufacturers about putting together a three-dimensional, key-frame animation system. The company currently uses VAXes but is "sticking to our guns and working on a multiprocessor system of our own design."

Csuri, interested in artificial intelligence, said, "I have several excellent graduate students trying to put together an expert system for three-dimensional character animation that will control a figure so that it moves very smoothly. (See photo 1.) There is a lot of exciting discussion going on—what sorts of tasks does an animator do that could be automated in an expert system to facilitate decision making? As far as I am concerned, this is the future of character animation, but the problems are very difficult. The easy problems have been solved, but there are a whole bunch of nasty, difficult things that are still out there."

Csuri advised, "It's really important to have a tutor or mentor, to be

We don't care which computer you own. We'll help you get the most out of it.



CompuServe puts a world of information, communications, and entertainment at your fingertips.

CompuServe is the easy to use videotex service designed for the personal computer user and managed by the communications professionals who provide business information services to over one fourth of the FORTUNE 500 companies.

Subscribers get a wealth of useful, profitable, or just plain interesting information like national news wires, electronic banking and shop at home services, and
Circle 80 on Inquiry card.

sophisticated financial data. Plus, a communications network for electronic mail, a bulletin board for selling, swapping, and personal notices and a multi-channel CB simulator.

You get games on CompuServe, too. Classic puzzlers, educational, sports and adventure games and fantastic space games featuring MegaWars, the "ultimate computer conflict."

To learn more about CompuServe, call toll-free, 800-848-8199, for an illustrated guide to the CompuServe Information Service. The videotex service for you, no matter which computer you own.

CompuServe

Consumer Information Service, P. O. Box 20212
5000 Arlington Centre Blvd., Columbus, OH 43220
800-848-8199 In Ohio Call 614-457-0802
An H&R Block Company



Photo 11: *Chrome Dog*, created by Gene Miller. A new mapping process being developed at MAGI by Miller is dramatically demonstrated here, along with the capability to digitally compose a synthetic image on a real background. First, an object is modeled from ellipsoids, the primitives are blended together using Miller's Fuse Body program and then surreally combined with a shot of MAGI's parking lot scanned in video digitizing. Then, to get a wide-angle view of the parking lot, MAGI photographed a silver Christmas tree ball and scanned it in. Finally, the reflected image is mapped onto the object and voilà!—instant chrome dog. (The author is grateful to MAGI for the use of this experimental image.)

around someone who has a lot of experience. That means getting access to this kind of person by joining a lab or company or by getting into an academic setting. In a recent meeting of 150 college deans in Dallas, we asked who would have jobs for our graduates, and over two-thirds of them raised their hands! It's very clear that there is a need for trained people in the field."

Phillip Mittelman (Mathematical Applications Group Inc./Synthavision)

The first company to do computer

scene simulation was MAGI (Mathematical Applications Group Inc.), which produced a shaded picture for the cover of *Computer World* magazine's first issue, in 1967. (An example of MAGI's work is shown in photo 11.) Actually, MAGI sort of backed into its role as filmmaker because it originally conceived its ray-tracing software programs for civil and governmental studies of nuclear particles and radiation. Dr. Phillip Mittelman, the founder of MAGI, recalled, "The technique we had developed was one where you describe the world as made of three-dimensional

objects, and you trace radiation—neutrons and gamma rays—around through this three-dimensional environment. We observed that if we traced light rays around instead, we had, in effect, simulated photography. That's the basis of our whole idea: you track the light rays and find out what the color and intensity would be at each point on the film. Bob Goldstein was the person who adapted our radiation programs for picture making, working on it alone for a long time. So, MAGI's Synthavision process, which today is very fast and efficient for moviemaking, rests

WHY PAY MORE FOR LESS?

SUNOL SYSTEMS announces Winchester storage break-through



Totally Corvus Compatible

- **Over 20 Host Adapters Available**

S-100	Apple II, III
IBM P.C.	North Star
Altos	Victor
DEC	TRS-80 Models I, II, III
Osborne	Zenith Z89/90/100
Xerox 820	Texas Instruments
Atari 800	NEC PC-8000

Plus Many More

- **Up to 60% More Useable Storage**

Using Run Length Limited Coding
8, 16, 25, 35, and 51 Megabytes/Drive of
useable storage capacity (up to 4 drives
per controller for a total of 204 Mega-
bytes.)

- **Local Area Network**

Omninet™ Compatible

- **Multiplexer**

Up to 64 users

- **Integral Removable Back-Up**

Optional 32 Megabyte Removable Tape
Cartridge

- **High Reliability**

Error Correction Code and Off-Line
Diagnostics.

- **Comprehensive Display**

Dynamic display of the Drive, Status,
Track, Head, Sector and much more

- **High Performance**

50% Faster data transfer Rate 7.5 Mega-
bits/Second
Large 16K Byte Data Buffer

Major Pricing Break-through, starting at \$1,995.

Visit your local dealer for complete information or call or write. Dealer inquiries welcome.

Sunol Systems, 1072 Serpentine Lane, P.O. Box 1777, Pleasanton, CA, 94566, (415) 484-3322.

International Distributors:

HONG KONG: Convergent Microsystems
Unit 713 Hunghom Com. Ctr.
T.W.A. Ma Tau Wei Rd.
Kowloon, Hong Kong
Telephone: (3) 636397

CANADA: McKenzie Brown Ltd.
267 Richmond St. West
Toronto, Ontario M5V1W9
Telephone: (416) 593-6880

BELGIUM: Ditec Diffusion
Rue Grisar 46
1070 Brussels
Telephone: 524-0153

Apple is a registered trademark of Apple Computers Inc. IBM is a registered trademark of International Business Machines Corp. Xerox is a registered trademark and Xerox 820-II are trademarks of the Xerox Corp. Atari is a registered trademark and Atari 800 is a trademark of Atari Inc. Osborne is a trademark of the Osborne Corp. North Star is a trademark of North Star Computers Inc. Corvus Systems and Omnet are trademarks of Corvus Systems Inc.

on a bedrock of radiation transport technology.

"We were totally independent and out of touch with the picture making that was going on at the University of Utah and places like that in the early days. At one time we showed some of our work to some IBM people and they said, 'My gosh, you've solved the hidden line problem!' We were really quite naive. We said, 'What's a hidden line problem?' With ray tracing, since you follow the ray until it hits something and then

bounce it off, you don't concern yourself with what's behind that surface. There could be a thousand objects behind it; we didn't care. The first animation we did, probably the first shaded computer animation ever done on a commercial basis, involved three-dimensional lettering for IBM's Office Products Division. That was at least 12 years ago."

MAGI recently got a new computer, a Gould SEL 3287, "a real number cruncher," roughly one-third the speed of a Cray for a small fraction

of what a Cray costs. "It's literally eight times faster than the computer we used for *Tron*," said Larry Elin, an art director for 10 years with the company. "We find that we wind up making pictures that are eight times more complicated. It's interesting that when you get a faster computer, you don't make faster pictures—you make better pictures!" MAGI is also working on a system called Synthamation for rapidly combining computer animation with hand-drawn animation for large-scale productions. It gives the animator unprecedented freedom to move around in the scenes and gives the characters an airbrushed, three-dimensional look.

Richard Moszkowski

Having discussed the state of the art with so many movers and shakers in the computer-graphics business, it seems appropriate to wrap up the story with a young man in the trenches. He is a self-described hacker/survivor/dreamer whose talent in programming graphics has led him to some enviable jobs. In just a few years he has gained experience and an excellent overall vision of the field. Richard Moszkowski, a student at UCLA in the late 1970s, started as a programmer for John Whitney Sr. He then worked for some game companies (designing a game built into a watch) and Digital Productions (where he worked around the Cray). Now back to games again, he is designing a light pen and stereo three-dimensional glasses for the Vectrex machine.

A free agent and therefore uncommitted to plugging the virtues of any particular system, Moszkowski was a likely candidate to offer an unbiased assessment of where things are and where they're going.

"One indicator of how things are now is that the equivalent of Ivan Sutherland's Sketchpad program is running on microcomputers. That software marked the beginning of computer graphics for mainframe machines in the 1960s at MIT. On the other hand, we now have the use of supercomputers for motion-picture animation. And this year we have the 32-bit computer-on-a-chip, such as

The Best Modem Is Now The Best Buy!

Is the Hayes® 1200 Smartmodem™ a smart buy? We say it's not. Our Bytcom® 212AD sells for a hundred dollars less and it needs no software!

Bytcom® 212AD Best buy!	Hayes® 1200 Not smart!
Use w/dumb terminal or PC	NOT SMART
Disconnect mode	NOT SMART
Bootstrap mode	NOT SMART
Help Menu	NOT SMART
Full bell diagnostics	NOT SMART

That's why we say the Bytcom® 212AD is a best buy. And Hayes' Smartmodem? It's a good 'bye!



Dealer inquiries welcome.

BYTCOM

(415) 485-0700 Call toll free outside California: (800) 227-3254

2169 Francisco Boulevard Suite H, San Rafael, CA 94901

COMPUTER HUT™

COMPARE
OUR
SERVICE & PRICE!

SPECIAL OF THE MONTH

IBM-PC & XT
CALL FOR
PRICE

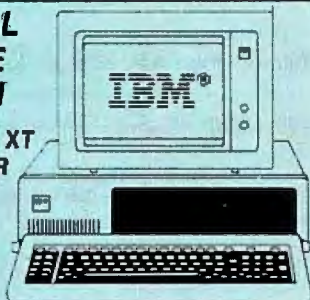

HARDWARE FOR IBM-PC DISK DRIVES

Tandon	
TM100-2 DS/DD	\$229
PANASONIC JA 551	\$199
SHUGART SA-455 half-high	\$199
TEAC FD-55B Slimline	\$219
MAYNARD ELECTRONICS	
Floppy Disk Controller	\$169
FDC w/Par. Port	\$219
FDC w/Ser Port	\$239
SANDSTAR SERIES	CALL
QUADRAM	
Quadboard-PP,SP,C/C,Mem + s/w	
64K.....	\$279 384K.....\$549
0K.....	\$235
Quad 512 + SP,Mem with s/w	
64K.....	\$249 512K.....\$639
Quadboard II-2SP, C/C, Mem + s/w	
64K.....	\$279 256K.....\$439
Quadcolor.....	CALL
AST RESEARCH	
MegaPlus II 4-Funct 64K + s/w	\$279
6-Pack 5-Funct 64K + s/w	\$279
I/O Plus.....	\$135
TECMAR	
Graphics 720 x 400 16 colors	\$559
HERCULES	
Hi Res Graphics 720 x 384, PP, + s/w.....	\$359
FREDRICKS ELECTRONICS	
COLORPLUS 640 x 200, 16-Color + s/w.....	\$399
AMDEK	
MAI Graphics 640 x 400	\$479
MICROLOG	
Baby Blue.....	\$359
Baby Talk.....	CALL
USI	
Multidisplay.....	\$395

HARD DISK - IBM-PC & XT

MOUNTAIN — External Syst.	
5MB.....	\$1539 10MB.....\$1839
15MB.....	\$2309 20MB.....\$2549
MAYNARD.....	CALL
TALLGRASS.....	CALL

PRINTERS

EPSON	
FX80.....	CALL FX100... CALL
brother	
HR1 A Par....	\$599 Ser.....\$699
HR-15 Par....	\$479 Ser.....\$519
HR-25.....	CALL
DYNAX	
DX-15 Par....	\$459 Ser.....\$489
C-ITOH	
STARWRITER A-10	CALL
STARWRITER F-10 P	\$1199
PROWRITER 8510 P	\$399
PROWRITER 8510 SP 180 CPS	\$649

star MICRONICS	
Gemini 10X ...	\$299 15X ... \$399

OKIDATA	
82A.....	CALL 83A..... CALL
84P.....	84S.....
92P.....	BEST 92S..... BEST
93P.....	PRICES 93S..... PRICES

NEC	
3510.....	\$1485 7710.....\$1995
3515.....	\$1479 7715.....\$2039
3530.....	\$1575 7720.....\$2495
3550.....	\$1799 7730.....\$1995
2000 Series.....	CALL

TOSHIBA	
P1350.....	\$1549
IDS, DAISYWRITER.....	
CALL	
SILVER-REED	
EXP 500 Par ..	\$429 Ser.....\$459
EXP 550 Par ..	\$639 Ser.....\$679
EXP 770.....	CALL



MODEMS

HAYES	
Smartmodem 1200	\$499
Smartmodem 1200B w/Smartcom II.....	\$429
NOVATION,	CALL

COMPUTERS

IBM Compatible

EAGLE	CALL
COLUMBIA	
DATA PRODUCTS, INC.	
CORONA	CALL
TAVA PC	CALL

DEC RAINBOW.....	CALL
------------------	------

MONITORS

AMDEK	
Video 300G ...	\$139 300A.....\$149
Video 310A	\$189
Color II.....	\$429 Color II + CALL
PGS	
HX12 Hi Res RGB monitor....	BEST PRICES



SOFTWARE FOR IBM-PC

LOTUS 123.....	\$329
Word Perfect	\$309 WordStar CALL
DBase II.....	\$399 VisCalc.....\$189
Multiplan... ..	\$195 Multimate...\$329
MICROSOFT WORD.....	\$279

AND MORE

COMPUTER HUT

CANADIAN
AUTHORIZED DEALER

MICROCONTEXT INC.
5253 AVE DU PARC
MONTREAL
QUE H2V4P2.

(514) 279-5114

Published Prices are for U.S.A. Only
Please call for Canadian Prices

ANY PRODUCT NOT LISTED? CALL

COMPUTER HUT
OF NEW ENGLAND INC.
101 Elm St., Nashua, NH 03060

ORDERS & INFORMATION
(603)889-0666

ORDER-LINE ONLY
PLEASE
(800) 525-5012

All products usually in stock for immediate shipment and carry full manufacturers' warranty. Price subject to change — this ad prepared two months in advance. You get the lowest price. We honor personal checks — allow 10 days to clear. COD up to \$200 add 3%. Visa, MasterCard add 3%. For shipping & insurance add 3% or \$5.00 min. for small items and \$8 min for monitors, printers, etc. APO & FPO orders add 12%. Include phone number. Call (603) 889-0666 for a return authorization number prior to returning any material.

Apple is a trademark of Apple Computers Inc. IBM is a trademark of IBM Corp.

Circle 85 on inquiry card.

the 68020. DEC [Digital Equipment Corporation] is coming out with their Micro-VAX, National is introducing their 32032, and there are 256K RAMs coming out. Finally, the Weitek array-processor chip has hit the scene, capable of doing 10 million floating-point instructions per second—for 600 bucks! Weitek is developing what we want: supercomputers on VLSI [very-large-scale integration] technology."

"There are two ways that the super graphics machines of the future will be built," Moszkowski said. "One is bigger and faster computers, single-instruction, hundred-megahertz machines. In this case you're limited by the heat dissipation. As you go faster and faster, the heat rises incredibly, and so does the cost. The other, what we're going to witness in the next three or four years, is micrographics engines one-tenth the speed of a Cray, 10-megahertz machines made of off-the-shelf components. They will consist of a 32-bit VLSI chip, about 8 megabytes of RAM [random-access read/write memory], some kind of floating-point coprocessor, a floating-point array processor, and possibly also some cheap little z-buffer. All this will fit onto one or two boards and will cost a few thousand dollars. That's great—a real number-crunching microcomputer as opposed to just a data-processing micro. The next thing they will do is put a couple of these together, and then another and another. Pretty soon there'll be scores of them together in racks. Each of them will process individual frames of film, and working together they'll crank out film faster than a supercomputer. So, when you walk into the room, it will be like walking into the Disney studios where you see a lot of little bald-headed guys with glasses, each doing their own frame, only you'll see rows and rows of little blinking LEDs [light-emitting diodes] instead.

"I grew up on micros, I've seen them grow, and they are really going to take over. When you can put a hundred thousand gates on a single integrated circuit and sell it for under 50 dollars a chip, there's no way to stop it. That's just what the future is

For More Information

Papers and Articles

Atherton, P., K. Weiler, and D. Greenberg. "Polygon Shadow Generation." *Computer Graphics*, 12, August 1978.

Baer, A., C. Eastman, and M. Henrion. "A Survey of Geometric Modeling." *Institute for Physical Planning Report*, 66, March 1977. Published by Carnegie-Mellon University, Pittsburgh, PA.

Blinn, James F. "Simulation of Wrinkled Surfaces." *Computer Graphics*, 12, August 1978, page 286.

Blinn, James F., and M. E. Newell. "Texture and Reflection in Computer-Generated Images." *Communications of the ACM*, 19, October 1976, page 542.

Catmull, Ed. "A Hidden Surface Algorithm with Anti-Aliasing." *Computer Graphics*, 12, August 1978, page 6.

Phong, Bui-Thong. "Illumination for Computer-Generated Images." *Communications of the ACM*, 18, June 1975, page 311.

Smith, Alvy Ray. "Spline Tutorial Notes." *Introduction to Computer Animation* (SIGGRAPH Tutorial Book 7), July 1983.

Sørensen, Peter. "An Apple for the Dreamsmiths." *Cinefex*, 6, October 1981.

Sørensen, Peter. "Tronic Imagery." *BYTE*, November 1982, page 48.

Sutherland, Ivan, R. Sproull, and R. Schumacker. "A Characterization of Ten Hidden Surface Algorithms." *ACM Computing Surveys*, 6, March 1974, page 1.

Whitted, Turner. "An Improved Illumination Model for Shaded Display." *Communications of the ACM*, 23, June 1980, page 343.

Books

Beatty, John C., and Kellog Booth. *Tutorial: Computer Graphics*, 2nd ed. Los Angeles, CA: IEEE Computer Society Press, 1982.

Foley, James, and Adries van Dam. *Fundamentals of Interactive Computer Graphics*. Reading, MA: Addison-Wesley, 1982.

Newman, W., and R. Sproull. *Principles of Interactive Computer Graphics*. New York, NY: McGraw-Hill, 1979.

Schacter, B.J. *Computer Image Generation*. New York, NY: John Wiley & Sons, 1983.

Periodicals

Computer Graphics, ACM/SIGGRAPH, 1133 Avenue of the Americas, New York, NY 10036

Computer Graphics and Image Processing, Academic Press Inc., 111 Fifth Ave., New York, NY 10003

Computer Graphics World, 54 Mint Street, San Francisco, CA 94103

IEEE Computer Graphics and Applications, IEEE Computer Society, 10662 Los Vasqueros Circle, Los Alamitos, CA 90720

Organizations

Eurographics Association, POB 199, CH-1211, Geneva 16, Switzerland

IEEE Computer Society, POB 80452, World Way Postal Center, Los Angeles, CA 90080

NCGA (National Computer Graphics Association), 8401 Arlington Blvd., Fairfax, VA 22031

SIGGRAPH (Special Interest Group for Graphics of the Association for Computing Machinery), 1133 Avenue of the Americas, New York, NY 10036

going to be. We are taking grains of sand, which are common and cheap, produced with more efficiency than anything in our society. When you start putting them together, they become an entity that is more than the sum of its parts. I don't think the day is too far away when you will be able

to make your own computer-animated movies at home." ■

Peter Sørensen (Second Genesis, 6867-1/2 Fountain Ave., Hollywood, CA 90028) is a freelance author and computer-graphics consultant who has designed and directed special effects for film and video.

ACCOUNTING SOFTWARE FROM OPEN SYSTEMS GETS YOU UP AND RUNNING . . . FAST.

Accounting For The Serious Business User

The IBM PC and XT, the Apple LISA and Apple III, the DEC Rainbow, the Victor 9000, the Wang Personal, the TI Professional, the Zenith Z-100 . . . What do these top-selling business computers have in common? All of these popular products plus over 30 other micro-computers run the **Software Fitness Program™** accounting applications plus the **Team Manager™** report writer.

You can choose Open Systems' accounting applications in COBOL or BASIC on single- or multi-user computers running on every popular operating system including CP/M, CP/M-86, MP/M, MP/M-86, MS-DOS, PC-DOS, OASIS, RM/COS or XENIX. Over



200,000 of our applications have already been installed in over 200 different types of businesses.

Powerful Yet Simple To Use

We've got the most advanced and comprehensive accounting software you can buy-yet our products with training disks and owner's manuals will put the computer novice at ease.

And with our newest product, the **Team Manager** report writer, a user can select from over 800 predefined data dictionary elements to create an unlimited number of simple or complex reports.

If you're looking for on-track accounting solutions to increase your profits . . . look to the **Software Fitness Program** **Accounts Receivable,**

Accounts Payable, General Ledger, Payroll, Job Cost, Inventory, Sales Order Processing, PLUS the Team Manager report writer. Our competition can't even come close.

If your bottom line is your top priority, today and tomorrow, we've got solutions. Ask for a demonstration from your local computer dealer.



OPEN SYSTEMS INC

430 Oak Grove
(612) 670-3515

Minneapolis, MN 55403
TWX 910 576 1743

CALL TOLL-FREE 800/328-2276
FOR THE NAME OF A LOCAL DEALER.

Dealer Inquiries are invited.

The
SOFTWARE FITNESS
PROGRAM™



SPINWRITER INTR GET YOUR PAPERWORK



1 CUT SHEET GUIDE.1,2



2 DEMAND DOCUMENT TRACTOR.1,2



5 BIDIRECTIONAL TRACTOR.1,2 AND/OR BOTTOM FEED.2



6 SINGLE SHEET FEEDER.1,2



9 MANUAL DOCUMENT INSERTER.1,2

No other printer gives you so many options for automatic paper handling.

These nine NEC forms handlers can automate most of the printing operations in your

office. And to put them to work, you don't have to change the way you work. Because they handle your existing forms, letterheads and envelopes.

With most other printers, you'd be lucky to find even one of these productivity tools.

Why is NEC so committed to forms handlers, while others ignore them? For one thing, we make the world's finest letter quality printers. And we believe that if you buy a computer system in the first place, you ought to be able to take advantage of everything it can do.

Shift from word processing to billing, shipping or inventory control in seconds.

Seconds is all it takes for the average operator to change most of these NEC forms handlers.

Want to dash off a few hundred original letters to your customers? Just snap on our automatic Single Sheet Feeder.

If you add our Dual Bin or Envelope Feeder, you can take care of second sheets or envelopes at the same time. And you'll have the whole package in the mail in about half the time it would take to do it manually.

One of our most popular options is the Bidirectional Tractor. It gives you the precise forward and reverse paper motion you need to print subscripts, superscripts and complex graphics and tables.

YOU CAN GET YOUR CORRESPONDENCE IN THE MAIL 50% FASTER.



PRODUCES 9 WAYS TO WORK MOVING FASTER.

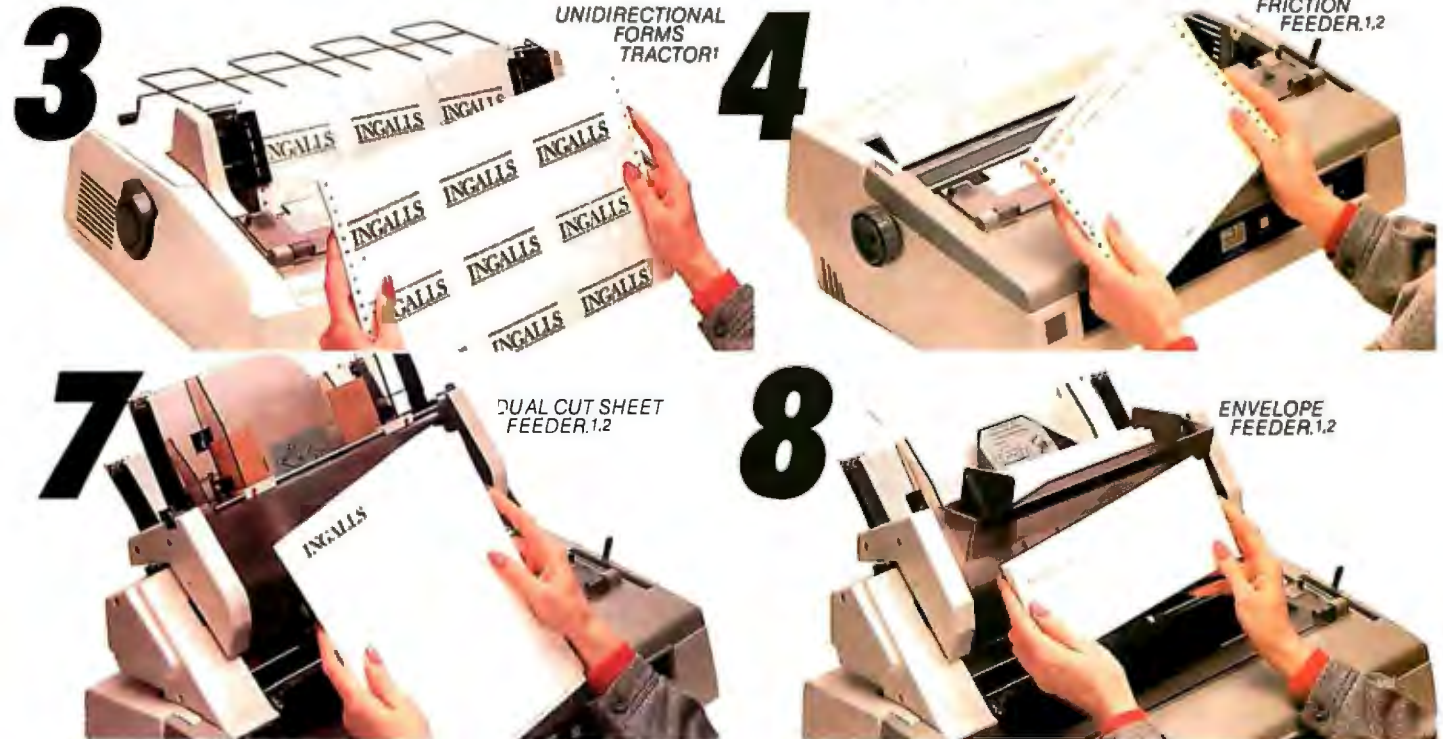

A SPINWRITER
CAN TAKE MOST
OF YOUR OFFICE
FORMS OFF
YOUR HANDS



NEC forms handlers are designed and built by the same people who make the Spinwriter.

You'll find most competitive forms handlers, when you can find them, are made by third parties. Which means they're compromises.

NEC forms handlers, on the other hand, are anything but. They have all been conceived by the Spinwriter team. So they are perfectly integrated with the Spinwriter. That's why most NEC devices can be used on any Spinwriter model, including our new 2000 series. **Spinwriters have a hard-earned reputation for reliability.**

Spinwriters are known for their dependability. In fact, five years without a failure is not unusual. Which is about twice as good as any other printer.

If you ever do need a little service it's nearby and our modular design makes it fast and easy.

Where can you find Spinwriters and NEC form handlers? At participating

1. 2000 SERIES. 2. 3500 SERIES.

Circle 263 on inquiry card.

ComputerLand stores, Sears Business Systems Centers, IBM Product Centers, Entre Computer Centers and authorized NEC Spinwriter distributors nationwide. Or call 800-343-4418 for product literature. In Massachusetts call (617) 264-8635. And find out why more and more PC users are saying "NEC and me."

NEC AND ME

NEC Information
Systems, Inc.
1414 Mass. Ave.
Boxborough, MA
01719



Simulation of Weighted Voting: The Banzhaf Index

Sometimes the little guy carries the big stick

by Philip A. Schrodt

In this election year it is fascinating to try to determine how major political parties choose their candidates and get them elected. The candidates must please as many people as possible and make involved political deals and trades. The Banzhaf index, an approximation of voting power, explains how the dark horse can end up as the front runner.

Consider the following situation: a parliament containing four parties meets to form a government. The parties control the following votes:

A	225
B	198
C	73
D	42

The party that can assemble a coalition containing a majority of the votes (270) chooses the prime minister. From which party is the prime minister chosen? Looking at party sizes, you would assume party A, with 41 percent of the votes, or possibly B, with 37 percent, because these are considerably larger than the others. In fact, the prime minister comes from party C, with only 14 percent of the votes. Why? Because of coalitions.

There are a total of seven possible coalitions with more than 270 votes: AB, AC, ABC, ABD, ABCD, BC, and BCD. No other coalition has enough votes to form a majority. You can reduce the number of coalitions even further because the partners want to keep the coalition as small as possible.

You form coalitions by promising ministerial posts to potential partners. Only a limited number of posts exist, and each party wants to control as many ministries as possible. Therefore, the practical number for a coalition is just enough votes to form a majority, but no more. These are called "minimum winning coalitions," or MWC, a concept developed in detail by William Riker (see reference 3).

The MWC principle reduces the coalitions to AB, AC, and BC. Notice that party D entirely disappears from the calculations. There are no circumstances in which a minimum winning coalition needs to include D, so even with 8 percent of the votes, party D is irrelevant. The remaining parties are equal, despite the disparity of votes, because each one must join another to make a majority. If, in addition, you rule coalition AB out because the two major parties don't want to share power, party C becomes the sole determining party and, therefore, claims the prime minister position. Party C, with only 14 percent of the votes, plays a pivotal position.

This situation is not hypothetical; it is a simplified version of the Italian Chamber of Deputies after the June 1983, election. The large parties are the Christian Democrats (A) and the Italian Communist party (B). Party C is the Socialist party. The prime minister of Italy, Bennito Craxi, is a Socialist.

Table 1 analyzes the Italian Chamber of Deputies with Banzhaf indexes, measuring the proportion of the time a party is pivotal in an MWC. In the 1983 election the two leading parties had roughly 67 percent of the parliamentary votes between them. However, since they were unwilling to form a coalition, they had less than 40 percent of the Banzhaf power. The Socialists had 27 percent of the Banzhaf power even though they had a mere 7 percent of the votes. They used that power to gain the prime minister position. The Banzhaf power is by no means the sole determining factor here, but it provides a better guide than simple vote distribution.

The Banzhaf Index

The Banzhaf index is named after John F. Banzhaf III, who first used it in a study of voting in the Nassau County, New York, legislature. In 1964 this legislature had six members with the following number of votes: 31, 31, 28, 21, 2, and 2. Banzhaf noted that in this situation the members with two votes were essentially powerless. Their votes made no difference whatsoever in the final outcome of the election. Surprisingly, this was also true of the member with 21 votes. You could have a winning majority (58 votes) with the two-member combinations [31,28] and [31,31], but even the four-member combination [31,21,2,2] did not constitute a majority. Therefore, the six-

member legislature was effectively a three-member legislature.

The Banzhaf index is simply the probability that a particular voter or party will be a pivotal member in a winning coalition (when all coalitions are assumed equally probable). A pivotal member is one whose departure can cause the coalition to lose. A member who is not pivotal has little political pull because the other coalition members lose nothing if he or she leaves. The Banzhaf index is one measure of the influence that a member or party has on a legislative body.

If every member has a single vote, then all Banzhaf indexes are equal to $1/n$, where n is the number of votes. The index becomes more interesting in *weighted voting* situations, where members or parties have different numbers of votes.

Weighted voting situations occur in a number of different situations. The most familiar one for political scientists is the multiple-party parliamentary system, like the Italian example above, in which parties must assemble a winning coalition to form a government. In Israel the Likud coalition has a bare majority in parliament; thus, tiny fringe parties in that coalition become pivotal and have substantial power over government policy.

Weighted voting occurs in a variety of other situations, such as corporate stockholders' meetings, where the voting is based on the number of shares owned. A variety of international organizations, including the International Monetary Fund and the European Economic Community, use weighted voting. Even the United Nations Security Council, with its veto power for the five permanent members, can be analyzed with the Banzhaf index. As Riker and Ordeshook (reference 4) show, the five permanent members have 98 percent of the Banzhaf power while the 10 nonpermanent members share the remaining 2 percent.

The electoral college used in presidential elections in the United States is another example of weighted voting. Table 2 gives the Banzhaf power of the various states in deter-

Italian Chamber of Deputies, June 1983

Party	Votes	Proportion	Banzhaf Index	Banzhaf without DC-PCI Coalitions
Christian Democrats	255	.357	.324	.223
Communist	198	.314	.224	.154
Socialist	73	.116	.224	.270
Italian Social Movement	48	.067	.074	.102
Republican	29	.046	.055	.078
Democratic Socialist	23	.037	.044	.061
Liberal	16	.025	.035	.049
Radical	11	.017	.020	.028
Proletarian Democrats	7	.011	.014	.019
Small regional parties	6	.010	.012	.016

Table 1: The proportion of time a party is pivotal in an MWC.

United States Electoral College, 1984

States	Votes	Proportion	Proportion Population	Banzhaf	Banzhaf Population
CA	47	.0873	3.69	.0932	3.95
NY	36	.0669	3.82	.0710	4.06
TX	29	.0539	3.78	.0554	3.90
PA	25	.0465	3.90	.0482	4.07
IL	24	.0446	3.91	.0446	3.91
OH	23	.0428	3.95	.0484	4.48
FL	21	.0390	4.02	.0393	4.05
MI	20	.0371	4.03	.0377	4.10
NJ	16	.0297	4.07	.0280	3.83
MA NC	13	.0242	4.15	.0234	4.03
GA IN VA	12	.0223	4.16	.0223	4.16
MO WS TN	11	.0204	4.31	.0201	4.25
LA MD MN WA	10	.0186	4.48	.0177	4.29
AL KY	9	.0167	4.51	.0165	4.46
CO CT IA OK SC	8	.0148	4.90	.0145	4.83
AZ KS MS OR	7	.0130	5.14	.0127	5.03
AR WV	6	.0111	5.28	.0109	5.19
NE NM UT	5	.0093	6.30	.0088	6.03
HI ID ME MT NV	4	.0074	8.22	.0068	7.55
NH RI					
AK DE DC ND SD	3	.0056	10.33	.0053	9.77
VT WY					

* Based on 150,000 Monte Carlo experiments. Population ratios are multiplied by 1,000,000,000.

Table 2: The Banzhaf power of each state in determining the outcome of the 1984 presidential election.

mining the outcome of presidential elections. Two things are clear. First, the Banzhaf power does not differ dramatically from the proportional power—as is usually the case when large numbers of voters are involved. Second, the Banzhaf power favors large states over small. This partially compensates for the electoral college itself, which favors small states over large. The Banzhaf power per person in the larger states is more evenly balanced than the proportional power per person.

"Quarreling members" affect the Banzhaf indexes as well. In Italy the two largest parties, the Christian Democrats (DC) and the Communists (PCI), will not enter a coalition together. The small parties of the political center—the Socialists, Republicans, and Liberals—therefore have a disproportionate amount of Banzhaf power, roughly double their proportional power. Italian parliamentary coalitions are extraordinarily unstable because of the impossibility of this DC-PCI partnership.

Even so, the political center prefers to keep these two major parties at odds with each other. Coalitions must be rounded out with an assortment of small parties that control only one or two votes each. This arrangement keeps the small parties in business and gives them their power.

Calculating Banzhaf Indexes

You can calculate Banzhaf indexes in one of two ways. If there are only a few parties, a computer can quickly go through all possible coalitions. For a set of n parties, the number of possible coalitions is $2^n - 1$. So, for example, a 10-party system involves calculating only 1023 coalitions.

For a larger system, however, exhaustive calculation becomes impossible. For example, in the 51-state United States electoral college, there are about 2,251,800,000,000 possible coalitions. Even at computer speeds, the time required for these calculations is prohibitive. If one coalition could be evaluated each microsecond (and it can't), the computation would require 71 years to

complete. That's a bit long to wait for results. Instead, you can obtain approximate results using what is known as Monte Carlo simulation.

In Monte Carlo simulation, a random-number generator sets up coalitions randomly. The system evaluates each coalition first to see if it contains enough votes to win; if so, it determines the pivotal members. After the system generates a large number of random coalitions, the percentage of times a party is pivotal should be roughly equal to its Banzhaf index. I've used this method on systems with as many as 200 voters (presidential nominating conventions). The indexes converge fairly rapidly.

The time it takes to evaluate each coalition is greater for the Monte Carlo method than it is for the exhaustive method. For example, it takes about 1.5 times as long to run 1023 Monte Carlo experiments as it does to compute them exhaustively (53 seconds versus 35 seconds on an Apple II). The additional overhead comes from setting up the coalitions. You may need to experiment to find

the most efficient means of evaluation. The 150,000 experiments used to generate table 2 took about six hours, running the Apple II with a "Mill" coprocessor. It took only 30,000 experiments, however, to produce reasonably similar results.

The Program

Running the program (see listing 1) is fairly straightforward. You simply enter the vote data, choose the Monte Carlo or exhaustive method, and then let the program compute the indexes. You may repeat this as often as necessary.

The first prompt in the program asks you whether you want to enter information from a .TEXT file. If you have prepared the vote data beforehand, respond "yes" to this question and give the program the filename; otherwise, enter the data directly from the keyboard.

The input consists of identification information and vote information. Up to 10 lines can identify the file. Terminate this with a "null record"—a line consisting of only a Return

Text continued on page 152

RIDE THE \$100 BUS? LEAVE THE MAIN/FRAMES TO US!

These are but a few of the \$100 Boards that "run like a rabbit" in Integrand Main/Frames.

75 models
From \$175

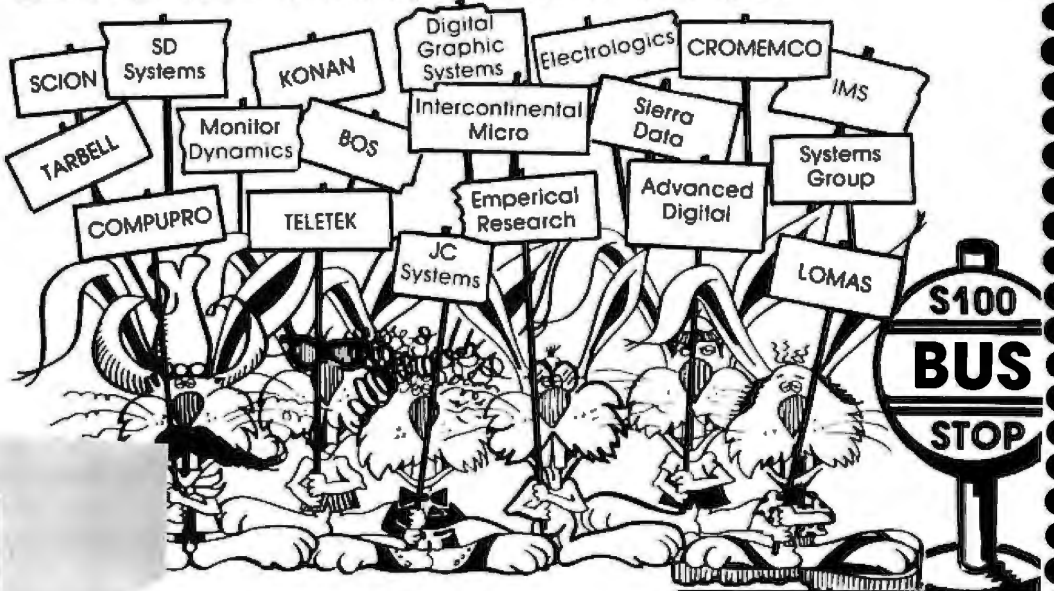

Write or call for our 32 page FAKT PAKT CATALOG which includes our application note: "Making micros better than any ol' box computer"

INTEGRAND

8620 Roosevelt Ave./Visalia, CA 93291
209/651-1203

We accept BankAmericard, Visa and MasterCard

COMPUTER WAREHOUSE

CALL TOLL FREE **1-800-528-1054**

QUADRAM

Quadlink	\$449
Quadboard 64K	\$249
Quadboard 256K	\$389
Quadboard II 64K	\$249
Quadboard II 256K	\$389
Microfazer (ME16) 16K	\$129
Microfazer (ME32) 32K	\$149
Microfazer (MSS16) 16K	\$149
Microfazer (MSS32) 32K	\$179

PRINTERS

C-Itoh	
A10-20	\$499
F-10-Parallel or Serial	\$935
55 CPS Serial or Parallel	\$1319
8510 Parallel (Prowriter)	\$329
8510SP (Prowriter SP)	\$559

Computer International

Daisywriter 2000 w/48K	\$999
------------------------------	-------

Comrex

CR-2	\$449
------------	-------

Datasouth

DS180	\$1155
-------------	--------

Diablo

620	\$850
630 AP1	\$1699
630 ECS/IBM	\$2075
S-11	\$559
P-11	\$559

Inforunner

Riteman	\$329
---------------	-------

IDS

Microprism 480	\$385
Prism 132	\$1310
Prism 132 Color	\$1500

Juki

6100	Call
------------	------

Epson

All Printer Models	Call
--------------------------	------

NEC

PC-8023A	\$385
PC-8025	\$669
3510	\$365
3550	\$1710
7710	\$1900
2010	\$785
2015	\$785
2050	\$910

Okidata

82A	Call
83A	Call
84P	Call
84S	Call
92	Call
93	Call
2350P	Call
2410P	Call

Olivetti

PRAxis 41 (w/interface)	\$539
2300INK JET	\$319

Panasonic

1090	\$299
------------	-------

Qume

11/40 w/interface	\$1369
11/55 w/interface	\$1569
Letter Pro 20P	\$609
Letter Pro 20S	\$609

Silver Reed

EXP400	\$325
EXP50P	\$579
EXP50S	\$610
EXP500	\$389

Star Micronics

Gemini-10X	Call
Gemini-15X	Call
Delta 10	Call

Tally

MT 160L w/Tractors	Call
MT 180L w/Tractors	Call
Spirit 80	Call

Toshiba

P1350 Serial or Parallel	\$1445
--------------------------------	--------

Transtar

120P	\$449
120S	\$489
130P	\$669
130S	\$709
140S	\$1179
T315	\$449

SPECIAL OF THE MONTH SANYO*EPSON SYSTEMS

DUAL DRIVE SYSTEM \$1495

SANYO MBC-555 • SANYO CRT-36 HI-RES GREEN MONITOR
EPSON RX-80 WordStar • CalcStar

• Mailmerge • InfoStar • Spell Star
• Easywriter • MS-DOS • Sanyo Basic
Above with Sanyo CRT-70
Color Monitor **\$1939**

SINGLE DRIVE SYSTEM \$1175

SANYO MBC-550 • SANYO CRT-36 HI-RES GREEN MONITOR • EPSON RX-80
WordStar • CalcStar • Easywriter
• MS-DOS • Sanyo Basic
Above with Sanyo CRT-70
Color Monitor **\$1629**

VIDEO TERMINALS

ADDS	
A-1 Green	\$480
A-2 Green	\$490
Viewpoint 60	\$619

Altos

Smart II	Call
----------------	------

Hazeltine

Esprit I	\$485
Esprit II	\$540
Esprit III	\$735

Qume

QVT 102 Green	\$535
QVT 102 Amber	\$550
QVT 103 Green	\$840
QVT 103 Amber	\$850
108 Green	\$680
108 Amber	\$699

Televideo

910+	\$539
914	\$539
914	\$539
924	\$669
925	\$689
950	\$889
970	\$969

Wyse

Wyse 50	\$489
Wyse 100	\$680
Wyse 300	\$1020

Visual

Visual 50 Green	\$619
Visual 55 Green	\$709

Zenith

Z-29	\$644
------------	-------

MODEMS

Hayes	
Smartmodem	\$199
Smartmodem 1200	\$485
Smartmodem 1200B	\$430
Micromodem IIe	\$235

MONITORS

Amdek	
Video 300	\$130
Video 300A	\$145
310A	\$160
Color I	\$270
Color I Plus	\$275

BMC

12" Green	\$85
13" Color	\$210

Princeton Graphic

HX-12	\$499
-------------	-------

Taxan

12" Amber	\$125
-----------------	-------

Zenith

12" Green Screen	\$95
12" Amber Screen	\$120

DISK DRIVES

Rana	
Elite 1	\$215
Elite 2	\$345
Elite 3	\$410
Controller (w/Drive only)	\$ 65
1000 w/DOS (for Atari)	\$305

DISKETTES

Maxell	
MD-1 (Qty. 100)	\$230
Scotch	
744-0 (Qty. 100)	\$200
Elephant	
S/S S/D (Qty. 100)	\$155

COMPUTERS

Altos	
All models	Call
Columbia	Call
Corona	Call

Eagle

PC-E	\$1775
PC-1	\$2645
PC-2	\$3075
PC-XL	\$3955
1620	\$3955
1630	\$5625
1640	\$7225

NEC

PC-8201A CPU	\$589
PC-8206A 32K Ram	\$289
PC-8221 A Thermal Printer	\$129
PC-8261 A Recorder	\$89
PC-8201A-90 Battery Pack	\$15

Northstar

Advantage	\$2160
Advantage w/5MB	\$3345
Advantage w/15MB	\$4315

Pied Piper System

Communicator I Portable, Z-80, 64K Ram, Full sized keyboard, Slim line 5 1/4 Disk Drive with 1M Byte of storage, Monitor output, Perfect Word, Perfect Calc, Perfect Speller, Perfect Filer, CPM, 90-day nationwide warranty, BMC Green Monitor, Tilt & Swivel Stand, Carrying Case

Sanyo	
MBC-550 System	\$1175
MBC-555 System	\$1495

Televideo Systems

802 H	\$4210
803	\$1795
1603	\$2150
806/20	\$4775
800 A (user station)	\$999
Teleport	Call

Zenith

Z-100 Low Profile	\$2625
Z-100 All-In-One	\$2800

Order Line: 1-800-528-1054
Order Processing & Other Information: 602-954-6109



2222 E. Indian School Rd.
Phoenix, Arizona 85016

Store Hours: Tue-Fri 10-5:30 Saturday 9-1
Order Line Hours: Mon-Fri 10-5:30 Saturday 9-1



Prices reflect 3% to 5% cash discount. Product shipped in factory cartons with manufacturer's warranty. Please add \$8.00 per order for shipping. Prices & availability subject to change without notice. Send cashier's check or money order...all other checks will delay shipping two weeks.

Listing 1: A program to compute Banzhaf indexes using either Monte Carlo simulation or an exhaustive evaluation.

```
PROGRAM BANZDEMO;
(* program for computing Banzhaf indices using Monte-Carlo simulation
or exhaustive evaluation.
Apple II Pascal *)
(**C copyright (C) 1983, Philip A. Schrodtt *)

uses applestuff;
  (* Two procedures used from applestuff:
  randomize: randomly set seed of random number generator
  random: function generating random numbers with a
  Uniform[0,1] distribution *)

const maxvot=200; (* maximum number of partys allowed *)

var votes: array[1..maxvot] of integer; (*votes by party*)
    ncex,totpivots,nid,np,mwcvote:integer; (* number of coalitions evaluated;
    total pivots,number of id lines,
    number of parties,votes required for mwc*)
    numpivots: array[1..maxvot] of integer ;(*number of pivots*)
    name: array[1..maxvot] of string; (* party names *)
    id: array[1..10] of string; (* run identification information*)
    mem: array[1..201] of boolean; (*coalition membership*)
    (* Warning: change 201 to maxvot+1 if maxvot is changed *)
    bi: array[1..maxvot] of real; (* Banzhaf indices*)
    printflag:boolean;
    totvot,nex,kz,ka,kb,npp1: integer;(* assorted counters *)
    inf,pr: text; (*input file,printer*)
    sta:string;

procedure banzprint;forward;

function answer(S:string):boolean;
(* writes question S and checks for 'Y' answer *)
var C:char;
begin write(S,'? -->');read(C);writeln;
    if C=Chr(27) then Exit(program);
    answer:=((C='Y') or (C='y'))
end;

function iconv(S:string):integer;
(* converts string S into integer, ignoring all chars except numerals,
and '-'. No error checking.
Warning-- this is an extraordinarily forgiving integer input procedure...*)
var i,p,k:integer;
    neg:boolean;
begin
    i:=0;neg:=false;
    for k:=1 to Length(S) do begin
        p:=ord(S[k]);
        if (p<58) and (p>47) then i:=i*10 + (p-48)
            else if p=45 then neg:=true;
        end;
    if neg then iconv:= -i else iconv:=i;
end;

procedure sortfile;
(* bubble sort 'name' and 'votes' by votes *)
var ka,kb,kc:integer;
    sta:string;
begin
    write('Sorting data');
    for ka:=1 to np-1 do begin
```

Listing 1 continued on page 144

A Stickler for Profit.

MICROCENTRE™

The Workstation That Optimizes Your Computer Use

We've all seen how microcomputers can increase personal productivity. But computers are not used all the time. MICROcentre™ lets departments share a common computer system to reduce costs while improving profit-center efficiency.

This secure, easily movable storage system opens in seconds into a

complete work station. Any place. Any time. And MICROcentre™ is built to conform to the user's natural movements for convenience and comfort over extended periods of time.

The MICROcentre™ is designed to hold most personal computer systems—IBM PC, Apple II+ and IIe, Hewlett Packard, etc.—and provides storage space for your manuals and software. Plus, the stylish European locks protect your components as well as your valuable data.



There are many other outstanding qualities that separate MICROcentre from anything else on the market. To find out more about them, call (213) 350-8371.



MICROcentre™
Ready to Work When You Are
Patent Pending

CONTINENTAL ENGINEERING GROUP, INC. EL MONTE, CA

Circle 47 on inquiry card.

```

    write(' ');
    for kb:=ka to np do
        if votes[kb]>votes[ka] then
            begin sta:=name[ka];name[ka]:=name[kb];name[kb]:=sta;
                kc:=votes[ka];votes[ka]:=votes[kb];votes[kb]:=kc;end;
    end;
    writeln;
end;

procedure readstring(s:string;var n:string;var v:integer);
(* breaks out the party name and votes from input string *)
var ka:integer;
begin
    ka:=pos(':',s);
    if ka=0 then begin n:='error';v:=0;
        exit(readstring);end;
    n:=copy(s,1,ka-1);
    if ka=length(s) then v:=0
        else v:=iconv(copy(s,ka+1,length(s)-ka));
end;

procedure readdata;
(*read vote data *)
var ka,kb:integer;
    sta:string;

procedure readfile;
(* read from a file *)
begin
    write('Enter file name-->');readln(sta);
    if (pos('.text',sta)=0) and (pos('.TEXT',sta)=0) then
        sta:=concat(sta, '.TEXT');
    reset(inf,sta);

    (* read file identification info *)
    nid:=0;
    repeat
        nid:=nid+1;
        readln(inf,id[nid]);
        writeln(id[nid]);
    until (length(id[nid])=0) or (nid=10);
    if nid=10 then begin
        writeln('Sorry, maximum of ten lines allowed...');
        repeat readln(inf,sta) until length(sta)=0;end
    else nid:=nid-1;

    (* read vote data *)
    readln(inf,sta);
    ka:=0;
    while (not eof(inf)) and (length(sta)>0) and (ka<=maxvot) do begin
        ka:=ka+1;writeln(sta);
        readstring(sta,name[ka],votes[ka]);
        readln(inf,sta);
    end;
    if ka>=maxvot then writeln('Read stopped at ',maxvot,' parties');
    close(inf);
end;

procedure read2;
(* tail-end of READDATA procedure, which is otherwise too long *)
begin
    nex:=0;
    for ka:=1 to np do nex:=nex+votes[ka];

```

When you visit your dealer and compare the Princeton IBM-compatible HX-12 side-by-side with the IBM color monitor, your eyes will see the difference.

The HX-12 gives you higher resolution and finer dot pitch (.31mm) than the IBM 5153's medium resolution (.43mm) for a cleaner, sharper image.

Compare our full range of colors and our crisp whites without red bleed. You'll also see a difference in

our non-glare screen—a feature your eyes will really appreciate in a long work session.

The Princeton HX-12 comes with a cable that plugs directly into the IBM PC, ready to burst forth into 16 superb colors. All at a suggested retail price (\$695) that's a pleasure for sore eyes and overworked budgets.

Apple IIe users: call us to learn how you, too, can now enjoy the visible superiority of the Princeton HX-12.

Ask your local dealer for a demonstration and let your eyes decide. Or call us at 800-221-1490 for more information and the name of your nearest dealer.

If you're ready to move up to color, graduate to the Princeton HX-12. It's right at the head of its class.



**Princeton
Graphic
Systems**

1101-1 State Road, Princeton New Jersey 08540
609 683-1660 TLX:6857009 PGS Prin.
800-221-1490 Circle 291 on inquiry card.

DON'T COMPROMISE:

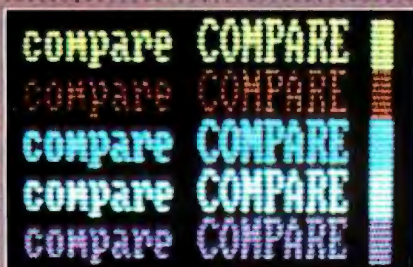

OURS: .31mm dot pitch, 80 column text.



THEIRS: .43mm dot pitch, 80 column text.

THE PRINCETON HX-12 HIGH RESOLUTION RGB COLOR MONITOR

for the image
your eyes deserve



```

writeln('Total votes entered: ',nex);
write('Enter number of votes of minimum winning coalition:');
readln(mwcvote);
sortfile;
end;
begin
  if answer('Is vote data on a .TEXT file')
  then readfile
  else begin (* read from keyboard *)
    writeln('Enter identification info (null to stop):');
    nid:=0;
    repeat
      nid:=nid+1;
      readln(id[nid])
    until (length(id[nid])=0) or (nid=10);
    if nid=10 then writeln('Sorry, maximum of ten lines allowed...')
    else nid:=nid-1;
    writeln('Enter party id and number of votes separated');
    writeln('  by : for each party; null record to finish');
    ka:=0;
    repeat
      readln(sta);
      if length(sta)>0 then begin
        ka:=ka+1;
        readstring(sta,name[ka],votes[ka]);
        if votes[ka]<0 then begin
          ka:=ka-2;
          writeln('Backspace -- next entry will replace');
          writeln('          ',name[ka],' : ',votes[ka]);
        end;
      end;
    until (length(sta)=0) or (ka=maxvot);
    if ka=maxvot then writeln('Maximum of ',maxvot,' parties allowed');
    end;
  np:=ka; npp1:=np+1;
  read2;
end;

procedure init; (* initializes assorted parameters *)
begin randomize;
  for ka:=1 to maxvot do numpivots[ka]:=0;
end;

procedure randcoal;
(* creates a random coalition and counts pivots*)
var pr,ka:integer;
begin pr:=random;
  for ka:=1 to np do mem[ka]:=(random<pr);
end;

procedure allcoal;
(* this increments the mem array to get the next coalition.
  Cycles through all coalitions by treating 'mem' as though it were
  a sequence of binary numbers 1 to 2^np -- "allcoal" in effect does
  a binary add of "1" to "mem" *)
var ka:integer;
begin ka:=1; mem[ka]:=(not mem[ka]);
  while not mem[ka] do begin
    ka:=ka+1;
    mem[ka]:=(not mem[ka]);end;
end;

procedure countpivot;
(* determines the pivotal members in the current coalition

```

GREAT PRICES! GREAT SERVICE!

Looking for a great deal on business software?

800-SOFTWARE is hard to beat. You see, we became one of America's largest software marketers by offering great prices—and a lot more.

Here are some of the reasons to pick up the phone and pick up a bargain:

LOW DISCOUNT PRICES.

Our prices are fabulous! Generally 40-50% off suggested list price. How do we do it? By buying and selling in enormous volume. (All our programs are the very latest versions. And when "updates" appear, we'll get them for you, fast!)

FAST DELIVERY.

The key to our quick delivery is our giant inventory. We have what you want. Now. And we'll rush it to you like our business depends on it. (Because it does.)

FREE TECHNICAL SUPPORT 90 HOURS A WEEK!

That's right. We offer full technical support at no charge, whatsoever, seven days a week.

That means if you have a question on Sunday, at night, or during any of the 90 hours we're open each week, you can get answers. Fast. (And remember, our technical product experts are not ordertakers. Their only job is helping you get the most out of the products we sell.)

- Quantity discounts available through our National Accounts Program.
- Purchase orders accepted. Please call in advance.
- Prompt U.P.S. or Federal Express shipping.
- Overnight delivery available.

Circle 3 on inquiry card.

CHECK OUT ALL OUR INCREDIBLE BUSINESS SOFTWARE PRICES:

WordStar®	\$269
WordStar® Pro. Pack.	\$389
SuperCalc® 2	\$169
SuperCalc® 3	\$279
Lotus 1-2-3™	CALL
dBase II™	\$399
Quickcode™	\$199
Crosstalk™	\$119
EasyWriter II System™	\$199
I.U.S. Accounting™	\$299/mod
Norton Utilities™	\$59
Perfect Link™	\$119
Multiplan™	\$189
4-Point Graphics™	\$129
Hayes SmartModems™	CALL
Memorex™ or Maxell™ Diskettes	CALL

WE ALSO CARRY SOFTWARE FROM:

Ashton-Tate, Aspen, ATI, CDEX, Digital Research, Fox and Geller, IMSI, I.U.S., Life-tree, MicroPro, Microsoft, Peachtree, Perfect, Software Publishers, Sorcim, Visi-Corp and much, much more!



CUSTOMERS TELL OUR STORY BEST.

"I very much appreciate your helpfulness and speed in filling my order. Rarely today do I have the opportunity to deal with a firm which shows such a high

degree of professional ability."
Joe Neil, Lihue, HA

"Thank you very much for the very prompt service you gave me. I would be delighted to do business with you anytime in the future that you have something I need."

William Drescher,
Lansing, MI

RELIABILITY AND REPUTATION.

When you buy from us, you're in good company. You see, some of our best customers are America's biggest corporations. Like IBM, Chevron, Hewlett-Packard, G.E., Price Waterhouse and Honeywell.

They order from us because they know we're not running our business from a phone booth (we have a million dollar inventory!). And because we offer extra discounts on quantity orders and other special services for our National Accounts customers.

Also, we fully guarantee every product we sell. That's how we earned our membership in the respected Direct Mail Marketing Association.



**800 SOFTWARE IS READY
TO SERVE YOU.
TO ORDER CALL TOLL-FREE
800-227-4587 or 415-644-3611**

800-SOFTWARE

940 Dwight Way, Berkeley, CA 94710



- Call for shipping charges, other low software prices or for a free catalog.
 - Prices may change.
 - International dealers and orders welcome: TELEX #751743 800-SOFTWARE UD.
- CA residents add sales tax.

© Copyright 800-SOFTWARE 1983

```

    and increments numpivot array *)
var totvot,ka:integer;
begin totvot:=0;
  for ka:=1 to np do if mem[ka] then totvot:=totvot+votes[ka];
    if totvot>= mwcvote
      then begin
        for ka:=1 to np do
          if mem[ka] then if (totvot-votes[ka]) < mwcvote
            then numpivots[ka]:=numpivots[ka]+1
            else ka:=np;  (*note: this shortcut assumes sorted votes...*)
        end;
      end;
end;

procedure exhaust;
(* evaluation of Banzhaf indices by computing all coalitions *)
var ka:integer;
begin ncex:=0;
  for ka:=1 to npp1 do mem[ka]:=false;
    repeat ncex:=ncex+1;
      allcoal;
      countpivots;
      if (ncex mod 20)=0 then write(' ');
    until mem[npp1];
    (* stop when np+1 element of mem is 'true' *)
end;

procedure randcomp;
(* evaluates Banzhaf indices using Monte-Carlo methods *)
var ka:integer;
begin
  write('Enter number of random coalitions to generate:');
  readln(sta);
  nex:=iconv(sta);
  writeln('A "." is printed for each 20 coalitions');
  for ka:=1 to nex do begin
    randcoal;
    countpivots;
    if (ka mod 20)=0 then begin write(' ');
      if (ka mod 500)=0 then
        writeln('Total coalitions:',ka);
      end;
    end;
  nex:=nex;
end;

procedure banzcomp;
(* computes Banzhaf indices*)
var ka:integer;
begin
  totpivots:=0;
  for ka:=1 to np do totpivots:=totpivots+numpivots[ka];
  if totpivots=0 then begin
    writeln('Error -- no pivots recorded');
    exit(banzprint);end;
  for ka:=1 to np do bi[ka]:=numpivots[ka]/totpivots;
end;

procedure print(st:string);
begin
  writeln(st);
  if printflag then writeln(pr,st);
end;

```

Buy Hardware/Software at Wholesale, And Save On Software Rentals, As A NETWORK™ Member Only!

Save hundreds of dollars when you buy DIRECT from America's Number 1 Computer Buying Service at just 8% above DEALER WHOLESALE PRICES, plus shipping.

Members receive The Personal Computer NETWORK's Giant Catalog featuring thousands of products and the lowest prices on the widest selection of computer software and hardware in the nation!

RENT BEFORE YOU BUY—Members are eligible to join The NETWORK's Business and Game Software Rental Libraries for a much smaller fee than other software rental services. And The NETWORK's rental charges are far less — just 20%-25% of the Member WHOLESALE PRICE!

Join The NETWORK today for as low as \$8 for one year (or \$15 for two years) and receive all these exclusive, money-saving benefits:

- REAL BUYING CLOUT**—Buy at just 8% above DEALER WHOLESALE PRICES, plus shipping. (On credit card orders there is a 3% service charge.)
- CONVENIENT SHOP-AT-HOME CATALOG**
- KNOWLEDGEABLE SERVICE CONSULTANTS**
- FULLY INSURED FAST HOME DELIVERY**
- OPTIONAL BUSINESS SOFTWARE RENTAL LIBRARY**—Members join for just \$30 per year in addition to the basic membership fee. Rent business software at just 20%-25% of The NETWORK's low prices for a 7-day period (plus a 3-day grace period for return shipping). 100% of your rental fee applies towards purchase.
- OPTIONAL GAME SOFTWARE RENTAL LIBRARY**—Members join for just \$10 per year in addition to the basic membership fee. All the same conditions apply as for benefit five.
- SPECIAL SAVINGS BULLETINS**—Save even more on limited-quantity merchandise!
- DISCOUNT COMPUTER BOOK LIBRARY**—Save up to 50%!
- MEMBERSHIP SATISFACTION GUARANTEE**—If you are not satisfied, notify us within 30 days to receive a 100% money-back refund.
- PRODUCT SATISFACTION GUARANTEE**—If you are not satisfied with any hardware, return it within 15 days for a 100% money-back refund.

Low prices, fast home delivery and two software rental libraries are only the beginning! The NETWORK is your source for everything from memory chips to mainframes—and it's all just 8% above wholesale, plus shipping.

HARDWARE

Monitors (color and monochrome)
Printers
Complete Systems
Disk Drives (full/half height, add-on/add-in)
Multi-Function Boards
Graphics Boards
Modems
Local Area Networks
Memory Chips (all speeds available)
S-100 Components

SOFTWARE (rent or buy!)

Business	Scientific
Recreational	Data Bases
Compilers	Educational
Word Processors	Graphics
Utilities	CP/M-MS/DOS

SUPPLIES & ACCESSORIES

Blank Diskettes (all formats)
Paper Stock
Ribbons
Print Wheels
Cables
And More!

Choose hardware and software from hundreds of manufacturers, including:

- | | |
|--------------------|-----------------------|
| • Altos | • MicroPro |
| • Amdek | • Microsoft |
| • Apparat | • Morrow |
| • AST | • Motorola |
| • Ashton-Tate | • NEC |
| • Atari | • Northstar |
| • CDC | • Okidata |
| • Coleco | • Peach Tree |
| • Columbia | • Princeton |
| • Commodore | • Quadram |
| • Corona | • Sanyo |
| • Cromemco | • Sierra On-Line |
| • DEC | • Software Publishing |
| • Digital Research | • Softword |
| • Eagle | • Tandon |
| • Epson | • Tecmar |
| • Franklin | • Texas Instruments |
| • Hayes | • Toshiba |
| • IBM | • Visicorp |
| • IUS | • Zenith |
| • Lotus | |

PORTABLE SPECIAL

	Retail	Wholesale
NEC 8201 Notebook 16K RAM, 32K ROM, Text Editor, Communications, Basic, 8-line 40-Char. Display	\$799	\$559*
Televideo Teleport 9" screen, 64K Z80-A, 2 368K Drives, WP, Calc, Graphics	\$1999	\$1535*

*NETWORK Members pay just 8% over the wholesale price, plus shipping

SPECIAL V.I.P. MEMBERSHIPS

Available at \$15 per year or \$25 for two years. V.I.P. Members receive additional benefits:

- BOTH SOFTWARE RENTAL LIBRARIES FOR \$35** in addition to the V.I.P. membership fee
- EXTENDED 10-DAY SOFTWARE RENTAL PRIVILEGES** (plus 3 days for return shipping)
- ADVANCE NOTIFICATION OF SPECIAL SAVINGS BULLETINS.**

CALL TOLL FREE

1-800-621-S-A-V-E
In Illinois call (312) 372-4488



Your Membership Validation Number: **B515**
You can validate your membership number and, if you wish, place your first money-saving order over the phone by using your VISA, MASTERCARD or AMERICAN EXPRESS. Our knowledgeable service consultants are on duty Mon-Fri 8 AM to 7 PM. Sat 9 AM to 5 PM CST.

Call now... Join the NETWORK and start saving today!

PERSONAL COMPUTER NETWORK
180 North Michigan Avenue
Chicago, Illinois 60601

All items subject to availability, prices subject to change without notice.
Copyright 1984, PC NETWORK INC

THE NETWORK · MEMBERSHIP APPLICATION

YES! Please enroll me as a member of The NETWORK™ and rush my catalog featuring thousands of computer hardware and software products, all at just 8% above DEALER WHOLESALE PRICES. I will also receive all the other exclusive, money-saving services available to Members. I am under no obligation to buy anything. My complete satisfaction is guaranteed.

Please check (✓) all boxes that apply:

Basic Membership

One-year membership for \$8
 Two-year membership for \$15 (SAVE \$1)
 Business Software Rental Library for \$30 add'l. per year—members only
 Games Software Rental Library for \$10 add'l. per year—members only

Special V.I.P. Membership

One-year membership for \$15
 Two-year membership for \$25 (SAVE \$5) **\$15**
 BOTH Business and Game Software Rental Libraries for \$35 add'l. per year—V.I.P. members only

Bill my credit card: VISA MasterCard American Express Exp. Date: _____ mo. year

Account Number: _____

Check or money order enclosed for \$ _____

Name _____
 Address _____ Apt. No. _____
 City _____ State _____ ZIP _____
 Telephone (_____) _____

My computer(s) is: IBM PC Apple II TRS-80
 Atari Commodore Other _____

Signature _____ (Signature required to validate membership)

```

procedure banzprint;
(* computes and prints results *)
var ka:integer;
    sta, stb, sty:string;

procedure printres; (* prints individual results *)
var rato, dif, prop:real;
begin
  for ka:=1 to np do begin
    prop:=votes[ka]/totvot; dif:=bi[ka]-prop; rato:=bi[ka]/prop;
    stb:=copy(concat(name[ka], ' ', ' '), 1, 10);
    write(stb, ' ', votes[ka]:5, ' ', prop:8:5, ' ', bi[ka]:8:5);
    writeln(' ', dif:8:5, ' ', rato:8:5, ' ', stb);
    if (not printflag) and ((ka mod 20)=0) then begin
      writeln('          <PRESS RETURN>');
      readln(sta);
      writeln(sty); end;
    if printflag then begin
      write(pr, stb, ' ', votes[ka]:5, ' ', prop:8:5, ' ', bi[ka]:8:5);
      writeln(pr, ' ', dif:8:5, ' ', rato:8:5, ' ', stb); end;
  end;
end;

begin
  writeln;
  printflag:=answer('Do you want hard copy');
  if printflag then rewrite(pr, 'printer:');
  print(' ');
  for ka:=1 to nid do print(id[ka]);
  print(' ');
  str(mwcvote, sta);
  print(concat('Votes for minimum winning coalition= ', sta));
  str(ncex, sta);
  print(concat('Total Experiments= ', sta));
  banzcomp;
  str(totpivots, sta);
  print(concat('Total Pivots= ', sta));
  print(' ');
  totvot:=0; for ka:=1 to np do totvot:=totvot+votes[ka];
  sty:='NAME          VOTES   PROP VT   BANZHAF          DIFF          RATIO          NAME';
  print(sty);
  printres;
  if printflag then close(pr);
end;

(* main program *)
begin
write(chr(12)); (* clear screen *)
writeln('          BANZHAF INDEX DEMONSTRATION PROGRAM');
writeln('          (c) 1983, Philip A. Schrodtr');
writeln;

repeat
  init;
  readdata;
  writeln;
  writeln('Enter Y for exhaustive evaluation,');
  if answer('          N for Monte-Carlo evaluation') then exhaust else randcomp;
  banzprint;
  writeln;
until (not answer('Do you wish to compute additional indices'))
end.

```

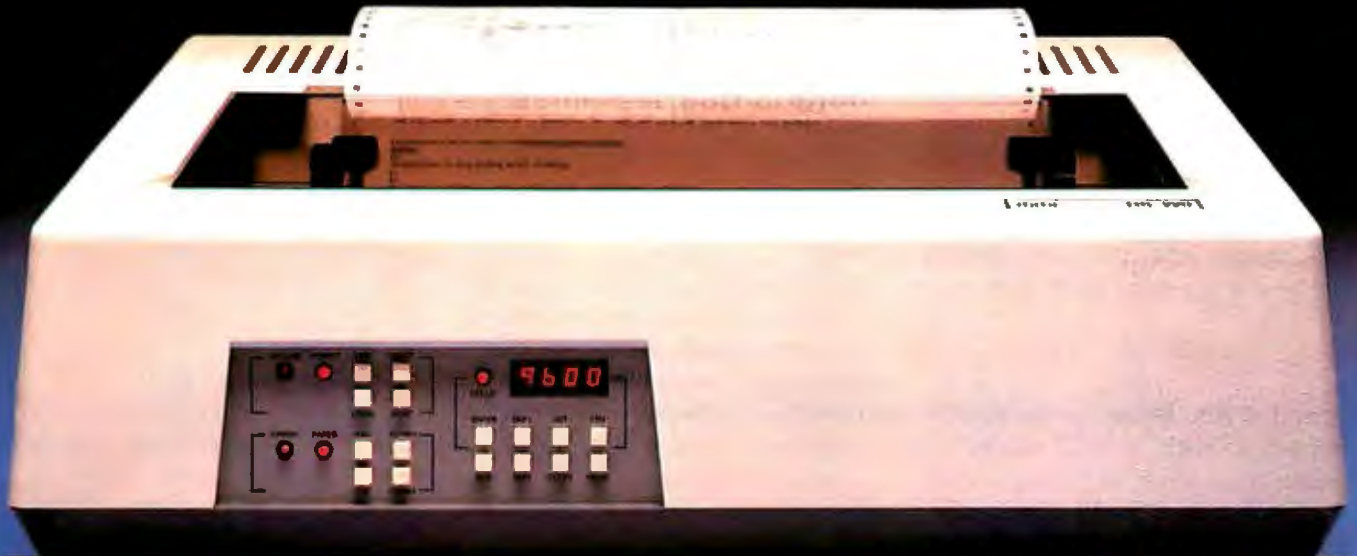

HIGH PERFORMANCE

NOW AVAILABLE IN A THREE-SPEED

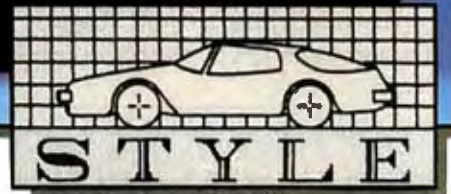

SPEED

Class



INTRODUCING THE NEW DS 220 MULTI-MODE MATRIX PRINTER

First there was the Datasouth DS180. The original high-performance printer. The printer that raised the standards of on-the-job performance to new heights. A tough act to follow.

And now, following in the same tradition, is the new Datasouth DS220. State-of-the-art performance, taken to higher levels. In a new 3-speed multimode form. Ready to run data, near letter quality and graphics output—in a single printer.

At data speed, the Datasouth DS220 leaves competitors in the dust. By using high speed tabbing to zip over blank spaces and true logic seeking to print the next available

character, the Datasouth DS220 charges through printed copy at speeds rivaling more expensive line printers.

At 40 CPS NLQ speed, the Datasouth DS220 creates near letter quality output with the kind of class that might make you wonder if it was produced by a daisy wheel printer. With its fine tuned 18 x 48 dot matrix, multiple fonts are produced with the precise clarity required for word processing applications.

And for graphics, the Datasouth DS220 adds high performance style to popular microcomputer applications programs through high resolution dot

addressable output. Sharp new details emerge from business charts and graphs, and engineering drawings.

And those are just its printing capabilities. Its fully instrumented dashboard allows push button programming of up to fifty features for forms control, communications and print style selection.

Best of all, the Datasouth DS220 costs much less than you might expect for a high performance three speed. Go to your nearest showroom and run a Datasouth DS220 through the gears. See how little it costs to own three high performance printers in one high performance package.

datasouth

H I G H P E R F O R M A N C E M A T R I X P R I N T E R S

Find Datasouth Printers At
Participating **ComputerLand** Stores
And Other Fine Dealers.

AVAILABLE NATIONWIDE
THROUGH OUR NETWORK OF
SALES AND SERVICE DISTRIBUTORS
CALL TOLL FREE:
1-800-222-4528

Datasouth Computer Corporation
Box 240947 · Charlotte, NC 28224
704/523-8500 · Telex 6843018 DASOU UW

Text continued from page 140:

(read as a string of length zero).

The vote input consists of a party name and the appropriate number of votes separated by a colon (:). For example,

Communist:	290
Republican:	40
Liberal:	30
Christian Democrats:	320

The system truncates names to 10 characters in the final index printout but they may be any length on input. The vote entry is "bullet-proofed," so if you accidentally enter a letter in the vote count, the program doesn't crash—it ignores the error. The entry

#%\$3\$#%\$' ''') (\$6

is read as 356. Terminate the vote information with a null record as before. If you enter data directly from the keyboard and find a mistake after pressing Return, enter a negative vote in the next entry to void the error. Then you can retype the previous entry. For example,

Liberal:	35
X:	- 1
Liberal:	30

changes the Liberal entry to 30 votes.

You may enter a maximum of 200 parties. You can probably expand this by increasing the dimensions in the program's array declarations, but 200 is close to the maximum possible on an Apple II. The system sorts the parties by the total number of votes, so the output is not in the same order as the input. The sorting reduces the running time by not evaluating parties without enough votes to be pivotal.

After you enter the null record, the program displays the total number of votes entered and asks for the number of votes needed to win. Usually, this is the number of votes needed for a simple majority, but sometimes it is for a two-thirds majority or some other amount. Then the program asks you whether you want to evaluate the coalitions with the exhaustive method or the Monte Carlo method. If you choose the latter, it

asks you how many random coalitions to generate. This number depends on how patient you are but should probably be at least 1000. On the Apple II 32,767 is the maximum. In either mode, the system prints a period after it evaluates every 20 coalitions so you can tell if the program is still running.

After evaluating the indexes, the program prints the results. It first asks if you want hard copy. If you respond "yes" to this prompt, the output is routed to both a printer and the screen. If you ask for hard copy and don't have a printer, the program crashes. If you do not ask for hard copy, the program pauses and waits for a Return after sending each screen of information.

Six items are printed:

NAME	party name, truncated to 10 characters
VOTES	the number of votes for the party
PROP VT	the <i>proportion</i> of the total vote that this party has

IBM PC-8087 SUPPORT FROM MICROWARE

87FORTRAN/RTOS™ is a MicroWare adaptation of the Intel Fortran-86 compiler; a full ANSI-77 subset with 8087 extensions and overlays. It generates in line 8087 code allowing use of all 8087 data types, including 80 bit reals and 64 bit integers. The complete subset I/O is supported including Internal and External Files and List Directed I/O.

87FORTRAN/RTOS uses the Intel large memory model, allowing data/code structures which utilize the full megabyte. The compiler provides direct access to 8088 ports and supports logical operations on 8 and 16 bit operands normally treated in assembly language. It is ideal for large applications which are number intensive or control hardware.

87PASCAL/RTOS™ is Intel's ISO-Standard Pascal with 8087-8088 exceptions. These make it possible to use all the 8087 data types directly, while generating modules in one of the three Intel Memory Models.

87FORTRAN/RTOS and **87PASCAL/RTOS** include RTOS and support for one year..... each **\$1350**

PC TECH JOURNAL REVIEW:

"The MicroWare package is preferable ... it executes the basic operations more rapidly and MicroWare provides a free update service."

87BASIC™ includes patches to the IBM Basic Compiler and both runtime libraries for USER TRANSPARENT and COMPLETE 8087 support. Provides super fast performance for all numeric operations including trigonometrics, transcendental, addition, subtraction, multiplication, and division..... **\$150**

87MACRO™ - our complete 8087 software development package. It contains a "Pre-processor" which converts 8087 instructions into 8088 escape codes, source code for a set of 8087 macros, and an object library of 8087 functions which include transcendental, trigonometrics, hyperbolics, encoding, decoding and conversions..... **\$150**

PLM-86 with RTOS..... **\$1100**

MICROWARE BEST SELLERS!

8087-3 CHIP in stock with 180 day warranty and 8088 exchange **\$175**

FASTPAK™+8087 includes one runtime library (87BASIC, 87MACRO or 87PASCAL), the 8087 chip, the 87/88GUIDE, and installation instructions **\$325**

MATRIXPAK™ manages a **MEGABYTE!** Written in assembly language, our runtime package accurately manipulates large matrices at very fast speeds. Includes matrix inversion and the solution of simultaneous linear equations. Callable from MS Fortran 3.13, MS Pascal 3.13, SSS Fortran, and MicroWare 87MACRO, 87BASIC, and RTOS compilers each **\$150**

87/88GUIDE - an excellent tutorial on writing 8087 code and interfacing it with compilers. Full of code that runs! **\$30**

MICROSOFT FORTRAN 3.13

MICROSOFT PASCAL 3.13 These new IEEE compatible compilers support both double precision and the 8087..... each **\$259**

MICROSOFT C COMPILER includes Lattice C and the MS Librarian.. **\$350**

Float 87 for MS C **\$125**

64K RAM Upgrade **64**

SuperSoft Fortran **340**

SSS 8087 Support **50**

SuperSoft Voice Drive **895**

87BASIC+ **75**

TRACE86 Utility **125**

Microsoft Business Basic Compiler **495**

Computer Innovations C86 **345**

STSC APL★PLUS/PC **545**

64K QUAD RAM **319**

Sandstar WS2 Hard Disk System **1355**

Multitool Word MW **269**

Multitool Word W/Mouse **329**

SANDSTAR 64K Card..... **275**

RTOS™ — Real Time Multi-Tasking Operating System

RTOS is a MicroWare configured version of iRMX-86, Intel's legendary operating system. It includes the Intel Assembler, ASM-86, which supports the 8086, 8087, 8088 and 80186. All modules produced by the compilers or ASM-86 are combined, loaded and managed with the Utilities LINK-86, LOC-86 and LIB-86. These products make it possible to load modules anywhere in RAM, and resolve external references between runtime modules. Overlays with a single root job are supported by the linker. RTOS/ASM-86/LINK-86/LOC-86/LIB-86 **\$600**

iRMX-86, LINK-86, ASM-86, LOC-86 and LIB-86 are trademarks of Intel Corp. IBM PC is a trademark of IBM Corp.

Micro Ware

P.O. Box 79
Kingston, MA
02364
(617) 746-7341

You Can Talk To Us!

SUPER SIX™



**SUPER SIX, THE FIRST 6MHz S-100 SINGLE BOARD COMPUTER
TO SUPPORT BANKED CP/M™ 3.0**



SUPER SIX & CP/M™ 3.0 A PERFECT MATCH

Advanced Digital has found the perfect match to its powerful, high-speed SUPER SIX single board computer. It's Digital Research's new CP/M 3.0. Because of SUPER SIX's 128 KB of RAM, it is the only S-100 board to support CP/M 3.0 in the banked mode; or run CP/M 2.2 with 64 KB of extra buffer.

SUPER SIX & TurboDOS™ ANOTHER PERFECT MATCH

When you combine the TurboDOS multi-user operating system with the 6 MHz SUPER SIX, you'll find your system running 1-1/2 times faster than



before. Add the 4 MHz or 6 MHz SUPER SLAVE™ processor board(s) and you will have the fastest multi-user, multi-processor system available today.

See the SUPER SIX at your quality computer dealer or contact:



5432 Production Dr.,
Huntington Beach, CA 92649
Phone: (714) 891-4004
Telex: 183210 ADVANCED HTBH

SUPER SIX FEATURES:

- 128 KB of Bank — selectable RAM
- 6 MHz, Z-80B CPU
- DMA Controller
- 6 MHz, Z-80B DART (2 Serial RS-232 Ports)
- 6 MHz, Z-80B PIO (2 Parallel Ports)
- 6 MHz, Z-80B CTC (Clock Timer)
- Double/Single Density Floppy Disk Controller — Supports 8" and 5-1/4" Drives Simultaneously
- 2/4 KB of Monitor EPROM
- S-100, IEEE 696 Compatible

CP/M is a trademark of Digital Research Corp.
TurboDOS is a trademark of Software 2000 Inc.
SUPER SIX and SUPER SLAVE are trademarks of
Advanced Digital Corp.

BANZHAF the Banzhaf index
DIFF the difference between the Banzhaf index and the proportion of votes (B/P)
RATIO the ratio of the Banzhaf index to the proportion of votes (B/P)

The system also prints file-identification information, the total number of coalitions evaluated, and the number of votes needed for a minimum winning coalition. It formats the output for an 80-column screen; if you have only 40 columns, press control-A to get the DIFF and RATIO information.

Final Remarks

I have not included any procedures for leaving out impossible coalitions, but they are easy to add. For example, to run the Italian system without the DC-PCI coalition, simply change "countpivots;" to

```
if not (mem[1] and mem[2])
  then countpivots;
```

in the "exhaust" procedure. You can use this to check through a list of prohibited coalition partners before counting the pivots.

Banzhaf indexes are not a perfect measure of voting power; they are only an approximation. Their chief weakness is assuming that all coalitions

are equally probable. In reality, coalitions are more likely to form along ideological lines. (The indexes can be recomputed easily with this restriction.) Second, the Banzhaf index does not take into account political maneuvering based on past favors or future promises among potential coalition partners. A skilled politician can have influence despite a weak Banzhaf position. Finally, the difficulty in computing Banzhaf indexes means that most negotiators have only a vague notion of their true power. Nevertheless, the Banzhaf index probably measures influence more accurately than the simple proportion of votes.

The upcoming presidential nominating conventions in the United States provide opportunities for parliamentary-style weighted voting, though this has not happened for a number of years. But if, for example, the Democratic party is unable to nominate a candidate on the first ballot, and if the various candidates can keep their delegates under control, then some interesting bargaining could occur to assemble a winning coalition. Jesse Jackson could easily be in a pivotal position. As these various examples illustrate, it is not the individual number of votes but the number of pivots that is important. It is misleading to look at vote totals alone. The use of Banzhaf

indexes casts a light on political power that makes the unexpected a little less of a surprise. ■

Philip A. Schrodt (Dept. of Political Science, Northwestern University, Evanston, IL 60201) is an associate professor in the political science department at Northwestern University. He also teaches mathematical methods in the social sciences program. His book, Microcomputer Methods in Social Science Research, has just been published by Sage Publications. Dr. Schrodt, who holds an M.A. in mathematics and a Ph.D. in political science, is the originator of the generic word-processor concept (April 1982 BYTE).

REFERENCES

1. Brams, Steven J. *Paradoxes in Politics*. New York: Free Press, 1976.
2. Brams, Steven J. *Game Theory and Politics*. New York: Free Press, 1975.
3. Riker, William H. *The Theory of Political Coalitions*. New Haven, CT: Yale University Press, 1962.
4. Riker, William H., and Peter C. Ordeshook. *An Introduction to Positive Political Theory*. Englewood Cliffs, NJ: Prentice-Hall, 1973.

Program Availability

The program in listing 1 is available as part of a set of three mathematical political science programs. The other two programs cover the Richardson arms race model (July 1982 BYTE, page 108) and alternative voting methods. The set is available for \$25 postpaid in either Apple or IBM format and includes additional documentation. It is available from the author at Polymath Associates Software, Route 1, Box 380, Clinton, NY 13323.

Your HP Computer Deserves the Best!

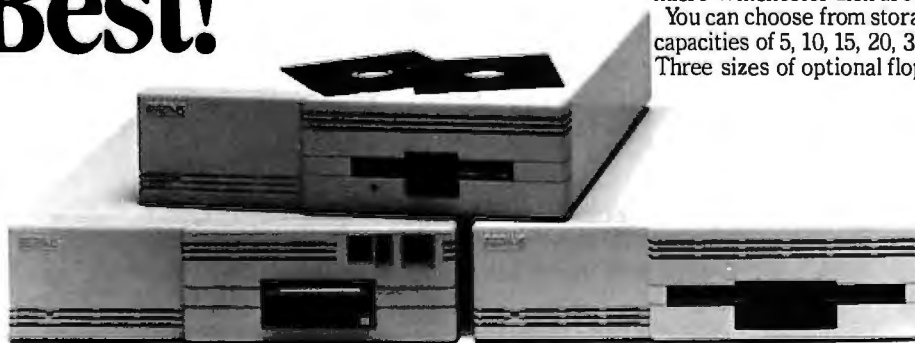

Give your HP computer a high-performance disk drive like our new Series 3000 Winchester subsystem. Transferring data at 174 kbytes/s... It's the fastest micro-Winchester disk around! You can choose from storage capacities of 5, 10, 15, 20, 30 MB. Three sizes of optional floppy

drives: 3 1/2", 5 1/4", 8". And local back-up too.

Our Multi-port Option allows two or three HP computers to share one disk drive. Everything is 100% HP compatible. No software or hardware changes needed.

For complete specifications, please call 415/651-3300, or write today.

BERING

The Specialist in HP Compatible Disk Products.

1400 Fulton Place, Fremont California 94539 TELEX 171596

Anyone who pays \$2395 for a terminal ought to have his head examined.

Some people think our prices are mind-blowing. Until they learn more about our terminals, and how much sense they make for professional users.

Take the Ann Arbor Guru™, for example. It's simply a well-considered investment in your own talent.

To help you get ahead in your work, the Guru features an unprecedented 28K of memory. Imagine. Enough memory to fill 15 pages of an 80x24 display. Or six full

pages of 8½x11 text. All locally resident for editing, printing, transmission, or just for context.

The Guru display also shows a lot of thought for your needs. You can display up to 66 lines of up to 170 characters. Then zoom and scroll—horizontally and vertically—to view any portion of the memory, displaying as much or as little data as you like.

Of course, all this is in addition to Ann Arbor's standard 15-inch screen, portrait or landscape. Dozens of programmable keys. ANSI-

standard coding. Pause and Meta functions. And incomparable data line monitoring.

Now, we'd be the last people to say that an Ann Arbor Guru is for just anyone.

But if you think you're worth it, it would be crazy to settle for anything less.

For more information, write to Ann Arbor Terminals, Inc. at 6175 Jackson Road, Ann Arbor, Michigan 48103. Or call 313/663-8000.

Circle 27 on inquiry card.

ANN ARBOR TERMINALS

Once you've worked with them, you won't work without them.

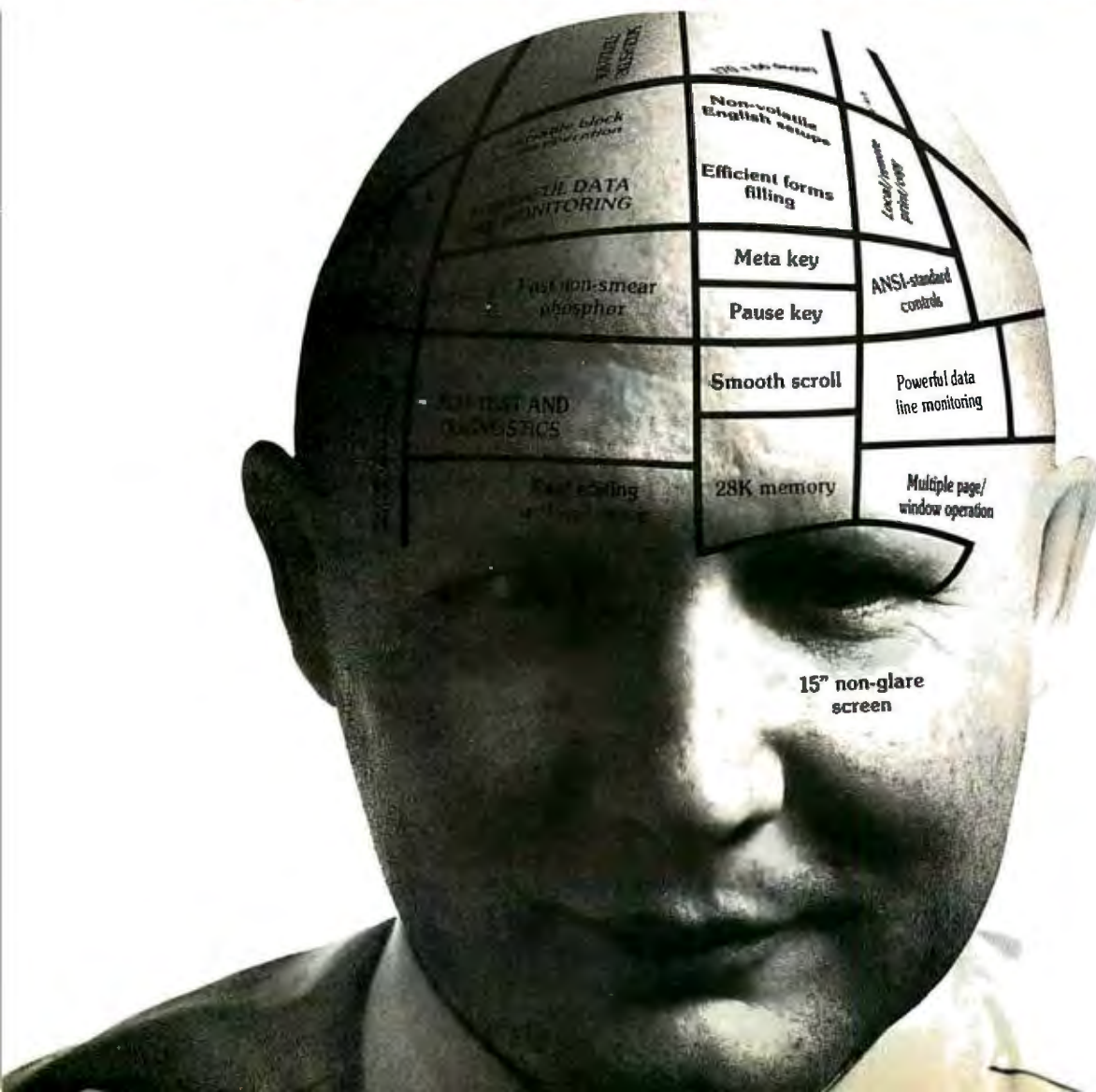

KNOWLEDGE SYSTEMS INC.

Information Processing Components, Selected for Performance and Value.

NO SURCHARGE FOR MASTER CARD AND VISA

PREPAID PRICES INCLUDE SHIPPING AND INSURANCE, UPS Ground Continental USA only

A		C oh	
6-Pack 64K	269	Prowriter 8510P	120 cps 353
Combo Plus	269	Prowriter 8510SP	180 cps 495
Mega Plus	269	Prowriter 8510SPC	80 cps co 589
64 K Ram Set	55	Prowriter 1550P	120 cps 581
Micro Graphic		Prowriter 1550SP	180 cps Call
RGB, Monochrome, Printer	398	Prowriter 1550SPC	180 cps co Call
Plantronics		New CX4800 plotter	610
Color Plus	375	New A10 25 cps Daisy Wheel	549
Hercules Com		Starwriter F10 40 cps Daisy Wheel	997
Hercules Graphics Card	370	Printmaster F10 55 cps Daisy Wheel	1323
Amdek		We Know How to Make Your Prowriter IBM Compatible	
MAI	477	Okidata	
Koala		92p	160 cps 433
Koala Graphic Tablet	Call	93p	160 cps 705
IBM		IBM Printer Ro	45
Micro		2350	350 cps 2000
Micro		2410	2380
Micro		iconics	
dBase I	389	Gemini 10	120 cps 285
Friday	184	Gemini 15	120 cps 423
TK Solver		Delta 10	160 cps 448
Solver Pac	88	Delta 15	160 cps 633
Seasoned System		NEC	
Sure Stroke Dvorak Tutor	48	3550	40 cps 1767
Sorcim		7710	55 cps 1963
Super Calc III	287	Brother	
M		HR1	16 cps 569
Wordstar	258	HR25	23 cps 765
Mail Merg	131	Dynax	
Spellstar	131	DX15	14 cps 453
Pro Pack	475	Keyboard	149
Realworld GI		Prism 132 color	1535
Realworld AR	533	Prism 80 color	1419
ATI		T	
For Most Software Programs	69	315 color	450
Hayes		550	595
Smart Com	72	500	431
Micro Rim		Juki	
RBase	Call	6100	18 cps 487
Micro		Teletex	
300	207	1014	12 cps 455
1200	493	smant	
1200E	432	80 cps	315
Micromodem IIe W/T	242	Franklin C	
US Robc		Columbia	1709
Password	340	TAVA PC	2750
Autodial 212A	460	1900	
N		300	
Access 1,2,3	473	SB	750
Apple Cat II	277	SB	650
Promet		CP	110
Pro Com 1200	375	Tu	630
PC212A		300	
PC212A	415	300A	
P212A	415	300C	

HAVE IT YOUR WAY

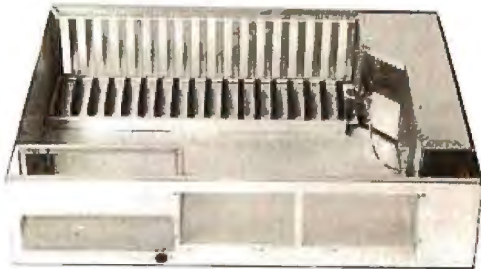

You want a computer. You like the flexibility and options of the IBM PC. EXCEPT there are some things that you want your way. YOU:

- Don't like the funny keyboard.
- Want 1/2 height drives so you can add a hard disk later.
- Want a powerful supply that is adequate for disk expansion.
- Want more than three additional slots.
- Want a faster or different CPU.
- Want higher resolution graphics.
- Want Dvorak or other keyboard layout.

	List	Our		
TIME SPECTRUM	395	Call		
APS TEK	369	Call		
CRAMBO	359	Call		
BIG BLUE	600	Call		
EASIBOARD + 15		350	914	56
Maynard Sandstar		230	925	
PC CT 80186 8MHz		Call	950	91
Scion & Halo @ 150		1595		
Intelligent High Res G		995	50	56
PROTIUM		1195		
Keytronics Keyboard QWERTY		209	ann	49
Keytronics Keyboard DVORAK		209		
Keytronics Keyboard 5151		255		
Lotus 1-2-3 users — you need this keyboard.				

	List	Our		
Tandon TM100-2		238	300A	14
Teac 55B 1/2 Height		210	300C	13
Panasonic/Shugart 1/2 CDC		205	310A	17
		215		

	List	Our		
Super 5 1/2 Height		203	RGB III	44
Quentin Ap 100-Y		242	RGB 420	53
Quentin Ap 105-Y		213		
Quentin Controller		48	PGS HX1	48
Rana		Call	MAX 12	19



Circle 203 on inquiry card.

	RGB	Call		
	Pi 2 12" Green			
	Pi 3 12" Amber			14
	8112 Hi/Res			19
	JB 1201			16
	JB 1205A			17
	JC 1410			81

California Residents add 6.5% State Sales Tax

Shipping extra for outside USA, FPO and APO

Please include an address reachable by UPS, no P.O. boxes, and your phone number where you can be reached during the day.

(213) 344-4455

Knowledge Systems Inc.
19707 Ventura Blvd.
Woodland Hills, CA 91364

ORDERING TERMS

Prepaid: Money Orders, Cashier's Checks, Certified Checks, Bank Wire Transfers, Master Card, Visa, AMEX (add .3% for AMEX) and Personal Checks (allow 15 banking days for all personal checks). Please include Valid Driver's License and Major Credit Card for Identification.

Queue Simulation

A microcomputer can help you manage waiting lines

by E. Hart Rasmussen

When we wait at the supermarket checkout counter, are stuck in rush-hour traffic, or have trouble getting a telephone call through, we are in a *queue*. Queue is another word for "waiting line." If we could get a firm handle on how queues work, we would be able to manage them better and perhaps even eliminate them.

Simple waiting lines can be analyzed mathematically, but most queuing situations are so complex that they defy precise description. For these situations, a computer can help us. Specifically, we can use a computer to model and simulate a queuing situation so that we can make predictions about it and learn how it behaves.

There are many sophisticated commercial queue-simulation programs available, but they are expensive and for large computers only. In this article, I present an Applesoft BASIC program that can simulate many queuing problems.

Know Your Ps and Qs (Probabilities and Queues)

My doctor's nurse knows that the average examination takes 17 minutes, so she schedules three patients an hour, one every 20 minutes. At first glance, it looks as if I should

never have to wait for the doctor. In reality, he needs a sizable waiting room. Why? Because examinations may take more time than expected, and patients don't always arrive on time.

A queue formation occurs when a unit that seeks a service must wait because the service facility is busy servicing another unit. To simulate a queue formation, we need to break it into its basic components.

The basic components are: the arrival of units seeking service, the interval between arrivals, the number of service facilities, and the rate at which the service facilities operate. Figure 1 illustrates some basic ways in which service facilities, or stations, and units may be combined.

We next need to make some assumptions about these components. For instance, we must assume that the overall capacity of the service facility exceeds the overall demand. (In queue terminology, we say that the mean service rate exceeds the mean arrival rate for a single channel.) If we didn't assume this, our queue would theoretically grow to infinite size. We also assume that the intervals between arrivals and service times are variable. To study the queue, we must be able to describe these patterns of arrivals and service

times, even if they seem to be unpredictable. Research has shown that the patterns of arrivals and service times often are completely random and can be described with the Poisson distribution. The formula for the Poisson distribution is shown in figure 2. With this formula, we can easily program the random element that we need in our simulation.

Queues of the type shown in parts a and b of figure 1 (that is, with service provided on a first-come, first-served basis with Poisson distribution for an infinite number of arrivals and services) can be described by the mathematics shown in table 1.

The Program

The flowchart in figure 3 shows the logic of a program that simulates a multichannel, single-phase service problem. The Advance module provides the executive control that keeps track of time and events; it passes control to the appropriate action module as successive events are simulated. In the Arrival module, as one arrival occurs, the time for the next arrival is calculated in accordance with the specified algorithm. The arriving unit then joins the queue if all service stations are occupied, or it moves on to seize an available station. The Departure

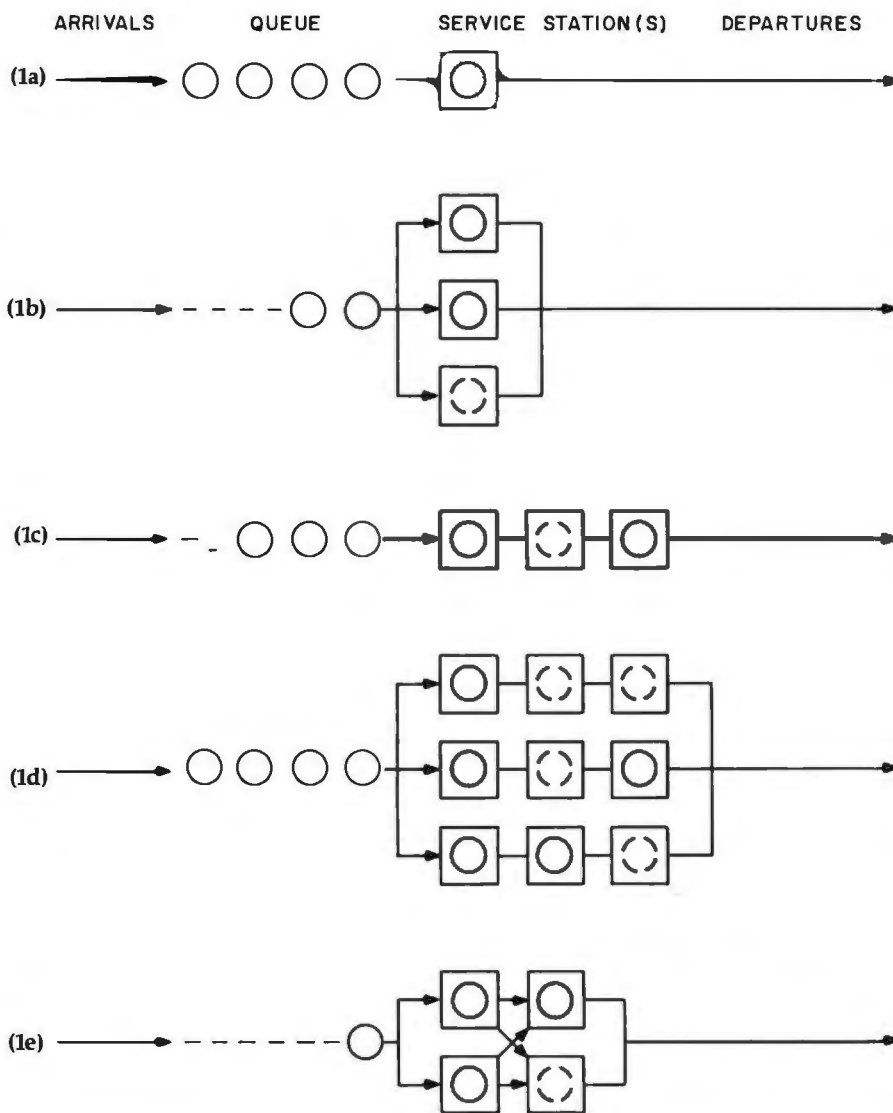

Figure 1: Fundamental queuing models: (1a) single-channel, single-phase service; (1b) multiple-channel, single-phase service; (1c) single-channel, multiple-phase service; (1d) multiple-channel, multiple-phase service; and (1e) channel switching. The first two models are simulated by the author's program. The broken circles indicate an open service station.

module frees a station when the service is completed and terminates the simulation if the sample size has been reached. Otherwise, it checks to see if any units are waiting in the queue and, if so, lets a unit leave the waiting line. The Seize module seizes an available service station and calculates the service time in accordance with the prescribed algorithm.

Listing 1 shows the Applesoft BASIC queue-simulation program. The listing is grouped in sections that correspond to the flowchart in figure 3. All variable names used in the program are listed in table 2.

I have defined the frequently used variables at the start of the program.

I've dimensioned the arrays to allow 10 service stations, but they can easily be changed to accommodate a larger number. The opening screen and data input (lines 7000-7999) and the start of the simulation (lines 8000-8799) are at the end of the program so the sections of the program that are executed over and over can have the lowest possible line numbers.

The keyboard is used to input data. The only exception is the data for non-Poisson distributions, which is input through DATA statements.

The times for the first arrival and the departure times for any units in a service station are calculated in lines 8000-8799. Depending upon the

instructions given during data input, the program uses either a Poisson distribution or a user-defined probability distribution. Arrival intervals and service times can have different distributions, and the random-number generator is used to calculate the randomly varied event intervals in accordance with the specified distributions.

The Advance module determines the earliest event by first assuming that the event is an arrival (line 2000) and then checking if any departure occurs earlier (lines 2100-2130). The clock is then advanced to the earliest event (line 2300). Counters necessary to the calculation of queue statistics are incremented (lines 2310-2420), and control passes to the appropriate event module.

The Arrival module counts the total number of arrivals (line 3000) and calculates the time of the next arrival (lines 3050-3130). If no station is open, the queue length is incremented by line 3230 and the program checks to see if the new queue length exceeds the previous maximum (line 3240).

The Departure module frees the station (line 4000), increments counters (lines 4010-4050), and checks to see if the sample size has been reached (line 4100). If the simulation has not been completed, a unit waiting in the queue (if any) is allowed to seize the free station. The Seize module sets the key that indicates a particular station is in use (line 4250) and then calculates the departure time from that station (lines 4300-4430).

When the sample size has been reached, the program leaves the simulation loop at line 4100 and passes to the section that calculates the statistics for the simulation (lines 5000-5199). After the calculations are completed, the user is given a choice (lines 5200-5399) of sending output to the screen or to a printer. If screen output (lines 5700-5999) is chosen, the user gets a second opportunity to get a printed report (lines 5400-5699). If any non-Poisson distributions have been used, that fact and the parameters for the distribution(s) are recorded on the report (lines 6500-

KEY TRONIC PERFECTS THE IBM* PC KEYBOARD



Familiar Key
Legends Rather
Than Symbols

SHIFT Key in Familiar
Typewriter Location

LED Indicators On All
Lock Keys To Show Status

RETURN Key in Familiar
Typewriter Location

Convenient
ENTER Key

Enhance your IBM* Personal Computer System with a Key Tronic keyboard peripheral. This low-profile keyboard is plug-compatible and has familiar key placement. It also features reliable microprocessor electronics, solid-state capacitance switches, and positive tactile feedback.

Special keyboard available for the handicapped — factory direct.

Also available in Foreign and Dvorak layouts.

*IBM is a registered trademark of IBM Corporation

Suggested Retail Price: \$209.00

To order Model KB-5150 call Toll Free 1-800-262-6006 for the retailer closest to you. (7am-3pm Pacific Time) Warranty information may be obtained, free of charge, by writing to the address below.

 **key tronic**

THE RESPONSIVE KEYBOARD COMPANY

DEPT. E • P. O. BOX 14687 • SPOKANE, WASHINGTON 99214 USA

RETAILERS: For the Distributor in your area, call Toll Free 1-800-262-6006 Dept. D (7am-3pm Pacific Time)

6999). When the printing is completed, control is passed back to screen output (line 5690) and the user is given an opportunity to run additional simulations without restarting the program (lines 6000-6499).

The program length is about 7000 characters; it uses a total of about 8200 bytes of memory during execution. The run-time depends somewhat on the type of probability distribution (it runs faster when the formularized Poisson distribution is used). On my Franklin 1000, one simulation takes from 0.33 to 0.47 second, which means that a 2000-sample simulation takes 10 to 15 minutes.

User-Defined Probability Distributions

The program can evaluate queuing situations with unique, user-defined probability distributions. The arrival intervals and service intervals can have different distributions, independent of each other. The choice of the type of distribution to be used is made from the keyboard in lines 7200-7599. The program logic can most easily be explained by table 3, which lists the values that the key P assumes for the various possible combinations.

Figure 2 shows the shape of the Poisson distribution curve (curve 1) and two arbitrary, user-defined curves. The distribution of curve 2 was used in the simulations reported in parts e and f of figure 4. The user must input this nonstandard distribution via DATA statements starting at line 9000. The DATA statements provide the coordinates for the line segments that represent the special distribution. As an example, the distribution shown as curve 3 should be input as follows:

```
9000DATA0,.25,.1,.25,.35,.5,.65,1.5,
    .9,1.75,1,1.75
```

If arrival and service intervals have identical, non-Poisson distributions, we define the interval only once. If they have different, non-Poisson distributions, the definition of the arrival-interval distribution precedes the definition of the service-time distribution. For example,

Text continued on page 168

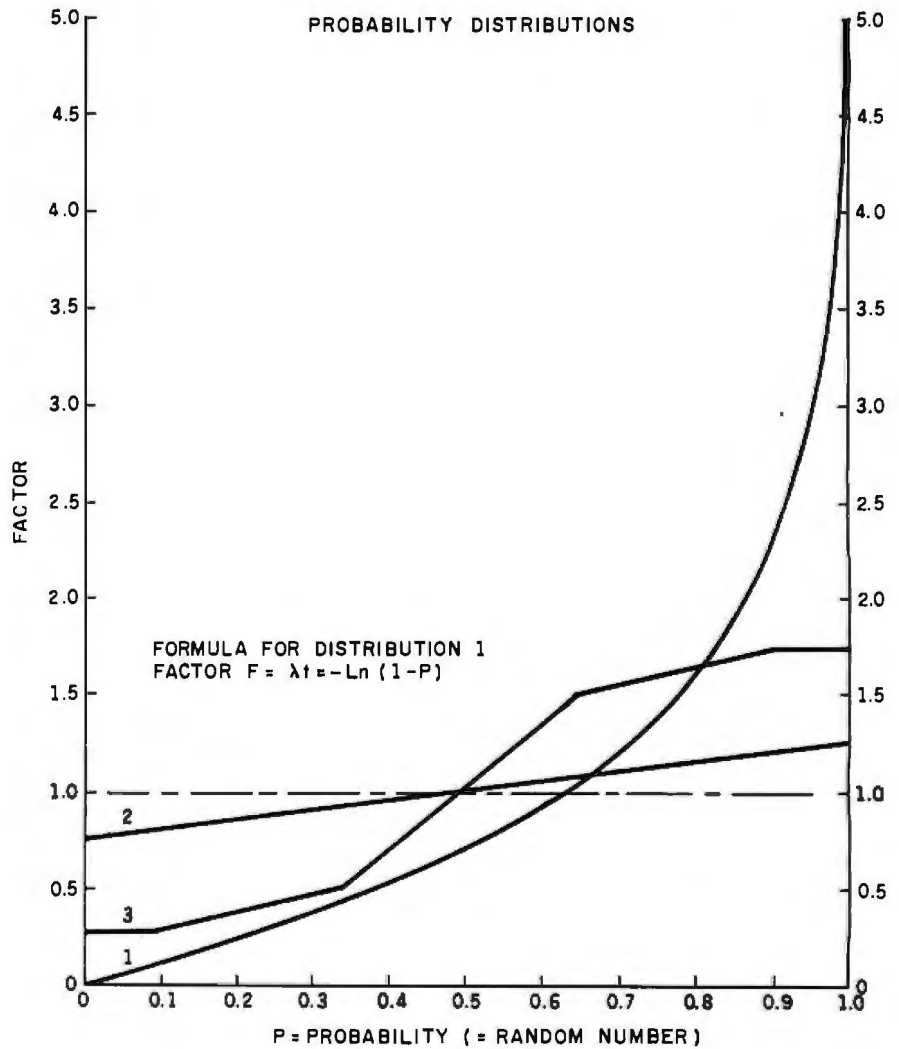

Figure 2: Probability distributions. Curve 1 shows the Poisson probability distribution. Curves 2 and 3 are arbitrary distributions that can replace the Poisson distribution.

Queue Component	Variable		Equation	
	Theory	Program	One S	Multiple S
Mean arrival rate	λ			
Mean service rate	μ			
Mean arrival interval	$\frac{1}{\lambda}$	AI		
Mean service time	$\frac{1}{\mu}$	SI		
Number of stations	S	S%	1	S
Utilization factor	U	US(Z)	$\frac{\lambda}{\mu}$	$\frac{\lambda}{\mu}$
Average length of queue	L_q	QA	$\frac{U^2}{1-U}$	$\frac{U^{(S+1)}}{(S-1)(S-U)^2} \times \frac{1}{\left(\sum_{n=0}^{S-1} \frac{U^n}{n!}\right) + \frac{U^S}{S!(1-U/S)}}$
Average waiting time in queue	w_q	Q1	$\frac{L_q}{\lambda}$	$\frac{L_q}{\lambda}$

Table 1: Queuing theory variables and equations. S! and n! are the factorial values of these variables.

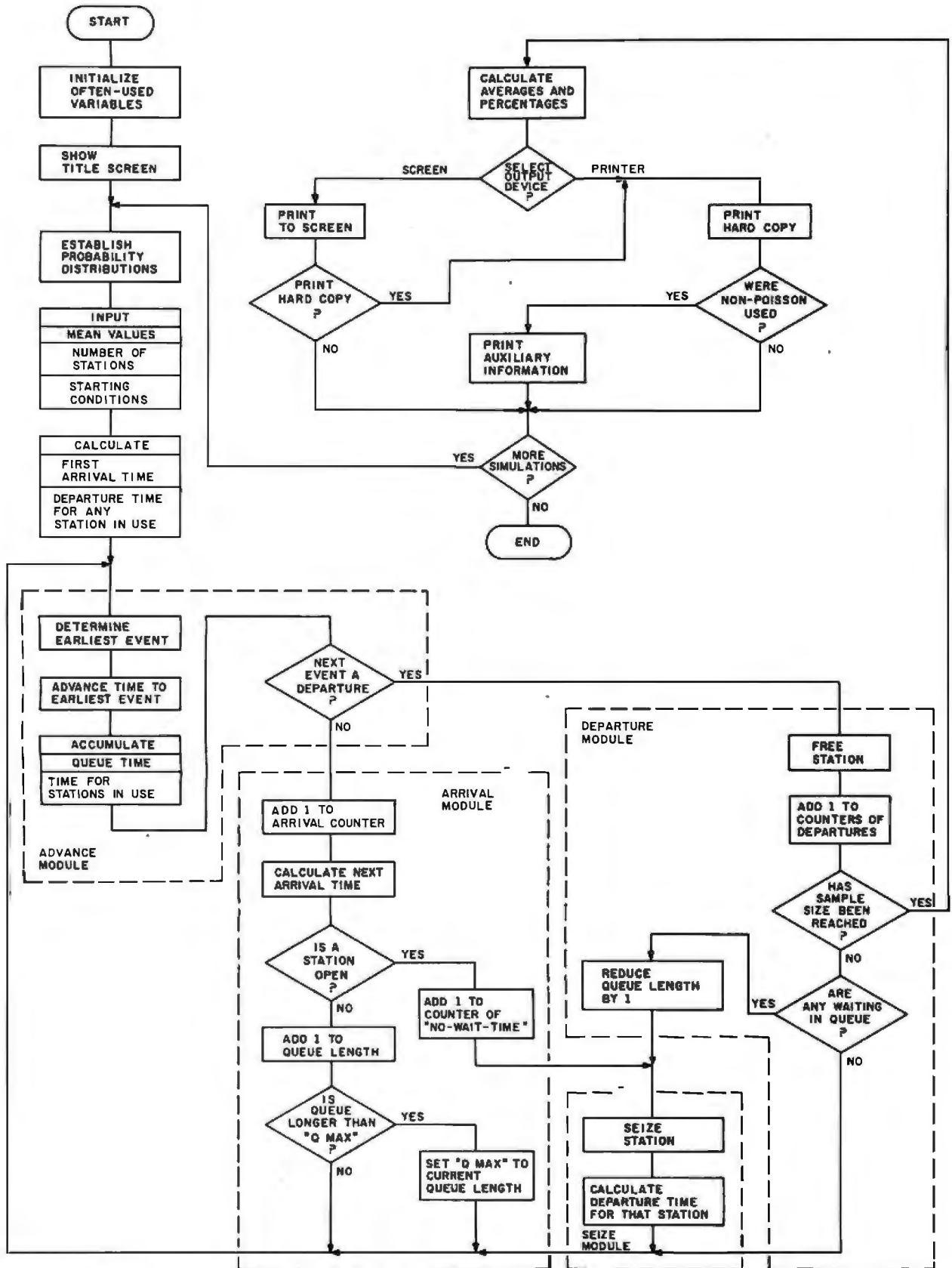

Figure 3: A flowchart for the author's queue-simulation program.

Listing 1: A program, written in Applesoft BASIC, for queue simulation.

QUEUE SIMULATION

```

JLIST0,1999          START
1000 DIM FA(25,2),FS(25,2),TD(10),S%(10),ST(10),CS%(10)
1010 R = 0:Z = 0:A = 0:TA = 0:S% = 0:T = 0:QL% = 0:C1% = 0:C2% = 0
1020 ONERR GOTO 8800
1100 GOTO 7000

JLIST2000,2999      ADVANCE MODULE
2000 A = TA - T:N = 0
2100 FOR Z = 1 TO S%
2110 IF S%(Z) = 0 THEN 2130
2120 IF A > = TD(Z) - T THEN A = TD(Z) - T:N = 1:S = Z
2130 NEXT
2300 T = T + A
2310 QT = QT + QL% * A
2400 FOR Z = 1 TO S%
2410 IF S%(Z) = 1 THEN ST(Z) = ST(Z) + A
2420 NEXT
2500 IF N = 1 THEN 4000

JLIST3000,3999      ARRIVAL MODULE
3000 C1% = C1% + 1
3050 IF P < 3 THEN R = RND (1):F = - LOG (1 - R): GOTO 3130
3100 R = RND (1):X = 0
3110 IF R > FA(X,1) THEN X = X + 1: GOTO 3110
3120 F = FA(X - 1,2) + (R - FA(X - 1,1)) * (FA(X,2) - FA(X - 1,2)) / (FA(X,1) - FA(X - 1,1))
3130 TA = T + F * AI
3200 FOR Z = 1 TO S%
3210 IF S%(Z) = 0 THEN S = Z:C0% = C0% + 1: GOTO 4250
3220 NEXT
3230 QL% = QL% + 1
3240 IF QM% < QL% THEN QM% = QL%
3250 GOTO 2000

JLIST4000,4249      DEPARTURE MODULE
4000 S%(S) = 0
4010 CS%(S) = CS%(S) + 1
4050 C2% = C2% + 1
4100 IF C2% = > C% THEN 5000
4150 IF QL% = 0 THEN 2000
4200 QL% = QL% - 1

JLIST4250,4999      SEIZE MODULE
4250 S%(S) = 1
4300 IF P = 2 THEN 4400
4310 IF P = 4 THEN 4400
4320 IF P = 5 THEN 4400
4340 R = RND (1):F = - LOG (1 - R): GOTO 4430
4400 R = RND (1):X = 0
4410 IF R > FS(X,1) THEN X = X + 1: GOTO 4410
4420 F = FS(X - 1,2) + (R - FS(X - 1,1)) * (FS(X,2) - FS(X - 1,2)) / (FS(X,1) - FS(X - 1,1))
4430 TD(S) = T + F * SI
4600 GOTO 2000

JLIST5000,5199      CALCULATE AVERAGES AND PERCENTAGES
5000 FOR Z = 1 TO S%: IF CS%(Z) = 0 THEN 5030
5010 TS(Z) = INT (100 * ST(Z) / CS%(Z) + .5) / 100
5020 US(Z) = INT (10000 * ST(Z) / T + .5) / 100
5030 NEXT
5040 Q0 = INT (10000 * C0% / C1% + .5) / 100
5050 Q1 = INT (100 * QT / C1% + .5) / 100
5060 IF C1% = C0% THEN Q2 = 0: GOTO 5080
5070 Q2 = INT (100 * QT / (C1% - C0%) + .5) / 100
5080 QA = INT (100 * QT / T + .5) / 100

```

Listing 1 continued on page 164

DBMS ?

DBMS, n., A buzzword for Data Base Management System. A structure in which to collect information on a given subject in one or more files. A software program enabling you to store, manipulate and retrieve your information contained in those files.

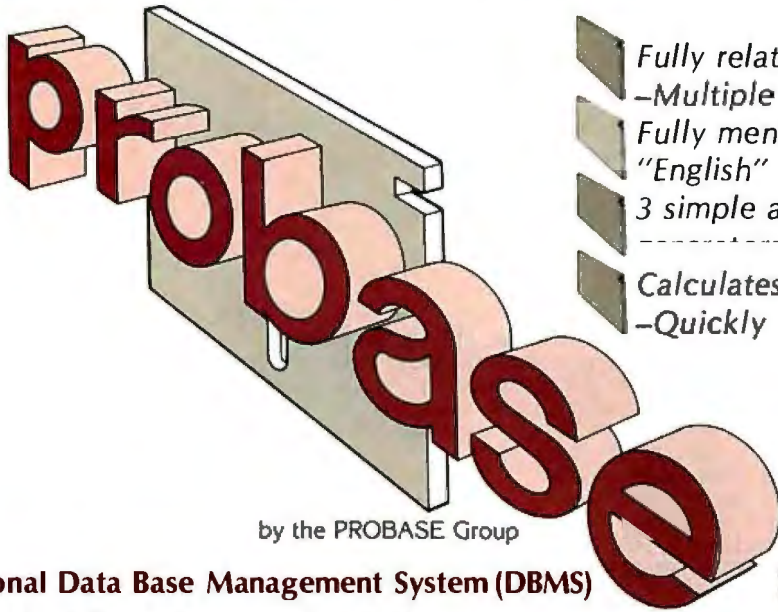

- Fully relational data base management
- Multiple file and disk access.
- Fully menu driven - Presented in "English"
- 3 simple and automatic program generators
- Calculates
- Quickly

Probabase®

by the PROBASE Group

Fully Relational Data Base Management System (DBMS)

Probabase's Quick Gen "tells" your computer how to enter, find, sort, calculate, analyze and present information. Easily add, change, delete, or browse through your data. Probabase's ability to combine and collect data on a given subject from many separate files allows you immediate access to all of your information - Bookkeeping, Cost Accounting, Inventory, Personnel, Portfolio Analysis, Sales, etc. Menu Gen joins files together in an easy-to-use selection list. Report Gen compiles virtually any comparative reports you need, including projections and forecasts. And prints them in any format you choose.

Probabase® Requires No Training

Press a 'function' key for help. Concise documentation with samples on-screen assists you with your current task. And returns where you left off. Complete documentation includes a handy 2-part tutorial manual.

Easy Enough For Non-Technical Users

Probabase's three program generators (Quick, Menu, Report) create data base management applications according to your direction - automatically. Enter your requests using simple selections and fill-in-the-blank menus. Inquire, generate a report, create or up-date your data bases, design entry screens... Programming and code entry are completely eliminated, so you don't need to be a programmer, or even have computer experience, to produce professional automated business reports.

Powerful Enough For Programmers

Access 3 different files at once and work with as many as you need within a single program. Combine your files in "one-to-many" or "many-to-one" relationships. When you program in Probabase; all of your tools are immediately available: Macro Instruction Language, Subroutine Calls, Programmable Function Keys and more. Program, test and debug without an outside editor, assembler or compiler. Make changes and corrections instantly.

Free disk space... Probabase; efficiently compresses screens and program tables onto your disks. And Probabase need not be present on disk when you run your applications. Enjoy more disk storage capacity and faster throughput by eliminating extra program code.

Available in PC-DOS, MS-DOS and CP/M86 (all using 128k) and CP/M (128k). Enjoy the newest, most effective data base management systems.

Circle 115 on inquiry card.



Probabase®

Another Solution® from

Data Technology Industries™

701 A Whitney Street San Leandro, CA

94577

800-258-7071

(415) 638-1206

Write or Call Today and Find Out How You Can Put Probabase To Work For You.

Listing 1 continued:

```
JLIST5200,5399          SELECT OUTPUT DEVICE

5200 HOME : PRINT CHR$(7): PRINT CHR$(7): VTAB(7)
5210 PRINT TAB(10)"SIMULATION COMPLETED"
5220 PRINT : PRINT TAB(13)"READY TO REPORT"
5230 PRINT : PRINT TAB(11)"Shall Report go to"
5240 PRINT : PRINT TAB(7)"SCREEN (S) or PRINTER (P) ?"
5250 PRINT : PRINT TAB(19)" "; GET AS
5260 IF AS = "S" THEN 5700
5270 IF AS = "P" THEN 5400
5280 PRINT CHR$(7): PRINT " Please answer 'S' or 'P'": GOTO 5250
```

```
JLIST5400,5699          OUTPUT TO PRINTER

5400 HOME : PRINT : INPUT "What is Date of Report? ";DS
5410 PRINT : PRINT "What is Project Identification?"
5420 PRINT : INPUT IS
5430 PRINT : PRINT "Press RETURN when PRINTER is ready "; GET AS
5440 PR# 1
5450 PRINT : PRINT TAB(12)DS: PRINT
5460 PRINT TAB(40 - LEN(IS) / 2)IS
5470 PRINT TAB(32)"QUEUE SIMULATION"
5480 PRINT : PRINT : PRINT
5490 PRINT TAB(12)"1 (ONE) QUEUE SERVED BY ";S%;" PARALLEL SERVICE STATIONS
5500 PRINT TAB(12)"AVERAGE ARRIVAL INTERVAL WAS SPECIFIED AS ";AI;" TIME UNITS"
5510 PRINT TAB(12)"AVERAGE SERVICE TIME WAS SPECIFIED AS ";SI;" TIME UNITS"
5520 PRINT TAB(12)"QUEUE LENGTH AT START OF SIMULATION WAS ";QL
5530 PRINT : PRINT TAB(12)"STATUS OF SERVICE STATIONS AT START WAS:"
5540 PRINT : PRINT TAB(20)"STATION"; TAB(36)"STATUS": PRINT
5550 FOR Z = 1 TO S%: IF AS(Z) = "Y" THEN S$(Z) = "USED"
5560 IF AS(Z) < > "Y" THEN S$(Z) = "OPEN"
5570 PRINT TAB(23)Z; TAB(37)S$(Z): NEXT
5580 PRINT : PRINT TAB(12)"SAMPLE SIZE IS ";C%;" DEPARTURES"
5590 PRINT : PRINT TAB(12)"TIME ELAPSED FOR SIMULATION IS "; INT(T + .5);" TIME UNITS"
5600 PRINT : PRINT TAB(12)"STATUS OF SERVICE STATIONS AT END IS:" : PRINT : PRINT TAB(12)"STATION NUMBER OF UTIL
IZATION AVERAGE TIME STATUS"
5610 PRINT TAB(12)" DEPARTURES % PER SERVICE": PRINT
5615 FOR Z = 1 TO S%: IF S$(Z) = 0 THEN S$(Z) = "OPEN"
5620 IF S$(Z) = 1 THEN S$(Z) = "USED"
5625 PRINT TAB(15)Z; TAB(24)CS%(Z); TAB(35)US(Z); TAB(49)TS(Z); TAB(22)S$(Z): NEXT
5630 PRINT : PRINT : PRINT TAB(18)"QUEUE CONTENT"; TAB(42)"ENTRIES ZERO"
5640 PRINT TAB(12)"CURRENT MAXIMUM AVERAGE"; TAB(40)"TOTAL ZEROS %"
5650 PRINT TAB(15)QL%; TAB(24)QM%; TAB(32)QA; TAB(41)C1%; TAB(8)C0%; TAB(16)Q0
5660 PRINT : PRINT TAB(12)"AVERAGE WAIT TIME"; TAB(42)"AVERAGE WAIT TIME": PRINT TAB(15)"ALL ENTRIES"; TAB(40)"
UNITS ENTERING QUEUE"
5670 PRINT TAB(18)Q1; TAB(48)Q2
5680 IF P > 1 THEN 6500
5690 PR# 0: GOTO 6000
```

```
JLIST5700,5999          OUTPUT TO SCREEN

5700 HOME : PRINT
5710 PRINT " QUEUE SIMULATION"
5720 PRINT : PRINT TAB(2)"MEAN ARRIV T"; TAB(15)AI; TAB(24)"MEAN SERV T"; TAB(36)SI
5730 PRINT TAB(2)"QUEUE START"; TAB(15)QL; TAB(24)"STATIONS"; TAB(36)S%
5740 PRINT TAB(2)"SAMPLE SIZE"; TAB(15)C%; TAB(24)"TOT TIME"; TAB(35) INT(T + .5)
5750 PRINT : PRINT " STAT DEPART UTILIZ AVG TIME STATUS": PRINT
5760 FOR Z = 1 TO S%
5770 IF S$(Z) = 0 THEN S$(Z) = "OPEN"
5780 IF S$(Z) = 1 THEN S$(Z) = "USED"
5790 PRINT TAB(4)Z; TAB(9)CS%(Z); TAB(17)US(Z); TAB(25)TS(Z); TAB(35)S$(Z)
5800 NEXT
5810 PRINT : PRINT " QUEUE CONTENT ENTRIES %"
5820 PRINT " CURR MAXI AVERAGE TOTAL ZEROS ZERO"
5830 PRINT TAB(2)QL%; TAB(8)QM%; TAB(14)QA; TAB(23)C1%; TAB(29)C0%; TAB(35)Q0
5840 PRINT TAB(2)"AVG WAIT A"; TAB(13)Q1; TAB(22)"AVG WAIT Z"; TAB(33)Q2
5850 PRINT : PRINT "Do you want printed copy? Then press 'Y'"
5860 PRINT "Otherwise press RETURN when ready "; GET AS
5870 IF AS = "Y" THEN 5400
```

```
JLIST6000,6499          SELECT MORE SIMULATIONS OR END

6000 HOME : PRINT : PRINT
6010 PRINT "Want to do another Simulation (Y/N) ?"
6020 PRINT : PRINT TAB(19)" "; GET AS
6030 IF AS = "Y" THEN CLEAR : DIM FA(25,2),FS(25,2): RESTORE : GOTO 7200
6040 IF AS = "N" THEN END
6050 PRINT : PRINT CHR$(7): PRINT "Please answer 'Y' or 'N'": GOTO 6020
```

Listing 1 continued on page 166

Einstein had every gift a great thinker needs. Except one.

The FinalWord.

With it, he would've been able to make sure every one of his great ideas ended up where it belonged. On paper.

Because The FinalWord offers great thinkers an arsenal of word processing commands so powerful, they're free at last to concentrate solely on having great ideas. While the FinalWord concentrates on making them look good on paper. You never format. You only think.

In fact, one reviewer called The FinalWord "the thinking person's word processor." Einstein would've liked that.

And, here's something else to think about. With The FinalWord, you never have to worry about losing your big idea to a system crash or power failure. Because The FinalWord continuously saves it in back-up.

Put The FinalWord to the test at your local computer store. It may not make you an Einstein. But then again, everything is relative.

The FinalWord

Finally, word processing becomes thought processing.

Circle 221 on inquiry card.

Mark of the Unicorn
222 Third Street
Cambridge, MA 02142
(617) 576-2760

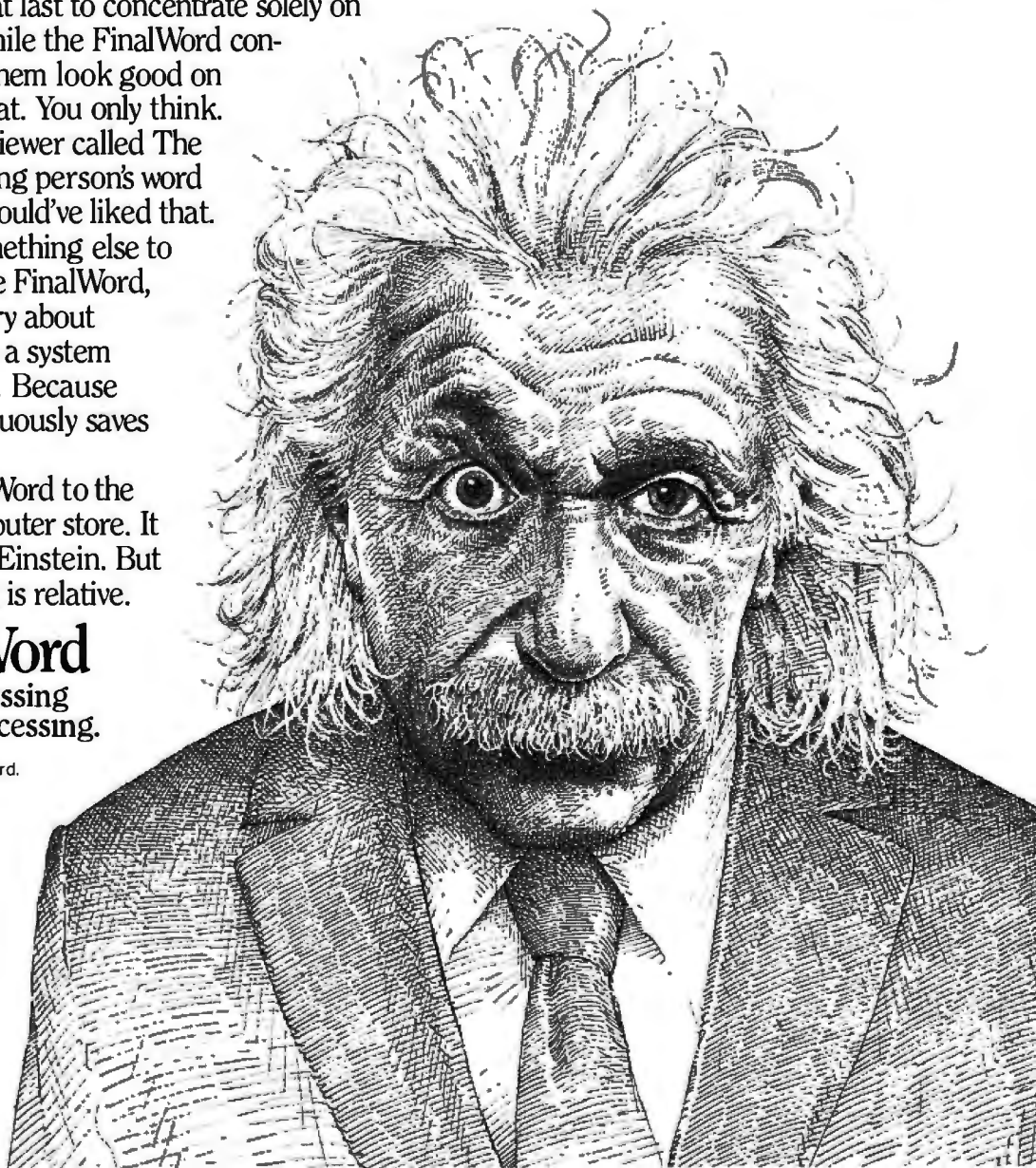

Listing 1 continued:

```
JLIST6500,6999          AUXILIARY PRINTER OUTPUT

6500 PRINT : PRINT : PRINT TAB( 12)"NOTE:"
6510 ON P GOTO 5690,6520,6550,6580,6610
6520 PRINT TAB( 12)"SERVICE TIME HAD PROBABILITY DISTRIBUTION:": PRINT
6530 GOSUB 6750
6540 PRINT : GOTO 5690
6550 PRINT TAB( 12)"ARRIVAL TIME HAD PROBABILITY DISTRIBUTION:": PRINT
6560 GOSUB 6700
6570 PRINT : GOTO 5690
6580 PRINT TAB( 12)"ARRIVAL AND SERVICE HAD IDENTICAL NON-POISSON DISTRIBUTION:": PRINT
6590 GOSUB 6700
6600 PRINT : GOTO 5690
6610 PRINT TAB( 12)"ARRIVAL TIME HAD PROBABILITY DISTRIBUTION:": PRINT
6620 GOSUB 6700
6630 PRINT : PRINT
6640 PRINT TAB( 12)"SERVICE TIME HAD PROBABILITY DISTRIBUTION:": PRINT
6650 GOSUB 6750
6660 PRINT : GOTO 5690
6700 X = 0
6710 PRINT TAB( 12)FA(X,1);" ";FA(X,2);" ";
6720 IF FA(X,1) = 1 THEN RETURN
6730 X = X + 1: GOTO 6710
6750 X = 0
6760 PRINT TAB( 12)FS(X,1);" ";FS(X,2);" ";
6770 IF FS(X,1) = 1 THEN RETURN
6780 X = X + 1: GOTO 6760
```

```
JLIST7000,7199          OPENING SCREEN

7000 HOME
7010 PRINT : PRINT : PRINT : PRINT
7020 PRINT " *****"
7030 PRINT " * * * * * "
7040 PRINT " *   QUEUE SIMULATION * "
7050 PRINT " * * * * * "
7060 PRINT " *           BY           * "
7070 PRINT " * * * * * "
7080 PRINT " *   E HART RASMUSSEN * "
7090 PRINT " *           P M S           * "
7100 PRINT " * * * * * "
7110 PRINT " *****"
7120 PRINT : PRINT : PRINT
7130 PRINT "           Press RETURN to start"
7140 PRINT : PRINT TAB( 19): GET A$
```

```
JLIST7200,7599          ESTABLISH PROBABILITY DISTRIBUTIONS

7200 HOME
7210 PRINT " Shall ARRIVAL and SERVICE have"
7220 PRINT : PRINT " identical Distributions (Y/N) ";; INPUT A$
7230 IF A$ = "Y" THEN P = 1: GOTO 7260
7240 IF A$ = "N" THEN P = 2: GOTO 7300
7250 PRINT CHR$( 7): PRINT " Please answer 'Y' or 'N' ";; INPUT A$: GOTO 7230
7260 PRINT : PRINT " Are they both Poisson ";; INPUT A$
7270 IF A$ = "Y" THEN 7600
7280 IF A$ = "N" THEN P = 4: GOTO 7400
7290 PRINT CHR$( 7): PRINT " Please answer 'Y' or 'N' ";; INPUT A$: GOTO 7270
7300 PRINT : PRINT " Does ARRIVAL have Poisson ";; INPUT A$
7310 IF A$ = "Y" THEN 7400
7320 IF A$ = "N" THEN P = 3: GOTO 7360
7330 PRINT CHR$( 7): PRINT " Please answer 'Y' or 'N' ";; INPUT A$: GOTO 7310
7360 PRINT : PRINT " Does SERVICE have Poisson ";; INPUT A$
7370 IF A$ = "Y" THEN 7400
7380 IF A$ = "N" THEN P = 5: GOTO 7400
7390 PRINT CHR$( 7): PRINT " Please answer 'Y' or 'N' ";; INPUT A$: GOTO 7370
7400 ON P GOTO 7600,7410,7420,7430,7440
7410 GOSUB 7550: GOTO 7600
7420 GOSUB 7500: GOTO 7600
7430 GOSUB 7500: RESTORE : GOSUB 7550: GOTO 7600
7440 GOSUB 7500: GOSUB 7550: GOTO 7600
7500 X = - 1
7510 X = X + 1: READ FA(X,1),FA(X,2)
7520 IF FA(X,1) < 1 THEN 7510
7530 RETURN
7550 X = - 1
7560 X = X + 1: READ FS(X,1),FS(X,2)
7570 IF FS(X,1) < 1 THEN 7560
7580 RETURN
```

Listing 1 continued on page 168



Adam B. Green, Chairman, SoftwareBanc

TIME IS MONEY

Do you want to spend your time as intelligently as you spend your money? The decision may be yours, but your concerns are ours. We know you don't want to spend more time learning business software than you do using it. So we provide the productivity tools you can bank on to INVEST IN YOURSELF, time and time again.

It's no wonder over 50% of our business comes from repeat customers and referrals. For quality seminars, videotapes, books and software, you can count on SoftwareBanc for a guaranteed return on your investment.

\$ SEMINARS

As a full service organization, we provide fine professional training. Adam B. Green, well known dBASE II educator, uses a custom video presentation to highlight these invaluable lectures. \$200/day

dBASE II Fundamentals
dBASE II Programming
Advanced dBASE II Techniques

Problem Solving with 1-2-3
Exploring UNIX

Chicago
March 12-15

Atlanta
May 14-18

*Boston/Waltham
June 18-21

Toronto
July 9-13

New York
August 13-17

* In cooperation with Bentley College, Waltham, MA

\$ VIDEOTAPES

Learn the basics of dBASE II in three hours with this professionally produced training package. We give you everything you need to reproduce Adam B. Green's popular dBASE II seminar in your own home or office. You receive everything but the lunch!

dBASE II Demo	\$ 25.00
dBASE II Fundamentals (VHS or BETA)	\$295.00
dBASE II Fundamentals (U-MATIC)	\$395.00

\$ BOOKS

Built on years of practical experience in testing, supporting and teaching dBASE II, we take pride in offering you our accumulated knowledge. Interest adds up with new tips and techniques never before published!

dBASE II User's Guide	\$29.00
Advanced dBASE II User's Guide	\$29.00
Report Writing in dBASE II	\$11.95
101 Questions in dBASE II	Soon

\$ SOFTWARE

As an authorized dealer of every product we sell, you are assured of expert technical support, knowledgeable salespeople and fast, dependable service with a smile!

dBASE II with free dBASE II User's Guide	\$439
WordStar	\$269
1-2-3 with free 123 Trans	\$399

(Available at SoftwareBanc Seminars)

Take stock in SoftwareBanc! Call or write for the free catalogs which include our complete product line, seminar curriculum and unique services.

At SoftwareBanc, a wise investor is our best customer.

To order, call (800) 451-2502 or (617) 641-1241 in Mass. Hours are 9 a.m. - 8 p.m. EST Monday - Friday and 9 a.m. - 5 p.m. EST on Saturday.

Payment may be made by: MC/VISA, MO, check or COD. Terms available to qualified customers. MA residents add 5% sales tax. Add \$5 for S&H. Prices subject to change without notice. Dealer Inquiries Invited. Ask about our Discount Savings Plan.

dBASE II is a registered trademark of Ashton-Tate
1-2-3 is a registered trademark of Lotus Development Corp.
WordStar is a registered trademark of MicroPro
UNIX is a registered trademark of Bell Laboratories

Circle 327 on inquiry card.



SoftwareBanc

661 Massachusetts Avenue, Arlington, MA 02174

(800) 451-2502

(617) 641-1241 in MA

Listing 1 continued:

```

JLIST7600,7999          INPUT SIMULATION DATA

7600 HOME : PRINT
7610 PRINT : INPUT "What is AVERAGE Arrival Interval? ";AI
7620 PRINT : INPUT "What is AVERAGE Service Time? ";SI
7630 PRINT : INPUT "How many Service Stations are used? ";S%
7640 PRINT : PRINT "Is there a waiting Queue at Start ";: INPUT A$
7650 IF A$ = "N" THEN PRINT : GOTO 7680
7660 IF A$ < > "Y" THEN PRINT CHR$(7): PRINT "Please answer 'Y' or 'N' ";: INPUT A$: GOTO 7650
7670 PRINT : INPUT "How many are waiting? ";QL%:QL = QL%:QM% = QL%: PRINT
7680 PRINT "Are any Service Stations in Use ";: INPUT A$
7690 IF A$ = "N" THEN 7900
7700 IF A$ < > "Y" THEN PRINT CHR$(7): PRINT "Please answer 'Y' or 'N' ";: INPUT A$: GOTO 7690
7710 IF S% = 1 THEN A$(1) = "Y": GOTO 7900
7720 PRINT : PRINT "      Service Station #      In Use (Y/N)": PRINT
7730 FOR X = 1 TO S%
7740 PRINT "          ";X;: INPUT "          ";A$(X)
7750 NEXT
7900 PRINT : INPUT "Size of Simulation Sample: ";C%
```

```

JLIST8000,8799          CALCULATE FIRST ARRIVAL AND DEPARTURE(S) TIMES
```

```

8000 HOME : PRINT : PRINT : PRINT : PRINT : PRINT TAB(15)"PLEASE WAIT"
8010 PRINT : PRINT TAB(10) " ";: FLASH : PRINT "SIMULATION RUNNING"
8020 NORMAL
8090 IF P < 3 THEN R = RND(1):F = - LOG(1 - R): GOTO 8130
8100 R = RND(1):X = 0
8110 IF R > FA(X,1) THEN X = X + 1: GOTO 8110
8120 F = FA(X - 1,2) + (R - FA(X - 1,1)) * (FA(X,2) - FA(X - 1,2)) / (FA(X,1) - FA(X - 1,1))
8130 TA = F * AI
8150 FOR Z = 1 TO S%
8160 IF A$(Z) = "Y" THEN S%(Z) = 1
8170 IF S%(Z) = 0 THEN TD(Z) = S% * 100 * AI: GOTO 8300
8180 IF P = 4 THEN 8240
8190 IF P = 5 THEN 8240
8200 R = RND(1):F = - LOG(1 - R): GOTO 8270
8240 R = RND(1):X = 0
8250 IF R > FS(X,1) THEN X = X + 1: GOTO 8250
8260 F = FS(X - 1,2) + (R - FS(X - 1,1)) * (FS(X,2) - FS(X - 1,2)) / (FS(X,1) - FS(X - 1,1))
8270 TD(Z) = F * SI
8300 NEXT
8500 GOTO 2000
```

```

JLIST8800,              ERRORS IN DATA STATEMENTS
```

```

8800 HOME : PRINT : PRINT :
8810 FOR X = 1 TO 3: PRINT CHR$(7): NEXT
8820 PRINT " PLEASE CORRECT THE DATA STATEMENTS"
8830 PRINT : PRINT : PRINT " NON-POISSON DISTRIBUTIONS"
8840 PRINT : PRINT " SHOULD BE IN DATA STATEMENTS"
8850 PRINT : PRINT " STARTING AT LINE 9000"
8860 PRINT : LIST 9000,
8870 END
```

Text continued from page 160:

```

9000DATA0,.25,.1,.25,.35,.5,.65,1.5,
.9,1.75,1,1.75
9010DATA0,.75,1,1.25
```

assigns a distribution according to curve 3 to arrival intervals but distributes service times according to curve 2. Make sure that the defined distribution averages a value of 1.

Some Sample Problems

Parts a through f of figure 4 show examples of printed output from sim-

ulations done by the program. Notice that all input data is repeated on the printed report. Parts e and f of the figure show simulations using non-Poisson distributions. This is noted at the bottom of the report; and the coordinates for the specified distribution curve(s) are shown. Part c of the figure shows a simulation of three parallel service stations. Notice that station 1 has been used most often. This is because of the way the program chooses open stations. The

average utilization factor of 91.6 percent for all three stations is close to the theoretical, overall utilization factor of 90.9 percent.

The results of the simulation are summarized in table 4 and compared with the theoretical values (where this is possible), which can be calculated using the formulas listed in table 1. Notice that even with 5000 simulations there is up to 20 percent difference between the analytical and the simulated results. This does not

Variable	Description	Input	Output	
			Printer	Screen
A	Time advance			
AI	Mean arrival interval	yes	yes	yes
A\$	Answer to yes/no question			
A\$(Z)	Station status at start	yes	yes	
C%	Sample size	yes	yes	yes
C0%	Number of arrivals with no wait time		yes	yes
C1%	Total number of arrivals		yes	yes
C2%	Total number of departures			
CS%(Z)	Number of departures from Station Z		yes	yes
D\$	Date of report	yes	yes	
F	Simulation factor, a function of random			
FA(a,2)	Probability distribution for arrival intervals			
FS(b,2)	Probability distribution for service intervals			
I\$	Project identification	yes	yes	
N	Switch for next event (0 = arrival; 1 = departure)			
P	Switch for type of probability distributions			
Q0	Percent of arrivals with no wait time		yes	yes
Q1	Average wait time, all arrivals		yes	yes
Q2	Average wait time, arrivals entering queue		yes	yes
QA	Average length of queue		yes	yes
QL	Length of queue at start	yes	yes	yes
QL%	Length of queue		yes	yes
QM%	Maximum length of queue		yes	yes
QT	Cumulative queue time (i.e., SUM QL%*T)			
R	Random number = RND(1)			
S	Station number with earliest departure			
S%	Number of service stations	yes	yes	yes
S%(Z)	Station status; 0 = open, 1 = used			
S\$(Z)	Station status		yes	yes
ST(Z)	Total time Station Z has been in use			
SI	Mean service time, all stations	yes	yes	yes
T	Time, cumulative from start		yes	yes
TA	Time for next arrival			
TD(Z)	Time for departure from Station Z			
TS(Z)	Average service time at Station Z		yes	yes
US(Z)	Percent of utilization of Station Z		yes	yes
X	General counter			
Z	Counter for stations			

Table 2: Queue simulation variables.

indicate any flaw in the program but merely illustrates the possible differences between a finite and an infinite population.

A comparison of lines 1, 2, and 3 in table 4 shows that multiple service channels with identical total capacity provide slightly improved service as more channels are used. A comparison of lines 1 and 4 shows the dramatic reduction in queue length and waiting time when a second ser-

Text continued on page 174

Arrival Interval	Service Interval	Value of P
Poisson	Poisson	1
Poisson	Non-Poisson	2
Non-Poisson	Poisson	3
Non-Poisson	Same non-Poisson function as in Arrival Interval column	4
Non-Poisson	Different non-Poisson function than in Arrival Interval column	5

Table 3: P values.

ERG/68000 MINI-SYSTEMS

Full IEEE 696/S100 Compatibility

HARDWARE OPTIONS

- 8MHz, 10 MHz, or 12 MHz
68000/68010 CPU
- 68451 Memory Management
- Hardware Floating Point
- Multiple Port Intelligent I/O
- 64K/128K Static RAM (70 nsec)
- 256K/512K/1MB Dynamic RAM (150 nsec)
- Graphics-Digital Graphics
CAT-1600
- DMA Disk Interface
- SMD Disk Interface
- 1/4" or 1/2" Tape Backup
- 5 1/4" or 8" Floppy Disk Drives
- 5MB-474MB Hard Disk Drives
- 7/10/20 Slot Back Plane
- 20 or 30A Power Supply
- Desk Top or Rack Mount Encl.

SOFTWARE OPTIONS

- 68KFORTH¹ Systems Language
- CP/M-68K²O/S with C, 68K-BASIC¹,
68KFORTH¹, FORTRAN 77, Z80
Emulator, Whitesmiths³ C, PASCAL
- IDRIS³ O/S with C, PASCAL,
FORTRAN 77, 68K-BASIC¹, CIS
COBOL⁴, INFORMIX⁵ Relational
DBMS
- UNIX⁶ SYS V O/S with C, PASCAL,
FORTRAN 77, BASIC, RM COBOL⁷,
ADA⁸, INFORMIX⁵ Relational DBMS
- VED 68K Screen Editor
- Motorola's MACSBUG and FFP
Package

Trademark ¹ERG, ²Digital Research,
³Whitesmiths, ⁴Micro Focus, ⁵RDS,
Inc., ⁶Bell Labs, ⁷Ryan McFarland,
⁸U.S. DoD

30 Day Delivery - OEM Discounts



since 1974

Empirical Research Group, Inc.
P.O. Box 1176
Milton, WA 98354
206-872-7655

Figure 4: Simulation results with (4a) one service station, (4b) two service stations, (4c) three service stations, (4d) doubled service capacity, (4e) service time has probability function from curve 2 of figure 2, and (4f) both service and arrival times have probability functions from curve 2 of figure 2.

(4a) 1 (ONE) QUEUE SERVED BY 1 PARALLEL SERVICE STATIONS
AVERAGE ARRIVAL INTERVAL WAS SPECIFIED AS 11 TIME UNITS
AVERAGE SERVICE TIME WAS SPECIFIED AS 10 TIME UNITS
QUEUE LENGTH AT START OF SIMULATION WAS 8

STATUS OF SERVICE STATIONS AT START WAS:

STATION	STATUS
1	USED

SAMPLE SIZE IS 5000 DEPARTURES

TIME ELAPSED FOR SIMULATION IS 55470 TIME UNITS

STATUS OF SERVICE STATIONS AT END IS:

STATION	NUMBER OF DEPARTURES	UTILIZATION %	AVERAGE TIME PER SERVICE	STATUS
1	5000	91.98	10.2	OPEN

QUEUE CONTENT			ENTRIES	ZERO
CURRENT	MAXIMUM	AVERAGE	TOTAL ZEROS	%
36	46	10.81	5027	370
				7.36

AVERAGE WAIT TIME ALL ENTRIES	AVERAGE WAIT TIME UNITS ENTERING QUEUE
119.25	128.73

(4b) 1 (ONE) QUEUE SERVED BY 2 PARALLEL SERVICE STATIONS
AVERAGE ARRIVAL INTERVAL WAS SPECIFIED AS 11 TIME UNITS
AVERAGE SERVICE TIME WAS SPECIFIED AS 20 TIME UNITS
QUEUE LENGTH AT START OF SIMULATION WAS 8

STATUS OF SERVICE STATIONS AT START WAS:

STATION	STATUS
1	USED
2	USED

SAMPLE SIZE IS 5000 DEPARTURES

TIME ELAPSED FOR SIMULATION IS 55025 TIME UNITS

STATUS OF SERVICE STATIONS AT END IS:

STATION	NUMBER OF DEPARTURES	UTILIZATION %	AVERAGE TIME PER SERVICE	STATUS
1	2531	92.05	20.01	OPEN
2	2469	88.93	19.82	USED

QUEUE CONTENT			ENTRIES	ZERO
CURRENT	MAXIMUM	AVERAGE	TOTAL ZEROS	%
2	38	7.12	4993	718
				14.38

AVERAGE WAIT TIME ALL ENTRIES	AVERAGE WAIT TIME UNITS ENTERING QUEUE
78.42	91.59

(4c) 1 (ONE) QUEUE SERVED BY 3 PARALLEL SERVICE STATIONS
 AVERAGE ARRIVAL INTERVAL WAS SPECIFIED AS 11 TIME UNITS
 AVERAGE SERVICE TIME WAS SPECIFIED AS 30 TIME UNITS
 QUEUE LENGTH AT START OF SIMULATION WAS 0

STATUS OF SERVICE STATIONS AT START WAS:

STATION	STATUS
1	USED
2	USED
3	OPEN

SAMPLE SIZE IS 5000 DEPARTURES

TIME ELAPSED FOR SIMULATION IS 55615 TIME UNITS

STATUS OF SERVICE STATIONS AT END IS:

STATION	NUMBER OF DEPARTURES	UTILIZATION %	AVERAGE TIME PER SERVICE	STATUS
1	1709	93.9	30.56	OPEN
2	1646	91.71	30.99	OPEN
3	1645	89.11	30.13	OPEN

QUEUE CONTENT			ENTRIES		ZERO
CURRENT	MAXIMUM	AVERAGE	TOTAL	ZEROS	%
0	33	6.06	4998	774	15.49

AVERAGE WAIT TIME ALL ENTRIES	AVERAGE WAIT TIME UNITS ENTERING QUEUE
67.47	79.83

(4d) 1 (ONE) QUEUE SERVED BY 2 PARALLEL SERVICE STATIONS
 AVERAGE ARRIVAL INTERVAL WAS SPECIFIED AS 11 TIME UNITS
 AVERAGE SERVICE TIME WAS SPECIFIED AS 10 TIME UNITS
 QUEUE LENGTH AT START OF SIMULATION WAS 0

STATUS OF SERVICE STATIONS AT START WAS:

STATION	STATUS
1	USED
2	OPEN

SAMPLE SIZE IS 5000 DEPARTURES

TIME ELAPSED FOR SIMULATION IS 55796 TIME UNITS

STATUS OF SERVICE STATIONS AT END IS:

STATION	NUMBER OF DEPARTURES	UTILIZATION %	AVERAGE TIME PER SERVICE	STATUS
1	2973	54.6	10.25	USED
2	2027	36.27	9.98	OPEN

QUEUE CONTENT			ENTRIES		ZERO
CURRENT	MAXIMUM	AVERAGE	TOTAL	ZEROS	%
0	9	.24	5000	3556	71.12

AVERAGE WAIT TIME ALL ENTRIES	AVERAGE WAIT TIME UNITS ENTERING QUEUE
2.72	9.42



- Implements the entire IEEE-488 standard - system controller or device, transfer commands and data, perform serial and parallel polling.
- A resident firmware Interpreter accepts Tektronix Standard Codes and Formats, IEEE-488 command mnemonics, and any ASCII string or code. The interpreter routines may be called from assembly language, BASIC, Pascal, and other languages.

- Supports the PrtSc (print screen) key, and all BASIC print statements for IEEE-488 printers.

- Small size - see BYTE 11/83 p.314

- Uses only 16 bytes of RAM - leaving the entire 640K memory address space open.

- A 116 page Reference Manual provides a tutorial and programming examples for digitizing, interactive bus control, bus diagnostics, and many other applications.

- \$395 complete. There are no extra software or cabling charges. MasterCard or Visa telephone orders accepted.

CAPITAL EQUIPMENT CORP.
 10 Evergreen Ave., Burlington, MA 01803
 Call (617) 273-1818
IBM is a trademark of International Business Machines Corp.

Less for Your Money

If you do word processing on your personal computer, you probably know that there are many programs for sale to help you with your spelling. But the **biggest** spelling error you'll ever make is paying too much for your spelling correction software. The Random House ProofReader gives you less for your money - less trouble, that is, and fewer spelling errors. The Random House ProofReader is based on the world famous Random House Dictionary. It contains up to 80,000 words, depending on your disk capacity. You can add new words with the touch of a key. It shows you the error and the sentence it's in. It instantly suggests corrections. It even re-checks your corrections. And it costs half as much as other programs with far less power. The Random House ProofReader is compatible with all CP/M 2.2®, MS-DOS® and IBM Personal Computer® systems.



**The
Random
House
ProofReader
\$50**

For orders or information, see your local dealer or call 505-281-3371. Master card and VISA accepted. Or write Random House ProofReader, Box 339-B, Tijeras, NM 87059. Please enclose \$50 and specify your computer model, disk size and memory.

Random House and the House design are registered trademarks of Random House, Inc. CP/M is a registered trademark of Digital Research, Inc. IBM and IBM Personal Computer are registered trademarks of International Business Machines, Inc. MS-DOS is a registered trademark of Microsoft, Inc.

(4e) 1 (ONE) QUEUE SERVED BY 1 PARALLEL SERVICE STATIONS
AVERAGE ARRIVAL INTERVAL WAS SPECIFIED AS 11 TIME UNITS
AVERAGE SERVICE TIME WAS SPECIFIED AS 10 TIME UNITS
QUEUE LENGTH AT START OF SIMULATION WAS 5

STATUS OF SERVICE STATIONS AT START WAS:

STATION	STATUS
1	USED

SAMPLE SIZE IS 5000 DEPARTURES

TIME ELAPSED FOR SIMULATION IS 55556 TIME UNITS

STATUS OF SERVICE STATIONS AT END IS:

STATION	NUMBER OF DEPARTURES	UTILIZATION %	AVERAGE TIME PER SERVICE	STATUS
1	5000	89.66	9.96	OPEN

QUEUE CONTENT			ENTRIES		ZERO
CURRENT	MAXIMUM	AVERAGE	TOTAL	ZEROS	%
1	24	3.11	4995	533	10.67

AVERAGE WAIT TIME ALL ENTRIES	AVERAGE WAIT TIME UNITS ENTERING QUEUE
34.59	38.72

NOTE:
SERVICE TIME HAD PROBABILITY DISTRIBUTION:

0 .75 1 1.25

(4f) 1 (ONE) QUEUE SERVED BY 1 PARALLEL SERVICE STATIONS
AVERAGE ARRIVAL INTERVAL WAS SPECIFIED AS 11 TIME UNITS
AVERAGE SERVICE TIME WAS SPECIFIED AS 10 TIME UNITS
QUEUE LENGTH AT START OF SIMULATION WAS 0

STATUS OF SERVICE STATIONS AT START WAS:

STATION	STATUS
1	OPEN

SAMPLE SIZE IS 5000 DEPARTURES

TIME ELAPSED FOR SIMULATION IS 55109 TIME UNITS

STATUS OF SERVICE STATIONS AT END IS:

STATION	NUMBER OF DEPARTURES	UTILIZATION %	AVERAGE TIME PER SERVICE	STATUS
1	5000	90.64	9.99	OPEN

QUEUE CONTENT			ENTRIES		ZERO
CURRENT	MAXIMUM	AVERAGE	TOTAL	ZEROS	%
1	2	.12	5001	2496	49.91

AVERAGE WAIT TIME ALL ENTRIES	AVERAGE WAIT TIME UNITS ENTERING QUEUE
1.34	2.67

NOTE:
ARRIVAL AND SERVICE HAD IDENTICAL NON-POISSON DISTRIBUTION:

0 .75 1 1.25

Accounting software so perfect you'll want to change it immediately.

It's perfect because you *can* change it.

Which is one thing you can't do with canned accounting programs. Instead, you're stuck doing bookkeeping their way.

Well, rather than let your accounting software run your business, we suggest you run our business accounting software: Sensible Solution Management.

Straight out of the box, it's ready to get down to business with single-entry general ledger,

accounts payable and receivable, payroll, inventory control and order entry.

Language so you can modify the program to take into account your needs.

Canned Accounting vs. The Sensible Solution		
	The Typical Accounting Package	Sensible Solution Management
Can the program be changed to suit special needs?	No	Yes
Can you use your business's existing forms?	No	Yes
Is source code included in the program's price?	No	Yes
Can you easily transfer your data when you buy a new computer?	No	Yes

You can change it to use your business forms and checks. Work in your company's commission rates. Add space for your product codes. Or do just about anything else your way.

So if you've got accounting software you can't change, change to the Sensible Solution.

And kick the canned forever.

But instead of locking you in to our way of accounting, we also supply you with source code and The Sensible Solution

The Sensible Solution™

The Sensible Solution Programming Language for most single and multi-user operating systems is \$695 (single-user) or \$995 (multi-user) with Accounting Modules at \$250 each. For more information, write or call: O'Hanlon Computer Systems, 11058 Main Street, Bellevue, WA 98004. Phone (206) 454-2261. Telex 152974. Dealer and distributor inquiries welcome.

Number of Stations	Mean Interval		Percent of Utilization		Average Queue Length		Average Waiting Time	
	Arrival	Service	Analytical	Simulated	Analytical	Simulated	Analytical	Simulated
1	11	10	90.9	92.0	9.1	10.8	100.0	119.3
2	11	20	90.9	90.5	8.7	7.1	95.2	78.4
3	11	30	90.9	91.6	8.3	6.1	91.6	67.5
2	11	10	45.5	47.2	.24	.24	2.6	2.7
1	11	10 ¹	90.9	89.7	n.a.	3.1	n.a.	34.6
1	11 ²	10 ²	90.9	90.6	n.a.	.12	n.a.	1.3

Table 4: Analytical and simulated solutions of queuing problems. The superscript 1 indicates that the service interval had linear probability distribution. The superscript 2 indicates that both the arrival and the service interval had linear probability distribution.

vice line is opened. (I hope the manager of my local supermarket reads this.)

The significance of the probability distribution is clearly demonstrated by comparing lines 1, 5, and 6. The average waiting time is reduced by 60 percent or more when the service interval follows a narrow, linear distribution rather than the Poisson distribution, and waiting is all but eliminated when both arrival and service intervals fall in a narrow range. This shows that good scheduling reduces wasteful waiting time without having to change the service capacity.

Conclusion

The program I have presented cannot compete with the very powerful, special-purpose simulation languages that are commercially available. But it does give you the ability to analyze queuing situations with your own probability distributions. My program only simulates single-phase service. But with the program's

modular structure, you should be able to expand it to include other queuing models. A second Departure module with a second Seize module can be added for simulation of multiphased service. Or a switch can be inserted in the Arrival module to activate an additional service station whenever the queue length exceeds a specified value.

Other possible variations include putting a limitation on the queue length (limited parking space, for example) and counting the number of customers lost because they leave without joining the queue. You could use this information to justify more parking space. In short, the program is flexible; you should be able to adapt it to many queuing situations. ■

Bibliography

1. Buffa, E.S. *Operations Management*. New York, NY: John Wiley & Sons, 1972.
2. Churchman, C.W.R., R.L. Ackoff, and E.L. Arnoff. *Introduction to Operations Research*. New York, NY: John Wiley & Sons, 1957.

3. Emshoff, J.R., and R.L. Sisson. *Design and Use of Computer Simulation Models*. New York, NY: Macmillan, 1970.
4. Gorney, L. "Queuing Theory." Part 1, BYTE, April 1979, page 132. Part 2, BYTE, May 1979, page 176.
5. Morris, R.C. "Simulating Batch Processes." *Chemical Engineering*, May 16, 1983, page 77.
6. Morse, P.M. *Queues, Inventories and Maintenance*. New York, NY: John Wiley & Sons, 1958.
7. Pritsker, A.A.B. *The GASP IV Simulation Language*. New York, NY: John Wiley & Sons, 1974.
8. Pritsker, A.A.B., and R.E. Young. *Simulation with GASP-PL/I*. New York, NY: John Wiley & Sons, 1975.
9. Pritsker, A.A.B., and C.D. Pegden. *Introduction to Simulation and SLAM*. New York, NY: John Wiley & Sons, 1979.
10. Satty, T.L. *Elements of Queuing Theory*. New York, NY: McGraw-Hill, 1961.
11. Schriber, T. *Simulation Using GPSS*. New York, NY: John Wiley & Sons, 1974.
12. Whitehouse, G.E., and B.L. Wechsler. *Applied Operations Research: A Survey*. New York, NY: John Wiley & Sons, 1976.

E. Hart Rasmussen is a professional engineer and the president of Project Management Services, 81 Fawn Hill Rd., Upper Saddle River, NJ 07458.

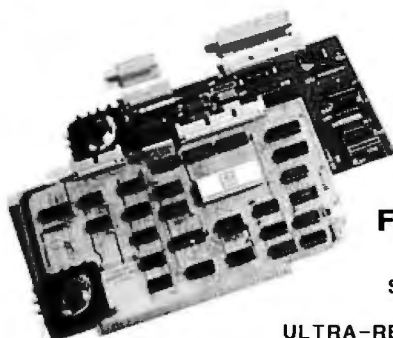

ULTRA-RES™ GRAPHICS

IEEE-696 S-100

IBM-PC

- 1 X 512 X 512 \$495
 - 3 X 512 X 512 \$1250
 - 1 X 1024 X 1024 \$995

- 1 X 512 X 512 \$495
 - 1 X 1024 X 1024 \$995
 - CONSOLE EMULATOR \$50

- PLOT 10 \$150

FEATURES

Software drivers, Hardware zoom, Programmable Display Resolution, Windowing, Multi-Controller Capability, NEC UPD7220 Graphic Controller

Starting Prices

ULTRA-RES Trademark CSD Inc.
 IBM-PC Trademark IBM

C.S.D. Incorporated
P.O. BOX 253 Sudbury, MA 01776
(617) 443-2750

Now there's a real-time video image acquisition and display module that plugs directly into the IBM PC and PC-XT.

It's called the PCVISION™ Frame Grabber. From Imaging Technology — the leading OEM supplier of low cost, board level image processors.

The PCVISION Frame Grabber converts a standard analog video signal (RS-170) from a camera to digital data at 30 frames per second, and stores the resulting 6-bit pixel data in a 512 × 512 frame memory.

It allows your IBM PC or PC-XT to access stored images for process-

ing or manipulation, and features up to 64 gray scales per pixel, full color support, low cost, easy installation and high reliability.

The PCVISION Frame Grabber turns your IBM PC into a low cost, multi-featured image processing system for **teleconferencing, robotic vision, factory inspection, medical imaging, microscopy, X-ray analysis** and many other applications in business, industry, medicine and research.

The PCVISION Frame Grabber comes complete with demonstration software, cables and full documentation for fast, easy installation

and integration.

All for just **\$2995** (camera and display monitor not included).

To find out how the PCVISION Frame Grabber can provide your IBM PC with the high performance, multi-featured image processing capabilities of systems costing much more, call our Sales Department at (617) 938-8444. Or write to the address below.

IMAGING

Imaging Technology Incorporated
600 West Cummings Park, Woburn, MA 01801
Telex: 948263

Circle 183 on inquiry card.

PCVISION™

THE IBM PC PLUG-COMPATIBLE BOARD THAT TURNS YOUR PC INTO A REAL-TIME IMAGE PROCESSOR RIGHT BEFORE YOUR EYES.



A hand in a dark suit sleeve points upwards and to the left towards a stylized, cross-hatched landscape. The landscape features three prominent, rounded hills or mountains, each with a dark, cross-hatched texture. The sky is filled with white, fluffy clouds. The overall style is a high-contrast, black and white illustration with a heavy use of cross-hatching for shading and texture.

**Visual
introduces
the Commuter:[™]
It can take your
business places
it's never been before.**

Heavyweight power, memory, and true IBM[®] PC compatibility in a portable 16 pound computer.

The portable computer can be a very powerful business ally.

But like any good business partner, the right one can be very hard to find. Some portables are powerful. Some are IBM compatible. Some are affordable. And some are actually portable.

However, there's never been one portable computer that could gracefully combine all of the above. Until now.

Put the power of a desk-top computer in your hands.

Introducing Commuter,[™] the powerful portable computer. When you carry it, you're carrying all the capacity, capabilities, and features of a desk-top computer. Yet you're carrying only 16 pounds.

Commuter comes with a 16-bit 8088 processor. 128K of memory, expandable to 512K. Single or dual floppy disk drives, each with 360K bytes of storage. A large 80 column by 16 line optional flat panel display, designed to be easily removed when Commuter is used with an external monitor. A full 83 key keyboard with an IBM PC layout, including numeric pad and ten function keys. And IBM compatible color graphics and monochrome support.

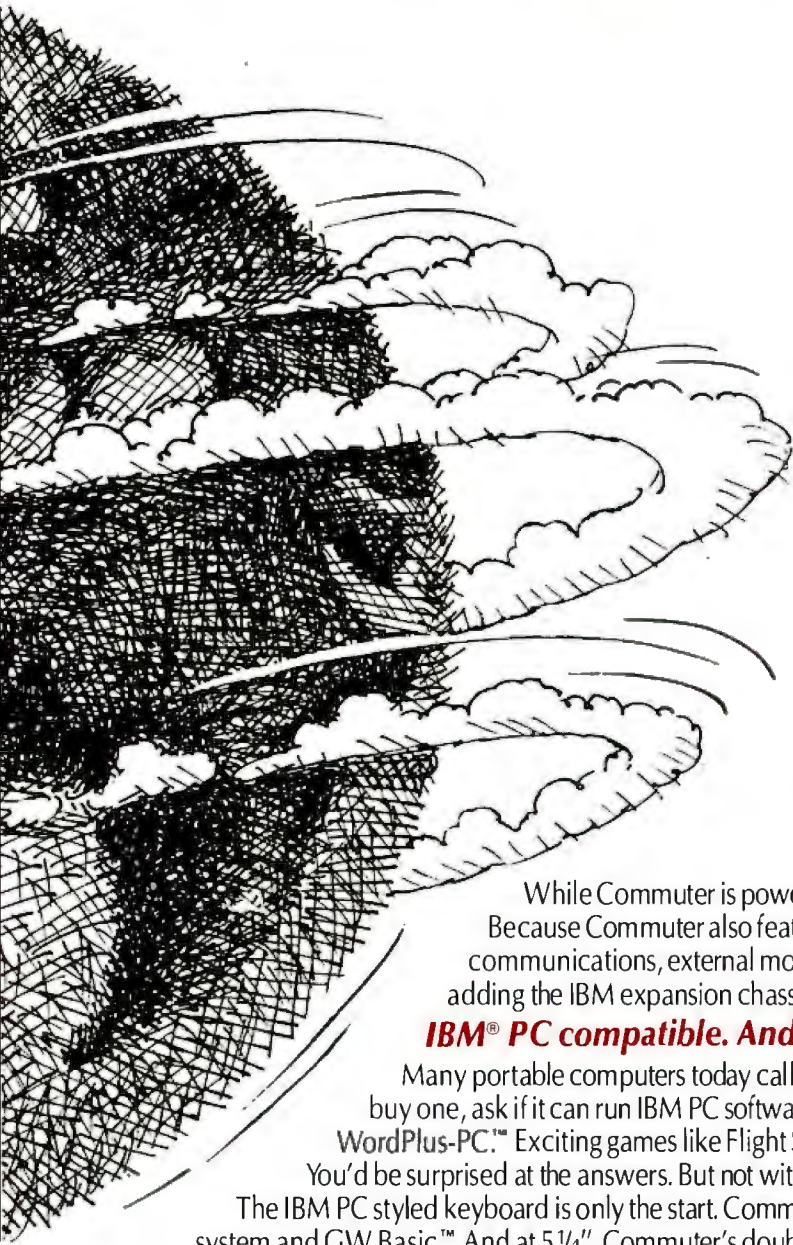

While Commuter is powerful enough to stand alone, it can really grow on you. Because Commuter also features built-in ports for adding printers, hard disk, communications, external monitors, and your television set. Even a built-in port for adding the IBM expansion chassis.

IBM® PC compatible. And downright sociable.

Many portable computers today call themselves IBM compatible. But before you buy one, ask if it can run IBM PC software. Business programs like Lotus®1-2-3™, VisiCalc™ or WordPlus-PC.™ Exciting games like Flight Simulator.™ Or educational games from Spinnaker.™

You'd be surprised at the answers. But not with Commuter. In fact, think of it as an IBM PC to go.

The IBM PC styled keyboard is only the start. Commuter comes bundled with the MS-DOS™ operating system and GW Basic.™ And at 5 1/4", Commuter's double-sided double-density diskettes are directly transferable to and from the IBM PC. So you can take advantage of the hundreds of business accounting, word processing, financial planning and other software packages available for the IBM PC. Without having to modify a thing.

At \$1,995 and 16 pounds, it's never been easier to pick up a portable computer.

At 15" x 18" x 3 1/2" with built-in handle and carrying case, the Commuter can go anywhere a briefcase can. It fits easily under an airplane seat. Because it weighs just 16 pounds (about half the weight of other portables in its class), Commuter is very easy to handle. And its \$1995 price can save your business a small fortune even before you pick it up.

For more information on Commuter, the portable computer, call us today at 1-800-847-8252 (in Massachusetts, call 1-800-462-5554), or write Visual Computer Incorporated, 135 Maple St., Marlboro, MA 01752. Or visit your local Commuter dealer and weigh the differences for yourself. But hurry. At only 16 pounds and \$1995, Commuters are definitely going to be picked up fast.

Commuter. It can take your business places it's never been.

Circle 372 on inquiry card.

Visual Computer Incorporated is a wholly owned subsidiary of Visual Technology Incorporated. COMMUTER is a trademark of Visual Computer Incorporated. IBM is a registered trademark of International Business Machines Corp. Lotus and 1-2-3 are trademarks of Lotus Development Corp. VisiCalc is a trademark of VisiCorp. WordPlus-PC is a trademark of Professional Software Inc. Spinnaker is a trademark of Spinnaker Software Corp. MS-DOS, GW Basic and Flight Simulator are trademarks of Microsoft Corp.



VisiCalc®, Lotus™ 1-2-3™ and Multiplan® users endorse Dow Jones Spreadsheet Link™.



“The analysis I do with Spreadsheet Link would be impossible any other way.

I track more than 200 securities. This software really gives me a handle on my investments. I can download stock quotes and fundamental information from Dow Jones News/Retrieval® directly into my spreadsheets, and analyze it using my own formulas.”

Ronald Eldredge
Lockhart Financial Services



“The speed of collecting and entering data is invaluable.

Spreadsheet Link does exactly what I want it to do. It's a tremendous help in manipulating data. I think anyone who does spreadsheet analysis will find this an important addition to their software library.”

Anne Freilich
Wensley Management Corporation



“The comprehensive information I get from Dow Jones News/Retrieval is a real plus.

Without Spreadsheet Link, I'd have to enter data keystroke by keystroke into my templates. This software makes spreadsheet analysis much easier and more useful to me. I'm getting very satisfactory results, and I'm still exploring the possibilities.”

Douglas Gill
Grayson Gill, Inc.



Compatible with Apple II and IBM personal computers.

**For a free brochure, call
1-800-345-8500 ext. 165
(Alaska, Hawaii and foreign call 1-215-789-7008 ext. 165)**

Copyright © Dow Jones & Co., Inc., 1983. All rights reserved.

DOW JONES SOFTWARE™

... Plan on it.

VisiCalc is a registered trademark of VisiCorp.
Lotus and 1-2-3 are trademarks of Lotus Development Corporation.
Multiplan is a registered trademark of Microsoft Corporation.

A Risky Business—An Introduction to Monte Carlo Venture Analysis

A simple method for analyzing business risks

by Pat Macaluso

A business enterprise is aptly named a venture. It is a ship launched on a sea of uncertainty. The business of business is the taking of intelligent risks. Precious resources are committed to what can only be a hope of future gain. To reduce the risk, it would be helpful and profitable to have some insight as to possible future events.

It turns out that future prospects, elusive as they are, can be estimated in a way that is surprisingly useful for business purposes. The method involves four steps: (1) formulate a model of the venture; (2) distribute appropriate data in the model; (3) sample from the model data; (4) analyze the sample.

The Monte Carlo Method

Aside from an investor's knowledge of a proposed venture, the Monte Carlo method requires nothing more than a personal computer and a program that is almost trivial in its simplicity. I'll use an example to illustrate how it works. We take at random a possible selling price, a possible sales volume, and so on. The selections are made from a range of possible values in each case

according to the estimated probability of their occurrence. From this sample data, a corresponding outcome is calculated. This process is repeated for the entire range of possibilities. The resulting collection of outcomes is then arranged in sorted order. Examination of this distributed result yields information on the range of future outcomes and the relative chance of their occurrence. We'll see how this is done in detail later on, but the analysis might run something like this: in this business venture there is a 10 percent chance you will lose your shirt; a 65 percent chance you will achieve a 15 percent return on investment after taxes; a 5 percent chance you will really clean up, and so forth.

Such a formulation, even if stated less colorfully or dressed up in graphs and tables, may sound strange or even unsettling. Wouldn't it be simpler and more understandable to take the most likely selling price, sales volume, etc., and come up with a most likely result? Unfortunately that is not the case. Such an approach tends to underestimate the risks. It also throws away most of the information we have that bears on future possibilities.

In projecting sales figures for a product, sales managers can say that a realistic sales level will be 50,000 units. They can also say that there's little chance of 80,000 and no chance of more than 90,000 units being sold. Further, they might add that it is very likely that at least 15,000 units and quite certain that 5000 units will be sold. The manager is expressing a wealth of hard information along with his uncertainty. He is weighing the size of the total market, the effect of competition, replacement rates, captive markets, limits on plant capacity, and so on. In other words, estimates by an informed person, though couched in uncertainty, contain valuable information that bears on future outcomes.

Faced with an investment decision, would you throw such information away, especially if it is easily expressed in a form suited to quantitative analysis? The most likely value or single-point methods do just that. They are quite inferior to the Monte Carlo sampling approach that allows us to use the extra information.

The most likely value method of risk analysis has tended to persist since calculations could be made by

hand and managers felt they understood the result. It certainly seemed more definite and less threatening than a distribution that told of possible bad outcomes as well as the desired profitable ones. Times have changed. Many executives, aided by easier access to computers, have responded with increased sophistication as the safety of investments has become harder to gauge.

We can better understand the nature of the Monte Carlo method with the aid of a simple example. Suppose we wanted to determine the chance of getting "snake eyes," or two ones, in the roll of dice. We can calculate this precisely from probability theory as being one out of 36 tosses on the average. But what if we had no theoretical solution, as is the case with business ventures? There is another way to estimate the chance of snake eyes. We can tally the result of thousands of rolls of the dice. Even better, we can simulate it on a computer. The result will, in general, not be exactly 1 in 36 but it will tend to approach it more and more closely as the size of the sample increases. We will have performed a random-sampling experiment. It is easy, it works, and it is more than adequate when applied to business situations.

How Do I Get Started?

We present here three useful items for anyone who wishes to explore this method of risk analysis: (1) a simple technique for building a model of the venture; (2) a way to construct a sample from a distribution that is universal in its application; (3) a complete but elementary venture-analysis program to carry out the calculations. The program (see listing 1) can serve as a core upon which a more sophisticated or customized system can be built. More details are supplied in the author's book (see text box at the end of this article) but all the essentials are provided in this article.

A word of caution is in order. Compared to the sometimes mind-boggling complexity of actual business ventures, the model shown here will appear quite simplistic. Perhaps crude would be a better description.

Listing 1: Monte Carlo Venture Analysis program, written in Microsoft BASIC, can be modified for your own use by programming your own model equation and changing the numbers in the DATA statements accordingly.

```

1000 'MONTE CARLO VENTURE ANALYSIS
1005 '
1010 CLEAR
1020 GOSUB 11000 'Specify runs, samples, etc.
1030 '
1040 FOR L=1 TO NR 'Carry out NR runs (10 max.)
1045 PRINT L
1050 FOR J=1 TO NS 'of NS samples each (200 max.)
1060 '
1070 FOR K=1 TO NV 'for a model with NV variables
1080 P=RND 'Generate a random probability
1090 GOSUB 21000 'Find its posn. in a distrbn. of values
1100 GOSUB 22000 'Find corresp. posn. of variable value
1110 GOSUB 23000 'Calc a sample value V for a variable
1120 NEXT K
1130 '
1140 GOSUB 31000 'Calc a sample outcome from the model
1150 NEXT J
1160 '
1170 GOSUB 41000 'Sort outcomes in ascending order
1180 GOSUB 42000 'Calc statistics for each run
1190 GOSUB 43000 'Calc 11 cum distrbn points for each run
1200 NEXT L
1210 '
1220 GOSUB 44000 'Avg & std devn over all samples
1230 GOSUB 45000 'Std devn of avg of NR run averages
1240 GOSUB 46000 'Cum distn of outcomes over all samples
1250 '
1260 GOSUB 51000 'Display statistics for each run
1270 GOSUB 52000 'Display distn of outcomes over all samples
1280 '
1290 END
1300 '
11000 '--- Initiate the simulation
11010 '
11020 NV=4
11030 DIM OU(200),CD(10,10),ST(10,2),FD(10)
11035 PRINT"PATIENCE PLEASE. RUN NUMBER WILL DISPLAY WHILE COMPUTING."
11040 INPUT"NUMBER OF RUNS";NR
11050 INPUT"SAMPLES PER RUN";NS
11060 INPUT"ENTER RANDOM SEED <-32768 TO 32767>";RS
11070 RANDOMIZE RS
11080 IF NR<2 THEN NR=2:IF NR>10 THEN NR=10
11090 IF NS<10 THEN NS=10:IF NS>200 THEN NS=200
11100 RETURN
11110 '
12000 '--- Sum of squared deviations
12010 '
12020 SS#=0:FOR I=1 TO T
12030 SS#=SS#+(OU(I)-AV)^2:NEXT I:RETURN
12040 '
13000 '--- Standard deviation
13010 '
13020 SD=(SS#/(T-1))^.5:RETURN
13030 '
21000 '--- Find the interval of P
21010 '
21020 FOR I=1 TO 5:READ P2
21030 IF P>P2 AND P<=P1 THEN II=I:PA=P1:PB=P2
21040 P1=P2:NEXT I:READ X#:RETURN
21050 '
22000 '--- Find the corresponding value interval
22010 '
22020 FOR I=1 TO 5:READ V2
22030 IF I=II THEN VA=V1:VB=V2
22040 V1=V2:NEXT I:READ X#:RETURN
22050 '
23000 '--- Calc. a sample value V; assign to model variable
23010 '
23020 V=((PA-P)/(PA-PB))*(VB-VA)+VA
23030 IF K=1 THEN SP=V
23040 IF K=2 THEN UC=V
23050 IF K=3 THEN SV=V
23060 IF K=4 THEN FC=V
23070 RETURN
23080 '
31000 '--- Calc. a sample outcome and running sum for model
31010 '
31020 SO=((SP-UC)*SV)-FC
31030 OU(J)=SO:S#=S#+SO
31040 RESTORE:RETURN
31050 '
41000 '--- Sort sample outcomes in ascending order
41010 '

```

Listing 1 continued on page 181

What good then is such an approach, aside from tutorial use? The answer may be somewhat surprising unless you are already well into this subject. Simple models work remarkably well to the extent that they embody the essentials of the enterprise they represent. There are advantages to stripping away nonessentials. At the very least, the act of analysis sharpens our understanding of the venture. It reveals what weaknesses may exist in the data, which factors are most critical, and so on.

The outcome of a simulation is a way to integrate the complexity of distributed values in a model. It is a tool that helps the entrepreneur make the actual decision. That decision will weigh factors that the model did not or could not include. The user must also decide exactly what the problem is and frame the model accordingly. For example, is a product to be made in new, expanded, or shared facilities? If the latter, how will the effect of displaced products and production turnaround be handled in the model? Is the venture analyzed on its own merits or in comparison with other projects? It is clear that the real work is done both before and after the simulation. The program is just a convenient calculation tool.

Building a Model

The example we will use here is an estimate of the gain (or loss) to be expected in the production and sale of an item with a small-to-modest market. The model we will use is a simple one. Our purpose is to illustrate the technique without getting lost in the details. This will make it easier to highlight the possible weaknesses, as well as the strengths, of this approach.

As a starter, we need a model in the form of an equation that represents the venture. How do we develop such an equation? We can start at the top by noting that our objective, expected gain, can be taken as the difference between total income and total expense before taxes. Thus: Gain = Income - Expense. We proceed with our top-down design by detailing income as: Income = Selling Price \times Sales Volume, or SP*SV

Listing 1 continued:

```

41020 D=NS
41030 IF D<=1 THEN RETURN
41040 D=INT(D/2):R=NS-D:EX=0
41050 FOR I=1 TO R:DI=D+I
41060 IF OU(I)<=OU(DI) THEN GOTO 41080
41070 OT=OU(I):OU(I)=OU(DI):OU(DI)=OT:EX=1
41080 NEXT I
41090 IF EX=0 THEN GOTO 41030
41100 EX=0:GOTO 41050
41110 *
42000 *--- Avg, sum of sq devns, std devn for each run
42010 *
42020 T=NS:AV=S#/T:ST(L,0)=AV
42030 GOSUB 12000:ST(L,1)=SS#
42040 GOSUB 13000:ST(L,2)=SD
42050 S#=0:RETURN
42060 *
43000 *--- Extract and store cum. distrn in steps of 10%
43010 *
43020 PF=INT(NS/10+.5)
43030 FOR I=0 TO 10:CD(L,I)=OU(I*PF)
43040 NEXT I:CD(L,0)=OU(1)
43050 RETURN
43060 *
44000 *--- Avg and std devn over all samples and runs
44010 *
44020 S#=0:SS#=0:FOR I=1 TO NR
44030 S#=S#+ST(I,0):SS#=SS#+ST(I,1):NEXT I
44040 AV=S#/NR:AD=(SS#/(NS*NR-1))^.5
44050 RETURN
44060 *
45000 *--- Std devn of avg outcomes for NR runs
45010 *
45020 SS#=0:FOR I=1 TO NR
45030 SS#=SS#+(ST(I,0)-AV)^2:NEXT I
45040 SD=(SS#/(NR-1))^.5
45050 RETURN
45060 *
46000 *--- Final distribution in steps of 10%
46010 *
46020 FOR I=0 TO 10:S#=0
46030 FOR M=1 TO NR
46040 S#=S#+CD(M,I):NEXT M
46050 FD(I)=S#/NR:NEXT I
46060 RETURN
46070 *
51000 *--- Display statistics for NR runs
51010 *
51015 PRINT CHR$(26)
51020 PRINT"STATISTICS FOR";NR;"RUNS OF";NS;"SAMPLES EACH. SEED=";RS
51030 PRINT""
51040 PRINT"RUN          AVG OUTCOME          STD DEVN"
51050 PRINT"-----"
51060 PRINT""
51070 FOR I=1 TO NR
51080 PRINT I,ST(I,0),ST(I,2):NEXT I
51090 PRINT""
51100 PRINT"AVG=";AV,"STD DEVN=";SD
51110 PRINT""
51120 INPUT"PRESS RETURN TO CONTINUE";X%
51130 RETURN
51140 *
52000 *--- Display outcomes over all samples and runs
52010 *
52015 PRINT CHR$(26)
52020 PRINT"OUTCOMES FOR";NR*NS;"SAMPLES. SEED=";RS
52030 PRINT""
52040 PRINT"% CHANCE          OUTCOME WILL EXCEED"
52050 PRINT"-----"
52060 PRINT""
52070 FOR I=0 TO 10
52080 PRINT 100-I*10,FD(I):NEXT I
52090 PRINT""
52100 PRINT"AVG=";AV,"STD DEVN=";AD
52110 PRINT""
52120 RETURN
52130 *
62000 *--- Data statements in order as per subr. 23000
62010 *   One pair (5 proby, 5 values) for each model var.
62020 *   Change NV in subr 11000 if model in 31000 changes
62030 *
62040 DATA 1 , .90, .50, .10,0 ,          'SP proby; discount-
62050 DATA 3.00,3.40,4.20,5.00,5.40,      'ed selling price
62060 *
62070 DATA 1 , .85, .50, .15,0 ,          'UC proby.
62080 DATA 0.40,0.45,0.50,0.70,0.90,    'Unit distrn cost
62090 *
62100 DATA 1 , .85, .50 , .20 , 0 ,      'SV proby.
62110 DATA 4000,8000,12000,15000,15000, 'Sales volume

```

Listing 1 continued on page 182

Listing 1 continued:

```
62120 '  
62130 DATA 1 , .80 , .50 , .20 , 0 , 'FC proby.  
62140 DATA 14000,14000,14000,14000,14000,'Fixed cost  
62150 '  
62200 'FOR A DIFFERENT VENTURE, PROCEED AS FOLLOWS:  
62210 'REPLACE LINE 31020 WITH NEW MODEL EQUATION.  
62220 'MODIFY LINES STARTING AT 23030 ACCORDINGLY.  
62230 'MODIFY NV IN LINE 11020 IF NECESSARY.  
62240 'EDIT DATA SECTION AT 62000 FOR NEW ESTIMATES.  
62250 END
```

using BASIC notation. Likewise we can assume that: Expense = Fixed Cost + Variable Cost, or FC+VC. The latter can be expressed as: Variable Cost = Unit Cost × Sales Volume, or VC=UC*SV. Putting it all together, we have:

$$G = SP*SV - UC*SV - FC$$

Thus, the formidable phrase "formulate a model of the venture" requires nothing more than a simple equation. Some arbitrary decisions will have to be made on just what stance, variable costs versus fixed costs in a way that reflects the quantity produced rather than the quantity sold. Likewise, it may be necessary to use a fraction of the anticipated selling prices to allow

for discounts. Every venture has its own scenario. The user needs to adjust either the model or the data to allow for the specific case. This can be done in stages by continuing the top-down expansion of the model.

Constructing a Distribution

Each value that may be assigned to a variable, for example, the sales volume, has a probability of occurrence associated with it. We have seen an example of this in the game of dice where a die has possible values of one through six, each with an equal chance of occurrence. The collection of values and their associated probabilities for a given variable is called a distribution. In this case, many tosses of a single die produce a uniform distribution, since each

value has the same chance of occurring.

A more common type of distribution is represented by the heights of people. We usually find many people in the five- to six-foot range, somewhat fewer in the four- to five- or the six- to seven-foot range, and many fewer at other heights. If we tabulate and plot the count of the heights, we get something like a bell-shaped curve. This is called a normal or Gaussian distribution. There are a rather large number of different kinds of formal distributions, each with a different shape. Some of them represent actual collections of specific things quite well. The problem with formal distributions is that they require various constants to be determined and specified. It would also be necessary to select a suitable distribution and perform special calculations or transformations to use them.

We present here a simple distribution that avoids all of these complications. It will approximately fit your data, whatever it may be. To illustrate its construction and use, we will con-

Modula-2. Simply Better.

More and more software developers are finding a new language simply better than C or Pascal. They're finding

Modula-2, by Niklaus Wirth, the creator of Pascal. For professional programmers, it's simply a better language.

Modula-2. Simple like Pascal (if you know Pascal, you can be writing Modula programs in hours) but with much more power and flexibility. Power to handle any professional application, so there's no need for extensions.

Modula-2. Better than C because it gives you strong typing and superior separate compilation facilities. That means you write cleaner programs, faster.

Only LOGITECH's Modula-2/86 system translates directly into high-speed native code for PC-DOS™, MS-DOS™ and CP/M-86™.

No other system speeds your Modula programs along faster than our native code compiler. And our high-level, symbolic debugger ensures your programs arrive in flawless running condition.

Multi-level overlays, 8087 support, ROMable code, and a full library of standard modules make Modula-2/86 the perfect system for every professional application.

We also offer the only VAX/VMS™ resident and cross compiler for the 8086.

For VAX mainframes to PCs, look to LOGITECH's Modula-2 software development systems. For professional programmers, it's simply a better choice.



LOGITECH

805 Veterans Blvd., Redwood City, CA 94063
415-326-3885
LOGITECH SA (In Europe)
CH-1143 Apples, Switzerland

PC-DOS is a TM of IBM. MS-DOS is a TM of Microsoft. CP/M-86 is a TM of Digital Research. VAX/VMS is a TM of Digital Equipment Corp. 0384

GET YOUR MESSAGE THROUGH.

EVEN WHEN YOUR MODEM SENDS IT BY WAY OF THE OKEFENOKEE SWAMP.

When you send data by telephone through nasty environments like this, it can run into problems tougher than just alligators. Problems like impulse noise. Chatter from the switchgear. Static from the atmosphere or bad weather. Distortion due to crosstalk or just plain white noise.

To get your message through, your IBM PC or XT needs the advanced performance features of the PC: IntelliModem™. It's got the best receive sensitivity available today—actually down below -50 dBm. So now you can achieve a high level of data transmission integrity. Even with bad connections.

Get patented modem technology.

The PC: IntelliModem is elegantly simple. Its patented design does it all on a single microprocessor chip, with just one crystal. Other modems take

two, four or more μ Ps (and even more oscillators), and still accomplish less.

How do we do this? By creating architectural innovations in firmware, and by pushing the chip to its limit, close to 12 MHz. Since it uses fewer parts, the PC: IntelliModem's no-compromise design offers higher reliability, a more compact form factor, and lower costs.



This design elegance leads naturally to more elegant performance. Take line status detection, for example. The PC: IntelliModem's adaptive, decision-directed logic monitors line status more closely than other modems. Even at weak or degraded signal levels. So it can make connections with less chance of error, by detecting signals for dial tone, remote ringback, busy and voice—some of which other modems ignore.

Plan ahead with integrated voice and data.

For opening up a whole new world of integrated voice and data applications, there's nothing like the PC: IntelliModem. Literally. Its easy-to-use software package—PC: IntelliCom™—lets you switch repeatedly between talking or listening and sending or receiving data. All at

Make sure your modem has all these PC: IntelliModem features

Integrated Voice/Data

- Switch between voice and data communications
- Programmable telephone handset jack
- Status Reporting**
- Line status detection (dial tone, busy, remote ringback, voice answer, modem answer, incoming call)
- Audio monitor
- Programmable status LED
- PC: IntelliCom™ Software Included**
- 99-name on-line telephone directory
- Auto-dial, auto-repeat dial, auto-answer
- Link to another number if busy
- File transfer
- Data capture to diskette
- Programmable auto log-on sequences
- Compatible with Crosstalk™ and PC-Talk III™**
- Pulse and Tone Dialing**
- Receive Sensitivity: -50 dBm**
- Speeds: 110, 300, 1200 baud**

the touch of a single function key. That means now both you and your computer can talk on the same line. Without having to hang up, re-dial or plug and unplug a lot of cables.

So if you're designing microcomputer datacomm products—or just looking for a PC/XT modem for yourself, check out the PC: IntelliModem at your local dealer. You'll get the message. And so will they. Or contact: Bizcomp, 532 Weddell Drive, Sunnyvale, CA 94089; 408/745-1616.

Bizcomp: A history of innovation.

1980	Invented first command-driven modem
1981	Introduced proprietary line-status monitoring
1983	Designed first single- μ P 212A-compatible modem
1983	Introduced first integrated voice/data modem for IBM PC
1983	Granted patent on command-driven modem

BIZCOMP®
We've got people talking.

sider the number of units of a product that might be sold from a total production of 15,000 units.

Number sold	Probability	Meaning
4000	1.00	Certain to sell 4000 or more
8000	0.85	85 percent chance of 8000 or more sales
12,000	0.50	Even chance of 12,000 or more sales
15,000	0.20	20 percent chance of selling all units
15,000	0.00	No chance of sales exceeding units produced

Several points of interest should be noted. First, we start and end with two certainties, namely 100 percent and 0 percent situations. This is not at all difficult for someone who knows the business area being simulated. In our example, the user knows from experience that the established outlets will absorb at least 4000 units. The other limit of 15,000 units is also quite certain. In this example, the user has decided to accept a 20 percent risk of loss of sales in excess of 15,000 units, perhaps counting on a

second production run if all goes well. This illustrates an immediate advantage of this method of representing distributions. It naturally and easily takes care of cutoffs at both extremes, including special situations such as captive outlets and lost opportunity.

Another important feature is that the distribution is in cumulated form. This is a great advantage since other distributions must be converted to cumulative distributions before they can be used practically. A cumulative distribution in effect adds up all the chances on one side of any particular value. Instead of saying there is one chance in six of getting a four on the toss of a single die, we say there is a 50 percent chance of getting a four or higher. We can see why we need cumulative estimates in the case of a "continuous" distribution such as the number of units sold. It would be difficult to deal with the 1 out of 10,000 chance that we will sell exactly 8000 units. Much the same applies to the 35 percent chance that between 8000 and 12,000 units will be sold. It's

much easier to deal with the 85 percent chance that sales will be greater than 8000. This will become evident when we see how the actual calculations are carried out.

A close look at the estimated sales and their probabilities shows that they are not symmetrically distributed around the 50 percent (or even) chance point. This is often a problem with formal distribution functions since there are many varieties of skewed or nonsymmetric distributions. Again we have an advantage in that our estimate of the probable distribution is directly applied. Another feature is that the 50 percent estimate need not be one of the five cumulative points. The three middle estimates can be any that are suited to the data. It is not uncommon for the second and fourth estimates to be something like 95 percent and 5 percent or 90 and 10, etc. These correspond to easily visualized chances such as one out of twenty, one in ten, and so on. These might correspond to a pessimistic and optimistic estimate in addition to a more central or fifty-fifty estimate.

Sampling from the Distribution

We now have a distribution, that is, a quantitative expression of the uncertainties affecting a variable in our model of the business venture. The question is: how do we use it? In our example, the Monte Carlo method requires us to select at random one of the possible sales levels between 4000 and 15,000. The random selection must conform to the distribution, which is not uniform and for which we have only five points. The simplest method is to assume that the distribution between two successive levels or points is uniform. This allows us to obtain intermediate values by simple or linear interpolation. A plot of our sales volume distribution in figure 1 illustrates the process. If we compare the tabulated distribution with the plot in figure 1 and with the formula

$$V = (((P1-P)/(P1-P2))*(V2-V1)) + V1$$

we should be able to see how this works. Thus, using the BASIC ran-

THE SYSTEM

JOIN NOW AND SAVE!

dBase II™ **WORDSTAR™**
\$359 **\$259**
 (For SYSTEM members only) (For SYSTEM members only)

"THE SYSTEM" HAS THE NEW IBM PC JR. SOFTWARE NOW! CALL FOR OUR LOW PRICE

DO YOU QUALIFY to be a member of "the SYSTEM"?

CALL TOLL FREE NOW!...
800-421-4003
 In California call 1-800-252-4092

BY 384

THE ONE AND ONLY

CRAMBO

You've got a problem. Go to your favorite computer store. Ask to see their Combo Cards. Then ask about their RAM Cards. See the problem? Just too many to pick from. Now, ask to see the CRAMBO™. No problem. There's only one. Ours. Except you don't know what a CRAMBO is. You've probably guessed it's a Combo Card piggy backed to a RAM Card. So it only takes up one slot in your IBM/PC. That's right. But here are the details.

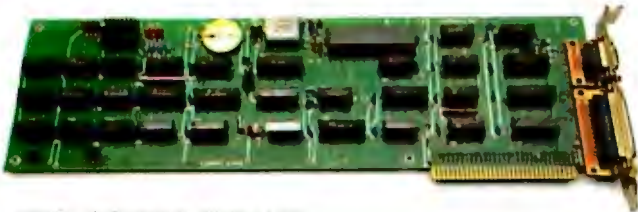

THE COMBO II CARD:

For **\$189** you'll get a Clock Calendar, Async Communications, Parallel Printer and a Game Adapter.

THE 512K RAM CARD:

It too, is only **\$189** with 64K of RAM installed. And when you need more RAM, 64K increments are available for \$64 each. And, SDRIVE, the electronic disk emulator, is available at no cost with the RAM Card.

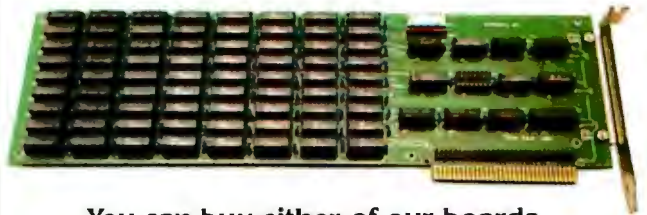

You can buy either of our boards separately for use in the XT or PC expansion chassis. But only our boards can be piggy backed to give you the one and only CRAMBO. And for only **\$359**.

Go check out the CRAMBO at the same store carrying all those Combo Cards and RAM Cards. If they don't have the CRAMBO have them call us. **800/525-7674**. Or write: Apparat, Inc. 4401 South Tamarac Parkway, Denver, Colorado 80237, 303/741-1778.

IBM PC is a registered trademark of International Business Machine Corp.

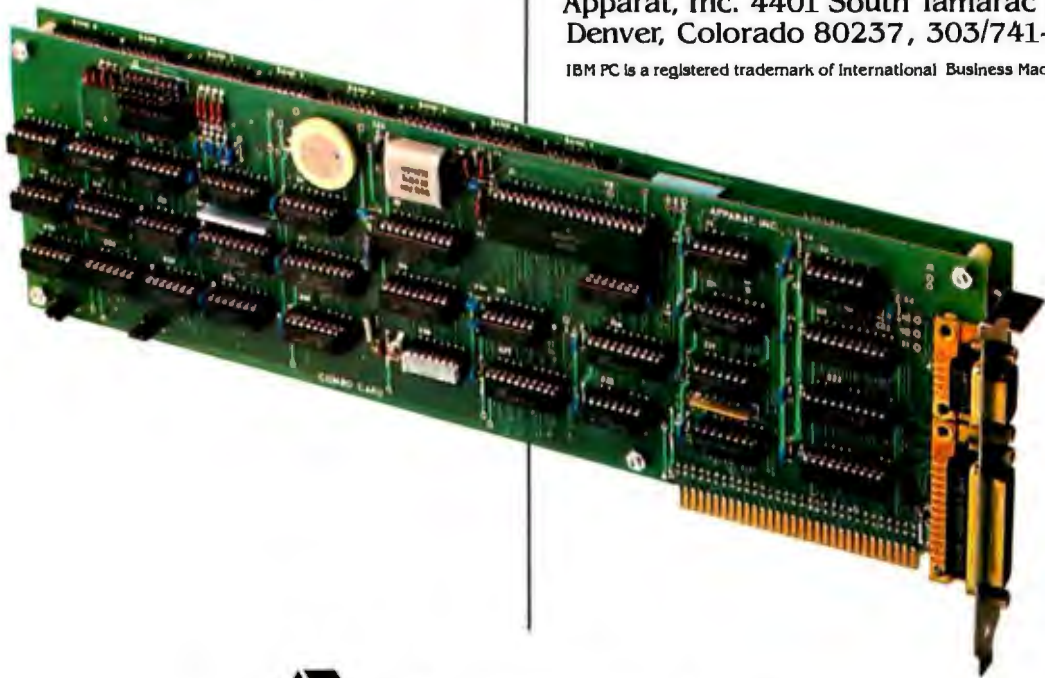

 **Apparat, Inc.**

Circle 28 on inquiry card.

APPLE

Compatible

IBM-PC

Compatible

S-100

Compatible

• DOT MATRIX PRINTERS •

Okidata		Epson	
ML-80\$279	RX-80 Call
ML-82A319	RX-80F/T Call
ML-83A619	MX-100 Call
ML-84 Par.1039	FX-80 Call
ML-92 Par.469	FX-100 Call
ML-93 Par.749		
Star Micronics			
NEW! Riteman		Gemini 10X\$299
Inforunner\$319	Gemini 15X499
NEW! Panasonic			
KX-P1090\$339	Delta 10 Call
		Radix 10 Call
Anadex		Mannesman Tally	
DP9620B\$1195	160L\$579
DP9625B1295	160L639
WP60002195	180L849
DP65002495	Spirit339
CITOH		IDS	
8510AP\$399	Prism 80\$999
1550P719	Prism 80 (color)1439
CX-4800 (color)579	Prism 1321239

• DAISYWHEEL PRINTERS •

NEC		Diablo	
2010 (Ser.)\$879	620\$998
2030 (Par.)879	630 R-1551899
2050 (IBM-PC)999	630 ECS/IBM2195
3510 (Ser.)1499	Qume	
3550 (IBM-PC)1899	11/40\$1399
7710 (Ser.)2159	11/551599
C ITOH		Silver Reed	
Starwriter\$1219	Exp 500\$669
Printmaster1569	Exp 550439

We have cables, printwheels, ribbons, paper surge protectors, and other accessories for your printer in stock at outstanding prices.

• MONITORS •

Amdek		Zenith	
300G 12" Gr.\$139	123 12" Gr.\$118
300A 12" Amber159	122 12" Amber145
310A 12" Amber169	131 Med. Res. RGB	319
Color I299	135 High Res. RGB	549
Color II+449	BMC	
Color III385	12AU 12" Gr.\$85
Panasonic		Nec	
12" Green\$169	JB1201\$159
12" Amber189	JB1205169
13" RGB399	JC1216469
Taxan		Sanyo	
KG12" Green\$169	CRT-36 12" Green	169
RGBvision 1 Color	315	CRT-7 RGB Color	Call

• MODEMS •

D.C. Hayes		Novation	
Smartmodems		D-Cat\$155
300 Baud\$219	J-Cat110.00
1200 Baud529	Apple Cat II279
1200B (IBM-PC)499	212 Smartcat429
Micromodem II269	Access 1-2-3 Call
Signalman		U.S. Robotics	
MK VIICall	Password\$359
Volksmodem59.95	AutoLink 212A465

• TERMINALS •

TeleVideo		Esprit Systems	
910\$499	Esprit\$499
914619	Esprit II549
924739	Esprit III669
925749	Esprit III (color) Call
950945	Exec 10/102 Call
9701099	Exec 10/25 Call
TeleVideo Personal Terminal			
Personal Terminal\$439		
Personal Terminal		w/300 baud Modem559
Personal Terminal		w/1200 baud Modem899
Zenith			
Z-29\$699		
ZTX-10\$339	ZTX-11\$399
Lear Seagler		Wyse	
ADM3A\$535	WY-50\$579
ADM11589	WY-100845
ADM12Call	WY-2001095
ADM36999	WY-300 Call

• CROMEMCO •

Introducing the C-10MP Package. This new system couples the popular C-10 hardware and the software developed by Cromemco with the most popular software offered by MicroPro.

Word Star - Info Star - Calc Star - Mail Merge

List Price \$2195 Our Low Price \$1975
- Other Cromemco Systems from Mini Micro Mart -

C-10 Super Pack\$1599
CS-1 with Z-80A, 64KZ, 2DS/DD 5 1/4 Drives	3389
CS-1 with DPU, 256KZ, 2DS/DD 5 1/4 Drives	4239
CS-1HD with DPU, 256KZ, 21MB hard disc	6789

We also carry the entire Cromemco line of S-100 board level products and software
 Cromix\$499 CDOS \$79

• EAGLE PC •

Simply, a better PC! 128k RAM (expandable to 512 on the main CPU board), DS/DD 320k disc drives, serial ports, 1 parallel port, MS-DOS, Eagle Calc and Eagle writer included.

The EAGLE SPIRIT portable w/10 MB hard disk is now available.

• COLUMBIA VP PORTABLE •

Featuring IBM-PC compatibility teamed with the most comprehensive software package in the industry. Includes 128k RAM, 2 5 1/4, 320k drives, and a 9 inch 80x25 display.

• SANYO MBC550 •

Not only is the Sanyo MBC550 priced less than one-third that of a comparably equipped IBM-PC. It is also less expensive than most 8 bit computer packages. Includes a 160k drive, 128k RAM, M5-DOS, WordStar and Calc Star.

• IBM-PC BOARDS •

Amdek MAI Graphics Board\$499
AST Research Six Pak Plus 64k299
AST Research Mega Plus II 256k599
AST Research Extender Card55
CCS 132 Column Super Vision Board680
Hercules Graphics Card369
Microsoft 256k RAM Board445
Microsoft 64k System Board275
Microsoft 256k System Board429
Plantronics Color Plus Call
Quad Ram Quadlink Call
Quad Ram Quadboard285
Tecmar 1st MATE Board295
Tecmar Graphics Master589
64K Memory Chip Kit (9 chips, 150 NS) Call

• S-100 BOARDS •

Advanced Digital Super 6/6mhz Board	\$759.00
Advanced Digital CP/M 3.0350.00
CompuPro CPU-Z 6mhz 2-80249.00
CompuPro CPU-8085/88359.00

We also carry S-100 boards from California Computers Systems, Dual Systems, Memory Merchants, North Star, Scion, Systems Group and many more.

• DISC DRIVES •

Rana Elite I w/controller (Apple II)\$359
Rana Elite II w/controller (Apple II)529
Rana Elite III w/controller (Apple II)649
Rana 1000 (for Atari)359
Rana 2000 (internal for IBM)249
Tandon TM-100-2 5.25 DSDD Call
Tandon TM-55-2 1/2 Height Drives Call

• HARD DISC SYSTEMS •

Tallgrass Technologies	
GMB Hardfile Disk for IBM-PC\$1895
20MB Hardfile Disk for IBM-PC2795
70MB Hardfile Disk and Tape Backup Call

Corvus Omninet

An easy, low cost way to make personal computers part of a powerful information management network.

Corvus Omninet Disc Server\$829
Corvus GMB Hard Disc1695
Mirror Card Backup for IBM-PCXT412
Corvus Print Server839
The Bank 200MB Tape Drive1895



All prices, F.O.B. shipping point, subject to change. All offers subject to withdrawal without notice. Advertised prices reflect a 2% cash discount (order prepaid prior to shipment). C.O.D. credit card orders 2% higher.

Mini Micro Mart

943 W. Genesee St. Box 2991 Syracuse, N.Y. 13220

(315) 422-4467 TWX-710-541-0431

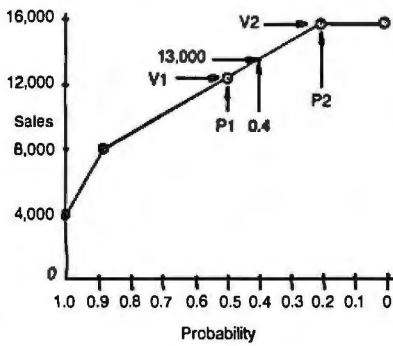

Figure 1: Sampling by interpolation. The probability of achieving a certain sales figure ranges from 1 (a certainty) to 0 (impossible). The approximate mid-range of 13,000 sales has a probability of 0.4.

dom-number generator, a random probability P between P1 and P2 selects a sales volume V between V1 and V2.

There are several ways you could arrange such tables relating possible values to their probability of occurrence. The important thing is to be consistent so that your tables, formulas, program, interpretation, and logic all hang together. In the sample venture analysis we are developing here, we will use the format of our sales volume example. The specifications for a variable are: (1) use five levels with probabilities of 1 and 0 at the extremes; (2) estimate values in terms of "equal to or greater than"; (3) always start with the estimate for which the probability equals 1. That's almost all there is to it.

We need to develop similar tables for each of the variables in the equation representing the venture. These are shown as DATA statements at the end of listing 1. The program is now ready to sample them using a succession of random numbers. Each sampled value gets plugged into the equation. This yields one possible outcome. The program does this repeatedly, saving the results in a table of outcomes for further analysis.

Note how the fixed cost, which is a constant, is represented in the DATA statement on line 62140 of the program. This wastes random numbers and running time but it simplifies programming and is very flexible. With this arrangement any variable can be treated as either a

constant or a distribution without re-programming.

Does It Really Work?

At this point you may be wondering whether we can really get away with fitting or representing the smooth curve of a distribution of expected values with straight line segments, and only four of them at that. It turns out that, in almost all cases, the use of precise distributions, or of more points, makes little significant difference in the results. This has also been my own experience with venture analysis in the chemical industry over many years.

If we think about it we can see why this is so. The most obvious consideration is that any estimate of future events is subject to error, however informed it may be. As Murphy, who by the workings of his own law must be counted an optimist, would put it, "The future is uncertain; you can count on it." There is a deeper reason, however, why this simplified approach works. It lies in the use of a distribution or spread of values. The mere fact that an informed estimator has set approximate upper and lower limits adds far more information to the simulation than any refinements in the detailed form of the distribution.

It is the introduction of distributions that transforms the formerly popular (but wrong) single-point estimates into a sound and informative analysis. This does not mean that the forecast of outcomes is necessarily correct. Even when wrong, the method provides good information on which of the variables are most important. It may show that a doubling of promotional expenses will have very little effect, whereas a 10 percent increase in inventories can turn a profit into a loss. Such a use of venture analysis is called sensitivity analysis.

A Venture-Analysis Program

Now we know how to sample a distribution by going in with a random probability P and coming out with a corresponding value V. The program shown in listing 1 implements this and does a complete risk

analysis. It embodies our specific model example. The program is easily modified for other venture analyses by simply replacing the equation, or model, in subroutine 31000. It is a no-frills program designed for ease of understanding.

The style of programming followed here consists of putting everything possible into subroutines. These are invoked by a short calling section at the start of the program.

It looks simple and that's the way it should be. We are looking at the main features of the program, avoiding all detail at this level. We see that the program starts with a specification section and ends with a sorted tabulation and display. The simulation is performed in three nested FOR...NEXT loops. The task carried out by each called subroutine is described in the remarks to the right.

Subroutines are used even if they are called only once. There are many advantages to this. Each subroutine performs a single task, which is described in its header. This makes it easy to follow the flow of the program. Another feature is that GOTOs, whether explicit or implied, never branch out of a subroutine. If such an excursion is necessary, a call is made to another subroutine. This is not a dodge since a subroutine always returns to the point immediately following its invocation. We could say that this programming style produces a bunch of grapes (GOSUBs) instead of a bowl of spaghetti (GOTOs). It is much easier to pick your way through a cluster of grapes than a tangle of spaghetti. GOTOs are used, of course, but they branch to points within their own routines. This makes it much safer to modify the program when necessary. It's about the closest approach we can make to structured programming in Microsoft BASIC.

As a further aid to understanding the program, the meaning of the program variables is shown in table 1. The Monte Carlo sampling is carried out in subroutines 21000 through 23000 and is applied to the model equation in subroutine 31000. The outcomes are stored in the array variable OU. They are converted to a

DIAMOND DELIVERS!

dBase II \$ call
 Infostar \$259
 Multiplan \$159
 Multitool Word \$249
 Wordstar/Spellstar/Star Index \$319
 Wordstar Pro Pak/Lotus 123/dBase II \$379
 dBase II/Quickcode \$1039
 \$579

	LIST	SALE		LIST	SALE
Alpha Software	\$250	\$135	Micropro	\$250	\$135
APPLE-IBM CONNECTION	\$295	\$169	MAILMERGE	\$250	\$135
DATA BASE MANAGER II			SPELLSTAR	\$250	\$135
			WORDSTAR/MAILMERGE	\$645	\$309
Ashton-Tate	\$700	\$359	PLANSTAR	\$695	\$99
dBASE-II	\$295	\$99	CALCSTAR	\$195	\$99
FRIDAY	\$650	\$125	STARBURST	\$195	\$99
			SUPERSORT II	\$200	\$99
Condor	\$150	\$99	Microsoft	\$195	\$139
CONDOR 3	\$195	\$145	MOUSE	\$100	\$69
			MULTITool FINANCIAL	\$150	\$99
Continental	\$400	\$269	MULTITool BUDGET	\$350	\$239
HOME ACCOUNTANT	\$150	\$99	PASCAL COMPILER	\$250	\$239
ULTRAFILE	\$150	\$145	FORTRAN	\$500	\$349
			C COMPILER	\$395	\$239
Digital Research	\$200	\$109	Peachtree	\$495	\$329
PASCAL MT + 86	\$150	\$44	PEACHTEXT 5000		
CONCURRENT CP/M 86	\$60	\$269	Professional Software		
C BASIC 86	\$400	\$349	WORD PLUS W/BOSS	\$125	\$85
PERSONAL BASIC	\$500	\$79		\$140	\$85
CP/M 86	\$95	call	Software Publishing	\$140	\$95
ACCESS MGR			PFS REPORT		
DISPLAY MGR			PFS FILE		
DR LOGO			PFS GRAPH		
PC DOS LANGUAGES	\$350	\$265	PFS WRITE	\$295	\$159
	\$300	\$219		\$295	\$159
Dow Jones			Sorcim		
MARKET ANALYZER	\$195	\$119	SUPERCALC 2	\$375	\$269
MARKET MANAGER	\$150	\$109	SUPERWRITER	\$250	\$169
				\$300	\$199
Financier			Visicorp	\$300	\$205
PERSONAL SERIES II	\$295	\$189	VISICORD	\$300	\$205
TAX SERIES	\$295	\$199	VISICALC IV		
	\$99	\$69	VISIFILE		
Fox & Gettel			VISITREND/PLOT		
QUICKCODE	\$295	\$189	VISISCHEDULE	\$395	\$269
GRAFOX	\$99	call			call
GRAPH			AST Research		
OUTL	\$250	\$239	6 PAK PLUS-64K	\$699	\$499
			ALL OTHER AST PRODUCTS	\$599	\$429
Howard Software					
TAX PREPARER	\$395	\$59	Hayes		
	\$100	\$249	SMARTMODEM 1200	\$680	\$489
Information Unlimited	\$400	\$99	SMARTMODEM 1200B	\$295	\$219
EWI/ESI/EMI	\$175	call		\$395	\$269
EASY SPELLER II	\$595		Quadram	\$395	\$425
EASYFILER			QUADLINK	\$595	\$269
EASYMAILER			QUADCOLOR	\$395	
ACCOUNTING SERIES	\$195	\$119	64K EXPANDABLE BOARD		
	\$225	\$139	256K		
			QUADBOARD EXP TO 384K	\$499	\$355
Lifetree					
VOLKSWRITER	\$500	\$319	Hercules		
VOLKSWRITER INTL			GRAPHICS CARD		
Micro Data Base					
KNOWLEDGEMAN	\$495	\$339			

At Diamond Software we offer the best selling business application software for your IBM PC, CP/M or Apple Computer at the lowest possible prices. And we maintain a complete technical department to assist you before, during and after your system purchase. Not only that, we offer same day shipment on most items and we accept Visa, Mastercard and also American Express. We'll even pay the shipping charges if you send us a money order, cashiers, company or personal check. Purchase orders are gladly accepted from qualified organizations and we welcome dealer inquiries. Call Diamond today, you'll be glad you did.

TO ORDER CALL TOLL-FREE 1-800-227-0545



Diamond Software Supply 484 Lake Park Ave., Suite 123 • Oakland, CA 94610

For price quotes, information, or in California call 1-415-893-7676. We credit your order for the call. Technical Department (415) 893-7678. International Telex 338139 (attn. 149)

Support, Service and Price.

Shipping/Handling UPS surface \$3.00 plus an additional \$3.00 per item for UPS Blue. C.O.D. orders add \$4.00. For personal check allow 2 weeks for delivery.

AD	Standard deviation over all samples.
AV	Average or mean.
CD	Array of cumulative distribution values.
FC	Fixed costs.
FD	Array of averages for selected cumulative distribution points.
NR	Number of runs.
NS	Number of samples per run.
NV	Number of variables in model equation.
OU	Array of outcomes for a single run.
P	Probability.
P1	Probability estimate point in a distribution.
P2	Probability estimate point in a distribution.
PA	Store of selected P1.
PB	Store of selected P2.
PF	Step increment for summary cumulative distribution.
RS	Random seed.
S#	Sum.
SD	Standard deviation.
SO	Single outcome calculated from the model equation.
SP	Selling price (effective).
SS#	Sum of squared deviations from the average.
ST	Array of run statistics.
SV	Sales volume.
UC	Unit distribution cost.
V	Sample value calculated from a distribution.
V1	Estimated value point in a distribution.
V2	Estimated value point in a distribution.
VA	Store of selected V1.
VB	Store of selected V2.
X\$	Sink for dummy read, input, etc.

Table 1: Variables used in the Monte Carlo Venture Analysis program.

cumulative distribution by a Shellsort in subroutine 41000.

All that remains after this is to display the results. We could simply list our 200 outcomes in a table with their associated probabilities. Thus, the 20th outcome in the list would represent the minimum result of 90 percent of the trials. Such a table would not be very appealing. A better solution is to show probable outcomes in steps of 10 percent.

Some Results

With our program complete, our model specified, and our estimates in hand, we can now launch our venture thousands of times and see what the future promises. A typical run of 2000 samples gives the following pro-

COHERENT™ IS SUPERIOR TO UNIX* AND IT'S AVAILABLE TODAY ON THE IBM PC.

Mark Williams Company hasn't just taken a mini-computer operating system, like UNIX, and ported it to the PC. We wrote COHERENT ourselves. We were able to bring UNIX capability to the PC with the PC in mind, making it the most efficient personal computer work station available at an unbelievable price.

For the first time you get a multi-user, multitasking operating system on your IBM PC. Because COHERENT is UNIX-compatible, UNIX software will run on the PC under COHERENT.

The software system includes a C-compiler and over 100 utilities, all for \$500. Similar environments cost thousands more.

COHERENT on the IBM PC requires a hard disk and 256K memory. It's available on the IBM XT, and Tecmar, Davong and Corvus hard disks.

Available now. For additional information, call or write,

Mark Williams Company
1430 West Wrightwood, Chicago, Illinois 60614
312/472-6659



jection. All values are rounded to the nearest \$100.

Percent Chance	of Gain Exceeding
100	-1900
90	8900
80	15,300
70	19,900
60	24,300
50	27,900
40	31,100
30	35,000
20	39,400
10	45,600
0	58,400

Not surprisingly, Monte Carlo simulation with its distributed inputs gives a corresponding spread of outcomes. The first thing we note is that there is a possibility of a small loss. If we were to plot the above results we would find the chance of a loss is about 2 percent. The traditional single-point method would ignore the possibility of loss and come up with an overestimation of the gain as a most likely \$30,400. This is very reassuring to people who like to keep their head in the sand.

We have achieved our objective of placing a probability estimate on a range of possible outcomes. Remember that we are dealing with essentially a one-shot proposition, and therefore the information in the two extremes is meaningful. If we were really dealing with the long run, then the extremes would hardly matter. We could be virtually certain of achieving something close to the long-term expectation or average of \$27,600.

In spite of all that has been and can be said, many users still feel uncomfortable with this form of analysis. The reason is a basic one. This is the human predilection for twisting the facts of uncertainty into something that seems more certain. The analyst can help here by working up the results into a form the decision maker can relate to more easily. One type of analysis that is guaranteed to spark interest is a sensitivity analysis. Simply rerun the analysis with the same random seed but with a small percentage increase in sales. Do the same for each variable in turn and show which variable is most important in affecting the outcome. In models with more variables than in

our example, such sensitivities are not always obvious.

Another possibility is to do some "what if?" simulations in which different possible estimates are used. The results can then be presented as a statement of conditions or scenarios required to avoid a loss or make a given profit. Presenting the results in the form of charts or curves can also help.

Have We Taken Enough Samples?

You may have wondered why the program carries out ten runs of 200 samples each. Why not one run of 2000 samples? By making several small runs instead of one large run we obtain information on the adequacy of our sample size. Recall that a Monte Carlo simulation is in the nature of an experiment. It does not give a precise answer even when one is possible. By examining the results of several runs we can get a measure of how well we are zeroing in.

Here's how it works for our example: the following averages are for ten runs of 200 samples each. All the figures, including the standard deviations, are supplied by the program. The standard deviation is a statistical measure of the amount of variation or spread in the data represented by an average:

Run	Average	Standard Deviation
1	28,100	14,100
2	28,000	14,000
3	28,700	13,900
4	27,400	13,200
5	26,800	14,000
6	27,600	13,200
7	26,100	12,500
8	29,000	12,700
9	28,100	13,900
10	25,900	13,200

As expected, we find a fair amount of fluctuation. What about our overall average and standard deviation? For the 2000 samples we have:

27,600 Average
13,400 Standard Deviation

We appear to have gained nothing from our ten-part breakdown. But there is more information to be squeezed from this data. Suppose we take the average of the ten averages

and, again courtesy of our program, take a standard deviation. This time it is for the average of the averages. We can do this since each average represents the same sample size. As expected, we get the same average but note the new standard deviation:

27,600 Average
1000 Standard Deviation

Statistical theory tells us that the true average has a 68 percent chance of being within one standard deviation or \$1000 of our estimated average. If we had made only one run of 2000 samples, we would have little idea of how we were doing. The large standard deviation of \$13,400 would have left us with a range of about \$14,000 to \$41,000 in which to expect the average in 2 out of 3 chances.

Note that we have given no hard criteria or explicit formula for determining an optimum or safe sample size. Experience shows that a venture analyst should have and does have a feel for what is acceptable. For example, if you had made several ten-run simulations with different sample sizes, you might have come up with:

Samples per Run	Overall Average	Overall Standard Deviation	Standard Deviation of Ten Averages
20	28,100	13,700	3300
100	27,800	13,700	1700
200	27,600	13,400	1000

In view of the approximate nature of the estimates, a sample size of 200 appears adequate. Should your model have more variables you might need to increase the sample size beyond 200. Fortunately, even fairly involved business-risk simulations need no more than five or six of their variables to be distributed. The other variables that are treatable as constants can be directly programmed as such into the model. This saves space and conserves the supply of nonrepeating pseudorandom numbers. It allows a realistic but no-frills simulation to be run on a microcomputer.

Conclusion

We have demonstrated with the aid of a simple example the nature of a

100 MHz scope, counter, timer, multimeter: All one integrated system.

100 MHz dual time base scope.

3.5 ns risetime; sweeps from 0.5 s to 5 ns/div; alternate sweep; $\pm 2\%$ vertical/horizontal accuracy; vertical sensitivity to 2 mV/div @ 90 MHz.

9-digit fluorescent display.

Digitally accurate readouts accompany the CRT waveform. Error messages and prompts also appear on the display.

Dc volts and ac coupled true RMS volts. Measured through the Ch 1 scope input.

Gated measurements. Use the scope's intensified marker to measure frequency, period, width and to count events within specified portions of the signal.

Auto-ranged, auto-averaged counter/timer.

Frequency, period, width, delay time, Δ -time, plus totalize to more than 8 million events—with 7 digits plus exponent displayed.

Auto-ranged DMM.

Use floating DMM side inputs with up to 5000-count resolution. Get precise readouts of average dc and true RMS voltage. Measure resistance from milliohms to gigohms.

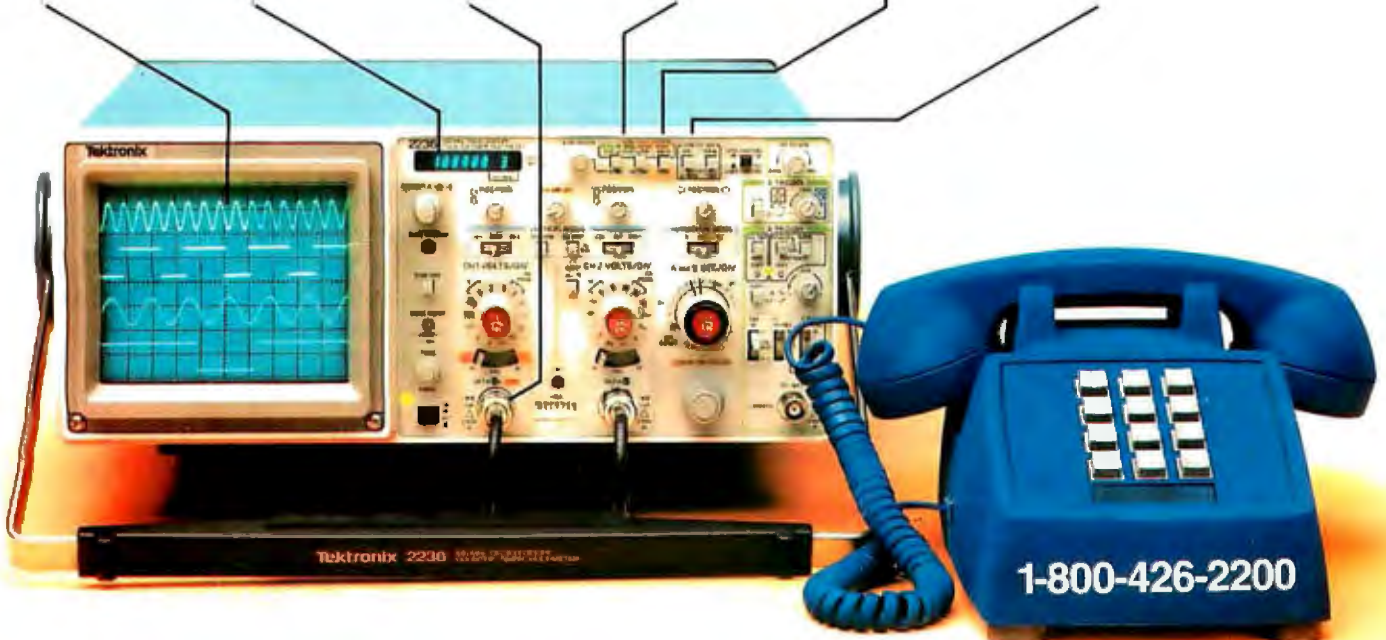

Now make measurements faster, easier, with greater accuracy and user confidence.

The Tek 2236 makes gated counter measurements, temperature, time, frequency, resistance and voltage measurements push-button easy. You see results concurrently on the 9-digit numeric readout and CRT display.

Its complete trigger system includes pushbutton trigger view, plus peak-to-peak auto, TV line, TV field, single sweep and normal modes.

At just \$2650*, the 2236 includes the industry's first 3-year warranty on all parts and labor, including the CRT.

Integrated measurement system. 3-year warranty. 15-day return policy. And expert advice. One free call gets it all! You can order, or obtain literature, through the Tek National Marketing Center. Technical personnel, expert in scope applications, can answer your questions and expedite delivery. Direct orders include operating and

service manuals and worldwide service back-up.

**Call toll-free:
1-800-426-2200,
Extension 145.**

In Oregon, call collect: (503) 627-9000, Ext. 145. Or write Tektronix, Inc. P.O. Box 1700 Beaverton, OR 97075

Tektronix®
COMMITTED TO EXCELLENCE

EMPLOYMENT OPPORTUNITIES

FLIGHT SIMULATION ENGINEERS AND MANAGERS

Join REFLECTONE In Tampa

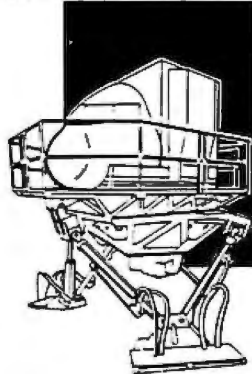

A pace-setting company in a trend-setting city

REFLECTONE, INC., is setting the pace in flight simulation technology. The expertise of our accomplished engineering team is reflected in our recent award of three major military contracts. To meet the sophisticated demands these contracts create, we're seeking highly talented flight simulation engineers/managers of all disciplines and skill levels.

Reflectone offers a small company atmosphere with large corporation advantages. As one of our valued professionals, you will enjoy the cross-discipline technical exposure and personal recognition only a small company environment can provide. Also Reflectone offers the rapid advancement opportunities and an excellent salary/benefit package found in major corporations.

Trend-setting Tampa, on Florida's scenic Gulf Coast, is yet another reason to make the REFLECTONE move. Our growing city boasts affordable housing, no state income tax, excellent schools and, of course, beautiful weather all year round with virtually endless sunshine and beaches. No wonder Tampa's been chosen the site of Superbowl XVIII and the 1984 USFL Championship game.

If you're ready to be challenged by a company whose standards are high and location is invigorating, you're ready for REFLECTONE. For confidential and immediate consideration, please send your resume to, or call collect:

Joe Ruocco
REFLECTONE, INC.
5125 Tampa West Blvd.
Tampa, FL 33614
(813) 885-7481

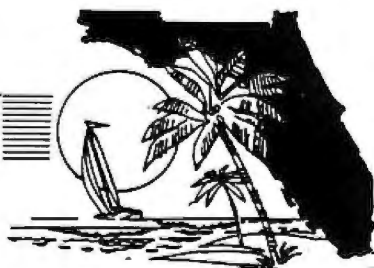

An Equal Opportunity Employer M F

Monte Carlo simulation and how it can be applied to a business venture. In particular we have seen that:

- An expert's estimates of the uncertainties of his field—sales, production, marketing, costs, timings, and trends—is valuable information. It is the raw material for risk analysis by means of Monte Carlo simulation.
- There is a very simple, practically universal technique for expressing such estimates in the form of a distribution and taking random samples from it.
- A model can be built as each situation requires by a simple top-down design method that starts broadly and gets more detailed in stages.
- We can apply simple statistics through a program to get a handle on the adequacy of our experimental (simulated) probe into possible outcomes.

This article has touched on these subjects in an introductory way. Professional risk analyses will require familiarity with the venture to be modeled. Professional programs may need to provide for things like multiple years, time value of money, and various kinds of return on investment.

A personal computer makes it convenient to include such features incrementally. The simplicity of Monte Carlo sampling allows each programming addition to be small and modular. Fast execution times are not necessary. This allows interpreter languages to be used for easy changes in models and data. The availability of state-of-the-art implementations of BASIC and APL, particularly on the IBM PC, is favorable to increased use of this form of simulation. ■

This article includes material from the author's book Learning Simulation Techniques on a Microcomputer Playing Blackjack and other Monte Carlo Games published by Tab Books.

Pat Macaluso (9 Church Ct., White Plains, NY 10603) is a consultant, teacher, and writer on microcomputers with special interests in APL and applications software development.

Announcing 4 New Collector Edition

BYTE COVERS

The 4 Byte covers shown below are the newest additions to the Collector Edition Byte Covers series. Each full color print is 11" x 14", including a 1 1/2" border, and is part of an edition strictly limited to 500 prints. Each print is a faithful reproduction of the original Byte painting, printed on museum quality acid free paper, and is personally inspected, signed and numbered by the artist, Robert Tinney. A Certificate of Authenticity accompanies each print.

Collector Edition Prints are carefully packaged flat to avoid bending, and are shipped first class within one week of receipt of order. The price of each print is \$25. All 4 prints are available as a set (Set 21-24) for only \$80.

Other Collector Edition Byte Covers are also available from Robert Tinney Graphics. For a color brochure, or to order one or more of the prints shown, please check the appropriate box in the coupon below.



#21 The Wall Street Terminal \$25



#22 "Opening Files..." \$25



#23 The Stacks \$25



#24 Inside IBM \$25

Please send me the following Prints (\$25), or Sets (\$80).

QTY.	TITLE & PRINT NO.	AMOUNT
_____	_____	\$ _____
_____	_____	\$ _____
_____	_____	\$ _____
_____	_____	\$ _____
postage & handling \$3.00 (Overseas \$8.00)		\$ _____
TOTAL		\$ _____

Please send me your color brochure.

I have enclosed check or money order.

Visa MasterCard

Card No. _____

Exp. Date: _____

SHIP MY PRINTS (OR BROCHURE) TO:

Name: _____

Address: _____

City: _____

State: _____ Zip: _____

Mail this coupon to:

robert tinney graphics
1864 N. Pamela Drive
Baton Rouge, LA
70815

FOR VISA OR MASTERCARD ORDERS
or for more information
CALL 1-504-272-7266
Daytime or Evenings

Simulation and Graphics on Microcomputers

Some graphic examples that may be worth a thousand words

by Ronald R. Miller

It is difficult to relate the output of a simulation model to the physical system it describes. Graphic representations of results can make simulations more credible and more interesting. On most large computers, however, there are software and hardware barriers between the user and graphical output. Microcomputers, on the other hand, are easy to use, and simple graphics are easy to produce without help from a programmer or systems specialist. Examples show bar charts, snapshots,

dot plots, bit density plots, and contour plots of simulation results generated using an Atari 800 microcomputer, a color television, and an Epson MX-80 printer (costing about \$600) with graphics capability. All the user must do to obtain such plots is write short programs (less than 100 statements) in BASIC.

Simulations Need Graphics

Vendors of graphics software have spent a lot of money advertising the benefits of graphics in displaying

computer output. Virtually every computer installation boasts of some graphics capability. Yet those of us who use computers and their output see very little graphics in practice. That is unfortunate because graphics is a tremendous aid in validating, verifying, and making credible simulation models.

Just how hard is it to determine whether a simulation model behaves properly? Consider the usual path (see figure 1) a model follows in going from concept to computer output.

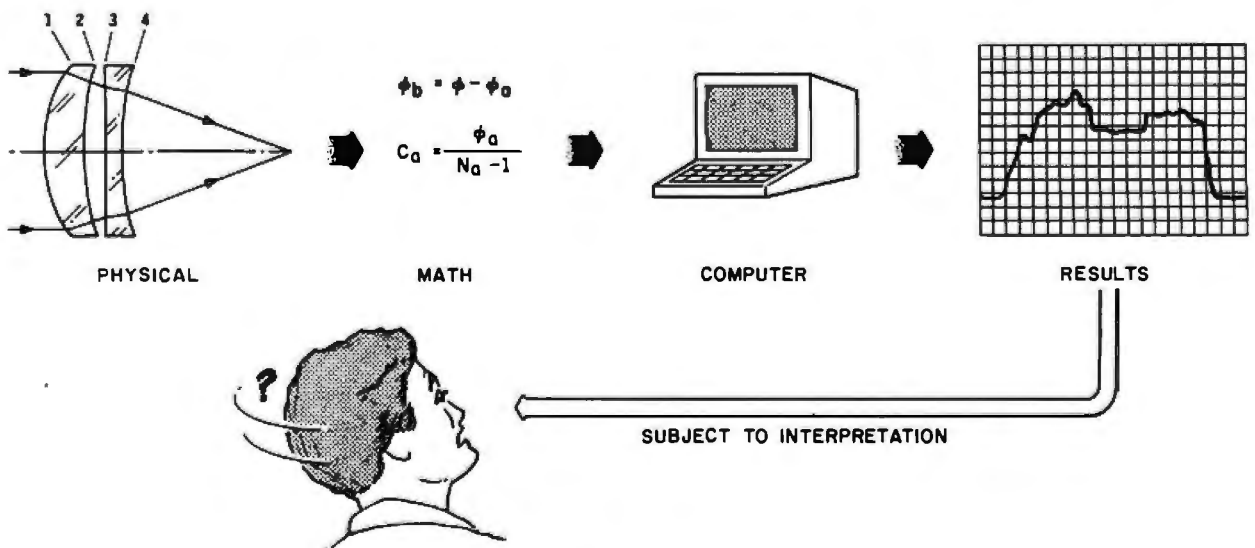

Figure 1: Distance between the simulation user and the underlying system. It is difficult to relate the result of a simulation to the physical system it describes.

Step 1 is usually the translation of the concept, say of a physical system, into a mathematical model. There are many pitfalls in this translation. It takes a mathematician of great skill to build a model of a physical system that adequately captures its essential features.

There are even more pitfalls in building computer models from mathematical models. The computer model requires a translation from traditional mathematics into numerical methods and discrete computations. Most simulation specialists are aware of the problems computers have with rounding and truncating numbers. Some are aware of the fact that computer solutions of perfectly good equations can go bad without any warning. Few simulation specialists realize, however, that a computer model of any complexity can never be fully tested. For example, each branching condition in a computer program creates two different execution paths. It is not uncommon for a small simulation program to have over 100 branching conditions. This represents a potential of two to the hundredth power or 1.27×10^{30} paths through the program. Even at today's computer speeds, one could never test every path.

Finally, there is the interpretation of model results. Each person usually has a different idea of what the results mean and whether they are valid in a particular situation. This problem is compounded by the fact that the mathematical modeler, the programmer, and the user are often different people, and each typically understands little of the others' areas of expertise. Under these conditions, believing the results of a simulation is like believing a rumor after 100 people have passed it on.

Graphics provides a window through which one can observe the behavior of a simulation. Everyone agrees that this is useful. Yet even with a lot of motivation and money, there is still not much graphics. Why? The answer is simple. Graphics is difficult to generate. The layers of hardware, software, and people between the computer and its users are a barrier that few can afford to penetrate.

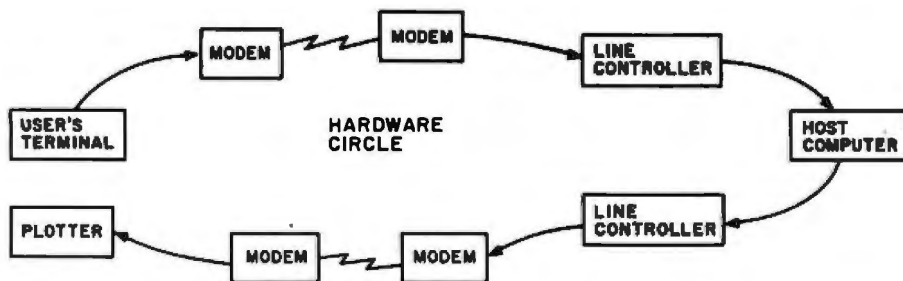

Figure 2: Layers of hardware between a computer user and a plotter. Many layers of hardware make systems inflexible and unreliable.



Figure 3: Layers of software between the user and graphical output. Lack of knowledge of software layers denies most users access to graphics.

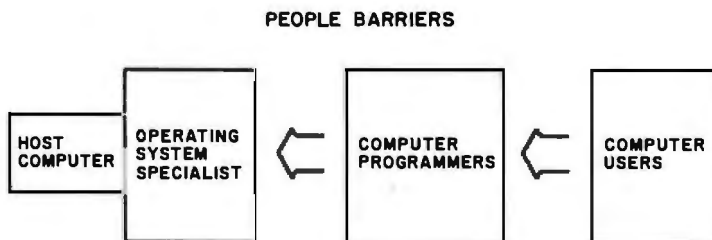

Figure 4: Layers of people between the user and the computer form a barrier. This barrier is difficult to penetrate.

Most users are not aware of how much hardware (see figure 2) there is between a computer terminal and the typical plotter. When problems occur, it is hard to determine if their source is hardware, software, or administrative (e.g., failure to activate a communications channel). When everything is working properly, the software forms the largest barrier to the computer user. For users to produce graphics on most systems, they must understand an installation's administrative procedures, operating system commands, editor commands, a programming language or the graphics vendor's software commands or both, and postprocessor commands that drive a particular graphics device (see figure 3). The 12-inch stack of documentation on the software layers forces most graphics customers to look for technical help.

The problem in finding technical help is that the user needs informa-

tion from two different groups of people (see figure 4). One group is the operating system specialists who implement an installation's administrative procedures, install software packages, and determine the source of system problems. The other group is the computer programmers who use these software packages as components in computer models. Assembling a team to implement graphics for a simulation is thus expensive. The cost and complexity limit graphics to projects that have the required time and budget.

Producing Graphics on Microcomputers is Easy

The best approach to penetrating the hardware, software, and people barriers is to eliminate them partially or completely. This is exactly what microcomputers do. The following characteristics of micros make them accessible:



Technical Information (602) 842-1133
 Call for programs not listed. We will try to meet or beat any legitimate price for CP/M or IBM PC Software. Most disk formats available.

DATA BASE MANAGEMENT SYSTEMS

UNBEATABLE PACKAGE PRICE!!
 DBASEII+Everymans database primer + Extra Diskette with Dbase Accounting, Mail list and Inventory Programs. For IBM PC and List and Inventory Programs. For IBM PC and CP/M Call for our special price.

Fox and Geller Quickcode	\$175
DB+SORT	\$89
Condor III	\$330
NWA Statpack	\$350
TIM IV	\$269
Infostar	\$259
PFS File	\$95
DBM II (ALPHA)for IBM PC	\$195
Personal Pearl	\$145
Fast Facts for IBM PC	\$135

WORD-PROCESSING

Wordstar, Mail Merge, Spellstar, Index ..	\$369
Wordstar	\$245
Mail Merge or Spell Star	\$135
Microsoft Word W/Mouse	\$295
Word Perfect	\$295
Volkswriter for IBM PC	\$115
Aspen Spellchecker	\$36
Metasoft Benchmark	\$265
Multimate	\$295
Peachtext 5000	\$219

SPREADSHEETS

Calcastar for IBM PC... \$65 ... Others	\$95
Supercalc II	\$159
Supercalc III	\$215
Microsoft Multiplan	\$159
!TK Solver	\$215

ACCOUNTING

TCS. Equivalent of Peachtree - Specially Augmented By Warehouse Software Customized For Your IBM PC Terminal and Printer - GL, AR, PA, AP, CP/M, for PC XT, DOS 1.1, 2.0
 Each Module **\$75** For All Four **\$275**

CYMA	Call
Peachtree GL, AR, AP	\$245
Home Accountant Howardsoft	\$95
MBSI	CALL

TRANSFER PROGRAMS

Move-It	\$85
Microstuff Crosstalk	\$105

Best Price in U.S. for IBM PC or Clones
 Multifunction Board—Includes Async Adapter, Parallel Adapter, Clock with Battery, Back-Up and Software, 64K Memory Expandable to 484K.
 1 year warranty **\$265** |

LANGUAGES

Lifeboat C Compiler	\$295
Microsoft C Compiler	\$335
Microsoft Pascal Compiler	\$245
Microsoft Basic Compiler	\$285
Microsoft Basic Language	\$250
CBASIC 86 for IBM PC	\$165
CBASIC CP/M-80	\$99
CB-80 Compiler	\$295

16 Pounds of IBM PC DOS Compatible Portable Computer-Hyperion-2 Disc Drives - Software.
 List 3690 **Sale \$2995** |

FOR PC DOS

Norton Utilities	\$55
Copy II PC	\$34
Prokey	\$55
Howardsoft Tax Preparer 84	\$185
Hayes 1200 Modem	\$485
Hayes 1200B Modem	\$430
Anchor Signalman 1200Baud Modem	\$285
Plantronics Color + Board	\$345
MPI 320K Disk Drives	\$215
256 K Ram Board	\$299
TAXAN RGB Hi-Res Monitor	\$450
Gemini 15X, 10x Printers	Call
Corona Computer - Port. or Desk Top	Call

TERMS: Prices include 3% cash discount. Add 3% for charge orders. Shipping on most items \$5.00.
 AZ orders +6% sales tax. Prices subject to change.

TOLL FREE ORDER LINE 1-800-421-3135
WAREHOUSE SOFTWARE
 4935 West Glendale Ave., Suite 12
 Glendale, AZ 85301

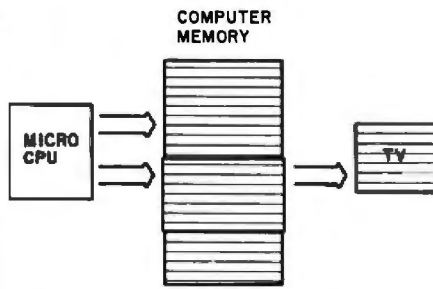

Figure 5: Microcomputer systems keep an image of the graphics screen in memory. In raster graphics the television displays a section of the computer's memory that the computer can change easily at high speed.

- Their operating systems do not require administrative procedures such as acquiring charge numbers, establishing user identification numbers, allocating disk space, or unlocking data security systems. Users just turn microcomputers on and use them.
- The operating systems are simple and easy to use. Thus the learning curve is short.
- All graphics hardware and software are integrated into one unit. This improves both reliability and reproducibility.
- Graphics is part of the built-in programming language (usually BASIC). Thus, the programmer can add graphics to his or her toolkit by simply learning a few extra statements or commands.
- Color graphics is usually built in. No additional translation process is required.
- The built-in character set is easy to change to a set that is relevant to the simulation. This allows the programmer to relate the graphics to the system being simulated.
- Built-in raster graphics makes pictures easy to change because the television picture is being redrawn many times per second. Changing a picture is fast and cheap. Animation is possible.
- The plotting capability of low-cost dot matrix printers allows one to readily obtain hard copies of the graphics screen. The user can have compact high resolution plots at the touch of a button.

The direct driving of displays (see figure 5) is what makes micros such powerful graphics machines. Direct

drive means part of the computer's memory is devoted to maintaining the display. There is a mapping of memory onto the video display. Dot matrix printers with graphics capability can also access this section of computer memory to produce a hard copy of the display. What you see on the display is what you see on the printer, dot for dot. The contents of memory can also be stored on disk or transmitted over telephone lines. This means pictures can be stored, transmitted, and retrieved just like any other data.

Micros Do Have Limitations

Micros cannot replace expensive graphics systems costing over \$20,000 because of limitations in speed, memory size, and display resolution. Typical microcomputers address between 64K bytes and 256K bytes of memory and have a maximum graphics resolution of 200 by 300 dots using one color. A typical minicomputer-based graphics system has more than two megabytes of memory and a graphics resolution of 1024 by 1024 dots using eight colors. Microcomputers have no graphics standards, and graphics is normally not transportable between micros, particularly ones from different manufacturers. Many small applications, however, do not need more capability than the micros provide and most applications require only an hour or two of programming time to produce pictures. Since the investment in programming time is small, users who switch computers are generally willing to rewrite graphics programs from scratch.

Users can learn about microcomputer graphics easily from hobby-level magazine articles and books. These articles and books give simple explanations and nice comparisons between graphics methods and systems. However, these sources do not help the user determine whether micros are suitable for a given application. The best approach is to employ common sense. Even if an application turns out to be unsuitable for microcomputers, the education gained will be valuable in software design for a larger system.

Better Business BASIC.

**Finally! A BASIC compiler
that means business.**

Microsoft® Business BASIC Compiler allows you to create professional applications for MS™DOS systems that are so fast your users will never know they were written in BASIC.

Because the compiler produces native code, your software will run three to ten times faster than the same interpreted programs.

But speed isn't everything. Microsoft's Business BASIC also has business savvy. Based on the de facto standard Microsoft BASIC, it includes a rich set of extensions:

Decimal floating point arithmetic (14-digit precision-BCD format) for extremely accurate dollars and cents calculations.

Two types of arrays provide maximum program flexibility: static arrays for speed, dynamic arrays for expandability.

Over twenty string handling functions provide sophisticated

character manipulation capabilities. Strings can be up to 32K bytes.

Multi-line functions and subprograms allow you to define routines with local or globally defined variables.

Separate module compilation means complex programs can be broken down into smaller units. Coupling multiple modules together permits creation of very large programs, up to one megabyte.

**Get the better Business BASIC.
Call 800-426-9400 to order.**

In Washington State, call 206-828-8088. Ask for operator A3 who will rush you your order, send you more information, or give you the name of your nearest dealer to see Microsoft Business BASIC in action.



Some Very Graphic Examples

The following examples demonstrate the kinds of graphics that micros can produce. One obvious application for this capability is in education where small-scale problems are studied in detail. However, any simulation that fits on a micro

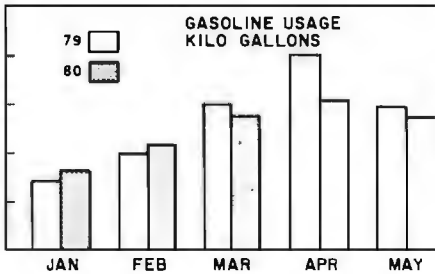

Figure 6: Bar chart representation of simulation output. Conventional bar charts can be generated easily on a video-display terminal and reproduced on a dot matrix printer.

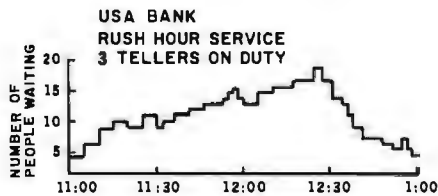

Figure 7: Time plot of the state of a queuing system. The fine resolution of the graphics screen allows compact summaries of the results of a simulation.

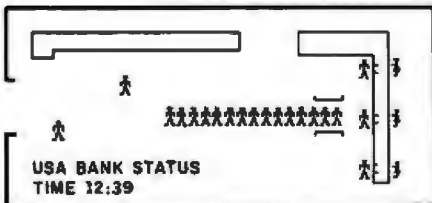

Figure 8: Graphical representation of the current state of a queuing system. The ability to redefine the computer's character set simplifies the graphic representation of objects involved in a simulation.

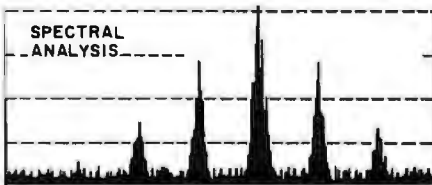

Figure 9: Dot plot representation of simulation output. The dot plot capability of dot matrix printers allows printing of simulated displays from test equipment such as a spectrum analyzer.

can use these graphic techniques.

Figure 6 shows a conventional bar chart. The resolution of this picture is 61 dots/in horizontally and 76 dots/in vertically. The maximum resolution of the printer is 120 dots/in horizontally and 216 dots/in vertically. It takes about 30 BASIC programming statements to produce this plot, representing about 30 minutes of programming effort.

Queuing problems are perfect targets for graphical output. It is much more informative to see queues evolve in time than to have only peak and average statistics as outputs. A good enhancement to the plot of

figure 7 would be to place the results of many simulation runs on the same graph. This plot was produced with about 30 BASIC statements representing about 30 minutes of programming time.

Figure 8 is a snapshot of the state of a small bank simulation. Snapshots provide information in a form that is easy to understand. Snapshots can even be changed 60 times per second to produce real-time output. The user could then watch customers arrive at the bank and be served. If the waiting line gets too long, the user can easily add another teller and rerun the simulation. This kind of

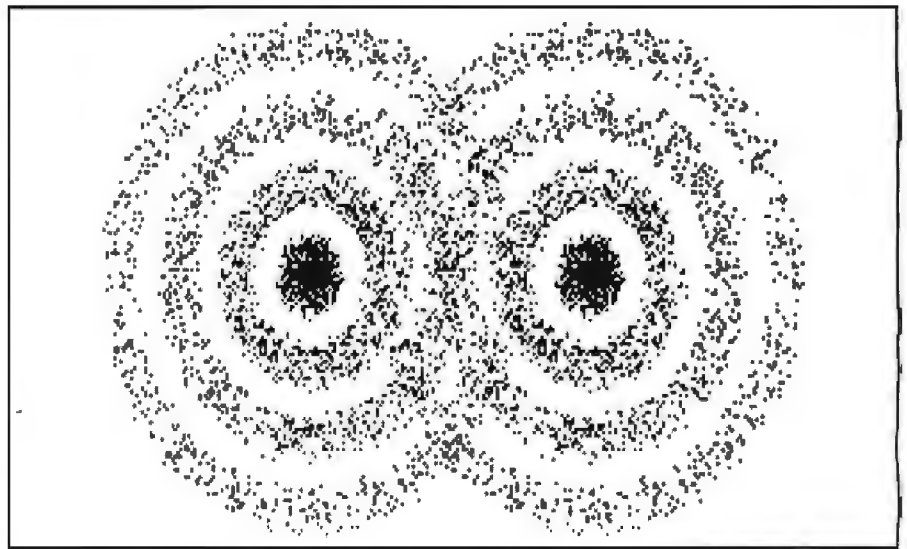

Figure 10: Bit density plot of wave propagation. Two-dimensional wave propagation can be displayed using bit density plots on a grid of over 60,000 discrete points.

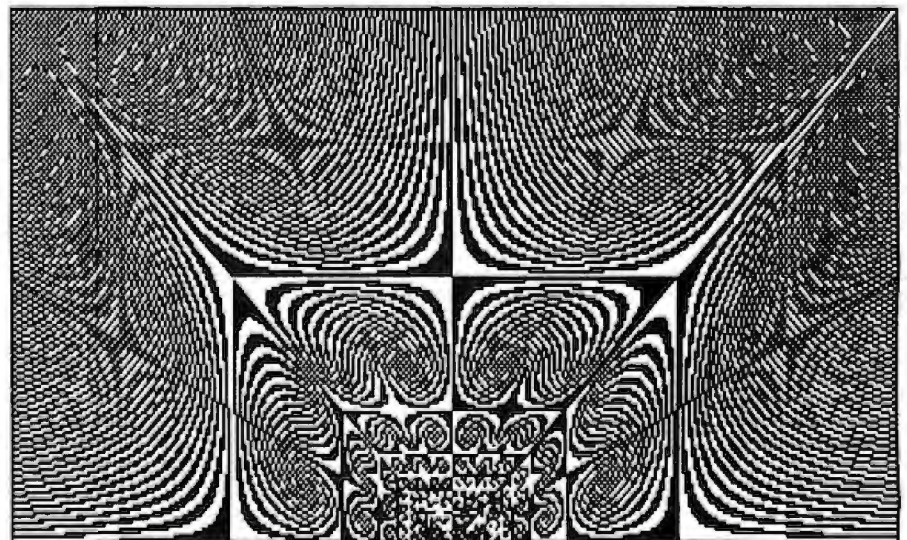

Figure 11: Contour plot using varied dot densities. Some computer output is not numerical and only has meaning when displayed graphically as in this moiré.

Capable COBOL.

For over twenty years, COBOL has proved it can handle the most awesome data handling requirements of the business world.

And Microsoft® COBOL brings this power to the MS™-DOS environment in an even more flexible version that's the ideal choice for transporting and adapting the thousands of mainframe and minicomputer programs now on the market.

Microsoft COBOL was designed after the ANSI COBOL standard. Its quality and performance has been fully certified by the GSA.

Microsoft COBOL includes a complete set of file handling facilities including support for sequential, line sequential, relative and B+ tree indexed sequential (ISAM) files.

The advanced screen handling features, compatible with Data General® make it easy to create forms and menus for interactive user programs. Direct cursor positioning, highlighting, automatic format conversion, projected fields, and automatic field skip

are just some of the capabilities.

An interactive source code debugging tool is included which allows you to step through your program in symbolic form. There is no need to wade through object code and addresses in memory to see what is going on. It's a complete development package.

Like all Microsoft Languages, the standard linking interface makes it easy to combine assembly language subroutines.

And applications developed with the compiler can be distributed without a runtime support charge.

**Get the capable COBOL.
Call 800-426-9400 to order.**

In Washington State, call 206-828-8088. Ask for operator A3 who will rush you your order, send you more information, or give you the name of your nearest dealer to see Microsoft COBOL in action.



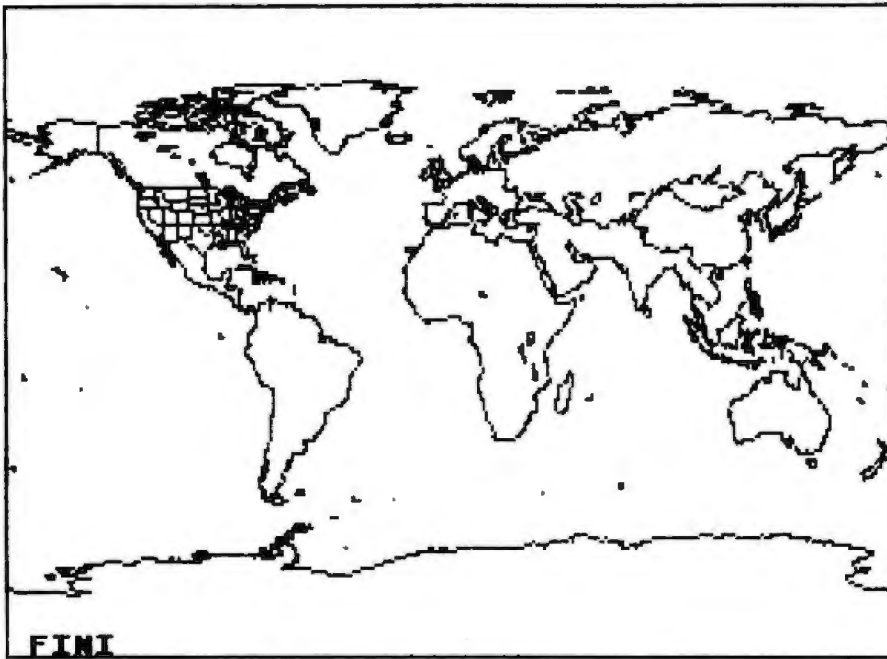

Figure 12: Cylindrical equatorial projection. Geographic maps make good backgrounds for plotting results of demographic, economic, political, or meteorological simulations.

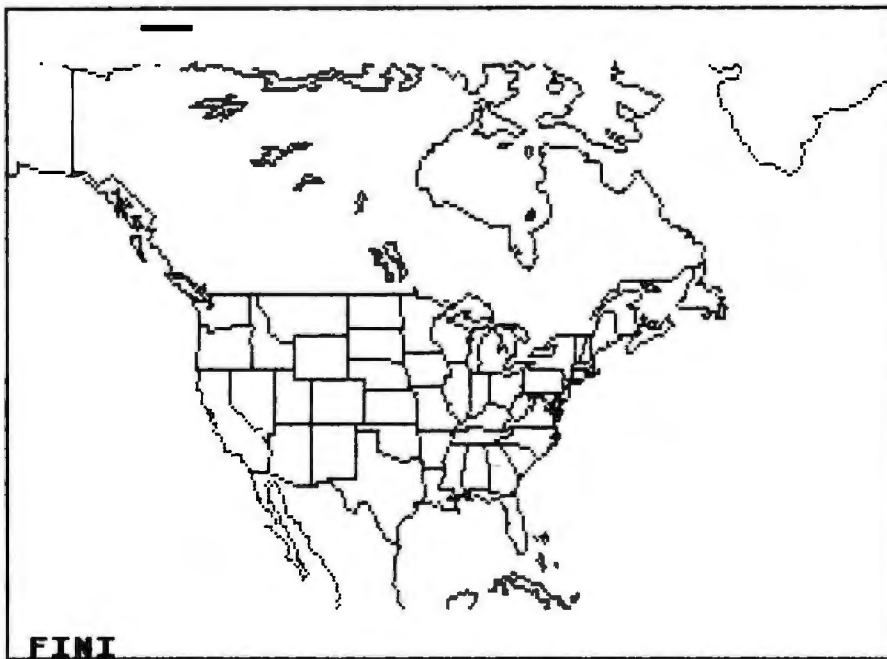

Figure 13: Cylindrical projection of North America. Geographic maps can be manipulated to produce the appropriate background for plotting simulation results.

simulation has high credibility since anyone can observe and understand the behavior of the model.

In the analysis or simulation of electronic circuits, we could present results in the form that test equipment displays would produce for real circuits. This makes it easy to compare theoretical and actual circuit performance. Figure 9 shows an example derived from a spectrum analyzer. Simulation of test equipment

displays is also useful in computer-aided instruction.

The resolution of raster displays is good enough to generate plots using dot densities to represent a third dimension. The entire plot in figure 10 was produced with the single statement PLOT X,Y. This plot is a good example of the fine resolution available on a \$600 dot matrix printer. This plot took 2 hours to generate and 45 seconds to print. One exciting idea is

to generate plots using red and blue dots and print them using color separation and color carbon paper. The plots would appear to be three-dimensional when viewed through red-green glasses.

The plot in figure 11 looks complex, but was generated by about 30 BASIC statements. It shows the effect on the eye of varying dot densities. In color, this plot is spectacular because of the blending that occurs when colors are plotted next to each other on a television. Even in black and white, one sometimes sees brown bands in the dot patterns. This kind of plot would be useful in producing contours or surface maps. It is another way to produce the illusion of three dimensions.

Figure 12 was produced with 100 BASIC statements that access a file of 8800 coordinates representing the surface of Earth. The program plotted this map in 12 minutes and printed it in 45 seconds. This program with data costs about \$21.

Figures 12 and 13 were produced by the same program. Figure 13 demonstrates zooming in on a selected part of Earth's surface. Once these maps are plotted, they can be saved on disk and used repeatedly. It takes about 60 seconds to save or retrieve a map from disk. ■

References

- Belle, R.G., N.L. Rapagnani, "Color Computer Graphics." *Aeronautics and Astronautics* (June 1981).
- Brannon, C. "Character Generation on the Atari." *Compute*. Volume 3, Number 2 (1981).
- Grappel, R.D. "Color Graphics Techniques Say It with Pictures." *EDN*. Volume 26, Number 11 (1981): 131-137.
- Inman, D. *Introduction to TRS-80 Graphics*. Forest Grove, Oregon: Dillithium Press, 1979.
- Koons, H.C. *MAPWARE*. Sunnyvale, California: Atari Program Exchange.
- Mini Micro Systems*. December 1979.
- Poole, L. et al. *Your Atari Computer: A Guide to Personal Computers*. Berkeley, California: Osborne/McGraw-Hill, 1981.
- Watson, A. III. "A Simplified Theory of Video Graphics, Part 1." *BYTE*, November 1980, page 180.

This article was reprinted from the June 1982 *Simulation*—a publication of the Society for Computer Simulation, La Jolla, CA.

Potent Pascal.

Microsoft® Pascal may be the most powerful software development environment available for the MS™ DOS system. It combines the programming advantages of a structured high-level language with the fast execution speed of native code compilation.

And it exceeds the proposed ISO and ANSI standards with logical extensions that make the language more powerful and versatile. For example, programming capabilities even allow you to manipulate data at the system and machine level.

It gives you single and double precision IEEE floating point arithmetic. Numeric operations take advantage of the 8087. Or automatic software emulation is

provided if the coprocessor is not installed.

Support for long heap allocation and separate module compilation gives you the flexibility to create large programs up to one megabyte.

And the standard linking interface makes it easy to combine Microsoft FORTRAN or assembly language subroutines.

**Get the potent Pascal.
Call 800-426-9400 to order.**

In Washington State, call 206-828-8088. Ask for operator A3 who will rush you your order, send you more information, or give you the name of your nearest dealer to see Microsoft Pascal in action.



It Reads, Writes and It Paints in 3-D, Keeps and Talks to

It's called "OPEN ACCESS," and it's the result of 60 man-years of effort to create a truly do-it-all, super-program—one that can perform virtually every task you're ever likely to encounter.

The beauty of it is, all that capability resides on a single program. You don't have to re-enter data. Or spend time trying to get unmatched programs to work together.

OPEN ACCESS takes its name from the source of its power—a relational data-base manager that gives you access to more data in more ways than any comparable software.

OPEN ACCESS includes an electronic spreadsheet, 3-D graphics, word processor, appointment scheduler and telecommunications module—all revolving around the powerful information manager.



1

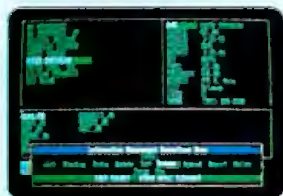

INFORMATION MANAGEMENT—THE MASTERMIND. This advanced data-base manager stores and retrieves multiple files quickly, easily and reliably. What's more, it shares all information with the other programs, so you never have to re-enter the same data

2

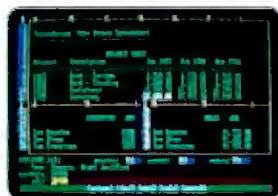

ELECTRONIC SPREADSHEET—NUMBER CRUNCHING AND GOAL SEEKING. It helps you produce forecasts, cost estimates and "break-even" points—in seconds, instead of hours or days. Best of all, it allows "goal seeking." Ask, for example, "What sales must I have the rest of the year to net \$1 million?," and OPEN ACCESS will figure it out!

3

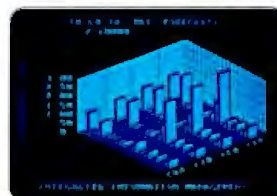

3-D GRAPHICS—NOT JUST PRETTY PICTURES. These graphics distill raw data into trends that can be instantly visualized, helping you discern the important facts from a wealth of information.

does Arithmetic. Your Appointments the World.

Because they do not have a dedicated relational data-base manager that can quickly direct massive amounts of data, other programs simply can't do what OPEN ACCESS can. Some don't have a communications program, others no dedicated word processor. None have a time management program.

There's just one conclusion: At \$595*, OPEN ACCESS can do more for you than any other comparable business program on the market. Bar none. But the only way for you to be convinced is for you to see OPEN ACCESS work its magic on your work load. So call your local software dealer today, or call us at SPI, at 619-450-1526.

*Introductory price



SOFTWARE PRODUCTS INTERNATIONAL

10240 Sorrento Valley Road
San Diego, CA 92121

4

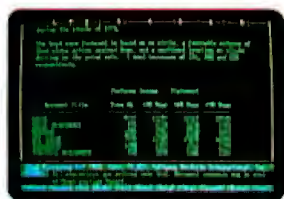

WORD PROCESSING—EDITOR
EXTRAORDINAIRE! Superior word processors make it easy to correct typos, change words, shuffle paragraphs and format documents. This is one of that breed. Use it to write efficient memos, letters, proposals and reports.

5



TELECOMMUNICATIONS—YOUR LINK WITH THE WORLD. This program gives you access to virtually any other computer system in the world. Not only can you transmit and receive reports from your colleagues, you can also subscribe to special data banks that know everything from GM's stock price to the relative humidity in Genoa. Now that's power!

6



TIME MANAGEMENT—CONSERVING YOUR MOST PRECIOUS RESOURCE. This module helps you keep track of all your appointments, hour by hour, day in and day out. It alerts you to standing obligations, automatically coordinates meeting times with other busy professionals, and lists all your associates on a Rolodex™-like file.

Going Further

A compendium of conferences, organizations, books, and software for simulationists

by Charles A. Pratt

Simulation is one of the oldest and best established applications for computers. Engineers in the aerospace field began work on simulation with analog computers in the early 1950s. As a result of this relatively long history, in computer terms, simulation has developed a body of literature and a methodology shared by few other application areas. The conferences, organizations, books, and software list that follows should get you off to a good start on the subject.

Conferences

Until recently, simulationists were just not interested in anything except very large computers, because the size of their programs was far beyond the capacity of the first microcomputers. This sentiment has changed radically in the last few years due to the increased capacity of microcomputers.

The first real sign of this acceptance was the conference called Modeling and Simulation on Microcomputers, held in San Diego by the Society for Computer Simulation (SCS) in January of 1982. Initiated by Dr. Lance A. Leventhal (at the time the technical editor for SCS's monthly journal, *Simulation*) and me to encourage communication between the experienced simulationist and people working with microcomputers, it remains the only existing conference on this specialized subject. Dr. David M. Chereb responded to the need by becoming chairman of

that first conference. At that meeting, he presented an econometric model of the U.S. that ran on a 48K-byte TRS-80. The variety of applications presented in 1982 astounded all of us. Some of those applications involved computational fluid dynamics, a model of the educational system in Mexico, a weather-impact model, a physiological model, a model of army mobilization, and robot kinematics.

The second year of the conference, 1983, continued with the presentation of several serious engineering simulations on microcomputers. Several languages specifically designed for modeling on microcomputers were introduced: Micro-Sim, Micro-Passim, Tabletop Simgscript, Tutsim, and Micro-Rsmm.

The titles of some of the papers planned for the 1984 conference further demonstrate the diversity of uses for simulation:

•Microplan: A Microcomputer-

Based Traffic Control Plan Generator

- Can an Early Retirement Incentive Program Pay for Itself?
- Transit: Route Scheduling and Performance Optimization
- Microcomputer Modeling and Simulation in Government Tax Revenue Estimation
- Microcomputer Seismic Signal Simulation
- M-CUPS: A Chemical Process Simulation Written in UCSD Pascal
- Consistency of Price Cycles in the Dow Jones Industrial Average

Two other conferences covering simulation on both microcomputers and larger machines are the Summer Computer Simulation Conference (Boston, July 23-25, 1984) and the Winter Simulation Conference (Dallas, November 28-30, 1984). Contact the Society for Computer Simulation, POB 2228, La Jolla, CA 92038, (619) 459-3888 for more information on these conferences.

Organizations

The Society for Computer Simulation is the only organization made up exclusively of people interested in computer simulation. The SCS has several active regional councils that have one or more meetings each year.

The IEEE Computer Society has a simulation technical committee that publishes the quarterly journal, *Modeling*. The society can be contacted at 1109 Spring St., Suite 300, Silver Spring, MD 20910, (301) 589-8142. The SIGSIM group (Special Interest Group—Simulation) of the Association for Computing Machinery (ACM) can be contacted at 11 W. 42nd St., New York, NY 10036, several in organization

International Association for Mathematics and Computers in Simulation (IMACS)

(has representatives in many countries)
c/o Prof. A. W. Bennett
Dept. of Electrical and Computer Engineering
Clemson University
Clemson, SC 29632
U.S.A.

Scandinavian Simulation Society (SIMS)

Technical Research Centre of Finland
VTT/Sah, 02150 Espoo, Finland

Japan Society for Simulation Technology (JSST)

c/o Dr. Michio Nakano
Dept. of Control Engineering
Tokyo Institute of Technology
4259 Gokiso-cho, Atsuta-ku, Nagatsuta-cho, Tokyo 152, Japan

Association Francaise d'Intelligence Artificielle et des Systèmes de Simulation (AFIAS)

211, Rue Saint-Honoré
75001 Paris
France

Dutch Benelux Simulation Society (DBSS)

P.O. Box 100
H. Kerckhoffs
Department of Mathematics/
Informatics
Julianalaan 132
2628 BL Delft, The Netherlands

Arbeitsgemeinschaft für Simulation (ASIM)

Prof. Dr.-Ing. W. Ameling
Lehrstuhl für Allgemeine Elektrotechnik und Datenverarbeitungssysteme
RWTH Aachen
Schinkerstrasse 2
D-5100 Aachen, West Germany

Microcomputer Software

Item Name	Brief Description	Contact	Computer	Operating System/ Other Software Required	Peripherals Required	Cost
ACES: All-Purpose Continuous Equation Simulator	Graphics solution to over 100 coupled first-order nonlinear differential equations using powerful fourth-order integration routine. Over 100-page manual.	Jay Wilson Modulo 2 Company POB 58781 Tukwila, WA 98188 (206) 271-9258	Apple II work-alike	DOS 3.3	disk drive	\$199.95
ASSE: Ada Simulation Support Environment	Package system for combined discrete-event activity scanning and process interaction (transaction flow) modeling in Ada.	Dr. Heimo H. Adelsberger Institut für Statistik Augasse 2-6 Vienna, Austria A-1090 347541, ext. 757		CP/M	64K bytes, screen, printer	\$5000
EZQ Differential Equation Solver	Solve differential, difference, and algebraic equations on an Apple II with graphical and tabular output.	Acme Software Arts Box 6126 Evanston, IL 60204 (312) 942-6412	Apple II	DOS 3.3	64K bytes of memory, one disk, printer optional	\$79.95

Table 1: The Society for Computer Simulation's latest list of simulation software available for microcomputers, originally published in the SCS journal *Simulation*. Contact the manufacturer for definitive data.

Item Name	Brief Description	Contact	Computer	Operating System/ Other Software Required	Peripherals Required	Cost
H-Champ	Helmsman's application environment software package, supporting users of hard disk, multiuser micros, and Unix minis.	Helmsman Systems Inc. Mr. Silverstein 1030 S. Winchester #205 San Jose, CA 95128 (408) 246-8300	Z80, 8080, 8085, 8088, 8086, 68000, Z8000, etc.	CP/M 8-bit, CP/M 16-bit, MS-DOS 2.0, and Unix		\$695
ISG: Interactive Scientific Graphics	Package of UCSD Pascal procedures, with interactive features, plots sets of functions with full labeling.	Thomas H. Bleakney 18537 Arrow Hwy. Suite D-105 Covina, CA 91722 (213) 339-8716	Apple II, II Plus	Pascal 1.1	language card or other 16K- byte RAM card	\$95
ISL-Apple	Ideal for educators. Solves nonlinear differential equations up to 10 times faster than Apple BASIC. Uses game paddles and graphics.	R. D. Benham 5312 W. Tucannon Kennewick, WA 99336 (509) 783-3829	Any Apple II with 48K bytes of memory	Apple DOS version 3.3	disk drive	available upon request
m-CPS: Chemical Process Simulation	m-CPS is a hydrocarbon simulation using the SRK equation of state. Includes a database of over 60 compounds. Free format input file.	Ofelt and Associates 8007 Oak Moss Dr. Spring, TX 77379 (713) 376-3614	Apple II Plus/IIe, 64K	Pascal	two disk drives, op- tional printer	\$250
Micro-Dynamo System Dynamics Modeling Language	Micro-Dynamo compiles and simulates complex models of cause-and-effect relationships over time. It lets you create your model and specify what variables are printed and plotted—without complicated format statements. Interprets model internally to produce both tabular and plotted results.	Software Sales Addison-Wesley Publish- ing Company Inc. Jacob Way Reading, MA 01867 (617) 944-3700	Apple II, IBM PC	Pascal operating system	two disk drives, color or b/w monitor, printer recommended	\$245
Micronet	A network-based discrete-event language that operates as a simulation system for microcomputers.	Pritsker & Associates Inc. POB 2413 A West Lafayette, IN 47906 (317) 463-5557	Apple II Plus, Apple IIe, IBM PC, IBM PC XT	various		\$2500
Micro-Passim	A simulation support package for combined discrete-event and continuous models in UCSD Pascal. Both process interaction and event scheduling world views are implemented. Example models included in the documentation.	Dr. Claude C. Barnett Physics Dept. Walla Walla College College Place, WA 99324 (509) 527-2881	Apple II and III, PDP 11/23, IBM PC, etc.	UCSD Pascal	disk drive	\$125

Item Name	Brief Description	Contact	Computer	Operating System/ Other Software Required	Peripherals Required	Cost
Micro-Sim	Simulation package for simulating queuing networks. Has graphics and is interactive.	Stewart Hoover 36 Evergreen Rd. Sudbury, MA 01776 (617) 443-9023	Terak, Apple	UCSD Pascal	some graphics capability	\$50
Scheduling Simulator	A system especially designed to simulate the orders being processed in a job shop environment such that trial schedules may be run and analyzed.	Lionel Poizner 81 Millwick Dr. Weston, Ontario Canada M9L 2R4 (416) 781-F.A.S.T.	Apple II and other such microcomputers	DOS 3.3	four disk drives, printer	\$535
SIMAN simulation package	General-purpose simulation language with special manufacturing systems features. Three modeling orientations available, graphical and statistical output.	Dennis Pegden System Modeling Corporation 226 Highland Ave. Suite B State College, PA 16801 (814) 238-5919	MS-DOS micro-computers	Standard FORTRAN	190K bytes of RAM	\$900
Sim-By-Int	"Simulation-By-Interview" . . . Program examples of code for user-interactive definitions of dynamic systems.	G. R. Marr Jr. POB 143 Little Silver, NJ 07739 (201) 747-2606	various	CP/M, UCSD Pascal, dBASE II	KB/CRT/printer	\$5
Simsript 11.5	Language for computer modeling.	C.A.C.I. 12011 San Vicente Blvd. Los Angeles, CA 90049 (213) 476-6511	IBM PC			
SMP: System Modeling Program	A continuous-time system simulation language with direct equation input for the Apple computer.	Dr. Steven E. Reyer 8664 N. Pelham Pkwy. Bayside, WI 53217 (414) 351-2087	Apple II Plus, 48K	DOS 3.3	optional printer	
TDKIN: Three-Dimensional Kinematics	Computer program that assembles and solves the equations resulting in the solution of kinematics of three-dimensional mechanisms.	Harry W. Townes 514 North 10th Ave. Bozeman, MT 59715 (406) 994-6297	Microcomputers or mainframes written in FORTRAN 66	FORTRAN compiler or CP/M	optional printer	variable; depends on purchase of source code or CP/M relocatable files
Transit	Estimates and traces future performance of transport systems.	Y. J. Stephanedes 500 Pillsbury Dr. SE Minneapolis, MN 55455	IBM PC, Apple II	UCSD Pascal	screen for graphics	\$100
Tutsim	Interactive simulation program for continuous dynamic systems on mini- and micro-computer systems with block diagram and bondgraph model input.	Applied i 200 California Ave. Palo Alto, CA 94306 (415) 325-4800	Apple, CP/M-based, PDP-11, LSI-11, IBM PC	variable according to computer used	graphical output	\$350- \$2000

**LOOK NO FURTHER!
we'll get you low
prices and fast
service, or else!**



ALPHA OMEGA

COMPUTER PRODUCTS

COMPUTERS

CORONA Desktop, 128K, 2-320K Drives, Monitor	\$2645
CORONA Portable (same as above)	2625
ROMAR 64K Apple compatible	SAVE
IBM PC Systems	SAVE
KAYPRO II Portable	SAVE

DISKETTES

SCOTCH 3M SSDD	\$23
MAXELL MD2 DSDD	39

PRINTERS

C. ITOH 8510 P. 120 cps	SAVE
EPSON FX80 160 cps	SAVE
EPSON FX100 160 cps	SAVE
OKIDATA Microline 92 160 cps	469
OKIDATA Microline 84 200 cps	1035
DELTA 10 160 cps	SAVE
GEMINI 10X 120 cps	279
NEC 3550 35 cps L/Q	SAVE
JUKI L/Q 18 cps	489
DYNAX DX15 L/Q 13 cps	475
PRINTER Pal	24

MODEMS

HAYES Smartmodem 300	\$205
HAYES Smartmodem 1200	489
HAYES Smartmodem 1200B	442
HAYES Micromodem II	265
ANCHOR A. Mark I	81

MONITORS

TAXAN 12" Amber	\$125
GORILLA 12" Green	85
USI P13 12" Amber	145
AMDEK 300G 12" Green	135
AMDEK 300A 12" Amber	145
AMDEK Color I 13"	269
AMDEK Color II 13" RGB	419
BMC 13" Color	219

APPLE PERIPHERALS & SOFTWARE

VIDEX Videoterm 80C	\$219
VIDEX Ultraterm	279
MICROSOFT 16K RAMcard	69
MICROSOFT 280 Softcard	245
MICROSOFT Premium Pack	479
MICROSOFT Premium Softcard IIE	345
KRAFT & TG Joystick	45

HAYES Mach II Joystick	33
QUENTIN Applemate Drives	233
LAZER 1/2 Height Drives	229
WIZARD BPO 16K Buffer Int.	139
PROMETHIUS Versacard	149
EPS Keyboard	289
KENSINGTON Systemsaver	68
KOALA Pad	93
PFS Filing System	86
PFS Report	86
DBase II	389
Wordstar	249
Home Accountant	65
Multiplan	172
DB Master Version 4	249
DB Utility 1 or 2	95
Magic Window II	109
Zaxxon	29
Chopfliter	25
Zork I/II/III	28
Wizardry	39
Sublogic Pinball	27

IBM PERIPHERALS & SOFTWARE

TANDON TM55-2 Thin Line	\$235
TANDON TM100-2	235
SHUGART 1/2 Height	235
MICROSOFT Mouse	145
QUADRAM Quadboard w/64K	269
QUADRAM Quadlink	SAVE
QUADRAM Quadcolor I	215
64K RAM Kit 200 ns	55
KRAFT & TG Joysticks	46
HAYES Mach II Joystick	35
CORONA Int. 5MB Hard Disk	1545
Property Management	335
Home Accountant +	99
Volkswriter	119
PFS Filing System	93
PFS Report	86
Lotus 1,2,3	SAVE
DBase II	389
Friday	189
Wordstar	279
Multiplan	169
Flight Simulator	33
Deadline	38
Zork I/II/III	28

Hundreds of available items. Call for complete pricing information.

We do not charge for VISA or MASTERCARD.

(818) 345-4422



18612 Ventura Blvd., Tarzana, CA 91356

All products are in factory sealed packages. We guarantee all items for 30 days. Within this period, defective merchandise returns must be accompanied by RMA number. All other returns will be subject to a 10% restocking fee. For prepaid orders there will be a 3% shipping charge; 5% for UPS Blue Label; \$5.00 minimum; all orders outside U.S. at 15% shipping. There will be an additional \$4.00 surcharge on C.O.D. orders. Cash or Cashiers Check is required on C.O.D. orders. Calif. residents add 6.5% sales tax. Prices subject to change without notice.

Books

Although many good books on simulation are available, few cover microcomputers. Tab Books Inc. (Blue Ridge Summit, PA) published two in 1983 that can be very helpful. A good introduction is *Learning Simulation Techniques on a Microcomputer Playing Blackjack & Other Monte Carlo Games* by Pat Macaluso, for \$10.95. It covers a good deal of the terminology and concepts used in designing models. The title may mislead you; blackjack is used as an example, but the other program is a simulation that can be applied to business ventures. (See Mr. Macaluso's article on page 179.) The other Tab Book, *Forecasting on Your Microcomputer* by Daniel B. Nickell (\$14.95), concentrates on forecasting and uses modeling as one of several techniques. A chapter on the mathematical principles involved is written in a way that makes them clear even to the reader without a mathematical background.

science and can start the beginner on an established methodology.

A list of books in this specialty would be incomplete without mentioning the publications that result each year from the SCS conference mentioned above. Both the conference and the books are titled *Modeling and Simulation on Microcomputers*. A new book is published each year and is available for \$20 from the Society for Computer Simulation. Each contains a description of a variety of models, usually without code. ■

Charles Pratt has served as executive director of the Society for Computer Simulation (POB 2228, La Jolla, CA 92038) since August of 1980. He has a bachelor's degree in economics from Guilford College in North Carolina.

One of Japan's leaders would like to go to work for you.



Fujitsu, Japan's largest computer company, sends you their best. The new Micro 16s personal business computer. A combination of thoughtful planning, innovative thinking and quality craftsmanship. Just what you'd expect from a Japanese company that's been making computers for three decades.

The Micro 16s is a complete computer system. The options of other computers are our standards. For example, its price includes the CP/M-86[®] operating system, SuperCalc^{2™} electronic spreadsheet, WordStar[®] word processing, a high resolution color graphics monitor, and two microprocessors, the Z80[®]A 8-bit and 8086 16-bit.

The Micro 16s will run any of the more than 3,000 CP/M[®] software programs on the market today. Optional operating systems for the Micro 16s include MS[™]-DOS and the

multi-tasking Concurrent CP/M-86[™].

The Micro 16s also comes with a detachable keyboard, dual built-in 5¼" floppy disk drives, 128 kilobytes of internal memory expandable to over one megabyte, and expansion slots for future growth.

The unique and flexible design of the Micro 16s makes it easy to add advanced microprocessors of tomorrow, hard disks, mainframe communications or local area networking when the time is right.

Put a Japanese leader to work for you. Fujitsu's Micro 16s. For more information or the name of your nearest dealer call toll free 1-800-MICRO 16. Or write Fujitsu Microelectronics, Inc., Professional Microsystems Division, 3320 Scott Blvd., Santa Clara, CA 95051.

FUJITSU

Fujitsu's Micro 16s.™

SuperCalc™ is a trademark of Sorcim Corp. WordStar® is a trademark of MicroPro International. CP/M-86® and Concurrent CP/M-86™ are trademarks of Digital Research, Inc. MS™ is a trademark of Microsoft® Z80® is a trademark of Zilog, Inc.

You're traveling through 140°



DISK

terrain at 300 rpm.

**Only one disk
guarantees safe passage
through the torrid zone
of drive heat.**

Maxell.

A lifetime warranty. And manufacturing standards that make it almost unnecessary. Today and in the long run, you'll be glad you chose Maxell.

Consider this: Every time you take your disk for a little spin, you expose it to hazardous drive conditions. Temperature build-up can sidetrack data. Worse, take it to the point of no return. Maxell's unique jacket construction defies heat of 140°F. And keeps your information on track.

And Maxell runs clean. A unique process impregnates lubricants throughout the oxide layer. Extending media and head life. How good is Gold? Maxell's the disk that many drive manufacturers trust to put new equipment through its paces. It's that bug-free.

So you can drive a bargain. But in accelerated tests, Maxell floppys lead the industry in error-free performance and durability. Proving that if you can't stand the heat you don't stand a chance.



maxell®

IT'S WORTH IT.

Maxell Corporation of America
60 Oxford Drive, Moonachie, N.J. 07074
201-440-8020

Circle 223 on inquiry card.



Blow 'em to Smithereens!

Old Ironsides™ is a registered trademark of Optimum Resource, Inc. Apple and Apple II, II+, IIe and III are registered trademarks of Apple Computer, Inc. A/M33-14

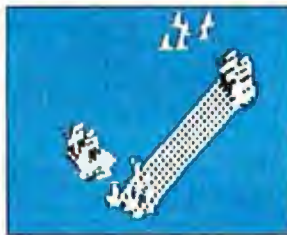

You're at the helm of the awesome warship — *Old Ironsides*™. Your arch enemy is armed to the teeth with deadly firepower! The fate of 100 crew members is in your hands. Any miscalculation in strategy or tactics and your bloodthirsty opponent could blast you out of the water!

Use paddles or keyboard to play this NEW two-player game. *Special Freeze Frame feature stops and starts the action at any point.* Developed by Optimum Resource, Inc. by Richard Hefter and Jack Rice.

Apple II or Apple II+ with 48K and one disk drive, 3.3 DOS; and Apple IIe or Apple III.

Look for *Old Ironsides* in finer computer stores everywhere. Or, order by calling toll-free 1-800-852-5000, Dept. AD-4. Only \$39.95 each.

Certificate of Merit For Outstanding Achievement

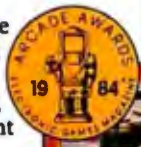

Old Ironsides™
Weekly Reader
Family Software

A division of Xerox Education Publications
 Middletown, CT 06457



Reviewer's Notebook

by Rich Malloy

The really big item this month is the Tandy TRS-80 Model 2000, which is described in an article on page 306 of this issue. From the brief experience I've had with the 2000, I have been much impressed. Let's hope that Radio Shack makes available a good technical reference manual so that the hackers can turn it into an even better machine.

Wang's Professional

Lately, we've received a few systems that are obviously not meant for hackers. Most prominent among them is a hard-disk version of the Wang Professional Computer (see Elaine Long's review of the floppy-disk version on page 360 of the December 1983 BYTE). This is a fairly well designed system. In fact, I used it to write this month's column, but not without some difficulty. This machine takes some getting used to. The keyboard, in particular, has a touch that is a little too light. Also, it's hard to make the machine work correctly with a non-Wang printer. But overall the system is pretty good.

I particularly like the monitor support arm, which allows the monitor to hover a few inches over your desk. This should be great for people like me whose desks are already covered with a few inches of various materials.

Again, although it is a fairly powerful machine (it has an 8-MHz 8086 microprocessor), the Wang PC is not meant for hackers. It is clearly designed for the office. And although it is disk-compatible with the IBM PC, you will probably have to buy all your software and accessories from Wang itself. The software selection is of good quality. We have Multiplan, 1-2-3, TK Solver, and version 2.0 of Wang's word processor, which is supposed to be identical to Wang's

dedicated word processors. But the number of packages available is rather small. Also, the user-friendly menu system that leads you through MS-DOS version 2.0 can drive experienced computerists batty. The Wang PC is probably a good machine for your cousin the lawyer.

DEC's Rainbow

In response to a previous column, Digital Equipment Corporation has sent us a new version of its Rainbow, this one called the Rainbow 100 Plus. I can tell because it came with a little plastic sticker saying "100 Plus" that we're supposed to stick onto the front of the machine.

Also, we've finally received a copy of MS-DOS for the Rainbow, with a Format program included. Now we can format our own disks, but few other MS-DOS machines can read them. The Rainbow uses single-sided, quad-density disks. Fortunately, the Rainbow can read other MS-DOS disks, but only if they're single-sided. And in my experience, it can't read all the files on a single-sided PC-DOS disk all the time.

As for software compatibility, this machine cannot run many of the IBM PC programs. You will probably have to buy most of your software from DEC. And as for expansion slots, after you install a hard-disk drive, some extra memory, and a color graphics board, there are no slots left.

The Rainbow is a slick, good-looking office computer with a number of nice features. But, like the Wang PC, this is not a hacker's machine. In time, however, the Rainbow will probably evolve into a very impressive system.

The Compaq Plus

Another recent entry into our computer room is the Compaq Plus, the

10-megabyte version of the original IBM PC clone. This machine sports a 3½-inch hard disk, which reportedly is surrounded by a sizable cushioning system. This, too, is an office machine, but it is built to travel.

Unlike the Wang and the Rainbow, the Compaq should have no problems with any IBM PC software. The Compaq has traditionally scored very high in most IBM PC-compatibility tests, and at \$4995 it represents a serious alternative to the IBM PC XT.

The Tava

We also received the Tava computer, another IBM PC clone, but with Asian roots. The Tava has been raising a few eyebrows by advertising a price of \$995. But before you sell your shares of Big Blue, you should note that that price doesn't include any disk drives or a monitor. Two double-sided disk drives with a controller will set you back an additional \$670.

As for performance, our Tava was not completely without problems. First, we couldn't get it to turn on because its fan was stuck. Then we didn't have an operating system, or a serial port or parallel port for that matter. We tried PC-DOS, and most IBM programs ran without a problem. Some programs, however, didn't recognize the Tava's color graphics adapter as a bona fide board. Tava sent us a parallel port (just a connector that plugs into the motherboard), and the serial ports (there are two) should arrive any day.

I really like the Tava's documentation—a single piece of paper saying, in effect, that you should insert a disk into one of the drives and turn the machine on. ■

Rich Malloy is BYTE's product-review editor.

Compupro's System 816/C and System 68K—the Two and Only

Take a look at Compupro's new reversibles—they're 8085/8088 on one side and 68000 on the other

by Ed Teja

Compupro's two new computer systems, the System 816/C and the System 68K, are based on the same S-100 bus enclosure, and they both use the same memory and I/O (input/output) boards. When loaded with the same options, they differ only in their microprocessors. The System 816/C uses an 8-bit, 6-MHz 8085 microprocessor and a 16-bit, 8-MHz 8088 microprocessor. The System 68K, on the other hand, uses a 16-bit, 4- or 8-MHz 68000 microprocessor. The systems come with different versions of CP/M.

Both systems feature two solidly built metal enclosures, the Desktop Enclosure 2 and the disk-drive enclosure. The Desktop Enclosure 2 houses a 20-slot motherboard, the central processing unit, memory, I/O boards, a constant-voltage power supply, a line filter, and a large fan. The disk enclosure contains the disk drives

and another fan. Photos 1 and 2 show the front and back of the enclosures, respectively.

Each system costs \$8995—not expensive as business systems go, but definitely not economical enough for most hobbyists. Besides the hardware and software, though, you also get repair service under Xerox's Americare program. This program gives you free on-site service for one year if you are within a 100-mile radius of one of Xerox's 82 service centers. Outside that radius, you either pay a service charge for on-site work or you can take the system into a service center. This bundled-in service program beats any other available form of technical support hands down and makes the package a better risk for businesses. That is, it's a better risk if these are the right computers. Let's take a closer look at the machines and see.



Photo 1: The front of Compupro's System 816/C computer. The System 68K looks the same. (All photos were taken by Carey Hillhouse.)

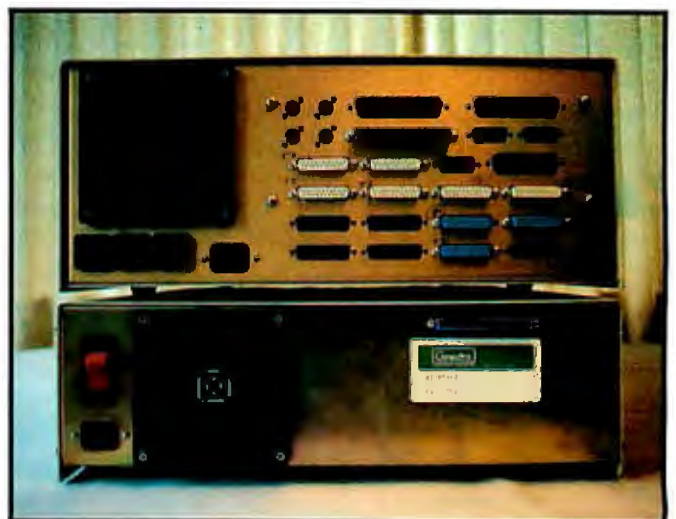

Photo 2: The rear of the System 816/C. The system operator (user 0) plugs into the bottom right connector. The wide connector at the top center connects to the disk drives.

System 816/C Hardware

The heart of the System 816/C is the 8085/8088 central processing unit, shown in photo 3. This board allows the computer to run either 8-bit or 16-bit CP/M programs at high execution speeds.

Most of the System 816/C's I/O functions are handled by the System Support 1 and Interfacer 3 boards. The System Support 1 board provides an RS-232C port and most of the I/O support features, such as the clock/calendar, dual-interrupt controllers, and triple interrupt timers. The Interfacer 3 board furnishes eight fully programmable asynchronous serial channels to which the user's terminals are connected. The System 816/C comes configured to support three users; however, you can expand it to handle 15 users. There are two parallel ports: one handles the endless variety of Centronics/Epson-type printers, while the other is an untyped port to use as you will.

The system comes with 512K bytes of CMOS (complementary metal oxide semiconductor) RAM (random-access read/write memory) dwelling on two of Compu-pro's RAM 22 cards. These cards act as a byte-wide memory for 8-bit systems and then switch automatically to a word-wide configuration for 16-bit operation by reading the state of the SXTRQ signal on the S-100 bus. A single DIP (dual in-line package) switch assigns each memory board a starting address that is a multiple of 256K bytes, within the 16 megabyte address space specified by the IEEE-696 standard. If you want to add memory, simply buy additional RAM 22 cards (\$2495 each), set the switch, and plug the boards in. You don't have to reconfigure the system—an autoconfiguration routine takes care of that.

Compupro designed its RAM 22 cards especially for use with 8086/8088 processors at speeds exceeding 10 MHz. In particular, the RAM 22 is suitable for DMA (direct memory access) operations. DMA is critical in multiuser systems, because you can't expect a processor

to handle multiple users and I/O as well.

For more permanent storage, the System 816/C comes with two 8-inch, double-sided, double-density floppy disks in a separate cabinet. The system I used came with Qume Trak 842 drives. Together, the floppy disks give you 2.4 megabytes of storage, formatted in 1024-byte sectors. These drives also read single-sided, single-density disks.

Compupro's Disk 1 board handles the disk operations and houses the phantom boot EPROM (erasable programmable read-only memory) that can handle eight different processors or boot routines. The board furnishes fully arbitrated DMA data transfers that can cross 64K-byte boundaries.

An Intel 8272 floppy-disk-controller chip is the heart of the disk-controller board. According to the manual, this lets the controller format disks with a true IBM 3740/System 34 disk format. But this presents a problem if you try to use the controller with a disk that was formatted using a 1791 disk-controller chip, because the 1791 inserts a byte of zeros immediately after the header CRC (cyclic redundancy check) bytes. The zeros can confuse the 8272. I didn't have a 1791-formatted disk with which to test this, and it isn't clear what the confusion ultimately does. But this could lead to some interesting service calls for the Americare folks.

One of the System 816/C's most powerful features is its optional M-DRIVE/H solid-state disk emulator, shown in photo 4. A solid-state disk emulator configures and uses RAM as if it were a disk drive, but without the slow access times inherent in a disk drive. Even the 30- to 65-millisecond average access times offered by many Winchesters seem slow next to solid-state disk access times.

The system I used came equipped with a single 512K-byte M-DRIVE/H board. You can add 4 megabytes worth of RAM disk (on eight boards) if you need it. Compupro's software recognizes the presence of the RAM disk

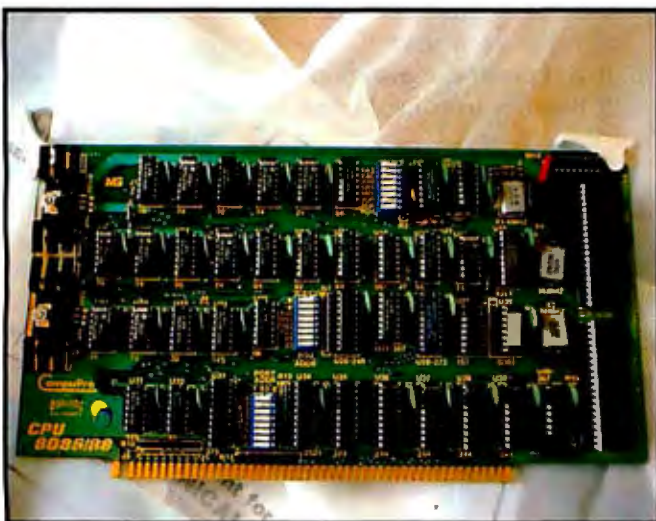

Photo 3: The 8085/8088 central processing unit of the System 816/C.



Photo 4: The M-DRIVE/H solid-state disk emulator.

At a Glance

Name

System 816/C

Manufacturer

Compupro
3506 Breakwater Court
Hayward, CA 94545
(415) 786-0909

Price

\$8995

Processors

8085 and 8088

Memory

512K bytes of RAM

Data storage

Two double-sided, double-density 8-inch floppy drives furnishing up to 2.4 megabytes of storage

Hardware needed

Terminal, printer

Software supplied

CP/M-80, CP/M-86, MP/M 8-16, Supercalc-86, dBASE II

Options

512K bytes of solid-state disk (\$1895)

Audience

System developers and professional users

and treats it as drive M when you boot the system. Addressed as two I/O ports, the board takes up none of the system's 16 megabytes of address space. The board formats as 504K bytes of disk space. Although not cheap (\$1895 per 512K-byte board), this is one of the few system-performance options that carries its own weight. The RAM disk can make the difference in whether the System 816/C, or any other computer, works fast enough for your application. It's hard to imagine using a powerful computer system such as the 816/C without a solid-state disk of some sort. The disk-access bottlenecks that naturally occur when several users share the same resources would eliminate any advantage that the system offers. You'd be better advised to buy individual desktop computers for each user than one powerful system that doesn't offer a solid-state disk.

System 816/C Software

Each System 816/C comes with CP/M-80, CP/M-86, MP/M 8-16, Supercalc-86, and dBASE II. These programs should prove adequate for the business that is just becoming computerized. If they aren't, other applications programs are available from many sources.

To take full advantage of the System 816/C, you'll want to use the multiuser MP/M 8-16 operating system. This is Compupro's proprietary implementation of Digital Research's MP/M-86. MP/M 8-16 lets you run 8-bit and 16-bit programs simultaneously, and it is compatible with all CP/M and MP/M operating environments.

To make the user interface—called the Terminal Message Process (TMP)—more useful, Compupro has modified it as a system shell. This shell has six functions:

1. It makes terminal, printer, user, and drive assignments during log-in.
2. It lets the system operator make changes in printer default assignments.
3. It lets the system operator make changes in the user default number.
4. It lets the system operator make changes in the default drive for each user.
5. It accepts and executes user command lines.
6. It handles user log-in and log-out.

The system operator (user 0) can reset any of these characteristics every time the system is booted. In this way, the system operator controls which users have access to which system resources. You can give every user access to every resource if you want, but you might want to protect certain files or other resources.

Unfortunately, MP/M isn't the answer for all multiuser applications. If you are running a manufacturing program that requires every operator to have access to files on a record-by-record basis, MP/M can't handle the job, because it has no record-locking feature. On a file-by-file basis, however, it performs well. MP/M 8-16, in particular, is convenient because it allows one user to run an 8-bit program at the same time that another user is running a 16-bit program.

At a Glance

Name

System 68K

Manufacturer

Compupro
3506 Breakwater Court
Hayward, CA 94545
(415) 786-0909

Price

\$8995

Processors

68000

Memory

512K bytes of RAM, 1.5 megabytes of solid-state disk

Data storage

Two double-sided, double-density 8-inch floppy drives furnishing up to 2.4 megabytes of storage

Hardware needed

Terminal, printer

Software supplied

CP/M-68K, C Compiler, MAPFORTH

Audience

System developers and professional users

Introducing the Most Powerful Business Software Ever!

TRS-80™ (Model I, II, III, or 16) • APPLE™ • IBM™ • OSBORNE™ • CP/M™ • XEROX™



The VERSABUSINESS™ Series

Each VERSABUSINESS module can be purchased and used independently, or can be linked in any combination to form a complete, coordinated business system.

VERSARECEIVABLES™ \$99.95
 VERSARECEIVABLES™ is a complete menu-driven accounts receivable, invoicing, and monthly statement-generating system. It keeps track of all information related to who owes you or your company money, and can provide automatic billing for past due accounts. VERSARECEIVABLES™ prints all necessary statements, invoices, and summary reports and can be linked with VERSALEDGER II™ and VERSAINVENTORY™.

VERSAPAYABLES™ \$99.95
 VERSAPAYABLES™ is designed to keep track of current and aged payables, keeping you in touch with all information regarding how much money your company owes, and to whom. VERSAPAYABLES™ maintains a complete record on each vendor, prints checks, check registers, vouchers, transaction reports, aged payables reports, vendor reports, and more. With VERSAPAYABLES™, you can even let your computer automatically select which vouchers are to be paid.

VERSAPAYROLL™ \$99.95
 VERSAPAYROLL™ is a powerful and sophisticated, but easy to use payroll system that keeps track of all government-required payroll information. Complete employee records are maintained, and all necessary payroll calculations are performed automatically, with totals displayed on screen for operator approval. A payroll can be run totally, automatically, or the operator can intervene to prevent a check from being printed, or to alter information on it. If desired, totals may be posted to the VERSALEDGER II™ system.

VERSAINVENTORY™ \$99.95
 VERSAINVENTORY™ is a complete inventory control system that gives you instant access to data on any item. VERSAINVENTORY™ keeps track of all information related to what items are in stock, out of stock, on backorder, etc., stores sales and pricing data, alerts you when an item falls below a preset reorder point, and allows you to enter and print invoices directly or to link with the VERSARECEIVABLES™ system. VERSAINVENTORY™ prints all needed inventory listings, reports of items below reorder point, inventory value reports, period and year-to-date sales reports, price lists, inventory checklists, etc.

VERSALEDGER II™ \$149.95
 VERSALEDGER II™ is a complete accounting system that grows as your business grows. VERSALEDGER II™ can be used as a simple personal checkbook register, expanded to a small business bookkeeping system or developed into a large corporate general ledger system **without any additional software.**

- VERSALEDGER II™ gives you almost unlimited storage capacity (300 to 10,000 entries per month, depending on the system),
- stores all check and general ledger information forever,
- prints tractor-feed checks,
- handles multiple checkbooks and general ledgers,
- prints 17 customized accounting reports including check registers, balance sheets, income statements, transaction reports, account listings, etc.

VERSALEDGER II™ comes with a professionally-written 160 page manual designed for first-time users. The VERSALEDGER II™ manual will help you become quickly familiar with VERSALEDGER II™, using complete sample data files supplied on diskette and more than 50 pages of sample printouts.

SATISFACTION GUARANTEED!

Every VERSABUSINESS™ module is guaranteed to outperform all other competitive systems, and at a fraction of their cost. If you are not satisfied with any VERSABUSINESS™ module, you may return it within 30 days for a refund. Manuals for any VERSABUSINESS™ module may be purchased for \$25 each, credited toward a later purchase of that module.

To Order:

Write or call Toll-free (800) 431-2818
 (N.Y.S. residents call 914-425-1535)

- * add \$3 for shipping in UPS areas
- * add \$4 for C.O.D. or non-UPS areas

- * add \$5 to CANADA or MEXICO
- * add proper postage elsewhere

DEALER INQUIRIES WELCOME

All prices and specifications subject to change / Delivery subject to availability.

COMPUTRONICS

50 N. PASCACK ROAD, SPRING VALLEY, N.Y. 10977

* TRS-80 is a trademark of the Radio Shack Division of Tandy Corp. • APPLE is a trademark of Apple Corp. • IBM is a trademark of IBM Corp. • OSBORNE is a trademark of Osborne Corp. • CP/M is a trademark of Digital Research • XEROX is a trademark of Xerox Corp.

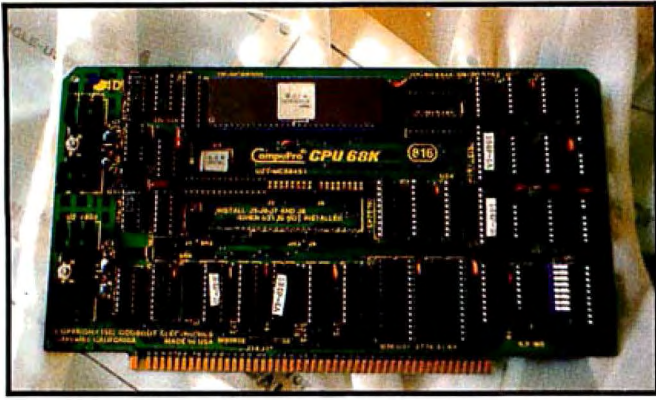

Photo 5: The System 68K's central processing unit's 68K-byte board.

The only problem with this software package is that you'll have to format and copy all of your disks under CP/M. For some unexplained reason, the Diskcopy utility doesn't run under MP/M, but that is a minor inconvenience.

System 68K Hardware

The only real difference between the System 816/C and the System 68K is the central processing unit's 68K-byte board, shown in photo 5. As the name implies, this board is an S-100 processor card that uses the 68000 processor. It upgrades any IEEE-696/S-100 computer system from 8 to 16 bits. The 68000 runs at either 4 or 8 MHz (standard at 8 MHz) and works with a variety of 8- and 16-bit memory and peripheral devices. Another version that runs at 5 or 10 MHz is available. The board furnishes two sockets for up to 16K bytes of ROM (read-only memory), a jump-on-reset feature, and it even has provisions for an optional memory-management unit. A 24-bit addressing scheme accommodates up to 16 megabytes of memory, including a 64K-byte block of I/O addresses.

For \$695, you can add the central processing unit's 68K bytes to your System 816/C. You simply unplug the old processor board, plug in the new board and change a few DIP switch positions, and change a jumper on the Disk 1 card.

Once you've made these changes, you've turned your System 816/C into a System 68K. Buying the System 68K does have one advantage over upgrading a System 816/C, however—it already comes with 1.5 megabytes of M-DRIVE/H.

System 68K Software

Compupro's version of CP/M-68K comes on two disks. The first disk contains CP/M-68K and its C compiler configured for the System 68K. The second disk gives you everything you need to create a customized system, including the source, library, and submit files needed to modify the BIOS (basic input/output system) to meet your system requirements. Thus, one System 68K can act as a development system for other CP/M-68K systems.

The CP/M-68K operating system that Compupro pro-

vides requires at least 256K bytes of RAM addressed at 0; a floppy-disk drive connected to the Disk 1 board (addressed at hexadecimal C0); a terminal set for 9600 bps (bits per second) with an 8-bit word length, no parity, two stop bits, and, to accommodate system I/O, Compupro's System Support 1 board with its I/O address set to hexadecimal 50.

You also get a third disk containing another stand-alone system, MAPFORTH. The system includes the operating system, a FORTH compiler and interpreter, and a variety of precompiled utilities written in FORTH. You can't use FORTH and CP/M-68K together, but at least for the moment you can write FORTH programs. Later, these should port over to other operating systems with little problem.

Using CP/M-68K proved straightforward. The only bug appears in the Diskcopy utility. You can only Diskcopy a single-sided disk to a single-sided disk. You can copy individual files to a larger disk with PIP (peripheral-interchange program), but you cannot use the Diskcopy routine. This problem occurs with the System 816/C version of CP/M, too.

Performance

"A High-Level Language Benchmark" (September 1981 BYTE, page 180) and "Eratosthenes Revisited: Once More through the Sieve" (January 1983 BYTE, page 283) compared the computational speed of a variety of 8- and 16-bit computer systems. The benchmarks with which the comparisons were performed were all written in high-level languages, such as FORTRAN, FORTH, Pascal, and C. Digital Research's CP/M-68K operating system comes with a C compiler, so I was able to make a direct comparison with the machines already reviewed.

In the September 1981 article, the fastest execution time recorded was logged by a 68000 programmed in assembly language. It executed the program in 1.12 seconds. A PDP-11/70 running C came in second place, executing the benchmark in 1.52 seconds. Also in the 4.00 seconds-and-under category was an 8086 (assembly language), a PDP-11/70 running NBS Pascal, a Z8000 running Onyx C (Unix), and a 5-MHz 8088 programmed in assembly language. According to my testing, the System 68K should fit in next, because it ran the benchmark in 4.5 seconds, tying for seventh place with a PDP-11/60 running NBS Pascal. A PDP-11/40 running C placed ninth with an execution speed of 6.1 seconds. This puts Compupro in the top third of the 26 16-bit machines tested (25 reported in the article, plus the Compupro).

The much more comprehensive 1983 survey tested 17 different 68000-based machines, with the same benchmark used earlier. Four of these executed the program in less than 4.5 seconds, the fastest being an 8-MHz machine programmed in assembly code. Only one other 68000-based machine ran faster than 4.0 seconds—a machine programmed in SMPL that ran in 2.6 seconds.

In short, the Compupro System 68K compares favorably with other systems. It isn't the fastest or most efficient, but it is competitive.

INTERFACE IT.....PUT IT IN PRINT

THE **JUKI**® MODEL 6100

THE
LETTER QUALITY
DAISYWHEEL
PRINTER HAS PC
COMPATIBILITY

\$599

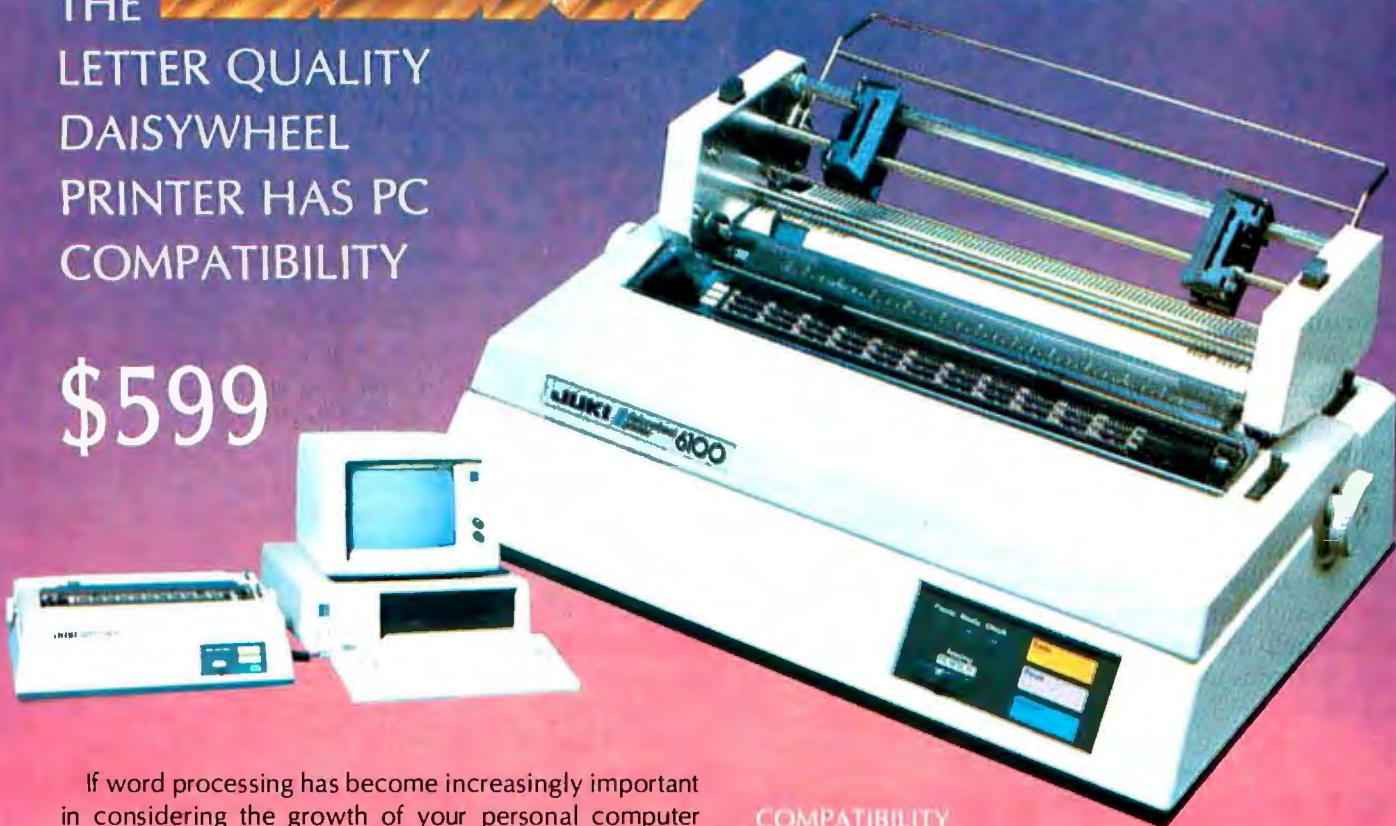

If word processing has become increasingly important in considering the growth of your personal computer system, then your choice in selecting a printer should be a major decision, not a major investment. If PERFORMANCE, COMPATIBILITY and PRICE are significant factors in determining your decision, then the Juki Model 6100 Letter Quality, Daisywheel Printer will benefit you. Here's why...

PERFORMANCE

Engineered for precision performance, the Juki Model 6100 has been field tested and proven for accuracy, reliability and versatility. It prints bi-directionally at 18 cps, has proportional spacing, 10/12/15 pitch and performs the latest word processing functions including superscript, subscript, bold/shadow printing, double strike, underlining and graphics. It houses over 40 built-in control commands, has a buffer memory expandable to 8k, and operates on a linear induction motor ensuring accurate positioning. Also, the Juki Printer is lightweight and conventional in design, has a low noise level and is available with a Tractor Feed.

COMPATIBILITY

Interface it... the Juki Letter Quality, Daisywheel Printer is compatible with all major personal computers and is equipped with Centronics Parallel interface as standard equipment and is available with the RS-232C Serial connection as well. It conveniently uses IBM Selectric™ ribbons and 100 character Royal/Adler™ daisywheels with a variety of type styles to choose from.

COST BENEFIT

With all the advanced features of a higher priced unit combined with convenience and dependability, the low cost of the Juki Model 6100 adds up to one thing... hard copy at a soft price.

At \$599.00 the Juki Model 6100 Letter Quality, Daisywheel Printer will complement your personal computer system with a minimum investment.

Contact your local
Juki Distributor for
further details.



JUKI INDUSTRIES OF AMERICA, INC.

ACORN DATA PRODUCTS
7304-L South Alton Way
Englewood, CO 80112
303/779-6644
Serving:
MT, WY, CO, UT, NM

BUTLER ASSOCIATES, INC
82A Winchester Street
Newton, MA 02161
617/964-5270
Serving:
ME, NH, VT, CT, RI, MA

COMPUTER SERVICES
INTERNATIONAL CORP.
560 Sylvan Avenue
Englewood Cliffs, N.J. 07632
201/569-6300
Serving: METRO NY, E. PA, NJ

GENTRY ASSOCIATES, INC.
7665 Currency Drive
Orlando, FL 32809
305/859-7450
Serving:
TN, NC, SC, MS, LA, AL, GA, FL

INFORMATION SYSTEMS, INC.
2420 E. Dakton Street, Unit K
Arlington Heights, IL 60005
312/228-5480
Serving:
WI, IL, MN, IA, MO, NE, ND, KS, SO

INTERNATIONAL BUSINESS
SYSTEMS CENTER
7023 Little River Turnpike
Annandale, VA 22003
703/750-3885
Serving: MD, DE, DC, VA

DSSMANN COMPUTER
TECHNOLOGIES, INC.
6666 Old Collamer Road
E. Syracuse, NY 13057
315/437-6666
Serving: UPSTATE NY

SIGMA DISTRIBUTING
2110 116th Ave. N.E.
Bellevue, WA 98005
206/454-6307
Serving:
WA, OR, ID, AK

SOUTHERN MICRO
DISTRIBUTORS
8708 Royal Lane
Irving, TX 75063
214/258-6636
Serving: TX, OK, AR, LA

STAR-TRONIC
DISTRIBUTOR CO.
23976 Freeway Park Drive
Farmington Hills, MI 48024
313/477-7506
Serving: MI, IN, OH, KY, W, PA, WV

TECHNOLOGY MARKETING CORP.
2300 Valley View Lane
Suite 109
Dallas, TX 75234
214/243-7994
Serving: TX, OK, AR, LA

VITEK
930-G Boardwalk Avenue
San Marcos, CA 92069
619/744-8305
Serving:
S. CA

WESTERN MICRO
TECHNOLOGY
10040 Bubb Road
Cupertino, CA 95014
408/725-1660
Serving: N. CA, NV, AZ

NATIONAL HEADQUARTERS:
JUKI INDUSTRIES OF AMERICA, INC.
DA DIVISION
299 Market Street
Saddle Brook, NJ 07662
201/368-3666

WEST COAST:
JUKI INDUSTRIES OF AMERICA, INC.
CALIFORNIA DIVISION
3555 Lomita Boulevard
Torrance, CA 90505
213/325-3093



Photo 6: The stack of manuals that you get with either computer.

Documentation

Compupro's documentation is aimed at system integrators, not users. As a result, the system does not come with one system manual, but with a manual for each board and software program, as photo 6 shows. This miasmatic approach to system documentation produces literature that is both thorough and thoroughly confusing. It isn't always clear which manual you should be reading. Individual manuals should not be eliminated, but a system manual should be added. It would also be a great help if there were at least a user's cross reference that pointed to the proper manual for answers to questions.



5 1/4" DISK CONTROLLER

KEY FEATURES

- Full sector buffering
- Logical sector addressing
- Multiple sector, cylinder operation
- 11 bit burst ECC
- Self-diagnostic capability
- Automatic sector alternation for the defective sectors
- Automatic Error Retry
- Industry Standard SASI I/F

National Computer Ltd.

LIASON OFFICE IN CALIFORNIA
PHONE:(408)734-1006 FAX:(408)744-0709

AKEBONO BLDG. 2-6-12 IWAMOTO-CHO
CHIYODA-KU, TOKYO, JAPAN
PHONE:(03)863-6705 TLX:J27542
FAX:(03)864-4581

Using the System

In spite of the documentation problem, the system proved simple to configure and begin using. There really isn't much to know, and there is plenty of information in the *MP/M 8-16 Technical Manual and Installation Procedures* to get you up and running in half an hour. The system doesn't come with a terminal, but I pressed an Adds Viewpoint terminal into service and it worked well.

Playing with a new system with no regard for the consequences can uncover some interesting anomalies. By trying thousands of things that didn't work, I discovered a minor problem with the shell program; it is possible to create a user interface that doesn't allow any users to sign on. All passwords become invalid, but the system insists on a password. The situation produces the kind of frustration experienced by Wordstar users who have just been told the disk is full. You know what you want to do, but there's no way to tell the system.

There is one other trap that is easy to fall into. Using the M-DRIVE/H is so much like using a fast disk drive, it is hard to remember that, when you turn off the power, the files on the M-DRIVE/H go away. Rebooting is no problem, because the boot routine doesn't reformat the M-DRIVE/H; but turning the power off without first putting the files you want to keep on a real disk is a definite mistake.

There seems to be no safeguard against making that error. A provision in MP/M 8-16 allows the system to automatically back up working files to the hard disk if you have one, but it has nothing that will rescue a user from the folly of turning off the power with data on the M drive. You could use the Sched (schedule) utility to cause the system to PIP all of the files from drive M to one of the floppy disks periodically, but that might prove disconcerting to unsuspecting users.

Conclusions

Although the System 816/C has a fairly high price tag (\$10,890 with M-DRIVE/H), in a multiuser application it provides high performance at only about \$3600 per user. Converting the System 816/C to a System 68K is simple and takes but a few minutes. And the System 68K's performance compares favorably to that of other 68000-based computers and PDP-11/60 minicomputers. The M-DRIVE/H solid-state disk emulator eliminates disk-access bottlenecks and the dual processor scheme of the System 816/C works well and is totally transparent to the user. The Americare program makes either computer a good bet for business and professional users. On the minus side, the System 816/C needs a Diskcopy routine that will run under MP/M. But the MP/M 8-16 shell will let you create exactly the system you want for each user. Well designed and executed, both computers are easy to love. ■

Ed Teja (238 Swift St., Santa Cruz, CA 95060) writes extensively about computers and peripherals. His latest book, A Designer's Guide to Disk Drives, will soon be published by Reston Publishing Company Inc.

Release Your Potential



With the p-System™ from

For: IBM PC & XT CORONA COLUMBIA EAGLE COMPAQ COLBY DOT HYPERION

Do you feel stifled by your operating system? The p-System from NCI will release you. It is the complete program development environment for the IBM Personal Computer and compatibles. This is the fast p-System with the special p-machine emulator developed by NCI.

The p-System from NCI gives you everything you need in one system at far less than the cost to add similar utilities to any other OS. It includes a powerful screen editor, a multi-function file manager and RAMdisk support for fast access to files. Dynamic memory allocation lets you create programs larger than 64K and a print buffer frees your

computer to perform other tasks while printing.

This operating system is stable, friendly and easy to use. Command options are presented on a menu requiring only a single keystroke. The 8087 Numeric Coprocessor Support allows extremely fast floating point calculations and the asynchronous I/O lets you use serial printer and communications routines.

With the p-System you can choose either UCSD Pascal, Fortran 77 or Basic as your programming language. NCI also offers hard disk support for the IBM XT, Corona, Columbia, Corvus, Tallgrass, Davong, Genie 5+5, QCS, Datamac,

Microdisk and Santa Clara. Corvus OMNINET support can easily be added as well as memory cards from AST Research and Tall Tree Systems, the Colorplus card and the Hercules graphics card.

When you buy the p-System from NCI you get technical support and complete documentation.

For full details call or write:

Network Consulting Inc.
Discovery Park,
Suite 110 - 3700 Gilmore Way
Burnaby, B.C. Canada V5G 4M1
(604) 430-3466

SPEED. PORTABILITY. RELIABILITY.

**CHICAGO
NEW YORK**

**FORMERLY
APPLEFEST
& PC'83**



**THE PERSONAL COMPUTER
USERFEST**

Plan now to attend the Personal Computer Userfests, the largest events ever . . . for Apple and IBM PC users.

Userfest brings together two of the largest, most successful shows ever conceived for personal computer users: Applefest and PC'83. Now that Apple and IBM can run each other's software, and with so many products adapted for both systems, the two shows merged beautifully.



At Userfest you'll see—and try out—all of the newest state-of-the-art products for your Apple, IBM PC or work-alike. Each Show has hundreds of displays and exhibits, and thousands and thousands of products including innovative new software, power peripherals, accessories, support services, books and publications. Products to help you explore the full potential of your computer for office, home and school applications.



Userfest features all the major makes of Apple and IBM computer compatibles. In fact, it's the largest display of these products, and biggest gathering of IBM and Apple experts, ever assembled in either city. Hence, you can learn more in two days at Userfest than you could in months of visiting computer stores or reading trade journals.

And best of all, everything on display at Userfest is for sale, usually at special show prices, so you can save hundreds, even thousands of dollars by making your purchases at the Show.



So don't miss the Personal Computer Userfest when it comes to Chicago and New York in 1984. It's a once-only opportunity.



Order your tickets in advance and avoid long lines. Admission is \$10.00 for a one-day ticket, or \$20.00 for four days. Children's tickets (under 10 years of age) are \$4.00 and \$8.00. If you need hotel accommodations and/or airline reservations, check the line on the Advance Ticket form.



**FEATURING
IBM, APPLE &
WORK-ALIKE
COMPUTERS &
COMPATIBLES**

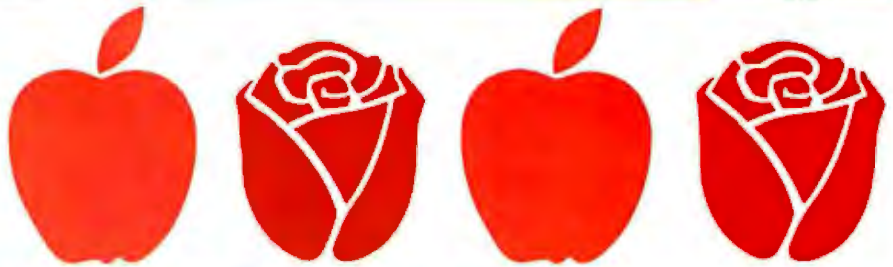

**THE PERSONAL COMPUTER
USERFEST**



**USERFEST/
CHICAGO**

Thursday-Sunday
May 3-6, 1984
10:00AM to 5:00PM daily
O'Hare Exposition Center
9291 West Bryn Mawr
Rosemont, Illinois
(next to Chicago's O'Hare Airport)



**USERFEST/
NEW YORK**

Thursday-Sunday
September 20-23, 1984
Madison Square Garden
10:00AM to 5:00PM daily

For information about exhibiting
at the Personal Computer User-
fests, call or write Northeast
Expositions, 822 Boylston Street,
Chestnut Hill, Mass 02167.
Tel: 617-739-2000.



For hotel information call or write
Trade Show Department, Fox
Travel, P.O. Box 498, Waltham,
Mass 02254. Tel: 617-890-1770
or 800-225-8410 ext. 314.

Userfest (formerly known as
Applefest and PC'83) is pro-
duced by Northeast Expositions,
822 Boylston Street, Chestnut
Hill, Mass 02167.

**ADVANCE
TICKET
ORDER FORM**

Mail this form (or a facsimile)
with full payment to Northeast
Expositions, 822 Boylston Street,
Chestnut Hill, Mass 02167.
Tel: 617-739-2000. No ticket
orders accepted 14 days or
nearer to each Show. Your tick-
ets will be mailed one month
prior to the Show. Sorry, no tele-
phone or credit card orders please.

Name: _____
Company (if any): _____
Address: _____
City: _____ State: _____ Zip: _____
Tel: Day (_____) _____ Evening (_____) _____
Enclosed is full payment for:
_____ quantity adult one-day tickets @ \$10.00 each _____ quantity adult four-day tickets @ \$20.00 each

use this line for children's ticket orders
 Check here if you need hotel and/or airline information

Microsoft Flight Simulator

Even experienced pilots will find this program useful and challenging

by Stan Miastkowski

As any programmer knows, simulations are one of the toughest programs to write. The seemingly endless list of interacting variables that comprise events that happen in the "real world" makes for a programmer's nightmare. That's why simulations used by serious researchers are often run on mainframe computers or even supercomputers like the Cray-1. Their incredible speeds and megamemories make them capable of processing the numerous variables and the endless streams of data used in such advanced fields as weapons and weather research—not to mention that the government is often the only entity capable of laying down the substantial bucks required for systems like these.

Despite the inherent roadblocks, programmers of mini-computers and microcomputers are forging new ground in simulations. Not all of the work is being done in esoteric scientific fields. In fact, microcomputer-based simulations are becoming increasingly common in the entertainment arena. Some of the most advanced work has been done by Atari's Chris Crawford (see "Chris Crawford: Artist as Game Designer," June 1982 *Popular Computing*, page 55), who's responsible for such groundbreaking games as *Eastern Front*.

Flight simulators for microcomputers have been around almost since the beginning. Most have been rather crude, relying on slowly updated primitive graphics or an instrument panel only. Although fun for the nonpilot, they haven't had enough features for an experienced pilot to find them useful or challenging. The Microsoft Flight Simulator is a refreshing exception, a fast-moving, realistic package that makes you consider all the variables and make the fast decisions that a pilot must make.

Flight

Although highly experienced pilots with tens of thousands of hours "behind the stick" often tell you that fly-

ing becomes boring, don't be deceived. Flying an airplane, be it a Cessna trainer or a Boeing 747, is an exhilarating experience that requires complete concentration on the numerous visual and sensory cues (sound, movement, etc.) that assail the senses from the instruments, radios, and outside world. It truly uses the brain's ability to parallel-process large amounts of data. But how do you develop a flight simulator?

The complete-environment simulators used by the airlines for training pilots are one extreme. Sometimes costing nearly as much as a real airplane, these closed-cockpit simulators are mounted on hydraulic legs to simulate movement and utilize high-resolution computer-generated graphics projected onto a large screen that sits in front of the pilots. The mind-boggling array of instruments in a modern jet cockpit are all there, and the whole thing is usually controlled by a superminicomputer such as a Digital Equipment Corporation VAX. So realistic are these simulators that the FAA (Federal Aviation Administration) recognizes them as equal to flying a real aircraft for part of a pilot's training program.

Obviously, more than a couple of compromises are in order for a flight simulator that uses a personal computer. Movement must be simulated on the screen only, and computer-generated representations of the instruments also must be on the screen. In addition, the programmer must be well aware of the limitations of the processor, memory, and graphics capability of the computer used.

The Microsoft Simulator

The Microsoft Flight Simulator runs on the IBM Personal Computer (along with the Corona [with graphics board], the Chameleon, the Compaq, and several other PC clones), a logical choice because of its 16-bit processor and high-resolution graphics. It comes on a single 5¼-inch floppy disk, so it can be used on a single-drive

(1a)



(1b)



Photo 1: The view forward while waiting for takeoff clearance is shown in 1a. Note the instrument status. Photo 1b shows the situation just after lift-off, banking to the right. Instrument indications correspond to control settings and aircraft speed and attitude.

system. The disk's built-in copy-protection scheme allows you to make a single backup copy, a wise thing to do because the simulator quickly can become habit forming and the disk will get heavy use. It requires only the minimum memory (64K bytes), although you'll need the color/graphics card.

A word about the video display: although when you boot the disk the flight simulator asks you which type of display you're using (color TV/composite monitor, black-and-white TV/monitor, or RGB monitor), the realism of the simulator depends highly on the use of color. It will work in full color only with a color TV or composite monitor; an RGB (red-green-blue) display will display black and white. Although a color composite monitor is by far preferred, I found a color TV adequate (though a bit tiring on the eyes). You *need* color for one good reason: a pilot uses color to sort out the visual cues, both from the instruments and the view out the window. The one exception is night flying (available in the simulator) where, in real conditions, instruments are red-lighted to ensure that night vision isn't affected. In the simulator's night-flying mode, the instruments remain the same color they are in the "daylight," not exactly realistic but still quite usable.

I strongly recommend staying away from this package if you don't have access to a color video display. Although you can still use it, it will soon become frustrating. Lack of color takes away a large degree of its realism. Besides, if you're color blind, the real world denies you the medical certificate needed to fly as pilot in command.

The simulator comes with a complete 93-page manual that includes several charts used for both VFR (visual flight rules) and IFR (instrument flight rules) flying. These are partial versions of actual government maps, the ones used by pilots during real flights. The manual, though a complete step-by-step run-through of the simulator, is a bit difficult to use as a reference guide.

I found I had to make up my own place markers for areas I'd be referencing often.

When you first boot the disk and select the video-display type, you're given the option of entering demo mode or regular flight mode. The demo mode is a good place to start, taking you through a short flight and letting you get a feel for the features.

The video display is divided horizontally into two parts (see photo 1). The top part is the view out the "windshield" of the airplane. This high-resolution view is upgraded about three times a second, resulting in a sometimes-uncanny degree of realism. The resolution is excellent, and objects on the ground are clearly discernible for what they are, rather than just a hazy intersection of jagged lines. However, don't expect to see intimate details of the cities and towns you're "flying" over. Because of obvious memory limitations, three-dimensional objects are outlines, without details filled in.

The lower part of the display contains the instrument cluster, including the standard airspeed indicator, artificial horizon, altimeter, turn coordinator, heading indicator, and rate-of-climb indicator found in every airplane. In addition, you'll find an Omni-Bearing Indicator with glide slope (for landings during instrument conditions), a clock, magnetic compass, and various annunciator lights that monitor lights, landing gear, carburetor heat, and outer/middle/inner markers (also used for instrument landings). There's also a full complement of instruments that monitor the engine, including a tachometer, oil temperature and pressure gauges, and, most important, dual fuel gauges for left and right tanks. A single NAV/COM (navigation/communication) radio is provided, as is a radar transponder that sends a coded signal every time a pulse from tracking radar hits the airplane.

All in all, the plane is very well outfitted. About the only things missing are an ADF (automatic direction

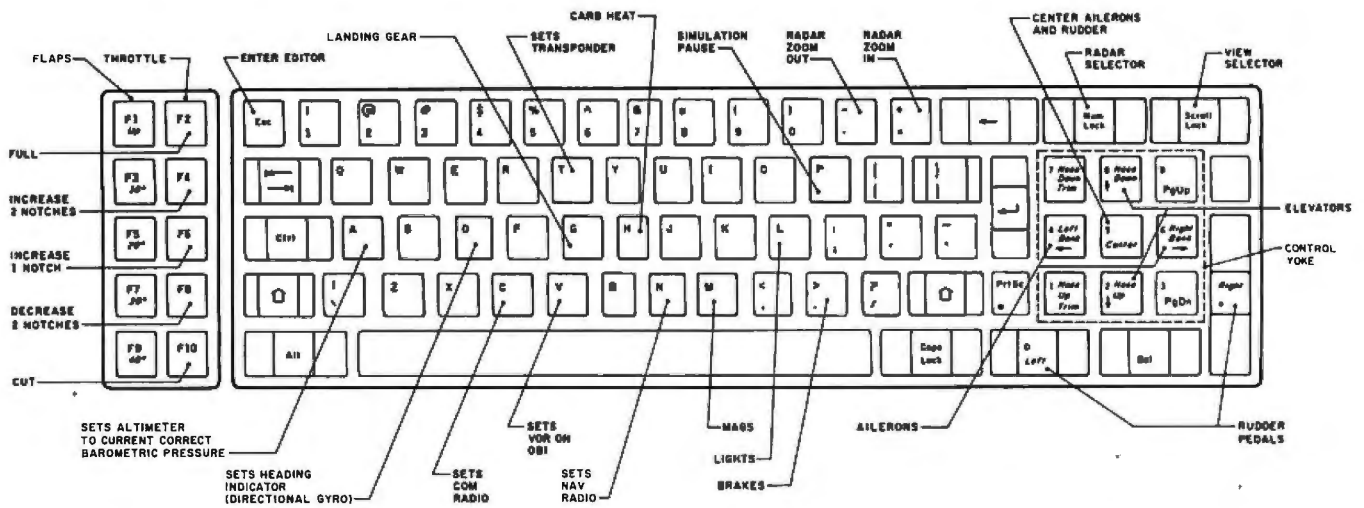

Figure 1: Aircraft controls for the flight simulator. The British Ace mode adds a declare-war key (W) along with bomb-drop (X) and machine-gun burst (space bar).

finder) and a second (or even third) NAV/COM radio. The many frequency changes needed during instrument flight and during a departure from or approach to a moderately busy airport can be maddening with only a single radio.

The Microsoft Flight Simulator was designed by its author, Bruce Artwick of Sublogic Corporation, to simulate a Cessna 182. This single-engine aircraft—called the Skylane—delivers relatively high performance. Because an airplane like the Skylane has enough power and controls to get you into trouble, it's not normally used for student training. The simulator acts surprisingly close to the Skylane, the major difference being that the simulator can climb a bit faster than the "real thing." Another difference between the simulator and the Skylane is that the simulator has a retractable landing gear instead of the Skylane's fixed landing gear.

Flight Controls

In an actual airplane, you control it using four major controls:

1. **Yoke.** This is the "steering wheel" of the airplane. Turning it right or left controls the *ailerons* on the tips of the wings and banks the aircraft right or left. Pushing it in and pulling it out controls the *elevator*, the large horizontal wing on the back of the airplane. Pushing it forward tilts the nose down; pulling it backward tilts the nose up.
 2. **Rudder.** This is the vertical wing on the back of the airplane, which is controlled by two pedals on the floor. It controls the left to right axis of the airplane. Maneuvers such as turns actually cause the airplane to *slip* sideways unless the turn is *coordinated* with the rudder. On the ground, most airplanes have the front-wheel steering connected to the rudder pedals.
 3. **Throttle.** The amount of power in an airplane controls its rate of climb and descent as well as its airspeed.
- In fact, proper use of the throttle is one of the most

difficult aspects of flight to learn. Landing an airplane properly is a fine art of controlling descent using power and the yoke so that the airplane *stalls* (stops flying) several inches above the runway.

4. **Trim.** Depending on the power and airspeed, as well as conditions such as passenger and equipment load and quantity and location of fuel, the force needed on the yoke to make the airplane perform a maneuver can vary greatly. The trim is a fine adjustment that equalizes the forces on the airplane.

Obviously, there's no yoke, throttle, trim lever, or rudder pedals on the IBM PC. Therefore, these variables are controlled by the keyboard (see figure 1). The primary controls are clustered on the numeric keypad located on the right side of the IBM keyboard. The primary yoke controls are in a standard cross configuration, with 2 (↓) and 8 (↑) controlling the nose attitude (elevator) and 4 (←) and 6 (→) controlling left and right banking (ailerons). The 0 (left) and + (right) keys are your "rudder pedals" and throttle position is controlled by the even-numbered F2 through F10 function keys on the left side of the keyboard. In all cases, pressing key 5 on the keypad centers the yoke. Because you don't have that "seat of the pants" feel, indicators on the panel show you the position of your controls. You do, of course, also get visual cues, such as when the ground is rushing up on you and your airspeed is increasing dramatically. The odd-numbered function keys (F1 through F9) control the flaps, which are used to increase lift, primarily during a descent to the runway, when you're flying comparatively slowly.

Other keys on the main keyboard control functions such as turning the lights or carburetor heat on and off and setting the frequency on the radios. The most important one is P, for pause. It lets you take a break during a difficult instrument approach—something you obviously can't do in real life.

(2a)

```

Simulation Control
User mode      - - - - - --> 0
Sound         - - - - -
Auto-coordination - - - - -
Slew          - - - - -
Reality mode   - - - - -
Demonstration mode - - - - -
Europe 1917?  - - - - -
Communication rate - 128

Aircraft Position
North position - - - - - 17178
East position  - - - - - 16671
Altitude       - - - - - 591
Pitch         - - - - -
Bank          - - - - -
Heading       - - - - -
Airspeed      - - - - -
Throttle      - - - - -
Rudder        - - - - - 2767
Ailerons      - - - - - 2767
Flaps         - - - - -
Elevators     - - - - - 32767

MFS Edit Mode pg.1      Hit esc to exit

```

(2b)

```

Environmental Control
Time: Hours   - - - - - --> 12
      Minutes - - - - -

Season
Cloud layer  tops
Cloud layer  bottoms
Cloud layer  tops
Cloud layer  bottoms
Wind level 3: knots
              degrees
Shear zone altitude 3 8997
Wind level 2: knots
              degrees
Shear zone altitude 2 999
Wind level 1: knots
              degrees
Shear zone altitude 1 997
Surface wind: knots
              degrees

Reliability factor - 100

MFS Edit Mode pg.2      Hit esc to exit

```

Photo 2: Pages 1 (2a) and 2 (2b) of Editor screens. As you can see, many variables can be changed to vary flight conditions.

The Editor

One of the keys to any good simulator is to make sure it doesn't repeat itself. This is where the Microsoft Flight Simulator shines. The Editor (see photo 2) lets you set up an almost infinite variety of flight conditions, including the time of season, time of day, cloud layers, wind, turbulence, and, most important, the location. The simulator is a real-time program, and you can actually fly between Seattle and Los Angeles, although it will take several hours. The simulator has geographic detail and airport information for four areas: Seattle, Los

Angeles, Chicago, and New York/Boston. Each area comprises about 10,000 square miles. For convenience sake, you'll probably want to limit your flights to airports within these areas, which include plenty of variety. You tell the simulator the latitude and longitude of where you want to start (normally on the ground at the airport). You can also start off in the middle of a flight if you wish.

In addition to the 10 preset modes, you can set up and store up to 20 more modes.

Ten preset flight modes are included on the disk, ranging from easy flight to advanced instrument conditions in bad weather. One of the modes is British Ace (see photo 3), where you're a World War I ace flying against Germany. When you get sick of normal flying, you can enter this mode and have machine guns and bombs at your disposal over the terrain of France and Germany. It's a pleasant diversion that still requires a good deal of flying skill, and you won't succeed if you haven't spent some time using the easy flight mode.

In addition to the 10 preset modes, you can set up and store up to 20 more modes. This gives you a large variety of flights that you can make.

A Sample Flight

To give you an idea of how the simulator works, let's take a quick flight. When you choose the easy flight mode (which is automatically entered from the first menu), you're lined up on the active runway of Meigs Field, a small airport located next to Lake Michigan near Chicago. Because it's an uncontrolled airport (no control tower), you're all set to take off. You can, if you wish, "taxi" around the airfield using a unique "radar" feature (see photo 4) that you don't find in a real airplane. Pressing Num Lock gives you a view of the airport from above,

At a Glance

Name

Microsoft Flight Simulator

Use

Simulates VFR/IFR flight in a Cessna 182 single-engine aircraft

Manufacturer

Microsoft Corporation
10700 Northrup Way
Bellevue, WA 98004

Price

\$50

Features

High-resolution real-time graphics display, full VFR/IFR instrumentation, 10 preset flight modes, 20 customizable flight modes, parameters can be stored in RAM to restore position, British Ace World War I game, pause key, and ability to make single backup

Format

5¼-inch floppy disk for IBM Personal Computer; requires 64K bytes of RAM, a single floppy-disk drive, and a color-graphics board

Documentation

93-page tutorial manual

Audience

Student pilots, experienced pilots, prospective pilots, and anyone interested in a full-featured simulation of what flying an airplane is like

PC PEACOCK™ Brings Living Color to Your IBM PC™



Computing is dull in black and white. But it doesn't have to be.

PC PEACOCK brings the excitement of color to your IBM computer. Pictures, charts and graphs "come alive" in multicolor brilliance. PC PEACOCK works with all color and composite monochrome displays to produce crisp, detailed images.

You'll see your favorite programs in the splendor of color. PC PEACOCK is fully compatible with all software for your IBM PC — including the wide variety of graphics programs. The medium multicolor mode and high resolution monochrome mode enhance your display capabilities for business, home and education.

And PC PEACOCK is convenient. Its parallel port allows you to connect a printer to your computer without wasting an additional expansion slot. Connections for all displays (RGB, composite, monochrome and televisions) are included.

PC PEACOCK is designed to provide years of worry free performance and is backed with an outstanding TWO YEAR warranty.

So bring living color to your IBM PC, with the PC PEACOCK Color Graphics Adapter. PC PEACOCK is available now at your local IBM dealer

For more information on all of MA System's IBM and Apple products, please call or write

MA SYSTEMS
I N C O R P O R A T E D

2015 O'Toole Ave., San Jose, CA 95131 (408) 943-0596

Circle 216 on inquiry card.

IBM PC is a trademark of
International Business Machines Corp

PC PEACOCK is a trademark of MA Systems Inc



Photo 3: The view forward in the British Ace mode selected by the Europe 1917 option in photo 2b. Note the addition of a sighting device in the windshield and an armament indicator and attack radar at the lower right.

with your aircraft in the middle. You can taxi around the airfield using your throttle, and zoom the view in or out using the + or - keys. If only real airplanes had this. The taxiways at large airports are confusing masses of intersections and branches going off in many directions. They can be murder if you're not familiar with the airport. I well remember flying a small Piper aircraft into Logan Airport in Boston and being told by ground control to taxi "using the inner delta." Absolute gibberish!

Once you're lined up on the runway (see photo 1a), you can hear the engine sounds coming from the speaker. (It can be turned off.) After a standard pretake-off check, you apply full throttle by hitting the F2 key. The engines rev up, and you steer to keep yourself in the middle of the runway using the rudder keys. When you reach 55 knots as shown on your airspeed indicator, you raise the nose by pressing key 2 about six times. You're off (see photo 1b). In addition to the airport and the lake, the John Hancock Tower is visible. For this VFR flight, the tower is an excellent reference.

The adjustments that you must make on the flight simulator are very much what would be done in a real aircraft. After the gear is up, you gain a bit of airspeed and can slightly reduce power to get the best rate of

climb. The easy flight mode is a perfect way to get used to the feel of your computerized airplane. Turns are automatically coordinated, which means you don't have to worry about the rudder controls whenever you bank the aircraft.

Landing, as in a real airplane, is the toughest part. The best thing to do before even attempting it is to fly out over the lake and try turns, ascents, descents, and flying at a constant altitude until you're absolutely sure you're comfortable with your aircraft. Experienced pilots will spend a great deal of time looking at their instruments, the best cues for what's happening. Unless you're particularly talented (or lucky), you'll probably crash more than a couple of times. As in a real aircraft, there's a strong tendency to overcorrect on your controls, making the situation worse. With all the graphics and sound, you might expect a realistic crash. Sadly, that's not the case. If you crash, all you see is "CRASH!" on the screen. If you spin into the lake, you'll see "SPLASH!" Somehow, I expected more.

You have to face the fact that unless you're specially gifted you're going to botch up landings. Although I've done hundreds of real landings, I found getting used to using the keyboard a big hurdle to overcome. As pre-



The personal,
portable
daisywheel
printer.

Only \$599.

The new briefcase size Transtar 120 is easy to take with you to work, to school and home again. The 120 is light, only 19 pounds, and easy to use with all the best selling word processing programs.

Plug it into your computer and watch this precision printer purr along at 14 cps. It's a tough, durable little machine and does everything a big, heavy, expensive printer does — including superscript, subscript, underlining and boldface, only a little slower. Automatic single sheet loading adds new convenience.

Just think of it: everything you want in a letter-quality printer ... anywhere you want it.

Only \$599.



Transtar 120

P.O. Box C-96975, Bellevue, WA 98009

Circle 358 on inquiry card.

by **Vivitar**

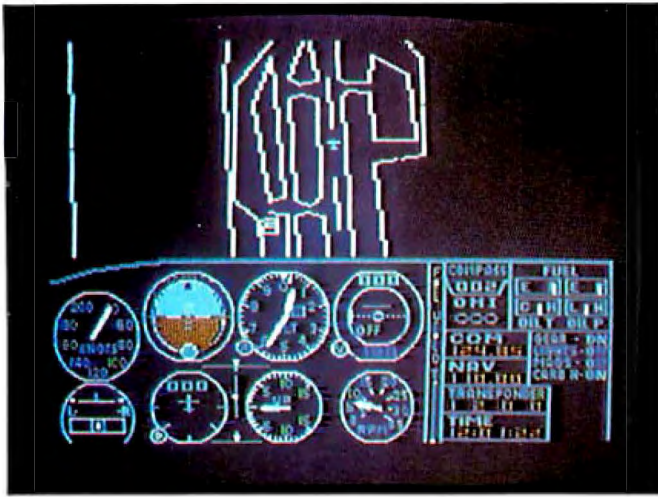

Photo 4: "Radar" view of your aircraft at rest on the runway. Left to right, the top four round instruments are airspeed, attitude, altimeter, and Omni-Bearing with glide slope (navigation); the bottom four round instruments include a turn coordinator, heading indicator, vertical-speed indicator, and tachometer. Also shown are control-position indicators for ailerons, elevator (and trim), rudder, flaps, and throttle. Beneath the compass (top right) are outer/middle/inner marker lights, communication and navigation radios, an identification transponder, and a clock. The top, far right, of the instrument panel holds fuel and engine oil temperature and pressure gauges as well as landing-gear, lights, magneto, and carburetor-heat indicators.

viously mentioned, a landing involves a great deal to reach the ground at the same time the runway starts—without hitting the ground. It's damn tough in the simulator and took me about 15 tries to get it right. There was a satisfying feeling of accomplishment when I finally made it and heard the squeal of the wheels hitting the pavement. Even then you have to be careful—otherwise you'll bounce a few times before coming to a stop.

Advanced Flying

Once you've conquered the rigors of basic flying (which might take weeks of concentrated effort for beginners), you can graduate to more involved flights, such as those at night or from airports with control towers. Messages from the tower appear as text that marches across the top of your screen. Just as in a real airport, you'll receive clearance, contact ground control, taxi to the active runway, contact the tower (which will give takeoff clearance), and take off. All along the way you'll be told to change frequencies and will stay in contact with controllers until you're out of the airport area. It's incredibly realistic.

The pinnacle of the pilot's art is flying by instruments. Getting an instrument rating is a long and involved process that requires many hours of concentrated ground and flight instruction. Although Microsoft's manual tells you all you need to know about how to operate the instruments, understanding *how* to fly by instruments is well beyond its scope. If you plan to do any extensive instrument flying, Microsoft suggests obtaining the *Instrument Flying Handbook* published by the FAA. If you're

not familiar with instrument flight, it's an absolute essential.

Instrument flying with the simulator is, if possible, even more fun than VFR. Like the real thing, it requires intense concentration. You can fly complete trips in IFR, receiving instructions from the ground and tracking your course using VOR (VHF omnidirectional range) stations along your path. You might be asked to fly a holding pattern and then make an instrument approach through heavy overcast. Breaking out lined up with the runway and making a perfect landing is truly an exhilarating experience. If you're a real glutton for punishment, you can even program in some heavy turbulence or aircraft problems that can be surprising. Making a successful landing after one of these flights may tempt you to kiss the carpet under your computer.

The Negatives

Despite its fantastic graphics and realism, I had one large problem with the simulator, the keyboard. After many hours of use, I still had to stop and think about which keys I needed to press in order to get the airplane to do what I wanted it to. Sometimes the delay was fatal. Unlike a real aircraft simulator, it's never possible for more than a few seconds to actually feel like you're flying a real aircraft. Airplanes use controls, not keyboards; and whatever sense of reality existed quickly evaporated when I had to press a key. As a pilot, that reality of the keyboard was an intense bother, although I suspect someone who's never flown an airplane won't have that problem to the same degree that I did.

With all the features programmed in, it's difficult to criticize the simulator for a few minor inconsistencies over a real aircraft. The major one, which amused me greatly, was the ability to do barrel rolls and even fly upside down. The actual aircraft the simulator is patterned after is incapable of doing that. Airplanes designed for inverted flight must have special oil and carburetion systems that work in any attitude.

Conclusions

The Microsoft Flight Simulator is a tour de force of the programmer's art. It acts like a real airplane, and the numerous variables that must be kept track of in actual flight are required here as well. It can be an excellent introduction to how an aircraft actually operates for a budding or student pilot and can even help instrument pilots or those going for an instrument rating sharpen their skills. It is, however, no substitute for professional FAA-approved flight instruction and is not recognized by flight schools or the FAA, so don't expect credit. The major block to its being rated excellent is that you *must* use a keyboard. I suspect that prospective pilots who use the flight simulator first may have some problems in converting to a real control yoke and rudder pedals. ■

Stan Miastkowski (POB 445, Peterborough, NH 03458) is a licensed pilot and currently is the computer columnist for Esquire magazine.

Think ahead.

The Accounting Partner™ can carry you into the future for only \$395.

Face it.

If you have a growing business with sales up to 5 million, there's a 90% chance you'll be using a micro-computer by 1990.

That's why Star Software Systems™, probably the most sophisticated name in computer software, created The Accounting Partner.

The Accounting Partner

is a complete, user-friendly

accounting package comprised of General Ledger, Accounts Receivable,

Invoicing, Accounts Payable, Purchase Orders and Payroll Programs. All for the single price of \$395.

Suppose you're the average businessman shopping for a micro-computer. Chances are, you'll wind up paying three, maybe four thousand dollars for it.

Then, it's awfully easy to get hooked into spending an equal amount just for the software. It's like paying as much for your tires as you did for your car.

And that's where The Accounting Partner is light years ahead. For only \$395 it will satisfy your accounting needs. A value no other system can match.

And the bonus is how easy The Accounting Partner is to use. With menu-driven programs, fully formatted screen displays, extensive error checking, on-line editing and updating, integration calculations performed and complete audit trails.

Also, The Accounting Partner is compatible with any CP/M®, CP/M-86®, MS-DOS™ or PC-DOS® computer (8-bit or 16-bit)*.

For feature-by-feature breakdowns see your local Star dealer or call Star Software Systems at (213) 538-2511.

*Handles totals up to \$999,999,999.99.
CP/M® and CP/M-86® are registered trademarks of Digital Research, Inc. MS-DOS® is a trademark of Microsoft, Inc. PC-DOS® is a registered trademark of IBM.
Requires a minimum of 56K RAM, two disk drives or hard disk, a 24 x 80 video display with cursor addressing and a printer with 132 columns.
16 bit systems require 128K RAM.
Customer support available for nominal fee.



THE ACCOUNTING PARTNER™ ... \$395.



Era one.

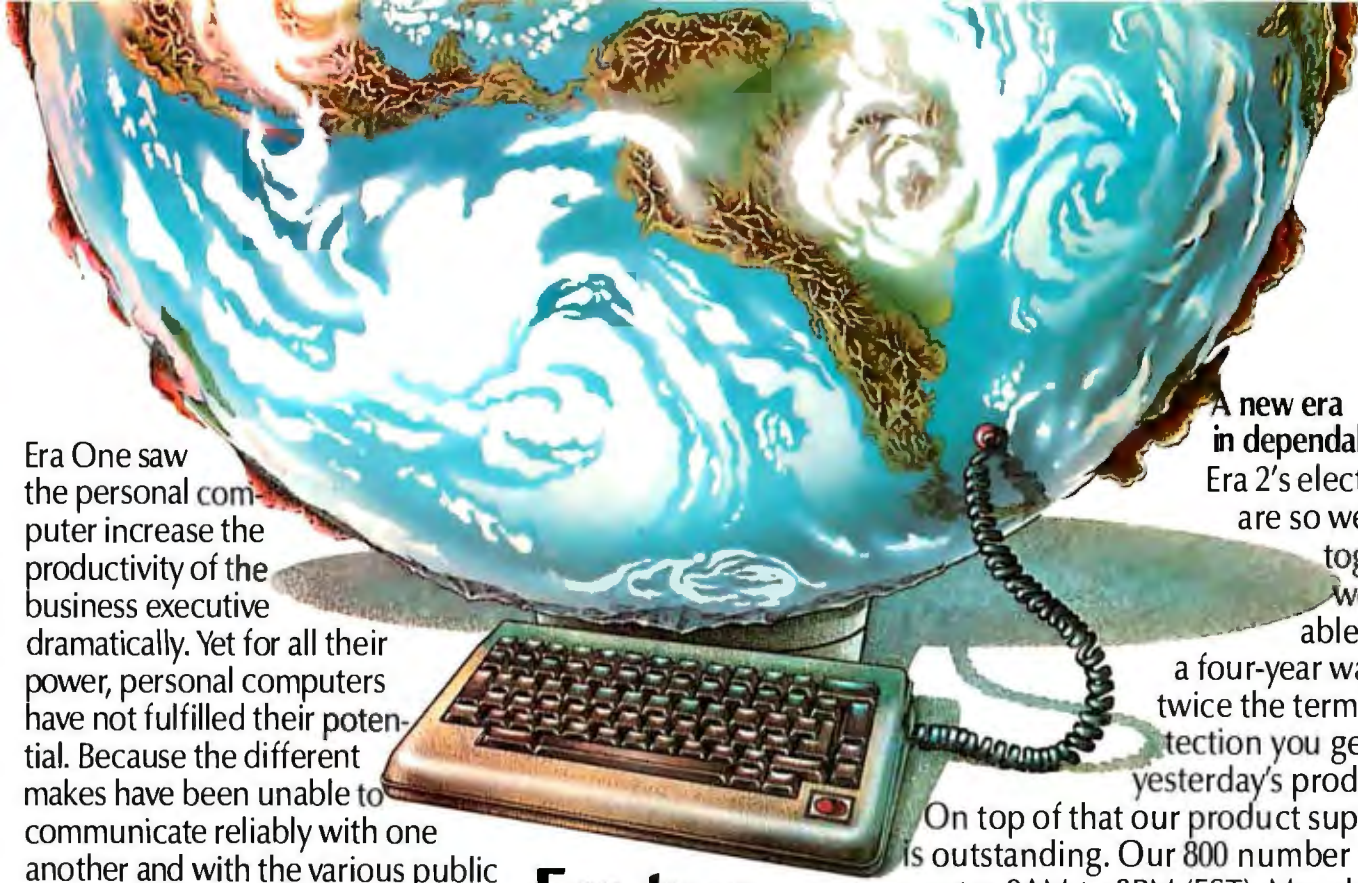

Era One saw the personal computer increase the productivity of the business executive dramatically. Yet for all their power, personal computers have not fulfilled their potential. Because the different makes have been unable to communicate reliably with one another and with the various public data networks.

Era two.

But now, Microcom moves the personal computer into a new era of communications compatibility with Era 2—the first Personal Computer Communications System with the industry-standard communications protocol MNP. Era 2 finally enables dissimilar personal computers to communicate with one another reliably and cost effectively. It also allows the personal computer to access public data networks easily and error-free.

A closer look at Era 2.

Era 2 with MNP is a 1200 baud Communications System (software and inboard modem) designed to operate with the IBM PC, PC XT, compatibles and PCjr; Apple IIe, Apple II Plus and Apple II. Its features include IBM 3101, Digital VT-100 and VT-52 terminal emulations. Era 2 executes multiple functions with a single keystroke. Stores a virtually unlimited number of telephone numbers – each one up to 31 digits. Era 2 is Bell 212A compatible, works with Pulse or Touch-tone™ dialing. Its speaker alerts you to busy signals, wrong numbers, etc. Era 2 gives your personal computer error-free compatibility with other personal computers, data bases, mainframes, almost any information source that can be reached by telephone line.

Microcom, Era 2 and MNP are trademarks of Microcom, Inc. Apple is a trademark of Apple Computer Inc. Digital is a trademark of Digital Equipment Corporation. IBM is a trademark of International Business Machines Corporation.

A new era in dependability.

Era 2's electronics are so well put together we're

able to offer a four-year warranty—twice the term of protection you get from yesterday's products.

On top of that our product support is outstanding. Our 800 number operates 9AM to 8PM (EST), Mondays through Fridays, 9AM to 5PM Saturdays with experts available to solve any problem or answer any question.

The state of the price of the state of the art.

We're able to offer Era 2 for an amazing \$429. By any standard the price/value ratio of Era 2 is outstanding.

Move your personal computer forward into a new era of communications. Visit your Era 2 dealer soon. Call 800-322-ERA2 (in MA, 617-762-9310) for the name of one nearest you. Or write us, Microcom, Inc., 1400A Providence Highway, Norwood, MA 02062. We'll send you a brochure with complete information on Era 2. **Only from Microcom: The Personal Computer Communications System with MNP.**



The Eagle PC

A clone with a few improvements and a few mistakes

by Tom Wadlow

The *Eagle PC Reference Guide* describes the Eagle PC as "a compact, modular personal or business computer system for the serious user with an eye to his budget." The Eagle is all those things, but it does have its shortcomings.

The bottom-of-the-line Eagle PC is the Eagle PC-E, which costs \$1995 for 64K bytes of RAM (random-access read/write memory), one 320K-byte floppy-disk drive, a keyboard, a parallel port; and two serial ports. It comes with no display board, monitor, or software. For \$3495, you can get the Eagle PC-2, which comes with 128K bytes of RAM, two 320K-byte floppy-disk drives, a monochrome monitor, MS-DOS and CP/M-86, Eaglewriter, and Eaglecalc. Photo 1 shows the Eagle PC-2.

Hardware

Physically, the Eagle PC resembles the IBM PC. A pleasant feature for those with limited desk space is the little alcove underneath the chassis. You can slip the keyboard into this alcove when the system is not in use. The cavity, shown in photo 2, extends to the rear of the machine on the right side so that the keyboard cable can be routed through it. This is far superior to IBM's layout, in which the keyboard cable must come around the side of the machine, where it can get in the way. Unfortunately, the Eagle's cord enters the keyboard enclosure at an angle that guarantees the keyboard will not slide easily into the alcove. You can get around this by picking the keyboard up as you place it in the cavity, but a quick, one-handed push would have been nicer.

The Eagle has carried over one of my pet gripes from the IBM. I prefer to place my monitor beside the computer rather than on top of it. Both IBM and Eagle put their video connectors and power connectors on opposite sides of the rear of the chassis, so no matter which

side you put the monitor on, one of the cables will be too short. An extra six inches of cable would eliminate this problem.

The Eagle's construction leaves something to be desired if you intend to do simple maintenance on it. There are no less than 17 small screws of three similar (but not identical) sizes that you must remove to get at the inside of the unit. As a result, changing one of the power-supply fuses (two are outside, one inside) or adding a new set of memory chips involves removing and replacing 17 soft-metal Phillips-head screws. Do it with extreme care and you won't have a problem. But it doesn't take much to strip the slots for the screwdriver and wind up with a jammed screw.

The Eagle does not perform a lengthy memory test on power-up, as the IBM PC does, so the machine will boot almost instantly when turned on. It can also be warm-started in the same manner as the IBM PC, by typing Ctrl-Alt-Del as one keystroke. And like the IBM, the Eagle cannot perform this vital function (short of turning the power off) when a program bug trashes the software that listens for a Ctrl-Alt-Del.

In my opinion, the hierarchy of personal computer features should be as follows: display, keyboard, mass storage, and anything else. The quality of the display should take precedence in both design time and effort over the keyboard, and the keyboard over the mass storage, and so on. Engineering involves compromises between goals and costs, and while a properly designed computer will still have compromises, they should be deep enough inside the machine to escape notice. Compromising a display or keyboard is asking for trouble.

By this measure, the Eagle isn't quite up to what I would like to see in a personal computer. The optional Eagle display, when no motion is taking place, is a very



Photo 1: *The Eagle PC.*

close copy of the IBM monochrome display. Motion, however, is a different story entirely. The Eagle monochrome display scrolls in a visible ripple that is quite unpleasant to watch. Combining this with the long-persistence phosphor on the monitor makes the Eagle display annoying for any serious text editing. An IBM monochrome display board does work quite well, however, in place of the Eagle display. It produces both attractive text and acceptable speed. I couldn't tell if bad interactions take place between the two printer ports when an IBM display is used. Since the expansion bus is also IBM PC compatible, most of the display boards on the market should work with the Eagle. As with all such mix-and-match components, you should check with the manufacturers to ensure compatibility.

My biggest complaint about the Eagle concerns the keyboard (see photo 3). The keyboard is the means by which you communicate with your computer. The better you can do that, the better you can use your computer. I am a touch-typist and have used dozens of keyboards, both professionally and personally, over several years. These days, I move quite easily between my home IBM keyboard (with its accursed Shift and Backspace keys) and a Lisp Machine keyboard at work (which has seven different kinds of Shift keys, any combination of which can be, and often is, used with a single character). As you can see, I am used to dealing with a variety of often quite peculiar keyboards.

The Eagle keyboard certainly qualifies as peculiar. While the alphanumeric keys are laid out more traditionally than on the IBM keyboard, they are not as widely spaced. My left hand always found the proper Home keys, but my right hand invariably went one key too far to the right. The Eagle keys have a mushy feel, with very little tactile feedback. This is fine if you just want to hit

a key or two, but with extensive typing or word processing, it becomes quite bothersome.

There are some serious errors in the layout of the other keys. My particular favorite is the way the cursor-control keys are laid out. The IBM PC places cursor control on the 2-4-6-8 keys of its numeric keypad. This layout is satisfactory, unless you want to enter numbers and move the cursor at the same time, which is not uncommon. Eagle chose to remove the cursor-control keys from the numeric pad and place them between the Enter key and the numbers. So there, in a vertical column, you have Up, Right, and Down. The Backspace key does double duty as Left, but you have to type Shift-Backspace to get the proper Left code. This layout is not very intuitive, not to mention being somewhat uncomfortable, and you



Photo 2: *The expansion-card connector cavity. The keyboard connector is to the left of the card connectors. The dark rectangle at the top is the magnetic catch. To get at the expansion slots, you can remove the piece of metal to which the cavity door is hinged.*



Photo 3: *The Eagle's keyboard.*

spend a lot of time rubbing out characters every time you want to move left.

A little experimentation produced the undocumented fact that the 2-4-6-8 keys on the number pad do produce cursor-control codes when shifted. Unfortunately, neither the Shift-Lock nor the Alpha-Lock keys affect the number keys at all, so you must always hold down a Shift key to use this feature.

Many of the function keys are labeled with functions for one or more of the Eagle applications programs. For example, hitting the function key labeled Files in Eaglecalc displays a directory of the current disk. While I have nothing against this per se, it seems to me that a general-purpose keyboard and a nice set of cardboard overlays would save us all the trouble of explaining to a novice why the Files key doesn't work with dBASE II or some other non-Eagle product.

Eagle does have one special key that I do like a great deal—the Help key. And it does exactly what you would expect it to when you use it with Eagle software.

Unlike the IBM keyboard, the Eagle keyboard has mechanically locked Shift-Lock and Alpha-Lock keys that actually give some indication of the state of the keyboard. It is just a hint, though, since a program can set these locks in software. Thus, under some all-too-frequent circumstances, the actions of the two lock keys can be reversed, so that lowercase can be achieved only by keeping the Shift-Lock down.

The keyboard has lots of other peculiarities, such as the numeric keypad with convenient Plus, Minus, and Times keys, but no Divide. Or the Enhance key, which is as big as the Enter key and takes up a space that would be a pretty good location for a correctly configured set of cursor-control keys. Enhance is used only in Eaglewriter, and I really had to dig in the manual to find out

where. But the major peculiarity of this keyboard is that it exists at all. Several companies are making good money selling properly designed keyboards for the IBM PC. If Eagle had simply chosen one of those keyboards, it would be in a very enviable position compared to the IBM PC. Perhaps the “not invented here” syndrome isn't limited to IBM. As Eagle's keyboard exists today, the only people that will benefit by its presence are the companies that sell Eagle-compatible replacement keyboards.

The Eagle can support two double-sided double-density disk drives; the second drive is optional. They are half-height Teac drives, and the design of the enclosure precludes any possibility of converting to more than two half-height drives (as you can do with the IBM PC). I had no problem running the disks with MS-DOS 1.1 (giving each a formatted capacity of 320K bytes) or with MS-DOS 2.0 (capacity 360K bytes). Disk access is not as fast as the IBM PC; in fact, formatting a single floppy disk on the Eagle takes several times longer than formatting on the IBM. It seems to be a problem with either the disk controller or the low-level Eagle software, since both MS-DOS and CP/M-86 maintain this snail's pace.

The Eagle has a three-slot expansion bus for the addition of special boards. One of these slots is used for the display board and one is used for the disk controller, so, in effect, you have only one slot to play with. Luckily, the major uses of the expansion slots are already taken into account on the motherboard. For instance, the Eagle has enough memory-chip sockets to handle up to 512K bytes of RAM. Eagle has also done what IBM should have: included one parallel and two serial ports on the motherboard. So most typical uses for a PC can be met with an Eagle and one board.

Access to the expansion bus is through a plate screwed

WE ALL AGREE



Auto Cut Sheet Feed (option)

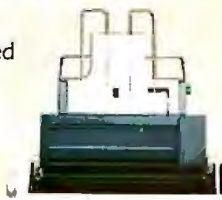

Tractor Feed (option)



Keyboard (option)



We can't think of anyone who isn't better off with A DX-15 DAISY WHEEL PRINTER.

Dynax's DX-15. And if you want the kind of printer that lives in the fast lane, the DX-15 is your printer. It does it all, certainly all that far more expensive models can do. The DX-15 offers you some important options like Keyboard, Tractor Feed and Auto Cut Sheet Feed. Not only that, the DX-15 is a very durable unit, be it for business, home or word processing applications. And who says a great printer has to be expensive? Not us! What we say is you'll be dumbfounded when your dealer tells you just how inexpensive the DX-15 happens to be. Give him a call or drop by. Dynax's DX-15 says it ALL.

Dynax, Inc.

5698 Bandini Blvd., Bell, CA 90201
(213) 260-7121

Circle 135 on inquiry card.

At a Glance

Name

Eagle PC

Use

IBM PC-compatible desktop computer

Manufacturer

Eagle Computer Inc.
983 University Ave.
Los Gatos, CA 95030
(408) 395-5005

Components

All models: The system unit is 20.5 inches wide by 5.75 inches high by 13 inches deep. The keyboard is 19 inches wide by 1.75 inches high by 8.75 inches deep. The entire system weighs about 40 pounds. All feature a 4.77-MHz 8088 microprocessor, a 105-key separate keyboard with 24 user-definable keys, RAM expandable to 512K bytes on the main board, two built-in RS-232C ports, and one parallel port. Also, they have three expansion slots—one for the disk controller, one for the display (except PC-E), and one for additional devices.

Eagle PC-E: 64K bytes of RAM and one 320K-byte floppy-disk drive

Eagle PC-1: 128K bytes of RAM, one 320K-byte floppy-disk drive, and a 12-inch, 720- by 320-pixel monochrome monitor

Eagle PC-2: 128K bytes of RAM, two 320K-byte floppy-disk drives, and a 12-inch, 720- by 320-pixel monochrome monitor

Eagle PC-XL: 128K bytes of RAM, one 320K-byte floppy-disk drive, and a 10-megabyte hard-disk drive

Software

MS-DOS, CP/M-86, Eaglewriter, and Eaglecalc are included with the Eagle PC-1 and PC-2. This software costs \$810 separately.

Options

Hardware

64K-byte RAM add-on kit	\$135
8087 coprocessor	\$495
320K-byte floppy-disk drive	\$500
10-megabyte hard disk	\$2495
32-megabyte hard disk	\$3995
Hard-disk interface	\$125
Monochrome monitor	\$329
Monochrome adapter	\$295
Medium-resolution color board	\$295

Software

MS-DOS	\$60
CP/M-86	\$60
MP/M-86	\$395
GW BASIC	\$245
Eaglewriter	\$495
Eaglecalc	\$195
Flex Menu	\$50

Documentation

An Eagle PC Reference Guide for novice users, but no technical documentation. Eagle-supplied programs contain a great deal of on-line documentation.

Price

Eagle PC-E	\$1995
Eagle PC-1	\$2995
Eagle PC-2	\$3495
Eagle PC-XL	\$4495

Comments

Poor keyboard, marginal display. Seems to run most IBM PC software.

to the bottom of the Eagle chassis. Thus all the boards are "upside down" compared to their orientation on an IBM PC. Even so, I found it much easier to swap boards on the Eagle than on the IBM PC. The light weight of the system unit made it very easy to disconnect the cables, flip the unit over, and pop the boards out. The connectors on the side of the board stick out into a small cavity, actually inside the body of the Eagle. On the IBM, the connectors stick out the back. To get at the board connectors, you can open a small magnetically latched door on the side of the Eagle. The keyboard connector is in the same area.

I wonder about Eagle's decision to use a magnetic latch on a piece of equipment that is going to be in the immediate vicinity of delicate magnetic media. Surely a mechanical catch would have worked equally well and eliminated the threat to the floppy disks.

Firmware

The ROM (read-only memory) routines in the Eagle are different from the IBM PC's firmware routines. Unfortunately, Eagle does not include any documentation on the low-level differences between its machine and the IBM. Eagle claims to have several technical manuals in the works, but as of this writing none were available.

Eagle now offers Revision C of its ROM set, which is supposed to emulate the IBM PC better and increase dis-

play performance. The revision also makes the Eagle fully compatible with IBM-style keyboards and the Epson MX-80 printer. I was not able to test these new ROMs, but they are currently available from Eagle.

Extensive installation instructions accompany the new ROM set. You'll need to open the Eagle chassis, so be careful that you don't strip those soft screws. Performing the ROM upgrade might be an excellent opportunity to replace the screws with better quality ones to avoid future problems.

Software

Eagle sells several application packages for the Eagle PC. Because the machine seems to run MS-DOS fairly well, many more packages should run with it. Eagle's version of MS-DOS is labeled 1.25 rather than 1.1 or 2.0. A version of CP/M-86 is also available.

Eagle supplies a menu-driven disk utility that performs copies and formatting. It's a good idea, but I managed to crash the program (and the machine) in the first few minutes of running the disk utility by bumping some keys on the keyboard and causing a DIVIDE OVERFLOW error. Of all utilities, a disk-copy program (the first program you should use on any new system) should be absolutely bombproof.

Eagle does not supply a BASIC interpreter with its machine. BASIC being the quasi-standard that it is, this is



UNIX, with change.

With Idris, developers get the functionality, compatibility and portability of UNIX. And pocket the Idris difference.

- **GREATER PORTABILITY.**

Applications developed under Idris on any micro compiler can run on any other which supports Idris. These are PDP-11s (including PRO-350 and Micro-11), numerous Motorola 68Ks and the 8086/88 based IBM PC and DEC Rainbow.

Idris runs under MS/DOS as an application!

- **COMPLYING WITH THE UNIX USER GROUP STANDARDS.**

- **TWICE THE NUMBER OF USERS** as UNIX on comparable hardware, because Idris is optimized for microprocessors.

- **MORE DISK SPACE FOR FILES AND PROGRAMS.** Idris occupies less than 1.5 megabytes of disk.



- **MORE COST EFFECTIVE PER USER.**

The \$550 end-user price is for as many users as the hardware will allow.

- **MORE TASKS RUN SIMULTANEOUSLY**

because Idris requires less memory. Typically, 50 KB for the Kernel plus 50 KB for a compile. For example, you can overlap communication simultaneously with word processing and spreadsheet analysis and Fortran compilation.

- **EASY END-USER LICENSING**

provided by use of Whitesmiths' authorization seal.

That's UNIX with change. To get more out of your computer, call or write to Whitesmiths, Ltd.

Whitesmiths, Ltd.

Circle 381 on inquiry card. 97 Lowell Road Concord, MA 01742
(617) 369-8499 Telex 951708 SOFTWARE CNCM

UNIX is a trademark of Bell Laboratories; DEC, PDP-11 and Rainbow are trademarks of Digital Equipment Corporation; IBM and IBM PC are trademarks of International Business Machines Corporation; MS-DOS is a trademark of Microsoft Corp.; Idris is a trademark of Whitesmiths, Ltd. Distributors: Australia, Fawnray Pty. Ltd., Hurstville, (612) 570-6100; Japan, Advanced Data Controls Corp., Chiyoda-ku, Tokyo (03) 263-0383; United Kingdom, Real Time Systems, Douglas, Isle of Man 0624833403; Sweden, Unisoft A.B., Goteborg, 031-13-56-32.

surprising. Instead, Eagle offers GW BASIC as a separate product.

Eaglewriter is a word-processing program that is tailored to the Eagle's keyboard. It can be used with other keyboards (IBM's, for instance) but is best suited to the Eagle's. Eaglewriter uses explicit end-of-line marks and a large set of commands. It is very flexible in dealing with the printer. It has several kinds of global search and replacement commands, a real must for serious editing. Most important, Eaglewriter has a macro capability. Macros are stored sequences of commands that the user can create. Eagle supplies several macro packages that do such varied and useful things as mail merges, sorting, selective printing (printing a portion of the file), multifile printing, boilerplate letters, and filling in forms. Macros are usually seen only on mainframe computers or expensive professional workstations, though they are becoming more popular on personal computers. It is very encouraging to see that Eaglewriter is equipped with such a powerful tool.

I was not too impressed with Eaglewriter's human interface, but I suspect this is a matter of taste rather than bad design. One slight drawback is the cumbersome way that Eaglewriter handles files larger than 16K bytes. Since handling files is a fairly mechanical operation (there is a 12-step procedure for it in the manual), the Eagle's designers might have let the program perform the operation for you. Unfortunately, they didn't.

Eaglecalc is a typical spreadsheet program designed to be compatible with the Eagle keyboard. It has a spreadsheet size of 255 rows by 64 columns. It performs adequately and has the right features, such as variable-width columns and formatting. It can be run independently of the Eagle keyboard, but it functions at its best with the dedicated function keys. It also has a fairly extensive Help utility.

Both Eaglewriter and Eaglecalc can be called via a menu that can be invoked by placing the proper disk in drive A and rebooting. The menu is somewhat useful for a novice user but very limited in function. The menu system has no provision for switching application programs short of rebooting. Each menu has a QUIT command that prints a message telling you to turn off the power and then paralyzes the processor. None of the menus has any provision for dropping into the DOS command processor (you can do it, but you have to type Control-C at exactly the right time). Unlike some other menu systems, this one is written as a binary program file, so it cannot be extended. Eagle does offer a program, Flex Menu, that lets you design your own menus, but it wasn't included in the package I tested.

System Support

For the novice user, the Eagle documentation is pretty good. Because it has a cookbook approach, you don't need much technical background to read it. In addition, the manuals are full of examples. However, no technical documentation is provided for advanced users.

Except for BASICA, all the IBM software at my disposal ran on the Eagle. This included the Multiplan spreadsheet, dBASE II, Peachtext, Wordstar, the Finalword, and Laboratory Microsystems' FORTH. Conversely, Eaglewriter and Eaglecalc both ran on the IBM PC. MS-DOS 2.0 also ran on the Eagle with no noticeable difficulties.

Eagle isn't the easiest company to deal with for user support. A call to the company's headquarters for technical answers involves a lot of time on hold and replies such as, "That's not my department, but I'll forward you to the XXX department." But there are people deep in the bureaucracy who know the answers to technical questions; it just takes patience to reach them.

Conclusion

The Eagle is a fairly acceptable machine. The problems with the display are slightly annoying but not enough to remove the machine from serious consideration as an alternative to the IBM PC. With the latest ROM set, the Eagle display should perform acceptably.

The Eagle keyboard is a more serious problem, but if you're doing only a small amount of typing, it might not present too much of a problem. For serious word-processing, database, and spreadsheet applications, you should seriously consider a better keyboard, such as an IBM or an IBM compatible. ■

Tom Wadlow is an engineer at the Lawrence Livermore National Laboratory. He can be reached at POB 2755, Livermore, CA 94550.

DECADES OF SERVICE
FROM THE NATION'S LARGEST NEC DEALER

NEC THE PERFECT SOLUTION

Advanced Personal Computer **PC-8800**



INCLUDED:

- Comprehensive Business Software
- High Resolution Graphics
- 8 & 16 Bit Power
- Built-in Reliability
- User Friendly

PC-8200 portable computer

- Low Prices
- Support
- Service
- Leasing
- Exporting

NEC, IMS, MORROW ON GSA & N.Y.S. OGS CONTRACTS

Washington Computer Services

97 Spring Street (212) 226-2121 an affiliate of (WASHINGTON) ELECTRIC COMPANY, INC. since 1972

HOURS: 9AM - 5 PM / Monday-Friday TELEX: 12-5606 CABLE: WASHCOMPNYK

PLEASE! Do not confuse us with mail order dealers. We are a full service distributor serving the data processing & installation needs of business and industry from micros to mainframes. System houses, educational institutions & governmental agencies given special consideration. Dealer and international inquiries welcome.

YOU *NEED* MORE THAN JUST MAIL ORDER PRICES

MICROCHARGE

MICROHOUSE will finance your purchases. Buy your computers, peripherals, or software now—and PAY LATER.

CORPORATE PLAN

Volume purchasers need SPECIAL ATTENTION. We offer research, technical support, and special pricing. Call for your account representative.

SELECTION

We have one of the largest selections in the industry. We carry peripherals, software, and supplies for all major computers.

SALESMAN

Don't be shocked when you call and hear a friendly voice. Our salesmen enjoy working with you. They also answer compatibility and information requests.

TECHNICAL SUPPORT

We support all products we sell. During our 4 years we have developed one of the best staffs in the industry.
(215) 868-4133.

INSTANT SOFTWARE

We can immediately send in-stock software to you over the phone.

MICROLINE

The first dedicated computer shopping center. Use your modem to look at descriptions, prices, order or see what's available.
(215) 868-1230

PAYMENT

Talk about flexible. We accept VISA, MasterCard, American Express, cash, COD's and purchase orders. And, of course MICROCHARGE.

FORMAT CONVERSION

We have the capability to copy files and programs between many of the most popular computers.

LANGUAGES

FORTRAN	\$289
C Compiler	329
BASIC Compiler	285
BASIC Interpreter	249
COBOL	539
muLISP/muSTAR	144
muMATH/muSIMP	189
PASCAL	249
CBASIC	95
CBASIC Compiler	329
PLI-80	489
DR-LOGO	89
Access Manager	199
Display Manager	269

DATA/GRAPHICS

PFS: File	\$95
PFS: Report	79
PFS: Graph	95
dBase II	429
Visifile	179
Quickcode	179
Infostar	279

FINANCIAL

Home Acct.	\$94
Visicalc	164
Visitrend/Plot	199
TK Solver!	205

MISCELLANEOUS

Crosstalk	\$109
Word & Mouse	339
Norton Utilities	59
Password 1200	379
Apple Cat II	279
D-Cat Modem	159
Maxell MD-1	29
Maxell MD-2	40
Quadboard 64K	279
CCS 132 col for IBM	599
Visiword	259
CDEX Training	59
BMC 12" green	89
Cables	Call

(800) 523-9511 **MICROHOUSE**

215 • 868 • 8219

BOX 499, DEPT. 200
BETHLEHEM, PA 18016

Prices subject to change without notice

OUR AD #B1

ALL MAIL: Conroy-LaPointe, Inc., P.O. Box 23068, Portland, OR 97223
SHOWROOMS AT: PORTLAND, OR or SEATTLE, WA - BOTH OPEN M-SAT 10-5

HARDWARE for The APPLE II+ / IIe SOFTWARE for APPLE II+ / IIe

	LIST PRICE	OUR PRICE
APPLE IIe, 128K, 80 COLUMN APPLE IIc STARTER SYSTEM by APPLE (S/R A) 64K and 80 column Disk I with controller Apple Monitor		CALL
APPLE IIe STARTER SYSTEM by CONROY-LA POINTE (SYSTEM B) 128K and 80 column 1 Micro-Soft Drive with controller File, Utility and Apple DOS 3.3 Diskette Zenith 12" Green Monitor RF Modulator (for color TV) Game Paddles Game w/color graphics and sound 50 Blank Generic Diskettes		CALL
LIMITED WARRANTY: is 100% Parts & Labor for 90 days by us.		



VIDEO CARDS

* ALS, Smartcom II (+ or e)	\$ 179	\$ 199
ComX, 80 col +64K RAM (I/e) 1 yr. wty.	\$ 199	\$ 99
Videa, Video Term 80 col (+ or e)	\$ 345	\$ 228
* UltraTerm (+ or e)	\$ 75	\$ 78
Soft Video Switch (II+)	\$ 145	\$ 99
Enhancer II (II+)	\$ 79	\$ 59
Function Strip (II+)	Up to 35% off	

MISCELLANEOUS

ALS, The CP/M Card V3.0 (+ or e)	\$ 399	\$ 299
Z-Cart (+ or e)	\$ 35	\$ 129
ASTAR, RF Modulator, to use TV	\$ 35	\$ 25
* CCS, Serial Interface 7710A (Set BAUD)	\$ 150	\$ 99
Chalkboard, Power Pad	\$ 100	\$ 75
Eastside, Wild Card (copier, + or e)	\$ 140	\$ 99
Wild Card Plus	\$ 190	\$ 139
Kensington, System Saver	\$ 90	\$ 85
Key Tronic, KB200 keyboard (II+)	\$ 298	\$ 219
Koala, Touch Tablet w/Micro Illustator	\$ 125	\$ 85
Kraft, Joystick (Ap II/II+)	\$ 65	\$ 49
Paddle (Ap II/II+)	\$ 50	\$ 39
M&R, Super Pan (+ or e)	\$ 50	\$ 39
* Microsoft, Z80 Softcard (+ or e)	\$ 345	\$ 235
* 280 Softcard Plus (+ or e)	\$ 645	\$ 459
* 280 Softcard Prem. Pack (II+)	\$ 655	\$ 395
* 280 Softcard Prem. Pack (I/e)	\$ 349	\$ 269
* Micro Tek, Dumping 64, Buffer	\$ 175	\$ 119
* Orange Micro, Grappler Plus (e or +)	\$ 175	\$ 119
16K Buffer Board for Grappler +	\$ 245	\$ 179
Buffered Grappler+, 16K	\$ 50	\$ 39
Printer, Lower Case Chip (II+)	\$ 375	\$ 275
* PCPI, Appli-Card, 14 features 6MHz	\$ 595	\$ 479
128K RAM Ext. w/Applikisk 6MHz	\$ 75	\$ 59
RH Electronics, Super Fan II	\$ 299	\$ 199
* Tran/Sum, Accelerator II	\$ 285	\$ 185
Transend/SSM, AI/OI, Serial/Para I/F	\$ 40	\$ 29
TG Products, Game Paddles (II+)	\$ 50	\$ 45
Joystick (II+)	\$ 229	\$ 169
Videa, PSID I/F Card	\$ 179	\$ 119
WICO, Mouse, Complete	\$ 130	\$ 89
Handler Pak (Word, List & Spell)		

DISK DRIVES

AmDisk II, 3" Micro-Floppy, 143K	\$ 299	\$ 249
* CENTRAL PT., Filr, Util & Apple DOS	\$ 20	\$ 15

μ-SCI	PRICE	OUR PRICE
A2, 143K Disk Drive	\$ 479	\$ 230
A82, 143K to 328K Drive	\$ 569	\$ 429
MICRO-SCI A2 Controller Card	\$ 100	\$ 79
* A40, 160K, Drive	\$ 449	\$ 299
* A70, 286K, Drive	\$ 599	\$ 299
A40 A70 Controller	\$ 100	\$ 79

1/2 HIGH ALPS, A40, Belt Dr. 163K	\$ 249	\$ 199
TEAC, T40, Direct Dr. 163K	\$ 349	\$ 239
TEAC/TD, 180, Sided, 326K	\$ 449	\$ 329
Controller Card by ComX	\$ 110	\$ 99

Rana Elite I, 163K, 40 Track	\$ 379	\$ 249
Elite 2, 326K, 80 Track	\$ 649	\$ 399
Elite 3, 652K, 160 Track	\$ 849	\$ 499
Elite Controller	\$ 145	\$ 84

RAM EXPANSION

* ALS, A DO Ram (II+)	16K	\$ 100	\$ 99
* ComX, 16K RAM Card, (II+)	for I/e, 1 Yr. Wty.	\$ 199	\$ 99
* ComX, RAM Card 1 Yr. Wty. (II+)	16K	\$ 179	\$ 99
* Microsoft, RAM Card (II+)	16K	\$ 100	\$ 69
* Titan/Sumum RAM Card (II+)	32K	\$ 249	\$ 169
RAM Card (II+)	64K	\$ 425	\$ 299
RAM Card (II+)	128K	\$ 599	\$ 399

BUSINESS

Applied Soft Tech., VersaForm	\$ 389	\$ 259
Artscl, Magic Window II	\$ 150	\$ 99
Magic Combol (Wind Mail & Words)	\$ 225	\$ 149
* Ashton-Tate, dBase II (Req CP/M 80)	\$ 700	\$ 385
Friday (Requires CP/M 80)	\$ 295	\$ 199
BPI Systems, GL,AR,AP,PR or IV, ea.	\$ 395	\$ 269
Broderbund, Bank Street Writer	\$ 70	\$ 47
Continental, GL,AR,AP or PR each	\$ 250	\$ 165
Home Accountant	\$ 75	\$ 49
FCM	\$ 100	\$ 69
Dow Jones, Market Analyzer	\$ 350	\$ 275
Market Manager	\$ 300	\$ 235
Market Microscope	\$ 700	\$ 525
Fox & Geeler, Quickcode (for dBase II)	\$ 295	\$ 185
dGraph (for dBase II)	\$ 295	\$ 185
dtUtility (for dBase II)	\$ 99	\$ 66
Hayden, Pie Writer (Specify 80col. bd)	\$ 150	\$ 99
Hawthorn, Real Estate Analyzer II	\$ 195	\$ 129
TX Preparer, 1984 Call	\$ 250	\$ 185
LJK, Letter Perfect w/Mail Merge	\$ 150	\$ 99
Micro Craft, (requires Z80 CP/M-Card)	\$ 995	\$ 499
Verdict or Billkeeper	\$ 180	\$ 119
Micro Pro, (all require Z80 CP/M Card)	\$ 495	\$ 325
* WordStar w/Applicard/CP/M/SPECIAL	\$ 485	\$ 230
* WordStar** + Training Manual/SPECIAL	\$ 250	\$ 129
MailMerge** SPECIAL	\$ 250	\$ 129
SpellSta** SPECIAL	\$ 250	\$ 129
* WordStar Professional, 4 Pak SPECIAL	\$ 895	\$ 429
Microsoft, Multi-Pan/CP/M/Apple DOS	\$ 275	\$ 175
Financial, Multitool (CP/M or DDS)	\$ 100	\$ 75
Budget, Multitool (CP/M or DDS)	\$ 150	\$ 115
* Osborne/C.P. Soft. (Disk and Book) (Stat., Bus. & Math)	\$ 100	\$ 49
Some Common Basic Programs (75 ea.)	\$ 100	\$ 49
Practical Basic Programs (40 ea.)	\$ 100	\$ 49
Peachtree, Requires CP/M & MBasic, 64K		
Series 40 GL, AR & AP, all 3	\$ 395	\$ 239
Series 9 Text & Spell, Mail, all 3	\$ 395	\$ 239
Perfect, Perfect Writer	\$ 349	\$ 219
Perfect Writer/Speller-2 pak	\$ 399	\$ 249
Perfect Filter or Perfect Calc. ea.	\$ 249	\$ 149
Writer/Speller/Filter/Calc(4)	\$ 969	\$ 499
Parsoft, Personal Pearl	\$ 235	\$ 195
Parsoft, Word Juggler (I/e)	\$ 299	\$ 179
Lexcheck (I/e) (use w/Juggler)	\$ 149	\$ 99
Sensible, Sen. Speller, specify 800 Bd. Bookends	\$ 125	\$ 85
Sierra/On-Line, ScreenWriter Pro	\$ 200	\$ 135
ScreenWriter II	\$ 130	\$ 89
The Dictionary NEW!	\$ 100	\$ 69
Gen. Manager II NEW!	\$ 230	\$ 155
* Silicon Valley, Word Handler	\$ 60	\$ 35
* List Handler	\$ 50	\$ 35
* Handler Pak (Word List & Spell)	\$ 130	\$ 89
Software Publishing, PFS: File	\$ 125	\$ 84

Stoneware, DB Master Version 4.0	\$ 350	\$ 299
DB Utility I or II	\$ 99	\$ 69
Videx, Appletwiter II preboot disk	\$ 20	\$ 15
Visicart, 80col. preboot disk	\$ 50	\$ 39
UltraPlan (specify board) (+ or e)	\$ 189	\$ 129
VisiCorp/Personal Software		
Visicalc 3.3	\$ 250	\$ 169
Visicalc Enhanced (I/e)	\$ 250	\$ 179
Visifile or VisiDex, each	\$ 250	\$ 179

UTILITY & SYSTEM

Beeble, Apple Mechanic or Diskquik, ea.	\$ 30	\$ 22
Double Take	\$ 35	\$ 25
Typelaces (Req. Ap. Mechanic)	\$ 20	\$ 15
DOSS Back or Utility City, each	\$ 30	\$ 22
Top Disk II	\$ 20	\$ 15
Central Point, Filr, DOS 3.3 & Util.	\$ 20	\$ 15
Copy II Plus (bit copier)	\$ 40	\$ 30
* Einstein, Terminal Prog. (SM or MM, ea.)	\$ 129	\$ 85
Epson, Graphics Dump	\$ 15	\$ 9
Hayes, Terminal Prog. (SM or MM, ea.)	\$ 100	\$ 85
Insoft, GAFORTH by Paul Lutus	\$ 75	\$ 59
Microsoft, A.L.D.S.	\$ 125	\$ 75
Fontan 80	\$ 195	\$ 149

COMPLETE MICROSOFT LINE IN STOCK

* Omega, Locksmith (bit copier) Ver5.0	\$ 100	\$ 75
Penguin, Complete Graphics System II	\$ 70	\$ 53
Graphics Manager	\$ 40	\$ 34
Zoom Grappler	\$ 30	\$ 24
Quality, Bag of Tricks	\$ 40	\$ 29
UtilCo, Essential Data Duplicator III	\$ 80	\$ 49

HOME & EDUCATIONAL

Beeble Bros., Beeble Bag	\$ 30	\$ 22
Broderbund, Chopfliter	\$ 35	\$ 25
Arcade Machine	\$ 60	\$ 40
Label Runner	\$ 35	\$ 25
* Budget Co., Pinball Constr. Set	\$ 40	\$ 27
* Continental, Home Accountant	\$ 75	\$ 49
Datasol, Azeo, or Zoom, each	\$ 40	\$ 27
Edu-Ware, (Large Inventory)	\$ 35	\$ 29
Hayden, Sargon II (Chess)	\$ 50	\$ 34
Sargon III (Chess)	\$ 50	\$ 34
Insoft, Zork I, II, III, or Star Trek, each	\$ 40	\$ 27
Koala, Full line in stock, CALL	Call	
Learning Co., (Large Inventory)	Call	
Micro Lab, Mine 2049er	\$ 100	\$ 69
Monogram, Dollars and Cents	\$ 100	\$ 69
Scarborough/Lighting, MasterType	\$ 40	\$ 27
Sierra/On-Line, Ultima II	\$ 60	\$ 40
SK-Tech, Wizardy	\$ 50	\$ 39
Spinmaker, Kidzcomp (others in stock)	\$ 30	\$ 20
Sub Logic, Flight Simulator II	\$ 50	\$ 37
Terrapin, Logo	\$ 50	\$ 39
OTHER BRANDS AND PROGRAMS IN STOCK, CALL.		

OVERSTOCK SPECIALS

WHILE THEY LAST

CORVUS 8 Meg	\$2095	\$1495
11 Meg	\$2750	\$2185
Drives Are Without Interface	\$330	\$295
IBM-PC Interface Manual, S/W/Cable Kit	\$370	\$249
IBM-PC Omni Transporter, 4 Pak SPECIAL	\$1895	\$1395
Apple Interface, Manual, S/W & Cable Kit	\$695	\$249
* CCS, Serial Interface 7710A (Set BAUD)	\$65	\$59
* ComX, 16K RAM Card, 1 Yr. Wty., for II+	\$179	\$99
* ComX, 80 col. +64K RAM		
for I/e, 1 Yr. Wty.	\$189	\$99
Silicon Valley, List Handler	\$50	\$35
Word Handler	\$60	\$39
* Videx, Videoterm, 80 column card for II+	\$345	\$229

MISCELLANEOUS

Electronic Protection, Lemon	\$ 60	\$ 40
Lime	\$ 90	\$ 60
Peach	\$ 95	\$ 66
Orange	\$ 140	\$ 95
Kensington, PC Saver** Line Card	\$ 50	\$ 39
Network X, Wiretrax, 4 outlet, w/Filter	\$ 70	\$ 49

NEC Computer, PC8201A	\$ 799	\$ 699
16K to 64K		
Data Recorder, PC8281A	\$ 115	\$ 99
Printer, PC8221A, Thermal		
40 col.	\$ 170	\$ 149

HP H/P 12C, Calculator	\$ 120	\$ 99
H/P 10C, Calculator	\$ 90	\$ 75
41CX, Calculator NEW!	\$ 325	\$ 275
41C, Calculator	\$ 195	\$ 149
41CV, Calc., w/2.2K Mem.	\$ 275	\$ 219

for the ATARI		
RANA 1000 Drive, 320K	\$ 449	\$ 369
KDALA, Pad w/Micro IIe	\$ 100	\$ 75

★ MEANS A BEST BUY

DISKETTES

	LIST PRICE	OUR PRICE
BROWN DISK		
10 ea. Rise I, DS/DD, 48TPI	\$ 45	\$ 32
10 ea. Rise II, DS/DD, 96TPI	\$ 60	\$ 45
* CCS, 100 ea SS/DD, 40T (Apple, IBM)	\$ 55	\$ 179
10 ea SS/DD, 40T (Apple, IBM)	\$ 55	\$ 19
100 ea DS/DD, 40T (IBM, H/P)	\$ 750	\$ 295
10 ea DS/DD, 40T (IBM, H/P)	\$ 75	\$ 35
DYSAN, 10 ea SS/SD (Apple), etc.	\$ 69	\$ 39
10ea DS/DD 48T(IBM/H/P), etc.	\$ 89	\$ 49
MAXELL, 10each, MD1, SS/DD	\$ 55	\$ 29
10each, MD2, DS/DD	\$ 75	\$ 39
VERBATIM, 10 ea MD25-01, SS SD	\$ 49	\$ 25
10 ea MD34, DS DD	\$ 84	\$ 45

* GENERIK™ DISKETTES

— AS LOW AS \$1

10 ea SS/SD, 35 Track (Apple, Atari)	\$ 42	\$ 17
100 ea SS, SD, 35 Track (Apple, Atari)	\$ 415	\$ 130
1000 ea SS, SD, 35 Track (Apple, Atari)	\$ 4150	\$ 985
10 ea DS/DD, 48TPI (IBM, H/P)	\$ 63	\$ 25
100 ea DS, DD, 48TPI (IBM, H/P)	\$ 626	\$ 170
1000 ea DS, DD, 48TPI (IBM, H/P)	\$ 6260	\$ 1400

W/jackets, no labels, top quality. 90 day limited warranty by us



GENERIK™ DISKETTES
SS SD \$1.00 Each
DS DD \$1.40 Each
Each at 100 quantity.

©1983 by COMX Corporation.
Minimum order quantities apply.
Above money back guarantee is by COMX Corporation, not us.

MODEMS AND ACCESSORIES

ANCHOR, Signalman Mk I Modem (RS232)	\$ 99	\$ 75
Signalman Mk II	\$ 399	\$ 269
HAYES, IBM-PC Smartmodem 1200B	\$ 599	\$ 439
IBM-PC Smartcom II Software	\$ 119	\$ 89
Stack Chronograph (RS-232)	\$ 249	\$ 189
Stack Smartmodem 300(RS-232)	\$ 289	\$ 225
Smartmodem 1200 (RS-232)	\$ 699	\$ 536
Smartmodem 100 (5-100 bus)	\$ 399	\$ 275
Micro modem I/e w/Smartcom	\$ 329	\$ 239
IBM-PC to Modem Cable	\$ 39	\$ 29

NOVATION

IBM-PC Access 1-2-3 Package	\$ 595	\$ 445
Apple II + Modem, 300 BAUD	\$ 399	\$ 269
212 Apple Cat, 1200 BAUD	\$ 725	\$ 569
PC-Cat with Crosstalk	\$ 595	\$ 419
Jal	\$ 189	\$ 139
Cal	\$ 149	\$ 104
212 Auto Cat	\$ 695	\$ 579
Smart Cat 103/212	\$ 595	\$ 415
TRANSEND/SSM, Trans		

-LA POINTE™

Formerly
Computer Exchange™



Circle 95 for IBM Peripherals. Circle 96 for Apple. Circle 97 for all others.

LOW PRICES TO PROFESSIONALS WHO KNOW WHAT THEY WANT AND KNOW HOW TO USE IT!

THE IBM-PC SUPPLY CENTER

256K IBM-PC
Two 320K Disk Drives by CDC
90 Day Warranty By Us
Call for Details

MEMORY CHIP KITS	LIST PRICE	OUR PRICE
Add-on to your memory cards or mother board. 100% tested. With 90 day warranty.		
* 64K Kit, 200NS, 9 chips, 4164	\$ 50	\$ 45
16K Kit, 200NS, 9 chips, 4116 (for PC-1 motherboard)	\$ 50	\$ 18

AMDEK	MAI 4-in-1 Multiple Board, Color Graphics, Mono, 128K	\$ 599	\$ 610
AST	ComboPlus, 64K S/P/C	\$ 395	\$ 270
	ComboPlus, 256K S/P/C	\$ 695	\$ 495
	MegaPlus II, 64K, 25/P/C	\$ 495	\$ 345
	MegaPlus II, 256K, 25/P/C	\$ 795	\$ 565
	256K MegaPlus II Expander	\$ 395	\$ 295
	SixPakPlus, 64K, S/P/C+S/W	\$ 395	\$ 295
	SixPakPlus, 256K, S/P/C+S/W	\$ 695	\$ 465
	SixPakPlus, 384K, S/P/C+S/W	\$ 895	\$ 565
	For SixPak w/ Game Port, add I/O Plus II, 25/P/C	\$ 315	\$ 195

CCS	SuperVision, 132 col. mono board Z Plus 64, test 280B, 64K game port	\$ 850	\$ 595
		\$ 875	\$ 695

* ComX	256K RAM Card with Fasttrak™ RAM disk emulator and spooler software.	\$ 495	\$ 290
--------	--	--------	--------

for the IBM-PC or XT

DRIVES AND ACCESSORIES

GD CONTROL
DATA OR Tandon
320K/360K DS DD DISK DRIVES
With Detailed Installation Instructions
30 Day Warranty by Factory Authorized Distributor
Same as now installed by IBM. **\$229** \$239 For One.
HALF \$199 HEIGHT

AMDEK	LIST PRICE	OUR PRICE
Amdisk V, 1/2 height, internal, 320K/360K	\$ 329	\$ 249
Amdisk III, Dual 3" Micro Floppy, 320K/360K	\$ 599	\$ 529
Cable, Amdisk III to IBM-PC interface	Call	Call

MAYNARD
Floppy Drive Control Bld.-up to 4 drives same with Parallel Port

	\$ 195	\$ 165
	\$ 275	\$ 205

QUADRAM	6 Meg. Removable	\$2295	\$1785
QUADISK	6 Meg. Fixed	\$1995	\$1595
	12 Meg. Fixed	\$2250	\$1750
	20 Meg. Fixed	\$2650	\$2060
	27 Meg. Fixed	\$2895	\$2335
	72 Meg. Fixed	\$6500	\$4950

CALLON AVAILABILITY

CURTIS	PC Pedastal™ for Display 3 to 9 foot keyboard cable	\$ 80 <th>\$ 65</th>	\$ 65
	Vertical GPU "System Stand"	\$ 25	\$ 19
	Microchrome EXT. Cable Pair	\$ 50	\$ 35

HERCULES	Monochrome Board	\$ 499	\$ 349
Key Tronic	KB5150, Std. keyboard	\$ 269	\$ 199
Koala	Koala Pad™ w/PC Design Programmer's Guide	\$ 150	\$ 109
		\$ 15	\$ 12

MAYNARD	Multifunction (6) Card, MFC Modules for above card	\$ 89	\$ 79
	SandStar, no RAM card	\$ 230	\$ 180
	SandStar, 256K card	\$ 499	\$ 395

MICROSOFT	RAMCard 256K	\$ 550	\$ 385
	SystemCard 256K	\$ 625	\$ 435
	SystemCard 64K	\$ 395	\$ 275
	Mouse	\$ 195	\$ 145

MOUSE SYSTEMS, PC Mouse w/soft.	\$ 295	\$ 195
---------------------------------	--------	--------

ORCHID	PCnet™ Starter Kit, LAN	\$1490	\$1190
	PCnet™ Circuit Board Kit	\$ 695	\$ 545

PLANTRONICS	ColorPlus, 16 color bnd. w/Para Port	\$ 475	\$ 375
-------------	--------------------------------------	--------	--------

QUADRAM	NEWEST VERSION	\$ 680	\$ 485
* Quadlink	Quadboard, no RAM, expand to 384K	\$ 295	\$ 215
	Quadboard 64K, expand to 384K	\$ 395	\$ 279
* Quadboard, 384K	Quadboard 64K, expand to 384K	\$ 595	\$ 395
	Quadboard II, no RAM, expand to 256K	Call	Call
	Quadboard II, 64K, expand to 256K	\$ 395	\$ 285
	Quad512 + 64K plus serial port	\$ 395	\$ 285
	Quad 512 + 256K plus serial port	\$ 550	\$ 420
	Quad 512 + 512K plus serial port	\$ 895	\$ 625
	Quadcolor I board, 16 colors	\$ 295	\$ 225
	Quadcolor II board, use with Quadcolor I	\$ 275	\$ 209
	Quadcolor 12" RGB Monitor	\$ 795	\$ 499
	Quadscreen, 17" 968 x 512 Monitor	\$1995	\$1585
	Microfazer, w/copy, PP, 8K,MP6 w/PS	\$ 189	\$ 129
	Microfazer, w/copy, PP, 64K,MP64w/PS	\$ 319	\$ 219
	#MP128 w/PS	\$ 465	\$ 295
	Microfazer, Snap-on, 8K, PP, Epson #ME6, w/PS	\$ 179	\$ 145
	Microfazer, Snap-on, 64K, PP, Epson #ME64, w/PS	\$ 319	\$ 235

All Microfazers are expandable (w/copy to 512K)(Snap-on to 64K)

Tecmar	1st MATE, 64K	\$ 389	\$ 295
	2nd MATE, 256K	\$ 589	\$ 439
	Captain, 64K S/P/C/Prog	\$ 424	\$ 324
	Captain, 384K S/P/C/Prog	\$ 795	\$ 595

TG PRODUCTS	Joystick	\$ 60	\$ 40
	WICO, IBM-PC Mouse	\$ 100	\$ 69

Prices and availability subject to change. Call

\$55
9 Each, 4164, 200 ns, MEMORY EXPANSION
90 Day Warranty by us

\$325 \$295 Two or more.
ComX 256K RAM BOARD
Fully Compatible 2 Year Limited Warranty by ComX
With Fasttrak RAM Disk Emulator and Spooler Software
Works on DOS 1.1 or 2.0

*** MEANS A BEST BUY**

320K/360K DS DD DISK DRIVES
With Detailed Installation Instructions
30 Day Warranty by Factory Authorized Distributor
Same as now installed by IBM. **\$229** \$239 For One.
HALF \$199 HEIGHT

AMDEK
Amdisk V, 1/2 height, internal, 320K/360K
Amdisk III, Dual 3" Micro Floppy, 320K/360K
Cable, Amdisk III to IBM-PC interface

LIST PRICE	OUR PRICE
\$ 329	\$ 249
\$ 599	\$ 529

Call

MAYNARD
Floppy Drive Control Bld.-up to 4 drives same with Parallel Port

\$ 195	\$ 165
\$ 275	\$ 205

QUADRAM	6 Meg. Removable	\$2295	\$1785
QUADISK	6 Meg. Fixed	\$1995	\$1595
	12 Meg. Fixed	\$2250	\$1750
	20 Meg. Fixed	\$2650	\$2060
	27 Meg. Fixed	\$2895	\$2335
	72 Meg. Fixed	\$6500	\$4950

CALLON AVAILABILITY

8" CP/M-80 SOFTWARE

MUCH MORE IN STOCK

LIST PRICE	OUR PRICE
\$ 700	\$ 386
\$ 295	\$ 249
\$ 70	\$ 43
\$ 150	\$ 99
\$ 500	\$ 339
\$ 350	\$ 235
\$ 850	\$ 575
\$ 550	\$ 376
\$ 350	\$ 250
\$ 295	\$ 185
\$ 99	\$ 82
\$ 295	\$ 186
\$ 50	\$ 34
\$ 95	\$ 40
\$ 95	\$ 49
\$ 495	\$ 239
\$ 250	\$ 129
\$ 855	\$ 429
\$ 275	\$ 195
\$ 750	\$ 350

SOFTWARE FOR IBM-PC or XT

BUSINESS	LIST PRICE	OUR PRICE	
ALPHA , Database Manager II	\$ 295	\$ 195	
ASHTON-TATE			
dBase II, req. PC-DDS & 128K	\$ 700	\$ 385	
dBase II User's Guide (Book)	\$ 30	\$ 20	
Everman's DB Primer (Book)	\$ 15	\$ 12	
Finder	\$ 700	\$ 395	
* APPLIED SOFT. TECH. , Versatrom	\$ 295	\$ 195	
ASK MICRO , GL, AR, AP, INV or PR ea.	\$ 495	\$ 295	
BPI, GL, AR, AP or PR	\$ 595	\$ 395	
* CONTINENTAL , Home Accountant	\$ 150	\$ 89	
FCM (Filing, Cataloging, Mailing)	\$ 125	\$ 89	
Property Management	\$ 495	\$ 329	
DOW JONES , Market Analyzer	\$ 350	\$ 270	
Market Manager	\$ 300	\$ 235	
Market Microscope	\$ 700	\$ 525	
* EINSTEIN , Writer	NEW!	\$ 300	\$ 199
Memory Trainer	NEW!	\$ 80	\$ 65
Speller	NEW!	\$ 150	\$ 95
Mailier	NEW!	\$ 80	\$ 65
Writer	NEW!	\$ 300	\$ 195
FOX & GELLER , Quickcode (MSDOS)	\$ 285	\$ 179	
dGraph (MSDOS)	\$ 285	\$ 179	
dUtil (MSDOS or CP/M86 ea.)	\$ 99	\$ 59	
Grafico (Color Graphics Brd)	\$ 295	\$ 195	
HAYDEN , IBM Pie Writer	\$ 200	\$ 135	
Pie Speller	\$ 100	\$ 69	
HOWARD SOFT.			
Real Estate Analyzer II	\$ 250	\$ 189	
Tax Preparer, 1984-1983	\$ 295	\$ 220	
IUS , EasyWriter II(WP)	\$ 350	\$ 259	
EasySpeller II	\$ 225	\$ 149	
EasyFiller (a DBMS)	\$ 400	\$ 299	
Business System: GL+AR+AP	\$1495	\$985	
GL, AR, AP, PR, DE or INV, each	\$ 595	\$ 395	
* INSOFT , Data Design (easy to use DBMS)	\$ 225	\$ 189	
LIFETREE , Volkswriter	\$ 285	\$ 195	
* LOTUS , 1-2-3	\$ 495	\$ 329	
MICROCRAFT , Verdict or Billkeeper, ea.	\$ 995	\$ 469	
MICRO LAB , Tax Manager	\$ 250	\$ 169	
MICROPRO , WordStar®	\$ 495	\$ 239	
MailMerge™	\$ 250	\$ 129	
SpellStar™	\$ 250	\$ 129	
* WordStar Professional , 4 Pak	\$ 695	\$ 429	
StarIndex™	\$ 195	\$ 109	
InfoStar™	\$ 495	\$ 299	
ReportStar™	\$ 350	\$ 199	
StarQuest™	\$ 195	\$ 115	
MICRORIM , Rbase, Series 4000	\$ 495	\$ 335	

UTILITY & SYSTEM	LIST PRICE	OUR PRICE
MICROSOFT , Multiplan	\$ 275	\$ 175
Word	\$ 375	\$ 275
Word with Mouse	\$ 475	\$ 339
Financial Statement	\$ 100	\$ 89
Budget	\$ 150	\$ 109
MONOGRAM , Dollars & Sense	\$ 165	\$ 110
* OSBORNE/COMK , (Book & Business, Statistics & Main Programs on 5 1/4" DD disks)		
Some Common Basic Prog. (70 ea.)	\$ 100	\$ 69
Practical Basic Programs (40 each)	\$ 100	\$ 69
PBL CORPORATION		
Personal Investor 1.1	\$ 145	\$ 99
PEACHTREE , Peach Pak (GL, AR, AP)	\$ 395	\$ 239
Peach Text 5000	\$ 395	\$ 239
PEARLSOFT , Personal (DBMS & MIS)	\$ 295	\$ 195
* PERFECT , Perfect Writer™	\$ 349	\$ 219
Writer & Speller, 2 Pak	\$ 399	\$ 249
Business BASIC, each	\$ 249	\$ 149
Perfect Writer, Speller, Filer, Calc (4)	\$ 969	\$ 499
Perfect Writer™ or Perfect Calc, each	\$ 299	\$ 219
SOFTWARE ARTS , TKI Solver	\$ 120	\$ 94
SOFTWARE PUBLISHING , PFS:File	\$ 145	\$ 94
PFS:Report	\$ 125	\$ 84
PFS:Write	NEW!	\$ 90
PFS:Calc	NEW!	\$ 140
SORCIN , SuperCalc II	\$ 295	\$ 195
SuperCalc III	\$ 395	\$ 255
SSI/SATELLITE , WordPerfect	\$ 495	\$ 375
Personal WordPerfect	\$ 195	\$ 149
STC/SOFTC , The Creator	\$ 300	\$ 185
STONEWARE , Advanced D.B. Master	\$ 595	\$ 395
SYNAPSE , File Manager	\$ 100	\$ 67
SYNERGISTIC , Data Reporter	\$ 275	\$ 189
T/MAKER , T/Maker III	\$ 250	\$ 169
VISICORP , VisiCalc 4	\$ 250	\$ 179
VisiFile or VisiSchedule	\$ 300	\$ 219
Desktop Plan I	\$ 300	\$ 219
Visi Word with VisiSpell (128K)	\$ 375	\$ 269

UTILITY & SYSTEM

1983 CL SOFTWARE AWARD:

"Copy II PC by Central Point Software is still the best software buy of 1983 and 1984. It will copy more copy protected software and faster than any other backup system. Unlike other copiers it makes an exact duplicate of your original and it does 100% verification of copy. Documentation is excellent!"

- * **CENTRAL POINT**, Copy II PC, Backup \$ 40 \$ 30
- * **COMX**, Fasttrak™, RAM/Disk emulator and printer spooler program. Works on any PC/DOS version or RAMCard. Menu Driven \$ 100 \$ 59

HOME & EDUCATIONAL	LIST PRICE	OUR PRICE
DIGITAL RESEARCH		
Concurrent CP/M-86™	\$ 350	\$ 225
CP/M-86™	\$ 60	\$ 40
CBASIC 86™	\$ 200	\$ 135
CBASIC Compiler (86 or MSDOS), each	\$ 600	\$ 365
Pascal/MT + (CP/M-86)	\$ 400	\$ 269
Pascal/MT + (MSDOS)	\$ 600	\$ 399
PL/I (MSDOS) or CP/M-86, each	\$ 750	\$ 499
Access Mgr (MSDOS) or CP/M-86, ea.	\$ 400	\$ 179
Display Mgr (MSDOS) or CP/M-86, ea.	\$ 500	\$ 339
Speed Prog. Pkg. (CP/M-86)	\$ 200	\$ 135
CIS COBOL-86	\$ 850	\$ 525
DR LOGO-86	\$ 100	\$ 89
HAYES , Smartcom II (DataCom.)	\$ 119	\$ 89
MICROCOM , Microterm/rd (Data Com.)	\$ 100	\$ 65
MICROSTUF , Crosstalk X.VI (Data Com.)	\$ 195	\$ 129
MICROSOFT , nuMath/nuSimp	\$ 300	\$ 225
Business BASIC Comp.	\$ 600	\$ 450
Pascal Compiler	\$ 350	\$ 265
C Compiler	\$ 500	\$ 375
BASIC Compiler	\$ 395	\$ 285
FORTRAN Compiler	\$ 350	\$ 255
COBOL Compiler	\$ 750	\$ 585
BASIC Interpreter	\$ 350	\$ 255
NORTON , Utilities 2, 014 programs	\$ 80	\$ 55
ROSESOFT , Prokey	\$ 75	\$ 49

OUR AD #B1

VISA

Master Charge

©1984 by Conroy-LaPointe, Inc.
All rights reserved.

NATIONAL ORDER DESK

TOLL FREE (800) 547-1289

Order Desk Hours: 6AM to 6PM PST

Oregon TOLL FREE [800]451-6151 On Your Order Portland: 245-6200 [503]245-1030

FREE GIFT

Use of our order forms qualifies you for a free gift with your order. Get on our mailing list now for order forms, and our new newsletter and sales special announcement. Our customers are already on our list.

MAIL TO: P.O. Box 23068, Portland, OR 97223

NAME _____

ADDRESS _____

CITY _____ STATE _____ ZIP _____

COUPON

STSC APL*PLUS and IBM PC APL

Two APLs for the IBM PC

by Jacques Bensimon

When details of the much-anticipated IBM Personal Computer (PC) were made public in 1981, I sadly joined the ranks of the crystal-ball gazers whose various predictions bit the dust that summer. You see, I had convinced myself that IBM was about to share with the world what often seems to be the computer industry's best-kept secret, namely that APL is one of the most powerful, expressive, and—not undesirable in the context of a personal computer—fun-to-use programming languages ever devised.

Looking back on it now, I suppose that it was extravagant of me to expect Big Blue to embrace APL as the premiere language for its PC while the rest of the microcomputer universe remained entrenched in BASIC. It was not unreasonable to expect, however, that IBM would at least include in the PC's character set the special symbols that are the hallmark of APL; this would have paved the way for headache-free design of APL interpreters for its new machine. IBM, after all, was an important (though at times unwilling) contributor to the development of APL in the mid-60s and remains to this day one of the language's most avid users; surely that called for encouragement of APL in the PC environment. And yet, as I stared at the Personal Computer's 256 characters, I could find no trace of most APL symbols among that dizzying collection of playing-card suits, happy faces, musical notes, and generally unusable mathematical symbols. I was not happy.

But time passes, wounds heal, life goes on, and I have forgiven IBM. I can afford to be magnanimous because

the void caused by IBM's omission was quickly filled. First (in June 1982) came the University of Waterloo's microAPL, an offering intended for the educational market. Next out of the gate (in December 1982) came STSC Inc. with its ambitious APL*PLUS/PC Application Development System. STSC, a leading vendor of APL timesharing and consulting services, was already a supplier of APL-language processors for IBM mainframes, DEC VAX superminis, and, remarkably, Radio Shack TRS-80 Model III microcomputers. And most recently (in June 1983), IBM itself introduced a surprising Personal Computer APL System, the first major piece of software for the PC to come out of the halls of IBM.

It won't give away too much of the ending for me to tell you right off the bat that the news is mostly good: both STSC's APL*PLUS/PC and IBM's PC APL fully implement conventional APL's language component; differences between the two packages—and there are many—arise from language *extensions* to handle such things as report formatting and error trapping and from the mechanisms used to provide access to disk files, video screen, printers, and communication ports. (More on all this later.)

STSC's Version of APL

For the not-insignificant sum of \$595, you can buy the APL*PLUS/PC Application Development System. It consists of a 5¼-inch disk in single-sided format (but recorded on both sides) that contains the APL interpreter and a collection of utility workspaces, a 24-pin ROM IC

At a Glance

Name

APL*PLUS/PC Application Development System release 1, version 2.6

Type

APL language interpreter

Manufacturer

STSC Inc.
2115 East Jefferson St.
Rockville, MD 20852
(301) 984-5000

Format

5¼-inch single-sided floppy disk and 24-pin ROM IC

Language

8088 machine language

Computer

An IBM Personal Computer (or PC XT) running PC-DOS version 1.1 or 2.0, with a minimum of 128K bytes of RAM, at least one disk drive (single- or double-sided) and an 80-column display (monochrome or color/graphics)

Documentation

A 450-page programmers reference manual, 8½ by 11 inches, in a 3-ring binder; a 170-page tutorial, *APL Is Easy!*; and a 380-page textbook, *APL: An Interactive Approach*

Price

\$595

At a Glance

Name

IBM Personal Computer APL System version 1.00

Type

APL language interpreter and auxiliary processors

Manufacturer

International Business Machines
POB 1328
Boca Raton, FL 33432
(305) 998-2000

Format

5¼-inch single-sided floppy disk

Language

8088 machine language

Computer

An IBM Personal Computer (or PC XT) running PC-DOS version 1.1 or 2.0, with a minimum of 128K bytes of RAM, at least one disk drive (single- or double-sided), an Intel 8087 numeric coprocessor and a 40- or 80-column graphics display

Documentation

A 370-page reference manual, 5½ by 8½ inches, in a 3-ring binder

Price

\$195 (from IBM Product Centers; authorized IBM dealers might charge differently)

(read-only memory integrated circuit) providing the APL symbols, a plasticized card showing the keyboard location of the characters, and extensive documentation including a 450-page programmer's reference manual, a tutorial introduction, *APL Is Easy!*, and the classic textbook, *APL: An Interactive Approach* by Gilman and Rose (second edition revised, Wiley, 1976). The textbook makes frequent references to a now-defunct desktop APL computer called the IBM 5100; interestingly, the Personal Computer's lesser-known name is the IBM 5150.

STSC deserves high marks for its well-designed integration of APL with the PC. The custom ROM chip replaces the character-generator ROM on either the monochrome or the color/graphics display adapters mounted inside the PC's system unit. I found the replacement instructions clear and easy to follow; the entire procedure took less than 10 minutes. With the new ROM in place, about one-quarter of the PC's original characters (mostly the novelty and mathematical characters with 8-bit values in the range 0-31 or 224-255) give way to the missing APL characters; unaffected are the ASCII characters in the range 32-127, the line-drawing graphics, and most of the international accented letters and punctuation.

Beyond this unobtrusive addition of APL symbols to the PC, STSC seems to have put great thought into the environment presented to users of its system. The keys on the cursor pad and some of the Alt/function-key combinations allow you to move quickly around the screen, move to the beginning or end of a line, edit the contents of a line, insert or delete lines and characters, make one

line a continuation of another, and break continued lines into two lines.

Flexibility in managing the display and the fact that the APL interpreter will process the screen line that contains the cursor when you press the Enter key make it very easy to modify, combine, and reenter previous inputs, to simulate full-screen editing of defined functions, and to store already displayed output in a variable as an afterthought. All of this encourages the experimental approach to APL programming, in which the germ of an idea gradually evolves into a complete algorithm with the computer itself helping you make design decisions along the way.

Before I discuss IBM's package, I'd like to offer a few more preliminary observations about STSC's APL in the PC environment. You can assign sequences of characters to the 10 function keys (as well as to the Shift/function-key and Ctrl/function-key combinations) by using the programs in the utility workspace MULTIKEY. You can choose to make the assignments last only for the duration of the current session or to make them permanent for a particular copy of the APL interpreter. Typical uses include storing often-needed commands or making available single characters (such as the line-drawing graphics) that cannot otherwise be entered from the keyboard. In practice, I found this feature be of limited usefulness: what we really need is a system function that allows us to define function keys from our own workspace as the need arises.

If you install an Intel 8087 Numeric Data Processor in

Benchmark		IBM PC APL (w/ 8087)	STSC APL*PLUS (w/ 8087)	STSC APL*PLUS (w/o 8087)	Advanced BASIC (8087 N/A)
1. Plus Reduction	$Z++/VI$	90 msec.	102 msec.	157 msec.	1155 msec.
2. Logical Reduction	$Z+V/VL$	0.4	3	N/C	-
3. Maximum Reduction	$Z+[/[1]MI$	40	25	N/C	660
4. Exponentiation	$Z+VI*.1$	390	282	2466	3781
5. Absolute Value	$Z+ VR$	80	79	130	1007
6. Indexing	$Z+VR[VI[120]]$	20	14	N/C	114
7. Sorting	$Z+VI[VR]$	600	112	N/C	-
8. Take	$Z+^2 1+MR$	9	24	N/C	-
9. Membership	$Z+VI\epsilon VI$	150	146	N/C	105215
10. Transposition	$Z+2 1QMC$	450	60	N/C	-
11. Outer Product, Characters	$Z+VC\circ.=VC$	360	141	N/C	-
12. Outer Product, Integers	$Z+(150)\circ.+150$	2530	439	N/C	13169
13. Inner Product, Reals	$Z+VRL.+VR$	210	341	546	2012
14. Matrix Division	$Z+MR\div 10+VR$	70	1488	2206	-
15. Fibonacci Series	$Z+1 1$ $L:+(100>pZ+Z,+/\sqrt{2+Z})/L$	2200	3827	3943	832
16. Multiplication	$Z+VR\times 3.14$	100	136	468	1314
17. Division	$Z+VR\div 3.14$	110	142	724	4653
18. Logarithm	$Z+\bullet VR$	150	143	5094	2394
19. Sine	$Z+1\circ VR\times .1$	411	438	12009	3913
20. Sieve of Eratosthenes	(Listing 2)	1680 sec.	1693 sec.	N/C	1722 sec.
21. Chess Problem	(Listing 3)	33.316 min.	28.345 min.	N/C	-

Note 1: The times given for benchmarks 1-19 are in milliseconds and are adjusted to represent one execution of the given expression (net of looping overhead).

Note 2: The variables used in benchmarks 1-19 are defined by
 $MI+10 10pVI+(500p0 1 0 0 1)/.1500$
 $VL+1 0 1 1 0 0 0 1$
 $MR+10 10pVR+VI+0.1$
 $MC+26 26pVC+'ABCDEFGHIJKLMNPOQRSTUVWXYZ'$

Note 3: The times given for benchmark 20 are in seconds and represent ten executions of the programs in Listing 2.

Note 4: The times given for benchmark 21 are in minutes and represent one execution of the function FMATE of Listing 3 with left argument 2, right argument (7p0), 3 4 4 3,(10p0), 1,(14p0),5 0 1 0 6 1 1 1 0 0 1 0 1 2 0 6,(4p0),1,12p0 and global variables A and B set to 1 and -1 respectively.

Table 1: Twenty-one benchmarks for the two versions of APL. "N/C" (no change) and "-" denote benchmark tests that were not run. Benchmark 21 solves the chess problem in the text on page 256.

your PC, APL*PLUS/PC will automatically take advantage of the coprocessor to accelerate all floating-point computations. If you choose not to use the 8087 (the chip currently costs anywhere from \$200 to \$260, and IBM Product Centers sell an 8087/8088 matched pair for \$260), the interpreter will use software floating-point routines to provide the same range and precision at the expense of speed. The benchmark timings in table 1 may help you decide whether you can live with the difference.

IBM's Version of APL

In the other corner, weighing in at a modest \$195, the pride and joy of the IBM Madrid Scientific Center: the

IBM Personal Computer APL System. It comes boxed in the obligatory (and rather pleasant) 8- by 9½-inch format and consists of a single-sided 5¼-inch disk, a set of keytop decals, and a 370-page reference manual. (The manual is good but will not teach you the language; buy *APL: An Interactive Approach*.) However, this implementation requires an 8087 chip, significantly increasing its price for most users.

IBM's integration of APL with the PC falls far short of STSC's: because no ROM character generator is provided (I hope all you add-on manufacturers out there are paying attention), APL characters can be displayed only if your system has the color/graphics adapter and



Divine inspiration for people who use the IBM PC and XT.

Introducing SAVVY PC™. Now you can create custom databases in less time, with less effort and for less money.

SAVVY PC is unique. It integrates a database management system with a truly "natural" command language and a self-documentation capability. There has never been a faster or easier database building tool than SAVVY PC.

SAVVY PC speaks English. You won't have to master the rigid syntax and complex symbols of typical computer programming languages to develop a wide range of business and personal applications.

Because SAVVY PC is a fully integrated database, your applications can directly access all master files, speeding and simplifying operations. And because SAVVY® can recognize your personal word patterns, you can misspell, mistype, abbreviate or rephrase and still command your computer.

The speed, flexibility and economy of computing with SAVVY PC is truly inspired.

For more information and the name of the SAVVY dealer in your area, or to arrange for a SAVVY PC demonstration call 1-800-551-5199. (In New Mexico call 505-242-3333.)

SAVVY PC is a product of Excalibur Technologies Corporation, 800 Rio Grande Boulevard N.W., Mercado 21, Albuquerque, New Mexico 87104.

**Dealer Inquiries
Invited**



SAVVY®

A product of **Excalibur**
TECHNOLOGIES CORPORATION

Circle 154 on inquiry card.

SAVVY is a registered trademark of Excalibur Technologies Corporation. SAVVY PC is a trademark of Excalibur Technologies Corp. IBM is a registered trademark of International Business Machines Corporation.

The Origins of APL

The acronym APL derives from the title of the book *A Programming Language* (Wiley, 1962) by Dr. Kenneth Iverson, then an applied mathematician at Harvard University. Finding that standard mathematical symbolism was inadequate for communicating the results of his studies of sorting and other algorithmic processes, Iverson developed his own concise and consistent notation for the description of solution procedures.

Iverson's Notation, as APL was then known, was not originally meant to be a computer programming language; it evolved into one during the years Iverson spent refining his creation at the IBM Thomas J. Watson Research Center. It was there in 1965 that the first experimental APL interpreter was completed for use in Iverson's research. APL's interactive design was so successful that

use of the interpreter quickly grew to include helping out with the day-to-day work of the research center staff. With its fame spreading by word of mouth, it wasn't long before APL had become an underground sensation throughout IBM. Dubbed APL360, a version of the interpreter was eventually released to interested outside organizations, primarily universities and timesharing companies. Two of the timesharing firms, I.P. Sharp Associates (where Iverson currently continues his research) and Scientific Time Sharing Corporation (now STSC Inc.), have since then played an important role in shifting APL from the scientific to the commercial world, primarily through the addition of an integrated file system, a powerful formatting facility, and exception-handling (error-trapping) features.

a graphics monitor. If you prefer the high resolution of the monochrome adapter and display, you'll have to mentally map the mathematical and international characters that appear on your screen into their corresponding APL characters; this actually isn't too bad because, in assigning the correspondence, IBM took advantage wherever possible of similarities between APL symbols and original PC characters.

To further confuse the character-set issue, the internal APL 8-bit representation of the 256 characters (i.e., the order in which they appear in the atomic vector $\square AV$) is not documented and bears no resemblance to the display representation mentioned above—in other words, it makes no attempt to look like ASCII (American National Standard Code for Information Interchange) code. This adds all kinds of needless translation difficulties to the use of files, printers, and communication ports. The keytop decals are a nice touch: they require patience to install, but once in place they show clearly the location of APL characters on the keyboard.

IBM's APL provides a limited but still very useful capability to modify and reenter any line appearing on the screen. Lines entered from the keyboard are restricted to 80 characters (with no continuation allowed), and there are no provisions for recalling the last input line to the display when it has scrolled off the top. A handy feature for those who have both monochrome and color/graphics monitors is the capability to switch from monochrome to color/graphics with the press of an Alt/function-key combination. This is the only use of the function keys: you cannot program them with your own character sequences.

The Benchmarks

I have already mentioned that these two packages offer all the language-related features commonly found in APL systems. But before I turn to extensions and system-related features, I'll deal with two questions about the language aspect: How accurate are the implementations, and how fast are they?

After several weeks of using the two systems, I have yet to run across a single instance of a primitive function not returning a correct result when presented with

valid arguments. STSC's APL, however, does tend to be too lenient, sometimes returning a result when the arguments to a function are invalid. For example, the use of transposition in listing 1 should have caused a DOMAIN ERROR message. Unless your algorithms hinge on the occurrence of certain errors (not a good practice), this kind of bug should not be a problem.

I used a set of 21 benchmarks to compare the speeds of the two packages; table 1 summarizes the results. Each benchmark was run under IBM's APL (necessarily with the 8087 coprocessor), STSC's APL*PLUS (with and without the 8087), and, in some cases, IBM's Advanced BASIC (which cannot use the 8087). I excluded from BASIC those benchmarks that I considered awkward in the language, such as those involving character data (which is treated differently in BASIC), the sorting and matrix division benchmarks (which are not primitives in BASIC and depend critically on the algorithms used), and the chess-problem benchmark (which I'm not being paid enough to attempt in BASIC).

Benchmarks 1 through 15 have been floating around APL literature for years and crop up often in manufacturers' advertising. I added benchmarks 16 through 19 to further exercise the floating-point capabilities of the packages. The times shown in table 1 for these benchmarks represent single executions of the expressions but are based on 100 consecutive repetitions; they are adjusted to nullify the effects of the required looping.

Benchmark 20 is the prime-number-generating Sieve of Eratosthenes. The January 1983 BYTE (page 290) contained an APL version of the benchmark that did not faithfully apply the algorithm described by the authors of the article (and gave incorrect results to boot). A letter published in the May 1983 issue (pages 8-9) offered a correct APL solution but used a significantly modified algorithm to reduce execution time, which goes against the spirit of benchmarking. Listings 2a and 2b present the APL and BASIC programs that I used in my timings. Note that to be consistent with results previously published by BYTE, the times shown in table 1 for this benchmark represent 10 executions of the programs.

Benchmark 21 is the solution of the chess problem (see the text box on page 256) using the APL functions in

Text continued on page 254

THE WY300 TERMINAL GREAT COLOR FOR UNDER \$1000

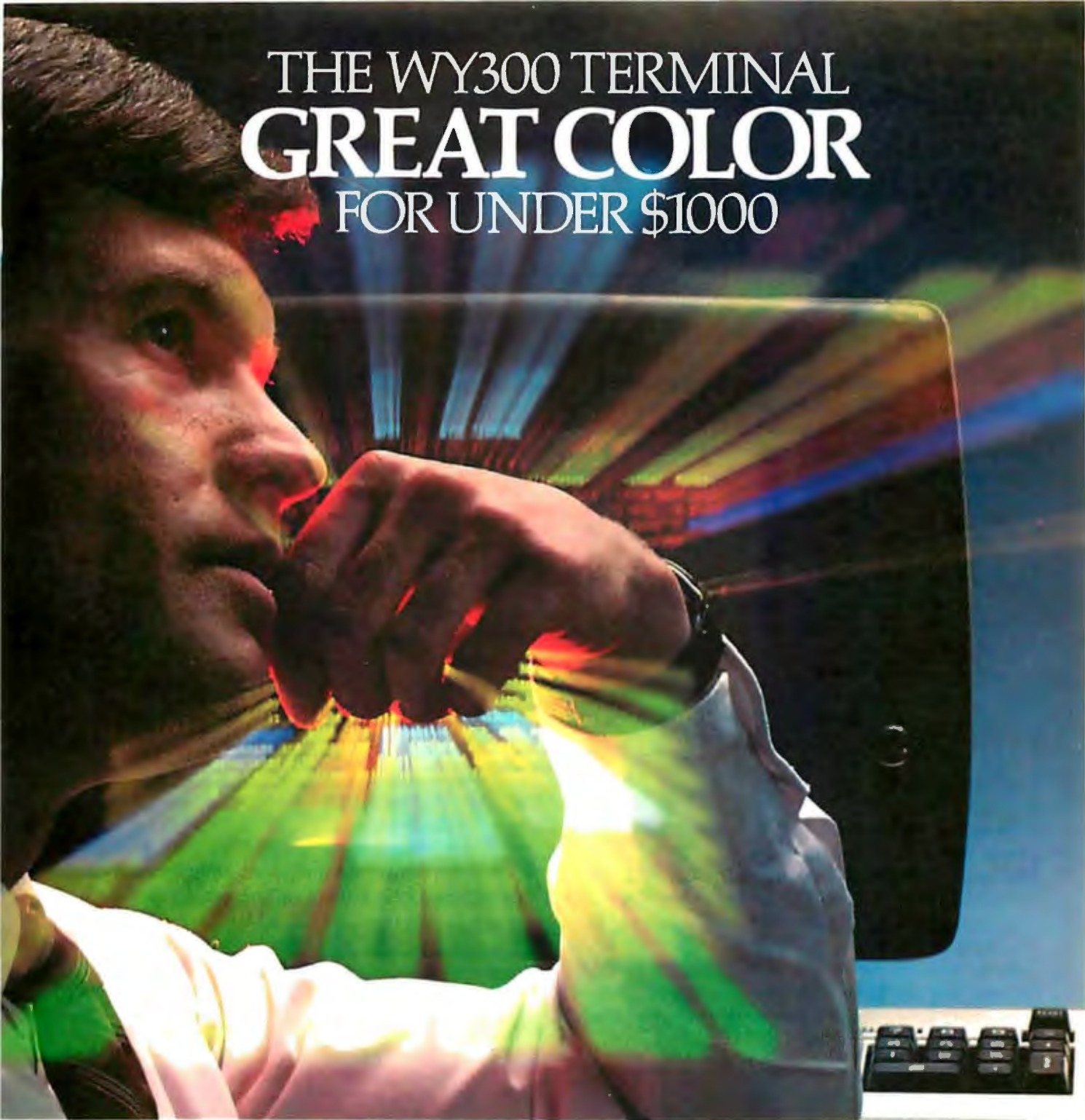

IF COLOR IS A LUXURY YOU THINK YOU CAN'T AFFORD, THINK ABOUT OUR WY300—the smart color terminal as low as \$975.*

*Quantity 100

The WY300's high-resolution 8-color display adds vivid relief to any text editing or data entry task, without adding significantly to the price you'd pay for monochrome.

Ergonomically designed with a swivel and tilt CRT and a detachable keyboard, the compact WY300 fits into the workplace as comfortably as it does into your budget.

On top of that, the WY300 gives you a host of features like a soft downloadable



character generator; extensive alphanumeric and line drawing symbols; and compatibility with most standard,

monochrome oriented, off-the-shelf software.

Best of all, the WY300 is plug compatible with our monochromatic WY100's and most ASCII terminals. So, using color is as easy as it is inexpensive.

Need more information? Call or write us today. We'd like to convince you our smart color terminal is your wisest buy.

WYSE

Circle 386 on inquiry card.

■ ■ ■ ■ *Make the Wyse Decision.*

WYSE TECHNOLOGY 3040 N. First St., San Jose, CA 95134, 408/946-3075, TLX 910-338-2251, Outside CA call toll-free, 800/421-1058, in So. CA 213/340-2013.

A Brief Look at APL

When using APL, you are essentially interacting with a very powerful **programmable** calculator: you enter a valid APL expression, hit the Return key, and the answer (if any) is displayed starting on the next line; for example,

```

      3×4
12
      3÷4
0.75

```

Notice that entries are indented six spaces to distinguish them from the computer's answers and that no explicit command is required to have results displayed. The number of operations, or *primitive functions*, available in the language is very large; other examples include

```

      2*3
8
      5⌊8
5
      5⌈8
8
      5|28
3
      3>5
0
      'A'≠'B'
1

```

These illustrate, respectively, the *exponentiation*, *minimum*, *maximum*, *residue* (or remainder), *greater than*, and *not equal to* functions. You can see from the last two examples that the comparison functions return the numeric values 1 or 0 to represent logical true or false.

The examples so far have shown functions that operate on two objects, their so-called *left* and *right arguments*; they are known as *dyadic* functions. There are also *monadic* functions that operate on a single (right) argument. The examples

```

      ÷4
0.25
      *1
2.718281828
      ⌊5.8
5
      !4
24
      ~0
1

```

illustrate the *reciprocal*, *exponential*, *floor* (or integer part), *factorial*, and *logical negation* functions.

Because the number of primitive functions is so large and because you can define your own, functions in an

APL expression are executed in the order in which they are encountered going from *right to left* across the line, except as modified by parentheses:

```

      9-2×5-3
5
      9-(2×5)-3
2
      (9-2)×5-3
14

```

The seemingly strange choice of right-to-left execution stems from the desire to have a monadic function's argument appear on its right, where it belongs naturally, while keeping the design of the interpreter simple and efficient.

I intentionally used the vague term *object* when referring earlier to the right or left argument of a function. A lot of the power of APL derives from the fact that these objects need not be single numbers (*numeric scalars*) or single characters (*character scalars*) but can in fact be entire vectors, matrixes, or higher-dimensional arrangements of numbers (*numeric arrays*) or characters (*character arrays*). Unlike other languages, APL treats arrays as wholes, accepting them as arguments and returning them as results:

```

      1 3.2 5 7 + 2 4 6 8.4
3 7.2 11 15.4
      'ABBE!' = 'ABLE?'
1 1 0 1 0

```

You can assign a name to an array without, as in other languages, having to first declare its **type** and shape to reserve its storage; APL manages all available memory space and allocates it dynamically. The *assignment* function (denoted by the left-pointing arrow) attaches the name on its left to the array on its right:

```

S←6.28÷2
V←'JOSEPH'
MAT←3·3pVEC←1 -1 2 2 0 6 3 -1 9
S
3.14
      V
JOSEPH
      VEC
1 -1 2 2 0 6 3 -1 9
      MAT
1 -1 2
2 0 6
3 -1 9

```

The following examples use the variables defined above to illustrate, without additional comment, some of the many other primitive functions that APL provides for the manipulation of arrays:

```

6      ρV                (shape)
      ΦV                (reverse)
HPESQJ
      2ΦV              (rotate)
SEPHJO
      V[1 2 4]         (index)
JOE
      1 0 1 0 1 1/V    (compress)
JSPH
      V+V, ' IS HERE' (catenate)
      V
JOSEPH IS HERE
      ρV
14
      +/VEC           (sum)
21
      +\VEC           (running sum)
1 0 2 4 4 10 13 12 21
      L/VEC           (minimum)
~1
      [ \VEC          (running maximum)
1 1 2 2 2 6 6 6 9
      ΔVEC           (grade up)
2 8 5 1 3 4 7 6 9
      SORTEDVEC+VEC[ΔVEC] (sort)
      SORTEDVEC
~1 ~1 0 1 2 2 3 6 9
      5+SORTEDVEC     (drop)
2 3 6 9
      ~3+SORTEDVEC    (take)
3 6 9
      ρMAT
3 3
      ΦMAT           (reverse)
2 ~1 1
6 0 2
9 ~1 3
      ΘMAT           (reverse)
3 ~1 9
2 0 6
1 ~1 2
      ΩMAT           (transpose)
~1 2 3
~1 0 ~1
2 6 9
      MATINV+ΘMAT    (matrix inverse)
      MATINV
3 3.5 ~3
0 1.5 ~1
~1 ~1 1
      MAT*.*MATINV   (matrix multiplication)
1 0 0
0 1 0
0 0 1

```

Programming in APL is the process of creating new functions. These *user-defined functions* are denoted by names rather than by symbols but are otherwise used just like primitive functions. They can be monadic, dyadic, or even *niladic* (requiring no arguments) and may or may not return a result. You indicate to APL that you wish to temporarily leave *calculator mode* and go into *function-definition mode* by **typing** the triangular *del* character followed by a *function header*. The function header is APL's only declarative statement; it specifies the function's name, its syntax (the number of arguments it requires and whether or not it returns a result), and the names of any **temporary** local variables it uses. While you're in function-definition mode, APL prompts you with bracketed line numbers and then records (rather than acts upon) the statements that you enter. You have already seen two of APL's three types of executable statements: the assignment, which does not display a result, and the APL expression not ending with an assignment, which does display its

result (if any). The third type of statement is the *branch* (denoted by the right-pointing arrow), which can alter the top-to-bottom sequence of execution of a defined function's lines by directing execution to a given line.

APL work is organized around the concept of the *workspace*: the *active workspace* is that portion of the computer's memory in which all of the functions and variables you create are stored and in which all of the computations you request take place. You may, at any time during your APL session, have the current contents of the active workspace preserved in secondary storage as a named *saved workspace* (which usually appears as a file on your disk). Once saved, a workspace can be reactivated (loaded) at a later time, thus restoring the active workspace to its original state, or its contents (variables and functions) can be selectively copied into the current active workspace. An APL application usually consists of a saved workspace containing all of the pertinent functions and variables along with a *latent expression*, a special vector containing the character representation of an APL statement to be executed automatically as soon as the saved workspace is loaded. The latent expression will typically initiate execution of the application's master function.

Most APL implementations provide a **battery** of so-called *system commands* to manage the saving, loading, copying, and erasing of workspaces and to make possible examination and control of their contents. These system commands are not, strictly speaking, part of the APL language and therefore cannot be lines in defined functions. The trend in recent years has been for APL systems to provide *system functions* that duplicate the action of system commands and can be used under program control.

The language has two advantages that cannot be readily conveyed by a quick printed tour of its facilities. One is the ease with which you can learn the language: the **simplicity** of APL syntax, the absence of red tape in using arrays, and the immediate feedback of calculator mode combine to provide an environment in which you can freely experiment with language features, concentrating at first on a few functions and gradually building up your repertoire. The second advantage is the sense of **programming confidence** that you will experience as a user of APL. The power and **versatility** of the language encourage you to tackle even the most difficult tasks with the knowledge that the step between a mental solution and a computer solution is a short one. APL drastically reduces **programming time** because a verb-oriented oral description of an algorithm can often be immediately written down as a function-oriented APL expression. This leads to terse programs and explains the often-heard criticism that APL is unreadable. APL is in fact quite readable, but you should not expect to grasp at a glance the meaning of a line of APL any more than you would a pageful of BASIC or five pages of COBOL.

listing 3. I include it in this review for two reasons: first, because it involves the cooperation of several functions, one of which (FMATE) is recursive, it gives a thorough workout to the systems' function-calling mechanism (with the associated stacking of the execution environments and creation of local variables); second, it provides a good example of APL's capability to make short work of a relatively complex programming problem. I spent more time selecting data structures than I spent actually writing code for the functions, with the entire process taking about 10 hours. With most programming languages, this recreational exercise would have been a major project.

Now, what are we to make of the results of all these benchmarks? If you consider speed to be the deciding factor in choosing between the IBM and STSC APL systems, you'll find no final pronouncement here. I'm calling it a draw. IBM showed up slightly faster in the sim-

Listing 1: An example of STSC APL code that should have caused a domain error but didn't.

```

      □ I O ← 1
      0 1 ⍋ 2 2 ρ 1 4
1 2

```

Listing 2: The prime-number-generating Sieve of Eratosthenes (using the algorithm originally described in BYTE) in APL (listing 2a) and BASIC (listing 2b).

(2a)

```

      ∇ PRIMES
[1]   I ← 1 ⍋ F ← (8191 ρ Y), E
[2]   Y: F [ I + P × 1 ⍋ (8191 - I) ÷ P + 1 + I ] ← N
[3]   N: → F [ I + I + 1 ]
[4]   E: ( ∇ Y +. = F ), ' PRIMES '
      ∇

```

(2b)

```

10  DEFINT A-Z
20  OPTION BASE 1
30  DIM F(8191)
40  C=0
50  FOR I=1 TO 8191
60    F(I)=1
70  NEXT I
80  FOR I=1 TO 8191
90    IF F(I)=0 GOTO 170
100   P=I+I+1
110   K=I+P
120   WHILE K<=8191
130     F(K)=0
140     K=K+P
150   WEND
160   C=C+1
170 NEXT I
180 PRINT C; " PRIMES "
190 END

```

ple arithmetic benchmarks (with the exception of exponentiation), quite a bit faster in the inner product and heavily-looping Fibonacci series benchmarks, and shockingly faster in the matrix division benchmark. STSC, on the other hand, did much better in the categories of indexing, sorting, transposition, and outer product, and put it all together to come out on top in the grueling chess-problem marathon. If nothing else, these timings point out where the authors of the packages chose to cut corners: it is a fairly common practice in designing APL interpreters to implement some primitive functions (especially those considered infrequently used) as a combination of calls to other already-coded functions, which essentially means that those functions are written not in assembly language but rather in a subset of APL. I would guess that this was the fate of STSC's matrix division primitive and of IBM's outer product, dyadic transposition, and maybe even grading (sorting) primitives.

Without the 8087 coprocessor, STSC's APL still performed quite acceptably in the floating-point benchmarks; the difference became painful only in the case of logarithmic and trigonometric functions. The multiplication, division, and exponentiation benchmarks were slowed down by factors of about 3, 5, and 9, respectively. That's a far cry from the factors 78, 82, and 170, which represent the published relative speeds of the 8087 and the 8088 performing single instances of those same double-precision operations. This is probably due to the fact that, overall, the 8088 spends the majority of its time retrieving operands from memory and storing results back into memory. Nevertheless, if your applications tend to be numerically oriented, the coprocessor is likely to be a good investment.

As for BASIC, although it did very well in the Fibonacci series benchmark and held its own in the Sieve of Eratosthenes (both of which involve a lot of looping), it ran out of breath trying to keep up with APL's easy handling of array operations in the other benchmarks. BASIC's apparent superiority over STSC's APL without the 8087 in the logarithmic and trigonometric benchmarks is a result of the fact that version 1.1 of BASIC calculates such functions to single precision only, less than half the accuracy of STSC's software emulation of the 8087.

Other Features

To be great, an APL system must provide many facilities beyond the language itself. This is especially true of an APL system running in a microcomputer environment, where users expect to have direct control of the hardware and where there's a need to support a wide array of peripheral devices. I'll discuss STSC's and IBM's efforts in this direction under several broad headings.

Workspace size: Your workspace under STSC's APL can be as large as your machine's total memory minus an interpreter and operating-system overhead of approximately 90K bytes. A parameter on the operating system command that starts up APL even allows the interpreter to use memory beyond the 544K-byte maximum recog-

QUARK INTRODUCES CATALYST™ IIe.

The Only Hard Disk
Program Selector
for the Apple IIe and
Apple II Plus.

A hard disk makes your Apple IIe or 64K Apple II Plus even more powerful. And makes you even more productive. But you still have to load a new floppy and reboot when you need to change programs. And the more programs you have, the more time you waste.

That's why Quark developed Catalyst™ IIe. A unique ProDOS program selector that lets you switch between even copy-protected programs. Without rebooting. A few keystrokes move you from Word Juggler IIe to your spreadsheet, then to your file management system, and so forth.

The convenient menu lists the programs you've stored on your hard disk, organized in any way you wish. You can automatically install virtually any

programs which use Apple's new ProDOS operating system. Including software from Quark, Apple Computer and other leading manufacturers. You can even load CP/M programs on the menu, when you use the CP/M CARD from Advanced Logic Systems.

Catalyst IIe is an affordable \$149. So see your favorite dealer today for a complete demonstration. And while you're there, look into Quark's other office automation tools for the Apple IIe and Apple III. Especially our popular Word Juggler™ word processor, which now includes the Lexicheck™ spelling checker. A powerful combination, intelligently priced at only \$189 for the Apple IIe and \$229 for the Apple III.

All prices suggested U.S. retail. For the name of the Quark dealer nearest you, call, toll-free, 1 (800) 543-7711.

Quark, Catalyst, Word Juggler and Lexicheck are trademarks of Quark Incorporated. Apple, ProDOS and ProFile are registered trademarks of Apple Computer, Inc. CP/M is a registered trademark, and CP/M CARD is a trademark of Digital Research, Inc.

Notes on the Chess Benchmark

Given sufficient time, this set of five functions (see listing 3) will solve any chess problem that ends in checkmate, including problems that involve castling, en-passant capture, or under-promotion of a pawn to a knight. WSINIT must be run once to define some global variables.

To solve a problem, assign to variable *A* the attacking color and to *B* the defending color (White = 1, Black = -1), and then run FMATE. The left argument of FMATE is the maximum number of moves to mate, and the right argument is a 69-element numeric vector representing the position. The first element is either 0 or the square number on which an en-passant capture can take place on the next move. Squares are indicated in algebraic chess notation (e.g., c5 is 35 and f2 is 62). The next four elements are either 1 or 0 to indicate whether or not castling is still possible (in the order White queen- and king-side, then Black queen- and king-side). The remaining 64 elements are the contents of the chessboard from the top left corner to the bottom right corner as seen from White's side (0 = empty, 1 = pawn, 2 = knight, 3 = bishop, 4 = rook, 5 = queen, 6 = king, positive for White, and negative for Black).

The result of FMATE is a two-element numeric vector that contains, if a solution is found, the "from" and "to" square of the winning move (in algebraic notation, with a negative "to" square indicating pawn-to-knight promotion); or, if no solution is found, either 0 1 or 0 0 (0 0 indicates that the attacker has no legal move in the given position).

The functions should run in any APL system if statements using the diamond separator are broken up into several lines and if the

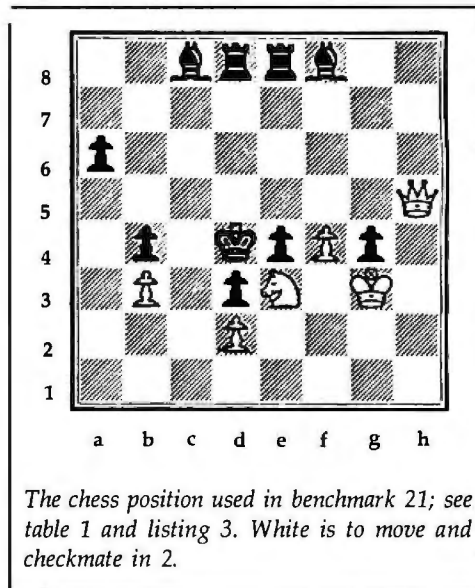

The chess position used in benchmark 21; see table 1 and listing 3. White is to move and checkmate in 2.

sequence "[,0]" is substituted for the hyphen-comma overstrike character (as in lines 5 through 9 of function MLIST). I'd be interested in timings of the benchmark problem on hardware more powerful than the PC (see note 4 in table 1 for its definition, and expect the solution 85 15). FMATE makes no attempt to examine potential moves in an intelligent order and can take a long time to execute.

nized by version 1.1 of DOS (disk operating system). Under IBM's APL, all memory up to the 544K-byte maximum can be used, with system overhead ranging between 84K and 113K bytes, depending on which auxiliary processors (APs) you choose to load. (I'll be coming back to the subject of APs later on.)

There is, however, a twist to IBM's use of memory: the first 64K bytes of the active workspace constitute what IBM calls the *main workspace*; whatever is left over is labeled the *elastic workspace*. All real APL work, like statement execution or the creation and modification of APL arrays and functions, takes place in the main workspace; the interpreter uses the elastic workspace strictly for the temporary storage of APL objects when space is needed for an operation in the main workspace. I find this quasi-virtual memory scheme a rather timid way for IBM to deal with the segmented architecture of the 8088 microprocessor.

Although the shuttling of data between the main and elastic workspaces is not usually noticeable, this arrangement does have some drawbacks: IBM APL arrays are limited to 32K bytes, and certain operations (such as adding two large numeric vectors) cannot be carried out because of the need for both the arguments and the result to fit simultaneously in the 64K-byte main workspace. (Under STSC's APL, an array can occupy a full memory segment, or 64K bytes, and as long as there is

room in memory for the result, operations between large arrays can take place.)

Report formatting: STSC's APL*PLUS offers the powerful and much-imitated \square FMT formatting function. Its capabilities are too numerous to detail here (as witness the fact that STSC offers a separate manual on its use), so I'll limit myself to the example given in listing 4a. STSC also provides the utility workspace FORMAT containing a set of rather slow functions that simplify adding titles, column headings, and row names to reports being formatted with \square FMT.

IBM's APL offers Picture Format, an extension to the simple dyadic format available on all APL systems. Picture Format has for many years been discussed and refined by various authors within IBM, and the result of all this work is a facility that cannot hold a candle to STSC's good old \square FMT; listing 4b shows an example of its use. Not only is Picture Format of limited capability (e.g., it is unable to duplicate the first example with its different floating decorators for positive and negative numbers), but it is also hard to learn because it attaches various unintuitive meanings to the digits that appear in the picture argument. All I can say for Picture Format is that it's better than nothing. (Note: You must specify your intention to use Picture Format when you load IBM's APL from DOS; it'll cost you an extra 7.6K bytes of overhead.)

Text continued on page 260

Information and
Data Processing

Computer Applications

Software

Engineering
Legal Protection
Flexibility
Maintenance
Management
Packages
and more!

Computer Systems

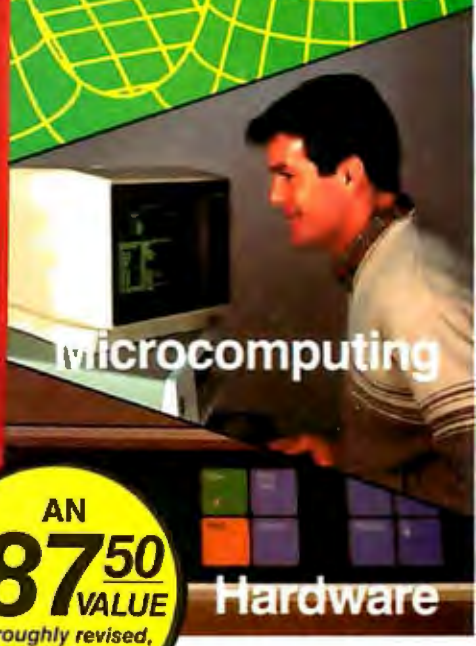

Microcomputing

Hardware

AN
\$87⁵⁰
VALUE
Thoroughly revised,
updated and
reorganized.

THE MOST COMPLETE
COMPUTER INFORMATION RESOURCE

Encyclopedia of Computer Science and Engineering

IS YOURS
FOR ONLY **\$2⁹⁵!**

WHEN YOU JOIN THE LIBRARY OF COMPUTER AND INFORMATION SCIENCES

You simply agree to buy 3 more books—at handsome discounts—within the next 12 months.

Indispensable to consultants, business people, data processing professionals, and enthusiasts, the ENCYCLOPEDIA OF COMPUTER SCIENCE AND ENGINEERING is a veritable data base of information on:

- Hardware
- Software
- Programming languages
- Artificial Intelligence
- Computer Applications
- Personal computing and much more!

The Encyclopedia is organized to make finding and using its wealth of information easy. Articles are alphabetically arranged and are cross-referenced to related articles and to specific subject matter. The clear and expanded appendices include abbreviations, acronyms, special notation and terminology, as well as numerical tables, the mainstay of applied technologies. A complete 5,000-term index contains references to sub-categories, doubles as a computer science dictionary, and is an invaluable tool for locating specific information.

Praise For the First Edition:

Called "Impressive...comprehensive...well done" by *Datamation*, and "...a real treasure cache" by *Business Management*, the new Second Edition promises to eclipse *Computer Management's* statement on the original of "There isn't another book like it." Send for your *free* 10-day trial.

This up-to-date Second Edition contains:

- Over 1,670 pages of revised, expanded, and updated text.
- 550 articles on virtually every aspect of the computer sciences
- 301 distinguished contributors
- Over 500 photos, and over 250 diagrams, graphs and charts

The Library of Computer and Information Sciences is the oldest and largest book club especially designed for the computer professional. In the incredibly fast-moving world of data processing, where up-to-date knowledge is essential, we make it easy for you to keep totally informed on all areas of the information sciences. In addition, books are offered at discounts up to 30% off the publishers' prices. Begin enjoying the club's benefits today!

4 Good Reasons to Join

1. The Finest Books. Of the hundreds of books submitted to us each year, only the very finest are selected and offered. Moreover, our books are always of equal quality to publishers' editions, *never* economy editions.

2. Big Savings. In addition to getting the ENCYCLOPEDIA OF COMPUTER SCIENCE AND ENGINEERING for \$2.95 when you join, you keep saving substantially—up to 30% and occasionally even more. (For example, your total savings as a trial member—including this introductory offer—can easily be over 50%. That's like getting every other book free!)

3. Bonus Books. Also, you will immediately become eligible to participate in our Bonus Book Plan, with savings up to 70% off the publishers' prices.

4. Convenient Service. At 3-4 week intervals (16 times per year) you will receive the Book Club News, describing the Main Selection and Alternate Selections, together with a dated reply card. If you want the Main Selection do nothing and it will be sent to you automatically. If you prefer another selection, or no book at all, simply indicate your choice on the card, and return it by the date specified. You will have at least 10 days to decide. If, because of late mail delivery of the News, you should receive a book you do not want, we guarantee return postage.

If the reply card has been removed, please write to:

The Library of Computer and Information Sciences

Dept. 7-CJ8 Riverside, N.J. 08075 to obtain membership information and an application.

Listing 3: A complicated chess-problem solution program, FMATE, and its associated functions (subroutines). See the text box on page 256 for more details.

```

▽ WSINIT;□IO
[1] □IO+1
[2] ΔN+ -21 -19 -12 -8 8 12 19 21
[3] ΔB+ -11 -9 9 11 0.×17
[4] ΔR+ -10 -1 1 10 0.×17
[5] ΔK+ -11 -10 -9 -1 1 9 10 11
[6] ΔQ+ΔK0.×17
[7] ΔA+(Φ18)0.+10×18
[8] ΔC+ 4 2 ρ 11 51 81 51 18 58 88 58
[9] □IO+0
[10] ΔF+(-ΔFεΔA)/ΔF+1100
[11] ΔZ+100ρ64 ◇ ΔZ[ΔA]+164
▽

▽ MA+M FMATE BD;KA;KB;L;N;LA;LB;SA;SB;IA;IB;FA;FB;BA;BB;MB;□IO
[1] □IO+0 ◇ KA+'ρKB+ΔA[-5+BD16×A,B] ◇ KB+KB[1] ◇ L+0=N+M-1
[2] LA+'ρρSA+A MLIST BD ◇ IA+ -1 ◇ FA+0
[3] A:→(LA=IA+IA+1)ρD ◇ +(B,(KA,MA[1]))[KA=MA[0]]SCHECK BA+(MA+SA[IA;])MMAKE BD)ρA
[4] FA+1 ◇ →L+X ◇ →((A,KB)SCHECK BA)+A
[5] X:LB+'ρρSB+B MLIST BA ◇ IB+ -1 ◇ FB+0
[6] B:→(LB=IB+IB+1)ρC ◇ +(A,(KB,MB[1]))[KB=MB[0]]SCHECK BB+(MB+SB[IB;])MMAKE BA)ρB
[7] →LρA ◇ →(0=1ρN FMATE BB)ρA ◇ FB+1 ◇ →B
[8] C:→(L∨FB)ρ0 ◇ +(A,KB)SCHECK BA)ρ0 ◇ →A
[9] D:MA+0,FA
▽

▽ ML+TN MLIST BD;P;T;L;PW;ΔP;LS;LO;LE;PS;TS;SW;I;□IO
[1] ML+ 0 2 ρ□IO+0 ◇ PW+(TN≠1)Φ 2 7 ◇ ΔP+TN× -9 11 1 2
[2] LS+LO+100ρ1 ◇ LS[ΔF,PS+(L+TN=T+×P+5+BD)/ΔA]+0 ◇ TS+(|L/P),0
[3] LO[(T=-TN)/ΔA]+0 ◇ LE+LS^LO ◇ +(SW+0,P,N,B,R,Q,K)[TS[I+0]]
[4] P:T+((LO[2ρT]≤BD[0]=2ρT),^LE[2+T])/T+P+(3+1ρL+PW=10|P+PS[I])ρΔP
[5] ML+ML;P,[0.5]T,-L[1]/T ◇ →SW[TS[I+I+1]]
[6] N:ML+ML;P,[0.5]LS[T]/T+100|ΔN+P+PS[I] ◇ →SW[TS[I+I+1]]
[7] B:ML+ML;P,[0.5](,^LS[T]^1,LO[0 -1 +T])/,T+100|ΔB+P+PS[I] ◇ →SW[TS[I+I+1]]
[8] R:ML+ML;P,[0.5](,^LS[T]^1,LO[0 -1 +T])/,T+100|ΔR+P+PS[I] ◇ →SW[TS[I+I+1]]
[9] Q:ML+ML;P,[0.5](,^LS[T]^1,LO[0 -1 +T])/,T+100|ΔQ+P+PS[I] ◇ →SW[TS[I+I+1]]
[10] K:T+LS[T]/T+ΔK+P+PS[I] ◇ +(∧/L+BD[2 3 -TN])ρY ◇ +(∧/L+L^∧(LE[P- 10 20 30]),^LE[P+ 10 20])ρY
[11] →(((-TN),P)SCHECK BD)ρY ◇ →L[0]+X ◇ T+T,(((TN),P-10)SCHECK BD)+P-20 ◇ →L[1]+Y
[12] X:T+T,(((TN),P+10)SCHECK BD)+P+20
[13] Y:ML+ML;P,[0.5]T ◇ →SW[TS[I+I+1]]
▽

▽ NB+MV MMAKE BD;UP;FT;P;□IO
[1] UP+MV[1]<□IO+0 ◇ NB+5+BD ◇ BD+5+BD ◇ FT+ΔZ[MV+|MV] ◇ BD[FT]+0,P+BD[FT[0]] ◇ →(1 6 =|P)/P,K
[2] E:NB[0,(∨ΔCεMV)/ 1 2 3 4]+0 ◇ NB+NB,BD ◇ →0
[3] K:→(20≠|-/MV)ρE ◇ BD[FT]+ΦBD[FT+FT[1]]+1,-1-2=8|FT[1]] ◇ →E
[4] P:→(2≠|-/MV)ρX ◇ NB[0]+MV[0]+×P ◇ NB+NB,BD ◇ →0
[5] X:→(NB[0]≠MV[1])ρY ◇ NB[0]+BD[FT[1]]+8××P]+0 ◇ NB+NB,BD ◇ →0
[6] Y:→(1 8 ∧,≠10|MV[1])ρE ◇ BD[FT[1]]+ 5 2 [UP]××P ◇ →E
▽

▽ YN+CS SCHECK BD;PS;P;LE;T;□IO
[1] BD+5+BD,□IO+0 ◇ PS+CS[0]×17 ◇ P+CS[YN+1]
[2] +(PS[1]εBD[ΔZ[P+CS[0]× -11 9]])ρ0
[3] +(PS[2]εBD[ΔZ[100|P+AN]])ρ0
[4] LE+100ρ1 ◇ LE[ΔF,(0≠64ρBD)/ΔA]+0
[5] →(∨/PS[3 5]εBD[ΔZ[(,^1,LE[0 -1 +T])/,T+100|P+ΔB]])ρ0
[6] →(∨/PS[4 5]εBD[ΔZ[(,^1,LE[0 -1 +T])/,T+100|P+ΔR]])ρ0
[7] YN+PS[6]εBD[ΔZ[P+ΔK]]
▽

```

Listing 4: A formatted output in APL. Listing 4a shows an example of the powerful STSC APL formatting function. Listing 4b shows the less powerful IBM APL Picture Format option.

(4a)

```

D+82679 10582 121383
A+1234.567 0 -98765.4
F+'G<Z9/99/99>,P<$>Q< >M<($>N<)>O<ZERO >F13.2'
F □FMT (D;A)
8/26/79 $1,234.57
1/05/82 ZERO
12/13/83 ($98,765.40)

```

Listing 4 continued on page 260

RUN "TAXES" I/O ERROR Disk Media Error

A Modern Day Fable.

Once upon a time there was a very diligent man, Jack. Every year the man promised his very faithful wife that he would keep accurate records to make tax time more bearable.

One sunny day, Jack traded in his family cow for a new computer. That starry night, he began to enter all of his tax records onto disk. "How easy and accurate this will be," he stated.

The months went by. Tax time approached. Confidently, Jack inserted his data file and entered "Run Taxes." "Just watch," he said to his wife. But alas. His CRT, as if it were alive, proclaimed, "I/O ERROR." "Gads," he stammered in frustration. "Oh my," said his wife.

Then entered his neighbor carrying three beans, a golden lyre and the new Discwasher® Clean Runner™ Interactive Drive Cleaner. The good neighbor told Jack, "Preventive maintenance will destroy dirt in the disk drive and keep it running clean."

The good neighbor promptly inserted the Clean Runner Interactive Drive Cleaner into the drive and cleaned the read/write heads for Jack. Saying "Bye," he left to tend to his garden. Diligent Jack then proceeded to run his tax data and this time all went well.

The moral of the story, Discwasher Clean Runner is a disk of prevention for a bit of frustration.

The End.

Not all endings are that happy. A dirty read/write head can cost not only many hours of time but also the loss of valuable data.

- ✦ Discwasher® Clean Runner™ Interactive Drive Cleaner is one disk that contains both the program software and the cleaning surface. There is no program to enter.
- ✦ Clean Runner is an interactive system. It responds to your individual entries as it leads you step-by-step through the cleaning process.
- ✦ Clean Runner directs the head(s) of your drive to a different track for each cleaning. Clean Runner provides a contamination-free cleaning surface.
- ✦ Clean Runner effectively works on both single or double-sided drives.
- ✦ Clean Runner is programmed for 20 cleaning operations.



A Disk Of Prevention For A Bit Of Frustration

Circle 125 on inquiry card.

discwasher 1407 N. Providence Rd., P.O. Box 6021, Dept. BY, Columbia, MO 65205 USA A DIVISION OF JENSEN an ESMARK Company

(4b)

'55/05/05	(55,551.50)'	▼ D,[1.5]A
8/26/79	1,234.57	
1/05/82	.00	
12/13/83	(98,765.40)	

Text continued from page 256:

Error trapping: When an error occurs during execution of a statement, STSC's APL suspends processing at the point of error, retrieves the current contents of the special character vector $\square ELX$ (error latent expression), and executes them as a line of APL. You might have previously set up $\square ELX$ to force an exit from the executing function (returning some specific result indicating that a problem was encountered) or to generate a branch to a different part of the function, where the cause of the error may be determined by examining the system-generated variable $\square DM$ (diagnostic message). If the program is sufficiently sophisticated, it may then be able to take corrective action and resume execution.

IBM's tool for the automatic handling of errors is the elegant system function $\square EA$ (execute alternate). It takes two character-vector arguments representing APL expressions and attempts to execute the one on its right; if it fails because of an error, it goes back and executes the left argument instead. This allows you to exercise very fine control over errors occurring in different parts

of a statement: for example, the expression in listing 5 adds the inverse of matrix A (or a matrix of 0s if A is not invertible) to the inverse of matrix B (or to a matrix of 1s if B is not invertible).

One problem with $\square EA$, however, is that if an error occurs in a defined function called from $\square EA$'s right argument, the execution state of that function is discarded before processing of $\square EA$'s left argument begins. This means that it becomes impossible to determine the cause of the error, to recover the values of the function's local variables, or to automatically resume execution at the point of error.

Disk file access: This topic brings up a long-standing philosophical debate between STSC and IBM on the subject of APL's control over its hardware environment (i.e., peripherals). STSC holds the view that APL should provide primitive system functions and variables that allow you to manage every aspect of your computer and has accordingly never been shy about adding such facilities to its APL interpreters. (APL*PLUS/PC boasts more than 100 system functions and variables as well as approximately 20 documented memory locations that you may modify to further control the system's behavior.) IBM, on the other hand, believes that such matters belong outside the realm of the APL language and should be handled by external programs (auxiliary processors) operating independently of the APL interpreter. You communicate your wishes to an auxiliary processor (and it in turn communicates results to you) by the clever device of sharing one or more variables in your workspace with the auxiliary processor: when you assign a value to a shared variable, the auxiliary processor can examine and modify it so that when you next look at the variable, it contains the result of your request. For example, a hypothetical clock/calendar auxiliary processor named AP24 (auxiliary processors are distinguished by number) might work as shown in listing 6.

The example demonstrates the use of the system function $\square SVO$ to first "offer" to share VAR with AP24 and then to verify that the share was "accepted." If you want to program in assembly language, check out the IBM APL reference manual to find out how to create your own auxiliary processors to complement (or replace) the ones distributed with the system; this is potentially a very powerful capability.

Now, then, what about disk file access? Not surprisingly, STSC provides an abundance of excellent system functions to support two kinds of file organizations: the *APL component file*, a random-access arrangement of arbitrarily shaped APL arrays, and the so-called *native file*,

THE PURCHASING AGENT

We can buy any microcomputer product for you from our 292 participating wholesalers. Here are the net prices on a few of the 7,000 products we can buy for you, acting as your purchasing agent.

<p>COMPUTERS</p> <p>Altos580-10 4,199 586-20 w/o Term. 6,018 986-40 9,027</p> <p>CompuPro Godbout: Sys. 816A RAM 21* 4,075 Sys. 816AH* 6,630 Sys. 816C* 6,632 Sys. 816D* 10,324 816 68K RAM 21* 6,632 *Completely Assembled</p> <p>M-Drive-H CPU 68K 500 Disk 3 587 RAM 21, 128K, 14 Mhz 788 RAM 22, 256K 1,292 Pragmatic 20 meg. 2,990 Pragmatic 40 meg. 4,686</p> <p>Columbia Sys., 2-320K Sys., 12 meg. 2,779 Sys., portable 4,119 Sys., 2320 2,320 Coronadesktop, 2-320K 2,487 Eagle 1630 4,699 Molecular SM 8 10 meg. 4,648 Morrow Micro D, MD-3 1,585 NEC APC-H03 2,999 APC-H12 Col. Graph. 618 APC-H26, 10 meg. 2,172</p>	<p>COMPUTERS</p> <p>Northstar Advantage w/Dual Floppies 2,107 w/5 meg 3,249 w/15 meg 4,315</p> <p>Onyx C5002A, 256K, 14M 9,022 Sage II, w/2-640K 3,470 IV, w/12 meg 5,830 IV, w/18 meg 6,273 IV, w/40 meg 7,965 Sanyo 555, w/2-160K 1,100 Televideo TS-803 2,027</p> <p>TPC-2, port. CALL Zenith ZF-100-21 2,245 ZF-110-22 2,712 ZW-120-32 4,339</p> <p>HARD DISKS</p> <p>Tailgrass 20 meg, w/1ape 3,097 All others CALL</p> <p>IBM PERIPHERALS</p> <p>Keytronic 5150 Keyboard 189</p> <p>MODEMS</p> <p>Hayes 1200 499 US Robotics Password 349</p>	<p>MONITORS</p> <p>Amdak RGB II 450 NEC 1203 536 1410 RGB 780 Princeton RGB w/cable 485</p> <p>PLOTTERS</p> <p>Houston Instr., DMP 41 2,321 Strobe M 100 461 All others CALL</p> <p>PRINTERS</p> <p>Anadex 96258, par 1,190 C. Itoh A 10 20 534 F-10, 40 cps 1,000 Diablo 620 875 NEC 7710 1,900 Okidata CALL All others CALL</p> <p>TERMINALS</p> <p>Televideo 925 715 WYSE WY-50 539 All others CALL</p> <p>TAX SOFTWARE</p> <p>Microtax CALL</p>
--	---	--

CALL US FOR THE NET PRICE ON ANY OF THE 7,000 OTHER PRODUCTS WE CAN BUY FOR YOU AS YOUR PURCHASING AGENT.

Since 1980 B-84-3



THE PURCHASING AGENT, INC.

574 Weddell Drive, Suite 5
Sunnyvale, CA 94089
(408) 744-0646



STOP STRUGGLING WITH SPREADSHEETS!

THERE'S AN EASIER WAY TO DO YOUR BUSINESS PLANNING: PROFIN.

If you don't have days, or even hours, to do projections with a spreadsheet, consider this:

There is now a highly specialized software tool expressly for the business person who needs the answers more than the workout.

TIME-CONSUMING WORK ALREADY DONE FOR YOU

If you want to do forecasts and budgets, return on equity, discounted cashflows, net present values, capital expenditure analysis, interest calculations, depreciation comparisons or taxation scheduling without setting up the mathematical calculations or laying out a spreadsheet, you need Profin.

Profin is an easy-to-use (menu driven) program which leads you through your business analysis step by step. You simply answer the questions as they appear on the screen.

REPORTS AUTOMATICALLY LAID OUT

Once you've completed entry, you'll be able to see any or all of the following reports laid out for you:

- income statements
- interest schedules
- capital expenditures
- tax schedules
- returns on equity
- discounted cashflows
- and balance sheets.

You can then make any changes to any of the information already entered and look at revised reports.

And you can automatically load your Profin reports onto a Multiplan, VisiCalc, SuperCalc or Lotus 1-2-3 screen (or any other spreadsheet that reads D.I.F. files) to carry out further manipulations.

Circle 398 for Dealer Inquiries. Circle 399 for End-User Inquiries.

SPECIALIZED HELP FOR BUSY PEOPLE

Think of it this way: spreadsheets are great for the hobbyist who gains satisfaction from hours in front of the screen. But if you're a business person with little computer experience and even less spare time, you need the specialized tool: Profin.

Available under \$300 for CP/M-80, MS-DOS, and IBM PC-DOS from your local retailer.

Also available: PLANFIN. For sales, marketing and other executives who just want simple forecasts and budgets, Planfin gives you operating income statements plus net income and discounted cashflow reports in less than 15 minutes. Under \$200.

BUSINESS SOFTWARE™



Please send me more information about how Profin and Planfin beat the spreadsheets for budgets and forecasts.

Name _____

Address _____

City/State/Zip _____

Computer Brand Owned or Planned to Buy _____

Mail to: Business Software, Inc.
12021 Wilshire Blvd., #194 Los Angeles, CA 90025

which is simply a DOS file viewed as a long sequence of bytes that you can read or modify at will. The file functions are easy to use and extremely fast. You might especially enjoy the capability to snoop around DOS files interactively.

IBM, of course, provides a file auxiliary processor (named AP210) and a collection of APL-defined functions that use the auxiliary processor to achieve a pale imitation of STSC's file capabilities. AP210 illustrates all that goes wrong in practice with the elegant concept of auxiliary processors: it's difficult to use interactively

Listing 5: An example of the IBM PC "execute alternate" function, which tries to evaluate the expression on the right and, if an error occurs, evaluates the alternate expression on the left.

```
( ('(ρA)ρ0' □EA '⊠A' ) + '(ρB)ρ1' □EA '⊠B'
```

Listing 6: An example of auxiliary processors (APs) in IBM APL. Given a hypothetical auxiliary processor AP24 that gives time and date information, the name VAR is associated with AP24 (lines 1 and 2). This association is confirmed by the query in line 3 and the response in line 4. VAR then returns the time when passed the message 'TIME?' (lines 5, 6, and 7) and the date when passed the message 'DATE?' (lines 8, 9, and 10).

```
24 □SVO 'VAR'
1
□SVO 'VAR'
2
VAR←'TIME?'
VAR
THE TIME IS 11:07:45
VAR←'DATE?'
VAR
THE DATE IS 12/01/83
```

Listing 7: An example of the replicate extension to the compress (/) function. Normally, the compress function uses the left argument as a logical mask through which filter selected components of the right argument (see listing 7a). If the left argument contains numbers greater than 1, the corresponding element is repeated that many times in the result.

```
(7a)
1 0 1 0 1 / 'ABCDE'
ACE
0 1 1 1 0 / 'ABCDE'
BCD
(7b)
0 0 3 0 0 / 'ABCDE'
CCC
1 0 0 2 0 / 'ABCDE'
ADD
```

because of the many steps involved in initiating and verifying shares, assigning data and hard-to-remember request codes to the shared variables, and retrieving data and success/failure codes from the shared variables. Also, because the auxiliary processor has no knowledge beyond the shared variables, it can't take advantage of available memory in your workspace and must use its own small buffers for disk access, which limits data transfers to 2K-byte chunks and creates unnecessary time and space overhead.

Printer and communication ports support: STSC provides a very powerful system function, called □ARBIN, that's somewhat tedious to use. It gives you detailed control over all of the parallel and serial ports in your PC and enables you to send or receive characters in any of the following modes: typewriter-pairing and bit-pairing APL/ASCII overlays (which enable communications with timesharing APL systems and with high-quality APL printers), 8-bit ASCII, and Epson dot-graphics (which enables printing of all 256 characters using the graphics features of Epson graphics printers). In addition to □ARBIN, STSC also supplies the *system terminal mode*; with the push of a function key, you can transform the PC into an excellent APL/ASCII terminal that emulates the Datamedia 1520 and enables you to switch between your APL workspace and a remote computer.

IBM provides more modest capabilities through two auxiliary processors. AP80 supports the first parallel port but will print APL characters only if your system has an IBM Graphics Printer (which, despite rumors to the contrary, is not quite compatible with Epson graphics printers); AP232 supports the first serial port and does a reasonably thorough job of it, although you would have to write a fairly sophisticated program to duplicate STSC's capability to make APL printouts with a serial printer. A set of APL functions furnished with the system uses AP232 to provide a very limited form of terminal simulation.

Full-screen I/O (input/output): STSC provides system functions that enable you to capture or modify characters and video attributes in any rectangular region of the screen. IBM's AP205 offers the same capabilities plus an excellent form-designing feature that should make it easy for you to support full-screen applications.

Machine language and memory access: In addition to vector-oriented versions of BASIC's PEEK and POKE functions, both APLs provide you with the capability to call machine-code subroutines stored in the workspace; in STSC's case, the code can be given access to APL objects and can modify them if necessary. IBM gives you the potentially powerful capability to write your own auxiliary processors.

Speaker support: A system function in STSC's APL allows you to generate a sequence of tones of specified frequency and duration. IBM offers a more sophisticated music-playing capability through auxiliary processor AP440 (similar to BASIC's PLAY statement).

Miscellaneous extensions: STSC's APL supports the *diamond* statement separator (which allows multiple APL

ADDS STACKS UP BEST



Designed for Operator Enjoyment.

The leader in quality and reliability now offers the Viewpoint family with all the most user-requested features:

- Earth-tone colors and small size to complement any office environment.
- Tilt and swivel display for operator comfort.
- Low profile keyboard with adjustable height for easier data entry.



VIEWPOINT®/Color.
The first truly low-cost color terminal.



VIEWPOINT®/90.
OEM's delight... double-high/ double-wide, split screen, programmable function keys, down-line loadable, and more.



**VIEWPOINT®/78 and
VIEWPOINT®/78 Color.**
IBM functionality in mono-chrome and color.



VIEWPOINT®/60.
A fully featured editing terminal.



VIEWPOINT®.
Best price / performance in a conversational terminal.

VIEWPOINT is a registered trademark of Applied Digital Data Systems Inc.

ADDS
Applied Digital Data Systems Inc.
A Subsidiary of NCR Corporation

100 Marcus Boulevard, Hauppauge, NY 11788 (516) 231-5400
Atlanta, GA (404) 456-7120 • Boston, MA (617) 875-2337
Dallas, TX (214) 387-2337 • Palo Alto, CA (415) 856-0560
Philadelphia, PA (215) 564-0135 • Phoenix, AZ (602) 968-0950
Shamburg, IL (312) 843-7555 • Tustin, CA (714) 730-6700
ADDS, UK 44 01 949 1272.

IT ALL ADDS UP.

statements on one line), the *replicate* extension to the compress (/) function (see listing.7 for some examples), and a *string search* primitive. It also provides system functions that can load or copy workspaces from within defined functions; this enables you to split very large applications among several workspaces in a transparent manner.

IBM's APL allows *ambivalent* defined functions (i.e., functions that can be used with either one or two arguments). System commands are provided to store and retrieve workspaces in *transfer form*, an ASCII-like representation of APL functions and variables that lets them be moved to or from other APL systems. (I used this feature to transfer the benchmarks from STSC's APL to IBM's through files created by the STSC native file facility.)

Both APLs allow you to sort character arrays by using dyadic forms of the grade primitive functions.

Planned extensions: Release 2 of STSC's APL*PLUS/PC (which will probably be available by the time you read this) promises to add several new features. Some of them are:

- APL keyword form, which substitutes English words for APL symbols and lets you program in APL without installing the character ROM
- on-line documentation in the form of a user-modifiable Help facility
- graphics primitive functions to support the IBM color/graphics display adapter (as well as the higher-resolution Hercules Graphics Card and possibly others)
- detached I/O, which enables input to the APL interpreter to come from a file and APL output to be redirected to a file
- the capability to execute DOS commands from within APL

- the capability to easily program the function keys

As for IBM's plans beyond version 1.00 of PC APL, your guess is as good as mine—IBM never announces its plans in advance.

Conclusions

After using the two packages, I feel that STSC's APL*PLUS/PC represents the more serious effort to provide a heavy-duty APL system that does not sacrifice control over any aspect of the IBM Personal Computer. I especially like its terminal mode and other communications features, file system (particularly the native file facility), flexible printer support, and clean integration of APL characters into the PC environment.

IBM's APL succeeds admirably in delivering the power of the raw APL language to the PC. It also makes a valiant effort to apply auxiliary processors to the task of controlling peripherals, but unfortunately it comes up short in this respect. The strengths of IBM's approach are that it provides a language uncluttered by special features, which makes it suitable for educational purposes (especially at its \$195 price), and it gives an ambitious user the capability to customize the system by writing auxiliary processors. Unfortunately, the IBM APL's low price of \$195 is offset by the major expense of installing an 8087 chip, which most people won't already have. ■

Jacques Bensimon has a master's degree in mathematics from New York University and works as a financial systems analyst for Becker Paribas Inc. in New York City. He can be reached at One Strawberry Hill, Stamford, CT 06902.

EPROM PROGRAMMER & UV ERASER FOR THE 80's

S15 PROGRAMS OVER 300 DEVICE TYPES

MOS (8K - 256 K, SINGLE & 3 VOLTAGES) BIPOLAR PROMS, 40 PIN MICROS

- Stand Alone
- 256K Buffer (200 ns)
- Integrated keypad
- EPROM simulation
- Fast algorithm
- Power down sockets
- Temp compensated Ref. voltages
- 16 formats & 8 baud rates
- Auto-user friendly-mode



S15F \$995

OVER 26 FUNCTIONS

- Edit
- Delete
- CRC check
- 16 Diagnostic Functions
- Block Move
- And More !
- Over Program
- Insert

BUY-11A \$95.50

- Heavy duty
- Timer
- Safety switch
- 110/220 voltage

BUY-11B \$66.50

- Heavy duty
- Safety switch
- UV indicator

BYTEK

COMPUTER SYSTEMS CORP

(305) 994-3520

4089 S. Rogers Circle #7, Boca Raton, FL 33431

OTHER COMPLETE SYSTEMS

S15R (remote)	\$695
S15P (4 key)	\$795
S15B (bipolar)	\$895
S15G (gang)	\$1095

The truth about information management:

The Knowledge Manager beats dBASE over 250 ways.

"... the leading seller is no longer the best."

You get more from the Knowledge Manager. Relational data management, ad hoc queries (like IBM's SQL/DS), spreadsheet, math and statistics, printed forms management, screen I/O management, a full-scale programming language. All for less than the list price of dBASE. Plus you can now get a text processor, a forms painter, color graphics and a run-time version.

Records	dBASE II	KnowledgeMan
1,000	6.15	5.38
2,000	14.93	11.13
5,000	64.16	33.73
10,000	205.50	69.53

*K-MAN V1.05, dBASE II V2.3D, IBM XT, 256K RAM, heavily populated directory.

Handwritten note:
"K-man" isn't only more expensive than dBASE, I've checked it against other & it seems to be a generation or two ahead!"

All completely integrated: So you can do just about anything you wish. Like financial modeling, order entry, job costing or decision support.

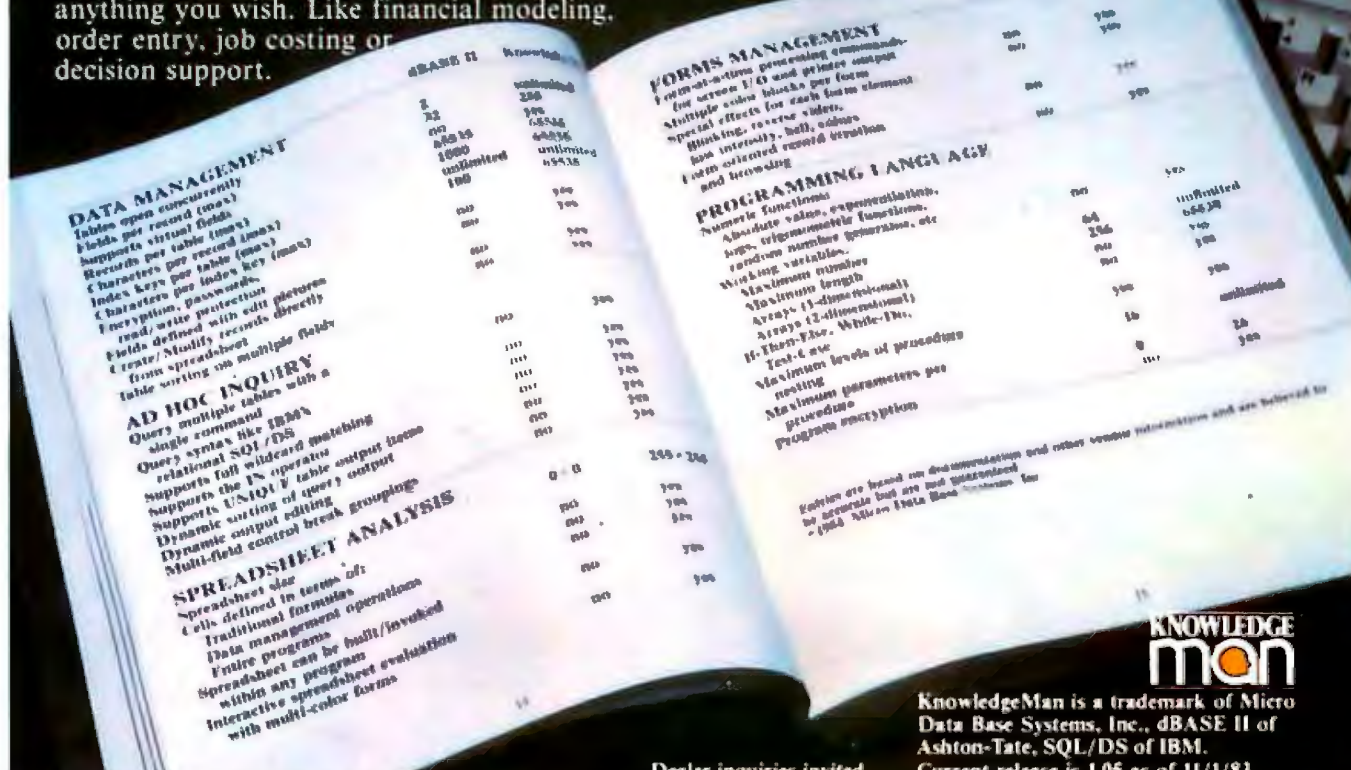

KnowledgeMan is a trademark of Micro Data Base Systems, Inc., dBASE II of Ashton-Tate, SQL/DS of IBM. Current release is 1.05 as of 11/1/83.

Dealer inquiries invited.

Please send me:

- Free feature-by-feature comparison
- Forms painter information
- Graphics information
- Text processor information
- Run-time package information
- Please accept my order for KnowledgeMan Package \$500.00
- Shipping and Handling* 10.00 (Indiana residents must add 5% sales tax \$25.00)

- 5 1/4" IBM PC SS
- 5 1/4" Victor/Sirius
- 5 1/4" DEC Rainbow (Dig. RX50)
- *Add \$20.00 if outside U.S., Canada or Mexico
- Check or money order enclosed (must be drawn from U.S. bank in U.S. currency)
- MasterCard No. _____
- VISA No. _____
- American Express No. _____

Name _____
 Title _____
 Company _____
 Address _____
 City _____
 State _____ Zip _____
 Send To:

MDBS/Consumer Products

47902
463-2581

Disk Format:
 8" IBM-3740 SS/SD

VISA and MasterCard orders may be placed by phone (317) 463-2581.

Or Contact Your Local Dealer.
 PRICES SUBJECT TO CHANGE WITHOUT NOTICE

THE ONE COMPUTER TO HAVE WHEN YOU'RE HAVING MORE THAN ONE.



If you're considering linking up more than one computer, there's only one computer worth considering.

The British Broadcasting Corporation Microcomputer System by Acorn.

One of the BBC Micro's many built-in features is an economical and powerful communications network.

We call this the Econet™ local area network.

Econet lets you combine up to 254 BBC's into a single communications system. Virtually no other system lets you hook up this

many computers this easily.

What's more, you can link two micros without any special hardware. And all computers on the Econet network can share disc drives and printers.

But what really makes Econet such a great network of computers is the computer it networks. The BBC Micro. The most versatile computer anywhere for its size and price. Its enormous built-in expansion potential means it can handle anything from basic tasks to advanced Econet networking. It also means changing technology won't change it into an obsolete

system overnight.

All of which make Acorn the perfect communications system for schools or business.

If you'd like to learn more about how Acorn can build you the perfect communications network, write Acorn Computers Corporation, 400 Unicorn Park Drive, Woburn, Massachusetts, 01801, or call toll-free 1-800-225-8001 (in Massachusetts call 617-935-1190). We'd be happy to communicate with you.

ACORN COMPUTER

© 1983 Acorn Computers Corporation
Circle 394 on inquiry card.



Chalk Board's Powerpad and Leonardo's Library

A new large touch panel for the Atari 400/800, the Commodore 64, and the Apple II comes with a wide selection of software

by Elaine Holden

At last! Technology is finally beginning to incorporate educational philosophy. A new company, Chalk Board Inc., has come up with the Powerpad (hardware) and Leonardo's Library (software). The Powerpad, shown in photo 1, is a touch-sensitive pad that is used by the programs in Leonardo's Library as the primary input. The programs teach visual arts, music, mathematics, science, language arts, and social studies. However, only a fraction of the total series of educational packages is currently on the market.

The Powerpad does not involve traditional teaching approaches such as ditto sheets (those awful purple unreadables handed out by many teachers) and workbooks. Instead, there is direct interaction and immediate feedback with this teaching tool. This is referred to as the multimodal approach. In other words, if you touch it while you hear it and see it, you remember it longer.

Powerpad

The main component of the product is a 12-inch by 12-inch touch pad housed in a 20-inch by 17-inch hard plastic case. Mylar overlays that are part of the software package take the place of a conventional keyboard. Some areas of the pad are defined as keys, depending on the program. The flexi-

bility of the Powerpad expands the range of potential users. Because an intricate keyboard is not involved, children and nontyping adults can learn with the computer in a much more relaxed and natural fashion.

The Powerpad connects through the game input port of your computer. It is lightweight, well constructed, and very versatile. [Editor's Note: See the text box on page 270 for technical notes on the Powerpad.]

Leonardo's Library

The set of learning packages is named after Leonardo da Vinci, who explored many areas of study. Similarly, Chalk Board's library tries to cover many disciplines in the Renaissance tradition. Each discipline has packages that range over five levels of sophistication and complexity. Almost any child or adult can locate a program at the appropriate educational level without becoming frustrated.

Included with each software package is a Mylar overlay sheet that fits over the active surface of the Powerpad. The overlay defines areas of the pad's surface that correspond with specific functions. The matching overlay imprinted with color-coded "buttons" serves as the menu and as special function keys.



Photo 1: The Powerpad with the Mylar overlay for Micromaestro.

For this review, I had access to three of the available packages from Leonardo's Library—Leo's 'Lectric Paintbrush, Micromaestro, and Powerpad Programming Kit. The first two packages help learners discover art and music; the third allows you to use the Powerpad as an input device in your own BASIC programs.

Leo's 'Lectric Paintbrush

Briefly, this program lets you finger-paint electronically. Using Leo's 'Lectric Paintbrush has to be the most fun I've had since I dipped my fingers into a paint dish as a six-year-old in Mrs. Sparrow's first-grade class.

Brush, paint, and crayons are often regarded as too messy for frequent use by children. Only when art class has begun or mother has the patience can a child paint. We tend to forget that a child's timetable may be different from ours, and later we are often disappointed when children do not develop enthusiasm for art.

With this program, you don't need paints or even paper. A stylus is provided, but I much preferred my fingers. The stylus, however, is useful for drawing fine lines. All you have to do is press the pad and the image appears on the screen.

The 36-page instruction booklet provided a very considerable walk-through of all the capabilities of the Paintbrush program, but it did not answer all my questions. It did, in fact, raise some of its own. These probing but

nonthreatening questions provide directions for the learner without stifling the process of discovery. I had to experiment and explore to answer the questions.

Eight colors are provided for the palette. With the colors and my fingers, I was ready to create a masterpiece. Naturally, at first, I left small green fingerprints all over the place while trying to pinpoint where I left off. There's no way to tell on the Powerpad where I had already painted. The images show up only on the screen. Then I discovered that, much like my Logo program, the Powerpad has a Pen-up command that lets me see where my finger is without marking on the screen. When my finger is in the right place, I press the Pen-down area to recommence drawing.

First, I attempted to draw a landscape. Traditionally, a bright yellow sun hovers over all my versions of Mt. Monadnock. I used the Fill command to color in my sun. This is when I discovered that an incomplete circle (or any other shape, for that matter) will leak color all over the landscape. Cancel stopped the process and I cleaned up.

You can also move objects. The manual suggested making clouds. They fit in the picture, so I did. To and End commands define objects. I defined a cloud and used the Move command to put a second cloud, just like the first, in another place. Failing to recall the Pen-up command, I first positioned the cloud in the treetops. Even-



Photo 2: A landscape created with Leo's 'Lectric Paintbrush.

tually it made its way across the sky to the right position, then I cleaned up all my little fluffy fingerprints. The result is shown in photo 2.

You can get quite carried away with this and before long discover that all the computer's memory is used up. Economical use of computer memory is learned through trial and error at this stage but, to make it less frustrating, a Hashmark key (#) is provided on the Mylar overlay as well. When pressed, this key provides a vertical gauge of memory to the right of the picture. The artist can determine how much memory is left because, as he draws, this gauge fills with color.

Pictures can be saved; very clear directions are provided for this, with sample experiments. The experiments stimulate a learner rather than just provide him with lockstep directions. Too many programs give such precise directions that the student behaves like a robot. This is not teaching, this is programming.

Complete referencing is the form of an index is also provided. This is very useful for beginners. It is clearly organized and not complicated.

Micromaestro

This program is an answer to a music teacher's prayer. Limited funds prohibit quantity purchases of pianos, so classes often only hear music, but never make it. Prior solutions have included recorders for all (an agony of sound) and cardboard keyboards (no sounds but everyone got to practice).

Structured music class, individual classroom practice, and home use are all possibilities for Micromaestro, shown in photo 1. Naturally, this program is not a substitute for the real McCoy. I have yet to be convinced that any electronic marvel will ever take the place of a real piano. But basic music theory and composition can effectively be learned through this program. Its visual display function is especially useful, because it lets you

At a Glance

Name

Powerpad, Leonardo's Library

Type

Hardware and accompanying Programming Kit;
Software: Micromaestro,
Leo's 'Lectric Paintbrush

Manufacturer

Chalk Board Inc.
3772 Pleasantdale Rd.
Atlanta, GA 30340
(800) 241-3989

Price

Powerpad, \$99.95
Micromaestro, \$24.95
Leo's 'Lectric Paintbrush, \$24.95
Powerpad Programming Kit, \$24.95
Other software in the Library will be available at prices ranging from \$24.95 to \$49.95

Format

Cartridge or disk

Documentation

36- to 40-page booklets plus self-explanatory keys on the Mylar overlays

Computer Needed

Commodore 64 and VIC-20, Atari, Apple, IBM PC

Audience

Preschool to adult

see what you are playing on your computer screen. Photo 3 shows you what I mean.

Very little music theory is directly provided in the 40-page user's guide. I assume that this is because it is the most basic of the proposed five music packages and

The Technical Side of Powerpad

The Powerpad contains an x, y matrix of 120 by 120 wires. The wires are connected to several 4051 eight-channel analog multiplexer/demultiplexers. The 4051s along one axis are connected to +5 volts. A 4024 seven-stage binary counter makes the 4051s transfer the +5 volts to its matrix wires, one wire at a time. When the user presses the Powerpad matrix, the wires under the point of pressure touch each other so that the potential from one axis is carried over to the wires of the other axis. When this happens, the scanning process stops and the SENSE line to the computer goes low. This alerts the computer that the Powerpad has been touched and the coordinates of the touched area may now be read. The coordinates are stored in two 4021 8-bit shift registers that, for programming purposes, are treated as one 16-bit register. The 16-bit register always contains the values present in the two 4024 binary counters. The x -axis coordinate is stored in the least significant 7 bits of the register, and the y -axis coordinate is stored in the next 7 bits. The most significant 2 bits of the register are always

01. These are discarded by the computer.

To read the coordinates, the computer pulses the CLOCK line to the Powerpad high 16 times. At each pulse, the shift register outputs one bit of its contents to the DATA line through a 4069 inverter. When all the data has been read, the computer pulses the CLEAR line to the Powerpad high. This tells the Powerpad to place the SENSE line low and continue scanning for a touch. Note that the binary counters are not set to zero. Instead, they retain their count and continue the scan from there.

The scanning begins from the point 0, 0. The y axis is scanned from 0 to 119 while x remains at zero; then x is incremented by one, and the y axis is scanned again.

By the way, the Powerpad uses the same I/O port on the Commodore 64 that the keyboard uses. This means that you cannot use the keyboard while the Powerpad is communicating with the computer, although Chalk Board Inc. says that it will tell you how to use both if you join the Padmasters Guild, the Powerpad users group.

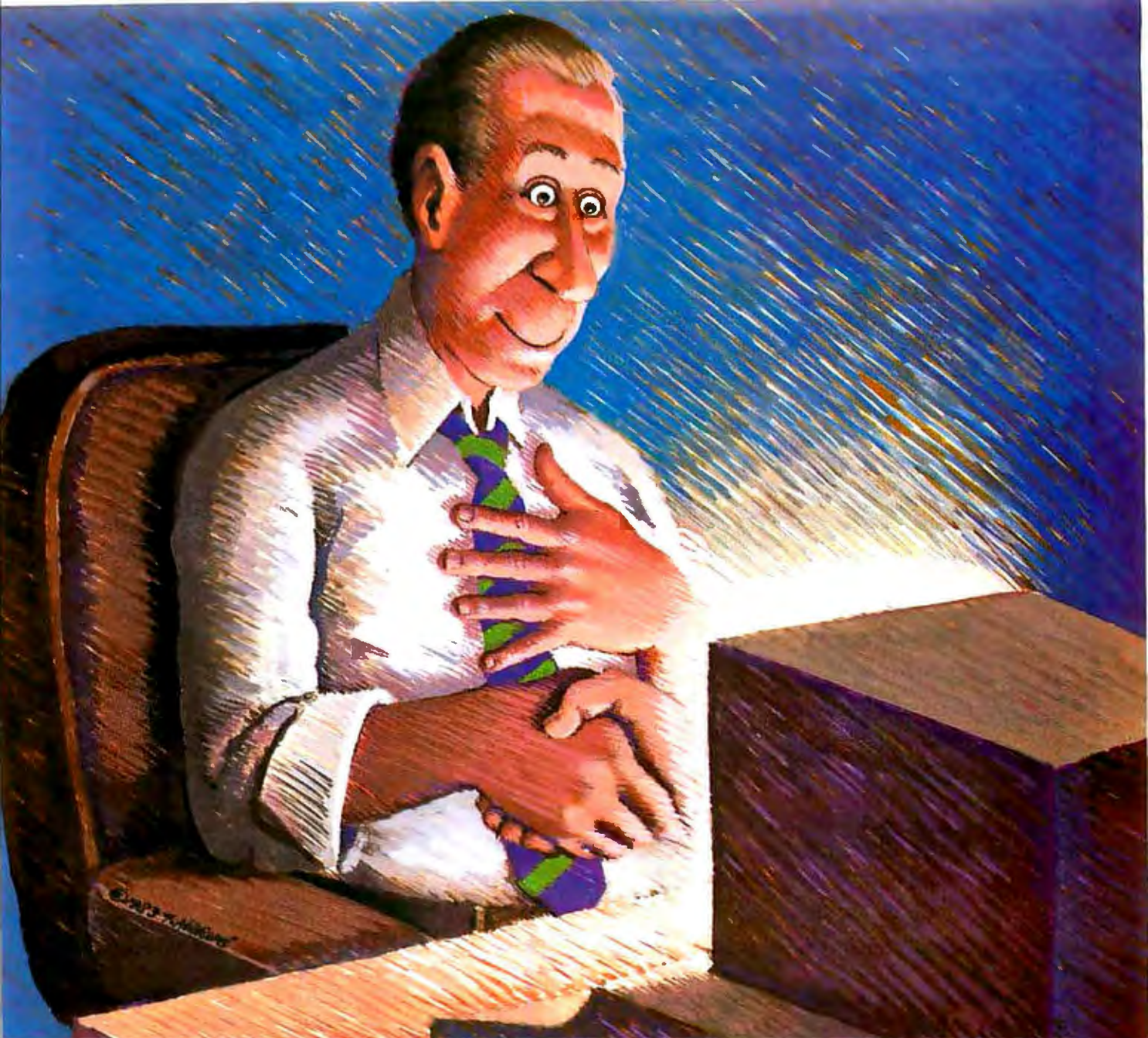

Encounter REVELATION

For \$950, Revelation Software by Cosmos will give your PC capabilities that no microcomputer has ever had before. Through a versatile, high performance Relational Data Base Management System developed by Cosmos, Revelation will give your microcomputer all the power and sophistication of a minicomputer:

Revelation features a data base with variable-length fields and records, (up to 64K), and unlimited files and accounts. File size is

limited only by disk size.

Also featured: A powerful, hybrid programming language.

A fourth generation applications and program generator
Our programs write programs!

Communications functions that give your PC the power to utilize applications, programs, and data from thousands of existing mainframe and minicomputers.

8087 math chip support
Revelation co-exists with MS/DOS™ or PC/DOS™ 1.0, 1.1,

2.0 versions, and is compatible with the IBM PC™, XT™, COMPAQ™, Corona™, Columbia Multi-Personal® and the Eagle 1600™. It's also compatible with mini-computers utilizing the PICK Operating System™. Minimum configuration requires 320K memory and 8087 math chip.

MS/DOS™ of Microsoft Corp. IBM PC Registered TM of International Business Machines Corp. COMPAQ™ of COMPAQ Computer Corp. PICK Operating System™ of

PICK SYSTEMS, Eagle 1600™ of Eagle Computers, Corona PC™ of Corona Data Systems, Columbia Multi-Personal™ of Columbia Data Products Inc.

COSMOS

Telephone 1-800-422-2511
Inside Washington 206-496-5974.

P. O. Box AH, Morton, WA 98356
Circle 102 on inquiry card.



Photo 3: A visual reproduction of music played with Micromaestro.

also because the truly capable music student will attain a lot on his own.

The program carries the student along by suggesting various notes to play. Nothing much beyond this is suggested for songs, the remainder of the booklet being taken up with instructions on the use of various keys, symbols, and game suggestions. Hopefully, the remaining four packages in this series will teach some theory.

Powerpad Programming Kit

This programming kit consists of a blank overlay and a book that explains how to program the Powerpad with BASIC. This is not for the very young or the recent convert to the Computer Age. I was delighted with the program. Middle-school students who are familiar with computers and BASIC are naturals for this kit. I feel that average inquisitive elementary-age youngsters would have a problem, though, unless they are first instructed in the fundamentals of programming.

Conclusions

Leonardo's Library and the Powerpad are fine examples of educational tools. They follow sound educational philosophy, they stress creativity and problem

solving, and they have the element of surprise. With these programs, students cannot rush through an exercise to get done, look at the back of the book for answers, or ask someone else—they must discover on their own.

The electronic wizardry of the Powerpad is impressive, and the rigid plastic housing keeps it quite safe. I would say it will last for a long time under normal use. The Mylar overlays also seem durable but, should accidents occur, they can be replaced for only \$6.

In order for the student not to feel alone with his discoveries, another feature is the Padmasters Guild and the Chalk Board newsletter. The Guild membership is free to anyone owning a Programming Kit and costs \$9.95 a year for everyone else. Included is a hot-line number for troubleshooting and publications on new programs for the Powerpad written by other programmers. The newsletter answers questions and publishes users' comments and ideas. These features, plus the excellent software, add up to a useful tool in education. ■

Elaine Holden (22 Elm Street, Peterborough, NH 03458) is the supervisor of reading and language arts at the Merrimack School District in New Hampshire.

A CASE THAT'S AS ADVANCED AS YOUR COMPUTER!



A. The strong stainless steel tongue and groove frame, designed for moisture and dust resistance, is the only one of its kind.

B. Secure three-point latching is provided by lock and key combined with an easy to use combination lock. Our Sureglide™ cam action swivel closures hold even when the case is dropped.

C. Customized foam interior is die cut to fit and protect your computer. On larger cases the lid is padded with convoluted urethane foam for complete protection. On 20" cases the lid contains a folio designed to hold floppy discs, full 15" printout paper and manuals.

D. A sturdy wall of high impact resistant ABS (used in football helmets and auto bumpers) provides durable outer protection as well as good looks. The inconspicuous exterior of the case camouflages your computer for added security.

E. Comfortable padded handle makes carrying easy. Larger models also have easy glide reinforced wheels and the convenient T-bar pull handle that flips up when you need it, folds down for travel.

American Tourister computer cases offer you a way to carry, protect and camouflage your personal computer or printer in style. They're built with the same high quality and features that have made American Tourister luggage famous for more than 50 years.

Quality control atmospheric, stress and "abuse" tests

maintain the strict American Tourister quality standard. And in the event of loss, damage or theft, the unique American Tourister lifetime case registration program will verify the date of purchase for insurance claims. Available in metallic graphite gray and classic black.

FULL ONE YEAR LIMITED WARRANTY
30 DAY MONEY-BACK GUARANTEE!
USE YOUR VISA, MASTERCARD OR AMERICAN EXPRESS



TO ORDER,
CALL
TOLL FREE **1-800-341-6311**

IN RHODE ISLAND, CALL 401 273-2020.

© 1983 American Tourister, Inc. 91 Main Street, Warren, RI 02885



Simulated Computer II

by Richard Grehan

Back in my college days, the only programming languages I had under my belt were BASIC and FORTRAN. I saw the computer as a mass of equipment so hopelessly complex that assembly-language programmers were like Nobel laureates. If you find yourself viewing the prospect of having to learn assembly language with the same pessimism that I felt back then, or if you just want to get a better idea of what goes on inside a computer, then Simulated Computer II deserves your attention.

Simulated Computer II from Carousel Software Inc. takes you on a fantastic voyage inside an imaginary computer. You can watch system registers being loaded, memory locations being modified, and even see and hear information flow from one location to another. Simulated I/O (input/output) devices allow you to load programs, execute them, and display their results. Also included are a programmable sound generator and a "turtle screen," a version of the line-drawing creature used with the popular Logo programming language.

Main Display

Nearly all of Simulated Computer II's action takes place on a single screen. It displays the four major components of the simulated computer (see photo 1). In the upper left is the *input device*, a stylized representation of a terminal complete with screen, keyboard, and a pair of tiny hands ready to begin typing. As you enter commands, the hands actually dip down to strike keys on the imaginary keyboard (a very nice touch that enhances the reality of the simulation; I give the designers an A+ for that one).

The upper-right portion of the display holds the computer's *output device*, where all program output and system error messages appear. This is a printer—obviously equipped with a tractor feed, since you can see the little holes in the paper—that makes a wonderful sputtering sound as its print mechanism operates.

The lower half of the screen displays the computer's *memory*, a whopping 24 memory locations arranged in a 4 by 6 matrix of boxes. The address of each box is easily identified by an attached tag, so there is no confusion about where things are coming from or going to. The last four locations have special functions with regard to sound and graphics, which I will describe in detail shortly.

The central processing unit sits in a sovereign position in the upper center of the screen. Six boxes inside

the central processor represent its registers. Two of them, the accumulator and the program counter, are directly accessible by user programs. The other four—the instruction register, fetch register, increment register, and execute register—are used by the processor for its internal operation. The contents of these registers are visible at all times. (This simulated computer is a base-10 machine; registers and memory locations can hold numbers in the range ± 999 . Having all operations performed in decimal numbers—rather than the expected binary or hexadecimal—is actually a good idea, since people trying to learn what goes on inside a computer have enough on their hands without having to worry about number base conversion.)

Connecting everything is the *system bus*, the real star of the show. Information traveling from one part of the computer to another is represented by a white, glowing electron that whizzes along the bus. This is the addicting part of the simulation. You find yourself entering and running programs just to watch the light show, and, best of all, you get to see exactly what's going on.

Simulated Computer II sports a pretty lean instruction set (see table 1). All mnemonics are three characters long, usually followed by a two-digit address. I believe that the designers were trying to find the balance between a product that was too simplistic and one that was too complex.

The two primary system commands are LOAD, which allows you to enter program and numeric data into memory; and RUN, which begins execution. Instructions may be loaded directly into memory in their mnemonic representation, but when RUN is executed, Simulated Computer's first action is to scan through all memory locations, translating all mnemonics to their operation code values so that all you see in the memory boxes are numbers. The subtle lesson being taught here, something that people familiar only with high-level languages are largely unaware of, is that data and instructions are indistinguishable until they reach the central processor.

Various versions of the RUN command let you execute programs at speeds from about 5 seconds per instruction up to a half-second per instruction or even single-step, which causes the system to wait for a keypress between each event.

Sound

Simulated Computer's sound capability is accessed by



Photo 1: The Simulated Computer's main display, showing (clockwise from upper left) the input device (a terminal), the central processing unit, the output device (a printer), and system memory.

storing a number into memory location 20. The number must be greater than 0 and less than 37 (less than 92 for the Commodore 64 version). These values seem to correspond to three octaves of an even-tempered scale starting one octave below middle C. However, I found it nearly impossible to determine the relationship of value stored to pitch produced since the generated sound is just a short beep. Even running the program at top speed, time between tones is nearly 6 seconds. Add to that the racket of the electrons racing from place to place as instructions are executed, and you can hang up the hope of generating even simple melodies.

Turtle Graphics

Memory locations 21, 22, and 23 control "a memory-mapped turtle." (For anyone not familiar with the turtle, it is the software incarnation of a small robot used to produce line graphics. You program the turtle to move along a path, and it leaves a "trail" on the screen as it carries out your commands.) Storing a number in location 21 tells the turtle which color to draw, location 22 determines the angle (in clockwise degrees) through which it will rotate before drawing, and location 23 selects the distance it will move. It is the act of storing a number in location 23 that actually sends the turtle on its way.

At a Glance

Name
Simulated Computer II

Type
Educational Simulation

Manufacturer
Carousel Software Inc.
877 Beacon St.
Boston, MA 02215
(617) 437-9419

Available From
Apex Resources Inc.
17 St. Mary's Court
Brookline, MA 02146
(617) 566-1569

Price
\$29.95 suggested retail

Format
Cassette or disk

Language
Compiled FORTH (a FORTH interpreter is not required)

Computer
Atari series of microcomputers with 32K bytes of RAM or Commodore 64

Documentation
Approximately 35 pages

Audience
Anyone interested in learning the fundamentals of assembly-language programming (age range recommended by manufacturer: 12 to adult)

Mnemonic	Instruction Code	Description
LDAxx	1xx	load accumulator with contents of xx
STAxx	2xx	store contents of accumulator into xx
ADDxx	3xx	add contents of xx to value in the accumulator
SUBxx	4xx	subtract contents of xx from value in the accumulator
MULxx	5xx	multiply accumulator by contents of xx
DIVxx	6xx	divide accumulator by contents of xx (results rounded to nearest one)
INPxx	7xx	input to location xx
OUTxx	8xx	output from location xx
JMPxx	9xx	unconditional jump to location xx
STP	000	stop
SKPcc	0cc	skip next instruction if condition cc is true; values for cc: 01 - accumulator < 0 02 - accumulator > 0 03 - accumulator = 0 04 - accumulator <= 0 05 - accumulator >= 0 06 - accumulator <> 0

Table 1: Simulated Computer II instruction set. The variable *xx* represents a memory location and must be in the range 0 to 23.

When the turtle receives a command, the main display disappears and is replaced by the *turtle screen* (see photo 2). This is an aerial view of the little fellow, surrounded by a rectangular border near the edges of the screen. As a program runs, the system flips back and forth between the main and turtle screens, and you can watch the graphics commands execute step by step.

I discovered that if you command the turtle to move some distance that would send it off screen, it rams into the border with a painful crashing sound and the program halts. I really wish the little printer had sputtered out ERROR-INJURED TURTLE.

A Sample Machine Cycle

Since the beauty of this simulation is its ability to reveal the individual actions that must take place for a single machine instruction to execute, let's take a look at what happens when we single-step through an LDA06 (load the accumulator from memory location 6). We'll assume that our instruction is stored at location 00:

1. The number 00 appears inside the program counter and fetch register boxes in the central processor. The numbers gleam brightly for an instant when they ap-

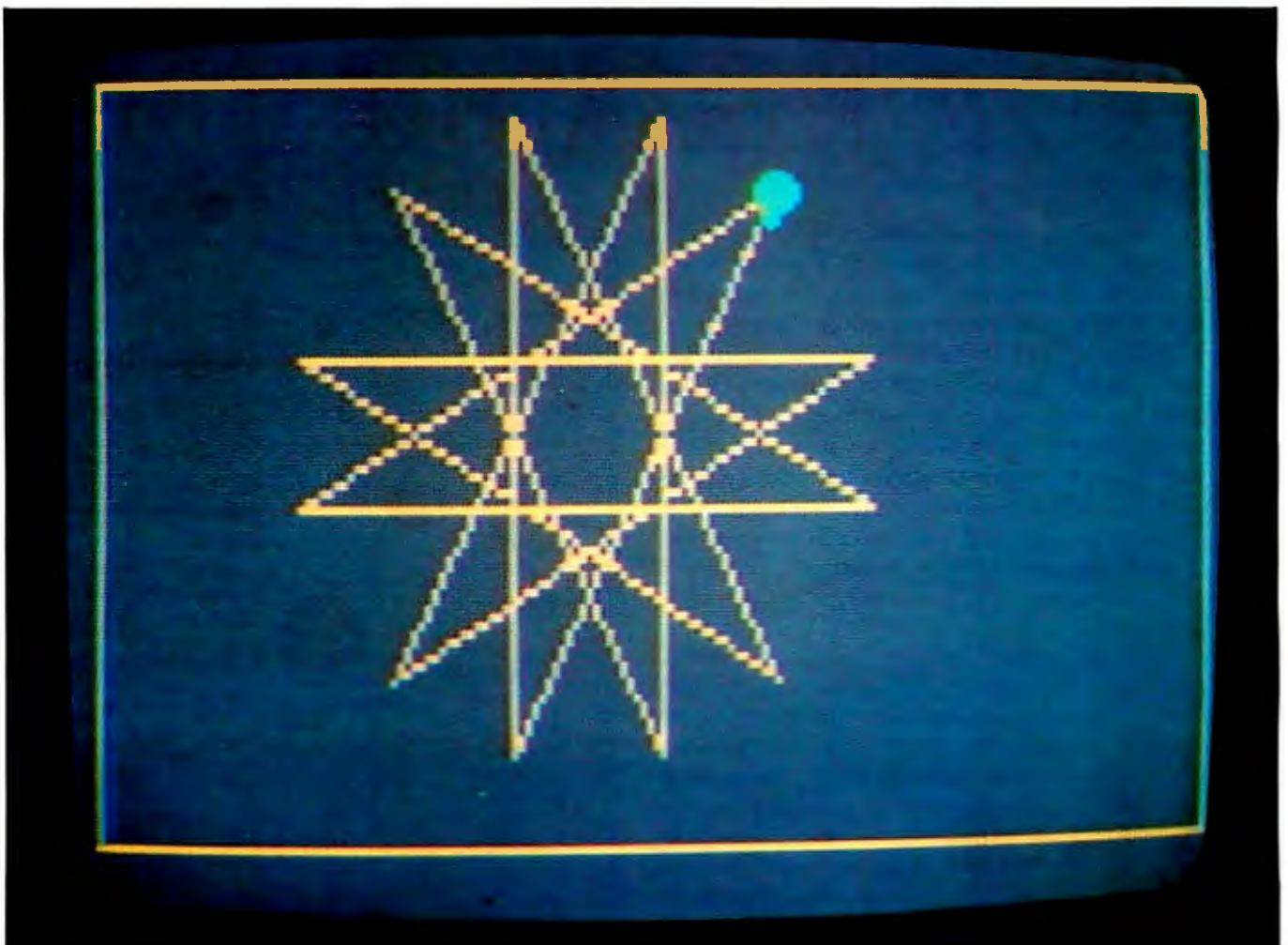

Photo 2: Simulated Computer II's turtle hard at work on the turtle screen producing a 12-point star.

EQUATIONS PROCESSED NO PENCIL. NO PAPER. NO MANUAL LABOR.

The TK!Solver® program will take on **your** toughest problems—linear, quadratic, simultaneous equations, whatever. Then stand back. Because TK!Solver turns your personal computer into a simple, yet powerful, desktop equation processor.

Whether your problem is a simple formula or a model consisting of many equations, TK!Solver can help improve your productivity. Once the equations are written, enter the known values, press the ! key, and TK!Solver gives you the answer.

Engineers, scientists, architects, financial analysts and planners, educators, researchers, and other professionals who use equations and mathematical models can work more creatively with TK!Solver.

TK!SOLVER GIVES YOU: BACKSOLVING

If the programs you use now require you to rewrite the same equation to solve for different unknowns, TK!Solver can dramatically improve your productivity. Enter your problem once and then solve for the unknowns no matter where they are in your equation.

ITERATIVE SOLVING

If TK!Solver can't solve an equation directly, take an educated guess at the answer. Type the ! key and the TK!Solver program starts with your guess and performs repeated approximations to converge on the answer.

LIST SOLVING

Given a list of input values, TK!Solver automatically calculates the equation for every value in

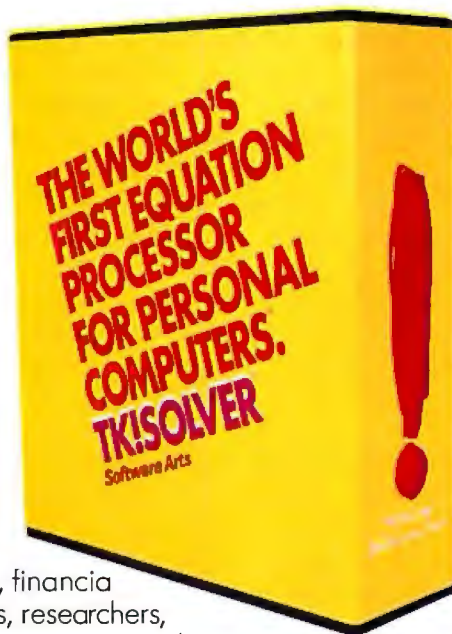

your list. For example, if you want to know how different interest rates will affect monthly loan payments, enter a list of interest rates and let TK!Solver calculate the payment amount for each value.

UNIT CONVERSIONS

Any type of unit conversion—Fahrenheit to Celsius, meters to feet, dollars to deutschmarks, newtons to dynes—can be made

program automatically converts the variable value to the unit you specify.

TABLES AND PLOTS

Quickly generate tables and plots of your results on your screen or printer.

AVAILABLE NOW

You can run the TK!Solver program on the IBM® PC and XT and compatible machines, the Digital™ Professional™ 350, the Digital™ Rainbow™ 100, the Wang Professional Computer, Apple® IIe, and on the following personal computers using MS™-DOS: TI Professional Computer, GRiD Compass Computer,™ Canon AS-100, Eagle® 1600, Toshiba T300, and the Zenith Z-100.™

SEE IT TODAY

There's more. Lot's more. But you'll have to see it to believe it. And that's easy. Bring your own equations into your nearest computer retailer and ask to see the TK!Solver program in action.

The world's first equation processor for personal computers.

TK!Solver®

By Software Arts,™ creators of VisiCalc®
27 Mica Lane, Wellesley, Massachusetts 02181 617-237-4000

TK, TK!, TK!Solver, the stylized ! and the slogan "THE WORLD'S FIRST EQUATION PROCESSOR FOR PERSONAL COMPUTERS" are trademarks or registered trademarks of Software Arts, Inc. Software Arts is a trademark of Software Arts, Inc. and Software Arts Products Corp. The TK!Solver program is a product of Software Arts, Inc., which is solely responsible for its contents. VisiCalc is a registered trademark of VisiCorp. Apple is a registered trademark of Apple Computer Inc. IBM is a registered trademark of International Business Machines Corporation. GRiD Compass Computer is a trademark of GRiD Systems Corporation. Z-100 is a trademark of Zenith Data Systems. Eagle is a registered trademark of Eagle Computer, Inc. Digital, Professional, and Rainbow are trademarks of Digital Equipment Corporation. WANG is a registered trademark of Wang Laboratories Inc. MS is a trademark of Microsoft Corporation.

Copyright © 1984 Software Arts, Inc. All rights reserved.

pear so we don't miss their arrival.

2. The contents of location 00 scintillate, and a buzzing electron zips out of that box and races over to the instruction register. There is another flash, and the number from address 00 appears; we've just witnessed a fetch from location 00. Meanwhile, the fetch register is cleared and the letters PC appear in the increment register. This means that the program counter is about to be incremented—an important action; most microprocessors set the program counter to point to the instruction following the one being executed.
3. The program counter flashes, and a 01 appears in it. The letters LDA pop up in the execute register. The computer has correctly decoded the contents of the instruction register.
4. The number in location 06 flares briefly, and another electron rushes out of that box, depositing the number in the accumulator. A 01 appears in the fetch register. Our load was successful, and the contents of the fetch register show that the computer is ready to execute the next instruction.

A rather drawn-out process just to get the contents of a memory location into the accumulator, I agree. The point is, that was a close approximation of what happens when a real computer executes a "load accumulator" instruction, and we were able to watch each individual step. This is what a graphic simulation is all about.

Documentation

At the time this article was being written, only a rough draft of the documentation was available. The final version should be a booklet about 35 pages long. In any case, the rough draft was extremely well written and easy to follow.

The first two chapters guide you through the process of loading Simulated Computer II on your computer, then describe the different elements of the display. This is followed by instructions for entering a number of example programs and a wonderful breakdown of central processor operations as you process a program in single-step mode (possibly the most worthwhile part of this entire simulation).

One chapter is devoted to sound generation—more than it deserves, I think—and one to turtle graphics. A lot is left to user innovation at this point. Several "program challenges" presented problems requiring programming solutions. I was pleased to find that sample solutions to these challenges were printed in the appendixes.

Conclusion



Although I agree with the designers' decision to keep the instruction set simple, I feel that their omission of indexed addressing and subroutine CALL/RETURN instructions was a mistake. It's easy to see from table 1 that Simulated Computer's instruction decoding scheme limits the number of processor instructions to 10, so that any additions would require a major overhaul of the entire product. However, given the importance of address indexing and subroutines, I urge the designers to include this in the next version of the program. Subroutines could be used to introduce users to the stack, which is also missing from the current design.

My other big objection concerns the sound generator. If there were some way to turn off the noise of the electrons and run the processor at twice its current top speed, maybe you could make a little melody or even a scale. As it stands, I don't see much use for this feature at all. Tom Smith of Carousel Software explained that, limited though it was, sound was found useful in motivating children who might not be attracted by other parts of the simulation. As he put it, "Different kids respond to different things."

Despite my complaints, I remain generally enthusiastic about Simulated Computer II. Introductory computer classes from high school up to continuing education should have something like this in their software libraries. I recommend it to anyone interested in learning more about what "goes on under the hood." Certainly programmers about to take their first jump into assembly or machine language will find it a worthwhile introduction to what lies ahead. I sure could have used it when I learned assembly language a few years ago. ■

Richard Grehan (621 North 100W. Apt. C., Orem, UT 84057) is an educational software applications programmer for WICAT Systems.

LOWEST PRICES EVER
for SERVICE, SAVINGS, and SATISFACTION
Call for Shamrock Specials !!

SAVE
DYNAX DX-15
\$439

PRINTERS

Gemini 10X.....269
Okidata 92P.....429
Epson RX-80.....269
FX-80.....Call
Juki 6100.....459
Prowriter.....349
NEC 3550.....1839
2030.....Call

MONITORS

Princeton HX12.....469
Max 12...In Stock
Amdex 310A.....169
Taxan Amber.....129
Color II+.....429

Columbia 1600-1.....2650
Compaq.....Call

ACCESSORIES

Grappler+.....119
Microsoft Mouse.....129
Kensington Fan.....59
Kraft Joystick.....39
Corvus.....Sale
Grappler+ Workalike.....79
Kuala Pad Apple.....79
Thin Line Drive/eorIBM.....198
Micro Sci A2.....205
Rana Elite 1.....229
Tandan 100-2.....239
Sony 3 1/2 Drive.....Call
Mockingboard.....Call

MODEMS

Hayes 1200.....479
1200B.....389
MM //e.....239
Signalman Mark XII.....279
Volks Modem 300 baud.....59
Novation Apple Cat 2.....Call
Pro-modem 1200.....Call

MODULES

STB RIO+.....249
Super RIO.....279
AST 6 Pak.....279
Mega+.....279
Quadboard.....249
Graphix Plus.....299

PC 64K
2-Drives, Controller
Color & Monochrome,
Parallel Port
\$2495
XT's JR's

BEST PRICES ON BUSINESS SOFTWARE—CALL FOR DETAILS

714 841-6160



Computer Price Club

NO CLUB FEE

16783 Beach Blvd.
Huntington Beach, CA 92647



PRICES SUBJECT TO CHANGE WITHOUT NOTICE.
CASH PRICE!

BIG TIME STATISTICS GO SMALL



Statpro™ brings the power of mainframe statistics you use on your personal computer.

Until now, serious statistical analysis meant mainframes, computer centers and a lot of extra work for you.

Enter Statpro, the most powerful statistical software system ever developed for personal computers.

It lets you do almost everything you do on a mainframe on your IBM® or Apple® personal computer. Including descriptive statistics, regression, ANOVA, factor and cluster analysis, to name just a few capabilities.

And Statpro's awesome power isn't limited to number crunching. You can plot all your results in four-color graphics, such as scatter, triangle and regression plots, dendrograms, histograms and pie charts.

What's more, Statpro has sophisticated database management capabilities which make entering, manipulating, transforming and editing data quick and easy.

Most important of all, you get this incredible power in one integrated, fully documented, easy-to-use package.

Statpro for personal computers. Another example of why small is beautiful.

Contact your local dealer. Or Wadsworth Professional Software, Inc., Statler Office Building, 20 Park Plaza, Boston, MA 02116.

800-322-2208
In Massachusetts call (617) 423-0420.

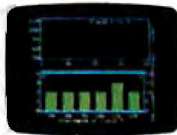

 **Wadsworth Professional Software**

Statpro is a trademark of Wadsworth Professional Software, Inc. Apple is a registered trademark of Apple Computer, Inc. IBM is a registered trademark of International Business Machines, Corp.

Don't buy a spreadsheet

A lot of electronic spreadsheets just can't cover your needs. They don't go far enough.

They're unable to work like you or adapt to the way you think.

Time for Microsoft® Multiplan®, the high energy spread. A spreadsheet with more workspace than the other leading spread. Full of high performance capabilities for your IBM® PC, PC XT, PC jr. or other MS™-DOS microcomputer.

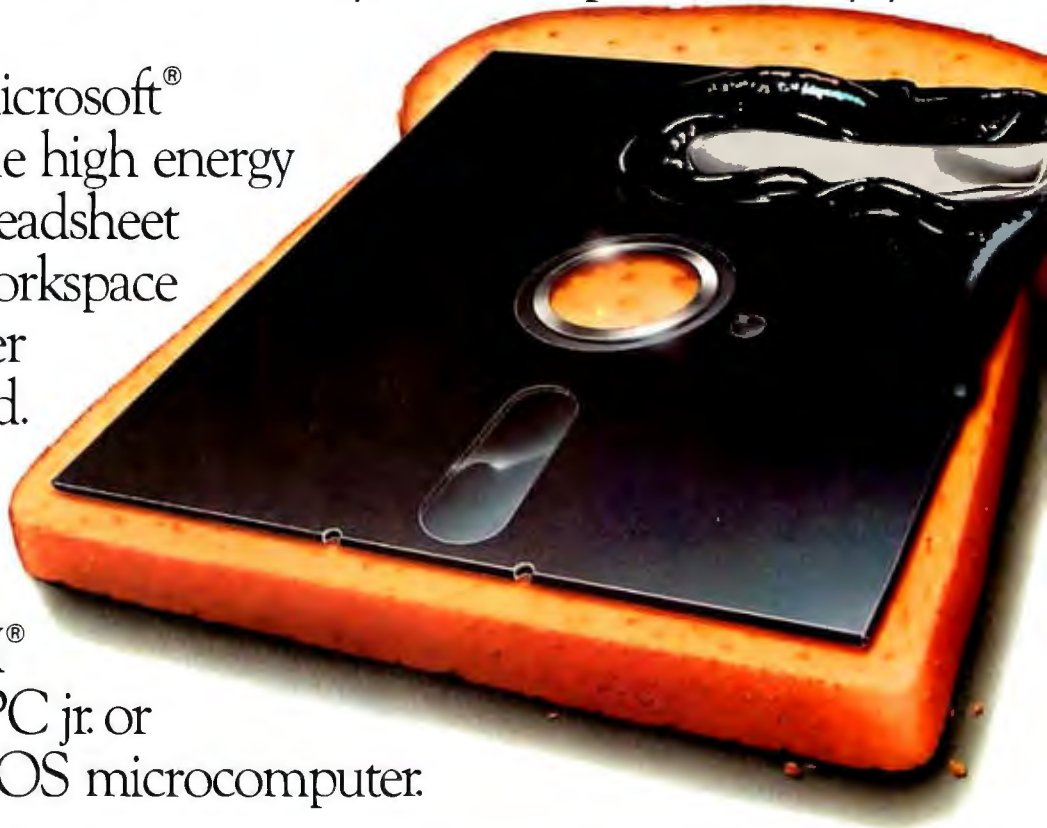

Multiplan loves you as you are.

Other spreadsheets force you to learn how they think. Multiplan learns how you think. It remembers the way you work. Anticipates frequent commands. Even offers suggestions on spreadsheet set-up.

Commands are in English. So are formulas. Instead of typing mysterious coordinates like H54 - L73 = BK154, you can simply name worksheet areas: Sales - Costs = Profit.

that spreads too thin.

Multiplan can link information in different spreadsheets. When you make a change on one, every related one is changed.

Multiplan has optional Multiplan Application Programs that work with you to design and build custom spreadsheets for Budget Analysis, Financial Statement Analysis or Cash Planning in minutes. Not hours. Or days.

The trained mouse.

Microsoft's Mouse is a speedy little critter that flies through Multiplan so easily you barely have to lift a finger to select and execute commands. Small wonder Microsoft gets more performance out of a spreadsheet. We designed the MS-DOS operating **MICROSOFT** system that tells the IBM PC how to think. And our BASIC is the language spoken by nine out of ten microcomputers worldwide.

To get the best spread call 800-426-9400 (in Washington state call 206-828-8088) for the name of your nearest Microsoft dealer. Now featuring Multiplan at a reduced price: **\$195.**

Suggested list price shown for Multiplan.

Microsoft and Multiplan are registered trademarks and MS is a trademark of Microsoft Corporation. IBM is a registered trademark of International Business Machines Corporation.



MULTIPLAN

Bank Street Writer

*A word processor simple enough for children,
but powerful enough for many writers*

by Mario Pagnoni

"Word processing is the best invention since the erasable pen." With that perceptive comment, my 10-year-old son, James, thanked the computer industry. James, like many of his teachers, is finding that word processing is one of the best educational uses for computers. Sure, schools are using drill and practice programs, tutorials, simulations, and other forms of "computer-assisted instruction." And they're making strides teaching programming languages like BASIC, Logo, and PILOT. But through all the hoopla about the computer "saving" education, many teachers remain skeptical.

One thing that does impress many educators, though, is the machine's ability to help children express themselves. Children use word processing for a variety of writing tasks including stories, poetry, school reports, and letters to Grandma. James and his brother, Joseph (age seven), have used word processing for about a year. Their writing has improved and they enjoy it more.

For Joseph, word processing arrived just in time. Remembering his struggles with messy, erasure-riddled papers in our pre-word-processing days, he said, "The best thing is, when you erase your mistakes, the paper doesn't scrunch up and tear." Word processing bought time for his fine motor coordination to catch up to his expressive skills. And it's even more beneficial for those "special needs" children for whom the physical process of writing is difficult or impossible.

Everyone seems to agree that processing words is great for children. As they learn to manipulate text, they begin to look into the very fabric of writing. They become acutely aware of the effect of the different arrangements of their words. Moreover, they become conscious of the logical progression of thoughts expressed in good writing. Their writing gradually becomes clear and uncluttered.

Children today take to all phases of computing with little or no instruction. "It's the parents and teachers who need the handholding," said one computer instructor. "To get children writing, all you have to do is give them a word-processing package they can handle."

The problem is just that—finding a word-processing

program that children can handle. Most are difficult to learn and even more difficult to use. And if, after mastering a program, the children don't run it for a while, they forget how to use it. Powerful editors with exotic functions bewilder children. Having to spend a long time learning a program frustrates them, and they may give up before doing any actual writing. Manuals are often confusing and intimidating. According to William Zinsser, author of *Writing with a Word Processor*, "If any single force is destined to impede man's mastery of the computer, it will be the manual that tries to teach him to master it."

One word-processing program that solves these problems and opens the world of processing words to children is Bank Street Writer by Broderbund Software Inc.

Bank Street Writer is a well-designed, inexpensive, easy-to-use word processor. It's not only simple for children to learn, it provides prompts to help them remember how to use it. Developed by the highly respected Bank Street College of Education to serve children, it is billed by Broderbund as "the home word processor." While it lacks the sophisticated features of a business word-processing package, it does everything most nonprofessional writers want. It's ideal for people with little or no computer experience.

Bank Street Writer consists of three programs—the writer itself, a tutorial (on the flip side of the disk), and the utility program (used to change how the writer communicates with your peripherals).

The Tutorial

Bank Street Writer features a logical, interactive tutorial containing five brief lessons. Working through the exercises (in less than 30 minutes) is all most children need to begin working with the writer program, and many don't need the tutorial at all. The same goes for the printed documentation. It is a concise, 28-page pocket-size manual with a useful index/glossary feature. It would be even more useful if you needed it more. The program is so simple and logical that you could misplace the manual after the first few days and never miss it.

At a Glance

Name

Bank Street Writer

Type

Word-processing program

Manufacturer

Broderbund Software Inc.
17 Paul Dr.
San Rafael, CA 94903
(415) 479-1170

School Package

[three copies of Bank Street Writer and teacher materials]
Scholastic Inc.
730 Broadway
New York, NY 10003

Format

5¼-inch disks with program on one side and tutorial on the other

Computers

Apple II Plus, IIe, Atari 400, 800, and 1200 with 48K bytes of memory and I drive, Commodore 64, IBM PC

Price

Home version: \$69.95 (two copies and user's manual)
School version: \$95 (three copies and teacher's manual)

Documentation

Broderbund version: 28-page pocket-size user's manual
Scholastic version: three-ring indexed binder

Comments

Simple enough for children and powerful enough for most adults

Audience

School age to adult

The Writer

Because the entire program loads into memory at the start, it is easy to use with just one disk drive. Boot the program disk, then replace it with a data disk. Boot time is quick—you'll be ready to write in about 12 seconds. There are no exotic graphics, just a blinking, beckoning cursor.

The writer program has three modes—Write mode (to enter text), Edit mode (to make corrections and revisions), and Transfer mode (to "communicate" with your drive or printer). You can get from one mode to another by hitting the Esc key. If you get confused, all you need do is press Esc until you come to a familiar mode. A message in the screen's upper-right corner always indicates which mode you are in.

Write mode gives you a 38-character screen that allows 18 lines of writing. A rectangle that resembles a sheet of paper outlines the screen; the area inside that border is for text. Outside the border, at the top of the screen, is an area devoted to prompts. This virtually eliminates the need to memorize commands. The few that you do need to know are logical: Control-I to indent 8, 16, 24, or 32 spaces; Control-C to center text; and Control-S to determine how much space is left in your file.

Bank Street Writer accommodates files of 1300 words if you have a 48K-byte machine—3200 words if you have an additional 16K-byte RAM (random-access read/write memory) card. To overcome these file-length limits you can create short files and then link them before printing. When text memory is almost filled, an additional prompt appears—"NOTE: ROOM FOR 50 WORDS REMAINING" (it counts every six characters as a word).

Bank Street Writer displays uppercase and lowercase letters on the Apple II without additional hardware. Hit Shift-N and the following letter will be capitalized. Hit Shift-N a second time for caps lock and once more to unlock the caps. If your machine has the Shift-key modification for capitalization, you can "notify" the Bank Street Writer through the Utility mode (this is unnecessary with the Apple IIe).

The program features word wrap so that carriage returns are necessary only to start a new paragraph. After 18 lines of text, the screen automatically scrolls up eight lines to allow for more typing. Characters can be erased in either direction with the left and right arrow keys.

In the Edit mode the cursor-movement keys (the four arrow keys on the Apple IIe, and I,J,K, and M on the Apple II Plus) are displayed in the prompt area. You'll have to "memorize" that B gets you to the beginning of your document, E to the end, U takes you up 12 lines, and D down 12 lines. To edit text, enter the Edit mode and use the cursor-control keys to locate your error. Then press Esc to get back to Write mode and type the correction.

Bank Street Writer "knows" whether it is booting on an Apple II Plus or IIe and loads the appropriate version. The IIe uses the open and closed apple keys to select a function and the II Plus uses the left and right arrow keys. In either case you access the function by highlighting your choice and pressing Return. Edit mode functions include Erase, Unerase, Move, Moveback, Find, Replace, and Transfer.

You can erase up to 15 lines of text at a time. To do this, select Erase from the prompt menu. Follow the step-by-step directions that tell you to place the cursor at the beginning of the text you want to erase—then hit Return. Place the cursor at the end of the text that you want erased—hit Return. The appropriate text will be highlighted and you will be asked, "Are you sure you want to erase highlighted text (Y/N)?" (Bank Street Writer always double-checks your command before executing it.) If, after erasing text, you decide that the erased portion should have stayed, you can Unerase (now there's a term children can understand). It could be the first example of "computerese" that demystifies. If you have to learn to Access and Interface and Paginate, you may as well learn to Unerase.

The Move function is similar to Erase. You highlight the section of text you want to move (again, up to 15 lines) and indicate its destination. You are then asked, "Are you sure?" All of this is well prompted and, of course, you can Moveback if you change your mind. The Unerase and Moveback functions only allow you to undo

your last move *immediately after* that move. Thus, if you Erase a passage and then enter some new text, you will not be able to Unerase your original passage.

There are also powerful Find and Replace functions. Select Find on the edit menu. Type in the word or words (up to 29 characters) that you want to find. The first appearance of the word will be highlighted. Answer "Y"(es) to the prompts to find subsequent occurrences of the word(s). Replace operates in a similar way, replacing the word you searched for with the replacement of your choice.

Transfer mode (which you enter from Edit mode) is for disk and printer operations. It allows you to initialize disks, Save and Retrieve files, Rename or Delete files, Clear memory, Print-draft, Print-final, or Quit the writer program. If you attempt to Quit Bank Street Writer without saving your document, you will be reminded that "You did not save this text. Are you sure you want to quit now (Y/N)?"

The Print-draft function prints your text exactly as you see it on the screen (38 characters per line). This is useful for proofreading and leaves generous margins for teachers' comments. It also makes it easy for students to go back to the computer and find their mistakes on the screen. Some students "paste up" two print-drafts (side by side) to create a two-column effect for their school newspaper.

Print-final prompts you with options about how you want the printed document to look. You can select page numbering and double or triple spacing, for example. You can print copy that is 40 to 126 characters per line. Another useful feature allows you to see and adjust page breaks before printing. All of this formatting goes quickly, especially if you accept the default values by pressing Return after each question.

The Utility Program

You access the utility program by pressing Esc while Bank Street Writer is booting. It is used to list the names and passwords (used to lock files) of each file on your data disk, and to convert Bank Street Writer files (binary) to standard text files and vice versa. Conversions are slow. It took 15 minutes to convert this review (about

2600 words). You can also change default values like width of margins and page length through the utility program. In addition, the cursor can be changed from a blinking line to a white square, and you can engage a typing keyclick sound. The keyclick option is helpful to experienced typists who don't need to look at the keyboard or screen. Those barely audible clicks reassure them if they feel that they may have missed a key. I appreciated the keyclick option for a different reason. It reminded me that, although the program was designed for children, it is powerful enough for most adults.

Drawbacks

Bank Street Writer does not support right justification, tabbing, or embedding commands for things like underlining or boldface, though Broderbund does plan enhancements. Nor does it support split-screen operation, subscripts, or superscripts. These criticisms are almost invalid when you consider that the program was not designed for professional writers. This software isn't for formatters; it's for writers and would-be writers of all ages. My only complaints are that it's slow going from the Write mode to the Edit mode as text memory gets filled, and that there is no storage buffer that saves deleted text and lets you reinsert it elsewhere. Bank Street Writer supports all parallel and serial printers that are Apple compatible.

Conclusion

Bank Street Writer is great for school and the home, too. If you're planning to write the great American novel or do technical writing involving superscripts and indexes, look elsewhere. If, however, you want a program that your family can actually use the first day—a program that helps you recover from mistakes—then I recommend Bank Street Writer without reservation. ■

Mario Pagnoni (76 Emsley Terrace, Methuen, MA 01844) is a teacher/freelance writer who spent last year teaching his children at home. He is working on a "how-to" book for home schoolers that emphasizes the use of microcomputers in education.



ADVANCED INDUSTRIAL GRADE

The most advanced industrial grade high-tech, high quality, sleek style S-100 bus main frame.

- *Front panel LED display for TIME/DATE and temperature of internal system air flow...*
- *Heavy duty power supply meeting today's standards for multi-user multi-tasking high speed CPU applications...*
- *A variety of front panels for floppy and winchester configurations...*
- *Synthesized warning voice indicator...*



2100 N. Hwy. 360, Suite 1807, Grand Prairie, Texas 75050, (214) 660-1955, Telex 703033



BEFORE YOU DAMAGE YOUR COMPUTER, PLUG IT IN RIGHT.

INTRODUCING THE WIRE TREE™ AC SURGE PROTECTOR, FROM NETWORKOR™

Power surges and voltage spikes. Their causes can be as simple as someone opening your refrigerator, or running a power tool, or switching on a fluorescent light.

But their results can be devastating. They can wipe out your computer's memory. Even damage its sensitive circuits.

That's why smart computer users protect their personal computers by plugging them into The Wire Tree from Networkor.

The Wire Tree has four outlets and provides

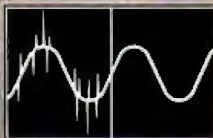

Voltage surge enters The Wire Tree.

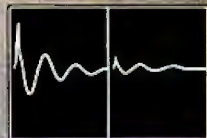

Constant power output

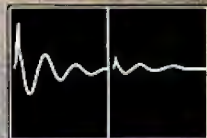

R.F. interference enters The Wire Tree.



Filtered power output

power surge protection that conforms to IEEE guidelines.

It comes with a bracket to mount underneath your desk or table and has a unique cable support feature which organizes your system's power cords into a neat bundle and moves them out of your way. And it lets you control system power from a single illuminated on/off switch.

You've invested a lot of time and money in your computer system. Protect that investment with The Wire Tree. Only \$69.95. Ask for one at your local computer store.



Networkor, Brooklyn, N.Y. 11237 (212) 821-7555



ANNOUNCING
A PROUD ADDITION
TO YOUR FAMILY.

The next addition to your family could be the bright little newcomer in the growing family of IBM® personal computers.

Name: PCjr. Weight: 12 pounds.

Heritage: more than 30 years of computer experience.

"Junior" is a powerful tool for modern times. Yet it's simple enough for a child to enjoy.

BRINGING HOME BABY

It's a big day when PCjr comes home.



The surprises begin the moment you open the carton.

Surprise #1 is the IBM "Freeboard"—

a keyboard that doesn't need a connecting cord.

The Freeboard frees you to move around and relax.



Then there's the Keyboard Adventure—an instructional exercise for first-time users. It's built into the computer and explained step-by-step in the Guide to Operations. It will help anyone begin learning as soon as PCjr is hooked up to a TV set.

In systems equipped with a diskette drive, there's a program that lets you explore computer fundamentals at your own pace, with PCjr as your teacher.

And to get you off and running from the very first day, a sample diskette with eleven useful mini-programs (ranging from a spreadsheet for monthly expenses to a word game and a recipe file) is also included.

But there are still more surprises.

FAMILY COMPUTING MADE EASY

Many IBM software programs written for other IBM personal computers will run on PCjr. And inexpensive new ones written especially for PCjr are being released.

An easy-to-use diskette word processing program, for example, uses pictures as well as words to guide you along. A comprehensive

IBM home budget program makes keeping track of money easier. There's also a selection of educational programs for children at home and at school.

And when the work is finished (or perhaps before), the fun can begin. Just slip in a game cartridge and stand back.

GROWING UP WITH JUNIOR

Add a printer. A diskette drive. An internal modem for telecommunications. Increase user memory from 64KB to 128KB. With these and other add-it-yourself options, even the lowest-priced PCjr can grow up *real* fast.

PCjr is a powerful tool for home, school or college. With its optional carrying case, it's a powerful tool anywhere you care to take it.

SEE JUNIOR RUN

Junior's starting model includes a 64KB cassette/cartridge unit and Freeboard for about \$700. A 128KB model with diskette drive is about \$1300. (Prices apply at IBM Product Centers. Prices may vary at other stores.)

Your local authorized IBM PCjr dealer proudly invites you to see this bright little addition to the family. For the store nearest you, just call 1-800-IBM-PCJR. In Alaska and Hawaii, 1-800-447-0890.



SPOC The Chess Master

by Emil Flock and Jonathan Silverman, Computer Hand Holding



Photo 1: Screen generated by SPOC. The board is shown after move 8. . .QxP? in table 2.

At a Glance

Name

SPOC The Chess Master, version 2.0

Type

Chess-playing program

Programmer

Jacques F. Middlecoff

Manufacturer

Cypress Software
1450 Koll Circle, Suite 108
San Jose, CA 95112
(800) 321-3900
(408) 995-5185

Price

\$39.95

Format

5¼-inch floppy disk for IBM PC-DOS

Language

FORTRAN and assembly

Computer

IBM PC or XT, 128K bytes of RAM

Documentation

12 pages (5½ by 7 inches)

Audience

Chess players at all levels

The pleasure of playing chess on a microcomputer comes, in part, from the heartfelt appreciation of losing to a good opponent. You can replay the game from the printout, changing an occasional move and learning how to avoid specific problems. In addition, the computer never coughs while you're deep in thought and never blows smoke in your face, glares at you, or tries to confuse you.

If you like to recreate Bobby Fischer's prize-winning games, computer chess may not be for you. But if you want to practice with an opponent that puts up with untold verbal abuse and never gets tired, a chess program is the answer.

Few computers, and certainly no microcomputers, can seriously compete with a human chess master; however, computer chess programs can force the average person to play better chess. Lazy players who make blunders and initiate half-baked attacks usually lose badly to a program.

Computers—mainframes, minis, and micros—tend to play ugly, inelegant chess. They are impatient, which almost always leads to defeat against a master player. Robert Byrne, one of the best chess players in the United States, wrote that "computers lack positional judgment and do not know what to do in tranquil situations. However, tactically they are freer from error than the average human player."

Chess involves subtleties that are beyond everyday imagination. It is, indeed, an art form. You can lose a game

Mean rating of USCF members (December 1983)	1537
E	0-1199
D	1200-1399
C	1400-1599
B	1600-1799
A	1800-1999
Expert	2000-2199
Master	2200-2399
Senior Master	above 2400
Highest active rating (Anatoly Karpov)	2710 (FIDE)
Highest rating ever (Bobby Fischer)	2760 (FIDE)
Belle's rating (approximate)	2203
SPOC's estimated rating	1700

Table 1: Chess rankings for the United States Chess Federation (USCF) and Fédération Internationale pour le Développement des jeux d'Échecs (FIDE).

completely and irretrievably by making a small error. A seemingly tiny positional disadvantage in the opening can lead to a devastating defeat by the middle of the game. "Endgame" study is an art form all its own. It's easy to lose early in the game to a world-class human chess player.

Mainframe and minicomputer chess programs are beginning to play well by any standards. A program called Belle achieved a master rating at 1983's United States Open against some top-notch human players (see table 1).

Computer Chess Theory

In 1949 Claude Shannon showed that a typical chess game contains some 10^{120} possible continuations. Today's "supercomputers" do 80,000,000 operations per second. Even a supercomputer would take 10^{110} seconds to run the entire chess tree. (Our universe is only 10^{17} seconds old.) The human player escapes this massive and impossible task by considering only a fraction of the moves available following any given move—and the machine must also. While the computer examines a vast number of continuations compared to the human player, that number is tiny compared to the total possible.

In chess the branching factor—the average number of possible moves from a given position—is 35. Therefore, a complete list of legal moves for a depth of three moves from any given position could contain 1.8 billion entries. To help prune this enormous tree, Belle uses an alpha-beta algorithm that throws away any move not better than the one already under consideration. Belle also remembers repeated positions.

Microcomputer Chess

The state-of-the-art chess programs for the IBM Personal Computer include two main contenders: SPOC (Selected Pruning Optimization Chess) and Bluebush (Bluebush Inc., 3379 St. Mary's Place, Santa Clara, CA 95051). These programs are new and haven't been thoroughly tested under tournament conditions. In this review we will concentrate on SPOC. After playing many

games to test its skill as an opponent, we've chosen SPOC's best effort to give you an idea of its quality of play (see the text box "Modern Benoni Defense" on this page).

For the average tournament chess player (who rates around 1500 on the United States Chess Federation's scale), SPOC is a worthy opponent. It plays at an average rating of about 1700 points, or as a "B" player (sometimes better, sometimes worse). SPOC has nine levels of play. When you give it three minutes to move (level 6), it plays like a strong amateur. We didn't try its "postal chess" mode (level 9, 60 minutes per move) because of the time involved to finish even one game. It played a number of fairly decent blitz games (level 2, 10 seconds per move).

Playing Against SPOC

You load SPOC by typing its name in at the PC DOS prompt. SPOC then asks you (1) to select the level of play (1-9), (2) if you want to print the moves, (3) if you have a color display, and (4) if you want to resume a previous game saved on disk. If you press F10 during the startup questions, it starts over and asks each question again, ignoring invalid answers.

You may choose to play either black or white. When you have chosen your color, the chessboard and playing pieces appear on the screen. If SPOC has white, it starts its own clock and begins "thinking" about its move. If SPOC has black, it starts your clock and waits for your move. At tournament level, the clocks accumulate time for a 40-move sequence, similar to a real tournament. For other levels, the clocks reset themselves after showing the accumulated time for each single move. (You will find you have a compelling desire to disconnect the loud beep that occurs each time SPOC makes a move.)

You move the chess pieces with the cursor keys. Position the cursor over the piece you want to move and press the carriage return. Next, position the cursor where you want to put the piece and enter another carriage return. SPOC doesn't follow the "if you touch it, you move it" rule. Until you press Return at a new square, you can retract your move.

SPOC checks the legality of all your attempted moves and growls at you if you try to castle out of check or move your King as if it were a Knight. (Castling is accomplished by moving your King two squares in the direction you wish to castle.) SPOC also handles "en passant" captures properly. [Editor's note: This is not always the case. I tested one version of SPOC and it did not execute an "en passant" capture correctly.]

Function keys let you change the level of play (F2) and save the game to disk (F1). To abandon the game and return to PC-DOS, press the Escape key (Esc). The SPOC version we tested lets you set up game positions with a stand-alone program on a separate disk. Just load the desired game position into SPOC and play.

How a Computer Plays Chess

How does a computer play chess? First, it generates

Modern Benoni Defense

White: SPOC *The Chess Master*, tournament level 6

Black: Jonathan Silverman, USCF Expert

San Francisco

October 2, 1983

SPOC's notation	Descriptive notation
1. d2-d4	1. P-Q4, N-KB3
2. g8-f6	
3. c2-c4	2. P-QB4, P-K3
4. e7-e6	
5. g1-f3	3. N-KB3, P-B4
6. c7-c5	
7. d4-d5	4. P-Q5, P×P
8. e6×d5	
9. c4×d5	5. P×P, P-Q3
10. d7-d6	
11. c1-f4	6. B-B4, P-QR3
12. a7-a6	
13. e2-e3?!	7. P-K3?!, P-QN4
14. b7-b5	
15. a2-a4	8. P-QR4, P-N5
16. b5-b4	
17. f1-c4	9. B-B4, QN-Q2
18. b8-d7	
19. e1-g1	10. castles, N-N3
20. d7-b6	
21. d1-d3!?	11. Q-Q3!?, P-N3
22. g7-g6	
23. e3-e4	12. P-K4, B-KN2
24. f8-g7	
25. c4-b3	13. B-QN3, P-QR4
26. a6-a5	
27. f1-e1	14. R-K1, castles
28. e8-g8	
29. b1-d2	15. QN-Q2, B-R3
30. c8-a6	
31. d2-c4	16. N-B4, N-R4
32. f6-h5	
33. f4-c1	17. B-B1, K-R1
34. g8-h8	
35. e1-d1?	18. R-Q1?, R-R2
36. a8-a7	
37. d3-e2?!	19. Q-K2?!, R-K2
38. a7-e7	
39. c1-g5	20. B-N5, P-B3
40. f7-f6	
41. g5-d2?	21. B-Q2?, N×QP
42. b6×d5	
43. b3-c2	22. B-B2, QR-K1
44. e7-e8	
45. g2-g3	23. P-KN3, P-B4

a list of all its legal moves (the first ply) and all the legal responses to each of these (the second ply) as depicted in figure 1. This tree is extended, branch by branch (ply by ply), until the computer begins running out of time. Belle builds a tree of some 30 million positions, allowing a "look-ahead" of four moves (eight plies). SPOC

46. f6-f5
 47. e4-e5
 48. g7×e5
 49. d2-h6?
 50. e5-f4
 51. e2-f1
 52. a6×c4
 53. f1×c4
 54. d5-b6
 55. h6-g7
 56. h8×g7
 57. c4-a6
 58. f4-e5
 59. f3×e5
 60. e8×e5
 61. a6-a7
 62. e5-e7
 63. a7×a5
 64. f5-f4
 65. g3-g4
 66. h5-f6
 67. g4-g5
 68. f6-e4
 69. c2×e4
 70. e7×e4
 71. h2-h4
 72. f4-f3
 73. a5-a7
 74. f8-f7
 75. a7-a6
 76. e4×h4
 77. d1-d5
 78. b6×d5
 79. a6×d6
 80. d8×g5
 81. d6-g3
 82. d5-f4
 83. g3×g5
 84. f4-e2
 85. g1-f1
 86. h4-h1
 87. g5-g1
 88. h1×g1
24. P-K5, B×P
 25. B-R6?, B-B5
 26. Q-B1, B×N
 27. Q×B, N-N3
 28. B-N7ch, K×B
 29. Q-R6, B-K4
 30. N×B, R×N
 31. Q-R7ch, R-K2
 32. Q×P, P-KB5
 33. P-N4, N-B3
 34. P-N5, N-K5
 35. B×N, R×B
 36. P-R4, P-B6
 37. Q-R7ch, R-B2
 38. Q-R6, R×P
 39. R-Q5, N×R
 40. Q×P, Q×Pch
 41. Q-N3, N-B5
 42. Q×Q, N-K7ch
 43. K-B1, R-R8ch
 44. Q-N1, R×Q mate

In this game, SPOC holds its own at the beginning, then it makes the subtle mistake of developing a Bishop before a Knight, followed by an incorrect Queen posting. SPOC does come up with one move currently in vogue in master play—half move 8—a testament to its quality of play.

A few annotations on specific moves are in order here:

4. *Out of its own book openings, SPOC begins to "think" for itself and continues to make book moves (see reference 1).*

6. *A logical move, attacking the weak Queen pawn. However, white usually develops the Queen Knight first. This later becomes a problem.*
7. *In this opening, white customarily answers . . . a7-a6 (. . . P-QR3) with a2-a4 (P-QR4), to prevent black from expanding on the Queen side.*
8. *The idea chosen by SPOC of following . . . b7-b5 (. . . P-QN4) and then attacking the pawn chain has gotten some attention lately in master play. It's dubious here, though, because white will have trouble bringing his Queen Knight into play.*
9. *Defending the Queen pawn so the Knight can come to d2 (Q2). Again, white will have a pawn loose if 10. b1-d2 d7-b3 (N-Q2, N-N3).*
11. *Here the Queen controls three important squares: d5, c4, and e4 (Q5, QB4, and K4), permitting the Queen Knight to enter the game. But the Queen is also somewhat vulnerable on this square.*
13. . . . *White was threatening 14. a4-a5 (P-R5), winning the Queen pawn when the Knight retreats. Now black threatens 14 . . . c8-a6 (. . . B-QR3), skewering the Queen and Rook.*
16. *White has brought a Knight to c4 (QB4), an important objective in the Benoni defense. From here, the Knight attacks black's Queen and Queen Rook pawns, blockades his Queen Bishop pawn, and helps control e5 (K5). Unfortunately, the Knight is pinned, which points up the drawback of 11. d1-d3 (Q-Q3). In short, SPOC has played the opening logically, but not especially well. Black stands better and he now begins counterplay.*
17. *Defending the Queen Knight pawn, but now the Queen Rook is a shut-in. However, 17. f4-g5, f2-f6 18. g5-e3, f6-f5 or 18. g5-h4, h5-f4 (17. B-N5, P-B3 18. B-K3, P-B4 or 18. B-R4, N-B5) also favors black.*
17. . . . *This is partly to get the King off the white Bishop's diagonal in preparation for . . . f7-f5 (P-B4). But it is also a waiting move, because it is not obvious how white can improve his position. This tactic pays off, because SPOC now begins a series of weak moves.*
21. *A difficult move to understand, as it just gives up a pawn. After 21. g5-c1 (B-B1), though, black is ready to play 21 . . . f6-f5 (P-B4) with the variations 22. c1-g5, h5-f6 (22. B-N5, N-B3) or 22. f3-g5, f5×e4 23. g5-e6 [23. g5×e4, h5-f4 24. c1×f4, f8×f4 25. f2-f3, g7-d4 26. g1-h1, by×d5], e-e6 24. d5×e6, d6-d5 (22. N-N5, P×P 23. N-K6 [23. N×KP, N-B5 24. B×N, R×B 25. P-B3, B-Q5ch 26. K-R1, N×QP], R×N 24. P×R, P-Q4, all in black's favor. The bottom line is: black's pieces are active; white's, passive.*
24. *If 24. d2-c1, d5-b6 (24. B-B1, N-N3), black wins.*
25. *Black loses a piece, but there is little hope.*

Of the rest, SPOC exhibits two flaws that are common to most chess programs (and many human players): a propensity for pointless checks and the inability to resign at an appropriate moment. The latter trait inspires black to sacrifice his Queen (on move 41) for mate.

typically looks at 500 positions (level 6) and looks ahead at least three plies (a move and a half). It goes further on those branches containing captures and checks.

The heart of the program is a scoring function. Each board position in the tree is scored by material, positional, strategic, and other criteria that are inserted as

coefficients in this equation. Finally, the computer applies a "mini-max" selection technique to choose its own best (maximum) score and its opponent's best (the computer's minimum).

This whole scoring and mini-maxing process begins after the computer jumps out of its "book" (a predefined

EXPOTEK

1-800-528-8960

Guaranteed Low Prices

IBM CALL SAVES

AST, Hercules, Microsoft, Maynard, Persyst, Profitsystems, Quadram, STB, Talltree

Ram Memory 4184-150 \$59/9 per set

TERMINALS

Adds	
A-1 Green	\$485
A-2 Green	490
Viewpoint 60	619
Hazeltine	
Esprit I	485
Esprit II	540
Esprit III	735
Qume	
QVT 102 Green	535
QVT 102 Amber	550
QVT 103 Green	840
QVT 103 Amber	850
Televideo	
910 +	549
925	699
950	899
970	975
Wyse	
Wyse 100	680
Wyse 300	1020
Esprit III	735
Visual	
Visual 50 Green	599
Visual 55 Green	720
Zenith	
Z-29	635

MODEMS

Hayes	
Micro-Modem II	250
Micro-Modem II w/term.pkg.	279
Smart Com II	89
Smart 300	199
Smart 1200	485
U.S. Robotics	
212A Auto Dial	469
Password	375

PRINTERS

C. Itoh	
Pro-writer I (8510A) Par.	339
Pro-writer (8510A) Serial	439
1550 Parallel	529
1550 BCD SERIAL	589
F-10 40CPS	949
F-10 55CPS	1269
Daisywriter	
Daisywriter 2000	999
Daisywriter Cable	40
Datasouth	
DS120	595
DS180	1155
DS220	1590
Diablo	
620 (25CPS/Serial)	875
630 (40CPS/Multi-IF)	1710
Epson	
All models	Call - Save \$
Juki	
6100-18	469
Oki-Data	
All models	Call - Save \$
Mannesman-Tally	
160L	589
180L	829
NEC	
3550 (For IBM PC)	1589
3510	1365
7710	1890
Qume	
1140 W/IBM Interface	1359
1155 W/IBM Interface	1489
Star Micronics	
Gemini 10X	CALL
Gemini 15X	CALL
Gemini 15	370
Silver Reed	
EXP 550P	575
Toshiba	
P-1350	1499
Transtar	
120 P	499
315 Color Printer	499
Sheet Feeders & Tractors CALL	

COMPUTERS

Altos	
580-10	3550
586-10	6598
586-14	7680
8600-12	8399
Columbia	Call
Eagle	Call
Franklin	Call
Pied Piper	Call
NEC Portable	Call
Northstar	
Advantage	2160
Advantage w/5MB	3345
Advantage w/15MB	4315
Televideo Systems	
802 H	4210
803	1815
1603	2150
806/20	4775
800 A (user station)	999
Teleport	Call
Zenith	Call

MONITORS

Amdek	
Video 300 GREEN	129
Video 300 AMBER	145
Color 1 Plus	275
Color II Plus	425
BMC	
12" Green	89
12" Color	219
NEC	
JB 1201	155
JB 1260	115
Taxan	
12" Amber	125
Zenith	
12" Green Screen	95
12" Amber Screen	120

DISK DRIVES

CDC	
5 1/4" 9409-DS/DD	379
Tandon	
5 1/4" TM 100-1 SS/DD 160K	150
5 1/4" TM 100-2ADS/DD 320K	225
TM101-4(96 TPI Quad Den)	339
8" TMB48-2(DS/DD)1.2 MG	400
Pertec	
5 1/4" FD200-5 (160 K SS/DD 40TR)	139
5 1/4" FD250-5 (320 K DS/DD 40TR)	195
Micro-Sci	
A-2 (35TR)	225
A-40 (40TR)	269
A-70 (Quad)	329
Rana	
Elite I	249
Elite II	399
Elite III	509

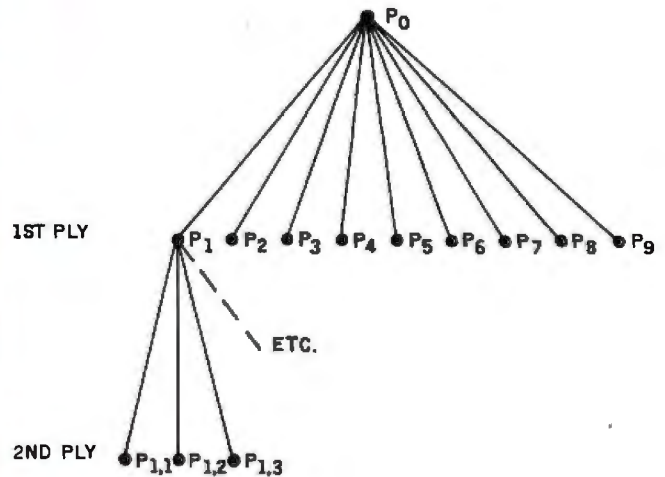

Figure 1: A chess tree two plies deep.

list of the program's favorite openings). The computer "memorizes" many openings in order to get past the critical first 8-12 moves, much as tournament players do. Belle's book contains 350,000 opening moves; SPOC's has about 3000. This means SPOC is forced out of book much earlier in a game than Belle.

Because SPOC only looks three plies deep, it relies on an extensive scoring function written in FORTRAN. A random-number generator prevents it from playing the same openings again and again. As it progresses to higher playing levels, SPOC restricts itself to its best openings. You can begin play at level 1 to get the widest choice of openings and then change to higher levels (F2) after a few moves. A handy move-immediate feature (F3) forces SPOC to make obvious moves like Queen recaptures.

SPOC jumps into a separate endgame routine when it determines that there is not much power left on the board. In an endgame with no Queens, the King becomes a powerful piece. Before the endgame, SPOC's scoring function discourages King moves after castling. (You can't coax SPOC's King out from behind its protective wall of pawns.) Once the program decides that the endgame has started, however, it lets its King roam.

How to Beat SPOC

By examining the actual moves a computer makes, you can understand something about its scoring function. For example, if it makes useless checks, you can assume that the scoring coefficient for checking moves is too large. If it is slow to recognize sacrifices, perhaps the material coefficient is overriding the danger coefficients. It is difficult to work an instinct for the kill into the scoring function.

There are a number of ways to beat SPOC depending on your chess experience.

PUT YOUR COMPUTER TO WORK AT THE SCENE WITH RYDEX REMOTE INTELLIGENCE



First your computer helped do the books, then it played some games and helped type your letters. Now, put it to work, 24 hours a day. A RYDEX IC unit lets you activate relays, monitor temperature and control motors, effective control over practically any real world device. The technology is here, the applications are astounding. Your computer with a single RS232 serial port can connect directly, or by modem, to one or hundreds of IC units.



No special computer knowledge is needed; you communicate with the IC using simple BASIC commands. An IC system is easy to install with complete user instructions. Or if you are considering controlling an entire factory, then our technical staff can be called in to assist.



In the home or in the field, a RYDEX IC puts your computer to work. The modular structure of the IC series allows you to buy a single unit to attach to your home computer. Familiarize yourself with environment control by securing your household, controlling appliances and monitoring energy consumption.



Automate your plant or office next, using RYDEX IC's connected to your business computer system. The IC lets you capture vital data, analyze it, and react immediately when the need arises. At the lab, oil rig, mill or factory; RYDEX IC's create a network for information flow and control.



Consider the advantages of RYDEX intelligent control. **MODULAR:** You build your network as you require using interchangeable IC units. **ON SITE DATA CONVERSION:** The transmission of signals is controlled by the IC unit, with retransmission if an error occurs. Eliminate the possibility of expensive errors. **INTELLIGENCE:** Relieves you and your computer of the responsibility for critical timing, counting and converting necessary in control environments. **ISOLATION:** If you work in a hazardous environment, the IC takes the risk while you and your computer are safe elsewhere.



AFFORDABLE: Here's the final word on RYDEX IC's. Most units can be installed for less than \$1,000.

For further information contact:
RYDEX INDUSTRIES
Use inquiry card, or immediately

CALL (604) 278-6772

Or write to:
RYDEX INDUSTRIES CORPORATION 200 - 4040 NO. 3 ROAD, RICHMOND, B.C. V6X 2C2

IC
INTELLIGENT CONTROL
BY
RYDEX

1. Exploit its materialistic nature. Maintaining the balance of pieces is essential for SPOC; it's not likely to sacrifice material for positional advantage.
2. Take it out of its book early. If you don't, the middle game is sure to be a real fight. However, if you can play an opening SPOC doesn't "know," it starts its positional slide sooner.
3. Exploit its early Queen moves. This kind of mistake is a "natural" result of SPOC wanting to bring its heavy artillery to the front line. Chess "rules of thumb," such as "develop Knights before Bishops and minor pieces before major pieces," are hard to translate into a scoring equation.
4. Offer it "poisoned" pawns. Even the big machines have trouble here. Computer chess programs are "willing to give up too much for a pawn," says Belle's author, Ken Thompson.
5. Give it useless checks to make. SPOC will waste moves putting you in check because that's the first step to checkmate. These possibilities get good grades from the scoring function.
6. When all else fails—try speculative attacks on SPOC's King. Throw a few pieces at it. It never expects you to sacrifice.

The opening in table 2, ending in photo 1, shows you how to use the strategies above to defeat SPOC. An early stroll of its Queen leads to the capture of a poisoned pawn and then to the exchange of a pawn for a Knight.

Conclusion

While a Senior Master would be able to exploit SPOC's weaknesses, 90 percent of the estimated 40 million American players who "know" the moves would not. Even many tournament players would have trouble beating SPOC (the average ranking of the United States Chess Federation's 30,000 chess players is 1537).

Some informed people expect the programs to start beating the best of human chess masters. Professor Monroe Newborn of McGill University, who wrote *Ostrich*, predicts that a program good enough to be the world chess champion will be developed within two or three years.

David Levy, author of *All About Chess and Computers*, isn't so sure: "...the best chess programs see 10,000-50,000 times more (than humans) but do not understand what they see. . . . (This) produces a kind of monkey/typewriter situation. . . . (The computer) appears to play moderately well, whereas it is actually playing very weak chess so much of the time that its best results resemble the moves of strong players. Some programmers . . . argue that as the search becomes deeper, strategy and tactics merge into one. But in my opinion this view is erroneous."

David Slate, author of Northwestern University's *Nuchess*, has said that a chess program is "...like sharks swimming around, it's not very bright, but once it gets a taste of blood, it's right there and goes munch, munch, crunch."

Sicilian Defense

White: Jonathan Silverman, USCF Expert

Black: SPOC The Chess Master

October 3, 1983

SPOC's notation	Descriptive notation	
1. e2-e4	1. P-K4, P-QB4	
2. c7-c5		
3. b1-c3	2. N-QB3, N-QB3	
4. b8-c6		
5. g2-g3	3. P-KN3, P-KN3	
6. g7-g6		
7. f1-g2	4. B-N2, B-N2	
8. f8-g7		
9. d2-d3	5. P-Q3, P-Q3	
10. d7-d6		
11. g1-e2	6. KN-K2, P-K3	
12. e7-e6		
13. c1-e3	7. B-K3, Q-N3?!	SPOC moves its Queen too soon.
14. d8-b6?!	8. castles, QxP?	A shameless grab for which SPOC soon pays.
15. e1-g1		
16. b6xb2	9. R-N1, Q-R3	
17. a1-b1		
18. b2-a3	10. N-N5, Q-R4	
19. c3-b5		
20. a3-a5	11. NxPch, K-K2	
21. b5xd6		
22. e8-e7	12. R-N5, QxP	
23. b1-b5		
24. a5xa2	13. BxP, B-Q2	
25. e3xc5		
26. c8-d7	14. P-B4, P-N3	
27. f2-f4		
28. b7-b6	15. N-B5ch, K-B3?	
29. d6-f5		
30. e7-f6?	16. P-K5ch, NxP	
31. e4-e5		
32. c6xe5	17. PxNch, . . .	A hopeless position for SPOC.
33. f4xe5		

Table 2: Chess moves used to defeat SPOC.

Whether you're a "patzer" (a Yiddish word used in chess lingo for "wood pushers" or inexpert players) or an expert, SPOC's utilitarian, methodical play can wear you out. We've had a great deal of fun with it, however; it has improved our play and our appreciation for the game. SPOC's ability to start a game from any board position and present it on the screen is a nice added feature. But the important thing is the level of play and that level is surprisingly high. ■

References

1. Harston, William R. *Benoni*. London: B.T. Bataford Limited, 1977.
2. Levy, David N.L., and Monroe Newborn. *All About Chess and Computers*. Potomac, Maryland: Computer Science Press, 1982.
3. Mantanovic, Aleksander (editor). *Encyclopedia of Chess Openings*, volume C, 2nd edition. Belgrade: Chess Informant, 1981.
4. Shannon, Claude. "Chess-Playing Machine." *Scientific American*, 1950, 182, volume 2, pages 48-51.

Emil Flock and Jonathan Silverman (Computer Hand Holding, 1800 Market St., #91, San Francisco, CA 94102) are both editors. Emil Flock is editor of Mentor, the magazine on disk, and The Reference Encyclopedia for the IBM PC. He worked on the original version of Ostrich. Jonathan Silverman is a professional writer and editor, and an amateur chess player.

A Complete Graphics Department For Just \$2295



Realize day-in and day-out solid performance from a quiet and capable desktop plotter. It's true. For only \$2295* the Houston Instrument HIPLØT™ DMP-29 will provide you with world-class multi-color hard copy graphics, and deliver a level of quality and performance that you would expect in a plotter costing three times as much.

It's a hard worker. The DMP-29 goes about its job with amazing speed and precision. Unbeatable resolution and repeatability are yours in both 8½" x 11" and 11" x 17" formats, and 8-pen capability assures you of fast attention-free flexibility when multi-color output is required. High pen speed combined with an addressable resolution of 0.001" assures fast, accurate and stepless traces.

It's friendly. You can call 21 different functions directly from the front-panel membrane keyboard. It's tolerant too. The DMP-29 will modestly protect itself from user errors, as when attempting to place a pen in an already occupied stall.

And it's smart. An extensive set of firmware routines makes life easier for the user. A small sampling of the built-in talent inherent in the DMP-29 includes character generation, circle, arc and ellipse synthesis, line type variations, viewport/windowing, clipping and scaling.

For the name, address and phone number of your nearest representative, write Houston Instrument, P.O. Box 15720, Austin, TX 78761. Phone 512-835-0900, or 800-531-5205 if outside Texas. In Europe contact Bausch & Lomb Belgium NV., Rochesterlaan 6, 8240 Gistel, Belgium. Tel 059-27-74-45, tlx 846-81399.

houston instrument

* U.S. Domestic price only
™ Trademark of Houston Instrument

M.U.L.E.

Beneath its clever packaging lies a fascinating economic simulation

by Gene Smarte

*Whoa, mule, whoa!
Whoa, mule, I say!
I ain't got time to kiss you now,
The mule has run away.*
—"Buckin' Mule," traditional folk song

The fun-to-use economic strategy game M.U.L.E. (multiple-use labor element) lets you plot the economic development of a new territory on a planet called Irata. With your grubstake of money and goods and your knowledge of capitalism, you and three other "planeteers" are ferried to an undeveloped area of the planet. Once there, using the limited supplies of the general store, the planet's only structure, you must decide how to make the best use of your resources. Your supply ship won't be back for at least six months.

Before the game begins, the program introduction takes you through a demonstration in which you (and the computer, when there are fewer than four players) select a color and the type of creature—there are eight kinds—you wish to be. A brief description of each and its advantages and disadvantages is included. The computer always picks the mechanical Mechtron—but so can you. You also select the game level: beginner, standard, or tournament.

As the game begins, you have just landed on Irata and are watching your only link with help, your supply ship, cruise off into space. A status report lists the resources of each planeteer and the general store. (In the tournament-level game, the planeteers have but one round to become self-sufficient because their supplies are good for only one month.)



Photo 1: After you've chosen the level of difficulty, picked the number of planeteers, and decided which of eight characters you'd like to be, the disk leaves the demo mode and loads the game. You'll see your spaceship pass over Irata, descend and deposit you and your fellow planeteers, and disappear from view.

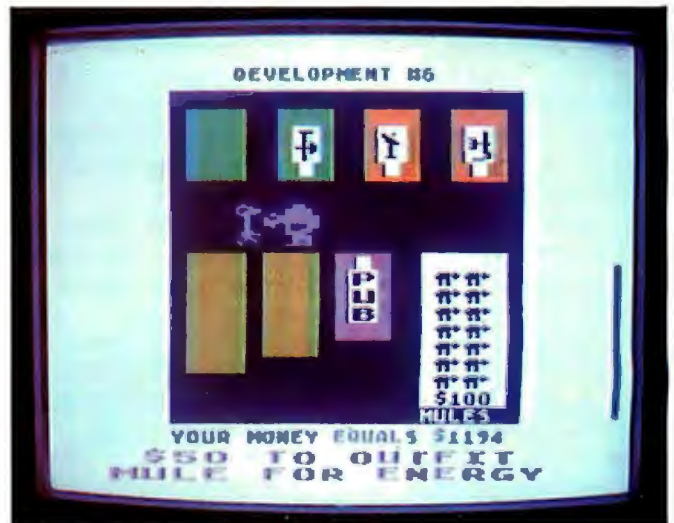

Photo 2: Inside the general store. After selecting a plot of land, you pay your money, outfit a M.U.L.E. for your selected task, and head out to install the critter. The empty colored rectangles become additional choices as the difficulty of the game increases. The vertical bar at the right edge is a shrinking time indicator; when it's gone, your time is up.

While "mule" might conjure up images of bearded prospectors and four-legged flop-eared beasts of burden, this M.U.L.E. is actually an intelligent (though sometimes unpredictable—it can run away) machine designed to resemble a real mule. You purchase it at the general store. Each M.U.L.E. must be outfitted for the task you choose: farming, energy production, or mining. Those are the main tasks of this game.

As in real societies, or "life in the rest of the galaxy," as mentioned in the player's guide, a balance must be struck between various needs and wants. In the case of Irata, you must have food, so farming is a requirement; you must have energy for the creation of all products, so energy production is necessary; and you must mine Smithore, the stuff from which a M.U.L.E. is made (except at the beginner's level), to ensure availability of the M.U.L.E. as the scope of Irata's development increases.

After the resource status report, the display shows an aerial view of the area of Irata to be developed. The landscape includes a fertile river valley ideal for farming, prairies for open-space energy production, and mountains for mining. A cursor scans the territory, and each planeteer chooses a plot of land by pressing a joystick push button. The color-coded plots correspond to the colors the planetees select earlier in the game.

After the first round of plot selection, each planeteer has a limited time to enter the general store, decide which type of production best suits the plot just selected, outfit a M.U.L.E. accordingly, lead, via the joystick, the M.U.L.E. out to the plot, and install him (a M.U.L.E. is referred to in the masculine). Should you have some time left over, you can return to the pub in the general store and do a little gambling or go Wampus hunting. Gambling is an automatic way to win, but it ends your

turn. The Wampus, as explained in the *Player's Guide*, lives in mountain caves, and when he opens his door a light flashes that signals his whereabouts. You must move quickly if you expect to capture him. He's difficult to catch, but he'll pay you to let him go.

When each planeteer has installed a M.U.L.E., production begins automatically. But, just as in real life, random events can help or (more likely) hinder your production. Planetquakes, meteor showers, and an imaginative array of pest attacks can wipe out a turn's production. These random events are particularly clever in concept and execution and had me looking forward to the next one.

After production, planeteer and store resources are displayed and an auction for each commodity begins. Here, a dog-eat-dog capitalist mentality can help. But you must remember that if, for example, all the planetees try to corner the Smithore market and no one does any farming, you all have a good chance of perishing on Irata (shudder). I liked this touch of realism.

If you have the cash, you can buy what you want, and you can sell any surpluses, providing someone is interested. Both buying and selling prices are set by the planetees with some limits in the beginner's level. The program sets the store's rate of exchange. With the conclusion of the auctions, an updated status report prepares you for the next round of plot selections as your first month of development ends. The game continues for 6 turns (beginner) or 12 turns (standard and tournament levels). At the conclusion, the player who has accumulated the highest net worth is the winner.

It's impossible to adequately describe all the interaction and economically realistic subtleties of M.U.L.E. The standard level increases the complexity of the beginner level with land auctions and selling, development-

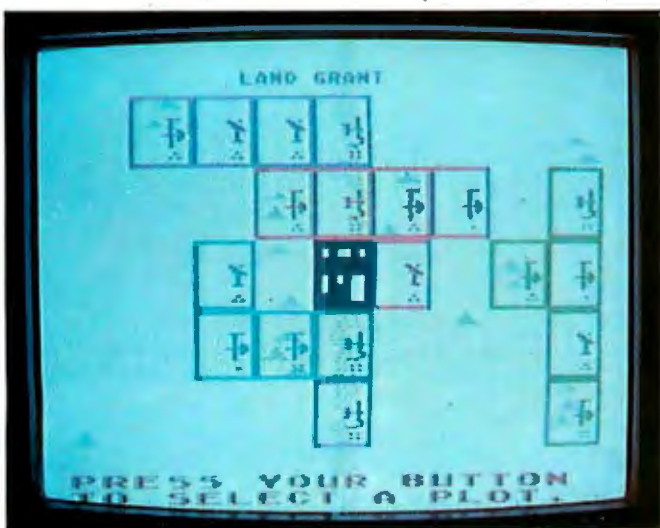

Photo 3: After five rounds, Irata real estate is getting scarce. Colored squares identify players' plots. Symbols within each square indicate that a M.U.L.E. has been installed. The best food production is in the central river valley; energy gathering is best in the plains; the mountains are loaded with Smithore.



Photo 4: One of the three auctions that concludes each round. In this case, the seller has come down to \$32 per unit; the buyers, however, are unimpressed as they are holding fast below the rock-bottom bid of \$15.

We were born out of a million hard(ware) luck stories.

Introducing the Moore Business Center.
A supply store for the computer age.

Promises, promises.

The people who sold you your hardware and software told you to call them any old time, with even the smallest problem.

But the problem is that most of your questions deal with "afterproducts." And that's an area the manufacturer doesn't seem to care much about.

Fortunately, there has now sprung up a group of retail stores that care very much about your accessory needs.

Enough to line their shelves with a mind-boggling array of flexible disks, printer ribbons, storage binders, printout labels, and on and on.

Enough to stock their stores with all the computer furniture and equipment you'll ever need to build quiet, physically comfortable work stations.

Enough to offer you the technical expertise and personal assistance required to satisfy a demanding computer operation.

We're the Moore Business Center, with over 100 years of dedication to the business community. Now, our retail computer supply stores are ready to serve you.

So forget all the hard(ware) luck stories of the past. From now on, it's strictly RAMs to riches.



MOORE BUSINESS CENTER

PHONE 800-238-2300 EXT. 41 FOR A STORE LOCATION OR CATALOG.

At a Glance

Name

M.U.L.E.

Type

Economic strategy game

Manufacturer

Electronic Arts
2755 Campus Dr.
San Mateo, CA 94403
(415) 571-7171

Price

\$40

Authors

Dan Bunten, Alan Watson, Jim Rushing, and Bill Bunten

Format

One 5¼-inch floppy disk

Language

Assembly language

Computers

Atari 400, 800 with 48K-byte RAM. Commodore 64

Documentation

6-page disk jacket, 20-page M.U.L.E. Player's Guide

Audience

Capitalists, entrepreneurs, and pioneers

strategy nuances, and gyrating resource prices. You can also sell below a "critical level" if you think that you can make it up later. The tournament level adds Crystite mining and Collusion (private trading between friends). Tournament play requires some fast thinking and razor-sharp business savvy because the time allowed for decisions is significantly shorter.

M.U.L.E.'s packaging and documentation make entertaining reading. In addition to providing an interesting description of the game's flow, the authors unveil their personal strategies. And the 20-page *M.U.L.E. Player's Guide* is peppered with playing tips along with the economic realities of pricing, economies of scale, the learning-curve theory of production, and the law of diminishing returns. This is definitely not a simplistic, learn it/be bored with it, kill-the-galactic-villains time-waster.

Conclusion

M.U.L.E. is an intriguing way to illustrate some of the triumphs and perils of free enterprise. While it falls in the broad category of games, it also offers an excellent means to test your business mettle. It's realistic, too, because just when you think you've done everything right, an unforeseen disaster can happen, like having your M.U.L.E. run away. ■

Gene Smarte is a BYTE technical editor. He can be reached at POB 372, Hancock, NH 03449.

UNIX

and MS-DOS, and VMS too!

UniPress can meet your software needs, for a range of hardware, including VAX, MC68000, and IBM-PC.

UniPress, your UNIX source.

PACKAGING: VAX/VMS and UNIX, MC68000/UNIX on Sun, Masscomp, Apollo, Tandy 16, Apple Lisa, Sritek Board for IBM PC, Dual, Plexus, Callan, and Cyb. Perq and Perkin Elmer, too. Source code, as well as binary. Maintenance available. Inquire regarding other hardware.

UniPress Software

UNIX SOFTWARE

Priced from

- Full UniPlus + UNIX for Apple LISA \$ 495
- EMACS—Multi-window text editor (Gosling version) 395
- LEX—Powerful word processor 500
- PHACT—Isam file manager 250
- /RDB—Relational database tools 250
- MENU SYSTEM—Menu generation 495
- UniCalc—Powerful spreadsheet 350
- MIMIX—CP/M emulator 495
- Lattice C cross compiler—to 8086 and 68000 (includes linker, librarian, disassembler, etc.) 5000

MS-DOS SOFTWARE

- Software tools—Unix-like facilities add power to MS-DOS: includes ed, grep, sort, diff, cat, etc. 200
- PHACT—Isam file manager 250
- C compiler—Full C language 395
- Coherent—Unix-like operating system for IBM-PC XT 500

VMS SOFTWARE

- EMACS—Multi-window text editor (Gosling version) 2500

OEM and dealer inquiries invited.
Quantity terms available.

Call or write for more information.

UniPress Software, Inc.

1164 Raritan Avenue, Highland Park, NJ 08904
201-985-8000 Toll Free: 800-222-0550 (outside NJ)
Telex: 7094 18

Mastercard and Visa

Overseas distribution available through
Lifeboat Associates — Japan

Unix is a trademark of Bell Laboratories.
VMS is a trademark of Digital Equipment Corp.
MS-DOS is a trademark of Microsoft.
UniCalc is a trademark of Lattice, Inc.

NEVADA SOFTWARE

FOR CP/M. TOP QUALITY, BOTTOM PRICE.

Nevada makes it easy and economical to get the software you want and need. Need a better BASIC? We've got it. Is BASIC not solving your business or engineering problems? Nevada COBOL or FORTRAN will. The media praises Nevada, and it's priced right: just \$39.95—about 1/10 what comparable quality costs. For about half the price of one competitive package, you can own the *entire* Nevada Software library! So don't wait; order one or two or all of our bargains—today.

NEVADA BASIC™
Diskette & 220-page manual
For business, education
engineering, science

Finally, a better BASIC. This straightforward language lets beginners write useful programs without limiting them to simple programs. New Nevada BASIC's interpreter has Prof. Starkweather's great built-in full-screen text editor. You can define single- and multi-line functions. Plus there are full-matrix operations, Random Access and Sequential files, program execution with a simple command, BCD Math—no round-off errors. With Nevada BASIC, micros can run like minis costing thousands more.

NEVADA COBOL™
Diskette & 165-page manual
For business

Whether you do business computing or learn computing for business, COBOL is the language; more business application software is in COBOL than in all other languages combined. Based on ANSI-74 standards, Nevada COBOL offers many advanced features: Random Access and Sequential files, debugging capability, COPY statement, character string, 16 bit binary and decimal data types. Colleges use the line documentation as class room texts. It's field-proven by 10,000+ worldwide business, government and education users. Join them.

COBOL Application Package—Book I.
Superior user documentation that saves even experienced programmers many hours.

NEVADA FORTRAN™
Diskette & 214-page manual
For science & engineering

"If you want to learn or teach someone FORTRAN, this is the package to buy." ACCESS, March/April 1983. For learning and teaching, for scientists and engineers, Nevada is the perfect FORTRAN. Based on ANSI-66 standards (FORTRAN IV), its advanced features include IF...THEN...ELSE constructs, COPY statement, CHAINing with COMMON, TRACE style debugging, and 150 verbal error messages. And you can intermix in-line FORTRAN and Assembly Language statements for special micro needs. Requires 48K RAM. If you're shopping for FORTRAN, look no further.

NEVADA PILOT™
Diskette & 131-page manual
For dialogue

Perfect for training, testing, virtually all programmed instruction, and word puzzles. It's the ideal companion language for BASIC, COBOL, and FORTRAN application packages, because it so quickly solves training and documentation problems. Nevada PILOT meets all PILOT-73 standards and has many new features including a built-in full-screen text editor. Prof. Starkweather's documentation is exceptional; the manual comes with 10 free programs. See MICROCOMPUTING review, January 1983, and you'll be convinced.

NEVADA EDIT™
Diskette & 59-page manual
For text editing

"A well-thought-out product with excellent documentation and an astoundingly low price." MICROCOMPUTING, May 1983. Now, high-quality text editing for micros. A character-oriented full-screen display editor, Nevada EDIT is great for program editing as it's specifically designed to create COBOL, BASIC, and FORTRAN programs. Simple to-configure, you customize tab stops, default file type, keyboard layout, and CRT by menu selection. Nevada EDIT may pay off better than any software purchase you've made.



EACH ONLY \$39.95
COBOL Applications Package—Book I: \$9.95

Money back guarantee: you must be completely satisfied, or return the package(s)—in good condition with the sealed diskette(s) unopened—within 30 days, and we'll gladly refund your money.

CP/M is a registered trademark of Digital Research, Inc. TRS-80 is a registered trademark of Tandy Corp. Apple II is a trademark of Apple Computer, Inc. Osborne is a registered trademark of Osborne Computer Corp. Xerox 820 is a trademark of Xerox Corp. Kaypro is a trademark of Non-linear Sys. Health-Zenith is a trademark of Health Corp. IBM is a trademark of International Business Machines, Corp. Nevada BASIC, Nevada COBOL, Nevada FORTRAN, Nevada PILOT, Nevada EDIT, and Ellis Computing are trademarks of Ellis Computing, Inc. © 1983 Ellis Computing, Inc.



Send to
ELLIS COMPUTING, INC.
3917 Noriega Street
San Francisco, CA 94122 Phone 415/753-0186

Please send me: **Software Packages**
 BASIC COBOL FORTRAN PILOT EDIT

Disk Format

- 8" SSSD (Standard CP/M IBM 3740)
- 5 1/4" Diskette for:
 - Access
 - Apple CP/M
 - DEC VT 180
 - Epson QX-10
 - Heath Hard Sector (Z-89)
 - Heath Soft Sector (Z-90)
 - IBM-PC (Baby blue or big blue card)
 - Kaypro Double Density
 - Micropolis Mod II (Vector Graphic)
 - NEC PC 8001
 - Northstar Double Density
 - Northstar Single Density
 - Osborne (Single Density Disk)
 - Sanyo
 - Superbrain DD, DOS 3.X (512 byte sec)
 - Televideo
 - TRS-80 Model I (Relocated to 4200 hex)
 - Xerox 820 (Single Density)

Send my order for _____ packages @ \$39.95 each Total _____

COBOL Application package @ \$9.95 each Total _____

California residents add 6 1/2% Sales Tax. Sales Tax _____

Outside North America, add \$6 per package for shipping. (Postage paid within North America.) Checks must be in U.S. dollars and drawn on a U.S. bank. Shipping _____

Check enclosed Mastercard VISA TOTAL _____

Card # _____ Exp. Date _____

Signature _____

Ship to: Name _____

Street _____

City/State/Zip _____

The CP/M operating system, an 8080, 8085, or Z-80 microprocessor, and 32K RAM are required. Note: Double Density drives can read Single Density diskettes.

The Witness

A prose murder-mystery game for detectives whose business is trouble

by Dennis Barker

Somebody was nuts. I was nuts. Everybody was nuts. None of it fitted together worth a nickel . . . I was in bad with the police, I had spent ten dollars of my twenty expense money, and I didn't have enough leverage anywhere to lift a dime off a cigar counter.

—Philip Marlowe, speaking in *Trouble Is My Business*
by Raymond Chandler

I can understand Marlowe's lament now that I've played *The Witness*, the second prose murder-mystery game from Infocom. I logged a considerable number of hours trying to crack this programmed puzzler, but the case remains unsolved, wide open, no good leads, no evidence that sticks. This is one mystery-game review you can read without worrying about the solution being revealed.

Stu Galley, the author of *The Witness*, has styled his prose after that of Chandler, Ross Macdonald, and other captains of the hard-boiled mystery. Galley, a programmer at Infocom, has apparently read enough of the genre to emulate the style without mocking it. The descriptions are well done—quick but thorough and evocative. The narrative is detailed enough so that the player can imagine the surroundings but not have his mental picture cluttered with knickknacks. Because they provoke use of the imagination, the all-prose games are like the radio dramas of pretelevision days.

The story of *The Witness* begins: "Somewhere near Los Angeles. A cold Friday evening in February 1938." The player is the detective, dispatched by police chief Klutz to assist a nervous Mr. Linder, who says his life is being threatened by a somewhat sleazy Mr. Stiles. Linder's wife has recently killed herself. Stiles has allegedly been sending nasty notes.

A taxi drops you off at the Linder joint. The questions and decisions begin before you enter the house. Do you go to the front door? (Nah, too obvious.) Do you check out the garage? Do you stalk around the backyard? Re-

member, you have only 12 hours (720 moves) to solve the mystery, and every move kills a minute.

If you take the right steps, you can meet the main characters before they get away from the house. There's Freeman Linder, who's made millions in the Orient trade. There's his daughter Monica, a tough dame who acts "as though you were a masher who just gave her a whistle." There's Phong, the mysterious butler. And there's Stiles, who apparently was on very good terms with the late Mrs. Linder and allegedly wants Mr. Linder to join her in that Big Sleep.

The best detectives operate in a mode that balances logic and instinct. *The Witness* gives you plenty of opportunity to exercise both. You can minimize dead ends by keeping a list of questions asked and responses received. I sketched each room as it was described. Because the Linder house is big, I had to make lots of maps. However, the maps I drew were not much help. Despite an effort to diagram the layout of the place and to chart my steps, I frequently ran into walls and windows. This can be a problem when you're trying to shadow someone. At one point, I gave up mapping and relied on instinct, luck, and the handy LOOK AROUND command, which flashes a description of the surroundings on the screen. I have yet to determine if the trouble is due to a bug in the program or in the player.

Infocom's parser, the program's language analyzer, is obviously a remarkable improvement on the simple two-word verb-noun commands of earlier adventure games. A player can interact with *The Witness* on a more articulate basis, which makes for a greater sense of realism. Despite this remarkable addition of adjectives, prepositions, indirect objects, and compound verbs, I still felt considerably limited in the vocabulary I could use. The rule book points out that the parser uses far more words than it understands, but when you're onto a hot lead, with clues and questions running through your mind, it's hard to remember that you're talking to a computer

INTRODUCING
THE ONLY S100 BUS 16 BIT
SINGLE BOARD COMPUTER!

LOMAS DATA PRODUCTS PRESENTS:

THUNDER 186

THUNDER 186 provides the earth shaking performance you have come to expect from LOMAS DATA PRODUCTS, now in a full 16 bit single board computer. THUNDER 186 utilizes a highly integrated 80186 microprocessor from Intel to bring all the features required of an S100 bus computer system together on a single height IEEE-696 board.

The Thunder 186 features:

- 8 Mhz 80186 micro-processor (10 Mhz 8086 performance).
- Floppy disk controller, controls both 5 1/4" and 8" disk drives simultaneously.
- Two RS232 serial ports with full handshaking.
- One parallel printer port.
- Either 128K bytes or 256K bytes of no waitstate dynamic RAM with parity.
- Full IEEE-696 (S100) bus compliance.

THUNDER 186 is the only single board 16 bit computer that requires no additional boards to complete a functional system. THUNDER 186 is fully supported by our full line of operating systems: MS-DOS**, CP/M-86*, MP/M-86*, and CONCURRENT CP/M-86*, which are all available immediately. Thunder 186 includes CONCURRENT CP/M-86 in the low introductory price.

128K Byte version \$1250.00
256K Byte version \$1595.00

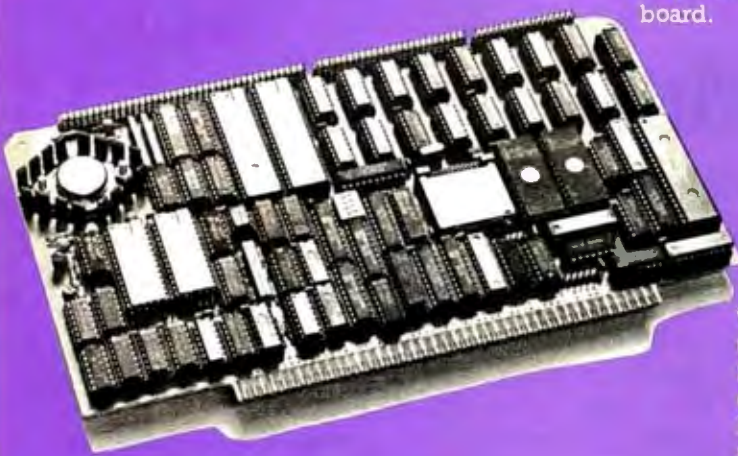

LIGHTNING 286

*CP/M-86 and CONCURRENT CP/M-86 are trademarks of Digital Research. **MS-DOS is trademark of Microsoft. ***Lightning One is trademark of Lomas Data Products, Inc.

When we introduced our Lightning One*** in January of 1982 it was the fastest CPU board on the S100 BUS available. Now our Lightning 286 replaces the Lightning One as the fastest board on the S100 BUS. We have incorporated the Intel 80286 microprocessor on a CPU board that again brings new levels of performance to micro-computers. The 80286 is capable of supporting up to 16 megabytes of physical memory and up to 1 Gigabyte of virtual address space when utilized in virtual address mode. In real address mode, the 80286 is compatible with the vast library of 8086/88 programs already written. We have the three major operating systems available immediately on our Lightning 286, no need to wait for third party support to take advantage of this exciting new processor.

The LIGHTNING 286 features:

- Up to 64 Kbytes of onboard EPROM
- 9 Vectored interrupts expandable to 65 levels
- Full compliance with IEEE 696
- Multi-layer board for low-noise reliable operation

In addition to these features, a high speed memory bus expansion port has been included

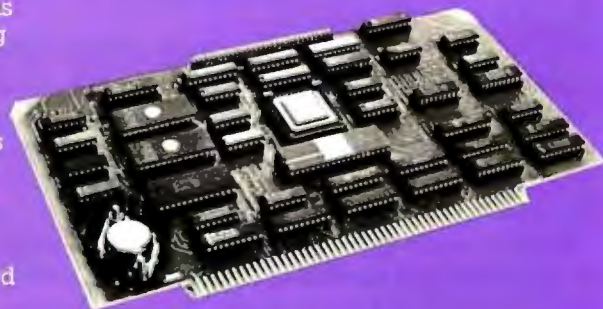

that will allow extension of the memory with a high speed dynamic memory board. The use of the companion memory board will allow use of an 8 Mhz 80286 without memory wait states. The board will contain 1 Mbyte of memory, and will allow cost efficient expansion of 80286 memory space.

Price \$1395.00

If your application requires 16-bit computing power and versatility, call Lomas Data Products today.

Dealer inquiries invited.

LOMAS DATA PRODUCTS, INC. □ 66 Hopkinton Road, Westboro, MA 01581 □ Tel: (617) 366-6434

LDP

Circle 214 on inquiry card.

program. Generally, the linguistic limitations cause only a minor inconvenience; you may have to rephrase a question until the parser understands. But in a few cases the restrictions impede the detective work. Here's a perfect example.

I asked one character to please tell me about Monica and her father. The program informed me that I couldn't use multiple indirect objects with the word "tell." This is an unfortunate snag. A detective dealing with several characters, particularly characters who are suspect, would want to know about the relationships between them. It's a line of questioning that can help reveal motives, and unearthing motives is what investigation is all about. Certain grammatical constructions are important to the detective of a programmed mystery.

The game's designers have provided some very helpful commands. The ones I used most frequently, besides the usual legwork commands (e.g., WALK WEST), were EXAMINE, which lets you look closely at something; ANALYZE, which includes checking for specific substances and fingerprinting; and SEARCH (something or someone), to which some characters do not react favorably. And as Holmes had his Watson, you have Sgt. Duffy, who can be called in for assistance. Duffy can handle analysis, booking, questioning, and other tasks—if you can find him. Failing that, you can still shout obscenities and even shoot at characters. (Galley anticipated certain input statements and apparently expected some players to get very frustrated.)

The Witness, in the Infocom tradition, is attractively packaged. The *National Detective Gazette*, the main piece of documentation, is cleverly and clearly written and features some nice illustrations. The graphic artists involved in this project deserve a round of applause. The reference card is straightforward and explains booting and playing procedures in terms simple enough to be followed by the village idiot. This is commendable.

Playing time varies greatly. Infocom games have reportedly taken from 20 to 60 hours (real time). You can play The Witness for five minutes if you like, store your game position, and resume the investigation later. If you arrest a character judged innocent by the grand jury (it takes a lot of evidence to convince the jurors), the session is ended for you. Wrong moves can be counted against you. Think before you act; think again before you enlist the steel.

Frustration is a part of this game. Questions multiply, answers are scarce. Hours after suspending play, you might find yourself evaluating a move you made or pondering that response a suspect made. How often have you played Monopoly and then wondered hours later why you didn't buy Baltic Avenue?

Remarkably, The Witness gives you an idea of the sort of situations an investigator is up against. Dropped into a situation in which a crime has been committed, you have to decide what questions to ask and whom to ask. You have to determine who's lying and who's got something to hide. You have to make assumptions about people you've only recently met. And your approach is

At a Glance

Name

The Witness

Type

Prose murder-mystery game

Manufacturer

Infocom Inc.
55 Wheeler St.
Cambridge, MA 02138
(617) 492-1031

Author

Stu Galley

Price

\$49.95; \$59.95 for DEC RT-II, NEC APC, and CP/M versions

Format

.5¼- or 8-inch floppy disk

Computer

Any of the following with 48K bytes of RAM, one disk drive, and a black-and-white or color monitor: Atari 400 or 800, Apple II, Commodore 64, DEC Rainbow or RT-II, IBM PC, NEC APC or PC-8000, Osborne, TRS-80 Models I or III, TI Professional, CP/M-based computers

Documentation

A computer reference card, *National Detective Gazette*, and assorted props (including a suicide note, a telegram, and a matchbook)

Audience

Game players

based on scant clues: a note, a matchbook, a trace of gunpowder, a conflicting statement. Kojak never had it so rough. Of course, there is one big difference between being a detective and playing an adventure game. Real-life detectives sometimes must look down the barrel of a gun; the game player only has to look down the tube of a video display.

No law-abiding gumshoe likes a dead end, a lying suspect, or a stiff. But these are the elements of a good mystery and a good mystery game. Galley and the Infocom staff have succeeded in designing what Sherlock Holmes would call "a three-pipe problem."

A Tip

If you begin to feel as if the district attorney is breathing down your neck, everyone's lying to you, and the Scotch is starting to taste sour, you probably need some help. An *Invisiclues* booklet contains some hints that might assist your investigation. It costs \$7.95 and comes with a special pen that lets you reveal clues one at a time. To order, telephone (800) 262-6868; in New Jersey, (800) 238-2200. Above all, keep cool. And remember: it's Chinatown, Jake. ■

Dennis Barker is a copy editor at BYTE. He can be reached at POB 372, Hancock, NH 03449.



Displays and hard copy output courtesy of ISSCO, SAS/GRAPH™-SAS Institute Inc., Swanson Analysis Systems, Inc. and GDS-Applied Research of Cambridge
 CP M-86 is a registered trademark of Digital Research, Inc. Copyright © 1983, Tektronix, Inc. All rights reserved #UNO-220
 VT100 is a registered trademark of Digital Equipment Corporation

Powerful text editing. High-speed graphics. Color copies. The new desktop family from Tek!

VT100 text editing and PLOT 10 color graphics are now packaged as basic desktop units and priced from \$3995* complete.

Tek's new 4100 Series desktop terminals answer a range of resolution, screen size, color palette and local intelligence needs. All three feature outstanding 60 Hz non-interlaced displays and rapid 16-bit graphic processing speeds.



As simulated, Tek's 60 Hz refresh rate and bright phosphors result in a flicker-free image with perceivably better definition than that provided by 30 Hz terminals quoting greater pixel densities.

Standard capabilities include 38.4K baud communications; easy color selection from the keyboard; 4096 x 4096 addressable display space; a separate display surface for alphanumerics or communications dialog; and compatibility with ANSI X3.64 screen editors, including DEC VT100 extensions.

Each offers an unconditional, one-year on-site warranty. Tek Warranty-Plus extends this coverage two additional years at minimal cost.

For less than \$1,600, you can add Tek's compact, plug-compatible 4695 Color Graphics Copier. With a palette of up to 125 shades, the 4695 lets you reproduce graphic and alphanumeric displays on report-size paper or transparency film at the push of a button.



All 4100 Series terminals feature programmable keyboards with innovative Joydisk for convenient graphics input.

At any time, you can plug into Tek's new 4170 Local Graphics Processing unit. The CP/M-86-based 4170

	4105	4107	4109
Display Size	330mm (13")	330mm (13")	483mm (19")
Displayable Colors			
Graphics	8	16	16
Alphanumeric	8	8	8
Palette	64	64	4,096
Resolution	480x360	640x480	640x480
Segment Memory		128K Bytes	256K Bytes
Price	\$3,995	\$6,950	\$9,950
Warranty-Plus	\$195	\$295	\$395

provides up to 886K RAM for standalone programming and pre- or post-processing—to help you conserve host power while you build upon a central data base.

Factor in compatibility with Tek PLOT 10 software and 4110 Series terminals, and you'll discover the first desktop graphics that you can't outgrow. Call your Tek Sales Engineer for a demonstration. For the number, or for literature, contact:

U.S.A., Asia, Australia, Central & South America, Japan

Tektronix, Inc.
P.O. Box 4828
Portland, OR 97208
Phone: 800/547-1512
Oregon only: 800/452-1877

Europe, Africa, Middle East

Tektronix Europe B.V.
Postbox 827
1180 AV Amstelveen
The Netherlands
Telex: 18312—18328

Canada

Tektronix Canada Inc.
P.O. Box 6500
Barrie, Ontario L4M 4V3
Phone: 705/737-2700

*All prices quoted are U.S. Dollars only.

Tektronix
COMMITTED TO EXCELLENCE

Product Description



The Tandy TRS-80 Model 2000

A Powerful New MS-DOS Machine

by Rich Malloy

You somehow knew that Radio Shack was eventually going to come out with an IBM PC-compatible computer, but the actual announcement was surprising nonetheless. Also surprising was the fact that Radio Shack chose not just to copy the IBM Personal Computer, but to design a much more powerful machine.

The Tandy TRS-80 Model 2000 has a number of notable features: a true

16-bit Intel 80186 microprocessor with a high clock speed, high-capacity floppy-disk drives, optional high-resolution color graphics, MS-DOS version 2.0, modest compatibility with the IBM PC, and a low price. To be sure, other machines boast such features, but this is the first to combine these features with a marketing structure as formidable as that of Radio Shack.

Physical Appearance

The 2000 departs radically from the traditional look of TRS-80 computers. The color scheme is the ubiquitous off-white. The keyboard is thin and light and has a very ergonomic look, and the monochrome monitor is small and stylish. Both are detached from the system unit, which resembles that of many other 16-bit computers.

Closely examined, the new model

has a number of interesting features. Most notable is the system unit's ability to rest horizontally on a desk or, like the DEC and Wang machines, vertically on the floor. And the computer's nameplate can be rotated 90 degrees to suit either orientation.

The nameplate itself is unusual: it reads "Tandy TRS-80 Model 2000." No Radio. No Shack. Apparently Radio Shack encountered some resistance to the word "Shack" on its high-end computers. The implication here is that, in the future, any new computer over \$2000 will carry the Tandy label. Although Radio Shack denies the possibility, I wouldn't be surprised to find the Radio Shack Computer Centers renamed Tandy Computer Centers.

Immediately below the nameplate (or beside it, as the case may be) are two minor but important details: an easy-to-find power switch and a Reset button. For the benefit of those who abhor Reset buttons, the Control-Alternate-Delete key trio used by the IBM PC will also usually reset the machine.

The Displays

Radio Shack offers a choice of two displays: a small green monochrome monitor for \$250 and a large color RGB (red-green-blue) monitor for \$799. A two-color graphics option is available for both monitors for an additional \$449. Extra memory chips for eight-color graphics on the color monitor sell for \$199. In addition, a small pedestal base is available for the monochrome monitor for \$90.

The monochrome monitor has a 25-MHz bandwidth without interlacing. The characters are sharp and steady: the character font is simple and readable, although not as ornate as the IBM PC's monochrome monitor. If you desire, you can replace the entire 256-character set with your own character set. Characters can also be displayed in either double-width or double-height sizes.

The color monitor uses the same character generator as the monochrome monitor. The characters are well formed and readable in most colors.

The graphics resolution of both

At a Glance

Name

The Tandy TRS-80 Model 2000

Manufacturer

Radio Shack
1800 One Tandy Center
Fort Worth, TX 76102
(817) 390-3011

Processor

16-bit Intel 80186 at 8-MHz

Memory

128K to 768K bytes, with parity

Disk Storage

Two half-height, quad-density 5¼-inch floppy-disk drives (720K bytes each)
Alternate configuration: one 10-megabyte hard-disk drive plus one floppy-disk drive

Displays

Monochrome: 12-inch green display (80 by 25 characters) with optional two-color graphics (640 by 400 pixels)
Color: 14-inch RGB display (80 by 25 characters) with optional eight-color graphics. Sixteen possible colors to choose from

Keyboard

Detachable keyboard with 90 keys, standard typewriter layout, 12 function keys, numeric keypad, inverted-T cursor pad

Interfaces

One parallel and one serial interface

Expansion

Four expansion slots with nonstandard connectors

Software

Includes MS-DOS version 2.0 plus GW-BASIC

Compatibility

Can read 320K- and 360K-byte MS-DOS disks; can run some IBM PC software

Price

Basic system plus monochrome display: \$2999
with color display and eight-color graphics: \$4197
Hard-disk system plus monochrome display: \$4499

monitors is an impressive 640 by 400 pixels (picture elements). When the eight-color graphics option is installed, eight out of a possible sixteen colors can be displayed at once. (These colors are the standard white, black, red, green, blue, magenta, cyan, and yellow, with each color available in both high and low intensity.) Color-mapping hardware allows you to change colors quickly on the screen.

Seeing a display of color graphics on a Radio Shack business computer is somewhat unusual. More unusual, however, is the speed with which the graphic images are drawn. Thanks to a faster microprocessor, the Model 2000 can draw charts and graphs in what seems to be less than half the time required by the IBM PC.

The Model 2000 reportedly has smooth-scrolling capability (i.e., it can scroll pixel by pixel rather than line by line), but I did not see this demonstrated. The scrolling I *did* see was very fast.

The Keyboard

The keyboard on the 2000 has a very nice touch and is one of the

finer keyboards available. It lacks the peculiarities that have plagued other computers and previous Radio Shack designs. The typewriter keys appear in a standard IBM Selectric typewriter configuration. Cursor keys are in an inverted T, just to the right of the typewriter keys, and a numeric keypad is placed to the right of the cursor keys. A row of twelve function keys is arranged in groups of four and runs along the top of the keyboard. This logical arrangement makes it easy to find a particular function key.

The Insides

Tandy has decided to use Intel's powerful but infamous 80186 microprocessor chip, which is similar to Intel's 8086 chip except that it incorporates several necessary support functions directly into the central processing unit (CPU). These functions include a clock-pulse generator and two high-speed direct-memory-access (DMA) controllers. The true 16-bit processing power of the 80186 gives it about a 40 percent speed advantage over the 8088, and the 8-MHz clock speed of Tandy's 80186 chip

Printed On An Epson Printer

By The *Fancy Font*® System

Letter Quality

Say goodbye to correspondence quality and hello to *Fancy Font's* high-resolution, proportionally spaced, letter quality. *Fancy Font* provides fonts in sizes from 8 to 40 points; styles include Roman, Bold, Italic, Script, Old English, and more. All this on low-cost Epson (MX, RX, FX) and Gemini 10X printers. *Fancy Font* is an easy-to-use software package for CP/M and IBM PC compatible systems; no special hardware or installation is required.

Create Your Own Characters

You can use over 30 font sets in the *Fancy Font* package and furthermore, can create any new characters or logos you like, up to 1 inch by 1 inch. A database of over 1500 characters is included that makes it possible to print foreign languages and mathematical notations.

Font Style Samples

small medium **large** *Bold* *Italic*
Sans Serif *Script* **Old English**

$$A = \int_0^a \sqrt{a^2 - x^2} dx$$

Φ Ψ Ω Β Ε ϐ Δ Ж ± ÷ ≠ ≅ ≳ ⊕ @ § Ω ○ ● # † ‡

Numerous Applications

Fancy Font customers, numbering in the thousands, are constantly discovering new applications.

- Business and personal letters
- Custom forms, invoices, labels, signs
- Foreign Languages
- Mathematical Notation, Greek
- Super- and Sub-scripts
- View Graphs
- Custom Letterheads
- Resumés
- Articles for publication
- Newsletters, brochures
- Complete manuals
- Advertisements
- Invitations, place cards

InfoWorld
Software Report Card

Fancy Font

	Poor	Fair	Good	Excellent
Performance	<input type="checkbox"/>	<input type="checkbox"/>	<input type="checkbox"/>	<input checked="" type="checkbox"/>
Documentation	<input type="checkbox"/>	<input type="checkbox"/>	<input type="checkbox"/>	<input checked="" type="checkbox"/>
Ease of Use	<input type="checkbox"/>	<input checked="" type="checkbox"/>	<input type="checkbox"/>	<input type="checkbox"/>
Error Handling	<input type="checkbox"/>	<input type="checkbox"/>	<input type="checkbox"/>	<input checked="" type="checkbox"/>

Copyright, 1983 by Popular Computing, Inc., a subsidiary of CW Communications, Inc. Reprinted from InfoWorld, 5/2/83

(This ad was printed on an Epson MX-80 printer. Call for an actual sample.)

Highlight: **IBM and CP/M order now - (213) 821-8476 - M/C Visa**

"The quality of print is excellent, and the variety of type styles and sizes is even better."

Pat McKeague, InfoWorld, 5/2/83
Available for Epson FX, MX, RX, Gemini 10X, IBM Graphics Printer, Riteman Informer, TI 855/850, Cltch and NEC8023 (IBMPC only)

SoftCraft, Inc., 8726 S. Sepulveda Bl. #1641, LA, CA 90045
phone: (213) 821-8476

Fancy Font System \$180.00 _____
Fancy Font Demo Disk \$ 10.00¹ _____
California Residents add 6.5% sales tax _____
Outside US add \$10 (only \$2 for demo) postage _____

Diskette Format:
 8" CP/M Epson QX10 Osborne Kaypro
 IBM PC² Victor 9000² Apple CP/M³

¹ \$7.50 applicable towards purchase of Fancy Font
² PC DOS/MSDOS systems require 128K memory. IBM printer works.
³ Fully transparent 8-bit printer interface required

gives it another 40 percent advantage over the IBM PC's chip. Additionally, the 80186 has a dedicated adder circuit for very quick memory-address calculations. The result, claims Radio Shack, is a program execution time three to six times faster than the 4.77-MHz 8088. We did some informal tests with Multiplan and were impressed not only with the processing speed, but also with the disk-access speed.

The 80186 has been chosen by several system designers because of its speed and high level of integration (see "The Pronto Series 16," June 1983 BYTE, page 168). Unfortunately, Intel reportedly had to redesign parts of the chip and is several months behind in its shipping schedule. A number of systems are waiting for the chip, and even Tandy may have problems getting it. As of this writing, the Model 2000 has not yet appeared in large numbers. But if anyone has enough clout to get the chip, it's Radio Shack.

The Tandy 2000 also has a socket for the 80187 floating-point numeric processor. Radio Shack isn't saying much about this capability, and it might be awhile before this chip is available, but when it is, this machine should be a devastating number cruncher.

As for memory, the Model 2000 comes with a minimum of 128K bytes. An additional 128K bytes can be placed on the motherboard, but beyond that you will have to add expansion boards populated with either 128K or 256K bytes. The upper memory limit is 768K bytes.

Disk Storage

One of the problems with a faster microprocessor is that floppy disks tend to fill up faster. Radio Shack has more than compensated for this less-than-major difficulty. The Model 2000 uses quad-density disks, with each disk holding 720K bytes of data—twice that of the 360K limit of the double-sided IBM PC disks under PC-DOS version 2.0.

Interfaces

The Model 2000 comes with both a Centronics parallel printer port and an RS-232C serial port. An optional

SHARP INTRODUCES

COMPUTERS TO GO

With Sharp's PC-5000 you can take your entire office with you, wherever you go. Do word processing on the train, order entry from a customer's office or spread sheet analysis in your hotel room. It goes anywhere.

It's small.

It weighs under 10 lbs. and fits in a standard briefcase.

It prints. Quietly, with a optional correspondence-quality printer.

It comes with software. Word processing and communications. Also available are spread sheeting, executive planning and scheduling.

It remembers over 80 (128K) typewritten pages. And can be expanded to handle over 500 (896K).

It's compatible with a wide array of 16-bit IBM software.

It communicates with other computers and databases.

It's AC/DC with rechargeable 8-hour batteries.

It all means travel time and commuter time no longer have to be downtimes.

For more information call toll-free now at 800-447-4700 or send in the coupon.



FROM SHARP MINDS
COME SHARP PRODUCTS

Sharp Electronics Corp., P.O. Box 204, Wayne, NJ 07470

Please send me more information about Sharp's PC-5000.

Please set up a demonstration.

Name _____ Title _____

Company _____

Street _____ City _____

State _____ Zip _____

Phone (____) _____

Dept. 5-B-3-4

HOFACKER

Books • Software • Hardware Add-Ons • for your ATARI 600K/ 800 KX Commodore-64, VIC-20, Sinclair, Tandy, Apple II Osborne-DSI

BLI-ZE-TEXT -- More than just a word processor for the C-64! More than 70 functions, abbreviations, use any printer, manual software included for electronic mail and networking. The best wordprocessor for the C-64.
Order No. 895 \$89.00

MACROPIRE -- Editor/Assembler for the C-64
The best macroassembler you can buy!
Order No. 4903 \$99.00

SUPERBOOKS for your C-64
The Great Book of Games, Vol. 1
46 programs for the Commodore 64
Order No. 182 \$9.95
Programs from this book on disk \$19.95

MORE ON THE SIXTYFOUR
Tips, tricks, hints, very important sub-routines
Order No. 183 \$9.95
Programs from this book on disk \$19.95

How to program in 6502 Machine Language on your C-64
Order No. 184 \$12.95
Commodore 64 Time out, Vol. I
Order No. 185 \$12.95
Small Business Programs for the C-64
Order No. 186 \$12.95

HARDWARE ADD-ONS for your C-64
Parallel printer interface, KIT
Order No. 4990 \$19.95

Universal Expansions Board
Order No. 4970 \$6.95
Expansion Board #17 -- Moves up to 4 5 1/4" boards (bare board)
Order No. 4952 \$29.95

Order and Distributor required same invoice.
ECCOMP PUBLISHING, INC.
53 Redrock Lane
P.O. Box CA91766
Phoenix, AZ 85024, Tel. 29 8 181

Wordprocessor for all ATARI computers. No one can provide better software for this price!
ATEX-1
This wordprocessor is an excellent buy for your money. It features screen-oriented editing, scrolling, string search, seven review left and right margin justification. Over 30 commands. Text can be saved on disk or cassette.
Order No. 7210 cassette \$29.95
Order No. 7216 disk \$34.95
Order No. 7217 cartridge \$59.00

Games for the ATARI Computer
This book describes advanced program ming techniques like player missile graphics and use of the hardware registers. Contains many ready to run programs in BASIC and one called GUNFIGHT in machine language.
Order No. 362 \$7.95

How to program your ATARI in 6502 Machine Language
Beyond access to machine language for the BASIC programmer.
Order No. 188 \$9.95

FORTH on the ATARI -- Learning by Using
Introduction, programs, applications, learning exerc. set.
Order No. 170 \$7.95
Complete construction article and software on how to build an EPROM burner
Order No. 172 \$9.95

HAC KERBOOK for your Atari computer
This is a very important sub-routine in 6502 machine language. How to make portable cassettes, disks, and EPROMs. Complete construction article and software on how to build an EPROM burner
Order No. 172 \$9.95

Copyright © 1983 by ECCOMP Publishing, Inc.
PAYMENT: Check, VISA, MC, CA orders & S. & W. orders. Outside U.S. add 15% for shipping and handling.
Shipping and handling \$2.95.
For customer contact call 529-713

Circle 143 on inquiry card.

(6502 & Z-80 dual processor) \$4K COMPUTERS

(Apple compatible) in super modern styles. US\$420

US\$420 (IBM pc look alike case & keyboard) US\$450
*Add \$4 as shipping charge

US\$400
*Above prices exclude drives, monitor & keyboard
*Detail brochure forwarded on request

US\$360
*We also sell cases, keyboards, power supplies, motherboards, components separately and interfaces.
*Full repair & guarantee available
*Assembled in Canada with C.S.A. (Shipment from WA, U.S.A.)

ABC COMPUTERS LTD. (6 stores in B.C. Canada)
663 E. HASTINGS ST., VANCOUVER, B.C. CANADA V6A 2Z8
PH: (604) 254-2834 & 254-1082 Dealer inquiries welcome

Apple is a registered trademark of Apple Computer, Inc.

Circle 6 on inquiry card.

board allows you to interface the 2000 with a standard television and a joystick. Another optional board lets you interface with a mouse. This board also includes a clock and the MS-Windows operating environment.

Expansion Capabilities

The Model 2000 has four horizontal expansion slots accessible from the rear panel. Expansion boards are slipped in like trays. Each board has a nonstandard connector that consists of three rows of about 30 pins (see table 1 for a list of expansion boards available for the Model 2000).

The Model 2000 can also be purchased with a 10-megabyte hard-disk drive instead of one of the floppy drives. This configuration costs \$4250 without a monitor. Since the hard-disk drive sits to the left of the floppy-disk-drive enclosure, a second floppy-disk drive can still be added. Radio Shack has not yet made this second drive option available.

Software

Of course, the most important part of any new machine is its software. Radio Shack's last 16-bit computer, the 68000-based Model 16, was hampered for a while by the lack of 16-bit software. The Model 2000, with its popular MS-DOS operating system, should have a much easier time.

The standard system comes complete with MS-DOS version 2.0 and Microsoft's GW-BASIC interpreter. In addition, Radio Shack offers many software package options (see table 2). More packages should be available in the future, but don't expect your local Radio Shack store to carry a huge assortment of MS-DOS software—these stores already stock a wide assortment for the other TRS-80 machines, and Radio Shack says that it does not want to overburden its dealers.

As you can see from table 2, Radio Shack offers at least one example from each of the main categories of applications software. You can be fairly sure that all major MS-DOS software houses will supply configurator programs that allow you to configure their software for the Model 2000.

A notable feature of the Model

ZENITH/Heath Users

Double Your 5 1/4" disk storage capacity without adding a drive.

Get twice as much from your H88 or H89 microcomputer. Our FDC-880H floppy disk controller, in conjunction with your 5 1/4" drives, for example, expands memory capacity from 256 bytes to 512 bytes per sector.

And it handles single and double-sided, single and double-density, 8" and 5 1/4" drives — simultaneously.

C.D.R. Systems Inc.
Controlled Data Recording Systems Inc.
7210 Clairmont Mesa Blvd., San Diego, CA 92111
(619) 560-1272

Circle 58 on inquiry card.

BASF DISKETTES

BASF Diskettes at competitive price. Call TOLL FREE (800) 235-4137 for prices and information. Visa and Master Card accepted.

PACIFIC EXCHANGES
100 Foothill Blvd
San Luis Obispo CA
93401 (In Cal call
(405) 54-1-1037)

Circle 277 on inquiry card.

Radio Shack TRS-80™ Computers

At Guaranteed Savings

from **Pan American Electronics**

1117 Conway Ave.
Dept. B
Mission Texas 78572
PH. 512/581-2786
Telex 767339
TO ORDER
CALL TOLL FREE
800-531-7466

Full Line Computers, Printers & Peripherals

Circle 279 on inquiry card.

SIBEC 51

8051-Based Single-Board Computer with Monitor/Debugger

- Versatile - 4 28-pin byte-wide sockets; monitor will program EEPROMs.
- Affordable - just \$335
- Perfect for System Development and Educational Applications

Binary Technology
P.O. BOX A-58 • MANOYER NH 02756 • 603 643 2881

Circle 44 on inquiry card.

SemiDisk™ and SemiSpool:™

SURE-FIRE WAIT-REDUCTION!



512Kbyte SemiDisk™ I \$1095

Time was, you thought you couldn't afford a SemiDisk. Now, you can't afford to be without one.

	256K	512K	1Mbyte
SemiDisk I, S-100	\$895	\$1095	\$1795
IBM PC		\$1095	\$1795
TRS-80 Model II		\$1095	\$1795
SemiDisk II, S-100		\$1395	\$2095
Battery Backup Unit	\$150		

Time was, you had to wait for your disk drives. The SemiDisk changed all that, giving you large, extremely fast disk emulators specifically designed for your computer. Much faster than floppies or hard disks, SemiDisk squeezes the last drop of performance out of your computer.

Time was, disk emulators were afraid of the dark. When your computer was turned off, or a power outage occurred, all your valuable data was lost. But the SemiDisk changed all that. Now, the optional Battery Backup Unit helps take the worry out of power interruptions. It keeps the SemiDisk powered for up to 5 hours during a power failure.

Time was, you had to wait until your printer finished printing to use your computer. That's changed, too. Now, the SemiSpool print buffer in our Version 5.0 software, running under CP/M 2.2, frees your computer for other tasks while your data is printing. With a capacity up to the size of the SemiDisk itself, you could implement an 8 Mbyte spooler!

But one thing hasn't changed. That's our continuing commitment to supply the fastest, highest density, easiest to use, most compatible, and most cost-effective disk emulators in the world.

SemiDisk.
It's the disk the others are trying to copy.

SemiDisk Systems, Inc.

P.O. Box GG Beaverton, OR 97075 (503) 642-3100

Call 503-642-5510 for CBBS®/NW, a SemiDisk-equipped computer bulletin board 300/1200 BAUD
SemiDisk trademarks of SemiDisk Systems, Inc. Copyright © 1983 SemiDisk Systems, Inc. CP/M Trademark Digital Research

Circle 317 on inquiry card.



Expansion Boards	Price
Monochrome graphics adapter	\$449
Eight-color graphics adapter (Monochrome adapter + extra memory)	\$698
TV/Joystick adapter	\$250
Mouse/Clock adapter (Includes MS Windows)	\$120
128K-byte memory board	\$499
256K-byte memory board	\$798
Other options	
Monochrome monitor	\$249
Color monitor	\$799
Second 128K-bytes memory	\$299
Digi-Mouse	\$100
Floor stand	\$145
Monochrome display pedestal	\$ 90

Table 1: Expansion boards and options for the Model 2000.

Software	Type	Price
Planetfall	Game	\$ 50
Videotex Plus	Communications	\$ 50
Witness	Game	\$ 50
MS-Assembler	Macro assembler	\$100
Home Account. Plus	Personal finance	\$125
PFS:Report	Report generator	\$125
PFS:Write	Word processing	\$140
PFS:File	Database	\$140
PFS:Graph	Business graphics	\$140
Multiplan	Spreadsheet	\$249
Multimate	Word processing	\$250
GW-BASIC compiler	BASIC compiler	\$300
MS-Pascal compiler	Pascal compiler	\$300
MS-FORTRAN	FORTRAN compiler	\$350
MAI/Basic Four	Purchase orders	\$395
	Accounts payable	\$495
	Accounts receivable	\$495
	General ledger	\$495
	Inventory control	\$495
	Payroll	\$495
COBOL	RM-COBOL compiler	\$595
dBASE II	Database	\$595

Table 2: Software offered by Radio Shack for the Model 2000.

2000's BASIC interpreter is its graphics capabilities. Because of the Model 2000's fast processor, its version of BASIC runs rings around that of the IBM PC. To see the FILL routine in action is especially impressive.

Watch for one particular software package for this machine. Ovation, which should be available during the second quarter of 1984, lets you go from spreadsheet to word processor to database manager very easily without having to cut and paste to transfer data. Demonstrations of Ovation at COMDEX in November left no doubt that applications software has advanced to a new level.

As for that other operating system, CPM/M-86, Radio Shack has expressed no interest in making a second operating system available for the Model 2000.

Compatibility

Radio Shack stresses that its machine is an MS-DOS machine, *not* an IBM PC clone. Yet in its advertising, Radio Shack repeatedly makes direct comparisons with the machine from Boca Raton. And obviously, compatibility with the IBM PC is important because of IBM's ever-growing library of software. To its credit, Radio Shack makes it quite

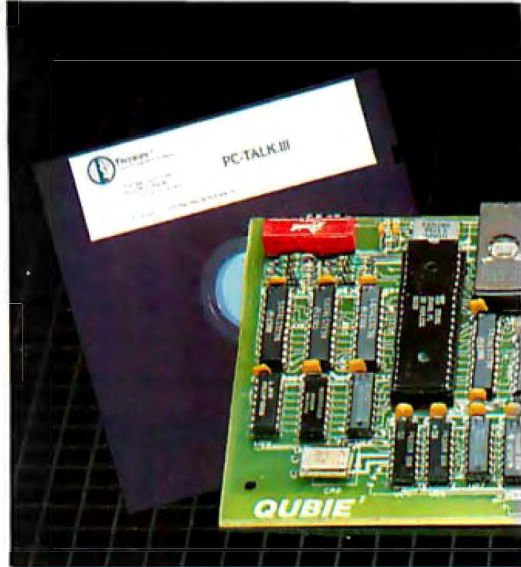

Flip the pages. You see PC modem cards with fewer features advertised for as much as \$599. Up until now that's how much it cost to make a modem capable of transmitting at 120 characters per second (1200 baud). It doesn't take a computer to figure out the savings in phone line charges when you communicate four times faster than the 30 character per second modems (300 baud). Now you can have the solution to your communication needs at an affordable price.

SEE HOW THEY WORK

You can imagine how precise the components have to be to convert tones over a phone line into 120 characters every second. Precision equates to cost. With the advent of the mass market in personal computers the economies of scale drove the costs of manufacture down, but did not effect the precision required. The technology used is called "analog filtering". It is the process of sending (modulating) and receiving (demodulating) tones with perfect pitch. A lot of adjusting, noise suppression, and a little magic is required. Real expensive. Some use lots of chips and filters (known as discrete components). The latest rage is LSI (Large Scale Integration) technology. Which is the same old analog stuff condensed onto fewer chips.

ADVANTAGE #1

Digital Signal processing

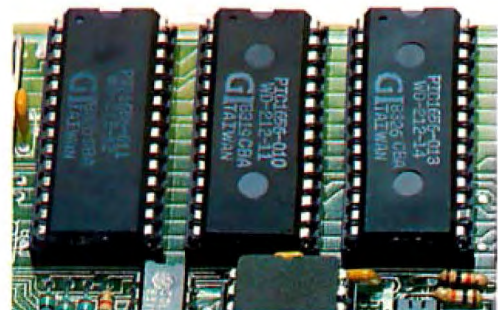

A NEW IDEA

We took a different approach. Through the use of four microprocessors the tones are chopped up digitally and measured millions of times per second, eliminating the need for analog circuitry. Two microprocessors do the modulating, two the demodulating. The chips are programmed to emulate the 103 (30 characters per second) or 212 (120 characters per second) standards and determine the correct speed automatically. It's a proven technology that provides outstanding performance. Best of all, it's inexpensive and reliable.

\$299 212A

**1200 Baud,
Auto-Dial,
Modem for IBM PC**

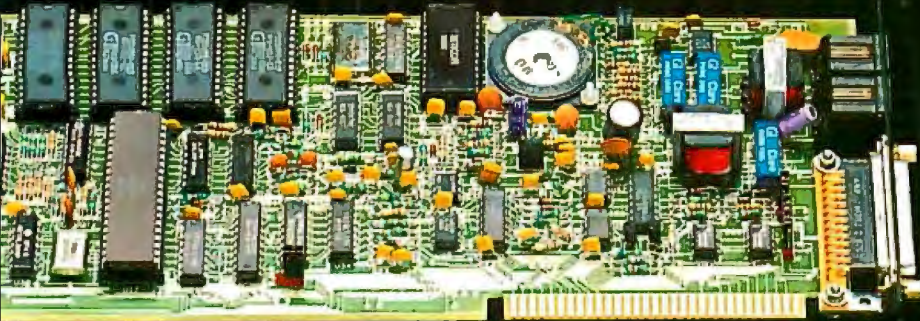

PC 212A/1200:

A GENUINE BREAKTHROUGH

NO CORNERS CUT

We included every feature you would want in a modem card. It's FCC registered for direct connection to your modular phone jack with the cord which is included. There is a separate modular jack for your telephone or you can listen through the onboard speaker. The autodialer works on rotary lines, tone lines, or a combination of both, and will pause for use with Sprint or MCI. It will work in originate or auto-answer modes. A separate microprocessor, a Z8, controls all the functions.

ADVANTAGE #3

Just one slot in PC or XT

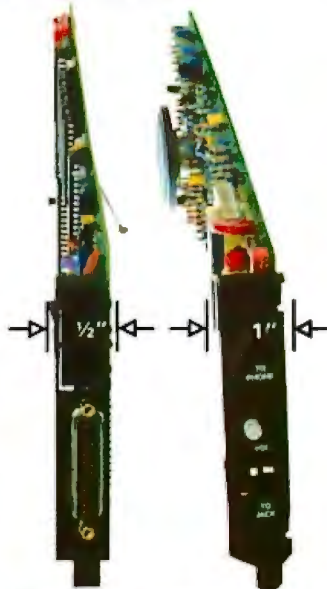

require service, we will fix or replace it within 48 hours. Notice also there are no hidden charges in our price. Nothing extra for credit cards or COD charges. We even pay UPS shipping. If you still are not convinced, and are ready to buy another brand of modem, ask them if they will take our acid test.

THE ACID TEST

Qubie' gives you a 30 day satisfaction guarantee on your modem. If you are not completely satisfied we will refund the entire amount of your purchase including the postage to return it. If you can, get anyone selling one of our competitor's products to give you the same guarantee. Buy any modem you like and return the one you don't like. We know which one you will keep.

ORDER TODAY

It's easy to order by mail or by phone.

BY PHONE: Call us and one of our sales staff can answer any questions you have and take your order. Have your Visa or Mastercard number handy when you call.

(805) 987-9741

BY MAIL: We need your name and street address, daytime phone number, how many modems you want, and whether your computer has single or double sided drives.

VISA & MASTERCARD



\$299 includes: PC 212A/1200 auto-dial modem card, PC-TALK III software, cord to connect to modular phone jack, and manual. 1 year limited warranty.

Optional: Connector and circuitry to use serial port for another serial device \$25.

SHIPMENT

We pay UPS surface charges. UPS 2 day air service add \$5 extra. Credit card or bank check orders shipped next day. (Personal checks take 18 days to clear)

QUBIE'

4809 Calle Alto Camarillo, CA 93010

Circle 302 on inquiry card.

ADVANTAGE #2

Optional external serial port connector



AN ASYNCHRONOUS ADVANTAGE

The modem board is addressed in the software as COM1 or COM2 and we have a handy little option you ought to consider. If you would like to use the asynchronous communications port when your modem is not in use, we will add a connector and the necessary circuitry for just \$20. This saves you the hundred bucks or so you would spend for another async card and saves a valuable slot. It can be configured as COM1 or COM2 and works just like IBM's does.

THIN IS IN

It plugs into your IBM PC or XT and occupies any one slot since it is just 1/2 of an inch thick. This is made possible by using a special speaker which is just 1/8" tall. Competing brands either use a conventional cone type speaker, or they just skip the speaker altogether. Some modems also have large transformers which allow a valuable space.

LET'S TALK SOFTWARE

Our modem is 100% compatible with the Hayes software commands so you can use any of the popular communications packages like IBM's Asynchronous Communications Support, CrossTalk, Transend, or PC Modem. We go one better than the competition. We include PC-TALK III. PC WORLD magazine referred to it as "the benchmark that other PC communications packages are measured against." It stores phone numbers, handles setting the modems characteristics, saves to disk files, transmits from disk files, even binary files. You can program up to forty keys to have things like passwords and log-on information be entered when you hit them. And to make sure data is sent and received accurately, the XMODEM protocol detects errors caused by poor line quality and automatically retransmits the data.

WHY BUY FROM US

Because besides having the best product on the market, we stand behind it and you. You get factory direct technical support after the sale. If at any time during the one year warranty period your modem should

People & Technology™

ACCESS TOMORROW'S COMPUTER SOLUTIONS TODAY!

We've broken the disk access bottleneck using advanced 3M™-patented technology never before available for the IBM PC. Now, for the first time, this advanced storage technology is made available exclusively to the small-to-mid-sized business user by People & Technology.™

INTRODUCING . . .

ELECTRONIC File Cabinet™ SERIES 100

20 Mb Disk Drive

- IBM™ compatible
- Plug-compatible w/ most PC/DOS and MS/DOS (version 1.1 and 2.0)
- Mainframe data access time & reliability for your PC . . . only 65 ms!
- All installation software, cabling, and comprehensive operations/information manual included
- Look-alike IBM packaging
- Bank financing available
- **Only \$2,350 . . . more storage for less money!**

For product and ordering information, call our 24 hour toll free order line at **800-443-0100 Ext. 428**

People & Technology
Access tomorrow's computer solutions today.

People & Technology™

844 Manatawna Ave.,
Phila., PA 19128

People & Technology and Electric File Cabinet are registered trademarks of People & Technology. IBM is a registered trademark of International Business Machines. 3M is a registered trademark of 3M Corporation. Price subject to change without prior notice.

Software	Publisher	Runs on Model 2000?
1-2-3	Lotus Development	No
Accounting	IUS	Yes
Accounting	Open Systems	Yes
Bottom Line Strategist	Ashton-Tate	Yes
DJ Market Analyzer	Dow Jones	No
Easywriter	IUS	No
Peachtext	IBM	No
Planfin	Business Software	Yes
Quickcode	Fox & Geller	Yes
Random House Dictionary	Aspen/Wang	Yes
Smartcom	Hayes	No
Spellguard	Sorcim	Yes
Supercalc2	Sorcim	No
Superwriter	Sorcim	No
Tax Preparer	Howardsoft	Yes
The Word Plus	Oasis	Yes
Visicalc	Visicorp	No
Volkswriter	Lifetree	No
Wordplus/The Boss	Professional Software	No
Wordstar	Micropro	No

Table 3: Partial list, compiled by Radio Shack, of popular MS-DOS software, indicating which packages will run on the Model 2000. For more information, check your local Radio Shack dealer.

clear that several IBM PC programs will not run on the 2000.

In brief, any IBM PC program that, for the sake of speed, bypasses MS-DOS routines and directly accesses the IBM's memory is unlikely to run on the 2000. Similarly, any program that makes use of certain unique keys on the IBM keyboard or the unique graphics features is also unlikely to run (see table 3 for a list provided by Radio Shack of those programs that will or will not run).

In some cases, the obstacle to running a particular program is trivial. For example, Radio Shack mentioned a program that accesses a certain memory location in the IBM PC to ascertain whether a monochrome or color monitor is being used. To make this program run on the 2000, you simply change two bytes in the program so that it accesses the equivalent memory address on the 2000.

Obviously, some programs are more difficult than others to "port" to the 2000. Note that the best-selling 1-2-3 package from Lotus Development is not among those offered by Radio Shack. This may reflect Tandy's preference for Ovation as much as the difficulty of porting 1-2-3.

Two additional levels of compatibil-

ity with the IBM PC require mention. The first is disk compatibility and the

Radio Shack makes it quite clear that several IBM PC programs will not run on the 2000.

second is hardware compatibility. With regard to disks, the 2000, because it uses a quad-density disk format, has sacrificed complete compatibility with the IBM. The 2000 can read an IBM disk but it cannot write to one, and, while this situation is better than nothing, I'm sure that the limitation will be more than a little frustrating. (I should note that the 2000 did have trouble reading one of my IBM PC disks.)

As for hardware compatibility with the IBM PC, there is almost none. The expansion slots are completely different. The monitors are said to be specially designed for the 2000. The only common points seem to be the related CPU chips and the serial and parallel ports.

Several manufacturers, such as Tecmar, AST, and Quadram, have developed expansion boards for the IBM

Introducing the world's first complete, self-contained, 16-bit portable computer system.

The Panasonic Sr. Partner with a built-in printer.

The Panasonic Sr. Partner is one of the most flexible and versatile portable computers on the market today. So there are many reasons to buy one.

Runs IBM PC Compatible Programs.

To begin with, the Sr. Partner runs IBM PC compatible programs. So you can pick from hundreds of popular programs from an existing software library. Including Lotus® 1-2-3®, Multiplan® and even Flight Simulator®.

In addition, included with the Sr. Partner are five of the most respected business-related programs including VisiCalc®, WordStar®, PFS® Graph, File and Report plus G.W. BASIC®.* All at no extra charge.

This "bundle" allows you to go to work immediately doing word processing, electronic spread sheets, file management, graph development and your own programming.

And because it also accepts IBM PC compatible hardware, the Sr. Partner's technical capabilities can be expanded even further.

Built-in Printer.

The Sr. Partner is the only portable in its class with a built-in printer. It has graphics capability and can provide you

or your customers with printouts of statistics, budget figures, conference notes, graphs and much, much more.

The printer is also extremely quiet and offers an 80-character line and the 132-character line that's perfect for spread sheets and other accounting programs. And its bi-directional logic design delivers fast printing.

A Complete System.

The Sr. Partner is an integrated system that doesn't require costly add-ons to be called complete.

It has 128K internal memory (RAM), expandable to 512K. A nine-inch, high-resolution CRT with monochrome screen. An 8088 microprocessor with a MS-DOS™ 2.0 operating system. An 8087 co-processor socket. A built-in, double-sided, double density, 360K, 5¼-inch disc drive and the capability of handling another one just like it. Built-in color and graphics at no extra cost. An option slot for IBM hardware. An RGB monitor output. A centronics parallel interface I/O port that accepts optional peripherals. And an RS-232 serial interface I/O port. All for a price that's surprisingly affordable.

The Sr. Partner is also backed up by a 12-month limited warranty. Most of the competition offers only 90 days.

*Software package subject to change

Registered Trademarks: WordStar - MicroPro International Corporation, PFS - Software Publishing Corporation, 1-2-3 and Lotus - Lotus Development Corporation, VisiCalc - Visicorp, Flight Simulator, G.W. BASIC and Multiplan - Microsoft

Circle 280 on Inquiry card.

And if the Sr. Partner should ever need servicing, we have a national network of authorized service dealers.

Over 60 Years of Dependability.

We're not one of those "here today, gone tomorrow" companies.

Our parent, Matsushita Electric Industrial Co., has been in business since 1918 and is one of the world's largest consumer electronics manufacturers.

Matsushita's recent contributions and innovations to computer and office technology include: a data entry system that directly connects facsimile data to a computer. An online optical character reader. A "pocket terminal" telephone data entry system. And a 64K static memory chip.

For more information about the Sr. Partner, write to: Computer Department, Panasonic Industrial Company, Division of Matsushita Electric Company of America, One Panasonic Way, Secaucus, NJ 07094. Or call: (201) 392-4261.

The Panasonic Sr. Partner. It's everything you've always needed in a portable computer but never had before.

Panasonic

just slightly ahead of our time.

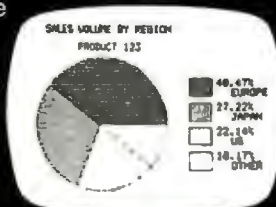

You don't need a computer to talk to another computer.

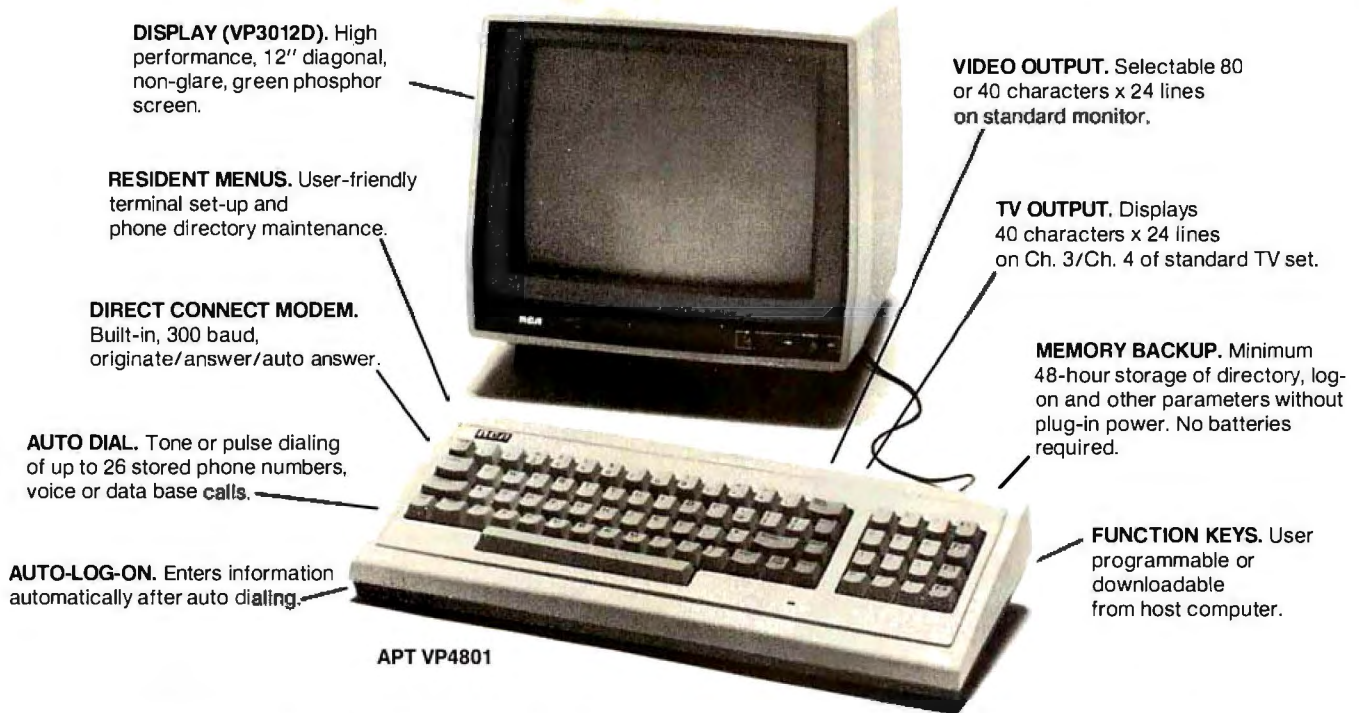

DISPLAY (VP3012D). High performance, 12" diagonal, non-glare, green phosphor screen.

RESIDENT MENUS. User-friendly terminal set-up and phone directory maintenance.

DIRECT CONNECT MODEM. Built-in, 300 baud, originate/answer/auto answer.

AUTO DIAL. Tone or pulse dialing of up to 26 stored phone numbers, voice or data base calls.

AUTO-LOG-ON. Enters information automatically after auto dialing.

VIDEO OUTPUT. Selectable 80 or 40 characters x 24 lines on standard monitor.

TV OUTPUT. Displays 40 characters x 24 lines on Ch. 3/Ch. 4 of standard TV set.

MEMORY BACKUP. Minimum 48-hour storage of directory, log-on and other parameters without plug-in power. No batteries required.

FUNCTION KEYS. User programmable or downloadable from host computer.

APT VP4801

The new RCA APT (All Purpose Terminal) expands your data communications capabilities for a lot less money.

For business, professional and personal data communications, you'll find more user-friendly features and greater communications capabilities in the RCA APT than in other terminals selling for up to three times the price.

The new APT terminals are ideally suited to multi-data base time sharing and dedicated, direct computer-connected applications. They feature menu-controlled operation and a programmable "personality" to match specific communications requirements for your data bases.

A single keypress can dial a stored number, send the log-on sequence to the host computer, and return terminal control to the user. Password protection prevents unauthorized access to designated numbers. APT can also be used as an auto-dialer for voice communications.

OTHER FEATURES

RS232C port for direct computer connections at data rates to 9600 baud, or for connecting high speed modems and other accessories. Parallel printer port for hard copy. Numeric keypad, can dial phone numbers not in terminal directory. Built-in speaker with adjustable volume control for audio monitoring of phone line. Smooth scroll display. Automatic screen blanking to reduce possibility of burn. Briefcase size: 17" x 7" x 2". Weight: under 4 lbs.

Quite simply, matching features with price, there is no other professional quality terminal available today that can do as much at such low cost.

APT terminals list for \$399, in your choice of full stroke or membrane keyboard versions. Either style is also available with a display monitor for \$598 list. The data display monitor alone, VP3012D, \$199 list.

For more information—or to order—call 800-233-0094. In Penna., call collect to 717-393-0446. Or write for fully descriptive brochure to RCA MicroComputer Products, New Holland Avenue, Lancaster, PA 17604. OEM and dealer pricing available. The new RCA APT. Expansive. Not expensive.

APT VP3801. Flexible membrane keyboard version designed for travel and hostile environments.



RCA

PC. If these manufacturers will support the Tandy 2000 in the same way, the new machine's owners and Tandy itself will benefit greatly.

Apart from the IBM PC, the second area of compatibility is with other Radio Shack computers. Quite probably, the new 2000 will find its way into offices that already have a Model III or 4. Unfortunately, although they share the same disk size, they cannot read each other's disks. It would, of course, be too much to expect that these two different machines would run each other's programs. But it might sometimes be useful to be able to transfer a text file from the Model 4 to the 2000. Until someone writes a routine, you'll have to resort to using a serial cable.

Currently, the only visible compatibility with Models III and 4 is that the default disk drive is the lower one.

Conclusion

The designers at Radio Shack have corrected many of the faults present in the IBM PC, and, in some respects, have completely surpassed it. Most importantly, they have accomplished this at a very reasonable price.

Anyone who does serious number crunching should consider the 2000 (particularly if the 80187 chip appears). A significant amount of MS-DOS software will probably become available for this machine. But users who require a particular software package should first check if that software is compatible.

This new machine should be a very effective competitor for the IBM PC—it will allow Radio Shack to enter markets it has hitherto had difficulty penetrating. And, because of Radio Shack's formidable marketing, this strong product could spell trouble for some of the other MS-DOS machines on the market. ■

Rich Malloy is BYTE's product-review editor.

In a future issue we hope to present a detailed System Review of this product that will include results of several benchmark programs and compatibility tests. . . . R.M.

TWO-FINGER TYPERS:

What About The Undetected Errors You Make Because You Can't Watch The Screen?

INTRODUCING TYPEQUICK

Faster Speed, Fewer Errors And Improved Productivity

In A 15-Hour Microcomputer Course

Two fingers are fine for playing "Chopsticks," but mistakes on your computer are just too time-consuming. It's the errors you don't see that are the worst, but how can you read the screen when you're searching for keys?

BREAK THE KEYBOARD BOTTLENECK

TYPEQUICK, the serious keyboard training course for the successful micro user, will quickly teach you to touch type so that you can watch the screen for errors. It will hold your interest, but it's not a game. It's the same course used in many colleges because it's so effective.

TYPEQUICK is the easy and rewarding way to learn in the convenience of your office or home in about 15 hours. The course will increase your quickness and accuracy with its unique pacing system which forces you up to speed—a proven success.

In ten enjoyable lessons, TYPEQUICK encourages and reinforces like a good teacher, changes the exercises to remove weak keys, waits for you to correct errors, uses mostly words and

text, and displays and prints three reports per lesson.

RUNS ON MOST SYSTEMS

Available for PC-DOS, MS-DOS, CP/M, and CP/M 86. Requires 128K (64K under CP/M) and 160K disk drive. About \$85—with a money-back guarantee—at your local computer or software retailer.

Ask to see TYPEQUICK at your retailer today, or send for an informative brochure. It's the only touch typing course worth your time and money—a very important step to improved productivity.

TYPEQUICK

I need to get serious about my keyboard productivity. Please send me more information about TYPEQUICK immediately.

Name _____

Company _____

Address _____

City/State/Zip _____

Machine Type _____

Op. Sys. _____

Disk Format _____

Mail to: TYPEQUICK
12021 Wilshire Blvd. #219
Los Angeles, CA 90025

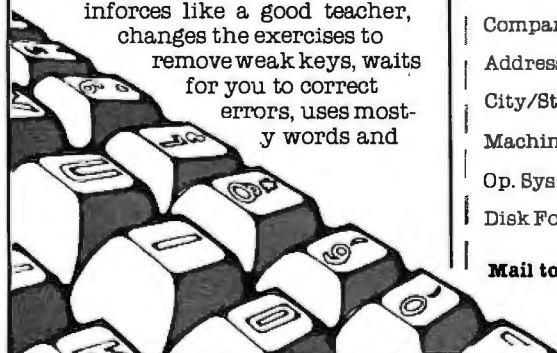



CRAFTSMEN OF THE NEW TECHNOLOGY.
BEST PRICES WITH QUALITY SUPPORT* ON SOFTWARE AND HARDWARE.

ORYX SYSTEMS

QUALITY DISCOUNTS

APPLE/ FRANKLIN

ASHTON-TATE	
d-Base I	\$ 389
ASPEN/WANG SOFTWARE	
Grammatik	\$ 60
Proofreader	42
BEAGLE BROS.	
Apple Mechanic	\$ 22
DOS Boss	17
Utility City	22
BRODERBUND	
Bank Street Writer	\$ 45
General Ledger w/AP	305
Payroll	275
CDEX	
Visicalc Training	\$ 45
CONTINENTAL SOFTWARE	
Home Accountant	\$ 49
DOW JONES	
Market Analyzer	\$ 245
Market Manager	219
Microscope	525
HOWARD SOFTWARE	
Tax Preparer '84	\$ Call

LOGO CORNER

Krell Logo

LINK SYSTEMS	
Datafax	\$ Call
Datalink	79

d-BASE II CORNER

Ashton-Tate	
d-Base II	\$ Call
Bottom Line	259
Strategist	410
FPL	189
Friday	189
Human Soft	
d-Base Plus	\$ 95
Fox & Geller	
Quick Code	\$ 175
D Util	58
Software Banc	
d-Base II	
User's Guide	
w/ d-Base II	\$ 15
Purchase	
w/o d-Base II	20
Purchase	
Anderson-Bell	
Abstat	\$ 349
Tylog Systems	
d-Base Window	\$ 159
d-Base Door	\$ Call
All above available PC-DOS	

MICROPRO	
Wordstar (Special) w/ CP/M Card, 70 col. & 64K)	\$ 350
Infostar (Includes CP/M, 70 col., 64K) ..	350
Pro Pak (WS/MM/SS/Index) ..	399

MICROSOFT	
Cobal-80	\$ 499
Fortran-80	145
TASC Compiler	119
A.L.D.S.	79
Multiplan (DOS)	169

OMEGA	
Locksmith	\$ 79

PEACHTREE (CP/M)	
Peachpak 40 G/L + A/R + A/P (Special) ..	\$ 215
All Other Peachtree Products ..	Call

PENGUIN SOFTWARE	
Complete Graphics ..	\$ 50
Graphics Magician ..	39
Complete Graphics/ Apple Tablet	86

SIERRA ON-LINE	
Homeward	\$ Call

SOFTECH	
Basic Compilers' Runtime	\$ 169
Softtech	94
UCSD P-system Set ..	469

SOFTWARE PUBLISHING	
PFS: File	\$ 79
PFS: Graph	79
PFS: Report	79

SUPERSOFT	
Basic Tutor	\$ 79
Fortran	299

SYSTEMS PLUS	
Landlord	\$ 375

VISICORP	
Visicalc (II or IIE)	\$ 165
Visischedule	195

CP/M SOFTWARE

COMPUVIEW	
*V-Edit 8080 Z80, IBM/PC	\$ 130
*V-Edit CP/M 86, MS DOS	160

DIGITAL RESEARCH	
*Pascal MT + W/SPP ..	\$ 389
DR Assembler & Tools ..	149
CP/M 2.2	125
C Basic 2	95
PL/1-80	375
C Basic Compiler (CB-80)	299
Access or Display Mgr ..	299
C Language/Compiler ..	260
Concurrent CP/M 2.0 ..	225
All B' - 86 Version of Above	\$ Call

INFOCOM	
*Deadline	\$ 49
*Starcross	39
*Suspended	39
*Zork, I, II, III (each) ..	39
Planet Fall	49

LEXISOFT	
*Spellbinder	\$ 239

MARK OF THE UNICORN	
*Final Word	\$ 199

MICROPRO	
*WordStar	\$ Call
*InfoStar	Call
*Pro-Pack (WS/MM/SS Index) ..	Call
All others	\$ Call



PEACHTREE CORNER

- ▶ PeachPak 4 (GL, AP, AR)
- ▶ General Ledger / Accounts Payable / Accounts
Receivable / Sales Invoicing / Inventory Control /
PeachPay Payroll
- ▶ PeachText
- ▶ PeachText w/ Random House Thesaurus
- ▶ Spelling Proofreader
- ▶ PeachCalc
- ▶ Job Cost System
- ▶ Client Posting & Accounting
- ▶ Graphics Language
- ▶ Business Graphic System

MICROSOFT	
Basic 80	\$ 239
Basic Compiler	249

NORTHWEST ANALYTICAL	
*Statpak	\$ 365

OASIS	
The Word Plus	\$ 103
Punctuation and Style ..	90

ORGANIC SOFTWARE	
*Datebook	\$ 229
*Milestone	229

PICKLES & TROUT	
CP/M for TRS-II	\$ 180

PRO/TEM SOFTWARE	
*Footnote	\$ 105

REVASCO	
Z80 Disassembler	\$ 85

SORCIM	
*Supercalc III	\$ 249
Superwriter (w/Speller & Mailer) ..	169

Basic-8086	225
C Cross Assembler ..	400
*ScratchPad	187
T MAKER III	215

IBM/PC

Please see CP/M listing. All products with a * in front are also made for PC/DOS and are priced the same unless otherwise specified.

ALPHA SOFTWARE	
Data Base Mgr. II	\$ 179
Mailing List	72
Executive Pkg.	105
Type Faces	79
Question	35
Apple-IBM Connection ..	189

CENTRAL POINT	
Copy II PC	\$ 34

CONTINENTAL	
Home Accountant	\$ 89

Ctek	
PC Calculator	\$ 29
Prog. PC Calculator ..	49
Prog. PC Calculator w/ Fin. Mod.	55

DIGITAL RESEARCH	
Concurrent CP/M 86 ..	\$ 225
CP/M-86	39
Cobal 86	499
Pascal MT + 86 CP/M 86 w/SPP	375
SPP 86	130
C Basic 86	135
Pascal MT+ (PC/DOS) ..	385
DR Logo	109

DOW JONES	
Market Analyzer	\$ 245
Market Manager	219

ECO-SOFT	
Microstat	\$ Call

FINANCIER	
Tax Series	105
Financier II	\$ 129

FYI	
Superfile	\$ 139
FYI 3000	287

GRAPHIC SOFTWARE	
Super Chartman II	\$ 299
Super Chartman IV	199
Bath (above)	350

LIFETREE	
Walkwriter Deluxe	\$ 179

PEACHTREE	
Please see listing under CP/M	
PeachText 5000	\$ 215

PEARLSOFT	
Personal Pearl Acct'g (GL, AP, AR, P, INV) ..	\$ 650

STAR SOFTWARE SYSTEMS ACCOUNTING PARTNER

Easy to use menu-driven programs for the beginner that can be linked with a sophisticated system as needed.
Your "Partner" includes: general ledger, accounts receivable, accounts payable and payroll. Also included for a nominal fee is an "800" number for access to the Star Question Center Back-Up Support Unit.

Fortran 80	330
Cobal 80	449
Macro 80	130
MuMath/MuSimp	179
MuLisp/MuStar	155
*Multiplan	165

MICROSTUF	
*Crasstalk	\$ 109

STAR SOFTWARE SYSTEMS	
*Legal Time, Billing	845
Property Mgmt.	845
*Acct' Partner	299

SUPERSOFT	
*Diagnostic II	\$ 89
Disk Doctor	74
*Fortran 4	299

FORMATS AVAILABLE

All prices below are for B' standard. Other formats are available. Some formats subject to "Download" fee and require minimum 2 weeks for delivery. Please inquire.

SUPERSOFT	
C Compiler - 8086 ...	\$ 350
Star Edit	180
Disk Edit	75
Basic Compiler	225
Fartron IV PC/DOS	
or 8086	299
8087 Support	40
Diagnostics II	89
Scratch Pad	187
SYSTEMS PLUS	
Landlord (prop mgmt) \$	375
Runtime Basic	
(req'd for above)	45
... and many more!	

We offer the following complete systems w/ full support on our technical line.*

Franklin 1000 & 2000
 NEC APC & 8800
 Corona
 Columbia
 Televideo
 Hyperion

APPLE/ FRANKLIN BOARDS

ALS CP/M Card	\$ 299
ALS Smarterm	249
ALS 2-Card II	129
ABT Keyboard	99
Axlon Ramdisk 128K	299
Bit 3 Dual Comm-plus	209
CCS 7710 Async Serial	119
Central Point Alaska	Coll
East Side Wild Card	Coll
Microsoft 16K Romcard	69
Microsoft Softcard	219
Microsoft Softcard +	419
Microsoft Premium Softcard (IIE)	335
Microtek Printer I/F	75
Microtek Dumping-16	195
Microtek Dumping-GX	119
Mountain A-D/D-A	279
Mountain Music System w/Software	299
PCP 4 MHz Appli-Card + 88 Card	599
PCP 88 Card 16 Bit + 64K	475
Prometheus Versacord	159
Prometheus Graphiti Cord	99
SSM ASIO Serial I/F w/cable	129
SSM AIO-2 Serial/Parallel	179
Street Echo II Speech Synthesizer I/F	129

Tymac Parallel I/F w/cable	79
Videx Display Enhancer	99
Videx Display Enhancer II	109
Videx Func. Strip	59
Videx Videoterm VT-600	235
Videx Ultraterm	259
Wesper 16K Rom Card	69

IBM/PC BOARDS

AST RESEARCH	
ComboPlus 64K Clock/Calendar, Serial & Parallel, I/F, Expandable to 256K	\$ 279
MegaPlus 64K, Clock/Calendar, Serial Port, Expandable to 512K w/Megapak	269
Extra parts available for Megaplus and I/O Plus II includes Game, Parallel & Serial	40
Megapak 256K upgrade for Megaplus	\$ Coll
I/O Plus II Clock/Calendar and Serial Port	115
LNW Products	\$ Coll

DISPLAY CARDS CORNER

Hercules Graphics Board	\$ 359
Orchid Monochrome Graphics Adapter	360
Plantronics Colorplus	389
USI Display Card (color/monochrome)	\$ Coll
Amdex MAI Card	\$ Coll
Tecmar Graphic Master	\$ Coll

MAYNARD ELECTRONICS

Floppy Drive Controller	\$ 155
Floppy Drive Controller w/Parallel Port	209
w/Serial Port	219
Sandstar Mem. Card - 3 modules cap.	194
Sandstar Multifunction Card - 6 modules cap.	93
Sandstar Modules	\$ Coll

QUADRAM

Quadboard 64K, Clock/Calendar, Serial & Parallel Ports, Software	\$ 279
Microfozer Stack Printer Buffer (expandable to 512K)	
▶ Parallel/Parallel BK	132
▶ Parallel/Parallel 64K	188
▶ Serial/Parallel BK	170
▶ Serial/Serial BK	170

Quadlink 64K Memory, Game Part allows Apple Software to run on IBM/WPC	\$ Coll
Tecmar Products	\$ Coll

XEDEX/MICROLOG

Baby Blue	\$ 425
-----------------	--------

TALL TREE	
512K JRAM Memory Board	\$ 699

MONITORS

Amdex Video 300A	
Amber	\$ 149
Amdex RGB Color II+	Coll
NEC 12" Hi-Res Green	169
Sanya 12" Hi-Res Green	199
USI Hi-Res 12" Amber	159
NEC JB-1260 Green	119
PGS RGB Color	\$ Coll
NEC JC-1216 RGB	435
Panasonic Monitors	
Taxan 12" Amber	142
Taxan 12" Green	132
Taxan 12" Low RGB	323
Taxan 12" High RGB	459
Taxan RGB Cable for PC	17

SONY

Profeel 12"	\$ Coll
Profeel 19"	\$ Coll
Profeel 25"	\$ Coll

MODEMS

Hayes Smartmodem	
300	\$ 205
Hayes Smartmodem 1200	495
Hayes Chronograph	189
Navatan	
212 Auto-Cal	565

US Robotics Auto-Dial	
(full auto 300/1200) ..	459
US Robotics Auto-Link	
(auto-answer 300/1200) ..	410
US Robotics Password	
.....	379

DISK DRIVES

Tandon TM-55-2	\$ 255
Tandon TM-100-2	239
Davong DSI-501 Hard \$	Coll
Davong DSI-512 Hard \$	Coll
Davong DSI-519 Hard \$	Coll
Corona 5 MB Hard	
w/ Controller	1,395
Corona 10 MB Hard	
w/ Controller	1,795
CDC 1800	249
Carvus	\$ Coll
Tall Grass	\$ Coll

PRINTERS

Anadex	
C. Itah Starwriter	\$1,149
C. Itah Prowriter 8510 ..	Coll
C. Itah Prowriter 1550 ..	689
NEC 3550	\$ Coll
NEC 8023A	\$ 389
NEC 2031	\$ Coll
Okidata	
Microline 82A	\$ Coll
Microline 83A	\$ Coll
Microline 92	\$ Coll
IDS/Data Products	
Prism 80 (w/4 options) ..	1,399
IDS/Data Products	
Prism 132 (w/4 options) ..	1,547
IDS/Data Products	
MicroPrism	399
Siemens	
Ink Jet Printers	\$ Coll
Silver Reed	
Doisy Wheel	\$ Coll
Star Micronics	
Gemini 10X	319
Star Micronics	
Gemini 15X	\$ Coll
GE Printers	\$ Coll
Epson FX-80	599
Transtar T-130-P	699
Transtar T-315P Color ..	519
Transtar T120P	475
Mannesmann Tally	
MT 180L	\$ Coll
MT 160L	595
Spirit	\$ Coll
... and much more.	

DISKETTES

3M 5" DS, DD, Box ...	\$ 40
Maxell 5" DS, DD, MD2, Box	40
Verbatim 5" DS, DD, Box ..	35
Ultra Magnetics 5" DS, DD, Bonus Box (12 Diskettes)	35
(3 Boxes Minimum)	

PLOTTERS

Enter P100 Sweet P Apple/Franklin, IBM/PC	\$ Coll
Strobe M100 Plotter w/ I/F Apple/Franklin ..	499
Strobe M100 Plotter (RS 232)	499
Panasonic Digital Plotter	\$ Coll

MISC.

Alpha-Delta "MACC"	
Surge Protector	\$ 69
Chalk Board	\$ Coll
Koala Technologies	
Graphic Tablet	\$ 95
Symtec Light Pen	
IBM/PC	140
Symtec Light Pen	
Apple/Franklin	200
TG Joystick IBM/PC	49
TG Joystick	
Apple/Franklin	46
Versa VersaWriter	
Tablet IBM/PC	235
Apple/Franklin	59
Wico Analog Joystick ..	18
Wico Apple Adapter ..	\$ Coll
Wico IBM/PC I/F Card ..	\$ Coll
Keytronic Keyboard	
IBM/PC	\$ Coll
Keytronic Keyboard	
Apple/Franklin	249
Curtis PC Products	\$ Coll
Seattle Computer	
8087 Package	\$ 299
CP/M is a registered trademark of Digital Research. IBM and the IBM logo are registered trademarks of International Business Machines. Apple and the Apple logo are registered trademarks of the Apple Computer Company. Franklin and the Franklin logo are trademarks of the Franklin Computer Company.	

Please:

- ▶ Wisconsin residents add 5% for sales tax.
- ▶ Add \$3.50 for shipping per software and light items. For multiple and other items, call.
- ▶ Foreign — add 15% handling & shipping for prepayment. (Int'l money order.)
- ▶ Prices are subject to change without notice.
- ▶ All items subject to availability.

Store prices are strictly retail.

ORYX SYSTEMS, INC.

CRAFTSMEN OF THE NEW TECHNOLOGY

425 First Street
 P.O. Box 1961
 Wausau, WI 54401

*For technical assistance, order status and in Wisconsin:
 715-848-1374

Int'l Telex: 260181
 ORYX SYS WAU

We welcome:

- ▶ COD (Add \$2.00 per shipment. Cash or certified check required.)
- ▶ Visa, MasterCard & American Express. (Add 4%.)
- ▶ Checks. (Allow 1-2 weeks for clearing.)

Working Hours:

Mon.-Thurs. 8:30-5:30 • Fri. 8:30-6:30
 Sat. 10:00-2:00 • Central Time

ORDER TOLL FREE OUTSIDE WISCONSIN 1-800-826-1589



A Closer Look at the IBM PCjr

Comparing the PCjr to the PC and evaluating its performance and expandability

by G. Michael Vose and Richard S. Shuford

IBM finally starts shipping PCjrs to customers this month. As IBM dealers try to cope with an avalanche of initial orders, many questions remain about the machine's design, its operation, and its future in the volatile microcomputer market.

BYTE recently took a closer look at

the PCjr. Our examination focused on the new machine's performance as compared to the IBM Personal Computer (PC); we also examined its expandability, compatibility with its big brother, and graphics capabilities. Our report reveals a few surprises (see the accompanying text box,

"Benchmarking the PCjr," on page 324.)

The debut of IBM's home computer on November 1, 1983, provoked a cool media reception and a simultaneous outpouring of enthusiastic praise from personal computer market researchers. The microcomputer man on the street was glad to see the cat-and-mouse game between the media and Big Blue come to an end, quelling the hysteria to be the first to get the story, which is a distinction few people recognize. Besides, it had become clear that nobody would get the story until IBM wanted it released.

The media's reaction to the low-key presentation of the product, made at IBM's Gallery of Art and Science in New York, was lukewarm in part because the scribes viewed the PCjr, based on Intel's 8088 microprocessor, as being woefully short on state-of-the-art technology. What many of the press pundits failed to appreciate was that the PCjr, as the following pages demonstrate, is a product designed to do for the home market what the PC did for the business market—provide a solid, well-conceived, and well-designed machine backed by the world's largest computer company.

The press also seemed predisposed to criticize the PCjr in order to vent



Photo 1: The IBM PCjr.

the frustration built up during the months before the announcement by Big Blue's careful manipulation of information-gatherers to keep everyone off the track.

The market-research crowd crowed about the new machine, seeing it as the proverbial goose of golden-egg fame. The industry-watchers' only questions were, "Why are there no shipments before Christmas?" and "When will all of Big Blue's competitors file for Chapter 11?"

In the midst of this post-announcement media blitz, BYTE visited IBM's public relations office in Delray Beach, Florida, to get to know the PCjr.

A Description of the PCjr

The PCjr, billed by IBM as "the company's most affordable personal computer," is a repackaged, slightly redesigned IBM PC. (See "IBM Announces the PCjr," by Rich Malloy, December 1983 BYTE, page 358.) It comes in two versions, one with 64K bytes of memory that uses cartridge-based software, and the other with 128K bytes of memory and one double-density, double-sided disk drive with a capacity of 360K bytes. Major options include a thermal printer, joysticks, and a plug-in modem card. Table 1 shows the software products created especially for the PCjr, and table 2 lists a variety of IBM PC packages and their compatibility with the PCjr.

The PCjr comes in three separate pieces: keyboard, system unit, and power transformer. The transformer connects to a rear-mounted jack on the system unit and to a standard 110-volt, 60-Hz electrical outlet. The transformer drives a 33-watt, three-voltage-level, two-stage power supply.

The motherboard contains an Intel 8088 microprocessor running at 4.77 MHz. A power-on self-test routine, cassette BASIC interpreter and operating system, I/O (input/output) drivers, and a disk bootstrap loader are provided by 64K bytes of ROM (read-only memory). RAM (random-access read/write memory) consists of eight dynamic 64K by 1-bit chips with a 150-nanosecond access time.

Software Product	Price
Monster Math	\$30
Animation Creation	\$40
Mouser	\$35
Scubaventure	\$35
Homeword*	\$75
Crossfire	\$35
Mine Shaft	\$35
Bumble Games*	\$40
Juggles' Butterfly*	\$35
Bumble Plot*	\$40
Personal Communications Manager	\$100
IBM PCjr BASIC (cartridge)	\$75
Turtle Power	\$50
Fixed Disk Organizer	\$50
Adventures in Math	\$35
DOS 2.10	\$65
Home Budget, jr	\$45
Casino Games 1.05	\$35
Strategy Games 1.05	\$30
Easywriter 1.15*	\$175
pfs:FILE 1.05*	\$140
pfs:REPORT 1.05*	\$125
Time Manager 1.05*	\$100
BASIC Program Development System 1.05	\$130

*Prices will vary at authorized IBM Personal Computer dealers.

Table 1: Software packages for the PCjr.

An expansion slot accepts a board providing an additional 64K bytes of RAM. The PCjr uses the Motorola MC6845 graphics display controller (see the section on graphics and display, page 326) and the Texas Instruments SN776486N three-voice sound chip (there is no internal speaker for this chip, but its output can be sent to an external speaker or to a TV speaker).

The machine includes a single serial port and interfaces for a joystick and a cassette recorder, along with dedicated expansion slots for an internal 300-bps (bits per second) modem and the disk controller. An optional parallel printer attachment connects to the right side of the system unit with four screws.

The only innovative technology employed in the PCjr is an infrared (IR) optical transmission link between the machine's keyboard and the system unit. (For additional information on IR technology, see "Use Infrared Communication for Remote Control," by Steve Ciarcia, April 1982 BYTE, page 40.) The IR link lets the keyboard be moved up to 20 feet from the system unit, as long as the keyboard remains in front of it. This optical-link technology is new to

microcomputers but has been used for years in remote controllers for television sets.

IBM adopted this technology because it perceives that a home computer, used primarily in settings that do not include a desk, needs a keyboard unencumbered by an umbilical link to the rest of the machine. The company apparently feels that a home environment demands a more mobile keyboard and that the trade-off of an occasional lost character won't matter much in this application. A keyboard cord is available for people who don't feel comfortable with the infrared link and for applications, such as a classroom, where multiple PCjrs are in use. Connection of this cord disables the IR link.

The keyboard contains a CMOS (complementary metal-oxide semiconductor) version of the Intel 8048 microprocessor to handle the interpretation of keystrokes and serial encoding of keystroke data for transmission by two infrared-emitting diodes. The system unit contains an infrared receiver and circuitry to demodulate the 40-kHz carrier signal from the keyboard and send it on to the central processing unit.

The keyboard, when used without

Program Name/Version	Operates on IBM PCjr	Comments	Requires DOS 2.10	Requires BASIC Cartridge
Adventure/1.00	yes	cannot set foreground and background colors	no	no
Adventure in Serenia/1.00	yes	colors may vary from IBM PC	no	no
Adventures in Math/1.00	yes		no	yes
Animation Creation/1.00	yes	will run on an IBM PCjr with 64K memory	no	no
APL (A Programming Language)/1.00	no		n.a.	n.a.
Arithmetic Games (Set 1)/1.00	yes	no color on composite monitor	yes	yes
Arithmetic Games (Set 2)/1.00	yes	no color on composite monitor	yes	yes
Asynchronous Communications Support/2.00	no		n.a.	n.a.
BASIC Compiler/1.00	yes	must have sufficient storage for Compile and Link	yes	no
BASIC Primer/1.00	no		n.a.	n.a.
BASIC Programming Development System/1.05	yes	not recommended for IBM PCjr; use same procedure to load DOS 2.10 as for DOS 2.00	yes	no
Binary Synchronous 3270 Emulation/1.00	no		n.a.	n.a.
BPI Accounting Software (all)	no		n.a.	n.a.
Bumble Games/1.00	yes		no	yes
Bumble Plot/1.00	yes		no	yes
Casino Games/1.05	yes		no	yes
COBOL Compiler/1.00	no	compiler output will run on IBM PCjr if there is sufficient storage	n.a.	n.a.
Decathlon/1.00	no		n.a.	n.a.
Diskette Librarian/1.00	yes		yes	yes
Dow Jones Reporter/1.00	yes		yes	yes
Easywriter/1.15	yes		yes	no
Fact Track/1.00	no		n.a.	n.a.
Filecommand/1.00	yes	use same procedure to load DOS 2.10 as for DOS 2.00	yes	no
Fixed Disk Organizer/1.00	no		n.a.	n.a.
FORTTRAN Compiler/1.00	no	compiler output will run on IBM PCjr if there is sufficient storage	n.a.	n.a.
Home Budget, jr/1.00	yes		yes	yes
Homeword/1.00	yes		no	no
Juggles' Butterfly/1.00	yes		no	yes
Learning DOS 2.00/1.00	no		n.a.	n.a.
Learning To Program in BASIC/1.00	no		n.a.	n.a.
Logo/1.00	yes		yes	no
Macro Assembler/1.00	yes		yes	no
Mailing List Manager/1.00	no		n.a.	n.a.
Monster Math/1.00	yes		no	yes
Multipian/1.10	yes		yes	no
Multiplication Tables/1.00	no		n.a.	n.a.
One-Hundred-and-One Monochrome Mazes/1.00	no		n.a.	n.a.
Pascal Compiler/1.00	no	compiler output will run on IBM PCjr if there is sufficient storage	n.a.	n.a.
Peachtext/1.00	yes	not recommended for IBM PCjr	yes	no
Peachtree Accounting Software (all)	no		n.a.	n.a.
Personal Communications Manager/1.00	yes		no	no
Personal Editor/1.00	yes		yes	no
pfs:FILE/1.05	yes		yes	no
pfs:REPORT/1.05	yes		yes	no
Private Tutor/1.00	no		n.a.	n.a.
Professional Editor/1.00	yes		yes	no
SNA 3270 Emulation/RJE Support/1.00	no		n.a.	n.a.
Strategy Games/1.05	yes		no	yes
3101 Emulation/1.00	no		n.a.	n.a.
Time Manager/1.05	yes		yes	no
Turtle Power/1.00	yes		no	no
Typing Tutor/1.00	no		n.a.	n.a.
UCSD p-System (all products)	no		n.a.	n.a.
Visicalc/1.20	yes		yes	no
Word Proof/1.00	yes		yes	no

Table 2: IBM PCjr software compatibility chart.

Hayes™

More micro software is written for Hayes than for any other modems!

Because Hayes, the telecomputing leader, continues to lead the way! With popular-selling modems that make telecomputing a breeze for beginners or professionals. And with sophisticated engineering that appeals to software developers.

Send for our free *Communications*

a hundred software programs written for Hayes modems by independent programmers. For diverse communication functions, from the practical to the fun. But all maximizing the advanced telecomputing capabilities of Hayes modems.

Whether you're collaborating on

in the field. Doing your gift shopping via computer. Or collecting and analyzing commodity or stock information. Let Hayes provide the superior communications link!

Mail the coupon today for your free copy of the Hayes Communications Directory. (Or pick one up at



ADVISOR

ELEGAMMON

Provides a comprehensive portfolio management system for active trader, money manager or investor.

Protects sensitive telephone lines so that no unauthorized person can decode files.

telephone lines for accessing international Telex network.

Aviation software simplifies planning and increases safety.

Automatically logs-on to networks, answers phone, saves incoming stored on disk, edited, and printed.

Transfers files between mainframes.

Automatically answers phone in your name; receives, delivers messages.

Allows users to play backgammon with players at distant locations.

Mail To: Hayes Microcomputer Products, Inc.
Attention: Marketing Services, 5923 Peachtree Industrial Blvd., Norcross, Georgia 30092.

Name _____

Address _____

City _____ State _____ Zip _____

- Please send additional information on:
- Smartmodem 300* **
 - Smartmodem 1200* **
 - Smartmodem 1200B* (plug-in board for IBM PC)
 - Micromodem IIe* (for Apple computers)



B-3

*FCC approved in U.S.A.
**DOC approved in Canada.
©1983 Hayes Microcomputer Products, Inc.

NOTE: More and more software is being written for Hayes modems everyday. Please let us know if you would like to have your program included in our next software directory.

Circle 416 on inquiry card.

the optional cord, is powered by four AA batteries. The keyboard is in a perpetual standby state until a key is pressed. Only then do the 80C48 processor and the IR transmitter draw power. As soon as the character data has been transmitted, the keyboard reenters the standby, power-down mode.

The 62 unmarked, carbon-contact/rubber-dome keybuttons return scan codes rather than ASCII (American National Standard Code for Information Interchange) codes. (See "Compatibility" on page 328.) These keys will stymie the efforts of a touch-typist but will feel comfortable to children and novice computerists. We discovered a key-rollover problem when typing BASIC programs in. When three keys were pressed simultaneously, as is common with fast touch-typists, releasing the first two keys caused the machine to display the first and third characters; the second letter was lost.

The IR transmission link is susceptible to interference from very bright light, including sunlight, and high-voltage sources, including some television sets. The system unit issues loud beeps when there is high-energy interference affecting the unit; during our tests of the PCjr in IBM's office building in Delray Beach, these beeps were frequent enough to be annoying.

The absence of markings on the keybuttons requires a keyboard overlay for key labeling. The standard, attached overlay is color-coded and attractive but forces you to tilt the keyboard slightly forward to see the legends. An alternative would be to hunch forward to look down on the keyboard from a position above and perpendicular to it. Virtually everything about the keyboard, from the square, rubber-topped keybuttons to the overlay, and even the IR link, guarantees a vigorous after-market in keyboard replacements for the PCjr.

The System Software

The base model of the PCjr comes with cassette BASIC in ROM. An enhanced version of BASIC, called Cartridge BASIC, is available for \$75. This version of BASIC is comparable to the

Benchmarking the PCjr

To evaluate the PCjr's performance, we ran a set of standard BYTE benchmark programs. These benchmarks were developed over the past two years and were used to evaluate the IBM PC (see "A Closer Look at the IBM PC," by Gregg Williams, January 1982 BYTE, page 36), the Victor 9000 (see "Victor Victorious: The Victor 9000 Computer," by Phil Lemmons, November 1982 BYTE, page 216) and numerous other popular microcomputers.

The PCjr we benchmarked contained the full 128K bytes of RAM and the color display adapter. The monitor used was the IBM Color Monitor. The test machine was "fully loaded" with optional peripherals.

Listing 1 shows BASIC benchmark programs developed by Richard Willis; the results are summarized in table c on the next page. The listings for the benchmarks summarized in table a can be found in the articles cited above. The Visicalc and Wordstar benchmarks consisted of: (1) a recalculation of a small spreadsheet containing two columns of numbers, six digits in one, seven in the other; (2) reading a large text file into memory, moving a page forward and back, and rewriting the file after making an editing change.

The three tables (a, b, and c) on the next page summarize the results of these benchmarks.

The Results

The PCjr executes BASIC programs from 24 percent to 32 percent slower than the PC. Because the BASIC interpreter in the two machines is fundamentally the same, this speed degradation is due to the screen update lag created by the PCjr's use of RAM for video buffering. Using main memory rather than a separate 16K bytes of RAM on the monochrome or color adapter display boards, as is the case with the PC, places the microprocessor in a wait state as often as two out of every three clock cycles while the screen updates. (See the section on graphics and display in the main text, page 326.)

The disk read/write operations in BASIC, not involving any significant

Listing 1: A benchmark program by Richard Willis. Results for these benchmarks are summarized in table c.

```

10 *          *****
20 *  WRITE-TO-SCREEN
30 * (FIXED # OF DIGITS)
40 *
50 WIDTH 80
60 SCREEN 0
70 DEFINT I,J
80 J=12345
90 TO=TIMER
100 FOR I=1 TO 1000
110 PRINT J
120 NEXT I
130 T1=TIMER
140 TDIF=T1-T0
150 LPRINT USING "###.### SECONDS";TDIF
160 RETURN
170 *  BENCHMARK ROUTINE
180 *          *****
190 *  WRITE-TO-SCREEN
200 * (VARIABLE # OF DIGITS)
210 *
220 WIDTH 80
230 SCREEN 0
240 DEFINT I,J
250 J=12345
260 TO=TIMER
270 FOR I=1 TO 1000
280 PRINT I
290 NEXT I
300 T1=TIMER
310 TDIF=T1-T0
320 LPRINT USING "###.### SECONDS";TDIF
330 RETURN
340 *  BENCHMARK ROUTINE
350 *          *****
360 *  SCREEN 1 GRAPHICS
370 *
380 CLS
390 SCREEN 1
400 DEFINT I
410 TO=TIMER
420 FOR I=0 TO 319
430 LINE (I,0)-(319-I,199),I MOD 2
440 NEXT I
450 FOR I=0 TO 199
460 LINE (0,I)-(319,199-I),I MOD 2
470 NEXT I
480 T1=TIMER
490 TDIF=T1-T0
500 LPRINT USING "###.### SECONDS";TDIF
510 RETURN
520 *  BENCHMARK ROUTINE
530 *          *****
540 *  SCREEN 2 GRAPHICS
550 *
560 CLS
570 SCREEN 2
580 DEFINT I
590 TO=TIMER
600 FOR I=0 TO 639
610 LINE (I,0)-(639-I,199),I MOD 2
620 NEXT I
630 FOR I=0 TO 199
640 LINE (0,I)-(639,199-I),I MOD 2
650 NEXT I
660 T1=TIMER
670 TDIF=T1-T0
680 LPRINT USING "###.### SECONDS";TDIF
690 RETURN
700 *  BENCHMARK ROUTINE

```

screen updates, demonstrate a 15 percent to 24 percent slower execution time for disk reads and writes. The PCjr does not use direct memory access (DMA); the PC does. The use of DMA is largely responsible for the PC's outstanding performance in disk

familiar IBM Advanced BASIC (BASICA), with some additional enhancements for graphics and sound and support for light pens and joysticks. The Cartridge BASIC is required to obtain disk BASIC file

I/O functions.

PCjrs equipped with a disk drive use the \$65 IBM PC-DOS 2.1 operating system, an upgrade of the earlier PC-DOS series. (BYTE will assess the modifications to this operating sys-

(a)

```

710 *          *****
720 *      BUBBLE SORT
730 *
740 DEFINT A,B,F,I
750 DIM A(50)
760 FOR I=1 TO 50
770 A(I)=51-I
780 NEXT I
790 T0=TIMER
800 F=0
810 FOR I=1 TO 49
820 IF A(I)=A(I+1) THEN 870
830 B=A(I)
840 A(I)=A(I+1)
850 A(I+1)=B
860 F=1
870 NEXT I
880 IF F=0 THEN 900
890 GOTO 800
900 T1=TIMER
910 TDIF=T1-T0
920 LPRINT USING "###.### SECONDS";TDIF
930 RETURN
940 * BENCHMARK ROUTINE
950 *          *****
960 * TEXT MANIPULATION
970 *
980 DEFINT I,J,K
990 DIM A$(1120)
1000 DIM B$(7)
1010 DIM C$(560)
1020 T0=TIMER
1030 FOR J=0 TO 4
1040 FOR I=1 TO 224
1050 K=(256*J+I+31) MOD 256
1060 A$(224*J+I)=CHR$(K)
1070 NEXT I
1080 NEXT J
1090 FOR J=1 TO 7
1100 B$(J)=" "
1110 FOR I=1 TO 80
1120 B$(J)=B$(J)+A$(80*(J-1)+I)
1130 NEXT I
1140 NEXT J
1150 CLS
1160 FOR J=1 TO 7
1170 PRINT B$(J);
1180 NEXT J
1190 PRINT
1200 FOR I=1 TO 560
1210 C$(I)=A$(1121-I)
1220 IF ASC(C$(I))65 THEN 1250
1230 IF ASC(C$(I))90 THEN 1250
1240 GOTO 1260
1250 C$(I)=CHR$(176)
1260 NEXT I
1270 FOR J=1 TO 7
1280 B$(J)=" "
1290 FOR I=1 TO 80
1300 B$(J)=B$(J)+C$(80*(J-1)+I)
1310 NEXT I
1320 NEXT J
1330 FOR J=1 TO 7
1340 PRINT B$(J);
1350 NEXT J
1360 T1=TIMER
1370 TDIF=T1-T0
1380 LPRINT USING "###.### SECONDS";TDIF
1390 RETURN

```

operations. The PCjr's performance in the absence of DMA is a testament to the efficiency of the disk routines in PC-DOS 2.1 and the hardware design of the slim-line drives.

Benchmark	IBM PC Time	PCjr Time	Ratio	4-MHz Z80 MBASIC 4.51 Time
empty loop	6.43	8.51	1.32	5.81
division	23.8	30.2	1.27	24.9
subroutine	12.4	16.0	1.30	9.4
MID\$ search	23.0	29.6	1.29	18.6
sieve	190	236	1.24	151
disk (read)	31.9	28.7*	39.5	1.24
disk (write)	28.5	29.6*	32.6	1.15

* PC-DOS 2.0

Benchmarks for the PCjr against the PC and an 8-bit microcomputer: a 4-MHz Z80 running MBASIC 4.51. The ratio compares PCjr and PC performance. All times (in seconds) and ratios are valid to three significant digits.

(b)

Benchmark	IBM PC Time	PCjr Time	Ratio
Visicalc	1.59	3.68	2.31
Wordstar 3.24 (read)	11.9	8.12	0.68
(write)	30.2	35.0	1.16
page forward	2.18	4.42	2.02
page back	2.24	4.46	2.04

Benchmarks comparing execution times for a Visicalc spreadsheet recalculation, Wordstar read/write operations, and page forward/back maneuvers in Wordstar using double-spaced text.

(c)

Benchmark	IBM PC Time	PCjr Time	Ratio
write screen (fixed)	50.2	41.8	0.83
write screen (variable)	48.9	37.8	0.77
medium-resolution graphics	23.7	31.8	1.34
high-resolution graphics	54.5	73.7	1.35
bubble sort	25.9	32.4	1.25
text manipulation	32.7	40.3	1.23

Benchmarks of a variety of tasks, as shown in listing 1.

tem in a future Technical Forum.) This operating system is designed for the entire IBM PC family of computers (referred to at the fall COMDEX technical presentations as consisting of the PC, PC XT, and PCjr

only). PC-DOS 2.1 consumes 24,688 bytes of memory, compared to 24,576 for version 2.0.

Although the PC and the PC XT will run PC-DOS version 2.1 as well as versions 1.0, 1.1, and 2.0, the PCjr

requires version 2.1. This requirement derives from new disk-interface routines dictated by the disk-drive hardware used in the PCjr. PC-DOS versions other than 2.1 may boot and run in the PCjr, according to IBM

dealer literature, but the company will guarantee data integrity with version 2.1 only. Our attempts to boot version 2.0 were unsuccessful.

The MODE command in PC-DOS 2.1 enables the alteration of the monitor's screen display in machines equipped with the 64K-byte Memory and Display Expansion board. The PCjr uses a 40-column display as a default because it is designed to be used with television sets, but the display format can be altered to display 80 columns with the DOS (disk operating system) command MODE 80.

The PC-DOS 2.1 system disk contains the files BASIC.COM and BASICA.COM. These files are the standard IBM PC disk and Advanced BASICs, respectively. They are for use only by the PC and the PC XT, however. The PCjr, whether using ROM or Cartridge BASIC, does not load or access these files. Commands to invoke BASIC are trapped and vectored directly to motherboard ROM or the cartridge vector address, as appropriate. For disk BASIC programming, 59,604 bytes of RAM (in a 128K-byte PCjr) are therefore available to the user.

Graphics and Display

There is no expansion slot in the PCjr dedicated to a video-display adapter card, and with good reason: the video circuitry is built into the motherboard circuitry. Using the Motorola MC6845 for most of its functions, the video-graphics subsystem makes available several modes of operation that will be familiar to users of the PC's color/graphics adapter. But a new wrinkle has been added—a video gate array (VGA), the proprietary LSI5220 chip. The gate array makes possible two new high-bandwidth video-graphics modes that provide more colors at higher resolutions than were possible on the standard PC. There is also a new low-bandwidth graphics mode (see table 3). The PCjr can switch display modes without clearing the video buffer, enabling some new kinds of display manipulation.

The VGA provides a color-selection palette and separate selection of background (frame) color. A program

Mode	Number of Colors	Compatible with Color/Graphics Adapter	Requires 64K-byte Memory and Display Expansion Board	Buffer Size (Bytes)
40-column alphanumeric	16	yes	no	2K
160 by 200	16	no	no	16K
320 by 200	4	yes	no	16K
640 by 200	2	yes	no	16K
80-column alphanumeric	16	yes	yes	4K
320 by 200	16	no	yes	32K
640 by 200	4	no	yes	32K

Table 3: PCjr video modes.

can change the screen-display colors caused by a given set of display data merely by changing the values in the palette registers. Sixteen colors are available in the palette; in modes that use fewer colors, any combination can be chosen for display. Black-and-white display modes use a full gray scale.

The big difference from the PC's video architecture is that part of the main system memory must be used to contain the video-display data, thus the 8088 processor must share memory space and memory-access time. At least 16K bytes of memory must always be reserved for the display buffer, though only 2K bytes are used for a 40-column alphanumeric display, and the two high-bandwidth graphics modes require a 32K-byte buffer.

The designers of the PCjr did provide a measure of compatibility in display addressing; in early reports on the PCjr, this point was sometimes lost. In the big PC, the color/graphics display buffer, although separate from the main memory, is mapped into the 8088 processor's address space beginning at location hexadecimal B8000. The PCjr contains special address-mapping circuitry that traps memory references made by the 8088 to addresses in that region and redirects them into the low-range addresses of main memory where the PCjr's display data is kept, using a processor page register as an index. Consequently, some programs that bypass the operating-system display routines will run unmodified on the PCjr.

Because the main memory is shared, the processor and video-dis-

play circuitry must access it at different times. The 8088 can read or write memory during only one of every three memory clock cycles. Display refreshing takes place during the other two cycles. In the unexpanded PCjr, the first refresh memory cycle fetches a byte that contains the ASCII value of the character to be displayed via an 8-bit data path; the second refresh cycle fetches the display attribute of the character. But when the 64K-byte Memory and Display Expansion board is plugged into the PCjr, the memory addressing is reconfigured so that even-addressed bytes reside on the motherboard and odd bytes on the expansion card. During both refresh cycles, 16 bits of character and attribute data are fetched via a 16-bit data path, doubling the bandwidth of the display. The denser graphics modes and the 80-column alphanumeric mode require the greater bandwidth. In either case, the 8088 can get to memory every third memory cycle, or approximately every 1.1 microseconds.

All of this gives rise to a limitation of the PCjr: the unexpanded 64K-byte system cannot use several of the video modes; in fact, text display is restricted to 40 columns in the minimal unit.

The PCjr does not contain any circuitry to emulate the functions of the PC's monochrome display adapter, so the IBM Monochrome Display cannot be used with the PCjr. The IBM Color Display with its RGBI (separate red, green, blue, intensity) inputs works fine, but at \$680 it's rather expensive for use with a computer that has a base price of \$669. A radio-frequency modulator for using the

LOTUS

123™

Lotus 1 2 3™ and Dataproducts P Series color printer are the best combination for any business assignment.

Everyone's talking about the best software package on the market, the Lotus 1 2 3. Dataproducts wants you to go one step further with their P Series color printer.

The versatile P Series translates the wealth of information generated by the Lotus 1 2 3 into brilliant full color charts, graphs and text.

It delivers a full page of text quality print in nothing flat while its sheet feeder automatically prevents loading hassles. And the P Series uses pin feed or plain paper and has the brains to fill every

appropriate line with crisp, sharp copy, even if it has to justify to do it. And the P Series color printer has dual speed capability for correspondence quality output for word processing applications, and high speed output for draft or spreadsheets.

The Dataproducts P Series color printer. And the Lotus 1 2 3. There's no better combination on the market. For more information go 1234 to your nearest computer store and ask about our P Series color printer, or call Dataproducts, 1-800-258-1386.

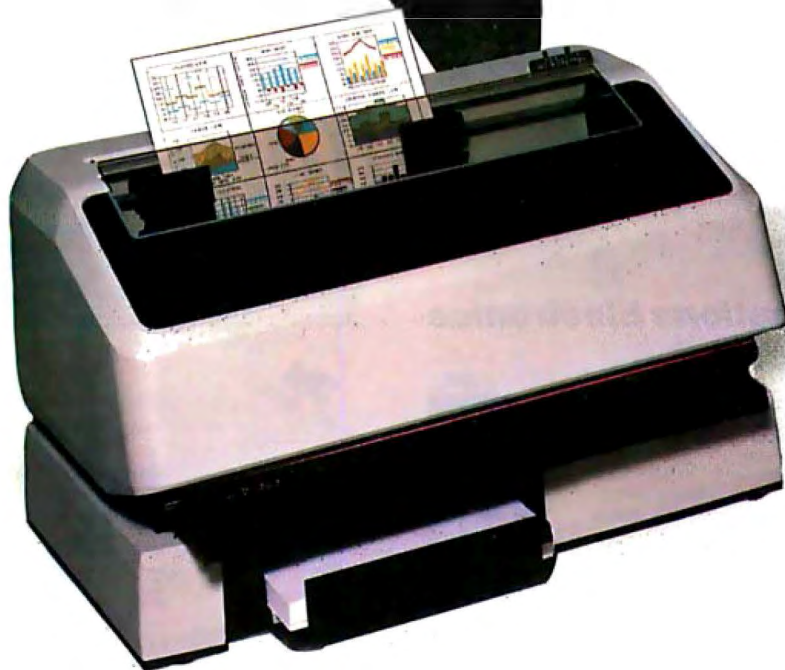

Dataproducts computer printers

Nobody puts ideas on paper so many ways.

1-2-3 and Lotus are trademarks of Lotus Development Corporation

computer with a TV is built in, but the cable to connect it costs \$30. (And you wouldn't want to try viewing 80-column text on a TV.) You can also use a composite-video monitor. Like most of the PCjr's connections to external equipment, the cables plug into Berg-type pin connectors.

Compatibility

One of IBM's design goals for the PCjr was a certain amount of compatibility with its bigger siblings, the PC and the PC XT. As we have seen with the redirection of video-display addresses, the engineers took some effort to achieve this. Yet the PCjr is not 100-percent compatible with the other PCs. The contents of the ROM are certainly different, and there are certain hardware differences.

The incompatibilities between the members of the IBM PC family can be isolated into three categories: timing dependencies, unequal configurations, and actual hardware differences. Sources of incompatibility include the PCjr's smaller amount of memory, the lack of DMA (direct

memory access) data transfers in the PCjr, different hardware addresses for the disk controller, and out-of-sync timing from the slower execution speed.

Even if there are no known sources of incompatibility, you can't be sure that a given program will run unless you try it. While visiting in Delray Beach, we tried to run a few pieces of IBM PC software we happened to have on hand.

Word processing proved to be a trove of success. Three popular programs—Sorcim's Superwriter (version 1.01), Mark of the Unicorn's Finalword (version 1.1), and Micro-pro's Wordstar (version 3.24)—seemed to run fine, although we didn't have time to exhaustively test every function. (We didn't have a copy of version 3.3 of Wordstar with us, so we don't know if the new program's direct screen accesses are compatible or not.) Jim Button's popular Freeware data-storage program, PC-File (version 8.6), also ran just fine, even though it had been compiled from BASIC under PC-DOS 1.1. But

our string of successes ended when we tried Orion Software's J-Bird arcade game. Somehow the graphics display was hopelessly scrambled.

As IBM's technical staff emphasized during a seminar at COMDEX, the safest route for software compatibility is through use of the disk operating system. If relied upon for all services, the latest version of PC-DOS, 2.1, can shield application programs from the hardware differences. It remains to be seen if IBM's DOS software will provide support for all the functions that programmers need to write state-of-the-art code—support like that provided by Microsoft's Windows environment.

The PCjr keyboard is a good example of how the DOS shields programs from hardware differences. The keyboard has only 62 keys, as the DOS BIOS (basic input/output system) contains a routine to translate the scan codes to the same ones

Diskette Users...

When you've heard from all the animals in the diskette zoo, but you need fast delivery and high quality diskettes...



Call Communications Electronics

Diskette order desk
800-521-4414
In Canada 800-265-4828



CE... your best source for diskettes
For you the diskette buyer, it's a jungle out there. There are so many different brands to choose from, you need to go on an safari to find a good brand at a reasonable cost. Fortunately, CE has already hunted for the best diskettes and offers you an excellent choice at a CE price. To save you even more, CE also offers bulk product where 100 diskettes are packaged in the same box without envelopes or labels. Since we save packaging costs, these savings are passed on to you. Diskette envelopes are also available from CE.

Other Useful Computer Accessories
When the responsibility is on you to buy, the concern you also do is to get the best value for your money. Each item comes with the best price guarantee. Each item comes with the best price guarantee. Each item comes with the best price guarantee. Each item comes with the best price guarantee. Each item comes with the best price guarantee.

Buy your diskettes from CE with confidence
To get the fastest delivery from CE of your computer products, we recommend you phone your order directly to our Computer Products Division and charge. We are a member of the IBM Business Partner Program. We offer the best price guarantee. We offer the best price guarantee. We offer the best price guarantee. We offer the best price guarantee.

Mail orders to Communications Electronics, Box 1002, Ann Arbor, Michigan 48106 U.S.A.
If you have a Visa or Master Card, you may call and place a credit card order. Order toll-free in the U.S. Dial 800-521-4414. In Canada, order toll-free by calling 800-265-4828. If you are outside the U.S. or in Michigan dial 313-973-8888. Telex anytime 810-223-2422. Order today.
Copyright 1983 Communications Electronics Ad #102783



Choose your brand
Choose your price

Product Description	Wabash Part #	CE Quant. 100 min (per disk \$)	Ultra Part #	CE Quant. 100 min (per disk \$)	3M Part #	CE Quant. 100 min (per disk \$)	Memorex Part #	CE Quant. 100 min (per disk \$)	Burroughs Part #	CE Quant. 100 min (per disk \$)	Dyan Part #	CE Quant. 100 min (per disk \$)
8" SSSD IBM Compatible 128K/5, 28 Sectors	F111	1.89	81720	1.89	88850	1.84	3088	1.84	FD-101	2.08	E	2.89
8" SSSD Shugart Compatible 32 Hard Sectors	F31A	1.89			88850-32	1.94		1.94	FD-108	2.08	E	2.89
8" SSSD IBM Compatible 128 B/S, 28 Sectors	F131	2.39			88900	2.28		2.28	FD-106	1.89		2.89
8" OSDD Soft Sector (Unformatted)	F14A	2.99				3.18		3.14	FD-109	3.29	809000	3.89
8" OSDD Soft Sector (28 B/S, 28 Sectors)	F144	2.99							FD-110	3.29		
8" OSDD Soft Sector (12 B/S, 18 Sectors)	F145	2.99							FD-111	3.29		
8" OSDD Soft Sector (1024 B/S, 8 Sectors)	F147	2.99	83708	1.19					FD-112	3.29		
5 1/4" SSSD Soft Sector w/Hub Ring	M11A	1.49	80209	1.79	8D	3.58	3194	3.58				
5 1/4" SSSD Same as above but bulk product	M11B	1.29	00153									
5 1/4" SSSD 10 Hard Sector w/Hub Ring	M11A	1.49	90010	1.39								
5 1/4" SSSD 16 Hard Sector w/Hub Ring	M11A	1.49	90015	1.79								
5 1/4" SSSD Soft Sector w/Hub Ring	M13A	1.79	81401	1.89	51	1.94	3481	1.94	89D-11	2.08	801187	
5 1/4" SSSD Same as above but bulk product	M13B	1.59	000	1.59								
5 1/4" SSSD Soft Sector Floppy (both sides)	M18A	2.89										
5 1/4" SSSD 10 Hard Sector w/Hub Ring	M43A	1.79	91410	1.89	58							
5 1/4" SSSD 16 Hard Sector w/Hub Ring	M44A	2.89	91418	1.69	59							
5 1/4" OSDD Soft Sector w/Hub Ring	M14A	2.89	82401	2.79	50							
5 1/4" OSDD Same as above, but bulk product	M14B	2.49	00140	2.49	5D							
5 1/4" OSDD 10 Hard Sector w/Hub Ring	M54A	2.89	82410	2.79	5D-05D-10RH	2.88						
5 1/4" OSDD 16 Hard Sector w/Hub Ring	M54A	2.89	82410	2.79	5D-05D-16RH	2.88						
5 1/4" SSSD Soft Sector w/Hub Ring (80 TP)	M19A	2.59	91801	2.59	5D-05D-8RH1	2.78						
5 1/4" OSDD Soft Sector w/Hub Ring (16 TP)	M19A	3.89	92601	3.89	5D-05D-8RH2	3.78						
5 1/4" Floppy Diskette for Apple/Lisa Computer	M19A	3.89	92601	3.89	5D-05D-16RH1	3.78						
					5D-05D-16RH2	3.78						
					5D-05D-32RH	4.34						
					5D-05D-64RH	4.34						
					SAPPLE FW	4.34						

For more information about this brand call:

For more info on Wabash call
800-323-9868
In Illinois 312-993-9365

Lifetime warranty call us at
For more info on Ultra call
408-728-7777
Monday-Friday 9 am-6 pm PT

Lifetime warranty
For more info on 3M call
800-328-9438
In Washington 812-732-8928

8 year warranty
For more info on Memorex call
800-538-8080
In California 800-877-3525

1 year warranty
For more info on Burroughs call
800-448-1422
Monday-Friday 9am-4pm ET

1 year warranty
For more info on Dyan call
800-552-2211
In California 406-70-6066

BASF QUALIMETRIC™ FLEXYDISKS® BUILT FOR ETERNITY - WARRANTED FOR A LIFETIME.

BASF Qualimetric FlexyDisks® offer you more...an extraordinary new lifetime warranty. The BASF Qualimetric standard is a dramatic new international standard of quality in magnetic media...insurance that your most vital information will be secure for tomorrow when you enter it on BASF FlexyDisks today.*

We can offer this warranty with complete confidence because the Qualimetric standard reflects a continuing BASF commitment to perfection...a process which begins with materials selection and inspection, and continues through coating, polishing, lubricating, testing, and 100% error-free certification. Built into our FlexyDisk jacket is a unique two-piece liner. This BASF feature traps damaging debris away from the media surface, and creates extra space in the head access area, insuring optimum media-to-head alignment. The result is a lifetime of outstanding performance.

When your information must be secure for the future, look for the distinctive BASF package with the Qualimetric seal. Call 800-343-4600 for the name of your nearest supplier.

Circle 39 on inquiry card.



ENTER TOMORROW ON BASF TODAY



BASF

used by the 83-key setup. In this way, you can emulate any keystroke combination from the big PC on the PCjr's keyboard. (You can even emulate the Num Lock key, which produces a less-than-useful working condition on a keyboard without a numeric keypad, as one of us found by accident during our examination of the PCjr.)

Expandability

IBM states publicly that there are no architectural limits to memory or disk-storage expansion of the PCjr. The *IBM PCjr Technical Reference Manual* confirms that a 512K-byte block of 8088 address space is reserved for future user RAM (see figure 1).

Additional electrical power will be needed, however, for any expansion of RAM or disk storage. No room exists within the system-unit chassis for memory above 128K bytes, nor for another disk drive; therefore, expansion requires the use of the 60-pin I/O expansion bus. The power available at the connector for the expansion bus is limited to 400 mA of +5V DC. Because disk drives require +12V DC, no power is available at the connector for floppy expansion unless an additional power supply is provided. Similarly, 400 mA of +5V DC could marginally power 64K bytes of additional RAM, but expansion beyond this limit also requires additional power.

It seems likely that significant expansion will dictate a separate box containing power supply, additional RAM up to a maximum of 512K bytes, and one or more floppy drives and/or a hard disk. Because the electronics and housing for this kind of expansion unit could cost from \$800 to \$2500, expanding the PCjr is costly.

Expanding the basic PCjr unit with IBM peripherals could drive the cost to \$2,073 for a system with 128K-byte RAM, disk drive, keyboard cord, thermal printer, joysticks, and carrying case. Other than cassette BASIC, there is no software bundled with the machine.

Conclusions

One surprise beneficiary of limitations in the PCjr's design will be the

BIOS/Diagnostic/Cassette Basic Program Area	FFFFF	} Cartridge Chip Selects
Standard Application Cartridge	F0000	
Standard Application Cartridge	E8000	
Reserved For Future Cartridge	E0000	
Reserved For Future Cartridge	D8000	
Reserved For Future Cartridge	D0000	
Reserved for I/O ROM	C0000	
Video RAM	B8000	
Reserved Future Video	A0000	
Reserved Future User RAM	20000	
Expansion RAM	10000	
Base RAM	00000	

Memory Map

Figure 1: The IBM PCjr memory map.

older generation of microcomputer-software vendors. Their products, largely derived from programs written for 8-bit computers, naturally work at their full capabilities in a relatively small memory space and with few system resources. It's the newer software houses—especially the ones whose products are "integrated" and therefore memory-hungry—that will gnash their teeth trying to figure out how to sell programs to owners of PCjrs.

Their molars may get relief, however, if the memory cavity enjoyed by the ROM cartridges can be filled. As much as 192K bytes of ROM could be addressed (with some ingenuity), enough perhaps to accommodate slimmed-down versions of some of the larger IBM PC packages. There are two other advantages to putting

application programs in ROM: they execute faster (read-only memory needs no delays for refreshing), and the single floppy-disk drive is freed from program-loading duties; it can be dedicated to holding the application's data files. But it will take time for ROM-cartridge versions of popular programs to be produced.

The PCjr may turn out to be "the hobbyist's IBM." Unstymied by features left out of the design and attracted by the low (for IBM) cost, hobbyists and experimenters could soon be happily running a "poor man's clone" with wire-wrapped accessories hanging off on every side: an interface for a better keyboard, outboard memory expansion, and a DMA-based controller for a second floppy-disk drive connected by clip-leads to a Navy-surplus power sup-



Reliable.

You can count on 3M diskettes. Day after day.

Just like the sun, you can rely on 3M diskettes every day. At 3M, reliability is built into every diskette. We've been in the computer media business for over 30 years. And we've never settled in. We're constantly improving and perfecting our product line, from computer tape and data cartridges to floppy disks.

3M diskettes are made at 3M. That way, we have complete control over the entire manufacturing process. And you can have complete confidence in the reliability of every 3M diskette you buy.

Look in the Yellow Pages under Computer Supplies and Parts for the 3M distributor nearest you. In Canada, write 3M Canada, Inc., London, Ontario. If it's worth remembering, it's worth 3M diskettes.



Circle 351 on inquiry card.

3M hears you...

3M

ply. Stimulus for ingenuity might turn out to be the biggest feature under the Peanut's shell.

The computer industry's rumor mill is still grinding with speculation that IBM will or will not support the PCjr, will or will not restrict production, will or will not produce upgrades for the machine. It's a popular pastime to be paranoid about IBM, but if the events surrounding the introduction of the PCjr are an indication, even the Blue Giant is finding it cannot absolutely control the volatile small-computer field.

The PCjr is appropriately designed for the home market. It is more affordable than the PC, yet it provides sufficient compatibility with its big brother to enable a worker to use a PC at the office and to work at home on the PCjr (with some limits) by simply transporting disks. In this context, the PCjr will seem awkward to use—the single floppy-disk drive will require much swapping of disks for format, copy, and backup operations, for example.

Although the PCjr is officially a

home computer, you can be sure that IBM will try to sell it to schools and colleges, where students will be more tolerant than business users of the keyboard and the limited memory and storage. IBM is making the Logo language available for the PCjr, a strong hint of its desire to sell to the education market. Furthermore, IBM's dialect of BASIC is superior to that available on the Apple II and Commodore computers used by many schools (although the Extended BASIC for the TRS-80 Color Computer is almost as good).

The PCjr will be costly to expand for additional memory or disk storage. The new, low-cost bubble memory or EEPROM (electrically erasable programmable ROM) chips might be an alternative to a second disk drive.

The PCjr performs well compared with low-cost machines like the Commodore VIC-20 and 64, but it is slower than the PC. It cannot be compared in cost with most of the competing home computers.

The software and hardware aftermarket for the PCjr will be vigorous.

Vendors have already announced keyboard replacements, and several are planning to make memory-expansion boards to compete with the IBM board, which sells for \$140.

There is still some question as to the magazine address space of the PCjr. Several publications have already been announced, and one, *PCjr*, published by Ziff-Davis, will have prepared three issues before customers begin receiving machines. Should the PCjr fail to attract a market, a lot of folks will be crushed by the resulting fall. ■

Bibliography

1. Ciarcia, Steve. "Use Infrared Communication for Remote Control." *BYTE*, April 1982, page 40.
2. *IBM Personal Computer Seminar Proceedings*, Vol. 1, No. 3. Boca Raton, FL: IBM Corporation, 1983.
3. Lemmons, Phil. "Hard Choices for Software Houses." *BYTE*, April 1983, page 242.
4. Malloy, Rich. "IBM Announces the PCjr." *BYTE*, December 1983, page 358.

G. Michael Vose is *BYTE*'s features editor. Richard S. Shuford is special projects editor for *BYTE*. They can be reached at POB 372, Hancock, NH 03449.

GTEK DEVELOPMENT HARDWARE/SOFTWARE

HIGH PERFORMANCE/ COST RATIO

INC. (601) 467-8048

EPROM PROGRAMMER

Compatible w/all Rs 232 serial interface & select baud rate • With or without hand Bidirectional Xon/Xoff and CTS/DTR's Read pin compatible ROMS • No modules • Intel, Motorola, MCS86. Hex Split facility for 16 bit data paths • Read formatted list commands • Interrupt program and verify real time while sending data • Program single byte, block, or whole EPROM • Intelligent diagnostics discern bad and erasable EPROM • Verify erasure and compare commands • Busy light • Complete w/Textool zero insertion force socket and integral 120 VAC power (240 VAC/50Hz available)

DR Utility Package allows communication with 7128, 7228, and 7956 programmers from the CP/M command line. Source Code is provided. PGX utility package allows the same thing, but will also allow you to specify a range of addresses to send to the programmer. Verify, set the Eprom type.

MODEL 7316 PAL PROGRAMMER
Programs all series 20 PALS. Software included for compiling PAL source codes.

Software Available for CPM,¹ ISIS,² TRSDOS,³ MSDOS.⁴

1. TM of Digital Research Corp.
2. TM of Intel Corp.
3. TM of Tandy Corp.
4. TM of Microsoft.

Post Office Box 289
Waveland, Mississippi 39576
(601)-467-8048

Avocet Cross Assemblers are available to handle 8748, 8751, Z8, 6502, 680X, etc. Available for CP/M and MSDOS computers. Order by processor type and specify kind of computer.

Model DE-4 U/V Products hold 8, 28 pin parts. High quality professional construction.

MODEL 7324 PAL PROGRAMMER
Programs all series 20 & 24 PALS. Operates stand alone or via RS232.

S879 stand alone MODEL 7956
program. driven.

MODEL 7956 GANG PROGRAMMER
Intelligent algorithm. Stand alone. Copies eight EPROMS at a time. With RS-232 option \$1099.

MODEL 7228 EPROM PROGRAMMER
All features of Model 7128 plus Auto Select Baud, super fast adaptive programming algorithms. Low profile aluminum enclosure. Programs 2764 in one minute!

MODEL 7316
\$549

MODEL 7128
\$429

MODEL 7324 PAL PROGRAMMER
\$1195

MODEL 7128 EPROM PROGRAMMER Programs and Read:				
NMOS	NMOS	CMOS	EEPROM	MPU'S
2508	2758	27C16	5213	8748
2516	2716	27C32	5213H	8748H
2532	2732	C6716	X2816	8749H
2564	2732A	27C54	48016	8741
68766	2764		12816A	8742H
68764	27128			8741H
8755	27256			8751
5133				

Model 7128-1, L2, L2A . \$239.00
Model 7128-24 \$329.00
DR8 or DR5 \$ 30.00
DR8PGX or DR5PGX \$ 75.00
Cross Assemblers \$200.00
XASM (for MSDOS) \$250.00
U/V Eraser DE-4 \$ 78.00
RS232 Cables \$ 30.00
8751 adapter \$174.00
8755 adapter \$135.00
48 Family adapter \$ 98.00

Be confident because your PowerType Daisywheel correspondence becomes you.

When you can't personally be there, only the clearest typed correspondence should be your substitute. With a PowerType Daisywheel printer your documents look highly professional. And so do you!

PowerType. It's "typewriter friendly." Using a simple drop-in ribbon cassette, it bi-directionally types executive quality correspondence at 18 cps with a print wheel that holds 96 flawless characters.

Designed for personal or business applications, PowerType's carriage accepts paper that ranges

from letter to legal size, from fanfold to roll to cut sheet. You can set right and left margins, vertical and horizontal tabs.

Plus, of course, PowerType has both serial and parallel interfaces to enable it to connect to just about any personal or business computer.

So the next time you're going face to face through the mail, rely on PowerType. It will help you make a professional impression. And that's always very becoming.

star
MICRODES-INC

THE POWER BEHIND THE PRINTED WORD

Computer Peripherals Division

P.O. Box 612186, Dallas/Ft. Worth Airport, TX 75261 (214) 450-1000

Circle 333 on Inquiry card.



Undo.Windows.

New Microsoft® Word. It makes your IBM Personal Computer think it's better than a \$10,000 word processor.

With Microsoft Word, what you see on the screen is what you get on the paper. So it's easy to spot mistakes. **Boldface**, underline, and *italics* look like this, not this: ^Bboldface^B, ^Sunderline^S, ^Iitalics^I.

And, when you make changes, paragraphs are automatically reformatted. Flush right, flush left, centered or justified. It even gives you several columns on a page, like a newspaper.

Word forgives and doesn't forget.

There's an "uh-oh" command called Undo. Make a mistake? Or just want to experiment? Hit Undo.

A close-up photograph of a hand holding a large, black, three-dimensional block letter 'W'. The hand is positioned at the bottom center, with the thumb and index finger gripping the letter. The letter is held up against a plain white background, casting a soft shadow. The word 'WORD' is implied by the single letter shown.

Mouse. Finally.

Word undoes your last change and remembers things the way they were.

Word does windows. Up to eight, to be exact. So you can transfer or edit between eight different documents. Or between eight different pieces of the same document.

Word travels fast.

Word has a Mouse, a handy little critter that lets you move copy, select commands and edit faster than you can say "cheese."



Word also lets you create your own style sheets, so you can standardize your documents, memos, files and letters.

It's not surprising that Microsoft has a way with Word. We designed the MS™-DOS operating system that tells the IBM® PC how to think. And we pioneered the first microcomputer BASIC, the language spoken by nine out of ten micros worldwide.

For a few final words, call 1-800-426-9400 (in Washington State call 206-828-8088) for a free Word brochure and the name of your nearest Microsoft dealer.

MICROSOFT
The High Performance Software

The Japan Shows

An Update on the Japanese Computing Scene

NEC introduces an impressive 16-bit computer, and Canon previews a remarkable, inexpensive laser printer

by Richard Willis

Business applications of microcomputers were the overriding emphasis at the 1983 Japan Data Show, held in Tokyo October 18-21, 1983. Individual personal computers took a back seat as computer makers put forward a wide range of networking and office-automation systems promising to transform the Japanese workplace into a futuristic information-intensive environment. But the home computer was also given its due. After a long, exhilarating day interfacing with the office workstation, tomorrow's Japanese workers will apparently look forward to spending the evening in front of their own ultra-high fidelity, satellite downlink videotex banking and home-management terminals and laser-disk-driven arcades. At least that's the scene painted by some of the same manufacturers at the Japan Electronics Show, held the week before in Osaka. You have to wonder whether, at some point, people will start to overdose on all this technoculture.

Restraint is clearly not the operative term for describing the Japanese love affair with the latest electronic gadgetry—nor for describing the means by which such innovations are promoted. The Data Show and Electronics Show are cases in point. Big Japanese trade shows like these are an organized assault on all the bodily senses, at least an order of magnitude more intense than one experiences at NCC or COMDEX. Multimedia theaters at many of the larger firms' booths extol the exhibitor's technical wizardry, often with only minimal reference to specific products. Legions of young women sporting brightly colored blazers and overamplified microphones keep the halls brimming with decibels. Most of all, there are the crowds, a continuous human crush in the aisles and the booths that can only be compared to rush hour on the subway (see photo 1). A week-long NCC or COMDEX show in the U.S. may draw 100,000 to 150,000 visitors. The Japan Data Show, four

days long on about the same amount of real estate, attracts close to 400,000.

Fewer Machines, Better Systems

The shows clearly revealed some new and significant movements within the Japanese microcomputer industry. Microcomputers are beginning to have a real impact on the Japanese workplace. Because even the simplest of business applications requires the computer to deal with *kanji* characters, microcomputers did not really begin to penetrate the business world until the introduction of 16-bit microprocessors. Even when the 16-bit machines first appeared, they left a lot to be desired in terms of software support, for their makers lacked the three or four years of hard-won business-market experience that benefited Western systems designers. Now, however, at least a few Japanese manufacturers seem to have realized the necessity of providing total systems packages, including a full range of applications software, for each new machine they introduce. And all the makers are working hard to improve their support of existing models by enhancing both hardware and software.

Almost every major firm at the Data Show was touting its new data-networking capabilities. But most of these systems were large-scale proprietary networks, specifically tailored to the needs and conditions in the Japanese office or factory and in many cases tied to one or more of the company's mainframe computers. There did not appear to be any standardized, compact network system emerging that might eventually have an impact on the American office-automation market.

And while software is receiving tremendous, much-needed emphasis in Japan, there is little or no consensus among computer makers as to which operating system (OS) to adopt. Microsoft got a jump on the market



Photo 1: The 1983 Japan Data Show was fairly well attended.

by developing a Japanese-language version of MS-DOS, currently the most widely used OS among garden-variety 16-bit machines. But some manufacturers had already started to develop their own proprietary operating systems for their high-end hardware. Others are abandoning standard operating systems in favor of

building custom OS modules into each individual task-environment program, claiming that this strategy can improve performance substantially. Some machines provide a combination of stand-alone program modules (usually for word-processing and similar text-intensive tasks) and OS-dependent programs. And while some manufacturers have stuck with MS-DOS, others are moving to CP/M-86. There is considerable behind-the-scenes interest in Unix, but very few of the major manufacturers have introduced Unix packages for their machines, and its acceptance will probably remain in doubt until the next generation of processors arrives.

The effect of this fractious environment is, not surprisingly, to discourage independent software development, the force that has driven the American microcomputer industry ahead so vigorously. Most third-party software development is carried out under contract with a single large manufacturer for a specific machine. There are very few Japanese-written standard software packages (such as Visicalc or Wordstar), and it's doubtful that a healthy, inventive, *independent* software industry will emerge in Japan any time soon.

Recent BYTE reports from the Japanese computer shows ("New Japanese Microcomputers," April 1983, page 110, and "Update on Personal Computing in Japan," September 1983, page 250) have given fairly detailed summaries of the models produced by each of the major Japanese manufacturers, and most of these product lines have undergone incremental upgrading rather than total overhaul. Relatively few of the machines exhibited this year were new introductions. I will focus on those new systems that demonstrate significant technical advances or that typify major trends in the Japanese market, especially those that may soon affect us in the U.S.

Good News for Mouse Fans

Published surveys give Nippon Electric Corporation (NEC) over a third of the personal and desktop computer market in Japan, and the company shows no sign of



Photo 2: NEC's new PC-100 8086-based system with a color display. A monochrome display is also available. Both CRTs can be turned horizontally.

slacking off. In what was perhaps the most significant system introduction of the show, NEC unveiled its new PC-100, an 8086-based personal computer (see photo 2). This reasonably compact system is built around a very high-resolution display, a mouse, and a bundled software package. The 8086 processor runs at 7 MHz, and there is provision for an optional 8087 numeric coprocessor. The standard memory complement is 128K bytes of RAM (random-access read/write memory) expandable to 640K bytes, plus video RAM of 128K bytes for monochrome display or 512K bytes for color. The unit can be configured with one or two built-in 320K-byte 5¼-inch floppy-disk drives.

The video RAM is organized as a 1024 by 1024 bit map, of either one plane for monochrome or four planes for color. The 14-inch CRT (cathode-ray tube) display units offered with the system, both the monochrome (soft white) and the color, will display any 720- by 512-pixel window of the bit map, with smooth scrolling that can be controlled by either the mouse or a keystroke command. The color unit can display 16 colors from a palette of 512.

The real kicker is that the display can be turned vertically or horizontally to suit the application. In this characteristic, the system is similar to the Corvus Concept ("What a Concept," May 1983 BYTE, page 134). The user has a choice of four different *kana* or alphanumeric character formats (up to 64 lines of 120 characters) and two *kanji* character formats when the display is set horizontally, and three *kana* and one *kanji* format when the display is in its vertical orientation. A new type of display controller is used in this system; instead of employing its μ PD7220 controller chip, NEC has designed an analog-output controller circuit, which may indicate that NEC plans to integrate the system with other video media in the future. Both the color and monochrome displays produce beautifully crisp visuals. All in all, the PC-100 sets a new high standard for personal computer graphics capability.

The two-button mouse that comes with the PC-100 is identical to the

Microsoft mouse; Alps Electric, a major Japanese maker of electromechanical devices, developed it under contract from Microsoft and now sells or licenses it to NEC. The mouse's tail (cord) plugs handily into the right edge of the detached keyboard unit. The keyboard itself is extremely simple in layout, with the Japanese Industrial Standard (JIS) *kana* pattern and 10-key pad, five numbered function keys, and a bare minimum of special-purpose keys, all in a lightweight, low-profile enclosure.

The most revolutionary aspect of the PC-100 is that it is one of the first Japanese computers to come complete with a well-chosen package of software. The key element of the package is a Japanese-language word-processing program called JS-Word that employs a screen-icon-and-mouse control structure similar to the Apple Lisa or the new Microsoft Windows system. Up to eight overlapping windows, each carrying its own appropriate icons, can be opened on the screen at one time. Japanese textual material may be entered either in *kana* or in Roman-character equivalent form and then converted to *kanji*. Jean Yates, writing in a recent issue of *The Yates Perspective* (a newsletter covering software trends, with an emphasis on Unix) after a hands-on demo of JS-Word, describes it as one of the best word-processing programs she has seen, surpassing even Microsoft's Word (a fascinating irony because JS-Word was developed by ASCII-Microsoft, Microsoft's Japanese partner/subsidiary).

Also provided in the package are a Japanese-language version of Multiplan, a BASIC interpreter (whose program files, incidentally, can be edited by JS-Word), and some utilities, including software support for the standard RS-232C interface. The operating system is a Japanese-language version of MS-DOS dubbed version 2.01.

NEC clearly has designed a winner in the PC-100, a machine with a nearly perfect mix of capabilities at an impressive price: \$2200 (in Japan) for a two-disk monochrome system with monitor, \$3200 for color. A full *kanji*-

capable, 18-magnet dot-matrix printer plus interface is available for another \$1100. While the system does not have the total integration of different task environments offered by systems like the Lisa (you must load the various function programs separately and pass data via disk files), it goes a long way toward providing simple, accessible computing power and will undoubtedly appeal to many Japanese business and personal users. The question is whether this machine will be imported into the U.S.; the NEC spokesperson I talked to was noncommittal on this point. However, last May an NEC executive said that the PC-9801 (NEC's other new high-end computer) would not be exported but, rather, that NEC was developing a new machine with high-resolution graphics for introduction in America. So there is a very high probability that we will see the PC-100 here. It is also a good bet that it will feature a software package composed of Microsoft's Tools running under that company's Windows operating environment. If and when the PC-100 does show up in the U.S., it will certainly pose some stiff competition for Epson's QX-10 Valdocs system and perhaps also for Apple's mouse-and-icon-based Macintosh system.

The introduction of the PC-100 gives NEC a third 16-bit personal computer; the other two are the N5200 (sold in the U.S. as the APC; see October 1983 BYTE, page 280) and the PC-9801. Each of these machines now will be steered toward specific segments of the Japanese microcomputer market.

Daring Sordplay

While almost all Japanese companies are intensely competitive and ambitious, this year's prize for Most Audacious Agenda by a Start-Up Company must go to Sord Computer. Founded by a small group of very young engineers and programmers in the early seventies, Sord has been gaining steadily on its giant competitors in the microcomputer industry and now holds about 7 percent of the overall market (about 13 percent if the focus is narrowed to



SALVO Shatters The Information Barrier!

At last. Create your own applications in a fraction of the time compared to BASIC, COBOL or any data base language. You know exactly what you want. Now, let your personal computer generate that information by using SALVO, the fourth generation information manager from Software Automation, Inc. It's Better. Faster. And Easier to use.

Natural Language Interpreter. Unique to SALVO, this allows you to enter the following type command, "List my customers and their orders." Watch as SALVO generates the application. *It truly shatters the information barrier.* In minutes you get what you want, the way you want it. Inventory, Accounting, Mailing Lists, Sales Reports and more.

Fourth Generation Language. SALVO is a powerful nonprogrammer's language combined with a true relational DBMS. This method increases your productivity 10 to 20 times normal! People in all

professions can benefit from SALVO. Regardless of their level of expertise.

Applications Development Package. SALVO is a complete tool for information management. Develop your own applications. Maintain your data base. Retrieve information using natural language. All of these functions can be performed by nonprogrammers. SALVO is also a complete application generator for advanced users and professional programmers. SALVO's secret is simple. Technological innovations including artificial intelligence (expert systems, natural language processors) combined with relational data structures.

SALVO runs on most personal computers. Compatible with MS-DOS, PC-DOS and CP/M. SALVO requires only 64K memory. SALVO is available at your local computer store or you may contact us for information on how to get your own personal preview copy.



14333 Proton Road, Dallas, Texas 75234
(214) 392-2802

See SALVO At Softcon Booth L4023
New Orleans Feb. 21-23.

business microcomputers). One might expect a small company such as this to adopt a relatively cautious product strategy, choosing to address only a few markets that offered the best chance of success. Sord, however, has never shown the least sign of faint-heartedness as it charged ahead, achieving (according to a recent study) the highest five-year sales-growth rate of any company in Japan. Sord's current line of microcomputer products, together with several new products to be introduced in the coming months, will put the company into virtually every micro-computer category, from video-game-oriented home computers, to portables, to business machines, to main-frame-challenging super-microcomputers. All in all, Sord seems to be in an excellent position to continue its so-far spectacular growth.

Indicative of Sord's capabilities is its latest high-end machine, the M68, one of the first Japanese desktop computers to be built around the Motorola MC68000 16/32-bit micro-processor (see photo 3). The M68 runs its 68000 at 10 MHz and comes standard with 256K bytes of parity-checked RAM, expandable to 1 megabyte. It also includes an auxiliary Z80A on line with 128K bytes of additional video RAM. The Z80 can function as an I/O and display controller for the 16-bit system or it can be used to run existing 8-bit software under CP/M-80. It is augmented by an Am9511 (Advanced Micro Devices) arithmetic processor that performs 16- and 32-bit fixed-point and 32-bit floating-point arithmetic operations.

The M68's monochrome and color displays have a resolution of 640 by 400 pixels; 16 displayable colors can be chosen from a palette of almost 5000. This is excellent resolution for any sort of business graphics but a little coarse for CAD (computer-aided design) work, one of the more obvi-



Photo 3: The Sord M68, a 68000-based desktop system. In the spring of 1984, the machine will be available with 1 megabyte of RAM standard, expandable to 4 megabytes, using 256K-bit dynamic RAMs.

ous applications for a system with such computing power. Sord is planning to offer a higher-resolution display with the M68 at some future date.

The M68 comes standard with a pair of 1.2-megabyte 5¼-inch floppy-disk drives and two RS-232C ports, one Centronics and one IEEE-488 interface port. A hard-disk controller is built in, but the drives (either a 7.5-megabyte 5-inch or a 20-megabyte 8-inch) must be added externally. A pair of expansion slots can be fitted with specialized interface modules, including a network-communication controller, analog- or digital-signal interfaces, and a module that interfaces the M68 to an S-100 expansion chassis.

Sord is now exporting the M68 system to the U.S. at a very attractive price; a 256K-byte system with dual floppy-disk drives and a monochrome monitor lists for \$4890. But the real bargain will arrive in the spring of '84, when Sord starts shipping M68s with Fujitsu 256K-bit dynamic RAMs installed. The base system will then have 1 megabyte of main memory and will sell for \$5690 with a monochrome monitor or \$5990 with color. Additional 1-mega-

byte memory modules—up to a total of 4 megabytes—can be added for \$2390 each.

In the matter of software for the M68, Sord seems to have expansive plans, especially at the OS level. The company literature lists six operating systems that can be run, including CP/M-86, RDOS, the UCSD p-System, and a version of CP/M-80. With an optional 8088 module installed, the machine will run MS-DOS. And Sord is planning to release a Unix system for the M68 sometime in 1984.

At the same time that Sord is trying to be all things to all programmers, it is also continuing to promote its own proprietary software philosophy, as embodied in the package called PIPS (Pan-Information Processing System). PIPS is

the pride and joy of Sord and probably is the best-known standard software package of Japanese origin. As Sord products start arriving in the U.S., PIPS will no doubt follow, heavily promoted.

The PIPS framework, designed by a banker, reflects a banker's way of looking at data (mainly numbers) in that all data in the system is thought to be organized in tables. At the heart of PIPS is a database manager; information is entered into the system in the same manner as to any relational database, though it is not clear whether the internal data structures of PIPS are true relational records or classical data tables. Once the database is established, it can be operated upon in various ways. The best analogy I can invoke here is that of a tool chest. The PIPS tool chest has several drawers, each containing a certain category of tools—Sorting and Searching, Arithmetic, Graphing, and so on. In general, only one drawer of the tool chest can be open at a time, but when you change drawers, you don't have to pick up all the data, put it away, and then pull it out again; the data of the table you're working on is always actively at hand. You call up the specific tools,



For users of Apple, IBM, TRS/80, Atari, Commodore, Texas Instruments, and other brand name computers:

Here's the easiest way to buy quality diskettes at discount prices

Now you can get error-free double density diskettes by IBM, Control Data, Maxell and Verbatim delivered to your door. For some of the lowest prices around.

You save because we ship huge volumes of magnetic media in boxes of 10.

To order, use this form.

For even faster service, call toll-free.

1-(800)-FLOPPYS or
1-(800)-521-5700

Michigan • 1-800-482-4770

Canada • 1-800-265-4824

Alaska/Hawaii • 1-800-821-9029

CALL FOR FREE CATALOGUE

ALL MAJOR CREDIT CARDS ACCEPTED

Shipping & handling F.O.B. Southfield
Transaction Storage Systems Inc., Southfield, MI



EXPECT A MIRACLE

Circle 357 on inquiry card.

Size	IBM	Qty.	Verbatim	Qty.	Control Data	Qty.	maxell	Qty.
5-1/4" SS	23.90		23.90		19.90		28.90	
5-1/4" DS	34.90		34.90		29.90		41.90	
8" SS	24.90		—		28.00		—	
8" DS	39.90		—		29.90		—	
Sub Totals	\$		\$		\$		\$	

Name _____ Title _____
 Company _____
 Address _____
 City _____ State _____ Zip _____
 AMEX MASTERCARD VISA
 Card # _____ Exp. Date _____
 Shipping and handling 1-6 boxes add \$4.00 per order
 7 or more add \$6.00 per order.

Clip and mail today to: Transaction Storage Systems, Inc.,
 22255 Greenfield Road, Southfield, MI 48075



PRINTER RIBBONS

	PRICE	PER RIBBON	PER DOZEN
Anadex 9500	13.50	147.00	
Apple DMP	5.95	68.40	
Centronics 150/152	7.00	81.00	
C. Itoh Prowriter	5.95	68.40	
Commodore Pet 8023P	7.00	81.00	
Epson MX-FX 70/80	5.25	60.00	
Epson MX-FX 100	9.95	108.00	
Gemini - 10	2.50	27.00	
NEC 3500 M/S Single Sided	6.95	80.40	
NEC 3500 Nylon	9.75	114.00	
NEC PC 8023A	5.95	68.40	
Okidata 80/82/83/92	2.50	27.00	
Okidata - 84	5.00	57.00	
Radio Shack D.W. II M/S	5.00	57.00	
Radio Shack D.W. II Nylon	6.75	78.00	
Radio Shack DMP - 2100	7.50	87.00	
Radio Shack LP I II III IV & V	6.00	69.00	
Silver Reed EX55 Single Strike	5.00	57.00	
Toshiba - 1350	7.50	87.00	
Wang Bearclaw	9.00	105.00	
Xerox 610/620 M/S	7.75	84.00	

Add \$2.00 Shipping

To Order Call (313) 569-3218 or

Write for our Catalog

DWIGHT COMPANY, INC.

15565 Northland Drive - West Tower
Southfield, Michigan 48075-6496

Circle 133 on inquiry card.



A word for this Punch/Reader Combo is

Speed! Model 510 punches paper tape at 110cps, reads at 150cps. This rugged machine is computer compatible offering RS232C, current loop, parallel inputs. The ASCII-to-Baudot code conversion permits direct keyboard entry for Telex/TWX transmission. Plus: 256 character storage, 75-9600 baud rate, 5-8level tape, stock. ADMAS TER CORP. 416 Junipero Serra Dr., San Gabriel, CA 91776 * 213/285-1121.

Circle 10 on inquiry card.

or operations, to act upon the tabulated data by typing short mnemonic commands, as in Wordstar. Once you start a given process, the system will automatically request any additional parameters needed to define the operation. Unlike spreadsheet programs such as Visicalc, which are organized by cells, PIPS is column-oriented, so when you perform any operation that creates new data from existing data, you create a new column in the table. After the table has been stretched and scrambled and otherwise massaged to produce the desired results, various output formats, both tabular and graphic, can be specified for reporting the data. "Programs" in PIPS thus consist of sequences of table-manipulation commands.

First released in 1980, PIPS was the first real integrated package of software tools for microprocessors. In 1980, Software Arts (now Visicorp) was just starting to work on the file protocols that would allow Visicalc data to be passed to other Visicorp tools, and Lotus's 1-2-3 was just science fiction. On the other hand, many aspects of PIPS—such as its confinement to columnar data structures—look rather primitive nowadays. However, the most sophisticated structures aren't always the most useful, and many people who work with financial data find the PIPS format intuitive and powerful. At any rate, Sord is constantly upgrading the package, so PIPS may someday attract some interest over here.

Mr. T Meets the Computer

Another of the major contenders in the Japanese microcomputer arena is Fujitsu, one of Japan's high-tech powerhouses, and the country's largest computer maker. Unlike many other firms now selling computers, Fujitsu did not start out making TVs, rice cookers, or cameras. Fujitsu's focus always has been on the industrial applications of electronics. Personal computers are Fujitsu's first venture over the rocky shoals of consumer marketing, but the company is apparently determined that it will not be out-hyped by anyone.

Fujitsu's presentation at the '83

COMPUTER RUNS MOTORS

\$225⁰⁰



- ROBOTS
- PROCESS CONTROL
- CONVEYORS
- ONE PORT RUNS UP TO FOUR MOTORS

Use your computer with the CDFR controller to command speed and direction of two independent motors from a single output port. For robot drive motors or any two functions requiring proportional bipolar control of 15Vdc up to 12 Amps each. Normally the controller installs between the computer, a 12Vdc battery, and two DC PM motors mounted right and left on a robot. Simple software commands set speed and direction latches in the CDFR thus freeing your computer for other tasks. Two CDFR's control four motors with a single port. The CDFR speed control uses CMOS, optoisolators & relayless PWM power circuitry. One year limited warranty. Buy now with parallel interface for \$225.00, or serial for \$315.00. Other robotics components available. MC, VISA, MO, or check.

VANTEC

15445 VENTURA BLVD., SUITE 10-281
SHERMAN OAKS, CA 91413
(213) 993-1073



Circle 370 on inquiry card.

FLOPPY DISK-DRIVE REPAIR

Command Services exclusively repairs Tandon and Shugart disk drives. We are affordable, fast and experienced. For service, call toll free: M-F, 9 a.m.-5 p.m., 7-9 p.m. 1-800-782-5500 In New York State call: 1-800-328-1800

Command Services Corporation
7143 Henry Clay Blvd.
Liverpool, New York 13088
315-457-1432



Circle 71 on inquiry card.



FLEXIBLE DISCS

WE WILL NOT BE UNDER-SOLD!! Call Free (800)235-4137 for prices and information. Dealer inquiries invited and C.O.D.'s accepted.

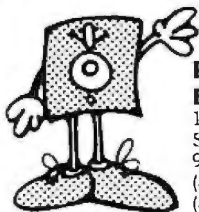

PACIFIC EXCHANGES

100 Foothill Blvd.
San Luis Obispo, CA
93401. In Cal. call
(800)592-5935 or
(805)543-1037



Circle 277 on inquiry card.

AFFORDABLE M-68000 COMPUTER SYSTEM

M68KCPU 6-10 MHz CPU, 20K static RAM, 16K EPROM, on board monitor, two RS-232 serial ports, 16-bit parallel port, 5 timer/counters expansion bus.
Bare board.....\$ 99.95
Complete Kit.....\$615.00
M68512K 128-512K static RAM, floppy disk controller & hard disk interface
Bare board.....\$ 99.95
Complete Kit (128K)...\$725.00
M68KE Enclosure with power supply, fan, filter, 4 slot card cage.....\$249.00
M68KASM M68000 Macro Cross Assembler for CP/M80, IBM PC, TRS-80 and Apple II computers.....\$149.00
UPS shipping & handling \$ 4.00
COD orders add \$ 3.00
Foreign orders add \$20.00
California residents add 6.5% tax

EMS Educational Microcomputer (714) 533-0133
Sysma
P.O. Box 16115 • Irvine, CA 92713

Circle 141 on inquiry card.

...SORRY CHARLIE
FOR LEAVING
YOU OUT!



**FEATURES
INCLUDE:**

16 Bit CPU
With 128K RAM Memory
Expandable to 256K,
Two 320KB Slimline
Disk Drives,
Floppy Disk Controller,
Monochrome Monitor and
Adapter, Parallel and
Serial I/O's.

**BEST OF ALL!
TEN DAYS FREE TRIAL!
ALL YOU PAY IS
SHIPPING!**

**FOR MORE DETAILS
CALL OR WRITE
TO: TAVA CORPORATION
16861 Armstrong,
Irvine, California 92714
714/261-0200
Headquarters/Telex: 181667
Answer Back COMPDSHACK IRIN**



IBM® COMPATIBILITY AFFORDABLE PRICE TAVA PC

**THE SMART COMPUTER USER
WANTS REAL VALUE WITH
IBM COMPATIBILITY!**

Circle 342 on inquiry card.

THE TAVA PC. The ultimate Personal Computer. It gives you IBM PC® Compatibility at a fraction of the cost. Choosing a personal computer is a difficult decision. But, when your decision is a TAVA PC, it's not hard at all! The TAVA PC runs under DOS 1.1, 2.0, CP/M86®, and p-System®. You can choose from a large library of all the most popular IBM PC software products such as dBaseII®, Lotus 1-2-3®, Visicalc® and thousands more.

CP/M86 is a registered trademark of Digital Research, Inc.
1-2-3 is a registered trademark of Softch Microsystems

IBM PC is a registered trademark of IBM Corp.
Visicalc is a registered trademark of Visicorp

Data Show exemplifies the trend toward building better systems around existing hardware. None of the microcomputers shown by Fujitsu this time were new (although some of the microprocessor-based workstations for the company's larger office computers were). The main attractions here were Fujitsu's proprietary fiber-optic "data highway," which tied a number of different machines on the floor into a large-scale mainframe at a company facility 10 miles away; a digital voice mail system capable of storing spoken messages and delivering them to integrated phone/data terminals; and a multichannel mobile data-communications system designed to support portable data terminals installed in automobiles (for salesmen, law-enforcement officers, and irrepressible hackers).

As far as personal computers were concerned, Fujitsu was standing firm on a fairly strong product line, the popular FM-7 8-bit and FM-11 16-bit

machines. Also prominently featured was a 16-bit personal workstation computer, the 9450-II, which is now about a year old. This machine is the Ferrari of Fujitsu's personal computer line, but unlike the NEC PC-9801, with which it directly competes, I didn't see any huge stacks of 9450s bulging from the doorways of shops in Akihabara, Japan's mammoth retail electronic district. It seems that Fujitsu is conducting a more focused marketing program for the 9450, aiming to establish its credentials as a business machine rather than a mass-market toy.

Far from a toy, the 9450 employs a pair of MN1613s, a proprietary Fujitsu 16-bit microprocessor. The standard RAM complement is 256K bytes to 384K bytes. The unit can be configured with two 1-megabyte floppy disks, either 5¼-inch or 8-inch, or one floppy disk and one 10-megabyte hard disk. Display resolution is 640 by 480 pixels in both color and monochrome. The color display produced

by this machine is as sharp and brilliant as any I have seen. Even though its *kanji* font is only 16 by 15 pixels, the characters are highly readable. An optional 8086 board is planned, although, surprisingly, the company says it intends to support CP/M-86 rather than MS-DOS.

The 9450 runs a proprietary multi-tasking operating system called APCS-III and offers an integrated package of business software—word processing, spreadsheet, graphics, and accounting—called the EPOC series.

One other Fujitsu product deserves special mention here, both for its technological achievement and its cultural overtones: the MyOASYS-2 personal word-processing system (see photo 4). This compact unit, about the size of the Otrona Attaché portable, has some rather powerful features for its size and price. For about \$2200 you get a complete word-processing system, including a built-in video screen capable of displaying 14 lines of 40 *kana* or *kanji* characters or up to 80 alphanumeric characters, a 5¼-inch disk drive, and a printer, either thermal-transfer or wire-dot-matrix. Both the display and printer use a 16- by 16-pixel representation for *kanji* characters, with over 7200 character fonts stored in ROM. The system can perform semiautomatic *kana-to-kanji* conversion at the word level, with reference to a dictionary of about 40,000 words standard, plus up to 10,000 user-chosen readings. Additional disk-based software enables the MyOASYS-2 to perform simple graphics and calculations as well.

Every bit as interesting as the machine itself is the way in which the MyOASYS-2 is being promoted in Japan. Fujitsu has chosen Takamiyama, past winner of the Emperor's Cup (the grand championship of sumo wrestling) and one of Japan's best-known sports personalities, as the media representative for its MyOASYS series of word processors. You see Takamiyama's clowning visage plastered everywhere in Japan—in subway cars, on train platforms, and in full-size cardboard mannequins in front of computer



Photo 4: Sumo wrestler Takamiyama demonstrates the portability of the Fujitsu MyOASYS-2 word processor. If asked, he could probably demonstrate the portability of a Subaru.

(5a)

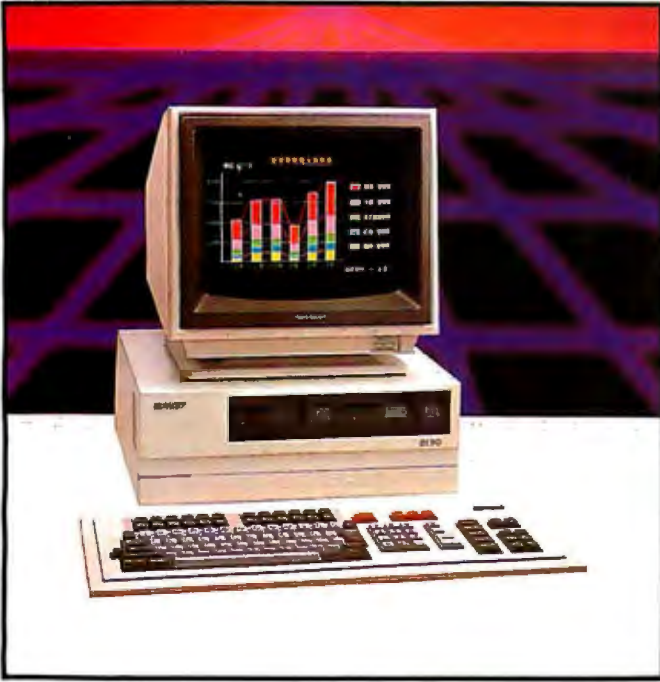
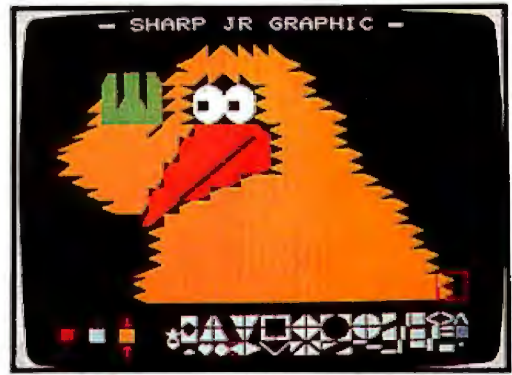

Photo 5: 5a shows Sharp's top-of-the-line office computer, the OA-8100, which employs a 68000 processor and supports Unix System III. 5b shows a TV graphic generated by the Sharp C1 home-graphics processor. Note the palette of shapes at the bottom of the screen. Pictures are created by "picking up" copies of the shapes and positioning them (by cursor movement) at the desired location on the screen. Memos also can be created by picking from a different palette.

(5b)



stores—but the sight of this 6-foot 3-inch 440-pound mountain of a man prancing (yes, prancing) across the TV screen, word processor in hand and three leotard-clad nymphs in tow, can only be compared to a certain scene from *Fantasia!*

See Sharp or Be Flat

If Fujitsu has worked its way down the scale from mainframes to microcomputers, Sharp has climbed upward, from pocket calculators. Sharp is number two in total PC sales in Japan but holds a much smaller share of the business computer market (about 6 percent), and the company is clearly aiming to improve that situation with its latest round of product introductions. Most significant of these is the OA-8100 (see photo 5), the only other 68000-based office computer besides the Sord M68 (and the OEM version of the M68 sold by Fuji-Xerox). What's more, Sharp has taken the plunge and is offering Unix System III with the 8100, even though a full *kanji* version of this operating system has yet to be developed. (This does not mean that applications packages running

under Unix cannot use *kanji*, only that the system commands must be entered in English, if you can call "chmod," "mkdir," and "nroff" English.)

The 8100 comes in three configurations, numbered 8130, 8140, and 8150, the main difference being the disk complement. Memory capacity is 512K bytes to 4 megabytes. Various combinations of floppy- and hard-disk drives (10, 20, 40, 74, and 135 megabytes) can be ordered. The display has exceptionally high resolution—1152 by 750 pixels in monochrome and 768 by 550 pixels in color, with 16 colors displayable on the latter. The data sheet lists support for RS-232C and Ethernet interfaces, plus a circuit-switching/packet-switching communications controller.

The most popular of Sharp's serious personal computers, the cleverly packaged PC-5000, is now being sold in the U.S. This integrated unit, with a proprietary CMOS (complementary metal-oxide semiconductor) 8088-type microprocessor, 128K bytes of RAM, and an 80-character by 8-line LCD (liquid-crystal display) is priced at \$1995, with an optional

built-in thermal-transfer printer for an additional \$395 and external dual floppy-disk drives for \$995. This portable has several interesting systems features: its MS-DOS operating system is contained in one of three 64K-byte CMOS ROMs, the others being a system ROM and a BASIC interpreter ROM; in Japan, an additional *kanji* ROM module is added. The unit can accept 128K-byte nonvolatile magnetic bubble-memory cartridges. And dot-addressable graphics can be performed within its 640- by 80-pixel LCD. Weighing this machine's features—choice of microprocessor, memory capacity, display size, quality of keyboard, integrated printer, standard operating system, battery power—against its competition, the PC-5000 stacks up as one of the best values in the portable market.

In its new assault on the business market, Sharp has not abandoned the home-entertainment scene. The company is continuing to push the integration of the home computer with other electronic entertainment media. At this year's Electronics Show, Sharp added to its line the C1, a video game and graphics system



Photo 6: Matsushita ("National" in Japan, "Panasonic" in the U.S.) showed its new portable voice-recognition module, the JH-600. The unit can be used by itself to recall short memos related to spoken inputs or can be connected to other systems as a controller or data-entry device.

completely integrated into the cabinet of either a 14-inch or a 19-inch color TV. This system has nowhere near the capabilities of the Sharp X1 introduced last year ("New Japanese Computers," April 1983 *BYTE*, page 118) but seems instead to be intended for families with very young children. While the X1 can display 25 lines of 80 characters on its high-resolution color monitor, the C1's screen is organized (in the two interactive program modes) as 20 lines of 28 "blocks" each.

The C1 does not include a keyboard; instead, all interaction with the system is accomplished through a small controller box on a cord. This box has four cursor-control buttons, a Select button for stepping through a menu, a Start button, a Cursor Mode button to choose shape, color, or position modes, and a Pickup button. The Pickup button is the key element in the C1's elegantly simple human-interface scheme. In character mode, you simply move the cursor down into a chart of available characters (alphanumeric, *kana*, and just a few *kanji* for days of the week),

position the cursor over the desired character, and press the Pickup button. Then when you move the cursor, it carries a copy of that character to anywhere in the array of blocks you wish to deposit it. In graphics mode, the pickup process is the same, except that the character chart is replaced by a palette of about 60 different shapes and five colors that can be used to create as sophisticated a display as any six-year-old is likely to conceive (see photo 5b).

While this human-interface system will never make the keyboard obsolete, it is certainly an excellent entry method for very young children. If Sharp were to implement a turtle-graphics capability into the system as well, it could be an unbeatable product. The C1 does have sufficient underlying graphic resolution for such an application because it also supports a number of video games in the form of cartridges that are plugged into the front of the console; a second controller box can be added for competitive games, and a game sound synthesizer is built into the system. Once a memo or graphic has

been created, it can be saved to any audiocassette recorder. Unlike the X1, the C1 does not allow computer-generated graphics to be superimposed on regular television images. The 19-inch version of the C1 sells for about \$640 in Japan.

Its Master's Voice

Like many American companies, the Japanese are experimenting with voice-entry systems. One or two firms at the show were demonstrating voice-recognition modules for their workstations. But the most remarkable voice-entry product I saw was a little portable machine from Matsushita (which uses the brand name National in Japan and Panasonic in the U.S.), the JH-600 Voice Recognition Computer (see photo 6). This unit is very similar in appearance to the company's JR-800 portable, except that the latter's 8-line by 36-character LCD has been replaced with a single-line 20-character display and a loudspeaker. Voice pickup is via external microphone.

The JH-600 is capable of recognizing as many as 62 different phrases up to 1.2 seconds in length, from either of two human speakers. Recognition is accomplished by pattern matching (using Walsh and Hadamard transforms) with phrases stored in the unit's memory. The total length of all stored phrases cannot exceed 42 seconds. To program the voice-recognition function, you first select a memo number, 1 to 62, and then type in a short memo that will be associated with the corresponding spoken input. This memo can be up to 36 characters in length and may or may not be an actual transcription of the word or phrase to be spoken. For example, you can store the spoken names of several people but put their phone numbers in the corresponding memo. After each memo is entered, you switch to voice-entry mode, press a button identifying yourself as either speaker A or B, and speak the desired word or phrase into the microphone. A light flashes to show that the entry has been accepted, and you then proceed to the next memo/phrase entry. Once all the desired phrases have been stored, you can

DIMENSION. THE MOST POWERFUL, MOST COMPATIBLE PERSONAL COMPUTER YOU CAN BUY.

Introducing the capability the world has been waiting for. A single personal computer able to handle Apple,[®] IBM,[®] TRS-80,[®] UNIX[™] and CP/M[®] based software.

The Dimension 68000 Professional Personal Computer does it all. It actually contains the microprocessors found in all of today's popular personal computers. And a dramatic innovation creates the environment that these systems function merely by plugging in the software.

Add to this the incredible power of a 32 bit MC68000 microprocessor with up to 16 megabytes of random access memory.

Dimension. At about the same price as the IBM[®] PC, it's obviously the best value you can find. For more information ask your dealer or call us at (214) 630-2562 for the name of your nearest dealer.

dimension



68000

A product of
Micro Craft Corporation
4747 Irving Blvd., Suite 241
Dallas, Texas 75247. ©1983

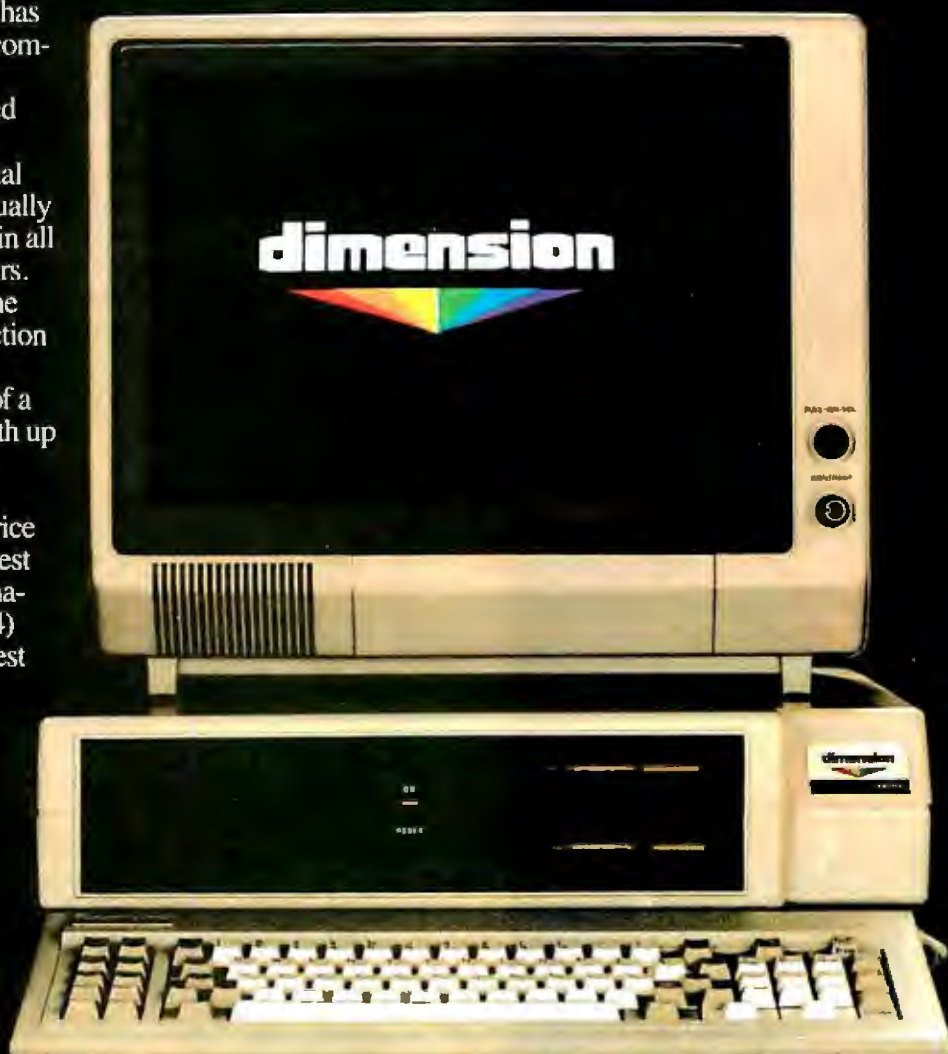

Apple is a registered trademark of Apple Computer, Inc.; IBM is a registered trademark of International Business Machines Corporation; TRS-80 is a registered trademark of Radio Shack, a Tandy Corporation company; UNIX is a trademark of Bell Laboratories, Inc.; CP/M is a registered trademark of Digital Research Corporation.



Get the total picture.

IBM COMPATIBLE - \$599!

Improve your present computer system with a high-resolution color monitor from NEC.

NEC's JC-1216 gives you the highest resolution you can get in a color monitor. And it can reproduce as many different colors and shades as the best microcomputers can generate. Compatible with a wide variety of computers, including IBM,* Zenith,* H-P,* and others, including NEC's own PC-8000 and PC-8800.

Compare these specs with your present monitor:

- 12-Inch diagonal screen
- RGB input signal with TTL level
- Switchable Pos/Neg display characters
- 80-character, 25 line display
- 640[H] x 240[V] resolution
- 8 x 8 dots, 10MHz video bandwidth

*NEC CG-91 cable required



Productivity at your fingertips



NEC Home Electronics (U.S.A.), Inc.
Personal Computer Division
1401 Estes Avenue
Elk Grove Village, IL 60007
(312) 228-5900

NEC Corporation, Tokyo, Japan



Photo 7: The Sony SMC-777 Z80-based home-graphics computer includes a single 3 1/2-inch drive and lists for about \$650 in Japan.

switch to recognition mode, speak any one of the phrases, and see the corresponding memo pop up on the display. The pattern discrimination is quite powerful; in the noisy exhibition hall, the unit was able to distinguish between "Carrillo," "Cabrillo," and "Castillo," three freeway exits here in Santa Barbara that are often confused by human listeners taking directions over the phone.

In addition to displaying a memo for each phrase recognized, the JH-600 will transmit the memo number over three interfaces: an RS-232C port, a special interface for the company's JR-800 portable, and a 6-bit parallel control output. Thus the unit could be used to enter a predefined set of commands or other information into a larger personal computer. One application suggested by the manufacturer is the vocal entry of BASIC programs; the 62 possible phrases would hold most of the BASIC commands, a handful of variable names, and numbers 0 through 9. Just put the program editor in autonumber mode and start talking.

The JH-600 can function as a multi-step programmable calculator and report its numerical results in synthesized (Japanese) speech. It can also act as a straight RS-232C terminal.

The unit employs a complex VLSI (very-large-scale integration) speech processor integrated circuit, and, at the time of the shows, Matsushita was still adjusting its process line to mass-produce the chips. Volume production of the JH-600 was due to start in early 1984, but no decision has been made on whether the unit will be exported to the U.S.

Matsushita was also displaying its new MSX-standard computer, the CF-2000. MSX is a combination hardware/software standard developed by Microsoft that theoretically allows home computers developed by various manufacturers to use each other's software. On the hardware side, MSX specifies a Z80 processor and a TI 9918 video controller and also defines other details such as I/O ports, joystick interfaces, etc. The standard software for MSX machines is a form of Microsoft BASIC. MSX has been accepted (in some instances grudgingly) by 18 companies at last report, including most of the major manufacturers of Japanese home computers.

The CF-2000 comes with 16K bytes of program RAM and another 16K bytes of video RAM. Up to two additional 16K-byte RAM modules can be plugged into the two cartridge slots, which also accept 48K-byte ROM cartridges containing such game hits as Boogie Woogie Jungle. The unit will generate a video display of 24 lines of either 32 or 40 characters; the character set includes alpha- numerics, *kana*, 19 simple *kanji*, and some graphic symbols. The CF-2000 sells for about \$230 in Japan.

It's a Sony

Sony introduced a couple of new home computers this time around, establishing a new HiTBiT product line (HiTBiT being an English play on the Japanese word *hitobito*, or "people"). One was an MSX-standard home computer, the HB-55, which will list for \$230. This unit looked very similar to the Matsushita CF-2000—in fact, there were a half-dozen or more of these "cookie

COMPUTER GRAPHICS '84™

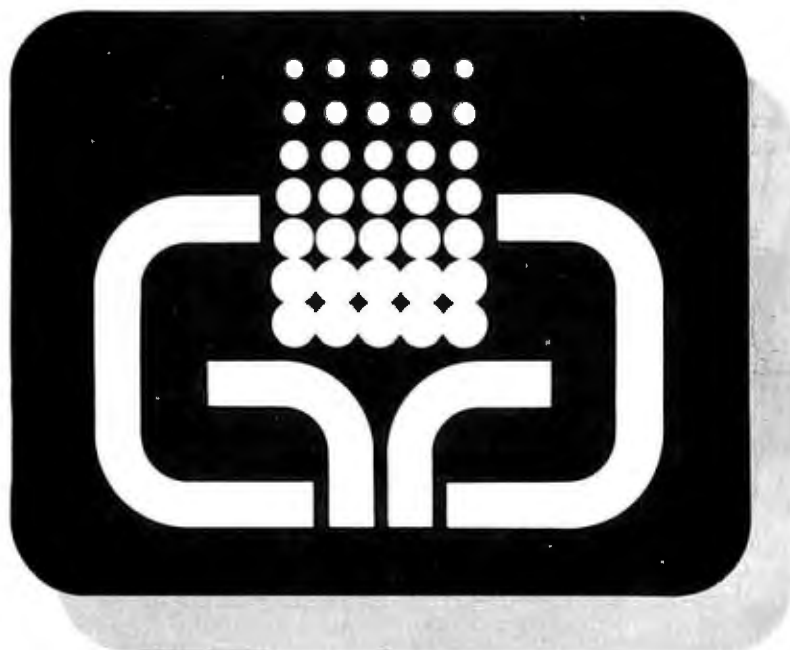

GUESS WHAT ELSE YOU CAN DO WITH COMPUTER GRAPHICS!

Many people have not yet discovered how much more they can accomplish with computer graphics than without it. And many who already use computer graphics aren't aware of how much more they can accomplish with it.

For all these people, the National Computer Graphics Association is pleased to present what's new—at Computer Graphics '84.

Computer Graphics '84 will help those who have systems get more out of them. Users will not only learn how to do better what they're already doing, but also how to do more kinds of things with the systems they already have.

Those who have not

yet begun to explore the world of computer graphics will find guidance in selecting and using the hardware and software to meet their needs, now as well as in the future.

COMPUTER GRAPHICS '84

From May 13 to 17, 1984, Computer Graphics '84 will fill the Anaheim Convention Center with a 7-acre exposition featuring more than 200 leading vendor of computer graphics hardware, software, systems and services. At the same time, more than 200 computer graphics experts will be leading more than 70 tutorials and technical sessions for professionals who use, or

should use, computer graphics technology in: Architecture, Biomedicine and Science, Defense Automation, Higher Education, CAD/CAM, Printing and Publishing, Business Graphics, Cartography and Mapping, Shipbuilding, Statistics,

Videotechnology and Visual Arts.

WHATEVER YOU DO

...see Computer Graphics '84. It will help you get more done, better, with computer graphics technology.

I WANT TO KNOW MORE!

Please rush me registration information on Computer Graphics '84 Conference and Exposition

I cannot attend, but I would like to receive information about the National Computer Graphics Association

Call or write today to:
NCGA
Dept. XA
8401 Arlington Blvd.
Fairfax, VA 22031
(703) 698-9600

Name _____

Address _____

City _____

State _____

Zip _____

MAY 13-17, 1984 ANAHEIM CONVENTION CENTER, ANAHEIM, CALIFORNIA

(8a)



(8b)



Photo 8: Canon's new low-cost laser printer is shown in 8a. The unit has many similarities to the company's line of personal cartridge copiers. Although Canon plans to sell only the mechanism (8b), a prototype of a complete printer was on display at the Data Show.

cutter" home computers at the shows; with little to recommend one over another. That's the down side of standards.

Sony's other release was much more interesting—a \$650 home computer called the SMC-777 (see photo 7) with one of Sony's 3½-inch, 280K-byte microfloppy drives built in. This Z80-based machine comes with 64K bytes of program RAM and 38K bytes of video RAM and will generate a full 25-line by 80-character display on an RGB (red-green-blue) monitor or 25 lines of 40 characters on a TV (with external modulator). Graphics resolution is 640 by 200 pixels, 4-color, or 320 by 200 pixels, 16-color. Character and graphic displays can be superim-

posed. Also included is a TI 76489 sound-generator chip. Optional plug-in boards can be added to create a 4096-color palette, to provide *kanji* display capability, or to interface with the company's SMC-70 desktop computer. A second 3½-inch drive can be added externally. The SMC-777 does not conform to MSX, since that standard makes no provision for disks. A Sony spokesman in this country said the company had not decided whether to bring the SMC-777 to the U.S. For one thing, Sony isn't sure which of its marketing divisions should handle it.

International Marketing Agreements

While Apple did not have a booth in Tokyo, it was announced shortly before the show that the company had signed a nonexclusive distributor agreement with Canon Sales Ltd. under which Canon would take on the promotion and sales of Apple products in Japan. This should help Apple's position considerably; at last count, it had less than 1 percent of the Japanese market.

A number of marketing agreements are working in the other direction. For example, Mitsubishi has an extensive line of personal and office computers in Japan, hardly any of which are ever seen in the U.S. But the company is now producing an IBM-compatible PC clone that is being sold here by Sperry (under the Sperry trademark) and also by Lead- ing Edge Products.

Canon's Peripheral Vision

Far and away the most significant development in peripherals was Canon's new laser-printer mechanism, a device that could make high-end daisy-wheel printers obsolete. Canon has combined the cartridge copy system of its PC-10/PC-20 line of personal copiers with a laser-diode writing system to come up with the world's smallest, and least expensive, laser printer (see photo 8).

While the company says it has no current plans to sell complete printers directly to consumers, its OEM (original equipment manufacturer) prices for the print mechanism are

remarkable—about \$2000 for sample quantities, dropping to near \$1000 in production quantities. For this price, the unit (called the LBP-CS) includes the entire printing system up to a serial video interface. From there, the end-product manufacturer would add font generation logic, timing and control electronics, and whichever form of data interface is desired.

This means that a straightforward office printer using the Canon mechanism could be brought to market in the \$2500 to \$3000 price range, landing squarely in the territory now occupied by high-speed daisy-wheel and dense-pattern dot-matrix printers. And the Canon system has the potential to far outperform these competing technologies. Its print speed is eight letter-size pages per minute, which for a character printer would correspond to more than 500 characters per second. The unit can generate images with a resolution of up to 300 dots per inch, about twice that of the best multipass dot-matrix printers. This will allow many different high-quality fonts to be produced, including, of course, *kanji* characters. And with appropriate interface electronics, all manner of graphic images can be created as well. Like the company's PC-10 and PC-20, the entire copy process—photosensitive drum, toner, etc.—is contained in a replaceable cartridge that's good for a few thousand copies. However, the cartridge used by the LBP-CS is different from that used by the copiers. For one thing, the drum has the opposite optical "polarity," i.e., it picks up toner in those areas that have been exposed by the laser radiation rather than where the dark printing of an original has been imaged.

All told, the Canon printer is a significant advance in hard-copy technology, especially in view of the fact that existing laser printers whose print specifications are not much better still cost 5 to 15 times as much. While the Canon is not designed for the sort of high-volume applications now being handled by laser printers, such as cranking out 10,000 invoices every day, it is perfectly suited for the small- to medium-size office environ-

(9a)

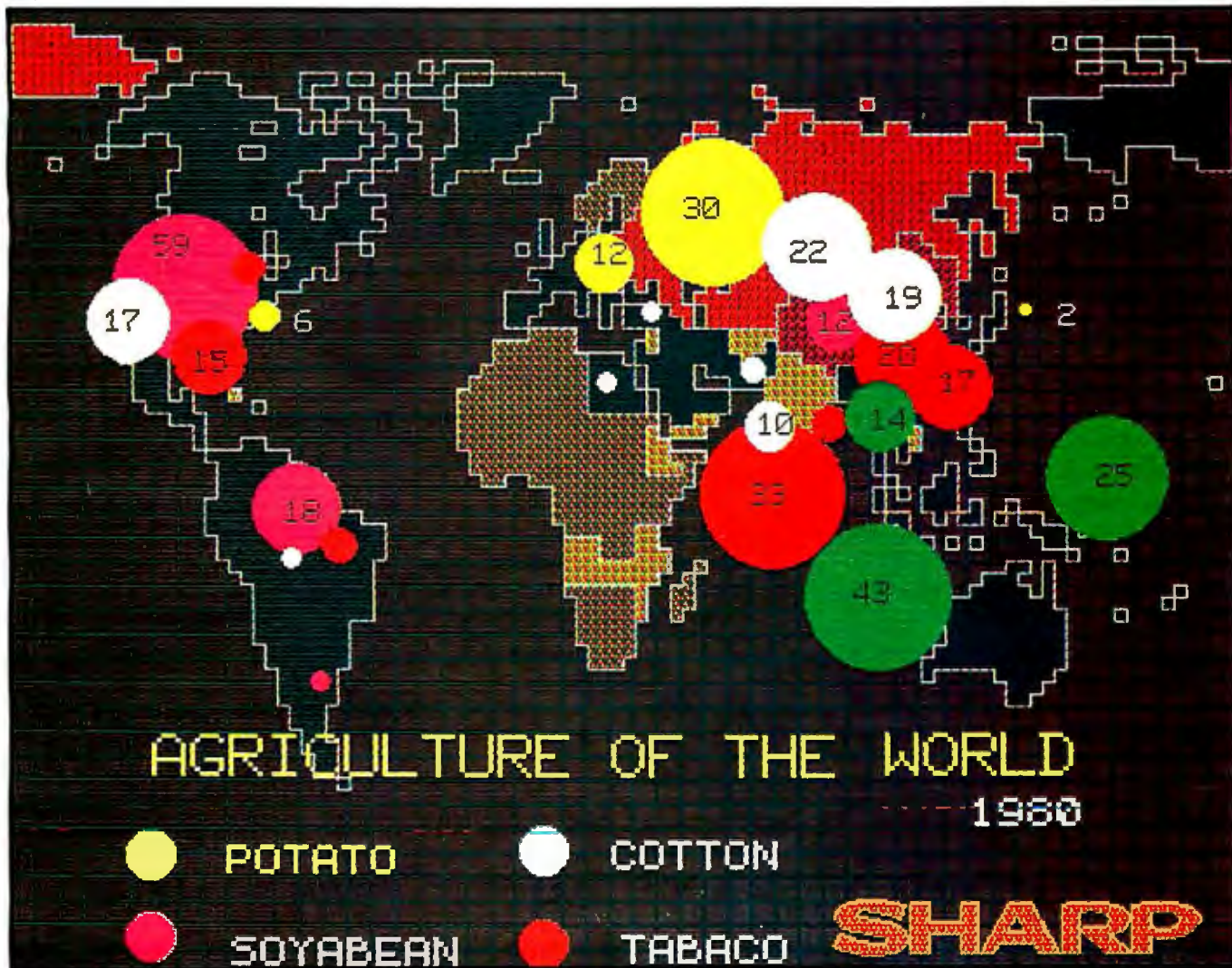

(9b)



Photo 9: Images from the new color printers shown in Tokyo. The resource map in 9a is from Sharp's scanned-head ink-jet printer. The baboon head (9b) was created by a sequential thermal-transfer printer driven by a video-frame-capture device.

ment. A Canon representative said that several companies have begun to design end-market printers using the new mechanism but declined to say who they were.

A number of other developments in print technology were on display at the Data Show, most involving ink-jet and thermal-transfer printing. Both methods are now able to produce remarkably vivid full-color images. Two such images are shown in photo 9.

Storage Trends

The Japanese seem to be paying remarkably little attention to hard-disk storage, certainly nothing like the venture frenzy now being witnessed in this country. A couple of the majors were starting to show expanded-capacity 5¼-inch Winchester disks—up to 40 megabytes—but with business use of microcomputers just now

picking up, it seems that most Japanese customers have yet to discover that they need more on-line storage than they can get with 8-inch floppy disks. Floppy-disk drives are moving forward, however, with the new pre-occupation being *thinness*. Single drives are now available from a couple of manufacturers in a 28.5-mm (1.12-inch) height, and dual drives sharing the same motor are only 40 mm (1.57 inches) high. This would allow you to put *eight* floppy disks in an IBM PC if it had the power to run them. ■

Richard Willis (POB F, Goleta, CA 93116) heads a small consulting firm specializing in electronic systems for production test and control applications. He received his master's degree in electrical engineering from Caltech in 1973 and has been studying Japanese at the University of California, Santa Barbara. He is a member of the Computer and Automated Systems Association of the Society of Manufacturing Engineers.

The User Goes to COMDEX, 1983

by Jerry Pournelle

I think it stands for COMPUTER Dealers EXposition. There's more than one COMDEX now, but the fall meeting, just after Thanksgiving in Las Vegas, is always the biggest, and traditionally it's where the most important new technologies are announced.

Fair warning. This year more than 80,000 attended to see something like 1500 exhibits (see photo 1). Clearly, I didn't look at them all. If I'd spent five minutes at each exhibit, it would have taken me two weeks to cover a five-day show. Thus, I can report only what I saw, and although I tried to find the most significant exhibits,

I may have missed something important.

Second warning. Unlike my columns, in which I report on very little that I haven't tested myself, in show reports I talk about stuff I've seen but not tried. I presume what I saw will work when you get it home, but I can't guarantee it.

The Big Hits

Picking the "best of show" out of a zoo like COMDEX isn't easy; but I've singled out three items worth special attention. Each will be discussed in detail. They are Xerox Americare service, Ovation's wonder-

ful new software, and Helix Labs' PC Bubble Disk.

Getting There Isn't Half the Fun

COMDEX is no place for users. It's too crowded. It's also nearly impossible to get there. My son Alex and I went up on Sunday, the day before the show officially opened. Weeks before, Rick Foss, our crack travel agent, had gotten our tickets. It didn't matter. The PSA flight was oversold. We were squeezed aboard the plane as the last two let on.

Two days before COMDEX we received an Eagle Spirit XL, which is a portable version of the IBM PC XT,



Photo 1: The user's panoramic view of COMDEX.

1500 booths, 80,000 attendees, and, surprisingly, some nifty stuff

complete with a 10-megabyte hard disk. Eagle rushed the Spirit—we've named it Denny Colt—so we could take it to COMDEX.

I was also carrying Adeline, my Otrona. It's not that we didn't trust the Spirit, but I'd never traveled with it before, and I'd really hate being without a machine for a week. If Alex hadn't been with me I'd not have carried both; but it seemed the intelligent thing to do as we left the house.

Hah. It didn't seem so smart when we got on the airplane. Every seat was filled. So was every overhead rack. It turns out that the Apple people couldn't get flights from Silicon Valley to Las Vegas, so they went by way of Burbank—and they had *lots* of equipment. We gulped hard and prepared to stuff the machines under the seats and ride with our knees up to our chins; but that was not to be.

"That won't fit," one harried flight attendant said. "We had one just like it a few minutes ago, and it won't fit."

Now I'd have been much surprised if she'd ever seen an Eagle Spirit before, but there was no point in telling her. She'd made up her mind. We would have to check those computers.

By this time I'd lost most of my composure and a good part of my gruntle as well. My disposition wasn't helped by a mental picture of Adeline and Denny Colt tumbling down a baggage conveyor belt. I explained to the crew that tossing computers about wasn't a particularly desirable thing and sadly watched as they took both machines out . . .

It all came out well. Ms. Carol Franklin, the chief flight attendant, arranged to have a station agent meet the plane and hand-carry our machines. When we reached the hotel both worked flawlessly.

Incidentally, the Spirit *will* fit under both aisle and center seats, as we found when we returned from Las Vegas. You won't be very comfortable if you've legs as long as mine, but it can be done. It will also fit in over-

head storage, provided the airplane *has* overhead racks; the one we returned on didn't.

A Maturing Industry

Sunday evening we registered and cruised through the exhibition hall to establish some landmarks. Monday morning was a press breakfast.

The big announcement was that a full year of Xerox Americare service will now be bundled with each Compro business system sold. Xerox's Joe Cleary, Americare's honcho, had a few words about parts and service; Xerox has stockpiled a *lot* of spare parts for the machines it services. Those include Osborne computers, incidentally. Americare is completely separate from Xerox Computer. It doesn't sell anything but service.

You can buy different packages of services, with options for Americare to come to you, or vice versa, and so forth. The contracts aren't particularly cheap, but you wouldn't expect them to be. The important thing is that you can get service for a wide range of

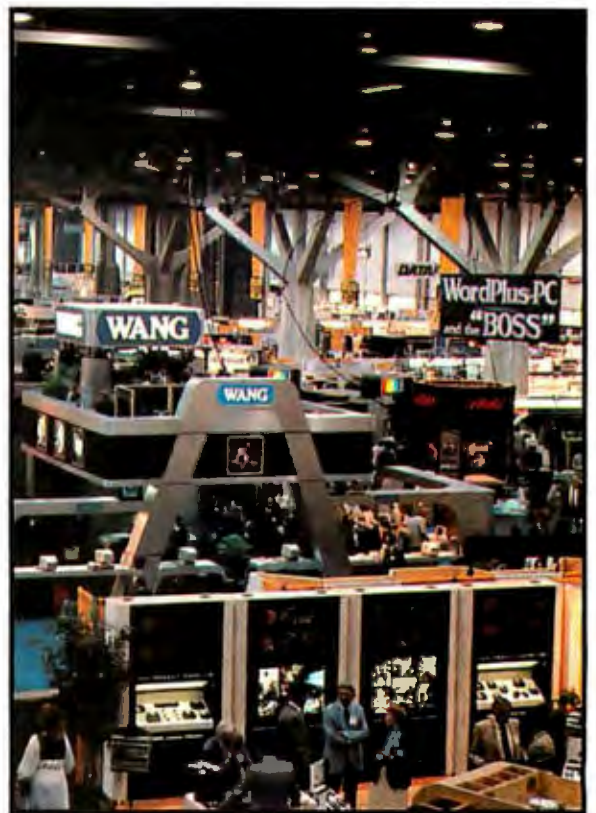



Photo 2: The new and disdained keyboard arrangement from DEC.

machines. (I wish I could list them, but my notes seem to be indecipherable. I'm usually not coherent in the early hours.)

At first thought Xerox Americare didn't seem like big news, but on reflection I think that in its quiet way this was the most important announcement of the show because it's a sign that the micro industry is mature enough to attract not just hobbyists and micro nuts, but small businesses. The availability of skilled outside service means we don't have to stay exclusively with the big companies. It also means the micro customer base is expanding, which means that prices will continue to fall.

It's good news for us all.

PC Compatible

The Las Vegas Convention Center is enormous. In addition, exhibits were also housed in the Sahara and Riviera Hotels, miles from the Convention Center. Not only were all the exhibition halls filled; a dozen smaller halls were also used. Every one of them, as well as the wider corridors, was filled with exhibits.

Half the exhibits were IBM PC look-alikes. I know, that's got to be an exaggeration; there aren't 750 computer companies in the world. Still, a lot of new computers were on

display, and just about every one was billed as IBM PC compatible. "Look!" they exclaimed. "We look just like IBM, only we're *not* IBM. Isn't that amazing?"

I'm not so certain I'd want to be known as an imitator, but most of these companies want that very badly. We can call this "The Compatibility COMDEX." Even the beer and coffee were IBM PC compatible.

Of the PC work-alikes, the Eagle line remains my favorite, partly because I'm most familiar with them—I have both the Eagle 1600 and the Spirit XL—and partly because they go beyond "being just like" the IBM machines. The Eagles are faster and, in my judgment, better engineered.

Of the "just like IBM" machines, the one that most impressed me was the Panasonic. The company claims it's 100 percent compatible with the PC, and one of its salesmen told me he no longer carries software when he goes to demonstrate the Panasonic to dealers; he has them take PC software off their own shelves. He has, he says, yet to find PC software that won't run.

The Panasonic is portable, which is to say it has a handle and can be carried if you don't mind getting muscular biceps. It's *very* competitively priced and should be a real challenge

to the Compaq and other "me-too" machines.

How Are the Mighty Fallen

Digital Equipment Corporation, aka DEC, had a large booth, but I didn't see many people at it. I don't know how many Rainbow computers DEC has sold, but I'd be very much surprised if the number approached Zenith's Z-100 sales.

DEC has come out with yet another lousy keyboard with a big key just to the left of the space bar that transmits a complex escape sequence, the >< key between the Z and the left Shift, bad keys to interfere with hitting Return, and other such insults to touch-typists (see photo 2). DEC claims this keyboard will be standard on all its new offerings, including the new VT-200 replacements for the VT-100 terminal.

DEC is primarily a minicomputer company, of course. Part of the mini tradition is to isolate your customers from anyone else. Use a proprietary operating system, make people run software written just for your machine and useless for any other machine; that way you keep your customers away from the competition.

DEC made it, what with disk formats that no one else can read or write to and its own operating system. True, the Rainbow can run both 8- and 16-bit software, which is a big plus, but on the other hand, little outside software is currently available. DEC wanted to keep its people from using software written for the IBM PC. It succeeded beyond its wildest dreams.

I didn't notice one single exhibit advertise itself as "DEC compatible."

For the Most Important Person in My Life...

Last year we saw laser printers that could also double as your office copier. I had thought they'd be available at reasonable prices by summer, but I never saw any. John Carr, our long-suffering editorial associate, was getting fed up with not having a copier, so we went out and bought one of those Canon machines that you see Jack Klugman advertising.

We love it. It has never failed to work. We never have to mess with

ORDER DESK ONLY
(800) 272-3360
 TOLL FREE IN CALIFORNIA

ORDER DESK ONLY
(800) 292-3360
 TOLL FREE OUTSIDE CALIF.

"WHY PAY MORE" COMPARE THESE PRICES MC-P APPLICATIONS BRINGS SOFTWARE & HARDWARE AT UNBEATABLE PRICES

NO MAIL ORDERS FOR: Lotus 1-2-3

SOFTWARE

	LIST	OUR
APPLIED SOFTWARE TECHNOLOGY		
VersaForm	\$389	\$269
ASHTON TATE		
Financial Planner	700	452
Friday	295	199
BPI ACCOUNTING SYSTEMS		
GL/AP/AR (Each)	395	285
CONTINENTAL		
Property Management	495	327
FOX & GELER Quick Code	295	174
FUNK SOFTWARE Sideways	60	45
HOWARD SOFT		
Real Estate Analyzer II Apple...	199	135
Tax Preparer Apple	199	135
Apple	199	135
IBM	250	165
HUMAN SOFT DB Plus		89
LATTICE C Compiler	700	285
LIFEFREE Volkswriter	195	129
METASOFT Benchmark	499	375
MICROSTUFF Crosstalk	195	129
MICROPRO Spell Star	250	162
Word Star w/Applicard	495	349
Mail Merge	250	162
Super Sort	250	149
Calc Star	145	86
Info Star	495	320
Report Star	350	221
MICROSOFT		
Flight Simulator (IBM)	50	35
Flight Simulator (Apple)		29
Multitool Word W/Mouse	475	339
Multitool Financial	100	69
Multitool Budget	150	99
Pascal Compiler	350	245
C Compiler	500	345
PBL CORPORATION		
Personal Investor	145	98
PETER NORTON		
Peter Norton Utility	80	57
PEACHTREE		
Peach Pack (AR, AP, GL)	595	239
Peach Text 5000	395	245
ROSESOFT Prokey	75	57
SOFTWARE ARTS T.K Solver	299	219
SOFTWARE DIMENSIONS		
Accounting Plus		
GL, AR, AP, PR, INV	495	295
SOFTWARE PUBLISHING		
Pfs:File	140	79
Pfs:Report	125	79
SATELLITE SOFTWARE		
Word Perfect	495	325
SOFTWARE PUBLISHING		
Pfs: File		
Apple	125	85
IBM	140	95
Pfs: Report	125	85
SOFTWARE SYSTEM		
Multimate	495	315
SORCIM SuperCalc II	295	185
SuperCalc III	395	275
SYNPSE File Manager	150	97

LOTUS 1-2-3
\$299⁰⁰
WORD STAR
\$275⁰⁰
DBASE II
\$379⁰⁰
EDIX/WORDIX
\$129⁰⁰
MULTIPLAN
\$168⁰⁰
HOME ACCOUNTANT
\$ 52⁰⁰
BANK STREET WRITER
\$ 46⁰⁰

	LIST	OUR
HAYES MICROCOMPUTER PRODUCTS		
Hayes Stack Chronograph (RS-232)	\$249	185
Hayes Stack Smart Modem (RS-232) 300 Baud	289	199
Smart Modem 1200B		
Smart Modem 1200	699	495
ADVANCED LOGIC SYSTEM (Apple II)		
Z-Card	169	115
Printer Mate (Parallel)	99	55
CP/M Card (W/ CP/M 3.0)	399	315
MICROSOFT		
Softcard (Apple)	345	259
Ram Card (Apple)	100	75
64K Ram Card (IBM)	350	249
MPC PERIPHERALS (Apple)		
Parallel Interface Card (w/Cable)	90	68
MOUSE SYSTEMS		
PC Mouse w/Software	295	218
NOVATION		
Apple - Cat II	389	275
212 Auto Cat	695	595
Smart-Cat 103/121	595	445
Smart-Cat 103	2429	187
PEGASUS		
Hard Disk 10 mgb		1439
PERSONAL COMPUTER PRODUCTS		
Applicard 6 Mhz	375	280
KRAFT & TG Joystick		
IBM	70	49
Apple	65	45
CDC DISK DRIVE		265
VERBATIM DISC		
S/S D/D 10 Pk.	49	24
AMDEK MAI BOARD	599	495
ELECTRONICS PROTECTION DEVICES		
Orange	140	99
Peach	98	69
QUADRAM		
Quadboard 64K	395	295
Quadlink	680	525
MEMORY CHIP SET		
(64K/9 chips)	95	55
PRINTERS		
Mennesman Tally MT 160L	798	669
NEC 7730 RO Parallel	2595	2295
Daisy Writer 2000	1395	1185
Qume 1140	1685	1525
MONITORS		
Amdek 12" 310A	230	185
Quadchrome 17"	695	525
Princeton Graphics RGB Hi Res	795	495

TANDON TM1000-2	
\$219⁰⁰	
OKIDATA 92	
\$479⁰⁰	
AMDEK COLOR II	
HI RES RGB	
\$435⁰⁰	
AST MEGA PLUS 64K	
\$275⁰⁰	
NOVATION J-CAT	
\$105⁰⁰	
EPSON FX 100	
\$735⁰⁰	
HERCULES GRAPHICS CD	
\$369⁰⁰	
KOALA TOUCH PAD	
\$ 95⁰⁰	

WOLF Move-It	199	125
VISICORP		
Visicalc IV	250	175
Visifile (Apple)	250	187
Visifile (IBM)	300	195
VisiSchedule	300	195
VisiWord w/free VisiSpell	375	285
Visitrend/Plot	300	195

CALL FOR SOFTWARE & HARDWARE PRICES NOT LISTED HERE

"INTERNATIONAL DEALER ENQUIRIES WELCOMED"

Circle 226 on inquiry card.

MC-P APPLICATIONS, INC.
 111 W. St. John St., Suite 307
 San Jose, CA 95113 Phone (408) 293-3360
 Telex: 294207 MCPA UR
 HOURS: 8 a.m. to 5:30 p.m. — Mon. - Sat.
 Call for prices in AUSTRALIA
 at 02-929-8468

TERMS: All prices subject to change. Cashier's check/MO/Bank Transfer. Allow time for company or personal checks to clear. Prices reflect cash prepaid discount. VISA/MASTER CARD/COD/PO's -3%. California residents add sales tax. **SHIPPING:** \$4 per item for UPS surface (\$8 for Blue Label); Monitors \$20, Printers \$25, within continental USA.

toner or other copier supplies because the Canon uses a cartridge system that's good for about 3000 copies. When it's used up, you put in a new one. The cartridges cost about \$60 (that's about 2 cents a copy).

We got the model that has a paper-feed system. You can override that by inserting a sheet of paper, which means that you can make it print on both sides of the paper if you like.

We've been very pleased with it.

At COMDEX, Canon announced a laser printer built much like our Canon office copier. It uses the same paper-feed system, including the override feature, so you can hand-feed special paper (or print on both sides). It uses the same cartridge system. I couldn't tell whether the cartridges were identical to those in our copier. I'd be surprised if they were.

The model on display at COMDEX was really nice. It isn't any larger than our daisy-wheel printers, and it's much faster (about 12 pages a

minute). The character set is very nice, and it's certainly a letter-quality printer. There's provision for full fonts: uppercase and lowercase, italics, small capitals, etc., as well as for special graphics, or for that matter, for downloading your own design. It doesn't have a tractor, but it does have a single-sheet feeder.

We've used our Canon office copier long enough to have considerable confidence in the cartridge system and sheet feeder being used.

I liked the Canon enough that I wanted one, but the company isn't selling them yet. All Canon would say is that you should be able to get one by the fall of 1984 and the end-user price will be less than \$4000. Canon doesn't intend to sell direct to end users at all; it will sell the units to other manufacturers for incorporation into systems with a non-Canon brand name. I confess I was considerably impressed. Unless I hear good reason not to, I expect to get one when it comes out; I like the speed, and it's very quiet.

Big Bubbles

There was a lot of new hardware, including machines based on the Intel iAPX186 chip; but what impressed me most was Helix Laboratories' Helix PC Bubble Disk for the IBM PC. (Helix also makes them for Apple II and Iie machines.)

The Helix PC Bubble Disk is a board containing half a megabyte of bubble memory. You drop it into the PC, and the machine thinks this is a fast hard disk. It has its own ROM (read-only memory) aboard to read in the programs required to access it.

Because it's bubble memory, it's nonvolatile. You could even use it to transfer programs from one machine to another. It also has a write-protect switch (accessible from the back of the PC cabinet) and power-failure protection circuitry. Helix wants \$1500 for the 500K-byte board, but when Intel lowers the price of the bubble chips, it expects to cut that by a hundred dollars or so.

We're getting a Helix PC Bubble Disk board, so there'll be a full report

Our Specialty: 68000, 6809 CPU, graphic, database, communication, export

Come visit us in our New York City Showroom *IBM COMPATIBLE

PRINTERS

GEMINI
DIABLO

M.T.

NEC Letter Quality
2050 20 cps for IBM,

3550 35 cps for IBM,

7710 55 cps for serial,

DYNAX HR25 23 cps serial,

DX15 13 cps

COMREX Comwriter II,

C.ITOH F-10 40 cps Excellen,

A-10 18 cps

DIABLO 630 API w/interface,

QUME 11+ 40 cps

50 cps

STAR Letter Type 1

TRANSTAR

MODEMS

HAYES Smartmodem 300/1200 bps 499

Micromodem II w/software . . . 270

NOVATION Smartmodem 300/1200 bps 415

PC cat 300/1200 bps 450

LEXICON 300 bps acoustic coupler . . 125

USR

EDGE software

SANYO MBC 550, 555

TELEVIDEO 1605 256K RAM

ZENITH Dual drives, Color

128K RAM, graphic

ROMEMCO RAM, mon

keyboard, soft

EC AM, Z-80 & 8i

RAINBOW monitor, CP/M, key

EC APC Color APC 128K RA

Dual 8" drives

POWERFUL 68000 CPU

Cromemco 512K RAM 68000 & 4120

CS1D5 Z80 & two floppies

DUAL 68000 CPU, 80MB SMD

hard disk, intelligent I/O,

UNIX, Database

WICAT 1 to 12 users, 68000 CPU,

256K to 4.5MB RAM, 10MB

to 474MB hard disk, graphic

ALTOS, NORTHSTAR, OSM

Amber Monitor: Panas Comrex

HAZELTINE Esprit II 56

Esprit III 625

WYSE 50 585

VISUAL 55 725

QUME VT-100/VT-102 compatible . . 895

102 520

103 132 col. 890

Prices subject to change. American Express, Visa/Mastercard add 3%. F.O.B. point of shipment. 20% restocking fee for returned merchandise. Personal checks take 3 weeks to clear. COD on certified check only. N.Y. residents add sales tax. Manufacturers' warranty only. International customers, please confirm price before order. Accept P.O. from Fortune 500, schools and gov't.

Computer Channel TELEX:
21-55 44th Road 429418

Long Island City, NY 11101 CSTNY

For information CALL (212) 937-6363

To order CALL 1-800-331-3343

Computer Channel

There are a lot of powerful reasons to write software for HP systems.



You're looking at two of them.

An enhanced UNIX™ operating system. And the cash bonuses you'll earn when you sell your UNIX-compatible applications with an HP system.

Those are compelling reasons to participate in HP's special program for software companies.

We have a whole range of products that can run UNIX, from our popular line of MC 68000-based machines to our powerful 32-bit systems. And we'll be expanding that range all the time.

While we're giving you a wider choice of products for your programs, we're also making it even easier for you to write them.

We've developed an especially powerful version of the industry standard UNIX, called HP-UX. Its enhancements provide for graphics, data base management and networking, to name just a few.

When you team up with HP, you have our full service organization behind you. Our factory and field support teams are dedicated to problem-

solving. So, if you or your customers have any questions about HP-UX, just give us a call. We're ready to help.

And we're ready to make your efforts very rewarding. When your customer buys an HP system because of your application, we'll give you a cash bonus of 30% of your software's sales price — up to 6% of the net HP system's price. Our only restriction is that, to qualify for the bonus, your software must sell for at least \$10,000.

There are lots of other good reasons to write HP-compatible software for UNIX or any of our other operating systems. To find out all about them, write to Hewlett-Packard, Attn: Gwen Miller, Dept. 57190, 19447 Pruneridge Avenue, Cupertino, CA 95014. In Europe, contact Henk van Lammeren, Hewlett-Packard Nederlands B.V., Dept. 57190, P.O. Box 529, 1180 AM Amstelveen, The Netherlands.



UNIX is a trademark of Bell Laboratories.

BD02315

in an upcoming column. Meanwhile, I saw it running at COMDEX, and this is my choice for the most exciting new hardware at the show.

Mass Storage

Last year I speculated that if the industry could get together on the size and format of disk drives of 3+ inches, these drives plus memory drives and cartridge hard-disk drives would take over, leaving little place in the market for conventional 8-inch and 5¼-inch floppy disks.

That doesn't seem to be happening. Instead, even someone as conservative as I am now must admit that 5¼-inch technology is reliable and here to stay. That's not optimum, because when they designed 5¼-inch disks they didn't put in communications lines that let the machine know whether there's a disk in the drive. With 8-inch disks there's a hardware method of telling whether the drive is ready; thus, a "drive not ready" error can be compensated for. It's much harder to recover from that kind of error in 5¼-inch disks because there's no way for the machine to determine whether there's a disk present until it actually tries to read it.

Even so, 5¼-inch drives are gaining on the vest-pocket drives. I think that's a shame; the vest-pocket disks are, I think, more convenient, and certainly make for smaller and lighter machines. However, the industry's failure to agree on a standard—at least three sizes and formats are out there, each with powerful advocates—has hurt the vest-pocket disk's chances of taking over. Example: the Jonos, a really nice little portable, began with 3½-inch vest-pocket disks, but it can now be bought with 5¼-inch disks.

Meanwhile, few companies seem to have gone with the 5¼-inch removable hard-disk cartridges. These hold 5 megabytes and looked like a good deal last year, although my engineer friend Tony Pietsch was a bit concerned about some of the technical details. Whether it's spindle wear or something else, I didn't see any removable cartridge systems, although there may well have been

some I overlooked. Certainly, they weren't very much in evidence.

However, Rana did have on display its new 2.5-megabyte 5¼-inch floppy-disk system. This is a special drive that uses a preformatted floppy disk. The formatted floppy disks will cost (initially) about \$15 each. Compare that to \$90 for a 5-megabyte hard-disk cartridge. Also, the Rana drive system will sell for less than removable hard disks. We're getting an early copy of the Rana 2.5-megabyte drive; full report in an upcoming column. Meanwhile, this new development may well be the salvation of floppies for some time to come.

Carrying the Mail

Tony Pietsch contracted with Bill Godbout to furnish WRITE, the text editor Tony wrote more or less to my specifications, for the Compupro 10, a multiuser system better known in my columns by the code name Shirley. Shirley uses the MP/M-8/16 operating system, which has some significantly different quirks from the CP/M 2.2x environment that WRITE was developed in. Tony ground up a new version of WRITE to run on Shirley, but he didn't get finished until the absolute last minute.

He also hadn't arranged for a hotel room. That turned out to be a mistake: nobody was accepting reservations in Las Vegas during COMDEX. Tony didn't want to go up and sleep in the park, so he prevailed on me to carry a copy of WRITE for Shirley, which I duly did. Of course, there were a couple of system options and switches that had to be set right, and nobody knew how to do that, so it took a couple of phone calls to Pasadena to get WRITE going; but by Monday afternoon, I could see WRITE running on four different terminals, all powered by the same central machine.

Interestingly enough, running four at once didn't slow things down at all; at least I didn't notice anything, with one exception. When you write to the hard disk, you have to wait your turn; so if two users try to save text at the same time, one has to wait while the other gets done. Even with waiting it takes about as long to save

on Shirley as it takes me to save onto floppies with my single-user system.

A Standing Ovation

Ovation Technologies has what may be the best microcomputer software I've ever seen.

I met Robert Kutnick, Ovation's director of development, at the Tandy press breakfast. The Ovation software was running on one of the new Tandy 2000 machines. Alas, I was more concerned with talking with the Tandy design people—on that, see below—and thus never saw a demonstration of Ovation with that machine. However, Dr. Kutnick was kind enough to give me a ride from Caesar's Palace, where the breakfast was, to the Convention Center, and during the ride he invited me to come see Ovation's product.

I went more out of gratitude for the ride than anything else. I don't usually watch software demonstrations; I prefer to get the stuff to Chaos Manor and bang on it myself. Worse, Ovation didn't even have its software running in its exhibit booth; for marketing reasons I don't need to understand, it was exhibiting the Real Thing only up in its suite in the Hilton.

It's nearly impossible to get anywhere in the Hilton during COMDEX. There aren't enough elevators, and there are too many people looking for free dinner and drinks at hospitality suites. However, the Ovation suite was on the same floor as the Xerox Americare party I was going to, so it wasn't hard to stop by, which I did, and wow! am I glad.

Ovation has a combination text editor and spreadsheet that interact so that the overall effect is wonderful.

Let me describe. You write a letter. In the letter you put some numbers. Now you go through and put the cursor on each number. You can give that number a *variable name*. The name is known to the computer; the number in the letter stays the same. But *now* you can redefine that variable as, say, the sum of some other variables. When you do, *kazango!*, the number is changed in the letter.

There's more. Now assume you want to make a graph. You use the



WITH THE PASSWORD™ MODEM AND TELPAC™ BEN FRANKLIN COULD HAVE PUBLISHED THE FRIDAY EVENING POST.

The Password™ modem and Telpac™ software deliver text fast, far, cheap, and letter-perfect. Fast? Ten times faster than an expert typist (and four times faster than most other modems). Far? Crosstown or crosscountry. Letter perfect? Multiple accuracy checks of your text are just one editorial benefit. Cheap? Thousands of words by phone lines, for less than express mail. And if the text is to be typeset,

the cost will be half or less—the proofreading zero!

Password is USR's virtually automatic modem: 300/1200 baud, auto dial/answer, auto mode/speed select, two-year warranty. \$449.* Telpac, the USR friendly telecommunications software package,

\$79. Write or call for complete descriptions—both Telpac and Password do far more than this!



U.S. ROBOTICS INC.

1123 WEST WASHINGTON • CHICAGO, ILLINOIS 60607
(312) 733-0497

*Suggested list for Password complete with power adapter, phone cable, RS232 interface.

Password, Telpac, and USR logo are trademarks of U.S. Robotics Inc.

Circle 362 on inquiry card.

TOTAL CONTROL

FORTH: FOR Z-80®, 8086, 68000, and IBM® PC

Complies with the New 83-Standard

GRAPHICS • GAMES • COMMUNICATIONS • ROBOTICS
DATA ACQUISITION • PROCESS CONTROL

● **FORTH** programs are instantly portable across the four most popular microprocessors.

● **FORTH** is interactive and conversational, but 20 times faster than BASIC.

● **FORTH** programs are highly structured, modular, easy to maintain.

● **FORTH** affords direct control over all interrupts, memory locations, and i/o ports.

● **FORTH** allows full access to DOS files and functions.

● **FORTH** application programs can be compiled into turnkey COM files and distributed with no license fee.

● **FORTH** Cross Compilers are available for ROM'ed or disk based applications on most microprocessors.

Trademarks: IBM, International Business Machines Corp., CP/M, Digital Research Inc., PC/Forth+ and PC/GEN, Laboratory Microsystems, Inc.

FORTH Application Development Systems include interpreter/compiler with virtual memory management and multi-tasking, assembler, full screen editor, decompiler, utilities, and 130 + page manual. Standard random access files used for screen storage, extensions provided for access to all operating system functions.

Z-80 FORTH for CP/M® 2.2 or MP/M II, \$50.00;
8080 FORTH for CP/M 2.2 or MP/M II, \$50.00;
8086 FORTH for CP/M-86 or MS-DOS, \$100.00;
PC/FORTH for PC-DOS, CP/M-86, or CCPM, \$100.00; **68000 FORTH** for CP/M-68K, \$250.00.

FORTH + Systems are 32 bit implementations that allow creation of programs as large as 1 megabyte. The entire memory address space of the 68000 or 8086/88 is supported directly

PC FORTH + \$250.00
8086 FORTH + for CP/M-86 or MS-DOS \$250.00
68000 FORTH + for CP/M-68K \$400.00

Extension Packages available include: software floating point, cross compilers, INTEL 8087 support, AMD 9511 support, advanced color graphics, custom character sets, symbolic debugger, telecommunications, cross reference utility, B-tree file manager. Write for brochure.



cursor to open a hole in the letter; that's where the graph will be printed. Now you put the cursor on each number you want to be in the graph, or specify the variable name associated with the number; touch a special function key; and, kazango!, there's your graph, right there in the middle of the letter.

Suppose it was a pie graph and you decide to change to a bar graph. Nothing to it. Now, use the cursor to change one of the bars on the graph—and the number in the text instantly changes to match it!

There's more, but you get the idea.

I don't recommend that people go out and buy software until I've had a chance to wring it out, examine the documents, test it at boundaries, and the like. On the other hand, Ovation isn't ready to sell the program this week anyway.

We're getting Ovation here Real Soon Now. I can hardly wait. It's potentially the most powerful micro software I've ever seen; and it's real easy to use, too. Before you buy a spreadsheet or text editor for your IBM PC, do try to look at Ovation. You might like it.

Tandy Strikes Again

Tandy introduced its Model 2000 at a press breakfast in Caesar's Palace. After speeches by at least four different people, each of whom repeated what the last one had said, they literally unveiled the machines, which had previously been covered with a tablecloth.

It's nice-looking equipment.

The Tandy 2000—there's nowhere on it the words "Radio Shack"; apparently the company is a bit concerned about its image with the business community, as indeed it darned well ought to be—uses an Intel iAPX186 chip. The "one-eight-six," as it's known in the development community, is one of Intel's 8086 family. It will run any software developed for the 8086 and 8088 chips. It also has some unique instructions of its own, and it's a lot faster than the 8086 or 8088.

What this means is that any PC-DOS software that's hardware independent (not written specifically to

Business as Usual?

Business as usual these days means a computer that's up and "humming." But if your computer were stolen or damaged, you wouldn't have business as usual.

YOU'D HAVE TROUBLE!

You can get fast replacement for your entire system and be back in business in a hurry by protecting your computer with SAFEWARE Personal Computer Insurance. It's the only coverage designed specifically for personal computers used for business — in your office, shop or home.

SAFEWARE protects ALL hardware, ALL purchased software and ALL media against theft, damage or any other kind of loss, regardless of use, after a low \$50 deductible.

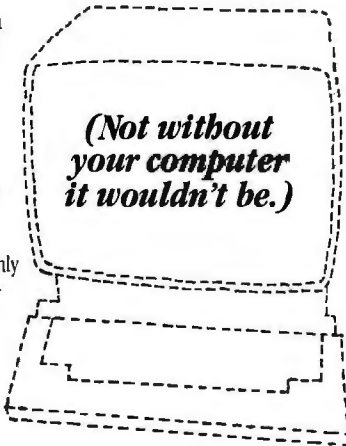

Fast, courteous claims handling prevents your losing valuable business computing time.

Find the premium price for the coverage you need listed in the table below, available for as low as \$35 per year. Fill in the coupon today. Your coverage will begin as soon as your coupon application is received. Or for even faster coverage, call our toll free number:

1-800-848-3469

(In Ohio call 1-614/262-0559)
Phones open 8 a.m. to 8 p.m.
Monday through Saturday

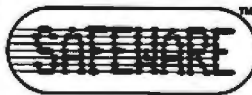

Mail to: SAFEWARE, P.O. Box 02211, Columbus, OH 43202.

Before I'm out of business,

please issue my SAFEWARE Insurance Coverage.

Name _____

Street _____

City _____ State _____ Zip _____

System value \$ _____ Check SA MasterCard

Card # _____ Exp. Date _____

Total Hardware, Media & Software System Value	Annual Premium
\$ 2,001-\$ 5,000	\$ 60
\$ 5,001-\$ 8,000	\$ 75
\$ 8,001-\$11,000	\$ 90

Call toll-free for rates on higher coverage. Coverage differs in Texas. It's an underwriting requirement that you insure your system for its full value.

BYT

Self-dFENSE™ for EDP managers.

The micro invasion has begun. And, chances are, you've now got a lot of different people in a lot of different departments using a lot of different micros.

Now there's a way for you to control and maximize the benefits of all the different micros in your domain.



Fight back with dBASE II.®

dBASE II is the relational database management system from Ashton-Tate that enables you to manage your micro-based corporate data resources with the high level of consistency and sophistication you've enjoyed with mainframe and minicomputer systems.

Armed with dBASE II and the dBASE II RunTime™ program development module, you can write programs which will enable micro users in each department to "do their own thing" while creating complete database consistency throughout the company.

dBASE II is a powerful, flexible way for you to effectively manage the micro proliferation.

Help is here.

If you'd like to know more about how dBASE II and RunTime can help you win the micro management battle, contact Ashton-Tate today. 10150 West Jefferson Boulevard, Culver City, CA 90230. (800) 437-4329, ext. 212. In Colorado (303) 799-4900. In the U.K. (0908) 568866.

ASHTON · TATE ™

dBASE II is a registered trademark and RunTime is a trademark of Ashton-Tate.
Suggested retail price for dBASE II is \$700.
© Ashton-Tate 1984

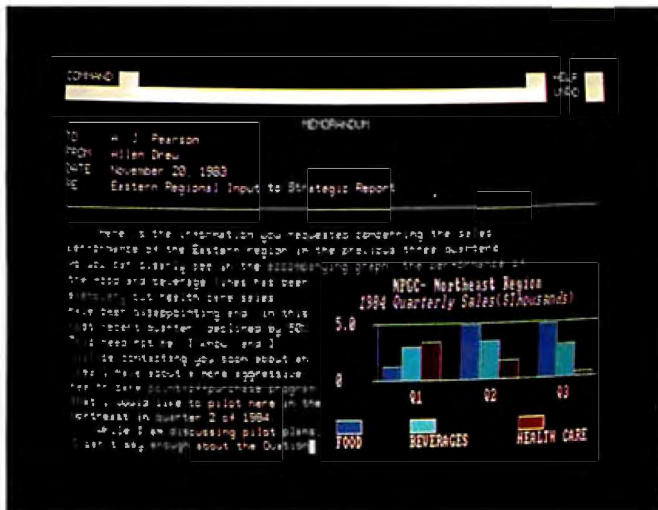

Photo 3: Color graphics on the Tandy Model 2000. Monochrome is standard, but color doesn't cost much more. The Model 2000 shows all the signs of being a great success if the Radio Shack image can be overcome. But can Tandy get enough 80186s to build the 2000?

make use of the IBM PC's graphics and such like) will run with the Tandy 2000. However, there may be problems with some copy-protected software.

The machine will be described in great detail in other BYTE articles, so I'll only mention my impressions. (See "The Tandy TRS-80 Model 2000" on page 306.)

First, we liked the color graphics (see photo 3). The machine seems fast, and it does a nice job with its extensive color capabilities. Alex will probably have more to say on that; he's the graphics freak in Chaos Manor.

Second, it looks like a good, well-made machine, with good all-around capability.

Incidentally, the Tandy 2000 is going with Microsoft operating systems, including Xenix. It's my impression that more companies are drawing away from Xenix, which is a Microsoft "sort of Unix," than are adopting it.

Zenith

Zorro, our Z-100, has become a workhorse here, so I was glad to see new Zenith products. The most impressive was a 25-inch RGB (red-green-blue) monitor. It was displaying Microsoft's new Windows program on a Z-100. Believe me, a 25-inch monitor is *big* (see photo 4).



Photo 4: The Zenith 25-inch RGB monitor. The Zenith Z-100 is running Microsoft's Windows program. You can read it from across the booth. Zenith also showed its newest 13-inch RGB monitor intended for both Zenith and IBM products.

Zenith also announced an 8087 board for the Z-100. Jim Hudson, who developed the 8087 math board for our Compupro, also has an 8087 for the Z-100. The Zenith one is much simpler, only four chips; Hudson's board uses an S-100 slot and contains 256K bytes of memory. We're getting both boards, so I'll be able to report on them in a future column. Meanwhile, there's a growing list of software that makes use of the 8087. It's a worthwhile capability if you do any number crunching at all; the 8087 does floating-point arithmetic about a zillion times faster than the 8086.

Meanwhile, the Hudson and Zenith boards have different niches, and I expect them to coexist.

Alex notes: "Zenith put a quieter fan on its new Z-100s. Even in the noise and haste of COMDEX it was noticeable." That makes me wonder if I can get one of the new fans and retrofit it; we like Zorro, but he is a bit noisy. Alex also notes that the new ROMs and BIOS (basic input/output system) for the Z-100 are much advanced over the versions we have, and it's time to update. Apparently Zenith has made update offers to people who bought its machines, but since Zorro still belongs to Zenith Data Systems we don't always get the notices, alas.

It wasn't at the Zenith booth, but we saw the Macrotech 1-megabyte

memory board working in a Z-100. Macrotech's memory still has the lowest cost per kilobyte, as far as I can tell, anyway.

We continue to hear the rumor that Zenith will come out with a Z-100 with a detached keyboard, but there was no sign of one at the show. Maybe it is just a rumor after all.

MPI

Zenith also had the Printmate 150 printer in its booth. This is our favorite dot-matrix printer, for reasons I've given in the column. Having an outside printer in a Zenith booth is a first, since previously only Heath stores carried the Printmate.

MPI, "The Printer People," was displaying the Sprinter in its own booth. The Sprinter is a small portable printer. Like the Printmate 99, it can take tractor feed or single sheets of paper such as letterhead; and like the 150, it has the capability for up to 68K bytes of print buffering.

The Sprinter comes in a hard shell case and is designed to be rugged enough to go as checked luggage. John Matlock of MPI has taken his on three trips now and swears that the only signs of travel are some black marks on the case. I was supposed to receive a demonstration model of the Sprinter at COMDEX so I could test that myself, but Alex and I were so burdened with stuff that we just

The difference

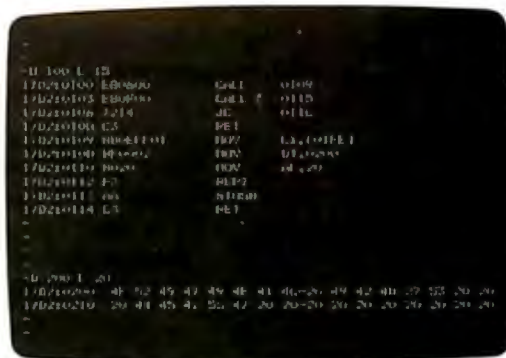

Original IBM Debug Program

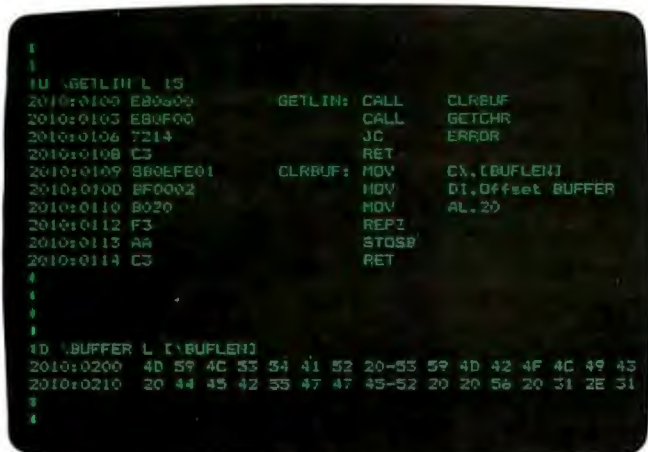

Mylstar Symbolic Debugger V1.1

is Mylstar's Symbolic Debugging Program*

The plain and simple difference is that Mylstar's Symbolic Debugging Program speaks to your IBM PC in a language you both can understand, plain and simple.

Employing the same command structure, it allows you to use symbol names, mathematical expressions, batch files, on-line help, multi-command macros and other time-saving entries.

It's the enhancement to the *IBM Debug Program* you've been looking for—because it fills in the gaps—shortening the frustrating debugging process by as much as 50%—leaving you more time to do the work you need to do and the work you want to do, plain and simple.

Mylstar's Symbolic Debugging Program has been programmer-tested for over a year at Mylstar Electronics, Inc., (formerly D. Gottlieb & Co.), designers of the video arcade game, Q*BERT™

TO ORDER...
Call (312) 562-7400 or mail coupon today.

*Designed for IBM PC-DOS 1.1 with 128K RAM minimum



**MYLSTAR
ELECTRONICS
INC.**

165 West Lake Street
Northlake, Illinois 60164

A Columbia Pictures Industries Company

Mylstar Electronics, Inc.,
165 W. Lake St., Northlake, IL 60164

Please send me Mylstar's Symbolic Debugging Program for use with the IBM PC computer. Enclosed is \$125, plain and simple.

Check Money Order

115

NAME _____

FIRM _____

ADDRESS _____

CITY _____

STATE _____

ZIP _____

Illinois residents add 7% sales tax
Allow 2-4 weeks for delivery

couldn't carry anything more. MPI is shipping one instead, and I'll carry it on my next few lecture tours. I continue to be impressed with MPI's printers.

The portability of the Sprinter generated some humorous advertising, including buttons that said "Handle me," and "Pick me up," and "I'll go with anybody," which seemed a bit daring for a Salt Lake City firm . . .

Teletype

Teletype is back in micro land with a terminal. It's a bit expensive, about \$1500, but it has a number of pages, lots of memory, and lots of features. It may well be worth it.

When I went into the Teletype exhibit area, I was approached by a young salesman.

"I want a five-level Baudot machine," I said wickedly.

He was completely nonplussed. Fortunately, a sales manager was nearby, who said, "In the Smithsonian, I imagine."

After all, in the early days of the micro revolution, old Teletype elec-

tromechanical bangers were often the only terminal equipment we could get, which is why one of the "devices" in CP/M is to this day the TTY: or Teletype. It's also why to this day some programs have the Delete key "echo" the deleted letter; if you're

Because the Hilton exhibit area is in a direct line between the Hilton lobby and the main Convention Center, it was always full of traffic.

using the Teletype as a console, it has to be that way because a TTY can't backspace.

Alas, for all its early dominance, Teletype didn't understand what was happening and made no concessions to the micro revolution; and whereas most micro people owned some kind of Teletype device early on, it wasn't long before the micro community had left the company behind.

I don't really miss the sound of the

old TTY banging away, and I'm sure glad I don't have to remember what five-level Baudot is; but I'm also glad to see Teletype coming back. It's like welcoming the return of an old friend.

The Mad Computer

The Mad machine was over in the Hilton exhibition hall; this was exceedingly hard to get to because the security people *never* let us in before show hours, and because the Hilton exhibit area is in a direct line between the Hilton lobby and the main Convention Center, it was always full of traffic. I very nearly didn't go in there at all.

Alex did get there, and persuaded me to go see the Mad computer. He votes the Mad "best-looking computer in the show," and says, "It has one well-kept secret: it has IBM slots in it. Another module can hold four more IBM PC cards. Because it uses the Intel iAPX186 chip, it can't use IBM memory boards (because the 186 is a true 16-bit device, and Big Blue stayed with an 8-bit bus). Most other

AN ORDINARY DISK
CAN TAKE YOUR
BUSINESS AND
ZAR NOUC BO
NOR ZIBE DAG.

expansion boards should work fine."

Alex also noted, "The gimmicks for Mad are impressively different: modularity and ergonomics. The basic computer has two modules: the computing module and the data module. The computing module has the processor, memory, two serial ports, one parallel port, video, and keyboard interface. The data modules contain either two half-high IBM-type floppies or one floppy and a 10-megabyte hard disk. Of course, you can buy the hard-disk module later and run both. Interestingly, the hard disk is powered by the main computer.

"The Mad's screen has 720- by 350-dot resolution; add more RAMs, get more resolution. The keyboard (and the whole computer) conforms to European ergonomics standards, but it still looks good. It has a Selectric keyboard layout, without extra keys in the wrong places. If you're looking for a machine that will look good in the office while working well, look at the Mad."

I did note that Mad claims high

compatibility with the IBM PC, while running much faster than the PC. It certainly is a handsome machine. Alex and I played about with one for a while, and it's quite fast. Like the Eagle, it's an improvement on the PC rather than just a copy.

Mad claims high compatibility with the IBM PC, while running much faster; like the Eagle, it's an improvement on the PC rather than just a copy.

Networks

A number of networking systems were on display; so many that Alex makes them (along with windows) one of the two themes of this year's COMDEX.

Networking is a subject of sufficient complexity that I want to deal with it in the column rather than in a show report. For here, I'll just report that there are a lot of ways to get computers to talk to each other,

and no one standard method has emerged.

This was one of Bill Godbout's laments at his press breakfast. CompuPro has taken a firmly wishy-washy stand on networks by cutting holes and covers for a bewildering variety of plugs and jacks and sockets on the back of its machines. Godbout did cite some studies that indicate that perhaps the best network arrangement is nodal, with perhaps four machines connected together into a node, then one connection from that to similar nodes. The CompuPro 10 is a four-user system, which isn't a total coincidence.

Corvus, meanwhile, has taken a firm stand for Omninet. No wonder, since it's its baby. Omninet has the advantage that the cable connecting systems is simple—just twisted pairs of wires—and the maximum distance between nodes can be about 2000 feet. This is almost as long as Ethernet, which uses coaxial cable and is 10 times as fast but more than twice as expensive. We have a Corvus system here, and we're beginning to

Let the gibberish stop here.

The TDK No-Risk Disk.SM

Because no matter how many times you play it, the TDK No-Risk Disk won't scramble your thoughts or play games with your words.

Not once. Not ever.

Our lifetime replacement warranty guarantees that.

And our almost 50 years of experience in developing superior magnetic recording products support that.

That incidentally is more than you can say for any other disk.

Bringing us to our point.

Don't play games with an ordinary disk.

When you can play for keeps with an extraordinary disk.



TDK offers a complete line of the most popular disks in 5¼- and 8-inch formats.

TDK. THE NO-RISK DISK.SM

string twisted pairs of wire from the back room to my office, so we'll be able to report in detail later.

Meanwhile, there's no agreement on what will be *the* network; but there's wide agreement that networking is desirable.

Bottom Line

COMDEX is huge. If you don't believe that, consider that I was a week in Las Vegas and didn't manage to make one single wager. Now true,

I'm hardly a gambling man, but I do like to buy about \$50 worth of chips and shoot craps until it's gone; but not this time. Between the breakfasts and the evening receptions and the dinner parties, I found COMDEX all work and very little play.

It's a strenuous show, and I don't recommend that readers go to it; but it's a must for anyone trying to keep up with this bewildering world of microcomputers.

Onward and upward. I love it. ■

Jerry Pournelle welcomes readers' comments and opinions. Send a self-addressed, stamped envelope to Jerry Pournelle, c/o BYTE Publications, POB 372, Hancock, NH 03449. Please put your address on the letter as well as on the envelope. Due to the high volume of letters, Jerry cannot guarantee a personal reply.

Jerry Pournelle is a former aerospace engineer and current science-fiction writer who loves to play with computers.

Products Mentioned

Canon U.S.A. Inc. One Canon Plaza Lake Success, NY 11042 (516) 488-6700	Laser Printer	MPI 4426 South Century Dr. Salt Lake City, UT 84107 (801) 263-3081	Printmate 99 Printmate 150 Sprinter
Compupro 3506 Breakwater Court Hayward, CA 94545 (415) 786-0909	Compupro 10 WRITE	Otrona Corporation 4755 Walnut St. Boulder, CO 80301 (303) 444-8100	Attache Computer
Corvus Systems 2029 O'Toole Ave. San Jose, CA 95131 (408) 946-7700	Omninet	Ovation Technologies 770 Dedham St. Canton, MA 02021 (617) 821-1420	Software
Digital Equipment Corporation 146 Main St. Maynard, MA 01754 (617) 897-5111	Keyboard	Panasonic Consumer Products One Panasonic Way Secaucus, NJ 07094 (201) 348-7000	Panasonic Computer
Eagle Computer 983 University Ave. Los Gatos, CA 95030 (408) 395-5005	Eagle 1600 Series Eagle Spirit XL	Rana Disk Systems 21300 Superior St. Chatsworth, CA 91311 (818) 709-5484	2.5-megabyte System
Helix Labs 16776 Bernardo Center Dr. Ste. 106A San Diego, CA 92128 (619) 451-0270	Helix PC Bubble Disk	Tandy Corporation One Tandy Center Fort Worth, TX 76102 (817) 390-3011	Model 2000
Jonos Ltd. 1835-A Dawns Way Fullerton, CA 92631 (714) 999-6661	Jonos Computer	Teletype Corporation 5555 West Touhy Ave. Skokie, IL 60077 (312) 982-2000	Terminal
Macrotech International Corporation 20630 Lassen St. Chatsworth, CA 91311 (818) 700-1501	Memory Board	Xerox Service Group Xerox Square 025 Rochester, NY 14644 (716) 423-5078	Americare
Mad Computer Inc. 3350 Scott Blvd., Bldg. 13 Santa Clara, CA 95051 (408) 980-0840	Mad Computer	Zenith Data Systems 1000 Milwaukee Ave. Glenview, IL 60025 (312) 391-8865	Color Monitors

See Software.

Dick is a programmer. Dick is bored. Harried. Dick struggles with trace chores. Debugging routines. Nonexistent documentation. Hidden bugs. So Dick is four months behind schedule. And customers are upset when bugs slip through. They yell and make Dick upset. They make Dick's boss upset. Nobody is very happy.



See Software Run.

Jane is a happy programmer. She uses ANIMATOR.[™] It's a visual programming aid for Micro Focus COBOL. It runs on a micro. It makes child's play of test and debugging tasks.

With ANIMATOR Jane sees a picture of the program explaining itself. In real time. In COBOL source code. ANIMATOR tracks the program's exact execution path. Including subroutine branches. Jane can have the program run fast. Or slow. Or stop. With one key. This makes it easy to spot problems. Insert fixes. Set breakpoints. Instantly.

Jane's programs are best sellers. They're delivered on time. With no hidden bugs. Jane's boss likes this about Jane. Because he doesn't like customers to yell at him.

Run, Software, Run.

This software vendor just went public. Because he doubled productivity. Eliminated bugs. Cut costs. Produced terrific applications. Beat the competition to market. And customers don't yell at him anymore. All thanks to ANIMATOR.



See ANIMATOR now.

Let ANIMATOR help you do better work. And speed your applications to market. For detailed information or a demo, contact:

MICRO FOCUS

2465 East Bayshore Road
Palo Alto, CA 94303
(415) 856-4161

© 1983 Micro Focus Inc.

THE *first* **BYTE**



COMPUTER SHOW

Chicago
McCormick Place
May 10-12, 1984

Welcome to the new computer shows designed specifically for BYTE subscribers. . .the *BYTE Computer Shows*. The first will be in Chicago's McCormick Place on May 10-12, but you don't have to travel cross-country to get there—others will be held this year in San Francisco, Boston and Los Angeles.

The *BYTE Shows* will be "selling" shows—where you can buy, not just look. *BYTE* subscribers will enjoy special reduced admission prices to all *BYTE* shows, and conference seminars. Those seminars will be targeted to the interests of *BYTE* subscribers, and led by such *BYTE* favorites as

Jerry Pournelle.

The *BYTE Shows* will be professionally produced by The Interface Group—the same pros who bring you the Comdex Shows. Their show know-how, combined with *BYTE*'s editorial expertise, will make the *BYTE Shows* ideal information centers and shopping marts for *BYTE* subscribers.

More details on *BYTE* subscriber benefits will be coming to you by mail. But plan now to be in Chicago May 10-12, or at the *BYTE Show* nearest you!

BYTE
the small-systems journal



Pascal's Design Flaws

Modula-2 Solutions and Pascal Patches

*A description of seven subtle problems with Pascal,
and a look at how Modula-2 avoids them*

by Mark C. Johnson and Allen Munro, Behavioral Technology Laboratories

Niklaus Wirth was only warning to the task of creating the perfect programming language when he developed Pascal. If you regularly program in Pascal you probably have pet peeves about its "bugs" or "gaps"—the design flaws of the language that you encounter again and again. Pascal, like other languages originally designed to teach computer programming, has several serious deficiencies. Wirth's newest structured language, Modula-2, remedies some of Pascal's flaws and also provides mechanisms to enforce modular program design more strictly than does Pascal.

The most important components of Modula-2 are not its ability to "fix" Pascal's structure, but rather the features associated with the concept of the module. Modules provide for secure independent development of different portions of a program in a way that Pascal constructs do not. Even those Pascal implementations that provide separately compiled units such as the UCSD (University of California at San Diego) p-System do not provide for truly modular development.

Our focus here, however, is not

Modula-2's underlying design concepts. Instead, we want to examine some of the flaws of Pascal, to see how Modula-2 solves them, and also to show how working Pascal programmers get around these flaws. In addition, our analysis should help you form some opinions on the value of the Modula-2 compensations for some of Pascal's design flaws.

Pascal's Seven Deadly Sins

We will examine seven separate problems with Pascal with different degrees of detail. Many of the solutions may be familiar to you, but you may find a useful Pascal trick or two that you haven't encountered elsewhere. While some of the problems are straightforward, others are more subtle and may call for more than one solution, each appropriate in a different programming context. For each language-design flaw, we present first the nature of the problem, then the approach taken in Modula-2, and finally one or more Pascal methods for getting around the difficulty.

Short-Circuited Boolean Expression Evaluation

For processing a Boolean expres-

sion (e.g., in an IF statement), the Pascal-language definition does not permit what we call short-circuited evaluation—cessation of the evaluation when the expression is false. In fact, in most implementations, evaluation of a Boolean expression proceeds inexorably from left to right until the end of the expression. This can be inefficient, because the result of a Boolean expression can often be determined without a complete evaluation. Encountering a false part on one side of an AND expression means the result will be false, regardless of the complexity of the other side. For example, consider:

```
IF FALSE AND
  (
    (A=B) OR (B=C) OR (C=D) AND
    (ARCTAN(X*Z) / 99.0 = 22.0)
  )
THEN DO_SOMETHING;
```

Clearly, the procedure DO_SOMETHING will never be invoked because of the false on the left side of the AND. In Pascal, the right side will be evaluated anyway, which is inefficient.

In the same manner, a true condition on one side of an OR expression

forces an expression to be true, regardless of the other side. In the statement below, DO__SOMETHING will always be called:

```
IF TRUE OR
(
(A=B) OR (B=C) OR (C=D) AND
(X*2/ 99.0= 22)
)
THEN DO__SOMETHING;
```

In addition to being inefficient, full Boolean evaluation causes problems when part of the expression is undefined. For example, suppose you wish to see if someone struck the Escape key. You might use the following code:

```
READLN(STRNG);           {STRNG is
                          declared STRING}
IF STRNG[1]=CHR(27)      {Escape is
                          ASCII 27}
THEN WRITE('Escape was
detected!');
```

This works fine, unless the user hits Return without entering anything. In such a case, the variable STRNG has a length of zero and that causes a value-range error for the IF statement. In Modula-2, this problem is easily avoided with the following test for the length of the string:

```
IF ( LENGTH(STRNG)< >0) AND
( STRNG [1]=CHR (27) )
THEN WRITESTRING('Escape was
detected!');
```

If the first part of the IF expression, LENGTH(STRNG)< >0, is found to be false, then the evaluation is short-circuited, and the second conjunct is never evaluated. This prevents a reference to STRNG[1] that produces an error.

If you attempt such an approach in UCSD Pascal, you will discover, to your dismay, that the compiler generates code that blindly evaluates the entire expression. Even when the first part is false, the second conjunct will be evaluated, despite the fact that "FALSE AND X" must always be false, regardless of the value of X. In this Escape-detection example, the Pascal code still produces a value-

range error.

One well-known substitute for AND expressions in Pascal is to use two IF statements as below:

```
IF ( LENGTH(STRNG)< >0 ) THEN
IF ( STRNG[1]=CHR(27) ) THEN
WRITE('Escape was detected!');
```

If the first IF is false, then the second IF will not be evaluated. Thus, for AND-type expressions, the Pascal programmer can simulate a short-circuited evaluation of the Boolean expression.

Short-circuited evaluation works equally well with OR conjuncts in Modula-2. In Pascal it is necessary to

If you attempt such an approach in UCSD Pascal, you will discover, to your dismay, that the compiler generates code that blindly evaluates the entire expression.

find a way to replace the OR expression with nested IF statements in order to prevent the unwanted evaluation of its second part. If the first conjunct is true, there is no need to evaluate the second, since the entire expression must be true.

Suppose you want to call procedure WHATEVER if the user either types the Escape key followed by the Return key, or if just "Return" is entered. In Modula-2, short-circuiting makes the following statement a good solution:

```
IF (LENGTH(STRNG)=0)
OR (STRNG[1]=CHR(27))
THEN WHATEVER;
```

In Pascal, to accomplish the same result, code like this must be used:

```
IF LENGTH(STRNG)=0
THEN WHATEVER
ELSE IF STRNG[1]=CHR(27)
THEN WHATEVER;
```

Here, the second conjunct is the IF expression of the IF statement embedded in the IF statement of the first conjunct. A match for either IF expression results in WHATEVER, but the second IF expression is evaluated only if the first is false.

To get the same results provided by the short-circuited evaluation of expressions in Modula-2, you have to put forth more effort in Pascal and the end result is not as readable.

Machine-level Access

One of the goals of high-level languages is to avoid machine-dependent code. Machine-independent programs are both more portable and more reliable than machine-dependent programs. Of course, in the real world you often find yourself forced to access actual machine addresses, or call subroutines contained in ROM (read-only memory) at some machine address. Since machine independence is a fundamental principle of Pascal, the language has no explicit way to access machine addresses, as BASIC does with PEEK and POKE.

In Modula-2, the standard data-type ADDRESS is provided to enable access to particular locations in memory. ADDRESS is defined as a pointer to a word, so it is machine-dependent—word size is, after all, a machine-dependent quality. Suppose that a variable SOMEADDR is defined as an address and assigned a particular address value. An operation like PEEK can be performed simply by looking at the value of the word pointed to by SOMEADDR:

```
SOMEWORD := SOMEADDR ^;
```

To perform the equivalent of a POKE statement, you simply assign an address to a variable of the ADDRESS type and then assign a word to the location pointed to by the address:

```
SOMEADDR := 28990;
SOMEADDR ^ := SOMEWORD;
```

The ADDRESS data type permits the assignment of cardinal values—those between zero and MaxCardinal—directly to its variables.

ANNOUNCING THE INSIDE STORY ON DATA SPEC™ CABLES.

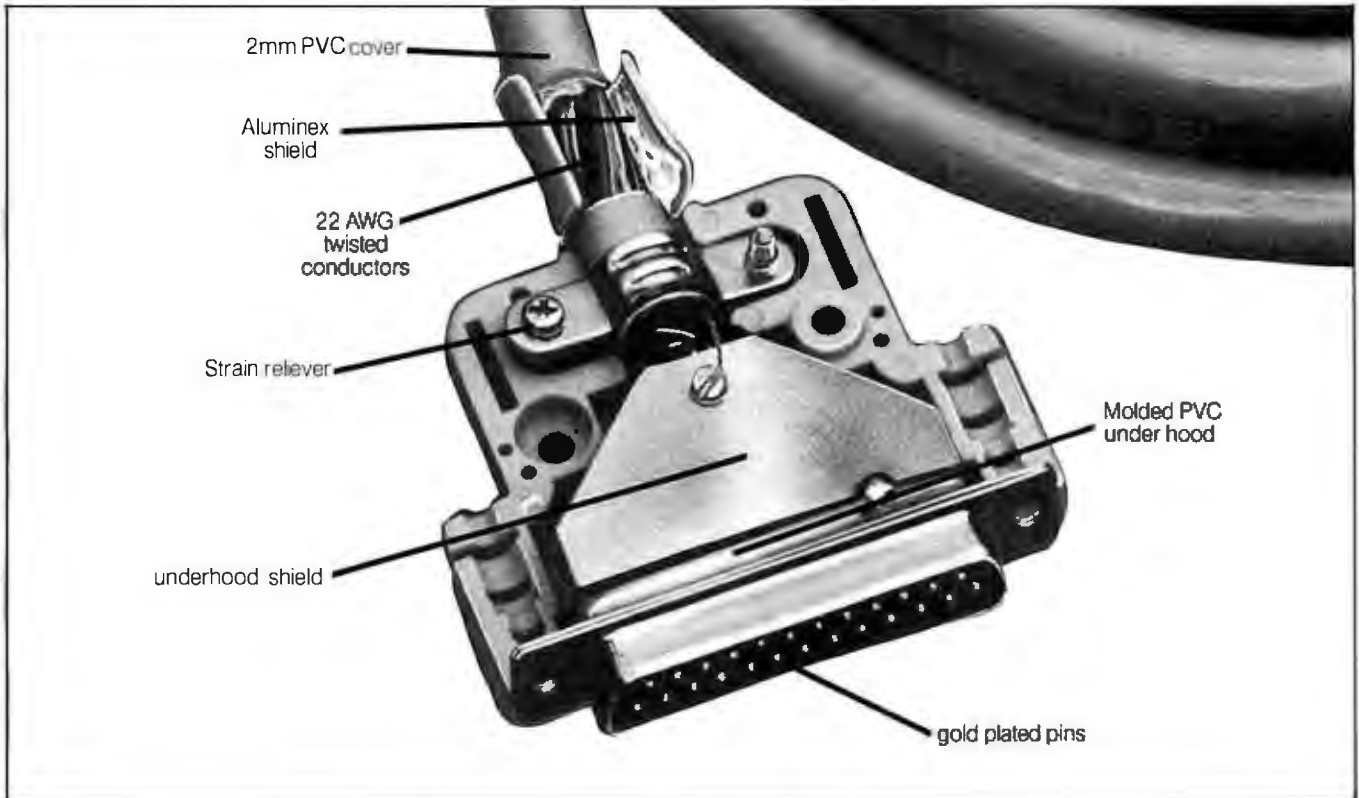

Take a look at the picture above. The shielding under the RS232 connector hood of DATA SPEC™ cables is different from anything you've seen before. No flimsy foil. Or painted hood. Instead, DATA SPEC™ gives you an extra heavy gauge shield under the normal hood which ensures that the cables exceeds the FCC requirements on emission standards.

And, if you look further inside, under the shield, you'll see the advent of PDT™* Technology. DATA SPEC™ cables are the first to employ this technique outside of aerospace applications. PDT Technology ensures that you will never have to solder a broken joint or even open the hood.

However, the biggest news is actually the littlest part of the story. The price.

You can find out about it at your dealer who carries DATA SPEC™ products. Modern manufacturing techniques have made DATA SPEC™ cables priced lower than lesser quality shielded cables.

DATA SPEC™ cables. There's more to it than meets the eye.

*PDT (Poly-vinyl doping technique) involves the injection of poly-vinyl under the shield to fuse the conductors and pins together, thus ensuring reliability under the most adverse conditions. PDT is a registered trademark of Advanced Tool Technology Inc.

DATA SPEC™

THE FAMILY OF HIGH INTEGRITY COMPUTER SUPPORT PRODUCTS.

18215 Parthenia Street, Northridge, 91326 CA (213) 701-5848

Circle 111 for Dealer inquiries.
Circle 112 for End-User inquiries.

Listing 1: Calling a machine-language program in ROM from an assembly-language procedure designed to be linked to Pascal as an EXTERNAL procedure.

```
{Pascal program which calls a routine at C005 Hexidecimal}
PROGRAM trycall;

PROCEDURE CALL(LOCATION: INTEGER); EXTERNAL;

BEGIN
CALL(-15104); {-15104=C500Hex address of ROM in slot 5}
END.
```

Below is the external assembly procedure which calls a routine at the address passed to it.

```
.MACRO POP ;Stores 1 word off stack
PLA
STA %1
PLA
STA %1+1
.ENDM

.MACRO PUSH ;Loads 1 word onto stack
LDA %1+1
PHA
LDA %1
PHA
.ENDM

.PROC CALL,1 ; {procedure call(addr: integer)}

CALLADDR .EQU 0 ; must be page zero address
POP RETURN ; save return to PASCAL
POP CALLADDR ; save ADDRESS to be JSR
JSR @CALLADDR ; jump saving return (call) to address in
; CALLADDR
;do any other special stuff here
;that may be needed before return to
;pascal, if this is not a general-purpose "caller".

PUSH RETURN ; Push return address to Pascal
RTS ; Now back to Pascal

RETURN .WORD ; Temporary area for return address
.END
```

Modula-2 implementations may optionally provide a facility to specify a fixed address for a variable when it is declared. This feature has the following form:

```
VAR KEYBOARDSTATUS [28990]:
CARDINAL;
```

Another example of machine-level access is provided in the Volition Systems' implementations of Modula-2 that permits the use of CODE procedures. A CODE procedure's body consists of a sequence of machine-code instructions and operands. Because a p-machine approach is used in these implementations, such a procedure consists of p-code instructions rather than the machine instructions of the actual central processing unit. This means that such CODE procedures can give access

only to the pseudomachine; it would be interesting to see this capability in a native machine implementation of Modula-2.

Standard Pascal provides no direct means for achieving low-level machine access. Fortunately, there are ways around the problem. A pointer variable in Pascal—as in Modula-2—is a variable that can access actual machine addresses. Suppose we want to PEEK address 23120. We could declare a variable such as IPTR to be an ^INTEGER (pointer to an integer). If we could make the assignment

```
IPTR:=23120,
```

we could print the value contained in that location with the statement

```
WRITELN('Value at address 23120
is=', IPTR ^);
```

The catch here is that strong type checking in Pascal forbids the assignment of 23120 (an INTEGER type) to IPTR (an ^INTEGER). Using variant records, however, you can define two types of elements that share the same memory location. Define one of the elements to be an INTEGER and the other to be a POINTER to an INTEGER:

```
TRICK: RECORD CASE BOOLEAN OF
TRUE: ( I: INTEGER );
FALSE:( IPTR: ^INTEGER );
END;
```

Now, make the assignment

```
TRICK.I:= 23120;
```

Since TRICK.I and TRICK.IPTR share the same location in memory, we in fact have assigned 23120 to IPTR as well. Thus IPTR^ refers to the contents of 23120, the desired result.

This technique lets us simulate PEEK and POKE statements in Pascal. But suppose we have a subroutine contained in a ROM that we wish to call. Pascal has no direct analog to the call to an address that BASIC provides. The UCSD implementations, however, make it possible to link an externally assembled subroutine to a Pascal program. Such an EXTERNAL assembly-language routine can actually perform the call to the ROM address. Figure 1 gives a sample program using this technique.

An option to include in-line native-code procedures would probably be more convenient in Pascal than separately linked assembled code, such as that in figure 1. But at least it is possible to use native code modules in Pascal implementations such as UCSD's.

Pascal Lacks Open Array Parameters

How many times have you, as a Pascal programmer, wished you could write a procedure or function that could take arrays of some base type as parameters without regard to the bounds of the array? Wouldn't it be nice to be able to write a single procedure that sorts an array of inte-

The latest software production solution from FORMASTER

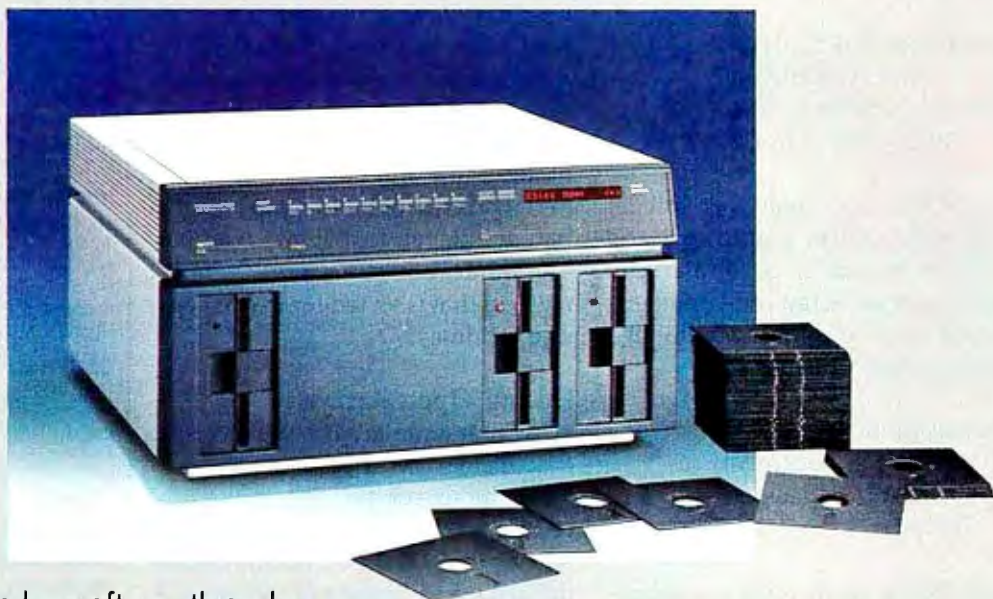

If you're trying to mass produce software through a time-consuming microcomputer operation...or think that high performance diskette duplication equipment is too expensive...you're looking at the solution. The FORMASTER™ Series Two.

The only intelligent, all-format duplicator with speed, copy accuracy, and low cost.

The same state of the art technology you find in FORMASTER Series One systems that are processing millions of diskettes around the world has been built into the Series Two. Features like the unique flexibility to intelligently write and verify all 5¼" or 3½" diskette formats, including complex GCR formats such as Apple, Commodore, and Victor.

The Series Two has the speed and copy accuracy to reduce your production costs. Up to 120 fully verified copies per hour. And you're assured of superior copy quality with bipolar bit-slice verification technology, self-checking memory and electronics, and time-proven operational software. You can even adjust production yields for different grades of media.

Best of all, it's extremely simple to use. With load-and-go Program Disks from FORMASTER's library of over 200 formats, it's like running an office copier.



The FORMASTER Series One intelligent diskette duplicator produces up to 326 fully verified copies per hour, with CopyLock™ piracy protection and copy serialization added automatically.

The right combination for piracy protection.

Like the Series One, the Series Two fills the hardware role in FORMASTER's unique CopyLock™ software protection process. The special CopyLock diskette signature simply cannot be reproduced by the end user's computer. Offered in both turn-key and custom versions for most popular computers, no other technology gives you the value-added security of CopyLock's combination hardware/software piracy protection, the most effective type of solution available today.



And if you need a larger-volume production solution...

The FORMASTER Series One product line now includes an integrated automatic loader with a new jam-proof design that handles up to 300 diskettes without operator attention.

These are just the latest solutions from FORMASTER to make software production easier—and more profitable. Call us at (408) 942-1771 and see how we can help you be successful in the software business.

FORMASTER

CORPORATION

1983 Concourse Dr., San Jose, CA 95131. (408) 942-1771. Telex 466462.
FORMASTER U.K. Corporation: Milton House, 172-184 Bath Road, Slough, Berks. SL1-3XE,
England, Tel. (0753) 820981, Telex 925-859

The Leader in Software Production Technology

Reps wanted

gers into ascending order or that prints out an array of strings, no matter how many elements the array has?

If you write a procedure SORT__INT(A), that sorts an array of integers, your procedure declaration might begin:

```
PROCEDURE SORT__INT
  (VAR A: ARRAY50);
(*Type ARRAY50 declared as
  ARRAY[1..50] of INTEGER*);
```

Here SORT__INT will sort integer arrays with a lower bound of 1 and an upper bound of 50. But if you need to sort an array of 51 integers, you will have to declare the following new procedure:

```
PROCEDURE SORT__INT
  (VAR A: ARRAY51);
(*Type ARRAY51 declared as
  ARRAY[1..50] of INTEGER*);
```

Pascal forces us to redo the whole procedure we wrote for sorting 50 integers in order to sort an array of 51 integers.

This approach wastes programmer time and computer memory. It also discourages the writing of modular code for use in more than one program. It would be better if we could write a procedure that sorts integer arrays of any length, place it in a system library, and retrieve it for use in later programs. Without this capability, programmers are forced to write special-purpose code each time an integer array of different length is to be sorted. There are also the attendant risks of error that otherwise would not be present if a well-tested library module could be used for the same purpose.

Modula-2 permits the use of open array parameters. An open array parameter is one that specifies the base type of the array (INTEGER, in the case of the proposed SORT__INT procedure) without constraining the bounds of the array. In Modula-2, the opening of the SORT__INT declaration could be

```
PROCEDURE SORT__INT
  (VAR A: ARRAY OF INTEGER);
```

Whatever the upper and lower bounds of the actual array parameter passed to SORT__INT, within the procedure they will be considered to be 0..HIGH(A), where HIGH(A) is the number of elements in the array.

As much as a Pascal programmer might wish for open arrays, they aren't available in Pascal. There are ways, however, to get some of the advantages of the Modula-2 open array concept within Pascal. Two methods are illustrated here. One is quite simple, but does not lend itself to the practice of building user-transparent independent library modules. The other requires a more complex method that is suited for use in separate modules.

Faking Open Arrays

In order to write a Pascal procedure that operates on arrays without specifying the size of the array in the procedure declaration, you must pass two arguments—the first element of the array and the size of the array. A trick must be employed to access other elements of the array, given the first element.

The simple method requires that the programmer using the sort procedure define a variant record.

```
TYPE SINGLE__ELEMENT:
  ARRAY [1..1] OF INTEGER;
```

then:

```
VAR INTVARIANT: RECORD CASE
  INTEGER OF
    0: (I__ARRAY: ARRAY[1..50] OF
      INTEGER);
    1: (I__ELEMENT: SINGLE__
      ELEMENT);
END;
```

INTVARIANT is a variant record that can contain either an array of fifty integers or a single element array. The two variants of INTVARIANT, I__ARRAY and I__ELEMENT, share the same location in memory. Now we can pass I__ELEMENT to the sort procedure in order to get at the elements of I__ARRAY.

Within the sort procedure you must turn off range checking in order to refer to elements outside the

Where to buy Toshiba for peanuts.

EASTERN

R & D/CAMELOT ASSOCIATES, INC.
Northampton, MA (413) 253-7378
DIGITAL ENTRY SYSTEMS
Waltham, MA (617) 899-6111
MICROAMERICA (800) 343-4411
Framingham, MA In MA (617) 877-8500
CYBER/SOURCE
Southfield, MI (313) 353-8660
GENERAL BUSINESS COMPUTERS, INC.
Cherry Hill, NJ (609) 424-6500
MONROE DISTRIBUTING COMPANY
Cleveland, OH (216) 781-4600
ROBEC DISTRIBUTORS
Line Lexington, PA (215) 822-0700

SOUTHERN

MICROAMERICA (813) 623-6526
Tampa, FL In FL (800) 282-3385
MICROAMERICA (800) 241-8566
Norcross, GA In GA (404) 441-0515
MICROAMERICA (800) 638-6621
Rockville, MD In MD (800) 492-2949

CENTRAL

TEK-AIDS INDUSTRIES, INC. (312) 870-7400
Arlington Heights, IL or (800) 323-4138
KALTRONICS DISTRIBUTORS, INC.
Northbrook, IL (312) 291-1220
MICROAMERICA (800) 323-6827
Schaumburg, IL In IL (800) 942-4690
GENERAL MICROCOMPUTER
South Bend, IN (219) 277-4972
MIDTEC ASSOCIATES dba CRYSTAL COMPUTERS
Lenexa, KS (913) 541-1711
B & W DISTRIBUTORS
St. Louis, MO (314) 569-2450
SMC INTECH SYSTEMS CORP.
Carrollton, TX (214) 446-9055
COMPU SHOP
Richardson, TX (214) 783-1252
MICROAMERICA (800) 527-3261
Richardson, TX In TX (800) 442-5847
SYSPRINT, INC.
Richardson, TX (214) 669-3666

WESTERN

PG.I. CORPORATION
Tempe, AZ (602) 968-3168
MICROAMERICA (800) 421-1485
Carson, CA In CA (800) 262-4212
BYTE INDUSTRIES, INC. (415) 783-8272
Hayward, CA or (800) 972-5948
outside CA (800) 227-2070
PREMIER SOURCE DISTRIBUTING
Irvine, CA (714) 261-2011
CYPRESS DISTRIBUTING COMPANY, INC.
San Jose, CA (408) 297-9800
PARAGON SALES, INC.
San Jose, CA (408) 263-7955
MICROWARE DISTRIBUTORS, INC.
Aloha, OR (503) 642-7679
ANACOMP, INC. (206) 881-1113
Redmond, WA or (800) 426-6244

CANADA

PWT COMPUTER GROUP
Mississauga, Ontario (416) 624-7455

OR THESE TOSHIBA AMERICA, INC. REGIONAL OFFICES:

177 Madison Avenue, Post Office Box 2331R
Morristown, NJ 07960 (201) 326-9777
662 Office Parkway, The Colonnade Building
St. Louis, MO 63141 (314) 991-0751
2555 Cumberland Parkway, Suite 285
Atlanta, GA 30339 (404) 434-3891
18017 Sky Park Circle, Suites P and Q
Irvine, CA 92714 (714) 250-0151

TOSHIBA

Circle 355 on inquiry card.

Toshiba introduces a great new printer.



For peanuts.

If you're anxious to show off your new Junior, PC, Apple,[®] or any other micro without shelling out a lot, we modestly offer this suggestion: try Toshiba's spectacular new P1340 printer.

The new P1340 offers many superior features found in Toshiba's deluxe P1350 series. But now you can have them for peanuts: \$995 suggested list price.

Just like the P1350 series, P1340 performance begins with Toshiba's pioneering 24-pin print head. So you get letter-quality printing at dot matrix speed. Instead of spinning your daisy wheels at 40 cps, the P1350 series prints 100 cps in crisp, clear letter mode. And at 61

cps, the new P1340 still outpaces daisy wheels by 50 percent.

In draft modes, these Toshiba printers accelerate even more. The P1350 series speeds to 192 cps. And the P1340 hustles along at 93.

Just like the P1350 series, the P1340 prints high-resolution 180 by 180 dot-per-inch graphics. So your micro can really show its stuff.*

For even more flexibility, the P1350 series and P1340 with Qume SPRINT 5™ emulation handle all popular word processing programs. Now you can have multiple fonts, pitches, line spacing and compressed print. Plus true proportional spacing on the P1340.

Then, for ease of paper handling,

there's no match for our ultra-reliable paper feeders. The P1340 features friction feed with a built-in forms tractor. Friction feed is also standard on the P1350 series. But for even more versatility, you can add an optional forms tractor or automatic sheet feeder.

So learn more about Toshiba's P1350 series today. And while you're at it, check out the new P1340, our performance printer for peanuts. It's as easy as calling one of the distributors listed here. Or phoning toll-free 1-800-457-7777, Operator 32.

*Graphics from IBM PC and many other micros to P1350 series and P1340 utilize PaperScreen with color graphics adapters. Apple[®] is a Registered Trademark of Apple Computer, Inc. SPRINT 5™ is a Trademark of Qume Corporation. ©1983 Toshiba America, Inc.

In Touch with Tomorrow

TOSHIBA

Information Systems Division, TOSHIBA AMERICA, INC.



IEEE-488

High Speed Interfaces
for Personal Computers

IBM PC™

IBM PC Compatibles

RAINBOW 100™

Zenith Z-100™

TI professional

Language Support—BASIC,
C, FORTRAN, Pascal, Assembly

Operating Systems—PC DOS,
MS-DOS, CPM 86/80, Z DOS, UNIX

Software Compatible with our
family of IEEE-488 Interfaces
for VAX, PDP-11, LSI-11, S-100
BUS, STD BUS, SBX, and
Multibus-computers.



NATIONAL INSTRUMENTS

The Leader in IEEE-488
Computer Interfaces

12109 Technology Blvd.
Austin, Texas • 78727

800/531-5066 • 512/250-9119

Rainbow™ is a trademark of Digital Equipment Corp.
IBM PC™ is a trademark of International Business Machines.

Listing 2: A program demonstrating calls to a general sort module depending on a user-supplied interface mechanism. To use the sorting procedure `PASC_INT_SORT` to sort a different array of integers, a separate variant declaration, similar to that of `INVARIANT`, is required.

```
PROGRAM VAR_ARRAY_DEMO;

TYPE SINGLE_ELEMENT = ARRAY[1..1] OF INTEGER;

VAR INTVARIANT: RECORD CASE INTEGER OF
    0: ( I_ARRAY: ARRAY[1..50] OF INTEGER); (*actual array*)
    1: ( I_ELEMENT: SINGLE_ELEMENT); (*to satisfy Pascal*)
END;

I: INTEGER;

PROCEDURE PASC_SORT_INT (VAR ITEM: SINGLE_ELEMENT; ARRAYSIZE: INTEGER);
(* This procedure sorts an array of integers by increasing value,
using a selection sort technique. *)
VAR I,J,TEMP: INTEGER;
BEGIN
    (*$R- must turn off range checking *)
    FOR I:=1 TO ARRAYSIZE-1 DO
        FOR J:=I+1 TO ARRAYSIZE DO
            IF ITEM[J] < ITEM[I] THEN
                (*ITEM[J] smallest so far. Exchange w/ ITEM[I]*)
                BEGIN
                    TEMP:= ITEM[I]; (*save element I in temp*)
                    ITEM[I]:= ITEM[J]; (*put element J into element I*)
                    ITEM[J]:= TEMP; (*put temp into element J*)
                END;
            (*$R+ may turn range checking back on*)
        END; (*PASC_SORT_INT*)
    END;

BEGIN (*MAIN*)
    FOR I:=50 DOWNT0 1 DO INTVARIANT.I_ARRAY[I]:=50-I+1;
    WRITELN('Sorting array I_ARRAY. Please wait...');
    PASC_SORT_INT(INTVARIANT.I_ELEMENT, 50);
    :
    :
    :
END. (*MAIN*)
```

bounds of the variant passed, `I_ELEMENT`. For example, the procedure `PASC_SORT_INT` shown in listing 2 turns off range checking so that it is possible to refer to elements of `I_ELEMENT`, even though `I_ELEMENT` is only a single element array. In the body of `PASC_SORT_INT`, `ARRAYSIZE` is used to check that the upper boundary of the actual array is not exceeded. (In Modula-2, a separate size parameter need not be passed, since the standard procedure `HIGH()` is used to return the upper bound of an array.)

This method is quite easy to implement. Unfortunately, it requires that the programmer consciously engage in variant record trickery every time the general procedure for sorting integers is to be used. Every time, you've got to declare the array to be sorted, not as a straightforward array, but rather as a variant record, with one variant the actual array to be sorted. Is there a way to imitate open

arrays in Pascal without having to make a variant record declaration global to the call of the sort procedure?

Invisible Open Array Trickery

There is a somewhat more complicated approach that conducts its dirty work invisibly to the calling program or procedure. With this technique, an independent library module such as that given in listing 3 simulates `PEEK` and `POKE` statements to place values in the array. You do not have to be aware of the variant record tricks to use this library unit.

The success of the invisible approach to imitating open arrays depends on the version of Pascal employed for the program. As it happens, in the UCSD Pascal Version II.0 implementation (and its offspring, Apple Pascal), the address of the leftmost `VAR` parameter of a procedure is placed in the memory location immediately before the location re-

Text continued on page 382

NO COMPROMISES. TRUE CP/M® FOR YOUR IBM PC® WITH THE BYAD DS2



DS2

True CP/M with No Compromises

Now, without the pain of rewrite or special translations, thousands of true CP/M applications are at your command with BYAD's DS2 plug-in expansion system.

BYAD has designed the DS series to run on the smallest, single drive 48K IBM PC or look alike system. With a single cold boot, the familiar CP/M prompt appears on the terminal, delivering 64K additional RAM and the basis for your use of programming languages, word processing software and business application packages.

How It Works

When the DS series disks are booted, the operating system becomes CP/M 2.2. The DS2 Z80 co-processor and the IBM PC's 8088 microprocessor run as a distributed processing system with the Z80 becoming the host CPU and the 8088 an intelligent I/O processor.

The DS2 also contains an IBM compatible RS-232, RS-422, and 20ma current loop lines.

The I/O processing system (8088 and memory) is totally interrupt driven, fully buffered, and uses DMA transfers to and from the Z80 host in addition to the printer, serial I/O, and the keyboard type-ahead buffers. The I/O system uses track and directory buffering which greatly enhance the performance of the large CP/M library.

Utility Software Support

Two, single sided diskettes supply the DS series software. One diskette contains the CP/M 2.2 operating system configured for BYAD's DS2 hardware along with all CP/M utilities (SUBMIT, PIP, STAT, etc.). The second diskette contains BYAD's additional utilities and BIOS documentation. Although all of BYAD's software has been designed to run on a single drive system, the programs will take advantage of the second drive and additional memory if available. The following is a listing of the major utilities supplied.

SETUP	Configure system
FORMAT	Format disk
COPYDISK	Copy diskette
FILECOPY	Copy a file using a single drive
FILEX	Copy CP/M files compatible with the IBM drives
TRANSFER	Move files between two CP/M systems
MAKEDOS	Convert CP/M to PC-DOS 1.1
GETDOS	Convert PC-DOS 1.1 to CP/M

For more information about no compromise CP/M for your IBM, call or write these BYAD DS2 authorized representatives:

In USA

Multi-User Computer Systems
Suite 200-12
5151 Adanson Road
Orlando, Florida 32804
305 629-1718
305 774-4427

In Canada

M.C.P. Micro-Computer
Products Inc.
620 View Street Suite 216
Victoria, British Columbia
V8W 1J6
604 382-4363

BYAD

BYAD Inc.

95 West Algonquin Road
Arlington Heights, Illinois 60005
312 228-3400

CP/M® is a registered trademark of Digital Research.

IBM® is a registered trademark of International Business Machine Corporation. Circle 50 on inquiry card.

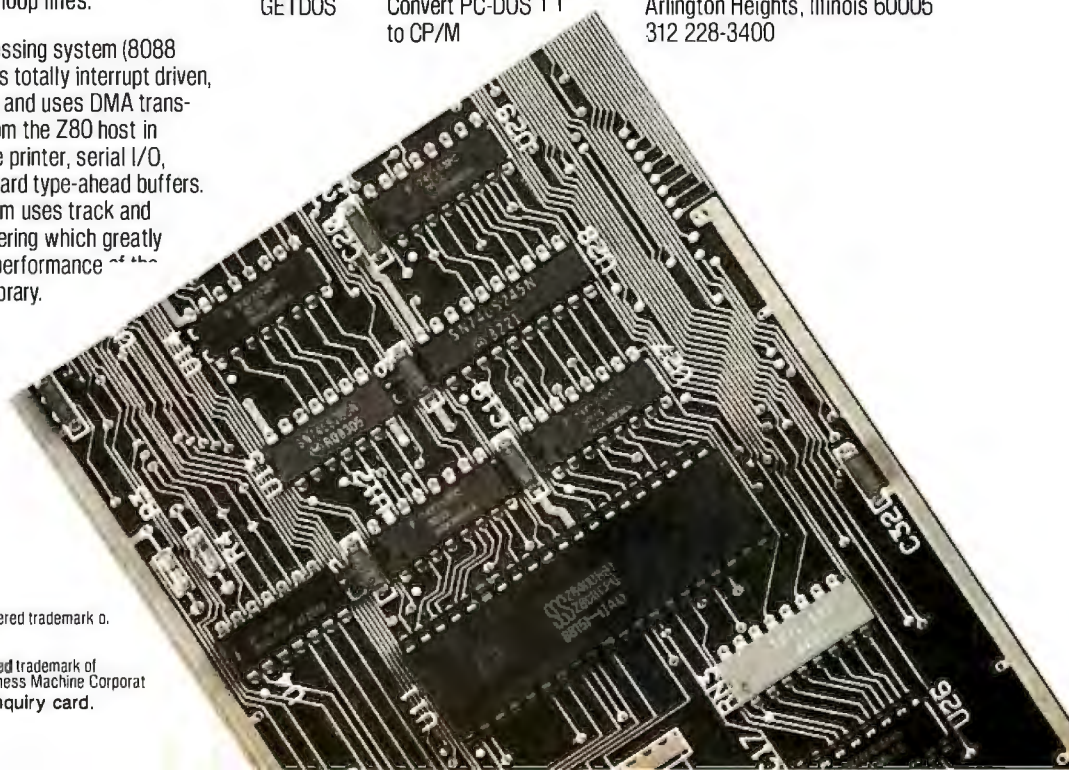

SPECTACULAR OFFERS

wabash

6 YEAR WARRANTY

M11	5 1/4"	SINGLE SIDE SINGLE DENSITY	1.49*
M13	5 1/4"	SINGLE SIDE DOUBLE DENSITY	1.89*
M14	5 1/4"	DOUBLE SIDE DOUBLE DENSITY	2.79*
M16	5 1/4"	DOUBLE SIDE QUAD DENSITY	4.19*
F111	8"	SINGLE SIDE SINGLE DENSITY	1.89*
F1312	8"	SINGLE SIDE DOUBLE DENSITY	2.39*
F144	8"	DOUBLE SIDE DOUBLE DENSITY	2.99*

maxell

LIFETIME WARRANTY

MD1	5 1/4"	SINGLE SIDE DOUBLE DENSITY	2.09*
FD1-128	8"	SINGLE SIDE DOUBLE DENSITY	3.49*

BASF

2 YEAR WARRANTY

54968	5 1/4" ss,dd	1.79*
53428	8" ss,dd	1.89*

BASF

LIFETIME WARRANTY

54974	5 1/4" ss,dd	2.19*
54998	8" ss,dd	2.29*

TDK

LIFETIME WARRANTY

2501	5 1/4" ss,dd	2.19*
2801	8" ss,dd	3.59*

Memorex

1 YEAR WARRANTY

3481	5 1/4" ss,dd	1.99*
3062	8" ss,dd	2.09*

3M

LIFETIME WARRANTY

744D-0	5 1/4" ss,dd	1.99*
740-0	8" ss,dd	2.30*

FUJI

LIFETIME WARRANTY

MD1D	5 1/4" ss,dd	2.19*
FD1S	8" ss,dd	3.09*

WE ALSO STOCK AT FANTASTIC LOW PRICES



Floppies, Tape, Data Cartridges, Data Cassettes, and Disk Packs

* QUANTITY 100. SMALLER QUANTITIES ADD 5%

DISK DRIVE HEAD CLEANING KITS
5%
15.95

C-10 CASSETTES
Get 8 cassettes, and Cassette/8 Library-Album **8.00**

SMART POWER CENTER
Turn one outlet into six!
Power Surge Control
RFI Filtration
15 Amp Circuit Breaker **59.95**

LIBRARY CASES
8" Kas-sette/10 **2.99**
5 1/4" Mini Kas-sette/10. **2.49**

BOOK VALUES

FULL SELECTION, DISCOUNT PRICES

on hundreds of titles published by ALFRED, HAYDEN, DILITHIUM, SAMS, TAB, MCGRAW HILL and many others.

SOFTWARE

AT FANTASTIC PRICES SAVE UP TO 50% on thousands of software packages for all systems, including Business, Language, Engineering, Games, Graphics, Utility, and many more.

• Written purchase orders accepted from government agencies and well rated firms for net 30 day billing • International orders accepted with a 15.00 surcharge for handling, plus shipping charges. • C.O.D. requires a 10% deposit. • We accept Visa, Mastercard, Money Orders, and Certified checks. • Checks require bank clearances. • All shipments F.O.B. San Diego. • Minimum shipping and handling 2.00, minimum order 10.00. • California residents add 6% sales tax. Prices and terms subject to change without notice. • All sales subject to availability, acceptance, and verification. • All sales are final. • Satisfaction guaranteed or full refund

We also offer printer ribbons, printwheels, type elements, equipment covers, power consoles, paper supplies, storage and filing equipment, furniture and many other accessories for word and data processing systems. Write for our free catalog.

Orders Only
800-854-1555

Information
619-268-3537

Modem Hotline (Anytime)
619-268-4488
Exclusive Monthly Specials

ABC

DATA PRODUCTS

ITT TELEX 4992217
8868 CLAIREMONT MESA BLVD
SAN DIEGO, CALIFORNIA 92123

Listing 3: A module for sorting integers that does not require knowledge of the variant record tricks outside of the actual sorting unit. The client modules need not provide special record formats for the arrays to be sorted. This method is likely to prove more implementation-dependent, however, than that in listing 2.

```
(*S+*)
UNIT SORT_UNIT;

INTERFACE (*procedure defined here is callable by a program*)
PROCEDURE SORT_INT (VAR INT: INTEGER; ARRAYSIZE: INTEGER);

IMPLEMENTATION (*code below is not accessible to any calling program*)

PROCEDURE PUT_ITEM(VAR FIRST: INTEGER; WHICH_ITEM: INTEGER;
                    VALUE : INTEGER);
(*order of declaration of parameters is important!*)
(*FIRST must be first parameter*)

(*PLACE HOLDER MUST be first declared variable. This ensures that
address of 'FIRST' is at X[-1]*)
VAR PLACE HOLDER: ARRAY[0..0] OF INTEGER;
(*VARIANT lets us "peek" at elements of array*)
VARIANT: RECORD CASE INTEGER OF
    0: ( PTR: ^INTEGER);
    1: (ADDRESS: INTEGER);
    END; (*CASE*)

BEGIN
    (*R-*)
    (*put location of 'name' into 'address'*)
    VARIANT.ADDRESS := PLACE HOLDER[ -1 ];
    (*R+*)
    (*bump address to access desired element *)
    VARIANT.ADDRESS := VARIANT.ADDRESS
        + (WHICH_ITEM-1) * SIZEOF (FIRST);
    VARIANT.PTR^:=VALUE;
END; (*PUT_ITEM*)

(*this procedure reads the value of an element of the array*)
FUNCTION GET_ITEM(VAR FIRST: INTEGER; WHICH_ITEM: INTEGER):INTEGER;

    (*order of declaration of parameters is important!*)
    (*FIRST must be first parameter*)

    (*PLACE HOLDER MUST be first declared variable. This ensures that
address of 'FIRST' is at X[-1]*)
    VAR PLACE HOLDER: ARRAY[0..0] OF INTEGER;
    (*VARIANT lets us "peek" at elements of array*)
    VARIANT: RECORD CASE INTEGER OF
        0: ( PTR: ^INTEGER);
        1: (ADDRESS: INTEGER);
        END; (*CASE*)

    BEGIN
        (*R-*)
        (*put location of 'FIRST' into 'address'*)
        VARIANT.ADDRESS := PLACE HOLDER[ -1 ];
        (*R+*)
        (*bump address to access desired element *)
        VARIANT.ADDRESS := VARIANT.ADDRESS
            + (WHICH_ITEM-1) * SIZEOF (FIRST);
        GET_ITEM:= VARIANT.PTR^
    END; (*GET_ITEM*)

PROCEDURE SORT_INT (* VAR INT: INTEGER; ARRAYSIZE: INTEGER *);
(* This procedure sorts an array of integers by increasing value,
using a selection sort technique. *)
VAR I,J,TEMP: INTEGER;
BEGIN
    FOR I:=1 TO ARRAYSIZE-1 DO
        FOR J:=I+1 TO ARRAYSIZE DO
            IF GET_ITEM(INT,J)<GET_ITEM(INT,I) THEN
                (*INT[J] smallest so far. Exchange w/ INT[I]*)
                BEGIN
                    TEMP:= GET_ITEM(INT,I);           (*save element I in temp*)
                    PUT_ITEM( INT,I, GET_ITEM(INT,J) ); (*put element J into element I*)
                    PUT_ITEM( INT,J, TEMP );          (*put temp into element J*)
                END;
            END; (*SORT_INT*)
        END;
    END;

BEGIN
END. (*SORT_UNIT*)
```

WE'RE
MAKING
NEWS!

DIRECT SOFTWARE DISCOUNT DIGEST

● CPM®
● IBM®
● APPLE®

TO ORDER CALL (415) 459-1282 • TOLL FREE (800) 533-3012 CA (800) 533-3011 USA

Direct Software™ Discount Prices Save \$\$ and Make Sense to Smart Buyers Who Know What They Want!!

DIRECT SOFTWARE™ MAKES PRIME PRODUCTS SO AFFORDABLE THAT THOSE IN-THE-KNOW WILL FIND IT UNWISE TO RESIST. OUR PRODUCTS ARE BACKED BY SUPPORT AND SERVICE, WITH SAME-DAY SHIPMENT ON MOST ORDERS. COMPARE OUR PRICES AND SAVE:

List Sale

ALPHA SOFTWARE

Apple-IBM Connection	250	169
Data Base Manager II	295	249
Typeface	125	79

ANDERSON — BELL

ABSTAT	395	319
--------	-----	-----

ASHTON-TATE

dBASE II	700	389
Friday	295	199

ASPEN SOFTWARE

Grammatik	75	56
Proof Reader	50	38

A.T.I.

Training WordStar	75	60
Training dBASE II	75	60
Training Multiplan	75	60

CDEX

MYB-Lotus 1-2-3	70	60
MYB-Visicalc	70	60

DIGITAL MARKETING

Milestone	295	249
Datebook II	295	249
Footnote	129	109
Bibliography	125	109
Notebook	150	119
MICROLINK II	89	79

ACCOUNTING

List Sale

REAL WORLD

Accounts Payable	650	459
Accounts Receivable	650	459
Payroll	650	459
General Ledger	650	459
RM Cobol		169

I.U.S.

General Ledger	595	359
Accounts Receivable	595	359
Accounts Payable	595	359

MBA

General Ledger	595	349
Accounts Payable	595	349
Accounts Receivable	595	349
ALL THREE ABOVE	1785	999

List Sale

DIGITAL RESEARCH

Concurrent CP/M 86	350	249
CB 80 Compiler	500	369
CBASIC (CP/M 80)	150	100
SID (CP/M 80)	75	63

FOX & GELLER

Quickcode	295	175
dGraph	295	175
dUtil	99	58

CONDOR

Condor 3	650	349
CROSSDATA	99	89

GAMMA PRODUCTION, INC.

Taxwizard '83 (IBM)	60	50
Taxwizard '83 (CP/M)	50	40

HUMANSOFT

DBPlus	125	89
--------	-----	----

IUS

Easy Filer	400	229
Easy Planner	250	179
Easy System	395	239
(writer, mailer, speller)		

LEXISOFT

Spellbinder	495	249
-------------	-----	-----

LIFETREE

Volkswriter	195	125
Volkswriter Deluxe	245	199

SPECIALS

	List	Sale
DBASE II + Quickcode	995	525
DBASE II + dUtil	799	429
DBASE II + DGraph	999	539
DBASE II + ABSTAT	1095	717
DBASE II + DBASE Window	949	558
DBASE II + WordStar	1195	629

WORDSTAR \$248 | dBase II \$389

Supercalc III \$249 | LOTUS \$319

RBASE 4000 \$345

LOTUS

1-2-3	495	319
-------	-----	-----

METASOFT

Benchmark Word Processor	499	279
Benchmark Mail List	250	179

MICROPRO

WordStar	495	248
WordStar/MailMerge	645	347
WordStar/SpellStar	645	347
Professional Pak	845	395
InfoStar	495	258
InfoStar + CP/M Card	695	399
WordStar + CP/M Card	695	399
MailMerge	250	129
SpellStar	250	128
CalcStar	145	88
WordStar/Option	295	219

MICRORIM

R Base 4000	495	345
-------------	-----	-----

MICROSTUFF

Crosstalk	195	117
-----------	-----	-----

MICROSOFT

Multiplan	250	159
BASIC Interpreter	350	249
BASIC Compiler	395	285
Softcard	345	248
Flight Simulator	50	38
Word/Mouse	475	399

OASIS

The Word Plus	150	105
Punctuation & Style	150	99

PEACHTREE SOFTWARE

Peachpak 4	395	275
Peachpay	750	475
Peachtext 5000	395	219

PERFECT SOFTWARE

Perfect Writer	489	249
Perfect Speller	289	159
Perfect Filer	589	249
Perfect Writer/Speller	695	359

PETER NORTON

Norton Utilities	80	58
------------------	----	----

SELECT Information Systems

Select Word Processor	495	259
SelectWrite	99	79

SORCIM

SuperCalc I	195	129
SuperCalc II	295	169
SuperCalc III	395	249

SSI

Word Perfect	495	345
--------------	-----	-----

TYLOG

dBase Window	249	189
dBase Door	149	119

VISICORP

VisiOn Graph	250	199
Visicalc IV	250	169
Visicalc Advanced (Apple)	400	265

WOLF SYSTEMS

Move it (IBM)	150	98
Move it (CPM)	125	89

CALL FOR PRODUCTS NOT LISTED!

- Purchase orders accepted
 - Prompt UPS service
 - Dealer and Institutional discounts
 - Quantity discounts available
 - Call for charges and return policy;
- Prices may change
ALL SALES FINAL

Call today for our free catalog

TO ORDER CALL

(415) 459-1282

TOLL FREE

(800) 533-3012 CA

(800) 533-3011 USA

850 College Ave., Suite #3
Kentfield, CA 94904



for 6809
8080, Z80
8088, 8086

Real-Time Multitasking Executive

- ROMable (< 3K)
- No royalties
- Source code included
- Language interfaces
- Low interrupt overhead
- Inter-task messages

Options:

- C, Pascal, PL/M, Fortran i/f
- Extended memory (> 64K)
- Configuration Builder Utility
- Resource (semaphore) Manager
- Buffer Manager
- Integer Math Library
- Real-Time C Library

AMX (for 8080) \$800 U.S.
manual only \$ 75 U.S.

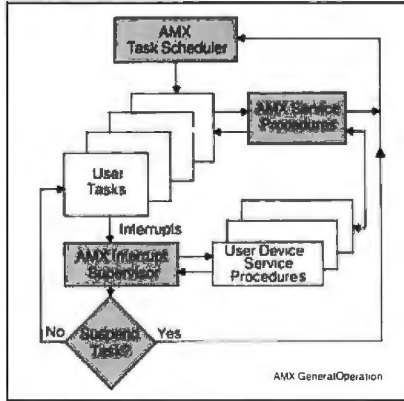

AMX, Real-Time C are TM of KADAK Products Ltd.
Z80 is TM of Zilog Corp.

KADAK Products Ltd.



206-1847 W. Broadway Avenue
Vancouver, B.C., Canada V6J 1Y5
Telephone: (604) 734-2796
Telex: 04-55670

Text continued from page 378:

served for the first local variable. Using a subscript one less than the defined range of the local array makes it possible to access the memory location containing the address of the VAR parameter. Each successive memory location for the other elements of the array can then be calculated, starting from this address.

This method, like the first, uses the variant record technique, this time to accomplish direct memory manipulation, through simulated PEEKs and POKEs. The article by Daniel Sokol in the September 1980 BYTE ("Notes on Absolute Location Interfaces to Apple," page 324) discusses simulating PEEKs and POKEs in Pascal.

Constant Expressions

Whenever constants must be used, it is good practice to assign names to them. This increases readability and makes program changes easier. For example, suppose you wish to have several arrays of different types, each having the same maximum size. By defining a constant

```
CONST ARRAYSIZE = 20;
```

you can change the size of the following arrays:

```
VAR X: ARRAY[1..ARRAYSIZE] OF  
      INTEGER;  
      Y: ARRAY[1..ARRAYSIZE] OF  
          CHAR;  
      Z: ARRAY[1..ARRAYSIZE] OF  
          REAL;
```

just by changing the constant ARRAYSIZE.

In Pascal, constants cannot be expressions. This greatly limits the usefulness of the CONST definition. For example, suppose array Y must have limits twice the size of X, while Z must be three times the size of X. Pascal requires that the three upper bounds' constants be declared in a manner that makes their inherent relation invisible. In Modula-2, the relation among the three constants can be made clear in a declaration with the form:

```
CONST XSIZE = 20;  
      TWICEX = XSIZE * 2;
```

Treat your personal computer to famous Diablo letter-quality printing.

Diablo 620 API (Up to 26 cps) Diablo 630 API (Up to 40 cps)



with
All-Purpose Interface for
Apple II, IBM PC, TRS-80, Commodore IEEE 488
Centronics "Parallel" and RS232C "Serial".

MTI has the Diablo 620 & 630 API ready for you.

The best letter-quality printers on the market. At MTI's best prices. Whether you buy, rent or lease our equipment, you'll find MTI is the one source for all the terminals, peripherals, systems, applications expertise and service you'll ever need. At good prices. Call us today.

New York: 516/621-6200, 212/767-0677, 518/449-5959
Outside N.Y.S.: 800/645-6530
New Jersey: 201/227-5552
Ohio: 216/464-6688

"QED" Discounts
VISA & MasterCard



Diablo Authorized
Distributor

Applications Specialists & Distributors, New York, New Jersey and Ohio.
DEC, Intel, Texas Instruments, Altos, Lear Siegler, Dataproducts, Diablo,
Esprit, Intecolor, Racal-Vadic, MICOM, Digital Engineering, U.S. Design,
Cipher, Protocol Computers, MicroPro, Microsoft, Polygon and Select.

ENTER... THE FUTURE!

TURBO PASCAL

Introductory offer
\$49.95

THIS IS THE PASCAL COMPILER EVERYBODY'S BEEN WAITING FOR... EVERYBODY EXCEPT THE COMPETITION!

Extended Pascal for your IBM PC, APPLE CP/M, MS DOS, CP/M 86, CCP/M 86 or CP/M 80 computer features:

- Full screen interactive editor providing a complete menu driven program development environment.
- 11 significant digits in floating point arithmetic.
- Built-in transcendental functions.
- Dynamic strings with full set of string handling features.
- Program chaining with common variables.
- Random access data files.
- Full support of operating system facilities.
- And much more.

ORDER YOUR COPY OF TURBO PASCAL TODAY TO TAKE ADVANTAGE OF OUR INTRODUCTORY SPECIAL.

For Visa and MasterCard orders call toll free

1-800-227-2400 X 968

IN CA: 1-800-772-2666 X 968

(lines open 24 hrs. a day, 7 days a week)

Dealer & Distributor Inquiries welcome.

	Turbo Pascal	IBM Pascal	Pascal MT+
PRICE	49.95	300.00	595.00
Compile & Link speed	1 second!!!	97 seconds	90 seconds
Execution speed	2.2 seconds	9 seconds	3 seconds
Disk Space 16 bit 8 bit	33K w editor 28K w editor!	300K + editor Not Available	225K + editor 168K + editor
8 and 16 bit	YES	NO	YES
built-in editor	YES	NO	NO
Generate object code	YES	YES	YES
One pass native code compiler	YES	NO	NO
Locates RunTime errors directly in source code	YES	NO	NO

Benchmark data based on EightQueens in "Algorithms + Data Structures" Programs by N. Wirth, run on an IBM PC.
 Turbo Pascal is a trademark of Borland International. MT+ is a trademark of MT MicroSystems. IBM is a trademark of International Business Machines.

LEARN TO WRITE A SPREADSHEET

Our Introductory offer includes **MICROCALC**, a spreadsheet written in Turbo Pascal. It can be on your disk, and ready to run. And we've included the source code to show you exactly how a spreadsheet is written!

Turbo Pascal includes a 250 page bound manual with extensive explanations and many illustrative examples.

Turbo Pascal \$49.95 + \$5.00 shipping per copy.

Check _____ Money Order _____
 VISA _____ MasterCard _____

Card #: _____
 Exp date: _____ Shipped UPS

BORLAND INTERNATIONAL

Borland International
 4807 Scotts Valley Drive
 Scotts Valley, California 95068

My system is: 8 bit _____ 16 bit _____

Operating system: CP/M 80 _____

CP/M 86 _____ MS DOS _____ PC DOS _____

Computer: _____ Disk Format: _____

Please be sure model number and format are correct.

NAME: _____

ADDRESS: _____

CITY/STATE/ZIP: _____

TELEPHONE: _____

California residents add 6 1/4% sales tax. Outside North America add \$15.00. Checks must be on a U.S. bank, and in U.S. dollars. Sorry, no C.O.D.



Check Our Services

We'll supply you with the best values, at the best prices, delivered when you need them. Everytime.

CONTINUOUS FORM PAPER

Handi-Pack 1000 Sheets 9 1/2" x 11"

1 Part, Blank, 15 lbs. Stock \$14.99

1 Part, Blank, 20 lbs. Stock, Clean Edge \$17.99

CARTRIDGE RIBBONS

Colors Also Available

1-11 12-23 24+

C. Itoh Prowriter \$7.99 \$7.19 \$6.39

Okidata 80, 82, 83A, 90 \$2.75 \$2.48 \$2.20

Call or write for our free catalogue.

Toll free: 1-800-343-7706.

In Massachusetts: 617-963-7694.

P.O. Box 103, Randolph, MA 02368



CHECK-MATE

COMPUTER SUPPLIES INC.



In every battle, we came up the victors. Not only in price, but in service and support as well.

Call to order: **1-800-257-5217**
(in NJ 609-424-4700)

We carry:

Intertec Data Systems
Corvus Concept
Corvus Hard Disk
C. Itoh Printers



TriStar Data Systems
2 Keystone Avenue
Cherry Hill, NJ 08003
609-424-4700
215-629-1289

WE SERVICE WHAT WE SELL

THRICEX = XSIZE * 3;

```
VAR X: ARRAY[1..XSIZE] OF
      INTEGER;
Y: ARRAY[1..TWICEX] OF
      CHAR;
Z: ARRAY[1..THRICEX] OF
      REAL;
```

Using this Modula-2 code, to increase the array sizes only requires a change of the single constant XSIZE, and the other arrays change accordingly. In Pascal, the best that we can do is to use constant identifiers that clarify their intended relation, as in:

```
CONST XSIZE = 20;
      TWICEX = 40;
      THRICEX = 60;
```

You have to hope that, if you must later modify the program by doubling the size of the arrays, the names TWICEX and THRICEX will help you to remember to change those constants as well as XSIZE.

Another problem with Pascal is in defining character constants. Suppose we wish to define ESCAPE as ASCII (American National Standard Code for Information Interchange) character 27. Pascal doesn't allow the expression

```
CONST ESCAPE = CHR(27).
```

In Modula-2, however, this declaration can be accomplished with

```
CONST ESCAPE = 33C
```

which declares that ESCAPE is a character constant with the octal value 33 (decimal 27).

The traditional Pascal programmer's solution to the prohibition of constant expressions is to use global variables as constants. A special initialization procedure is created that assigns to global variables the values that should remain constant throughout the program. The declaration of ESCAPE in Pascal is done like this:

```
CONST ESC_ORD = 27;
VAR   ESCAPE: CHAR;
      :
```

THE THINGS COMPUTER USERS HAVE NO POWER OVER.

A whole host of natural and human disasters can shut your electric power down at any time.

And lost power can cause your personal computer serious trouble. Big blocks of data can be garbled and wiped right off your discs. Your computer's main memory can go blank and sensitive electronic components can even be damaged.

Protect your data and your business profits from the power line with Elgar's Uninterruptible

Power Systems. Our desktop-size UPS monitors power from the line and when it fails, a battery back-up takes over and runs your computer long enough for you to shut your system down safely.

So don't leave your data unprotected another day. For more information or to order, call Elgar toll-free 800-227-3800, Ext. 7006. Major credit cards are welcome. To receive

a 24 x 36 inch poster of our "Power Disaster" scene, enclose \$2.00 for handling and write Elgar, Department P, at the address below.

ELGAR SAVES THE DATA

ELGAR

An Unan McGraw-Edison Company

8225 Mercury Court
San Diego, CA 92111

Circle 147 on inquiry card.

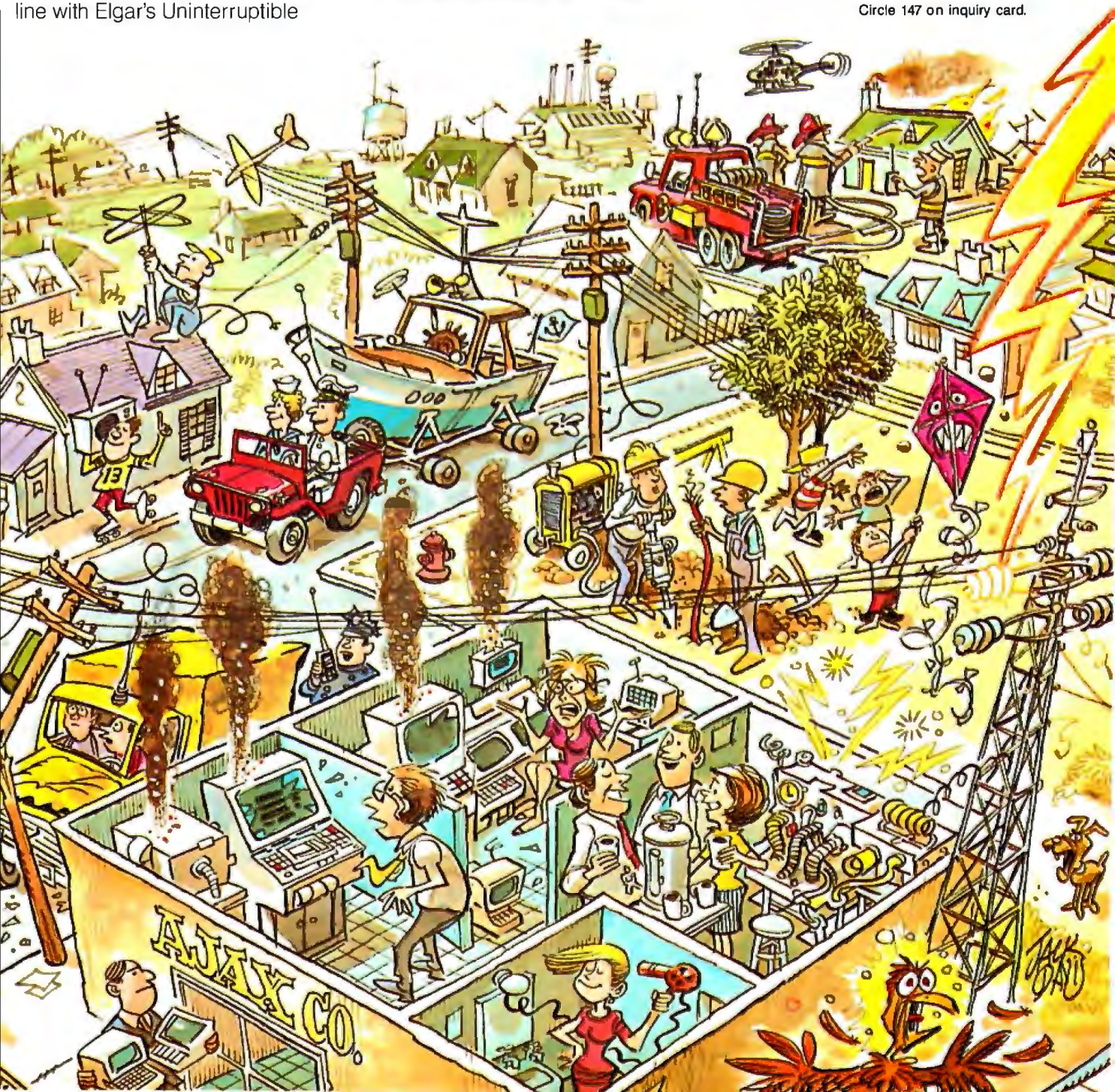

In the world of emulating terminals... VISUAL is a world apart.



VISUAL EMULATION CAPABILITY

VISUAL 50/55 are low cost smart terminals. The VISUAL 50 emulates DEC VT52*, Lear Siegler ADM3A*, Hazeltine Esprit™ and ADDS Viewpoint®. VISUAL 55 emulates the same plus Hazeltine 1500/1510 and VISUAL 200/210.

VISUAL 102 is 100% compatible with the DEC VT100/VT102* and also emulates the VT52. A Graphics Option Card provides Tektronix™ 4010/4014 compatible graphics.

VISUAL 300/330 are versatile terminals that can be easily customized. The VISUAL 300 emulates the DEC VT100 and VT52. VISUAL 330 emulates the DEC VT52, ADM3A, Hazeltine 1500 and Data General D200.

VISUAL 500/550 are low cost, high resolution graphic terminals with powerful alphanumeric capabilities. The VISUAL 500 emulates the VT52, ADM3A, Hazeltine 1500, D200 and Tektronix™ 4010/4014. The VISUAL 550 emulates the VT100, VT52 and Tektronix 4010/4014.

VISUAL terminals feature extended ergonomics including tilt and swivel non-glare 12" and 14" screens, detached keyboard, large character size, menu-style setup, sculptured key caps and more.

VISUAL has earned for itself an exclusive place . . . a solitary niche . . . in the arena of emulating terminals. Four great terminal series offer a combination of advanced features found on no other terminals anywhere in the world. Each series delivers higher performance at lower cost for its particular market segment. And nobody else gives such a wide choice of emulations as VISUAL . . . the pioneer in the field.

So check the chart before you choose your next terminal. See for yourself why VISUAL stands alone as the first choice for emulating terminals.

Service available in principal cities through Sorbus Service, Division of Management Assistance, Inc.

VISUAL

 See for yourself®

Visual Technology Incorporated
540 Main Street, Tewksbury, MA 01876
Telephone (617) 851-5000. Telex 951-539

*Registered trademark of
Visual Technology Incorporated

Circle 374 on inquiry card.

```

PROCEDURE INIT;
BEGIN
  ESCAPE := CHR(ESC_ORD);
  .
  .
END;          (*INIT*)

```

This approach is much less desirable than the use of true constants, since the value of a global variable could be inadvertently changed by any procedure in the program. To increase the probability of program correctness, adopt a special naming convention for global variables that masquerade as constants (e.g., ESC_CONST for ESCAPE) to reduce the chances of accidentally assigning values to them outside of the initialization procedure.

Restricted Declaration Order

In Pascal, all the declarations at a particular program level must be made in a particular order: first all the constant declarations, then the types, next variables, and finally procedures and functions. This strict constraint is likely to reduce program readability in some contexts, because it prevents grouping together of related declarations. In Modula-2, one can group related constant, type, and variable declarations for improved readability, as in:

```

(* 8-bit declarations *)
CONST MAXBYTE = 255;
      ZERO = 0;
TYPE BYTE = [ZERO..MAXBYTE];
VAR ABYTE, BBYTE: BYTE;

(* 12-bit declarations *)
CONST MAXTWELVEBIT = MAXBYTE
      * 16 + 15;
TYPE TWELVEBIT =
  [ZERO..MAXTWELVEBIT];
VAR ATWELVE, BTWELVE: TWELVEBIT;

```

There is no simple fix for Pascal's restrictions on declaration order. To some extent, the problem can be reduced by avoiding global constant and type declarations where only local ones are required. Such a practice promotes natural groupings. At times, however, Pascal programs must include long sequences of constant declarations followed by se-

quences of type and variable declarations, whose correspondence can only be determined by careful reading of the declarations and the judicious use of comments.

One method that Pascal programmers use to make relationships clear among constants, types, and variables is to make use of descriptive names. If the names of related elements contain the same meaningful elements (such as the declarations of the TWELVEBIT family illustrated above), the consequences of restrictions on declaration order can be partially overcome. But this brings up another problem with many Pascal implementations, that of restricted identifier lengths. Although the Pascal language definition puts no restrictions on the names of identifiers, many implementations are restricted to eight significant characters. The only patch for this limitation is to make certain that your identifiers differ in the first eight characters. This can be done quite easily, but it often results in cryptic acronyms and abbreviations that are not easy to interpret. Unfortunately, there is no simple solution to this problem.

CASE Limitations

The CASE statement is a very useful feature of Pascal. With it, we can perform one of a group of statements depending on the value of the CASE selection variable. For example, consider:

```

CASE A OF
1: WRITE('ONE');
2: WRITE('TWO');
3: WRITE('THREE');
END;

```

Here, we conveniently can print out the written equivalent of an integer. But what if A does not have the value one, two, or three? In standard Pascal, the result is not even defined. Fortunately, in Apple Pascal (and other UCSD Pascal successors) the CASE statement is defined to fall through this event. We can add a statement following CASE such as:

```

IF NOT ( A IN [1..3] ) THEN
  WRITE('A OUT OF RANGE');

```

Modula-2 provides a more elegant solution, permitting us to specify explicitly *within* the CASE statement an ELSE clause to be executed if none of the case labels are matched. Some recent Pascal implementations also provide such a special selector, sometimes called OTHERWISE.

Pascal requires that every label of the CASE statement must be enumerated. Suppose A can be 1 to 999. In Modula-2 we can use the following CASE statement:

```

CASE A OF
  1..9      : WRITESTRING('Less
                than 10 ');
  10..99    : WRITESTRING('Greater
                than 9, but less than 100');
  100..999  : WRITESTRING('Greater
                than 99, but less than 1000');
  ELSE      : BOUNDSERROR
END;

```

This statement is clearly much more readable than the equivalent Pascal statement, in which every label, including all those from 100 to 999, would have to be listed (100, 101, 102, 103, 104, etc., all the way to 998, 999:).

Because Pascal does not allow subranges as CASE selectors, programmers do not use the Pascal CASE statement for this type of programming. Instead, nested IF statements perform the same task:

```

IF A > 0
THEN
  IF A < 10
  THEN WRITE ('Less than 10')
  ELSE
    IF A < 100
    THEN WRITE ('Greater than 9, but
                less than 100')
    ELSE
      IF A < 1000
      THEN WRITE ('Greater than 99,
                  but less than 1000')
      ELSE BOUNDSERROR
  ELSE BOUNDSERROR;

```

This code is less readable than that using CASE selectors, although it may produce more efficient code.

Static Variables

In Pascal, variables that are local to

CPM / 80 MACRO ASSEMBLERS

We've been selling these industrial-quality assemblers to the development system market since 1978. They are now available for the CP/M market.

FEATURES:

- Fully relocatable
- Separate code, data, stack, memory segments
- Linker included
- Generates appropriate HEX formatted object files
- Macro capability
- Conditional assembly
- Cross reference
- Supports manufacturer's mnemonics
- Expanded list of directives
- 1 year free update

Assemblers now available include:

Chip	Price	Chip	Price
1802/1805	\$495	NSC800	\$495
8051	495	F8,3870	495
6500/01/02	495	Z8	495
6800/01/02	495	Z80	395
6805	495	9900/9995	595
6809	495	Z8000	695
8085	495	68000	695

Take advantage of leading-edge technology. Get your own Relms assembler today. Use your Master-charge, Visa or American Express, and order by phone: (408) 729-3011

*Relational Memory Systems, Inc.
1650-B Berryessa Road,
San Jose, CA 95133*

All software shipped on a 8" single density floppy disk. A signed object Code License Agreement required prior to shipping. Prices subject to change without notice.

relms®

a procedure are always allocated dynamically. That is, room for them is allocated automatically on entry to the procedure. When the procedure is exited, the memory used by the local variables is freed up for other use. While this is a useful feature because it saves memory, it can be a problem if the values must be retained between invocations of the procedure.

The easiest solution available to the Pascal programmer is to declare the variables in an outer block. The values of the variables will be retained as long as the block in which they are declared is not exited. But this means variables that really ought to be invisible outside of the procedure must be made global, and therefore visible, to the rest of the program. As global variables, they are vulnerable to modification by parts of the program that should have no knowledge of them.

In Modula-2, it is possible to declare a variable for use in procedures in such a way that its value is preserved across invocations of the procedure—as though the variable is global—while preventing any other part of the program from accessing it. To do this, one declares a module, providing a visibility barrier around the procedure. Suppose we want to count the invocations of a procedure DOSTUFF. The count variable, COUNTDOSTUFF, can be made inaccessible to the rest of the program if it and DOSTUFF are declared inside a module, STUFFMODULE, as follows:

```
MODULE STUFFMODULE;
EXPORT DOSTUFF;
  VAR COUNTDOSTUFF: CARDINAL;
  PROCEDURE DOSTUFF
    (I: INTEGER);
    VAR A,B,C: INTEGER;
  BEGIN
    COUNTDOSTUFF :=
      COUNTDOSTUFF + 1;
    .
    .
  END; (*DoStuff*)
BEGIN (*StuffModule's body*)
  COUNTDOSTUFF := 0;
END; (*StuffModule*)
```

If STUFFMODULE is declared at the top level, that is, just within the program module, then its body, which initializes the variable COUNTDOSTUFF, will be executed at the time that the program body is executed. The DOSTUFF procedure, which has been explicitly exported from the module, is available from everywhere else in the program, but its count variable, COUNTDOSTUFF, is inaccessible from outside the procedure DOSTUFF. COUNTDOSTUFF is a global variable in the sense that it exists outside of the procedure DOSTUFF, but it is a local variable in terms of its visibility outside of the procedure. UCSD Pascal also permits this feature of hidden variables that can retain their values in the unit construct. Those variables declared in the implementation portion of the unit, rather than in the interface, are present at the level of the unit, but are invisible to program entities outside the unit.

Switch or Fight

Our purpose here has not been to present Modula-2 as a panacea for all of Pascal's faults. In some ways Modula-2 makes life harder for the Pascal programmer. For example, consider the lack of a set of type-insensitive I/O (input/output) procedures, such as Pascal's WRITE and WRITELN. In Modula-2 you cannot mix types in a WRITELN statement. Instead, you must use a separate procedure to output each type, such as use WRITESTRING for strings and WRITEREAL for reals. Furthermore, each write procedure can have only a single parameter.

Like Pascal, Modula-2 is not without faults. Both are well designed, but each has features that at least some programmers will object to. ■

Allen Munro is assistant director of Behavioral Technology Laboratories (USC, 1845 S. Elena Ave., 4th Floor, Redondo Beach, CA 90277). He holds a Ph.D. from UCSD and a B.A. from Stanford.

Mark C. Johnson is project director, also at Behavioral Technology, and his interests include R-C gliders, sailing, and skiing—aside from computers and electronics. He holds an M.S. and B.S. from UCLA.

Our New B-Version Printers:

*User Friendly Controls. 20% Faster.
9% Lower Cost.*

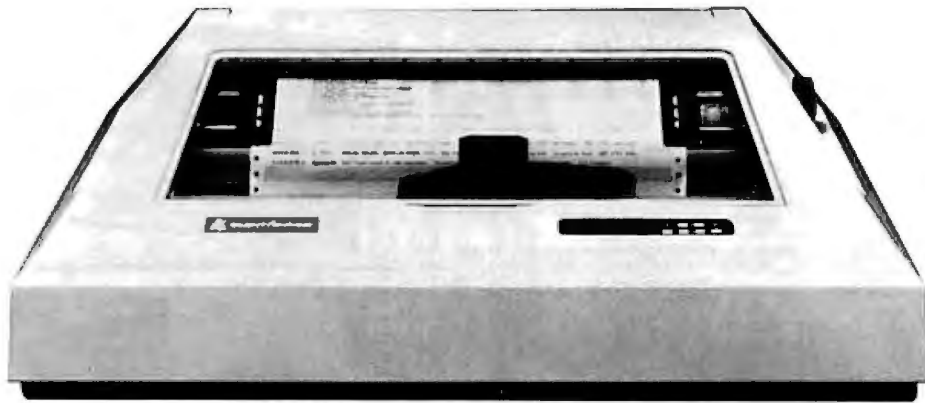

Strong. Silent. Types.

Perhaps the highest quality matrix-impact printer ever built, and certainly one of the quietest, the Silent/Scribe™ A-Version printers have earned a reputation for reliability since their introduction in 1982.

Now from that design, the B-Versions have evolved. Packed with even more performance – 20% faster – and with interface flexibility featuring plug-in Logi/Cards™ for an exact match to your computer.

The new B-Versions can simplify your life, regardless of your computer applications.

Running Word Processing? They give you high speed drafts and Letter Quality. Doing Spread Sheets? You can print 16 Characters-per-Inch to put the whole year on standard 8½-inch wide paper. Or you can go up to 13½-inch paper width if you wish.

Want to mix Word Processing, Math calculations, and Graphics? No problem. The new B-Versions handle text, math symbols (including super- and sub-script), complex

graphics, mid-line font changes, and underlining... the simplified programming and buffer memory is almost like getting a second computer free.

But with all that's new, some things haven't changed. The Anadex commitment to service and support. For example, any Anadex customer can call our toll-free numbers and get technical help. For as long as he owns the printer.

The new, B-Version Silent/Scribes. Now the highest quality matrix printers just got even better. Call us to arrange a demonstration.

Call (800) 4 ANADEX
In California 800-792-9992

 **Anadex**

©Copyright 1985. Anadex, Inc.

MADE IN
USA
FOR THE WORLD

**The more you know printers,
the more you'll like Anadex.**

ANADEX, INC. • 1001 Flynn Road • Camarillo, California 93010 • Telephone: (805) 987-9660 • TWX 910-494-2761
U.S. Sales Offices: Irvine, California (714) 261-6140 • Schiller Park, Illinois (312) 671-1717 • Wakefield, Massachusetts (617) 245-9160
Hauppauge, New York, Phone: (516) 435-0222 • Atlanta, Georgia, Phone (404) 255-8006 • Austin, Texas, Phone: (512) 327-5250
ANADEX, LTD. • Weaver House, Station Road • Hook, Basingstoke, Hants RG27 9JY, England • Tel: Hook (025672) 3401 • Telex: 858762 ANADEX G
ANADEX GmbH • Behringstrasse 5 • 8752 Mainaschaff • W. Germany • Tel: 011-49-06021-7225 • Telex: 4188347

COMPUTER MAIL ORDER

NEC PRINTERS

NEC 2050 \$999.00
 NEC 3550 \$1699.00

PERCOM/TANDEM DRIVES

5 1/4" 320K Floppy \$229.00
 5 Meg Hard w/Controller... \$1399.00
 10 Meg Hard w/Controller... \$1699.00
 15 Meg Hard w/Controller... \$2095.00
 20 Meg Hard w/Controller... \$2399.00

AMOEK

310A Amber Monitor \$169.00
 DXY 100 Plotter \$599.00
 Color II \$399.00

AST RESEARCH

Six Pak Plus...from \$279.00
 Combo Plus II...from \$279.00
 Mega Plus...from \$309.00
 I/O Plus...from \$139.00

QUADRAM

Quadlink \$499.00
 Quadboard...as low as \$289.00
 Quad 512 Plus...as low as \$249.00
 Quadcolor...as low as \$219.00
 Chronograph \$89.00
 Parallel Interface Board \$89.00
 64K RAM Chips Kit \$59.00

MICROPRO

WordStar/MailMerge \$349.00
 InfoStar \$299.00
 SpellStar \$159.00
 CalcStar \$99.00

MICROSTUF

Crosstalk \$105.00

MICROSOFT

Multiplan \$159.00

ASHTON TATE

dBASE II \$389.00
 Friday! \$185.00

IUS

EasyWriter II \$249.00
 EasySpeller \$119.00
 EasyFiler \$229.00

CONTINENTAL SOFTWARE

1st Class Mail/Form Letter. \$79.00
 The Home Acctnt. Plus \$88.00

AXIOM

AT-100 Atari Interface \$239.00
 CD-100 CBM 64/VIC 20 \$239.00
 GP-100 Parallel Interface...\$199.00

BMC

401 Letter Quality \$589.00
 BX-80 Dot Matrix.....\$269.00

CENTRONICS

122 Parallel \$399.00
 739-1 Parallel \$299.00
 739-3 Serial \$349.00

C.I.TOH

Gorilla Banana \$209.00
 Prowriter 851OP \$379.00
 Prowriter 1550P \$679.00
 A10 (18 cps) \$69.00
 F10-40 \$999.00
 F10-55 \$1499.00

COMREX

ComWriterII LetterQuality...\$499.00

DIABLO

620 Letter Quality \$949.00
 630 Letter Quality \$1749.00

DAISYWRITER

2000 \$999.00
 Tractor Feed \$109.00

EPSON

MX-80FT, MX-100, RX-80, RX-80FT, FX-80, FX-100.....CALL

IDS

Prism 80...For Configurations...CALL
 Prism 32...For Configurations...CALL

MANNESMAN TALLY

160L \$589.00
 180L \$799.00
 Spirit 80 \$309.00

IBM



VISICORP

VisiCalc	159.00	IBM APPLE	159.00
VisiCalc 4	159.00		
VisiCalc-Advanced	269.00		
VisiWord/Spell	249.00		
Visitrend/Plot	199.00	199.00	
VisiLink	169.00		
VisiFile	199.00	169.00	
VisiSchedule	199.00	199.00	
Visidex	159.00		
VisiPlot	135.00		
VisiTerm	75.00		
Desktop Plan	199.00	169.00	
Bus. Forecast Model	75.00	75.00	
Stretch Calc	75.00	75.00	
VisiTutor Calc	59.00	59.00	
VisiTutor-Advanced	75.00	75.00	
VisiTutor Word	59.00	59.00	
Vision Calc	249.00		
Vision Graph	129.00		
Vision Mouse	159.00		
Vision Host	319.00		

pfs

Write:	79.00	89.00
Graph:	79.00	89.00
Report:	79.00	79.00
File:	79.00	89.00
Solutions':as low as	16.00	16.00

*Call On Titles

LOTUS

1-2-3 \$319.00

PROFESSIONAL SOFTWARE

PC Plus/The Boss \$349.00

SYNAPSE

File Manager \$89.00

PRINTERS

NEC

2010/2030 \$899.00
 8023 Dot Matrix \$379.00
 8025 Dot Matrix \$669.00
 3510 Serial/LetterQuality...\$1449.00
 3530 Parallel/Letter Quality...\$1499.00
 7710/7730 Serial/Parallel...\$1949.00

OKI/OATA

82.83.84.92.93.2350.2410...CALL

SMITH CORONA

TP-2 \$399.00
 Tractor Feed \$119.00

SILVER REED

500 Letter Quality \$469.00
 550 Letter Quality \$699.00

STAR

Gemini 10X \$299.00
 Gemini P15X \$399.00
 Delta 10 \$559.00
 Serial Board \$75.00

TOSHIBA CALL

TRANSTAR CALL

PRINTER CABLES

Available for Atari, Commodore, IBM, Apple, Epson, Kaypro, TeleVideo, Franklin, Eagle, Sanyo, Osborne, NEC, Zenith and many others. We supply all your computer needs!

PAPER SUPPLIES

1000 shts. 8 1/2 x 11 Tractor Paper...\$19.99
 1000 shts. 14 1/2 x 11 Tractor Paper...\$24.99
 1 or 2" Address Labels \$9.99

MBC-550 PC ... CALL

MBC-555 PC ... CALL

MBC 1100 \$1499.00
 FDD 3200-320K Drive \$389.00
 MBC 1150 \$1899.00
 MBC 1200 \$1849.00
 FDD 6400-640K Drive \$469.00
 MBC 1250 \$2099.00
 PR 5500 Printer \$599.00

SANYO

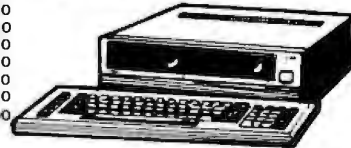

EAGLE

COMPUTER

We stock a full line of
EAGLE COMPUTERS
 CALL FOR PRICING

TERMINALS

914 \$569.00
 924 \$689.00
 925 \$739.00
 950 \$929.00
 970 \$1039.00

COMPUTERS

Teleport Portable CALL
 800A \$1099.00
 802 \$2699.00
 803 \$1949.00
 802H \$4695.00
 806/20 \$4999.00
 816/40 \$9199.00
 1602 \$3399.00
 1603 CALL

MONITORS AMOEK

300 Green \$149.00
 300 Amber \$159.00
 310 Amber \$169.00
 Color 1 \$279.00
 Color 1 Plus \$299.00
 Color 2 \$399.00
 Color 2 Plus \$419.00
 Color 3 \$349.00
 Color 4 \$699.00

BMC

12" Green \$79.99
 12" Green HI-RES \$119.99
 9191-13" Color \$249.99

GORILLA

12" Green \$88.99
 12" Amber \$95.99

NEC

JB 1260 Green \$109.99
 JB 1201 Green \$149.99
 JB 1205 Amber \$159.99
 JC 1215 Color \$299.99
 JC 1216 RGB \$429.99

PRINCETON GRAPHICS
 HX-12 RGB \$519.00

SAKATA

100 \$269.00

TAXAN

12" Green \$119.00
 12" Amber \$129.00
 Taxan 1 RGB \$279.00
 Taxan 210 \$299.00

USI

P1. 9" Green \$99.99
 P2. 12" Green \$119.99
 P3. 12" Amber \$149.99
 P4. 9" Amber \$139.99
 1400 Color \$269.99

ZENITH

ZVM 122 Amber \$109.00
 ZVM 123 Green \$89.99
 ZVM 135 Color/RGB \$469.99

MODEMS ANCHOR

Mark I (RS-232) \$79.00
 Mark II (Atari) \$79.00
 Mark III (TI-99) \$109.00
 Mark IV (CBM/PET) \$125.00
 Mark V (Osborne) \$95.00
 Mark VI (IBM-PC) \$169.00
 Mark VII (Auto Ans./Auto Dial) \$119.00
 Mark XII (1200 Baud) \$299.00
 TRS-80 Color Computer \$99.00
 9 Volt Power Supply \$9.00

HAYES

Smartmodem 300 \$219.00
 Smartmodem 1200 \$509.00
 Smartmodem 1200B \$459.00
 Micromodem II \$265.00
 Micromodem II Plus \$299.00
 Micromodem IIE \$269.00
 Micromodem 100 \$299.00
 Smart Com II \$89.00
 Chronograph \$199.00

NOVATION

J-Cat \$99.99
 SmartCat 103 \$179.00
 SmartCat 103/212 \$399.00
 AutoCat \$219.00
 212 AutoCat \$549.00
 Apple Cat II \$249.00
 212 Apple Cat \$569.00
 Apple Cat 212 Upgrade \$309.00
 Cat \$139.99
 P-Cat \$149.00
 PC-Cat \$339.00

ZENITH

ZT-1 \$309.00
 ZT-10 \$339.00
 ZT-11 \$369.00

APPLE INTERFACE CARDS & BUFFERS

Choose from PKASO, Orange Micro, MPC, MicroMax, Tymac, Quadram & Practical Peripherals CALL

WEST = CANADA = EAST
800.648.3311 800.268.4559 800.233.8950

MonitorCard

In NY call (702)588-5654, Dept. 0301
 Order Status Number: 588-5654
 P.O. Box 6689, Stateline, NY 89449

In Toronto call (416)828-0866, Dept. 0301

Order Status Number: 828-0866

2505 Dunwin Drive, Unit 1B

Mississauga, Ontario, Canada L5L1T1

In PA call (717)327-9575, Dept. 0301

Order Status Number: 327-9576

Customer Service Number: 327-1450

477 E. Third St., Williamsport, PA 17701

No risk, no deposit on C.O.D. orders. Pre-paid orders receive free shipping within the UPS Continental United States with no waiting period for certified checks or money orders. Add 3% (minimum \$5.00) shipping and handling on all C.O.D. and credit card orders. Larger shipments may require additional charges. NY and PA residents add sales tax. All items subject to availability and price change. We stock manufacturer's and third party software for most all computers on the market. Call today for our new catalog.

COMPUTER MAIL ORDER

APPLE/FRANKLIN DISK DRIVES MICRO-SCI

A2\$219.00
A40\$299.00
A70\$319.00
C2 Controller\$79.00
C47 Controller\$89.00

RANA

Elite 1\$279.00
Elite 2\$389.00
Elite 3\$569.00

APPLE IIe STARTER PACK
64K Apple IIe, Disk Drive & Controller,
80 Column Card, Monitor II & DOS 3.3
COMPLETE.....\$1199.00

FRANKLIN



ACE 1000 Color ComputerCALL
ACE Family Pack SystemCALL
ACE PRO PLUS SystemCALL
ACE 1200 Office Mgmt. SystemCALL
"NOT IIE EXPENSIVE"

HOME COMPUTERS

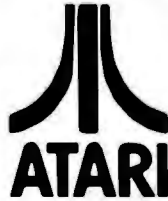

600XL.....\$189
800XL.....\$299

1200XL CALL
1400XL CALL

Commodore

CBM 8023...\$599

CBM 4032.....\$599.00
CBM 8096.....\$869.00
CBM 9000.....\$999.00
B128-80.....\$769.00
CBM 64K Memory Board.....\$269.00
8032 to 9000 Upgrade.....\$269.00
2031LP Disk Drive.....\$299.00
8050 Disk Drive.....\$949.00
8250 Disk Drive.....\$1199.00
4023 Printer.....\$379.00
8023 Printer.....\$569.00
6400 Printer.....\$1399.00
Z-RAM.....\$499.00
Silicon Office.....\$699.00
The Manager.....\$199.00
Soft ROM.....\$125.00
VisiCalc.....\$159.00

PROFESSIONAL SOFTWARE

Word Pro 2 Plus.....\$159.00
Word Pro 3 Plus.....\$189.00
Word Pro 4 Plus/5 Plus.....\$279.00
InfoPro.....\$179.00
Administrator.....\$399.00
Power.....\$79.00

We stock a full inventory of software for Commodore, such as:
Artworx, Broderbund, Commercial Data, Creative Software,
Epyx, HES, MicroSpec, Nufekop, Romox, Sirius, Synapse,
Thorn EMS, Tronix, UMI, Victory, Spinnaker, Rainbow & Timeworks!
CALL FOR DETAILS!



HANDHELD COMPUTERS



41CX.....\$249.99
41CV.....\$199.99
41C.....\$144.99
HP 10C.....\$51.99
HP 11C.....\$69.99
HP 12C.....\$88.99
HP 15C.....\$88.99
HP 16C.....\$88.99
HP 75C.....\$749.99
HPIL Module.....\$98.99
HPIL Cass. or Printer.....\$359.99
Card Reader.....\$143.99
Extended Function Module.....\$63.99
Time Module.....\$63.99

NEC

PC-8201 Personal Computer...\$599.00
PC-8221A Thermal Printer...\$149.00
PC-8281A Data Recorder...\$99.00
PC-8201-068K RAM Chips...\$105.00
PC-8206A 32K RAM Cartridge...\$329.00



PC-1500A...\$165.99
PC-1250A...\$88.99

CE-125 Printer/Cassette...\$128.99
CE-150 Color Printer/Cassette...\$171.99
CE-155 8K RAM.....\$93.99
CE 161 16K RAM.....\$134.99
CE 500 ROM Library.....\$29.99

TIMEX/SINCLAIR

Timex/Sinclair 1000.....\$24.99
Timex/Sinclair 2086.....CALL
16K Memory.....\$25.00
2040 Printer.....\$99.99
VuCalc.....\$17.99
Mindware Printer.....\$99.99

PERCOM

AT 88-S1\$369.00
AT 88-A2\$259.00
AT 88-S1PD\$429.00
AT 88-DDA.....\$119.00
RFD 40-S1.....\$449.00
RFD 40-A1.....\$269.00
RFD 40-S2.....\$699.00
RFD 44-S1.....\$539.00
RFD 44-S2.....\$869.00

TEXAS INSTRUMENTS

TX 99-S1\$279.00

RANA

1000.....\$319.00

TRAK

AT-D2.....\$389.00

1000.....\$319.00

AT-D2.....\$389.00

1000.....\$319.00

AT-D2.....\$389.00

1000.....\$319.00

AT-D2.....\$389.00

1000.....\$319.00

AT-D2.....\$389.00

1000.....\$319.00

AT-D2.....\$389.00

1000.....\$319.00

AT-D2.....\$389.00

1000.....\$319.00

AT-D2.....\$389.00

1000.....\$319.00

AT-D2.....\$389.00

1000.....\$319.00

AT-D2.....\$389.00

1000.....\$319.00

AT-D2.....\$389.00

1000.....\$319.00

AT-D2.....\$389.00

1000.....\$319.00

AT-D2.....\$389.00

1000.....\$319.00

AT-D2.....\$389.00

1000.....\$319.00

AT-D2.....\$389.00

1000.....\$319.00

AT-D2.....\$389.00

1000.....\$319.00

AT-D2.....\$389.00

1000.....\$319.00

AT-D2.....\$389.00

1000.....\$319.00

AT-D2.....\$389.00

1000.....\$319.00

AT-D2.....\$389.00

1000.....\$319.00

AT-D2.....\$389.00

1000.....\$319.00

AT-D2.....\$389.00

1000.....\$319.00

AT-D2.....\$389.00

1000.....\$319.00

AT-D2.....\$389.00

1000.....\$319.00

AT-D2.....\$389.00

1000.....\$319.00

AT-D2.....\$389.00

1000.....\$319.00

AT-D2.....\$389.00

1000.....\$319.00

AT-D2.....\$389.00

= WEST = = CANADA = = EAST =
800-648-3311 800-268-4559 800-233-8950

In NV call (702)588-5654 Dept. 0301
Order Status Number: 588-5654
P.O. Box 6689, Stateline, NV 89449

In Toronto call (416)828-0866 Dept. 0301
Order Status Number: 828-0866
2505 Dunwin Drive, Unit 18
Mississauga, Ontario, Canada L5L1T1

In PA call (717)327-9575 Dept. 0301
Order Status Number: 327-9576
Customer Service Number: 327-1450
477 E. Third St., Williamsport, PA 17701

CANADIAN ORDERS: All prices are subject to shipping, tax and currency fluctuations. Call for exact pricing in Canada.
INTERNATIONAL ORDERS: All shipments outside the continental United States must be pre-paid by certified check only. Include 3% (minimum \$5.00) shipping and handling. EDUCATIONAL DISCOUNTS: Additional discounts are available to qualified Educational Institutions.
APO & FPO: Add 3% (minimum \$5.00) shipping and handling.

Circle 87 on inquiry card.



PICK UP WHERE IBM® LEAVES OFF.

Portable or desktop, you're way ahead when you pick up a **corona PC™**. Because we give you everything you've ever wanted in an IBM¹-compatible PC and more. For a great deal less.

COMPATIBLE AND MORE.

Our systems run all software that conforms to IBM PC programming standards. And the most popular software does.

We deliver twice the memory, with room for eight times as much.

We deliver a fast-access 320K floppy drive, a communication port and an improved IBM PC keyboard with indicator lights.

Our systems include high-resolution monitors (12" desktop, 9" portable) for crisper, cleaner displays, and both have built-in high-resolution graphics (640 x 325).

You get a complete system, ready to go to work.



MORE SPEED.

Our RAM-disk software gives you temporary disk-type storage that works many times faster than disks.

PLUS SOFTWARE.

Our systems come with the operating system: MS-DOS.² A programming language: GW BASIC.² A training course: PC Tutor.³ A professional word processor: MultiMate.⁴ Plus DOS utilities and demonstration programs. Or you can get the p-System⁵ from N.C.I. and write or run portable Pascal packages.

ALL FOR A GREAT DEAL LESS.

Even with all the extra features and performance, our systems still cost significantly less than the equivalent IBM PC.

Drop by your nearest **corona PC** dealer for a very convincing demonstration. Or contact us at 31324 Via Colinas, Westlake Village, CA 91361. (213) 991-1144 or (800) 621-6746 toll-free. Telex 658212 WSLK, in Europe 76066 CDS NL.



MORE VERSATILITY.

With all the necessary features built into the main unit, the four expansion slots can be used for your special needs. For example, color or our optional 10MB hard disk.

© Corona Data Systems 1983. 1. TM International Business Machines. 2. TM Microsoft. 3. TM Comprehensive Software Support. 4. TM Softword Systems. 5. TM University of California.



corona™
data systems, inc.

Trademarking Software Packages

Trademark clearance can prevent litigation and loss of hard-earned goodwill.

by Robert Greene Sterne and Perry J. Saidman

The scene is all too familiar. The developer of a successful software package sits in the office of a trademark attorney fretting. He holds in his hand a certified letter he received the day before from another lawyer whose client is challenging his use of the brand name Aisle for his software package.

The letter states that the client owns a federal trademark registration for use of the name Isle on software and that he considers the use of Isle and Aisle for the same type of product likely to cause confusion in the marketplace. In addition, the letter warns that the developer "immediately cease and desist from using the Aisle trademark on his software packages" or be subjected to dire legal consequences.

The letter has made the developer furious. He can't believe that he has been forced to waste time with what he considers legal harassment when he should be working on his new advertising campaign, handling a dis-

satisfied customer, or taking care of other pressing business concerns that need his attention. But he decides to take the bull by the horns and deal with the matter because the letter says that he must respond within 30 days. He has brought the Aisle package to the marketplace, so he hopes he can take a tough position against the owner of the Isle trademark with the help of his lawyer.

A clearance search determines whether a word chosen as a trademark is already being used.

Choosing a Trademark

The developer's lawyer asks him to recount how he developed the Aisle package and how he chose its name. The software entrepreneur knows that the time it takes to tell his story will cost him a lot of money in legal fees, but he enjoys describing the history of his creation.

The story is really very simple. In early 1981, the developer saw a need and met it with his Aisle software package. Some of his friends who

own computers discovered his useful program and asked for copies, which he provided proudly and gladly. He later decided that he could sell such a package and started analyzing ads in computer magazines for marketing tips. Studying how they were written and designed, he noticed the symbols that appeared with their names: ©, ®, and ®.

He also learned that he must come up with a name for his program by which it could be distinguished from competing programs. Everywhere he looked he saw successful software packages with great names such as Visicalc, Wordstar, and Easy Writer. He finally settled on Aisle after considering many names. When he discussed his choice with his closest friends, they responded enthusiastically. He did not know of anyone else using the name Aisle for the type of software he produced, therefore he began to market the package under that name. A friend advised him to use an ® beside the Aisle name in all of his ads.

The lawyer interrupts the story to ask whether a clearance search of the Aisle mark had been conducted to determine whether anyone was

Change your face with one finger.

Now there's a printer that lets you express yourself.

It's the Letterprinter 100, from Digital.

When you're feeling very professional and business-like, then it looks just like this.

In fact, this is an actual printout. It's great for word processing.

You can send a nice polite letter to your most important client.

But there may be times when you want to put on a different face.

You can program your host computer to do it for you.

Or you can do it yourself.

Simply by pushing a button.



YOU CAN SHOUT AT THE TOP OF YOUR LUNGS.

TELL THEM THEY'D BETTER PAY THEIR BILLS

OR ELSE. THEY'LL GET THE MESSAGE. Or you can

be elegant. Impress people with your sophisticated style.

But back to business. The Letterprinter 100 gives you all of the typefaces on this page. If you don't see one you like, we'll customize one for you.

The Letterprinter 100 also gives you full graphics capabilities. Plus three printing settings: one for letter quality, one for graphics, and a high speed one that gives you draft-quality documents in only 10 seconds.

So face it. Why buy an ordinary printer when you can express yourself just by lifting a finger?

See the Letterprinter 100. It's just one of the family of printers Digital offers, including a daisy wheel printer, the LQP02, and a low cost Personal Printer, the LA50. Call

1-800-DIGITAL, extension 700, for the distributor nearest you.

Or write Digital Equipment Corporation, Terminals Product Group, 2 Mt. Royal Avenue, UP01-5, Marlboro, MA 01752.

Circle 122 on inquiry card.

digital

using the name on software. The developer says he is unfamiliar with the term clearance search but that he had never consulted a lawyer about the name. In addition, he says, he was unaware of the Isle trademark when he adopted the name Aisle. After he learned of Isle's existence, he also discovered that its sales are confined exclusively to the East Coast, while Aisle software is sold primarily on the West Coast. Becoming agitated, he points out that Aisle differs significantly from Isle. The lawyer calms him, then explains some principles of trademark law.

Trademarks Afford Protection

The major issue in most trademark-infringement suits, the lawyer notes, is whether the plaintiff's and defendant's trademarks, used on their respective goods, will likely cause confusion as to the goods' source or origin. Thus, he explains, even if two names differ, a court could find likelihood of confusion in the event the sound, appearance, and meaning of the two are close. In the developer's case, he says, even though the meanings differ, the appearance of the words Isle and Aisle is very similar and the sound is identical. He concludes that a court could therefore find a likelihood of confusion to exist.

The developer objects to the idea that the two words might cause confusion, saying that he did not know of any instance where a customer bought Aisle software thinking it was an Isle package. His lawyer points out, however, that it was the likelihood of confusion that constituted the legal test, not the actual confusion; the fact that no one had ever confused the two programs did not matter.

The lawyer goes on to explain that both the Aisle and Isle marks are arbitrary choices for names of software packages. Under trademark law, arbitrary means that the product's name does not describe its goods—in this case Isle and Aisle do not describe the function of the packages they name. Software, after all, is neither an island nor a lane. The lawyer offers an example to illustrate the point.

The primary meaning of the word "apple" is a type of fruit. Thus, the use of the word "apple" on any type of goods other than fruit, such as Apple bicycles, Apple sportcoats, or Apple computers, is an arbitrary use. Other examples of products with arbitrary trademarks include the Lisa computer, Camel cigarettes, and Dove soap. Arbitrary trademarks, he explains, tend to be strong trademarks that are protectable as soon as they are adopted. In other words, no customer recognition has to be developed through sales to protect them,

Adopting a new name will constitute trademark infringement if customers are likely to be confused as to source or origin.

in contrast to primarily descriptive, surname, or geographic trademarks, which do require customer recognition for protection.

A descriptive name is one that describes a function, property, or characteristic of the goods it labels. An example is Sortfile Plus, used for a software package that sorts files quickly and efficiently. Franklin is a surname used as a trademark for a personal computer, and an example of a geographic trademark is Palo Alto, used on a spreadsheet package. To afford protection, these types of trademarks require customer recognition. Because of their original meaning to the public, a secondary meaning must attach in the market through certain commercial activity. This secondary meaning is an indication of source for the trademarked goods. In other words, the Franklin or Palo Alto must be recognized by the interested public as symbols of computer goods from a particular source before they can be protected.

In the case of the Isle versus Aisle trademarks, the lawyer points out that they are both arbitrary names used for the same type of software,

Multi-function RS-232 Transfer Switches

MFJ-1240
\$ 79 95
Choice of
8 models

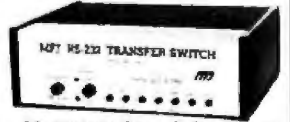

Multi-function RS-232 transfer switches let you switch your computer among printers, modems, terminals, any RS-232 peripherals; monitor data/line failure, protect data lines from surges, and use as null modem for less cost than a switch alone.

Switches 10 lines (2, 3, 4, 5, 6, 8, 11, 15, 17, 20). LED data/line indicators monitor lines 2, 3, 4, 5, 6, 8, 20. Metal oxide varistors protect data lines 2, 3 from voltage spikes and surges. Push button reverses transmit-receive lines (2, 3). PC board eliminates wiring, crosstalk, line interference. Connects any one input to any one output.

Model	Price	In	Out	Model	Price	In	Out
MFJ-1240	\$79.95	1	2	MFJ-1244	\$139.95	3	3
MFJ-1241	\$99.95	2	2	MFJ-1245	\$169.95	3	5
MFJ-1242	\$119.95	2	3	MFJ-1246	\$199.95	5	5
MFJ-1243	\$119.95	1	4	MFJ-1247	\$99.95	1	2

Switches 20 lines

AC Power Centers

MFJ-1108
\$ 99 95

MFJ-1108, \$99.95. Add convenience, prevent data loss, head bounce, equipment damage. Relay latches power off during power transients. Multi-filters isolate equipment, eliminate interaction, noise, hash. MOVs suppress spikes, surges. 3 isolated, switched socketpairs. One unswitched for clock, etc. Lighted power, reset switch. Pop-out fuse. 3 wire, 6 ft. cord. 15A, 125V, 1875 watts. Aluminum case. Black. 18x2 3/4x2 in. MFJ-1107, \$79.95. Like 1108 less relay. 8 sockets, 2 unswitched. MFJ-1109, \$129.95. Like 1107 but intelligent. Switch on device plugged into control socket and everything else turns on. Others available.



Acoustic/Direct Coupled Modem



Use with any phone anywhere MFJ-1233
\$ 129 95

MFJ-1233 Acoustic/Direct Coupled 300 baud modem. Versatile. Use with virtually any phone, anywhere. Use battery or 110 VAC. Direct connect mode: Plug between handset and base. Use with single or multi-line phones. Acoustic coupled mode: Use with phones without modular plugs. Quality muffs give good acoustic coupling, isolates external noise for reliable data transfer. Originate/answer. Self test. Carrier detect, ON LEDs. RS-232, TTL compatible. Reliable single chip modem. Crystal controlled. Aluminum cabinet. 9x1 1/2x4 in. Other models available.

Order from MFJ and try it. If not delighted, return within 30 days for refund (less shipping).

One year unconditional guarantee.

Order yours today. Call toll free 800-647-1800. Charge VISA, MC. Or mail check, money order. Add \$4.00 each for shipping and handling.

CALL TOLL FREE 800-647-1800

Call 601-323-5869 in MS, outside continental USA.

MFJ ENTERPRISES INCORPORATED

921 Louisville Road, Starkville, MS 39759

and therefore are likely to cause confusion. Consequently, the critical legal questions would involve priority and good-faith adoption in a remote geographic area. The general rule in trademark law is that the user who first applies a trademark to goods in a particular geographic area has exclusive rights to it and related products in that area. The law allows another user to use the same or a similar trademark for the same goods only if the second user has adopted, and first used, his trademark in good faith in a geographic area remote from the first user. This legal defense would be available to the Aisle developer under normal circumstances, the lawyer says, because the developer of Aisle was unaware of the Isle trademark when he chose the name Aisle and because he was selling Aisle software in an area remote from that where Isle was sold.

However, the lawyer notes ruefully that the owner of the Isle trademark was smart to take the initiative to obtain a federal registration of Isle. The Isle developer was granted such

protection a few months before Aisle's developer adopted a similar name. The federal registration provided nationwide constructive notice of the Isle trademark, which means that the law will presume people have notice of the trademark. Thus its owner can presume others are aware of its use, and the developer's defense of good-faith adoption is eliminated.

**Arbitrary trademarks,
such as Apple
computers, don't
describe the
function of the
products or services
they identify.**

The developer does not believe what he is hearing. He asks the lawyer pointedly whether the law was telling him to stop using the Aisle mark. The lawyer says that without a legal fight, the law was saying just that. The developer explodes,

vowing that he will not be party to such legal ransom by the owner of the Isle trademark, particularly now that his software package is known extensively by the Aisle name. He says he will refuse to change the name unless a court orders him to, and the meeting comes to an end.

Epilogue

Despite his lawyer's warning, the developer did not respond to the letter, and several months later he was served with a summons in a lawsuit. After spending \$30,000 in the defense of a preliminary injunction motion, the case was settled as follows: even though he still felt he had done nothing wrong, the developer agreed to stop using the Aisle mark on his package or "any confusingly similar variation thereof"; to destroy all labels, ads, promotional materials, and actual packages using the Aisle mark; and to pay court costs. Nevertheless, the developer disregarded the court order and subsequently was found to be in contempt of court, which resulted in a stiff fine, addi-

ADALAB™ Automates Lab Instruments



- Interactive Microware's general-purpose ADALAB™ data acquisition and control system interfaces with virtually any lab instrument using a recorder or meter, including GC and HPLC systems, spectrophotometers, pH meters, process control apparatus, thermocouples, etc.

- Lab Data Manager™ software facilitates single or multi-channel acquisition, storage, display and chart recorder style output of lab instrument data. IMI QUICKI/O software operates within easy-to-use BASIC!

- Thousands of scientists currently use IMI software and/or ADALAB products worldwide!

*Price includes 48K APPLE+ II+ CPU, disk drive with controller, 12" monitor, dot matrix printer with interface, IMI ADALAB™ interface card.

†Trademark of Apple Computer, Inc.



IMI's ADALAB INTERFACE CARD IS AVAILABLE SEPARATELY FOR ONLY \$495

(Includes 12-bit A/D, 12-bit D/A, 8 digital sense inputs, 8 digital control outputs, 32-bit real-time clock, two 16-bit timers plus QUICKI/O data acquisition software.)



INTERACTIVE MICROWARE, INC.
P.O. Box 771, Dept. 3
State College, PA 16801 (814) 238-8294

The Software Toolworks™ presents: **MyCalc**



Full featured MyCalc™ with sort, bar graphs, multiple files and more is ideal for financial planning and budgets. It sells for \$59.95 from The Software Toolworks, 15233 Ventura Blvd., Suite 1118, Sherman Oaks, CA 91403 (818) 986-4885.

CP/M is a registered trademark of Digital Research.

The Rixon PC212A... The Perfect Modem For Your IBM® PC ...Only \$499

The Rixon® PC212A offers you the only 300/1200 BPS full duplex card* modem with auto dial and auto answer that plugs directly into any of the IBM PC® * card slots. Because the Rixon PC212A was designed specifically for the IBM PC, it is loaded with user benefits.

The PC212A eliminates the need for an asynchronous communications adapter card and external modem cable, this alone saves you approximately \$190. The PC212A provides an extra 25 pin EIA RS232 interface connector, a telephone jack for alternate voice operation, and a telephone line jack for connection to the dial network. Without question, the PC212A is the most user friendly, most reliable, and best performing modem for your IBM PC. An internal microprocessor allows total control, operation, and optioning of the PC212A from the keyboard. A user friendly HELP list of all interactive commands is stored in modem memory for instant screen display. Just a few of the internal features are auto/manual dialing from the keyboard, auto dial the next number if the first number is busy and instant redial once or until answered. In the event of power disruption a battery back-up protects all memory in the PC212A. In addition, the PC212A is compatible with all of the communication programs written for the Hayes Smartmodem™**such as CROSSTALK.™+Also available for use with the PC212A is the Rixon PC COM I,™* a communications software program (Diskette) and instruction manual to enhance the capabilities of the PC212A and the IBM PC. PC COM I operates with or replaces the need for the IBM Asynchronous Communications Support Program. The program is very user friendly and provides single key stroke control of auto log on to multiple database services (such as The Source^{SM&}), as well as log to printer, log to file transfer and flow control (automatic inband or manual control). PC COM I is only \$49.00 if purchased at the same time as the PC212A. The PC212A comes with a 2 year warranty. For more information contact your nearest computer store or Rixon direct at 800-368-2773 and ask for Jon Wilson at Ext. 472.

PC212A\$499.
PC212A WITH
ASYNCH PORT\$539.

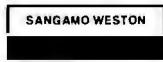

2120 Industrial Pky., Silver Spring, Md. 20904
301-622-2121 TWX 710-825-0071 TLX 89-8347

\$25 Rebate
on the PC212A
Contact your local retail computer store for details.



- IBM is a registered trademark of the International Business Machine Corp.
- ** Hayes Smartmodem is a product of the Hayes Stack™ series, a registered trademark of Hayes Microcomputer Products Inc.
- + CROSSTALK is a trademark of Microstuf Inc.
- # PC COM I is a trademark of Rixon Inc.
- & The Source is a servicemark of Source Telecomputing Corp.

3043B © RIXON INC. 1983

The Rixon PC212A Card Modem

Another Modem Good Enough To Be Called RIXON

Circle 306 on inquiry card.

OPEN UP AN ACCOUNTING DEPARTMENT FOR \$395.00

Why staff up? With the Desktop Accountant™, all the accounting help your office needs can be at your fingertips!

No matter what type of business you're in, Desktop Accountant will let you manage the financial end of it more professionally than ever before.

A Complete System with Support.

Desktop Accountant includes accounts receivable, accounts payable, payroll and general ledger programs, along with comprehensive user manuals and training aids, including an audio cassette tape. And our telephone "hotline" means personalized support.

Produces 42 Reports. "Keeping the books" has never been so easy! Desktop Accountant prepares every bookkeeping/accounting report your growing business requires: from invoicing to statements to aged A/R listings; from cash distribution to A/P checks to vendor activity reports; from complete payroll checks and stubs to W-2 forms; from the chart of accounts to balance sheet and income statement, as well as many other vital to efficient management.

Desktop Accountant is available for nearly every portable, personal and desktop computer. The system requires either CP/M® or MS-DOS™ (PC-DOS), Microsoft BASIC™, 64K RAM, two disk drives or hard disk, and a 132-column printer (or an 8½" x 11" printer with compressed print mode).

You won't find better quality software at such a low price. Just \$395.00 for most CP/M® formats (\$495.00 for IBM® and some CP/M formats) complete. Call for available formats.



Order Desktop Accountant today!

To order Desktop Accountant or for comprehensive literature, call toll-free:

1-800-832-2244

(In California call 1-800-732-2311)

or send orders to:
1280-C Newell Avenue, Suite 1201
Walnut Creek, CA 94596



* California residents add 6 1/2% Sales Tax • Payment by VISA/Master-Card/COD/MO/Cashier's Check • All Brand Names are manufacturers' registered Trade Marks • No sales to Dealers • Foreign orders please call or write before ordering • 1983 Rocky Mountain Software Systems.



HEROISM IN THE MODERN AGE

THE ROLE-PLAYING GAME OF TODAY

© Copyright 1983 Pacific Infotech Corp.



A sophisticated simulation of modern life and human psychology.

Includes: **BASIC MODULE** — create and guide characters through their lives...

PROJECT CONTACT (Scenario #1) — save the U.S.A. from a mad scientist and terrorist plot... you have only 60 hours to complete your mission...

HEROISM IN THE MODERN AGE is expandable to other modules and exciting scenarios.

At your computer store.

SYSTEM REQUIREMENTS:

IBM PC* with one double-sided or two single-sided disk drives, an 80-column monitor, and 64K RAM (96K for DOS 2.0). Color graphics/adaptor optional.

*IBM PC is a trademark of International Business Machines Corp.



10850 Wilshire Blvd.,
Suite 800
Los Angeles, CA 90024
U.S.A.

tional attorneys' fees, and bad publicity in the trade press.

Clearly, the developer did not handle this in a proper legal manner or cost-effectively. He could have maintained the hard-earned goodwill his trademark had won by taking a few steps to protect it.

He should have first obtained a legal opinion from a trademark attorney as to whether his proposed Aisle mark was available and registrable prior to using it. A clearance search would have cost him far less than the value of the goodwill in his trademark that he subsequently lost, not to mention the attorneys' fees resulting from the cease-and-desist letter and ensuing litigation.

If he had asked an attorney to check out his proposed mark, and the attorney had indicated that it was unavailable, the developer could have chosen one that was indeed registrable and begun using it properly in his software packaging, advertising, other promotional material, and documentation. Merely using the symbol of federal registration, the circled R, does not provide legal protection. Therefore, once the package was a commercial success, he should have applied for federal registration at the United States Patent and Trademark Office. Finally, to ensure that others were not using the Aisle name or marks similar to his on software products, he could have vigilantly policed the market for infringers.

Under the current state of the law, trademark protection is considered by many to be the most effective way to legally protect mass-marketed software. Thus, trademark consciousness makes good business sense. ■

Robert Greene Sterne is a partner in the law firm Saidman, Sterne & Kessler (412 Barr Building, 910 Seventeenth St. NW, Washington, DC 20006), specializing in computer and intellectual property law. He is co-chairman of the APLA 1984 National Institute on Computer Law and author of Trademark Law: Federal, Maryland Statutory and Maryland Common Law.

Perry J. Saidman is also a partner in the firm Saidman, Sterne & Kessler. A member of the United States Trademark Association, he teaches a patent bar review course sponsored by the Patent Resources Group and is author of Patent Law for General Practitioners and Business Lawyers.

Four Reasons Why The Dysan Difference is Worth Paying For

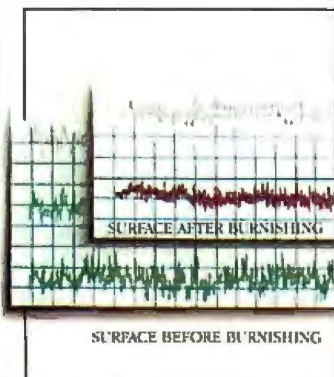

1. 100% Surface Tested

Only Dysan provides fully usable diskette surfaces that are truly 100% error-free across the entire face of the diskette. An exclusive on-and-between the track testing procedure guarantees error-free performance regardless of temperature and humidity distortions or slight head misalignments.

2. Advanced Burnishing Techniques

Dysan's advanced polishing methods create a smoother, more uniform diskette surface. This results in better signal quality on each track, less wear on drive heads and reliable access to data after millions of head passes.

3. DY¹⁰™ Lubricant

Dysan's proprietary DY¹⁰ lubricant complements the advanced burnishing process. Both maximize error-free performance while minimizing headwear. Optimal signal presence is maintained between the head and diskette surface during millions of write/read interfaces.

DY¹⁰ is a trademark of Dysan Corporation

4. Auto-Load Certification

Dysan's unique quality control methods reflect technological leadership in designing, producing and testing precision magnetic media. Each diskette is unerringly certified by Dysan-built, automated and microprocessor controlled certifiers. Your system and data base will benefit from Dysan's diskette reliability and unsurpassed quality.

Select from a complete line of premium 8" and 5¼" diskettes, in single or double densities, certified on one or both sides.



Corporate Headquarters:
5201 Patrick Henry Drive
Santa Clara, CA 95050
(800) 551-9000

An EPROM Simulator

This versatile project includes battery backup

by Albert S. Woodhull

An EPROM (erasable programmable read-only memory) is a convenient place to store a machine-language program (for instance, a bootstrap loader program for a large system or the entire application program in a data-collection system). The development cycle for such programs involves writing and assembling the program on a development computer system and programming (burning) an EPROM. The EPROM is then plugged into its socket on the target computer system and the program is tested.

EPROMs are great for programs that are already debugged, but they create a bottleneck in the development process. On my development system, the EPROM programmer takes up memory space needed by the editor I use for writing programs, so I have to power down and change the hardware configuration before programming the EPROM. And, of course, once a program is in EPROM it cannot be easily changed, so I can't use a monitor or debugger on the target computer to try out simple modifications at the machine-language level. A bug requires going back to the development system. I have often wished for something simpler.

There are several alternatives to EPROMs. Steve Ciarcia has written about the new electrically erasable nonvolatile memory chips in the December 1979 BYTE ("Add Nonvolatile Memory to Your Computer," page 36). These devices are an attractive possibility, but they are expensive and cannot be plugged into the same socket as an EPROM. Eric Rehnke described an EPROM emulator in the February 1982 BYTE ("Build an EPROM Emulator," page 194). This two-port memory gives a development system the ability to control the contents of a portion of the memory of a target system. While this approach is excellent for some purposes, I needed nonvolatile memory for development of bootstrap programs for the development system itself. I chose a third approach, a battery-powered RAM (random-access read/write memory) that could be unplugged from one socket and plugged into another without risk to chips or loss of data.

The EPROM simulator turned out to be an easy project. I decided to use a 2K-byte wide static-memory chip, the Hitachi 6116. I have been using these in my projects and for main memory in my development system. Standard 2716 EPROMs can be used

in the same sockets, a convenient arrangement for frequent changes of hardware configuration. The 6116 uses CMOS (complementary metal-oxide semiconductor) technology and requires very little power when deselected. By proper choice of operating conditions, the standby current drain of one of these chips can be held to less than 2 mA (milliamperes). CMOS chips also are relatively tolerant of voltage variations. Hitachi's data sheets specify the operating voltage of the 6116 as 5.0 volts ± 10 percent; many digital integrated circuits require ± 5 percent regulation. As I will explain later, the voltage tolerance for retention of data is more permissive than the operating voltage range.

Nicad (nickel-cadmium) rechargeable batteries are an obvious choice for powering the EPROM simulator. The *nominal* voltage of a nicad cell is 1.2 volts, but when fully charged, a battery of four cells will produce just over 5.5 volts. Nicad voltage holds up well during discharge; a 4.5-volt endpoint enables use of most of the charge. Size AA nicad cells are readily available and are rated at 450 milliampere-hours (mAh), enough to keep a 6116 chip alive for well over a week.

After choosing to power a 6116 RAM with nicad batteries, the problem I had to deal with next was protecting the memory chip and its data from damage while unplugging it from the development system and plugging it into the target computer. Plugging and unplugging solid-state components while power is applied is not a good idea. Pins won't make connections simultaneously and internal voltages momentarily can be the wrong polarity. Even if you could be sure components would survive the surges of power, there is too much chance of misalignment or short circuit with a large number of closely spaced connections. The answer to this is to use buffer circuits from which the power can be removed without turning off the RAM itself. Only inactive devices will be connected to the external plug during insertion or withdrawal. The buffer chips do not have to draw on the battery; they are needed only when power is available from a host development or target system.

The Circuit

The block diagram in figure 1 depicts the overall scheme. All connections to the 6116 RAM chip are isolated by tristate buffers. The buffer chips get their power from the host computer; the RAM is powered by a 5-volt battery. A diode allows the battery to be partially recharged from the computer but prevents the buffers from draining the battery when the host computer is off or the unit is unplugged. The diode also permits the RAM to get its operating current from the host when it is selected. During a read or write cycle, a selected RAM chip may need as much as 80 mA. The buffers for the address and control lines are always enabled; the data buffers are selected appropriately when the socket into which the simulator is plugged is selected for reading or writing.

Details of the circuit are shown in figure 2. Instead of conventional OR gates, I put an extra 74LS367 buffer chip on the board and used two buffer sections and pull-up resistors to gate the enable signals for the data buffers. I was planning for the

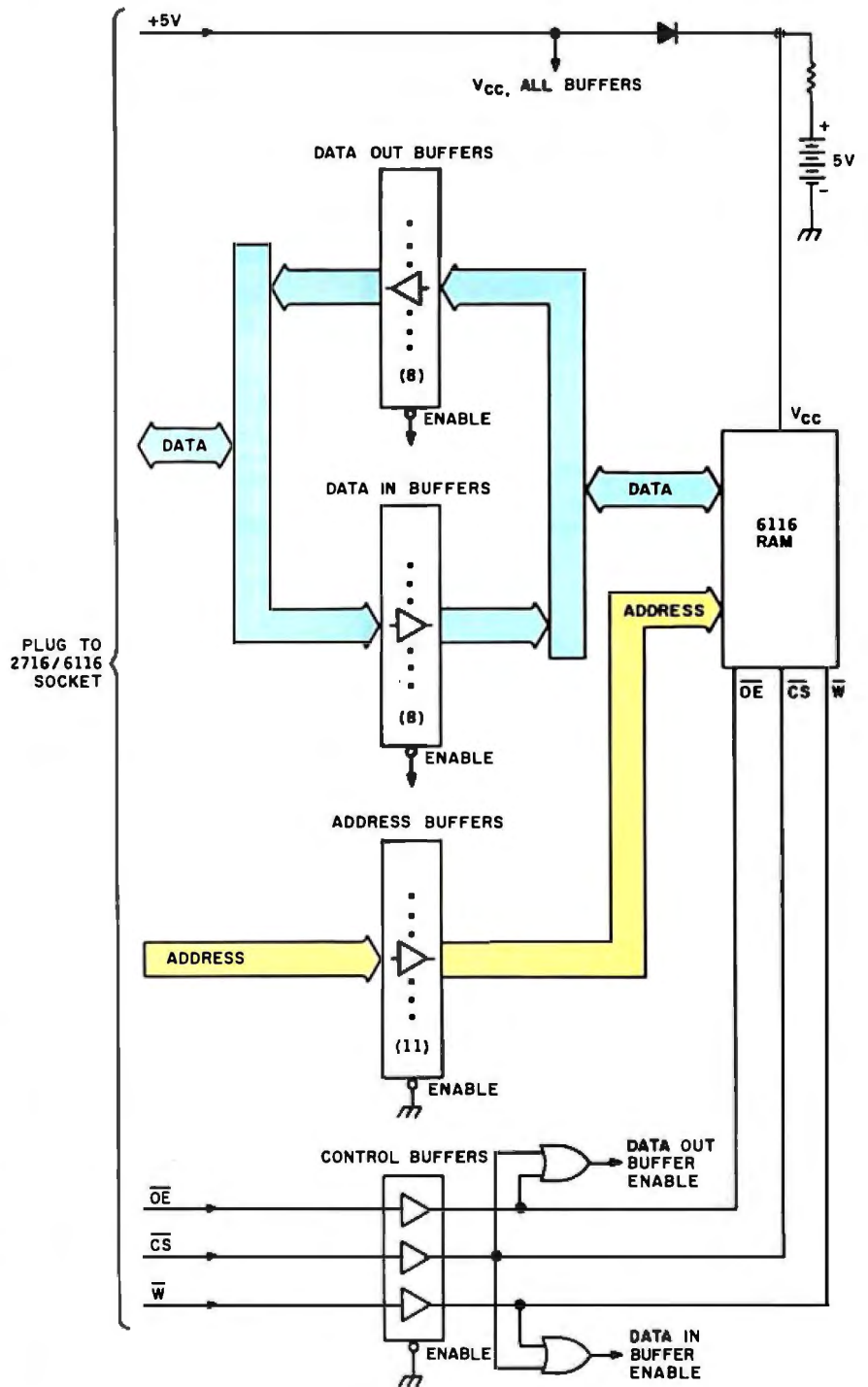

Figure 1: A block diagram of the EPROM simulator. All external connections go to a 24-pin DIP (dual-inline package) plug that can be inserted into a 2716 EPROM or 6116 RAM socket on the host computer. The host may be either the development system upon which a program is being written and assembled or a target system upon which the program will be run. All lines from the host are isolated from the RAM by 74LS367 buffers, and these buffers receive power from the host. The RAM is powered by a battery. The host may be powered down and the EPROM simulator removed to be plugged into an alternative host or a different host memory location, without damage to the RAM chip or loss of data.

future—someday I'll want to use 4K- or 8K-byte RAM and EPROM chips, and unused buffers then can be wired up for additional address lines. The switches on the CS and W lines

are for peace of mind. The CS switch guarantees that no transients will come through when the buffers are powered up or down; the W switch protects the RAM from accidentally



Computer-Line announces Compucard™

Extra Specials—Extra Discounts—Extra Savings

Call For Details

The Computer-Line believes that it is important to be competitive by offering low prices; however, we regard service as the most important aspect of a mail-order organization. All our lines are available so that you, the customer, are able to talk to fully qualified computer specialists trained to answer all your questions pertaining to our line of microcomputers. We are renowned for our excellent after-sales support and our promptness for delivery. Peace of mind and excellence in service is our pledge to all our customers.

COLUMBIA DATA PRODUCTS

- IBM PC Compatible • 128K Main Memory
- 8 Expansion Slots • 2 Serial and One Parallel Port Built In • 2 Double Sided/Double Density 320K Drives • Over \$3000 Free Software

Including:

- Perfect Writer/Speller
- Perfect Filer/Calc.
- Home Accountant
- Fast Graphs
- MS DOS/CP/M and more!

Prices too low to publish

HARD DISK UNIT

- Compatible to IBM PCXT
- Includes 12 megabyte hard disk

PORTABLE UNIT

- As for 1600-1 except this unit is truly portable

Available at retail stores

NEW FRANKLIN SYSTEMS

Compatible with the Apple computer!
1000 Pro Pack Plus: 1200 OMS Package:

- | | |
|----------------------------------|--------------------------------|
| Featuring: | Featuring: |
| • 1000 CPU | • 1200 CPU |
| • Franklin Monitor | • 80 Column Card |
| • 80 Column Card | • 2 Disk Drives + Controller |
| • Ace 10 Disk Drive + Controller | • CP/M Card + Software |
| • Ace Calc. | • Parallel & Serial Interfaces |
| • Ace Writer | • Wordstar |
| • Data Perfect | • Mailmerge |
| • Welcome Package | • Ace Calc. |
| | • Welcome Package |

TOO LOW TO PUBLISH

TOO LOW TO PUBLISH

IBM PERSONAL COMPUTERS

Take A Demonstration on the IBM PC. Our System Includes:

- Two Double-Sided Drives
- 64K of Memory
- Color Graphics Adaptor

ONLY \$2599.00

Maximum of 2 weeks delivery on all IBM systems.

SOFTWARE

BUSINESS	APPLE	IBM
Lotus 1-2-3	—	\$319.95
DB Master (version 4)	\$269.95	\$399.95
DBASE II	\$449.95	\$449.95
Friday	—	\$199.95
Multiplan	\$189.95	\$189.95
The General Manager	\$159.95	—
TK Solver	SCALL	SCALL
BPI-Gen Acct/Inv/Payroll	\$278.95	\$419.95
-Job Costing	\$419.95	—
Word w/Mouse	—	\$339.95
Wordstar Professional	\$439.95	\$439.95
Screenwriter II	\$ 89.95	—
Sensible Speller	\$ 89.95	—
PFS: Write/File/Report	\$ 84.95	\$ 99.95
Peachtree 5000	—	\$269.95
Supercalc 3	—	\$279.95
Vitecalc IV	SCALL	SCALL

HOME/GAMES/EDUCATION

Home Accountant	\$ 49.95	\$109.95
Dollars and Sense	\$ 74.95	\$129.95
Micro Cookbook	\$139.95	\$139.95
Bank Street Writer	\$ 49.95	\$ 46.95
Tax Advantage	\$ 46.95	\$ 46.95
Zaxxon	\$ 29.95	—
Lode Runner/Choplifter	\$ 24.95	—
Zork I, II, III	\$ 27.95	\$ 27.95
Deadline/Witness/Planet	\$ 35.95	\$ 35.95
Flight Simulator	\$ 34.95	\$ 34.95
Sargon III	—	—
Frogger	\$ 26.95	\$ 26.95
Temple of Apshai	\$ 29.95	\$ 29.95
Master Type	\$ 29.95	\$ 35.95
Kinder Comp/Alphabet Zoo	\$ 23.95	\$ 23.95
Story Machine/Facemaker	\$ 24.95	\$ 24.95
Snooper Troops Case #1/#2	\$ 34.95	\$ 34.95

DISK DRIVES FOR IBM

Tandon	
TM-100-2 320K IBM Compatible	\$219.95
TM-55-2 320K Half Height	\$219.95
CDC 320K IBM Compatible	\$245.00
Shugart and MPI	SCALL

DISK DRIVES FOR APPLE

Quentin	\$199.95
Rana Elite I	SCALL
Rana 1000 (for Atari)	SCALL
Micro-SCI	SCALL

PRINTERS

Special of the Month

F-10 Letter Quality
-40cps \$999.95

-Parallel or Serial

Epson	SCALL
Brother	
Dynax DX-15	\$ 469.95
Dynax DX-25	SCALL
Juki	
6100 Letter Quality	\$ 479.95
NEC Spinwriter	SCALL
Diablo-Transfer-OUME	SCALL
Data Products-Olivetti	SCALL
Okidata 82A	\$ 299.95
Okidata 84	SCALL
Okidata 92P 160CPS	\$ 449.95
Okidata 93P 160CPS	\$ 739.95
Okidata Pacemark 2410	\$2499.95
Okigraph I	\$ 39.95
Okidata Plug & Play	\$ 43.95
Star Micronics	
Gemini-10X 120CPS	\$LOW
Gemini-15X 120CPS	\$LOW
Toshiba 1350 Dot Matrix	\$1599.95
Integral Data Systems	
Micro Prism	\$ 499.95
Color Prism 132 4-Color	\$1499.95
C-Itch	
Prowriter I 8510 PAR	\$ 359.95
Prowriter II 1550 PAR	\$ 599.95

FOR IBM/PC

QUADRAM	
Quadboard	SCALL
Quadlink	SCALL
Microblazer	SCALL
TECMAR	
1st Mate	SCALL
2nd Mate	SCALL
Graphics Master	SCALL
APPARAT	
Ram Card	SCALL
Prom Blaster	SCALL
AMDEK	
Multiple Adapter Inter	SCALL
KEYTRONICS KEYBOARD	SCALL
USI	
Multi Display	SCALL
PLANTRONICS	
Color Plus	SCALL
BABY BLUE	SCALL
STB	
Super Rio	SCALL
MAYNARD CONTROLLER	SCALL
AST	
Six Pack	SCALL
Megaplus	SCALL
CPMBOplus	SCALL
I/O Plus	SCALL

FOR APPLE COMPUTERS

MICROSOFT	
Softcard Z-80	\$249.95
Ram Card 16K	\$ 77.95
ORANGE MICRO	
Grappler+ printer inter	\$109.95
Buffered Grappler+	\$159.95
VIDEX	
Video Term 600/601	SCALL
Function Strip	\$ 64.95
Display Enhancer II	\$ 99.95

MONITORS

AMDEK	
Video 300 (Green) Med-Res	\$129.95
Video 300A (Amber) Med-Res	\$139.95
Video 310 (Amber) Hi-Res	\$169.95
Color I+ Composite	\$285.95
Color II+ Plus RGB	\$399.95
BMC	
Lo Res Green	\$ 85.00
Hi Res Green	\$129.00
NEC MONITORS	SCALL

PRINCETON GRAPHICS

HX-12 Hi-Res RGB	\$469.00
For IBM/PC	
ZENITH	
ZVM-125 (Green) Med-Res	\$ 99.95
LEADING EDGE	
Gorilla Hi-Res Green	SCALL
Gorilla Hi-Res Amber	SCALL

MODEMS

D.C. HAYES	
Smartmodem 300 BAUD	\$199.95
Smartmodem 1200 BAUD	\$475.00
Smartmodem 1200B W/SCI	\$419.95
Smartmodem IIe W/SCI II	\$236.95
Chronograph	\$189.95
U.S. ROBOTICS	
300 BAUD	\$169.95
Auto Dial 1200	\$449.95
Password	\$339.95
NOVATION	
J-Cat	\$119.00
Apple-Cat II	SCALL
Apple-Cat Ite	SCALL
SIGNALMAN	

Call now for our lowest price ever

DISKS/SUPPLIES

Verbatim SS/DD 5 1/4 floppy	\$ 23.95
Verbatim DS/DD 5 1/4 floppy	\$ 31.95
Dynas SS/DD 5 1/4 floppy	\$ 27.95
Dynas DS/DD 5 1/4 floppy	\$ 36.95
ESK SS/DD 5 1/4 floppy	\$ 19.95
ESK DS/DD 5 1/4 floppy	\$ 27.95
Library Cases 5 1/4	\$ 1.50
Flip-N-File 25/50/70	SCALL
Lazercut paper 9 1/2x11 3000	\$ 29.00
" " " " 11 1/2x15 3000	\$ 39.00

NEW
48 HOUR SERVICE



THE COMPUTER-LINE™

Committed to bringing computers within the reach of all Americans

CALL (800) 255-4659 (Outside California)
CALL (800) 541-4300 (Inside California)

When in California, please visit us at:

21054 SHERMAN WAY
CANOGA PARK, CA 91303
CALL: (818) 716-1812

17791 FITCH ST.
IRVINE, CA 92714
CALL: (714) 863-9944

General/Mailorder (714) 863-9988
CUSTOMER SERVICE AND ORDER INQUIRY (714) 863-9933

When in Colorado, please visit us at:

1136 COLORADO BLVD.
DENVER, CO 80222
CALL: (303) 758-3261

Circle 401 on inquiry card.

TERMS: All prices reflect a 2.9% cash discount. All goods acknowledged faulty on receipt by the customer will be repaired or replaced at our discretion. Customers must call for an RMA number before returning any goods. This facilitates our quick attendance to faulty goods. We reserve the right to repair or return to the manufacturer for repair all goods becoming faulty within the specified warranty period. Any goods (hardware or software) returned for restocking are subject to a 15% restocking fee at our discretion. The charge for cancellation of orders is 20% at our discretion. No returns on software. We accept no responsibility for any false claims made by manufacturers. Prices quoted for stock on hand and subject to change without notice. Specialists in APD and international deliveries. Please add 3% (minimum \$3.00) for shipping. APD add to all prices 5% for shipping (minimum \$5.00). We will calculate exact freight. Please allow a minimum of 2 weeks plus mail time (if an order is mailed in) for receipt of all UPS delivered goods. All goods (other than APD or international) delivered UPS ground. All items listed available for 48 hour service provided products are readily available from the manufacturer.

ALL BRANDS ARE REGISTERED TRADEMARKS

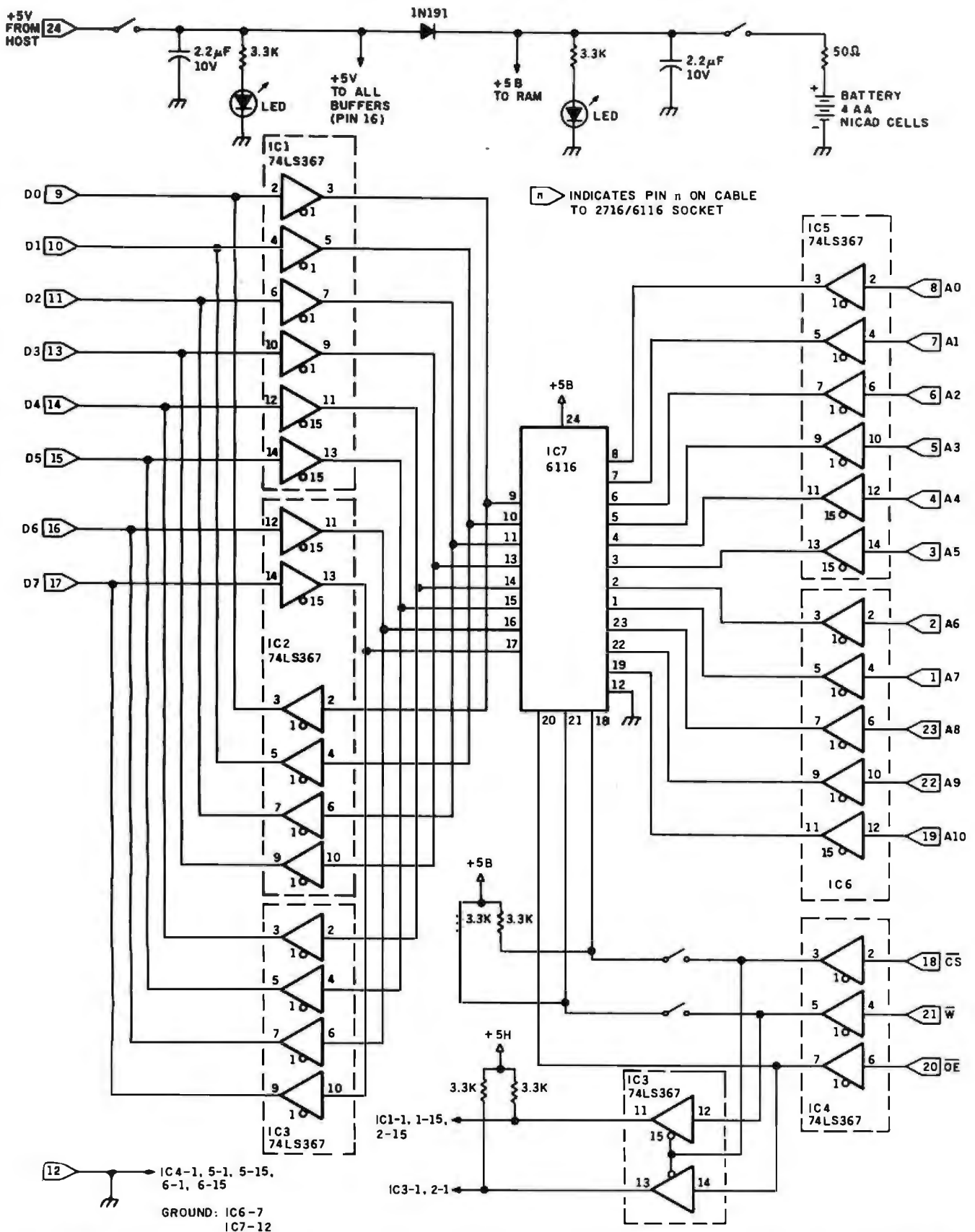
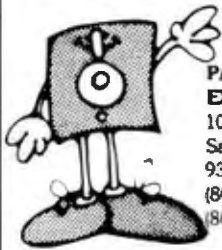

Figure 2: A detailed schematic diagram of the EPROM simulator. The pin numbers indicate the pinout of the plug that connects to a 2716 or 6116 socket on a host computer, other numbers indicate pin connections on the integrated circuits. For clarity, the enable lines to the buffers (six 74LS367s) are not shown; the connections are summarized at the bottom of the diagram. The control lines with overbars are active low lines, i.e., a zero-volt level on line \overline{CS} selects the RAM chip. Two sections of IC3, a 74LS367, are used as OR gates; because the output is high impedance when the buffers are not enabled, pull-up resistors are needed. Note that these pull-up resistors connect to the host-derived power, +5H, but the pull-up resistors on the control lines to the RAM chip must be connected to the battery line, +5B.

MEMOREX FLEXIBLE DISCS

WE WILL NOT BE UNDER-SOLD! Call Free (800)235-4137 for prices and information. Dealer inquiries invited and C.O.D.'s accepted.



PACIFIC EXCHANGES
100 Foothill Blvd.
San Luis Obispo, CA
93401. In Cal call
(800)592-5935 or
(805)543-1037

Circle 277 on inquiry card.



INDUSTRIAL/LABORATORY LOCAL AREA NETWORK

ADD/NET provides a modular, low cost, easy to use approach to factory and laboratory networking. ADD/NET modules may be used stand-alone or linked together in an extended network. Features include:

- Up to eight ports per module; interfaces include RS232C, RS422, RS449, IEEE-488, and industrial I/O
- Transparent communication from any port to any other port within the network
- User friendly menu permits easy interactive setup from a terminal
- Command mode permits computer controlled setup for dynamic linking of ports
- Multiple baud rates supported, with automatic baud rate lock-in and baud rate conversion
- Up to 2000 feet between network modules
- Error checking and correction for reliability
- Ideal for linking your factory and lab equipment with your mainframe, P.C. and peripherals

CALL TODAY (305) 293-2002
Adroit Electronics, Inc.
Dept. A, 3790 Silver Star Rd.
Orlando, FL 32808

Circle 11 on inquiry card.

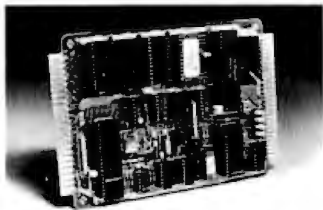

CONTROL THE WORLD!

The SYS-3A is a low cost, powerful microcontroller card with a Tiny BASIC language. Used in robotics, energy management, process control, science and education. Contains everything needed to write, debug, and permanently store programs that auto run on powerup. The 46 input/output lines include A/D, D/A, TTL I/O, and high current drivers. Multiple input ranges and drive capabilities. 4K RAM, 4K EPROM space, 2K software, & Tiny BASIC included. I/O and memory expandable. Programs both EPROM's and EEPROM's. RS-232C port connects to CRT terminals, printers, or personal computers. Software, hardware, peripheral cards available. 4.5" x 6.5". 5V operation.

OCTAGON SYSTEMS CORPORATION
6501 W. 91st Ave., Westminster, CO 80030
(303) 426-8540

Circle 272 on inquiry card.

12 Bit A/D Converter

Professional data conversion for your Apple® computer at a new low price of \$299⁹⁵

Compare with any competitive product at twice the price!

- 16 channels of analog input
- Full 12 bit data accuracy (1 part in 4096)
- No programming needed — convert any channel direct from Basic
- Complete accessory software on disk
 - Including high-speed access handler
 - "Demo-Scope" multichannel waveform display
 - Plain English discussion and example tutorial



6842 VALJEAN AVE.
VAN NUYS, CA 91406
(213) 989-1204

- Applications include:
 - Security
 - Control
 - Laboratory data acquisition
 - Voice analysis
 - Energy control

• 1982 Hollywood Hardware Inc.
• Apple is a Registered Trademark of Apple Computer Inc.

Circle 178 on inquiry card.

POWER PROTECTION FOR YOUR SYSTEM



The Datasaver™ AC Power Backup fits most desktop and portable microcomputer systems. Call Cuesta Systems, Inc. at (805) 541-4160 for product information and application literature.
VISA/Mastercard orders
INSTANT POWER

Circle 107 on inquiry card.

maxell®

Floppy Discs

CALL NOW - TOLL FREE
1-800-328-DISC

Dealer inquiries invited. C.O.D.'s and charge cards accepted.

All orders shipped from stock, within 24 hours. Call toll FREE.



North Hills Corporation
3564 Rolling View Dr.
White Bear Lake, MN 55110
1-800-328-DISC
MN Call Collect 1-612-770-0485

being written into. Both of these lines have pull-up resistors connected to the battery supply to ensure that the chip will be in the standby mode when the host power is off or disconnected.

The diode is a germanium type; this is not essential, but it reduces the diode voltage drop to about 0.25 volt. The 50-ohm resistor limits the charging rate of the battery and protects the diode from surges of current. The standby current demand of the RAM is so low that the voltage drop through this resistor during discharge is unimportant. The LEDs (light-emitting diodes) are frills, but I like to know when a circuit is enabled. The one on the battery-powered side of the circuit probably draws as much current as the RAM, and can be omitted if data retention for long periods is necessary.

Construction

My prototype was constructed on a small piece of perforated board using wire-wrap techniques; there is nothing critical about the wiring, with the possible exception of the cable to the RAM or EPROM socket on the host computer. I made this cable about eight inches long with some doubts about whether it would give me problems. I've had no problems with an 8080 processor with a 500-nanosecond cycle, but a shorter cable might be necessary with a faster system. Mechanical protection is also needed; a wire-wrapped prototype board like this is something like a pet porcupine. To avoid short circuits on a crowded bench, I mounted the entire assembly inside a small plastic box.

Data Retention and Battery Charging

The maximum supply voltage for the 6116 is specified as 7.0 volts. This is a maximum safe-voltage rating, with no guarantee that the part will actually work while the voltage is that high. The operating voltage range specification of 4.5 to 5.5 volts is for all phases of operation, including writing and reading data. In the EPROM simulator, reading and writing only take place while the host

Professional Software for the Software Professional

DMA products operate on
the full range of
Z80, 8086, 8088 processors,
including the IBM-PC

Here's what you can do!

Application Creation

FORMULA II™

The Application Creator

The first and only Application Creator—a do-it-yourself concept for office automation. FORMULA II lets you define your files, forms, menus, and reports—FORMULA II then creates your program. FORMULA II includes a Database manager with an English Query language and a Form/Report Creator with word processing features.

Communications

ASCOM™

ASCOM™ is the most versatile asynchronous communication package for microcomputers on the market. It features interactive, menu-driven, and batch operations; supports auto-answer and auto-dial modems; includes most popular protocols; provides network simulation; and many other options. Xerox Corporation, NCR, Monroe Systems for Business, and the big 8 accounting firms use ASCOM™.

SYNC/COM™—A

package that will be configurable for a variety of systems and includes a flexible interface to the operating system. 2780/3780/3270 protocols available on microcomputers with appropriate hardware.

TERMCOM™—A configurable terminal emulator allowing any personal computer to emulate most conversational and selected block mode terminals with asynchronous communications. Available December 1983.

Utilities

EM80/86™

This software emulator lets you use eight bit software on sixteen bit microcomputers without hardware modifications.

The 8086 O.S. Converter™

CP to MS—Permits execution of Digital Research's CP/M-86 programs under Microsoft's MSDOS (or PC DOS).

MS to CP—Permits execution of MSDOS programs under CP/M-86.

UT-86™

This package of user-friendly utilities for the IBM Personal Computer and similar systems includes copying, directory sorting, patching, and a general purpose file print utility.

Coming Soon

DMA. "C"™—A "C" language compiler which will generate either Z80 or 8086 assembly language code. Due to a unique optimization routine which is based upon a functional "P-code" model, the efficiency of DMA. "C" will far exceed that of existing compilers.

DMA DMA DMA

WE SPEAK YOUR LANGUAGE WE SPEAK YOUR LANGUAGE WE SPEAK YOUR LANGUAGE

DYNAMIC MICROPROCESSOR ASSOCIATES, INC.

545 FIFTH AVENUE, NY, NY 10017

Dealer Inquiries only • (212) 687-7115

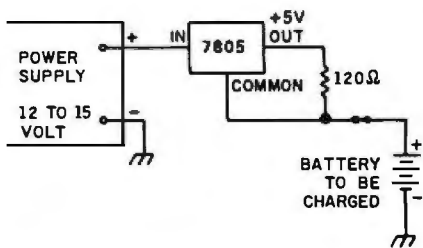

Figure 3: A constant-current circuit for charging nicad batteries. The regulator maintains 5 volts across the resistor, which passes a current of about 45 mA. The resistor current and the small operating current of the regulator itself flow through the battery to be charged. The power supply may be rated at anything from 12 to 35 volts.

computer supply is on; the diode will allow the battery voltage to be brought up if it is low. The voltage of a fully charged four-cell battery falls to 5.5 volts soon after the charger is disconnected. The rating sheets do not specify a supply voltage range for retention of data.

After constructing my EPROM simulator I experimented to try to determine these limits. With known data stored in the RAM, I charged the battery with an external charger, then checked and verified the data. Next, I loaded the battery with a resistor to discharge it to a low level and again checked the data. While charging at 45 mA, the battery voltage soared to about 6.3 volts, and during my discharge test I let the voltage fall to about 1.7 volts. The data remained intact in both cases. There is no guarantee that all 6116s will work this well, but it proved to me, at least, that retaining data with a battery is entirely feasible.

The battery cannot be fully charged from the host computer power supply with the circuit shown in figure 2. Diodes have a forward voltage drop that is relatively constant over a wide current range; with a germanium diode, this limits the voltage to which the battery can be charged to about 4.75 volts. If the EPROM simulator is constantly plugged into a computer that is used for a few hours each day, this should be good enough to retain data indefinitely, but an external charger will be needed if a full charge is required for maximum duration of data retention.

Standard nicads should be charged at about 10 percent of their Ah (ampere-hour) rating, requiring 14 hours for a full charge. A simple constant-current charger can be made with a standard voltage regulator chip and a resistor, as shown in figure 3. The regulator keeps the voltage across the resistor constant, which means the current through the resistor will be constant also. There is a small error due to the additional current that flows through the regulator's common terminal, but this is only a few milliamperes. The supply voltage must be greater than the fully charged battery voltage, plus the nominal output voltage of the regulator, plus about 2 volts. A 12-volt supply is adequate for charging the EPROM simulator battery, using a 5-volt regulator chip.

Using the EPROM Simulator

I'll describe the use of the EPROM simulator with an example. I gave it its first test by tracking down an an-

noying bug in my terminal I/O (input/output) routines, which normally are in EPROM where I can't modify them with the system debugger. I unplugged a RAM chip at a memory address I knew I would not need for my system routines, plugged the EPROM simulator into that socket, powered up, and copied the old system EPROM into the RAM with both the \overline{CS} and \overline{W} switches closed. I then opened both switches for protection, powered down the system, and replaced the system ROM with the EPROM simulator plug. With the \overline{CS} switch on, everything worked as it had with the EPROM in place. Finally, I closed the switch in the \overline{W} line and used the system debugger to quickly investigate several of the "what-if" questions I had about the program.

This EPROM simulator was a weekend project. By the next weekend I was wondering how I had lived without it. It makes any task involving development of code for an EPROM much more convenient. At the beginning of a project I know my programs will have bugs. Having my code as safe and portable as if it were in an EPROM, yet as easy to modify as if it were in RAM, makes starting such a project much more pleasant. ■

Albert S. Woodhull (33 Enfield Rd., RFD2, Pelham, MA 01002) has a Ph.D. in physiology and psychology and is an associate professor of computer studies and biology at Hampshire College in Amherst, MA. He uses computers for laboratory instrumentation in research in various aspects of physiology. His hobbies include ham radio operation, hiking, and backpacking.

DATA TRANSFER PROBLEMS?

Your Simple Solution is **REFORMATTER®** Diskette Conversion Software

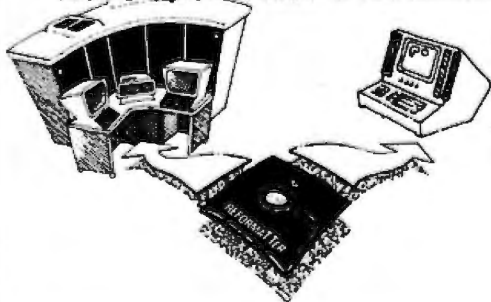

- Avoids serial communication protocols.
- Needs only one system to transfer data.
- Converts source code and data files.
- Allows 2-way transfer.
- Quick, reliable, and inexpensive.



467 Hamilton Avenue, Suite 2, Palo Alto, Calif. 94301

VERSIONS

Runs On	Reads/Writes
CP/M	↔ IBM 3740
CP/M	↔ DEC RT-11
CP/M-86	↔ IBM 3740
CROMIX	↔ DEC RT-11
DEC RT-11	↔ CP/M
MS-DOS	↔ IBM 3740
TRSDOS II*	↔ CP/M
TRSDOS II	↔ DEC RT-11
PRICE:	\$350 *\$249

Requires 8" floppy drive.

(415) 324-9114 TWX: 910-370-7457

WORK SMARTER - NOT HARDER

WITH THE SMART-CARD™ MANAGEMENT SYSTEM™*
FROM EXEC-U-PLAN™



DELUXE

Our most popular model

- Manages 288 projects: 2 panels—72 SMART-CARDS per side. Expands to 1440 w/purchase of extra panels
- 750 asst'd SMART-CARDS
- Color-coded signals
- Name or initials on cover
- Pen, tablet and business card storage
- Deluxe lock
- Plus the SMART-CARD Management System Manual

Leather grained vinyl **\$44.50**
Genuine leather **\$84.50**
Plus \$4 shipping and handling



THE TRAVELER

Our streamlined model

- Manages 144 projects
- 500 asst'd SMART-CARDS
- Color-coded signals
- Name or initials on cover
- Pen holder
- Plus the SMART-CARD Management System Manual

Leather grained vinyl **\$27.50**
Genuine leather **\$52.50**
Plus \$4 shipping and handling

Add \$750 per model for shipments to Canada, Alaska, Hawaii and Puerto Rico, \$12 to Mexico and \$18 to all other countries.
Copyright 1983 Executive Management Systems, Inc. and all patents pending. EXEC-U-PLAN™ SMART-CARD™ SMART-CARD Management System™ and the products named herein are trademarks of Executive Management Systems, Inc.



SUPER DELUXE

Our premier model

- Manages 576 projects: 4 panels—72 SMART-CARDS per side. Expands to 1440 w/purchase of extra panels
- 4 tabbed dual pocket dividers
- 1,000 asst'd SMART-CARDS
- Multi-function calculator
- Digital time piece and alarm
- Calendar-phone-address book
- Color-coded signals
- Name or initials on cover
- Pen, tablet and business card storage
- Deluxe lock
- Plus the SMART-CARD Management System Manual

Leather grained vinyl **\$85.00**
Genuine leather **\$155.00**
Plus \$4 shipping and handling



All Models Available in:

LEATHER GRAINED VINYL

Chestnut Brown (dark), Willow Brown (medium), Black, Burgundy and Natural Tan Suede.

GENUINE LEATHER

Black, British Tan and Burgundy.

SATISFACTION GUARANTEED

If for any reason you are not completely satisfied with your EXEC-U-PLAN SMART-CARD System, simply return it within 30 days of purchase for a full and prompt refund.

GET MORE DONE IN LESS TIME

Control 20-50—even hundreds of projects at a time with the smartest, easiest, most flexible method ever developed for planning and monitoring activities, schedules, appointments, performance, details and deadlines. The SMART-CARD Management System helps busy executives accomplish more in less time—by freeing the mind's memory banks and thought processes to focus where it counts! No matter how well organized you are, The SMART-CARD Management System will give you a better return on your time investment. **We guarantee it!**

CONTROL HUNDREDS OF PROJECTS WITH COMPUTER-LIKE EFFICIENCY

The SMART-CARD Management System is designed to function in many ways like a personal data processing center, but, with much greater flexibility and ease. Simply record all important information directly onto color-coded SMART-CARDS. Then insert them in the system's exclusive see-through panels—for visual control of hundreds of entries at-a-glance. Merge cards into the system after or priorities change. Retrieve information instantly. The SMART-CARD Management System's unique features and six special purpose cards help you plan and manage more effectively than ever before.

QUALITY CRAFTSMANSHIP

Individually crafted of the finest genuine leathers or rich leather grained vinyls, each SMART-CARD System comes personalized with your name or initials on the cover. Take the handsomely styled, highly portable EXEC-U-PLAN System with you to meetings, on business trips, or for a more productive daily commute.

WORKS FOR EVERYONE

Available in three styles to satisfy a wide range of needs and preferences, The EXEC-U-PLAN SMART-CARD Management System is ideal for all executives and professionals. With the system you're always so well organized, the time you save won't just be your own—it will increase the productivity of everyone around you. So, to Work Smarter, Not Harder, put the remarkable new EXEC-U-PLAN SMART-CARD Management System to work for you, and those around you, today!

***PATENT PENDING**

SPECIAL BONUS

Now—for a limited time only—receive a handsome, matching Pocket Organizer **FREE** with any model shown at left. This compact tuck-away version of the SMART-CARD Management System puts key data in your pocket—and lets you easily make new entries on-the-go. Retail value \$15.00.



EDIT CARD ORDERS
PHONE TOLL FREE

1-800-USA-0700

WRITE: **EXEC-U-PLAN™** DEPT. 184

31-17 QUEENS BLVD., LONG ISLAND CITY, N.Y. 11101

Circle 155 on inquiry card.

M A K E



NEW
FROM
PRENTICE[®]
CORPORATION



THE CONNECTION

POPCOM, X100
the new, easy-to-use communications tool that connects you and your personal computer to the wondrous, mind-expanding, enlightening world of information.

POPCOMTM X100

- **Automatic or manual dialing and answering** for all voice and data calls.
 - **Voice and data transmission during the same call** — ends the 3 separate calls ("I'm going to send," "I'm sending," "Did you get what I sent?")
 - **Smart modem compatible** — works with widely available communications software.
 - **Flexibility** — compatible with 103, 113, and 212A dial-up modems; connects to all standard single and multi-line equipment.
 - **Fast, easy setup** — 'tune' tells when the three cables are properly connected.
 - **Adjustment-free operation** — no manual switches to contend with. The X100 automatically takes its instructions from your PC or terminal.
 - **Automatic computer briefing** — reports to your PC all call-progress tones ... dial tone, busy signal, remote ringing, talk, even line disconnect — so your computer can do more.
 - **"In-Use"** light on multi-line phones — protects against inadvertent interruption.
 - **Smart Interface** — automatically adapts itself to various RS232 cables.
 - **Versatile installation** — fits conveniently on wall, desk or floor.
- Circle 288 on inquiry card.

See your dealer or write for more information. Make the connection between yourself and the challenging world of information.

- Please send me literature on POPCOM products.
 Please call me immediately.

NAME _____ TITLE _____

COMPANY _____ TEL: _____

ADDRESS _____ STATE _____ ZIP _____

PRENTICE CORPORATION, 266 Caspian Dr., P.O. Box 3544,
Sunnyvale, CA 94088-3544, (408) 734-9855 0102

SEVEN ACES

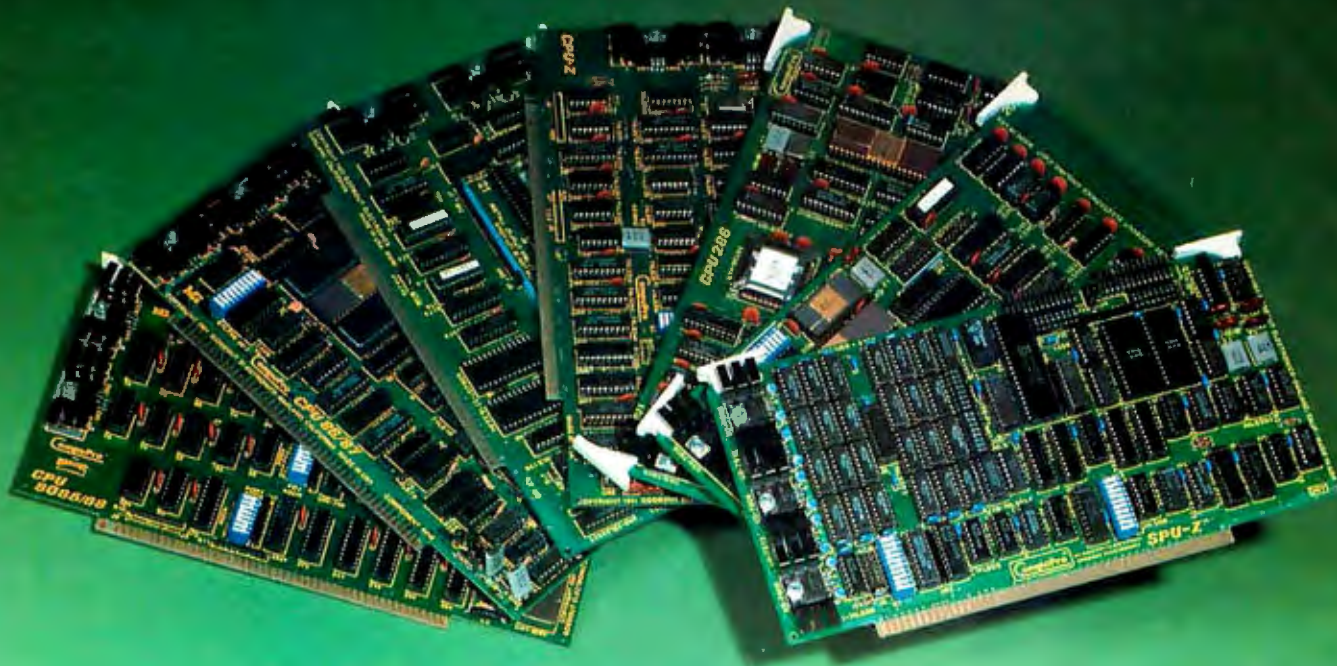

CPU's nimble and swift — a card sharp's delight.

When CompuPro introduced the first CPU board with both 8- and 16-bit capabilities, it was like handing a royal flush to systems integrators. How could we top that?

You gave us the answer. "Make a CPU that will access 16 megabytes at a swipe," you urged. So we designed CPU 68K. "Make one for people who need top speed and 16-bit power," you pleaded.

CPU 8085/88 is CompuPro's pioneering dual processor, running the vast library of both 8-bit and 16-bit programs at clock speeds up to 8 MHz. *Maximum* software access. \$495, \$595 CSC.

CPU 86/87 uses Intel's widely favored 8086 chip, so you get the broadest range of time-tested 16-bit software. Includes sockets for the 8087 math co-processor and 80130 firmware chip. \$800 10 MHz, \$850 CSC 10 MHz. With 8087 chip, \$1050 5 MHz, \$1150 CSC 5 MHz.

CPU 68K lets you rummage around in 16 Mbytes of memory at a time — not just the usual 64 Kbytes. Access huge databases, invert mammoth matrices, or turn titanic tables topsy-turvy. Includes socket for memory management unit. \$695 8 MHz, \$775 10 MHz, \$850 CSC 10 MHz.

CPU Z brings the Z80 chip's sophisticated instruction set to bear on the whole range of 8-bit software at clock speeds of 6 MHz. Ideal for multi-user installations, with 24-bit addressing that handles up to 16 Mbytes of memory. \$325, \$425 CSC.

CPU 286 is CompuPro's most far-sighted processor. It handles all 8086/8088 software, but many times faster with the help of a unique look-ahead capability. A memory management unit is *built-in*. \$1595 8 MHz, \$1750 CSC 10 MHz.

CPU 16032 features true 32-bit internal architecture that makes your micro byte off bigger words, like a mini. Ideal for Unix and other large operating systems. Includes sockets for floating point unit and memory management unit. Handles clock speeds up to 10 MHz. \$695, \$845 CSC. MMU available.

SPU-Z lets multiple users share expensive resources such as disk drives, printers and modems — not to mention data. Let our slave processor give individual attention where it's needed, freeing the more expensive CPU for bus management. \$695, \$795 CSC.

For your business, industrial and scientific computing solutions, call (415) 786-0909, ext. 206 today for the location of the **Full Service CompuPro System Center** nearest you.

CompuPro products are backed by a one-year limited warranty — two years for boards qualified under the Certified System Component high-reliability program.

CompuPro®

A GODBOUT COMPANY

3506 Breakwater Court, Hayward, CA 94545

For dealer locations see page 461.

Prices and specifications subject to change without notice.

©1983 CompuPro

410 BYTE March 1984

Circle 79 on inquiry card.

Simulation with Electronic Spreadsheets

Spreadsheet programs make a career change

by Art Matheny

Electronic spreadsheets aren't just for financial models. In fact, they can simulate many different types of dynamic processes. In this article, I present examples of dynamic process simulation using Visicalc on an Apple II and Supercalc on an Osborne 1. I assume that you can also apply my examples to other electronic spreadsheet programs.

Using an electronic spreadsheet, you can construct a table with rows and columns of different kinds of entries. The entries may be character data (such as names or labels), numeric values, or formulas. Formulas usually contain references to other entries in the table. If a formula uses an entry that is also a formula, this question is raised: "Which formula is evaluated first?" Visicalc and Supercalc both start at the first row and first column, go down the first column to the bottom of the table, then to the top of the second column, down the second column, then to the top of the third column, and so on until the programs have calculated all the entries. Or you can tell them to calculate by rows instead of by columns.

Ambiguities may arise when one

formula refers to another in one of two ways, a *forward* reference or a *circular* reference. A forward reference occurs when a formula refers to another formula that comes up later in the calculation sequence—further down the column or in any column further to the right. It is even worse if the second formula refers back to the first one, which is a circular reference. Figure 1 shows a spreadsheet with a circular reference. (The figures in this article use the notation of Supercalc.) Enter the formulas in cells A1 and B1 of figure 1 and recalculate the spreadsheet a few times.

With each recalculation, the numbers drift uncontrollably. You can, however, bring circular references under control. Figure 2 is an example of a useful circular reference. This spreadsheet calculates the balance of a savings account that is compounded monthly. The annual interest rate is entered in cell B2 and the monthly deposit in cell B1. Each time the spreadsheet is recalculated, a new month is computed. You can repeat the recalculations for as many months as you wish. To see how much money would be in the ac-

count after 20 years, press the recalculate key 240 times. Cell B3 keeps track of the number of months since the account was started. To reset to the starting condition, simply enter 0 in cell B1. Change the interest rate if you wish and then reenter the monthly deposit in cell B1.

The preceding example is an exact calculation for a savings account that is compounded monthly. The calculation is capable of being exact because the events that change the balance are discrete—that is, the time and interest payments change by fixed amounts that cannot be broken into smaller amounts. But dynamic processes are often continuous rather than discrete; that is, they may have no smallest discrete change because each change is infinitesimally small. Such processes are described by differential equations. The following differential equation describes the growth of population P with birth rate r :

$$dP = rPdt$$

The term dP refers to infinitesimal changes that occur in P as time (dt) changes infinitesimally.

A computer program can approximate the differential equation by using finite differences; thus,

$$\begin{aligned}dP &\rightarrow \Delta P \\dt &\rightarrow \Delta t\end{aligned}$$

The symbol Δ denotes a finite, rather than an infinitesimal, change in some

	A	B	C	D
1	1+B1	2*A1		
2				
3				
4				

Figure 1: A circular reference. A1 makes a forward reference to B1, and B1 refers back to A1.

	A	B
1	MONTHLY DEPOSIT	0
2	ANNUAL INTEREST RATE	.08
3	NUMBER OF MONTHS	IF (B1=0, 0, B3+1)
4	OLD BALANCE	IF (B1=0, 0, B6)
5	INTEREST	B2*B4/12
6	NEW BALANCE	B1+B4+B5

Figure 2: Compound interest calculated using a circular reference.

	A	B
1	TIME STEP	0
2	TIME	IF (B1=0, 0, B2+B1)
3	-----	
4	INITIAL POPULATION	100
5	BIRTH RATE	.1
6	OLD POPULATION	IF (B1=0, B4, B8)
7	BIRTHS	B1*B5*B6
8	NEW POPULATION	B6+B7

Figure 3: A spreadsheet simulation of a population explosion.

quantity. The differential equation can then be approximated by a finite-difference equation:

$$\Delta P = rP\Delta t$$

or

$$P_1 = P_0 + rP_0\Delta t$$

where P_0 equals population at the start of Δt , and P_1 equals population at the end of Δt ; thus, $P_1 - P_0 = \Delta P$.

The number of births during the time interval Δt is $rP_0\Delta t$. This equation can be used iteratively to simulate the population growth process. Given a starting population, the equation yields the population after a small time step, Δt . Starting from there, the equation can be used again for the next time step, and the next, and so on.

Figure 3 shows how to do this with an electronic spreadsheet. The formulas at B2 and at B6 contain IF functions. The IF function contains three arguments: the first is a condition and the other two are formulas. If the condition is true, the second argument is used; if the condition is false, the third argument is used. With the spreadsheet as shown, the condition is true in both cases. Thus, the time remains equal to 0, and the old population remains equal to the initial population. There is no change when

the spreadsheet is recalculated. Move the cursor to B1 and save the table. It is now ready for use.

To begin the simulation, change the value at B1 to some value greater than 0 (1, for example). Now repeatedly press the ! key or whichever key produces a recalculation. Note that the value at B8 increases exponentially with time. If you continue until the time equals 100, the population should be well over 1 million. At this point, you may need to change column widths and formats to clean up the spreadsheet. To reset the system, just change the value at B1 back to 0.

The next example, figure 4, is more complex in that there are two quantities that vary with time. This model simulates the decay of nuclear iso-

topes. Suppose you start with 1000 micrograms of a certain radioactive isotope. Let's call this the parent isotope. Each parent nucleus eventually emits an alpha particle and thus decays into the daughter isotope. It is often the case that the daughter isotope is also radioactive. The daughter nucleus eventually decays into the final product.

Change the time step in B1 to 1 or any other positive value to start the simulation. The value in B8 is the amount of parent isotope that decays during each time step. Those nuclei are all converted into daughter nuclei, which is why B8 is added to the current daughter amount in cell C9. Notice that the daughter amount increases at first, reaches a maximum level, and then declines. A Geiger counter held up to this sample would measure the total activity of both isotopes combined.

You can experiment with different decay rates for the two isotopes by changing the values in cells B6 and C6. The decay rate is the probability that a given nucleus will decay in a unit of time. The half-life of an isotope equals the natural logarithm of 2 ($\ln 2$) divided by the decay rate. The time step used in B1 should be less than one-tenth of the shorter half-life.

When you set the time step in any of these examples, you should be aware of the trade-off between accuracy and number of iterations. If the time step is too large, the finite-difference approximation will need only a few iterations, but accuracy will be poor. If the time step is too small, the approximation will need many iterations, but accuracy will be

	A	B	C
1	TIME STEP	0	
2	TIME	F (B1=0, 0, B2+B1)	
3	-----		
4	ISOTOPE	PARENT	DAUGHTER
5	INITIAL AMOUNT	1000	0
6	DECAY RATE	.05	.02
7	OLD AMOUNT	IF (B1=0, B5, B9)	IF (B1=0, C5, C9)
8	AMOUNT OF DECAY	B1*B6*B7	B1*C6*C7
9	NEW AMOUNT	B7-B8	C7+B8-C8
10	-----		
11	TOTAL ACTIVITY		(B6*B7)+(C6*C7)
12	LOG (ACTIVITY)		LN (C11)

Figure 4: A spreadsheet simulation of radioactive decay.

We're "Customer Friendly"

We're Sun Software. We're new and we're ready to start treating you like a valued customer—not just a voice on the telephone.

And we're convenient, too. Just call our toll-free number to order any one of over 2000 titles and more than 90 formats. Plus we guarantee that our prices are absolutely the lowest you'll find anywhere.

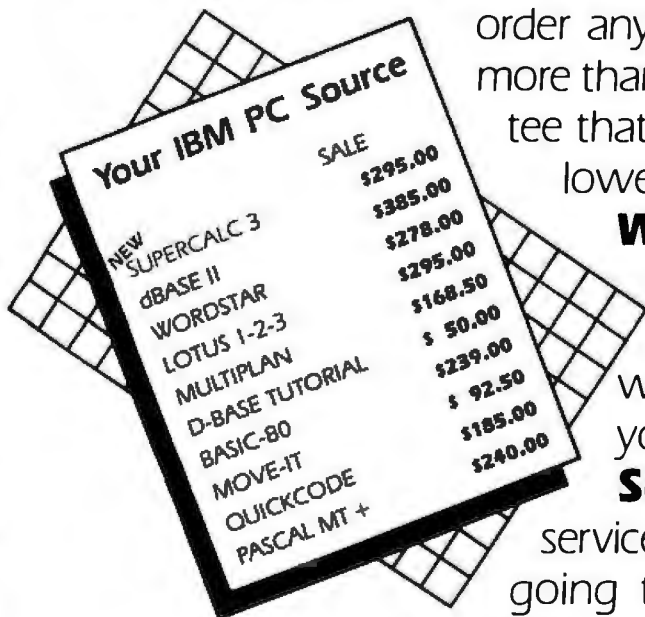

	SALE
NEW SUPERCALC 3	\$295.00
DBASE II	\$385.00
WORDSTAR	\$278.00
LOTUS 1-2-3	\$295.00
MULTIPLAN	\$168.50
D-BASE TUTORIAL	\$ 50.00
BASIC-80	\$239.00
MOVE-IT	\$ 92.50
QUICKCODE	\$185.00
PASCAL MT +	\$240.00

We'll take your order and get it to you in 5 days or less—virtually anywhere in the world. And if you're in the U.S., you'll never pay for shipping.

So call us to access the most in service, the best in selection. We're going to make "customer-friendly" state-of-the-art.

Call 1-800-222-7393

(In California call: 1-800-722-6284)

TELEX: 215604 PCS UR ATTN: Sunmicro

By modem: (213) 458-9209

Sun Software
1344 Fourth Street.
Santa Monica, CA 90401

TERMS: Shipping by UPS Surface, US Mail. Call for UPS Blue or next day delivery. C.O.D., Check, Master Card and Visa accepted. California residents add 6% tax. Los Angeles County residents add 6.5% tax.



**SUN
SOFTWARE™**

A division of Sunmicro Electronics, Inc.

©1983 Sunmicro Electronics, Inc.

	A	B	C
1 TIME STEP	0		
2 TIME	IF(B1=0,0,B2+B1)		
3	-----		
4 SPECIES	PREDATOR		PREY
5 INITIAL POP	50		200
6 BIRTH RATE	0		0.3
7 DEATH RATE	0.1		0
8 INTERACTION	0.001		0.003
9 OLD POPULATION	IF(B1=0,B5,B12)		IF(B1=0,C5,C12)
10 BIRTHS	B1*B8*B9*C12		B1*C6*C9
11 DEATHS	B1*B7*B9		B1*C8*C9*B12
12 NEW POPULATION	B9+B10-B11		C9+C10-C11

Figure 5: A spreadsheet simulation of predator-prey interaction.

very good. One way to judge the rate of error is to double the time step and compare the results.

The example in figure 5 is a finite-difference approximation of the Lotka-Volterra model of predator-prey interaction. When the prey population is high, the predators thrive and thus increase rapidly in number. As the predator population grows, however, the prey population declines because it has a difficult time surviving with all those predators around.

Fewer prey means starvation for many of the predators, so the predator population falls. With fewer predators around, the prey are able to reestablish themselves in large numbers. Whether this cycle really occurs in nature is open to question, but the mathematics of this model are quite fascinating nevertheless.

The model assumes that if the prey were left alone they would experience unrestricted growth at the birth rate specified in cell C6. It also

assumes that the predators have an intrinsic death rate, given in B7. The quantity in B8 is a measure of the skill of the predators in hunting prey, and the quantity in C8 is a measure of the probability that a prey individual will fail to escape an encounter with a predator. Using this simulation, you could construct a graph with the prey population on one axis and the predator population on the other. You could then follow the trajectory of this system for a complete cycle, modify the initial populations in B5 and C5, and draw other trajectories until a pattern emerges.

I have shown how spreadsheets can be used to model several dynamic systems. There are many other dynamic systems, discrete and continuous, that you can simulate with spreadsheets, which proves that spreadsheets can be used for much more than financial analysis. ■

Art Matheny earned an M.S. in physics at Purdue University. His hobbies are electronics and computer music. He can be reached at 1405 Four Seasons Blvd., Lutz, FL 33549.

FLOPPY DISK DRIVES SALES & SERVICE

SPECIALIZING IN FDD'S

H & M Disk Drive Services is a leader in the repair/refurbishment of 8-inch flexible disk drives. We service and repair 5¼ inch flexible disk drives from all manufacturers. Work is guaranteed!

- all 8 inch single-sided = \$45 plus parts
 - all 8 inch dual-sided = \$55 plus parts
 - all 5¼ inch single-sided = \$30 plus parts
 - all 5¼ inch dual-sided = \$40 plus parts
- (prices include bench and system tests plus alignments; all testing performed with state-of-the-art equipment)

NEW FDD'S FOR SALE

- 5¼ inch—Apple™ compatible ½-height. Enclosure & cable included. Controller not provided. High-performance, direct-drive motor MTBF in excess of 50K hrs. **\$229**
 - 5¼ inch—Panasonic™ ½-height D/S D/D Direct Drive. Compatible with Shugart™ SA-455 **\$219**
 - 5¼ inch—HiTech™ ½-height, 8" emulator. This 5¼" half-height drive replaces STD 8" drive. Software compatible. Will operate from existing hardware. Requires only +5v and +12v DC power. No AC. D/S D/D (1.6 M byte) **\$335**
 - 8 inch Seimens FDD100-8 S/S D/D **\$179**
 - Seimens FDD200-8 D/S D/D **\$229**
- Other FDD's available. Call for prices & availability. All drives include 90-day warranty; extended, 2-year warranty at a nominal fee.

H&M Disk Drive Services

Mail Order
Add \$7 Shipping
California residents
add 6% sales tax

689 L South State College Blvd.
Fullerton, CA 92631
(714) 526-1992

Peripheral Networking Now



Buy ASCII Intelligent Port Expanders

- Eliminate Manual Switching by Remote Control
- Improve Productivity and Reliability
- Share Printers, Modems or Plotters
- Expand Computers or Terminals
- Use Matrix Switching for Multiple Transmission or Security
- Supports Polling and Queing

INSTANT COMPATIBILITY with new computer devices and MAJOR OEM PRODUCTS:

Altos — Burroughs — Data General — DEC
H.P. — IBM — NCR — Northstar — Victor
and other key manufacturers.

Call 213-793-8979 to EXPAND YOUR SYSTEMS TODAY.



Advanced Systems Concepts Inc.
435 N. Lake Ave., Dept. B3
Pasadena, CA 91101
800-824-7080 Telex: 701 215

When it comes to software development, the difference between a Sage IV computer and other micros is like day and night.

With the Sage Computer it'll take you fewer days and nights to finish your program.

Speed is the reason. Speed resulting from the fast MC68000 microprocessor, fast architecture, fast operating systems, and blinding transfer rates.

The fact is, even we are surprised by the amount of software that's developed on Sage Computers.

So if you're a programmer, maybe you should spend some time learning how much time you could save using a Sage IV.

The Hottest Languages And Operating Systems.

Programs in nearly all of the important languages can be written on the Sage computer.

Included in the price is the **p-SYSTEM** operating system which supports **Pascal, BASIC, and FORTRAN.**

Other operating systems are optional. For **UNIX** fans there's **IDRIS**, which runs up to twice as fast (even without a Sage computer). **IDRIS** conforms to /usr/Group Standards Committee

standards and programs written under it are highly portable to other micros.

CP/M advocates please note that Digital Research has developed **CP/M-68K** for Sage hardware, providing a truly complete software development environment. Versions of **Pascal, BASIC, C-BASIC, C, and FORTRAN 77**, as well as a very fast **APL**, may be used under this operating system.

The Sage IV is also blindingly fast when

If you found your language here, you just found your computer. The 16-bit, 2-million operation/sec Sage IV micro with up to one MByte RAM and 18-MByte internal hard disk.

For more information and the name of your nearest SAGE dealer, call us today. And be sure to ask about our new software catalog describing over 200 application programs for Sage computers.

Sage Computer Corporate Office, 4905 Energy Way, Reno, Nevada 89502. Phone (702) 322-6868 TWX: 910-395-6073/SAGE RNO

Eastern United States
Sage Computer
15 New England
Executive Park
Suite 120, Burlington, MA
01803 (617) 229-6868



running **hyperFORTH** with its extended programmer and user interfaces.

Besides **IDRIS**, other **Multi-User** operating systems that run on the Sage Computer are **PDOS, MBOS, and MIRAGE.**

A lot of excitement has been brewing in the Pascal World over Niklaus Wirth's new **MODULA 2**—and it's available for Sage computers. So is **ADA**, for the record.

© 1983 Sage Computer Technology all rights reserved Sage & Sage IV are trademarks of Sage Computer Technology



Byte Book Club™

DATABASE DESIGN. By G. Wiederhold. 2nd Ed., 704 pp. The expanded second edition of this widely acclaimed book presents the methods, the criteria for choices between alternatives, and the principles and concepts that are relevant to the practice of database design.
701/326B \$32.00
(Counts as 2 of your 3 books)

MICROCOMPUTER GRAPHICS AND PROGRAMMING TECHNIQUES. By H. Katzan, Jr. 240 pp., 100 illus. and tables. Here's a stimulating introduction to computer graphics for small computers. It covers all the advances to date in color coding and computer graphics technology and—best of all—it's written for information professionals who can't draw! Includes actual graphics programs worth hundreds of dollars!
582576-7 \$22.50

COMPUTER PERIPHERALS FOR MINICOMPUTERS, MICROPROCESSORS, AND PERSONAL COMPUTERS. By C. L. Hohenstein
294/518 \$23.95

A PROGRAMMER'S VIEW OF THE INTEL 432 SYSTEM. By E. Organick. 418 pp., 75 illus. Really two books in one—an introduction to a powerful new computing tool and a practical guide to its many uses! Targeted at persons familiar with programming in Ada or Pascal, the book examines the i432's operating system, architecture, and language.
477/191B \$29.95
(Counts as 2 of your 3 books)

PROGRAMMING WITH ADA: An Introduction By Means of Graduated Examples. By P. Wegner
789/24X \$19.95

OPERATING SYSTEMS. By H. Lorin & H. M. Dietel
582354-3B \$25.95
(Counts as 2 of your 3 books)

MINICOMPUTER AND MICROPROCESSOR INTERFACING. By J. C. Cluley. 266 pp., 73 illus. and tables. Unless you are content to have your information processing system simply talk to itself, you need the intense coverage of interfacing provided so brilliantly by this compact volume. In addition to discussing the logical design of interfaces assembled from small-scale integrated circuits, the book gives you a lucid picture of the interface packages designed for microprocessor systems and the way in which they are used.
582585-6B \$27.50
(Counts as 2 of your 3 books)

AN INTRODUCTION TO VISICALC® MATRIXING FOR APPLE® AND IBM®. By H. Anbarlian. 252 pp., illus., softcover. Enables you to use VisiCalc matrixes—also known as templates and models—to put your Apple or IBM personal computer to productive use almost immediately. It describes the actual process of developing matrixes for such applications as expense vouchers, price/earnings ratios, payrolls, stock portfolios, and more.
016/054 \$22.95

ASSEMBLERS, COMPILERS, AND PROGRAM TRANSLATION. By P. Calingaert
582110-9B \$25.95
(Counts as 2 of your 3 books)

INTERFACE PROJECTS FOR THE TRS-80. By R. C. Hallgren
582466-3 \$18.95

POWERFUL TOOLS! POWERFUL SAVINGS!

New Members take any **\$1.00**
3 books for only **each***
Values up to **\$79.90**



APPLE PASCAL GAMES. By D. Herget & J. T. Kalash
582521-X \$19.95

MATHEMATICS FOR THE ANALYSIS OF ALGORITHMS. By D. H. Greene and D. E. Knuth. 107 pp. Gives you a clear picture of both the structure and the power of algorithms—and their intimate relationship to the world of the computer programmer.
582707-7 \$10.00

MICROPROCESSOR APPLICATIONS HANDBOOK. Edited by D. F. Stout. 472 pp., 284 illus. This BIG book on SMALL chips will help you make your systems timely, versatile, and cost-effective. The 16 expert contributors provide in-depth treatments of both hardware and software so you can completely analyze, design, construct, and program.
617/988B \$39.95
(Counts as 2 of your 3 books)

REAL-TIME COMPUTING With Applications to Data Acquisition and Control. Edited by D. A. Mellichamp. 552 pp., 260 illus. This comprehensive guide helps you specify the type of real-time computing system you need, start it up, and keep it running smoothly and productively.
582844-8B \$39.50
(Counts as 2 of your 3 books)

GUIDE TO THE IBM PERSONAL COMPUTER: Features DOS 2.0 and BASIC 2.0 for the IBM PC and XT. By W. Sikonowiz. 352 pp., illus. Going far beyond the manufacturer's manuals, this guide gives you the invaluable hands-on experience necessary to make the most of your machine.
574/847 \$19.95

LEARNING WITH LOGO. By D. H. Watt
685/703 \$14.95

COMPUTER GRAPHICS: A Programming Approach. By S. Harrington. 448 pp., 242 illus. Covering everything from viewing transformations, parallel projections, and perspective projection to line removal, shading, and the drawing of curves, this introduction to interactive graphics gives you hands-on experience.
267/510B \$25.95
(Counts as 2 of your 3 books)

THE BUSINESS GUIDE TO SMALL COMPUTERS. By L. Calmus
096/627 \$19.95

INTRODUCTION TO THE UCSD p-SYSTEM™. By C. W. Grant and J. Butah. 330 pp., illus. This book takes you through the whole process of implementing the UCSD p-System—and gives you hands-on programming experience in Pascal.
582767-0 \$24.95

MICROPROCESSOR AND MICROCOMPUTER DATA DIGEST. By W. H. Buchsbaum and G. Weissenberg. 336 pp., 199 diagrams. Containing all the detailed technical data for every microprocessor integrated circuit that is currently listed as a "standard," off-the-shelf item, this book presents the critical pin configurations, voltages, operating parameters, descriptions of each IC.
582835-9B \$29.95
(Counts as 2 of your 3 books)

ELECTRONICS DICTIONARY, 4/e. By J. Markus
404/313B \$32.95
(Counts as 2 of your 3 books)

MICROPROCESSOR DATA BOOK. By S. A. Money. 350 pp., 220 illus. A truly awesome collection of data about virtually every chip available today!
427/062B \$42.50
(Counts as 2 of your 3 books)

ANNOUNCING: The Most Important Computer Handbook Ever Published!



This Remarkable
New Reference
—a \$79.50 value—
Is Yours for only
\$3.00

The McGRAW-HILL COMPUTER HANDBOOK, 992 pp., 475 illus., edited by Harry L. Helms, with over 24 world-renowned contributors, is by far the most useful and comprehensive reference yet designed for today's computer user. Crammed with easy to get at information, ranging from design concepts to programming techniques, from data bases to interfacing, networking, speech synthesis and recognition to mention just a few of hundreds of entries, this one volume reference does it all—in language and presentation everyone can understand. Invaluable for home, office, and school use, The Computer Handbook "can be helpful to users in solving many mysteries, while opening new doors for exploration and serving as a continuing reference," writes Thomas C. Bartee of Harvard University.

279/721A \$79.50

(Counts as 3 of your 3 books)

* 3 books for only \$1.00 each . . . if you join now for a trial period and agree to purchase three more books—at handsome discounts—during your first year of membership. (Publishers' prices shown)

MICROPROCESSOR-BASED ELECTRONIC GAMES: Design, Programming, and Troubleshooting. By W. Buchsbaum and R. Mauro. 293 pp., illus., softcover. Turn your TV into a home arcade with the first technical guide dedicated to fun!
087/229 \$9.95

STRUCTURED PROGRAMMING: Theory and Practice By R. C. Linger, H. D. Mills & B. I. Witt
788/537B \$26.95
(Counts as 2 of your 3 books)

THE SMALL COMPUTER CONNECTION: Networks for the Home and Office. By N. L. Shapiro. 256 pp. Shows you how to use existing hardware and software to link your small computer to other computers—large and small—and to a vast universe of databases.
564/124 \$15.95

ELECTRONICS ENGINEERS' HANDBOOK, 2/e By D. G. Fink & D. Christiansen
209/812A \$79.90
(Counts as 3 of your 3 books)

Z80 USERS MANUAL. By J. Carr. 326 pp., with diagrams, charts, and tables. Takes you through every opportunity the ZAP can offer! It covers Z80 pin definitions, CPU control signals, support chips, interfacing peripherals, and much more.
582336-5 \$21.95

INTRODUCING THE UNIX SYSTEM. By H. McGilton & R. Morgan. 256 pp., 50 illus. soft. This book helps you over the initial hurdles of learning this new and powerful computertool—even if you have never used the Unix system or penetrated any of its literature.
450/013 \$18.95

HANDS-ON BASIC For the IBM® Personal Computer By H. Peckham. 308 pp., spiral-bound, softcover. Learn BASIC programming right at the computer! Step by step, this manual gives you hands-on experience with BASIC through a series of guided activities. Each of the 12 chapters requires at least one hour at the computer and at least one hour studying the text.
491/78X \$19.95

HANDS-ON BASIC FOR THE Atari 400/800/12XL By H. Peckham
491/941 \$19.95

THE C PRIMER. By L. Hancock & M. Kreider. 256 pp., 25 illus., soft-bound. This is the only book on the market that describes the C language clearly and simply from the novice's point of view.
259/81X \$14.95

MICROCOMPUTER INTERFACING By B. Artwick
789/436B \$28.00
(Counts as 2 of your 3 books)

APPLE PASCAL: A Hands-On Approach. By A. Luehrmann and H. Peckham. 426 pp., spiralbound. Finally—a how-to-use-PASCAL book for Apple computer users that makes a complete language as easy as (forgive us!) applesauce. Takes you from "total ignorance" all the way up to a very impressive competence in the use of that rather complex language, PASCAL.
491/712 \$19.95

PRINCIPLES OF INTERACTIVE COMPUTER GRAPHICS. By W. M. Newman and R. Sproull. 2nd Ed., 544 pp., illus. Now in a revised, updated Second Edition, this volume has long been THE standard source of information for designers! Now, as before, it is utterly comprehensive and up to the minute in its coverage.
463/387B \$32.50
(Counts as 2 of your 3 books)

Consider these Byte Books as well!

MICROCOMPUTER OPERATING SYSTEMS By M. Dahmke
150/710 \$16.95

TRS-80 GRAPHICS FOR THE MODEL I AND MODEL III By D. Kater & S. Thomas
333/033 \$14.95

THREADED INTERPRETIVE LANGUAGES By R. G. Loeliger
383/60X \$20.75

THE BRAINS OF MEN AND MACHINES By E. W. Kent
341/230 \$20.95

BASIC SCIENTIFIC SUBROUTINES, Vol. II By Dr. F. R. Ruckdeschel
542/023B \$26.95
(Counts as 2 of your 3 books)

CIARCIA'S CIRCUIT CELLAR, Vol. 2 By S. Ciarcia
109/63X \$15.95

BYTE BOOK OF PASCAL By B. W. Liffick
789/673B \$27.50
(Counts as 2 of your 3 books)

BASIC SCIENTIFIC SUBROUTINES, Vol. I By Dr. F. R. Ruckdeschel
542/015B \$27.95
(Counts as 2 of your 3 books)

CIARCIA'S CIRCUIT CELLAR, Vol. III By S. Ciarcia
109/656 \$15.95

MICROCOMPUTER DISK TECHNIQUES By P. Swanson
625/824 \$15.95

BUILD YOUR OWN Z-80 COMPUTER By S. Ciarcia
109/621 \$18.95

Why YOU should join the Byte Book Club™ now!

- **Best and newest books from ALL publishers!** Books are selected from a wide range of publishers by expert editors and consultants to give you continuing access to the best and latest books in your field.
- **Big savings!** Build your library and save money too! Savings range up to 30% or more off publishers' list prices—usually 20% to 25%.
- **Bonus books!** You will immediately begin to participate in our Bonus Book Plan that allows you savings up to 70% off the publishers' prices of many professional and general interest books!
- **Convenience!** 14-16 times a year (about once every 3-4 weeks) you receive the Club Bulletin FREE. It fully describes the Main Selection

and alternate selections. A dated Reply Card is included. If you want the Main Selection, you simply do nothing—it will be shipped automatically. If you want an alternate selection—or no book at all—you simply indicate it on the Reply Card and return it by the date specified. You will have at least 10 days to decide. If, because of late delivery of the Bulletin you receive a Main Selection you do not want, you may return it for credit at the Club's expense.

As a Club member you agree only to the purchase of three additional books during your first year of membership. Membership may be discontinued by either you or the Club at any time after you have purchased the three additional books.



Fill out the card and mail today! If the card is missing, write to:

BYTE BOOK CLUB™, P.O. Box 582, Hightstown, New Jersey 08520



ANADEX	\$1295
CITOH	\$595
DAISYWRITERS	\$1495
DIABLO	\$1195
DYNAX	\$599
EPSON	\$499
GEMINI	\$399
GE	\$1930
IDS	\$799
NEC	\$1915
QANTEX	\$1495
QUME	\$1995
SILVER REED	\$599
TALLY	\$399
TOSHIBA	\$2195

PRICES SO LOW— WE CAN'T LIST THEM!

ADDS	\$650
AMPEX	\$679
COMREX	\$149
ESPRIT	\$595
LEAR SIEGLER	\$595

All equipment is in factory cartons with manufacturers' warranty. Prices subject to change without notice. Most items in stock or shipped as received.

1 NATIONWIDE SERVICE. MOST PRODUCTS
SUPER WAREHOUSE

P.O. BOX 373 WALLINGFORD, CONNECTICUT 06492
ORDER LINE ORDER HOURS
203-265-1223 9:00 AM - 5:00 PM-EST
MONDAY-FRIDAY

PHONE ORDERS FREE
(ONE DOLLAR CREDIT FOR PHONE ORDERS)

Conducted by

From Logo to FORTH

Dear Jerry,

In BYTE's User to User, a reader implied that Logo is "baloney" (November, page 585). For several years I shared a similar opinion, but have recently reversed my thinking and see considerable value in Logo, particularly as a teaching tool. Two factors contributed to my about-face.

First, teachers understand Logo and are comfortable with it. As a result, they use it with confidence and encourage their students to use it. No other language has been received so well by teachers and has spanned such interest as Logo.

Second, Logo is the perfect language to introduce structured programming. When I teach FORTH to children or adults, I invariably begin with a version of Logo or Turtlegraphics. Most of my students can then make an easy transition to FORTH.

Logo has considerably reduced the level of technophobia among teachers, helping them to adjust to a new technology that is rapidly finding its way into the classroom. It is also a lot of fun, and school-age children find it challenging as well as enjoyable. Although there is no doubt there is more froth than substance to the Logo mystique, it is nonetheless a great instructional tool.

Michael N. Milone Jr.
Honesdale, PA

You are not alone in your admiration of Logo as a teaching language. Alas, DR Logo requires a color system, and we have only a monochrome for our IBM PC, while the Logo we have won't run with the Z-100, which is a color machine. Ah, well.

One day I'll get to play about with Logo and get Mrs. Pournelle interested in it. . . . Jerry

No Frills Nevada

Dear Jerry,

I have been following your column in BYTE for a few months now, and am grateful for the insight you've provided on those products that you've written about. I am curious, however, about a set of products advertised in BYTE from Ellis Computing, consisting of Nevada FORTRAN, EDIT, COBOL, and PILOT. Each

product carries a \$29.95 price tag and runs under CP/M (there are several disk formats available), so I am sure there must be a whole host of people in your audience who would benefit from this package if it is worthwhile enough. If you have already covered these software packages, forgive the intrusion, I only have a limited number of back issues of BYTE available.
John DaMassa
Davis, CA

I've had limited experience with the Nevada products, but what experience I have had is very good indeed. They're a bit "no frills" as you might expect from the price, but the stuff seems solid to me. I'm not overly enamored with the editor. . . . Jerry

Legal Clarification

Dear Jerry,

You and your readers are mistaken in most of your views regarding the legality of warranty disclaimers and license agreements sold in mass-marketed software. The following should provide a basic framework of the law:

Warranty Disclaimers

1. A manufacturer cannot disclaim an express promise. If the advertising, packaging, or operator's manual says a product will do "X," then it must.
2. A disclaimer first mentioned after the sale is void. The sales contract is "formed" at that instance. Any attempt to unilaterally modify a previously existing bilateral contract (between the seller and the purchaser) will fail for lack of consideration.
3. If the software is bought by a consumer and the seller provides a service contract (e.g., pay \$20 in advance and you will be sent all updates as they occur), then the Magnuson-Moss Warranty Act, 15 U.S.C. §§2301-2312, provides that the warrantor may not disclaim the implied warranties of merchantability or fitness for a particular purpose.

License Agreements

1. Software "perpetually licensed" is sold and licensed.
2. A self-executing license agreement (e.g., break the seal and you are deemed to have accepted the license

Do You Run Your Business OR DOES IT RUN YOU?

The biggest headache you may be facing these days is getting better control of your business. Tracking unpaid bills, sending out second billings, monitoring which salesman sold how much and to whom, keeping track of inventories, and on and on.

There's a remedy. It's called VersaForm...the business database.

VersaForm is a powerful database designed specifically for business, but based on the simplicity and convenience of your familiar business forms.

If you can fill out a business form, you can create a database.

VersaForm starts with your existing forms and procedures. As you copy your forms onto the screen, VersaForm automatically creates a database for you. It records and saves information from Purchase Orders, Invoices, Job Estimates, Disbursement Ledgers... maybe even a few things you're not recording that you should be.

VersaForm is an electronic file cabinet that will store all this information, yet have it at your fingertips when you need it! It's designed with a non-technical user in mind, so you can concentrate on streamlining your business with none of the usual database headaches.

Adapts to your business...your way.

With VersaForm you don't have to completely re-orient your staff. It fits right into the way you're doing business now. Only now your operations will be completed more efficiently and with electronic speed.

- A doctor in Moulton, Texas, posts his patient billing and completes his medical insurance forms with VersaForm.
- A small college in Wheaton, Maryland, uses VersaForm to create tuition invoices, class lists, accounts

receivable, and accounts payable.

- A computer supplies company in Mountain View, California, writes payables checks and does expense distribution with VersaForm.



- A roofing company in Green Bay, Wisconsin, computes job estimates, contracts, invoicing, and tracks actual costs with VersaForm.
- A manufacturer in Beaver Falls, Pennsylvania, uses VersaForm to build his company's parts records, and generates "where-used" lists.

VersaForm has the power to do these jobs and more because it's designed especially for business. It can also calculate taxes and prices, and can look up discounts, so you don't have to. VersaForm will even print on your own pre-printed forms.

Pull information together fast.

Pulling information together from paper files can be time-consuming and frustrating. Why make it tough? VersaForm puts vital reports like sales analyses, overdue payables, open purchase orders, and alphabetical employee lists at your fingertips. Minimum effort, maximum results.

All in one easy-to-use, integrated package.

VersaForm provides a screen formatter, a data entry program, a database, a report generator and a forms printer. And you can purchase pre-designed Templates for standard jobs like Purchasing, Invoicing, and Expense Journals. VersaForm is the all-in-one business productivity tool. Ask for a demonstration at your computer dealer. Or contact us directly.

VersaForm™

New! IBM PC/XT Release
• DOS Files
• Hard Disk Support

If you want to know more, send in this coupon. We've got a lot to tell you about.

Name _____
Company _____
Address _____
City _____ State _____ Zip _____

Type of Business _____
Mail to: Applied Software Technology
170 Knowles Drive
Los Gatos, California 95030
(408) 370-2662

142-E

For use with the Apple II, IIe and III, and the IBM PC and compatibles.

**Heart of TEXAS
COMPUTER SYSTEMS**

TRS-80

Model IV Portable: CALL

Model 12 & 16 at discount: CALL
TCS Model 12 with 2 drives: \$2995

Model 12/16 Accessories/discount.

TCS Model IV, 64K, 2 Drive w/RS-232
\$1499 (40 track) \$1699 (80 track)

The New TRS-2000: CALL
(IBM Compatible)

We carry the full TRS-80 line. Call for our discount prices.

DISK EXPANSION

	M-III	M-IV
1 Controller, Pwr.Sup. Hdwr. Instruct.	\$249	\$329
2 Kit 1, plus 1/40-trk.Tandon Dr.	\$429	\$479
3 Kit 1, plus 2/40-trk. Tandon Dr.	\$598	\$649
3a Kit 3 w/2 80 trk.drives (dual sided 40s)	\$698	\$729

Model IV needs 64K to operate. For 64K Kit, CALL.

Tandon

Quality disk drives--O.E. brand on IBM
Available bare and in cabinets.

TM50-1 SS Slimline: \$145
TM50-2 DS Slimline (IBM): \$209
TM100-1: \$159 CALL US IF YOU FIND
TM100-2: CALL LOWER PRICES!

CORVUS

25% OFF LIST PRICE!

OMNINET- A high speed multi-user network that
connects several computers for instant communication up
to 4,000 feet away.

Save over \$1,000 on a 20 mg. Corvus Hard Disk
system for IBM PC and other computers.
5mg. \$1649 10mg. \$2279 20mg. \$3049

**DAVONG
Systems, Inc.**

Single user or networking hard disk system for IBM &
Apple. Lowest prices anywhere. Priced from \$1375.
10, 15, 21, 32 mg. & cartridge tape backup--CALL.

star PRINTERS

Fast, dependable, versatile, low price.

Gemini 10X 9in., 120cps. Friction/Tractor
Gemini 15X 15in., 120cps. Friction/Tractor
Delta 10 10in., 160cps. Friction Tractor
Delta 15

PowerType Daisywheel

Call for our low, low prices!

DISKETTES \$1.50 ea.

CompuDisk, top quality mini floppy diskettes from \$1.50
complete with hub rings, protective envelopes, write
protect tabs, and adhesive labels. SSDD, DSDD, boxed or in
bulk. Money back guarantee. 100% Certified Error Free.
CALL!

**Heart of TEXAS
COMPUTER SYSTEMS**

P.O. Box 1327 Arlington, TX 76004
Toll Free 1-800-433-5184
Texas 1-817-274-5625

VISA, MC, cashier's check, money order. No tax out of state.
Texans add 5%. Prices subject to change.

BYTE's User to User

and its terms) probably has no legal effect. It has never been tested in court. However, such self-serving words when placed on an automobile check (e.g., parking-lot owner is not liable for damage done to your car) have been uniformly declared void.

There is a good discussion of the computer warranty issues in my book, *Computer Buyer's Protection Guide: How to Protect Your Rights in the Microcomputer Marketplace*, Prentice-Hall (ISBN 0-13-164195-6). There will be an in-depth analysis of software licensing in my next book, *The Law and Software*, also for Prentice-Hall.

L. J. Kutten
St. Louis, MO

Thanks for the briefing. However, why do you say I am mistaken? I've always believed those "licensing agreements" were unenforceable and unlikely to get any serious attention from a court, and I've said so, often.

If I were a software publisher, I'd rely on copyright law for protection, and not try to be a hog with "licenses." . . . Jerry

That's a Good Question

Dear Jerry,

You've made a fine contribution in promoting the phrase "Real Soon Now;" it rivals "The Check Is in the Mail" for implying implausibility. I recommend another useful phrase, which I'd appreciate your trying out on your friend Bill Godbout. It's a phrase I keep hearing from his Compupro dealers whenever I ask anything about my 68000/mapFORTH system.

The phrase is "That's a Good Question," and it is never accompanied by a useful answer. Examples: Why won't my system print using the Interfacer IV? Answer: TAGQ (in this case I was able to fix the bug myself). Why does the system refuse to boot if the Interfacer IV screens are precompiled? TAGQ. Can I add Compupro's hard disk under mapFORTH? TAGQ.

Compupro and its dealers seem to be concentrating on 8086 systems, which would be fine as long as they don't orphan the CPU-68K board. Since the dealers appear to know less than their customers about mapFORTH and the CPU-68K, we need someone knowledgeable at Compupro to whom we could talk directly. Perhaps you can convince Bill

Godbout of the worthiness of this idea, and then publish the person's name and number in your column. At present, Compupro asks that we work through their dealers, which is useless. The CPU-68K is a good product, and it deserves Compupro's support.

Richard F. Olivo
Northampton, MA

I agree that Compupro hasn't provided enough software support for their 68000 board. Indeed, their software department isn't very large. After all, it's only been a year or so since Dr. Godbout's idea of user support was to read the spec sheet over the phone to those who called with questions about one of their boards!

They're getting better, and I'll pass your letter along; perhaps it will encourage more activity.

They're also putting their Systems Center dealers through intensive training. . . . Jerry

Correction and Update

Dear Jerry,

I recently read your review "The User Looks at Books" (December, page 519). I am pleased that your "current favorite beginner's text" is my book, *A First Course in Computer Programming Using Pascal* (McGraw-Hill, 1982). However, my first name was listed incorrectly. I have listed it below.

I consider learning to program as a process that requires quite some time and effort. It may be possible to cover a little about records and pointers in a first course; however, in-depth coverage of records and pointers is usually included in a second course. Consequently, my book does cover the use of linked lists to form stacks and queues. The success of *A First Course in Computer Programming Using Pascal* encourages me to consider writing a second-course text, in which advanced topics could be given more complete coverage.

Arthur M. Keller
Stanford, CA

I'm sorry I got your name wrong; our copy of the book has fallen victim to the Brotherhood of Book Borrowers, and alas, has gone away forever.

I don't disagree with your decision to limit the scope of an introductory book, but I did feel obliged to let the readers know. When you get the next book done, I'd like to see it. . . . Jerry

"Kaypro 2... \$1595... Complete..."

Oh, mentor of highest wisdom, help all mystified first-time buyers discover the ultimate truth about personal business computers.

Tell them that, unlike other computer companies, Kaypro does not advertise a low "starter system" price, then charge extra for so-called "options" like a monitor, software, disk drives or peripheral interfaces.

Tell them that Kaypro 2 has become the fourth largest-selling personal business computer because we sell it complete. For \$1595.

Tell them that Kaypro 2 comes with a highly readable, 9" green-screen monitor. A 64K RAM, Z-80 microprocessor. Two built-in disk drives with a 400K capacity. A more complete keyboard than Apple IIe. Interfaces for both a printer and a telecommunications modem. And a full complement of CP/M software to handle the overwhelming majority of Word Processing, Data Base Management and Financial Spreadsheets needs, with top quality programs such as Wordstar.

All for \$1595.

Then, tell them to call 800-447-4700 for their nearest dealer, or call Kaypro at 619-481-4318.



KAYPRO

The \$1595 computer that really sells for \$1595.

YOURS FREE!

The essential new catalog of the business computer forms and supplies you need most!

It's quick • convenient • easy-to-use.



Now Deluxe Computer Forms, a division of Deluxe Check Printers, gives you the software-compatible checks, invoices, statements and word processing stationery you've been searching for. And accessories too.

And we can ship them all to you in as few as 3 working days!

Deluxe delivers your order in record time because we know how much you depend on it to make your office run smoothly. And we deliver it to your precise specifications. That means customization for your unique program needs, or personalization of any of our 200 standard forms for popular software programs. And you order only what you need—as few as 500 forms.

See what we've got to offer your business. Then see just how fast we can deliver it.

Send for your **FREE** catalog today!



DELUXE

530 N. WHEELER ST.
P.O. BOX 43846
ST. PAUL, MINNESOTA 55164-0046

YES. Rush me your complete, new catalog of computer forms and essentials.

My Name _____ Title _____

Company Name _____

Address _____

City _____ State _____ Zip _____

Phone _____

Clip out and mail or call TOLL FREE:

1-800-328-5727 Dept. #99

(In Minnesota, call 1-800-742-5685 Dept. #99.)

7325

BYTE's User to User

Encryption and Security

Dear Jerry,

Here is the letter you requested outlining my thoughts on cracking Charlie Merrit's encryption program (see "Interstellar Drives, Osborne Accessories, DEDICATE/32, and Death Valley," July, page 323). The first point I would like to emphasize is that the purpose of this exercise, in my view, is not to see whether the trapdoor algorithm can be broken. I know enough about number theory and NP-completeness to know that the algorithm is fundamentally sound, and that nothing short of a major mathematical revolution is going to change that. What I am concerned about is the *implementation* of the algorithm. A flawed implementation can reduce the algorithm to total worthlessness. It is entirely possible that people could be buying encryption programs they believe to be "unbreakable," which in reality provide little or no security. The purpose of this exercise is to point out that it takes more than a good encryption algorithm to make data secure.

Merrit's program provides the service of generating the prime-number keys for the user. This is a valuable service, as it would be unreasonable to expect the average user to come up with 200-digit prime numbers! However, this service can also provide some security problems. Let's assume the existence of a similar program written by someone who decided to take a shortcut and built a table of possible keys into the program (acknowledging that Merrit's program does not do this). The keys are very large because the larger the keys, the harder it is to distinguish the private key from the public key. Let us further assume the program is a roaring success, and there are hundreds of thousands of users of it. Does the program really provide security? The answer is no. Now let there be a hacker who, as hackers are wont to do, decides to disassemble the object code to see what makes the program tick. Never mind how protected the object code may be; there always seems to be a way to get around the protection. Now, the hacker is obviously going to discover the table of primes. In all probability, this table will be quite large, so as to provide the maximum number of keys practical to give the user. However, even if there were 10,000 primes in this table, it would be a simple matter to have a computer try each one in turn to see if it is the private key that

matches the known public key. A larger key length in this case would not offer much more security.

Even if the program in question did not use a table, but instead used a random-number generator, for example, there can still be problems. For example, if the random-number generator used a 16-bit seed, then the generator could produce only 65,536 distinct keys at most, no matter how long the keys were. Again, an exhaustive search for the private key becomes feasible. Even if the seed were significantly larger, there is still the problem of where the initial random seed comes from. Also, the random-number generator might be a very poor generator of random numbers. Just because the seed is a 64-bit number does not necessarily mean that the generator will produce all possible 2^{64} numbers. Especially if the programmer naively assumed that a super-duper complicated generator will produce "more random" numbers than a simpler, but mathematically guaranteed, producer of random numbers.

Even if it were not possible to get at the object code, it is still possible to crack the program if it can only produce a limited number of possible keys. Mathematically, there is no distinction between public and private keys; the two can be freely interchanged. Therefore, the key generator might produce the same key sometimes as a private key and sometimes as a public key. By running the key generating many times and saving the keys produced, it becomes possible that one of those keys might be the private key to go with the public key in question. Of course, with this approach, there is no way to know in advance whether it will work without trying it.

From what I have been told, I doubt that Charlie Merrit's program can be broken. However one can never be sure, and there's only one way to find out.

Jeff Cohen
Sunnyvale, CA

I've talked to Charlie Merrit, and he just chuckles; but he's willing to furnish you with a copy of his encryption program to work on. He says he uses the refresh counter on the Z-80 chip for his random-number source, and that's affected by barometric pressure and the phases of the Moon.

It really looks as if we've got unbreakable codes we can implement on micros. The implications are a bit staggering. "But Your Honor, I only have the public key. I can't decode those records . . ." . . . Jerry



Photo: Peter B. Kaplan

If you still believe in me, save me.

For nearly a hundred years, the Statue of Liberty has been America's most powerful symbol of freedom and hope. Today the corrosive action of almost a century of weather and salt air has eaten away at the iron framework; etched holes in the copper exterior.

On Ellis Island, where the ancestors of nearly half of all Americans first stepped onto American soil, the Immigration Center is now a hollow ruin.

Inspiring plans have been developed to restore the Statue and to create on Ellis Island a permanent museum celebrating the ethnic diversity of this country of immigrants. But unless restoration is begun now, these two landmarks in our nation's heritage could be closed at the very time America is celebrating their hundredth anniversaries. The 230 million dollars needed to carry out the work is needed now.

All of the money must come from private donations; the federal government is not raising the funds. This is consistent with the Statue's origins. The French people paid for its creation themselves. And America's businesses spearheaded the public contributions that were needed for its construction and for the pedestal.

The torch of liberty is everyone's to cherish. Could we hold up our heads as Americans if we allowed the time to come when she can no longer hold up hers?

Opportunities for Your Company.



You are invited to learn more about the advantages of corporate sponsorship during the nationwide promotions surrounding the restoration project. Write on your letterhead to: The Statue of Liberty-Ellis Island Foundation, Inc., 101 Park Ave, N.Y., N.Y.10178.



Save these monuments. Send your personal tax deductible donation to: P.O. Box 1986, New York, N.Y. 10018. **The Statue of Liberty-Ellis Island Foundation Inc.**

Reflections on PL/I

Dear Jerry,

As a long-time science-fiction buff I have always enjoyed your writing, in *Analog* as well as *BYTE*. But I should introduce myself . . .

My name is Kelly Cook. I was employed for 19 years at Kitt Peak National Observatory, first as an observer, later as an optician. As such, I specialize in the testing of large mirrors, which is how I got involved with computers and programming. In 1981, I left Kitt Peak to attempt a career change to programming. On the nonprofessional side, my main passion is designing war games.

What prompted this letter was your mention in *BYTE* about gathering times on different systems for your benchmark ("New Computers, Books, Languages, and Other Tidbits," October, page 107). So here is PL/I-86 on an IBM PC, wreaked keyboard and all (see listing 1). This was made possible by my client, Arizona Technologies, who makes large mirrors for telescopes. The client asked me to write a program for interferometric testing on the PC. Of course, such programs

have traditionally been done in FORTRAN on mainframes. Wanting to stick with FORTRAN, I started out with IBM's UCSD FORTRAN77. But a subroutine to put a very crude map of a mirror surface on the screen took 10 minutes to complete! With panic, I then turned to PL/I-86. Now the same routine takes only 14 seconds!

Your benchmark ran so fast that I added a 10-iteration loop to give my simple watch a better handle on it. The result of 92 seconds can then be divided to give a corrected time of 9.2 seconds (20 by 20 arrays). CP/M-86's Stat gave the object file size as 2K, but that is the smallest size that Stat can report so it's probably not very accurate. Linkage is another story. To make an object file into an executable COM file, it first has to be linked with PL/I's library of Built-In Functions. This means a great deal of disk grinding and a final file that Stat reports as 20K!

I had heard the tales about PL/I being a bear to learn. My experience is with FORTRAN and BASIC, plus a little dabbling in FORTH, C, and Pascal. PL/I may not be as simple as BASIC, but it's certainly easier to understand than C or

FORTH. It should be a snap for anybody who already knows Pascal. Just read the listing of your benchmark and see for yourself! The provisions for pointers and recursion can be tricky, but that is intrinsic in those concepts. Those things are just as tricky in Ada or C. And they are options, after all, so you can just ignore them if you want.

The bottom line is that PL/I-86 can be a bona fide lifesaver for anybody doing large-scale number crunching on a micro. **Kelly Cook**
Tucson, AZ

My late mad friend, Dan MacLean, became a PL/I enthusiast in his last year. Had he lived, I make no doubt that he would have converted me; Dan had his ways.

However, without his stimulus I became a backslider. Most of my previous programs have been done in CB-80. Most of my future ones will be done in Modula-2. We have PL/I, but so far I've done almost nothing with it.

But Dan Alderson (inventor of the Alderson Drive for those who've read The Mote In God's Eye) is a PL/I enthusiast, and as soon as he's properly set up with a machine, I'll have a PL/I consultant. . . . Jerry

WANTED

"Buyers," & We'll pay the shippin'

• CALL FREE (800) 654.4058 •

"Call For Reduced Prices At Various Quantities"

<p>Verbatim.</p> <p>5 1/4" sin-side dbi-den. 2 40</p> <p>5 1/4" dbi-side dbi-den. 3 45</p> <p>5 1/4" sin-side quad 3 20</p> <p>5 1/4" dbi-side quad 4 40</p> <p>8" sin-side sin-den. 2 75</p> <p>8" sin-side dbi-den. 3 05</p> <p>8" dbi-side dbi-den. 3 40</p> <p>Head Cleaning Kits.... 5 20</p> <p>Refills. 9 55</p>	<p>Dysan CORPORATION</p> <p>5 1/4" sin-side dbi-den. 3 20</p> <p>5 1/4" dbi-side dbi-den. 4 20</p> <p>5 1/4" sin-side quad 4 45</p> <p>5 1/4" dbi-side quad 4 95</p> <p>8" sin-side sin-den. 3 45</p> <p>8" sin-side dbi-den. 4 45</p> <p>8" dbi-side dbi-den. 4 95</p> <p>We Stock "Bulk-Packed" Diskettes</p>	<p>3M Scotch</p> <p>5 1/4" sin-side dbi-den. 2 20</p> <p>5 1/4" dbi-side dbi-den. 3 20</p> <p>8" sin-side sin-den. 2 35</p> <p>8" sin-side dbi-den. 2 95</p> <p>8" dbi-side dbi-den. 3 90</p> <p style="text-align: center;">Disk Minder • Smoked Plastic • Holds 75 Disks 16 75 ea</p> <p style="text-align: center;">Dealer Inquiries Welcomed</p>
---	---	---

Prices per ea. 10 per box. the **Diskette Connection**

Master Charge P.O. Box 1674 Bethany, OK 73006

* (Continental U.S. only. Add 3% on orders under 40)

From Computer Plus to YOU . . .

PLUS after PLUS after PLUS

 Model 100 BK 3679 Model 100 24K 1835	 Color Computer II 16K 1435 w/16K Est. Basic 1165 w/64K Est. Basic 1210	 Model IV 16K 1849 Model IV 64K 2 Disk & RS232 11699
 DMP120 6395 DMP200 1520	 Color Computer Disk Drive Drive D 5329 Drive 1 1235	 DWP210 1629

BIG SAVINGS ON A FULL COMPLEMENT OF RADIO SHACK COMPUTER PRODUCTS

<p>COMPUTERS</p> <p>Model 4 Portable 64K 2 Drives 1525</p> <p>Packet Computer 2 165</p> <p>Packet Computer 3 89</p> <p>Packet Computer 4 59</p> <p>Model 2000 2 Drive 2299</p> <p>Model 2000 Word Disk 3599</p> <p>Model 12 64K 1 Drive 2699</p> <p>Model 12 64K 2 Drive 3375</p> <p>Model 16B 1Dr 256K 4240</p> <p>Model 16B 2DR 256K 4915</p> <p>MODEMS</p> <p>Hayes Smartmodem II 225</p> <p>Hayes Smartmodem 1200 539</p> <p>Novation Smartcat 1200 410</p> <p>Novation J-Cat 115</p> <p>AC-3 129</p> <p>DC Modem I 89</p> <p>DC Modem II 160</p>	<p>PRINTERS</p> <p>Silver Reed EXP500 D W 425</p> <p>Silver Reed EXP550 D W 575</p> <p>Daisy Wheel II 1745</p> <p>DWP410 1159</p> <p>DWP210 629</p> <p>CGP115 159</p> <p>CGP220 Ink Jet 545</p> <p>DMP410 305</p> <p>DMP420 375</p> <p>DMP500 1219</p> <p>DMP2100 1689</p> <p>Gemini 10X 300</p> <p>Delta-10 470</p> <p>Gemini 15X 405</p> <p>Prowriter 379</p> <p>Prowriter II 649</p> <p>Okidata 649</p> <p>Epson 649</p> <p>DISK DRIVES</p> <p>Model III 4 Drive 0 515</p> <p>Model III 4 Drive 1 195</p>	<p>Model III 4 Drive 2 289</p> <p>Model III 4 Drive 3 259</p> <p>Primary Hard Disk M12 2689</p> <p>Primary Hard Disk Mill 1799</p> <p>ETC.</p> <p>CCR-81 Recorder 52</p> <p>Cassette Tapes (10 Pk) 9 95</p> <p>16K Ram Chips 25</p> <p>64K Ram Chips 75</p> <p>Model 4 64K Upgrade Kit 140</p> <p>M100 Bar Code Reader 89</p> <p>64K Printer Buffer 199</p> <p>Printer Stand 25</p> <p>Printer Cables 470</p> <p>Printer Ribbons 405</p> <p>Printer Paper 379</p> <p>Dust Covers 649</p> <p>Computer Books CALL</p> <p>Radio Shack software 10% off</p> <p>Send for complete listing of brand name software and hardware</p>
---	--	--

CALL TOLL FREE 1-800-343-8124

- LOWEST POSSIBLE PRICES
- BEST POSSIBLE WARRANTY
- KNOWLEDGEABLE SALES STAFF
- TIMELY DELIVERY
- SHOPPING CONVENIENCE

computer plus

P.O. Box 1094
480 King Street
Littleton, MA 01460 **SINCE 1973**

(IN MASSACHUSETTS CALL (617) 488-3193)

1st PLACE

COMPUTER SYSTEMS
13422 N. CAVECREEK RD.
PHOENIX, AZ. 85022

CALL FREE
1-800-841-2748

COMPUTERS

ALTOS 580-10	\$2945
ALTOS 586-10	\$4600
ALTOS 586-20	\$5565
ATARI	\$CALL
APPLE LOOK-A-LIKE	\$CALL
PIED/PIER (PORTABLE)	\$CALL
SANYO 550-555	\$CALL

TELEVIDEO

803	\$1769	1603	\$2019
PORTABLE	\$CALL

NORTHSTAR

ADVANTAGE	\$2099
-----------	-------	--------

PRINTERS

BROTHER HR15P	\$479
DAISYWRITER 48K	\$975
DATASOUTH 180	\$1095
DATASOUTH DS220	\$1499
GEMNI 10X	\$280
I.D.S. MICROPRISM 480	\$399
I.D.S. PRISM 132	\$1340
I.D.S. PRISM 132C	\$1489
JUKI 6100	\$459
OKIDATA (LOW PRICES)	\$CALL
QUME 1140+	\$1275
QUME 1155+	\$1475

DIABLO

620	\$860	630	\$1689
-----	-------	-------	-----	-------	--------

NEC

3550	\$1699	8025	\$659
7710	\$1849	2030	\$799

TERMINALS

ALTOS II	\$759
QUME 1026	\$529
TELEVIDEO 914	\$540
TELEVIDEO 924	\$670
TELEVIDEO 950	\$869
TELEVIDEO 970	\$975

MONITORS

AMDEK 300G	\$130
AMDEK 300A	\$145
AMDEK COLOR I+	\$275
AMDEK COLOR II+	\$429
B.M.C. GREEN	\$79
B.M.C. COLOR	\$219
N.E.C. 1216	\$429

DISK DRIVES

INDUS APPLE	\$259
MICRO SCI A2	\$229
ATARI 1050	\$365
INDUS ATARI	\$345
RANA 1000	\$330

MODEMS

HAYS SMART MODEM	\$199
SMARTMODEM 1200	\$485
SMARTMODEM 1200 B	\$429
MICROMODEM II E	\$240
U.S. ROBOTICS PASSWORD	\$349

1st PLACE

COMPUTER SYSTEMS
13422 N. CAVECREEK RD.
PHOENIX, AZ. 85022
OTHER INFORMATION: 602-867-9897



Send cashier's check or money order all other checks will delay shipping two weeks.
Prices & availability subject to change without notice.

BYTE's User to User

Listing 1: The program below performs a series of matrix operations to provide a benchmark. The original benchmark was published by Jerry Pournelle in "A BASIC and Pascal Benchmark, Elegance, Apologies, and FORTH" (October 1982, page 254). It's run ten times to allow more accurate measurement.

```
MATRIX:
Procedure options(main):

Zreplace
    maxsize by 45,
    m      by 20,
    n      by 20!

declare
    i, j, main_loop,
    (A, B)(m,n) float,
    C(m,n)      float static initial(0.0),
    Summ        float static initial(0.0),
    BELL        char,
    GUP         var char(80);

put skip list('input any darned number to start it. ')!
set list(GUP);

do main_loop = 1 to 10!

    call FILLA!
    put skip list(' A filled. ');

    call FILLB!
    put skip list(' B filled. ');

    /* FILLC call replaced by "initial" option during declaration */

    call MATMULT!
    put skip list('Multiplied. ');

    call SUMMIT!
    put skip(2) list('Summ is ', Summ);

FILLA: procedure!

    do i = 1 to m!
        do j = 1 to n!
            A(i,j) = i + j!
        end!
    end!

end FILLA!

FILLB: procedure!

    do i = 1 to m!
        do j = 1 to n!
            B(i,j) = fixed((i + j) / j)!
        end!
    end!

end FILLB!

MATMULT: procedure!
declare k!

do i = 1 to m!
    do j = 1 to n!
        do k = 1 to m!
            C(i,j) = C(i,j) + A(i,k) * B(k,j)!
        end!
    end!
end!

end MATMULT!

SUMMIT: procedure!

do i = 1 to m!
    do j = 1 to n!
        Summ = Summ + C(i,j)!
    end!
end!

end SUMMIT!

end! /* end main_loop */

BELL = ascii(7)!
put list(BELL)!

end MATRIX!
```

THE INTERNATIONAL VIDEO GAME OF THE YEAR COMPETITION
HERALDS THE "NEW AGE" IN VIDEO/COMPUTER GAMES

\$175,000 TO BE WON

CREATE A NEW VIDEO
GAME AND YOU COULD
MAKE YOURSELF A
MILLIONAIRE

**AND THAT'S
JUST FOR
STARTERS!**

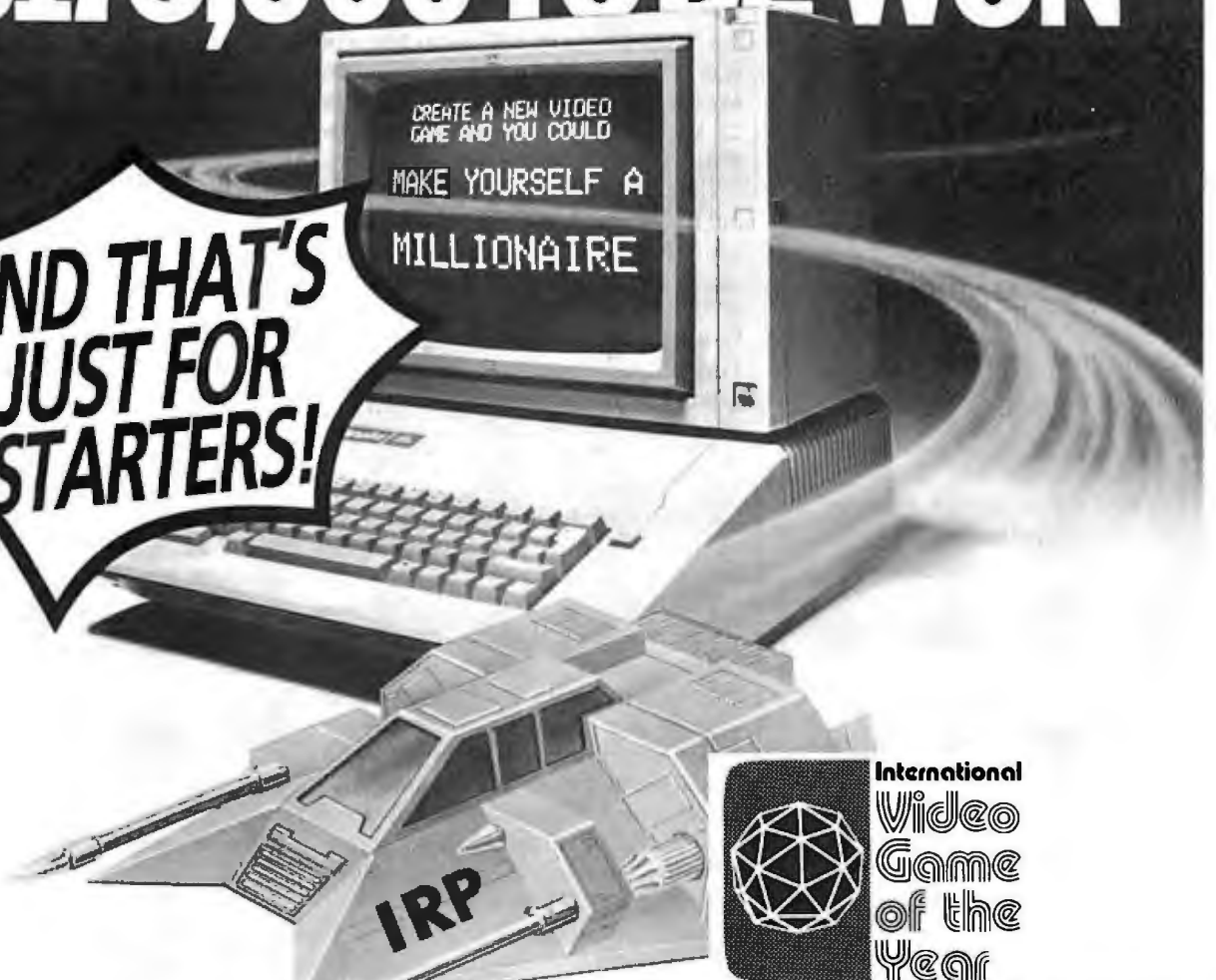

Create a brilliant, new video game and you could be on your way to becoming a millionaire. This fantastic competition, organised by I.R.P. (The International Register of Independent Computer Programmers Ltd) and the famous Mark McCormack International Management Group, offers programmers and inventors the opportunity of a life time. There are huge, immediate cash prizes and the on-going revenue of 10% of the sales of all games to distributors throughout the world, plus the chance to appear on an international TV show. Your skill and imagination could bring you fame and fortune!

\$100,000 FIRST PRIZE! **PLUS** FIVE \$15,000 RUNNER-UP PRIZES!

Devise a totally original new video game in one of these categories: SPORTS, SIMULATORS, ARCADE, STRATEGY, ADVENTURE/FANTASY or a special section which covers programmes that are not necessarily games but have outstanding Educational or Entertainment merit. We'll also be announcing a number of 'MERIT' awards which will be entitled to carry the message 'An International Video Game of the Year MERIT AWARD' on their retail packaging. It's a great challenge. And the rewards, both financially and in terms of prestige, are tremendous. This is the most exciting competition ever for creative computer and video enthusiasts.

YOU'RE A TV STAR TOO! All six winning games and their inventors will be featured on an internationally distributed, spectacular TV special. That's going to make your name!

HOW TO ENTER

Just send in your game, or games, programmed on cassette for any popular home computer. Use the coupon, today, and we'll send you all the facts you need.

CLOSING DATE FOR ENTRIES IS 31st MAY 1984

To: IRP Limited, Pinewood Film Studios, Iver, Bucks, England.

Name

Address

.....

.....

..... **B1**

Decision makers wouldn't be without AIM BENCHMARKS* For UNIX* Systems

AIM BENCHMARKS - The industry standard for UNIX Systems measurement

In use by over 100 leaders worldwide-

- to make their UNIX system purchase decision
- to fine-tune UNIX System performance
- to compare competitive UNIX systems
- to evaluate UNIX product improvements

AIM BENCHMARK's nine distinct tests measure any UNIX system including Version 7, System III, System V, and Xenix.

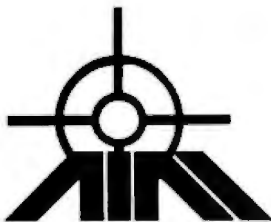

AIM TECHNOLOGY
 3333 Bowers Avenue, Suite 199
 Santa Clara, CA 95051
 (408) 727-3711
 Telex 705404

*AIM BENCHMARK is a trademark of AIM Technology
 *UNIX is a trademark of AT&T Bell Laboratories

BYTE's User to User

A Mariner Queries

Dear Jerry,

I just recently began reading BYTE and liked it so much that I rounded up some old issues. In your discussion of the 8087 ("New Computers, Boards, Languages, and Other Tidbits," October, page 107), you mentioned a lack of supporting software. Probably you know this by now, but Microsoft's implementations of FORTRAN and Pascal both fully support the 8087.

The real reason I'm writing is to find out if you have tested the piggyback 8087 board in your Z-100. If not, could you be persuaded to do so? I will be buying an H-100 in a few weeks. It will eventually be installed in the ocean-cruising sailboat I'm building, where it will serve as a navigation tool. Since number crunching is an inherent feature of navigation, I am extremely interested in having the 8087. It seems to me that a board that works in the Compupro ought to work in the Z-100, but it would sure be nice to know for certain. Can you help?

The last issue of the Heath Users' Group magazine, REMark, contained a couple of pieces of information that might interest you. Zenith is working on an interlaced scan routine to double the vertical resolution of the Z-100 display. At 640 by 450 pixels, it should be fantastic. Also, Zenith won a DOD contract competition and the Z-100 will be the desktop computer in all four military services. Will we be seeing Ada before long?

Robert D. Williams
 Hampton, VA

Regarding 8087 boards for the Z-100, watch my column. The Hudson board for the Compupro will not work with the Z-100; but the good news is that yesterday Jim Hudson called to say he'd finished the prototype Z-100 board. I haven't seen that board working yet, but I do have his add-on for my Compupro; and I know Jim well enough to have some confidence that his final product will be reliable. He's a perfectionist, and does his own work.

I've asked around, and my colleagues tend to agree that the H-100 is a good choice for your navigation computer, provided that you've given sufficient thought to waterproofing. I presume you've enough salt-water experience to appreciate just how serious corrosion problems can be. I'd particularly worry about the mechanical parts, such as switches, keyboards, fans, and floppy disks.

The Zenith is a good, rugged machine. The only one I can think of that's even more so is

the Compupro, and that's heavy enough to serve as a keel.

Good luck on your cruise, and keep me posted. Long ago I did a bit of blue-water midget ocean racing, and I've read Slocum and Hiscock and the other classics. I still delude myself that one day I'll take a long sailing cruise. . . . Jerry

A General Comment from Jerry

In the interests of sanity, we threw away all the mail dated prior to September 1, 1983. This wasn't easy to do, because there were some excellent letters that deserved reply; but it became obvious we just weren't going to keep up, and the sight of all that unanswered mail was depressing.

If you wrote earlier than that and still want an answer, please write again. This includes discussions of software for review. We have a somewhat better system now, and we're caught up for the moment. ■

Jerry Pournelle is a former aerospace engineer and current science-fiction writer who loves to play with computers.

Jerry Pournelle welcomes readers' comments and opinions. Send a self-addressed envelope to Jerry Pournelle, c/o BYTE Publications, POB 372, Hancock, NH 03449. Please put your address on the letter as well as on the envelope. Due to the high volume of letters, Jerry cannot guarantee a personal reply.

BYTE's Bits

Call for Papers

A call for papers has been issued by Computer Faire, sponsors of the annual West Coast Computer Faire and the PC Faire. The call is for papers to be delivered at next year's conference programs. The West Coast Computer Faire will be held in San Francisco on March 23-25, 1984. The dates for the PC Faire, also to be held in San Francisco, will be October 26-28, 1984.

Interested parties are invited to request a speaker's kit from Computer Faire Inc., 570 Price Ave., Redwood City, CA 94063, (415) 364-4294. ■

The Wang PC. The hardware that brings out the best in software.



The Wang Professional Computer runs hundreds of the most common business applications.

And almost all of the most popular software programs—including Visi On,[™] Lotus 1-2-3,[®] TK!Solver,[™] Multiplan[™] and Peachtree.[™]

And because the Wang Professional Computer is more powerful than most other personal computers—including the IBM PC—it runs all of these programs better. Applications are more responsive. Screens are faster.

The graphics are sharper.

In fact, many software companies have told us they prefer to see their software demonstrated on the Wang Professional Computer.

Which is only natural. Everybody likes to look their best.

For a demonstration of the Wang Professional Computer, call 1-800-225-9264. Or write to: Wang Laboratories, Inc., Business Executive Center, One Industrial Avenue, Lowell, MA 01851.

Visi On is a trademark of VisiCorp. Lotus 1-2-3 is a registered trademark of Lotus Development Corp. TK!Solver is a trademark of Software Arts Inc. Multiplan is a trademark of Microsoft Corp. Peachtree is a trademark of Peachtree Software Inc.



**The Office Automation
Computer People.**

Ask BYTE

Conducted by Steve Ciarcia

S-100 Versatility

Dear Steve,

I would like to learn assembly-language programming for the Motorola MC68000. There seem to be add-ons for the Apple that let you get an inexpensive system for a reasonable price, but none is available for a CP/M system. I have an S-100 Delta CP/M system with 64K bytes of RAM. Can I buy an inexpensive (much less than \$2000) S-100 board that would let me do it? Whatever system I bought would have to include a 68000 software-development system.

Would it be possible to design a modular system so that a person with a complete, one-processor system could add one or more additional processors, some RAM, or whatever was needed? What I'm talking about is a generalized hardware converter analogous to software converters for disk formats. The S-100 bus was supposed to be something like that, but I have had my Delta for two years and have yet to add my first board to it because I've never seen anything I wanted badly enough to pay the "Rolls-Royce" prices that S-100 bus designers seem to have to charge.

With an external converter, you could add whatever you wanted, even a Commodore 64 or VIC-20, to your big CP/M system and get pretty good color and all the things a large system does. With something like that, people might be able to combine all the little goodies you've designed.

Dean Dwyer
Torrance, CA

Your letter addresses quite a few good questions. Let me

answer them somewhat out of the order you posed them.

First of all, you have already taken the direction of a generalized system when you selected the S-100 bus. Any system designed around a popular bus will offer quite a bit of user flexibility. The S-100 bus is also very much alive and well since the introduction of the IEEE-696 proposed standard. Estimates of the number of S-100 bus systems in operation range around 500,000.

I do agree with your statement about the "Rolls-Royce" prices of some of the commercial boards offered for the S-100 bus. The way around these prices is to buy bare boards or to construct your own boards. A good reference manual for interfacing your own boards to the S-100 bus was written by Sol Libes and Mark Garetz, *Interfacing to S-100/IEEE 696 Microcomputers*, published by Osborne/McGraw-Hill. For example, you should be able to interface the speech generator with the information in this reference.

Another good source for S-100 and CP/M information is the monthly publication called *Microsystems*. Some advertisers in *Microsystems* have been addressing the question you have on running 68000 software with your 8-bit system. For example, HSC Inc. is advertising a C016 resource processor to run CP/M-86, CP/M-68000, MS-DOS, or Unix on a Z80 system (see *Microsystems*, September 1983, page 23). Avocet Systems Inc. is advertising several cross-assemblers that run on any computer with CP/M. Its ad claims to have a 68000 version coming soon (see *BYTE*, November 1983, page 435). . . . Steve

Income Tax Software

Dear Steve,

I have a Commodore 64 with a floppy disk, and I'm running Microsoft BASIC

and CP/M-80. Could you tell me what software is available for state and federal corporate and personal income taxes? Thanks.

Chester Fuchs
Yonkers, NY

Several income tax programs are available for the Commodore 64. Two that recently have been advertised are: *The Complete Personal Accountant* (Programmer's Institute, POB 3470, Dept. C, Chapel Hill, NC 27514, (800) 334-7638), which is a combination of programs for accounting, budget, mailing lists, spreadsheets, and income taxes; and *Tax Command* (Practical Programs Inc., POB 93014-S, Milwaukee, WI 53203, (414) 278-0829), which features built-in tax tables and most of the commonly used schedules.

From the advertisements, it appears that both programs are designed for personal income tax preparation. I am not aware of a program for corporate or state income tax for the Commodore 64. . . . Steve

Portable Terminal

Dear Steve,

I'm looking for a small portable terminal. My current line of thinking is to adapt a Radio Shack Pocket Computer, but I have had no luck obtaining technical information. Can you provide a source for technical information on the construction and internal operation of the PCs? Thank you for your help.

Tim McDonough
Springfield, IL

The IXO Telecomputing System sounds like the ideal solution to your problem. It features a keyboard with a full ASCII character set, has a built-in modem with autodialer, can emulate other terminals, has an uninterruptible power supply

(battery), and can fit in your pocket. In addition, it has optional RS-232C and video interfaces and a 20-column printer. Best of all, its price starts at about \$500. A review of this unit was presented in the April 1982 *BYTE* (page 6) and the May 1982 *Popular Computing* (page 16). For further information, contact IXO Industries Inc., 6041 Bristol Parkway, Culver City, CA 90230, (213) 417-8080.

If you have the urge to build your own, see my January and February 1984 article ("Build the Circuit Cellar Term-Mite ST Smart Terminal) on a low-cost, high-performance terminal. . . . Steve

Give Me a Break Key

Dear Steve,

I have written a communications program for my Commodore VIC-20 that lets me do much work from home. I am communicating with a Honeywell 6000 Level 66 mainframe. The problem is that the VIC-20 doesn't have a Break key, so I cannot exit any loops. I have tried sending many different ASCII values but have had no success. The Honeywell documentation does not mention how its terminals implement the Break function. If you know how to solve this problem, I would greatly appreciate it.

Michael J. McCarthy
Pittsburgh, PA

The Break key is used to indicate a need for immediate attention. It is a unique signal and is not in the standard ASCII code. Pressing the key causes the data line to go high for approximately 300 milliseconds, which is interpreted by the computer as a Break signal. This condition always occurs when operating in a full-duplex mode, but it can oc-

MEMORIES

**512KB TO 2 MB EDC
SINGLE BOARD
MULTIBUS MEMORY**

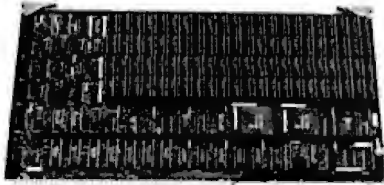

- Pin to Pin MULTIBUS compatibility for both 8 bit and 16 bit systems.
- Addressable up to 16 megabytes.
- On board parity with selectable interrupt on parity ERROR.

OR

- Error Detecting and Correcting (EDC).

SINGLE QTY. PRICE:

	Without/EDC	W/EDC
512KB	\$ 895.00	\$1495.00
2MB	\$5995.00	\$6495.00

NEW!

NEW!

**2MB Q-BUS
EDC
512KB TO 2MB
QUAD Q-BUS
MEMORY**

*WITH ERROR
DETECTION AND
CORRECTION*

**UNBELIEVABLE LOW
PRICE!**

Call for details!

**256KB TO 1 MB
SINGLE BOARD
LSI 11 MEMORY**

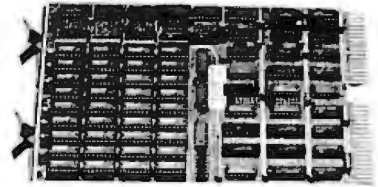

- Control Status Register (CSR)
- On board parity generator checker.
- Battery back-up mode.

SINGLE QTY. PRICE:

256KB \$525.00

DISK SYSTEMS COMPUTERS

2MB FLOPPY

Dual drive, double density, double sided 2MB floppy (8") with controller and bootstrap. Also reads single sided, single density!

CI-1220 TF \$2695.00



42MB, 70MB, 140MB formatted Winchester (8") disk system w/controller and 2MB floppy (8") backup w/controller.

CI-1240-WF: 42MB Winchester \$6995.00

CI-1270-WF: 70MB Winchester \$7495.00

CI-1340-WF: 140MB Winchester \$9995.00

10MB WINCHESTER OR 20MB WINCHESTER

RI.02 compatible Winchester subsystems. 2MB floppy single dual controller and bootstrap is supplied with each purchase.

CI-820:

10MB Winchester 2MB floppy (8")

\$4495.00

20MB version add \$500.00

CI-11/23AC: LSI 11/23CPU, 256KB, 4 x 8 backplane, power supply and chassis (excluding rack slides) \$2675.00

CI-11/23AF: LSI 11/23 + CPU, 1MB, 4 x 8 backplane, power supply and chassis (excluding rack slides) \$4125.00

"OFFERING QUALITY WITH AFFORDABLE PRICING"



Chrislin Industries, Inc.

31352 Via Colinas • Westlake Village, CA 91362
Telephone: 213-991-2254 • TWX 910-494-1253 CHRISLIN WKVG

Multibus is a Trademark of Intel Corporation. QBUS, LSI, is a Trademark of Digital Equipment Corporation.

cur during half-duplex operation only when the terminal is transmitting. When the computer is transmitting, the Break key is unrecognized. A simple way to achieve this 300-ms pulse is through the use of a one-shot circuit activated by the Break key. . . . Steve

Laboratory Automation

Dear Steve,

I am a radiological physicist and part of my work consists of the calibration of X-ray generators used in the treatment of cancer. Much of the work consists of the manual positioning of an ionization probe or diode within the radiation beam and then sampling the probe with an electrometer. The electrometer has a convenient output for use with analog plotters with inputs ranging from 0 to 10 volts (V) DC. This voltage is proportional to the radiation intensity.

The problem is the time, energy, and wear and tear on the equipment, and myself, when taking these measurements. Entering the room, walking a distance of 50 feet or so, opening and closing a one-ton door, positioning the probe, and starting and stopping the machine is a process that takes nearly four minutes per reading. Acquiring enough points to generate a beam profile can take several hours.

I have a TRS-80 Model III and a Starbuck Data Model 8882. The latter has an 8-channel 8-bit analog-to-digital (A/D) converter, eight on/off switch inputs, and eight on/off switch outputs. I am very happy with the 8882, and with the addition of a few simple circuits, which I hope you can provide, I will be able to perform my job much more effectively.

First, I would like to be able

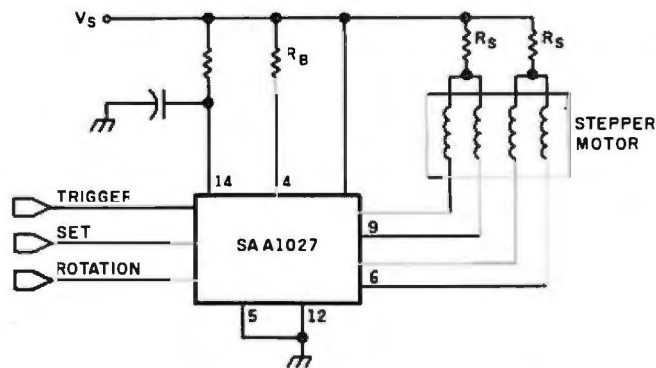

Figure 1: Stepper-motor controller.

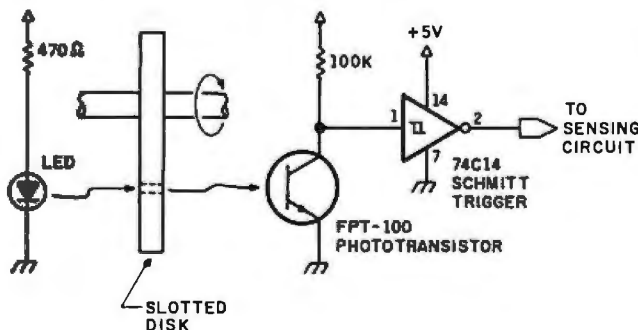

Figure 2: Position-limit sensor.

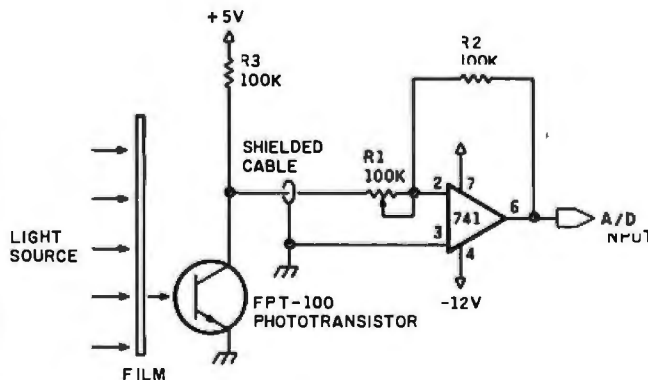

Figure 3: DC amplifier/scaler.

to control a three- or four-phase stepper motor with the opto output switches of the 8882. The stepper must have about 30 ounce-inches of torque to function effectively. I intend to keep track of the position of the probe by the number of pulses in either direction. I need a simple stepper-motor controller capable of direction and stepping logic from two of the eight output switches of the 8882.

Second, I need a limit switch capable of accurately sensing a position to a millimeter or less, possibly some sort of optical device. This circuit would be used to reference the stepper motor.

Third, I need a circuit that would convert film optical density into a voltage proportional to film density. I will use this device to convert a film exposed to the radiation beam into a dose profile. The stepper will be used to auto-

matically move the film over the density reader.

Last, I need a DC amplifier that will convert a voltage from the electrometer, or film-density reader, into a voltage in the range of 0 to 5 V for the Starbuck 8882 A/D. Because the electrometer may range from 0 to 10 V and the film-density reader also may vary out of the 0- to 5-V range, I need the capability of offset as well as amplification greater than and less than one to get the voltage between 0 and 5 V for the 8882. This will enable me to get full resolution out of the 8882.

I need circuits that are simple to build and understand because I have a very limited knowledge of electronics.

Your help could make a substantial contribution to the effectiveness of my job and the treatment of our patients.

Dwight T. Still
Lawrenceville, GA

Automating your TRS-80 to acquire beam profiles can be accomplished with some simple circuits and a little research into stepper motors.

Several manufacturers are now producing stepper motors that will match your needs. In particular, North American Philips Controls Corporation offers both the stepper motors and an integrated-circuit pulse-to-step drive controller in 16-pin DIP (dual-inline package). It also offers a Stepper Motor Handbook with all the information needed to design a stepper-motor device. You can obtain this handbook from North American Philips Controls Corp., Cheshire, CT 06410, (203) 272-0301.

Figure 1 was gleaned from the Stepper Motor Handbook and shows how simple the circuitry is with the SAA1027 controller. The direction of rotation is controlled by applying a low or high level to pin 3. The motor will step when a low-to-high transition occurs on pin 15. The

Want to hook IBM?

Terminals. Personal Computers. ASCII devices. Hook them all into the IBM world with the new AVATAR™ PA1000 Protocol Converter.

The PA1000 provides low-cost IBM 3278/2 terminal emulation and coaxial connection to an IBM 3274/3276 cluster controller. Then, a single keystroke switches you back into the asynchronous world through an auxiliary RS-232-C port to access other computer systems, public information services or copy a screen to a printer.

Our microprocessor-based unit provides user-selectable rates up to 9600 baud, terminal keyboard configura-

tions, screen management and local or remote print functions. And, you can hook the PA1000 to a modem for remote dial-in access.

Simple, economical access to the world of IBM, just when you thought there was no answer. At \$995, getting hooked has never been so affordable. For more information on our AVATAR PA1000 Protocol Converter, contact Avatar Technologies Inc. 99 South Street Hopkinton, MA 01748 Or call us at (617) 435-6872.

AVATAR™

Making IBM smarter since 1983.

IBM is a registered trademark of International Business Machines Corp.

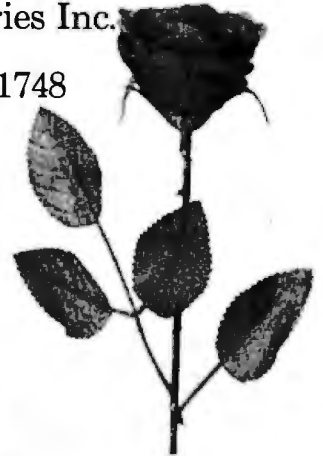

Imagine what you can do with 4 more serial ports...



Now imagine doing it for \$279.

For Port Expansion...

Model 524/\$279

Increase your I/O capabilities by interfacing your RS-232C peripheral devices to your computer with a BayTech Serial Port Expander. All BayTech Multiport Controllers - like the Model 524 - allow the user to mix and match peripheral devices of different configurations without the need to reconfigure the host device. BayTech's port expanders allow port selection through software control. Port configuration of the peripheral device ports may be changed by the user with the 524's menu-driven software.

For Multiplexing/Demultiplexing...

Model 524E/\$319.

BayTech's Model 524E, with its four buffered peripheral ports, allows four lines of data to be multiplexed and sent sequentially over a single communication line, then automatically demultiplexed by another 524E with distribution to the corresponding peripheral ports. 524E's configured back-to-back allow economical utilization of telephone communications.



For Time-Sharing...

Model 524DQ/\$319

The Model 524DQ allows one to four users to share a computer through a single port. Users requesting access when the host port is busy will be given a position in a queue with the 524DQ providing appropriate messages, i.e., "YOU ARE #1 IN THE QUEUE", "YOU ARE #2 IN THE QUEUE", etc. Users will be automatically advanced in the queue with the 524DQ updating status messages. The 524DQ allows the most economical multi-user productivity from a single-port computer.

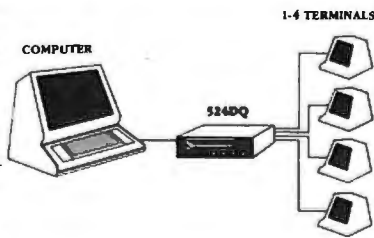

For Networking...

Model 524F/\$329

The Model 524F is BayTech's most versatile serial port expander. With its host port and four peripheral ports capable of any-port-to-any-port interconnection, applications are virtually unlimited. Because of its features, the 524F allows the user to create a local network providing simultaneous communication for four RS-232C devices.

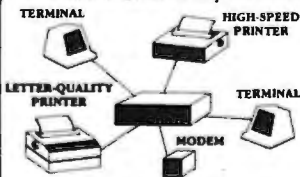

Other Models Available

BayTech continually develops new serial port expanders as the computer industry discovers new applications. Call us about our other models.

...need 8 ports...just \$499!

If you've found a BayTech Multiport above that handles your specific application, but you need even more expansion, choose an 8-port model from BayTech's new 528 Series. You get the same outstanding features but with 8 peripheral ports. And you get them at comparably modest prices.

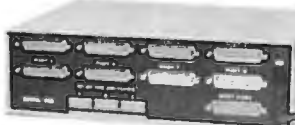

To place your order or discuss your expansion problems.

1-800-523-2702



BAY TECHNICAL ASSOCIATES, inc.

HIGHWAY 603, P.O. BOX 387
BAY ST. LOUIS, MS 39520
(601) 467-8231

Ask BYTE

values of R_s and R_b depend on the stepper motor chosen and the value of V_s . These values are tabulated in the handbook for various stepper motors.

Figure 2 shows a simple method of obtaining a reference position for the stepper motor. The method is analogous to the methods used in disk drives. An opaque disk with a small hole or slot can be mounted on the shaft of the stepper motor. A light source, such as an LED, can be mounted on one side of the disk and a phototransistor on the other side. When the light passes through the slot, the phototransistor will conduct and the voltage at pin 1 of the 74C14 Schmitt trigger will go to approximately 0 V. The Schmitt trigger will now convert this voltage change into a sharp 0-to-5-V transition at its output. This transition can now be monitored by a voltmeter or fed into one of the on/off switch inputs on the Starbuck 8882.

Figure 3 shows one simple method of converting a film density into an analog voltage. Again, a light source is applied to one side of the film, and a phototransistor is used to sense the light on the other side. However, in this case, the magnitude of the light is monitored by your A/D circuitry through the 741 operational amplifier. The 741 is connected as a simple inverting amplifier with gain controlled by the variable resistor $R1$. The DC gain of the circuit is set by the ratio $R2/R1$. The equation for the output voltage (V_o) is $V_o = V_i \times R2/R1$, where V_i is the input voltage at the junction of the phototransistor and $R3$. A shielded cable may be needed if the amplifier is placed a long distance from the phototransistor.

The circuit in figure 3 is simple in design and has no provisions for DC drift that can be caused by several factors, including ambient temperature changes. If small drift errors are a problem, you can find any number of texts on operational-

amplifier design at most public or company libraries and at most bookstores... Steve

Compatibility Revisited

Dear Steve,

As a businessperson who is a small computer user, I share the sentiments and frustrations of the first-, second-, and even third-time purchasers of small computers. In their ads, many companies claim "Apple compatible," "will run most software for..." "IBM compatible," or "runs CP/M software."

What are the main aspects of a computer and software that would make them truly "IBM" or "Apple" compatible? An article on this would be of great service for those of us who don't hold advanced degrees in computer science and engineering.

Jeff Van Buren
Morehead City, NC

There are almost as many definitions of "compatible" as there are "compatible computers." A good definition of a compatible computer is one that will run the same software and accept the same hardware expansion and accessory cards as the computer with which it is supposedly compatible. Some of the compatibles offer more features at a lower price and have captured a small share of the market.

To be truly 100 percent compatible requires the same operating system and interface address locations. This is difficult to achieve without violating software copyrights, so most "compatible" computers lack certain features. CP/M allows the closest compatibility because the operating system is the same and the BIOS (basic input/output system) accounts for the hardware variations. Unfortunately, disk sizes and formats have not achieved this level of compatibility.

Compatibility is an excellent



The best career move you can make is to the keyboard of your personal computer.

It's free. It's confidential.

Never before have technical and financial career markets undergone such rapid change.

But now there's a way to keep up with it. This new key to career opportunity is your personal computer. And the cost is nothing but a phone call.

Just call CLEO. That stands for Computer Listings of Employment Opportunities.

CLEO responds to your commands and it's interactive. You specify what job categories, companies, or geographic locations interest you. CLEO calls up the appropriate ads right on your screen. At every step, you're guided by explicit online instructions.

Daily updates keep CLEO job listings current. You can even apply for positions right from your

Circle 66 on inquiry card.

own terminal. For a detailed job search, or just an idea of what's available, CLEO is waiting for your call today. With today's opportunities.

CLEO access: (415) 482-1550 • (408) 294-2000 • (213) 618-8800 • (714) 476-8800 • (619) 224-8800 • (818) 991-8900

300 BAUD, full duplex, standard ASCII code.
Access assistance: (213) 618-1525

CLEO

Computer Listings of Employment Opportunities

An electronic publishing activity of The Copley Press, Inc.

Recruitment advertisers—call (213) 618-0200 collect to find out how you can place your ad on CLEO.

Ask BYTE

subject for an article, but it would have to concentrate on a particular computer. Trying to cover the field would require an encyclopaedia. . . . Steve

ZX81 Floppies and Interfaces

Dear Steve,

I have a Sinclair ZX81 and would like to use a floppy-disk drive with it. I know that I will also need an interface. Are there a drive and an interface that you know about that could be used? Thank you.

Denis Boulais
Iberville, Quebec, Canada

A floppy-disk interface is available for the Sinclair ZX81/Timex 1000 that will allow the use of the popular Shugart SA200 disk drives. Software commands include saving and loading BASIC programs as well as data, initialization of a disk,

CREATE, READ, WRITE, KILL, STAT, DIR(ectory), and NEWD(isk). All of these functions can be called from programs or from the immediate mode.

The FDC-100 interface is available for \$199. A single-drive package that includes interface, drive, and power supply (FDC-101) is \$499; a two-drive package (FDC-102) costs \$799. Contact Compusa, 1101 Bristol Rd., Mountainside, NJ 07092, (201) 654-7220. . . . Steve

Prototype Boards

Dear Steve,

I have been looking for a prototype board like the one pictured on the front of your book, *Build Your Own Z80 Computer*. The only boards I can find have extra pads for regulators, etc., which make them unsuitable for your application.

Would you please let me

know the manufacturer and model number of the card you used?

Robert Kanen
Long Valley, NJ

Vector Electronics has a complete line of prototype boards for many computer buses. The board shown on the cover of my book uses a 72-pin connector and was designed for the Digital Group system. I am not sure if this particular board is still available. Even if it is, obtaining 72-pin sockets will be very difficult.

I recommend one of the S-100 prototype cards that are made by Vector. The company has almost a dozen different combinations, from a blank, unetched printed-circuit board to one with power buses and pads. You will need a catalog to choose. Remember, too, that traces can be cut and rerouted to accommodate your layout.

Should you decide to expand your system, motherboards and cabinets will be readily available

with the S-100 pinout and geometry.

A catalog can be obtained from your local electronics dealer or from Vector Electronics Company, 12460 Gladstone Ave., Sylmar, CA 91342, (818) 365-9661. . . . Steve ■

inquiry

- Ciarcia

given.

in



Board for S-100 Bus

256K/1MEG Byte
Dynamic Ram
Model 256KM

features: 256K using 64K chips \$759.00

• 256K/1 mega Byte using 64K or 256K DRAMS • 8/16b Data • 24b Address • Parity per Byte • 175 nsec Access Time • will run Z80/Z8000 to 6 mhz, 8086, 80186, 80800 to 8mhz without wait states • transparent refresh, unlimited DMA.

FLOPPY DISK CONTROLLER Model FDC1 \$395

features: • Single or Double density, sides, in any combination of up to four 8" or 5.25" drives. • Digital phase locked loop. • DMA data transfer with cross 64K boundaries, 24B address, DMA arbitration. • Monitor/boot EPROM accommodating two different processors. • CPM Bios programs. • Serial port to 19.2K baud.

Z80B CPU BOARD Model Z80 CPU \$325

features: • 2, 4 or 6 mhz clock. • 22 bit Address by Memory Mapping in 16K blocks. • 2 or 4Kbyte EPROM (not supplied) with Phantom generation. • Jump on Reset. • Provision to run two different CPU's on the same bus, such model 80186 CPU.

80186 CPU BOARD Model 80186 CPU \$495

features: • Intel 80186 Based. • Executes 8086 codes plus 10 additional. • Built in DMA channels, timers, interrupt controller. • Interface to Numeric Data Processor, 8087. • 8 or 16 bit data transfer, with 4 or 8 mhz clock. • Provision to run 2 different CPU's on the bus, such as our M:Z80 CPU.

Board Sets: Z80 CPU, 256KM, FDC1, and CP/M 3.0
plus manual \$1390.

*CP/M is a registered trademark of Digital Research, Inc.

Delivery is within 3 to 5 working days. MC, Visa or COD orders accepted. (Add 6% for COD orders.) Shipping Extra. Illinois residents add 5 1/4% sales tax.

O.E.M. & DEALER PRICE AVAILABLE

S.C. DIGITAL, INC.

1240 N. Highland Ave., Suite #4 • P.O. Box 906, Aurora, Illinois 60507
Phone: (312) 897-7749

JUKI 6100 LETTER QUALITY PRINTER

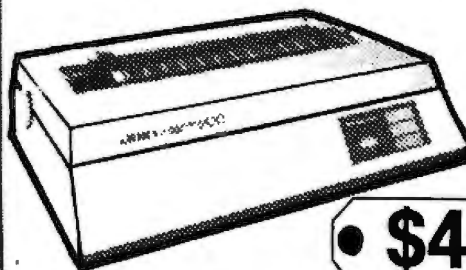

• \$469.

- 18 cps
- Word processing and graphic functions
- Proportional spacing control
- Uses IBM Selectric ribbons.
- Compatible with Kaypro, IBM, Apple, Osborne, and others.



Free shipping in U.S.

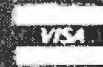

COMPUTERS and more

2420 University Ave., To Order
San Diego, Ca. 92104 (619) 291-1442



The power of dBASE without dBOTHER.

Now if you can read, you can build a powerful application with DATAEASE.™ Come see our entire integrated family — WORDEASE™, GRAPHEASE™, DOSEASE™ and our powerful MEDEASE™ application. Plus get your free demo diskette and details on our innovative service, support and multi-million dollar marketing and sales promotion programs.

DATAEASE™

**Softcon Booth A-761
Toll-free info line 800-243-5123**

Software Solutions, Inc., 305 Bic Drive, Milford, CT 06460 (203) 877-9268 TELEX: 703972

DATAEASE, GRAPHEASE, MEDEASE, WORDEASE and DOSEASE are registered trademarks of Software Solutions, Inc.

Event Queue

March 1984

March-April

Continuing Engineering Education Courses, Washington, DC, Orlando, FL, and San Diego, CA. More than 300 courses for practicing computer and information-processing professionals are offered by George Washington University. A few of the titles include "Local Area Computer Networks," "An Applications-oriented Approach to Artificial Intelligence," and "Minicomputers, Microcomputers/Processors for Non-electrical Engineers." Fees range from \$625 to \$875. Contact Continuing Engineering Education, School of Engineering and Applied Science, George Washington University, Washington, DC 20052, (800) 424-9773; in the District of Columbia, (202) 676-8522.

March-April

Courses from Integrated Computer Systems, various sites throughout the U.S. "Implementing Local Area Networks," "Designing Dedicated/Embedded Computer Systems," and "Computer Network Design and Protocols" are a few of the courses to be presented. For course information, contact Ruth Dordick, Integrated Computer Systems, 6305 Arizona Place, POB 45405, Los Angeles, CA 90045, (213) 417-8888.

March-April

Courses in C Language and Unix, various sites throughout the U.S. Three five-day courses are offered: "C Programming Workshop," "Advanced C Topics Seminar," and "Unix Workshop." For complete details, contact Joan Hall, Plum Hall Inc., 1 Spruce Ave., Cardiff, NJ 08232, (609) 927-3770.

March-April

Electronic Motion Control Association Seminar, Dallas, TX and Uniondale, NY. This two-day program combines tutorial sessions with technical paper presentations and displays of devices and systems. It also reviews DC motors and control systems and overviews step motors and step-motor drives. Registration forms and information are available from the Electronic Motion Control Association, Suite 1200, 230 North Michigan Ave., Chicago, IL 60601, (312) 372-9800.

March-June

Productivity '84, various sites throughout the U.S. This series of two-day programs serves as a showcase for Hewlett-Packard products. Seminars are available, and more than 25 products are to be demonstrated, including the HP 150 personal computer and laser printers. Admission is free to the public. For more information, contact Hewlett-Packard, Public Relations Department, 3000 Hanover St., Palo Alto, CA 94304, (800) 554-4466.

March-June

Seminars from Datapro Research Corporation, various sites throughout the U.S. Subject areas include data communications, microcomputers, and information systems. In-house presentations of technical programs can be arranged. For a 40-page catalog of seminars, contact Datapro Research Corp., 1805 Underwood Blvd., Delran, NJ 08075, (800) 257-9406; in New Jersey, (609) 764-0100.

March-July

Reliability and Maintainability Engineering Institutes and Short Courses, various sites throughout the U.S. A few of the programs

to be offered are "Reliability Engineering, Testing, and Maintainability Engineering" and "The Tenth Annual Reliability Testing Institute." For a complete schedule, contact Dr. Dimitri Kececioglu, College of Engineering, Aerospace and Mechanical Engineering Department, University of Arizona, Tucson, AZ 85721, (602) 621-2495.

March-August

Conferences and Expositions from the Society of Manufacturing Engineers, various sites throughout the U.S. and around the world. More than 25 conferences and expositions are scheduled. For a calendar, contact the Public Relations Department, Society of Manufacturing Engineers, One SME Dr., POB 930, Dearborn, MI 48121, (313) 271-0777.

March-October

Tutorial Short Courses from Hellman Associates, various sites throughout the U.S. Among the courses offered are "VLSI Design," "Digital Control," and "Error Correction." Fees are generally \$895. For a descriptive brochure, contact Hellman Associates Inc., Suite 300, 299 California Ave., Palo Alto, CA 94306, (415) 328-4091.

March 12-14

Auditing and Controlling Microcomputers, Houston, TX. This seminar reviews the technology behind microcomputers and shows how they can be used by an auditor for practice management or as a tool in an audit engagement. For a course outline, contact Miriam Hoyt, MIS Training Institute Inc., 4 Brewster Rd., Framingham, MA 01701, (617) 879-7999.

March 12-14

Softside of Software, Hilton Harvest House, Boulder, CO.

Examining the many facets of writing user-friendly software and documentation, this seminar focuses on documentation techniques, standards, software engineering tools, and designing on-line help. User and customer training are also addressed. The cost for all three days is \$595. For registration details, contact Cross Information Co., Suite B, 934 Pearl Mall, Boulder, CO 80302-5181, (303) 499-8888.

March 12-15

Interface '84, Convention Center, Las Vegas, NV. For details on this twelfth annual data communications/information-processing conference and exposition, contact the Interface Group Inc., 300 First Ave., Needham, MA 02194, (800) 325-3330; in Massachusetts, (617) 449-6600.

March 12-16

Auditing in the Contemporary Computer Environment, New York, NY. Participants will learn a comprehensive audit approach for computer-based systems. Topics include how to evaluate controls, how to prepare an audit report, and how to design a program of tests using questionnaires, checklists, software tools, and flowcharts. Contact the EDP Auditors Foundation, 373 South Schmale Rd., Carol Stream, IL 60187, (312) 682-1200.

March 13

NorWesCon-84, Red Lion Inn Convention Center, Bellevue, WA. The theme of this ninth annual Pacific Northwest industrial electronics trade show is "Discover Solutions in Technology." Almost 50 manufacturers will present exhibits, demonstrations, and seminars of original-equipment manufacturing and end-user products for

REPORT ON NEW PERIPHERAL HARDWARE:

CHOOSING A SERIAL INTERFACE FOR YOUR APPLE* COMPUTER.

The "Second Serial Hardware Decision"...

Once you've selected the right serial printer or modem for your Apple* system, your hardware decisions are over for a while. Right?

Wrong, of course! You still have to decide on an interface card. This "second serial hardware decision" is an important one—one made much simpler

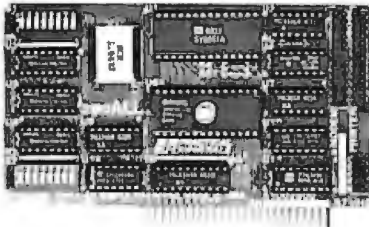

SERIALL Printer/Modem Interface by SERIALL™, the new serial interface for Apple computers.

At a significantly lower cost than Apple's own serial card—\$159.00 vs \$195.00—SERIALL gives you a bunch more features. Practical, everyday features, not useless extras.

For one, SERIALL is the only interface that provides graphics capabilities for serial printers including Apple's new dot matrix Imagewriter™.

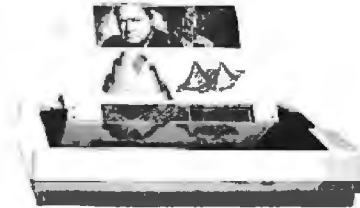

Graphics capabilities for serial printers

SERIALL also offers 27 easy commands for text formatting and screen dumps, making it the most intelligent serial interface you can use with an Apple.

Equally important, SERIALL gives you complete communications interfacing capability. You can use it for modems or in the special terminal mode for timesharing and talking to other computers.

In fact, SERIALL completely emulates the Apple serial card as a communications interface.

No additional software or hardware modification is required.

Finally, consider the quality. SERIALL's five-year warranty is proof that this interface is built to work long and hard. No other serial card is backed by a guarantee like this.

After comparing SERIALL feature-for-feature with other serial interface products, we think you'll agree—SERIALL truly is the Do-It-All serial card for Apple computers.



Available from Practical Peripherals—makers of MICROBUFFER™, PROCLOCK™, PRINTERFACE™, and GRAPHICARD™.

*Apple and Imagewriter are registered trademarks of Apple Computers, Inc.

PRACTICAL PERIPHERALS

31245 La Baya Dr., Westlake Village, CA 91362 • (818) 991-8200 • TWX 910-336-5431

Call Now TOLL FREE 800-368-3404

(In VA, Call Collect 703-237-8695)

AMPEX • INTERTEC • TEXAS INSTRUMENTS • GENERAL DATA
COMM. • ANDERSON JACOBSON • C. ITOH • QUME • BEEHIVE •
DATASOUTH • DIABLO • CENTRONICS • NEC • PRENTICE

MICROS

INTERTEC SUPERBRAIN II
64K DD* \$1798
64K CD* \$2143
64K SD* (96TPI) \$2689
*(Includes M/Soft BASIC)
DYNABYTE 8/16 BIT Call
BIT Call

NEC

7710 Ser. \$1899
7715 \$1949
7730 Par. \$1899
7720 \$2449
7725 \$2496
Std. Tr r77xx \$ 199
3510 \$1364
3515 \$1394
3530 \$1390
3550 (IBM) \$1709
DATASOUTH DS180 Call
DATASOUTH DS220 Call

DIABLO

620-SPI \$ 849
630-R-102/147 \$1949
630ECS \$2389
630-R183 \$1694
*(for IBM PC, Apple II, TRS-80)
630K104 (KSR) \$2265

QUME

Sprint 11/40 \$1288
Interface \$ 76
Sprint 11/55 \$1446

STAR MICRONICS

Delta 10 \$484
Bi-Dir Forms Tractor \$ 219
CENTRONICS: 122 Par. \$ 689
351 \$1673
BarCode \$ 98



AMPEX

D80 \$ 689
PHAZE (3270 Ex. Mem) \$1589

BEEHIVE (SMART DISPLAY)

DM5 Call
DM5A Call
DMB3 (Burroughs) Call
DM3270 (3270 Emulator) Call
Protocol Converter Call

QUME

QVT-102 \$ 549
QVT-108 Call

C. ITOH

CIT 101 \$1289
CIT 161 (64 Colors) Call
CIT 201 (Graphics fo
TEK 4010/4014) Call

CIT 414 (Graphics
640 x 480 Res.) Call
TEXAS INSTRUMENTS
745 Standard \$1172
745 Std. (Reconditioned) Call
765 Bbl M/my Call
785/787 Call
810 Basic \$1249
810 Package \$1439
820 Package RO \$1610
820 KSR Package Call
703 Std. \$ 459
707 KSR \$ 549
850 Trac or Feed \$ 549

MODEMS

Prentice Star 300 Bd. \$ 124
U.S. Rob
Password AD (212A) .. \$ 347
US Rob TelPack \$ 69
Stat Muxes Call
Ventel 212+ Call
Prentice 24/1 bd. Call

DISC DRIVES

QUME

Data Trak 5 \$ 289 or 2 for \$ 549
Data Trak 8 \$ 519 or 2 for \$ 999

BISYNC-3780 \$ 569
WordStar \$ 279
DataStar \$ 218
Mail Merge \$ 144
SpellStar \$ 144
Plan 80 \$ 249
d Base II \$ 489
CalcStar \$ 119
SuperSort \$ 144
SuperCalc \$ 144
InfoStar \$ 279
InfoStar (8") Special \$ 249
CIS Cobol \$ 689
Forms II \$ 159
MACRO 80 \$ 183
"C" Compiler \$ 239
WordStar Professional
(WS, SS, MM, S1) \$ 399
ReportStar \$ 199
StarIndex \$ 129
PlanStar Call
StarBurst Call
InfoStar Plus Call

IBM PC

256K RAM Bd. \$ 256
256K RAM Bd Full Parity \$ 305
BabyBlue \$ 600
BabyTex \$ 600
BabyTalk 3270 BISYNC \$ 895
8" Disk Controller \$ 395

We also make EIA RS 232 or RS 449 cables to your order, can supply you with ribbons, printer stands, print wheels, thimbles for all printers listed. Plus many, many more items. Most items in stock. CALL NOW.

All items shipped freight collect either motor freight or UPS unless otherwise specified. All prices already include 3% cash discount. Purchase with credit card does not include discount. Virginia residents, add 4% Sales Tax. For fastest delivery send certified check, money order or bank-wire transfer. Sorry, no C.O.D. orders. All equipment is in factory cartons with manufacturers warranty (honored at our depot). Prices subject to change without notice.



TERMINALS TERRIFIC

Terminals Terrific, Inc., P.O. Box 216, Merrifield, VA 22116
Phone: 800-368-3404 (In VA, Call Collect 703-237-8695)

Event Queue

the industrial electronics marketplace. Admission is free for all members of the industry. For information, call the sponsor, Almac Electronics Corp., 14360 South-east Eastgate Way, Bellevue, WA 98007, (206) 643-9992.

March 13-15

CIMCOM, Convention Center, Washington, DC. The Computer-integrated Manufacturing and Communications (CIMCOM) conference and exposition is sponsored by the Computer and Automated Systems Association of the Society of Manufacturing Engineers (CASA/SME). It will focus on software development and applications, beginning with manufacturing planning and continuing through the manufacturing-control processes. For information, contact CASA/SME, One SME Dr., POB 930, Dearborn, MI 48121, (313) 271-1500, ext. 521.

March 13-15

Micro/SET 84: Microcomputer Expo for Science, Engineering, and Technology, Engineering Society of Detroit, MI. Papers emphasizing microcomputer applications in research, design, engineering, and manufacturing will be presented. Complementing the conference program will be displays of scientific, engineering, and technical microcomputer hardware and software. For more information, write to the Conference Manager, Engineering Society of Detroit, 100 Farnsworth, Detroit, MI 48202.

March 13-15

Online Business Strategy Conferences and Exposition, Barbican Centre, London, England. Three concurrent conferences will be held: Mobile Communications, Telecoms Today, and Satellite Communications. Multiple-conference session registra-

tion is optional. Organized by Online Conferences Ltd., Registrations Dept., Pinner Green House, Ash Hill Dr., Pinner HA5 2AE, Middlesex, UK; tel: 01-868 4466; Telex: 923498 ONLINE G.

March 13-15

Optical Storage of Documents and Images, Biltmore Hotel, Los Angeles, CA. Topics to be covered are read-write and read-only storage of analog and digital information including office documents, engineering drawings, and parts catalogs. The fee is \$695 for the first person from an organization and \$595 for each additional attendee. For more information, contact Technology Opportunity Conference, POB 14817, San Francisco, CA 94114-0817, (415) 626-1133.

March 13-16

Inside the IBM PC, Sheraton-Hartford Hotel, Hartford, CT. This intensive seminar explores IBM PC-DOS, hardware, communications, networking, and graphics. It's designed for advanced IBM PC or XT users, programmers, engineers, and designers. The fees are \$345 per participant for a single day or \$295 per participant per day for two or three days. In-house presentations can be arranged. Contact the Center for Continuing Education, Northeastern University, 360 Huntington Ave., Boston, MA 02115. For information on in-house presentations, call (617) 329-8000.

March 14-16

The Seventeenth Annual Simulation Symposium, Bay Harbor Inn, Tampa, FL. Papers dealing with applications of simulation, simulation languages, and methodologies will be presented. Contact Alexander Kran, IBM Corp., B/300-40E, Hopewell Junction, NY 12533, (914) 894-7142.

The only way to make costly anti-static mats 100% effective.



Anti-static mats offer some protection. But the anti-static protection ends where the mat ends.

Someone walking past a terminal can generate enough static energy to zap your computer—creating anything from a glitch to a serious memory loss.

In dealing with real life situations, mat protection doesn't go far enough because the mat doesn't go far enough. So unless *everyone* is standing barefoot on the mat, you're asking for static problems.

Staticide® protection goes everywhere—static-proofs every square inch of your EDP or office environment.

One application of Staticide to floors, work stations and equipment keeps the entire area static-free for up to six months.

And now you can wipe out static on CRT screens, copiers and key-

boards with new Staticide® Wipes™. This convenient towelette cleans while eliminating static—without harming or damaging sensitive electronic components.

The Staticide System. 100% protection for just a small percent of what a mat will cost.

Best of all, people can behave like normal. No tiptoeing. No mat crowding. No kidding.

Staticide and Staticide Wipes. The only practical 100% solution.



Staticide

by ACL Incorporated

We take static from our customers.

 1960 E. Devon Avenue
Elk Grove Village, IL 60007
(312) 981-9212, TELEX: 4330251

Call or write for free literature.

Circle 9 on inquiry card.

ACL products available worldwide.

Event Queue

March 14-18

Managing the Audit Computer-based Bank Systems, Washington, DC. This course provides a comprehensive audit approach for evaluating and testing controls in computer-based bank systems. Information is available from Darlene Flooding, Bank Administration Institute, 60 Gould Center, Rolling Meadows, IL 60008, (312) 228-6200.

March 15-16

Technology Outlook, Wisconsin Center, Madison, WI. This seminar, conducted by the University of Wisconsin—Extension Engineering and Applied Science program, is designed for industrial executives seeking an understanding of telecommunications, automation, computer advances, and genetics. The fee is \$475. For information, contact the University of Wisconsin—Extension, Department of Engineering and Applied Science, 432 North Lake St., Madison, WI 53706, (608) 262-3748.

March 17

The Sixth Annual Delaware Computer Faire, Delaware

State College, Dover. Workshops, demonstrations, and sessions on the uses of computers in the classroom will be held. This program is tailored for kindergarten through senior high school teachers, administrators, and parents. Hardware and software will be exhibited. Contact Dr. William J. Geppert, Department of Public Instruction, Townsend Building, POB 1402, Dover, DE 19903, (302) 736-4885.

March 18-22

Saudicomputer '84—The Business Computer Show, al-Dhiafia Exhibition Centre, Riyadh, Saudi Arabia. For information, contact Philip Jenkinson, Saudicomputer '84, Overseas Exhibition Services Ltd., 11 Manchester Square, London W1M 5AB, UK; tel: 01-486 1951; Telex: 24591 Montex G.

March 19-21

The First Annual Computer Furniture and Home Office Show, Serra Grand Ballroom, Convention Center, Monterey, CA. Approximately 100 exhibits are planned. Seminars designed to introduce manufacturers and retailers to marketing and mer-

chandising techniques will be conducted. For further details, contact National Fairs Inc., 1902 Van Ness Ave., San Francisco, CA 94109, (415) 474-2300.

March 19-21

Material Characterization Techniques for Integrated-Circuit Processing, San Mateo, CA. This three-day course is designed to acquaint participants with current techniques for integrated-circuit development, process monitoring, and failure analysis. The course fee is \$450 for lectures only or \$695 for the third-day lab session. For information, contact Continuing Education in Engineering, University of California Extension, 2223 Fulton St., Berkeley, CA 94720, (415) 642-4151.

March 19-22

Automated Manufacturing Conference and Exhibition (AM84), Textile Hall, Greenville, SC. Representatives from more than 200 firms will present the latest automated manufacturing technologies at this combination exhibition and seminar. Conference details can be obtained from the AM84 Regis-

tration Control Center, POB 5616, Station B, Greenville, SC 29606, (803) 242-3170, ext. 260. Exhibition details are available from AM84, POB 5823, Greenville, SC 29606, (803) 233-2562.

March 19-22

The Eighth Annual Federal Office Systems Expo (FOSE '84), Convention Center, Washington, DC. The theme for this year's expo is "Realities of Integration: Technologies, Applications, Human Resources." More than 60 conference sessions and 1200 exhibits are planned. Address inquiries to Jacqueline Voigt, National Trade Productions, 9418 Annapolis Rd., Lanham, MD 20706, (800) 638-8510; in Maryland, (301) 459-8383.

March 22-23

Computers in Construction, New York, NY. This seminar is designed to assist construction contractors and construction management firms in acquiring computer systems. The fee is \$425 per registrant. More details are available from CIP Information Services Inc., 1105-F Spring St., Silver Spring, MD 20910, (301) 589-7933.

a message to our subscribers

From time to time we make the BYTE subscriber list available to other companies who wish to send our subscribers material about their products. We take great care to screen these companies, choosing only those who are reputable, and whose products, services, or information we feel would be of interest to you. Direct mail is an efficient medium for presenting the latest personal computer goods and services to our subscribers.

Many BYTE subscribers appreciate this controlled use of our mailing list, and look forward to finding information of interest to them in the mail. Used are our subscribers' names and addresses only (no other information we may have is ever given).

While we believe the distribution of this information is of benefit to our subscribers, we firmly respect the wishes of any subscriber who does not want to receive such promotional literature. Should you wish to restrict the use of your name, simply send your request to the following address.

BYTE Publications Inc
Attn: Circulation Department
70 Main St
Peterborough NH
03458

COMPU SHACK

PRICES AND AVAILABILITY SUBJECT TO CHANGE WITHOUT NOTICE
ALL RETURNED MERCHANDISE SUBJECT TO A 20% RESTOCKING FEE.

ADD 10% FOR NET TERMS

PRICES GOOD IN U.S. ONLY.

PRICES REFLECTED IN THIS SECTION ARE LOWER THAN FRANCHISE STORES.

WE TEST EVERY COMPUTER SYSTEM BEFORE WE SHIP IT!



IBM
PERSONAL
COMPUTER

Special
of the
Month!

IBM PC

64K, Two 320KB Disk Drives, Floppy Disk Controller, Video Card and High Res Monitor. **\$2599.00**

HARD DISK SYSTEM FOR IBM PC

256K IBM PC[®] 360KB Disk Drive, FDC, 10MB Hard Disk W/Controller, Cabinet Controller & Software, Video Card and Monitor **\$3999.00**

Hard Disk Sub-System for IBM PC By TAVA CORP **\$1275.00**

LOTUS 1-2-3 SOFTWARE **\$399**



FLOPPY DISK DRIVES For IBM PC

ADD-ON DRIVE FOR PC Jr.[®] .. CALL

TANDON

TM-100-2 DS/DD CALL

SLIMLINE 320KB **\$229.00**

PRINTERS

OKIDATA

82A **\$429.00**
83A **\$669.00**
84AP parallel **\$999.00**
84AS serial **\$1099.00**
92A **\$525.00**
93A **\$899.00**

Daisywriter Daisywheel

Printer **\$1175.00**

NEC SPINWRITER

NEC



7710-1 **\$2095** 3510 **\$1495**
7715-1 **\$2295** 3515 **\$1495**
7730-1 **\$2095** 3530 **\$1695**
7720-1 **\$2695** 3550 **\$1995**
7725-1 **\$2695** PC8023A **\$ 595**

COMPANY SHOWROOM
WALNUT CREEK, CA
(415) 945-8011

SPECIAL OF THE MONTH!



Desk Top IBM PC[®] Compatible Computer, 128K RAM, Two 320KB Disk Drives, Floppy Disk Controller, Video Adapter and Monitor, One Parallel Port, Two Serial Ports. System runs DOS 1.1, 2.0, and CP/M86[®]

\$1995

Suggested List **\$2395.00**

Low Price High Quality TAVA Personal Computer Uses The Industry Standard Operating Systems: CP/M86[®] MS DOS[®] UCSD p-system[®] One year warranty on all parts. Runs most of the Software for IBM PC, eg. Lotus 1-2-3[®] dBaseII[®] Words Star[®] Multiplan[®] PFS[®] and Thousands more



SHARP PORTABLE

A Portable IBM PC Compatible Light Weight Computer With 128K CPU, Liquid Crystal Display 8 linesx80, Keyboard, 128K Bubble **\$1995.00**
Normal Printer **\$2395.00**

INTRODUCING APPRICOT

A handsome Computer and almost totally compatible with IBM PC. Includes 256K Memory, Two Disk Drives and Monitor. A Complete System with **\$1250** worth of Software **\$2999.00**

AST RESEARCH

IO Plus-Parallel & Serial Port, Clock Calendar W/Bat. back-up, Superdrive, Superspool **\$199.00**

Superspool

Mega Plus—512K, Parallel & Serial Port, Clock Calendar W/Bat. back-up **\$999.00**

QUADRAM

Quad Board - 256K, Parallel Port, Serial I/O Clock Calendar with battery backup **\$450.00**
512K Ram with Serial I/O **\$799.00**

CONOGRAPHIC

Color Card **\$995.00**

HERCULES GRAPHICS CARD

This card gives you 720x350 graphics **\$499.00**
BIG BLUE **\$479.00**

MAYNARD SANDSTAR SERIES

Multifunction Card **\$95.00**
Floppy Disk Controller **\$225.00**
Memory Card **\$189.00**

HAYES MICROCOMPUTER PRODUCTS

Micromodem 300 baud **\$299.95**
Smartmodem 1200 baud **\$529.95**

MONITORS

AMDEK

300A **\$199.00** I **\$349.00**
300G **\$169.00** II **\$699.00**
310A **\$199.00** III **\$399.00**
IV **\$1199.00**

PRINCETON GRAPHICS SYSTEMS

High Res. Color **\$499**

APPLE IIe



Computer System Controller, Two Disk Drives, Monitor **\$1699**

ROMAR II Apple compatible Computer W/Z-Card Controller, Two Disk Drives and a Monitor for **\$1195.00**

BROTHER, TAVA, NEC, TANDON, SHUGART, AND OTHER MFRGR. PRODUCTS AVAILABLE!!

COMPU SHACK

HIGH TECHNOLOGY • LOW PRICES

Circle 81 on inquiry card.

CALL FOR STORE LOCATION

THE UNIQUE FRANCHISING CONCEPT WITH THE FOLLOWING FEATURES:

PRIVATE LABEL PRODUCTS WITH NO ROYALTIES, DISCOUNT PRICES, FULL SERVICE & SUPPORT, COURTESY AND MORE.

COMPANY SHOWROOM
TUSTIN, CA
(714) 730-7227

(714) 261-1000

FRANCHISE INQUIRIES WELCOME

14861 ARMSTRONG, IRVINE, CA 92714

HEADQUARTERS/TELEX: 181667—ANSWER BACK: COMPU SHACK IRIN

*IBM PC is a registered trademark of IBM Corp.
*dBASE II is a registered trademark of Ashton-Tate, Inc.
*LOTUS 1-2-3 is a registered trademark of Lotus Development
*Wordsstar, Spoolstar, Mailmerge are registered trademarks of Micropro International

Multiplan is a registered trademark of Microsoft Corp.
PFS is a registered trademark of Software Publishing Co.
CP/M86 is a registered trademark of Digital Research, Inc.
MS-DOS is a registered trademark of Microsoft Corp.
UCSDp is a registered trademark of Softech Microsystems

PR AT IOT AVAILABLE

ALL FLOPPIES REPAIRED QUICKLY AT LOW COST

March 22-25

The Ninth West Coast Computer Faire, Civic Auditorium and Brooks Hall, San Francisco, CA. This is one of the largest annual computer shows. For information, contact the Computer Faire Inc., Suite 201, 181 Wells Ave., Newton, MA 02159, (617) 965-8350; in California, (415) 364-4294.

March 23

The 1984 Computer Law Institute, Cleveland, OH. This event, sponsored by the Bar Association of Greater Cleveland, will cover current legal and tax issues that affect the computer industry. For details, contact Carole Falcone, Mall Building, Cleveland, OH 44114, (216) 696-3525.

March 24

The Seventh Annual Philadelphia Area Computer Society Computer Games Festival, La Salle College Ballroom, Philadelphia, PA. Recreational and educational games will be featured. For more information, contact Dr. Stephen A. Longo, Physics Department, Box 312, La Salle College, Philadelphia, PA 19141, (215) 951-1255.

March 25

The Fifth Annual Lake County Hamfest and Computer Fest, Madison High School, Madison, OH. Admission is \$3 in advance. For information, send a self-addressed, stamped envelope to Lake County Hamfest Committee, POB 150, Mentor, OH 44061, (216) 953-9784.

March 26-28

The Seventh International Conference on Software Engineering, Orlando, FL. This conference seeks to evaluate what has been learned from the past and to provide directions for future investigations into software engineering. Its theme is "Fifteen Years of Software Engineering: Re-

sults and Futures." A software tools fair will be held concurrently. Contact the IEEE Computer Society, POB 639, Silver Spring, MD 20901, (301) 589-3386.

March 26-29

The 1984 National Design Engineering Show & ASME Conference, McCormick Place, Chicago, IL. More than 600 companies will display and demonstrate products and services in this conference program sponsored by ASME (American Society of Mechanical Engineers). Almost 50 technical sessions and 20 short courses will cover engineering management and operations, CAD/CAM and CAE, materials and processes, mechanical and fluid systems, and electronics. Information is available from the National Design Engineering Show & Conference, 708 Third Ave., New York, NY 10017, (212) 661-8410.

March 26-29

Personal Computer Interfacing and Scientific Instrument Automation, Blacksburg, VA. These hands-on workshops, sponsored by the Virginia Polytechnic Institute and State University, provide participants with experience in wiring and testing interfaces on popular personal computers. For information, contact Dr. Linda Leffel, C.E.C., Virginia Tech, Blacksburg, VA 24061, (703) 961-4848.

March 26-30

The Sixth NC Industrial Automation and Robot Conference and Exhibition, Milan Fair, Milan, Italy. Controls for automated material handling, variable mission manufacturing systems, and quality control will be featured. A concurrent conference consisting of 20 sessions will be presented. For more information, contact the So-

ciety of Manufacturing Engineers, One SME Dr., POB 930, Dearborn, MI 48121, (313) 271-0023.

March 27-28

The Eighth Annual Computer Faire, University of Dayton Arena, Dayton, OH. Terminals, minicomputers, microcomputers, and word processors will be featured. Details can be obtained from Dan Schumacher, University of Dayton, 300 College Park Ave., Dayton, OH 45469, (513) 229-3511.

March 27-28

Meetings of the American National Standards Institute, Marriott Crystal Gateway Hotel, Arlington, VA. Two meetings are planned: the Annual Public Conference of the ANSI and the Seminar on Administering Domestic Standards Activities. The theme for the former is "Standards and the Law." The latter will focus on due process and such issues involved in standardization as the interpretation of standards and coordination of domestic and international activity. Contact Deborah R. Maskin, Communications Department, American National Standards Institute Inc., 1430 Broadway, New York, NY 10018, (212) 354-3315.

March 27-29

Southwest Computer Conference (SWCC), Myriad Convention Center, Oklahoma City, OK. This seventh annual business and industry conference is aimed at both management and technical personnel. It will feature more than 50 seminar presentations and 250 exhibits. For details, contact E. Z. Million, SWCC, POB 950, Norman, OK 73070, (405) 329-3660.

March 28-30

The Sixth Annual Computer Graphics Conference, Doral Hotel On-the-Ocean, Miami Beach, FL. The theme for this conference is "Forecast and Assessments." Further details are available from Carol Saphchin, Frost & Sullivan Inc., 106 Fulton St., New York, NY 10038, (212) 233-1080.

March 30-31

Third Annual Conference on Communication Technology, Joseph Stokes Auditorium, Children's Hospital of Philadelphia, PA. This program presents advances in technology and treatment alternatives for physically disabled and speech-impaired persons. Speakers, equipment demonstrations, and workshops are planned. The two-day registration fee is \$95, which includes all course materials. Group rates are offered. For full particulars, contact Joan Bruno, Children's Seashore House, 4100 Atlantic Ave., POB 4111, Atlantic City, NJ 08404, (609) 345-5191, ext. 278.

March 30-April 1

The NY Personal Computer Show, Exposition Rotunda, Madison Square Garden, New York City. Formerly called the Eighty/Apple/PC Computer Show, this event will feature products and services for all small computer systems. Complete show details can be obtained from the Kengore Corp., POB 13, Franklin Park, NJ 08823, (201) 297-2526.

April 1984

April 1-4

The 1984 EFT Expo, Hyatt Regency, Grand Cypress Resort, Orlando, FL. This annual convention and exposition, sponsored by the Electronic Funds Transfer (EFT) Association, provides the op-

It's True — We Did It!

WE STILL MEET OR BEAT MOST ADVERTISED PRICES.

Looking for a printer? The OKIDATA 82A for \$300 will put an end to that!



OUR PC FLYS

IBM Compatible
Simply a better PC. All models
available for immediate delivery
Call Lowest \$



Mannesmann Tally

- Standard — 7 x 9 160 CPS
 - NLO — 40 x 18 40 CPS
 - 2K Buffer and Tractor Standard
- 160 L 80 col. Call Best Seller
180 L 132 col. Call Best Seller
SPIRIT Call Best Seller



IDS

- Proportional Spacing
 - 8 Character Styles
 - 200 CPS Bi Directional
 - Color Optional
 - Sheet Feed • Graphics
 - 3.4K Buffer
- Prism 80
Prism 132 and Micro Prism \$ Call

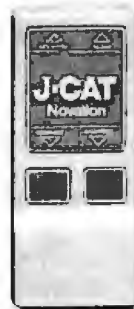

Red Hat
Special!

Novation
J-CAT

- 300 BPS Modem
 - Originate/Auto Answer
- Sizzling \$Call

NEW!

COLUMBIA

DATA PRODUCTS, INC.

Pick Up Columbia's
Portable VP Computer

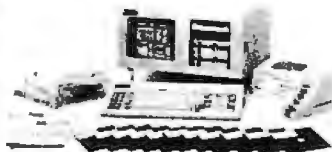

And Get A Real Handle
On IBM-PC Compatibility

Introducing . . .



the '380 terminal that emulates with DEC . . .
Freedom 1001

And — the **Signalman Mark XII** (1200 Band) Modem
for just \$285!

Or — Buy them as a package for ONLY \$634!



ALTOS
ZENITH
TELEVIDEO
SANYO
USI

FRANKLIN
HAYES
NOVATION
EAGLE
PRINTEK

VENTEL
AMDEK
MICOM
DATASOUTH
GTC

TAXAN
DIABLO
NEC
EPSON
TRANSTAR

OKIDATA
OSBORNE
COMREX
DAISYWRITER
JUKI

STAR
ADDS
DEC
C. ITOH
SILVER-REED

For Price Quotes and Ordering Call:

1-800-328-8905

For Technical Information and
Arizona Orders, Call:
602-949-8218

For Shipping and Order Status Information,
Call: 602-990-7556



LIBERTY GROUP, Inc.

4221 Winfield Scott Plaza • Scottsdale, Az 85251

Everything In
computer related
products:

- Computers
- Modems
- Printers
- Software
- Monitors
- Terminals
- Ribbons
- Office Furniture

Prices listed reflect a cash discount and are subject to change without notice. We welcome Certified and Cashiers Checks, Bank Wires and Money Orders. C.O.D.s are shipped with a minimum C.O.D. charge. Allow 3-7 days for personal checks to clear. Product is subject to availability. Equipment is in factory sealed boxes with manufacturer's warranty. There will be a restocking charge for returned merchandise. Call first for an RMA number. Software not warranted for suitability. No return of software which has been opened. Add 2% for shipping & handling charges (minimum \$2.50). All equipment shipped F.O.B. Scottsdale, Az 85251.

Circle 208 on inquiry card.

Event Queue

portunity to meet with leaders and experts in the field of automated payments systems and services. The fee is \$495 for EFT members and \$625 for nonmembers. For details, contact the Convention Coordinator, EFT Association, Suite 800, 1029 Vermont Ave. NW, Washington, DC 20005.

April 2-4

Speech Tech-84, St. Moritz Hotel, New York City. This voice-synthesis and recognition applications show covers voice input/output as applied to computers, telecommunications, robotics, education, and aids for the handicapped. The registration fee is \$150. For information, contact Stanley Goldstein, Media Dimensions Inc., 525 East 82nd St., New York, NY 10028, (212) 680-6451.

April 2-5

The 1984 Test & Measurement World Expo, Brooks Hall, San Francisco, CA. This is the third annual expo sponsored by *Test and Measurement World*, a magazine from Interfield Publishing. For details, contact Meg Bowen, Test & Measurement World Expo, 215 Brighton Ave., Boston, MA 02134, (617) 254-1445.

April 2-6

The Third Conference on Computing in Civil Engineering, Holiday Inn at the Embarcadero, San Diego, CA. Seminars, tutorials, and vendor displays will focus on computers in education, special applications, and future directions. Emphasis will be on computer-aided design and drafting. Complete conference particulars are available from the Society for

Computer Applications in Engineering, Planning, and Architecture Inc., 358 Hungerford Dr., Rockville, MD 20850, (301) 762-6070.

April 3-5

Cincinnati Business Show, Convention-Exposition Center, Cincinnati, OH. Exhibits include automated office equipment, computers, communications, telephone systems and equipment, word processors, business systems and forms, and software and computer peripherals. For information, contact Weber and Associates Inc., 10608 Millington Court, Cincinnati, OH 45242, (513) 791-6303.

April 3-6

DEXPO East 84, Bayside Exposition Center, Boston, MA. This conference, dedicated to professionals who use Digital Equipment Corporation

(DEC) equipment, is sponsored by the national independent DEC user group of Warwick, Rhode Island. Topics to be covered are office automation, personal computers, communications, security and disaster planning, education, graphics, technology trends, and other areas of interest. For information, contact Expoconsul International Inc., 55 Princeton-Hightstown Rd., Princeton Junction, NJ 08550, (609) 799-1661.

April 4-6

Introduction to Computers and Their Applications, Pinehurst Hotel and Country Club, Chapel Hill, NC. This educational workshop is designed for professionals and executives. For a brochure, contact Learning at Pinehurst, POB 2328, Chapel Hill, NC 27514, (919) 967-6996.

COMPETITIVE EDGE

P.O. BOX 556 Order Line 800-336-1410
PLYMOUTH, MI 48170 Info & Local 313-451-0665
Authorized Sales Center For
Compupro®, Lomas, Teletek, Seattle

Systems with constant voltage on drives & circuit boards choice of Compupro enclosure 2 & Para Dyn. drive cabinet or Pronto Roll-a-Round all in one 20 slot mainframe.

COMPUPRO® 85/88, Disk I, I/O-4, RAM 16, (2) 8" DSDD, CP/M\$3395.
COMPUPRO® 8086, Disk I, I/O-4, RAM 21 128K, 2-8" DSDD, CP/M3995.
COMPUPRO® 68K, Disk I, I/O-4, RAM 21 128K, 2-8" DSDD, CP/M3995.
TELETEK SYSTEMMASTER®, Z80A, 64K, (2) 8" DSDD Floppys, CP/M2995.
LOMAS LIGHTING286™ CPU, 128K RAM 67, LDP72, HAZ, 2-8" CP/M4695.
85/88, 86, 286 & Z80 Available in Multiuser & Hard Disks

NEW MINI-MICRO SERIES SINGLE BOARD Z80 OR 80186

TELETEKSYSTEMMASTER, 2-5" 48TPI Floppys, Cabinet, CPM1795.
TT SYSTEMMASTER, HD/CTC, 1-5" Floppy, 10MB Hard Disk, Cab2995.
LOMAS 80186, 256K, Concurrent CP/M 2-5" Floppys, Cab2235.
LOMAS 80186, 256K, CCP/M, 1-5" Floppy, 10MB Hard Disk3435.

Prices and specifications subject to change without notice

LOWEST PRICES ON COMPONENTS FROM COMPUPRO, LOMAS, TELETEK, SEATTLE

COMPUPRO Disk I	\$327	RAM22 A&T	\$1155	INTERFACER 4 A&T	297
CPU 68K A&T	459	RAM 21 A&T	723	INTERFACER 3 A&T	461
CPU 85/88 A&T	327	RAM 16 A&T	363	CPU 8086 A&T	495
Disk 3 A&T	525	RAM 17 A&T	329	CPU Z A&T	215
LOMAS 286	1116	RAM 67 128K	725	RAM 67 & BAT BU	800
LOMAS LDP72	220	LDP72/CPM86	399	HAZITALL	275
LOMAS 256K DRAM	636	128K DRAM	396	LIGHTNING I 86	420
TELETEK HD/CTC	499	SYSTEMMASTER	627	10 MB 1/2 HEIGHT	795
TELETEK SBC 1	577	SBC 2	CALL	TELETEK MDRIVE	795

TERMINALS, PRINTERS

QUME QT102 Green	\$539	QT102 Amber	549	TELEVIDEO 925	699
TELEVIDEO 950	899	F1040 CPS	1075	F10 Sheet Feed	495
dBASE II	425	SUPERCALC 2	199	DRI C for 86	225
PASCAL MT + 86	375	CB80	325	DRI CB86	375

COMPUPRO is a Godbout Company, CP/M, is a Registered Trademark of Digital Research, Supercalc is a TM of Sorcim

De Smet C

PCDOS - CP/M-86 - MPM-86 - CCP/M-86

\$ 109

- **OUTSTANDING PRICE/PERFORMANCE**
"SIEVE" Benchmark
135 bytes compiled - 6144 bytes linked
65 sec. compile (disk) - 11.5 sec. run (10 iterations)
- **FULL DEVELOPMENT PACKAGE**
C Compiler, Assembler, Linker, Librarian and Full Screen Editor • Native 2.0 Support
- **COMPLETE IMPLEMENTATION**
FULL K & R - plus - STUDIO LIBRARY
Both 8087 and Software Floating Point

To order specify OS & DISK SIZE/FORMAT.
Calif. residents add 6% sales tax.

C WARE

PO Box 710097

San Jose, CA 95171-0097

(408) 736-6905

PCDOS Trademark IBM - CP/M Trademark Digital Research

Your troubles are over!

THERE'S A NEW STAR IN WORD PROCESSING

ANYONE FAMILIAR WITH WordStar® CAN USE NewWord™/MergePrint IMMEDIATELY, AND ENJOY SUPERIOR PERFORMANCE AND EASIER INTERACTION—AT ABOUT ONE-THIRD THE COST OF WordStar®/MailMerge®

NewWord makes it easy for you to turn to uncomplicated, efficient word processing. Now you can get letter perfect, professional-looking documents without a great deal of sacrifice.

The proof of NewWord's superior performance is in the printout. With dot matrix printers, NewWord is exceptional, supporting every advanced capability including microjustification, variable line height/character width, and alternate pitches on the same line.

NewWord's full range of features are what you'd expect to find only on the most expensive word processors. NewWord also gives you such advanced features as unerase deleted text, find a specific page in a document, and multiple-line headers and footers. Its versatility includes automatically changing ruler lines, on-screen display of boldfacing and underlining, and automatic indentation for programming.

Yet, for all its sophistication, NewWord is simple to use. There are no complicated codes to memorize. On-screen menus of functions let you work effortlessly.

And if you're familiar with WordStar, you'll be able to write faster and more effectively immediately. NewWord is entirely compatible with WordStar—key stroke, command and file compatible. Even third party programs, video training and books.

NewWord comes with a complete user manual, including: an *Installation* guide to personalize NewWord, a *Do-It-Yourself* tutorial, an *Encyclopedia* of facts explained with numerous examples, and a handy *Pocket Reference* of commands.

We provide direct telephone support to NewWord users and dealers. A third party toll-free support service is also available as an option.

Perhaps the best thing about NewWord is that at **\$249.00**, NewWord costs less than programs featuring far fewer capabilities. And with *merge print* included, NewWord is an outstanding value.

Let a New Star work for you.

Call us today, toll-free

800-832-2244

(In California, call 800-732-2311)



**ROCKY MOUNTAIN
SOFTWARE SYSTEMS**

1280-C NEWELL AVE., SUITE 1001; WALNUT CREEK, CA 94596

WordStar and MailMerge are registered trademarks of MicroPro International, Inc.
NewWord and Newstar are trademarks of Newstar Software, Inc.

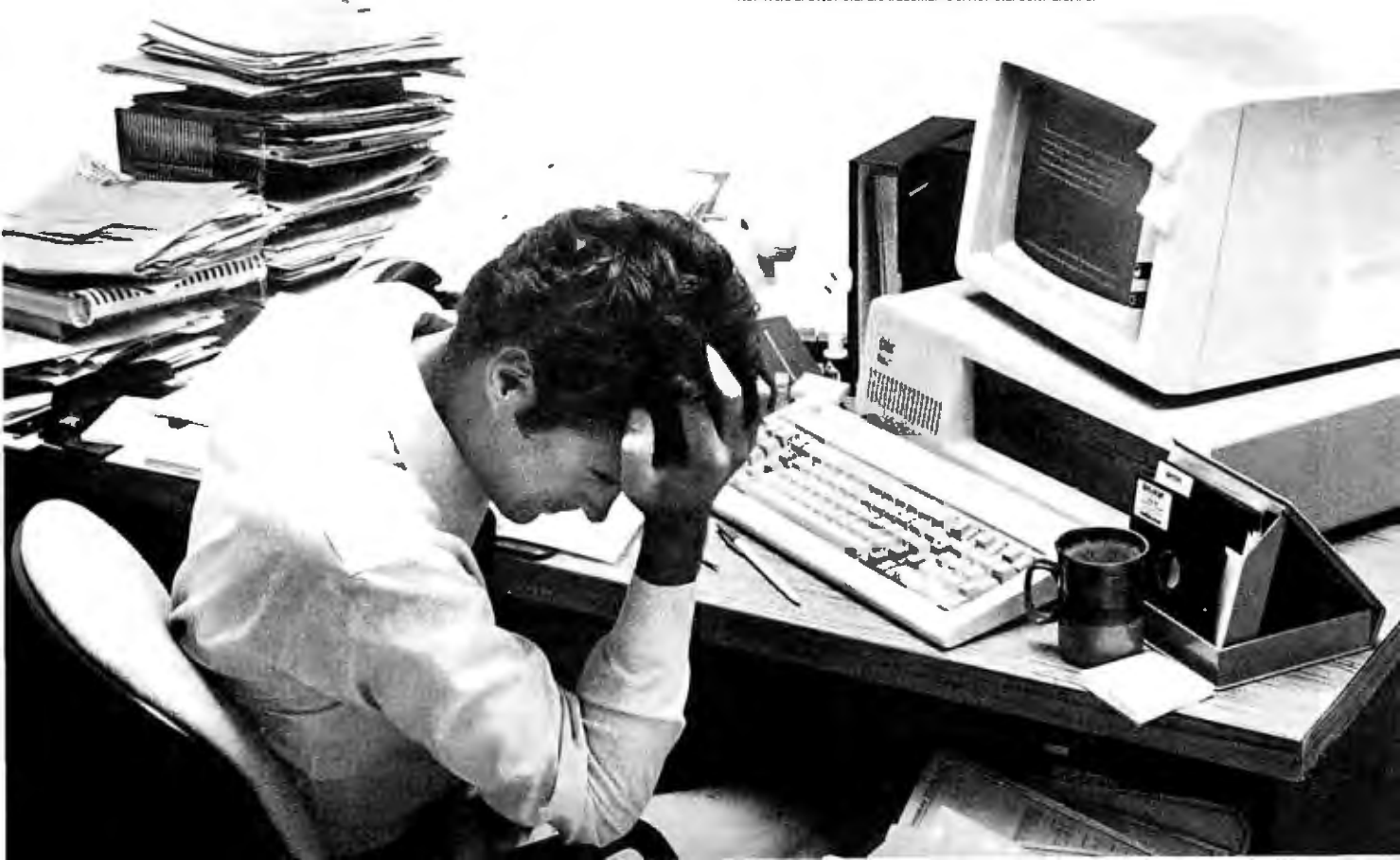



2 chips ... are better than one

Is your Apple's 6502 processor chip a little overworked lately? Have you been eyeing one of those new, 16-bit systems? But you don't want to give up all your Apple programs ...

Add the powerful 16-bit 8088 processor to your Apple with ALF's Processor Card. Let the 6502 and 8088 work together to tackle your toughest problems—like speeding up your Applesoft and Apple Pascal programs. With the Processor Card, you can use the CP/M™ 86 or MS-DOS™ operating system to run the latest 16-bit software, including many IBM PC programs.

64K or 128K of high-speed memory is available for ALF's Processor Card. Use the Processor Card with 128K as a fast disk emulator or to view sixteen hi-res images in under a second. Or run Basic, C, COBOL, or Pascal with 16-bit performance!

The ALF Processor Card is just \$395 (Applesoft speed-up software included). See your Apple dealer today, or contact ALF for more information.

Trademarks: "Apple": Apple Computer, "CP/M": Digital Research, "MS-DOS": Microsoft.

ALF

ALF Products Inc.
1315F Nelson St. Denver, CO 80215
(303) 234-0871 Telex: 4991824

Event Queue

April 4-11

CeBIT, Hannover, West Germany. This office-equipment and data-processing technology exhibition will bring together exhibitors from more than 25 countries. For information, contact Hannover Fairs Information Center, POB 338, Route 22 E, Whitehouse, NJ 08888, (800) 526-5978; in New Jersey, (201) 534-9044.

April 5-7

COMDEX/Winter, Convention Center, Los Angeles, CA. For information, contact the Interface Group Inc., 300 First Ave., Needham, MA 02194, (800) 325-3330; in Massachusetts, (617) 449-6600.

April 7-8

Eastern States Conference, Franklin Plaza Hotel, Philadelphia, PA. Speakers, demonstrations, and workshops focusing on "Computers and Reading/Learning Difficulties" are planned. For additional information, contact Educational Computer Conferences, Department N, 1070 Crows Nest Way, Richmond, CA 94803, (415) 222-1249.

April 8-11

World Retailers Business & Equipment Exposition, Palais des Congres, Paris, France. This exposition is sponsored by the National Retail Merchants Association (NRMA) and runs concurrently with NRMA's Ninth World Conference of Retailers. The exposition is designed to introduce store merchants to new developments, equipment, and procedures. Admission is free, although retail store merchants must show ticket. For complimentary tickets and details, write to Dan Soskin, NRMA Enterprises, 100 West 31st St., New York, NY 10001.

April 9-12

Intergraphics '84, Sasakawa Memorial Hall, Tokyo, Japan.

This conference and exposition is cosponsored by the Society of Manufacturing Engineers (SME) and the World Computer Graphics Association (WCGA). It will focus on the growing importance of computer graphics in business and manufacturing industries. For information, contact James McLaughlin, Society of Manufacturing Engineers, One SME Dr., POB 930, Dearborn, MI 48121, (313) 271-0023.

April 10-11

Business Expo & Conference '84, Convention Center, San Jose, CA. More than 30 workshops, seminars, and panel discussions have been scheduled. A few of the presentations are "Handling Training Crisis in Office Automation Explosion," "How to Select Small Business Computers," and "Managing Your Small Business." Complete details are available from Expo '84 Management, Cartledge & Associates Inc., Suite 205, 4030 Moorpark Ave., San Jose, CA 95117, (408) 554-6644.

April 12-14

Computers and Writing—Research and Applications, University of Minnesota, Minneapolis. Papers and panel discussions will focus on local-area networks, empirical studies of writer's behavior, and automatic evaluation or correction of writing. Demonstrations of hardware and software are planned. For further information, contact the Program in Composition and Communication, University of Minnesota, 209 Lind Hall, 207 Church St. SE, Minneapolis, MN 55455, (612) 373-2541.

April 13-14

The Fourteenth Annual Virginia Computer User's Conference, Sheraton Hotel, Blacksburg, VA. This con-

MicroAge[®]

**"BECAUSE WE COULDN'T
AFFORD MISTAKES!"**

"They guided us over the rough parts when we needed it"

"During September of 1982, we started our MicroAge Computer Store in Tulsa, Oklahoma with 3 people. Today we have 21 people working for us and two stores. By following MicroAge's advice and marketing strategy when we started in business, we were able to reach Tulsa's business computer buyers in a much shorter time than we could have on our own."

"Both of us had technical backgrounds in computers but lacked the marketing experience necessary to reach our goals. We used MicroAge's experience and leadership to guide us through the rough spots and boost our sales and marketing potential."

"MicroAge . . . they helped us build a sales organization to reach the Oklahoma businessman."

John E. Mosier

John Mosier
MicroAge Franchisee

George B. McLawhon

George McLawhon
MicroAge Franchisee

To build your own professional computer sales organization with MicroAge write to:

MicroAge[®]
COMPUTER STORES

"The Solution Store"[®]

1457 West Alameda • Tempe, Arizona 85282

(602) 968-3168



"There's no magic to using your personal computer for data acquisition."

Fred Molinari, President

There's no trick to it. Just take your choice of our new single board plug-ins and bring complete analog and digital I/O capabilities to your personal computer.

Whether you're working in laboratory research or industrial process control, our single boards can give you measurement and control capabilities without having to spend big bucks.

And who knows that better than the leading supplier of low cost data acquisition boards, systems, and software?

Our boards include A/D with programmable gain, D/A, digital I/O, clock and direct memory access capabilities. With power and performance to match your PC, our analog interfaces provide 12 or 16-bit A/D resolution and direct connection for high or low level signal inputs.

And these boards just plug into the PC's backplane. No messy external boxes or cables. User input connections are simple with our compatible line of screw terminal panels.

DATA ACQUISITION FOR PC'S					
	12-BIT A/D	12-BIT D/A	DIGITAL I/O	PROG CLOCK	SOFTWARE LIBRARY
IBM PC™	X	X	X	X	X
APPLE II™	X			X	
TI PROFESSIONAL™	X	X	X	X	X
DEC RAINBOW™	X	X	X	X	X
COMPAQ™ Portable	X	X	X	X	X



Data Translation is the leading supplier of personal computer hardware and software for data acquisition and control.

DATA TRANSLATION

World Headquarters: Data Translation Inc., 100 Locke Dr., Marlboro, MA 01752 (617) 481-3700 Tlx 951-646.
 European Headquarters: Data Translation, Ltd., 430 Bath Rd., Slough, Berkshire SL1 6BB England (06286) 341271x 849-852.
 In Canada: (416) 625-1907.
 IBM PC is a registered trademark of IBM. Apple II is a registered trademark of Apple Computer Corp. TI Professional is a registered trademark of Texas Instruments, Inc. DEC Rainbow is a registered trademark of Digital Equipment Corp. COMPAQ is a registered trademark of COMPAQ Computer Corp.



Event Queue

ference is sponsored by the Virginia Tech Student Chapter of the ACM (Association for Computing Machinery) and the computer science department of Virginia Tech. Topics include modeling and simulation, STARS and Japanese fifth-generation computers, and microcomputers. For information, contact Suzanne Nagy or Roger Goff, VCUC-14, 562 McBryde Hall, Virginia Tech, Blacksburg, VA 24061.

April 13-15

The International Personal Robotics Congress and Exposition, Convention Center, Albuquerque, NM. International corporations and high-technology executives can view the latest in robots designed to serve personal needs. For details, contact Albuquerque Convention and Visitors Bureau Inc., POB 26866, Albuquerque, NM 87125-6866, (505) 243-3696.

April 13-15

Interstellar Personal Computer Show, Interstate Fairgrounds, Spokane, WA. For details, contact Heymac Promotions, East 3607 33rd, Spokane, WA 99203, (509) 534-3661 (mornings) or (509) 327-4842 (afternoons).

April 13-15

Microcomputers and Basic Skills in College, Instructional Resource Center, City University of New York, NY. Papers will explore the use of microcomputers in post-secondary school basic-skills instruction, including English as a second language, reading, writing, and speech. Address inquiries to Geoffrey Akst, Conference Chair, Instructional Resource Center, City University of New York, 535 East 80th St., New York, NY 10021, (212) 794-5425.

April 14

Third Semi-annual Meeting of the Massachusetts Asso-

ciation of Computer-using Educators, Simmons College, Boston, MA. This meeting will feature demonstrations on the uses of computers in the classroom. Contact Dr. Leonard Huber, Hampshire Educational Collaborative, Center School, 36 Hadley St., South Hadley, MA 01075, (413) 534-4563.

April 14-15

The Ninth Annual Trenton Computer Festival, Trenton State College, NJ. More than 100 commercial exhibitors will complement five acres of flea-market tables. Contact Marilyn Hughes, Trenton State College, Trenton, NJ 08625, (609) 771-2487.

April 16-18

Softside of Software, Loew's L'Enfant Plaza Hotel, Washington, DC. For details, see March 12-14.

April 16-18

Videotex '84, Chicago, IL. The focus of this international conference and exhibition is commercial applications and activities of videotex. For details, contact Sally Summers, London Online Inc., Suite 1190, 2 Penn Plaza, New York, NY 10121, (212) 279-8890.

April 17-19

IPAD II, Marriott Hotel, Denver, CO. This is the second national symposium to promote a wider awareness of the technology surrounding the Integrated Program for Aerospace-vehicle Design (IPAD). The focus will be on advances in distributed database management technology to support integrated CAD/CAM requirements. It is sponsored by the National Aeronautics and Space Administration, the Department of the Navy, and the Industry Technical Advisory Board for IPAD. Information is available from the IPAD Project Office, Mail Stop 246,

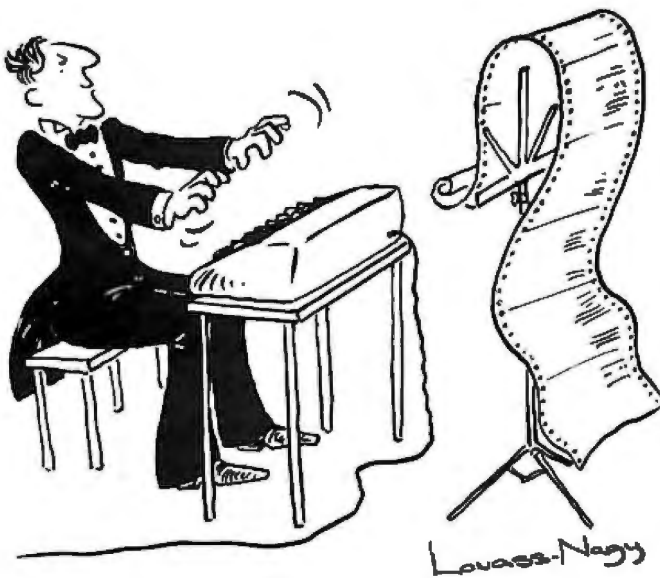

NEW PRODUCTS

Before Johann Sebastian Bach developed a new method of tuning, you had to change instruments practically every time you wanted to change keys. Very difficult.

Before Avocet introduced its family of cross-assemblers, developing micro-processor software was much the same. You needed a separate development system for practically every type of processor. Very difficult and very expensive.

But with Avocet's cross-assemblers, a single computer can develop software for virtually any microprocessor! Does that put us in a league with Bach? You decide.

The Well-Tempered Cross-Assembler

Development Tools That Work

Avocet cross-assemblers are fast, reliable and user-proven in over 3 years of actual use. Ask NASA, IBM, XEROX or the hundreds of other organizations that use them. Every time you see a new microprocessor-based product, there's a good chance it was developed with Avocet cross-assemblers.

Avocet cross-assemblers are easy to use. They run on any computer with CP/M* and process assembly language for the most popular microprocessor families.

5 1/4" disk formats available at no extra cost include Osborne, Xerox, H-P, IBM PC, Kaypro, North Star, Zenith, Televideo, Otrona, DEC.

Turn Your Computer Into A Complete Development System

Of course, there's more. Avocet has the tools you need from start to finish to enter, assemble and test your software and finally cast it in EPROM:

Text Editor VEDIT -- full-screen text editor by CompuView. Makes source code entry a snap. Full-screen text editing, plus TECO-like macro facility for repetitive tasks. Pre-configured for over 40 terminals and personal computers as well as in user-configurable form.

CP/M-80 version \$150
 CP/M-86 or MDOS version \$195
 (when ordered with any Avocet product)

EPROM Programmer -- Model 7128 EPROM Programmer by GTek programs most EPROMS without the need for personality modules. Self-contained power supply ... accepts ASCII commands and data from any computer through RS 232 serial interface. Cross-assembler hex object files can be down-loaded directly. Commands include verify and read, as well as partial programming.

PROM types supported: 2508, 2758, 2516, 2716, 2532, 2732, 2732A, 27C32, MCM8766, 2564, 2764, 27C64, 27128, 8748, 8741, 8749, 8742, 8751, 8755, plus Seeq and Xicor EEPROMS.

Avocet Cross-assembler	Target Microprocessor	CP/M-80 Version	•CP/M-86 IBM PC, MSDOS** Versions•
•XASMZ80	Z-80	\$200.00 each	\$250.00 each
•XASM85	8085		
XASM05	6805		
XASM09	6809		
XASM18	1802		
XASM48	8048/8041		
XASM51	8051		
XASM65	6502		
XASM68	6800/01		
XASMZ8	Z8		
XASMF8	F8/3870		
XASM400	COP400		\$300.00 each
XASM75	NEC 7500		
Coming soon: XASM68K...68000			\$500.00

(Upgrade kits will be available for new PROM types as they are introduced.)

Programmer \$389
 Options include:
 • Software Driver Package --
 • enhanced features, no installation required.
 • CP/M-80 Version \$ 75
 • IBM PC Version \$ 95
 RS 232 Cable \$ 30
 8748 family socket adaptor ... \$ 98
 8751 family socket adaptor ... \$174
 • 8755 family socket adaptor ... \$135

- **G7228 Programmer by GTek** -- baud to 2400 ... superfast, adaptive programming algorithms ... programs 2764 in one minute.
- Programmer \$499
- Ask us about Gang and PAL programmers.
- **HEXTRAN Universal HEX File Converter** -- Converts to and from Intel, Motorola, MOS Technology, Mostek, RCA, Fairchild, Tektronix, Texas Instruments and Binary formats.
- Converter, each version \$250

Call Us

If you're thinking about development systems, call us for some straight talk. If we don't have what you need, we'll help you find out who does. If you like, we'll even talk about Bach.

CALL TOLL FREE 1-800-448-8500
 (In the U.S. except Alaska and Hawaii)

ISA and Mastercard accepted. All popular disc formats now available -- please specify. Prices do not include shipping and handling -- call for exact quotes. OEM INQUIRIES INVITED.

*Trademark of Digital Research **Trademark of Microsoft



AVOCET SYSTEMS INC.

DEPT. 384-B
 804 SOUTH STATE STREET
 DOVER, DELAWARE 19901
 302-734-0151 TELEX 467210

Event Queue

NASA Langley Research Center, Hampton, VA 23665, (804) 865-2888.

April 18-19

Minnesota Office Systems Association Symposium and Exhibition, Hyatt Regency, Minneapolis, MN. Speakers, more than 100 exhibits, and 21 seminars will highlight this eleventh anniversary event focusing on "Evolving Technologies." Further information is available from the Minnesota Office Systems Association, POB 2144, Loop Station, Minneapolis, MN 55402-0144, (612) 293-1395.

April 18-20

The 1984 Rocky Mountain Data Processing Expo & Conference, Denver, CO. This is the seventh annual expo sponsored by the Mile High Chapter of the Data Processing Management Association. Displays will in-

clude mini- and microcomputers, word processors, software, educational services, and network systems. It is being held in conjunction with the DPMA's Region 4 conference. For information, contact Industrial Presentations West Inc., Suite 304, 3090 South Jamaica Court, Aurora, CO 80014, (303) 696-6100.

April 23-27

Auditing in the Contemporary Computer Environment, Philadelphia, PA. For details, see March 12-16.

April 24-25

Workspace 84, Moscone Center, San Francisco, CA. This second annual conference and exposition, sponsored by National Fairs Inc., will be devoted to the concerns of the automated office. For details, contact Charley Yourd, National Fairs Inc.,

1902 Van Ness Ave., San Francisco, CA 94109.

April 26-28

Science Park '84, New Haven, CT. This microcomputer conference and exposition is designed for small-business executives. For details, contact Science Park '84, Five Science Park, New Haven, CT 06511, (203) 436-3089.

May 1984

May-July

Courses from Integrated Computer Systems, various sites throughout the U.S. Among the courses to be presented are "Designing with 16-bit Micros," "Programming in C: A Hands-on Workshop," and "Hands-on Unix Workshop." The fee for each course is \$895. Enrollment details are available from Ruth Dordick, Integrated Computer Systems, 6305 Arizona Place, POB 45405, Los Angeles, CA 90045, (213) 417-8888.

May 1-3

Electronic Production Efficiency Exposition, National Exhibition Centre, Birmingham, England. This exhibition brings together various organizations involved in producing hardware and software for automated factories. Technical sessions will cover such issues as computer-aided design and manufacturing, integration, test diagnosis and repair systems, and electronic-manufacturing assembly techniques. Contact Network Events Ltd., Printers Mews, Market Hill, Buckingham, MK18 1JX, England; tel: (0280) 815226; Telex: 83111.

May 4-6

The Serious Computer Show, Currigan Hall, Denver, CO. Conference topics include

"Reducing Information Storage Costs Through Micrographics," "Software Integration for the '80s," and "The Law as It Relates to the Computer World." Microcomputers, peripherals, services, accessories, and supplies will be exhibited. For complete particulars, contact Industrial Presentations West Inc., Suite 304, 3090 South Jamaica Court, Aurora, CO 80014, (303) 696-6100.

May 5

The Sixth Annual Computer Conference for Educators, Lesley College, Cambridge, MA. Panel discussions, more than 20 presentations, and sessions that include hands-on workshops on software in science, social science, language arts, and mathematics will be offered. Additional information is available from Susan Friel or Nancy Roberts, Lesley College, 29 Everett St., Cambridge, MA 02238, (617) 868-9600.

May 7-9

EDP Audit, Controls, and Security Symposium, Woodfield Hyatt House, Woodfield, IL. This symposium provides seminars, workshops, and exhibits relating to the state of the art in electronic data-processing auditing. Address inquiries to EDP Audit Associates Inc., POB 255, Chicago Ridge, IL 60415, (312) 582-4622.

May 7-11

Tutorials for Professional Development, Marriott O'Hare, Chicago, IL. Two tracks, "Software Engineering" and "Networks and Communications," compose this program sponsored by the IEEE Computer Society and the Association for Computing Machinery. For a copy of the program, contact Tutorials for Professional Development, POB 639, Silver Spring, MD 20901, (301) 589-8142.

The Little Board®

Quantity One... \$349*

The world's simplest and least expensive single board computer



*Substantial Quantity discounts available

- 4MHz Z80A[†] CPU, 64K RAM
- Two RS232 serial ports
- Mini floppy controller
- Parallel printer port
- On-board -12V converter
- Only 5.75 x 7.75 inches
- Power Requirement: +5VDC @ .75A; +12VDC @ .05A
- Screws directly onto a mini floppy drive

All this... and CP/M^{††} 2.2 also!

[†] Z80A is a registered trademark of Zilog, Inc.
^{††} CP/M is a registered trademark of Digital Research

AMPRO
 COMPUTERS, INCORPORATED

67 East Evelyn Ave. • Mountain View, CA 94041 • (415) 962-0230

TIME is MONEY



PrintMate™ 150 doesn't waste either.

You can't afford to waste time waiting for your printer to finish before your computer can move on to something else. The PrintMate™ 150 is designed for **THRUPUT**. The large print buffers, high speed space skip and fast paper advance combine to generate 'usable' speed, not simply impressive spec sheet figures!

With the PrintMate™ 150's unusually large buffers, you can print and process simultaneously.

NO WAITING.

Most printers have very small buffers - 2K or 4K at most. Our 150 CPS wide carriage PrintMate™ 150 comes standard with a 4K buffer which is expandable to 20K, 36K, or 68K. MPI offers the biggest buffers in the business!

The PrintMate™ 150 has other outstanding features like an optional SoftSwitch™ front panel keypad and a fast and impressive near letter quality mode. Our exclusive applications packages (AP-PAKS), providing enhanced graphics printing along with a vast selection of decorative type styles, are available for selected microcomputers.

At a suggested list price of \$1045, the PrintMate™ 150 won't take your life's savings either. **STOP WASTING TIME AND MONEY. BUY A PRINTMATE™ 150 FROM MPI** — The American Printer Company! Call Us For More Information At:

1-800-821-8848

Model shown with optional SoftSwitch™ keypad



Micro Peripherals, Inc.
4426 South Century Drive
Salt Lake City, Utah 84123
(801) 263-3081

Event Queue

May 9-11

Session 84, Calgary, Alberta, Canada. This is the annual national conference of the Canadian Information Processing Society. The theme is "1984: Images of Fear, Images of Hope." Parallel seminars, panel discussions, technical papers, and exhibits of hardware, software, and services will assist in the exchange of views between users and suppliers. Conference information can be obtained from Ms. Marilyn Harris, Suite 722, Suncor Tower, 500 4th Ave. SW, Calgary, Alberta T2P 2V6, Canada, (403) 261-5903.

May 12-14

Softwest '84, Regency Hotel and Conference Center, Denver, CO. This conference and exhibition features seminars, lectures, and panel discussions on software, equipment, and peripherals

for Apple and IBM computers. For information, contact Colorado Conference Group, Suite C, 3312 Cripple Creek, Boulder, CO 80303, (303) 499-1034.

May 13-17

Computer Graphics '84, Convention Center, Anaheim, CA. This is the fifth annual conference and exposition sponsored by the National Computer Graphics Association (NCGA). For details contact the NCGA, 8401 Arlington Blvd., Fairfax, VA 22031, (703) 698-9600.

May 14-16

Annual Conference of ADCIS, Ohio State University, Columbus. This annual conference is sponsored by the Association for the Development of Computer-based Instructional Systems (ADCIS). Papers and demonstrations of hardware, software,

and courseware will emphasize portability. For details, contact ADCIS International Headquarters, 409 Miller Hall, Western Washington University, Bellingham, WA 98225, (206) 676-2860.

May 15-17

Criminal Justice Systems Conference, Virginia Commonwealth University, Richmond, VA. Presentations and panel discussions on recent developments in criminal justice applications of computer technology are planned. Additional sessions will address the uses of microcomputers in law enforcement. The fee is \$20. Information is available from Ben Wood, Department of Criminal Justice Services, 805 East Broad St., Richmond, VA 23219, (804) 786-4000.

May 15-17

Micro City '84, Exhibition

Complex, Bristol, England. More than 100 companies will exhibit computers, business systems, and communications equipment. For complete details, contact Tomorrow's World Exhibitions Ltd., 9 Park Place, Clifton, Bristol BS8 1Jp, England; tel: (0272) 292156/7.

May 16-18

Teaching Math with Microcomputers, Marriott Hotel, Miami, FL. This program, sponsored by the National Council of Teachers of Mathematics (NCTM), is designed to inform elementary, intermediate, and secondary school teachers of mathematics how to effectively use the microcomputer as a classroom tool. For further information, contact NCTM, 1906 Association Dr., Reston, VA 22091, (703) 620-9840.

1 Less Than 3 Minute

Your IBM Model 50, 60, 65, 75, or 85
Electronic Typewriter
can be an RS232C PRINTER or TERMINAL



CALIFORNIA MICRO COMPUTER Models 5060 and 5061 can be installed easily and require NO modifications to the typewriter.

or additional information contact:

CALIFORNIA MICRO COMPUTER
17791 Jamestown Lane Huntington Beach, CA
92647 (714) 848-3947



SAVE MORE THAN EVER ON 3M SCOTCH DISKETTES! NEW, LOWER PRICES.

Come share in the benefits of Disk World's mammoth buying power... buy genuine 3M Scotch diskettes at the lowest prices you'll ever see... less than half of what you'd pay in the store.
All 3M Scotch diskettes are factory packed in cartons of 10 with Tyvec envelopes, labels and reinforced hubs (on 5 1/4" only).

LIFETIME WARRANTY!

\$188
QTY. 50

1 ea. 5 1/4" SSDD

\$263
QTY. 50

5 1/4" DSDD ea. ↓

Other 5 1/4" C

5 1/4" SSDD

5 1/4" DSDD

8" Diskettes:

8" SSDD

8" SSDD

8" DSDD

its per diskette for quantities 1e

*Indicates Quantity 20 prices

\$2.89 ea.*

\$3.95 ea.*

\$2.02 e

\$2.49 ea

\$3.25 ea

NO DISKET

cleaning fluid

cleaning diskettes and 3U

\$23.00 + \$1.50 Shpg.



DISKET

\$14.95 + 3.00 Shpg.

FREE 20 Diskettes

safety

\$5.00

\$15.00

For the lowest prices, highest quality diskettes, storage cases, printer ribbons and computer paper products, get our catalog. Free with your order; \$1.00 otherwise. BONUS! Every catalog contains \$15.00 worth of bonus coupons.

SHIPPING: 5 1/4" DISKETTES—Add \$3.00 per 100 diskettes or fraction thereof. 8" DISKETTES—Add \$4.00 per 100 diskettes or fraction thereof. OTHER ITEMS: Add shipping charges as shown in ad. PAYMENT: VISA or MC. COD orders, add \$3.00. Taxes: Illinois residents, add 8% sales tax.

Nationwide: 1-800-621-6827

In Illinois: 1-312-944-2788

Minimum Order: \$35.00

WE WILL BEAT ANY NATIONALLY ADVERTISED PRICE!

DISK WORLD!

Suite 4806

30 East Huron Street

Chicago, Illinois 606

Distributor

3M

Look at what the best modem has been reduced to.

Our engineers have come up with some state-of-the-art LSI technology and a whole new modem.

It's smaller. J-Cat is about 1/5th the size of an ordinary modem. Easy to stick-on, tuck-in, put anywhere you want.

It's better. J-Cat does the things you need for professional performance. No fussing to get it into the right answer or originate mode; it does it automatically. LED's show you status; and audio "beeps" tell you when you reach a busy signal, detect a carrier, get a dial tone, etc.

And you can hook it into any modular RJ11C phone jack.

It costs less. If you've shopped around, you know a modem with close to these features costs \$250 or more. Our LSI technology has let us do the right thing with the price, too. Suggested retail—\$149.

Smaller is definitely better.

See your dealer. He has them right now.



The Novation J-CAT™

J-CAT FEATURES:

- Direct Connect, FCC Part 68 Registered
- Auto Answer
- Auto Search (Originate or Answer Mode)
- Disconnect/Test Key
- Connect/Break Key
- Self-Test
- Audio Line Status Indicator
- Dialtone/Busy Status at Serial I/O Connector
- Off Hook Control at Serial I/O Connector
- Compatible With EIA-RS232C or TTL Interfaces
- Low Power
- And it's from Novation, the world's leader in personal communications.

Novation



(800) 423-5419

In California:

(213) 996-5060

20409 Prairie Street, Box 2875
Chatsworth, CA 91311

Circle No. 75 on Free Information Card

May 19 -

The Seventh Annual Show & Tell Microcomputer Conference, University of Oklahoma Mathematics and Physical Science Complex, Norman, OK. Computer hobbyists are invited to speak briefly, demonstrate an example of their presentation, and answer questions in a Show & Tell period. For details, send a self-addressed, stamped envelope to Show & Tell, Dr. Richard Andree, University of Oklahoma, Mathematics Department, 601 Elm St., Norman, OK 73019.

May 20-23

The Thirteenth Mid-Year Meeting of the American Society for Information Science, Indiana University, Bloomington. The theme for this meeting is "The Micro Revolution: Implications for the Information Age." Joseph Weizenbaum, author of *Computer Power and Human Reason* and a computer science professor at MIT, will speak. For more information, contact Stephen Harter, School of Library and Information Science, Indiana University, Bloomington, IN 47405, (812) 335-5113.

May 20-25

The Fourth Jerusalem Conference on Information Technology—JCIT, Jerusalem, Israel. Papers, panel discussions, workshops, and exhibits will emphasize software engineering and manufacturing related to the theme of this international event, the "Next Decade in Information Technology." Until April 30, the registration fee is \$200. After that date, the fee is \$225. Isratech '84, the national exhibition of high technology, runs concurrently with JCIT. For information on Isratech '84, contact the Government of Israel Trade Center, 350 Fifth Ave., New York, NY 10118, (212) 560-

0660. For details on JCIT, contact the Fourth Jerusalem Conference on Information Technology, POB 29313, 61292 Tel Aviv, Israel; tel: (03) 258-535.

May 21-23

AAMSI Congress 1984—The Third Spring Joint National Congress, Hilton Hotel, San Francisco, CA. Invited and contributed papers, special sessions, tutorials, reviews, panel discussions, and demonstrations will explore the applications of computers and information technology and systems to all fields of medicine. A dozen professional organizations have joined the American Association for Medical Systems and Informatics (AAMSI) as program sponsors. For particulars, contact AAMSI, Suite 402, 4405 East-West Highway, Bethesda, MD 20814, (301) 657-4142.

May 22-25

COMDEX/Spring, Georgia World Congress Center, Atlanta. For details, contact the Interface Group, 300 First Ave., Needham, MA 02194, (800) 325-3330; in Massachusetts, (617) 449-6600.

May 22-26

Oficomp Korea 84—The International Korean Office and Information Management Exhibition and Conference, Korea Exhibition Center, Seoul, South Korea. Exhibits will include demonstrations of computers, communications equipment, and business machines. Contact Clapp & Poliak International, POB 70007, Washington, DC 20088, (301) 657-3090.

May 23-24

Automach-Australia '84, Royal Hall of Industries Showground, Sydney. This trade show serves to update Australian manufacturing industries on automated, integrated factory systems in-

corporating numerically controlled machinery, CAD/CAM, and robotics. Contact SME World Headquarters, One SME Dr., POB 930, Dearborn, MI 48121, (313) 271-1500. In Australia, contact Mr. Greco, Howard Rotavator Pty., POB 82, Parramatta 2150, New South Wales, Australia; tel: 630-1231; Telex: AA21328.

May 23-24

The 1984 Trends and Applications Conference, National Bureau of Standards, Gaithersburg, MD. Presentations will address current systems and applications as well as research into advanced concepts relating to the theme, "Making Database Work." Information can be obtained from Trends and Applications 84, POB 639, Silver Spring, MD 20901, (301) 921-3491.

May 23-25

The Eighth Conference on Computer Applications in Radiology, Stouffer's Riverfront Towers, St. Louis, MO. Patient information systems, personal computers and computers for the private of-

fice, teleradiology, computer-assisted instruction, and artificial intelligence are a few of the topics to be covered. Exhibits are included. The fee is \$350. For details, contact American College of Radiology, 20 North Wacker Dr., Chicago, IL 60606, (800) 227-5463; in Illinois, (312) 236-4963.

May 23-25

The Third Annual European Semiconductor Industry Conference, Hotel Kempinski, Berlin, West Germany. International industry leaders will discuss issues facing the semiconductor industry. Contact Barbara Chupp, Dataquest Inc., 1290 Ridder Park Dr., San Jose, CA 95131, (408) 971-9000.

May 29-31

Gulf Coast Computer and Office Show, New Orleans, LA. Speakers, technical sessions, and product displays will highlight this exhibition. For full details, contact Gulf Coast Computer and Office Show, 119 Avant Garde Circle, Kenner, LA 70062, (504) 467-9949. ■

In order to gain optimal coverage of your organization's computer conferences, seminars, workshops, courses, etc., notice should reach our office at least three months in advance of the date of the event. Entries should be sent to: Event Queue, BYTE Publications, POB 372, Hancock, NH 03449. Each month we publish the current contents of the queue for the month of the cover date and the two following calendar months. Thus a given event may appear as many as three times in this section if it is sent to us far enough in advance.

BYTE's Bits

Call for Papers

The conference chairperson for COMPCON Fall 1984 (September 16-19, Hyatt Regency Crystal City, Arlington, VA) has issued a call for papers on the theme "The Small Computer (R)evolution." Suitable

topics include user friendliness, embedded systems, and the architecture of small computer applications and products. Send three copies of your 1000- to 5000-word paper to Joe Batz, Small Computer (R)evolution, POB 639, Silver Spring, MD 20901, before April 2. ■

The Micromint Collection

Micromint. Supporting the varied projects that appear in Steve Ciarcia's monthly article in BYTE Magazine, "Ciarcia's Circuit Cellar." Offering a wide range of computers and peripherals designed to meet the exacting demands of the hobbyist as well as worldwide corporate clients.

TERM-MITE ST SMART TERMINAL BOARD

As featured in Ciarcia's Circuit Cellar BYTE Magazine, January & February 1984

All you need to build a Smart Video Terminal equivalent to the types advertised for \$1,000.00 or more is a Term-Mite ST circuit board, scanned or parallel keyboard, video monitor and power supply.

- Uses brand new Nat'l Semi NS455A Terminal Processor.
 - 24 lines by 80 characters, 25th reverse-video status.
 - Upper & lowercase. Line (block) graphics.
 - Selectable data rate, parity & display options.
 - Reverse video, half intensity, double height & width, underlined, blinking and/or blank character
 - Separate sync or composite video output. Self Test
- Term-Mite ST Video Display Terminal Board
BCC22 Assembled & Tested \$284.
BCC23 Complete Kit 244.

Z8 BASIC SYSTEM CONTROLLER NEW!!!

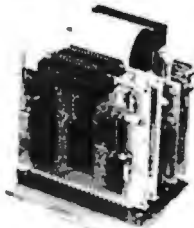

As featured in Ciarcia's Circuit Cellar BYTE Magazine, July & August 1981

The Z8 Basic System Controller is an updated version of our popular BCC01. The price has been reduced and features added. The entire computer is 4" by 4 1/2" and includes a tiny BASIC interpreter, up to 6K bytes of RAM and EPROM, one RS-232C serial port with switchable baud rates and two parallel ports. BASIC or machine language programming is accomplished simply by connecting a CRT terminal. Programs can be transferred to 2732 EPROMs with an optional EPROM programmer for auto start applications. Additional Z8 peripheral boards include memory expansion, serial and parallel I/O, real time clock, an A/D Converter and an EPROM programmer

- Uses Zilog Z8 single chip microprocessor.
- Data and address buses available for 124K memory.
- Can be battery operated.
- Cross assembles for various computers.

..... \$149.
New Low Price

Z8 MEMORY, I/O EXPANSION, CASSETTE INTERFACE

- 8K bytes of additional RAM or EPROM
 - Three additional 8 bit parallel ports
 - Cassette interface—300 baud K C Standard
 - Software real time clock
- BCC03 w/4K RAM Assembled & Tested \$150.
BCC04 w/8K RAM Assembled & Tested 180.

Z8 EPROM PROGRAMMER

- Transfer BASIC or Assembly Language application programs from RAM to 2716 or 2732 EPROM.
 - Comes with programming & utility routines on EPROM.
 - Requires BCC03 Z8 Expansion Board for operation.
- BCC07 Assembled & Tested \$145.

- Uses Analog Devices 75381 IC, 8-channel 0-01.
 - Adds process control capability to the Z8 system
 - Over 1,000 conversions per channel per second.
 - Monitors 8 analog signals in one of two 10V ranges.
- BCC13 Assembled & Tested \$140.

- Adds additional RS-232C and opto-isolated 20 ma. current loop serial port to the Z8 System.
 - Runs at 75 to 19,200 baud in all protocols.
 - Comes with listings of sample serial I/O routines.
- BCC08 Assembled & Tested \$160

Z8 16K MEMORY EXPANSION BOARD

- Add up to 16K of additional memory, RAM or EPROM, to your Z8 System Controller in any multiple.
 - Accepts 2016, 6116, 2716, or 2732 memory types.
 - Four 16K cards may be installed on the Z8 System bringing the total memory to 64K.
- BCC14 Assembled & Tested w/8K RAM \$120.
BCC15 Assembled & Tested w/16K RAM \$145.

COMING SOON! FORTH LANGUAGE VERSION OF THE Z8

With the new Z8 with on board 4K FORTH you can program high speed control functions in a few simple high level language commands. Perfect for data reduction, process control and high speed control applications.

BCC20 Z8F FORTH Microprocessor chip \$150.
BCC21 Z8F FORTH System Controller
(This board is a BCC11 with a BCC20 installed)
Assembled & Tested 280.

From Micro Heso
IBM PC, APPLE,
CP/M 2.2 8" \$ 75.

From Allen Ashley
TRS-80 Model I, III, Northstar 5 1/4" 75.
CP/M 2.2 8" 150.

Z8 FIVE SLOT MOTHER BOARD

- Expand your Z8 BASIC System with minimum effort
 - Contains five slots complete w 44 pin connectors
- MBO2 Assembled & Tested \$69.

TRIPLE VOLTAGE POWER SUPPLIES

+5V @ 300 ma. + / - 12V @ 25 ma.
UPS01 Assembled & Tested \$35.
UPS02 Complete Kit 27.
+5V @ 1 Amp. + 12V @ .5 Amp. - 12V @ 50 ma.
UPS03 Assembled & Tested 60
UPS04 Complete Kit 50.

SPEECH SYNTHESIZERS

MICROVOX TEXT-TO-SPEECH SYNTHESIZER

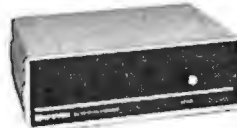

As featured in Ciarcia's Circuit Cellar BYTE Magazine September, October 1982.

Microvox is a second generation professional voice quality text-to-speech synthesizer that is easily interfaced to any computer, modern, RS-232C serial or parallel output device and provides speech of unbelievable clarity.

- Unlimited vocabulary.
 - 64 programmable inflection levels.
 - 6K text-to-speech algorithm
 - Full ASCII character set recognition and echo.
 - RS232C and parallel output.
 - 3000 character buffer, 3000 optional.
 - Adjustable baud rates (75-9600)
 - Spelling output mode.
 - 7 octave music and sound effects.
 - On board audio amplifier & power supply.
 - X-On/Off handshaking.
- WV01 Assembled with 1K buffer \$299.
WV02 Complete Kit with 1K buffer 219.
Add \$15.00 for 3K buffer option.

VOTRAX SC-01A PHONETIC SPEECH SYNTHESIZER IC

The SC-01A Speech Synt contained solid state dev thesises continuous spe Used in our Microvox an

SC01A Quantity 1-99 \$44. ea.
100 + 32. ea.
1000 + 24. ea.

MICRO D-CAM DIGITAL TV CAMERA

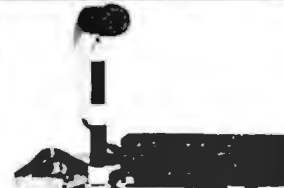

As featured in Ciarcia's Circuit Cellar BYTE Magazine, September & October 1983

- GIVE YOUR COMPUTER THE DIMENSION OF SIGHT
- Interprets, enhances and stores images
 - 256 x 128 digital image sensor.
 - Plug-in boards for the IBM-PC, APPLE II+ or e.
 - Software includes utilities for auto exposure, multi-level greyscale, screen dump and image enhancement.
 - Includes interface card, 4 foot extension cable, camera assembly, manual, and software on diskette
- DC01 IBM PC Assembled & Tested \$200.
DC02 IBM PC Complete Kit 264.
DC03 APPLE II Assembled 299.
DC04 APPLE II Complete Ki 264

300 BAUD ANSWER/ ORIGINATE MODEM KIT



As featured in Ciarcia's Circuit Cellar BYTE Magazine, March 1983

Micromint's latest 300 Baud Modem Kit is crystal controlled, uses the TI TMS99532 IC, contains just 25 parts and requires no calibration or adjustments. Use with acoustic coupler or in direct connect mode

MD04 Complete Kit as shown \$60.
MD05 Transfonner for Direct Connect Mode .. 9.
AC01 Acoustic Coupler Kit 20.

E-Z COLOR GRAPHIC INTERFACE WITH SPRITES

- APPLE II E-Z Color plug-in iccs
Editor on 3.3 disk
EZ01 Assembled & Tested \$150.
EZ02 Complete Kit 125.
- APPLE II E-Z Color Plus
- Allows the use of a single monitor or TV set.
- EZ11 Assembled & Tested w/Graphics Editor \$200.
- KRELL LOGO for E-Z Color and E-Z Color Plus
Supports Sprite Graphics
EZ21 Krell LOGO w full documentation \$89.
- Animation Software for E-Z Color Plus
- Draw with Sprites using Joystick or Koala Pad.
 - Animate Sprites from your own BASIC program.
- EZ21 Animation Software \$49.
- \$100 E-Z Color Graphics Board
- With sound generator & joystick interface.
 - MBASIC Graphics Editor on 8" diskette.
- EZ04 Assembled & Tested \$289.

MICROMINT INC. 561 Willow Avenue, Cedarhurst, NY 11516

To Order: Call Toll Free 1-800-645-3479
For Information Call: 1-516-374-6793
Call: Monday-Friday, 9-5 PM



As featured on the cover of BYTE Magazine. Also featured in Ciarcia's Circuit Cellar November, December 1982 & January 1983

The Computer With A Split Personality.
—Use it as an IBM PC look alike that directly boots PC DOS 1.1 and accepts all expansion boards designed for the IBM PC.
—Use it as a powerful 8088 single board computer for all your OEM applications. Just add serial terminal, disk drive and power supply. Directly boots CP/M-86.

Buy the MPX-16 in the form that best meets your needs or budget. As a bare board, as a wave soldered board that contains all components less ICs, as an assembled and tested circuit board or as a complete system.

- Directly boots PC DOS 1.1 and CP/M-86.
- Most IBM PC software executes with no modifications.
- IBM PC bus compatible + 9 expansion slots.
- Intel 8088 16-bit microprocessor.
- Optional Intel 8087 math coprocessor.
- 256K bytes on board memory.
- Up to one megabyte of system memory.
- Up to 64K bytes of system ROM/EPROM.
- 2 RS-232C Serial & 3 Parallel I/O ports.
- Disk controller for 5 1/4" or 8" drives.
- Seven levels of vectored interrupts.

MPX-16 Circuit Board Assembled
w/64K RAM \$1,200.
OEM 100 quantity price 900.
MPX-16 Circuit Board Assembled
w/256K RAM 1,400.
MPX-16 Semi-Kit (wave soldered circuit board w/all components) Less ICs 595.
Complete Kit of ICs w/256K RAM 595.
MPX-16 Unpopulated (bare) PC Board 300.
CP/M-86 Operating System + Manuals 80.
MPX-16 Switching Power Supply 300.
MPX-16 Technical Reference Manual 50.
MPX-16 Metal Enclosure with Fan 300.
Tandon TM 100-2 Double Sided/Density Drive 300.
IBM PC Keyboard Interface Adapter 100.

Shipping & handling additional on all MPX-16 orders.

IBM PC is a trademark of International Business Machines Inc.
CP/M-86 is a trademark of Digital Research Inc.
Z8 is a trademark of Zilog Inc

Circle 240 on inquiry card.

Clubs and Newsletters

Visitors Welcome in Atlanta

The Atlanta IBM-PC Users Group, a nonprofit corporation that assists users of the IBM Personal Computer and similar personal or desktop computers, welcomes visitors to its monthly meetings. General meetings are held the second Wednesday of every month at 7:30 p.m. and business-users meetings convene at the same time on the third Wednesday of every month. The club maintains a software library, a bulletin board, and a monthly newsletter, *Atlanta PC News*. A discount is offered to members at local computer stores. Annual dues are \$20 a year. For details, contact the Atlanta IBM-PC Users Group Inc., POB 76516, Atlanta, GA 30358, or call Will Macoy at (404) 433-4500.

Windy City Atarians

Suburban Chicago Atarians (SCAT) is an independent computer users group that meets on the first Saturday of each month at 11 a.m. A monthly newsletter containing articles, minutes of the meetings, and programs is produced. Membership is \$15 annually, which includes a subscription to the newsletter. Write to SCAT, POB 72266, Roselle, IL 60172.

A Real Network

The Real Estate Information Network Inc. (REINET) provides programs and other information for real estate professionals, appraisers, investors, syndicators, brokers, property managers, and attorneys. It supports various newsletters, a financial database, current sales and rental data, and other items of

interest for realty professionals. REINET takes special interest in the TRS-80 Model 100. A quarterly publication, *REINFO*, is produced. Membership requires a one-time connect charge of \$100; the hourly rate is \$4.50. For membership information, send a self-addressed, stamped envelope to REINET, POB 257, Nyack, NY 10960, or call Compuserve 72235,301.

Over Hill, Over Dale

Field Portable Computing, an independent quarterly newsletter produced by Breakthrough Inc., contains product reviews, industry trends, analyses, and information of interest to both users and manufacturers of battery-operated briefcase-style computers. Single issues are \$15; an annual subscription is \$48. For details, contact Breakthrough Inc., POB 230, Logan, UT 84321, (801) 753-7555.

Printscreen in the Bay Area

The Stanford/Palo Alto Users Group for the IBM PC meets at 7 p.m. on the last Wednesday of every month. The monthly newsletter, *PrtSc*, is free with an annual \$25 membership. For information, write to Linda de Sosa, POB 3738, Stanford, CA 94305, or call (415) 856-6281.

The Cottage Industry

Cottage Computing, a monthly publication from Home Business News, contains the latest information on computer-based businesses, book and software reviews, and business techniques. It contains bulletin-

board listings, an education column, product briefs, classified advertisements, and events. Nontechnical articles and paid advertising are accepted. Single issues are \$1 and subscriptions are \$12 a year. For information, contact Home Business News, 12221 Beaver Pike, Jackson, OH 45640.

An Original Eye Opener

The Original Apple //rs is a nonprofit organization that meets at 7:30 p.m. on the third Wednesday of each month in San Francisco. The newsletter, *Open Apple Gazette*, is produced monthly and contains articles on important points about the Apple III. Annual membership is \$30. Further details are available from Original Apple //rs, 1850 Union St. #494, San Francisco, CA 94123.

Model 100 Club in Britain

Users of the TRS-80 Model 100 in England have formed a club to ensure the machine's capabilities are realized. A quarterly newsletter is planned. An annual subscription is £12. Send a self-addressed envelope for details to REMSOFT, 18 George St., Brighton BN2 1RH, England.

Apples in Oak Ridge

Users of Apple, Franklin, and compatible computers are welcome to join a club in Oak Ridge, Tennessee, that meets to exchange knowledge, skills, and software in the areas of members' interests. An annual membership is \$15. For details, contact the

Computer & Program Exchange Club (CAPEC DEP-D), POB 1142, Oak Ridge, TN 37831.

Dues for News or Floppies

The Robin Owners Group is a nonprofit group dedicated to spreading information to owners and users of the DEC Robin (VT180). A newsletter is produced and costs \$2 for every four issues. Floppy disks containing public-domain software are \$2 and include a formatted disk. For details, contact John Comella, 2 Mockingbird Lane, Maynard, MA 01754.

Mother Hubbard Invites Women

The Mother Hubbard Users Group meets every month, alternating between mornings and evenings to allow all members to participate. This women's user group is designed to introduce computer novices to the uses of the Apple computer. Meetings are free and are held either in the Long Beach/West Orange County area of California or at CompuKids Inc. in Seal Beach. For details, contact Dory Spencer at (213) 438-5643 or Mary Kay Toumajian at (213) 597-6330, or write to CompuKids Inc., Rossmoor Shopping Center, 12385 Seal Beach Blvd., Seal Beach, CA 90740, (213) 430-7226.

C-64 Users of the South Bay

The South Bay Commodore 64 Users Group meets on the second and fourth Tuesdays of each month to discuss problems, programs, and hardware. Classes and

seminars are offered and a monthly newsletter is planned. For details, contact the South Bay Commodore 64 Users Group, POB 3193, San Ysidro, CA 92073.

North American Readout

The North American Computer Service Association (NAC/SA) is composed of charter memberships by participating companies and corporations. NAC/SA promotes the development of computer maintenance, services, and industry. The group offers courses, conducts surveys, sponsors conferences, and produces a newsletter entitled *Readout*. Associate member dues for corporations are based on the size of the company; a flat rate is available for individuals and educational institutions. For additional information, contact David Glascock, NAC/SA, 227 North Magnolia #202, Orlando, FL 32801, (305) 442-2000.

Virginia's Technical Network

CPro Users Group, a national users group for owners and users of Godbout's Compupro, is designed for technical people to share information, solutions, and applications. A monthly newsletter is produced, a bulletin board is maintained, and publication of the member list is anticipated. Membership is \$10. For details, contact Curt Hess, CPro Users Group, POB 1474, Woodbridge, VA 22193, (703) 690-3312.

What You Can Do For Your Club

The Society of Pet Handlers for Information Exchange (SPHINX) is a Commodore users group in the

San Francisco area. Meetings and classes are held, a newsletter is produced, and a bulletin board is maintained. SPHINX also distributes public-domain software and equipment. Suggestions are welcome. Annual membership dues are \$24. For information, send \$2 for a catalog, or contact SPHINX, 267 Arlington Ave., Kensington, CA 94707, (415) 527-9286.

Compucats of Maryland

The Compucats Computer Club, sponsored by the Software Development Company of Aberdeen, Maryland, opens the monthly meetings to all those interested in computing. Although the focus is on Commodore computers, many members own other systems. Meetings are held at 7 p.m. on the second Tuesday of each month and include demonstrations. The club sponsors shows and programming contests. A monthly program disk and a monthly newsletter entitled *The Compucats Chronicle* are produced. Dues are \$15 a year and provide members with access to the club-maintained library of hardware and software. For details, write to Betty Jane Schueler, Compucats Computer Club, 680 West Bel Air Ave., Aberdeen, MD 21001, or call (301) 272-4195.

Japanese Atari Club

An Atari users group, the Ryukyu Atari Motivators (RAM), welcomes new members, information, and newsletter exchanges. RAM is an affiliate of the Okinawa Computer Club, which serves users of many kinds of computers. For details, write W. Martin Justice, PSC#2, Box 11165, APO SF, CA 96367.

Introducing the 64K BYTE MODULE...

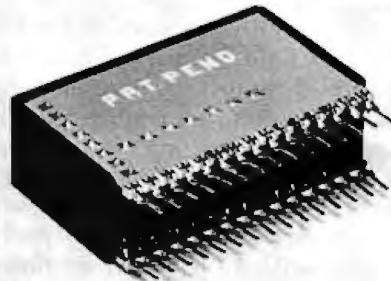

VK 64-1-8V

8 DYNAMIC RAM CHIPS IN 1 COMPACT UNIT.

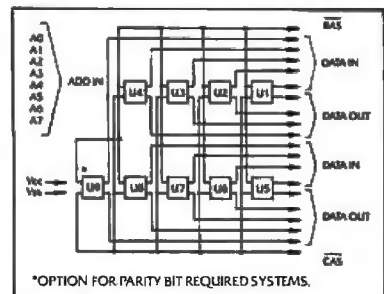

SCHEMATIC

*OPTION FOR PARITY BIT REQUIRED SYSTEMS.

Featuring

- 40% to 70% reduction in P.C. board area
- Possible reduction from 4 to 2-layer mother board
- Compactness gives shorter distances, lower distributed capacitance, higher speeds, less support components
- Higher speed, reliability due to lower chip temperatures
- Single +5V operation, expand in 64K byte increments
- 100% tested: each chip as well as the module is tested
- 200 nanosecond access time is standard; faster available
- 32-pin package
- Designed to be pin for pin compatible with upcoming 256K Byte Module, available soon from VANKELL INDUSTRIES.

NOW — Move up to the 64K Byte Module for maximum memory in the smallest amount of space!

The 64K Byte Module is available in two sizes (vertical and horizontal). Each size may be ordered with parity bit option. Application notes for the Zilog Z80 and the Intel 8088 microprocessors will be shipped with each order.

VERTICAL MODULES: 1.05" H x 1.7" L x .5" W

Model No. VK 64-1-8V \$195.00
Model No. VK 64-1-9V (with parity bit) \$209.00

HORIZONTAL MODULES: .45" H x 1.7" L x 1.15" W

Model No. VK 64-1-8H \$195.00
Model No. VK 64-1-9H (with parity bit) \$209.00

Also available ... a 64 x 1 x 4 module which is pin for pin compatible with the TI-4416 or an equivalent 16 x 1 x 4 chip.

Model No. VK 64-1-4 \$112.00

ORDER TOLL FREE: (800) 521-0060

California residents call: (800) 521-8165

Master charge, Visa, Bank Checks or Money Orders accepted. Mail orders accepted. California residents add 6.5% Sales Tax. All orders shipped UPS. Prepaid within continental U.S.

For product information call (818) 793-1140

VANKELL INDUSTRIES

100 N. Hill Ave. • Ste. 203 • Pasadena, Ca. 91106

See BASIC News

CBNews, the monthly newsletter of the CBASIC Compiler Users Group (CBUG), is produced by Software Magic for the benefit of CB80 users. It covers corporate news, letters, new products such as conversion tools, and bugs. Call the CB80 hotline, (213) 765-3957, with problems or questions. A 12-issue subscription is \$12. Contact *CBNews*, Software Magic, 11669 Valerio St. #213, North Hollywood, CA 91605, (213) 765-3957.

National Capital Group for Apple

Washington Apple Pi meets at 10 a.m. on the fourth Saturday of each month in Bethesda, Maryland, on the campus of the National Naval Medical

Center. Meetings include speakers and cover such topics as databases and the uses of personal computers by disabled persons. A sign interpreter and reserved seating are provided. The club maintains a hotline serving 4000 members and produces a monthly publication. For further information, contact Washington Apple Pi, Suite 201, 8227 Woodmont Ave., Bethesda, MD 20814, (301) 654-8060.

Massachusetts CP/M Users Meet

The Central Mass CP/M Users Group welcomes CP/M and VT-180 users to meetings held at 2 p.m. on the first Sunday of every month in Shrewsbury, Massachusetts. The intention of the meetings is to distribute information and there

are no dues. For further details, contact Brother Jim Smith, Saint John's High School, 378 Main St., Shrewsbury, MA 01545, or call (617) 845-1878.

Applications for the Blind

Raised Dot Computing Newsletter is free to owners of Braille-edit, a software program that works in print, braille, and voice. The monthly newsletter will cover the applications of small computers for the blind and for transcribers, low-cost braille devices and translation, and voice synthesis. Subscriptions are available in the two forms of print or audio; 12 print issues cost \$12 and 12 cassettes cost \$20. A sample print issue is free; back issues are \$2 each. For information, contact Raised Dot Computing, 310 South 7th St., Lewisburg, PA 17837, (717) 523-6739.

CP/M Grows in Napa Valley

The Napa Valley CP/M Users Group (NVCPMUG) meets at 7:30 p.m. on the second Wednesday of each month at the Napa Valley College Campus and welcomes anyone interested. Meetings are free and there are no membership dues. Topics include system languages and hardware applications related to CP/M. The

newsletter is on line 24 hours a day on the club's remote CP/M bulletin-board system (RCPM). To access the Napa Valley RBBS/RCPM, call (707) 257-6502, or mail a self-addressed, stamped envelope to NVCPMUG, POB 4096, Napa, CA 94558.

Cooking With Gas

The Sacramento Area Users of Televideo Equipment (SAUTE) meets twice a month to listen to lectures prepared by one of the members on applications relevant to programmers and systems analysts who use Televideo TS802 and TS803 systems. After each meeting is an open discussion; printed minutes are distributed. Exchanges of information or out-of-town members who would benefit from the communications are welcome. Dues are \$12 a year. For details, contact Ron Odom, SAUTE, 8200 Longden Circle, Citrus Heights, CA 95610.

Silicon Valley Hosts dBASE II Users

The dBASE II User Group/Silicon Valley meets at 7 p.m. on the first Wednesday of each month in Sunnyvale, California. It is designed for all levels of users of Ashton-Tate's dBASE II. There are no dues. For details, contact Melissa Gray, dBASE II User Group/Silicon Valley, POB 190, Mountain View, CA 94042-0190. ■

MICRO BEE SOFTWARE

Manufacturing licences for the popular Australian designed Micro Bee computer have recently been granted to many companies throughout the world.

MYTEK Computing is the largest and most respected producer of software for the Micro Bee Computer.

MYTEK Computing invites dealers to sample its large and extensive range of Micro Bee Software.

Micro Bee users are also invited to request to be included on MYTEK Computing's free mailing list. Catalogues are air-mailed regularly to all parts of the world.



1 Kent Street, Bicton, 6157, Perth, Western Australia
Telephone: (09) 330 7336

If you would like BYTE readers to know about your club or newsletter send the details accompanied by no more than one newsletter to Clubs and Newsletters, BYTE Publications, POB 372, Hancock, NH 03449. Overseas groups are encouraged to participate. Please allow at least three months for your announcement to appear.

CompuPro...

for Performance, Quality and Reliability

Anyone can sell you a box full of hardware. But is it too much computer? Too little? Will it run the appropriate software? What about service? If you need the right answers before and after the sale, call your nearest **Full Service CompuPro System Center**. For product information, see pgs. 119 & 410.

ALABAMA

Birmingham
Cost Plus Computers
(205) 879-5976

ARIZONA

Scottsdale
S-100
(800) 528-3138

CALIFORNIA

Bakersfield
Creative Computing Serv.
(805) 835-1118

Berkeley
American Computers
& Engineers
(415) 849-0177
Track Computer Center
(415) 845-6366

Burlingame
Mentzer Computer
Systems
(415) 340-9363

Canyon Country
Creative Computing Serv.
(805) 251-9877

Carmichael
Logic Systems
(916) 971-3133

Chatsworth
Priority One Electronics
(213) 709-6789

Hayward
Best Computers Hayward
(415) 886-4732

Irvine
Priority One Electronics
(714) 660-1411

Los Angeles
American Computers
& Engineers
(213) 477-6751
Gifford Computer
Systems
(213) 477-3921

Mountain View
ACC
(415) 969-4969

Oakland
Track Computer Center
(415) 444-8725

Pacific Palisades
System Interface
Consultants
(213) 454-2100

Pasadena
Omni Unlimited
(213) 795-6664

Petaluma
Advanced Information
Management
(707) 763-7283

Pleasanton
Best Computers
Stoneridge
(415) 463-2233

Sacramento
Logic Systems
(916) 922-3377

San Leandro
Gifford Computer
Systems
(415) 895-0798

San Rafael
Computer House
(415) 453-0865

Santa Barbara
Data Bank
(805) 962-8489

Santa Maria
Data Bank
(805) 922-1333

Santa Rosa
Matrix Computers
(707) 542-0571

Sunnyvale
Pragmatic Designs Inc.
(408) 736-8670

COLORADO

Lakewood
Rocky Mountain
Microsystems
(303) 232-4545

FLORIDA

Brandon/Tampa
Micro Computer
Technology
(813) 685-7659

Orlando
Data/Office
(305) 629-6776

Satellite Beach
Binary Magic, Inc.
(305) 777-7080

HAWAII

Kahului Maui
Capacity Plus
Computers
(808) 871-7984

ILLINOIS

Athens
Computers Plus
(217) 636-8491

La Grange Park
Small Business
Systems Inc.
(312) 579-3311

Skokie
Lillipute Computer
Mart Inc.
(312) 674-1383

MARYLAND

Bethesda
JR Systems
(301) 657-3598

MASSACHUSETTS

Boston
New England
Electronic Exchange
(617) 491-3000

Chestnut Hill
Key Micro Systems
(617) 738-7306

MISSISSIPPI

Pascagoula
Automated Accountants
(601) 769-2937

NEW YORK

Amherst
Gifford Computer
Systems
(716) 833-4758

Deer Park
Datapro Systems, Inc.
(516) 595-1311

New York
Park Plaza Computer
Center, Inc.
(212) 759-5820

Park Plaza Computer
Center, Inc.
(212) 505-8200
Park Plaza Computer
Center, Inc.
(212) 344-5151

Park Plaza Computer
Center, Inc.
(212) 595-5353

Staten Island
John D. Owens Assoc.
(212) 448-6283

NORTH CAROLINA

Greensboro
General Semantics
Computers
(919) 378-1500

OREGON

Portland
Microwest Computer
Products
(503) 238-6274

PENNSYLVANIA

Philadelphia
Information Network
Systems
(215) 364-8220

RHODE ISLAND

Coventry
Key Micro Systems
(401) 828-7270

TEXAS

Austin
CPA Systems, Inc.
(512) 458-9281
Informa, Inc.
(512) 459-4216

Dallas
Dator Systems
(214) 521-0915

Ft. Worth
Dataworth Computer
Systems
(817) 877-4041

Houston
Gifford Computer
Systems
(713) 680-1944

Informa, Inc.
(713) 861-7612

Sequin
CPA Systems, Inc.
(512) 379-0660

VIRGINIA

Woodbridge
Office Networks Corp.
(703) 690-3312

WASHINGTON

Bellevue
North Ridge
Computer Systems
(206) 453-0596

Seattle
American Computers
& Engineers
(206) 583-0130

WISCONSIN

Greenfield
Byte Shop
of Milwaukee
(414) 281-7004

Madison
Beam International
(608) 255-2325

AUSTRALIA

Bankstown
Automation Statham
Pty., Ltd.
(02) 709-4144

CANADA

Coquitlam, B.C.
CSC System Center Ltd.
(604) 941-0622

Vancouver, B.C.
Dynacomp Business
Computers Ltd.
(604) 872-7737

THE PHILIPPINES

Quezon City
Corona International Inc.
78-34-71

UNITED KINGDOM

Swansea
Comcen Technology Ltd.
(0792) 796000

CompuPro[®]

A GODBOUT COMPANY

3506 Breakwater Court, Hayward, CA 94545

Software Received

Apple

Capital Strategy for Investors, an investment-planning program. By performing mathematical calculations, this program not only lets you decide what to invest in, but how much to invest. The computer will provide information for optimal capital growth without financial strain, show the effects of the growth rate, and test the results of varied investment decisions. For II Plus, IIe, and III; floppy disk, \$69. Ventura Data Systems, 1061 Sage View, Chula Vista, CA 92010.

Family Medical Advisor, a medical-diagnostics program. This program is designed to analyze health symptoms and identify probable causes of medical conditions, including drug abuse and poisoning. Using almost 10,000 combinations of symptoms, the program helps to diagnose common ailments, obscure diseases, or childhood illnesses. You reply with yes and no answers to a series of questions. For informational purposes only. For the II; floppy disk, \$37.50. Navic Corp., Box 14727, North Palm Beach, FL 33408.

Gene Machine, an educational program for use by high school biology students. This program explores the basic ideas concerning the structure and function of the two nucleic acids, DNA and RNA. Also useful for chemistry courses that include aspects of the chemical basis of heredity. For II, II Plus, and IIe; floppy disk, \$65. HRM Software, 175 Tompkins Ave., Pleasantville, NY 10570.

The Graphics Department, an integrated graphics sys-

tem for use in business presentations. This program combines the graphics functions of plotting, chart generation, lettering, a graphics editor, and a slide projector to quickly create and enhance your own business presentations. For II, IIe, and III; floppy disks, \$124.95. Sensible Software Inc., 6619 Perham Dr., West Bloomfield, MI 48033.

Health Awareness Games, five interactive software programs suitable for school or home uses. A variety of age groups can increase their health awareness with programs entitled *Coronary Risk*, *Why Do You Smoke?*, *Exercise Weight*, *Life Expectancy*, and *Life Style*. For II, II Plus, and IIe; floppy disk, \$99. HRM Software (see address above).

Heredity Dog, an interactive, educational genetic simulation. High school students combine genetic differences in dogs as an introductory study of basic genetics. The computer shows potential outcomes in litters of pups. For II, II Plus, and IIe; floppy disk, \$49. HRM Software (see address above).

Homeword, a personal word-processing program that leads you through each step. You can write letters, school assignments, shopping lists, and memos. Text combined with pictures (icons) show you text commands and your formatted page. For II, II Plus, and IIe; cassette and floppy disk, \$49.95. Sierra On-Line, Sierra On-Line Building, Coarsegold, CA 93614.

Mad Rat, an arcade-type game. Three mice are trapped in a department store. You must get them to eat the

cheese while also keeping them away from the cat and the holes under the escalators. If the cheese drops through the escalator holes, it turns into more cats. Various skill levels. For II, II Plus, and IIe; floppy disk, \$24.95. Phoenix Software Inc., 64 Lake Zurich Dr., Lake Zurich, IL 60047.

Mastering the College Board Achievement Tests: English Composition, a comprehensive program for individuals preparing to take College Boards. This self-paced program has more than 1000 problems to give you practice in rewriting sentences, phrasing, identification of grammatical errors, and pointers on sentence structure. It provides scores and error analysis for further study. For II Plus and IIe; floppy disks, \$175. CBS Software, 1 Fawcett Place, Greenwich, CT 06836.

Murder by the Dozen, a whodunit-simulation series. This is a game containing 12 murder mysteries and their case histories. You are the top detective and must solve each case within a limited amount of time using clues and a map of the city. Up to four people can play individually or as a team. For II Plus and IIe; floppy disk, \$34.95. CBS Software (see address above).

Pconvert, a data-transferral system. Data, text, and code files can be transferred between DOS 3.3 and Apple Pascal format disks. You can use BASIC data or text files with Pascal programs; Pascal text or data files with BASIC programs; and code files from the Pascal 6502 assembler as DOS binary files. For II, II Plus, and IIe; floppy disk, \$34.95. DESC Software, POB 7212, Stanford, CA 94305.

Picture Writer, an artistic educational program. Children ages 4 through 12 can easily draw lines, shapes, and pictures. A tutorial teaches the child to draw original pictures using the keyboard, use the artwork on disk, alter or store pictures, and add color. This teaches spatial and color relationships and the basics of early programming skills. For II, II Plus, IIe, and III; floppy disk, \$39.95. Scarborough Systems Inc., 25 North Broadway, Tarrytown, NY 10591.

Project for an Energy Enriched Curriculum (PEEC), a collection of six independent, integrated programs on energy-conservation issues. Technical Education Research Centers (TERC) and the National Science Teachers Association (NSTA) aided in the development of these six programs that include *Electric Bill*, *Energy Conversions*, *Home Energy Savings*, *Personal Energy Inventory*, *Power Grid*, and *Temperature Grapher*. For II, II Plus, and IIe; floppy disk, \$225 for all six programs; also available individually. HRM Software (see address above).

Songwriter, a music-composing system for ages four through adult. Compose or learn theory with music and a metronome already on disk. Manipulate tempo or scale by touching a key; print out your composition; or hear it on a computer or stereo. Includes a cable that connects the stereo to the computer. For II, II Plus, IIe, and III; floppy disk, \$39.95. Scarborough Systems Inc. (see address above).

Super Quiz II, a multiple-choice test-generation system. This educational tool enables teachers and ad-

ministrators to create a test bank of up to 10,000 questions; add, edit, or replace questions; print copies of exams; and choose from a dozen other tasks. For II, II Plus, and IIe; floppy disk, \$49.95. Sterling Swift Publishing Co., 7901 South IH-35, Austin, TX 78744.

Termexec, a comprehensive communications package. You can log in via modem to a remote host computer, electronic bulletin-board system, or an information, news, or stock-market service. Features include expanded character set, long-file handling, scrolling, macro commands, exec files, full-screen editor, and more. A hotline is available for technical support. For II Plus and IIe; floppy disk, \$79.95. Exec Software Inc., 201 Waltham St., Lexington, MA 02173.

Atari

Cosmic Tunnels, an arcade-type game. Save your planet Sirref from energy starvation the Jebbs have imposed by destroying their space mines and missile launchers. Then retrieve as many glowing energy bars from four asteroids as you can while avoiding dynobots and quicksand. For 800 and 1200; floppy disk, \$34.95. Datamost Inc., 8943 Fullbright Ave., Chatsworth, CA 91311-2750.

FDOS, a disk operating system for FORTH users. In addition to performing normal DOS 2.05 file manipulations, this program also converts DOS files to FDOS files that are saved on your FORTH disk. You can create data files with existing BASIC programs operating under DOS 2.05, and then convert them for use in a FORTH program. For 400/800 and 1200; floppy

disk, \$39.95. Superware, 2028 Kingshouse Rd., Silver Spring, MD 20904.

Hellcat Ace, a flying-combat simulation. The three-dimensional scene is in the Pacific during WWII. You confront 14 scenes in time ranging from 1940 to defending the fleet from Kamikaze attacks during the invasion of Iwo Jima in March 1945. Become an ace by maneuvering your aircraft through aileron rolls, loops, split Ss, and Immelmann turns. For 400/800; floppy disk, \$29.95. Microprose Software, 10616 Beaver Dam Rd., Hunt Valley, MD 21030.

Major League Hockey, a hockey-simulation game. Use your maneuvering ability to score goals and beat the other team. Features include a scrolling display of the rink and a game timer. Because the ice rink is triple the screen size, your view of the rink changes according to where the puck is. For 400/800 and 1200; cartridge, \$44.95. Thorn Emi Home Video, 1370 Avenue of the Americas, New York, NY 10019.

Monster Smash, an arcade-type game. You are the master of the local graveyard. The monsters who have moved in have destroyed the peace and quiet and are trying to escape through the gates. You must smash as many monsters as possible but let all the visitors and children pass through the gates unharmed. For 400/800 and 1200; floppy disk, \$29.95. Datamost Inc. (see address above).

Mountain King, an arcade-type game. Armed only with a flashlight and a thirst for adventure, you delve into the heart of a secret mountain and try to capture the crown. Carry it safely to the top of

the mountain before your time expires and you will become Mountain King; if not, you will be destroyed. Requires a joystick. For 400/800; cartridge, \$25. CBS Software, 1 Fawcett Place, Greenwich, CT 06836.

Party Mix, a collection of five arcade-type games. In *Bop a Buggy*, you drive a two-wheeled buggy through various screens to cross the finish line. In *Tug of War*, your team tries to pull the opposing team across the line. In *Wizard's Keep*, you control a wizard who releases his fireball to hit chickens or ships. In *Down on the Line*, workers must move packages around on colorful conveyor belts. In *Handcar*, you race on railroad tracks across the desert. For the 2600; cartridge, \$9.95. Epyx/Automated Simulations, 1043 Kiel Court, Sunnyvale, CA 94089.

Pooyan, a high-resolution arcade-type game. Battle a pack of vicious wolves to protect your helpless piglets. You shoot arrows at wolves that float in the air by holding onto balloons. For 400/800 and 1200; floppy disk, \$29.95. Datasoft, 9421 Winnetka Ave., Chatsworth, CA 91311.

Scroll It, a machine-language program. You can implement variable-speed fine scrolling in a BASIC program. The fine scrolling can be continuous horizontal, vertical, or diagonal; the ANTIC character mode can be changed; and the screen can be coarse scrolled to any *x,y* location. For 400/800; floppy disk, \$19.95. Superware (see address above).

Solar Fox, an arcade-type space-adventure game for one or two players. As Earth runs out of energy, you must navigate your starship through a complex matrix of

solar cells guarded by fireball-shooting Sentinels. The faster your speed, the greater your reward. See if you can unlock the secret of the Solar Fox. For the 2600; cartridge, \$25. CBS Electronics, 41 Madison Ave., New York, NY 10010.

Space Knights, a group of simulated science-fiction adventure games. As you follow Jake and Lisa through challenging encounters, you try to land your rocket on the surface of an alien planet or race through the Corridor of Time. Learn vector-trigonometry fundamentals in *Navigate*. For 400/800; floppy disk and book, \$24.95. Reston Publishing Co. Inc., 11480 Sunset Hills Rd., Reston, VA 22090.

CP/M

Datacure, an error-detecting and backup/restore utility program for CP/M version 2.2 operating systems. Using proprietary error-detection and correction techniques, you can reconstruct the original contents of disk sectors that have gone bad. Rebuild the original file and regenerate all the information for a complete track or for sectors damaged by a multitrack scratch. Floppy disk, \$99. Colorado Online Systems Inc., 40 Balfour Lane, Ramsey, NJ 07446.

FORTRAN Relabel, a label-renumbering program. All the numeric labels in FORTRAN programs containing statements and all labeled line references can be renumbered using this program. Subroutines, function subprograms, and Microsoft EDIT80 line numbers are processed automatically. You specify ASCII code and the numeric value of desired

Software Received

label and increment. Floppy disk, \$29.95. Cleydale Engineering, POB 784, Dahlgren, VA 22448.

Magibind, a word-processing program. Upgrade your word-processing equipment with automatic numbering of chapters, paragraphs, and articles; automatic printing of personalized letters for mass mailing; print-time selection of records; automatic verification of data-file accuracy; flexible page heading and footing; and other capabilities. Floppy disk, \$250. Computer Editype Systems, 509 Cathedral Parkway 10A, New York, NY 10025.

Printman, a print-spooler system. An alternative to the standard DESPOOL and SPOOL programs. Minicomputer capabilities such as add, change, delete, list, and others give you increased system use. Perform more functions on files with special features and enter any number of items to the list. Floppy disk, \$195. Data Base Administrators Inc., W305 S4553 Brookhill Rd., Waukesha, WI 53186.

The Word Machine, a word-processing/text-editing program. Transform your computer into an automatic typewriter letting you create, edit, store, and print letters, forms, manuscripts, and personalized form letters. Detailed help instructions are included. Floppy disk, \$37. GB Associates, POB 3322, Granada Hills, CA 91344.

Commodore

The Complete Personal Accountant, five personal financial programs. This package transforms your computer into a financial manager with

a checkbook-maintenance program, a detailed summary budget, an appointments and payments calendar, a "what if" spreadsheet, and a tax-handling format. For the 64; floppy disk, \$79.95. Programmer's Institute, POB 3470, Chapel Hill, NC 27514.

Easy Finance I-V, five financial-calculation programs that include a loan-analysis program, an investments-analysis program, an advanced investments-analysis package, a business-management package, and a statistics and forecasting package. For the 64; floppy disks, I: \$39.95, II-V: \$24.95. Commodore Business Machines Inc., 1200 Wilson Dr., West Chester, PA 19380.

Easy Script, a word-processing program. You can create, store, modify, and print text. A training section introduces you to ten sections that include exercises, applications, and format examples. A reference section shows you how to use the facilities, including mail-merge. For the 64; floppy disk, \$50. Commodore Business Machines Inc. (see address above).

Final Orbit, an arcade-type game. You must stop the Maladroid fighters who are raiding the Earth. You lose energy each time Earth or your fighter gets hit. Try to regain energy by destroying a Maladroid base. Bumper Bash included for free. For the VIC-20; cartridge, \$39.95. Sirius Software Inc., 10364 Rockingham Dr., Sacramento, CA 95827.

Spitfire Ace, an air-combat simulation game. Fly your WWII fighter in loops, rolls, and split-S maneuvers to win in 14 scenarios. If you can complete five missions that include the Battle of Britain and the challenge of the first

jet fighter, you become an ace. For the 64; floppy disk, \$29.95. Microprose Software, 10616 Beaver Dam Rd., Hunt Valley, MD 21030.

Squish 'Em, an arcade-type game. As you climb to the top of a 48-story building to collect a suitcase of money, try to avoid being knocked off the building by a variety of Creepy Creatures or falling objects. For the VIC-20; cassette, \$19.95. Sirius Software Inc. (see address above).

3-D Othello, a three-dimensional board-game simulation of Othello in machine-language programming. Two players can compete in four skill levels with colorful graphics and sound effects for younger players. Helps to develop spatial perspective and strategic skills. Requires a joystick. For the VIC-20; cassette, \$15. Ojai Software, POB 1860, Ojai, CA 93023.

IBM Personal Computer

Aura, an integrated information-management system containing word-processing, electronic-spreadsheet, business-graphics, and communications programs with an optional micro-mainframe communications link. You can create business reports of customers with outstanding balances, weed inactive accounts from mailing lists, track sales by product and region, and create reorder lists of low inventory. Floppy disks, \$495; with communications-link capacity, \$995. Softrend, 87 Indian Rock Rd., Windham, NH 03087.

BASLIN, a BASIC line number/page program. This utility is designed to let BASIC use programs that were previously created as a program

library. You can combine programs, renumber the listing, and create a new, enhanced program. Floppy disk, \$35. Orion Co., 524 North 2nd St., Weatherford, OK 73096.

Burgertime, an arcade-type game. Your chef is in a maze surrounded by pickles, hot dogs, and eggs that are trying to get him. If they catch him, his fast-food career is over. Try to sprinkle pepper on a pickle and dodge down a ladder. Floppy disk, \$25. Mattel Electronics, 5900 Wilshire Blvd., Los Angeles, CA 90036.

Chartmaster, a commodity-and stock-charting program. You can examine, analyze, display, and print a variety of price charts. You can also generate high, low, close bar, and moving averages. The database can be updated by retrieving stock or commodity price information via data communications. Floppy disks, \$275. Professional Farm Software, 219 Parkade, Cedar Falls, IA 50613.

Conquest, a prehistoric-simulation game. As King of the Falcons, you use your strength and endurance against pterodactyl warriors. You must swoop down to destroy them while encountering hurricanes, tornados, and dragons trying to deter you. Floppy disk, \$39.95. Windmill Software Inc., 2209 Leominster Dr., POB 1008, Burlington, Ontario L7P 3W8, Canada.

CP+, a collection of training and productivity programs for your computer. It is a user-friendly interface between you and the command interface of the operating system and provides extended utility features. Designed for nontechnical users. Floppy disk, \$79.95. Taurus Software Corp., Suite 170, 3155 Kearney, Fremont, CA 94538.

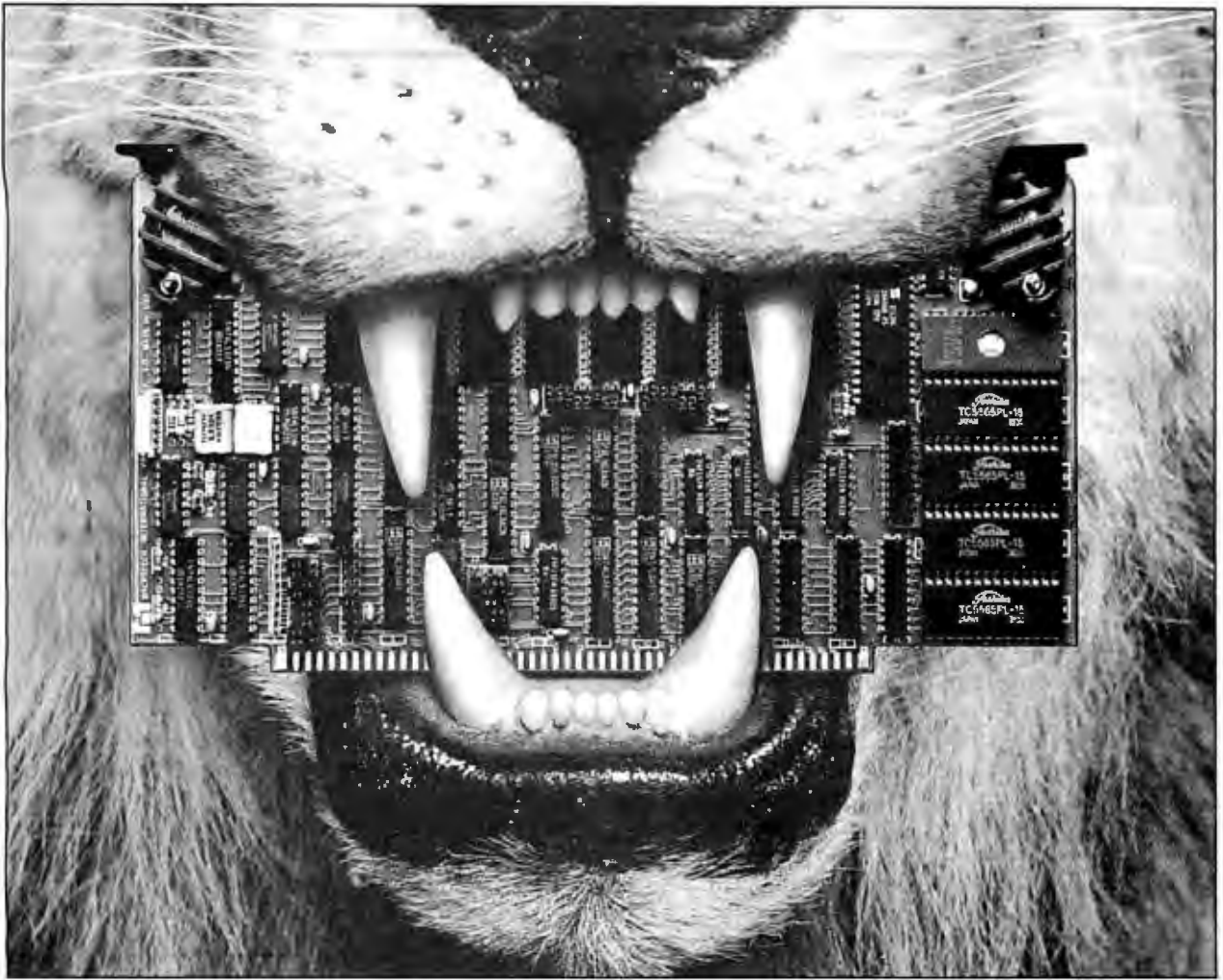

KING OF THE S-100 JUNGLE



You'll reign supreme when your S-100 system is equipped with Macrotech's high performance products. Our full megabyte high speed dynamic RAM and 16 channel intelligent DMA I/O boards provide the edge you need in today's competitive jungle.

Our one slot MAX dynamic RAM is field expandable from 256K to one megabyte. You get far more than just the low price per kilobyte of \$2.39. You get:

- IEEE 696 full parity detection • Virtual disk support in all popular Digital Research operating systems • High Speed Z80, 8085—6 MHz; 8086, 8088, 68,000—8 MHz No Wait States
- On-board refresh • 16-24 bit Memory Mapped Addressing option
- DMA fully supported in strict compliance with IEEE 696

Our ADIT 16-channel serial I/O board is no pussycat either. An on-board 6 MHz Z808 provides intelligence for a large array of commands. Plus important things like:

- Resident virtual disk interface • Memory to memory DMA
- 24-bit DMA addressing • Field expandable from 4 to 16 channels
- Full compliance with IEEE 696

Macrotech makes every slot in your computer really count! To get the rest of our story on the ADIT or the MAX, write or call us. In the S-100 jungle Macrotech products can be your key to success.

MACROTECH INTERNATIONAL CORP.

9551 Irondale Ave., Chatsworth, CA 91311, (213) 700-1501
TELEX: 9109970653

Dealer/Distributors: Priority One Electronics (800) 423-5922, (213) 709-5111

John D. Owens Assoc. (212) 448-6283. In England: Fulcrum [Europe] (0621) 828-763

Software Received

EMSearch Bioscience Software, a database-retrieval system. You can store, cross-index, and retrieve electron-micrograph records. For use in biological and materials science, this program uses 14 search categories (specimen, fixative, and user-defined) for 4200 to 8500 electron micrographs on one disk. No computer experience is necessary. Floppy disk, \$99. New Leaf Enterprises Inc., 1901 C Waters Edge, Ft. Collins, CO 80526.

The Executive's Guide to the IBM Personal Computer, a BASIC programming and Visicalc spreadsheet template for business purposes. Executives can learn to program chapter by chapter by using payroll, inventory, and other business examples. Mathematical experience is not required. Floppy disks, \$49.95. Reston Publishing Co., 11480

Sunset Hills Rd., Reston, VA 22090.

Financial Planning for Lotus 1-2-3, an electronic-spreadsheet template program. You can calculate 16 financial planning and forecasting problems contained on disk. Each program, called a worksheet, is a complete and ready-to-use program that solves several related financial problems with Lotus 1-2-3. Floppy disk, \$89.95. Howard W. Sams & Co. Inc., 4300 West 62nd St., Indianapolis, IN 46268.

Fontastic, a document-enhancing printer program. Designed to work with a word processor, this program lets you print diagrams, drawings, and foreign language characters with 20 fonts supporting sub- and superscripts, italics, underline, bold, and more. You can also

create your own character set. Floppy disks, \$125. IHS Systems, Suite 211, 4718 Meridian Ave., San Jose, CA 95118.

4-Point Graphics, a color-graphics program that features a four-part cursor for versatility in creating, manipulating, storing, and retrieving images from all or part of the screen. Dual memory buffers allow access to images for comparison, overlays, and creation of animation. Floppy disk, \$195. International Microcomputer Software Inc., 633 Fifth Ave., San Rafael, CA 94901.

The Idea Processor, an integrated word-processing system and textual data-management system that run simultaneously. This program lets you save spreadsheets and graphics in a database, cross-index them using 10 keywords, use graphics

from DOS-based programs in its printed documents, and put on a slide-show presentation with a graphics program. Floppy disk, \$295. Idea Ware, 225 Lafayette St., New York, NY 10012.

Knoware, an educational program for business professionals that teaches business applications. By playing games, you learn about spreadsheet applications, database management, text editing, financial decision-making, simple graphics, and programming techniques. Floppy disk, \$95. Knoware Inc., 301 Vassar St., Cambridge, MA 02139.

Match Wits, an educational game for the whole family. In six categories (words, sports, famous people, multiplication, cities, and animals), you try to match pairs to uncover a hidden picture puzzle. You

Egghead Bytes Back

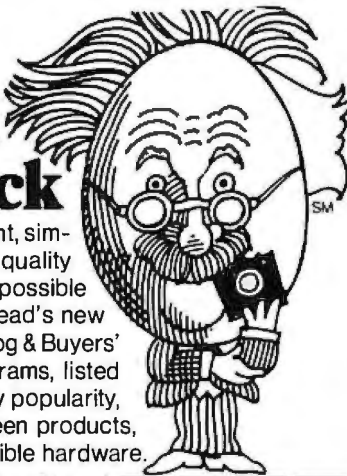

Finally there's a convenient, simple way to buy the hottest quality software at the lowest possible prices. Introducing Egghead's new Software Simplified Catalog & Buyer's Guide. Hundreds of programs, listed by category, prioritized by popularity, with the difference between products, what they do and compatible hardware.

Mail this coupon today, and we'll rush you Egghead's new Catalog & Buyer's Guide. Only \$1 plus 4-bits postage and handling.

Name _____

Address, Phone # _____

City, State, Zip _____

Check Money Order enclosed.

VISA, MasterCard # _____ Exp. Date _____

Washington State residents add 7.9% sales tax.

To order by phone: (206) 451-8155

EGGHEAD SOFTWARE 10636 Main St. #206
Bellevue, WA 98004



New Release!

MICROSTAT®

MICROSTAT® Rel. 4.0 has all of the powerful features that have made **MICROSTAT®** the most popular interactive statistics package for the past several years and now includes:

- Interface with ASCII files and external data base/spreadsheet files.
- Output redirection to text files for editing and report generation.
- Missing data handling.
- Improved Recode/Select options.
- Handles large data sets. File size is limited only by disk capacity for most procedures.

Runs under MS-DOS/PC-DOS, CP/M86, and CP/M. Requires 128K memory (64K for CP/M). The price of \$375 includes the expanded manual. A demo disk and manual are available for \$40.



P.O. Box 68602
Indianapolis, IN 46268-0602
(317) 255-6476



Registered trademarks: Ecosoft (MICROSTAT), Microsoft (MS-DOS), IBM (PC-DOS), Digital Research (CP/M, CP/M-86)

can also create and program your own categories. Floppy disk, \$29.95. CBS Software, 1 Fawcett Place, Greenwich, CT 06836.

Night Stalker, an arcade-type game. Your man is trapped in a maze with robots, spiders, and bats trying to track him down. Destroy them with your gun before they get him. Floppy disk, \$24. Mattel Electronics (see address above).

PC Write, a word-processor and text-editor program. This program helps you write and format any text. Features include insert, replace, delete, wordwrap, search, move and copy blocks, a split-screen mode, and functions for more advanced users. Floppy disk and manual, \$35. User registration fee, \$75. Quicksoft, 219 First North #224, Seattle, WA 98109.

Pits & Stones, an artificial-intelligence strategy game for all ages. Try to collect the most stones in your home pit by taking turns distributing them. Plan each move ahead while anticipating your opponent's strategies. Floppy disk, \$36.95. Orion Software, POB 2488, Auburn, AL 36831.

Realpac, a collection of real estate analyses programs. Features include files that let you calculate fixed rate, fixed principal reduction, graduated payment and equity, renegotiable/variable rate amortization schedules, internal rate of return calculator, and other programs related to real estate purchasing and sales. Floppy disks, \$275. Creative Business Computer Systems Inc., 6731 Red Rd., Coral Gables, FL 33143.

Rogue, a fantasy-adventure game. You are on a quest for the amulet of Yendor in the

Dungeons of Doom. Discover magical objects, food, and weapons, but beware of the monsters lurking in the darkness. Floppy disk, \$44.95. Artificial Intelligence Design Systems, POB 3685, Santa Clara, CA 95055.

SR-LIB, a library-manager program. You can create and modify library files that are compatible with the PC-DOS linker. Add object files, delete and replace modules in a library, and list the names of the modules in a library. Floppy disk, \$29.95. Software Research, POB 10004, Austin, TX 78766.

Scientific Mathematical Function Library, a mathematical-applications system. This Microsoft package is for C programmers in engineering and graphics who need more mathematical sophistication than C provides. Features include 20 functions, fatal errors, warning errors, and a math library of three files. Floppy disk, \$45. Soft C, 14350 Southwest Derby St., Beaverton, OR 97005.

Small Fortune Auto-Ledger, a general-ledger program. Handle your bookkeeping by structuring your accounts and reports. Designed for business-accounting needs, features include transaction entries, suggested accounts, setting up reports, testing templates, and updating records. Floppy disks, \$250. Emerald Software Inc., 2416 Warren Ave. N, Seattle, WA 98109.

Tiào Ch'i, a Chinese-checkers simulation game. Played on a six-pointed star, two to six players take turns consecutively moving men from their star point to the opposite star point. Whoever makes it in the least number of moves is the winner. Floppy disk, \$24.95. Microclassics, 315

OPTIMIZING C86™ Like a Puppet on a String!

Serious programmers can use Optimizing C86 to control the IBM PC and other MS-DOS/PC-DOS computers. Features include:

- **Full and Standard** versions of the C language — to balance portability with complete control of the machine.
- **Hardware and operating system interfaces** for: graphics, interrupt control, **8087** use, I/O ports, real time applications and for producing ROMS.
- **Standard MS-DOS Linker** support and option to produce MASM from C86. This helps integrate with MASM, MS FORTRAN and PASCAL.
- **A rich set of libraries** includes source for K&R functions, string handling, graphics, sorting, floating point (8087 and 8086/88), "**Large**" model (1,000K RAM), "Small" memory model, MS-DOS 1.1, 1.25, 2.0, 2. + +.
- Support for numerous **add-on libraries** including: HALO **Graphics**, C Tools, PHACT for **ISAM** file management and numerous others. Ask for a list.

Pull Charlie's strings with our fast, complete, reliable C Compiler — the **leading compiler for serious programmers** of MS-DOS and CPM-86 systems.



Computer Innovations
980 Shrewsbury Avenue
Suite J-504
Tinton Falls, N.J. 07724
(201) 542-5920

**"They Say It All...
We Do It All!"**

Visa and MasterCard accepted.

C86 is a trademark of Computer Innovations, Inc. CPM-86 and MPM-86 are trademarks of Digital Research. MS-DOS is a trademark of Microsoft. PC-DOS is a trademark of International Business Machines.

Computer problems? DON'T BLAME THE SOFTWARE!

Isolators prevent:

Pat. # 4,259,705

- CPU/printer/disk interaction
- Lightning or spike damage
- AC power line disturbances
- RFI-EMI interference



Commercial Grade Isolators

ISO-1 3 Isolated Sockets	\$ 81.95
ISO-2 2 Isolated Socket Banks, 6 Sockets	\$ 81.95

Industrial Grade Isolators

ISO-3 3 Double Isolated Sockets	\$122.95
ISO-11 2 Double Isolated Banks, 6 Sockets	\$122.95

Laboratory Grade Isolators

ISO-17 4 Quad Isolated Sockets	\$213.95
ISO-18 2 Quad Isolated Banks, 6 Sockets	\$180.95

Circuit Breaker, any model (Add-CB)	Add \$ 11.00
Remote Switch, any model (Add-RS)	Add \$ 20.00

ESP Electronic Specialists, Inc.
171 S. Main St., Box 389, Natick, Mass. 01780 (817) 655-1632

Toll Free Order Desk 1-800-225-4878
MasterCard, VISA, American Express

Software Received

West Grand Ave., El Segundo, CA 90245.

Osborne 1

Cost Estimating With Risk Analysis (CEWRA), a spreadsheet-template business program designed to let you estimate project costs using fundamental risk-analysis techniques. It includes three types of estimates: constant, uniform, and triangular for project-cost elements such as labor, materials, and capital. For use with Supercalc. Floppy disk, \$39. CPG Inc., POB 1057, Chester, VA 23831.

Multi-Factor Productivity Measurement Model for Small Business (MFPMM-SB), a spreadsheet-template small-business program. Enter the price and quantity data for input and output factors and you receive calculated desired productivity indexes, ratios, and their impact on profits. For use with Supercalc. Floppy disk, \$79. CPG Inc. (see address above).

TRS-80

Accounts Receivable, an accounting program that monitors sales and incoming funds. Features include a balance-forward system, a capacity of up to 2000 transactions per month with 150 customers on file, optional late-charge processing, mailing labels, and printing of general-ledger reports. For the Model 4; floppy disks, \$199.95. Radio Shack, 300 One Tandy Center, Ft. Worth, TX 76102.

COBOL for the TRS-80, Volume One, an instructional package designed to teach the fundamentals of COBOL programming to secondary and college-level students. Each chapter of the manual includes an overview, objectives, hands-on experience, flowcharts and diagrams where applicable, programs, discussion, a summary, and review. For Models II, 12, and 16; floppy disk, \$49.95. Radio Shack (see address above).

Corplan, a business-simulation program. This educational package is designed to

supplement business instruction at the college or advanced secondary levels by simulating corporate operations. This program puts a player or a team in control of a theoretical corporation, planning overall business policy and applying the decisions needed for success. No computer experience is needed. For Models III and 4; floppy disk, \$49.95. Radio Shack (see address above).

Diskdisk, a hard-disk file-allocation program. You can turn your hard-disk drive into a logical series of floppy-disk drives. Create files on a disk that appear to the system to be other disk drives. All system functions are available as if these files were actual drives. Mirror-image backups function normally. For Models I and III (version 5.1) and Model 4 (version 6.0); floppy disks, \$99. Logical Systems Inc., 8970 North 55th St., POB 23956, Milwaukee, WI 53223.

Examiner, a BASIC program for teachers to administer tests to students at a computer. Students find out immediately if their answers are

right or wrong. Teachers can display student grade lists and answers, and determine the selected test items that need review by the frequency of errors. For Models III and 4; floppy disk, \$69.95. Microsoft Services, POB 776, Harrisonburg, VA 22801.

Guardian, an arcade-type game. Protect ten energy modules that enemy ships are trying to steal from your planet's force field. Catch, but do not destroy, the enemy with a stolen module or else the energy will be lost and the enemy will transform to a higher energy state. For the Color Computer; floppy disk, \$29.95; cassette, \$27.95. Quasar Animations, 1520 Pacific Beach Dr., San Diego, CA 92109.

Investment Analysis, a portable three-program package. Fixed Income Security Evaluator calculates data useful for buying or selling fixed-income securities. Commission Calculator calculates commission charges for stock and option transactions. Option Strategy Evaluator calculates the results of option transactions involving vari-

For the Home and the Office
The ORGANIZER and the COPY STAND

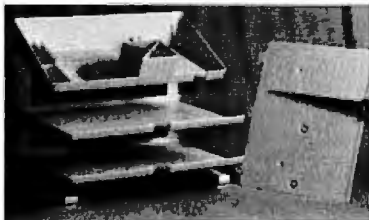

We designed it and priced it just for you. The Organizer with its multi-compartments keeps everything in easy reach. 14w x 10d x 12h, the stand with its free-moving locator is great for all documents.

Organizer 15.95 Stand 4.95
 Both for only 19.95
 Beige Gray Yellow Lt. Blue
GA Residents add 4% sales tax.
Send check to R.P.D. Products of GA.
P.O. Box 541, Pine Lake, GA 30072

Name _____
Address _____

Contractor

Accounting & Management

**JOB
COSTING
with
Bonding
Reports**



multi-state/multi-union variable-rate payroll with certified reports, subcontract management accounts payable, equipment costing, accounts receivable, general ledger, estimating and critical path. Fully integrated, excellent audit trail source code supplied. Mature installed 5 1/2 years nationwide. Multi-user available.



Written for
CP/M 80, CP/M 86
and MS DOS
1610 South Main - Dept. HB
Bountiful, Utah 84010
801-298-0052

Dynax Letter Quality

DX-15 Daisy Wheel Printer

- 3K Buffer
- 2 Color Printing
- Bold Printing
- Super/Sub Script
- Proportional Spacing
- Auto Double Strike
- Logic Seeking
- Bi-directional Printing
- Optional Key Board . . . \$145
- Brother HR1 \$555
- Epson FX80 \$549
- Sanyo, Monitor/Printer/Software. . . . \$1395
- CITH, Geminis and more

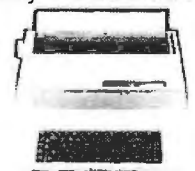

only \$435

ALL PRODUCTS UP TO 40% DISCOUNT

THE COMPUTER CLUB, INC.

8380 Miramar Rd. Ste 200

San Diego, CA 92126

(619) 578-5654



ous combinations of put and call purchases and sales. For the Model 100; cassette, \$69.95. Radio Shack (see address above).

LS-HOST/Term, a telecommunications package. This set of seven programs lets the Model 4 emulate an ADDS 25 terminal with video effects. The computer can also be remotely controlled by another computer or terminal. Package includes a binary-to-ASCII conversion utility and a file-transfer program using Christiansen protocol. For the Model 4; floppy disk, \$199. Logical Systems Inc. (see address above).

MLIB, a program that aids in the construction of Microsoft-compatible relocatable object-file libraries. Commands let you add, replace, copy, or delete modules from existing libraries or you can create new libraries from individual modules. For Models I and III; floppy disk, \$50. Misosys, POB 4848, Alexandria, VA 22303-0848.

Real Estate Investment Analysis, five financial-planning programs. Mortgage Analysis calculates percentages of loans, mortgages, amortization, and more. Mortgage Equity Analysis calculates values, resale prices, ratios, and yields. Present Worth Analysis calculates the present value and worth of steady and uneven income. Utility Routine Analysis calculates interest, expenses, budgets, capitalization rate, and more. Statistical Analysis performs tests using decision-tree and time-trend analysis to forecast net-operating income. For the Model III; floppy disk, \$99.95. Radio Shack (see address above).

The Traveling Appointment Manager, a portable appoint-

ment-reminder program. Keep track of personal and professional appointments. Enter dates up until the turn of the century. Old appointments are erased unless you reschedule them. You can also list things-to-do and print your calendar. For the Model 100; cassette, \$59.95. Traveling Software Inc., 11050 Fifth Ave. NE, Seattle, WA 98125.

The Traveling Time Manager, a portable time-keeping program. You can keep track of billable and nonbillable work hours. Other applications include keeping track of expenses, recording and listing student grades, managing equipment and machinery usage, tracking a runner's miles, and averaging time per mile. For the Model 100; cassette, \$59.95. Traveling Software Inc. (see address above).

TRS-80 Wordstar, an adapted version of the word-processing program by Micropro. Features include automatic line wrap, margin set, and various other text adjustments. On-screen help and prompts let you design and lay out your pages. The documentation describes the differences between the two versions. Includes sin-LDOS, an enhanced operating system. For the Model III; floppy disk, \$395. Logical Systems Inc. (see address above).

Other Computers

Picture Perfect, a business-graphics system. With this program you can transform your data into pies and exploded pies, vertical and horizontal bar charts, or line charts. Features include numerous bar and pie shading patterns. For the Hewlett-

Packard HP 150; floppy disk, \$295. Computer Support Corp., 4215 Beltwood Parkway, Dallas, TX 75234.

Stock Control, a stock-control system. You can keep 500 items per file with a two-second access time. Features in-

clude an audit trail, item/supplier search facilities, reorder levels, nine menu options, and unlimited entries. For the Timex/Sinclair 2000 (Spectrum); cassette, £14.95. Kemp Limited, 43 Muswell Hill, London N10 3PN, England. ■

This is a list of software packages that have been received by BYTE Publications during the past month. The list is correct to the best of our knowledge, but it is not meant to be a full description of the product or the forms in which the product is available. In particular, some packages may be sold for several machines or in both cassette and floppy-disk format; the product listed here is the version received by BYTE Publications.

This is an all-inclusive list that makes no comment on the quality or usefulness of the software listed. We regret that we cannot review every software package we receive. Instead, this list is meant to be a monthly acknowledgment of these packages and the companies that sent them. All software received is considered to be on loan to BYTE and is returned to the manufacturer after a set period of time. Companies sending software packages should be sure to include the list price of the packages and (where appropriate) the alternate forms in which they are available.

SUPPLIES FORMS & STATIONERY

for Apple, IBM PC, TRS-80 & other Desk-Top Computers

- Continuous checks, statements, or invoices . . . 500 for \$49.95 or less.
- Compatible with 350 software publishers.
- Diskettes, printer ribbons, Micro-perf™ letterheads, labels, work station aids.
- High quality, low prices, small quantities.
- Money-Back Guarantee.
- Next day shipment of supplies ordered by TOLL FREE phone.
- **Send today for your FREE CATALOG**

Please rush my FREE NEBS Computer Forms Catalog.

Name _____	Phone _____		
Company Name _____	Your Line of Business _____		
Street Address _____			
City, State and Zip _____			
Use computer for: (Check as many as apply)			
<input type="checkbox"/> Home	<input type="checkbox"/> Business	<input type="checkbox"/> Word Processing	<input type="checkbox"/> Accounting
<input type="checkbox"/> Apple	<input type="checkbox"/> TRS-80	<input type="checkbox"/> Plan to purchase within _____	<input type="checkbox"/> Have a printer?
<input type="checkbox"/> IBM PC	<input type="checkbox"/> Other _____		

NEBS Computer Forms
G6A 84 3 CODE 11008

12 South Street, Townsend, MA. 01469
A division of New England Business Service, Inc.

Books Received

Ada, An Advanced Introduction, Narain Gehani. Englewood Cliffs, NJ: Prentice-Hall, 1983; 700 pages, 18 by 24.3 cm, hardcover, ISBN 0-13-003997-7, \$28.95.

Advanced BASIC, Roy A. Boggs. Reston, VA: Reston Publishing Co., 1983; 208 pages, 15.3 by 22.8 cm, softcover, ISBN 0-8359-0161-0, \$16.95.

Affordable Word Processing, Richard A. McGrath. Englewood Cliffs, NJ: Prentice-Hall, 1983; 160 pages, 15.3 by 22.8 cm, softcover, ISBN 0-13-018259-1, \$10.95.

Applied Numerical Methods for the Microcomputer, Terry E. Shoup. Englewood Cliffs, NJ: Prentice-Hall, 1984; 272 pages, 15.8 by 23.8 cm, hardcover, ISBN 0-13-041418-2, \$25.95.

Basic Beginnings, Susan Drake Lipscomb and Margaret Ann Zuanich. New York: Avon/Camelot Books, 1983; 96 pages, 13 by 19 cm, softcover, ISBN 0-380-83774-9, \$2.25.

BASIC-80 and CP/M, Jack Jay Purdum. New York: Macmillan Publishing Co., 1983; 240 pages, 17.5 by 25.5 cm, softcover, ISBN 0-02-397020-0, \$16.95.

Basic & Pascal In Parallel, S. J. Wainwright. London, England: Bernard Babani Ltd., 1983; 64 pages, 11 by 18 cm, softcover, ISBN 0-85934-101-1, £1.50.

BASIC-PLUS for Business, Wilson T. Price. New York: Holt, Rinehart and Winston, 1983; 350 pages, 23.5 by 17.5 cm, softcover, ISBN 0-03-061768-5, \$17.95.

Basic Programs for Production and Operations Management, Pricha Pantumsinchai, M. Zia Hassan, and Ishwar D. Gupta. Englewood Cliffs, NJ: Prentice-Hall, 1983; 448 pages, 15 by 22.5 cm, softcover, ISBN 0-13-066266-6, \$14.95.

Battlestar BASIC for the

TRS-80, David H. Dasenbrock. Indianapolis, IN: Howard W. Sams & Co., 1983; 104 pages, 13.5 by 21.5 cm, softcover, ISBN 0-672-22006-7, \$12.95.

CP/M Bible, Mitchell Waite and John Angermeyer. Indianapolis, IN: Howard W. Sams & Co., 1983; 432 pages, 18 by 23 cm, softcover, ISBN 0-672-22015-6, \$19.95.

CP/M and the Personal Computer, Thomas A. Dwyer and Margot Critchfield. Reading, MA: Addison-Wesley, 1983; 512 pages, 21.8 by 28 cm, softcover, ISBN 0-201-1-355-9, \$19.95.

Churches, Charities & Computers, G. Walter Coles. Huntington Beach, CA: Coles Associates, 1983; 208 pages, 13.5 by 21 cm, softcover, ISBN-none, \$15.

Commodore Software Encyclopedia, 3rd ed. Commodore Business Machines Inc., West Chester, PA: Commodore Electronics Ltd., 1983; 896 pages, 21.5 by 28 cm, softcover, ISBN 0-672-21944-1, \$19.95.

The Complete Book of Home Computers, Van Waterford. Blue Ridge Summit, PA: Tab Books, 1982; 256 pages, 13 by 20.5 cm, softcover, ISBN 0-8306-1423-0, \$10.95.

Computer Assisted Investment Handbook, Albert I. A. Bookbinder. Elmont, NY: Programmed Press, 1983; 230 pages, 17.8 by 25 cm, softcover, ISBN 0-916106-03-9, \$19.95.

Concepts for Distributed Systems Design, Gregor von Bochmann. New York: Springer-Verlag, 1983; 274 pages, 17 by 25 cm, hardcover, ISBN 0-387-12049-1, \$19.

Conceptual Programming Using BASIC, Allen Baker and Kathy Hamrick. Englewood Cliffs, NJ: Prentice-Hall, 1984; 224 pages, 15 by 22.7 cm, softcover, ISBN 0-13-166678-9, \$16.95.

A Course on Programming in

FORTRAN, 2nd ed. Valerie J. Calderbank. New York: Methuen Inc., 1983; 196 pages, 15.5 by 23.5 cm, softcover, ISBN 0-412-23790-3, \$9.95.

Data Management and File Processing, Mary E. S. Loomis. Englewood Cliffs, NJ: Prentice-Hall, 1983; 512 pages, 16 by 23.5 cm, hardcover, ISBN 0-13-196477-1, \$29.95.

Developing Data Structured Information Systems, Michael H. Brackett. Topeka, KS: Ken Orr & Associates Inc., 1983; 206 pages, 21.5 by 28 cm, softcover, ISBN 0-9605884-1-8, \$20.

Developing Microcomputer-based Business Systems, Chris Edwards. Englewood Cliffs, NJ: Prentice-Hall, 1983; 224 pages, 15 by 22.5 cm, softcover, ISBN 0-13-204545-1, \$16.95.

Documenting Computer Application Systems, Derek A. Kelly. Princeton, NJ: Petrocelli Books, 1983; 186 pages, 16 by 24 cm, hardcover, ISBN 0-89433-206-6, \$19.95.

Documentation Development Methodology, Techniques for Improved Communications, Sandra Pakin & Associates Inc., Englewood Cliffs, NJ: Prentice-Hall, 1982; 240 pages, 22 by 28.8 cm, hardcover, ISBN 0-13-217167-8, \$35.

Dynamics of Visicalc, Barry D. Bayer and Joseph J. Sobel. Homewood, IL: Dow Jones-Irwin, 1983; 200 pages, 19 by 23.5 cm, softcover, ISBN 0-87094-391-X, \$19.95.

Executive's Guide to Computer-Based Information Systems, James C. Wetherbe. Englewood Cliffs, NJ: Prentice-Hall, 1983; 192 pages, 16 by 24 cm, hardcover, ISBN 0-13-295428-1, \$17.95.

Forecasting on Your Microcomputer, Daniel B. Nickell. Blue Ridge Summit, PA: Tab Books, 1983; 384 pages, 19.5 by 23.5 cm, softcover, ISBN 0-8306-0607-6, \$15.50.

High-Tech Consulting, John Zarrella. Fairfield, CA: Microcomputer Applications, 1983; 176 pages, 15.3 by 23 cm, softcover, ISBN 0-935230-08-4, \$18.95.

How to Program Your Atari in 6502 Machine Language, Sam D. Roberts. Holzkirchen, West Germany: Ing. W. Hofacker GmbH, 1982; 112 pages, 13 by 20.5 cm, softcover, ISBN 3-92-1682-97-5, \$9.95.

IEEE Transactions on Communications, The Institute of Electrical and Electronics Engineers Inc. Englewood Cliffs, NJ: Prentice-Hall, 1983; 192 pages, 22 by 28.5 cm, hardcover, ISBN 0-13-450271-X, \$30.

Inside the IBM Personal Computer, revised ed. Tenley Design. Washington, DC: Starware, 1982; 36 pages, 13.5 by 21.5 cm, softcover, ISBN-none, \$14.

Introduction to Data Base Management in Business, James Bradley. New York: Holt, Rinehart and Winston, 1983; 642 pages, 18 by 24 cm, hardcover, ISBN 0-03-061693-X, \$33.95.

Introduction to Information Processing, William M. Fuori and Dominick Tedesco. Englewood Cliffs, NJ: Prentice-Hall, 1983; 352 pages, 23.3 by 17.5 cm, softcover, ISBN 0-13-484634-6, \$9.95.

Introduction to Numerical Computation in PASCAL, P. M. Dew and K. R. James. New York: Springer-Verlag, 1983; 304 pages, 15.5 by 23.5 cm, softcover, ISBN 0-387-91216-9, \$16.

An Introduction to Visicalc Spreadsheets for the TRS-80 Model III, Harry Anbarlian. New York: BYTE Books/McGraw-Hill, 1983; 448 pages, 15.8 by 23.5 cm, spiral-bound, ISBN 0-07-001597-X, \$49.95. Includes 5¼-inch floppy disk.

Machine Code and Better Basic, Ian Stewart and Robin

Jones. Boston, MA: Birkhäuser, 1983; 200 pages, 16 by 24 cm, softcover, ISBN 3-7643-3115-1, \$11.95.

Manager's Guide to Computers and Information Systems, Larry E. Long. Englewood Cliffs, NJ: Prentice-Hall, 1983; 416 pages, 15.5 by 23.5 cm, hardcover, ISBN 0-13-549394-3, \$25.

McGraw-Hill Encyclopedia of Electronics and Computers, Sybil P. Parker, ed. New York: McGraw-Hill, 1984; 976 pages, 22.3 by 28.8 cm, hardcover, ISBN 0-07-045487-6, \$59.50.

Micro Cookbook, Fundamentals, vol 1. Don Lancaster. Indianapolis, IN: Howard W. Sams & Co., 1982; 384 pages, 13.5 by 21.5, softcover, ISBN 0-672-21828-3, \$15.95.

Micro Cookbook, Machine Language Programming, vol. 2. Don Lancaster. Indianapolis, IN: Howard W. Sams & Co., 1983; 13.5 by 21.5 cm, softcover, ISBN 0-672-21829-1, \$15.95.

Micros for Managers, Joseph R. Little, Philip E. Mackey, and Leroy J. Tuscher. Trenton, NJ: New Jersey School Boards Association, 1983; 276 pages, 21.5 by 28 cm, softcover, ISBN 0-912337-01-1, \$28.

Micro Software Distributors, Richard Loftin and Jack F. Shelton, eds. Washington, DC: Software Research Co., 1983; 192 pages, 20.3 by 26.8 cm, softcover, ISBN 0-940758-26-1, \$95.

Microcomputers, A Parent's Guide, Kenneth P. Goldberg and Robert D. Sherwood. New York: John Wiley & Sons, 1983; 208 pages, 15 by 23 cm, softcover, ISBN 0-471-87278-4, \$8.95.

Microcomputer Companies in the UK, 1st ed. Eurolec 58. Bristol, England: David Rayner Publisher, 1983; 370 pages, 21 by 30 cm, softcover, ISBN 0-900614-58-7, \$50.

Microcomputer Experimentation with the Synertek SYM-1, Lance A. Leventhal. Engle-

wood Cliffs, NJ: Prentice-Hall, 1983; 512 pages, 17.5 by 23.5 cm, softcover, ISBN 0-13-580910-X, \$19.95.

Needed: Professional Management in Data Processing, John J. Callahan. Englewood Cliffs, NJ: Prentice-Hall, 1983; 224 pages, 15.5 by 23.5 cm, hardcover, ISBN 0-13-610956-X, \$25.

New Technology Coloring Book, Rita Aero and Howard Rheingold. New York: Bantam Books, 1983; 80 pages, 21.3 by 27.5 cm, softcover, ISBN 0-553-34022-0, \$6.95.

Numerical Methods for Unconstrained Optimization and Nonlinear Equations, J. E. Dennis Jr. and Robert B. Schnabel. Englewood Cliffs, NJ: Prentice-Hall, 1983; 400 pages, 16 by 23.5 cm, hardcover, ISBN 0-13-627216-9, \$28.95.

101 Projects for the Z80, Frank P. Tedeschi and Robert Colon. Blue Ridge Summit, PA: Tab Books, 1983; 368 pages, 19.5 by 23.5 cm, softcover, ISBN 0-8306-1491-5, \$16.95.

PDP-11 Software Source Book, 1st ed. Maynard, MA: Digital Equipment Corp., 1983; 998 pages, 13.3 by 20.3 cm, softcover, free.

The Personal Computer BASIC(S) Reference Manual, Donald A. Sordillo. Englewood Cliffs, NJ: Prentice-Hall, 1983; 336 pages, 17.5 by 23.5 cm, softcover, ISBN 0-13-658047-5, \$16.95.

The Personal Computer Book, Peter A. McWilliams. Los Angeles, CA: Prelude Press, 1983; 336 pages, 15.3 by 22.8 cm, softcover, ISBN 345-31106-X, \$9.95.

The Personal Computer in Business Book, Peter A. McWilliams. Los Angeles, CA: Prelude Press, 1983; 288 pages, 15.3 by 22.8 cm, softcover, ISBN 345-31294-5, \$9.95.

Personal Computing with the UCSD P-System, Mark Overgaard and Stan Stringfellow. Englewood Cliffs, NJ:

Prentice-Hall, 1983; 464 pages, 15.5 by 23.5 cm, hardcover, ISBN 0-13-658096-3, \$23.95.

Pocket Guide to FORTH, Linda Baker and Mitch Derick. Reading, MA: Addison-Wesley, 1983; 110 pages, 10 by 15.5 cm, spiral-bound, ISBN 0-201-10103-3, \$7.25.

The Politics of Projects, Robert Block. New York: Yourdon Press, 1983; 152 pages, 15 by 23 cm, softcover, ISBN 0-917072-35-9, \$18.50.

Planning for Future Market Events Using Data Processing Support, Jerome Svigals. New York: Macmillan Publishing Co., 1983; 202 pages, 16 by 24.5 cm, hardcover, ISBN 0-02-949740-X, \$27.95.

Planning, Implementation, and Control in Product Test and Assurance, Richard H. Spencer. Englewood Cliffs, NJ: Prentice-Hall, 1983; 222 pages, 18 by 24.5 cm, hardcover, ISBN 0-13-679506-4, \$27.50.

Problem Solving and Structured Programming with FORTRAN 77, Martin O. Holoien and Ali Behforooz. Monterey, CA: Brooks/Cole Publishing Co., 1983; 528 pages, 18.5 by 23.5 cm, softcover, ISBN 0-534-01275-2, \$19.95.

Program Descriptions I for Hofacker Software for your Atari Computer, Winfried Hofacker. Holzkirchen, West Germany; Ing. W. Hofacker GmbH, 1982; 128 pages, 13 by 20.5 cm, softcover, ISBN-none, \$4.95.

Program Design with Pseudocode, T. E. Bailey and Kris Lundgaard. Monterey, CA: Brooks/Cole Publishing Co., 1983; 224 pages, 23.5 by 18 cm, softcover, ISBN 0-534-01361-9, \$10.95.

Programming with Graphics, Garry Marshall. Englewood Cliffs, NJ: Prentice-Hall, 1983; 128 pages, 15.3 by 22.9 cm, softcover, ISBN 0-13-729608-8, \$12.95.

Programming Your Timex/Sinclair 1000 in Basic, Mario Eisenbacher. Englewood

Cliffs, NJ: Prentice-Hall, 1983; 208 pages, 15 by 23 cm, softcover, ISBN 0-13-729863-3, \$9.95.

Questions & Answers on Word Processing, Peter A. McWilliams. Los Angeles, CA: Prelude Press, 1983; 224 pages, 15.3 by 22.8 cm, softcover, ISBN 345-31295-3, \$9.95.

Reference Manual for the ADA Programming Language, ANSI/MIL-STD-1815A-1983. United States Department of Defense. New York: Springer-Verlag, 1983; 340 pages, 21.5 by 28 cm, softcover, ISBN 0-387-90887-0, \$13.50.

Security Dictionary, Robert A. Hofmeister and David J. Prince. Indianapolis, IN: Howard W. Sams & Co., 1983; 176 pages, 13.7 by 21.5 cm, softcover, ISBN 0-672-220-20-4, \$8.95.

The Software Catalog, Spring 1983, New York: Elsevier Science Publishing Co., 1983; 808 pages, 21 by 28 cm, softcover, ISBN 0-444-00745-8, \$69.

The Software Catalog, Spring 1983 (Update), New York: Elsevier Science Publishing Co., 1983; 408 pages, 21 by 28 cm, softcover, ISBN 0-444-00749-0, \$15.

The Software Catalog, Fall 1983. New York: Elsevier Science Publishing Co., 1983; 1040 pages, 21 by 28 cm, softcover, ISBN 0-444-00776-8, \$69.

Stimulating Simulations for the VIC, 2nd ed. C. W. Engel. Rochelle Park, NJ: Hayden Book Co., 1983; 96 pages, 15 by 23 cm, softcover, ISBN 0-8104-5173-5, \$6.50.

Structured Computer Organization, 2nd ed. Andrew S. Tanenbaum. Englewood Cliffs, NJ: Prentice-Hall, 1984; 480 pages, 18.5 by 24.3 cm, hardcover, ISBN 0-13-854489-1, \$29.95.

Structured Digital Design Including MSI/LSI Components and Microprocessors, Raymond M. Kline. Englewood Cliffs, NJ: Prentice-Hall, 1983; 462

Books Received

pages, 18 by 24.3 cm, hardcover, ISBN 0-13-854554-5, \$28.95.

Synchronous Packet Radio Using the Software Approach, vol. 1, Robert M. Richardson. Chautauqua, NY: Richcraft Engineering Ltd., 1983; 232 pages, 21.5 by 28 cm, spiral-bound, ISBN 0-940972-07-7, \$22.

Telephony: Today and Tomorrow, Dimitris N. Chorafas. Englewood Cliffs, NJ: Prentice-Hall, 1984; 304 pages, 15.3 by 22.8 cm, softcover, ISBN 0-13-902700-9, \$19.95.

30 Games for the Timex/Sinclair Computer, Bill L. Behrendt. Englewood Cliffs, NJ: Prentice-Hall, 1983; 96 pages, 13.5 by 20.3 cm, softcover, ISBN 0-13-918896-7, \$4.95.

26 Basic Programs for Your Micro, Derrick Daines. Indianapolis, IN: Howard W. Sams & Co., 1982; 174 pages, 13.5 by 21.5 cm, softcover,

ISBN 0-672-22047-4, \$8.95.

Understanding Microcomputer Concepts, Jefferson C. Boyce. Englewood Cliffs, NJ: Prentice-Hall, 1984; 336 pages, 15.3 by 22.5 cm, softcover, ISBN 0-13-936956-2, \$14.95.

Using Business Basic, Wilson T. Price. New York: Holt, Rinehart and Winston, 1983; 267 pages, 19 by 23.5 cm, softcover, ISBN 0-03-063176-9, \$19.95.

Using 1.2.3, Geoffrey T. LeBlond and Douglas Ford Cobb. Indianapolis, IN: Que Corp., 1983; 448 pages, 18.8 by 23.5 cm, softcover, ISBN 0-88022-045-7, \$14.95.

VIC Graphics, Nick Hampshire. Rochelle Park, NJ: Hayden Book Co., 1982; 192 pages, 15 by 23 cm, softcover, ISBN 0-8104-1057-5, \$12.95.

VisiWord, David Myers. San Jose, CA: Visicorp, 1983; 272 pages, 18.8 by 23 cm, softcover, ISBN 912213-01-9,

\$18.95.

Who's Who in Microcomputing, 1983, Datapro Research Corp. New York: McGraw-Hill, 1983; 686 pages, 21.5 by 28 cm, softcover, ISBN 0-07-015405-8, \$39.95.

ZX-81/Timex, Programming in BASIC and Machine Language, Holzkirchen, West Germany: Ing. W. Hofacker GmbH, 1982; 148 pages, 13 by 20.5 cm, softcover, ISBN 3-921682-98-3, \$9.95. ■

This is a list of books received at BYTE Publications during this past month. Although the list is not meant to be exhaustive, its purpose is to acquaint BYTE readers with recently published titles in computer science and related fields. We regret that we cannot review or comment on all the books we receive; instead, this list is meant to be a monthly acknowledgment of these books and the publishers who sent them.

BYTE's Bits

Color Computer BBS On-Line

A computerized BBS (bulletin-board system) for users of the Radio Shack TRS-80 Color Computer is up and running 24 hours a

day in Santa Barbara, California. A 300- or 1200-bit-per-second modem is required, and the system permits both up- and downloading. For more information, call the CoCo Corner BBS at (805) 687-9400. ■

WAIT NOT, WANT NOT!

If you've been waiting for a disk emulator that can increase your system's throughput by as much as 50 times, the wait is over. **QUASI-DISK** is here!

QUASI-DISK is a high capacity, I/O mapped RAM board which acts like an additional disk drive on any S-100 system.

Here's what makes **QUASI-DISK** a better buy than the others:

- Fully S-100/696 compatible.
- **QUASI-DISK** offers 2 modes of expansion:
 - a) Chip capacity may be doubled with the addition of an add-on module.
 - b) Storage capacity may be increased to 4 Megabytes by replacing 64K RAMs with 256K devices.
- DMA compatible with transfer rates to 2 Megabytes/second.
- On board powerfail logic write protects disk during power failures.
- Optional battery back-up provides 2 hours of powerfail protection.
- External wall mount power supply allows system power to be switched off while data is retained indefinitely.
- Six layer printed circuit board improves performance and reliability.

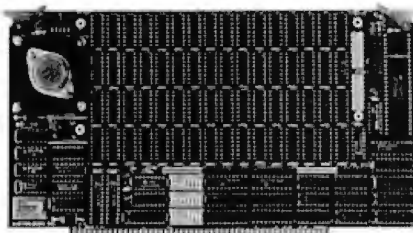

GUARANTEE

Unique design guarantees that **QUASI-DISK** will perform as advertised, in standard as well as non-standard S-100 systems. OR YOUR MONEY BACK

Prices valid until
March 31, 1984.

Manufactured by:

Electra™ **logics**

Incorporated

- Requires only 6 I/O addresses to access entire board.
- Supports extended I/O addressing when enabled.
- On board 22 bit address generator may be programmed for auto increment or decrement if desired.
- Any sector size may be implemented.

- Onboard LED's indicate "drive active" and "powerfail status".
- Price includes installation software on 8" SS/SD diskette with all source code supplied.
- Sample CP/M* Bios routines are included for integration into any CP/M* system.
- **QUASI-DISK** is covered by a 1 year warranty and an extended warranty option is also available.

QUASI-DISK (512K) — \$1299.00
Expansion Module
(additional 512K) — \$799.00
Back-up Battery (including wall mounting supply) — \$159.00

*CP/M is a registered trademark of Digital Research.

TIME SAVED IS MONEY

Book Reviews

Discover FORTH

Thom Hogan
Osborne/McGraw-Hill
Berkeley, CA: 1982
140 pages, softcover,
\$14.95

Reviewed by
Paul E. Hoffman

Although the microcomputer industry has adopted BASIC as a standard language, it is by no means the final word on languages. More than five other languages are becoming popular for specific applications and users, and FORTH is among the most recent.

Thom Hogan's *Discover FORTH* is not simply another language book because FORTH is not at all just another language. The concepts in FORTH programming are very different from those used in BASIC programming, and Hogan introduces FORTH programming innovatively in a nontechnical fashion. Hogan has previously authored *Osborne CP/M User Guide*.

To a BASIC programmer, FORTH programs resemble a long list of subroutine calls with few procedural steps. Once a procedure is defined in FORTH, it can be used anywhere else, so that a procedure can call any other procedure or even call itself. This is quite a different technique than programming in BASIC, and *Discover FORTH* holds the reader's hand, so to speak, throughout this learning process.

Why FORTH?

Although the FORTH language has been available in the microcomputer market for a few years, this is the first book to answer the question, Why should I be interested in another language, and why should it be FORTH? Hogan points out the uniqueness of

FORTH programming, such as relying on a memory stack and the absence of GOTO statements. He describes how FORTH is better suited to programming than other languages.

Several books on the market are introductions to FORTH, but *Discover FORTH* has more for the novice FORTH user. Hogan has kept in mind the fact that microcomputer users are not always oriented to bits and bytes, and many have programmed only in BASIC. The book thus has a friendly tone without talking down to people who know other languages but want a flavor of FORTH.

Hogan also realizes the advantages of humor in teaching. Without trying to be a laugh a minute, he succeeds in making an otherwise dry and sometimes complex language interesting. A few section headings are puns, as in "It's His FORTH Operation, Doctor" for the section discussing arithmetic operators, and "I/O You an Explanation" for the section describing how to use input/output operations.

Using FORTH

Hogan suggests that the FORTH language is one that should be learned by doing. The author gives short examples of programs that include the operations being described. Each example is shown in its environment so that the reader can easily follow the sequence. Since FORTH is an interactive language, results can be viewed at any time throughout the entire programming process. Because FORTH programs look very different from BASIC, Hogan recommends that the reader verify the results of steps explained in the book.

Two of the most difficult

FORTH concepts to teach are the use of the stack and the greatly reduced use of variables. Most programmers familiar with procedural languages such as BASIC have never used stacks and frequently use variables in their programs. Thus, FORTH's techniques for storing information during program execution need special attention.

Discover FORTH devotes chapters to each of these concepts early in the book to give the reader a clearer idea of why FORTH might seem strange. While many authors cover these basic FORTH structures only briefly, Hogan emphasizes them early enough so that you can be sure you understand them before reading on. He succeeds in explaining the concepts through the use of illustrations and real-world analogies.

Examples in FORTH

One problem with *Discover FORTH* is the rarity of examples. Although Hogan fully explains each FORTH word (which is the equivalent of a BASIC command), he offers only three or four small programs to show how to actually develop something with the language. This makes it harder to decide if you're interested enough in the language to buy the book. However, the examples he does provide are clear and explained fully in the text.

Regardless of Hogan's underuse of example programs, you will certainly know what each part of FORTH does by the time you finish reading the book. Since FORTH rarely uses variables (at least, not in the way they are used in BASIC), it is a major task to describe the structure of the language and diagram the actions of particular FORTH words.

The Book's Structure

The book is broken into three areas: the low-level concepts and history of FORTH, how words in FORTH make things happen, and how to make your computer run your FORTH programs. Because each area is covered thoroughly, the reader is left with the impression that the author said everything he wanted to in a small amount of space. The book demonstrates how FORTH can be taken out of its current jargon-riddled state and be tailored to the individual programmer. Hogan stresses this throughout the book and takes some of the edge off the strange words chosen for some FORTH concepts.

In essence, *Discover FORTH* is a practical book for anyone who is interested in a new and very different language for his microcomputer. It is written on a level that anyone can appreciate, and it shows FORTH's strengths as well as its weaknesses. As the title implies, the purpose of the book is to exhort you to become involved in FORTH, and it does so in a way not found in other FORTH manuals. ■

Paul E. Hoffman, president of Proper Software (Suite 1024, 2000 Center St., Berkeley, CA 94704), writes manuals for microcomputer companies in the San Francisco area.

BYTE's Bits

Electronic Bookshelf on Air

McGraw-Hill Book Company's Electronic Bookshelf is on air weekdays from 6 p.m. to 8 a.m. eastern standard time and for 24 hours on weekends. For a catalog of computer and electronic books, log on by calling (212) 997-2488. ■

What's New?

SOFTWARE



Magical Programming Language

MAGIC from Data Management Associates is a medium-level, portable programming language that creates applications programs without requiring a run-time package. The instruction set permits the creation and maintenance of machine-executable programs, and its file I/O capabilities support random, sequential, and ISAM file types. MAGIC has internal data areas that are said to be completely variable with buffers that are dynamically allocated for hardware and software efficiency. Other fea-

tures include BCD arithmetic with up to 36 digits, simplified screen formatting and data editing, the ability to mix assembly language anywhere in source code, and total string-manipulation capability.

MAGIC is available for CP/M; 8086; and 8088-based systems. It costs \$795, which includes a cross-referenced manual. For details, contact Data Management Associates Inc., POB 4340, Wilmington, DE 19807, (302) 655-8986. Circle 510 on inquiry card.

Utility Lets You Edit Any Byte

Media Magician is a full disk-editing utility that lets you view, change, and save any byte, string, or sector anywhere on a floppy or hard disk. It provides simultaneous screen displays of the hexadecimal and ASCII representations of each byte. Editing can be done on either window, and all changes in one window are immediately made in the corresponding display. Media Magician uses single-character commands for such functions as printing out a sector, searching for a specific string, comparing two sectors, and mov-

ing sectors. Other features include help screens and the ability to use IBM PC color or monochrome graphics.

Media Magician works with the IBM Personal Computer and machines running MS-DOS version 2.0. It requires 64K bytes of RAM and an 80-column display. The price is \$48.50, plus \$1.50 for postage and handling. Contact Photon Software, 636 120th Ave. NE, Bellevue, WA 98005, (800) 426-2675; in Washington, (206) 451-8272. Circle 502 on inquiry card.

Simulation Environment Is Interactive

GPSS/PC is a simulation environment designed for interactive use on the IBM Personal Computer. Using GPSS/PC, you can predict the effects of managerial or engineering decisions on complex real-world systems. The software features more than 70 blocks and commands, 45 SNAs (system numerical attributes), clock and internal precisions limited only by the amount of computer memory, full-period 32-bit random-number generators, and the ability to include exponents, cosines, tangents, and logarithms in complex expressions. All blocks and SNAs can be accessed from within the program or entered interactively through the keyboard during simulation. You can mix SNAs into complex expressions and construct accurate probability distributions without using GPSS functions.

GPSS/PC will expand beyond a megabyte of memory if your DOS permits. Models typically require approximately 0.003 second per block entry on the IBM PC's 4.77-MHz 8088 processor. Dynamic allocation of individual entry types and indirect addressing through transaction parameters are supported. The following are limited solely by the amount of memory in your computer: parameters per transaction, random-number generators, chains occupied by a transaction, and internal accumulators. Operator conveniences include on-line helps, command recognition, keystroke-error correction, assignable function keys, automatic spacing, cursor prompting, and a built-in line editor.

Production quantities of GPSS/PC will be available in May. For information on licensing fees, contact Minuteman Software, POB 171, Stow, MA 01775, (617) 897-5662. Circle 504 on inquiry card.

Pro-Accountant for DEC Professional

Deccomp's Pro-Accountant General Ledger accounting software operates on the DEC Professional 350 microcomputer. A novel feature of this system is its multitasking capability, which lets you set up posting of journals or generate and print reports in the background while continuing to use the keyboard for other tasks. Pro-Accountant can handle multiple companies and divisions on the same disk, and two years of detail is maintained with one year of budget amounts. When a report is generated, the profit account is automatically computed, which allows contribution income to be shown by individual or all departments. Pro-Accountant is menu-driven, and it fully supports all the Professional 350's special function keys.

Pro-Accountant costs \$1500. For complete details, contact Deccomp Inc., 14752 Sinclair Circle, Tustin, CA 92680, (714) 730-5116.

Circle 500 on inquiry card.

Sophisticated Word Processor for PC

Volkswriter Deluxe is a sophisticated word processor for business and professional users of the IBM Personal Computer and its compatibles. When used with a database manager, such as dBASE II, Volkswriter lets you compile a mailing list, send personalized form letters, and print labels. Through the use of virtual memory, document sizes can be as large as 1 megabyte. Page endings, underlining, boldface, double strike, and ~~strike-throughs~~ are shown on screen. Special features include horizontal scrolling up to 250 characters, chapter-end footnotes, and proportional spacing.

What's New?

This program comes preconfigured for 16 printers. Multiple fonts and color monitors are supported. It can handle multilingual keyboards and printer character sets and work with Lotus 1-2-3, Visicalc, and a variety of spelling checkers. Among the additional word-processing functions provided with Volkswriter are single-keystroke editing, on-screen reference guide, variable margins, superscripts, and subscripts.

Volkswriter Deluxe costs \$285. For more information, contact Lifetree Software Inc., Suite 315, 411 Pacific St., Monterey, CA 93940, (408) 373-4718.

Circle 501 on inquiry card.

Sort/Merge Co-routine Operates Interactively

Co-Sort from Information Resources is a general-purpose sort/merge co-routine for on-line report generators, database managers, mailing lists, and compilers. Co-Sort operates interactively with a calling program or off-line for utility sorting and merging. Its time-sorting algorithm is accessed interactively by programs in ASM, CBASIC, MBASIC, Pascal, and other languages that can call a machine-language routine. Any number and type of filters, inputs, keys, and outputs are permitted with Co-Sort, including exception processing. I/O records can be transferred in files or directly in memory without physical I/O.

Co-sort runs under CP/M-80, CP/M-86, or MS-DOS. It costs \$200, which includes programs and documentation in ASM and BASIC. For more information, contact Information Resources, POB W, Manhasset, NY 11030, (516) 365-7629.

Circle 507 on inquiry card.

Family Medical Program

Navic Corporation's Family Medical Advisor is an informational and educational program that analyzes overt symptoms and identifies the probable cause of a medical condition. This program prompts you with a series of yes-or-no questions to establish a pattern. It then analyzes your responses and lists related disorders with similar symptoms in descending order of probability. In the database are details on nearly 200 common illnesses.

Family Medical Advisor runs on an Apple II Plus with 48K bytes of memory and a disk drive. For more information, contact Navic Corp., POB 14727, North Palm Beach, FL 33408, (305) 627-4132.

Circle 508 on inquiry card.

LISP System for IBM PC

Gold Hill Computers has announced the availability of Golden Common LISP (GCLISP) for the IBM Personal Computer. GCLISP offers a full range of data types, including infinite-precision integers, floating-point numbers, arrays, character strings, lists, structures, and symbols. It supports object-oriented programming. GCLISP has been enhanced with such programming development aids and operating extensions as a full-screen intelligent editor, multitasking capabilities, macro instructions, memory allocation, garbage collection, and stream-oriented I/O.

Gold Hill Computers plans to support the iAPX286 and to release a GCLISP compiler. GCLISP requires PC-DOS 2.0 or greater and 256K bytes of memory. The suggested price is \$375, which includes comprehensive documentation. Dealer inquiries are invited. For further information, contact

Gold Hill Computers Inc., 163 Harvard St., Cambridge, MA 02139, (617) 492-2071.

Circle 505 on inquiry card.

Accounting Software

The Certified Accounting System is an integrated accounting package for microcomputers running under CP/M-80, CP/M-86, MS-DOS, and PC-DOS. A key feature of this software is that it supports end-user customization of input screens, files, and report formats. Certified Software lets you tailor input screens to your business documents and forms, change numeric and alphanumeric field lengths and types, design new printed reports to replace or supplement standard reports, modify program print positions to match print positions on existing forms, and create vertical accounting packages targeted at specific needs. This package has received independent third-party review and certification from Touche Ross & Co., an international accounting firm.

The Certified Software package comprises five basic accounting modules: general ledger, accounts payable, accounts receivable, inventory, and payroll. In addition, a customizing kit is offered. All the modules are available with or without the ability to automatically update the general ledger whenever new data are entered into any module. Without the automatic general-ledger update, the suggested retail price for each module is \$195. Individual modules with the update feature are \$295. A required system guide is \$45. The customizing kit is \$145. Dealer inquiries are welcome. For the name of your nearest dealer, contact Certified Software Inc., 9900 Southwest Wilshire St., Portland, OR 97225, (503) 297-8666. Circle 503 on inquiry card.

Business Graphics for Microangelo

The DaVinci Business Graphics package from Professional Research Consultants lets you create presentation-quality charts and graphs using the Scion Microangelo Color System. From two to eight Microangelo bit planes can be supported by DaVinci to generate 4 to 256 colors per image. This package handles pie charts, exploded pie charts, bar and three-dimensional bar charts, linear pie charts, and line graphs. A menu-driven interactive data-entry program, DaVinci allows you to enter data values, titles, color selections, and axis-scale information. Data can come from user-written programs or programs capable of generating ASCII data files. All parameters and options for a particular image are stored in a work space that can be loaded for displaying or modifying the graph.

DaVinci runs on any Z80-based S-100 system compatible with CP/M 2.2. It costs \$650. Additional details are available from Professional Research Consultants, 12832 Augusta Ave., Omaha, NE 68144, (402) 330-5433.

Circle 506 on inquiry card.

Integrated Package for Business

An integrated software package for business people using the DEC Professional 350, Propel is distributed by Pro Computing. Propel's applications are divided into three categories: telephone communications, written communications, and number processing. Its telephone communications capabilities are made up of a telephone directory with auto-dial functions, a telephone-call notebook, and an answering and message service. For writ-

What's New?

ten communications, Propel offers word processing, electronic mail, and meeting and reading notebooks. A spreadsheet and graphics constitute its number-processing abilities. In addition, Propel enables the Professional 350 to emulate DEC and IBM terminals for communicating with main-frame computers.

Propel can operate at four different levels of sophistication. Each level offers additional features for customizing applications. The software uses dedicated function keys, simple

menu hierarchies, single-key-stroke commands, and a consistent set of commands across all applications. Data transfers between applications are said to be simple. On-screen prompts for each menu option and help screens assist users.

Propel is available with or without the telephone functions for \$1195 or \$950, respectively. A toll-free hot-line number supports users. For full details, write to Pro Computing Inc., Suite 3314, One Penn Plaza, New York, NY 10119.

Circle 509 on inquiry card.

MASS STORAGE

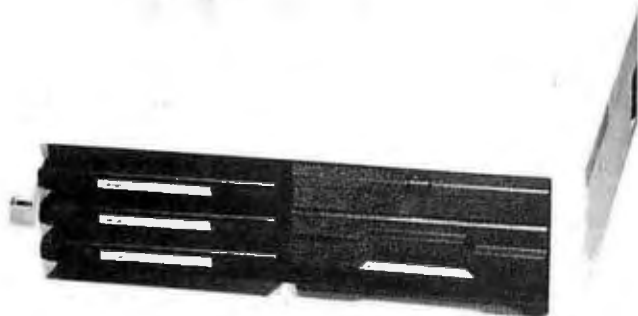

Fluid Dynamics Boosts Storage Capacities

Omega's engineers have adapted eighteenth-century Swiss mathematician Daniel Bernoulli's principle of fluid dynamics to flexible-disk subsystems. Called the Bernoulli Box, the unit controls the movement of air around a flexible disk as it spins under the recording head. As the disk is enveloped by air, it rises to within 10 microinches of the head, creating a soft interface that permits high media density and rapid access. The average access speed is 30 milliseconds, and the transfer rate is 1 megabyte per second. The removable flexible-disk cartridge can handle 10 megabytes of formatted data. Cabinet dimensions are 5½ by

19½ by 18 ⅞ inches.

The Bernoulli Box is available in 10- and 20-megabyte versions for the IBM PC XT and the Texas Instruments Professional Computer. The 10-megabyte unit, which is upgradable to 20 megabytes, has a \$2695 suggested retail price. The 20-megabyte unit lists for \$3695. The 10-megabyte upgrade kit is \$1000. The disk cartridges cost approximately \$60. Omega also produces 5¼- and 8-inch cartridge drives capable of holding 5.2 megabytes of data. For complete details, contact Omega Corp., 4646 South 1500 W, Ogden, UT 84403, (801) 399-2171.

Circle 514 on inquiry card.

5¼- and 3½-inch Winchester Unveiled

Microcomputer Memories has unveiled a line of Winchester-disk drives aimed at the OEM and systems integrators market. The drives have ST-506 interfaces and offer 6.38 and 12.75 megabytes of storage and are available in half-height 5¼- and 3½-inch formats. These devices are engineered with such safety features as head-landing zones for recorded-data protection. The 12-megabyte unit features two oxide platters and manganese/zinc read/write heads, permitting less critical densities and enhancing reliability.

The single-unit price of the 12-megabyte Winchester drive in a 5¼-inch enclosure is \$1300. OEM pricing can be less than \$700. Address inquiries to Microcomputer Memories Inc., 7444 Valjean Ave., Van Nuys, CA 91406, (213) 782-2222.

Circle 512 on inquiry card.

Microflopplodes Designed for Atari

A pair of 3-inch microflopplodes, the single-drive AMDC-I and the dual-drive AMDC-II, are compatible with Atari 400/800 and XL Series computers. Both units have an integral intelligent controller and DOS/XL operating system software. They can control up to four drives, each programmable for single- or double-density operation, and can be used in conjunction with 5¼-inch drives to boot Atari software. The media are Amdek's 3-inch cartridges, which feature an automatic shutter mechanism to protect against dust and fingerprints.

The AMDC-I provides 180K bytes of formatted storage. The AMDC-II gives you 180K bytes of double-density storage per side for a total of 360K bytes.

(Note that you must manually flip the cartridge.) The suggested retail price is \$599 for the former and \$850 for the latter. The 3-inch cartridge media are \$6.99 each. For full information, contact Amdek Corp., 2201 Lively Blvd., Elk Grove Village, IL 60007, (312) 364-1180.

Circle 511 on inquiry card.

Turbo-Disk Unveiled

The Turbo-Disk from New World Computer Company is a 5¼-inch Winchester-disk drive with a dozen read/write heads on each side of the disk. Its head slider assembly is mounted on a parallelogram that moves the read/write heads across a rotating disk in a purported 1/12th the time and distance of a single head. The Turbo-Disk provides an 8-millisecond access time for data under the heads and a 16-millisecond average access for remaining data. When not in use, the heads are locked above the disk surface, protecting data.

Turbo-Disk comes in configurations for the OEM and high-performance end-user markets. The first OEM model is a half-height 5-megabyte fixed-disk drive priced at \$1800. A 5-megabyte half-height fixed-disk drive enhanced with 5 megabytes of removable storage is available for \$2325. For end-users, the Turbo-Disk can be purchased as a 20-megabyte subsystem. This system features 5 megabytes fixed and 5 megabytes removable storage, plus 10 megabytes of additional storage in the form of two removable cartridges. It's provided with a power supply, disk controller, connecting cables, utility software, and a host interface that's compatible with IBM, Apple, DEC, S-100 bus, and Multibus systems. It lists for \$4950, with

What's New?

volume discounts available. Additional cartridges and an ST506/412 interface are optional. New World Computer Co. Inc., 6624 Owens Dr., POB 1479, Pleasanton, CA 94566, (415) 463-0330. Circle 515 on inquiry card.

Drive Stores 3.2 Megabytes at 170 TPI

MPI has announced Megadrive, a 5¼-inch floppy-disk drive with an unformatted storage capacity of 3.2 megabytes at 170 tpi. Standard features include back-up and program-load capabilities, 3-millisecond track-to-track access time, and a closed-loop positioning system designed to adjust the drive to media distortions caused by heat or humidity. Megadrive has a microprocessor coupled with a stationary quad sensor and a mylar reference scale that enables it to sense track locations and guide the head to the intended track, eliminating the risks associated with higher tpi densities. It's plug-compatible with existing 8-inch controllers with ST 850 interfaces, and it can read 48- and 96-tpi floppy disks. Mean time between failures is 8000 hours under typical usage.

OEM evaluation units are priced at \$500. Contact MPI, 9754 Deering Ave., Chatsworth, CA 91311, (213) 709-4202.

Circle 516 on inquiry card.

Subsystem Upgrades PC to XT Storage Capacity

Piiceon's WHAMS I-XT is a 10-megabyte Winchester-disk subsystem that upgrades the IBM PC to the storage capacity of a PC XT. The complete subsystem comprises a multi-function board equipped with

an RS-232C asynchronous serial port and room for up to 256K bytes of RAM, a half-height drive, and a drive connector cable. It's hardware- and software-compatible with the IBM PC and PC XT and runs all versions of PC-DOS, including DOS 2.0, as well as utilities.

WHAMS fits into the IBM's

second floppy-disk slot and requires two cable connections. It operates with the PC's power supply. Without RAM, WHAMS costs \$2375. Each 64K-byte RAM is \$90. For additional information, contact Piiceon Inc., 2045 Lundy, San Jose, CA 95131, (408) 998-4016.

Circle 513 on inquiry card.

PRINTERS



Qantex Compatible with Epson and Anadex ESC Codes

The Qantex Model 7065 serial dot-matrix printer is fully compatible with Epson and Anadex escape codes. Its operating speeds are 300 cps for draft copy; 250 cps, compose; 125 cps, near letter quality; and 65 cps, letter quality. In its dot graphics mode, this printer provides 144 by 144 bit-mapped dots per square inch at a repetition rate of 1500 dots per second per activated needle. Prominent print attributes include proportional spacing, right-hand margin justification, automatic underline, overprint and boldface, and downloadable fonts. The 7065 will store three letter-quality fonts on line before requiring a change of print wheels. Standard word-processing fonts are Trend and Courier; Emphasis, Cubic, Scientific, APL, Script, and

Italics are offered as options.

The Model 7065 is controlled by a Z80A microprocessor. The built-in 4.7K-byte buffer is expandable. The printer's single-sheet feeder incorporates a combination roller-tractor that lets you use continuous or cut-sheet forms. DIP-switch activated Centronics parallel or RS-232C serial interfaces are provided. Data-rate capabilities range from 110 to 19,200 bps.

Diablo compatibility is optional. In single units, the Model 7065 is \$1995. Purchasing information is available from North Atlantic Industries Inc., Qantex Division, 60 Plant Ave., Hauppauge, NY 11788, (800) 645-5292; in New York, (516) 582-6060.

Circle 517 on inquiry card.

Canon Unveils Three Printers

Canon U.S.A. recently introduced two near letter quality printers and a color ink-jet printer. The PW-1080A and the PW-1156A printers give you single-sheet insertion with roll, fan-fold, single-sheet, and multipart copy paper. They have a built-in, adjustable tractor feed, removable cartridge ribbon, and the ability to print four character styles on the same line. For high-resolution graphics, they provide N- by 16-dot matrix printing. Both operate at 160 cps. The PW-1080A prints 80 characters per line, and the PW-1156A can print 156 characters per line. Superscript, subscript, and international character sets are optional.

The PJ-1080A ink-jet printer can produce seven colors on paper and overhead transparencies. It has four character styles that it prints at 37 cps. The PJ-1080A has separate black and tri-color ink cartridges, high-resolution color-graphic printing of 640 dots per line, and automatic vertical and horizontal tabulation with page-length-per-inch setting. International character sets are available.

The suggested price for the PW-1080A is \$595. The PW-1156A is \$895, and the PJ-1080A is \$795. For more specifications, contact Canon U.S.A., 1 Canon Plaza, Lake Success, NY 11042, (516) 488-6700.

Circle 518 on inquiry card.

Color Printer for Atari

Axiom Corporation has introduced a multifunction, full-color printer that's compatible with Atari computers. The GP-700AT plugs directly into the Atari's serial port, eliminating the need for an 850 interface. It also permits daisy-chaining of cassettes and other

What's New?

peripherals without the 850 interface. Alphanumerics, symbols, and graphics elements can be output at speeds of up to 50 cps, and as many as 25 colors can be penned with a single pass of the four-hammer print head. A cassette ribbon, inked with black, magenta, cyan, and yellow, allows color mixing without smearing. A data-compression/expansion system that scans each line to be printed for repetitive data to

contract is said to send color information to the printer up to 100 times faster than conventional software.

The GP-700AT comes with a connecting cable and screen-dump programs. It lists for \$599. A complete description is obtainable from Axiom Corp., 1014 Griswold Ave., San Fernando, CA 91340, (213) 365-9521.

Circle 519 on inquiry card.



Thermal Printer Complements Portables

The TTX 1280 Portaprint, a three-pound battery- and AC-powered thermal-matrix printer, complements your portable or hand-held computer. This bidirectional printer operates at 40 cps (batteries) and 80 cps (AC). Portaprint uses a 5- by 7-dot nonimpact print head to produce a variety of character sizes and densities, specialized letters, and line and dot-by-dot placements. It offers graphics capabilities, bold and shadow printing, and oversized characters. Portaprint has a condensed-printing mode that lets

you expand its normal 80-column line so that 132-column spreadsheets can be printed on standard 8½- by 11-inch paper. Six-volt batteries provide 4000 to 5000 lines of print or approximately 2½ hours of operation.

The TTX 1280 Portaprint costs \$199. An AC adapter is supplied. Production quantities will be available in the spring. For full details, contact Teletex Communication Corp., 3420 East Third Ave., Foster City, CA 94404, (415) 341-1300.

Circle 521 on inquiry card.

Multifunction Printer from Epson

Epson's LQ-1500, a multifunction serial dot-matrix printer, can run at speeds from 60 to 200 cps. This 136-column unit has built-in character sets that provide the 96 ASCII characters, 13 international sets, and 128 downloadable characters. Its 45 standard fonts implement Pica and Elite spacing in regular, enlarged, emphasized, and condensed formats. Proportional spacing in regular and enlarged formats and regular and enlarged super- and subscripts are provided. A 24-pin print head forms characters with matrices spanning 9 by 17 to 37 by 17 dots. For graphics printing, variable resolution from 60 to 240 dots per inch can be achieved using 8- and 24-pin head configurations. Also supplied are a 15K-byte print line image buffer, bidirectional printing with logic seeking, automatic sheet loading, and software control over intercharacter spacing, print size, and vertical and horizontal tabs.

Centronics 8-bit parallel, RS-232C, and IEEE-488/GPIB interfaces are available. The LQ-15000 retails in the \$1200 to \$1500 range. OEM discounts are offered. Contact Epson OEM Products Division, 3415 Kashiwa St., Torrance, CA 90505, (213) 533-8277.

Circle 523 on inquiry card.

Smith-Corona Unveils Matrix Printers

Smith-Corona recently introduced a line of dot-matrix printers. At the high end is the D-300, which offers a printing speed of 140 cps and a column width of 132 characters (10 pitch). Among the key features of this near letter quality printer are six pitches, emphasized and elongated print, propor-

tional spacing, italics, bit-mapped graphics, character descenders, superscript, subscript, a 2K-byte buffer, and a 76-character ASCII set for printing in six foreign languages. Friction and tractor feed, bidirectional printing, shortline seek, and vertical and horizontal tabs are all standard. The character matrix ranges from 9 by 8 to 17 by 16 dots. Parallel and serial interfaces and self-test are supplied. The D-300 lists for \$795.

The D-200 differs from the D-300 in that it operates at 120 cps and its column width is 80 characters per line at 10 pitch. The suggested retail price is \$595.

The \$395 D-100 prints an 80-column line at 100 cps. This parallel printer, which is furnished with most of the accommodations of the D-300, has a full-line buffer capable of accommodating up to 132 characters. A serial interface is optional. Further information on these products is available from Smith-Corona, 65 Locust Ave., New Canaan, CT 06840.

Circle 522 on inquiry card.

Dot-Matrix Printer Supports Hi-Res Graphics

Apple's Imagewriter dot-matrix printer reproduces high-resolution graphics at speeds approaching 180 cps. The Imagewriter prints in a 7- by 9-dot matrix and provides variable resolution of 72 to 160 dots per inch. Such print features as variable pitch from 10 to 17 characters per inch, eight fonts, variable line spacing from 1/6 to 1/144 inch, and proportional font and line spacing are furnished. Fonts, underscores, superscripts, and subscripts can be mixed on the same line. Its bit-mapped graphics technology supports the Lisa's graphics capabilities.

What's New?

The Imagewriter uses either friction-feed or adjustable-width pin-feed tractors. Paper sizes range from 3 to 10 inches wide. Single sheets, fan-fold continuous forms, roll stock, and precut labels are all acceptable. Four copies can be printed simultaneously.

The Imagewriter uses a standard RS-232C interface to connect directly with the

Super Serial Interface card is required for the Apple II Plus and IIe. The suggested price is \$675, which includes cables, applications manual, user guide, and software for printing high-resolution graphics. Contact Apple Computer Inc., 20525 Mariani Ave., Cupertino, CA 95014, (800) 538-9696; in California, (408) 996-1010.

Circle 520 on inquiry card.



128K Standard with Leading Edge PC

The Leading Edge Personal Computer is an IBM PC-compatible offering 128K bytes of memory and an integrated RS-232C serial port. Salient features include a 7.16-MHz processing speed, seven IBM bus-compatible expansion slots, a digital time-of-day clock with battery backup, an 83-key IBM-format keyboard, and twin 5¼-inch 320K-byte floppy-disk drives. A 12-inch green-screen monitor with an 80 by 25

display format is standard. Microsoft DOS 1.25, Microsoft GW BASIC, and the Leading Edge Word Processor are bundled with the system.

The Leading Edge Personal Computer has a suggested retail price of \$2895. For further details, contact Leading Edge Products Inc., 225 Turnpike St., Canton, MA 02021, (800) 343-6833; in Massachusetts, (617) 828-8150. Circle 529 on inquiry card.

Senior Partner for Portable Computing

Panasonic's portable Senior Partner uses MS-DOS 2.0 and is compatible with IBM PC hardware and software. It incorporates a built-in thermal printer, a double-sided double-density 320K-byte floppy-disk drive, and a 9-inch display in a single 28.7-pound case. It has 128K bytes of RAM (expandable to 512K bytes) and is based on the 16-bit 8088 chip. For mathematics processing, the Senior Partner has a spare socket for an 8087 processor.

The thermal printer has graphics capabilities and can be switched from 80 to 132 characters per line. The video display has a green background and an 80 by 25 format. The format is adjustable to 40 characters per line. Senior Partner carries an RGB monitor port and Centronics parallel and RS-232C interfaces.

The Senior Partner measures 18¼ by 13¾ by 8¼ inches. It costs \$2495, which includes six software packages. Contact Panasonic Co., One Panasonic Way, Secaucus, NJ 07094. Circle 525 on inquiry card.

Turbodos System Carries Five Slaves

The QDP-400 TurboDOS multiuser system features a 6-MHz Z80B master central processor and up to five Z80A or Z80B slave processors. It comes with a standard 128K bytes of RAM, 128K bytes of RAM for each user, and a six-slot S-100 motherboard that accommodates double-height boards. Overall system speed is increased with a master controller DMA for disk and memory transfers. It's compatible with CP/M and MP/M applications software, and bank-switching of the operating sys-

tem in master and slave operations provides a transient program area for applications programs. TurboDOS networking gives users access to disks, magnetic tape cartridges, printers, modems, and other peripherals.

The QDP-400 features Winchester hard-disk storage for more than 30 megabytes and a double-sided double-density 8-inch 1.2-megabyte floppy disk. Up to 12 RS-232C serial ports with optional networking communications through serial channels and two Centronics parallel ports are available. System prices start at \$9995. Contact QDP Computer Systems, 10330 Brecksville Rd., Cleveland, OH 44141, (216) 526-0838. Circle 527 on inquiry card.

Single-Board Computer Controller

The Model 83-230 single-board computer from John Bell Engineering is designed for use as a print spooler or as a controller in security systems or robots. This 6502-based board has 55K bytes of dynamic RAM, 8K bytes of EPROM, four parallel ports, one serial RS-232C port, and four timers. It measures 4½ by 6½ inches and uses the 44-pin AIM bus. A 2716 monitor EPROM is available as a \$19.95 option. The bare board is \$49.95. The assembled and tested version is \$299.95. Full documentation is supplied.

A universal interface suitable for laboratory experiments and industrial-control applications is also available from John Bell Engineering. Designed for the IBM Personal Computer, the Model 83-064 has nine parallel 8-bit ports, 16 analog input ports, a timer, interrupt circuitry, and a prototyping area. It uses three 8255 programmable pe-

What's New?

ripheral-interface chips and an ADC-0817 analog input device. Analog inputs are 0 to 5 volts; the conversion time is approximately 200 microseconds per channel. The timer-oscillator runs at 32768 Hz and provides a total of 25 different frequencies. All I/O ports attach through 16-pin ribbon cables with DIP connectors. With documentation, the 83-064 costs \$299.95, assembled and tested. Contact John Bell Engineering Inc., 1014 Center St., San Carlos, CA 94070, (415) 592-8411.

Circle 530 on inquiry card.

Headstart Offers Up to 1 Megabyte RAM

Intertec's Headstart can be equipped with 1 megabyte of memory. Headstart comes with dual 8/16-bit microprocessors, 3½-inch 500K-byte (unformatted) floppy-disk drives, and built-in multiuser networking capabilities. System interfaces comprise coaxial communications, RS-449/RS-232C serial communications port, and a Centronics-type parallel port. A detached keyboard, a 12-inch nonglare screen, IBM PC compatibility, and RAM disk emulation capabilities are some of Headstart's highlights. It employs the 16-bit Intel 8088 and Zilog's 8-bit Z80A, respectively running MS-DOS and CP/M-80.

Up to 255 Headstarts can be linked with Intertec's high-speed coaxial interface. Networking capabilities include electronic mail and software file protection. A 5¼-inch 20-megabyte Winchester unit and an 8-inch Winchester with 25 megabytes of fixed storage and 25 megabytes of removable storage are offered as network enhancements.

Headstart can be obtained in 128K-, 500K-, and 1-megabyte versions. In as-

ending order, base prices are \$1895, \$3495, and \$4495. Software utilities and 5¼-inch floppy-disk drives are optional. For details, contact Intertec, 2300 Broad River Rd., Columbia, SC 29210, (803) 798-9100. Circle 524 on inquiry card.

PUBLICATIONS

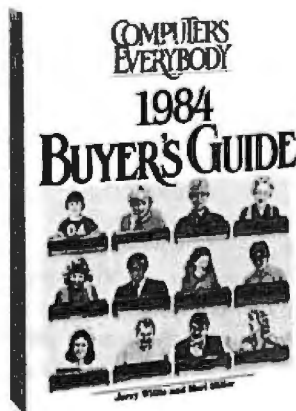

Computers for Everybody

Computers for Everybody 1984 Buyer's Guide by Jerry Willis and Merl Miller carries up-to-date information on microcomputers. It describes 143 computers in detail ranging from keyboard design to available software. Topics covered include an introduction and guide to hardware and software, steps in selecting a computer, and portable computers.

Computers for Everybody is available in paperback for \$19.95. Contact Dilithium Press, Suite 151, 8285 Southwest Nimbus, Beaverton, OR 97005, (800) 547-1842; in Oregon, (503) 646-2713. Circle 533 on inquiry card.

Statistics Program Directory

An Annotated Directory of Statistical and Related Microcomputer Software for Socio-

Economic Data Analysis by Kelly, Stevens, Stilwell, and Weber is available from Michigan State University. This directory describes more than 260 programs and places a special emphasis on those packages written for Apple, IBM, and CP/M systems. It also identifies and provides information on 30 generalized statistical packages.

The 165-page directory costs \$7. Copies can be obtained from the Department of Agriculture, Agriculture Hall, Michigan State University, East Lansing, MI 48824. Circle 532 on inquiry card.

Independent Maintenance Service Guide Offered

C/ESN Publications has introduced its first annual *Guide to Independent Service*, a directory of companies offering third-party on-site maintenance and depot repair to OEMs and end users. The directory contains a geographical index of service companies and provides such information as number of employees, service revenues, years in business, and hardware and software maintained. Services offered include depot and on-site repairs, remote diagnostics, repair of communications equipment, and operating-system and applications-software troubleshooting. Such management innovations as centralized dispatch, telephone support, and automated parts inventory are noted. Also included in the directory are details of each company's service contracts and feature articles of interest.

The cover price for the *Guide to Independent Service* is \$19.95. For more information, contact C/ESN Publications, POB 428, Peter-

borough, NH 03458, (603) 924-9457.

Circle 536 on inquiry card.

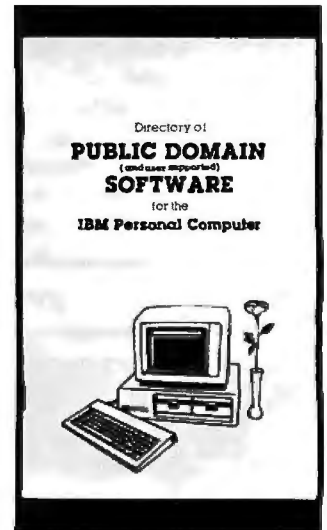

100 Plus Public-Domain IBM Programs

A catalog listing more than 100 public domain and user-supported programs for the IBM Personal Computer has been published by the PC Software Interest Group. Programs listed include financial and stock market analysis, word processing, communications, databases, BASIC utilities, graphics, spreadsheets, and print spoolers.

Copies of the book are available for \$2.95 plus \$1 for shipping. A set of the 10 most popular programs on disk costs \$59. The complete set of 75 programs on disk is \$439. Contact PC Software Interest Group, Suite 130R, 1556 Halford Ave., Santa Clara, CA 95051, (408) 247-6303. Circle 534 on inquiry card.

Graphics Market Subject of Directory

You can locate information on the computer graphics industry in *Computer Graphics Marketplace 1983-84*. Edited

What's New?

by John Cosentino, this book provides a listing of manufacturers, consultants, services, professional organizations, educational programs, conferences and conventions, and publications geared toward the graphics industry. Each entry includes names, addresses, telephone numbers, titles, and descriptions of each company's products or services. Product and geographical indexes augment the presentation.

This 102-page paperback costs \$32.50. It's available directly from the Oryx Press, 2214 North Central, Phoenix, AZ 85004, (602) 254-6156. Circle 535 on inquiry card.

Manual Experiments with Hero

Heath's Robot "HERO"; 68 Experiments: Fundamentals and Applications by Howard Boyet covers the basics behind controlling all of the Hero I's inputs, outputs, and applications. This 160-page book covers the Hero's use in such areas as industrial manufacturing, security systems, and home education. Its objective is to teach you how to become a robot innovator, capable of conceiving and implementing programs to control the Hero in a variety of applications. Topics addressed include machine-language control of inputs/outputs, user-dedicated keys, how to write an interpreter behind any higher robot language, and using Hero's motion-detection and range-measuring capabilities.

Heath's Robot "HERO" costs \$21.95. For more information, contact Microprocessor Training Inc., 14 East 8th St., New York, NY 10003, (212) 473-4947.

Circle 531 on inquiry card.

FOREIGN



Home Computers With Stereophonic Sound

The Enterprise 64 and 128 Home Computers from Elan Computers Ltd. have stereo sound capabilities and 256 colors. Distributed in 64K- or 128K-byte versions, the Enterprise comes with a 69-key full-travel keyboard, a built-in joystick, color and black-and-white video outputs, a 56 by 84 display format, the ability to display text and graphics simultaneously, and an integral word processor with word-wrap, justification, text centering, and paragraph moving. Cassette, RS-423 serial, and Centronics-type parallel interfaces are standard, and a cartridge slot and an expansion connector are furnished. Enterprise is equipped with a net-

work scheme that permits up to 32 computers to communicate and share resources. Cassettes or 3½-inch micro-floppy-disk drives serve as mass-storage devices.

A fully structured programming language based on BASIC and enhanced with special operation commands and graphic- and sound-control facilities is supplied. Video and strategy games, educational programs, and programming aids are available. For complete details, contact Elan Computers Ltd., 31-37 Hoxton St., London N1, England; tel: 011441 739 4282; Telex: 22717 ELCOM G.

Circle 540 on inquiry card.

Drafting System Introduced

Datagraph has introduced a computer-aided design and drafting system that's built around an IBM PC or IBM PC XT and designed to serve as a tool for creating technical drawings, circuit diagrams, building plans, sketches, and illustrations. It features a 20-inch high-resolution graphics monitor, a video controller with 512K bytes of RAM, 1024- by 1024- by 4-pixel graphics, a mouse or digitizer tablet, and a drum or flatbed plotter. Elements such as lines, circles,

arcs, rectangles, polygons, and text can be entered from a graphics tablet. Users can create and store elements. Drawings can be saved for manipulation or hard-copy printouts. Including the IBM, prices for the system range between DM 40,000 and DM 55,000, depending on configurations. Contact Datagraph GmbH, Giessener Str. 27, D-6302 Lich 1, West Germany; tel: 0 64 04/20 71; Telex: 48 28 90 video d.

Circle 537 on inquiry card.

Ball-Bearing Carriage Eliminates Noise

The Edcom slim-line floppy-disk drive uses a ball-bearing carriage to eliminate the noise and friction generated from a sliding read/write head. Edcom features a direct-drive brushless spindle motor, an automatic disk-ejection mechanism, a continuous band positioner, and ceramic heads. Memory capacity is 250K bytes double density and 125K bytes single density. The double-density transfer rate is 250k bits per second, and the single-density rate is 125k bits. Track density is 48 tpi, and track-to-track access averages 6 milliseconds. It works with Apple DOS, CP/M, and Pascal. Edcom measures 5.75 by 1.66 by 8.1 inches. For complete details, contact EDP Resources Co. Ltd., Number 5, 2/F., Newport Centre Phase 2, 116 Ma Tau Kok Rd., Tokwan, Kowloon, Hong Kong; tel: 3-342405-8; Telex: 37449 ACTEL HX.

Circle 539 on inquiry card.

Commodore Speech Unit

The Commtalk speaker synthesizer for the Commodore 64 and VIC-20 has a virtually unlimited vocabulary. It operates independently, affecting neither your computer's normal sound functions nor its BASIC language. Commtalk uses allophones, which are the variants of individual phonemes, to construct words. You can access speech directly through BASIC commands and create a library of words with strings. The synthesizer has the ability to talk with the continuous execution of a BASIC program. Speech is output through your monitor. Commtalk connects directly to the Commodore, leaving free its cartridge slot.

What's New?

CommTalk comes with a program cassette and manual. It costs £39; the PET version is £45. Contact Andor Systems, 28 Hillside Dr., Rathfarnham, Dublin 14, Ireland; tel: 01-900107.
Circle 538 on inquiry card.

PERIPHERALS



Phone Replacement Allows High-Speed Dialing

The Voice Oriented Auto Dialer, or VOAD, Keyboard Phone replaces standard rotary-dial or Touch Tone telephones and allows high-speed automatic dialing from a computer keyboard. VOAD permits detailed call recording, convenient access to such telecommunications systems as MCI or The Source, programming of call restrictions into a host computer, and, with the appropriate software, the selection of the most cost-effective call placement.

VOAD draws its power from the telephone line. It automatically selects Touch Tone or pulse modes and offers redialing capabilities. VOAD connects to an RS-232C port and comes with an RJ-11 jack for hook-up to a handset, headset, or speaker phone. It costs \$199.50; quantity and OEM discounts are available. Contact VOAD Systems, Suite 227, 8570 Wilshire Blvd., Beverly Hills, CA 90211, (213) 550-0629.

Circle 543 on inquiry card.



Mouse and CAD System Introduced

The Optomouse/AutoCAD package from USI Computer Products combines a digital mouse with a drafting and design software system. The Optomouse operates on a desktop grid and is accurate at speeds of up to 20 inches per second. It has four control buttons and is about the size of a deck of cards.

AutoCAD offers a variety of design and drafting applications ranging from architectural and landscaping drawings to drafting for mechanical, electrical, chemical, civil, and structural engineering. It lets you create and edit drawings of any size and scale. Drawings can be saved to disk, and complete drawings or combinations of design elements can be moved, copied, modified, erased, rotated, or rescaled through commands entered by

the mouse or keyboard.

The Optomouse/AutoCAD works with the IBM Personal Computer and its compatibles. The retail price is \$1200. For information, contact USI Computer Products Inc., 71 Park Lane, Brisbane, CA 94005, (415) 468-4900.

Circle 544 on inquiry card.

Single-Dot Editing with Light Pen

Magellan Computer's Light Pen System for the Apple II Plus allows single-dot editing on the Apple II Plus or IIe's high-resolution screen. The Light Pen has push-button control over drawing operations. It comes with an electronic module that connects to the computer's game I/O port. This

technique is transparent and allows game paddles, joysticks, and other peripherals to occupy the port as well.

Two programs are supplied: Quick-Draw lets you create and edit presentation-quality graphics; Amper-Pen lets you incorporate light-pen operations into Applesoft BASIC programs.

The Magellan Light Pen System costs \$189.95, including software and documentation. It's available from Magellan Computer Inc., Suite D, 4371 East 82nd St., Indianapolis, IN 46250, (317) 842-9138.

Circle 545 on inquiry card.

Digital Transmits to Computers

The Cybervision CV Series Digital-Camera detects an image and digitally transmits it to your computer for screening, printing, modification, transmission to another computer, or storage. A complete Digital-Camera includes an f1.6 lens with adjustable focus and f-stop, digital detector, an interface board, connecting cable, a tripod, and supporting software. Camera resolution is 128 by 256 pixels. The crux of this device is Micron Technology's IS32 OpticRAM.

The Cybervision CV Series Digital-Camera is designed for direct coupling to Apple, Commodore 64, IBM PC and PC XT, or Radio Shack TRS-80 computers. A version that can communicate with most microcomputers through an RS-232C cable is offered. The Digital-Camera may be ordered in kit form or completely assembled and tested. Prices begin at less than \$300. For full particulars, contact Cybergen Systems Corp., 2070 Walsh Ave., Santa Clara, CA 95050, (408) 727-6766.

Circle 541 on inquiry card.

What's New?

Dual-Channel Chromatography for Apple

A full chromatography system for the Apple II is available from Anadata Inc. The Chromcard II, a 17-bit dual-channel A/D converter, comes with 128K bytes of RAM and necessary hardware and software. Data is acquired and displayed from two independent chromatographs and then analyzed at speeds of up to 40 points per second. A finished analytical report and graphic data can be output after peak detection and integration. If automatic selection is inappropriate, you can impose your own baseline. Methods and data can be stored on disk for retrieval and reprocessing.

Chromcard II costs \$2450. For more information, contact Anadata Inc., 516 North Main St., Glen Ellyn, IL 60137, (312) 858-9606.

Circle 542 on inquiry card.

MISCELLANEOUS

Joystick Has ASCII Output

Turbo Stick is a high-pointing-speed joystick with full RS-232C ASCII output. Produced by the KA Design Group, Turbo Stick offers high resolution (i.e., one part in 4096) and dual fingertip-operated microswitches that let you alternate between an absolute mode with high pointing speed and a rate mode with high resolution. The switches can be redefined under software control to perform different functions.

Turbo Stick is suitable for graphics and instrumentation systems. It's priced at \$395. OEM discounts are available. For details, contact KA Design Group, 6300 Telegraph Ave., Oakland, CA 94069, (415) 654-6300.

Circle 555 on inquiry card.

RS-232C Adapters

Ora Electronics designed the Data Spec ARS232AM adapter to convert a 25-pin RS-232C female connector to a male connector and the ARS232AF to perform the reverse function. These adapters are fully shielded to standards that are said to exceed FCC requirements. They incorporate a PVC molding to ensure maximum integrity and durability under adverse conditions. All 25 RS-232C pins are connected, making these adapters compatible with virtually all equipment. For more information, contact Ora Electronics, 18215 Parthenia St., Northridge, CA 91325, (213) 201-5848.

Circle 554 on inquiry card.

Cable Tester Has Remote Indicator

The Datacom RS-232C Cable Tester with remote indicator is a pocket-sized, battery-powered unit for testing and verifying cable configurations. Cables can be tested in either Step or Scan modes, and the Tester has 50 LEDs that indicate connections on each end of the cable. Three additional LEDs indicate Open, Short, or Continuity for each connection of the cable under test. Cable connectors are dual male/female 25-pin D-type, which allow any configuration of RS-232C cable connectors to be tested. The remote indicator lets you test and verify operations on installed cables. The Tester weighs 8 ounces, and the remote indicator is 3 ounces.

The suggested retail price for the Datacom Cable Tester is \$399. For a complete product brochure, contact Datacom Northwest Inc., 11300 25th Ave. NE, Seattle, WA 98125, (206) 363-5805.

Circle 553 on inquiry card.



Datalife Detects Drive Problems

The Datalife Disk Drive Analyzer from Data Encore detects common disk-drive problems in Apple and IBM computers. Datalife runs four tests: disk alignment, disk clamping, write/read accuracy, and disk speed. It produces a display that indicates required adjustments and repair areas. System disassembly is not required. The entire test se-

quence takes only a few minutes.

The Datalife Disk Drive Analyzer comes on a 5¼-inch floppy disk. The suggested retail price is \$39.95. For more information, contact Data Encore, 585 North Mary Ave., Sunnyvale, CA 94086, (408) 720-7400.

Circle 552 on inquiry card.

RIBBON RE-INKERS

Introducing the Pika-Ink™, an incredible new device which extends the life of your fabric printer ribbons by a factor of TEN! Works with any fabric ribbon with 1/2-inch or narrower width. Automatically re-inks your ribbons either on or off the printer for consistent dark black print. Pays for itself on the first ribbon!

The Pika-Ink™ is a kit which includes • Stainless steel ink reservoir • ball bearing assembly • transfer felts • 115v 60Hz electric motor • power cord • special computer ribbon ink (extra ink available). Comes with complete instructions. Requires assembly and fabrication with hand tools.

	each	3+	10+
Pika-Ink kit	\$89	\$84	\$78

TERMINALS & PRINTERS

Micro Term E301	\$875	Qume QVT-108	\$850
Visual 55	\$850	Qume Sprint 11/40	\$1495
Visual 102	\$1050	Sprint Interface	\$90
Qume QVT-102	\$675	Sprint Tractor	\$235

RS-232 BREAKOUT BOX

The Pika-Box™ RS-232 I/O tester is the most advanced breakout box on the market today. An absolute necessity for anyone who uses or works with RS-232 peripherals, interfaces, or data lines. Saves hours of aggravation. Available in standard or deluxe tri-state models. Lifetime warranty!

- 25-pin male DCE and female DTE connectors.
- Individual LED's monitor pins, 2, 3, 4, 5, 6, 8, 15, 17, 20, 21, 22, 25, plus MARK and SPACE.
- 24 DIP switches allow signal lines to be individually interrupted.
- 25 test pins for monitoring or cross patching with included jumpers.
- Tri-State model displays signals as high, low, or invalid.
- Fits in shirt pocket. 2.9"x5.5"x1.5", wt. 8 oz, with batteries (included).
- Fully assembled, ready to use.

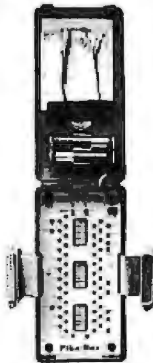

	list	each	3+
Pika-Box	\$199	\$179	\$174
Tri-State Pika-Box	\$249	\$219	\$211

RS-232 SWITCHES SAVE 40% TO 80%!

Allows several devices to share a single RS-232 data line. Enhances flexibility of your system and puts an end to juggling cables. You've heard them called AB switches or T-switches, and they have outrageous prices!

The Pika-Switch™ is an economical alternative in kit form. You assemble it yourself and save 40% to 80%! Available in two models: 2-device (AB + common) with 3 female connectors, and 5-device (ABCDE + common) with 6 female connectors. Switches any 8 lines. Silver plated switch contacts, gold plated connector contacts. Complete, nothing else to buy.



	each	3+
Pika-Switch # 2 (AB)	\$79	\$75
Pika-Switch # 5 (ABCDE)	\$145	\$135
Male Connector Option	No Charge	

TERMS: All Sales exclusively by mail/phone order. Cash, check, money order, MC, Visa. No COD. Add \$4.50 shipping, NM residents add 4% tax. (Foreign customers: payment must be in U.S. funds drawn on a U.S. bank, add 10% for air shipment).

pika

BOX

ORDERS ONLY Ask for Dept. 501
1-800-547-4000



In Oregon, and outside the U.S. call (503) 620-1602



Pika-Box

Div. of Applied Computing
Dept. 501
1808 Pomona Dr.
Las Cruces, N M 88001

CHECK SUNTRONICS NEW LOW PRICES

IBM Compatible Products Apple Compatible Products General Products-cont.

TOLL FREE (ORDERS ONLY)

1-800-421-5775

Calif. orders and all info Call 213-644-1149

S-100 Products



COLUMBIA PC 1600-1

Includes: Drives, Video Card, Perfect Software Package, MS-DOS, CP/M, Fast Graphics, BASIC, CP/M-86, Home Accountant and Communications Program.

PC 1600-1 only Call

COLUMBIA VP (Portable) only Call

EAGLE COMPUTER PC-2 only Call

AST SIXPACK CARD

Six-function card with 64K-348K RAM Memory, Parallel Port, Serial Port, Clock Calendar, Super Drive and Super Spool. AST Sixpack Card only 291.00

MSI DUAL I/O

2 Serial/2 Parallel Ports, Clock 175.00

MSI 256K RAM Board

256K RAM Board with 64K 199.00

256K RAM Board with 256K Call

MSI 256K w/Parallel or Serial Port

256K w/Parallel Port and 64K 259.00

256K w/Parallel Port and 256K Call

VISTA DISKMASTER

Diskmaster Floppy and Hard Disk Controller 225.00

APPRATE IBM PRQM Blaster 129.00

CABLE for IBM Parallel Printer 29.95

CABLE for Columbia MPC

Parallel Printer 29.95

CABLE for Eagle Parallel Printer 29.95



AFDC-1 Floppy Disk Drive Controller

Runs DOS 3.3 with any standard Shugart compatible 5 1/4" disk drive. (2 drives each card). Does not read 1/2 track. \$69.95

Apprate PROM Blaster 119.00

"ALS" 80 Column Card 159.00

"ALS" Z-CARD (Z80 CPU) 149.00

API Apple Parallel Printer Interface card.

Centronics Compatible \$45.00

Software

WORD PROCESSOR (Benchmark)

For IBM or MS-DOS \$299.00

MAILING LIST (Benchmark)

For Apple II 140.00

For IBM or MS-DOS 140.00

SPELLING CHECKER (Benchmark)

For IBM or MS-DOS 105.00

TELECOM (Benchmark)

For IBM or MS-DOS 85.00

CDEX IBM Training 52.00

TALLGRASS (J format) 50.00

General Products

5 1/4" Diskettes 10 up 100 up

SS DD (100% certified) 1.75 1.55

DS:DD (100% certified) 2.50 2.30

BMC PRINTER

8X-80 dot matrix printer with 80 cps. 9 x 7 print head. Quiet, reliable and priced for entry level end-user. \$259.00

MODEM Novation 103 Smart-Cat \$210.00

NEW MODEL SAMWOOD DISPLAY VIDEO MONITORS

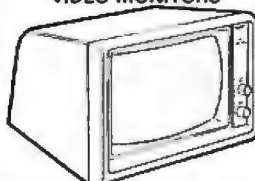

Features: • Anti glare screen • Attractive case • Std composite video input, also output for second monitor • 22 MHz video bandwidth • High resolution; 1,000 lines or 132 characters across • Adjustable contrast, brightness, V/H-hold, V-size, H-center • Input impedance: high or 75 ohm • Passes FCC test for computer equipment • UL approved

Compatible With: IBM, IBM PCjr, Apple II, Apple IIe, Commodore, Columbia MPC, Eagle, Radio Shack, Sinclair Timex, and more.

	Each	3-up
DM-216 12" Green	\$145.00	Call
DM-216 12" Orange	\$149.00	Call

DEALER INQUIRY INVITED

EPROM & RAM SUPER SALE

P/N	Description	8-24	25up
2716	(450nS)	3.95	3.95
2732	(450nS)	4.40	4.40
2764	(28 pin)	8.95	Call
4164	(in stock)	Call	Call
6116P-3	(150nS)	6.10	Call

Mother Boards & Card Cages

SLOTS	Bare Bd	KIT	A & T	w/CAGE
6	\$19.00	\$44.00	\$59.00	\$84.00
8	24.00	56.00	81.00	116.00
12	29.00	75.00	110.00	150.00

10MHz. No termination. Includes power indicator and wiring for multi fan. Uses OK connector for solderless installation and removal of power & reset lines.



64KSM A&T without RAM ... \$155.00

64KSM A&T w 64K RAM (32-6116's) .339.00

S-100 Board Uses 6MHz 6116's. 1/2 Amp max. power. BankSelect plus Extended

Addressing allows for multi-memory board set-up. 4 independent 16K Blocks

make easy use with multi-user systems. Any 2K RAM may be replaced by

a 2716 EPROM.

SBC-880 Z80A CPU, A&T \$169.00

SBC-880 Z80A CPU, Kit 149.00

4MHz Z80A CPU boards

with Serial Parallel Ports.

UFDC-1 Floppy Controller, A&T 245.00

UFDC-1 Floppy Controller, Kit 225.00

The UFDC-1 Floppy Controller uses the

WD1795 chip which runs either

and/or 8"5/4" Disk Drives.

CLOCK CALENDAR A&T 115.00

CLOCK CALENDAR Kit 95.00

This S-100 Clock Calendar Board has

4 interrupts, Time, Day of Week and Battery Backup.

Special Sale Items

Apple Keyboard Assm & Tested .. \$49.95

SUN-721 S-100 Prototype Board 9.95

SUN-722 Apple Prototype Board 5.95

See our January 1984 BYTE Ad for above item

descriptions. Quantities are limited.



SUNTRONICS CO., INC.
12621 Crenshaw Blvd., Hawthorne, CA 90250

STORE HOURS: MON.-FRI. 9:00am to 6:00pm SATURDAY 10:00am to 5:00pm

Mail Order—Min. Order \$10. Visa or MasterCard (please include expiration date). Add \$2.00 (shipping and handling) for first 3 pounds plus .50 for each additional pound to your order. CA residents add Calif. sales tax.

Apple Country Ltd. has your Number for ROCK BOTTOM PRICES



1-800-222-2602

MONITORS

AMDEK COLOR I PLUS	294.95
AMDEK COLOR II PLUS	424.95
AMDEK COLOR III	369.95
AMDEK COLOR IV	749.95
AMDEK VIDEO 300 (GREEN)	134.95
AMDEK VIDEO 300 (AMBER)	144.95
AMDEK VIDEO 310 (AMBER)	164.95
BMC 12" GREEN	89.95
BMC 13" COLOR	249.95
BMC 13" RGB AP2 COLOR	349.95
BMC 13" RGB IBM	419.95
COMMODORE COLOR 1702	289.95
COMEX 13" COLOR W/SOUND	269.95
COMEX 12" HI-RES AMBER	134.95
COMEX 12" HI-RES GREEN	129.95
COMEX 12" HI-RES LT GRN	129.95
COMEX 13" RGB COLOR	269.95
GORILLA 12" AMBER	99.95
GORILLA 12" GREEN	89.95
NEC 12" HI-RES GREEN	154.95
NEC 12" ECONO GREEN	109.95
NEC 12" LO-RES COLOR	289.95
NEC 12" AMBER SCREEN	164.95
NEC 12" COLOR - IBM	469.95
PRINCETON GRAPHICS HX-12	LOW !!
SAKATA 13" COLOR	264.95
SAKATA 13" RGB COLOR	499.95
SAKATA SUPER RGB	679.95
SAKATA 12" GREEN	109.95
SANYO CTR-70 HIREES COLOR	599.95
SANYO AUM-255 25" RGB	749.95
SANYO DMC-6500 13" RGB	399.95
TAXAN 12" GREEN	124.95
TAXAN 12" AMBER	129.95
TAXAN RGB VISION I	294.95
TAXAN RGB VISION III	439.95
ZENITH 12" AMBER	119.95
ZENITH 12" GREEN	99.95
ZENITH RGB ZVM-135 COLOR	519.95
USI 9" AMBER PI-4	129.95
USI 9" GREEN PI-1	119.95
USI 12" AMBER PI-3	149.95
USI 12" GREEN PI-2	139.95
USI 14" LO-RES COLOR	289.95

MODEMS

ANCHOR MARK I (RS-232)	79.95
ANCHOR MARK II (ATARI)	79.95
ANCHOR MARK III (TI99/4A)	99.95
ANCHOR MARK V (OSBORNE)	94.95
ANCHOR MARK VI (IBM PC)	199.95
ANCHOR MARK VII (RS-232)	109.95
ANCHOR MARK X11 (RS-232)	279.95
ANCHOR VULFMODEM	64.95
NOVATION J-CAT	104.95
NOVATION 212 AUTO CAT	579.95
SMARTCAT 212 (1200 BAUD)	429.95
SMARTMODEM 300 BAUD	194.95
SMARTMODEM 1200 BAUD	484.95
SMARTMODEM 1200B - IBM	449.95
US ROBOTICS AUTODIAL 212	449.95
US ROBOTICS PASSWORD	359.95

PRINTERS

ANADEX DP-9501A	1029.95
ANADEX DP-9625A	1399.95
ANADEX DP-9620A	1129.95
ANADEX WP-6000	2199.95
ANADEX DP-6500TR 500CPS	2329.95
APPLE IMAGEWRITER	LOW !!
CENTRONICS 352 DP	1999.95
C.ITOH A10 DAISY WHEEL	539.95
C.ITOH 8510SP	499.95
C.ITOH 8600BP	979.95
COMREXER I DAISY WHEEL	629.95
COMREX CR-II DAISY WHEEL	469.95
DAISYWRITER 2000 48K	LOW !!
DELTA-10	LOW !!
DELTA-15	LOW !!
EPSON FX-80 W/TRACTOR	LOW !!
EPSON FX-100 F/T	LOW !!
EPSON MX-100 F/T	LOW !!
EPSON RX-80	LOW !!
EPSON RX-90 F/T	LOW !!
GEMINI 10X	LOW !!
GEMINI 15X	LOW !!
GORILLA BANANNA	189.95
IDS MICROPRISM 480	479.95
IDS PRISM 132	1299.95
IDS PRISM 132C - COLOR	1499.95
JUKI 6100 PRINTER (P)	449.95
MANNESMANN TALLY MT160L	599.95
MANNESMANN TALLY MT180L	799.95
MANNESMANN TALLY MT1802	1499.95
MANNESMANN TALLY SPIRIT	399.95
NEC 3550 SPINWRITER-IBM	1754.95
OKIDATA MICROLINE 80	LOW !!
OKIDATA PACEMARK 2350S	LOW !!
OKIDATA PACEMARK 2410P	LOW !!
OKIDATA PACEMARK 2410S	LOW !!
OKIDATA 82A W/OKIGRAPH	LOW !!
OKIDATA 83A W/OKIGRAPH	LOW !!
OKIDATA 84P	LOW !!
OKIDATA 84S	LOW !!
OKIDATA 92P	LOW !!
OKIDATA 93P	LOW !!
OKIDATA 93S	LOW !!
PANASONIC P1090	329.95
PRINTMASTER (DAISY)	1549.95
PROWRITER I (8510P)	344.95
PROWRITER II (1550P)	619.95
QUME SPRINT 11/40+	1399.95
SANYO PR5500 DAISY WHEEL	659.95
SILVER-REED 550 DAISY	699.95
STARWRITER DAISY WHEEL	1099.95
TOSHIBA P-1350 LP	1579.95
TRANSTAR 315 COLOR	449.95
TRANSTAR 120P 14CPS	464.95
TRANSTAR 130P 18CPS	699.95
TRANSTAR 140P 40CPS	1229.95
MICROBUFFER (EPSON RS232)	134.95
GRAFITTI CARD (APPLE)	84.95
GRAPPLER + (APPLE)	119.95
MICROBUFFERII 16K (APPLE)	144.95
PKASO PRINTER I/F (APPLE)	129.95
WIZARD BFO 16K (APPLE)	129.95
WIZARD SOB 16K (APPLE)	179.95

OTHER PRINTERS AVAILABLE

COMPUTERS

APPLE IIE STARTER SYSTEM	LOW !!
APPLE MACINTOSH COMPUTER	LOW !!
COMMODORE 64 COMPUTER	LOW !!
COMMODORE 1541 DISK DRIVE	LOW !!
COLUMBIA VP PORTABLE	LOW !!
COLUMBIA 1600-1 COMPUTER	LOW !!
IBM-PC COMPATIBLE SYSTEM	
128K, 2-DS/DD DRIVES, KEYBOARD	
WITH COMPLETE SOFTWARE PACKAGE	
EAGLE PC PLUS-2 SYSTEM	3199.95
128K, 2-DS/DD DRIVES,	
MONITOR, EAGLEWRITER, MS-DOS,	
EAGLECALC, & CP/M-86	
EAGLE SPIRIT-II	2549.95
EAGLE SPIRIT-XL	3649.95
PORTABLE 128K EXPANDABLE TO	
640K ON BOARD, 1 320K FLOPPY,	
10 MEGABYTE HARD DISK, IBM	
COMPATIBLE KEYBOARD, 2 SERIAL	
1 PARALLEL PORT, MS-DOS 2.0,	
MONOCHROME MONITOR, CP/M 86	
NEC APC-H01	2049.95
NEC APC-H02	2549.95
NEC B201 COMPUTER	609.95
SANYO 550 COMPUTER	769.95
SANYO 555 COMPUTER	1049.95
TELEVIDEO TPC-1	LOW !!
IBM COMPATIBLE SYSTEM	
WILDCAT STARTER SYSTEM	1399.95
APPLE II COMPATIBLE SYSTEM	
64K, DETACHABLE KEYBOARD,	
2 APPLE COMPATIBLE DISK DRIVES,	
HI-RES 12" GREEN MONITOR,	
RGB & COMPOSITE COLOR OUTPUT,	
2 CPU'S (Z-80 A & 6502),	
80-COLUMN CARD & JOYSTICK	
ZORBA PORTABLE COMPUTER	1399.95
BUILT IN 7" GREEN SCREEN,	
2 DS/DD DISK DRIVES, RS-232,	
PARALLEL, IEEE488 BUS, KEYBOARD	
EMULATION MODE FOR OSBORNE I,	
KAYPRO II, XEROX 820, DEC VT-180,	
CROMEMCO 520, TELEVIDEO 802	
AND MANY MORE!	
WORDSTAR, MAILMERGE, CALCSTAR,	
C-BASIC, CPM 2.2, M-80	
ATARI HARDWARE	
ALIEN VOICE BOX	99.95
KOALA PAD TOUCH TABLET	79.95
RANA 1000 DS/DD DRIVE	299.95
TRAK AT-D2 DS/DD DRIVE	399.95
DISKETTES	
SS/SD ELEPHANT 16.95	OPUS 15.95
SS/DD ELEPHANT 19.95	OPUS 17.95
DS/DD ELEPHANT 25.95	OPUS 24.95

APPLE HARDWARE & SOFTWARE

4TH DIMENSION DRIVE-ONLY	199.95
4TH DIMENSION DRIVE+CTRL	289.95
ALS CP/M CARD	299.95
APPLE-CAT II MODEM	264.95
BANK STREET WRITER	54.95
BUFFERED GRAPPLER+	189.95
d-BASE II (REQ Z-80)	449.95
HAYES MICROMODEM IIE	234.95
MACH II JOYSTICK IIE	34.95
MASTERTYPE	29.95
MICROBUFFER II+ 16K (P)	199.95
PFS:FILE	99.95
PKASO/U PRINTER I/F	134.95
PREMIUM SOFTCARD IIE	334.95
QUADRAM 64K80COL CRD IIE	124.95
VDEX VIDEO TERM W/SFTSW	239.95
VDEX ULTRATERM	279.95
WORDSTAR W/ APPLICARD	299.95
IBM	
HERCULES GRAPHICS CARD	379.95
KOALA PAD TOUCH TABLET	99.95
KRAFT JOYSTICK	54.95
MICROPRO PRO PACK	429.95
MICROSOFT SYSTEMCRD 256K	449.95
MICROSOFT MOUSE	134.95
MOUSE SYSTEMS PC MOUSE	224.95
QUADCHROME MONITOR	549.95
QUADLINK APPLE EMULATOR	489.95
QUADRAM QUADBOARD I 64K	289.95
QUADRAM QUADCOLOR I	229.95
RANA DS/DD DISK DRIVE	259.95
STB SUPER I/O MULTIFUNCT	169.95
TG JOYSTICK W/TOGGLE	49.95
TRANSEND P.C. MODEM 1200	399.95
VERSAWRITER GRAPH TABLET	239.95
WIZARD SPOOLER P/S 16K	239.95
COMMODORE 64	
CALC RESULT ADVANCED	109.95
CARDBOARD/5 S SLOT EXPAN.	54.95
CARD7 GRAPHICS INTERFACE	64.95
DATASOFT Z-80 VIDEOPAK	224.95
DELPHI'S ORACLE DATA BASE	99.95
DISKEY	39.95
DONKEY KONG	37.95
EASY SCRIPT64	34.95
EASY SPELL 64	34.95
ELECTRONIC CHECKBOOK	19.95
FLIGHT SIMULATOR II	39.95
HOME ACCOUNTANT	59.95
HOMEWORD WORD PROCESSOR	49.95
KOALA PAD TOUCH TABLET	79.95
MSD-SDI1 DISK DRIVE	339.95
MULTIPLAN	74.95
OMNI-CALC	39.95
PAPER CLIP W/P	69.95
PAC-MAN	37.95
POPEYE	39.95
ROBOTRON	37.95
S.A.M.	44.95
SARGON II	27.95
VOICE BOX	99.95

We will try to meet or beat any advertised price!
CALL US... WE CAN HELP! 1-800-222-2602

For technical assistance, order status and California calls (619) 765-0239
Apple Country, Ltd., P.O. Box 1099, 2602 Washington St., Julian, Calif. 92036

Terms: We accept American Express. No extra charge for Visa/MasterCard, Cashier's Check, personal check (allow 2 weeks to clear) Shipping & Handling 5% (\$5 min.); APO FPO Alaska Hawaii & Monitors 5% (\$10 min.) Foreign orders 15% (\$15 min.) All items are new with manufacturer's warranty. Prices are subject to availability & change without notice. Purchase order must include check. California residents add 6% sales tax. Send \$1 (good toward first purchase) for new fall catalog.

Apple Country, Ltd. is a **DISCOUNT MAIL ORDER HOUSE** for the micro computer industry and is a California corporation not affiliated with Apple Computer Inc. Apple is a trademark of Apple Computer Inc.

Circle 29 on inquiry card.



MEGA-BYTES FOR MICRO-BUDGETS

expand your system... shrink your cost.

Why pay more for top quality peripherals and accessories when our prices are consistently among the lowest anywhere?
We invite you to compare prices, then call us.

MICROSOFT.	SALE PRICE
MULTIPLAN	\$176.00
MULTIWORD WITH MOUSE.....	339.63
MULTITOOl FINANCIAL STATEMENT.....	70.49
MULTITOOl BUDGET.....	104.96
SOFTCARD SYSTEM CARDS.....	CALL

MISC. ITEMS	SALE PRICE
92P... OKIDATA... PRINTER.....	485.10
93P... OKIDATA... PRINTER.....	812.70
NEC JB1260..... MONITOR.....	112.50
NEC JB1205..... MONITOR.....	177.50
AMDEK COLOR II... MONITOR.....	466.50
FX 80..... EPSON PRINTER.....	550.00
FX 100..... EPSON PRINTER.....	699.00

DYSAN DISKETTES	(Boxes of 10 each)	SALE PRICE
104/1	5.25" .SS.SD.....	\$32.83
104/1D	5.25" .SS.SD.....	34.72
104/2D	5.25" .DS.DD.....	41.04
3740/1	8" .SS.SD.....	34.09
3740/1D	8" .SS.DD.....	42.29
3740/2	8" .DS.SD.....	42.29
3740/2D	8" .DS.DD.....	49.24

VIDEOX	SALE PRICE
UL-00..... ULTRATERM.....	\$282.39
VT-600..... VIDEOTERM 60.Hz.....	207.87
VT-601..... VIDEOTERM 60.Hz SOFTSWITCH.....	230.22
VT-602..... VIDEOTERM 60.Hz SOFTSWITCH INVER.....	237.68
PS-000..... PSIO.....	170.61
ENH-000..... ENHANCER II.....	111.04
ENH-FS-000..... FUNCTION STRIP.....	29.06
ENH-FS-001..... ENHANCER II, FUNCTION STRIP.....	133.37

HARD DISK SYSTEMS	SALE PRICE
PEGASUS..... 10 MEG EXTERNAL.....	\$1,245.00
PEGASUS..... 23 MEG EXTERNAL.....	1,869.00
PEGASUS..... 40 MEG EXTERNAL.....	2,439.00
PEGASUS..... TAPE BACK UP... 23 MEG.....	795.00
PEGASUS..... 10 MEG INTERNAL.....	CALL
CORVUS..... 06N.....	1,795.00
CORVUS..... 06N with MIRROR.....	2,506.00
CORVUS..... 11N.....	2,575.00
CORVUS..... 11N with MIRROR.....	3,225.00
CORVUS..... 20N.....	3,415.00
CORVUS..... 20N with MIRROR.....	4,125.00

ORDERS ONLY 800-858-4810
IN CAL. 800-821-6662

 **COMMERCIAL BUSINESS SYSTEMS** 
2858 S. ROBERTSON BLVD. LOS ANGELES, CA 90034

INFORMATION
(213) 559-0596

Phone orders accepted on Visa and Mastercard only. California residents add 6.5% sales tax. No C.O.D. Actual shipping and handling charge added to all orders. Prepaid orders as follows: Money orders or cashier's check—merchandise shipped upon receipt. Personal checks must clear before shipping. 20% restocking fee. Prices and availability subject to change. \$100 minimum order.

BYTE Back issues for sale

	1976	1977	1978	1979	1980	1981	1982	1983	1984
Jan.				\$2.75	\$3.25	\$3.25		\$3.70	\$4.25
Feb.			\$2.75	\$2.75	\$3.25	\$3.25	\$3.70	\$3.70	\$4.25
March			\$2.75	\$2.75	\$3.25	\$3.25	\$3.70	\$3.70	\$4.25
April			\$2.75	\$2.75	\$3.25	\$3.25	\$3.70	\$3.70	
May		\$2.00	\$2.75	\$2.75	\$3.25	\$3.25	\$3.70	\$3.70	
June		\$2.00	\$2.75	\$2.75	\$3.25	\$3.25	\$3.70	\$3.70	
July	\$2.00	\$2.00	\$2.75	\$2.75	\$3.25	\$3.25	\$3.70	\$4.25	
Aug.		\$2.00	\$2.75	\$2.75		\$3.25	\$3.70	\$4.25	
Sept.		\$2.75	\$2.75	\$2.75	\$3.25		\$3.70	\$4.25	
Oct.			\$2.75	\$2.75	\$3.25	\$3.25	\$3.70	\$4.25	
Nov.				\$3.25		\$3.25	\$3.70	\$4.25	
Dec.		\$2.75	\$2.75	\$3.25	\$3.25	\$3.25	\$3.70	\$4.25	

Circle and send requests with payments to:
BYTE Back Issues
P.O. Box 328
Hancock, NH 03449

Prices include postage in the US. Please add \$.50 per copy for Canada and Mexico; and \$2.00 per copy to foreign countries.

Check enclosed

Payments from foreign countries must be made in US funds payable at a US bank.

VISA

Master Card

Card # _____

Exp. _____

Signature _____

Please allow 4 weeks for domestic delivery and 8 weeks for foreign delivery.

NAME _____

ADDRESS _____

CITY _____

STATE _____ ZIP _____

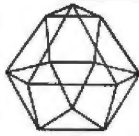

CHANNEL CONNECTIONS

The Channel Connecting You And Computers

APPLE SOFTWARE

AST Versa Form	\$245.00
Qbase	139.00
Templates PO/INV @	39.00
ML/CRJ/EJ @	33.00
ARTSCI Magic Window™	99.00
Magic Mailer	49.00
Magic Words	49.00
Magr. Calc.	99.00
ASHTON-TATE™ dBase II	385.00
Bottomline Strategist	279.00
Financial Planner	419.00
Friday!™	198.00
BEAGLE BROTHERS™	
Alpha Plot	28.00
Apple Mechanic	22.00
Beagle Bag	22.00
Doss Boss	17.00
Double Take	27.00
Pronto Dos	22.00
Utility City	22.00
BLUE CHIP Millionaire	39.00
BPI GL/AP/AR/INV/PR™ @	295.00
BRODERBUND™ A.E.	25.00
ChopLifter	25.00
Bank St. Writer	45.00
Lode Runner	26.00
G. W/AP	305.00
AR/PR @	275.00
CENTRAL POINT Copy II Plus	32.00
Filer	15.00
CONTINENTAL™GL/AR/AP/PR@	158.00
Home Accountant	49.00
FCM	68.00
CRANE Menu Generator	29.00
DATA SOFT (Zaxxon)™	25.00
Micropainter	25.00
DIGITAL RESEARCH™	CALL
DDW JONES™Market Analyzer™	275.00
Market Manager™	235.00
Market Microscope	525.00
Investment™Evaluater	129.00
Connector	85.00
EDUWARE	CALL
FOX & GELLER™Quick Code	195.00
dGraph	195.00
dUtil	69.00
Quick Screen	119.00
HAYDEN Pie Writer	99.00
HAYES® Smartcom I	89.00
INFOCOM™Deadline™	34.00
Zork I/II/III @	27.00
INSOFT Electric Duet @	22.00
GraphFortn @	56.00
KENSINGTON™ Format II	113.00
LOTUS™ Executive Briefing	
System	149.00
MICROCOM Micro Terminal™	59.00
MICRO PRO™ Inlostar	259.00
MICROSOFT Multiplan™	169.00
Budget System	109.00
Financial Statement	69.00
Other products	CALL
MONOGRAM Dollars & Sense	79.00
MUSE® SuperText Home Office	73.00
SuperText Pro. (Ile)	73.00
Castle Wolfenstein.™	22.00
PENGUIN	
Complete Graphics System II	49.00
Graphics Magician	39.00
Special Effects	29.00
PERFECT SOFTWARE™	CALL

PHOENIX Zoom Grafix™	34.00
QUALITY Bag of Tricks™	29.00
SENSIBLE Speller	83.00
SIERRA ON LINE	
Screen Writer II	85.00
Dictionary	69.00
Screen Writer/Dictionary	135.00
Frogger	25.00
Ultima II	39.00
SILICON VALLEY™	
Word Handler™	39.00
List Handler™	35.00
SIRIUS Type Attack	28.00
Pascal Graphics Editor	75.00
SOFTWARE PUBLISHING™	
(Specify Ile or Ite)	
* p/s: File	84.00
* p/s: Report	79.00
* p/s: Graph	84.00
* p/s: Write (Ile only)	84.00
SPINNAKER™	up to 30% off
SSM Transcend I	69.00
Also SEE MODEMS	
™ STONEWARE D.B. Master	145.00
D.B. Master Ver. 4	229.00
SUBLOGIC Flight Simulator	25.00
TERRAPIN Logo	119.00
™ VISICORP Visicalc®	
(I/II/I-) (Ile)	169.00
Other Products	CALL

APPLE HARDWARE	
CENTRAL POINT Alaska Card™	99.00
DANA™ Fan	59.00
EPS Keyboard	319.00
Prom @	29.00
GIBSON LABS LPS Light Pen	279.00
HAYES Modem II w/SC I™	249.00
KOALA™ Graphic Tablet	85.00
KRAFT Joystick	49.00
Paddle	39.00
MICRO SCI A2 w/o Controller	219.00
A2 Controller	79.00
A40 w/o Controller	299.00
A70 w/o Controller	399.00
A40/A70 Controller	79.00
™ MICROSOFT® 16K Ramcard	69.00
Softcard	219.00
Softcard Plus	449.00
Softcard Premium	479.00
Premium Softcard Ile	369.00
NOVATION	See MODEMS
ORANGE MICRO™	
Buffered Grappler 16K	179.00
PRACTICAL PERIPHERALS	
Microbulter II plus 16K PAR	199.00
Other Products	CALL
SSM	See MODEMS
TG Paddles	29.00
Joy Stick	45.00
Select a Port	45.00
Track Ball	49.00
Joy Stick (Ile)	49.00
TENCAL Cool & Time	75.00
VIDEX Videoterm w/ss	239.00
Ultraterm	279.00
WICO Joy Stick	59.00
IBM SOFTWARE	
AST Versa Form	245.00
Obase	139.00
Templates PO/INV @	39.00
ML/CRJ/EJ @	33.00

ASHTON-TATE™ dBase II	385.00
Bottomline Strategist	279.00
Financial Planner	419.00
Friday!	198.00
BLUE CHIP Millionaire	39.00
BPI™ GL/AP/AR/PR @	459.00
CENTRAL POINT Copy II PC	32.00
COMPREHENSIVE	
PC Tutor 1.1	45.00
PC Tutor 2.0	45.00
CONTINENTAL™ FCM	79.00
Home Accountant Plus	89.00
Property Management	329.00
DATAMOST Write On	89.00
DIGITAL RESEARCH™ CP/M 86	45.00
Concurrent CP/M 86	235.00
Dr. Logo	79.00
Other Products	CALL
DDW JONES™ Market Analyzer™	275.00
Market Manager™	235.00
Market Microscope	525.00
Investment Evaluator™	129.00
Connector	85.00
FINANCIER Financier II	159.00
Tax Series	139.00
FOX & GELLER Quick Code	195.00
dGraph	195.00
dUtil	69.00
HAYDEN Pie Writer	135.00
™ HAYES Smart Com II™	89.00
INFOCOM™ Deadline™	34.00
Zork I/II/III @	27.00
INSOFT Data Design	169.00
MICROCOM Micro Terminal	69.00
MICROSOFT™ Multiplan	169.00
Budget System	109.00
Financial Statement	69.00
Word	275.00
Word w/Mouse	339.00
Other Products	CALL
MONOGRAM Dollars & Sense	119.00
MUSE™ SuperText Pro	73.00
PEACHTREE Peachtext 5000	235.00
PERFECT SOFTWARE™	CALL
PETER NORTON Utilities	59.00
SIRIUS Type Attack	29.00
Gorgon II	29.00
SOFTWARE ARTS TK Solver	219.00
SOFTWARE PUBLISHING	
p/s: File	94.00
p/s: Report	84.00
p/s: Graph	94.00
p/s: Write	94.00
SPINNAKER™	up to 30% off
SSI Word Perfect	CALL
STONEWARE	
D.B. Master Advanced	449.00
SUPERSOFT® Personal Database	90.00
™ VISICORP	CALL
IBM HARDWARE	
AMDEK MAI Board	519.00
AST	Call
HERCULES Graphics card	399.00
™ HAYES Smartmodem 1200B /SCII	439.00
KOALA™ Graphic Tablet	109.00
KRAFT Joystick	49.00
Paddle	39.00
MICROSOFT® Mouse	149.00
System Card 64K	295.00
System Card 256K	465.00
MICROTEK O-Disc	329.00

QUADRAM Quadlink	485.00
Quadboard 64K	285.00
Quadboard II 64K	285.00
Quad 512 plus 64K	265.00
Quad 512 plus 256K	420.00
Quad 512 plus 512K	675.00
64K Ram Chips	79.00
Quadchrome	519.00
Quadscreen	1,595.00
TG Paddles	39.00
Joy Stick	49.00
Track Ball	49.00
WICO Joy Stick	59.00

MODEMS	
HAYES® Micromodem II	
w/SC I (Ile)	249.00
Smartmodem I (Ile)	89.00
Smartmodem 1200B	
w/SCII (PC)	439.00
Smartcom II (PC)	89.00
Smartmodem 1200	
(RS232)	499.00
Smartmodem 300	
(RS232)	205.00
Chronograph (RS232)	189.00
NOVATION Apple Cat II	
(300B) (Ile)	269.00
212 Apple Cat II (300/1200B)	
(Ile)	559.00
212 Apple Cat II	
Upgrade Kit	319.00
Cat (300B) (RS232)	139.00
D-Cat (300B) (RS232)	159.00
J-Cat (300B) (RS232)	109.00
Smart Cat 103	
(300B) (RS232)	199.00
Smart Cat 103/212	
(RS232)	409.00
212 Auto Cat (RS232)	569.00
SSM Modemcard w/SOURCE II	
Transmodem 1200 (Ile)	259.00
AIO-2 Ser/Par Interface	169.00

MONITORS	
AMDEK Video 300	135.00
Video 300A	149.00
Color I	289.00
Color I plus	319.00
Color II	439.00
Color III	389.00
Color IV	895.00
DVM Interface (Ile)	169.00
DVM Interface (Ile)	169.00
NEC 12" Green JB1201	159.00
12" Color JC1215	299.00
12" RGB JC1203 (PC)	559.00
JC1203 to PC Cable	24.00
PGS HX-12	539.00
QUADRAM Quadchrome	519.00
Quadscreen	1,595.00
TAXAN 13" Color	319.00
12" Green	145.00
12" Amber	149.00
RGB Vision 1 12" Lo	319.00
RGB Vision 3 12" Hi	559.00

PRINTERS	
EPSON FX 80/100	CALL
OKIDATA Complete Line	CALL
BROTHER	CALL
DISKETTES	
OYSAN® 5 1/4" SS/SD	32.00
5 1/4" SS/DD	37.00
5 1/4" DS/DD	43.00
Plastic Box Add	1.50
IBM, MAXELL, TOK. VERBATIM	CALL
other brands	

ORDERS ONLY

National: 1-800-821-4381
Calif: 1-800-421-3245

INFORMATION: (805) 683-1779/683-3006

ORDER HOURS: M-F 8-6pm, Sat. 8-5pm

STORE HOURS: M-F 9-6pm, Sat. 9-5pm

5788 DAWSON ST. GOLETA, CA 93117

TERMS: Add 3% for shipping & handling, \$3.00 minimum. Allow 2 weeks for checks to clear. Add 6% for Calif. Sales Tax. Add 2% to total for Visa & Master/Charge. All sales final for software, accessories & diskettes. Defective Hardware, Monitors, Printers returns must be within 10 working days of purchase accompanied by RMA # for exchange only. Apple is the Registered Trademark of Apple Computer Inc. IBM is the Registered Trademark of International Business Machines Corp. © 1984 Channel Connections, Inc. All rights reserved. Reproduction of this advertisement without written permission is prohibited.



74LS00

74LS00	.60	74LS166	2.50
74LS01	.60	74LS168	1.35
74LS02	.60	74LS169	1.35
74LS03	.60	74LS170	2.50
74LS04	.75	74LS173	1.50
74LS05	.75	74LS174	1.50
74LS08	.75	74LS175	1.50
74LS09	.75	74LS181	2.50
74LS10	.65	74LS190	1.45
74LS11	.75	74LS191	1.45
74LS12	.75	74LS192	1.35
74LS13	.95	74LS193	1.35
74LS14	1.25	74LS194	1.45
74LS15	.75	74LS195	1.35
74LS20	.60	74LS196	1.35
74LS21	.75	74LS197	1.35
74LS22	.75	74LS221	1.35
74LS26	.75	74LS240	1.85
74LS27	.75	74LS242	1.85
74LS28	.75	74LS243	1.85
74LS40	.75	74LS244	2.25
74LS42	.95	74LS245	3.95
74LS48	.95	74LS247	1.65
74LS51	.60	74LS248	1.65
74LS54	.60	74LS249	1.65
74LS55	.60	74LS251	1.75
74LS73	.95	74LS253	1.75
74LS74	1.42	74LS258	1.50
74LS75	.95	74LS259	2.95
74LS76	.95	74LS260	1.15
74LS78	.95	74LS261	3.75
74LS83A	1.15	74LS266	1.35
74LS85	1.25	74LS273	1.75
74LS86	.75	74LS275	4.95
74LS90	.95	74LS279	.95
74LS92	.95	74LS283	1.25
74LS93	.95	74LS290	1.25
74LS95	.95	74LS293	1.25
74LS96	1.25	74LS295	1.65
74LS107	.75	74LS298	1.65
74LS109	.75	74LS323	4.95
74LS113	.95	74LS324	2.15
74LS114	.95	74LS347	2.55
74LS122	1.05	74LS348	2.55
74LS123	1.35	74LS352	1.65
74LS124	1.35	74LS353	1.95
74LS125	.95	74LS363	1.95
74LS126	.95	74LS365	1.25
74LS132	1.35	74LS366	1.25
74LS133	.95	74LS367	.95
74LS136	.95	74LS368	.95
74LS138	1.10	74LS373	2.50
74LS139	1.10	74LS374	4.95
74LS145	1.75	74LS375	1.25
74LS148	1.75	74LS377	1.95
74LS151	1.25	74LS378	2.55
74LS153	1.25	74LS385	1.95
74LS154	1.70	74LS379	2.55
74LS155	1.25	74LS386	1.25
74LS156	1.35	74LS381	3.95
74LS157	1.25	74LS390	2.55
74LS158	1.25	74LS393	2.55
74LS160	1.25	74LS395	2.55
74LS161	1.25	74LS424	3.95
74LS162	1.25	74LS640	3.95
74LS163	1.25	74LS668	2.75
74LS164	1.65	74LS645	4.95
74LS165	1.25	74LS670	2.50
		74LS690	2.50

74S00

74S00	.75
74S02	.75
74S03	.75
74S04	.75
74S05	.75
74S08	.95
74S09	.95
74S10	.95
74S11	.95
74S15	.95
74S20	.95
74S22	.95
74S30	.95
74S32	.95
74S38	1.95
74S40	.95
74S51	.95
74S64	.95
74S65	.95
74S74	1.50
74S86	1.25
74S112	1.25
74S113	1.25
74S114	1.25
74S124	3.65
74S133	.95
74S134	1.25
74S135	1.65
74S136	2.25
74S138	1.95
74S139	1.95
74S140	1.25
74S151	1.95
74S153	1.95
74S157	1.95
74S158	1.95
74S160	2.95
74S161	3.95
74S163	3.95
74S174	2.25
74S175	2.25
74S188	3.55
74S194	2.55
74S195	2.55
74S196	2.55
74S225	7.75
74S240	2.95
74S241	2.95
74S242	3.95
74S243	3.95
74S251	2.25
74S253	2.25
74S257	1.95
74S258	1.95
74S260	1.25
74S280	2.95
74S283	3.95
74S287	3.95
74S288	3.95
74S289	4.95
74S373	3.95
74S374	3.95
74S387	3.95
74S471	7.95
74S472	7.95
74S473	7.95
74S474	9.95
74S475	9.95

FOR APPLE II & IIe

16K RAM CARD

Compatible with:
DOS 3.3 CPM
Visicalc, PASCAL
1 YR. WARRANTY

\$39.⁹⁵

FOR IBM P/C

MULTIFUNCTION BOARD WITH
128K, 2 Serial Port,
1 Parallel Port,
Real Time Clock

\$430.⁰⁰

Apple II/IIe Compatible Disk Drive

\$185.⁰⁰

CONTROLLER CARD

\$49.⁹⁵

SPEEDY EPROM PROGRAMMER For APPLE II PROGRAMMING

2716, 2732, 2764,
27128, 2532, 2564

IN 30 SECONDS WITH FIRMWARE

\$149.⁰⁰

Color Graphic Display Card

\$320.⁰⁰

IBM MEMORY EXPANSION KIT IBM 64K

\$59.⁹⁵

Joy Stick for IBM P/C

\$45.⁰⁰

High Resolution Color Monitor for IBM P/C

\$680.⁰⁰

8087 MATHEMATICS CO-PROCESSOR

\$250.⁰⁰

SUPER COOLING FANS For APPLE WITH SURG

\$39.⁵⁰

JOYSTICK FOR APPLE II

\$42.⁰⁰

7400 SERIES CALL FOR PRICE

Tel: 1-(800)-821-3628

MOS EPROM

2708	5.95
2716-450	3.95
2732-450	5.95
2732-250	6.95
2764-450	7.95
2764-250	9.95
2764-300	9.95
27128-250	25.95
TMS2516	4.95
TMS2716	7.95
TMS2532	5.95

STATIC RAM

2101	2.95
5101	4.95
2114-450	1.95
2114-200	2.15
2147	4.95
6116-4	5.75
6116-3	6.75
6116-2	7.95
6116LP-4	6.75
6116LP-3	6.95
6116LP-2	8.95

DYN. RAM

4116-200	1.95
4116-150	2.25
4116-120	2.95
4164-200	6.75
4164-150	6.95

CRYSTALS

32.758khz	1.75
1.0mhz	3.95
1.8432	3.95
2.0	2.95
2.097152	2.95
2.4576	2.95
2.2768	2.95
3.579535	2.95
4.0	2.95
5.0	2.95
5.0688	2.95
5.185	2.95
5.7143	2.95
6.0	2.95
6.144	2.95
6.5536	2.95
8.0	2.95
10.0	2.95
10.738635	2.95
12.00	2.95
14.31818	2.95
15.0	2.95
16.0	2.95
17.430	2.95
18.0	2.95
18.432	2.95
20.0	2.95
22.1184	2.95
32.0	2.95

SOUND CHIPS

76477	2.95
76489	8.95
AY3-8910	9.95
AY3-8912	12.95

MISCELLANEOUS

6502	4.95
68000	49.95
6748	24.95
8255-5	5.95
825123	2.55
825129	2.99
825131	3.99
93422	8.95
93L422	9.95
93425	3.95
93427	8.95
D2125AL-2	3.95
D2104	1.95
AYS-3600	12.95
6810	3.95
8304	3.95



TERMS: For shipping include \$3.00 for UPS Ground or \$5.00 for UPS Blue Label Air. Items over 4 lbs. require additional shipping charges. **\$20.00 minimum order.**



1-(800) 821-3628

4962 EL CAMINO REAL, SUITE 119 • LOS ALTOS, CA 94022

(415) 962-9265 • TLX: 171947 HANDWELL LTOS

MICROMAIL™



SPECIAL OF THE MONTH!



A Superior quality IBM PC Compatible Personal Computer. Runs DOS 1.1, 2.0, 2.1, CP/M86[®] UCSD p-System[®] Runs Lotus 1-2-3[®] Multiplan[®] Word Star[®] PFS[®] dBASEII[®] and many more! Hardware includes 128K CPU, Floppy Controller, Two DS/DD Disk Drives, Video Monitor, Video Adaptor, Parallel & Serial Ports.

**Suggested List \$2395
ALL FOR \$1995**

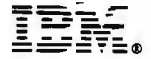

PERSONAL COMPUTER

Special of the Month!

COMPLETE SYSTEM VERY SPECIAL PRICE

64K, Two Disk Drives, Floppy Disk Controller, Video Card and High Res Monitor **\$2590**

256K RAM, 360KB Disk Drive, FDC, Video Monitor & Adaptor 10MB Hard Disk Sub-System. **\$3990**

APRICOT An IBM PC Compatible Computer W/Two Drives & Monitor **W/\$1250** worth of Software—Complete System. **\$2999**

SLIMLINE DISK DRIVE FOR IBM PC
DS/DD 320KB By TAVA CORP. **\$190**

ADD-ON Disk Drive for IBM PCjr[®] **CALL**

HARD DISKS FOR IBM PC[®] 

10 MB Hard Disk Sub-System by TAVA CORP. includes Software, Cables, etc. Internal. **\$1295**

MEMORY BOARDS

CONOGRAPHIC
High Res. Color Graphics Card **\$995**

QUADRAM
Quad Card. Fully pop. 256K **\$450**

QUADLINK **CALL**

AST SIXPAK 384K **CALL**

HERCULES Graphics Card **\$490**

APPLE IIe

Computer System, Controller, Two Disk Drives, Monitor **\$1590**

DISK DRIVE FOR APPLE
Slimline, or Standard **\$190**

PRINTERS

DAISYWRITER 2000 **CALL**

OKIDATA

82A	\$425	84A	\$975
83A	\$650	92A	\$525
93A			\$850

BROTHER

HR-1	\$675
DX-15	\$450

MONITORS

AMDEK

300A	\$190.00	I	\$340.00
300G	\$160.00	II	\$690.00
310A	\$190.00	III	\$390.00
IV			\$1190.00

PRINCETON GRAPHICS SYSTEMS

Hi-Res Color **\$490**

ROMAR II Apple Compatible Computer W/Z-Card Controller, Two Disk Drives and a Monitor for **\$1195**

NEC TANDON TAVA IBM APPLE QCS MAYNARD
LNW ROMAR PRODUCTS AVAILABLE

MICROMAIL

631 E. First St., Tustin, CA 92680

(714) 838-9100

*IBM PC is a registered trademark of IBM Corp.
*dBASE II is a registered trademark of Ashton-Tate, Inc.
*LOTUS 1-2-3 is a registered trademark of Lotus Development
*Wordstar, Spellstar, Mailmerge are registered trademarks of Micropro International
*Visicalc is a registered trademark of VisiCorp

Multiplan is a registered trademark of Microsoft Corp.
PFS is a registered trademark of Software Publishing Co.
CP/M86 is a registered trademark of Digital Research, Inc.
MS-DOS is a registered trademark of Microsoft Corp.
UCSDp is a registered trademark of Softech Microsystems

Lycy Computer Marketing & Consultants

TO ORDER
CALL US

TOLL FREE 800-233-8760
In PA 1-717-327-1824

PRINTER INTERFACING

PRINTER PAPER AVAILABLE

Available for IBM PC, Apple, Atari, Vic 20 & Vic 64

SAVE on these in-stock PRINTERS

LETTER QUALITY

SMITH CORONA TP2...\$449.00

DIABLO 630 ..\$1719.00

ALPHACOM 42\$89.00
ALPHACOM 81\$129.00
NEC 8023\$369.00
NEC 8025\$699.00
NEC PC-8200
COMPUTER\$CALL

EPSON

RX-80\$SAVES
RX-80FTON
FX-80In-Stock
FX-100EPSON
MX-80FTPRINTERS
MX-100\$CALL\$

MANNESMANN TALLY

SPIRIT 80\$CALL
MT 160L\$CALL

OKIDATA

80\$SAVES
82ACALL for
83ALOWEST
84PRICES
92on these
93In-Stock
PACEMARK 2350...PRINTERS

ATARI 850
REPLACEMENTS
IN-STOCK

CITOH

GORILLA GX100\$179.00
PROWRITER 8510\$339.00
PROWRITER II\$659.00
8800\$1025.00
STARWRITER\$1099.00
PRINTMASTER\$1499.00

STAR MICRONICS

GEMINI 10X\$269.00
GEMINI 15X\$CALL
DELTA 10\$479.00

MODEMS

ANCHOR MARK I ..\$79.00
ANCHOR MARK II..\$79.00
HAYES SMART ...\$239.00
HAYES MICRO II \$309.00
Micro Bit
MPP-1000\$129.75
NOVATION
CAT\$144.00
D-CAT\$155.00
J-CAT\$115.00
APPLE CAT II....\$279.00
212 APPLE CAT ..\$589.00

MONITORS

Sakata Color\$229.00
Amdek Color I\$275.00
Amdk 300 Green....\$149.00
Amdek 300 Amber ...\$149.00
Gorilla Green\$99.00

HES 64

Sound Box\$9.95
64Forth\$55.75
Heamon\$25.75
Turtle Graphics...\$37.75
Heswriter\$28.75
Gridrunner\$19.75

DUST COVERS

800\$3.99
400\$3.99
1200\$3.99
410\$3.99
810\$3.99
1050\$5.99
PROWRITER\$5.99
GEMINI 10X\$5.99
PERCOM DISK\$5.99

SSI

Battle of Shilo\$26.75
Tigers in the Snow...\$26.75
Cosmic Balance\$26.75



APPLE DUMPING GX\$99.75
APPLE DUMPING 64 (16 Buffer)\$179.75

INFOCOM

Zork I, II, or III\$26.75
Deadline\$33.75

CARDCO

Cardprinter / LO1\$499.00
Cardprint OM1\$109.00
5 Slot Expansion 64\$54.00
64 Write NOW\$39.00
64 Mail NOW\$29.00
2 Write NOW\$29.00
64 Keypad\$29.00
Universal Cass. Int.\$29.75
Printer Utility\$19.75
6 Slot Expansion\$79.95
3 Slot Expansion\$24.95
PRINTER INTERFACE\$39.75
PRINTER INTERFACE with
full graphics\$65.75
LIGHT PEN\$29.75

SPINNAKER 64

Kindercomp\$21.75
Story Machine\$23.75
Face Maker\$23.75
Snooper Trooper\$29.75
Delta Drawing\$34.75
Shamus II c/d\$24.95
Pinhead c/d\$22.95

SYNAPSE 64

ZEPELIN C/D\$24.75
BLUE MAX C/D\$24.75
DIMENSION X C/D\$24.75
EPYX 64
ASPHI R\$26.75
JUMPMAN JR R\$26.75
PIT STOP R\$26.75

commodore

BRODERBUND 64

BANK STREET
WRITER\$49.75
CHOPFLIFTER\$24.75
LODE RUNNER\$24.75
DROL\$24.75
KOALA TOUCH TABLET ..\$69.75

ATARI

Computers for people.
Voice Box 2 ..\$99.75

600XL ...\$CALL
800XLfor
1400XL...Lowest
1450Prices
1050 DISK DRIVE\$SAVES
1010 RECORDER\$74.75

PARKER BROTHERS

Tutankham R\$33.75
Super Cobra R\$33.75
Astro Chase R\$33.75
Frogger R\$33.75
QBert R\$33.75
Popeye R\$33.75

Monkey Wrench 2 \$52.75

SPINNAKER

Story Machine R ..\$26.75
Face Maker R\$24.75
Kinderomp R\$20.75
Fraction Fever R ..\$24.75
Delta Drawing R...\$26.75

BLANK DISKETTES ELEPHANT

Single Side 3D (10)\$17.75
Single Side DD (10)\$21.75
Double Side DD (10)\$26.75

MAXELL

MD I (10)\$26.75
MD II (10)\$36.75

CERTRON CASSETTES

CC-10 12 for\$15.99
CC-20 12 for\$17.99

INNOVATIVE CONCEPTS

Disk Storage (holds 10)\$4.95
Disk Storage (holds 15)\$9.95
Disk Storage (holds 50)\$26.95

TRAK DISK DRIVES

AT-D1\$379.00
AT-D2\$399.00
PRINTER CABLE\$22.95
Software for ATD-2\$22.95

RANA DISK DRIVE

COMPUTER CARE

BIB
5 1/4" DISK DRIVE
CLEANER\$12.75
COMPUTER CARE
KIT\$19.75

HARD DISK DRIVES for

APPLE IBM-PC

5MEG\$1349.00
10MEG ...\$1599.00
15MEG ...\$1999.00
20MEG ...\$2359.00

*Add \$10.00 for TRS 80 Drivers

TEXAS INSTRUMENT

Disk Drive...\$245.00

PERCOM

FOR ATARI COMPUTERS

AT88S1\$299.00
AT88S2\$535.00
AT**S1 PD...\$439.00
RFD40S1...\$399.00
RFD40S2...\$675.00
RFD44S1...\$449.00
AT88 doubler



TO ORDER



CALL TOLL FREE

800-233-8760

or send order to
Lycy Computer
P.O. Box 5088

Customer Service 1-717-327-1825 Jersey Shore, PA 1774C

POLICY

In-stock items shipped within 24 hours of order. Personal checks require four weeks clearance before shipping. No deposit on C.O.D. orders. Free shipping on prepaid cash orders within the continental U.S. PA residents add sales tax. All products subject to availability and price change. Advertised prices show 4% discount offered for cash, add 4% for MasterCard or Visa. DEALER INQUIRIES INVITED.

FORMULA INTERNATIONAL INC.

12603 Crenshaw Blvd., Dept. B, Hawthorne, CA 90250

For information (213) 973-1921 • Orders Only (outside Calif.) (800) 672-8758



pinecom™

No Copyright Problems!

Compare These Features with Our Competitors:

- Powerful Utility Program (100% Apple Compatible)
- 68-Key Upper & Lower Case Keyboard with Numeric Keypad
- 25 Pre-programmed Function Keys
- 2 Speed Auto Repeat Function
- 64K User Memory—expandable to 192K
- 5A Switching Power Supply (110/220VAC)
- All ICs Are Socketed for Easy Service
- Nation-wide Dealer Network for Convenient Technical Support

And best of all, the price Assembled and Tested is just.....

Pioneer of Low Cost Apple* Compatible Computer



Now with New Improved Keyboard and 64K RAM
\$499⁰⁰



pinecom™ DP-64

- Dual Processor (6502 and Z80A)
- Detached Keyboard
- 64K RAM Expandable to 192K
- 25 Function Key Keyboard
- Auto Repeat Keys w/Upper/lower Case
- 2 Slim Disk Drives (optional)
- 100% Apple II Compatible
- 40/80 Column Display (optional)
- Runs Both Apple Soft and CP/M Software



Model DP-64 Fully Assembled... **\$650⁰⁰**

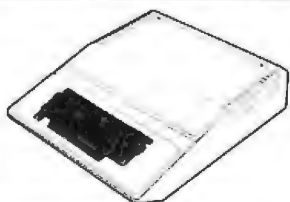

AP-II COMPUTER A&T

Apple Look Alike
48K User Memory
Supports Upper & Lower Case
100% Apple II* Compatible

\$455⁰⁰

MICRO-II COMPUTER

100% Apple Compatible • No Copyright Problems!



Model I 48K RAM.....

\$475⁰⁰

Model II 64K RAM.....

\$515⁰⁰

Model III 64K RAM w/Dual CPU...

\$555⁰⁰

(6502 for Applesoft & Z80A for CP/M)

Case and Keyboard Only..... **\$159.95**

All above models are standard with Numeric Keypad, Function Keys, Auto Repeat Keys, Upper/lower Case Function, Fully Assembled and Tested.

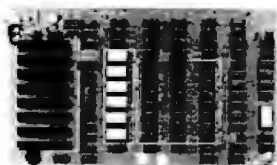

AP-II MOTHERBOARD

Apple II + * Compatible
48K Memory Space
8 Expansion Slots

Bare Board..... **\$69.95 ea.**

Assembled & Tested **\$295.00 ea.**

PRINTER by Super-5

Parallel Interface (Centronics Compatible) Standard
Microprocessor Electronics
80cps Bidirectional with Logic Seeking
96 Character ASCII
Adjustable Sprocket and Friction Feed

Model CP-80 **\$265⁰⁰**

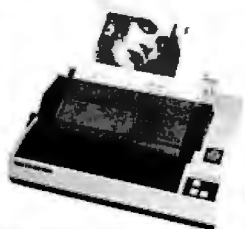

PERIPHERALS

- Autoterm 80-Col. w/Softswitch **\$99.95**
- 80-Column Card **99.95**
- 80-Column for Apple IIe* **49.95**
- Z80 CP/M Card (no software) **99.95**
- 16K RAM Card w/Cable **47.50**
- Parallel Printer Interface **85.00**
- Buffer for Printer Interface (16-64K) **85.00**
- Serial Printer Interface Card w/Adj. Baud **85.00**
- Disk Controller **65.00**
- Disk Controller DOS 3.2/3.3 Auto Select. **75.00**
- EPROM Writer Card (2716/2732/2764) ... **75.00**

3M DISKETTES SALE

Single Sided / Double Density Soft Sector

10 for **\$24⁵⁰**

SEND ONE DOLLAR FOR OUR DETAIL CATALOG

Shipping & Handling Charges
Under \$50.00 Over \$50.00

Purchase	Charge
10%	5%
15%	10%
25%	20%

Minimum Order \$10.00/Calif. Residents add 6.5% Sales Tax. Phone Orders Accepted on VISA or MC ONLY. NO C.O.D.'s. Prices subject to change without notice.



STORE HOURS
MON-FRI-10-7
SAT-10-6

Inside California
Outside Calif. (incl. Mexico & Canada)
Overseas

Circle 159 for Dealer inquiries. Circle 160 for End-User inquiries.

*Apple and Apple II are the trademark of APPLE COMPUTERS, INC.

MARCH SPECIALS

"WHEN YOU WANT IT RIGHT THE FIRST TIME,
YOU NEED AN EXPERT."

IBM-PC SYSTEMS

- #1 SYSTEM: 2-360K DRIVES, 64K,
GRAPHICS VIDEO CARD** \$ 2600
- #2 SYSTEM: 2-360K DRIVES, 64K, IBM
MONOCHROME CARD & CRT** \$ 2825
- #3 SYSTEM: 2-360K DRIVES, 64K,
GRAPHICS W/ PRINTER PORT** \$ 2745
- IF YOU SPECIFY THESE OPTIONS AT TIME OF ORDER, WE WILL
INSTALL AND TEST AT NO EXTRA CHARGE—
- OPTION A: RAM SETS, 64K BYTES PER SET,
MAXIMUM OF 3 SETS** \$50 PER SET
- OPTION B: 10M BYTE HARD DISK—INTERNAL** \$ 1150
- OPTION C: 8087 CO-PROCESSOR W/SOFTWARE
PATCHES** \$ 265
- OPTION D: 2 THINLINE 360K
DRIVES***SWAP***** \$ 120

CALL THE EXPERT
(213) 344-6063 (800) 528-9537

PC ACCESSORIES

- KEYTRONICS KEYBOARD \$ 195
- QUADLINK IBM TO APPLE CONVERTER \$ 495
- 10 MEGABYTE HARD DISK \$ 1575
- 64K RAM EXPANSION SET \$ 59
- RANA 2.5MB FLOPPY CALL
- TANDON TM100-2 DSDD DRIVE \$ 237
- AST RESEARCH EXPANSION CARDS:
- L/O PLUS \$ 120
- COMBO PLUS \$ 257
- SIXPAK \$ 270
- MEGA PLUS \$ 305
- MEGA PAK \$ 257

CALL THE EXPERT
(213) 344-6063 (800) 528-9537

SOFTWARE FOR IBM

- LOTUS 1-2-3 \$ 335
- DBASE II \$ 425
- FLIGHT SIMULATOR \$ 40
- MEGAWRITER (WORD PROCESSOR FOR PC/APPLE) \$ 90
- MEGASPELLER \$ 90
- MAIL MERGE \$ 95
- FRIDAYS \$ 260
- CATALIST (UNIVERSAL "MAIL MERGE") \$ 170

CALL THE EXPERT
(213) 344-6063 (800) 528-9537

VIDEO MONITORS

- ****MONTHLY SPECIAL**** JCS-RGB 13"
FOR PC \$ 390
- PRINCETON GRAPHICS HX-12 \$ 495
- BMC RGB \$ 445
- AMDEK AMBER 300A \$ 160
- AMDEK GREEN 300 \$ 140
- DYNAX AMBER 20MHZ \$ 140
- DYNAX GREEN \$ 129
- MB122G GREEN 12" (PC MONOCHROME) \$ 200
- MB122A AMBER 12"—BY ROLAND \$ 210

CALL THE EXPERT
(213) 344-6063 (800) 528-9537

DAISYWHEEL PRINTERS

- DYNAX DX-15 (15 CPS) \$ 465
- BROTHER HR-1 (19 CPS) \$ 630
- BROTHER HR-25 (25 CPS) \$ 795
- F-10 STARWRITER (40 CPS) \$ 1050
- F-10 PRINTMASTER (55 CPS) \$ 1400

CALL THE EXPERT
(213) 344-6063 (800) 528-9537

DOT MATRIX PRINTERS

- EPSON FX-80 \$ 550
- OKIDATA 82 \$ 440
- 92-TRACTOR \$ 46
- 92-PLUG-N-PLAY \$ 45
- OKIDATA 93 \$ 720
- 93-PLUG-N-PLAY \$ 45
- OKIDATA 84 \$ 1050
- PROWRITER 8510 \$ 360
- PROWRITER-II 1550 \$ 650
- GEMINI 10x \$ 279
- GEMINI 15x \$ 415
- MANNESMANN-TALLY 160L \$ 699
- IDS PREM-80 COLOR \$ 1150
- RITEMAN PORTABLE PRINTER \$ 385
- MOST PRINTER CABLES \$ 35

CALL THE EXPERT
(213) 344-6063 (800) 528-9537

MODEMS

- ANCHOR AUTOMATION "SIGNALMAN"
- MARK II (ATARI) \$ 89
- MARK III (TI) \$ 110
- MARK IV (COMMODORE PET-CBM) \$ 120
- MARK V (OSBORNE) \$ 100
- MARK XII (1200 BAUD SMARTMODEM) \$ 345
- THE NETWORKER FOR APPLE W/SOFTWARE \$ 159
- THE NETWORKER—NO SOFTWARE \$ 110
- HAYES SMARTMODEM 300 \$ 215
- HAYES SMARTMODEM 1200 \$ 505
- HAYES MICROMODEM II-E \$ 295
- NOVATION ACCESS 1-2-3 \$ 445

EXPERT COMPUTERS

21804 ROSCOE BLVD., SUITE 18
CANOGA PARK, CA 91304
(213) 344-6063
(800) 528-9537

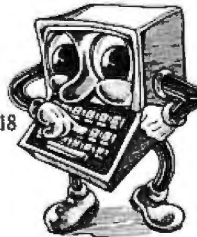

ADD 2% FOR VISA/MASTERCARD. 20% PREPAID DEPOSIT REQUIRED ON COD
ORDERS. CALIFORNIA RESIDENTS ADD SALES TAX. PRICES MAY CHANGE—CALL
TO VERIFY PRICES AND DELIVERY.

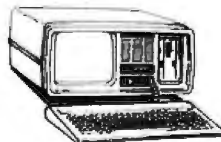
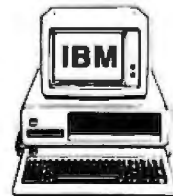

SANYO

FRANKLIN

Circle 152 on inquiry card.

EXPERT COMPUTERS

"When you know enough to buy mail order, you're wise enough to buy from an expert."

OTHER COMPUTERS

- COLUMBIA 1600-1 DESKTOP W/SOFTWARE \$ 2750
- COLUMBIA PORTABLE VP \$ 2599
- COLUMBIA HARD DISK DESKTOP \$ 3900
- CORONA DESKTOP-2 DRIVES \$ 2475
- CORONA PORTABLE-2 DRIVES \$ 2375
- EAGLE PC-2 \$ 2750
- PC-2 COLOR \$ 2500
- SPIRIT XL \$ 3900
- COLOR GRAPHICS BOARD \$ 240
- SASI INTERFACE \$ 110
- MONOCHROME ADAPTOR \$ 240
- MONOCHROME MONITOR \$ 280
- FRANKLIN FAMILY PAK \$ 1045
- PRO PLUS \$ 1267
- ACE 1000 \$ 795
- ACE PRO \$ 1137
- ACE 1200-1 DRIVE \$ 1399
- ACE 1200 OMS \$ 1595
- NEC APC GREEN-2 DRIVES #H02 \$ 2800
- EPSON QX-10 \$ 2195
- APPLE II-e STARTER SYSTEM \$ 1375
- SANYO MBC550 \$ 795
- MBC550 W/ADDED 360K 2ND DRIVE \$ 1055
- MBC555 \$ 1195

SANYO EXPLANATION: THE STANDARD MBC550 HAS ONE
SINGLE SIDED DRIVE AND 3 PIECES OF SOFTWARE. THE
STANDARD MBC555 HAS TWO SINGLE SIDED DRIVES AND
6 PIECES OF SOFTWARE. THE ENHANCED MBC550 HAS
ONE SINGLE SIDED DRIVE, ONE DOUBLE SIDED DRIVE, AND
3 PIECES OF SOFTWARE.

SEKON 64 SYSTEM (LIKE APPLE) \$ 1025

CALL THE EXPERT

(213) 344-6063 (800) 528-9537

APPLE ACCESSORIES

- ALS CP/M CARD \$ 285
- ALS SMARTER II (80 COLUMN CARD) \$ 145
- INDUS GT DRIVE W/ 3 SOFTWARES \$ 250
- RANA ELITE I \$ 265
- RANA ELITE II \$ 435
- RANA ELITE III \$ 555
- MICROTEK DUMPLING-16K \$ 160
- GRAPPLER+ \$ 125
- PROMETHEUS 16K RAM CARD \$ 60
- SEKON 16K RAM CARD \$ 55
- SEKON 80 COLUMN CARD \$ 85
- SEKON HUNTER (LIKE WILDCARD) \$ 90
- SEKON Z-80 CARD \$ 100
- SEKON DRIVES—THIN, DIRECT DRIVE, 35 TRACK \$ 220

CALL THE EXPERT

(213) 344-6063 (800) 528-9537

PEARLSOFT DATABASE SOFTWARE

WE STOCK PERSONAL PEARL IN FORMATS FOR APPLE,
KAYPRO, IBM-PC, EPSON QX-10, MULTITECH & NEC-
APC. WE CAN PROVIDE IT WITH ONE WEEK ADDITIONAL PRO-
CESSING TIME FOR VIRTUALLY ANY OTHER COMPUTER—PLEASE
SPECIFY.

PERSONAL PEARL \$ 200

ACCOUNTING PEARL—COMPLETE SYSTEM
FOR IBM-PC \$ 775

CALL THE EXPERT

(213) 344-6063 (800) 528-9537

DISKETTES

- VERBATIM VEREX SSDD \$ 17
- DATALIFE SSDD \$ 25
- DATALIFE DSDD \$ 33
- HEAD CLEANER KIT \$ 8
- FLOPIT (USE BACK SIDE OF DISKS) \$ 17
- DISKETTE HAMPER \$ 24
- LIBRARY CASE—HOLDS 10 DISKS \$ 2.25

DIGITAL RESEARCH COMPUTERS

(214) 271-3538

32K S-100 EPROM CARD PRICE CUT!

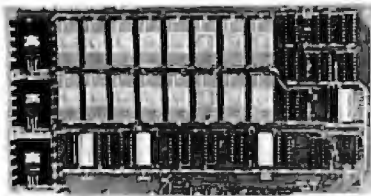

\$59.95

USES 2716's

Blank PC Board - \$34

ASSEMBLED & TESTED
ADD \$30

SPECIAL: 2716 EPROM's (450 NS) Are \$4.95 Ea. With Above Kit.

KIT FEATURES

- 1 Uses +5V only 2716 (2Kx8) EPROM's
- 2 Allows up to 32K of software on line!
- 3 IEEE S-100 Compatible
- 4 Addressable as two independent 16K blocks
- 5 Cromemco extended or Northstar bank select
- 6 On board wait state circuitry if needed
- 7 Any or all EPROM locations can be disabled
- 8 Double sided PC board solder-masked silk-screened
- 9 Gold plated contact fingers
- 10 Unselected EPROM's automatically powered down for low power
- 11 Fully buffered and bypassed
- 12 Easy and quick to assemble

256K S-100 SOLID STATE DISK SIMULATOR! WE CALL THIS BOARD THE "LIGHT-SPEED-100" BECAUSE IT OFFERS AN ASTOUNDING INCREASE IN YOUR COMPUTER'S PERFORMANCE WHEN COMPARED TO A MECHANICAL FLOPPY DISK DRIVE.

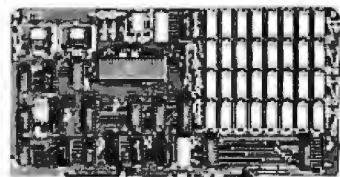

FEATURES:

- * 256K on board, using + 5V 64K DRAMS.
- * Uses new Intel 8203-1 LSI Memory Controller.
- * Requires only 4 Dip Switch Selectable I/O Ports.
- * Runs on 8080 or Z80 S100 machines.
- * Up to 8 LS-100 boards can be run together for 2 Meg. of On Line Solid State Disk Storage.
- * Provisions for Battery back-up.
- * Software to mate the LS-100 to your CP/M* 2.2 DOS is supplied.
- * The LS-100 provides an increase in speed of up to 7 to 10 times on Disk Intensive Software.
- * Compare our price! You could pay up to 3 times as much for similar boards.

BLANK PCB
(WITH CP/M* 2.2
PATCHES AND INSTALL
PROGRAM ON DISKETTE)

\$69.95

\$399.00

#LS-100 (FULL 256K KIT)

THE NEW ZRT-80

CRT TERMINAL BOARD!

A LOW COST Z-80 BASED SINGLE BOARD THAT ONLY NEEDS AN ASCII KEYBOARD, POWER SUPPLY, AND VIDEO MONITOR TO MAKE A COMPLETE CRT TERMINAL. USE AS A COMPUTER CONSOLE. OR WITH A MODEM FOR USE WITH ANY OF THE PHONE-LINE COMPUTER SERVICES.

FEATURES:

- * Uses a Z80A and 6845 CRT Controller for powerful video capabilities.
- * RS232 at 16 BAUD Rates from 75 to 19,200.
- * 24 x 80 standard format (60 Hz).
- * Optional formats from 24 x 80 (50 Hz) to 64 lines x 96 characters (60 Hz).
- * Higher density formats require up to 3 additional 2K x 8 6116 RAMS.
- * Uses N.S. INS 8250 BAUD Rate Gen. and USART combo IC.
- * 3 Terminal Emulation Modes which are Dip Switch selectable. These include the LSI-ADM3A, the Heath H-19, and the Beehive.
- * Composite or Split Video.
- * Any polarity of video or sync.
- * Inverse Video Capability.
- * Small Size: 6.5 x 9 Inches.
- * Upper & lower case with descenders.
- * 7 x 9 Character Matrix.
- * Requires Par. ASCII keyboard.

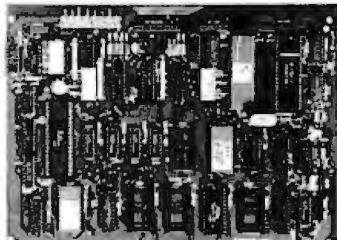

BLANK PCB WITH 2716
CHAR. ROM, 2732 MON. ROM

\$59.95

SOURCE DISKETTE - ADD \$10
SET OF 2 CRYSTALS - ADD \$7.50

WITH 8 IN.
SOURCE DISK!
(CP/M COMPATIBLE)

\$129.95

ZRT-80

(COMPLETE KIT,
2K VIDEO RAM)

Digital Research Computers

P.O. BOX 461565 • GARLAND, TEXAS 75046 • (214) 271-3538

64K S100 STATIC RAM

\$199.00
KIT

NEW!

LOW POWER!
RAM OR EPROM!

BLANK PC BOARD
WITH DOCUMENTATION
\$55

SUPPORT ICs + CAPS
\$17.50

FULL SOCKET SET
\$14.50

FULLY SUPPORTS THE
NEW IEEE 696 S100
STANDARD
(AS PROPOSED)

FOR 56K KIT \$185

ASSEMBLED AND
TESTED ADD \$50

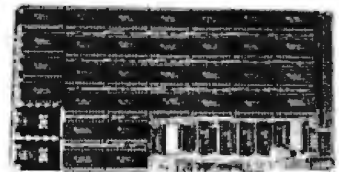

FEATURES:

- * Uses new 2K x 8 (TMM 2016 or HM 6116) RAMs.
- * Fully supports IEEE 696 24 BIT Extended Addressing.
- * 64K draws only approximately 500 MA.
- * 200 NS RAMs are standard. (TOSHIBA makes TMM 2016s as fast as 100 NS. FOR YOUR HIGH SPEED APPLICATIONS.)
- * SUPPORTS PHANTOM (BOTH LOWER 32K AND ENTIRE BOARD).
- * 2716 EPROMs may be installed in any of top 48K.
- * Any of the top 8K (E000 H AND ABOVE) may be disabled to provide windows to eliminate any possible conflicts with your system monitor, disk controller, etc.
- * Perfect for small systems since BOTH RAM and EPROM may co-exist on the same board.
- * BOARD may be partially populated as 56K.

64K SS-50 STATIC RAM

\$179.00
(48K KIT)

NEW!

LOW POWER!
RAM OR EPROM!

BLANK PC BOARD
WITH
DOCUMENTATION
\$52

SUPPORT ICs + CAPS
\$18.00

FULL SOCKET SET
\$15.00

56K Kit \$219

64K Kit \$249

ASSEMBLED AND
TESTED ADD \$50



FEATURES:

- * Uses new 2K x 8 (TMM 2016 or HM 6116) RAMs.
- * Fully supports Extended Addressing.
- * 64K draws only approximately 500 MA.
- * 200 NS RAMs are standard. (TOSHIBA makes TMM 2016s as fast as 100 NS. FOR YOUR HIGH SPEED APPLICATIONS.)
- * Board is configured as 3-16K blocks and 8-2K blocks (within any 64K block) for maximum flexibility.
- * 2716 EPROMs may be installed anywhere on Board.
- * Top 16K may be disabled in 2K blocks to avoid any I/O conflicts.
- * One Board supports both RAM and EPROM.
- * RAM supports 2MHZ operation at no extra charge!
- * Board may be partially populated in 16K increments.

32K S100 EPROM/STATIC RAM

NEW!

FOUR FUNCTION BOARD!

NEW!

EPROM II
FULL
EPROM KIT
\$80.00

A&T EPROM
ADD \$35.00

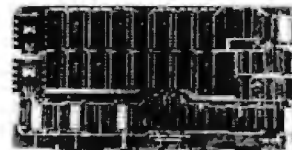

BLANK
PC BOARD
WITH DATA
\$38.95

SUPPORT
ICs +
PLUS CAPS
\$22.00

FULL
SOCKET SET
\$18

We took our very popular 32K S100 EPROM Card and added additional logic to create a more versatile EPROM/RAM Board.

FEATURES:

- * This one board can be used in any one of four ways:
 - A. As a 32K 2716 EPROM Board
 - B. As a 32K 2732 EPROM Board (Using Every Other Socket)
 - C. As a mixed 32K 2716 EPROM/2K x 8 RAM Board
 - D. As a 32K Static RAM Board
- * Uses New 2K x 8 (TMM2016 or HM6116) RAM's
- * Fully Supports IEEE 696 Buss Standard (As Proposed)
- * Supports 24 Bit Extended Addressing
- * 200 NS (FAST!) RAM'S are standard on the RAM Kit
- * Supports both Cromemco and North Star Bank Select
- * Supports Phantom
- * On Board wait State Generator
- * Every 2K Block may be disabled
- * Addressed as two separate 16K Blocks on any 64K Boundary
- * Perfect for MP/M* Systems
- * RAM Kit is very low power (300 MA typical)

32K STATIC RAM KIT — \$129.95

For RAM Kit A&T - Add \$40

TERMS: Add \$3.00 postage. We pay balance. Orders under \$15 add 75¢ handling. No C.O.D. We accept Visa and MasterCard. Tex Res. add 5% Tax. Foreign orders (except Canada) add 20% P & H. Orders over \$50, add 85¢ for insurance.

ADVANCED COMPUTER PRODUCTS

SEND \$2.00 for 1984 CATALOG

64K RAMS Set of 9 \$50.00

Apple Compatible Software BUSINESS

APPLIED SOFTWARE Versatorm	ACP PRICE
Versatorm Hard Disk	\$299.00
ARTS Magic Window II	99.00
Magic Combo	149.00
ASHTON-TATE dBASE II (CP/M)	385.00
Friday (CP/M)	198.00
BPI (GL, AR, AP, Pay, Inv)	299.00
BRODEBUND Bank Street Writer	499.00
BUSINESS SOLUTIONS The First Jack	149.00
CONTINENTAL (GL, AR, AP, Pay)	189.00
Home Accountant	49.00
DATAMOST Real Estate Inv.	99.00
DOW JONES Market Manager	248.00
Market Analyzer	289.00
Market Microscope	549.00
EAGLE Money Decisions	149.00
FOX & GELLER Clickcode	199.00
d Utility	69.00
d Graph	199.00
HAYDEN Pie Writer	149.00
Compuer Plus	79.00
Basic Compiler	45.95
HOWARD'SOFT Tax Preparer	149.00
Real Estate Analyzer	139.00
KENNINGTON Format II	99.00
LIGHTNING MasterType	35.00
LIVING VIDEOTEXT Think Tank	135.00
MICROPRO Wordstar	499.00
Malmmerge or Spellstar	139.00
Wordstar Prot. 4 Pak	449.00
Info Pak or InfoStar	Call
MICROSOFT Multiplan	179.00
Multicool Financial	79.00
Multicool Budget	119.00
MEGAHAUS Megawriter	499.00
PEACHTREE Series 40 (GL, AR, AP)	379.00
Series 9 (Text, Spell, Mail)	399.00
PERFECT SOFTWARE	Call
QUARK Word Juggler (file)	199.00
Leitchek (file)	99.00
Call for Apple II	
SIERRA ON-LINE	
Screenwriter II	89.00
Screenwriter Professional	149.00
General Manager II	169.00
Dictionary	79.00
SOFTWARE PUBLISHING PROFILE	249.00
PDFS/Graph or PDF/Report	89.00
STATE OF THE ART	Call
STONEWARE DB Master 4.0	249.00
BB Utility 1 or 2	79.00
SYSTEMS PLUS Acet Plus (GL, AP, AR)	599.00
VISION/P Visic 3.3	99.00
Visicalc Enhancer	99.00
Visilite or Visidex	179.00

IBM PC MULTICARD™

"MULTICARD" multifunction card for the IBM PC & XT expandable to 256K. Thousands of this popular card have already been shipped by ACP.

- 64-256K
- Parallel Port
- Serial Port
- 1 Year Warranty
- Disk Emulator Software
- Printer Spooler Software
- Clock/Calendar
- Clock Software

\$229⁰⁰ w/64K **\$229⁰⁰**

S-100 64K "CMOS" RAMCARD

Unbelievable Price! **\$299⁰⁰**

Assembled and Tested

- ACP has sold over 1000 of these IEEE compatible, low-priced, high-reliability 64K Static RAM Cards.
- Single 5-Volt operation.

SIEMEN'S SALE

You can now purchase Shugart compatible 8" Disk Drives below your existing factory direct pricing!

These Prices are the lowest ever published

*Siemen's \$500 FDD100-8... **\$169.00**

Also, with purchase of Disk Drives you can buy the Vista V-1000 Dual Case with Power Supply and Cable

for only **\$375.00**... Regular Price \$495.00

Other Limited! Factory Warranty 90 Days! Shipped Immediately from Stock! *OEM Quantities



DOT MATRIX PRINTER

COEX 80-FT

- 9x7 Dot Matrix, 80 CPS, Bi-Directional Printing
- 2K Buffered Memory
- 80, 96, 132 Columns, Graphics and Block Printing
- Selectable Char Pitch, Line Spacing and Feed



\$199⁰⁰

COEX Interface Card to Apple... \$49.95

ACP HAS DISK DRIVES

APPLE II™ COMPATIBLE APPLE COMPATIBLE DISK DRIVES

Thin Line Drive **\$199⁰⁰**

VISTA Solo 5 1/4" Std.	\$199.00
CUMANA 5 1/4" Std.	219.00
RANA Elite 1	249.00
Elite 2	399.00
Elite 3	499.00
Elite Controller	82.00
SUPER 5 Alps A40 Thinline	199.00
TEAC T40 Thinline	239.00
TEAC T80 Doublesided	329.00
Controller	58.00

TANDON 100-2

PC Compatible • Double Sided

\$229⁰⁰

TM100-1... \$179.00



Mounting Kit for IBM PC \$4.95



TOSHIBA Half-High

PC Compatible • Double Sided

\$179⁰⁰

APPLE™ COMPATIBLE DISK CONTROLLER

Only **\$49.95**

Apple Compatible Printer Interface

w/Apple to Epson Cable **\$49.95**

Apple IIe Compatible 80 Column Card w/64K

\$99.95

APPLE COOLING FAN



with Surge Suppression **\$49.95**

VISTA "SOLO"

Apple II/IIe Compatible Disk Drive **\$199.95**

Totally compatible to Apple Drives. Only **\$199.95**

Apple II 16K RAM CARD

Compatible with 280 Softcard™, PASCAL CP/M™ Full 1 year Warranty, Top Quality by COEX **\$49.95**

VISTA A800

8" Disk Controller for Apple **\$299.95**

VISTA "DISKMASTER"

IBM Compatible 3", 5", 8" and V1200 Compatible... **\$169.95**

CLEARANCE SALE

QTY	LIST	ACP
120	\$329.00	\$329.00
400	\$329.00	\$329.00
410	\$429.00	\$429.00
410	\$559.00	\$559.00
420	\$559.00	\$559.00
122	\$179.00	\$179.00
122	\$189.00	\$189.00
100	\$149.00	\$149.00

Mail Order: P.O. Box 17329 Irvine, CA 92713
Retail: 1310B E. Edinger, Santa Ana, CA 92705
(714) 558-8813
542 W. Trimble, San Jose, CA 95131
(408) 946-7810

Apple Computer Authorized Dealer

Complete Apple Support Facility
Complete Apple Service Center
We service most floppy disk drives



Apple IIe w/28K, 80 columns...
Apple IIe Starter System... \$199.00
Includes: Apple IIe w/64K, 80 Column Card, Monitor II & Disk II w/Controller...
Disk II w/Controller... \$399.00
Disk II... \$329.00
Monitor II Green III... \$179.00
Super Serial Card... \$189.00
In Color Text Card w/64K... \$95.00
Imagewriter Dot Matrix Printer... \$349.00
*Apple Products Available In-store Only!

Apple Compatible Hardware

	LIST	ACP
ALS CP/M 3.0 Plus Card	\$399.00	\$299.00
COMPUTER ACCESSORIES		
PowerControl Center P12		99.00
COEX IBM 9 Pin Card	99.00	49.95
Parallel Printercard w/Cable	99.00	49.95
Apple II Prototype Card	29.00	20.00
Apple II Extender Card	29.00	20.00
64K Extended 80 Column	199.00	99.95
CORVUS Hard Disk Omninet		119.00
EASTSIDE Hardcard (11" w/64)		99.00
Wildcard 2 (file)		Call
Wildcard Plus (64K in 10 sec)		49.00
FINGERPRINT Epson Enhancer		149.00
GIBSON Light Pen		249.00
IS PKASO Interface (II/III)	199.00	199.00
PKASO Interface (III)	199.00	199.00
KENNINGTON System Saver	89.95	89.95
PC Save	49.95	39.95
KEYTRONICS KB200 II + Keypad	298.00	225.00
KOALA Graphics Pad	125.00	95.00
KRAFT Joystick	65.00	49.00
Game Paddles	50.00	38.00
MCT Speed Demon	295.00	249.00
128K Bubble Memory	875.00	699.00
MPR Supr. Mod II RF Modulator	69.00	49.00
Supr. Fan	50.00	38.00
MICROPRO 6MHz Applicator w/Word		Call
MICROSOFT 2-80 Softcard	395.00	249.00
2-80 Softcard Plus	645.00	479.00
Softcard Premium Pak (II-4)	695.00	489.00
Softcard Premium Pak (file)	495.00	395.00
MONTHLY COMPUTER		
CPS Multifunction	239.00	169.00
Music System	395.00	335.00
A/D Plus DA	350.00	299.00
MICROTEK Dumping But. w/64K	349.00	265.00
ORANGE MICRO		
Grappler Plus	175.00	129.00
16K Bufferboard	175.00	129.00
Grappler Buffered w/16K	245.00	199.00
PCPI Applicator w/128K, 6MHz	595.00	499.00
8088 Coprocessor	985.00	499.00
Apple II w/128K, 4MHz	495.00	429.00
PERISOFT (All w/1 Year Warranty)		
PrinterIntell. Printer I/O	99.00	79.00
Messenger Univ. Serial I/O	135.00	109.00
Timelink Realtime Clock	110.00	89.00
Graftek Graphics I/O	175.00	139.00
Micro II w/64K Buffer	199.00	159.00
PRACTICAL PERIPHERALS		
Microbuffer 16K (Epson Parallel)	159.00	Call
Microbuffer 32K (Epson Parallel)	199.00	Call
Microbuffer 16K (Epson Serial)	179.00	Call
Microbuffer 32K (Epson Serial)	219.00	Call
Microbuffer In-line 64K (Parallel)	349.00	279.00
Microbuffer In-line 64K (Serial)	349.00	279.00
PROMETHEUS Versacard 4 in 1	199.00	166.00
QUADRAM Quadlink	680.00	499.00
Microtazer 16K (Parallel)	189.00	169.00
Microtazer 16K (Serial)	202.00	195.00
Microtazer 32K (Parallel)	225.00	199.00
SATURITAN		
32K Ramcard	219.00	189.00
64K Ramcard	349.00	289.00
128K Ramcard	499.00	399.00
Accelerator II Card	599.00	449.00
Nepeline 64K + 80	199.00	199.00
Nepeline 128K + 80	299.00	299.00
Nepeline 192K + 80	449.00	399.00
STREET Echo II (Apple)	149.00	99.00
Echo II Serial (In-line)	249.00	199.00
SYNETIX Sprite I	149.00	129.00
Sprite II	249.00	224.00
Supersprite	395.00	359.00
Flashcard 144K	449.00	399.00
Flashcard 288K	629.00	549.00
TG PRODUCTS		
Joystick	59.95	49.95
Select-a-port	59.95	49.95
Trackball	64.95	54.95
Joystick w/Toggle Ite	64.95	54.95
VIDEX Videotext (80)	349.00	199.00
Ultraform (132)	379.00	279.00
Enhancer II	149.00	99.00
VISTA COMPUTER		
A800 8" Disk Controller	379.00	299.00
A500 5 1/4" Disk Controller	499.00	49.95
V1200 Amlyn 6.2Mb	1549.00	1099.00
VOTRAX Type N Talk	259.00	199.00
Personal System	395.00	329.00
ROBOTS		
ANDROBOT	LIST	ACP
Topo w/Speech	\$1595.00	Call
Andrewagon	95.00	Call
Topoteach (I, II)	349.00	Call
Topoteach (II, file)	159.00	Call
Topolog		Call
F.R.E.D. (Educational Robot)	349.00	Call
F.R.E.D. Soft (II, file)	79.00	Call
RBX		
RBX Robot w/8K	1795.00	Call
16K Memory Add-in	12.00	Call
Robot Arm Option	895.00	Call
Voice Option	195.00	Call
Power Pack	94.00	Call
Robot Control Language (II, file)	395.00	Call
ZENITH HERO I	2495.00	Call

Apple™ Apple Trademark of Apple Computer
IBM™ IBM Trademark of International Business Machines

OTHER DRIVES WE STOCK

YANCOON 340-2 Thinline	\$479.00	SHUGART 801A	\$399.80
TEAC FDS58	199.00	QUME Datatrack 8	449.00
SEAGATE 10MB Hard Disk	699.00	SGC 1800 DS (320K)	249.00
MPI 852	239.00	SEAGATE ST308 (6MB Win)	499.00

800-854-8230
TOLL FREE
910-595-1565

ADVANCED COMPUTER PRODUCTS

Serving Computer Professionals Since 1976

TOLL FREE 800-854-8230

IBM PC



★ **COLOR SPECIAL** ★
THE COLOR GRAPHICS CARD
(same designer as ColorPlus Card)
 PRICE \$269.00
 BREAKTHRU! 1yearWarranty \$269.00

MULTI CARD II™ (exp.) \$199.00

(INTRODUCTORY OFFER)

Advanced Computer Product's best selling multifunction card for the IBM PC & XT (plus compatibles) now has been improved with expansion capability to a full 384K and at no charge an additional game port. You also get Print Spooler and Disk Emulation Software plus a full year SWAP-OUT Warranty at no extra charge. Why pay more when you can get the same function and performance as Quadboard II™ and AST Sixpak Plus™ for substantially less money. You compare! Try it at no obligation. 10 day no questions asked return privilege.

FUNCTION	Multicard II	Quadboard II	Sixpak Plus
Memory	0 to 384K	0 to 384K	0 to 384K
Parallel/Serial	Yes	Yes	Yes
Clock/Calendar	Yes	Yes	Yes
Game Port	Yes	Yes	No (\$50 list Opt.)
Software	Yes	Yes	Yes
Warranty	1 Year	1 Year	1 Year
ACP Price with 0K	199.00	229.00	229.00

EXPANSION MEMORY

- 64K Upgrade (Set of 9 64K RAMS) . . . \$50.00
- 256K RAM's (256K x 1) . . . \$79.00 ea
- 16K RAM's (16K x 1) . . . 10/\$9.99
- 8087 CPU (Arithmetic Processor) . . . \$199.00

IO/XT (Serial, Parallel, Clock/Calendar) . . . \$129.00

The most popular expansion card for the short slot of your IBM XT. All these functions on one card optimized to fit in one slot. 1 year warranty.

COLOR/GRAPHICS/COLOR/GRAPHICS

- Plantronics COLORPLUS™ . . . \$429.00
- Hercules GRAPHICS CARD . . . \$375.00
- Quadram QUADCOLOR I&II. . . Call
- Scanoptik COLORGRAPHICS . . . \$269.00
- Amdelk MAI . . . \$479.00
- Paradise MULTIDISPLAY . . . \$489.00
- CONOGRAPHIC CARO . . . \$895.00
- MA Sys PEACOCK . . . \$349.00

IBM PC COMPATIBLE DISK DRIVES

1/2 high Mounting Hardware \$4.95/set Mounts (2)

- Tandon TM-100-1 Single Sided (160K) . . . \$179.00
- Tandon TM-100-2 Double Sided (320K) . . . 229.00
- Control Data 9409 Double Sided (320K) . . . 259.00
- TEAC* 55B 1/2 high Double Sided (320K) . . . 199.00
- Toshiba* 1/2 high Double Sided (320K) . . . 179.00
- *IBM PC Mounting Hardware for 1/2 highs. . . 4.95
- Vista "Diskmaster" 5 1/4" & 8" Diskcontroller . . . 169.00

HARDWARE

- AST Sixpakplus w/0K(SPC) . . . \$229.00
- Megaplus II w/0K(SC) . . . 229.00
- IO Plus II (CS) . . . 115.00
- Game/Serial/Parallel Options . . . 35.00
- 64K Memory Upgrade . . . 50.00
- CHALKBOARD . . . Call
- COEX IBM PC Extender Card . . . 29.00
- IBM PC Prototype Card . . . 36.00
- DAVONG Hard Disk Drives . . . Call
- KENSINGTON PC Saver . . . 39.00
- KEYBOARD IBM PC Compatible . . . 149.00
- KEYTRONICS WP Keyboard KB5150 . . . 199.00
- KOALA . . . 99.00
- KRAFT or TG . . . Call
- IBM PC Joystick . . . 49.00
- Game Paddles . . . 39.00
- MICROSOFT Mouse . . . 169.00
- M&R PC-XT Exp Chassis (6 slots) . . . 439.00
- MOUSE SYS Mouse for PC . . . 239.00
- PERSYST Time Spectrum w/64K . . . 289.00
- PTI Back-up Power 200/400W . . . Call
- QUADRAM Quadboard II w/0K . . . 499.00
- Quadlink (Apple Prog.) . . . 499.00
- Quaddisk (up to 72Mb) . . . Call
- Microfazer MP64 w/64K . . . 199.00
- VISTA Turbocard w/0K . . . Call
- Maxicard w/64K (up to 576K) . . . 229.00
- PC Master (10 I/O) . . . 329.00
- Diskmaster (Floppy Cont.) . . . 169.00
- Dynaframe Hard Disk . . . Call
- PC Clock I/O . . . 129.00

SOFTWARE

- dBASE II/Friday . . . \$389.00/\$179.00
- Condor . . . \$389.00
- SuperCalc I/II/III . . . \$79.00/\$159.00/\$249.00
- Multiplan Vers. 1.1 . . . \$179.00
- Microsoft Mouse/Word . . . \$369.00

PRINTERS/MONITORS

- BROTHER HR-25 (23cps daisy) . . . Call
- HR-1A (16cps daisy) . . . Call
- COEX 80F/T (80cps) . . . Sale \$199.00
- DYNAX DX-15 (daisy, 2-color) . . . \$29.00
- DAISYWRITER 2000 (17cps) . . . 1049.00
- EPSON RX-80 (100cps) . . . 299.00
- FX-80/FX100 . . . Call
- NEC Spinwriter 3550 . . . 1875.00
- OKIDATA Model 82/83 . . . 399.00/619.00
- Model 84P/84S . . . 919.00/989.00
- Model 92P/92S . . . 495.00/595.00
- Model 93P/93S . . . 769.00/899.00
- SILVER REED EXP550 (17cps) . . . 649.00
- STAR Gemini 10X (120cps) . . . 309.00
- Gemini 15X (120cps) . . . 429.00
- Delta 10/15 (180cps) . . . Call
- TTX Model 1014 (12cps) . . . 529.00
- TRANSTAR 130P (16cps daisy) . . . 699.00
- 315 Color Printing . . . 519.00
- AMDEK Video 300G/A . . . 145.00/155.00
- Video 310A amber (IBM) . . . 159.00
- Color I (composite) . . . 299.00
- Color I Plus (earth/nonflare) . . . 329.00
- Color II RGB (IBM) analog . . . 449.00
- Color II Plus . . . 479.00
- Color III RGB (IBM) . . . 399.00
- Color IV RGB (IBM) analog . . . 779.00
- BMC 12" Green-Low cost . . . 89.00
- PGS HX-12 RGB (IBM) . . . 499.00
- ZENITH ZVM-121 12" green . . . 99.00
- ZVM-134 12" RGB color . . . 399.00

DISKETTES

- DYSAN 5 1/4" SS DD . . . 10/655 \$38
- DYSAN 5 1/4" DS DD . . . 10/65 46
- IBM 5 1/4" SS DD . . . 10/80 43
- IBM 5 1/4" DS DD . . . 10/65 47
- VERBATIM 525-01 SS DD . . . 10/45 23
- VERBATIM 550-01 DS DD . . . 10/55 34
- MAXELL M01 SS DD . . . 10/50 29
- MAXELL M02 DS DD . . . 10/60 38
- Flip Storage Box 5 1/4" (80 disks) . . . 19
- BULK SPECIAL SS . . . 10/25 19
- With Sleeve and Box . . . 100/195 149

IBM ACCESSORIES

- COMPUABLE . . . Call
- Keyboard/dive dust covers . . . \$16.00
- Computer keyboard vinyl cover . . . 9.00
- CURTIS PC Pedestal . . . 66.00
- FGS Adapter . . . 11.00
- Vertical PC Stand . . . 20.00
- Mono Extension Cable . . . 45.00
- Keyboard Ext Cable (3-9') . . . 35.00
- EDP PROTECTION DEVICES . . . Call
- The Lemon/Peach . . . 43.00/68.00
- The Orange/Lime . . . 122.00/76.00
- GILTRONIX SWITCH BOXES . . . Call
- 2 Way 8 Lines . . . 90.00
- 4 Way 8 Lines . . . 179.00
- 2 Way Centronics . . . 199.00
- RIBBONS . . . Each Dozen
- Epson MX-80 . . . 5.75 59.00
- Epson MX-100 . . . 10.95 120.00
- Star Gemini 10/15 . . . 2.50 26.00
- Okidata 80 82/83 . . . 3.95 44.00
- Okidata 84 82/83 . . . 4.95 55.00
- NEC 3550 . . . 11.95 135.00

MODEMS

- BIZCOMP Model 2120 (Internal) . . . Call
- HAYES Smartmodem 1200 . . . \$475.00
- Smartmodem 1200B . . . Call
- Smartmodem II . . . 445.00
- Smartmodem 300 . . . 199.00
- Smartmodem II . . . 99.00
- Smartmodem/IBM Cable . . . 25.00
- NOVATION Access 1-2-3 . . . Call

Wordstar 3.3 \$269.00

Micropro Pro Pak \$379.00

Rbase II \$329.00

T. K. Solver! \$319.00

PFS File/Graph \$95.00/\$95.00

Context MBA Call!

Lotus 1-2-3 Vers. 1A Call!

Copy II/PC Sideways

Volkswriter

Home Account

Peachtree

Crosstalk

Digital Research

Send for Free Catalog
 96 Pages of Selected Values

Circle 13 on inquiry card.

TERMS: We accept VISA, MC, MD, Cashiers and Personal checks. School and Company PO's. We do not charge your card until we ship. Personal checks require drivers license and credit card or No Discharge Affidavit on VISA or MC. COD's over \$500 require 20% deposit with order. Add 3% shipping and handling for UPS. We offer same-day shipment. Prices subject to change without notice. We reserve the right to substitute manufacturer. We are not responsible for typographical errors. Retail Sale Prices May Vary. IBM™ trademark of International Business Machines. Quadboard II™ trademark of Quadram Corp. Smart Plus™ trademark of AST Research Inc.

MAIL ORDER: P.O. Box 17329 Irvine, CA 92713
 Retail: 1310 E. Edinger, Santa Ana, CA 92705
 (714) 558-8813
 542 W. Trimble, San Jose, CA 95131
 (408) 946-7010

TOLL FREE
800-854-8230
 TWX
 910-595-1565

1984 CATALOG AVAILABLE SOON • 64K UPGRADE KITS - ONLY \$50.00

64K UPGRADE - ONLY \$50.00 • CUSTOM CABLES AVAILABLE

WE STOCK CABLES • RIBBONS • DISKETTES • SPARE PARTS

Davidge

Is now offering their OEM quality high performance Z80 based single board microcomputers at a substantial savings

\$ 495⁰⁰

- Includes:**
- CP/M 2.2
 - Davidge Utilities
 - Completely assembled, burned in and tested

These Boards Feature:

- 4 or 6 MHz
- 2 or 4 serial ports
- 5 1/4" and 8" floppy disk controller
- 2K Boot ROM with monitor
- 64K RAM
- Centronics parallel port
- High speed bidirectional parallel port
- DMA Controller
- SASI Interface*

* Options

Send Check or Money Order to:

Davidge Corporation
1951 Colony Street, Suite X
Mountain View, California 94043
or Call (415) 964-9497

Circle 120 on inquiry card.

\$ 300.00

8/16 Bit Fast Static Ram

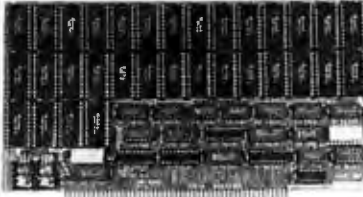

Lexicomp's SR-64K is the ideal low cost/ advanced technology memory board for SIMM/ IEEE 696.D2.I systems integrators.

Features:

- 24 Bit Addressing
 - 10 MHz Speed
 - 8000-FFFF Deselectable
 - Phantom. Pin 67
- Send for free brochure and price list.

Lexicomp

67 Valley Road · POB 222 · Lexington, MA 02173
Telephone: (617) 862-3088

Circle 207 on inquiry card.

C LANGUAGE PROGRAMMERS

**c-systems
C COMPILER
c-window™**

The **complete c language source level** program testing and debugging tool.

- Single step by c source line.
- Set breakpoints at line numbers.
- Display and alter variables by symbol name, using c expression syntax.
- No more printf or assembler level debugging!

c-window™ is a support package for the **c-systems C COMPILER** for 8086/8088 based systems.

Contact:

c-systems Fullerton, CA 92634
P.O. Box 3253 714-637-5362

TM c-systems

When it comes to quality software for microsystems, DYNACOMP delivers:

PERSONAL FINANCE SYSTEM: \$39.95

The Systems ... Apple Atari Canon Commodore Compustar CP/M Franklin H/Z-100 IBM PC Kaypro Morrow NEC North Star Osborne SuperBrain Timex TRS-80

The Software ...

ADVENTURE	BUSINESS	CARD GAMES	EDUCATION
ENGINEERING	GAMES	HOME FINANCE	INVESTING
LANGUAGES	SCIENCE	TAX PLANNING	UTILITIES

Name brand diskettes: \$19.95/10 (SS, SD w/hub ring). Includes FREE plastic storage box. Add \$2.00 shipping.

CALL OR WRITE FOR A FREE CATALOG
DYNACOMP, INC.
1427 Monroe Avenue, Rochester, N.Y. 14618
Telephone: (716) 442-8960

Circle 134 on inquiry card.

SL-MICRO

STATISTICAL LANGUAGE for MICROCOMPUTERS

features

- VALUE and VAR LABELS
- DATA TRANSFORMATION
- FREQUENCIES CROSSTABS
- PEARSON CORR REGRESSION
- CONDESCRIPTIVE

Only \$250. Manual \$15
Available for IBM PC, CP/M or MS-DOS. Many Formats.

**QSC BOX 23056
LANSING, MI 48909
PHONE (517) 641-4428**

Circle 303 on inquiry card.

wabash®

When it comes to Flexible Disks, nobody does it better than Wabash.

MasterCard, Visa Accepted.
Call Free: (800) 235-4137

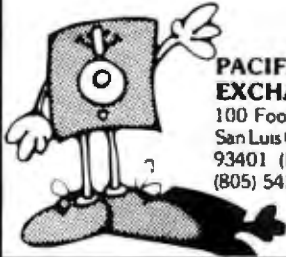

PACIFIC EXCHANGES
100 Foothill Blvd
San Luis Obispo, CA
93401 (In Cal call
(805) 543-1037)

Circle 277 on inquiry card.

ANALOG ↔ DIGITAL DIGITAL ↔ ANALOG

CONVERSION MODULES

SOFTWARE GAIN CONTROL

High accuracy — programmable gain instrumentation amplifier — custom board test — \$100 — 2 to 15 kHz conversion time — mixable high and low inputs — gain from 1 to 1024 — 12 bit — sample and hold amplifier 8 channel differential — 16 channel — analog to digital high accuracy — programmable gain instrumentation amplifier — custom board test — \$100 — 2 to 15 kHz conversion time — mixable high and low inputs — gain from 1 to 1024 — 12 bit — sample and hold amplifier 8 channel differential — 16 channel — analog to digital high accuracy — programmable gain instrumentation amplifier — custom board test — \$100 — 2 to 15 kHz

For additional details about the AD-100-4 and other fine California Data Corporation 100% individually tested, high reliability products, circle the reader service card number below or for faster response write or call us.

CALIFORNIA DATA CORPORATION
3475 Old Conejo Road, Suite C-10
Newbury Park, CA 91320
(805) 498-3651

Circle 56 on inquiry card.

PROGRAMMABLE COMMUNICATIONS TRANSLATOR

THE PCT-100 IS A CONFIGURABLE IN-LINE RS-232 PROTOCOL AND DATA TRANSLATOR. THE PCT-100 CAN PROVIDE:

- * TERMINAL OR PRINTER EMULATION
- * DEC OR IBM SYSTEM COMPATIBILITY
- * MACRO-FUNCTION KEYS
- * "TYPE-AHEAD" AND DATA BUFFERING
- * BAUD RATE CONVERSION
- * HANOSHAKE PROTOCOL TRANSLATION (E.G. CTS/RTS, XON/XOFF)

THE PCT-100 IS CONFIGURED USING A BUILT-IN COMMUNICATIONS TRANSLATION LANGUAGE. PROGRAMS CAN BE EASILY ENTERED & EDITED FROM ANY ASCII DEVICE.

PCT-100-PCB (PCB ONLY) . . . \$ 289
PCT-100-ASM (PCB W/ CASE) . . . \$ 339
PCT-512-MOD (POWER SUPPLY) . \$ 59



MSI



METHOD SYSTEMS INCORPORATED
19751 SOUTH LAKESHORE BOULEVARD
EUCLED, OHIO 44119
(216) 531-0404

Circle 231 on inquiry card.

IBM PC COMPATIBLE

Slimline Disk Drive . . . \$215.00 ea.
(Shugart SA 455, DS,DD 320KB)
Slimline Hard Disk . . . \$495.00 ea.
(Shugart SA 706 5MB)

Computer Case Call
Keyboard Call
Power Supply Call
Disk Controller Card Call
Color Graphic/Monochrome/Printer Interface Card Call
Compatible Bare PCB Call
3M Diskette SS/DD \$20/box
3M Diskette DS/DD \$28/box

Dealer Inquiries Welcome

ELECTRADE CO. (408) 946-2541
780 Trimble Rd., Suite 605
San Jose, CA 95131

Circle 144 on inquiry card.



S-100
ESTABLISHED 1977

MODEM ORDERS 602-948-1387
SALES 800 - 528-3138
TECHNICAL 602-991-7870

CompuPro

A GODBOUT COMPANY

SYSTEM 816/A	\$3899
SYSTEM 816/B	\$4899
SYSTEM 816/CH*	
w/40 Mb HARD DISK	\$8749
SYSTEM 816/68K*	\$8749
SYSTEM 816/10*	CALL

THE ABOVE FULLY ASM, TESTED,
& BURNED-IN

*INCLUDES ON-SITE XEROX SERVICE

CPU 8086 A&T	\$529
CPU 8086/87 A&T	\$739
CPU 68K W/CP/M 68K & map	
FORTH	\$732
SYSTEM SUPPORT 1 A&T	\$319
MDRIVE/H A&T	\$895
RAM 16 64K STATIC, 8 OR 16, A&T	\$389
RAM 22 256K STATIC, 8 or 16, A&T	\$1229
DISK I A&T	\$349
INTERFACER 3-8 SERIAL A&T	\$489
SIX SLOT MOTHERBOARD W/TERM	\$99

Qume TERMINAL QVT 102G \$469

LIBERTY

FREEDOM 100 TERMINAL	CALL
FREEDOM 200 TERMINAL	CALL
(EMUL TELEVIDEO 950 & ADM 31)	
TAXAN RGB 420 (IBM LOOK-ALIKE)	\$495
USI Pi 3 12" AMBER MON.	\$119



A whole computer system in one little box.SM

COMPLETE PORTABLE W/MODEMS, MX80 PRT. 12" MON. INCLD. 2 DSDD DRV. 320K RAM, Z80, 8088 CP/M 2.2&86 MSDOS, PCDOS INSTALL & COPY PROGRAMS + S.W.	CALL
--	------

MORROW



MD3 W/MDT60 TERMINAL & TALLY SPIRIT PRINTER	\$1,899
MD3 SYSTEM AS EQUIP ABOVE W/8088 CO-PROC & 256K RAM UPGRADE	\$2,399
MD11SYSTEM AS EQUIP ABOVE	\$2745
W/CP/M 3.0, 128K RAM, DSDD FLPY & 11Mb H.D	
MDP-3 PORTABLE Same as MD-3 w/5x7 Screen And	CALL
Detachable K.B.	
MD 2SYSTEM AS EQUIP. ABOVE	\$1599

DIGITAL RESEARCH

MP/MII	\$270
MP/M-86	\$390
CONCURRENT CP/M	\$210
CP/M PLUS	\$210
"C" COMPILER	\$210
PASCAL MT+86	\$360
SPEED PROG PKG	\$150
ACCESS MNGR-86	\$240
DISPLAY MNGR-86	\$300
PL/1-86	\$450

SDSYSTEMS

SBC 300 6 MHz	\$595
EXPANDORAM IV W/EDC 256K	\$1,435
VERSAFLOPPY II/696 W/CP/M 3.0	\$405
VFW-III 3x5 1/4" H.D. + 4x5 1/4" & 8" DRVS.	\$645
PROM100 2708, 2758, 2716's	\$210
RAMDisc 256K Disk Drive Emulator	\$635
ROMDisc 128K	\$255
SD 300 CHASSIS 6 Slot "Folded" Bus	\$480

PRINTERS

DAISYWRITER 2000 W/48K	\$998
OKIDATA 92	\$475
EPSON MX100	\$439
EPSON RX80 FT	\$389



FLUKE 77 \$119
MULTIMETER
0.3% DC Accuracy



Personal Speech
System \$285

SPECTRONICS CORPORATION

PE-14 Erases 6 Eproms	\$65
PE-14T Same as PE-14 w/Timer	\$89
PE-24T Erases 9 Eproms in 15 Min. W/Timer	\$135



SUPERSIX W/128K RAM	\$575
SUPERSLAVE, 6 MHz, 128K RAM	\$519
HDC-1001 H.D. CONTROLLER	\$398
CP/M 3.0	\$350
TURBODOS MULTI-USER	\$449
DMA MICRO-MAGNUM	
5Mb FIX + 5Mb REMOV H.D.	\$1,675
S-100 SUBSYSTEM	\$2,289
IBM-PC SUBSYSTEM	\$2,395

COLUMBIA

PORTABLE 1600-VP INCLD. ALL SOFTWARE PKG. W/1600-1	\$2595
---	--------

DEALER INQUIRIES WELCOME



MICROBUFFER/EPSON™ CARD	
MBS-16/32K SERIAL	\$125
MBS-32K SERIAL	\$153
MBP-64K PARALLEL	\$195

MICROBUFFER IN-LINE™ STAND ALONE	
MBIS SERIAL 64K	\$244
MBIP PARALLEL 64K	\$244
MICROBUFFER II +™ 16K, APPLE II, II+ IIe	\$181

PC MATE by **TEGMAR** FOR
IBM PC

CAPTAIN w/384K,	\$557
-----------------	-------

Clock/CAL w/Battery, Serial, Para, RamDisk, Spooler	
1st MATE 256K, CL CAL	\$419

W/BATTERY, SERIAL, PARA, RAM DISK, SPOOLER	
256K DYNAMIC MEMORY	\$349

TIME MASTER W/BATTERY BACK-UP	\$109
GRAPHICS MASTER	

HI RES RGB COLOR GRAPHICS	\$575
---------------------------	-------

IEEE 488 BD. W/Software	\$368
-------------------------	-------

5Mb CART WINCH IN PC	\$1479
----------------------	--------

33Mb + 5Mb REMOVABLE CARTRIDGE IN AN EXPANSION CHASSIS	\$3,219
--	---------



U.S. ROBOTICS

TELPAC SOFTWARE	\$55
-----------------	------

S-100 BOARD MODEM 300/1200 BAUD AUTO ANS/DIAL	\$299
---	-------

PASSWORD 1200 BAUD AUTO ANS/DIAL	\$299
-------------------------------------	-------

AUTO DIAL 212A	\$399
----------------	-------

PERSONAL MODEM W/SOFTWARE IBM-PC PLUG-IN BD.	\$299
---	-------

PERSONAL W/64K, SERIAL, PARA., CLOCK/CAL-BATTERY, SOFTWARE	\$469
--	-------

FLOPPY DISK DRIVES

ADD-ON DRIVES W/INDUSTRIAL

QUALITY CABINETS & 1 YR. WARRANTY

W/2 QUME 142 5 1/4" DSDD	\$449
--------------------------	-------

W/2 QUME 242 8" DSDD	\$999
----------------------	-------

W/2 QUME 842 8" DSDD	\$1,259
----------------------	---------

-BARE DRIVES

Qume 142 5 1/4" DSDD Thin	\$179
242 8" DSDD Thin	\$395
842 8" DSDD STD.	\$460

Tandon 100-2 5 1/4" DSDD	\$219
---------------------------------	-------

14425 North 79th Street
Scottsdale, Arizona 85260
TELEX: 16 5025 FTCC SEC PHX
Circle 311 on inquiry card.

FULL DEALER SUPPORT
VISIT OUR SHOWROOM
Hrs. 9:00AM - 5:30PM M-F

Subject to Available Quantities
Prices Quoted Include
Cash Discounts
Shipping & Insurance Extra

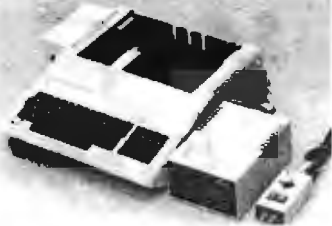

APPLE COMPATIBLE

- Disk Drive \$150.00 ea.
- Controller Card \$35.00 ea.
- Computer Case \$55.00 ea.
- Keyboard \$70.00 ea.
- (Numeric and Function Keys)
- Switching Power Supply . . \$49.50 ea.
- Joystick (Heavy Duty) . . . \$17.50 ea.
- Slim Fan \$25.00 ea.

Prices for dealers in quantities of 25 or more.
End Users Inquiries welcomed.

ELECTRADE CO. (408) 946-2541
780 Trimble Rd. Suite 605
San Jose, CA 95131

Circle 145 on inquiry card.

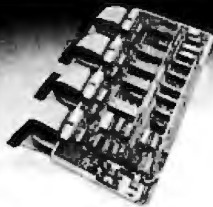

Multi-Port Serial Card for S-100 (IEEE-696) Systems

Designers who need an IEEE-696 serial interface card have a choice of either 2 or 4 ports with the Multi-Port Serial Card. Each port can operate as either a "data set" or as a "data terminal." Independent baud rate generators for each port (50 - 19.2k baud) and an 8-level vectored interrupt controller are provided. 36" cables are included.

Single Qty: \$280.00 (4-port),
\$210.00 (2-port).

Call: 1-800-426-8936
Dealer and OEM inquiries are invited.
Seattle Computer Products, Inc.
1114 Industry Drive, Seattle, WA 98033

Circle 314 on inquiry card.



64k Static RAM for S-100 (IEEE-696) Systems

The fully static design makes it easy to interface Seattle Computer's 64k Static RAM board with a variety of CPU and DMA devices in IEEE-696 systems. High-speed (85 ns) RAM chips enable operation to 10 MHz with no wait states. Board can be used as either 8- or 16-bit wide memory. 48k, 32k, and 16k OEM versions are available.

Single Qty: \$495.00
Call: 1-800-426-8936

Dealer and OEM inquiries are invited.
Seattle Computer Products, Inc.
1114 Industry Drive, Seattle, WA 98033

Circle 315 on inquiry card.

The INTELLIGENT GRAPHICS TERMINAL

All of this on a single S-100 board

- Full 512 color mapping palette
- TTL/analog RGB color or 8 level grey
- 680x480 4 color and/or 340x480 16 color
- Transparencies, overlays, multiple pages
- 8086, EPROM, 128K RAM expandable on-card
- Full editing terminal/graphics firmware
- Text throughput is greater than 2000 cps
- 10 windows, individually scrollable
- Programmable terminal formats to 113x40
- 64K x 64K virtual screen graphics with clipping and scale
- Drawn/filled circle, pie, arc, polygon
- Complex fill patterns and line styles

Low introductory prices: Assembled and tested \$895. Partial kit \$295.

Available soon: Fully integrated expansion card adds speech, sound effects, serial and parallel ports, and time-of-day clock.

Advanced Graphics Engineering
P.O. Box 3403, Reston, VA 22090
(703) 435-8110

Circle 15 on inquiry card.

SUPER FAST! Z80 DISASSEMBLER

- Two pass operation - generates labels at referenced locations.
- Generates Zilog mnemonics.
- Allows user defined labels.
- Allows define byte, define word and define space directives.
- COMPLETE cross-reference
- Output to console, list or disk device(s) in any combination.
- Generates mnemonics for CP/M system calls.
- Start and stop at any location in file.
- Source or complete listing type output.

Most formats available for Z80 CP/M, CDOS, and TURBODOS. **\$6995**

SLR Systems

For more information or to order call:
1-800-833-3061
In PA, (412) 282-0864
1622 North Main Street, Butler, PA 16001

Circle 324 on inquiry card.



Solve your disc problems, buy 100% surface tested Dysan diskettes. All orders shipped from stock, within 24 hours. Call toll FREE (800) 235-4137 for prices and information. Visa and Master Card accepted.

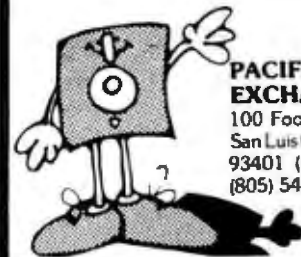

PACIFIC EXCHANGES
100 Foothill Blvd.
San Luis Obispo, CA 93401 (In Cal call (805) 543-1037)

Circle 277 on inquiry card.

DATA ACQUISITION and control for ANY computer



The Model 8232 communicates via RS-232, and has 8 analog inputs (0-5 VDC; 8 bits), 8 digital inputs and outputs, and a 2000 point buffer. Suitable for field data logging or lab use, the 8232 costs only \$540. Direct bus-connect unit for TRS-80/III & 4 is \$295. Detailed manual, \$6. Phone our applications engineer or write:

★★ **STARBUCK DATA COMPANY** ★★
PO Box 24, Newton, MA 02462 (617) 237-7695

Circle 336 on inquiry card.



INDUSTRIAL CONTROL MICROCOMPUTERS

We have six single board computers, two video boards and 20 other control products. You can use our products for security systems, heat control, light control, automated slide show, traffic lights, irrigation systems, home computer systems, automated process control, and robot control just to name a few. OEM prices available. For catalog call or write to:

JOHN BELL ENGINEERING, INC.
1014 CENTER STREET
SAN CARLOS, CA. 94070
(415) 592-8411

Circle 41 on inquiry card.

The Statistician

CPM IBM-PC
TRS-DOS XENIX

- Multiple Regression
- Stepwise Ridge
- AI Subsets
- Backward Elimination
- Time Series Analysis
- Descriptive Statistics
- Transformations
- Survey Research
- Nonparametrics
- X-Y Plots
- ANOVA
- Random Samples
- Data Base
- Search & sort
- Hypothesis tests

Please call TOLL FREE
1-800-334-0854 (Ext. 814)



for more information or write:
Quant Systems
Box 628
Charleston, SC 29402
VISA/MC Accepted

Circle 298 on inquiry card.

PIPELINE

COMPUTERS

Computer Components Unlimited may be the King
of Computer Peripherals — but . . .
PIPELINE will be the KING of all IBM Products . . .
The Source!

PC COMPATIBLE DISK DRIVES

TANDON

TM100-2(320K) 2 for \$415 1 for \$219

MPI

B-52(320K) 2 for \$380 1 for \$199

CDC

9409 Dbl/Dbl (320K) 2 for \$440 1 for \$229

SHUGART

SA 455 Slimline (320K) 2 for \$400 1 for \$209

PANASONIC

Slimline (320K) 2 for \$380 1 for \$199

TEAC

FD55A(160K) \$ 169

FD55B(320K) 189

MODEMS

ANCHOR

Mark VII, 300Baud \$ 139

Mark XII, 1200 Baud 299

HAYES

300 Smart Modem \$ 205

1200 Smart Modem 489

1200B Smart Modem 389

NOVATION

Access 123 Call

PRINTERS

EPSON

RX80, 120 cps \$ Call

FX80, 160 cps Call

OKIDATA

Microline 92 w/Plug & Play \$ 449

Microline 93 w/Plug & Play 749

NEC

3550PC Compatible \$1850

MONITORS

AMDEK

300G, 12" Green \$ 129

300A, 12" Amber 139

310A, 12" Amber Monochrome 169

Color I + Color Composite 289

Color II + RGB w/Cable 409

PRINCETON GRAPHICS

PG-S HX12 \$ 469

Other Models Call



IBM PC SYSTEM

- ★ 2/320K Drives Slimline
- ★ 256K Memory
- ★ Monitor (Green) and Interface Card

\$2850



SANYO COMPUTER

- ★ MBC 555
- ★ 2 Disk Drives
- ★ 128K, Full Software Package

\$1149



TANDON DISK DRIVE

- ★ TM100-2
- ★ 320K Dbl/Dbl

\$219



OKIDATA PRINTER

- ★ Microline 92A
- ★ W/Plug & Play

\$449



PGS MONITOR

- ★ PGS HX12
- ★ PC Copy

\$469



ANCHOR MODEM

- ★ Mark VII
- ★ 300 Baud

\$139

IBM & COMPATIBLE COMPUTERS

CORONA DATA SYSTEMS

PC II, 1 Drive(128K) \$1995

COMPAQ

PC Compatible \$2695

EAGLE

PC-2, 128K, 2-Drives, Monitor, Software \$2595

COLUMBIA

1600-1 2-Drives, Software \$2595

IBM

PC Jr. \$ 689

PC w/64K, 1-Drive 1995

PC w/64K, 2-Drives 2245

XTw/Hardisk, 128K 4695

SANYO

MBC-550, 1-Drive \$ 799

MBC-555, 2-Drives, more software 1199

TOSHIBA

T-300 PC Compatible List \$2995 \$2595

ALL INTERFACE CARDS FOR PC

AST No. 1

SixPac + \$ 269

Io + 119

Mega + 269

MegaPack 269

Additional Ports 50

QUADRAM

Color I \$ 209

Color II (640x200) 199

Quadlink 479

KEYTRONICS

Keyboard \$ 199

64K UPGRADE

9/4164 \$ 49

HERCULES

Color Graphics Card \$ 339

PLANTRONICS

Color Plus \$ 379

IBM

Dos2.1 \$ 59

Monochrome Monitor or Adaptor 309

Color Monitor 649

DISKETTES

Dbl/Dbl (lifetime guarantee) \$ 19

MORE ACCESSORIES

Koala Graphics Tablet \$ 89

8087 Co-Processor 109

Kraft Joystick 39

Sigma Controller Card 159

Cable for Printer 29

Amdek MAI Card 499

- Shipping Minimum 4.50
- Purchase Orders Accepted
- This Ad Supersedes all Others



Prices Subject to Change

Mon.-Fri. 7:30 a.m. to 7:30 p.m.

Saturday 9:00 a.m. to 4:00 p.m.

The Source!

PIPELINE

COMPUTERS

MAIL ORDER

1142 Manhattan Avenue, CP21
Manhattan Beach, CA 90266

WAREHOUSE:

12308 Burl Avenue
Hawthorne, CA 90250

ORDER DESK: (213) 970-0177



Circle 287 on inquiry card.

We Accept MC, Visa, Wire Transfers, Certified Checks

- COD's Available
- All Prices Reflect a Prepaid Discount

The Source!

APPLEWARE, INC.

The Apple Users Group Software Library Bonanza
At truly affordable prices!
 For the first time enjoy your Apple to its fullest capacity, using specially packed disks with over 60 outstanding programs each. (not available from any other source)

Each packed disk includes an extensive variety of interesting, useful and entertaining programs indispensable to all computerists! Each mixed category packed disk includes:

BUSINESS • EDUCATIONAL • DATA BASE • GAMES UTILITIES • SCIENCE • MUSIC • GRAPHICS • FINANCE
 Library Disks I, II and III are mixed categories. Dedicated disks are:

• **GAMES • UTILITIES • GRAPHICS • INTEGER • SCIENCE & TECHNOLOGY.** Each packed disk is available for only **\$59.95** each.

WHY PAY MORE?
 Order direct from this ad and **Save up to \$150.** Buy Library Disks I, II and III and get a special bonus disk **FREE** - over 260 programs for \$179.95 + \$3 shipping. For the best value, receive all 9 disks featuring over 600 of our best programs for only **65¢** each for a package price of only \$389. Postage Paid!

NEW Business • Professional • Executive Package (enabling you to bring your business to its highest level of efficiency) also available. (see Reader's Service Card for our complete catalog)

For Orders Only Call now
TOLL FREE: 1-800-327-8664
 Florida: 1-305-987-8665

Compatible with II, II+, IIe, IIx and Franklin Ace (For 3.3 DOS)

Circle 30 on inquiry card.

 **MagiKey***

THE FULL-FEATURED KEYBOARD EXPANDER
 Redefine any key to send a string of characters. MagiKey™ does more ...

- * automates application software, integrates function or cursor keys
- * "help" menus displayed at any time
- * built-in batch processing more powerful than SUBMIT or XSUB
- * strings can redefine keys, pause for fill-the-blanks keyboard input, or contain nested key definitions
- * invisible to system and software
- * for any 8080-8085-280-CP/M 2.2 no system or software modifications

\$100
 8" SSSD, Kaypro 5 1/4" - inquire about other 5 1/4" formats
 check, VISA, MC add 6% tax in CA

 **microSystems**
 16609 Sogawood Lane
 Poway, California 92064
 (619) 693-1022

CP/M (tm) Digital Research

Circle 293 on inquiry card.

CHIPS & DALE 

THE INFLATION FIGHTERS!

4116	200ns	8/\$12.00	
4116	150ns	8/\$13.75	
2114L	300ns	8/\$13.00	
2114L	200ns	8/\$13.00	
4164	200ns	\$5.50 each	
4164	150ns	\$5.95 each	
6116	150ns	\$5.20 each	
6116	200ns	\$4.85 each	
6116LP	150ns	\$5.85 each	
1791	Disk Controller	\$20.00 each	
1771	Disk Controller	\$16.75 each	
Z80A,Z80ACTC		\$3.50 each	
Z80A P10		\$4.00 each	
8251A		\$4.00 each	
8255		\$4.25 each	
2716-1	5V 350ns	8/\$4.25	\$5.00 each
2716	5V 450ns		\$3.35 each
2732	5V 450ns		\$3.85 each
2532	5V 450ns	8/\$4.25	\$5.00 each
2764	5V 300ns 28 pin		\$5.95 each
2564	5V		CALL
8087			CALL
68000			CALL

Allow up to 3 wks. for personal checks to clear. Please include phone number. Prices subject to change without notice. Shipping & Handling for Chips \$3.50. FOB Bellevue, WA. for all else. Washington state residents add 7.9% Sales Tax.

CHIPS & DALE 1-206-451-9770
 10655 N.E. 4th St., Suite 400
 Bellevue, WA 98004

Circle 62 on inquiry card.

S-100 COLOR GRAPHICS!
MICROSPRITE
 THE ORIGINAL TMS9918A GRAPHICS BOARD

- Field-proven board meets IEEE-696 standard; fully socketed with solder masks, silkscreen and gold contact fingers
- Prioritized display with backdrop and pattern planes plus 32 sprite planes; each pixel in a plane can be colored or transparent
- Three graphics and one text display mode, maximum graphics resolution is 256H x 192V in 16 colors
- Composite video output
- On-board 16K RAM is separate from system memory
- Vertical retrace interrupt for real time clock capability
- 0-4 wait states for use with fast MPUS
- All board options are DIP switch selectable
- Professional quality documentation with BASIC demonstration programs and 11 s TMS9918A manual
- Exclusive Graphics Editor available on 8" SSSD CP/M-compatible diskette

\$189.95*
 (A & T)

MicroDynamics Corporation
 6363 Poplar Ave • Suite 105
 Memphis TN 38119

ORDER DESK 1-800-237-8400 ext 440
 Technical Inquiries (901) 682-4054

*Price includes MICROSPRITE with documentation Graphics Editor diskette - \$9.95 Manual - \$19.95 Bare board - \$59.95 UPS ground - \$2.00 UPS air - \$4.00. COD - \$1.50 Foreign add \$15.00 VISA & MC welcome TN add 6%
DEALER AND OEM INQUIRIES INVITED

Circle 242 on inquiry card.

Apple II/IIe®
Robotic Development Package



2 Axis Stepper Motor System \$365
 (35 oz. in.)

- A6 T/D Plug-In Interface
- R2 D23 Dual Axis Driver
- (2) Size 23 Motors
- Positioning Command with Ramping from Applesoft® BASIC

Also Available with:
 (2) Size 34 Motors (220 oz. in.) & R2 D34 Dual Axis Driver **\$595**

ROGERS LABS (714) 751-0442
 2710 S. Croddy Way, Santa Ana, CA 92704

Circle 308 on inquiry card.

 **Scotch**
 DISKETTES

Call Toll-Free
 1-800-328-DISC for prices and information. Dealer inquiries invited. C.O.D. and charge cards accepted.
All orders shipped from stock, within 24 hours. Call toll FREE





North Hills Corporation
 3564 Rolling View Dr.
 White Bear Lake, MN 55110
 1-800-328-DISC
 MN Call Collect 1-612-770-0485

IBM PC, APPLE, etc. . .

SHARING AND SWITCHING PROBLEMS? GILTRONIX HAS THE SOLUTION!

 Any CPU

 Printer 1 Dot Matrix

 Printer 2 Letter Quality

 Modem or Other Peripheral

MANUAL UNITS 2-6 Ports Selecto-Switch OR **AUTOMATIC UNITS** 2-7 Ports Auto-Switch

Serial (RS 232)/Parallel (Centronics)

LOW COST ADD-ONS FROM THE MAIN MANUFACTURER

 **Giltronix**
 3780 Fabian Way, Palo Alto, CA 94303
 (415) 493-1300

Circle 167 on inquiry card.

dBASE II in ENGLISH I

NEW BOOK SENSATION
 SIMPLE - LOGICAL - EASY TO UNDERSTAND

PERHAPS THE FINEST COMPUTER BOOK EVER WRITTEN. WILL TEACH ANY NOVICE TO PROGRAM IN dBASE II.

238 pages full of great examples which are easy to follow on your computer.

Written by a Father and Son team who have bridged the generation gap in dBASE literacy.
ORDER YOUR COPY TODAY.
 Send \$29.95 or MC/VISA to:

ENGLISH I COMPUTER TUTORIALS
 1617 N Troy St.
 Chicago, IL 60647
 (312) 489-1688 Dealers Inquiry Invited

Circle 151 on inquiry card.

Verbatim flexible disks

Call Free (800) 235-4137 for prices and information. Dealer inquiries invited. C.O.D. and charge cards accepted.





PACIFIC EXCHANGES
 100 Foothill Blvd.
 San Luis Obispo, CA 93401. In Cal. call (800) 592-5935 or (805) 543-1037.

Circle 277 on inquiry card.

MEGA-BOARD™

new!

Ideal for

- **COMPUTERISTS**
- **OEM MANUFACTURERS**
- **DEVELOPMENT LABS**
- **UNIVERSITIES**
- **INDUSTRIAL APPLICATIONS**

THE ULTIMATE OEM/PC COMPATIBLE SINGLE BOARD COMPUTER

FULL IBM – PC* COMPATIBILITY!

DEALERS AND OEM MANUFACTURERS QUANTITY DISCOUNTS AVAILABLE

Standard Key-board Interface
(Full PC compatible)

Hardware Reset
(Overcomes reset flaw in PC)

Eight Compatible I/O Interface Connectors
(Full PC compatible)
(compatible with all IBM-PC* plug-in cards)

Power Connector
(Full IBM* pinout compatible)

Special J1 Interface
(Allows horizontal mounting of compatible expansion cards for easy bus expansion and custom configuring) (Board has 62 pin gold plated compatible connector)

8088 Processor
(Same as PC)

8087 Numeric Processor
(Same as PC)

Extended ROM Capability
(Runs all compatible PC ROMS) (Jumper programmable to accommodate all popular 8K, 16K, 32K and 64K ROM chips and NEW EE ROMS! VPP power pin available for EP ROM burning!) (External VPP voltage required)

Peripheral Support Circuits
(Same as PC)

Configuration Switches
(Same as PC)

Board Size
10.5 inch X 13.5 inch

Speaker/Audio Port
(Same as PC)

Wire Wrap Area
To facilitate special custom applications!

Full Mega-Byte Ram Capacity! On board!
(With parity)
 256K Bytes using 64K chips
 1 Mega Bytes using 256K chips

ONLY!
\$9995
Evaluation Board Kit

MEGA-BOARD™ Evaluation Board Kit!
(Blank board with full assembly instructions and parts list.)

Includes highest quality PC board with gold plating, silk screen, solder mask

- MEGA-BOARD™** with full assembly instructions \$99.95
- USERS MANUAL** with theory of operation, schematics, block diagram, application notes \$19.95
- MEGA-BIOS™** fully compatible MS-DOS/PC-DOS BIOS \$29.95

ORDER NOW!!!
SATISFACTION GUARANTEED!
10-day money back guarantee if not completely satisfied.

DTC™ DISPLAY TELECOMMUNICATIONS CORPORATION

4100 SPRING VALLEY ROAD
SUITE 400
DALLAS, TX 75234
(214) 991-1644

TERMS: Shipment made 2 to 5 weeks from receipt of order. VISA, MC, money order, company check accepted. COD'S require \$25 deposit. Balance UPS COD. Please add \$2.00 shipping and handling per order.

*IBM and IBM PC are trademarks of International Business Machines

True MAIL ORDER Prices

With so many so-called Mail Order establishments using "toll free" lines, and grandiose advertising, how can you, the customer, expect to receive true mail order savings? We have done away with these expenses to offer comparable service passing on the savings to you. Our reputation for low prices and satisfaction is outstanding.

FRANKLIN SYSTEMS!

1000 Pro Pack Plus:

Featuring:

- 1000 CPU
- Franklin Monitor
- 80 Column Card
- Ace 10 Disk Drive + Controller
- Ace Calculator
- Ace Writer
- Data Perfect
- Welcome Package

TOO LOW TO PUBLISH

1200 OMS Package:

Featuring:

- 1200 CPU
- 80 Column Card
- 2 Disk Drives + Controller
- CP/M Card + Software
- Parallel & Serial Interfaces
- Wordstar
- Mailmerge
- Ace Calc.
- Welcome Package

TOO LOW TO PUBLISH

SOFTWARE

	APPLE	IBM
Supercalc 3	—	\$274.95
Visicalc IV	\$ CALL	\$ CALL
Home Accountant	\$ 44.95	\$104.95
Dollars And Sense	\$ 69.95	\$124.95
Micro Cookbook	\$134.95	\$134.95
Bank Street Writer	\$ 44.95	\$ 44.95
Tax Advantage	\$ 41.95	\$ 41.95
Multiplan	\$184.95	\$184.95
The General Manager	\$154.95	—
TK Solver	—	—
BPI-GEN Acct/Inv/Payroll	\$274.95	\$414.95
BPI-Job Costing	\$414.95	—
Word W/Mouse	—	\$334.95
Wordstar Professional	\$434.95	\$434.95
Screenwriter II	\$ 84.95	—
Sensible Speller	\$ 84.95	—
PFS: Write/File/Report	\$ 79.95	\$ 94.95
Peachtext 3000	—	\$264.95
Lotus 1-2-3	—	\$314.95
DB Master (Version 4)	\$264.95	\$394.95
DBASE II	\$444.95	\$444.95
Friday	—	\$194.95

FOR IBM/PC

PLANTRONICS
COLOR PLUS
BABY BLUE
STB
SUPER RIO
MAYNARD CONTROLLER AST
SIX PACK
MEGAPLUS
CPMBOPLUS
I/O PLUS
AMDEK
MULTIPLE
ADAPTER INTER
KEYTRONICS KEYBOARD USI
MULTI DISPLAY
QUADRAM
QUADBOARD
QUADLINK
MICROFAZER
TECMAR
1ST MATE
2ND MATE
GRAPHICS MASTER
APPARAT
RAM CARD
PROM BLASTER

CALL
FOR
OUR
LOW
PRICES

DISK DRIVES FOR APPLE

Quentin	\$195.00
Rana Elite I	\$ CALL
Rana 1000 (for Atari)	\$ CALL
Micro-SCI	\$ CALL

DISK DRIVES FOR IBM

Tandon	
TM-100-2 320K IBM Compat	\$215.00
TM-55-2 320K Half Height	\$215.00
CDC 320K IBM Compatible	\$235.00
Shugart	\$ CALL
MPI	\$ CALL

MODEMS

D.C. HAYES

Smartmodem 300 BAUD	\$199.95
Smartmodem 1200 BAUD	\$475.00
Smartmodem 1200B W/SC II	\$419.95
Smartmodem IIe W/SC II	\$239.95
Chronograph	\$189.95

U.S. ROBOTICS

300 BAUD	\$169.95
Auto Dial 1200	\$449.95
Password	\$339.95

NOVATION

J-Cat	\$119.00
Apple -Cat II	\$ CALL
Apple-Cat IIe	\$ CALL

MONITORS

AMDEK

Video 300 (Green) Med-Res	\$124.95
Video 300A (Amber) Med-Res	\$134.95
Video 310 (Amber) Hi-Res	\$164.95
Color I+ Composite	\$280.95
Color II+ Plus RGB	\$394.95

BMC

Lo Res Green	\$ 80.00
Hi Res Green	\$124.00

NEC MONITORS

LEADING EDGE \$ CALL

Gorilla Hi-Res Green	\$ CALL
Gorilla Hi-Res Amber	\$ CALL

DISKS

DYSAN Single-Sided/

Double Density (10 Packs) \$26⁹⁵

• Double-Sided/Double Density (10 Packs) \$36⁹⁵

VERBATIM DATALIFE

• Single-Sided/Double Density (10 Packs) \$23⁴⁹

• Double-Sided/Double Density (10 Packs) \$31⁹⁴

ESK Research

• Single-Sided/Double Density (10 Packs) \$18⁹⁵

• Double-Sided/Double Density (10 Packs) \$25⁹⁵

PRINTERS

DOT MATRIX PRINTERS

OKIDATA 82A	\$319.95
—120 CPS	
—Parallel and Senal Interfaces	
OKIDATA 92P	\$459.95
—160 CPS with Correspondence Mode	
OKIDATA 93P	\$779.95
—As for 92P Except Full Width	

STAR MICRONICS: GEMINI 10X

—120 CPS/DOT Addressable Graphics

GEMINI 15-X

—Wide carriage/same features as 10X

PRICES TOO LOW TO PUBLISH!

LETTER QUALITY PRINTERS

JUKI 6100	\$439.95
C-ITOH F10	\$999.95
—40CPS PRINTER	
BROTHER DYNAK DX-15	\$478.95

PAPER/CABLES/RIBBONS

Send orders and inquiries to:

Computer Apparatus™

P. O. Box 32063 • Aurora, Colorado 80012

Telephone Inquiries: (303) 759-9251

Monday thru Friday — 9:00 a.m. to 5:00 p.m. (Mountain Standard Time)

**We built our reputation on low prices
for the informed computer user.**

DELIVERIES: 2 - 4 weeks average.

PERSONAL CHECKS: Cashier's check and money order will receive shipping preference.

VISA & MASTERCARD: Add 4% to total.

CATALOG: Send for full pricing details.

Prices subject to change without notice.

SHIPPING: UPS add \$2.00 plus 3% of order total, or we calculate exact freight.

ALL BRANDS ARE REGISTERED TRADEMARKS

Circle 400 on inquiry card.

SPECIALS on INTEGRATED CIRCUITS

6502 @ 4.90 6520 @ 4.00 6522 @ 5.00 4116 @ 1.85
 2532 @ 5.90 2716 @ 4.45 6116 @ 6.45 4164 @ 6.90

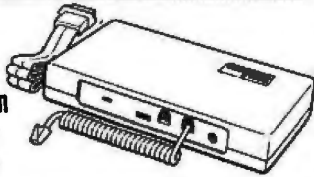
Anchor Automation Signalman MODEMS**FREE SOURCE MEMBERSHIP WITH VOLKSMODEM**

All Signalman Modems are Direct Connect, and provide the best price-performance values. Dealer/OEM Inquiries Invited

Volkmodem with computer cable 68
 Mark VII Auto Dial/Auto Answer 99
 Mark XII Smart Model 1200/300 299

DC HAYES Smartmodem 219
 DC Hayes Smartmodem 1200/300 519

**PROM QUEEN for VIC 170**

Apple Emulator for Commodore 64 **Call**

STAT Statistics Package for C64 95

Solid Oak 2 Level Stand for C64 or VIC 29

C64/VIC Switch (networking) 129

BACKUP V1.0 tape copier for C64 or VIC 20

CARDBOARD/6 Motherboard - VIC 64

CARDBOARD/5 Motherboard - C64 56

CARD PRINT G Printer Int. with Graphics 72

CARD PRINT B Printer Interface—C64/VIC 40

CARDBOARD/3s Motherboard - VIC 25

CARDCO C64/VIC Calculator Keypad 32

CARDRAM/16 RAM Expansion - VIC 44

Complete CARDCO Line in stock

CIE and VIE IEEE Interfaces in stock

MSD SuperDrive for C64 or IEEE 365

MAE Assembler for C64 50

Koala Pad Touch Tablet—C64 or VIC 75

CBC 4/12 Analog to Digital 4 chan/12 bit 199

MULTIPLAN for C64 79

Dust Cover for C64 or VIC 6

Grand Master Chess for C64 24

COMAL Language for C64 17

with sprites, color graphics, sound, turtle graphics.

Super BusCard by Batteries Included 159

ULTRA BASIC—64 with Turtle Graphics 37

Super Disk Utility—C64—includes backup 19

MicroChess—C64—8 levels of play 17

HES MODEM with software 55

Commodore 64 Programmers Reference Guide 16

WordPro 3+/64 with Spellright 85

VIController (also C64)—BSR Controller 50

COM VOICE Synthesizer for C64 or VIC 139

VIC products in stock—call for extra discounts.

Victory Software for VIC and C64 in stock.

APPLE—FRANKLIN ITEMS

FRANKLIN—complete line in stock

QUENTIN Drives for Apple/Franklin 219

Swapper Stopper 26

automatic switch between paddles and joystick

KRAFT Apple Joystick 40

Kraft Apple Paddle Pair 30

Koala Pad Touch Tablet—Apple/Franklin 90

SPINNAKER Software in stock

Electronic Arts Software in stock

16K RAM Card for Apple 59

Multiplan—Microsoft 185

Solid Oak 2 Level Stand for Apple 29

Serial Card for Apple 89

MPC RAM/80 column card for Ite (AP/TXT) 129

Z80 Softcard and CP/M (Microsoft) 235

RANA Elite I with Controller 389

Parallel Printer Interface/Cable 69

Microtek and MPC Interfaces in stock

Grappler + Interface 129

DC Hayes Micromodem II 299

PFS: File or PFS: Report or PFS: Graph 95

Videx 80 Column Card 209

Apple Blue Book 19

commodore

See us for Personal, Business, and Educational requirements. Educational Discounts available.

PETSCAN I \$245 base price

Allows you to connect up to 30 CBM/PET Computers to shared disk drives and printers. Completely transparent to the user. Perfect for schools or multiple word processing configurations. Base configuration supports 2 computers. Additional computer hookups \$100 each.

COMPACT/STCP \$115

Intelligent Terminal Package for PET, CBM, C64
 Includes ACIA Hardware / STCP Software

SCREENMAKER 80 Column Adapter for C64 139

Provide big screen capability for business applications.

Copy-Writer Word Processor for C64 49

Full-featured package with 800 lines of text in memory. Includes double column printing, graphic capability, full printer support.

Special Screenmaker/Copy-Writer Combo 179**VICTORY Software for VIC and C64**

Metamorphosis	16	Creator's Revenge	16
Labyrinth of Creator	16	Galactic Conquest	16
Kongo Kong	16	Annihilator	16
Chomper Man	16	Grave Robbers	13
Bounty Hunter	16	Adventure Pack I or II	16

PAPER CLIP Word Processor—CBM/C64 75

ORACLE Data Base from Batteries Included 109

SPINNAKER Software C64, Apple, IBM, Atari

Compute's First Book of PET/CBM 11

POWER ROM Utilities for PET/CBM 78

WordPro 4+ - 8032, disk, printer 295

VISCALC for PET, ATARI, or Apple 189

Compute's First Book of 64 Sound & Graphics 10.40

SM-KIT enhanced PET/CBM ROM Utilities 40

PET Spacemaker II ROM Switch 36

Compute's First Book of Games 10.40

Dust Cover for PET, CBM, 4040, or 8050 8

CmC Interfaces (ADA1800, ADA1450, SADI in stock)

Compute's Reference Guide to 64 Graphics 10.40

Compute's Machine Language for Beginners 11

HES Software and Hardware in stock

UMI products in stock

FlexFile for PET/CBM/C64 \$49

DataBase, Report Writer with calculations, Mailing Lists.

Easy to use, and can be modified.

FORTH for PET/C64 full FIG model - Cargile/Riley 50

includes all FORTH 79 Standard extensions, structured 6502 assembler with nested decision macros, standard 16x64 screens, agility to read/write BASIC sequential files, sample programs, introductory + reference manual.

Metacompiler for FORTH for independent object code 30

Floating Point for FORTH 20

KMMM PASCAL IV for PET/CBM/C64 99

Virtually full Jensen-Wirth implementation is now suitable for advanced placement courses.

EARL for PET/CBM Disk-based ASSEMBLER 65

SuperGraphics - BASIC Language Extensions 45

Fast graphics, sound, turtle graphics routines for PET/CBM.

RAM/ROM for PET/CBM 4K \$75 8K \$90

CBM Public Domain Software—C64/PET27 disks 75

STAT for PET/CBM/C64 and Apple 95

Comprehensive Statistical Analysis Routines

Includes complete file handling capabilities, summary statistics, confidence intervals, hypothesis tests, exponential mean tests, multiple and power series regression, analysis of variance, histograms, and non-parametric tests.

PageMate 60 Command Word Processor 40

Full-featured package for all Commodore computers (incl. VIC with 16K). Full screen editing, and supports disk, tape, and all printers.

DISK SPECIALS

Scotch (3M) 5" ss/dd	10/ 2.20	50/ 2.00	100/ 1.95
Scotch (3M) 5" ds/dd	10/ 2.90	50/ 2.65	100/ 2.60
Scotch (3M) 8" ss/sd	10/ 2.30	50/ 2.10	100/ 2.06
Scotch (3M) 8" ss/dd	10/ 2.85	50/ 2.70	100/ 2.65

We stock VERBATIM DISKS

Write for Dealer and OEM prices.

Sentinel 5" ss/dd	10/ 1.90	50/ 1.85	100/ 1.75
Sentinel 5" ds/dd	10/ 2.55	50/ 2.50	100/ 2.35

We stock Dysan disks

Wabash 5" ss/sd	10/ 1.50	50/ 1.45	100/ 1.40
Wabash 5" ss/dd	10/ 1.90	50/ 1.85	100/ 1.75
Wabash 5" ds/dd	10/ 2.60	50/ 2.50	100/ 2.40

We stock MAXELL DISKS

Write for dealer and OEM prices.

Disk Storage Pages	10 for \$4	Hub Rings 50 for \$6
Disk Library Cases	8"—3.00	5"—2.25
Head Disk Cleaning Kits	12	

AMARAY Disk Storage Systems in stock.
 Innovative Concepts FLIP 'N' FILES in stock.

CASSETTE TAPES—AGFA PE-611 PREMIUM

C-10	10/ .61	50/ .58	100/ .50
C-30	10/ .85	50/ .82	100/ .70

Hewlett Packard

Write or call for prices.

DATASHIELD BACKUP POWER SOURCE \$265

Battery back up Uninterruptible Power Supply with surge and noise filtering. The answer to your power problems.

CALL FOR PC PRICES

Multiplan—IBM or Apple 185

Quadboard for IBM available

KOALA PAD Touch Tablets—Apple, Atari, IBM, CBM

Peachtext 5000 Software Package 209

PFS Software for IBM and Apple in stock

SPINNAKER Software C64/VIC, Apple, IBM, Atari

VOTRAX Personal Speech System 280

BMC 9191 Color Monitor 229

BMC 12A 12" Green Monitor 79

Dynax (Brother) DX-15 Daisy Wheel Printer 469

Brother HR-25 Daisy Wheel Printer (25 cps) 769

Itoh Prowriter Parallel Printer 379

Panasonic 1090 Printer with Correspondence Mode 279

Daisywriter 2000 with 48K buffer 1020

Gemini 10X 289

EPSON, Okidata, Star Micronics printers in stock

USI CompuMOD 4 R F Modulator 29

We Stock AMDEK Monitors

Amdek DXY-100 Plotter 590

A P Products 15% OFF

COMPUTER COVERUPS IN STOCK

BROOKS 6 Outlet Surge Suppressor/Noise Filter 54

Surge Suppressor-6 outlet 29

Electrohome 1302-2 13" Hi-res RGB Monitor 335

Panasonic 12" Monitor (20 MHz) with audio 132

Synertek SYM-1 Microcomputer 189

ALL BOOK and SOFTWARE PRICES DISCOUNTED

USI Video Monitors—Green or AMBER 20 MHz hi-res.

Dealer and OEM inquiries invited

ZENITH data systems

ZVM-122A 99 ZVM-123G 89

ZVM-131 300 ZVM-135 490

Z29 Terminal (DEC and ADM compatible) 680

ZT-10 Intel. Terminal with Serial Port 340

Z100 16-bit/8-bit System 168

We stock entire Zenith line.

ATARI — WE STOCK ENTIRE LINE

SPINNAKER and Broderbund Software in Stock

WRITE FOR CATALOG. Add \$1.50 per order for United Parcel. We pay balance of UPS surface shipping charges on all prepaid orders (add extra for mail, APO/FPO, air). Prices include cash discount. Regular prices slightly higher. Prices subject to change.

215-822-7727

252 Bethlehem Pike
 Colmar, PA 18915

A B Computers

**COMPUTER DISCOUNT PRODUCTS FAIR PRICE POLICY****CDP GUARANTEES THE LOWEST AVAILABLE PRICE ON ALL COMPUTER PRODUCTS!**

You pay either our discount price OR the lowest advertised price from any competitor's display ad in this issue.*
 *CDP will attempt to post competitor's display ads but ultimate proof of price rests with customer. CDP will match both published price and terms. Excludes typographical errors, items out of stock, products sold only through authorized outlets, unless we are also authorized.



We'll see you in San Francisco at
COMPUTER EXPO
 Booth #742 March 23-25

CDP SPECIALS

VISI-ON	SCALL
16K RAM CARD	39.99
POWER STRIP w/Surge	17.99
APPLE FAN w/Surge, 2 Outlets	39.99
PAR. PRINTER CARD & CABLE	39.99
16K UPGRADE 4116 200 NS (Set/8)	9.99
64K UPGRADE 4164 200 NS (Set/9)	79.99

DISKETTES

OYSAN 5" SS/00 (10)	31.99
OYSAN 5" SS/00 (100)	299.99
OYSAN 5" DS/00 (10)	38.99
OYSAN 5" DS/00 (100)	369.99
MAXELL 5" SS/00 (10)	27.99
MAXELL 5" SS/00 (100)	259.99
MAXELL 5" OS/00 (10)	37.99
MAXELL 5" OS/00 (100)	359.99
VERBATIM 5" SS/00 (10)	24.99
VERBATIM 5" SS/00 (100)	229.99
VERBATIM 5" OS/00 (10)	36.99
VERBATIM 5" OS/00 (100)	349.99

EDUCATIONAL SOFTWARE SPECIAL

Additional 10% OFF with order of any 5 educational programs from DLM, SPINNAKER, LEARNING CO.

**MICROSOFT**

A.L.O.S.	75.99
APPLESOFT COMPILER	116.99
BASIC COMPILER	239.99
COBOL COMPILER	559.99
FLIGHT SIMULATOR (IBM)	34.99
MOUSE (IBM)	129.99
MULTIPLAN	155.99
MULTITOOL BUDGET	109.99
MULTITOOL FIN. SIMT.	69.99
SOFTCARD I	215.99
SOFTCARD PREMIUM (Ile)	359.99
64K IBM SYSTEMCARD	265.99
WORD	SCALL

APPLE SOFTWARE

BPI (GL, AP, AR, PAY, INV)	274.99
BRODERBUNO Arcade Machine	44.99
Bank Street Writer	44.99
Orcl	27.99
David's Magic Loderunner	25.99
CENTRAL POINT Copy II+	24.99
OATAMOST Aztec	25.99
Kids & Apple, VIC, COMM, ea.	26.99
OATASOFT Canyon Climber	14.99
Zaxxon	17.99
OLM Alien Addition	Sch-37.99, H-27.99
Alligator Mix	Sch-37.99, H-27.99
Demolition Division	Sch-37.99, H-27.99
Dragon Mix	Sch-37.99, H-27.99
Meteor Multiplication	Sch-37.99, H-27.99
Minus Mission	Sch-37.99, H-27.99
Verb Viper/World Invasion	37.99
Word Man/World Master	37.99
Word Radar/Spelling Wiz	37.99
EPYX Crush Crumble Chomp	19.99
GRAPH & CALC	99.99
HAYDEN Piewriter	94.99
Sargon II	24.99
Incredible Jack	129.99
KENSINGTON Format II	126.99
L&S Crossword Magic	39.99
LEARNING CO Bumble Games	26.99
Bumble Pilot/Magic Spell	26.99
Gertrudes Puzzle	29.99
Juggles Rainbow	19.99
Moplovn Parade	26.99
Rocky's Boots	33.99
LIGHTNING MasterType	29.99
MICROLAB Oata Factory	229.99
Miner 20-49er	27.99
ODESTA CHESS	53.99
Odin	37.99
PENQUIN Graphics Magician	38.99
SIERRA ON LINE Frogger	21.99
Screenwriter II	81.99
Ultima II	36.99
General Manager	146.99
ULTRASOFT Serpents Star	29.99
Mask of the Sun	29.99
VISICORP	SCall

ACCESSORIES

1984 Apple/Atari S/Ware Book	15.99
3 Ring Disk Sheets (10)	7.99
EPSON Printers	SCALL
Flip 'n File (original)	17.99
Flip 'n File w/Locktray (25)	17.99
Flip 'n File w/Locktray (50)	27.99
HAYES 300 Baud Smartmodem	199.99
1200 Baud Smartmodem	474.99
Library Case	1.99
KENSINGTON PC Saver	39.99
NOVATION J Cat	104.99
NOVATION 103/212 Auto Cat	419.99
NOVATION 103 Smart Cat	169.99
NOVATION Expansion Mod.	29.99
PAGEMATE Book Holder	29.99
Printer Stand Small (plxgls)	24.99
Printer Stand Large (plxgls)	29.99
RIBBONS - Brother	SCALL
MX & FX 80	4.99
MX & FX 100	7.99
OKI 82, 83, 92, 93 & Gem	2.99
USI Computer RF MOD	34.99

FingerPrint (Epson Enhancer) 44.99

APPLE HARDWARE

BASIS 108	SCALL
DAN PAYMAR Lower Case I (rev 1-6)	25.99
Lower Case 2 (rev 7)	19.99
DARK STAR Snapshot II	65.99
EASTSIDE Wildcard 2	109.99
FOURTH DIMENSION Drive	219.99
HAYES Micromodem IIe	SCALL
HOMES Repeat Key	19.99
KOALA PAO	85.99
KRAFT Joystick	39.99
KRAFT Paddles	31.99
LEONARD 128K Ram	359.99
MICRO-SCI Drive	219.99
MOUNTAIN CPS Card	159.99
Ramplus + 32K	159.99
NOVATION Applect II	259.99
Applect Upgrade 1200 Baud	309.99
ORANGE MICRO Grappler + Butterboard	114.99
Buttered Grappler + Butterboard	179.99
PADDLE ADAAPPLE	24.99
SATURN 128K Ram	379.99
Accelerator II	444.99
Neptune 64K	199.99
Neptune 128K	299.99
S. CORONA TP-2 PRINTER	SCALL
ALS CP/M 3.0	259.99

IBM

1/2 Height OS/DD Drive	239.99
ALPHA Oata Base MGR II	169.99
Apple-IBM Connection	129.99
Executive Package	115.99
Typecases	75.99
ASHTON TATE dBase II	209.99
Friday	198.99
Encyclopedia	59.99
Friday	SCALL
AST Boards	SCALL
BRODERBUNO Serpentine	26.99
CENTRAL POINT Copy II PC	25.99
EDUWARE Algebra I	29.99
EPYX Crush Crumble Chomp	19.99
Curse of Ra	14.99
Oil Barons	74.99
Temple of Apshai	22.99
Upper Reaches of Apshai	14.99
HAYES 1200B Modem	439.99
KENSINGTON PC Saver	SCALL
KRAFT Joystick	44.99
LIFETIME Volkswriter	119.99
LIGHTNING MasterType	26.99
LOTUS 1-2-3	SCALL
MICROLAB Highrise	22.99
Miner 20-49er	27.99
NORTON Utilities	59.99
PC CRAYON	49.99
PC TUTOR	47.99
POOL I, S	27.99
PLANTRONICS ColorPlus	379.99
SIERRA ON-LINE Frogger	26.99
Ulysses & Golden Fleece	29.99
SIR-TECH Wizardry	44.99
SUB LOGIC Pinball	29.99
TG Joystick	44.99
TITAN 64K BOARD	499.99
VISICORP, Visicalc or Visidex	164.99
Visifile, Trend/Plot, Schedule ea	199.99
Visilink	SCALL
Visi-on	SCALL
Visispell	179.99
Visiword	269.99

EAGLE PC SCALL

SPINNAKER

ALPHABET 200 (new)	19.99
DELTA DRAWING	32.99
FACEMAKER	21.99
FRACTION FEVER (new)	21.99
KINDERCOMP	19.99
MOSTAMAZING THING	26.99
SNOOPER TROOPS	27.99
STORY MACHINE	21.99

Beagle Bros

ALPHA PLOT	24.99
APPLE MECHANIC	19.99
BEAGLE BASIC	24.99
OOS BOSS	15.99
DOUBLE TAKE	24.99
FLEX TEXT	19.99
FRAME-UP	16.99
PRONTO OOS	19.99
TIP DISK #1	14.99
TYPEFACES	14.99
UTILITY CITY	19.99

ALL OF ABOVE 234.99

Continental

APPLE GRAPHICS BOOK	14.99
CPA (GL, AP, AR, PAY) ea	149.99
FCM/FL 1st CLASS MAIL (AP)	61.99
FCM/FL 1st CLASS MAIL (IBM)	71.99
HOME ACCOUNTANT+ (IBM)	84.99
HOME ACCNT.+ (KAYPRO, OSB)	59.99
HOME ACCNT.+ (TI PRO)	119.99
PROPERTY MANAGEMENT	295.99
TAX ADVANTAGE	39.99
ULTRAFILE (IBM)	155.99
HOME ACCOUNTANT (Ap)	44.99

KENSINGTON MICROWARE

SYSTEM SAVER
 • Surge Suppression
 • Fits Apple Stand
 • Dual Outlet
 • U.L. Listed
 • Great Gift! **\$65**

INFOCOM

DEADLINE	32.99
ENCHANTER	32.99
PLANETFALL	32.99
SUSPENDED	32.99
WITNESS	32.99
STARCROSS ZORK I, II, III	ea. 24.99

MicroPro.

MAILMERGE 139.99
 SPELLSTAR 139.99
 WORDSTAR PRO 389.99

INFOSTAR & WORDSTAR ea. 259.99

QUADRAM

APIC (APPLE // PARALLEL)	129.99
ERAM 80 column 64K I/E	SCALL
MICROFAZER	SCALL
QUAOBOARD I or II (64K)	269.99
QUAOCOLOR I	234.99
QUAOCOLOR II	269.99
QUAO 512+(64K)	219.99
QUAOCHROME MONITOR	499.99
QUADLINK	479.99

PRINTERS

DTC 380Z (Letter Quality)	999.99
Stylewriter	699.99
OKIDATA 82-93	SCALL
STAR GEMINI 10X	299.99
EPSON FX80	549.99

**MAIL & PHONE ORDERS:**

860 S. Winchester Bl.
 San Jose, CA 95128
 (408) 985-0400

SAN FRANCISCO:
 1230 Market St.,
 San Francisco, CA 94102
 (415) 626-2244
 MON-FRI 10AM-7PM
 SAT-SUN-HOL 10AM-5PM

SAN JOSE:
 860 S. Winchester Bl.
 San Jose, CA 95128
 (408) 985-0401
 MON-FRI 8AM-10PM
 SAT-SUN-HOL 10AM-5PM

SAN MATEO:
 4228 Olympic Ave.
 San Mateo, CA 94403
 (415) 571-1658
 MON-FRI 10AM-7PM
 SAT-SUN-HOL 10AM-5PM

- No Charge For Credit Cards
- Prices Subject To Change
- Software Sales Are Final
- Min. \$4.00 Shipping Charge
- Purchase Orders Call First





FLOPPY DISK SERVICES, INC.
741 Alexander Road
Princeton, NJ 08540
609-799-4440

LEADERS IN INNOVATIVE DISK DRIVE ENCLOSURES!

The **FD-PC8™** is a new 8" double-sided disk drive sub-system



IBM PC styling.

The FD-PC8 looks like your other IBM PC components. Same styling. Same color. Same dimensions. It stacks neatly under, on top of, or next to your IBM PC, and better still, is only one-half the height of standard 8" drives.

2 Drive System—\$1310 complete with cables.

SPECIFICATIONS

- Full one year warranty on materials and workmanship.
- Two fully assembled and tested Shugart double-sided 8" drives also available in one drive configuration.
- Exactly 1/2 the height of standard 8" drives.
- IBM PC styled and painted cabinet.
- All cabling included.
- IBM 3740 format compatible.
- No-mar rubber feet.
- Sturdy construction easily supports PC or monitor.
- Power supply designed for long life, trouble-free operation.
- Requires Maynard controller for use on PC.

NEW! FD-PC5™

This versatile new disk drive comes completely tested and assembled with a 4" cooling fan, and is designed to offer a variety of mounting options, with the power supply rated for any of the following:

- full-size floppy disk drive
- full-size hard disk
- one or two half-height floppy disk drives
- one or two half-height hard disks
- one or two 3.5" drives

Full 1 year warranty—cable choice optional



DISK DRIVES and other Goodies!

Shugart (1 year war.)	
sa-860 ds/dd half hgt 8"\$505.00 2 @ 495 ea
sa-455 ds 48tpi 1/2 hgt 5.25"265.00 2 @ 250 ea
sa-465 ds 96tpi 1/2 hgt 5.25"350.00 2 @ 325 ea
sa-300 ss 96tpi 3.5 inch265.00 2 @ 250 ea
sa-851 ds 8" full size495.00 2 @ 480 ea
W.S.T. (formerly SIEMENS)	
FDD-100-5B4 floppy 5.25"235.00
FDD-211-5 DS 48tpi for PC265.00
FDD-221-5 DS 96tpi full size335.00
FDD-100-5C3 (sa-400 compatible)475.00
Heath H-89 TWOET kit ...	
put 2 half height floppies internal to the H-89 with our exclusive mounting kit, call for details!	
Maynard Electronics for the IBM-PC	
Memory module (bare)210.00
64K305.00
128K410.00
192K510.00
256K615.00
With serial port add100.00
With 2 serial ports160.00
Controller w/mod ports265.00
FDC8 8" controller245.00

Standard controller\$195.00
Controller w/par port275.00
Controller w/ser port285.00
Hard disk module495.00
Modular board110.00
Multidisplay (mono & color board)575.00
PGS, HX-12 RGB color monitor525.00
Magnolia controller for the H-89425.00
Data connectors of all typesCALL
Power connectors for all drivesCALL

We offer a wide assortment of enclosure sizes, styles and systems, including both 5 1/4" and 8" IBM look-alikes, and more. All are well constructed, attractive and immediately available at competitive prices. Call for details and prices.

COME SEE US AT



**BOOTH #748 AND 750
SAN FRANCISCO—MARCH 22-25, 1984**

TERMS: MC, VISA, PREPAID. NO COD'S. PERSONAL CHECKS HELD FOR 10 DAYS.

Toll Free Order Line 800-223-0306 Ask for our free catalog.

Serial Parallel

NEW!

**Convert What You Have
To What You Want!**

- * RS232 Serial
- * 8 Baud Rates
- * Latched Outputs
- * Centronics Parallel
- * Handshake Signals
- * Compact 3/4" x 4/4" x 1/4"

No longer will your peripheral choices be limited by the type of port you have available! Our new High Performance 700 Series Converters provide the missing link. Based on the latest in CMOS technology, these units feature full baud rate selection to 19.2K, with handshaking signals to maximize transfer efficiency. Detailed documentation allows simplified installation. Order the Model 770 (Ser/Par) or Model 775 (Par/Ser) Today!

Buffer Products Coming Soon!

Jigatronics
WCON004110

only **\$89.95**

Connector Option \$10.00
CA Residents 6% Tax
UPS Shipping \$3.00

1875-A Penn Street
Post Office Box 2333
Oxnard, California 93020

CALL (805) 487-1665 or 487-1666
For FAST Delivery

Circle 150 on inquiry card.

Scotch® Diskettes

Rely on Scotch® diskettes to keep your valuable data safe. Dependable Scotch diskettes are tested and guaranteed error-free. The low abrasivity saves your read/write heads. They're compatible with most diskette drives.

(800)235-4137

DEALER INQUIRIES INVITED

PACIFIC EXCHANGES
2101 E. 9th Blvd.
San Jose, CA 95128-1144
415/291-1144
800/235-4137

Circle 277 on inquiry card.

300 BAUD MODEMS 1200 BAUD

HAYES SMARTMODEM 1200.....\$429
Includes Smartcom software!
SIGNALMAN..Free hour on 'SOURCE' MARK 12...300/1200 AUTO.....\$279
MARK 10...300 AUTO.....\$169
VOLKSMODEM & cable.....\$ 79
US ROBOTICS.....'Hayes Compatible' 'PASSWORD' 300/1200 baud.....\$339
'S100' card 300/1200.....\$339
'AUTO 212' dx. 300/1200.....\$419

DOT MATRIX PRINTERS LETTER QUALITY
CABLES 6 feet IBM CPM.....\$ 22
GEMINI 10X 120 cps graphics.....\$279
PROWRITER 120 cps hi density....\$344
DAISYWRITER fast! 40 cps 48K.\$CALL!

IBM HARD DISKS CPM
Complete Systems....controller & drive & software
10 Mbyte half height.....\$1295
23 Mbyte...\$2195 40 Mbyte.....\$2795

IMAGE COMPUTERS
P.O. Box 1164, Cardiff, CA 92007

(619) 942-7373
(619) 270-3600

DEALER INQUIRIES INVITED

Circle 182 on inquiry card.

CWE

PERSONAL SERVICE/FRIENDLY ADVICE
DISCOUNT PRICES

	Retail	CWE
PFS FILE: by Software		
Publishing.....	\$125	\$95
IBM.....	\$140	\$105
BANK STREET WRITER		
by Broderbund.....	\$69.95	\$49.95
TAX PRO1040 by S&S.....	Special	\$299
LOTUS 123™.....	\$495	\$325
dBase II™ by Ashton-Tate..		Call
The Home Accountant by Continental.....	\$74.95	\$54.95
The Home Accountant Plus — IBM.....	\$150	\$98.00

We sell a complete line of software and games; specializing in Educational and Business Programs.

CORPORATE ACCOUNTS WELCOME
Circuits World Electronics Corp.
156 Depot Road, Huntington Station, N.Y. 11746
CALL COLLECT (516) 423-9100
MasterCharge, Visa, Personal Checks Accepted.
Prices subject to change without notice.

Circle 64 on inquiry card.

FULL LINE OF TOP QUALITY, STATE OF THE ART STD BUS PRODUCTS AT AFFORDABLE PRICES. COMPLETE SOFTWARE SUPPORT AVAILABLE. ALL DELIVERED FROM STOCK.

Z80 CPU with two RS-232C ports	\$164.95
64K/128K DYNAMIC RAM card with 64K	229.95
64K BYTE WIDE MEMORY card	96.95
EPROM PROGRAMMER card	159.95
FLOPPY DISK CONTROLLER card	249.95
6 SLOT MOTHERBOARD with card cage	124.95

Many more cards and products available. Dealer inquiries welcomed. Please contact

R.L.C. ENTERPRISES
1117 Hillview Drive
Milpitas, CA 95035
(408) 946-7471

Circle 307 on inquiry card.

Bytcom®

212AD

now available at

Media Distributing

4444 Scotts Valley Dr
Scotts Valley Ca. 95066

CA 800-824-7386
US 800-824-7385

Call for price

Circle 266 on inquiry card.

ICs PROMPT DELIVERY!!!
SAME DAY SHIPPING (USUALLY)

DYNAMIC RAM		
256K	150 ns	\$85.00
64K	200 ns	5.97
64K	150 ns	6.09
64K	120 ns	6.90
16K	200 ns	1.56
EPROM		
27128	300 ns	\$22.50
2764	250 ns	8.30
2732	450 ns	4.75
2716	450 ns	3.60
2532	450 ns	4.75
STATIC RAM		
6264P-15	150 ns	\$35.97
6264LP-15	150 ns	42.00
6116P-3	150 ns	5.75

MasterCard VISA or UPS CASH COD

Factory New, Prime Parts

MICROPROCESSORS LIMITED
24000 South Peoria Ave
BEGGS OK 74241 (918) 267-4961

Prices shown above are for Jan. 13, 1984.
Please call for current & volume prices. Prices subject to change. Please specify highest price on some items due to varying shortages. Shipping and insurance extra. Leg. business prices shown. Federal Express Standard Air or 15 9P Delivery available by 4 PM CST. Call us tomorrow to give you the most complete.

Circle 245 on inquiry card.

Printer Cables

— Parallel —

\$35.00* ALTOS
\$35.00* ATTACHE
ATARI
CENTRONICS
COLUMBIA
EAGLE
IBM-PC
KAYPRO
OSBORNE
SANYO
TI-99

FREE SHIPPING

\$35.00* ATTACHE COM.
RS232 (DB25P)
(9 conductor 1-8, 20)

— SERIAL —

CABLES BY WORSWICK
4030 Wabaska Dr.
San Diego, CA 92107
619-222-3366

* CA Residents Add 6% Sales Tax (\$2.34)

Circle 385 on inquiry card.

1984 3M SPECIAL

We're bringing in the New Year with specials on quality 3M information processing products. Including:

- DISKETTES • MAG TAPE
- DATA CARTRIDGES

PLUS! Specials on many other products in our full-range discount catalog of computer supplies. Call, write, or utilize reader service to obtain your FREE catalog of 1984 3M Specials.

LYBEN COMPUTER SYSTEMS
1250-E Rankin Dr., Troy, MI 48083
Phone: (313) 589-3440

Simply #1 In Service & Reliability

3M Authorized Distributor
Information Processing Products

Circle 409 on inquiry card.

MICRO SALES

U.S.A. IN U.S.A. → BUY FACTORY DIRECT →

DISK DRIVE SPECIALS

We've Lowered Our Prices



Offering A Complete Selection And...
THE LOWEST PRICES IN BYTE!

8" Shugart 801R SS/DD — The Industry Standard	\$355.00
8" Shugart 851R Double Sided 1.2 Meg — The Old Reliable	457.00
8" Qume Datatrak-8 DS/DD "THE BEST" of the floppys	479.00
8" Mitsubishi Full Height Double Sided 1 Year Parts + Labor	445.00
8" Mitsubishi Thinline DS/DD 1 Year P+L Direct Drive	465.00
8" Tandon 848-1 Slimline SS/DD 600K 8YTES D.C. Motor	355.00
8" Tandon 848-2 Slimline Double Sided 1.2 Meg. D.C. Motor	475.00
8" Siemens 100-8 SS/DD ON SALE NOW!!! But How Long?	169.00
5 1/4" Mitsubishi Full height 96T.P.I DS/DD 750K M4852	295.00
5 1/4" Mitsubishi Slimline 96T.P.I. DS/DD 750K M4853	315.00
5 1/4" Special Package	375.00

5 1/4" Tandon TM 100-4 DS/DD 96T.P.I. 750K 369.00

WINCHESTER HARD DISKS SPECIALS

5 1/4" Miniscribe Hard Disk
*5 Meg \$589 *10 Meg \$749

8" Quantum 20* Megabyte Winchester — Two Platters	1895.00
8" Quantum 40* Meg Four Platter — Most Popular	2395.00
8" Quantum 85* Megabyte — Special Order on this Monster!	2895.00
8" IQMEGA 10* Meg* Removeable Disk Drive with SCSI Controlled Interface Board. Runs up to four drives	1895.00
8" IQMEGA 10 Meg* Cartridge Drive — No Control Interface	895.00
8" 10 Meg* Removeable Cartridge Media #M-2000-51	50.00

*LAST MINUTE SPECIAL!!! Buy any Winchester hard disk drive and get a Western Digital hard disk interface board AT COST!



California Computer Systems

YEAR END SALE

SAVE \$61.00

New CCS2066 64K Dynamic Memory
• 65,536 bytes of Dynamic RAM • Z-80/8080, S-100 compatible • Port bank/16 levels of 64K = system memory of 1024K • Independently addressed in 16K blocks • 200ns access and data lines • Hysteresis drivers and receivers for high noise immunity and minimal bus loading effects. Part #D 2066 64K

YEAR END SYSTEM SALE

- 2300A Mainframe
- 2066 64K Memory
- 2810 Z-80A CPU
- All AC/DC & Data Cables
- 2422 Disk Controller
- CP/M Operating System
- 2719 2-Port RS-232 Serial
- 8-bit Parallel I/O

A powerful package at ONLY \$1495.00

CCS CALSTAR SYSTEM

Low available and with FREESoftware: • Perfect Writer • Perfect Calc • Perfect Speller • Perfect Filer.
This powerful single box system includes: • Z-80 with 128K of RAM expandable to 56K • A networking interface • SASI hard disk interface to add-on a Winchester • CP/M 3.0 operating system • One parallel and two serial ports • Reads and writes the IBM 1740 format (compatible with XOR) AND • Two double-sided double-density 8" floppy drives for 2.4 Megabytes of formatted storage AND • Will run two or more 8" or 5 1/4" floppys. Part #S-1500-05

ON SALE NOW
~~\$2295.00~~



SPECIAL ONLY \$450.00

Limit 5 per customer
XOR-500 DAISYWHEEL PRINTER
A letter-quality daisy-wheel printer at an unheard of wholesale price. This 20 cps workhorse features a daisy-wheel compatible with QUME's products. Full 132 column format with 256 character buffer, serial AND parallel interfacing (standard), 8 level automatic impression control — original and 3 copies. The \$450.00 price is not a misprint. High reliability and quality performance sums-up the XOR-500 Daisy-wheel Printer.

XOR-500 TERMINAL SLASHED!

Cut another \$50
Only \$445.00
That's right! A 700.00 terminal for \$445.00, a special deal for our customers.

Features: ★ Screen tilt ★ Detached keyboard ★ 9 cursor control keys ★ 5 function keys ★ 7 screen attributes ★ 25th status line ★ 50-19.2 Kbaud ★ Column plus field tab ★ AND MORE
★ All these features with a full 6 month warranty makes this terminal the best buy on the market.

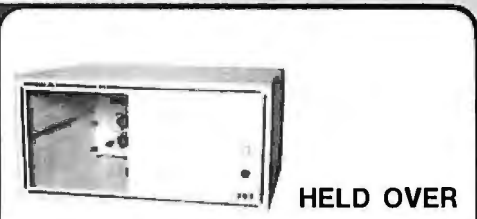

HELD OVER ON THE ORIGINAL S-100 MOD

For engineers, hobbyists, and anyone who wants to save a bundle, the S-1-MOD is the answer. Full regulated power to run up to four floppy disks coupled with a mammoth S-100 power supply and 12 slot bus, makes the S-1-MOD an exceptional computer base. Single board design means no wiring from the power supply to the motherboard. This eliminates all ground loop problems associated with other brands of mainframes who are forced to use termination. The S-1-MOD is being offered this month with a matching S-100-12 cabinet. Fan cooled, fused, with reset and keylock the cabinet is also enamel painted and silk screened. Four A.C. outlets are provided for peripheral hookup and plenty of cutouts available for RS-232, electronics + others. Our regular \$225.00 price for the S-1-MOD and 250.00 price for our 12 slot cabinet is being SLASHED!

SPECIFICATIONS:
Regulated +5V @ 5A +8V @ 30A +24V @ 3A +16V @ 6A -5V @ 1A -16V @ 6A
Unregulated +8V @ 30A +16V @ 6A -16V @ 6A
on't settle for those cheap 6 slot 120. OWN THE BEST! XOR S-1
elsewhere in this it \$395.00



HORIZONTAL OR VERTICAL
Fully Assembled and Tested Units
ONE YEAR P+L WARRANTY
On Shugart and Mitsubishi Subsystems

w/two Mitsubishi DS/DD Assem. + Tested 2.4 Meg	\$1170.00
w/two Shugart 801R SS/DD Assem. + Tested 1.2 Meg	975.00
w/two Shugart 851R DS/DD Assem. + Tested 2.4 Meg	1225.00
w/two Siemens 120-8 SS/DD Assem. + Tested 1.2 Meg	675.00
w/two Qume DT-8 DS/DD Assem. + Tested 2.4 Meg	1250.00
Cabinet Assem. & Tested w/Power Supply and Accs.	235.00
Cabinet Top and Bottom with Mounting Hardware Only	69.50
All cabinets A & T and subsystems include all AC/DC wiring and a 50 pin data cable except the horizontal model which includes the internal 50 pin cable and requires an external 50 pin cable part #C-6000-01	\$ 25.00

5 1/4" Subsystems — Cabinet — Power Supply — Drives — cables
w/two 48TPI SS/DD includes all cables Assem. + Tested 495.00
w/two 48TPI DS/DD includes all cables Assem. + Tested 595.00
w/two 96TPI DS/DD includes all cables Assem. + Tested

DO YOU NEED AN IBM-PC 16-BIT COMPUTER TO PROCESS YOUR DATA?

COMPLETE SYSTEM THE XPC BASIC COMPUTER

Model XPC with MS/DOS features: **ONLY \$1895** A New Model PC by XOR **ONLY \$895**

★MS/DOS standard, CP/M-86 operating system available at only \$65.00
★64K memory
★Green CRT
★2 serial, one parallel port
★2 floppy drives for a total of 750K storage
★Optional EPROM to 32K
★Optional Hard Disk add-on
★Optional floppy add-on
★Optional 8087 math co-processor
★Multi-function keyboard (this is one part of the system that's NOT like IBM's, it's better)
★Fully expandable memory On-Board to 256K PLUS 5 expansion slots (all IBM compatible)
★All available through U.S. Micro Sales and

So close to the IBM PC you'll have to look twice. Due to the thousands of requests we've been receiving by phone, mail and visitors, we've responded by getting XOR to design this fantastic 16-bit IBM duplicate. We're offering a ONE YEAR warranty (vs. 90 days). Need more information? Order the manual for \$5.00 (plus shipping). This low price includes drives, controllers, monitor, power supply, etc. About the keyboard... If you've ever seen or used the IBM PC keyboard, you'll understand why we HAD to come up with something better — and we did! As a matter of fact, for those of you who own an IBM PC — it's time to take a hammer to that keyboard and call **Toll Free** to pick-up one of our compatible replace-

The Features:
★64K RAM memory
★Expandable to 256K
★Full monitor PROM
★IBM PC compatibility
★Multi-function keyboard and cable
★Runs MS/DOS and CP/M-86 (not included) ★Power Supply +5V @ 10 Amp, +12V @ 6 Amp, -12V @ 1 Amp
★EPROM expandable on-board to 32K ★5 expansion slots with room for 4 more
INCLUDES: ★8 level interrupt ★2 serial and one parallel port ★3 timer channels ★4 DMA channels ★Reset port



maxell

DISKETTES

5 1/4" Specify Soft, 10 or 16 Sectors

		\$10	\$50	\$100
MD1-M	SSDD	26.50	130.00	255.00
MD2-DM	DSDD	38.00	185.00	360.00
MD1-DDM	SSQD	35.00	170.00	325.00
MD2-DDM	DSQD	43.00	210.00	410.00

8" Specify Soft or 32 Hard Sectors

		\$10	\$50	\$100
FD1-128M	SSDD	39.00	190.00	370.00
FD2-X-DM	DSDD	44.50	220.00	435.00

CALL TOLL FREE
800-824-7888
OPERATOR 906
(VISA, M.C., COD.
ORDERS ONLY)
7 Days a Week, 24 Hours a Day

(408) 252-4210
M-F, 8:00AM-5:00PM
FOR NEXT DAY
SHIPMENT
Inquiries Also

Creativity Unlimited

• Add \$2.00 Shipping
Per Order
• CA Residents Add Sales Tax
1741 Saratoga Avenue, Suite #201
San Jose, California 95129
Send for Our Free Catalogue • Dealer Inquiries Invited

Circle 105 on inquiry card.

PERIPHERALS FOR APPLE II AND IIe

ONE YEAR WARRANTY ON ALL ITEMS
ALL PRODUCTS BUILT IN U.S.A.

	EACH	P.C.B.
APPLE/SUGART DRIVE (5 1/4")	\$159	
DISK CONTROLLER (DOS 3.2-3.3)	49	\$ 9
80 COLUMN CARD (VIDEX EQUIVALENT)	129	19
80 COLUMN WITH 64K RAM (FOR IIe ONLY)	129	28
GRAPHER PRINTER INTERFACE WITH 16K TO 64K BUFFER AND GRAPHICS	179	19
QUAD CARD (4 FUNCTIONS) (PARALLEL, SERIAL, BSR, CLDCK) (PRINTER GRAPHICS ROM)	159	19
Z80 SOFTCARD (MICROSOFT EQUIVALENT)	89	19
5 1/4" FLOPPY DRIVE ENCLOSURE	9	

COLORADO COMPUTER PERIPHERALS
THE P.C.B. COMPANY
R.R. 6, BOX 7-D GOLDEN, CO 80403
(303) 279-4091

Circle 69 on inquiry card.

LSI C COMPILER for 8080/8085/Z80

New version of the compiler is available now!

The object code is **COMPACT** and is **FASTEST** in current C compilers.

Our "Sieve" program runs in **8.0 seconds (standard)**

and **6.2 seconds (optimized)**

(See January 1983 BYTE, pp 283-326)

price : \$500 (FOB Japan)

for pamphlet write:
P.O.Box 508 STA. CRUZ
CA. USA 95062

for further information contact:

LSI JAPAN CO., LTD.
2-24-9 YOYOGI SHIBUYAKU TOKYO (151) JAPAN
PHONE (03) 79-2427

Circle 410 on inquiry card.

IBM® PC/XT COMPATIBLE OEM COMPONENT SALE

Computer Case	\$140.00
Key Board	\$199.00
Power Supply	Call
Mother Board - Bare	\$ 95.00
Mother Board without ICs	\$225.00
Mother Board with ICs	\$525.00

Dealers/OEM Buyers
Quantity Discounts Available.

All items are fully PC/XT Compatible. Case comes with interchangeable rear panel for PC Users. Bare board comes with complete instruction with part list. 90 days manufacturers warranty on all items.

VISA and MasterCard welcome
Price change without notice
IBM is a trademark of International Business Machine



HiTech International, Inc.
4966 El Camino Real, Suite 101
Los Altos, CA 94022 (415) 949-0141
TX 171854 IBC

Circle 177 on inquiry card.

ScreenWiz FULL SCREEN CONTROL

An assembler subprogram you call from your programs to handle screen input/output as IBM mainframes do.

- Define full screen format specifications outside your program, and call ScreenWiz to retrieve the formats, and do all the I/O for you.
- One command input/displays a full screen
- Use all of your CRT video attributes
- Define up to 24 function keys
- Define templates for display and input.
- Validate input while keying. Insert and delete characters to correct fields
- Tab fields forward and backward
- Draw figures using vertical field displays
- Save memory; as only one format needs to be in memory at one time. Make the constants to display virtual, and they don't use any memory at all.
- Build help screens. Call them with one function key then return to where you were.

Available now for most popular -

BASIC	IBM PC	\$99
COBOL	CP/M-80	\$99
FORTRAN	Shipping	\$ 6
PASCAL	Source code included	

INTERDATA SYSTEMS INC.
15 Toronto St. Suite 700
Toronto, Ont. Canada M5C 2E7
(416) 366-2136 (call collect to order)
Visa, M/C
Am. Express

Circle 189 on inquiry card.

SMAL/80

SMAL/80	Assembler
HL=M (PTR);	LHLD PTR
DE=9;	LXI D,9
HL=HL+DE;	DAD D
IF A=L EQUAL	CMP L
THEN	JNZ L1
A=A-14	SUI 14
ELSE	JMP L2
A=L;	L1:MOV A,L
M(BC)=A;	L2:STAX B

New! Z-80 version (runs on 8080's): \$175. 8080 version only: \$150. Macro-processor only: \$75. Available on CP/M disks. Add \$4 for shipping. Complete tutorial text: "Structured Microprocessor Programming" (Publ; Yourdon Press) \$20 plus \$2 shipping. Send for your free button and literature or try the Ultimate Demo: SMAL/80 is Guaranteed!

Chromod Associates,
1030 Park Ave., Hoboken, N. J. 07030
Telephone: (201) 653-7615

Circle 411 on inquiry card.

TeleVideo USERS RETAIL

- Fast Dump/Restore CP/M, TurboDOS over 600k per disk... \$90.00
- New! Basic/Z with Graph/Z... \$345.00
- TurboDOS for TeleVideo... from \$300.00
- LYNC Communications Package... \$155.00
- 8" Disk Drive for 802 and 800A Drive, board and software... \$1200.00
- RM/COBOL Systems... from \$250.00
- New! DataFlex 2.0... from \$750.00
- New! 803, 803H, TPC-1 and MOUSE programs: Draw!... \$90.00
- Games Pak I... \$34.95
- 816 and 806C Tape Backup... from \$175.00
- Soft Standby Power Systems: 200VA/400VA/800VA... from \$550.00
- New! Anti-Static Products... from \$39.95
- RM/COBOL trademark of Ryan-McFarland Co.
- CP/M trademark of Digital Research
- TurboDOS trademark of Software 2000
- LYNC trademark of Norton-Lambert
- DataFlex trademark of Data Access

PLUS OTHER GOOD TELEVIDEO STUFF!
COGITATE, INC.
SPECIALISTS IN UNIQUE TELEVIDEO SOFTWARE
24000 Telegraph Road, Southfield, MI 48034
(313) 352-2345
VISA/MASTERCARD Accepted

Circle 68 on inquiry card.



flexible disks

Call Free (800)235-4137

for prices and information.

Dealer inquiries invited.

C.O.D. and charge cards accepted.

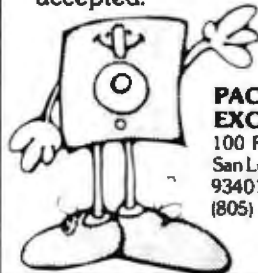

PACIFIC EXCHANGES
100 Foothill Blvd
San Luis Obispo, CA
93401 (In Cal call
(805) 543-1037)

Circle 277 on inquiry card.

USED PERSONAL COMPUTER BROKERAGE

- A nationwide database service matching buyers and sellers of used P.C.'s and peripherals.
- UPCB acts as middleman, providing security for both the buyer and the seller.
- All equipment tested and warranted by UPCB
- All makes and models accepted for listing
- Bonded and insured
- Reasonable listing rates and commissions

For more information mail today!
I am interested in Buying Selling

Name _____
Address _____
City, State, Zip _____
Telephone () _____

Mail to: **UPCB Fulfillment Dept.**
Suite 21 • 1116 A 8th Street
Manhattan Beach, CA 90266

Circle 412 on inquiry card.

Freedom - Freed the Prices!

We have met or have beaten most advertised prices.

Buy Direct!

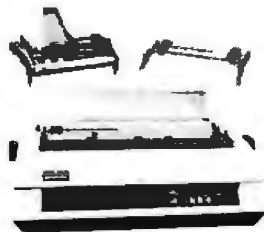

32 CPS
48K Buffer
Serial and Parallel
1 Year Warranty
380 Z \$ Unbeatable
38K STARWRITER .. \$ Unbeatable

DTC 380 Z

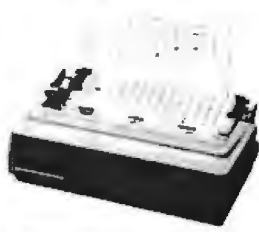

Mannesmann Tally

- Standard — 7 x 9 160 CPS
- NLC — 40 x 18 40 CPS
- 2K Buffer and Tractor Standard

160 L 80 col. Call Best Seller
180 L 132 col. Call Best Seller
Spirit Call Best Seller



IDS

- Proportional Spacing
- 8 Character Styles
- 200 CPS Bi Directional
- Color Optional
- Sheet Feed • Graphics
- 3.4K Buffer

Prism 80 \$ Call
Prism 132 and Micro Prism \$ Call
Auto Cassette Sheet Feed \$ Call



Star Micronics

Gemini 10X + 15X
120 CPS \$ Call
Delta 10X
160 CPS \$ Call
STX 80 \$ Call



EAGLE

OUR PC FLYS

IBM Compatible
Simply a better PC. All models
available for immediate delivery
Call Lowest \$



Juki 6100

18 CPS IBM Ribbons
Diablo Compatible 2K Buffer
Best Value Yet \$ Call



It's a Piece of Cake!

High Quality Software
for Personal Computers

- Word Processor
- Mail List
- Spelling Checker
- Telecom

NEW!

- Graphics Package
- Financial Planner
- Data Manager

Call for Price!



Red Hot Special!

Novation J-CAT

- 300 BPS Modem
- Originate/Auto Answer

Sizzling \$89.50

DAISYWRITER
FRANKLIN
ALTON HAYES
ZENITH NOVATION
TELEVIDEO ANADEX
SANYO AXIOM
USI DATASOUTH
TRANSTAR MICROTEK
PIED PIPER SWEET-P
RANA EAGLE
STB RITEMAN
QUADRAM
PRINCETON GRAPHICS

U.S. ROBOTICS
OKIDATA
COMREX
JUKI
STAR
NORTHSTAR
ADDS
KIMTRON
INTERCOLOR
COLUMBIA
CORONA
SILVER-REED

C. ITOH
DEC
AMPEX
TOSHIBA
VEW
RIXON
HAZELTINE
SEIKOSHA
TTX
WYSE
TEXAS INSTRUMENTS

SANYO P.C.
OTRONA
BLUE CHIP
PRINTACOLOR
OUME
KEYTRONICS
ANCHOR
BROTHER
VISUAL
DAISY

**Everything in
computer related products:**

- Computers
- Modems
- Printers
- Software
- Monitors
- Terminals
- Accessories
- Paper
- Ribbons
- Diskettes
- Office Furniture
- In-Store Training

For Price Quotes and Ordering, Call:

1-800-821-4128

For Technical Information and
Order Status, Call:

602-952-1057



**FREEDOM
COMPUTER MART
INC.**

3370 North Hayden Road • Suite 123-314
Scottsdale, Arizona 85251

Prices listed reflect a cash discount and are subject to change without notice. C.O.D.s are shipped with a minimum C.O.D. charge. Allow 3-7 days for personal checks to clear. Product is subject to availability. Equipment is in factory sealed boxes with manufacturer's warranty. There will be a re-stocking charge for returned merchandise. Call first for an RMA number. Software not warranted for suitability. No return of Software which has been opened. Add 2% for shipping & handling charges (minimum \$2.50) All equipment shipped F.O.B. Scottsdale, AZ 85251. Circle 161 on Inquiry card.

MAKE YOUR PROGRAMS TALK

Best buy in speech synthesis!!

With PROTALKER by Speech, Ltd. add natural sounding speech to your software. PROTALKER uses ADPCM technology to provide high fidelity reproduction of any speaker's voice & intonation. Record & play messages in any language. Choose the best storage/quality trade-off for your application via switch selectable digitizing rates of 2, 3, or 4 KB/sec. Manual comes with easy to follow programming examples. PROTALKER software includes: program for easy preparation of speech files; program to access PROTALKER from BASIC; and source for assembly language driver routines. Use PROTALKER to insert voice instructions in all your programs. PROTALKER for the developer who wants to program applications, not sentences.

Free software for ordering now!! PROTALKER & manual \$325. Manual only \$12. Specify S-100 or IBM PC board; CPM, CPM-86 or MS-DOS; 8" IBM SS-SD or 5 1/4" IBM PC disk format. M/C & VISA, include your card number & expiration date. CA residents add 6.5% sales tax.

SPEECH, LTD.

3790 El Camino Real, Suite 213
Palo Alto, CA 94306 415-858-2795

Circle 219 on inquiry card.

APPLE II COMPATIBLE DISK DRIVES

Mitac AD-1 only\$189.00
Controller Card\$55.00
Just Plug in and Run

VERBATIM

5 1/4" Diskettes SS DD Soft
per box of 10\$23.55

HARD DISKS

Mitac Performance and Quality
5 1/4" 10 MB Winchester Disk Drive

For Apple Users AD-100A ..only \$1395.00
For IBM Users AD-100Ionly \$1450.00

MONITORS

Mitac 12" 20 MHZ
Green\$115.00
Amber\$115.00

IBM PC COMPATIBLE DISK DRIVES

National JA-551-2 1/2 HT\$205.00

OZtech, Inc. VISA/MC Accepted
1400 Coleman Ave. Suite E-25
Santa Clara, CA 95050
(800) 222-6677
in Calif. (408) 980-9987

Circle 21 on inquiry card.

The FORTH ROBOT

The only educational robot arm to use FORTH the acknowledged control language.

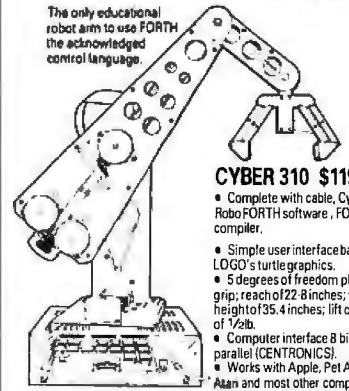

CYBER 310 \$1199

- Complete with cable, Cyber's RoboFORTH software, FORTH compiler.
- Simple user interface based on LOGO's turtle graphics.
- 5 degrees of freedom plus grip; reach of 22.8 inches; working height to 35.4 inches; lift capacity of 1/2 lb.
- Computer interface 8 bit parallel (CENTRONICS).
- Works with Apple, Pet Acorn, Alan and most other computers. State make when ordering.

Details from

Cyber Robotics America
c/o JMB Electronics Inc.
19151 Parthenia Street E.
Northridge CA 91344



Circle 109 on inquiry card.

WE SELL WHAT YOU NEED... NOT JUST WHAT WE STOCK. PLUS... LOW PRICES. TECH SUPPORT AND RELIABILITY.

DISKETTES	3M	MEMOREX	
SSDD - 8 IN.	\$2.20/50	\$2.35/100	
SSDD - 8 IN.	\$2.70/50	\$3.05/100	
SSDD - 5 1/4 IN.	\$2.10/50	\$2.10/100	
OSDD - 5 1/4 IN.	\$2.85/50	\$2.85/100	
DSDD - 96 TPI 5 1/4 IN.	\$4.30/50	\$4.45/100	
PLASTIC STORAGE BOX WITH KEY FOR 100 DISKETTES ...\$24.00			
TAPES AND CARTRIDGES (3M)			
0C100A	\$16.20/1-10	\$14.10/10-	
0C300XL	\$24.75/1-10	\$21.50/10-	
2400 FT TAPE SEAL	\$15.00/10-50	\$14.95/50-	
BLACK WATCH			
2400 FT TAPE SEAL	\$16.25/10-50	\$15.80/50-	
WINCHESTER DRIVES			
10MB (FORMATTED)		\$535	
15MB (FORMATTED)		\$750	
20MB (FORMATTED)		\$980	
32MB (FORMATTED)		\$1155	
FLOPPY DRIVES			
IBM/RADIO SHACK S. SIDE	INTERNAL	EXTERNAL	
IBM/RADIO SHACK O. SIDE	\$195	\$255	
APPLE	\$245	\$335	
APPLE	—	\$210	
HARD DISK SUBSYSTEMS			
	5MB	10MB	15MB
APPLE	\$1250	\$1450	\$1650
IBM	\$1300	\$1500	\$1700



Met-Chem

Met-Chem International Corporation
2911 Dixwell Avenue, Hamden, Conn. 06518
Phone: (203) 248-3212 or 1-800-636-2436

Circle 230 on inquiry card.

ORDER NOW!
We've Got You One Better.

We have developed a better way—new, improved software packages for simple everyday use in your business. Save time, money, and frustration on daily tasks using our **EASY** and **TESTED** mailing list program and cash flow system for your general ledger.

Balance your books before you post with CFS-1

Eliminate mailing costly duplicates with MS-2

\$190 **\$249**
Call
713-921-3414

Business Support Systems
2328 Telephone Rd. • Houston, TX 77023

Circle 49 on inquiry card.

LOOK!

SYSTEMS	
CompuPro 816A (A&T)	\$4308
Eagle PC2	2738
Columbia PC	CALL
Corona PC	CALL
LETTER QUALITY PRINTERS	
Dalsywriter 2000 48K	1053
NEC 3510	1455
Juki	CALL
DOT MATRIX PRINTERS	
Epsons FX, MX, RX	CALL
Okidata 92	442
Gemini 10x, 15x	CALL
Terminals, modems, software and more available	CALL

14 W. 3rd St., #5
Santa Rosa
CA 95401



Prices Subject To Change Without Notice

(707) 575-9472

VISA • MC • LEASING

Circle 380 on inquiry card.

wabash®

Flexible Diskettes

6 Year Warranty - 100% Certified
DELIVERED PRICES

5 1/4" \$160 each SINGLE SIDE SINGLE DENSITY 16 TPI WHUB RING Packed 10 per Soft Pack	BULK SSSD \$140 each 100/Case White Envelope WHUB RING
5 1/4" \$189 each DOUBLE SIDE SINGLE DENSITY 16 TPI WHUB RING Packed 10 per Soft Pack	BULK SSSD \$170 each 100/Case White Envelope WHUB RING
5 1/4" \$247 each DOUBLE SIDE DOUBLE DENSITY 16 TPI WHUB RING Packed 10 per Soft Pack	BULK DSSD \$225 each 100/Case White Envelope WHUB RING

Free shipping in continental USA. Call for quantity discounts. We accept money orders, certified checks, VISA and MasterCard. Personal checks accepted, but take two weeks to clear bank N.D. add 4%.



Software Services™

1326 - 25th St. S., Suite H
Fargo, ND 58103
1-800-634-2248

Circle 329 on inquiry card.



PERSONAL SERVICE/FRIENDLY ADVICE
DISCOUNT PRICES

COMPUTERS	Retail	CWE
DECmate II W/basic WP.	\$3,745	\$3,180
DEC Rainbow 100	\$3,495	\$2,975
NEC Portable W/14 applications Software Programs. Use alone or as an IBM Peripheral.	\$799	\$750
SPECIAL DSM ZEUS 4-2 CPU.....	\$5,595	\$4,899
PRINTERS		
Daisywriter 2,000 - 48K w/buffer	\$1,495	\$999
Panasonic 1090.....	\$499	less 25%
TERMINALS		
Televideo 925.....	\$995	\$895
950	\$1,195	\$899
WYSE 50 (emulates TV1910)	\$695	\$549
MODEMS		
HAYES: SmartModem 1200B	\$599	\$439
SmartModem 1200	\$699	\$484
MicroModem 11e w/Smartcom	\$329	\$239

Please, call for our surprising low prices! We carry an extensive line of all computer related products and brands not mentioned above. Prices subject to change without notice.

CORPORATE ACCOUNTS WELCOME
Circuits World Electronics Corp.

156 Depot Road, Huntington Station, N.Y. 11748

CALL COLLECT (516) 423-9100

MasterCharge, Visa, Personal Checks Accepted



Circle 65 on inquiry card.

GREAT DISKETTES

Super low prices
SYNCOM

The low priced, high quality diskette with a LIFETIME WARRANTY. Packed in polybags of 10 with Tyvek envelopes, labels and reinforced hubs. One of the best buys we've seen.

\$139 **\$185**
QTY. 20 ea. 5 1/4" SSDD QTY. 20

OTHER GREAT VALUES:

DISKETTE 70 - Holds 70 5 1/4" diskettes in dust free safety \$4.95 ea. \$3.00 Shpg

DISK CADDIES - Flip up style holds 10 5 1/4" diskettes. \$1.85 ea. \$2.00 Shpg

\$13.00 Bonus Offer!

For the lowest priced, highest quality diskettes, storage cases, printer ribbons and paper products, send for our catalog. FREE with your order. \$1.00 otherwise. BONUS! Every catalog includes \$15.00 worth of bonus coupons.

Shipping: 5 1/4" DISKETTES - Add \$3.00 per 100 or fraction thereof. OTHER ITEMS: Shipping charges as shown in addition to diskette shipping charges. Payment: VISA or MC. C.O.D. orders, add \$3.00. Taxes: Illinois customers, please add 8%.

Nationwide: 1-800-621-6827

In Illinois: 1-312-944-2788

Minimum Order: \$35.00

WE WILL BEAT ANY NATIONALLY ADVERTISED PRICE!

DISK WORLD!

Suite 4806 • 30 East Huron Street • Chicago, Illinois 60611



Circle 380 on inquiry card.

**TOLL-FREE
ORDERING:
800-222-8686**

**FOR TECHNICAL SUPPORT/
SERVICE / IN ARIZONA:
602-282-6299**

CCT CUSTOM COMPUTER TECHNOLOGY

1 CRAFTSMAN COURT — BOX 4160 — SEDONA, ARIZONA 86340

Purchase your Hardware and Software directly from an OEM/Systems Integrator. Take advantage of our buying power! We stock a full line of Board Level Components, Software, and Peripherals. Call for your needs. We'll give you the Lowest Prices, and the Technical Support and Know-How we are quickly becoming well-known for. Satisfied Customers Nationwide! The Nations's Custom Systems House for Business, Education and Science. Call for a system quote.

• FOREMOST QUALITY • ADVANCED SUPPORT • REASONABLE COST •

OF PRIME INTEREST

Our prime interest at CCT is **service and support**. We build and sell hundreds of systems per year to the serious computer market. We rigidly adhere to our strict policy of reliable machines, and reliable people behind them. We feel the CompuPro product line to be the state-of-the-art of the computer industry.

THE CCT EXCLUSIVE WARRANTY

With any system we build, we provide, in writing, an unconditional 12 month **direct** warranty on the entire system, including mainframe, boards, drives, power supplies, cabling and peripherals! We offer guaranteed 24 hour in-house repair and/or replacement with just a toll-free phone call. We can offer this, since we are so sure of our level of quality and reliability. It's great to know that in the event of a problem, you're not out of business waiting on service turnaround. Wedeliver!

Our various OEM contracts with all the manufacturers of the components we integrate, allow us this unprecedented flexibility. No factory O.K.'s necessary — just get it running — **NOW!**

- Wyse 100 terminal - 14" Green . . . \$699
 - WS Prom Option - Installed \$50
 - Mitsubishi 8" DSDD drives, full or half height. Set-up FREE OF CHARGE . . \$449
 - Okidata 82 \$389 / 83 . . . \$619
 - 84 . . . \$1029 / 92 . . . \$469 / 93 . . \$779
 - Ashton-Tate dBASE II 8" or MD . . . \$299
 - Supercalc 86 - for CP/M 86 & MP/M . \$99
 - Visual Terminals in stock Call
 - Lear Siegler ADM 20 \$499
 - Freedom 50 \$499/100-\$549
 - Hays Modem-\$259 • Diablo 620-\$1029
- We carry a full line of software in all available formats at discount prices.

TECH TIP CORNER

dBASE II USERS - CUSTOM TERMINAL KEYS! Implement your arrow keys; emulate Wordstar edit commands - send an SASE with \$2.00 - (ATTN: TTC). Tell us your arrow key codes. We'll return easy, detailed instructions to change almost anything. It's beautiful — Pat...



**PROFESSIONAL LEVEL BUSINESS SYSTEMS
STATE-OF-THE-ART QUALITY, PERFORMANCE, RELIABILITY**

CCT ANNOUNCES: OUR OWN IN-HOUSE ENGINEERED CUSTOM COMPUPRO SYSTEMS

CCT-1 — ENTRY LEVEL S-100 BUSINESS SYSTEM

- Enclosure 2-Desk-20 Slot Mainframe •
- CPU 8085/88 - 6Mhz 8085/8Mhz 8088 •
- Disk 1 - DMA Floppy Disk Controller •
- RAM 16 - 64K Static RAM - 12 Mhz •
- Interfacer 4 - 3 Serial/2 Parallel I/O •
- CCT 2.4 Dual 8" Mitsubishi DSDD Drive System - 2.4 Megabytes •
- CP/M 80 - 2.2 LD/M - CCT Modified •
- All Cabling, Complete CCT Assembly, Testing, and Minimum 20 Hour Burn-in •

**INTRODUCTORY PRICE:
\$3,399**

RUNS ALL STANDARD 8" CP/M SOFTWARE - INCLUDES OUR EXCLUSIVE 12 MONTH DIRECT WARRANTY

CP/M MP/M NOTE: Each copy we furnish is CCT modified for the target system. M-Drive/H and hard disk drivers are furnished, and the BIOS optimized for the fastest disk step rate, as well as terminal and printer compatibility.

★ ★ CCT-2 — THE FASTEST MICROCOMPUTER IN THE WORLD!! ★ ★

- Enclosure 2-Desk • 90K Baud Parallel Terminal Board • 78 Key Professional Ergonomic Keyboard
- CPU 8086 - 10Mhz • Disk 1 • 512K M-Drive/H • High Resolution Amber Monitor. **INTRODUCTORY PRICE:**
- 128K - 16 Bit Memory • CP/M 86 - CCT Modified • CCT 2.4 Dual DSDD Drive System **\$6,799**
- Interfacer 3-8 • SS1 • All Cabling, Complete CCT Assembly, Testing, & Minimum 20 Hour Burn-in

RUNS ALL CP/M 86 SOFTWARE - ULTRA FAST - INCLUDES 12 MONTH DIRECT WARRANTY

★ ★ CCT-3 — 10Mhz 68K System similar to above, with 128K RAM \$6,699 ★ ★

We are the largest in the custom configuration of complete state-of-the-art S-100 systems, at package pricing, with integration, burn-in and programming. We custom build CompuPro systems / hard disk systems for business applications. Call for CompuPro literature, CCT system configuration data and technical information. We can save you money!

★ SUPER PRICES ★ COMPUPRO COMPONENTS ★ IN STOCK ★

- SYSTEM SPECIALS — ALL CCT A&T, BURNED IN:** 816A-\$4299 816B-\$4999 816C-\$6499
- M-Drive CP/M - Blowout-\$39 • Disk 1w/CP/M-\$449 • M-Drive/H-512K-\$1149
 - CPU 8085/88-\$319 • CPU 8086/87-\$579/10Mhz-\$659 • CPU 68K-\$519/10Mhz-\$639 • CPU-Z-\$249
 - CPU 286-\$1249/10Mhz-\$1359 • Disk 1-\$369 • Disk 2-\$599 • Disk 3-\$599
 - RAM 17 (12Mhz)-\$329 • RAM 16 (12Mhz)-\$359 • RAM 21 (128K)-\$779 • RAM 22 (256K)-\$1399
 - Interfacer 1-\$229 • Interfacer 2-\$249 • Interfacer 3-5-\$399/3-8-\$459 • Interfacer 4-\$349
 - System Support 1-\$299 • Enclosure 2-Desk-\$599/Rack-\$649 • 20 Slot Motherboard-\$210
 - CP/M 80-\$99 • CP/M 86-\$150 • MP/M 8-16-\$699 • CP/M 68K-\$279 • UNIX - SOON
 - 86 Upgrade Kit: Consists of CP/M 86, 64K Ram, System Support 1, Cable - \$749
- Call for CSC Boards — New Releases — Operating System Mods/Updates

★ PRICE BREAKTHROUGH ★

Hard Disk Subsystems

CCT/Fujitsu 5 1/4" subsystem, includes Disk 3, custom enclosure & power supply, all cabling, A&T, formatted, burned-in. Ready for any CompuPro or similar S-100 system: **CCT-5 (5.5 Meg)-\$1599**
CCT-10 (11 Meg)-\$1899 / CCT-20 (22 Meg)-\$2299

? ? HARD DISK DECISIONS ? ?

Hard/Floppy Combinations

An exclusive CCT innovation. CCT/Fujitsu/Mitsubishi ultra-system: 5 1/4" hard disk next to a 1.2 Meg. DSDD 8" floppy. Includes Disk 3, custom horizontal enclosure and power supply, all cabling, A&T, formatted, burned-in. Will stand alone in any CompuPro system:
CCT-5/1-\$2099 CCT-10/1-\$2399 CCT-20/1-\$2799

★ NEW DISK 3/5 1/4" HD SYSTEMS ★

2.4 Megabyte Floppy Systems

CCT/Mitsubishi 2.4 Megabyte Dual DSDD 8" system. Includes custom horizontal enclosure, all cabling, A&T, burned-in. This is the fastest system available: **\$1149**
With stacked half-height drives: **\$1175**

All Systems Carry Our Exclusive 12 Month Warranty.

Prices & availability subject to change. All products new, and carry full manufacturer's warranties. Call for catalog. Free technical help to anyone. We can configure boards & software for your system. Plug-in and go. Arizona Residents add sales tax. **CompuPro®** Trademark — W.J. Godbout; **CP/M® MP/M®** Trademarks — Digital Research

WHOLESALE DISKETTES

5 1/4" Soft Sector	10	100
SS/SD	17.50	15.95/10
SS/DD	18.50	16.95/10
DS/DD	23.95	19.95/10

7 Year Gaurantee!

\$3.00 Shipping & Handling in Continental USA

RIBBONS

Ribbon Type	3	9	12
Apple DMP	5.11 ea.	5.41 ea.	4.11 ea.
C. Itoh Prowriter (all models)	5.11 ea.	5.41 ea.	4.11 ea.
Diablo Hytype II Multi-Strike	5.11 ea.	4.99 ea.	3.99 ea.
Epson/IBM FX/RX/MX-80	5.11 ea.	4.99 ea.	4.11 ea.
Epson/IBM FX/RX/MX-100	9.11 ea.	8.99 ea.	6.99 ea.
Gemini 10/10X/15/15X	2.11 ea.	2.11 ea.	2.11 ea.
NEC 3500 Multi-Strike	7.11 ea.	6.99 ea.	5.11 ea.
Okidata 80/82/83/92/93	2.11 ea.	2.11 ea.	2.11 ea.
Other Ribbons	CALL	CALL	CALL
Ship. + Hand. in Cont. USA	3.00	Free	Free

Order Toll Free 1-(800) 821-5339

or Call 1-(801) 298-0872

or Rush Check or Money Order To:

C. R. E. Wholesale Products

P. O. Box 361 N.S.L., Ut. 84054

Circle 103 on inquiry card.

WHOLESALE MODEMS

U. S. Robotics 1200/300 Baud

Password	359.00
IBM PC Modem Card	359.00
with 64K Ram	559.00
with 256K Ram	925.00
S100 Modem Card	359.00
Auto Dial	469.00

PRINTERS

Riteman (120 CPS 10" PAR)	299.00
(Epson, Gemini Compatible, 1 Year Warranty)	
Silver Reed	
EXP 500P (16 CPS Daisy Wheel 10" PAR)	469.00
EXP 500S (16 CPS Daisy Wheel 10" SER)	509.00
Daisy Writer	
2000-48K Buffer (20-40 CPS/PAR)	1099.00

Microline 82A (Ser/Par 120 CPS 10")	349.00
Other Printers	CALL
(Free shipping & handling in Continental USA)	

Order Toll Free 1-(800) 821-5339

or Call 1-(801) 298-0872

or Rush Check or Money Order To:

C. R. E. Wholesale Products

P. O. Box 361 N.S.L., Ut. 84054

Circle 104 on inquiry card.

*IBM PC Compatible



F. PROMS - CALL! Lowest Prices Anywhere

*4164-150P	\$520
*4164-200/250	505/469
4116-200	149
*4164-120	549
6116-P3	499

Disk Drives: (F.O.B. Tampa)

*TM-100-2	\$ 22424
-4	29983
*TM- 55-2	22386
*10 mb Win	1,38547

(MS/DOS 2.0/IBM plug in & go)
Add \$2.95 shipping to all orders 2.6% for credit card orders
OEM • Quantity discounts available • P.O.s on approval • C O D OK • Credit cards • FL residents add 5% tax • All new, no surplus, no seconds (Prices subject to change)

4920 Cypress St., Tampa, FL 33607
In FL, and for info., call 813-875-0299

FOR ORDERS ONLY, 800-237-8910

8 AM-8 PM EST

Circle 281 on inquiry card.

AP-PEEL®



Price
\$40.00 U.S.

NEW CONTROL FOR YOUR APPLE 2+*

AP-PEEL - Reprograms the reset key to give you complete control over operation.

AP-PEEL

- Protects disks from possible damage on start-up.
- Reset allows choice of entry to one of 5 modes of operation.
- Exit 'locked-in' programs to view any memory on screen.
- 'Page' through memory to look for key words in games.
- Make changes in memory at any time.
- Eliminates use of power switch to re-boot on 'locked-in' programs.
- Installed or removed in seconds.

A MUST FOR APPLE 2+ OWNERS

MGJ Co. Check or Money Order
88 Wellington Ave. Allow 30day delivery
VICTORIA, B.C. Allowing 30day delivery
CANADA V8W 4H6 *TM Apple Computer

Circle 234 on inquiry card.

SUPER LOW PRICES On 3M Diskettes With Lifetime Warranty!



Now, you can save more than ever on 3M diskettes! Packed in factory sealed cartons of 10 with Tyvel envelopes, labels and (on 5 1/4") reinforced hubs.

\$188 ea. 5 1/4" SSDD \$263 ea. 5 1/4" DSDD

5 1/4" SSDD	\$2.89 ea.	8" SSDD	\$2.02 ea.
5 1/4" DSDD	\$3.95 ea.	8" DSDD	\$2.49 ea.
		8" DSDD	\$3.25 ea.

Add 5 cents per diskette for quantities less than 50.
*Indicates Quantity 200 in these items.

OTHER GREAT VALUES:

DISKETTE 70—Holds 70 5 1/4" diskettes in dust free safety \$14.95 ea. + \$3.00 Shpg.

DISK CA DOIES—Flip up style holds 10 5 1/4" diskettes \$1.65 ea. + .20 Shpg.

\$18.00 Bonus Offer!

For the lowest priced highest quality diskettes, storage cases, printer ribbons and paper products, send for our catalog. FREE with your order; \$1.00 otherwise. BONUS! Every catalog includes \$15.00 worth of bonus coupons.

Shipping: 5 1/4" DISKETTES—Add \$3.00 per 100 diskettes or fraction thereof. 8" DISKETTES—Add \$4.00 per 100 diskettes or fraction thereof. OTHER ITEMS: Add shipping charges as shown in addition to diskette shipping charges. Payment: VISA or MC. COD orders add \$3.00. Taxes: Illinois customers, please add 8%.

Nationwide: 1-800-621-6827

In Illinois: 1-312-944-2788

Minimum Order: \$35.00

WE WILL BEAT ANY NATIONALLY ADVERTISED PRICE!

DISK WORLD!

Suite 4806 • 30 East Huron Street • Chicago, Illinois 60611

Authorized Distributor Information Processing Products 3M

Circle 52 on inquiry card.

"YELLOW PAGES" of the COMPUTER INDUSTRY MARKETPLACE

- Unique—Covers entire industry
- Over 3300 companies listed under several hundred categories:
 - Hardware—Software
 - Services (DP's, leasing consultants, etc.)—Retailers
 - Distributors—OEM's
 - Furniture—Supplies
- Answers a phone call away
- Price \$14.95 (1984-85 ed)
- Free listings—available to companies and individuals

WRITE: C.I.M. Dept. H.
9371 Kramer Ave. Unit I
Westminster, CA 92683
CALL: (714) 892-4488 ext 8

Circle 123 on inquiry card.

Bytcom® 212AD

now available at

TCI

Turnkey
Communications Inc.

1607-116th Ave NE #101

Bellevue Wash 98004

206-451-4370

\$439

Circle 52 on inquiry card.

SYMBOLIC DEBUGGING for IBM PC-DOS

The Mylstar Symbolic Debugging Program enhances your IBM PC-DOS Debug Program to make your work easier and simpler. Employing the same command structure, the Mylstar Program lets you use:

- *Symbol Names
- *Mathematic Expressions
- *Batch Files
- *On-Line Help
- *Multi-Command Macros
- *Loop Structures

Shorten your debugging process and work time. Designed for PC-DOS 1.0, 128K RAM minimum. Send \$125 check or money order to: Dept. 115B Mylstar Electronics.

**MYLSTAR
ELECTRONICS
INC.**
168 West Lake Street
Northlake, Illinois 60164
Tel (312) 563-7400
Telex 72-6463
A Columbia Pictures Industries Company

Dealer
Inquiries
Invited

Circle 259 on inquiry card.

Computer Components Unlimited's ST. PATRICK'S DAY SPECIALS

SAVE
20% to 40%
OFF
LIST



USI Monitors

- Any USI Monitor

\$119 2 or more **\$110** ea

CDC Disk Drive

- Model No. 9409T
- 5 1/4" Quad Density

\$159 2 for **\$300**

Hayes Micro Computer

- Smart Modem 1200 Baud
- Top of the Line

\$489 2 for **\$479**

TG Products

- Select-A-Port
- Your Connect-All

\$31

Sanyo Computer

- Model No.: MBC555
- 2 Slimline Disk Drives, 128K
- Color Composite & RGB Interface
- Complete Software Package

\$1249

Okidata

- Model No. 82A
- 120 cps
- Parallel & Serial Interface

\$299

Siemens Drive

- Model FDD100-8
- 8" Sgl Side/Dbf Density

\$149 2 for **\$280**

Quentin Research

- Thinline 5 1/4" Drive
- Apple Compatible
- Introductory Offer

\$189 2 for **\$360**

Tandon

- Model No. TM100-2
- 320K — Dbf/Dbf
- IBM Drive

\$219 2 for **\$420**

Rana Systems

- Elite I Disk Drive
- Apple Compatible
- 300% Faster, Tract-to-Track

\$249 2 for **\$400**

Micro Tek

- Dumping GX
- Grappler Compatible
- Graphics Interface for Apple

\$99

Dynax

- Model No. DX15
- 3K Buffer
- Letter Quality

\$469

Amdek

- Color 1 + Monitor
- 12" Color Composite

\$299

Astar

- RF Modulator

\$15

MORE



**Computer
Components
Unlimited**

A California Corporation



800-847-1718

OUTSIDE CALIFORNIA

RETAIL STORE:
11976 Aviation Blvd.
Inglewood, CA 90304

MAIL ORDER:
P.O. Box 1936
Hawthorne, CA 90250

**This Ad Supersedes All Others
(213) 643-5188**

All merchandise new. We accept MC, Visa, Wire Transfer, COD, Call, Certified Check, P.O.s from qualified firms, APO accepted. Shipping Minimum \$4.50 first 5 pounds. Tax: California Res. Only add 6% sales tax.

Prices Subject to Change

**Mon.—Fri. 7 a.m. to 6 p.m.
Sat. & Sun. 10 a.m. to 5 p.m.**

Circle 395 on inquiry card.

St. Patrick's Day Pot-O-Gold

Lowest Prices in this Magazine



MONITORS

Amdek	
Color I + Composite Video	\$ 299
Color II + RGB Video	419
300G, 12" Green	139
300A, 12" Amber	149
310A, Monochrome Amber	179
BMC	
12 AUW, 80 column	\$ 84
12 EUN Hi-Res Green	109
9191 Color New Version	239
IBM	
Monochrome Hi Res Green	\$ 319
RGB Color	699
Princeton Graphics	
PGS HX-12, IBM Copy	\$ 489
PGSSR-12, Hi-Res Color	649
PGS MAX-12, 12" Monochrome	199
USI	
PI 1, 9" Green, Hi Res, 20MHz	\$ 119
PI 2, 12" Green, Hi Res, 20MHz	119
PI 3, 12" Amber, Hi Res, 20MHz	119
PI 4, 9" Amber, Hi Rex, 20MHz	119
Zenith	
ZVM122, Hi-Res Green	\$ 109
ZVM123, Hi-Res Amber	109



PRINTERS

Dynax	
DX15, Letter Quality	\$ 469
DX25	Call
Epson	
RX-80 (120 cps)	\$ Call
RX-80FT (120 cps) Friction & Tractor	Call
FX-80 (160 cps)	Call
FX-100 (160 cps) 15" Carriage	Call
NEC	
8023A-C New Version (120 cps)	\$ 399
8025 (15" Carriage)	699
Okidata	
82A (120 cps) Par & Ser inter.	\$ 299
83A (15" Carriage)	569
84P (200 cps) Friction & Tractor	999
New Series Okidata	
92P (160 cps)	\$ 429
93P (15" Carriage)	739
Star Micronics	
Gemini 10X (120 cps)	\$ 299
Gemini 15X (120 cps) 15" Carriage	399
Power type (18 cps) Ltr. qual.	479

COMPUTER SYSTEMS

Apple	
IIe Starter System	\$1326
CPU Only	999
Mcintosh	Call
Compaq	
Portable (PC Compatible)	\$2795
Franklin	
Ace 1000, 64K	\$ 799
Ace 1200 OMS	1699
Kaypro	
Kaypro II	\$1450
Kaypro 4	1695
Kaypro 10	2495
IBM	
PC64K, 2-Drives	\$2295
XT Hard Disk Drive, 128K	4695
SANYO	
MBC-550 PC Compatible	\$ 849
MBC-555 2-Drives, more software	1249

5 1/4" DISKETTES

CCU	
Sgl/Dbl reinforced hub	\$18
100 for 150	
Dbl/Dbl reinforced hub	22
100 for 200	
Not Bulk Packed	
Dysan	
Sgl/Dbl	\$33
100 for 300	
Dbl/Dbl	39
100 for 370	
Maxell	
MD1 Sgl/Dbl	\$25
100 for 235	
MD2 Dbl/Dbl	38
100 for 360	
Memorex	
Sgl/Dbl	\$26
100 for 230	
Dbl/Dbl	35
100 for 320	
Verbatim	
Sgl/Dbl	\$26
100 for 240	
Dbl/Dbl	36
100 for 340	
Wabash	
Sgl/Dbl	\$22
100 for 200	
Dbl/Dbl	29
100 for 270	

8" DISKETTES

Dysan	
Sgl/Sgl	\$34
100 for 320	
Dbl/Dbl	53
100 for 480	
Maxell	
Sgl/Dbl	\$44
100 for 380	
Dbl/Dbl	50
100 for 469	
Memorex	
Sgl/Sgl	\$27
100 for 250	
Dbl/Dbl	38
100 for 350	
Verbatim	
Sgl/Sgl	\$30
100 for 280	
Dbl/Dbl	40
100 for 360	
Wabash	
Sgl/Sgl	\$24
100 for 220	
Dbl/Dbl	34
100 for 320	

DISK ACCESSORIES

Verbatim	
8" or 5 1/4" Head Cleaning Kit	\$ 11
Flip Tub	
5 1/4" Holds 50 disks, plexiglass	17
5 1/4" Holds 70 disks, plexiglass	21

APPLE DRIVES

Apple	
Disk 2	\$ 299
Disk 2 controller w/DOS 3.3	89
Micro Sci	
A-2 Fully compatible	\$ 209
Controller w/diagnostics	79
Quentin Research	
Applemate	\$ 209
Controller	75
Rana Systems	
Elite I	\$ 249
Elite I Dbl Sided	379
Elite III Quad Density	479
Controller, controls 4	85
Super 5	
Slimline	\$ 199
Controller	75

For the WIDEST VARIETY OF PERIPHERALS and the LOWEST PRICES in this Magazine

CALL 800-847-1718



Special Pricing from CCU and that's no blarney!!



DISK DRIVE CABINETS

5 1/4" Cabinets

Single Cab. w/ power supply	\$ 59
Dual Cab. w/ power supply	85
Dual Thinline Cab. w/ pwr. sup.	85

8" Cabinets

Single Cab. w/ fan & power supply	\$ 209
Dual Cab. w/ fan & power supply	259



5 1/4" DISK DRIVES

CDC

9409 dbi/dbi	\$ 229
9409T Quad Density	179

Panasonic

Slimeline 320K PC comp.	\$ 199
-------------------------	--------

Tandon

TM100-1, 160K	\$ 179
TM100-2, 320K	219
TM101-4 Quad Density	279

8" DISK DRIVES

Mitsubishi

2894 Dbl/Dbl	\$ 419
--------------	--------

Qume

DT8 Dbl/Dbl	\$
-------------	----

Shugart

801R Sgl/Dbl	\$ 359
851R Dbl/Dbl	479

Siemens

FDD 100-8 Sgl/Dbl	\$ 149
FDD 100-8 Sgl/Dbl	2 for 479

Tandon

TM848-1 Sgl/Dbl Thinline	\$ 299
TM848-2 Dbl/Dbl Thinline	399



PRINTER INTERFACES

Cables

IBM to Printer	\$ 25
Kaypro to Printer	25
RS232 Cables	19

Fourth Dimension

Card & Cable	\$ 49
--------------	-------

Microtek

Dumpling GX (Grappler Compatible)	\$ 99
Dumpling GX exp to 64K	149
Dumpling GX 16K w/16K exp to 64K	169
for each additional 16K	15

Okidata Options

Tractor for 82 & 92	\$ 59
Serial Interface	99

Orange Micro

Grappler +	\$ 119
Grappler + w/16K	179

Star or Epson

Epson Serial Interface	\$ 119
Star Serial Interface	59

Wesper Micro

Wizard Full Graphics Interface	\$ 89
--------------------------------	-------



MODEMS

Anchor

Mark VII 300 Baud	\$ 159
Mark XII, 1200 Baud	299

Hayes Micro Computer

Smart Modem 300 Baud	\$ 209
Smart Modem 1200 Baud	489
Smart Modem 1200B for PC	409
Micro Modem IIE	239

Novation

J-Cat	\$ 119
Apple Cat II	259

APPLE ADD ON'S

ALS

ZCard	\$ 119
CPM 3.0 Card	269

Apple

Disk II	\$ 269
Monitor II	99

Astar

RF Modulator	\$ 15
Fan w/Surge	39

Kensington

System Saver	\$ 69
--------------	-------

Koala

Graphics Tablet	\$ 99
-----------------	-------

Kraft

Joystick	\$ 49
----------	-------

Micro Max

Viewmax 80, 80 col. card	\$ 149
Viewmax 80E (F for IIE) 64K	139

Micro Soft

16K Card	\$ 69
Premium Soft Card IIE	379
Multiplan	189
Soft Card (Z80)	239

Micro Tek

Bam 16, 16K Memory	\$ 59
Serial Interface	99

TG

Joystick	\$ 44
Select-A-Port	31
Paddles	34

IBM ADD ON'S

Ast Research

Six Pack +	\$ 279
Mega +	279

IBM

Monochrome Adapter	\$ 319
Color Card	275

Plantronics

PC + w/Software	\$ 389
-----------------	--------

Quadram

Quad Color Card	\$ 219
Quad Link	499

64K Upgrade

64K of Memory	\$ 54
---------------	-------

USI Research

Paradise Systems multi-display card	\$ 399
-------------------------------------	--------

Sales Desk

(800) 847-1718 (213) 643-5188

Outside California Inside California

Customer Service & Technical

(213) 643-5191

All merchandise new. We accept MC, Visa, Wire Transfer, COD Call, Certified Check, P.O.'s from qualified firms, APO accepted. Shipping: Minimum \$4.50 first 5 pounds. Tax: California Res. Only add 6 1/2% sales tax.

Prices Subject to Change

Computer Components Unlimited

A California Corporation

RETAIL STORE:

11976 Aviation Blvd.
Inglewood, CA 90304

MAIL ORDER:

P.O. Box 1936
Hawthorne, CA 90250

Mon.—Fri. 7 a.m. to 6 p.m.
Sat. & Sun. 10 a.m. to 5 p.m.

This Ad Supersedes All Others
No Surcharge for Credit Cards

IBM PC =

1. DEC VT100?
2. DEC VT125?
3. DASHER D400?

SMARTERM™ DOES IT!

- full emulation (to PC limits)
- powerful file transfer
- full printer support
- multiple setups
- "smart" softkeys
- 132 column support available
- online help screens
- 30-day return policy

Available through your local software dealer or directly from:



Persoft Inc.

2740 Ski Lane
Madison, WI 53713
(608) 273-6000

Software for Professionals... by Professionals.

SMARTERM is a trademark of Persoft, Inc. • DEC & VT are trademarks of Digital Equipment Corp. • Dasher is a trademark of Data General Corp. • PC is a trademark of International Business Machines Inc.

Circle 285 on inquiry card.

5¼" DISK DRIVES

- ★ **QUME 142A**
Half Height, Double Sided, 40 TRK/Side **\$229**
Free Shipping
- ★ **TANDON: TM 100-2**
Double Sided, 40 TRK/Side **\$235**
Free Shipping
- ★ **CDC: 9409**
Double Sided, 40 TRK/Side **\$235**
Free Shipping
- ★ **SHUGART: SA 455**
Half Height, Double Sided, 40 TRK/Side **\$229**
Free Shipping

Order Toll Free:

1-800-531-5475 (Outside Of Texas)

(512) 250-1489 (In Texas)

Texas Residents Add 5% Sales Tax.

CompuAdd Corp

13010 Research Blvd., Suite 101
Austin, Texas 78750

Circle 77 on inquiry card.

RS-232 TO CURRENT LOOP CONVERTER

NEW!



Uses high speed optical isolators in both Transmit and Receive Data lines. An optional power supply is available to power the Current Loop. Order Now! Only \$49.95. Optional Loop Supply—\$14.95. Add \$1.75 for postage and handling (IL Res. add 6% sales tax). We accept MC, VISA. FREE: expanded illustrated catalog of interface and problem equipment. Phone: 815-539-5827.

B&B electronics™
Box 68B, MENDOTA, IL 61342

Circle 38 on inquiry card.

CONVERSE WITH YOUR COMPUTER

AT LAST! A FULL IMPLEMENTATION of the original ELIZA program is now available to run on your microcomputer!

Created at MIT in 1966, ELIZA has become the world's most celebrated artificial intelligence demonstration program. ELIZA is a non-drextive psychotherapist who analyzes each statement as you type it, and then responds with her own comment or question—and her remarks are often amazingly appropriate!

Designed to run on a large mainframe, ELIZA has never before been available to personal computer users except in greatly stripped down versions lacking the sophistication which made the original program so fascinating.

Now, our new microcomputer version possessing the FULL power and range of expression of the original is being offered at the introductory price of only \$25. And if you want to find out how she does it for teach her to do more, we will include the complete SOURCE PROGRAM for only \$20 additional!

Order your copy of ELIZA today and you'll never again wonder how to respond when you hear someone say, "Okay, let's see what this computer of yours can actually do!"

ELIZA IS AVAILABLE IN THE FOLLOWING FORMATS:

- 1 5¼ inch disk for the 48K Apple II, II Plus, IIe or III \$25 for Protected Version—\$45 for Applesoft Source Version
- 2 5¼ inch disk for the 64K IBM Personal Computer \$25 for Protected Version—\$45 for IBM Disk BASIC Source Version
- 3 5¼ inch disk or tape cassette for the Commodore 64 (specify which) \$25 for Protected Version—\$45 for Commodore BASIC Source Version
- 4 Standard 8 inch single density disk for all CP/M based computers \$25 for ELIZA.COM—\$45 with Microsoft BASIC-80 Source
- 5 5¼ inch disk for most CP/M based computers (specify computer) \$25 for ELIZA.COM—\$45 with Microsoft BASIC-80 Source

Please add \$2.00 shipping and handling to all orders (California residents please add 6% sales tax)

ARTIFICIAL INTELLIGENCE RESEARCH GROUP



921 North La Jolla Avenue, Dept B
Los Angeles, CA 90045
(213) 656-7366 (213) 654-2214
MC, VISA and checks accepted



Circle 33 on inquiry card.

Disks 'n Things

★ Dealer Inquiries Welcomed

maxell
Dysan
wabash

- ★ Factory Warranty
- ★ Finest Quality
- ★ Fast Delivery

SUPER LOW PRICES

CALL 213-706-8602

- Credit For Direct Dial Call With \$30 Order
- We Pay Shipping—MC/VISA—COD Costs
- 2% Discount For Cash
- Applicable to USA Customers Only

Disks 'n Things

5505 Sotwind Way
Agoura Hills, CA 91301

Price List Available

Circle 127 on inquiry card.

Maxell Floppy Disks

The Mini-Disks with maximum quality.



Dealer inquiries invited. C.O.D. accepted. Call FREE (800) 235-4137.

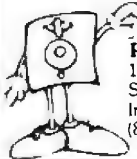

PACIFIC EXCHANGES
100 Foothill Blvd., San Luis
San Luis Obispo, CA 93401.
In Cal. call (800) 592-5935 or
(805) 543-1037.

Circle 277 on inquiry card.

MEMORY FOR IBM PC-XT



- 64K — \$159.95
- 320K — \$319.95
- 384K — \$359.95
- 512K — \$439.95

- Uses 64K Drams
- Gold Fingers — Solder Mask
- Addressing On Any 64K Block
- No Parity

Add 6% sales tax in California. Add \$2.00 for shipping. Add \$2.00 for C.O.D. Send check or money order to:

In Sync

5738 Commerce Blvd.
Rohnert Park, CA 94928
(707) 585-2793

Circle 184 on inquiry card.

6800 Family Software



Software for 6800/01/05/09 microprocessors.
SOFTWARE: C compiler, Pascal, multitasking DOS, macro-assemblers, FORTRAN, 16K BASIC
FIRMWARE: Fantom monitor/debugger, math library, 4K BASIC
CROSS-SOFTWARE: Assemblers, PL/W Compilers, Linker, Simulators

WINTERK

Winterk Corp
1801 South Street
Lafayette, IN 47904
317-742-8428

Circle 383 on inquiry card.

VISIT ONE OF OUR 6 RETAIL SHOWROOMS!

SAN FERNANDO VALLEY

21800 Ventura Blvd
Woodland Hills, Calif

ORANGE COUNTY

3313 S. Bristol St
Santa Ana, Calif

SAN DIEGO

4344 Convoy Street
Kearny Mesa, Calif

SUNNYVALE

1291 W. El Camino Real
Sunnyvale, Calif

DALLAS

4950 Beltline Road
Addison, Texas

LOS ANGELES

18503 Hawthorne Blvd.
Torrance, Calif

*Pricing May be slightly higher in our retail showrooms—Please call for local pricing.

SIX PAK PLUS—AST

Up to 384K RAM. Clock calendar with battery back-up. Serial port. Parallel printer port. optional game port. Super drive and super spool software included FREE!

64K, C,S,P List Price \$395.00 _____ \$269.95
256K, C,S,P List Price \$665.00 _____ \$489.95
For Game Port Option Add List Price \$50.00 - \$39.95

MEGA PLUS—AST

2K RAM, clock calendar with battery back-up. ports, parallel printer port, game port. Super drive and superspool software included FREE!

64K, C,S List Price \$395.00 _____ \$269.95
256K, C, 1 serial List Price \$665.00 _____ \$429.95
512K, C, 1 serial List Price 1059.00 _____ \$795.00
Second serial port option List Price \$50.00 _____ \$39.95
Printer port option List Price \$50.00 _____ \$39.95
Game port option List Price \$50.00 _____ \$39.95
Each additional 64K, Add List Price \$89.95 _____ \$44.95

COMBO PLUS—AST

Up to 256K RAM. Clock with battery back-up. Serial port. Parallel port. superspool software included FREE!

64K, C,S,P List Price \$395.00 _____ \$269.95
256K, C,S,P List Price \$695.00 _____ \$419.95

I/O PLUS—AST

Up to 2 serial ports, parallel printer port, clock calendar with battery back-up. Superdrive and superspool software included FREE!

Clock & 1 serial port List Price \$165.00 _____ \$129.95
Printer port option List Price \$50.00 _____ \$39.95
Second serial port option List Price \$50.00 _____ \$39.95
Game port option List Price \$50.00 _____ \$39.95

QUADBOARD I—Quadram

Up to 384K RAM, serial port, parallel port, clock calendar, RAM disk, and printer spooler software

Quadboard w/o RAM List Price \$295.00 _____ \$214.95
64K Quadboard List Price \$395.00 _____ \$275.95
256K Quadboard List Price \$595.00 _____ \$399.95
384K Quadboard List Price \$795.00 _____ \$595.00

QUADBOARD II—Quadram

Two serial ports, clock/calendar, memory expansion, and Quadmaster software

Quadboard II, 64K List Price \$395.00 _____ \$275.00
Quadboard II, 256K List Price \$595.00 _____ \$399.95

QUADLINK—Quadram

Allows IBM PC to run Apple software, includes interface card and software to allow your IBM PC to run both Apple DOS and PC DOS

Quadlink List Price \$680.00 _____ \$485.00

SYSTEM CARD—Microsoft

From the authors of PC-DOS—up to 256K RAM, serial port, parallel printer port, clock calendar, plus RAM drive disk emulation software, print spooler, time utilities, and terminal emulation software. DOS 1.1 or 2.0 compatible

64K system card List Price \$395.00 _____ \$279.95
256K system card List Price \$625.00 _____ \$429.95

DISKETTES For IBM PC

High quality double-sided, double-density diskettes, certified to be absolutely error free. Box of ten, warranted for one year

Box of 10 w/FREE! plastic case List Price \$39.95 _____ \$24.95
Bulk Pack 100 diskettes w/o plastic box List Price \$350.00 _____ \$199.95
Verbatim Datalife List Price \$49.95 _____ \$34.95

HI-RES COLOR MONITORS

Only the best: Princeton HX-12 or Quadchrome. 690 x 480 resolution, 16 brilliant colors, special .31mm dot pitch tube, includes FREE! cable

Princeton Graphics HX-12 List Price \$695.00 _____ \$529.95
Quadram Quadchrome List Price \$795.00 _____ \$549.95

AMDEK MONITORS

Full line of high quality monochrome and color video monitors

Video 310 Amber (IBM) List Price \$230.00 _____ \$179.95
Color II (RGB) List Price \$529.00 _____ \$429.95
Color III (RGB) List Price \$449.00 _____ \$399.95
Color IV (Analog RGB) List Price \$995.00 _____ \$775.00

HERCULES GRAPHIC CARD

Two pages of ultra-high resolution text and graphics 720 x 348, compatible with Lotus 123, Visicalc, dBASE II, etc. Includes parallel printer port

Hercules graphic card List Price \$499.00 _____ \$359.95

QUADCOLOR I & QUADCOLOR II

Quadcolor I delivers standard IBM PC color and graphics, add Quadcolor II and hi-resolution (640 x 200) color graphics are possible

Quadcolor I (basic board) List Price \$295.00 _____ \$234.95
Quadcolor II (add on) List Price \$275.00 _____ \$229.95

HAYES SMARTMODEMS

300 and/or 1200 baud direct connect, auto answer-auto dial, pulse or touch tone, auto baud rate selection. 1200B is a plug-in board for IBM PC only and includes Smartcom II FREE!

1200B with Smartcom II List Price \$599.00 _____ \$399.95
Smartmodem 1200 List Price \$699.00 _____ \$475.00
Smartmodem 300 List Price \$289.00 _____ \$199.95
Smartcom II List Price \$149.00 _____ \$79.95

THE BEST SOFTWARE For IBM PC

We have taken the top rated programs and reduced the price for a super value!

LOTUS 1 2 3 Best spreadsheet
Lotus 1 2 3 (1A) List Price \$495.00 _____ \$329.95
dBASE II Best Data base
Ashton-Tate dBASE II List Price \$700.00 _____ \$429.95
CROSSTALK Best communications package
MicroStuff Crosstalk List Price \$195.00 _____ \$129.95

KEYTRONICS KEYBOARD

Similar to the IBM PC keyboard, but with all the keys in the right places!

Keytronics/IBM List Price \$299.95 _____ \$199.95

JADE IS AN AUTHORIZED DEALER FOR EPSON, OKIDATA, TOSHIBA, MANNESMAN-TALLY, C. ITOH, etc. CALL FOR BEST PRICES!

OKIDATA PRICES SLASHED!

Okidata's new plug-n-play ROMS for Oki 92 or Oki 93 printers are fully IBM PC compatible! 412 ASXII characters, full graphics, complete Epson emulation, and near-letter quality printing not available with Epson

Okidata 92 160 CPS List Price \$599.00 _____ \$459.95
Okidata 93 160 CPS List Price \$999.00 _____ \$799.95
Plug-n-play for 92 List Price \$59.95 _____ \$49.95
Plug-n-play for 93 List Price \$59.95 _____ \$49.95
IBM PC to Oki or Epson cable List Price \$54.95 _____ \$32.95

COMREX CR-II

Best buy in letter quality printers. NEW! from Comrex! Full feature letter quality printer, FREE! 5K buffer, logic seeking bi-directional printing, boldface proportional spacing, double-strike, backspace, underline, true superscript and subscript, drop-in daisy wheel cartridge

CR-II parallel List Price \$599.00 _____ \$495.00
CR-II serial List Price \$644.00 _____ \$589.95
Tractor option List Price \$140.00 _____ \$99.95
Cut sheet feeder List Price \$259.00 _____ \$189.95
Keyboard option List Price \$199.00 _____ \$179.95

64K RAM UPGRADE For IBM PC

High speed RAM upgrade kit with parity (error detection) and one year warranty

64K kit for IBM PC List Price \$89.95 _____ \$49.95

320K DISK DRIVES

Tandon TM-100-2 double-sided, double-density 320K disk drive. Original equipment drive on IBM PC

Full size Tandon List Price \$395.00 _____ \$224.95

HALF-HEIGHT 320K DRIVES

Double-sided, double-density 320K drives for IBM PC Two drives fit in the space of one standard drive

Half-height 320K drive List Price \$395.00 _____ \$199.95
Teac Half-height List Price \$395.00 _____ \$239.95

HARD DISK For IBM PC

Hard disk with controller, software, and P/S

5MB system List Price 1995.00 _____ \$1395.00
10MB system List Price 2495.00 _____ \$1699.00
15MB system List Price 2995.00 _____ \$2199.00

PLACE ORDERS TOLL FREE

Continental U.S.

800-421-5500

Inside California

800-262-1710

For Technical Inquires
or Customer Service call:
213-973-7707

We accept cash, checks, credit cards, or purchase orders from qualified firms and institutions.

Minimum prepaid order \$15.00 California residents add 6 1/2% tax. Export customers outside the US or Canada please add 10% to all prices. Prices and availability subject to change without notice. Shipping and handling charges via UPS Ground 50¢/lb. UPS Air \$1.00/lb. minimum charge \$3.00 Prices quoted are for pre-paid orders only

JADE Computer Products 4901 West Rosecrans Avenue, Hawthorne, California 90250

Circle 192 on inquiry card.

EPSON Printer \$349⁹⁵ OKIDATA Printer \$349⁹⁵

EPSON

EPSON PRINTERS SAVE At Least \$150.00!

CALL US FOR THE BEST DEAL ON THE WORLD'S
BEST SELLING LINE OF PRINTERS!

EPSON RX-80 100 CPS w/tractor, graphics
PRM-29082 A 499.00 Value, Save 200.00 — \$349.95

EPSON RX-80FT 100 CPS with FREE graphics
PRM-29084 Friction & tractor feed — SAVE \$150.00

EPSON MX-80FT 80 CPS with FREE graphics
PRM-28082 Friction & tractor feed — SAVE \$150.00

EPSON MX-100 100 CPS 15" platten
PRM-28100 Friction & tractor — SAVE \$150.00

EPSON FX-80 160 CPS with FREE graphics
PRM-29080 Friction & tractor feed — SAVE \$150.00

EPSON FX-100 160 CPS 15" platten
PRM-29100 Friction & tractor feed — SAVE \$150.00

Commodore Interface & Cable — \$59.95

PRICES TOO LOW TO PUBLISH! OKIDATA—Microline 92 & 93

160 CPS, true correspondence quality printing, full graphics, IBM PC compatible (optional), handles single sheet as well as fan-fold paper, professional design construction and quality

Oki 92 parallel — SAVE AT LEAST \$120.00
Oki 93 parallel — SAVE AT LEAST \$200.00

2K serial board List Price \$150.00 — \$120.00

IBM PC ROMs for 92 List Price \$59.95 — \$49.95

IBM PC ROMs for 93 List Price \$59.95 — \$49.95

Extra Ribbon (2) List Price \$19.95 — \$9.95

Tractor for Oki 92 List Price \$89.95 — \$54.95

MICROLINE 82, 83, & 84

120 CPS (82, 83) 200 CPS (84), industry standard printers, serial and parallel interfaces, true lower case descenders, handles single-sheet as well as fan fold

Oki 82 List Price was \$499.00 Now on SALE for \$349.95

Oki 83 w/FREE tractor — SAVE \$120.00

Oki 84 parallel — SAVE \$350.00

Oki 84 serial — SAVE \$350.00

2K serial board List Price \$120.00 — \$99.95

Extrs Ribbons 82/92, 83/93 List Price \$19.95 — \$9.95

Tractor for Oki 82 List Price \$89.95 — \$54.95

Ribbons for 84 List Price \$19.95 — \$9.95

IBM PC ROMs For 82 or 83 — \$39.95

IBM PC For 84 — \$89.95

Commodore Interface & Cable — \$59.95

MICROFAZER—Quadram

The microfazer stand-alone printer buffers are available in any configuration of serial or parallel input, with serial or parallel output. All are expandable up to 64K of memory (about 30 pages of 8" x 11 text); the parallel-to-parallel version is expandable to 512K copy and pause feature included

Parallel/Parallel
8K List Price 169.00 — \$139.95
32K List Price 225.00 — \$164.95
128K List Price 445.00 — \$269.95

Serial/Parallel
8K List Price 199.00 — \$169.95
32K List Price 260.00 — \$199.95

Parallel/Serial
8K List Price 199.00 — \$169.95
32K List Price 260.00 — \$199.95

Serial/Serial
8K List Price 199.00 — \$169.95
32K List Price 260.00 — \$199.95

CALL US FOR SUPER LOW PRICES ON ALL STAR PRINTERS

GEMINI 10X & 15X

120 CPS, full graphics, friction & tractor, Epson FX-80 compatible

Gemini 10X — SAVE AT LEAST \$150.00

Gemini 15X — SAVE AT LEAST \$150.00

Serial I/O Card List Price \$69.95 — \$54.95

Serial I/O Card w/4K Buffer — \$99.95

Commodore Interface & Cable — \$59.95

DELTA 10 & 15

160 CPS, full graphics, 8K buffer, serial & parallel, Epson FX-80 compatible

Delta 10 — SAVE AT LEAST \$150.00

Delta 15 — SAVE AT LEAST \$150.00

RADIX 10 & 15

200 CPS, full graphics, 16K buffer, serial & parallel, semi-auto sheet feeder

Radix 10 — SAVE AT LEAST \$200.00

Radix 15 — SAVE AT LEAST \$200.00

POWER TYPE

18 CPS daisywheel printer, parallel and serial, four print sizes, Qume wheels and ribbons

PowerType List Price \$499.00 CALL for discount price

COMREX CR-II

Best buy in letter quality printers NEW! from Comrex full featured letter quality printer. FREE! 5K buffer, logic seeking bi-directional printing, boldface proportional spacing, double-strike, backspace, underline, true super-script and sub-script, drop-in daisy wheel cartridge

CR-II parallel List Price 599.00 — \$495.00

CR-II serial List Price 644.00 — \$589.95

Tractor option List Price 120.00 — \$99.95

Cut sheet feeder List Price 259.00 — \$199.95

Keyboard option List Price 199.00 — \$179.95

STARWRITER F10

High speed letter quality printer. 40 or 55 CPS daisy-wheel. Extensive built-in word processing functions. up to 15 inch paper width. Uses standard Diablo style print wheels

40 CPS, F10/parallel List Price 1895.00 — \$1125.00

55 CPS, F10/parallel List Price 1995.00 — \$1599.00

MANNESMAN-TALLY

Sprint, 80 CPS 10 inch parallel List Price 399.00 — \$329.00

16L, 160 CPS 10 inch List Price 798.00 — \$588.00

180L, 160 CPS 15 inch List Price 1098.00 — \$828.00

MICROBUFFER

Practical Peripherals, Inc

Stand-alone Microbuffers

Parallel, 32K List Price 299.00 — \$229.95

Parallel, 64K List Price 349.00 — \$269.95

Serial, 32K List Price 299.00 — \$229.95

Serial, 64K List Price 349.00 — \$269.95

64K add-on board List Price 179.00 — \$149.00

Microbuffers for Apple II

Parallel, 16K List Price 259.95 — \$189.95

Parallel, 32K List Price 299.95 — \$229.95

Serial, 16K List Price 259.95 — \$189.95

Serial, 32K List Price 299.95 — \$229.95

Microbuffers for Epson Printers

Parallel, 16K List Price 159.95 — \$129.95

Serial, 8K List Price 159.95 — \$129.95

5 1/4 inch DISK DRIVES

MPI B51 SS DD 48 TPI
List \$299.00 — \$189.95 ea 2 for \$179.00 ea

TANDON TM 100-1 SS DD 48 TPI
List 349.00 — \$225 ea 2 for \$195.00 ea

SHUGART SA 400L SS DD 48 TPI
List 299.00 — \$209.00 ea 2 for \$199.95 ea

TANDON TM 100-2 DS DD 48 TPI
List 399.00 — \$229.00 ea 2 for \$225.00 ea

5 1/4" CABINETS/POWER SUPPLY

Single cab w/power supply List Price 99.00 — \$69.95

Dual Cab w/power supply List Price 129.00 — \$85.00

8 inch DISK DRIVES

SIEMENS FDD 100-8 Single sided, double density
List 399.00 — \$179.00 ea 2 for \$175.00 ea

SHUGART SA 801R Single sided, double density
List 502.00 — \$355.00 ea 2 for \$349.00 ea

SHUGART SA-851R Double sided, double density
List 605.00 — \$459.00 ea 2 for \$455.00 ea

QUME DT-8 Double sided, double density
List 599.00 — \$479.00 ea 2 for \$459.00 ea

TANDON TM 848-1 SS DD thin-line
List 499.00 — \$369.00 ea 2 for \$359.00 ea

TANDON TM 848-2 DS DD thin-line
List 599.00 — \$439.00 ea 2 for \$435.00 ea

NEC FD1165 DS DD thin-line
List 599.00 — \$450.00 ea 2 for \$440.00 ea

DISK SUB-SYSTEMS—Jade

Handsome metal cabinet with proportionally balanced air flow system, rugged dual drive power supply, cable kit, power switch, line cord, fuse holder, cooling fan, nevermar rubber feet, all necessary hardware to mount two 8 inch disk drives, power supply, and fan. Does not include signal cable

Dual 8" Sub-Assembly Cabinet

Bare cabinet List Price 75.00 — \$49.95

Cabinet kit List Price 299.00 — \$199.95

A & T List Price 349.00 — \$249.95

8" Sub-System—Single sided, Double Density

Kit w/2 Siemens FD100-8Ds List Price 950.00 — \$579.00

A & T w/2 Siemens FD100-8Ds List Price 995.00 — \$595.00

Kit w/2 Shugart SA-801Rs List Price 1195.00 — \$939.00

A & T w/2 Shugart SA-801Rs List Price 1295.00 — \$969.00

8" Sub-Systems—Double Sided, Double Density

Kit w/2 Qume DT-8s List Price 1495.00 — \$1229.00

A & T w/2 Qume DT-8s List Price 1595.00 — \$1249.00

Kit w/2 Shugart SA-851Rs List Price 1495.00 — \$1199.00

A & T w/2 Shugart SA-851Rs List Price 1595.00 — \$1219.00

DUAL SLIMLINE SUB-SYSTEMS

Dual 8" Slimline Cabinet

Bare cabinet List Price 75.00 — \$59.95

A & T w/0 drives List Price 249.00 — \$164.95

Dual 8" Slimline Sub-Systems

Kit w/2 SS DD drives List Price 1195.00 — \$869.00

A & T w/2 SS DD drives List Price 1295.00 — \$879.00

Kit w/2 DS DD drives List Price 1395.00 — \$1060.00

A & T w/2 DS DD drives List Price 1495.00 — \$1099.00

DISK DRIVE POWER SUPPLY

Sufficient current to power up to three 8 inch drives

Power supply List Price 149.00 — \$89.95

PLACE ORDERS TOLL FREE!

Continental USA (800) 421-5500 Inside California (800) 262-1710 Los Angeles Area (213) 973-7707

We accept cash, checks, credit cards, or purchase orders from qualified firms and institutions. Prices quoted are for prepaid orders only and are subject to change without notice.

Minimum prepaid order \$15.00 California residents add 6 1/2% tax. Export customers outside the U.S. or Canada please add 10% to all prices. Shipping and handling charges via UPS Ground 50¢/lb UPS Air \$1.00/lb minimum charge \$3.00

for your APPLE

SUPER DISKETTE SPECIAL!

We bought out a major manufacturer's overstock, and we are passing the savings on to you! Single sided double density, package of ten with FREE plastic case
Box of 10 w/FREE plastic box List Price \$4.95 \$18.95

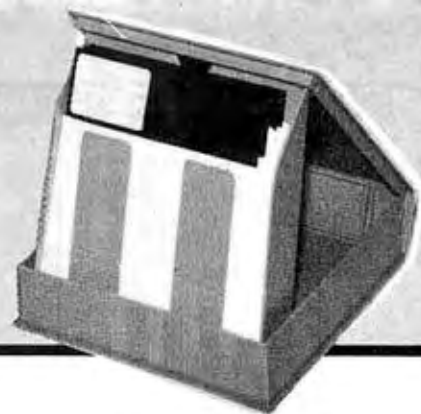

DISK DRIVE For APPLE

Totally Apple compatible, 143,360 bytes per drive on DOS 3.3 full one year warranty, half-track capability, reads all Apple software, plugs right into Apple controller as second drive. DOS 3.3, 3.2.1 Pascal, & CP/M compatible

Standard Disk II size List Price 299.00 \$199.95
Controller only List Price 99.00 \$60.00

HALF-HEIGHT DRIVE For APPLE

Totally Apple compatible. Works with all Apple software and controllers. Faster and quieter than most other drives, yet only half the size!

Half-height drive List Price 249.00 \$199.95

DUAL 8-inch DISK DRIVE SYSTEM

Up to 2 Megabytes for your Apple, two double density 8 inch slimline disk drives, cabinet, power supply, cable, controller, and software. Compatible with DOS, CP/M, Pascal and IBM 3740 formats

1 Megabyte Sub-system List Price 1995.00 \$1195.00
2 Megabyte Sub-system List Price 2495.00 \$1395.00

PRINTER CARD AND CABLE

For Apple; standard centronics parallel interface for Epson, Okidata, C. Itoh, Gemini, NEC, Comrex, etc. Includes printer cable and support graphics

Printer card & cable List Price 119.95 \$49.95

CP/M 3.0 CARD For APPLE—ALS

The most powerful card available for your Apple! 6 MHz, Z-80B, additional 64K RAM, CP/M 3.0 plus, 100% CP/M 2.2 compatibility, C Basic, CP/M graphics, 300% faster than any other CP/M for Apple

ALS CP/M 3.0 card List Price 399.00 \$299.00

BUFFERED GRAPPLER PLUS

Combines the flexibility of the Grappler+ with the convenience of the Bufferboard, all on a single board Expandable of 64K

Buffered Grappler w/16K List Price \$245.00 \$175.00

FAN/POWER CENTER For APPLE

Cooling fan for your overheated Apple II, II+, or IIe; also includes power switch and two switched outlets with voltage protection circuitry

Apple fan List Price 99.95 \$59.95

NEW! MICROMODEM IIe—Hayes

The standard in direct-connect, plug-in-modem cards for Apple, 110-300 baud, includes FREE Smartcom I

Micromodem IIe List Price 299.95 \$239.95

KOALA PAD—Koala Tech.

A touch sensitive pad that functions like a joystick or mouse, allowing you to move the cursor around the screen with the touch of a finger. Complete with software

Koala Pad List Price 124.95 \$99.95

16K RAM CARD For APPLE II

Expand your Apple II to 64K, use as language card, full one year warranty Why spend \$175.00?

16K RAM Card List Price 99.00 \$49.95

Z CARD For APPLE—ALS

Two computers in one, Z-80 and 6502, more than doubles the power and potential of your Apple, includes Z-80 CPU card, CP/M 2.2 and complete manual set, Pascal compatible, One year warranty

Z Card with CP/M 2.2 List Price 169.00 \$139.95

GRAPPLER PLUS—Orange Micro

The ultimate parallel printer graphics interface card with many new features, now at a new low price!

Grappler Plus List Price 175.00 \$119.95

80 COLUMN CARD

80 column x 24 line video card for Apple II addressable 25th status line, normal/inverse or high/low video, 128 ASCII characters, upper and lower case, 7 x 9 dot matrix with true descenders, CP/M, Pascal and Fortran compatible, 40/80 column selection from keyboard, 2 year warranty, Best 80 column card!

Viewmax 80 List Price 219.00 \$139.95
Visicalc/Easywriter Preboot List Price 30.00 \$24.95

64K STATIC RAM—Jade

Uses new 2K x 8 static RAMs, fully supports IEEE 696

Bare board List Price 69.00 \$49.95
Kit less RAM List Price 149.00 \$89.95
32K kit List Price 229.00 \$169.95
56K kit List Price 299.00 \$225.95
64K kit List Price 399.00 \$265.95
Assembled & Tested List Price 50.00 add \$30.00

EXPANDORAM III

High density memory board, 64K, 128K, or 256K

64K List Price 475.00 \$398.95
128K List Price 595.00 \$464.95
192K List Price 709.00 \$524.95
256K List Price 825.00 \$589.95

I/O-4 SSM MICROCOMPUTER

Two serial I/O ports plus two parallel I/O ports

I/O-4 A & T List Price 290.00 \$245.95

ISO BUS—Jade Computer

Silent, simple and on SALE! A better motherboard

6 Slot (5 1/4" x 8 1/2") 19 MHz

6 Slot Bare board List Price 40.00 \$22.95
6 Slot Kit List Price 60.00 \$39.95
6 Slot A & T List Price 75.00 \$49.95

12 Slot (9 1/4" x 8 1/2") 10 MHz

12 Slot Bare board List Price 54.00 \$34.95
12 Slot Kit List Price 110.00 \$69.95
12 Slot A & T List Price 140.00 \$89.95

18 Slot (14 1/2" x 8 1/2") 6MHz

18 Slot Bare board List Price 70.00 \$54.95
18 Slot Kit List Price 150.00 \$99.95
18 Slot A & T List Price 200.00 \$139.95

SBC-200 SD Systems

4 MHz Z-80A CPU with serial and parallel I/O

A & T List Price 350.00 \$299.95

ISOBAR

The ISOBAR looks like a standard multi-outlet power strip, but contains surge suppression circuitry and built-in noise filters, plus 15amp circuit breaker

4 receptacle List Price 89.95 \$59.95
8 receptacle List Price 99.95 \$69.95

DOUBLE D—Jade Computer

High reliability, double density disk controller

Bare board & hdwr man List Price 75.00 \$59.95
Kit w/hdwr & sftwr man List Price 399.00 \$299.95
A & T w/hdwr & sftwr man List Price 449.00 \$325.95
CP/M 2.2 with Double D List Price 200.00 \$99.95

THE BUS PROBE

Best selling inexpensive S-100 diagnostic analyzer

Bare board List Price 89.00 \$59.95
Kit List Price 249.00 \$179.95
A & T List Price 299.00 \$199.95

VERSAFLOPPY II—SD Systems

Double density disk controller for 5 1/4" and 8"

Versafloppy II with PROM List Price 400.00 \$344.95
Versafloppy II/696 A & T List Price 400.00 \$349.95
CP/M 3.0 with VF-II List Price 200.00 \$80.00

THE BIG Z—Jade

2 or 4 MHz switchable Z-80 CPU board with serial I/O

Bare board w/manual List Price 50.00 \$35.00
Kit w/manual List Price 249.00 \$179.95
A & T List Price 299.00 \$199.00

ULTRA-VIOLET EPROM ERASERS

Inexpensive erasers for industry or home

Spectronics w/o timer List Price 99.00 \$69.95
Spectronics with timer List Price 139.00 \$94.95
Logical Devices List Price 89.00 \$49.95



SMARTMODEM—Hayes

Sophisticated direct-connect auto-answer/auto dial modem, touch tone or pulse dialing, RS232C interface programmable

Smartmodem 1200 List Price 699.00 \$475.00
1200B for IBM PC List Price 599.00 \$399.95
Smartmodem 300 List Price 289.00 \$199.00
Hayes Cronograph List Price 249.00 \$199.95
Micromodem 100 List Price 399.00 \$299.95
Micromodem IIe List Price 299.00 \$239.95

1200 BAUD SMART CAT Novation

103/212 Smart Cat and 103 Smart Cat, 1200 and 300 baud, built-in dialer, auto re-dial if busy, auto answer/disconnect, direct connect, LED readout displays mode analog/digital loopback self tests, usable with multi-line phones

300 Baud 103 Smart Cat List Price 249.00 \$199.95
1200 Baud 212/103 Smart Cat List Price 595.00 \$449.95

J-CAT MODEM—Novation

1-5 the size of ordinary modems, Bell 103, manual or auto-answer, automatic answer/originate, direct connect, built-in self-test, two LEDs and audio beeps provide status information

Novation J-Cat List Price 149.00 \$114.95

JADIE

Computer Products

Circle 193 on inquiry card.
 4901 West Rosecrans Avenue, Hawthorne, California 90250

7400

*Number of Pins of each I.C. for many Socket purchases

MICROPROCESSOR COMPONENTS

Digitalker™

Table with 2 columns: Part No., Price. Lists various 7400 series components like 7400, 7401, 7402, etc.

Table with 2 columns: Part No., Price. Lists various 7400 series components like 7403, 7404, 7405, etc.

Table with 3 columns: Part No., Pins, Price. Lists MICROPROCESSOR CHIPS like CD1602, CD1603, etc.

Table with 3 columns: Part No., Pins, Price. Lists Z80, Z80A, Z80B, Z8000 SERIES components like Z80, Z80C, etc.

Table with 3 columns: Part No., Pins, Price. Lists 6500/6000/8000 SERIES components like MC6500, MC6501, etc.

Table with 3 columns: Part No., Pins, Price. Lists DYNAMIC RAMS like 1103, 4027, etc.

Table with 3 columns: Part No., Pins, Price. Lists STATIC RAMS like 1101, 2101, etc.

Table with 3 columns: Part No., Pins, Price. Lists PROMS/EPROMS like 2708, 2716, etc.

Table with 3 columns: Part No., Pins, Price. Lists BOOBA SERIES components like TMS501, TMS502, etc.

Table with 3 columns: Part No., Pins, Price. Lists DISK CONTROLLERS like IN5711, F0191, etc.

Table with 3 columns: Part No., Pins, Price. Lists SPECIAL FUNCTION components like CD2002N, CD2002M, etc.

Table with 3 columns: Part No., Pins, Price. Lists LOW PROFILE (TIN) SOCKETS like 1-9, 10-99, 100-up.

Table with 3 columns: Part No., Pins, Price. Lists SOLDERTAIL (GOLD) STANDARD like 1-9, 10-99, 100-up.

Table with 3 columns: Part No., Pins, Price. Lists LOW PROFILE (TIN) SOCKETS like 1-9, 10-99, 100-up.

Table with 3 columns: Part No., Pins, Price. Lists SOLDERTAIL (GOLD) STANDARD like 1-9, 10-99, 100-up.

Table with 3 columns: Part No., Pins, Price. Lists LOW PROFILE (TIN) SOCKETS like 1-9, 10-99, 100-up.

Table with 3 columns: Part No., Pins, Price. Lists SOLDERTAIL (GOLD) STANDARD like 1-9, 10-99, 100-up.

Table with 3 columns: Part No., Pins, Price. Lists LOW PROFILE (TIN) SOCKETS like 1-9, 10-99, 100-up.

Table with 3 columns: Part No., Pins, Price. Lists WIRE WRAP SOCKETS (GOLD) like 1-9, 10-99, 100-up.

Table with 3 columns: Part No., Pins, Price. Lists SOLDERTAIL STANDARD (TIN) like 1-9, 10-99, 100-up.

Table with 3 columns: Part No., Pins, Price. Lists WIRE WRAP SOCKETS (GOLD) like 1-9, 10-99, 100-up.

Table with 3 columns: Part No., Pins, Price. Lists SOLDERTAIL STANDARD (TIN) like 1-9, 10-99, 100-up.

Table with 3 columns: Part No., Pins, Price. Lists WIRE WRAP SOCKETS (GOLD) like 1-9, 10-99, 100-up.

Table with 3 columns: Part No., Pins, Price. Lists SOLDERTAIL STANDARD (TIN) like 1-9, 10-99, 100-up.

Table with 3 columns: Part No., Pins, Price. Lists WIRE WRAP SOCKETS (GOLD) like 1-9, 10-99, 100-up.

Table with 3 columns: Part No., Pins, Price. Lists SOLDERTAIL STANDARD (TIN) like 1-9, 10-99, 100-up.

Table with 3 columns: Part No., Pins, Price. Lists WIRE WRAP SOCKETS (GOLD) like 1-9, 10-99, 100-up.

Table with 3 columns: Part No., Pins, Price. Lists SOLDERTAIL STANDARD (TIN) like 1-9, 10-99, 100-up.

Table with 3 columns: Part No., Pins, Price. Lists WIRE WRAP SOCKETS (GOLD) like 1-9, 10-99, 100-up.

Table with 3 columns: Part No., Pins, Price. Lists SOLDERTAIL STANDARD (TIN) like 1-9, 10-99, 100-up.

Table with 3 columns: Part No., Pins, Price. Lists WIRE WRAP SOCKETS (GOLD) like 1-9, 10-99, 100-up.

DT1050 — Applications: Teaching aids, appliances, clocks, automotive, telecommunications, language translations, etc.

DT1050 Digitalker™ \$34.95 ea. MM54104 Processor Chip \$14.95 ea.

DT1057 — Expands the DT1050 vocabulary from 137 to over 260 words. Includes 2 ROMs and specs. Part No. DT1057 \$24.95 ea.

Table with 3 columns: Part No., Pins, Price. Lists INTERSIL components like 74029P, 74046V/K, etc.

Table with 3 columns: Part No., Pins, Price. Lists 30009 1983 INTERSIL Data Book (1256p) \$9.95

Table with 3 columns: Part No., Pins, Price. Lists 74HC High Speed CMOS components like 74HC02, 74HC03, etc.

Table with 3 columns: Part No., Pins, Price. Lists Programmable Array Logic (PALs) components like PAL10H8, PAL14H8, etc.

Table with 3 columns: Part No., Pins, Price. Lists 30012 1982 NATIONAL PAL Data Book (178p) \$5.95

Table with 3 columns: Part No., Pins, Price. Lists 74C-C/MOS components like 74C00, 74C01, etc.

Table with 3 columns: Part No., Pins, Price. Lists LINEAR components like LM732P, LM732CP, etc.

Table with 3 columns: Part No., Pins, Price. Lists LINEAR components like LM4031, LM4032, etc.

Table with 3 columns: Part No., Pins, Price. Lists LINEAR components like LM3090, LM3091, etc.

Table with 3 columns: Part No., Pins, Price. Lists LINEAR components like LM332, LM333, etc.

Table with 3 columns: Part No., Pins, Price. Lists LINEAR components like LM339, LM339A, etc.

30003 1982 Nat. Linear Data Book (1932p) \$11.95

Jameco Electronics logo and address: 1355 SHOREWAY ROAD, BELMONT, CA 94002. Includes phone number (415) 592-8097 and fax number 176043.

VOICE SYNTHESIZER FOR APPLE AND COMMODORE



• Over 250 word vocabulary affixes allow the formation of more than 500 words • Built-in amplifier, speaker, volume control, and audio jack • Recreates a clear, natural male voice • Plug-in user ready with documentation and sample software • Case size: 7 1/4" L x 3 3/4" W x 1-3/8" H

APPLICATIONS: • Security Warning • Telecommunication Teaching • Handicap Aid • Instrumentation • Games

The JES20 VOICE SYNTHESIZER will plug right into your computer and allow you to utter almost any syllable. Utilizing National Semiconductor's DIGITAL SPEECH Processor IC (with four custom memory chips), the JES20 compresses natural speech into digital memory. Including the original instructions and emphases. The result is an extremely clear, natural voice!

Case Size: **VOCABULARY EXPANSION MODULE**

- Expands to over 1000 basic words
- Allows selection of up to 8 additional word sets

Part No.	Description	Price
JES20CM	For Commodore 84 & VIC-20	\$114.95
JES20AP	For Apple II, II+, and IIe	\$149.95



JE664 EPROM PROGRAMMER 8K to 64K EPROMS — 24 & 28 Pin Packages

Completely Self-Contained — Requires No Additional Systems for Operation

- Programs and validates EPROMs
- Checks for properly erased EPROMs
- Emulates PROMs or EPROMs
- RS232C Computer Interface for editing and program loading
- Loads data into RAM by keyboard
- Changes data in RAM by keyboard
- Loads RAM from an EPROM
- Compares EPROMs for content differences
- Copies EPROMs
- Power: 115VAC, 60Hz, less than 10W power consumption
- Enclosure: Color-coordinated, light tan panels with milled end pieces in macho brown
- Size: 15 1/4" x 8 3/4" x 3 1/4" H
- Weight: 5 1/2 lbs.

The JE664 EPROM Programmer emulates and programs various 8-Bit Word EPROMs from 8K to 64K-8K memory capacity. Data can be entered into the JE664's internal 8K x 8-Bit RAM in three ways: (1) from a PROM or EPROM; (2) from an external module via the optional JE664 RS232C BUS; (3) from its own keyboard. The JE664's RAMs may be selected for emulation purposes from the panel's test socket to an external microprocessor. In programming and emulation, the JE664 allows for examination, change and validation of program content. The JE664's RAMs can be programmed quickly to all "1"s (or any value), allowing untested addresses in the EPROM to be programmed later without necessity of "1" bit erasing. The JE664 displays DATA and ADDRESS in convenient hexadecimal (alphanumeric) format. A "DISPLAY EPROM DATA" button changes the DATA readout from RAM word to EPROM word and is displayed in both hexadecimal and binary code. The front panel features a convenient operator. The JE664 Programmer includes one JIM16A Jumper Module (as listed below).

JE664-A JUMPER PROGRAMMER \$995.00

J 665 — RS232C INTERFACE OPTION — The RS232C Interface Option implements computer access to the JE664's RAM. This allows the computer to manipulate, store and transfer EPROM data and/or from the JE664. A sample program is supplied in BASIC for CP/M computers. Documentation is provided to adapt the software to other computers with a FOR A LIMITED TIME A SAMPLE OF SOFTWARE WRITTEN IN BASIC FOR THE TRS-80 MODEL II LEVEL II COMPUTER WILL ALSO BE PROVIDED.

JE664-ARS E-ROM Prog. w/J 665 Option \$1195.00

Assembled & Tested (Includes JIM16A Module)

EPROM JUMPER MODULES — The JE664's JUMPER MODULE (Personality Module) is a plug-in module that lets the JE664 do the proper programming to the EPROMs and configure the EPROM sockets connected to that particular EPROM

Model	Part No.	Programs	Price
AMD	2710	AMD	\$18.75
AMD	2716	AMD	\$18.75
AMD	2716	AMD	\$18.75
AMD	2716	AMD	\$18.75
AMD	2716	AMD	\$18.75
AMD	2716	AMD	\$18.75
AMD	2716	AMD	\$18.75
AMD	2716	AMD	\$18.75
AMD	2716	AMD	\$18.75

4-Digit Fluorescent Alarm Clock Kit



• Bright 4-digit 0.5" high display • 10 minute snooze alarm • 4 AMPS/HR indicator • Built-in alarm clock

The JE750 Alarm Clock Kit is a versatile 12-hour digital clock with 24-hour alarm. The clock has a bright 0.5" high blue-green fluorescent display. The display will automatically dim with changing light conditions. The 24-hour alarm allows the user to disable the alarm and immediately re-enable the alarm to activate 24 hours later. The kit includes all documentation, components, case and wall transformer. Size: 6 1/4" L x 3 3/4" W x 1 3/4" D.

JE750 Alarm Clock Kit \$29.95

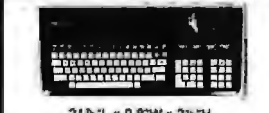

21 1/2" L x 8 8/8" W x 3 3/8" H



19 1/2" L x 7 1/2" W x 1 1/4" H



19 3/4" L x 6 1/2" W x 1 1/4" H

106-Key 8-Bit Serial ASCII Keyboard
• Numeric and cursor keypad • 10 user definable keys • 7 LED function displays • Security lock • N-key rollover • Uses Intel 8048/8748 • Color: white w/black panel • Documentation included • Weight: 6 1/2 lbs.
KB139 \$59.95

Micro-Switch 106-Key Keyboard 8-Bit Serial ASCII
• Numeric and cursor keypad • 6 user definable keys • Japanese/English characters • 8 LED function displays • Documentation incl. • Fits DTE-22 enclosure • Wt: 3 1/2 lbs.
KB106SD29-4 \$29.95

SMK 103-Key Unencoded Keyboard
Numeric and cursor keypad • SPST mechanical keyswitches • 40-pin header connection • Features: escape, control, cursor keypad, user function and special function keys • Fits DTE-22 enclosure • Weight: 3 1/2 lbs.
KB9000 \$19.95

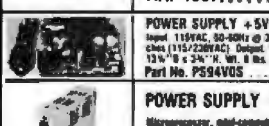
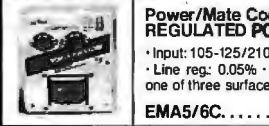
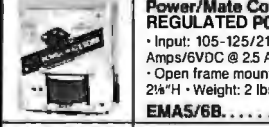

Power/Mate Corporation +5VDC @ 3 Amp REGULATED POWER SUPPLY
• Input: 105-125/210-250VAC at 47-63 Hz • Output: 5VDC @ 3.0 AMPS/6VDC @ 2.5 AMPS • Line regulation: 0.05% • Load reg: 0.1% • Open frame mounts on any 1 of 3 surfaces • Size: 4 1/4" L x 4" W x 2 1/4" H • Weight: 2 lbs.
EMAS/6B \$29.95

Power/Mate Corporation +5VDC @ 6 Amp REGULATED POWER SUPPLY
• Input: 105-125/210-250VAC at 47-63 Hz • Output: 5V @ 6A/6V @ 5A • Line reg: 0.05% • Load reg: 0.1% • Open frame mounts on any one of three surfaces • Size: 5 1/4" L x 4 1/2" W x 2 1/4" H • Wt: 4 lbs.
EMAS/6C \$39.95

Switching Power Supply for APPLE II, II+ & IIe
• Can drive four floppy disk drives and up to eight expansion cards • Short circuit and overload protection • Fits inside Apple computer • Fully regulated +5V @ 5A, +12V @ 3A, -5V @ .5A, -12V @ 5A • Direct plug-in power cord included • Size: 9 1/4" L x 3 3/4" W x 2 1/4" H • Weight: 2 lbs.
KHP4007 \$79.95

POWER SUPPLY +5VDC @ 7.5 AMP, 12VDC @ 1.5 AMP SWITCHING
Input: 115VAC, 50-60Hz @ 3 amp/230VAC, 30Hz @ 1 amp. Fan w/ power supply select switches (115/230VAC). Output: 5VDC @ 7.5 amp, 12VDC @ 1.5 amp. 8 ft. dia. power cable 11 1/2" W x 1 1/2" H x 3 1/2" D. Part No. PS49VCS \$39.95 each

POWER SUPPLY 4-Channel Switching
Microprocessor, mini-computer, terminal, medical monitoring and general control applications. Input: 105-130VAC 60-400Hz. Output: +5VDC @ 1A, -5VDC @ 1A, +12VDC @ 1A, -12VDC @ 1A. Line reg: ±0.3%, Load reg: 0.2%, Load reg: ±1%. Overcurrent protection. All. 100 mA load. Input: 1 1/2" H x 1 1/2" W x 1 1/2" D. Part No. FCS-684A \$69.95 each

DISKETTES AND ACCESSORIES

5 1/4" and 8" Diskettes		
Part No.	Description	Price
MS200	8" Single Sided Double Density	100
MS200	8" Single Sided Quad Density	100
MS200	5 1/4" Double Sided Double Density	100
MS200	5 1/4" Double Sided Quad Density	100

DISKETTE ACCESSORIES



• Attractive, functional disk storage system • 50/8 or 75/5 1/2" disk storage capacity • Easy filing and retrieving • Protects disk from dust contamination • Molded from durable smoked plastic with carrying handle • Size: 7 1/2" W x 6 1/4" H x 5 1/4" D • Weight: 2 lbs.



Diskette Envelopes
Sleeves for Bulk-Purchased Diskettes
• Four pack • Unbreakable hard shell • Anti-static property • Holds extra diskette
MP201 100 White 5 1/4" Envelopes \$1.49
MP202 100 White 5 1/4" Envelopes \$1.99
MP203 100 White 8" Envelopes \$1.99
MP204 100 White 8" Envelopes \$1.99



Vinyl Pages
For 3-Ring Binders
Prevents pages from getting scratched, bent, warped, and other damage. Reduces the risk of getting dirt under your 3-Ring Binder Disk. 1 1/2" x 1 1/2"



Mail Pak
• Holds up to 8 diskettes • Ideal for mailing and return mailings • Best priced and available • Unbreakable sleeve allows easy identification
MP05 Holds 3 or 5 1/4" Diskettes \$2.99 each
MP-06 Holds 2 or 8" Diskettes \$3.99 each

MINI-PAK
• Erases 10 5 1/4" diskettes • Protects disk from dust contamination • Durable smoked plastic • Size: 5 1/4" L x 1 1/2" D
MP-07 Erases 10 5 1/4" Diskettes \$2.99 each

\$10.00 Minimum Order — U.S. Funds Only
California Residents Add 8 1/2% Sales Tax
Shipping — Add 5% plus \$1.50 Insurance
Send S.A.S.E. for Monthly Sales Flyer!

MasterCard **Jameco ELECTRONICS** VISA
1355 SHOREWAY ROAD, BELMONT, CA 94002
3/84 PHONE ORDERS WELCOME — (415) 592-8097 Telex: 176043

8" FLOPPY DISK DRIVE

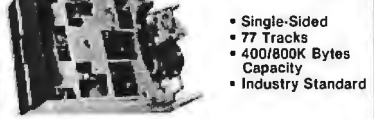

The FDD100-8 8" Floppy Disk Drive (Industry Standard) features 5 single or double density recording modes: FM single, FM double density, Transfer rate: 250K bits/sec, single density; 500K bits/sec, double density. The FDD100-8 is designed to work with the single-sided soft sector IBM Diskette or eq. disk cartridge. Power: 115VAC @ 50-60Hz, +24VDC @ 1.7 amps max., +5VDC @ 1.2 amps max. Unit as pictured above does not include case, power supply, or cables. Size: 8 5/8" W x 14" L x 4 1/2" H. Weighs 12 lbs. Incl. 96-pg. manual.

FDD100-8 . . \$169.95 ea.

5 1/4" APPLE™ Direct Plug-In Compatible Disk Drive

- Uses Shugart SA45B mechanism • 143K formatted storage • 25 tracks — compatible with Apple controller • Complete with connector cable — just plug into your disk controller • Size 8 1/4" L x 5 1/4" W x 2 1/4" H • Weight 4 lbs.

Part No. **ADD-514** \$195.95

5 1/4" TEAC DISK DRIVE
Single-Sided Half-Height 5 1/4" Drive

- Single or double density • 48 TPI • 40 tracks • 6ms track to track • 5W power consumption • Busless DC direct-drive motor • 160KBytes formatted storage • One year warranty parts and labor

Double your work space with the TEAC 5 1/4" FLOPPY DISK DRIVE. Because the TEAC FDS5A Drive is half the height of conventional drives, you can fit up to four TEAC Drives in the same space as two conventional drives fit. Or, have room for two floppy disk drives and a hard disk drive. Includes operating manual. Requires: +5VDC @ .55A and +12VDC @ 3A. Size: 5 1/4" W x 1 1/4" H x 8"D. Wt: 3 lbs.
FDS5A \$249.95

5 1/4" SHUGART DISK DRIVE
Double-Sided Half-Height 5 1/4" Drive

- Single or double density • 48 TPI • 40 tracks • 40KBytes formatted storage • 6ms track to track • 2 drive motor • 327KBytes formatted storage • One year warranty parts and labor

The JAS51 is perfect for word processors, personal and portable computers, small business computers and terminal add-ons. Includes operating manual. Requires: +5VDC @ .55A and +12VDC @ 1A. Size: 5 1/4" W x 1 1/4" H x 8"D. Wt: 3 lbs.
JAS51-2 \$239.95

5 1/4" PANASONIC DISK DRIVE
Double-Sided Half-Height 5 1/4" DRIVE
Shugart SA455 Equivalent

- Single or double density • 48 TPI • 40 tracks • 6ms track to track • 327KBytes formatted storage • One year warranty parts and labor

The JAS51 is perfect for word processors, personal and portable computers, small business computers and terminal add-ons. Includes operating manual. Requires: +5VDC @ .55A and +12VDC @ 1A. Size: 5 1/4" W x 1 1/4" H x 8"D. Wt: 3 lbs.
JAS51-2 \$239.95

SIGNAL CABLES

5 1/4" DRIVES USE 34-PIN ASSEMBLIES
8" DRIVES USE 50-PIN ASSEMBLIES
• S = SOCKET CONNECTOR
• C = CARD-EDGE CONNECTOR

SINGLE DRIVE CABLE

Drive	Style	Part No.	1-4	5+
5 1/4"	M	S34-36-C	7.95	7.25
5 1/4"	N	S34-60-C	8.95	8.39
8"	M	S50-36-C	10.95	9.95
8"	N	S50-60-C	12.49	10.95

DUAL DRIVE CABLE

Drive	Style	Part No.	1-4	5+
5 1/4"	O	S34-36C-18C	12.59	11.19
5 1/4"	P	S34-60C-24C	14.29	12.69
8"	O	S50-36C-18C	16.49	14.49
8"	P	S50-60C-24C	18.95	18.95

Power Cable Kits

Kits include: Connector shells, connector pins, and power cables.

Power Cable Kit for 5 1/4" Drive \$2.95
Part No. **PK-5**

Power Cable Kit for Full-Sized 8" Drive \$3.95
Part No. **PK-8**

Power Cable Kit for Oume Full-Sized 8" Drive \$4.95
Part No. **PK-Q**

UV-EPROM Eraser

8 Chips — 51 Minutes

1 Chip — 37 Minutes

Erases 2708, 2716, 2732, 2784, 2516, 2532, 2584. Erases up to 8 chips within 51 minutes (1 chip in 37 minutes). Maintains constant exposure distance of one inch. Special conductive foam liner eliminates static build-up. Built-in safety lock to prevent UV exposure. Compact — only 5.00" x 3.70" x 2.80". Complete with holding tray for 8 chips.

DE-4 UV-EPROM Eraser . . . \$79.95
UVS-11EL Replacement Bulb . . \$16.95

California Digital

Post Office Box 3097 B • Torrance, California 90503



FREE

Plastic library case supplied with all diskettes purchased from California Digital.

DISKETTES \$16.50

FIVE INCH SINGLE SIDED DOUBLE DENSITY

SoftSector	TanSector	Satteen	Each box	10 Boxes	100 Boxes
CAL DIGITAL	CAL-501 CAL-512 CAL-516		19.95	18.50	16.50
SCOTCH	MMM-744/0 MMM-744/10 MMM-744/16		26.50	24.50	21.75
VERBATIM	VRB-525/01 VRB-525/10 VRB-525/16		26.50	25.25	23.50
MEMOREX	MRX-3481 MRX-3483 MRX-3485		26.50	22.25	18.75
MAXELL	MXL-MD1 MXL-MM110 MXL-MM116		26.50	24.50	23.25
DYSAN	DYS-104/10 DYS-107/10 DYS-109/10		35.00	33.00	30.50

FIVE INCH DOUBLE SIDED DOUBLE DENSITY

CAL DIGITAL	CAL-551 CAL-561		24.95	22.75	20.50
SCOTCH	MMM-745/0 MMM-745/10 MMM-745/16		39.95	37.95	31.25
VERBATIM	VRB-550/01 VRB-550/10 VRB-550/16		39.95	37.95	32.75
MEMOREX	MRX-3491 MRX-3493 MRX-3495		35.00	31.25	26.25
MAXELL	MXL-MD2 MXL-MM110 MXL-MM116		39.95	37.95	34.75
MAXELL / 96	MXL-MD296 N/A		45.00	43.00	41.25
DYSAN	DYS-104/2D DYS-107/2D DYS-109/2D		42.50	40.50	35.50
DYSAN / 96	DYS-204/2D N/A		49.95	47.95	45.75

EIGHT INCH SINGLE SIDED SINGLE DENSITY

SCOTCH	MMM-740/0	29.50	27.50	23.80
MEMOREX	MRX-3062	27.75	26.60	22.25
VERBATIM	VRB-34/8000	31.50	29.50	25.60
DYSAN	DYS-3740/1	35.75	32.75	29.75

EIGHT INCH SINGLE SIDED DOUBLE DENSITY

SCOTCH	MMM-741/0	37.75	35.15	29.15
MEMOREX	MRX-3090	35.50	33.50	27.15
VERBATIM	VRB-34/8000	35.25	33.25	28.75
DYSAN	DYS-3740/1D	40.75	38.75	32.25
MAXELL	MXL-FD1	45.50	39.75	35.15

EIGHT INCH DOUBLE SIDED DOUBLE DENSITY

SCOTCH	MMM-743/0	47.50	44.25	37.50
MEMOREX	MRX-3102	39.25	36.75	31.50
VERBATIM	VRB-34/4001	41.75	37.50	32.25
DYSAN	DYS-3740/2D	54.65	49.75	40.50
MAXELL	MXL-FD2	52.50	48.75	40.45

SPECIAL

Shugart 410

\$129

These Shugart 410 5 1/4" disk drives are all factory fresh 1983 production, recently purchased from the Four Phase Division of the Motorola Corporation. These disk drives are single sided 80 track/96 TPI suitable for use with the Ranco Shack Model 1 and Model 3. On any other application that can support an 80 track second drive such as the IBM/PC. The 410 is full height and functionally the same as the Tandem TM 100-3. Complete with power connector and installation manual. When these Shugart 410s are liquidated the price will revert to our regular price of \$249. SHU-SA410

MEMORY

16K DYNAMIC	2732 EPROM
1.95	4.95
4116 150ns.	450ns.
2764 EPROM	16K STATIC
6.95	4.95
350ns.	6116 200ns.

4164 DYNAMIC MEMORY 150ns \$5.95

DYNAMIC MEMORY

4027 4K dynamic 250ns.	ICM-402750	1.31	32 +	100 +
2116150ns. 1K	ICM-41650	1.99	1.85	1.75
4116 200ns. 16K	ICM-416210	1.75	1.65	1.45
416 4150ns. 64K 128 refresh	ICM-416410	5.95	5.85	5.55
41256 150ns. 256K	ICM-4256150	10.95	10.50	9.50
DP8409 dynamic controller	ICY-8409	39.00	35.00	29.00
EPROMS				
2708450ns. 1K x 8	ICE-2708	4.55	4.75	4.55
2716 450ns. 2K x 8	ICE-2716	4.90	4.25	3.97
2716150ns. 450ns. Tri-voltage	ICE-2716TMS	7.95	7.55	7.25
2732450ns. 4K x 8	ICE-2732	4.50	3.75	3.55
2732 350ns. 4K x 8	ICE-2732350	8.50	8.00	7.60
2532450ns. 4K x 8	ICE-2532	10.95	10.50	9.50
2764350ns. 8K x 8	ICE-2764	6.95	6.95	6.95
27128 350ns. 16K x 8	ICE-27128	18.95		
STATIC MEMORY				
21L02 200ns. 1K static	ICM-21L0200	1.49	1.29	1.15
21L02450ns. 1K static	ICM-21L02450	1.29	1.15	.99
2112 450ns. 2K static	ICM-2112450	2.99	2.85	2.75
2114 300ns. 1K x 4	ICM-2114300	1.95	1.85	1.75
4044150ns. 4K x 1	ICM-4044150	2.49	3.25	2.99
5257 300ns. 4K x 1	ICM-5257300	2.50	2.25	1.89
6116 P4200ns. 2K x 8	ICM-6116200	4.85	4.65	4.50
6116P 3150ns. 2K x 8	ICM-6116150	5.25	4.05	4.85
9044 2167 150ns. 10K x 1 (20pin)	ICM-9167100	9.95	9.50	

CONNECTORS

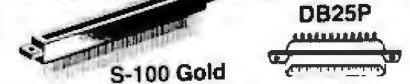

CONN. TYPE	catalog	each	10-99	100+
INSULATED EDGE CARD CONNECTORS				
50-pin edge	CHD-25P	5.95	5.29	4.15
50-pin socket	CHD-25S	5.95	5.29	4.15
50-pin edge	CHD-25P	8.95	8.15	6.90
50-pin socket	CHD-25S	8.95	8.15	6.90
34-pin edge	CHD-17P	4.30	3.90	3.50
34-pin socket	CHD-17S	4.30	3.90	3.50
28-pin edge	CHD-14P	2.75	2.45	2.15
28-pin socket	CHD-14S	2.75	2.45	2.15
24-pin edge	CHD-12P	1.99	1.80	1.68
24-pin socket	CHD-12S	1.99	1.80	1.68
16-pin edge	CHD-8P	1.50	1.35	1.15
16-pin socket	CHD-8S	1.50	1.35	1.15
12-pin edge	CHD-6P	1.50	1.35	1.15
12-pin socket	CHD-6S	1.50	1.35	1.15
8-pin edge	CHD-4P	1.50	1.35	1.15
8-pin socket	CHD-4S	1.50	1.35	1.15
4-pin edge	CHD-2P	1.50	1.35	1.15
4-pin socket	CHD-2S	1.50	1.35	1.15
RIBBON CONNECTORS				
50-pin edge	CHD-25P	5.95	5.29	4.15
50-pin socket	CHD-25S	5.95	5.29	4.15
34-pin edge	CHD-17P	4.30	3.90	3.50
34-pin socket	CHD-17S	4.30	3.90	3.50
28-pin edge	CHD-14P	2.75	2.45	2.15
28-pin socket	CHD-14S	2.75	2.45	2.15
24-pin edge	CHD-12P	1.99	1.80	1.68
24-pin socket	CHD-12S	1.99	1.80	1.68
16-pin edge	CHD-8P	1.50	1.35	1.15
16-pin socket	CHD-8S	1.50	1.35	1.15
12-pin edge	CHD-6P	1.50	1.35	1.15
12-pin socket	CHD-6S	1.50	1.35	1.15
8-pin edge	CHD-4P	1.50	1.35	1.15
8-pin socket	CHD-4S	1.50	1.35	1.15
4-pin edge	CHD-2P	1.50	1.35	1.15
4-pin socket	CHD-2S	1.50	1.35	1.15
DISK DRIVE POWER CONNECTORS				
5-pin edge	CHD-5P	7.95	6.35	5.87
5-pin socket	CHD-5S	7.95	6.35	5.87
3-pin edge	CHD-3P	1.95	1.85	1.75
3-pin socket	CHD-3S	1.95	1.85	1.75
2-pin edge	CHD-2P	1.95	1.85	1.75
2-pin socket	CHD-2S	1.95	1.85	1.75
AMPHEROHLE / CENTRONICS TYPE				
51-pin edge	CHD-51P	7.95	6.35	5.87
51-pin socket	CHD-51S	7.95	6.35	5.87
34-pin edge	CHD-34P	1.95	1.85	1.75
34-pin socket	CHD-34S	1.95	1.85	1.75
28-pin edge	CHD-28P	1.95	1.85	1.75
28-pin socket	CHD-28S	1.95	1.85	1.75
24-pin edge	CHD-24P	1.95	1.85	1.75
24-pin socket	CHD-24S	1.95	1.85	1.75
16-pin edge	CHD-16P	1.95	1.85	1.75
16-pin socket	CHD-16S	1.95	1.85	1.75
8-pin edge	CHD-8P	1.95	1.85	1.75
8-pin socket	CHD-8S	1.95	1.85	1.75
Hand-wired 25 pin				
Hand-wired 25 pin	CHD-25H	88	68	45

BLOWOUT SALE

\$169



California Digital has recently participated in the purchase of several thousand Siemens FDD 100-B floppy disk drives. These units are electronically and physically similar to that of the Shugart 801R. All units are new and shipped in factory sealed boxes. Manual and power connectors supplied free upon request. Your choice: 1.15 Volt, 50 Hz or 230 Volt, 50 Hz. NOTE: European customers, we have a large quantity of 120 volt/50 Hz units warehouse in Frankfurt Germany. Arrangements can be made to wait these drives in quantities of 50 or more in Frankfurt reducing import duty and freight charges.

REMEX DOUBLE SIDED \$219

California Digital has just purchased a large quantity of Remex RFD-4000 Eight Inch double sided disk drives. Remex is the only double sided disk drive that has a double gimbal mounted head assembly that guarantees lower head tracking. This drive is mechanically solid. Remex has always been known for producing premiere products for the floppy disk market. The Remex company is a subsidiary of the Ex-cell-o Corporation, a Fortune 500 Company.

Eight Inch Single Sided Drives

	One	Two	Ten
SHUGART 801R	385	375	365
SIEMENS FDD 100-8	169	169	159
TANDON 848E-1 Half Height	369	359	349

Eight Inch Double Sided Drives

SHUGART SA851R	495	485	475
QUME 842 "QUME TRACK 8"	459	459	449
TANDON 848E-2 Half Height	459	447	435
REMEX RFD-4000	219	219	209
MITSUBISHI M2894-63	447	439	433
MITSUBISHI M2896-63 Half Ht.	459	449	409

Five Inch Single Sided Drives

TEAC FD-55A half height	179	169	165
SHUGART SA400L	235	229	225
SHUGART SA410 96TPI/80 Trk.	129	129	119
SHUGART SA200 3/4 Height	159	149	139
TANDON TM100-1	189	179	175

Five Inch Double Sided Drives

TEAC FD55B half height	219	209	199
CONTROL DATA 9409 IBM/PC	259	249	239
REMEX RFD480 IBM/PC	199	189	175
SHUGART SA450	319	309	299
SHUGART SA455 Half Height	259	249	239
SHUGART SA465 Half Ht. 96TPI	289	279	269
TANDON TM50-2 Half Height	215	209	199
TANDON TM55-4 half Ht. 96TPI	329	319	309
TANDON 100-2	279	269	259
TANDON 101-4 96TPI 80 Track	369	355	350
MITSUBISHI 4851 Half Height	259	249	245
MITSUBISHI 4853 1/2 Ht. 96TPI	339	329	319
MITSUBISHI 4854 1/2 Ht., 8" elec.	465	449	439
QUME 142 Half Height	239	229	219

Three Inch Disk Drives

SHUGART SA300 with diskette	229	219	209
-----------------------------	-----	-----	-----

Five Inch Winchester Hard Disk Drives

SHUGART 612 13 M/Bytes	895	865	825
SHUGART 706 6 M/Byte, Half Ht	795	775	755
SHUGART 712 13 M/Byte, 1/2 Ht.	895	865	825
TANDON 503 19 M/Byte	895	875	855

Upon request, all drives are supplied with power connectors and manual.

ENCLOSURES

California Digital manufactures an assortment of stock and custom disk drive enclosures. If the volume is justified we will custom design an enclosure for your application. The following stock disk drive enclosures are available. All include power supplies. The "B" enclosures are supplied with exhaust fans.

Horizontal mount two 5 1/4" height drives	\$279.00	Horizontal mount one full height or two half height "B" disk drives.	\$239.00
Vertical mount two full height 5 1/4" disk drives.	\$299.00	Vertical mount two full height 5 1/4" disk drives.	\$139.00

New Location



California Digital has just purchased a new distribution center six times the size of our existing facility. The new warehouse and retail store is in the city of Carson at 17700 Figueroa Street. We are located just off the San Diego Freeway near the Good-year Blimp. Please stop by and visit our retail store when in the Los Angeles area. Store hours are 10 AM to 5 PM Monday through Saturday.

Telex 753607



Shipping: First five pounds \$3.00, each additional pound \$.50. Foreign orders: 10% shipping, excess will be refunded. California residents add 6 1/2% sales tax. • COD's discouraged. Open accounts extended to state supported educational institutions and companies with a strong "Dun & Bradstreet" rating. Retail location: 17700 Figueroa Street, Carson, CA. 90248.

DoKau

COMPUTER PRODUCTS, Inc.

ORDER TOLL FREE

(800)
538-8800

(CALIFORNIA RESIDENTS)

(800)
848-8008



TERMS: Minimum order \$10.00. For shipping and handling, include \$2.50 for UPS ground or \$3.50 for UPS Blue (air). For each additional air pound, add \$1 for UPS Blue shipping and handling. California residents must include 6% sales tax; Bay area and LA residents include 6½% sales tax. Prices are subject to change without notice. We are not responsible for typographical errors. We reserve the right to limit quantities and to substitute manufacturers. All merchandise subject to prior sale.

HOURS: Mon. - Fri. 7:30 to 5:00
Saturdays 10:00 to 3:00

VISIT OUR RETAIL STORE

2100 De La Cruz Blvd.
Santa Clara, CA 95050
(408) 988-0697

ALL MERCHANDISE IS
100% GUARANTEED

DoKau

STATIC RAMS

2101	256 x 4 (450ns)	1.90
5101	256 x 4 (450ns) (cmos)	3.90
2102-1	1024 x 1 (450ns)	.88
2102L-4	1024 x 1 (450ns) (LP)	.98
2102L-2	1024 x 1 (250ns) (LP)	1.45
2111	256 x 4 (450ns)	2.45
2112	256 x 4 (450ns)	2.95
2114	1024 x 4 (450ns)	8/7.95
2114-25	1024 x 4 (250ns)	8/8.95
2114L-4	1024 x 4 (450ns) (LP)	8/9.95
2114L-3	1024 x 4 (300ns) (LP)	8/10.95
2114L-2	1024 x 4 (200ns) (LP)	8/11.95
2147	4096 x 1 (55ns)	4.90
TMS4044-4	4096 x 1 (450ns)	3.45
TMS4044-3	4096 x 1 (300ns)	3.95
TMS4044-2	4096 x 1 (200ns)	4.45
MK4118	1024 x 8 (250ns)	9.90
TMM2016-200	2048 x 8 (200ns)	4.10
TMM2016-150	2048 x 8 (150ns)	4.90
TMM2016-100	2048 x 8 (100ns)	6.10
HM6116-4	2048 x 8 (200ns) (cmos)	4.70
HM6116-3	2048 x 8 (150ns) (cmos)	4.90
HM6116-2	2048 x 8 (120ns) (cmos)	8.90
HM6116LP-4	2048 x 8 (200ns) (cmos)(LP)	5.90
HM6116LP-3	2048 x 8 (150ns) (cmos)(LP)	6.90
HM6116LP-2	2048 x 8 (120ns) (cmos)(LP)	9.95
Z-6132	4096 x 8 (300ns) (Qstat)	33.95

LP = Low Power Qstat = Quasi-Static

DYNAMIC RAMS

TMS4027	4096 x 1 (250ns)	1.95
UPD411	4096 x 1 (300ns)	2.95
MMS280	4096 x 1 (300ns)	2.95
MK4108	8192 x 1 (200ns)	1.90
MMS298	8192 x 1 (250ns)	1.80
4116-250	16384 x 1 (250ns)	.49
4116-200	16384 x 1 (200ns)	.89
4116-150	16384 x 1 (150ns)	1.20
2118	16384 x 1 (150ns) (5v)	4.90
4164-250	65536 x 1 (250ns)	4.45
4164-200	65536 x 1 (200ns) (5v)	5.45
4164-150	65536 x 1 (150ns) (5v)	6.45

5V = Single 5 Volt Supply

EPROMS

1702	256 x 8 (1µs)	4.45
2708	1024 x 8 (450ns)	2.49
2758	1024 x 8 (450ns)	2.49
2758	1024 x 8 (450ns) (5v)	5.90
2716	2048 x 8 (450ns) (5v)	2.95
2716-1	2048 x 8 (350ns) (5v)	5.90
TMS2516	2048 x 8 (450ns) (5v)	5.45
TMS2716	2048 x 8 (450ns)	7.90
TMS2532	4096 x 8 (450ns) (5v)	5.90
2732	4096 x 8 (450ns) (5v)	3.95
2732-250	4096 x 8 (250ns) (5v)	8.90
2732-200	4096 x 8 (200ns) (5v)	10.95
2764	8192 x 8 (450ns) (5v)	5.95
2764-250	8192 x 8 (250ns) (5v)	13.95
2764-200	8192 x 1 (200ns) (5v)	23.95
TMS2564	8192 x 8 (450ns) (5v)	16.95
MC68764	8192 x 8 (450ns) (5v) (24 pin)	38.95
27128	16384 x 8 Call	19.95

5v = Single 5 Volt Supply

74LS00

74LS00	.23	74LS92	.54
74LS01	.24	74LS93	.54
74LS02	.24	74LS95	.74
74LS03	.24	74LS96	.88
74LS04	.23	74LS107	.38
74LS05	.24	74LS109	.38
74LS08	.27	74LS112	.38
74LS09	.28	74LS113	.38
74LS10	.24	74LS114	.38
74LS11	.34	74LS122	.44
74LS12	.34	74LS123	.78
74LS13	.44	74LS124	2.85
74LS14	.58	74LS125	.48
74LS15	.34	74LS126	.48
74LS20	.24	74LS132	.58
74LS21	.28	74LS133	.58
74LS22	.24	74LS136	.38
74LS26	.28	74LS137	.98
74LS27	.28	74LS138	.54
74LS28	.34	74LS139	.54
74LS30	.24	74LS145	1.15
74LS32	.28	74LS147	2.45
74LS33	.54	74LS148	1.30
74LS37	.34	74LS151	.54
74LS38	.34	74LS153	.54
74LS40	.24	74LS154	1.85
74LS42	.48	74LS155	.68
74LS47	.74	74LS156	.68
74LS48	.74	74LS157	.64
74LS49	.74	74LS158	.58
74LS51	.24	74LS160	.68
74LS54	.28	74LS161	.64
74LS55	.28	74LS162	.68
74LS63	1.20	74LS163	.64
74LS73	.38	74LS164	.68
74LS74	.34	74LS165	.94
74LS75	.38	74LS166	1.90
74LS76	.38	74LS168	.70
74LS78	.48	74LS169	1.70
74LS83	.59	74LS170	1.45
74LS85	.68	74LS173	.68
74LS86	.38	74LS174	.54
74LS90	.54	74LS175	.54
74LS91	.88	74LS181	2.10

74LS189	8.90	74LS363	1.30
74LS190	.88	74LS364	1.90
74LS191	.88	74LS365	.48
74LS192	.78	74LS366	.48
74LS193	.78	74LS367	.44
74LS194	.68	74LS368	.44
74LS195	.68	74LS373	1.35
74LS196	.78	74LS374	1.35
74LS197	.78	74LS377	1.35
74LS221	.88	74LS378	1.13
74LS240	.94	74LS379	1.30
74LS241	.98	74LS385	1.85
74LS242	.98	74LS386	.44
74LS243	.98	74LS390	1.15
74LS244	1.25	74LS393	1.15
74LS245	1.45	74LS395	1.15
74LS247	.74	74LS399	1.45
74LS248	.98	74LS424	2.90
74LS249	.98	74LS447	.36
74LS251	.58	74LS490	1.90
74LS253	.58	74LS624	3.95
74LS257	.58	74LS640	2.15
74LS258	.58	74LS645	2.15
74LS259	2.70	74LS668	1.65
74LS260	.58	74LS669	1.85
74LS266	.54	74LS670	1.45
74LS273	1.45	74LS674	9.60
74LS275	3.30	74LS682	3.15
74LS279	.48	74LS683	3.15
74LS280	1.95	74LS684	3.15
74LS283	.68	74LS685	3.15
74LS290	.88	74LS688	2.35
74LS293	.88	74LS689	3.15
74LS295	.98	74LS783	23.95
74LS298	.88	81LS95	1.45
74LS299	1.70	81LS96	1.45
74LS323	3.45	81LS97	1.45
74LS324	1.70	81LS98	1.45
74LS352	1.25	25LS2521	2.75
74LS353	1.25	25LS2569	4.20

6500 1 MHz

6502	4.90
6504	6.90
6505	8.90
6507	9.90
6520	4.30
6522	6.90
6532	9.90
6545	21.50
6551	10.85

2 MHz

6502A	6.90
6522A	9.90
6532A	10.95
6545A	26.95
6551A	10.95

3 MHz

6502B	9.90
-------	------

6800

68000	58.95
6800	3.90
6802	7.90
6808	12.90
6809E	18.95
6809	10.95
6810	2.90
6820	4.30
6821	3.20
6828	13.95
6840	11.95
6843	33.95
6844	24.95
6845	13.95
6847	10.95
6850	3.20
6852	15.70
6860	9.90
6862	10.95
6875	6.90
6880	2.20
6883	21.95
68047	23.95
68488	18.95

6800 1MHz

68B00	9.95
68B02	21.25
68B09E	28.95
68B09	28.95
68B10	6.90
68B21	6.90
68B45	18.95
68B50	5.90

8000

8035	5.90
8039	6.90
INS-8060	16.95
INS-8073	49.95
8080	3.90
8085	5.90
8085A-2	10.95
8086	28.95
8087	CALL
8088	38.95
8089	88.95
8155	6.90
8155-2	7.90
8156	6.90
8185	28.95
8185-2	38.95
8741	38.95
8748	49.95
8755	23.95

8200

8202	23.95
8203	38.95
8205	3.45
8212	1.75
8214	3.80
8216	1.70
8224	2.20
8226	1.75
8228	3.45
8237	18.95
8237-5	20.95
8238	4.45
8243	10.95
8250	18.95
8251	4.45
8253	6.90
8255	14.95
8255-5	18.95
8257	7.90
8257-5	8.90
8259	6.85
8259-5	7.45
8271	38.95
8272	38.95
8275	28.95
8279	8.90
8279-5	9.00
8283	6.45
8284	14.95
8286	6.45
8287	6.45
8288	24.00
8289	48.95

**Z-80
2.5 MHZ**

Z80-CPU	3.90
Z80-CTC	3.95
Z80-DART	10.95
Z80-DMA	13.95
Z80-PIO	3.95
Z80-SIO/0	11.95
Z80-SIO/1	11.95
Z80-SIO/2	11.95
Z80-SIO/9	11.95

4.0 MHZ

Z80A-CPU	4.29
Z80A-CTC	4.90
Z80A-DART	9.95
Z80A-DMA	12.95
Z80A-PIO	4.29
Z80A-SIO/0	12.95
Z80A-SIO/1	12.95
Z80A-SIO/2	12.95
Z80A-SIO/9	12.95

6.0 MHZ

Z80B-CPU	9.95
Z80B-CTC	12.95
Z80B-PIO	12.95
Z80B-DART	12.95

ZILOG

Z6132	33.95
Z8671	38.95

DISC CONTROLLERS

1771	15.95
1791	23.95
1793	25.95
1795	48.95
1797	48.95
2791	53.95
2793	53.95
2795	58.95
2797	58.95
6843	33.95
8272	38.95
UPD765	38.95
MB8876	28.95
MB8877	33.95
1691	16.95
2143	17.95

UARTS

AY3-1014	6.90
AY5-1013	3.90
AY3-1015	6.90
PT-1472	9.90
TR1602	3.90
2350	9.90
2651	8.90
TMS6011	5.90
IM6402	7.90
IM6403	6.90
INS8250	9.95

INTERFACE

8T26	1.54
8T28	1.84
8T95	.88
8T96	.88
8T97	.88
8T98	.88
DM8131	2.90
DP8304	2.24
DS8835	1.94
DS8836	.98

VOLTAGE REGULATORS

7805T	.74	7905T	.84
78MO5C	.34	7908T	.84
7808T	.74	7912T	.84
7812T	.74	7915T	.84
7815T	.74	7924T	.84
7824T	.74	7905K	1.44
7805K	1.34	7912K	1.44
7812K	1.34	7915K	1.44
7815K	1.34	7924K	1.44
7824K	1.34	79L05	.78
78L05	.68	79L12	.78
78L12	.68	79L15	.78
78L15	.68	LM323K	4.90
78H05K	9.90	UA78S40	1.90
78H12K	9.90		

C,T = TO-220 K = TO-3 L = TO-92

DIP SWITCHES

4 POSITION	.84
5 POSITION	.89
6 POSITION	.89
7 POSITION	.94
8 POSITION	.94

IC SOCKETS

	1-99	100
8 pin ST	.12	.10
14 pin ST	.14	.11
16 pin ST	.16	.12
18 pin ST	.19	.17
20 pin ST	.28	.26
22 pin ST	.29	.26
24 pin ST	.29	.26
28 pin ST	.39	.31
40 pin ST	.48	.38
64 pin ST	4.20	call

ST = SOLDERTAIL

8 pin WW	.58	.48
14 pin WW	.68	.51
16 pin WW	.68	.57
18 pin WW	.98	.89
20 pin WW	1.04	.97
22 pin WW	1.34	1.23
24 pin WW	1.44	1.30
28 pin WW	1.64	1.44
40 pin WW	1.94	1.75

WW = WIREWRAP

16 pin ZIF	5.90
24 pin ZIF	7.90
28 pin ZIF	6.90

ZIF = TEXTTOOL (Zero Insertion Force)

CRYSTALS

32.768khz	1.69
1.0 mhz	3.69
1.8432	3.69
2.0	2.69
2.097152	2.69
2.4578	2.69
3.2768	2.69
3.579535	2.69
4.0	2.69
5.0	2.69
5.0688	2.69
5.185	2.69
5.7143	2.69
6.0	2.69
6.144	2.69
6.5536	2.69
8.0	2.69
10.0	2.69
10.738635	2.89
14.31818	2.69
15.0	2.69
16.0	2.69
17.430	2.69
18.0	2.69
18.432	2.69
20.0	2.69
22.1184	2.69
32.0	2.69

RESISTORS

1/4 WATT 5% CARBON FILM, ALL STANDARD VALUES FROM 1 OHM TO 10 MEG OHM

50 pcs	1.25
100 pcs	2.00
1000 pcs	15.00

**5 1/4" DISKETTES
ATHANA**

SSSD	18.95
SSDD	22.95
DSDD	27.95

**BULK DISKETTES
5 1/4" DISKETTES
NO LABEL**

SINGLE SIDED DOUBLE DENSITY
(WITH JACKETS AND HUB RING)

Pack of Ten	\$ 16.95
Pack of 100	\$149.00

**SPRING
SPECIALS**

4116	250ns	49¢/ea
4116	200ns	89¢/ea

2708	8K EPROMS	2.49
2716	16K EPROMS	2.95
2732	32K EPROMS	3.95
2764	64K EPROMS	5.95
27128	128K EPROMS	19.95

4164	64K DYNAMIC 250ns	4.45
4164	64K DYNAMIC 200ns	5.45
4164	64K DYNAMIC 150ns	6.45

2114	450ns	8/7.95
------	-------	--------

**QUV-T8/1
EPROM Eraser**

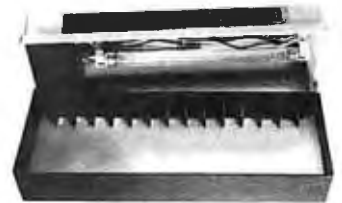

\$57.95

QUV-T8/1 Economy Model: This is a low cost EPROM Eraser housed in a plastic enclosure. The UV element and components are installed in the top lid and you place the EPROMS in the bottom half. No timer or switch option is included.

- Erases up to 8 EPROMS in 15 to 20 minutes.
- 12,000 u Watts at 1" distance.
- 90-Day Warranty

Do Kay

2100 De La Cruz Blvd.
Santa Clara, CA 95050

APPLE ACCESSORIES

80 Column Apple II+	149.95
80 Column Apple IIE	129.95
Z80 Apple II+	89.00
Z80 Apple II+ Kit	59.00
Z80 Apple IIE	89.00
Z80 Apple IIE Kit	59.00
16K Card	39.95
16K Bare Board	13.95
Cooling Fan	38.95
Power Supply	74.95
Joystick	29.95
RF Modulator	13.95
Disk Drive	199.00
Controller Card	59.95

micromax

VIEWMAX-80 149.⁹⁵

- 80 Column card for Apple II+
- Video Soft Switch
- Inverse Video
- 2 Year Warranty

VIEWMAX-80e 129.⁹⁵

- 80 Column card for Apple IIE
- 64K RAM expandable to 128K

64K RAM Upgrade 43.60

GRAPHMAX 129.⁵⁰

- Hi Resolution Graphics
- Printer Card
- Centronics Parallel Interface

**Graphmax with COLOR and ZOOM
Options 139.95**

APPLE COMPATIBLE DISK DRIVE



199.⁰⁰

- Shugart mechanism, made in U.S.A.
- Directly replaces Apple Disk II
- Fully compatible with Apple Controller or other Apple compatible controllers.
- One Year Warranty

CONTROLLER CARD 59.95

COOLING FAN

38.⁹⁵



APPLE COMPATIBLE POWER SUPPLY

74.⁹⁵



- Powers Apple-type systems
- +5V @ 5A +12V @ 3A
-5V @ .5A -12V @ .5A
- Includes Instructions

16K RAM Card Apple II+

- 2 Year Warranty



Assembled & Tested 39.95
Bare Board 13.95

APPLE COMPATIBLE JOYSTICK

29.⁹⁵



CALL TOLL FREE: (800) 538-8800
(800) 848-8008 In Calif.

Do Kay

2100 De La Cruz Blvd.
Santa Clara, CA 95050

The FLIP SORT™

The new Flip Sort™ has all the fine qualities of the original Flip Sort™, with some added benefits. Along with a new design, capacity has been **increased 50%** to hold 75 diskettes and the price is more reasonable than ever - **\$19.95**



The Flip Sort PLUS™

The Flip Sort Plus™ adds new dimensions to storage. Designed with similar elegant lines as the original Flip Sort™, in a transparent smoked acrylic. Holds over 100 diskettes and has all the outstanding features you have come to expect from the Flip Sort Family.

\$24.95



POWER SUPPLY

34.⁹⁵



MOUNTED on PC BOARD
Manufactured by CONVER

+5 VOLT, 4 AMP
±12 VOLT, 1 AMP

Dimensions: 8" x 4⁷/₈" x 2³/₄" deep

COMPUTER SUPPLIES
DISKETTES

5 1/4
5 1/8 S/D
MIN. ORDER 50 **\$160**

RIBBONS

OKIDATA,
MICROLINE 84 **\$377**

EPSON
MX100
MIN. ORDER 6 **\$784**

LABELS • CONTINUOUS FORMS

PeachText 5000 REG 395⁰⁰ 235⁰⁰
complete line of
EDUWARE SOFTWARE
plus other major brands

- Terms: Visa, M.C. or C.O.D.
- Dealer Inquiries Invited

**COMPU-MEDIA
SOFTWARE, INC.**
159 Main St. S.I.N.Y. 10307
CALL TOLL FREE 1-800-248-2418
in N.Y. State 212-967-1700



Circle 384 on inquiry card.

uniforth

One of the finest implementations of the FORTH language, field tested and reliable, UNIFORTH is available for the IBM PC as well as most systems with 8" disks and the following processors:

8080	PDP-11
Z80	68000
8086/8	16032

As a task, UNIFORTH is compatible with and supports all features and file types of the CP/M, CDOS, MS-DOS and OBC operating systems. As an operating system, UNIFORTH will function "stand-alone" on most commercial microcomputers.

The FORTH-79 Standard language has been extended with over 500 new words that provide full-screen and line-oriented editors, array and string handling, enhanced disk and terminal I/O, and an excellent assembler. Detailed reference manuals supply complete documentation for programming and system operation. In an easy-to-understand, conversational style using numerous examples.

Optional features include an excellent floating-point package with all transcendental functions (logs, tangents, etc.), the MetaFORTH cross-compiler, printer plotting and CP/M file transfer utilities, astronomical and amateur radio applications, word processing, etc.

Compare these features with any other FORTH on the market:

- Speed and efficiency
- Variety of options
- Ease of use
- Documentation quality

You'll find UNIFORTH is superior.
Prices start at \$35. Call or write for our free brochure.

Unified Software Systems
P.O. Box 2644, New Carrollton, MD 20784, (301) 552-1295

Circle 365 on inquiry card.

STOP GAMBLING -
Use your personal computer for expert handicapping like the experts do - - -

- **BASEBALL SYSTEM** Complete game and pitcher match-up, strength and performance evaluation, strongest play rating.
- **USFL FOOTBALL SYSTEM** predicts winning margin and total points.
- **BOTH SYSTEMS** include situation analysis, trend analysis, and unique handicapping guides. Simple operating manual. Use with Radio Shack, Apple, Commodore 64 and others.

START WINNING WITH

Send \$225. for either System includes free money mgt. program (worth \$50.) Enclose check, money order or Visa/MC card No.

- WRITE FOR MORE DATA FREE

**COMPUTER
HANDICAPPING
SYSTEMS**
P.O. Box 33034
Cleveland Ohio
44133-0034



• Order today-Win tomorrow

Circle 84 on inquiry card.

BASIC*—Extended BASIC for Apple Users
A powerful extension of Applesoft BASIC for engineers, scientists and students. Some of the BASIC* features are:

- **BUILT-IN COMPLEX ARITHMETIC**
Replaces Applesoft integer variables with complex variables for built-in complex arithmetic capabilities.
- **BUILT-IN COMPLEX FUNCTIONS**
Useful functions for complex arithmetic like CSQRT, CEXP, CABS and CLOG are available. Several complex/real and real/complex functions are standard.
- **POWERFUL EXTENDED HI-RES COMMANDS**
Area oriented byte graphic capabilities for pixel manipulation, image magnification, inter-screen and intra-screen image translation, and screen/memory data movement. Commands for screen switching and displays, and clearing screens to different background colors.
- **PROGRAMMABLE CHARACTER SETS**
Instead of the standard text screen, hi-res screens can be used for upper/lower cases and for mixed graphic modes. Programmable character sets for foreign language alphabets, variable fonts and animation applications.
- **VARIABLE PITCH SCREEN PRINTING**
Variable pitch printing capabilities permit printing 40 to 70 characters per line.

Several application programs (like FFT, EQUATION SOLVER) are contained in the BASIC* diskette to illustrate the powerful features of the language.

Requires APPLE II/II Plus with a 16K memory card or APPLE I/IE and one disk drive.
Price: \$60 + \$2 shipping and handling + 6% tax for California residents. We accept checks, Visa or Master Card.

Contact S.S. Reddi, Softesmythe Software,
PO Box 17043
Irvine, CA 92713
Phone: 714-540-1644 or 714-660-0167

Circle 408 on inquiry card.



**Best Prices On
TRS-80 Computers**

Our 6th year of discounts
Ed or Joe McManus
Fgt. Prepaid. Save Tax.
Toll Free 800-231-3680

Maryann Industries, Inc.
22511 Katy Fwy., Katy
(Houston) Tx 77450
1-713-392-0747
Telex 774132

See us in the Wall Street
Journal every Tues., Wed., Thurs.

Circle 222 on inquiry card.

Daisy Wheel Printer



\$249

- Dynax DX-15 Daisy Wheel 13 cps . \$425
- Silver Reed EXP 550 Daisy Wheel . \$595
- Brother HR-1 Daisy Wheel 16 cps . \$645
- Daisywriter 2000 w/48k \$999
- C. Itoh F-10 40 cps \$1095

* Prices subject to availability or change.

MICRO MART
8764 Complex Dr., San Diego, CA 92123
(619) 268-0169

Circle 239 on inquiry card.

DISK DRIVES
(For PC, Mod I, III & IV)

Tandon TM55-2	\$229
Tandon TM100-1	\$175
Tandon TM100-2	\$229
Tandon TM101-4	\$315
CDC 9409	\$239
Case and PS	\$ 45

PC EXPANSIONS

MAYNARD
Disk Controller \$162
Sandstar Series call
Internal 10MB Drive Systems. from \$969

QUADRAM
Quad board (64K) \$269

AST
Six Pak Plus: 64K SPC \$269
Mega Plus: 64K & SC \$269
I/O Plus (SC) \$114
2nd S or P or Game \$ 35

64K CHIPS
Set of nine \$ 55

HAYES
Smartmodem 1200 B \$435

VLM Computer Electronics
10 Park Place • Morristown, NJ 07960
(201) 267-3268 Visa MC. Check or COD

Computer Software Associates, an established software house, supplies software for COMMODORE, APPLE, and IBM home computers. CSA is currently looking to expand its product base of serious programs in the areas of home, education, and office.

Computer Software Associates offers over 30 years of market experience, worldwide distribution, innovative packaging, generous royalties, and programmer support.

Interested programmers should contact Mike Mahan, Product Development Department, Computer Software Associates, The Silk Mill, 44 Oak St., Newton Upper Falls, MA 02164 (617) 527-7510.



Circle 89 on inquiry card.

**SAVE 50%
ON BASF**



**LIFETIME GUARANTEE
DISKETTES**

Dealer Inquiries Invited

5 1/4" Soft Sector	Box/10
54974 1 side/dbl dens.	\$22.50
54980 2 sides/dbl dens.	\$30.80
54986 1 side/quad 96 tpi.	\$29.40
54992 2 sides/quad 96 tpi.	\$37.80
8" Soft Sector	
54998 1 side/sgl dens.	\$25.20
54021 1 side/dbl dens.	\$26.60
54061 2 sides/dbl dens.	\$34.30

Checks-VISA-MC-C.O.D./ Add \$2 Shipping
Call or write for our discount catalog.

LYBEN COMPUTER SYSTEMS
1250-E Rankin Dr., Troy, MI 48083
Phone: (313) 589-3440

Authorized Reseller
Information Processing Media

BASF

Circle 185 on inquiry card.

BUYER'S DISCOUNT GUIDE

Computer Savings

Coming Just Over The Horizon!

DISK DRIVES

SHUGART		
5 1/4" SA400 (35 TR) 160K	169.00	
5 1/4" SA400L (40 TR) 190K	189.00	
5 1/4" SA455L (40 TR) 320K 1/2 HGT	225.00	
8" SA801R(SS/DD) 600K	355.00	
QUME		
5 1/4" 142 (40 TR) 320K 1/2 HGT	225.00	
8" DT8 (842)	490.00	
MITSUBISHI		
8" M-2896-63 Thinline 8" DS/DD 1.2 MG	419.00	
8" M-2894-63 (110V) STD 8" DS/DD 1.2 MG	399.00	
CDC		
5 1/4" 9409-DS/DD	225.00	
TANDON		
5 1/4" TM100-1 SS/DD 160K	150.00	
5 1/4" TM100-2A DS/DD (320K) FOR IBM-PC	225.00	
TM101-4 (96 TPI Quad Den)	339.00	
8" TM848-2 (DS/DD) 1.2 MG	425.00	
SIEMAN'S		
8" FD100-8 (SS/DD) 110V 801 R	169.00	
8" FD100-8 (SS/DD) 220V Compatible	199.00	
MPI		
5 1/4" B-51 40TR SS/DD 180K	169.00	
5 1/4" B-52 40TR DS/DD 320K (FOR IBM PC)	210.00	

DRIVE CABINETS

8" CABINETS		
8" DDC88V28 w/PS vertical for 2-8" drives	269.00	
8" DDC88T-1 w/PS vertical for 2 or 4-8" thinline drives	269.00	
8" DDC88T-2 w/PS vertical for 2-8" thinline drives	200.00	
8" DDC8V w/PS vertical for 1-8" drive	249.00	
8" DDC88H w/PS horizontal for 2-8" drives	269.00	
5 1/4" CABINETS		
5 1/4" DDC5H w/PS horizontal for 1-5 1/4" drive	55.00	
5 1/4" DDC5V w/PS vertical for 1 ea. 5 1/4" drive	58.00	
5 1/4" DDC55V w/PS vertical for 2-5 1/4" drives (NEW)	85.00	
NEW "SLIMLINE" DRIVE CABINET		
5 1/4" DDC55H w/PS horizontal for 2 ea. 5 1/4" drive - Specify DRIVE	75.00	

TERMINALS

ADDS		
Viewpoint-A1 (White)	509.00	
Viewpoint-A2 (Green)	539.00	
Viewpoint-3A + (Green)	509.00	
Viewpoint 60-Same as Teletideo 925	715.00	
QUME		
QVT-102 80 Col. Green (910 comp)	549.00	
QVT-102 80 Col. Amber	560.00	
QVT-103 80/132 Col. Green	865.00	
QVT-103 80/132 Col. Amber	895.00	
QVT-108 80/132 Col. Amber (925 comp)	715.00	
TELEVIDEO		
TV910	529.00	
TV910+	565.00	
TV925 w/2nd page memory	715.00	
TV950 w/2nd, 3rd, 4th page memory	925.00	
TV970	1,019.00	
RG 1000/TV60 Graphics Upgrade for 925/950	1,100.00	
WYSE		
WYSE-100	725.00	
WYSE-300 (Color)	1,125.00	

PRINTERS

BROTHER		
HR-25 25 CPS Daisywheel	795.00	
HR-1A 17 CPS Daisywheel 3K Buff	495.00	
HR-1A 17 CPS Daisywheel 3K Buff	589.00	
DATA-SOUTH		
DS 180 180CPS/Serial or Par/Tractor	1,400.00	
DAISYWRITER		
Daisywriter 2000-48K Buffer/20TO40CPS LTR/Par	1,095.00	
DIABLO		
620 (25CPS/Serial)	920.00	
630 (40CPS/Multi-IF)	1,719.00	
630 ECS/IBM	2,100.00	
DYNAX		
Dynax-15 Par-13CPS Daisywheel	469.00	
Dynax 15 Serial-13CPS Daisywheel	525.00	
EPSON		
FX80 (160 CPS-Par 10")	CALL	
FX100 (160 CPS-Par 15")	CALL	
C. ITOH		
Pro-writer I (8510A) Par 120 CPS	359.00	
Pro-writer I (8510A) Serial 120 CPS	529.00	
F-10 40CPS/Diablo/Par or Serial	1,125.00	
F-10 55CPS/Diablo/Par or Serial	1,425.00	
JUKI		
6100-18CPS/Diablo Compatible Par/Daisywheel	569.00	
MANNESMAN-TALLY		
Spirit 80CPS Par 10"	330.00	
160L (160CPS-40CPS Letter Quality 10")	599.00	
180L (160CPS-40CPS Letter Quality 15")	839.00	

OUR BEST BUY

RITEMAN - Briefcase Size - 120 CPS - Par Port - Epson Compatible 289.00

OKI-DATA		
Microline 82A (SER & PAR-120CPS 10")	CALL	
Microline 83A (SER & PAR-120CPS 15")	CALL	
Microline 92 (PAR-160CPS-LTR-10")	CALL	
Microline 93 (PAR-160CPS-LTR-15")	CALL	
Microline 84P (PAR-200CPS-LTR-15")	CALL	
Microline 84S (SER-200CPS-LTR-15")	CALL	
STAR MICRONICS		
Gemini 10X NEW VERSION		
(PAR-120CPS-10")	CALL	
Gemini 15X (PAR-120CPS-15")	CALL	
Gemini Delta 10 (Par-160CPS-10")	CALL	
8K buffer serial)	CALL	
Star Radix 10 (Coming Soon)	CALL	
SILVER REED		
EXP 550P-17CPS Daisywheel-PAR	669.00	
EXP 550S-17CPS Daisywheel-Serial	699.00	
TOSHIBA		
P-1350 (192CPS-120CPSLTR (Specify Par or Serial)	CALL	

PRINTER ACCESSOR.

DIABLO		
Diablo 620-Uni-Direct Tractor	110.00	
Diablo 630-Bi-Direct Tractor	275.00	
Diablo 630-DBL Sheet Feeder	1,395.00	
JUKI-6100		
Serial Interface	55.00	
NEC		
Vertical Tractor	219.00	
Bi-Dir. Tractor	330.00	
Cut Sheet Feeder	1,100.00	
OKI-DATA		
82/92 Tractor	55.00	
Serial Intf. w/2K Buffer (For 92 & 93)	110.00	
Okigraph I 82A or 83A Graphics ROM	50.00	
Okigraph II 82A or 83A Disk for Apple	60.00	
STAR-MICRONICS		
Serial Intf. Bd	70.00	
Serial Intf. Bd w/4K Buffer	120.00	
TOSHIBA		
P-1350 Cut Sheet Feeder	800.00	
P-1350 Bi-Dir. Tractor	210.00	
TI-PROFESSIONAL		
LOTUS 1-2-3	369.00	
QUADRAM TI-64 64K Ram Card	206.00	
QUADRAM TI-92 192K Ram Card	339.00	

MODEMS

ANCHOR		
Anchor Mark XII Totally Hayes		
1200 Compatible	299.00	
Hayes Smart 300	219.00	
Hayes Smart 1200	499.00	
U.S. Robotics 212A Auto Dial	469.00	
U.S. Robotics (300/1200) Password	375.00	

ERASERS

E-PROM ERASERS		
QUV-T8/1H (hobby)	49.95	
QUV-T8/21 (Industrial version)	68.95	
QUV-T8/2P (w/timer & safety switch)	97.50	

SURGE ELIMINATORS

AC SURGE ELIMINATORS		
Lemon (6AC outlets-3 prong)	44.00	
Lime (5-3 prong pwr cord w/on-off switch)	69.00	
Orange-AC surge + EMI filter (6 outlets)	95.00	
Peach (3 outlets) AC surge/EMI filter	69.00	

Mail Orders

P.O. Box 3150
Salt Lake City, Utah 84110
Monday-Friday 8 AM to 6 PM
Saturday 10 AM to 5 PM

8 YEARS (1976) EXPERIENCE IN COMPUTER MAIL ORDER BUSINESS
CALIFORNIA RESIDENTS SAVE 6% SALES TAX

1-801-972-2717

BUYER'S DISCOUNT GUIDE

SYSTEMS



COMPUPROS S-100

COMPUPRO 816A 4,250.00
 COMPUPRO 816B 5,595.00
 COMPUPRO 816C 7,150.00
 Call for specifications



APPLE/ FRANKLIN

APPLE IIE Starter—Includes CPU 1 F.D. Monitor and 80 Col Card 1,325.00
 FRANKLIN ACE 1000 w/color 799.00
 FRANKLIN ACE 1200 OMS includes CPU-2 F.D. and bundled software 1,699.00

OUR BEST BUY
MAXELL

Sgl. side/dbl. den 5 1/4" 24.00
 Dbl. side/dbl. den 5 1/4" 36.00
 Dbl. side/quad den 5 1/4" 45.00

1-801-972-2717



IBM P.C.

IBM PC-1—Includes 64K RAM, 1 ea. 320K Disk Drive 1,995.00
 IBM PC-2—Includes 64 RAM, 2 ea. 320K Disk Drive 2,250.00
 IBM PC-3—Includes 256K RAM, 2 ea. 320K Disk Drive, Mono Adapter, Mono Display 2,999.00
 IBM PC-4—Includes 256K RAM, 2 ea. 320K Disk Drive, Color Card, Princeton HX12 Display 3,395.00



KAYPRO

KAYPRO 11 w/bundled software 1,475.00
 KAYPRO 4 w/bundled software 1,695.00
 KAYPRO 10 w/bundled software 2,495.00
 Call for specifications

KAYPRO II-IV ADD ONS

Sprinter K (5MHZ Speed-up) 99.00
 K-Clock (Batt Backup Clk/Cal) 99.50
 Video Output BD—(allows use of video monitor) 125.00



NEC PORTABLE

PC8201A-Portable 2.4 MHZ CPU 16K Ram/ Expands to 64K-32K RAM LCD Display—Keybd (67 key-5 function) Modem, Serial and Par Port-FD and Cassette Interface—Uses 4AA Batt—bundled software 660.00
 8201-06 Ram Chip - (8k) mod 105.00
 8206-A 32k Ram Cartridge - mod 329.00
 8221-A Thermal Printer - print 149.00
 8271-02 AC Adap/Print & Rec. - accs 15.00
 8271-A AC Adaptor - accs 17.00
 8281-A Cassette Recorder - accs 105.00
 9201A-90 Nicad Battery Pak - accs 16.00
 Modem Communication Cable - accs 25.00
 Thermal paper for 8221-A - accs (5 rolls per pack) 13.00



COLUMBIA

COLUMBIA (1600-1) 16 bit 128K Ram 2 ea. 320K Disk Drive-2 SER, 1 PAR, Key Bd, 8 slots Display Cd, bundled software 2,775.00
 V.P.—16 BIT 128K RAM 2 each 320K drives, SER & PAR Port, 8" monitor 2,690.00

SANYO PORTABLE

MBC-550 (PC Compatible) 1 F.D. w /software 849.00
 MBC-555 2 F.D. w/software 1,249.00

TOLL FREE
1-800-545-2633

1780 West 2300 South The Great Salt Lake Computer Co. Salt Lake City, Utah 84119

BUYER'S DISCOUNT GUIDE

Minimum Shipping \$3.00
TOLL FREE 1-800-545-2633
in the Continental U.S.A

QT PRODUCTS



QT 8" THINLINE MAINFRAME

•Provisions for 2 ea 8" thinline drives • 6 ea DB 25 cutout • 2 ea 50 pin • 2 ea 34 pin • 1 ea Centronic • EMI filter (fused) • 2 AC outlets • Power supply (+8V16A/-5V/+24V6A+5V6A)
QTC-IMF + DD6F (6 slot MB) 350.00



QT 5 1/4" MAINFRAME

•Provisions for any 2-5 1/4" drives • 15 ea DB 25 cutout • 2 ea 50 pin • 2 ea 34 pin • 1 ea Centronic • EMI filter (fused) • 2 AC outlets • Avbl. with 6-8 or 12 slot motherbd • Power supply (+8V16A/+12V5A)
7013/QTC-MF + MD12 (12 slot MB) 560.00



QT 8" MAINFRAME

•Provision for any 2-8" drives (hard or floppy)
•15 ea DB 25 cutout • 2 ea 50 pin • 2 ea 34 pin • 1 ea Centronic • EMI filter (fused) • 2 AC outlets • Avbl. with 6-8 or 12 slot motherbd • Power supply (+8V16A/-16V3A/+5V6A/-5V1A/+24V6A)
Desk Top Version
QTC-MF + DD6 (6 Slot MB) 575.00
QTC-MF + DD8 (8 Slot MB) 625.00
QTC-MF + DD12 (12 Slot MB) 675.00



QT STANDARD MAINFRAME

•Provisions for any 2-5 1/4" drives • 15 ea DB 25 cutout • 2 ea 50 pin • 2 ea 34 pin • 1 ea Centronic • EMI filter (fused) • 2 AC outlets • Avbl. with 6-8-12-18 or 22 slot MB • Power supply (+8V16A-16V3A)
Desk Top Version
7014/QTC-MF + 12 499.00
7016/QTC-MF + 18 525.00
7015/QTC-MF + 22 550.00



QT DISK DRIVE CABINETS

"All in one" Vertical Disk Drive Cabinet

For 1) 2 ea or 4 ea 8" thinline drive or 2 ea. std. 8" 2) 1 ea hard disk + 1 ea standard 8"
• Power supply (+5V6A/-5V1A/+24V6A)
• Positive pressure fan w/filter • EMI filter
• Power interface cable for any 8" drive
QTC-DDC88V For 2 standard size 8" drives 269.00
QTC-DDC88T For 2 thinline 8" drives 269.00
QTC-DD87 For 1 ea 8" drive 249.00
For 2 ea 8" standard size drives (horizontal)
• Power supply (+5V6A/-5V1A/+24V6A)
• Interface cable for any 8" drive
QTC-DDC88H 269.00

DATA CABLES

8"DSC 88-2SKT-for 2-8" drvs w/skt. conn. 20.00
5 1/4"DSC55-2SKT-for 1-5 1/4" drvs w/skt. conn. 20.00
RS232MM-5' (male to male) 19.00
IBM to PAR or COLUMBIA to PAR 32.00
Osborne to PAR 32.00
Kaypro to PAR 32.00
OKI-Data Serial 24.00

S-100 PRODUCTS

QT PRODUCTS

QT S-100 CARD CAGES

•Made of anodized steel • Card guides for ea. MB • 1-Indicates w/MB • 2-Indicates w/MB +1 ea fan • 3-Indicates w/MB +2 ea fans

CC4	20.00
CC4-1	60.00
CC6	22.00
CC6-1	70.00
CC6-2	90.00
CC8	31.00
CC8-1	100.00
CC8-2	120.00
CC12	41.00
CC12-1	140.00
CC12-2	160.00
CC12-3	180.00
CC18	50.00
CC18-1	200.00
CC18-2	220.00
CC18-3	240.00
CC22	75.00

QT S-100 MOTHERBOARDS

•Silence Plus • Built in Termination • IE696 • Terminal strip for easy power connection

4 Slot Motherboards	
QTC-MB4BB	15.00
QTC-MB4A	40.00
6 Slot Motherboards	
QTC-MB6BB	20.00
QTC-MB6A	48.00
8 Slot Motherboards	
QTC-MB8BB	25.00
QTC-MB8A	69.00
12 Slot Motherboards	
QTC-MB12BB	30.00
QTC-MB12A	99.00
18 Slot Motherboards	
QTC-MB18BB	45.00
QTC-MB18A	150.00
22 Slot Motherboards	
QTC-MB22BB	60.00
QTC-MB22A	185.00

QT/COMPUTIME BOARD SET

PN-2048 Best Bare Board Set Available

QTC-SBC 2/4 CPU (SBC880)
QTC-EXP + III 256K (CT256) Memory bd./
Expandable to 1 MG
QTC-FDC 5/8 Floppy disk controller
Bare Board Set 165.00
1) Includes manuals & assembly instructions
2) Parts available 3) Monitor & BIOS available

QT COMPUTIME CLOCK/CALENDAR

S-100 • Time in hrs. min. sec. • AM/PM or Military
Format • Date in Mo., Day, Yr., Day of Week & Leap Year
recognition • 4 hard interrupts (1024 Hz, 1 Hz 1 min,
1 hr) • On board battery (will last 14 mos. w/no power on)

QTC-CCS-BB (S-100)	45.00
QTC-CCS-A (A+T) for S-100	100.00
CPU BOARDS/MEMORY BOARDS/I/O	
QTC-SBC 2/4 BB (SBC880)	50.00
QTC-SBC 2/4 AA + T (SBC880)	265.00
DYNAMIC (64K/256K or 1 MEG)	
QTC-EXP + III Bare Bd. (CT256)	75.00
QTC-EXP + III 64K A + T (CT256)	375.00
QTC-I/O + BB 2 SER 2 PAR A + T	75.00
QTC-I/O + A + T	300.00
QTC-ADA ADA Converter A + T	575.00
QTC-Dual GPIB-488 IEEE 488 Interface Bd.	795.00

COMPUPRO PROD.



SYSTEMS

System 816A	4,395.00
System 816A with RAM 21	4,569.00
System 816A - H40	7,169.00
System 816B	5,595.00
System 816B - H40	8,349.00
System 816C	7,150.00
System 816C - H40	9,999.00
System 816D	11,099.00
System 816D - H40	13,995.00
System 816E (68K)	7,150.00
System 816E - H40	9,999.00
System 816Z	3,999.00
System 816Z - H40	6,725.00

CPU BOARDS

CPU Z 6 MHz	245.00
CPU 8085/88 - 6/8 MHz	369.00
CPU 8086 - 8 MHz	650.00
CPU 8086 - 10 MHz	750.00
CPU 68K - 8 MHz	575.00
SPUZ (March '84)	575.00

MEMORY BOARDS

RAM 16	475.00
RAM 17-64	369.00
RAM 21	839.00
RAM 22	1,475.00
M-DRIVE H	1,199.00

INTERFACE BOARDS

Interfacer 1	220.00
Interfacer 2	245.00
Interfacer 3	575.00
Interfacer 4	349.00

DISK CONTROLLERS

Disk 1	399.00
Disk 1A	575.00
Disk 2 (in 1. CP/M 80)	750.00
Disk 3	750.00

DISK DRIVE SUBSYSTEMS

8" Floppy/H-40	4,995.00
8" Dual H-40 w/encl.	6,000.00
Dual Floppy Subsystem	2,695.00

MOTHERBOARDS AND COMPUTER ENCLOSURES

6 Slot Motherboard	129.00
12 Slot Motherboard	149.00
20 Slot Motherboard	220.00
Enclosure 2-D	739.00
Enclosure 2-R	795.00

MISCELLANEOUS BOARDS/CONTROLLERS

Memory Manager	75.00
System Support 1	349.00
MPX 1	495.00
Active Terminator	60.00
8087 Support Board for 8085/88	379.00
WARRANTY: 1 year from date of purchase by end user	

OPERATING SYSTEMS

CP/M 80 2.2 (Disk 1)	150.00
CP/M 86 (Disk 1 8085/88)	199.00
MP/M 8-16 (For 8085/88)	495.00
MAP FORTH OS	169.00
CP/M 68K	269.00

SIERRA DATA S-100 BOARDS

SDS-SBC-100-Z80 (4mhz) master 2 serial 2 par/ floppy controller/64k ram	655.00
SDS-SBC-100S4mhs slave/2 serial 2 par/ 64k ram	565.00
SDS-ZSIO/4-4 serial port I/O bd	250.00
SDS-MUX-RS232 multiplexer bd	235.00
SDS-HDI-M-Hard disk bd for micropolis	129.00
SDS-CPM/B105-cp/m for SBC 100 w/BIOS	150.00
SDS-Turbodos-Multi-user for master & slaves	645.00

1-801-972-2717

BUYER'S DISCOUNT GUIDE

Call Toll Free
1-800-545-2633

DISPLAY MONITORS

GREEN	
BMC 12AU (15MHZ) 80 Col/12"	80.00
USI PI-1 (20 MHZ) Hi-Res/9"	119.00
USI PI-2 (20 MHZ) Hi-Res/12"	129.00
AMBER	
USI PI-4 (20 MHZ) Hi-Res/80-Col/9"	125.00
USI PI-3 (20 MHZ) Hi-Res/80 Col/12"	119.00
COLOR	
Amdex I-12" Composite (For Apple)	259.00
Amdex II-12"-RGB (For IBM-PC) w/audio	419.00

OUR BEST BUY
OUR BEST BUY FOR APPLE
Amdex I + Composite w/audio 275.00
OUR BEST BUY FOR IBM
Princeton HX-12-RGB (For IBM-PC) 469.00

DISKETTES

DISKETTES FOR APPLE, ETC.	
5 1/4" Soft Sector SS/DD	17.00/10
For IBM PC & PARTNERS for Qty of 100 (15% Discount)	
5 1/4" Soft Sector DS/DD	22.00/10

CENTECH

**COLOR CODE YOUR FILES:
5 COLORS IN EACH PKG. (RED,
YELLOW, BLUE, GREEN, BROWN)**

5 1/4" Sgl side/dbl den—Rainbow Pak	23.00/10
5 1/4" Dbl side/dbl den—Rainbow Pak	30.00/10
5 1/4" 10 sector—Rainbow Pak	24.00/10
5 1/4" 16 sector—Rainbow Pak	24.00/10
8" Sgl side/dbl den—Rainbow Pak	30.00/10
8" Dbl side/dbl den—Rainbow Pak	40.00/10
Lifetime Warranty	Also Available in Solid Color
Hub Rings	Specify Color

DISKETTE STORAGE

DISKETTE STORAGE DATA SAFE	
DS-50 (holds 50 disks)	15.00
LIBRARY CASES	
CAS-5 1/2 (Avail. beige, black, red, grey, blue) 2.35 ea.	
CAS-8	3.80 ea.
Color Burst Pack (Pack of 5 ea. CAS-5)	10.95

CONNECTORS RS232 Connectors SOLDER TYPE	
DB25P	2.50
DB25S	3.00
DB25 Hood	1.00
S-100 Connectors	10/25.00
DE9P	2.00
DE9 Hood	1.00

1-801-972-2717

IBM ACCESSORIES

AST PRODUCTS	
Combo Plus (Serial/Par/CLK 64 to 256K)	259.00
Six Pak Plus (Serial/Par/CLK 64K Expands to 384K)	279.00
Six Pak Plus (Serial/Par/CLK 384K)	569.00
Meg-A-Plus (Serial/CLK/64K Expands to 256K)	270.00
Meg-A-Pak (Expands Meg-A-Plus to 512K)	270.00
AST-5251 (Allows connection of IBM PC to System 340038)	749.00
Game Port Kit	45.00
Par Port Kit	45.00
Serial Port Kit	45.00

D.C. HAYES	
Smartmodem 1200B-Smartcom 2 software included	429.00
Smartcom II	79.00

KEYTRONICS	
Enhance your PC-with a superior keyboard	210.00

OUR BEST BUY
M.P.I.
B-52 (DS/DD) 320K (Saves Disk's & Disk Head) 210.00

PLANTRONICS COLOR PLUS	
Color + Color Display Card (16 colors)	395.00

PRINCETON GRAPHICS	
PGS HX12-Hi-Res Color, The Best	469.00

QUADRAM	
Quadlink—Allows Apple Software to be used in IBM PC HAS 64K Ram-Game Port Display Gen-Disk Intf. w/software	450.00
Quadcolor	219.00

SHUGART DISK DRIVES	
SA455L-1/2 HGT 320K DS/DD w/BRACKETS	225.00 ea. 420.00 for 2 ea.

TANDON DISK DRIVES	
TM 100-2A 320K DS/DD	225.00
TM55-2 1/2 HGT 320K DS/DD w/BRACKETS	249.00 ea. 440.00 for 2

VISTA	
Diskmaster (controls 5" & 8")	169.00

IBM UP-GRADE KIT INCLUDES 9 E/ 1164-200NS FOR EXPANSION ON ALL IBM PRODUCTS WITH PARITY \$55.00/per set

TOLL FREE 1-800-545-2633

APPLE/FRANKLIN

APPLE	
Disk II	269.00
Monitor II	99.00

ALS	
CPM 3.0 Card	269.00
Z-Card II	119.00
Smarterm	139.00

ASTAR	
RF Modulator	18.00

COMPUERVE	
Beginner's Kit (5 hrs. time)	39.95
Software for IIE	59.00

GENERIC	
80 Col. Video (Videx Compatible)	99.00
Joy Stick	20.00
Keyboard	175.00
Parallel Interface	49.00

HAYES JOYSTICKS	
Mach II (For I & IIE)	33.95
Mach III (with firing button)	42.95

HAYES MODEMS	
Micro-Modem II	259.00
Micro-Model II w/terminal package	279.00

KENSINGTON	
System Saver/Fan & Surge Pro	75.00

KOALA	
Graphics Tablet	89.00

KRAFT	
Joystick for IIE	44.00

MICRO-MAX	
View Max 80 (90 Col for II+)	149.00
View Max 80E (80 Col w/64K Memory Exp to 128K)	139.00

MICRO-SOFT	
Premium Soft Card IIE	379.00
Multi-Plan	189.00
Softcard (Z80)	239.00

MICROTEK	
Dumpling 64K/Interface and Graphics 64K Buffer	235.00
Dumpling GX-P/Par Interface Card and Cable	99.00
Parallel Interface Board (RV611C)	61.00
BAM 16 (16K Add-on Memory)	55.00
Serial Interface	99.00

NOVATION	
Apple Cat II w/software	269.00

ORANGE MICRO	
Grappler + (Graphics Interface)	119.00
Grappler + 16K (Buffer and 5 to 64K)	175.00
Buffer Board	135.00

TG PRODUCTS	
Joy Stick—For Apple II+	38.00
Paddles	29.00
Selecta Port	38.00

VIDEX	
Ultraterm	279.00
Videterm	179.00

VISTA	
A800 Floppy Controller for 8" Drives	300.00
A-800-1 Cable	27.00

APPLE DISK DRIVES ALL DRIVES 1 YR. WARRANTY

Vista Solo (35TR)	189.00
Micro-Sci A-2 (35TR)	209.00
Micro-Sci Controller	70.00
Super 5 "THINLINE" 1/2 size 163K 40TR Green	189.00
Super 5 "THINLINE" 1/2 size 163K 40TR (TEAC DIRECT DRIVE) Red	225.00
WESPER	
Specify Printer (Same as Grappler + 16K WIZARD IPI (Same as Grappler + Specify Printer)	149.00
WIZARD EBO (Internal Buffer for Epson)	79.00
	109.00

SANYO CP/M® COMPUTER + PRINTER = \$1795

NOW! The Affordable UPS For Your Personal Computer!

INDUSTRIALS \$359.00

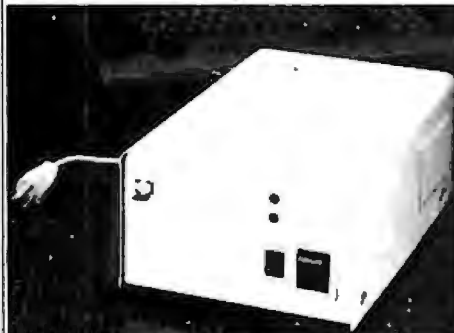

200 Watts For 5 Minutes of Uninterruptable Power With AC Surge and EMI/RFI Filtering BUILT IN! Perfect for Morrow Micro Decision, IBM PC™, Apple IIe, and many, many more!

BCPTIPC200 (Sh. Wt. 21 lbs.) \$359.00

MANNESMANN TALLY



Letter Quality Dot Matrix Printer For Complete Specifications, see page 41 of our new '83/'84 Engineering Selection Guide

- BCTALMT100L 80 column/160 cps (21 lbs.) \$589
- BCTALMT180L 132 column/160 cps (28 lbs.) \$829
- BCTALMTR160 Replacement Ribbon for MT160L \$15.75
- BCTALMTR180 Replacement Ribbon for MT180L \$17.80

Order Interface Cables at Left

PIXY 3 PLOTTER

High Quality, economical 3 color plotter. See page 37 of our '83/'84 Engineering Selection for details.

- BCTALPIX3P w/parallel interface (sh. wt. 16 lbs.) \$699
- BCTALPIX3S w/serial interface (sh. wt. 16 lbs.) \$769

TAXAN



18MHz 800 Line Resolution Yields An Incredibly Sharp 80 x 24 Display!

AMDER

BCTAXG12N0Y List: \$189.00

\$129.00

(Shipping Weight 18 lbs.)

GREEN

BCTAXG12N0Y List: \$179.00

\$119.00

(Shipping Weight 18 lbs.)

Buy From The World's Largest Supplier of S-100 Boards



CPU BOARDS

Item	Description	List Price	SALE Price
BCGBT51068	CPU 68K A&T 8MHz	\$ 695.00	\$ 595.00
BCGBT51588	CPU 68K CSC 10MHz	\$ 850.00	\$ 765.00
BCGBT51086	Co-Processor w/8086 only A&T	\$ 750.00	\$ 675.00
BCGBT51586	Co-Processor w/8086 only CSCS	\$ 850.00	\$ 785.00
BCGBT51067	CPU 8086/8087 A&T	\$1050.00	\$ 939.00
BCGBT51587	CPU 8086/8087 CSC	\$1150.00	\$1065.00
BCGBT51080	CPU 8085/88 A&T	\$ 495.00	\$ 389.00
BCGBT51580	CPU 8085/88 CSC	\$ 595.00	\$ 497.87
BCGBT51080	3/6MHz CPU-Z A&T	\$ 325.00	\$ 279.00
BCGBT51580	3/6MHz CPU-Z CSC	\$ 425.00	\$ 347.87

DISK CONTROLLER BOARDS

Item	Description	List Price	SALE Price
BAP0171ACPM	DISK 1 (A&T) w/CP/M® 2.2	\$670.00	\$499.00
<i>When purchased with two 8" disk drives: \$450.00</i>			
BCGBT4016	DISK 1 Floppy controller (A&T)	\$495.00	\$425.00
BCGBT41000	CP/M® 2.2 for Z80/8085 w/manuals & BIOS 8" S/D Disk	\$495.00	\$148.95
BCGBT41050	CP/M-86* for CPU 8085/88 & CPU 8086/87 CPUs w/manuals, BIOS 8" S/D Disk	\$495.00	\$249.00
BCGBT4025	DISK 2 8" hard disk controller	\$795.00	\$725.00
BCGBT4030	DISK 3 ST-506 type 5 1/4" hard disk controller w/CP/M-80* & CP/M-86* (A&T)	\$795.00	\$725.00

I/O BOARDS

Item	Description	List Price	SALE Price
BCGBT50010	System Support 1 Multifunction I/O (A&T)	\$450.00	\$375.00
BCGBT50010/50531	SS1 w/8231 Math Chip A&T	\$645.00	\$570.00
BCGBT50010/50320	SS1 w/8232 Math Chip A&T	\$645.00	\$570.00
BCGBT53030	Interfacer 3 - B port serial (A&T)	\$699.00	\$599.00
BCGBT53040	Interfacer 4 - 3 Serial 1 Centronics Parallel 1 Parallel (A&T)	\$450.00	\$389.00

8/16 BIT MEMORY BOARDS

Item	Description	List Price	SALE Price
BCGBT52018	RAM 16 12MHz 32K Static A&T	\$550.00	\$405.00
BCGBT52021	RAM 21 12MHz 128K Static A&T	\$995.00	\$895.00
BCGBT52022	RAM 22 12MHz 256K Static A&T	\$1750.00	\$1549.00
BCGBT52012	M-Drive/H 512K RAM Disk A&T	\$1475.00	\$1195.00

MAINFRAMES

Item	Description	List Price	SALE Price
BCGBT51200	20 Slot Desk Top (A&T)	\$925.00	\$795.00
BCGBT51250	20 Slot Rack Mount (A&T)	\$975.00	\$850.00

For more CompuPro Specifications see pages 2 - 33 of our New Catalog

Vector

Manufactured by Vector Electronic Co. under license from CompuPro

Item	Description	List Price	SALE Price
BCVCT8000GF2	Interfacer 1, 2-Serial (A&T)	\$295.00	\$219.00
BCVCT8000PF2	Interfacer 2, 3-Par., 1-Ser (A&T)	\$325.00	\$239.00
BCVCT8000GA170	RAM 17 64K 10MHz Static RAM (A&T)	\$450.00	\$389.00

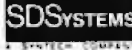

Item	Description	List Price	SALE Price
BCS0S30095	SBC-300 4MHz Z80 A&T	\$741.00	\$ 619.00
BCS0S30082	SBC-300 6MHz Z80 B CPU A&T	\$825.00	\$ 689.00
BCS0S30007	Z80 Starter System A&T	\$ 450.00	\$ 399.00
BCS0S30088	ExpandoRAM IV 256K A&T	\$1145.00	\$ 975.00
BCS0S30089	ExpandoRAM IV 256K w/EDC A&T	\$1990.00	\$1675.00
BCS0S30097	ExpandoRAM III/696 256K	\$ 825.00	\$ 749.00
BCS0S30076	PROM-100 w/software A&T	\$ 285.00	\$ 219.00
BCS0S30082	RAM Disk 256K A&T	\$ 875.00	\$ 775.00
BCS0S30081	RDIM Disc 128K A&T	\$ 350.00	\$ 319.00
BCS0S30088	I/O-8 4-Port Async Ser. A&T	\$ 600.00	\$ 549.00
BCS0S30093	I/O-8 8-Port Async Ser. A&T	\$ 695.00	\$ 589.00
BCS0S30094	I/O-8 4 Sync. 4 Async. 8-Port Serial I/O A&T	\$ 795.00	\$ 699.00
BCS0S30099	Versafloppy III Floppy & ST-506 Hard Disk Controller	\$ 895.00	\$ 759.00
BCPDBVF339145*	w/5 1/4" unbanked CP/M® 3.0	\$1083.00	\$ 888.00
BCPDBVF339146*	w/8" unbanked CP/M® 3.0	\$1083.00	\$ 888.00
BCPDBVF339147*	w/5 1/4" banked CP/M® 3.0	\$1083.00	\$ 888.00
BCPDBVF339148*	w/8" banked CP/M® 3.0	\$1083.00	\$ 888.00
BCS0S30098	Versafloppy II/696 (A&T)	\$ 400.00	\$ 344.00
BCPDBVF239141*	w/5 1/4" unbanked CP/M® 3.0	\$ 588.00	\$ 424.00
BCPDBVF239142*	w/8" unbanked CP/M® 3.0	\$ 588.00	\$ 424.00
BCPDBVF239143*	w/5 1/4" banked CP/M® 3.0	\$ 588.00	\$ 424.00
BCPDBVF239144*	w/8" banked CP/M® 3.0	\$ 588.00	\$ 424.00

*CP/M-Plus™ (3.0) configured for the SBC-300

See Complete Specifications on Pages 12-25 Of Our '83/'84 Engineering Selection Guide



BOARD LEVEL PRODUCT

Item	Description	List Price	SALE Price
BCOCTCP0816	8/16 Bit SBC (A&T)	\$ 895.00	\$ 795.00
BCOCT0807NBP	8087 for CPU 8/16	\$ 300.00	
BCOCTCPM86	CP/M-86*	\$ 150.00	
BCOCTCONCPM88	Concurrent CP/M-86*	\$ 195.00	
BCOCTMPM86	MP/M-86*	\$ 495.00	
BCOCTHDC	ST-506 Hard Disc Controller	\$ 595.00	\$ 525.00
BCOCTHDSUB19	19.2Mb Hard Disc Subsystem	\$2295.00	\$1995.00
BCOCT528TDD	256K Static RAM (A&T)	\$1850.00	\$1719.00
BCOCT512K	512K Dynamic RAM (A&T)	\$1450.00	\$1345.00

See Specifications on Pages 12-27 Of Our '83/'84 Engineering Selection Guide

COMPLETE OCTAGON 8/16" SYSTEMS

Item	Description	List Price	SALE Price
BCOCT816SMPM	w/256K Static RAM & MP/M-86*	\$7350.00	
BCOCT816SCPM	w/256K Static RAM & Concurrent CP/M-86	\$7350.00	
BCOCT816OMP	w/512K Dynamic RAM & MP/M-86	\$7350.00	
BCOCT816OCCPM	w/512K Dynamic RAM & Concurrent CP/M-86	\$7350.00	

See Complete Specifications on Page 5 Of Our New '83/'84 Engineering Selection Guide

Circle 292 on inquiry card.

Z80 SINGLE BOARD COMPUTERS

Part Number	Description	List Price	SALE Price
BCADCSUP0120	Super Six 6MHz 128K Master w/1 ADC PS1 RS232 Serial Adapter	\$995.00	\$649.00
BCADCSPRS10120	Super Slave 6MHz 128K	\$695.00	\$595.00
BCADCSB015	Super Quad for 5 1/4" drives	\$750.00	\$695.00
BCADCSB018	Super Quad for 8" drives	\$750.00	\$695.00

SOFTWARE & I/O PORT ADAPTERS

Item	Description	List Price	SALE Price
BCADCP31	PS/Net/ RS232 Serial Adapter	\$ 35.00	
BCADCCP5P	Centronics Parallel Port Adapter	\$ 35.00	
BCADCCPM22+†	Advanced Digital CP/M® 2.2	\$150.00	
BCADCCPM30+†	Advanced Digital CP/M Plus™ (3.0)	\$350.00	
BCADCTDS4U+†	TurboDos® 1.2, or 4 Multi-user	\$550.00	

*Replace * with 0 to specify Super Quad; † for Super Six † Replace † with 0 for 8" IBM® 3740 format, ‡ for 5 1/4" 48 TPI format or 96 for 5 1/4" 96 TPI format.

ST506/SA100Q

HARD DISK CONTROLLER

Item	Description	List Price	SALE Price
BCADCHDC10015	ST506 5 1/4" Winchester Cont.	\$500.00	\$450.00
BCADCHDC10018	8" Winchester Cont.	\$500.00	\$450.00
BCADCHDCINSTL	Install program for use with non-ADC CPU board (Supplied on 8" CP/M® compatible disk)	\$ 10.00	

See Complete Specifications on Pages 14 - 27 of our '83/'84 Engineering Selection Guide

MACROTECH International Corp.

MAX: 1 S-100 SLOT

1 MEGABYTE

The MACROTECH MAX is a 256K to 1 Megabyte S-100 IEEE/696 dynamic memory board. That's right, up to 1 Megabyte on a single standard size S-100 board. The first 384K is on the Host card that plugs into your motherboard. The remaining 640K is located on a unique "piggy-back" card that attaches to the host. The MAX family is ideally suited to applications where density, speed, and software flexibility are essential.

See Page 16 Of Our New '83/'84 Engineering Selection Guide for Complete Specifications

Ordering Information: The 256K and 384K versions include the fully socketed Host card. The 512K and larger versions also include the fully socketed "piggy-back" card.

Item	Description	List Price	SALE Price
BCMACMAX256	256K Dynamic RAM (A&T)	\$1125.00	\$1165.00
BCMACMAX384	384 Dynamic RAM (A&T)	\$1467.00	\$1395.00
BCMACMAX512	512K Dynamic RAM (A&T)	\$1880.00	\$1795.00
BCMACMAXM	1 MEG Dynamic RAM (A&T)	\$2449.00	\$2325.00
BCMACMAXTM	MAX Technical Manual	\$ 15.00	
BCMACMAXVDSK	MAX Virtual Disk Software supplies on 8" S/D Disk	\$ 25.00	
BCMACM3	Memory Mapping Option	\$ 91.00	
Attention CompuPro CPU 8085/88 Users: You must order the CPU modification hardware to insure complete compatibility.			
BCMACBMTDD	Hardware modification for CompuPro CPU 8085/88	\$ 10.00	

SEE PAGE 392 IN FEBRUARY BYTE

DRIVES & ENCLOSURES

5 1/4" FLOPPY DISK DRIVES

BCMPI51*	MPI Full Height SS 48TPI (5 lbs.)	\$200.00
BCMPI52*	MPI Full Height DS 48TPI (5 lbs.)	\$270.00
BCMPI91*	MPI Full Height SS 96TPI (5 lbs.)	\$275.00
BCMPI92*	MPI Full Height DS 96TPI (5 lbs.)	\$400.00
BCMPI501	MPI 1/2-Height SS 48TPI (4 lbs.)	\$260.00
BCMPI502	MPI 1/2-Height DS 48TPI (4 lbs.)	\$300.00
BCTNDTM1001	Tandon Full Height SS 48TPI	\$199.00
BCTNDTM1002	Tandon Full Height DS 48TPI	\$249.00
BCTNDTM1014	Tandon Full Height DS 96TPI	\$339.00

*Replace with M for MPI Door, or S for Shugart SA400 Type Door

5 1/4" Disk Drive Cabinets

BCJMR1C5	Single Drive Cabinet (5 lbs.)	\$ 79.00
BCJMR2C5	Dual Drive Cabinet (9 lbs.)	\$ 99.00
BCJMR2C5C	Dual w/Internal Data Cable (9 lbs.)	\$115.00

8" Floppy Disk Drives

BCSHUB01R	Shugart Full Height SS (18 lbs.)	\$349.00
BCSHUB01A	Shugart Full Height DS (18 lbs.)	\$479.00
BCSIEF001DOB	Siemens Full Height SS (18 lbs.)	\$189.00
BCOMETRAK842	Dume Full Height DS (18 lbs.)	\$459.00
BCMITM200463B	Mitsubishi Full Height DS (18 lbs.)	\$375.00
BCMP141S	MPI Full Height SS (11 lbs.)	\$360.00
BCMP142S	MPI Full Height DS (11 lbs.)	\$460.00
BCMP141D	MPI Dual 1/2-Height SS (22 lbs.)	\$780.00
BCMP142D	MPI Dual 1/2-Height DS (22 lbs.)	\$830.00
BCMP141M	MPI 1/2-Height SS (9 lbs.)	\$360.00
BCMP142M	MPI 1/2-Height DS (9 lbs.)	\$460.00
BCTNDTM8481	Tandon 1/2-Height SS (9 lbs.)	\$359.00
BCTNDTM8482	Tandon 1/2-Height DS (9 lbs.)	\$435.00

Dual 8" Disk Enclosures

All of these rugged enclosures feature forced, filtered air cooling, hefty power supply, with the heat producing elements mounted to outside for cool, reliable operation. The rear panels are punched for the appropriate data cables.

FDE002. Economical design for two standard size 8" floppies. Hinged lid for easy drive access. Power supply: 5V@4A, -5V@.8A, +24@3A.

DTL002. Cabinet for two 1/2-height 8" drives or 1 full height 8" floppy or Winchester. Includes Shugart type AC power cable.

Part Number	Description	List Price	SALE Price
BCIIFDE002	FDE002 Dual Enc. (35 lbs.)	\$359.95	\$325.00
BCIIDLTL002SHU	DTL002 Dual Thin Line (12 lbs)	\$225.00	\$175.00
BCIIDLTLMP1M1T	MPI 1/2-Height DTL adapter kit		\$ 24.95
BCIICBLSON304FM	Shugart to Dume AC Cable		\$ 4.95

BUY CABINETS WITH DRIVES AND SAVE!

WOW!!

2 SIEMENS FDD1008s !!
8" SINGLE SIDED DOUBLE DENSITY

&

IIIFDE002 Cabinet

\$499.00

BCP0BIIISIE

Combinations with FDE002

BCP0BIIIFDE2S2	w/2 SHU801R Drives	\$ 969.00
BCP0BIIIFDE2M2	w/2 MFM289463BS Drives	\$1049.00
BCP0BIIIFDE2Q2	w/2 DMETRAK842 Drives	\$1199.00
BCP0BIIIFDE2A51	w/2 SHU851R Drives	\$1239.00

Combinations with DTL002

BCP0BIIITND1	w/2 TNDTM8481 Drives	\$ 879.00
BCP0BIIITND2	w/2 TNDTM8482 Drives	\$1039.00
BCP0BIIIMP1	w/2 MPI141M Drives	\$ 879.00
BCP0BIIIMP2	w/2 MPI142M Drives	\$1039.00

Due to UPS Regulations, drives and cabinets will be shipped separately. Please include shipping for each disk drive and cabinet.

5 1/4" Hard Disk

BCMCP1302	Micropolis 20.4/25.9 Mb (12 lbs.)	\$1465.00
BCMCP1303	Micropolis 33.9/43.2 Mb (12 lbs.)	\$1875.00
BCMCP1304	Micropolis 40.8/51.9 Mb (12 lbs.)	\$2195.00
BCTNDTM501	Tandon 6 Mb (9 lbs.)	\$ 899.00
BCTNDTM502	Tandon 12 Mb (9 lbs.)	\$ 849.00
BCTNDTM503	Tandon 19 Mb (9 lbs.)	\$ 995.00

DUAL 5 1/4" HARD DISK DRIVE CABINET

All of the necessary power for two TANDON TM500 series or equivalent hard disk drives. Just imagine, you can have 100Mbytes of storage using two of the Micropolis 5 1/4" Winchester disk drives and this cabinet! Power supply: +5V@6A and +12V@6A. The rear panel is punched for two 20, two 34, and one 50 pin header connector Fan cooled.

BCIIH05002 Dual Hard Disk Enclosure (Sh. Wt. 20 lbs.) \$369.00

BUY CABINET WITH DRIVES AND SAVE!

w/2 TMS01 Drives	\$1599.00	
BCP0B502ND5	w/2 TMS02 Drives	\$1899.00
BCP0B503ND5	w/2 TMS03 Drives	\$2149.00
BCP0B1302ND5	w/2 MCP1303 Drives	\$2999.00
BCP0B1303ND5	w/2 MCP1303 Drives	\$3799.00
BCP0B1304ND5	w/2 MCP1304 Drives	\$4399.00

Due to UPS Regulations, disk drives will be shipped separately from cabinets. Don't forget to include shipping for each disk drive cabinet.

15M Byte Hard Disk For IBM PC™



International
Instrumentation
Inc. incorporated

50% More Capacity Than The XT!™

- Plug and Run — ready to go right out of the box!
- Complete with controller card, data cable, & internal mounting hardware
- Total PC/XT Compatible — will boot directly from the hard disk under DOS 2.0
- No special software needed
- 8K BIOS emulates XT command set
- Controller will support any 2 hard drives
- Hard disk can be partitioned into 4 operating systems
- 2:1 interleaving (data transfer rate 3 times faster than XT™)



INTERNAL 15M Byte Hard Disk With Controller

\$1495

BCIIHDPCK15 (Sh. Wt. 11 lbs.)

EXTERNAL 15M Byte Hard Disk With Controller

The 15Mbyte drive is mounted in a IIHD5001 cabinet with power supply. All hardware specifications are the same.

\$1695

BCP0BIIHDPCK15 (Sh. Wt. 16 lbs.)
External 15Mbyte Hard Disk w/Controller & Data Cable

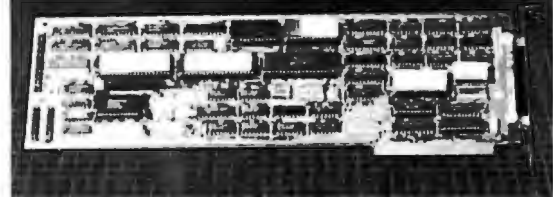

Backed By a 6-Month Warranty!

maxell
IT'S WORTH IT!



5 1/4" DOUBLE DENSITY DISKETTES

Part Number	Sectors	Tracks	Sides/Heads	Price Per Box of 10	
				1	2 or more
BCMXLMD1M	Soft	40	1	\$28.00	\$25.00
BCMXLMH100M	10 Hard	40	1	\$28.00	\$25.00
BCMXLMH116M	16 Hard	40	1	\$28.00	\$25.00
BCMXLM020M	Soft	40	2	\$42.00	\$36.00
BCMXLMH2100M	10 Hard	40	2	\$42.00	\$36.00
BCMXLMH2160M	16 Hard	40	2	\$42.00	\$36.00
BCMXLMD100M	Soft	80	1	\$36.00	\$33.00
BCMXLM0200M	Soft	80	2	\$44.00	\$40.00
BCMXLMH21000M	16 Hard	80	2	\$44.00	\$40.00

All mini disks with exceptional MD1 DDM, MD2HD, & MD2DDM are with hubbing

8" DOUBLE DENSITY DISKETTES

BCMXLF01120M1200	Soft	1	\$36.00	\$33.00
BCMXLFH132M1200	Hard	1	\$36.00	\$33.00
BCMXLF02120M1200	Soft	2	\$45.00	\$40.00
BCMXLFH2120M1200	Hard	2	\$45.00	\$40.00

Go on The Gold Standard!

Phone Today and Get On Our
Priority Interrupt Mailing List!



PRIORITY



ELECTRONICS



916 Deering Ave., Chatsworth, CA 91311-5887

Circle 292 on inquiry card.

ORDER TOLL FREE (800) 423-5922 - CA, AK, HI CALL (818) 709-5111

Terms: U.S. VISA, MC, BAC, Check, Money Order, U.S. Funds Only. Ca residents add 6 1/2% Sales Tax. MINIMUM PREPAID ORDER \$15.00. Include MINIMUM SHIPPING & HANDLING of \$3.00 for the first 3 lbs. plus 40¢ for each additional pound. Orders over 50 lbs. sent freight collect. Just in case, include your phone number. Prices subject to change without notice. We will do our best to maintain prices through March, 1984. Many quantities are limited. Sorry, no rainchecks, no refunds or exchanges on sale merchandise. Credit card orders will be charged appropriate freight. Sale prices for prepaid orders only. We are not responsible for typographical errors.

RETAIL STORE PHONE NUMBERS: (Chatsworth:) (818) 709-5464 - (Irvine) (714) 660-1411



AUTHORIZED DISTRIBUTORS

DISTRIBUTORS • AUTHORIZED DISTRIBUTORS • AUTHORIZED DISTRIBUTORS • AUTHORIZED DISTRIBUTORS

AUTHORIZED DISTRIBUTORS • AUTHORIZED DISTRIBUTORS • AUTHORIZED DISTRIBUTORS • AUTHORIZED DISTRIBUTORS

<p>ALABAMA</p> <p>Birmingham... American Electronic Supply Birmingham... J.L.S. Electronics Birmingham... Long's Electronics Birmingham... Microlog, Inc. Florence... Fuller Distributing Huntsville... Industrial Electronic Supply Huntsville... W.W. Electronics Mobile... Fortes Electronics Montgomery... Handey's Electronic Center Opelika... Southern Electronic Corp. Tuscaloosa... Radio Parts Inc.</p> <p>ALASKA</p> <p>Anchorage... Electronic Supply Center Anchorage... The Electronic Company Anchorage... Wapalco</p> <p>ARIZONA</p> <p>Lake Havasu City... Electronics 4-U Sierra Vista... B&S Electronics Tucson... Electronic City Tucson... Heathkit Electronic Center Yuma... Yuma Electronics</p> <p>ARKANSAS</p> <p>Little Rock... Southern Electronics</p> <p>CALIFORNIA</p> <p>Anaheim... Heathkit Electronic Center Anaheim... R.F. Electronics Antioch... Gooden Ch Electronics Bakersfield... Jay Kam Electronics Berkeley... Al Lasher's Electronics Buena Park... Heathkit Electronic Center Campbell... Heathkit Electronic Center Chicago... Payless Wholesale Chula Vista... Lion Electronics Chula Vista... Sago Electronics Clearlake... Clearlake Electronics Concord... Pacific Radio Supply Conning... New-Cat Electronics Costa Mesa... Mar-Vac Electronics Covina... G&H/MCO Elect. Supply Cucamonga... Abletronics Cypress... S.C.R. Electronics Davis... Paradyne Consumer Elect. El Cajon... Radio Shack Eureka... Redwood Electronics Fontana... Fontana Electronics Fresno... National Computer Fresno... Sparky Electronics Fresno... Whitcomb Electronics Fullerton... Industrial Electronics Gardena... Eagle Electronics Glendale... D&S Stereo Half Moon Bay... Strawflower Elec./Radio Shack Harbor City... Bluff Electronics Hawaiian Gardens... Carson Electronics Hollywood... Pacific Radio Exchange Inglewood... Radioland/Inglewood Elect. La Habra... A.B.C. Electronics La Mesa... Heathkit Electronic Center Lancaster... Consumer Electronics Los Angeles... Heathkit Electronic Center Mission Viejo... Heathkit Electronic Center Modesto... Inland Electronics Modesto... Pacific Radio Manteca... A.B.C. Electronics Center Morro Bay... Coast Electronics National City... Willy's Electronics Oakland... Cass Electronics Oceanside... Calco Digital Oceanside... Electronic Center Oroville... Radio Mart Palo Alto... U.S. Electronics Palo Alto... Zack Electronics Pasadena... Dow Radio Paso Robles... Mission Electronics Pomona... Heathkit Electronic Center Redding... Radio Mart Sacramento... Cal Radio & TV Sacramento... The Radio Place Sacramento... Zack Salinas... Salinas Radio San Bruno... Bruce Electronics San Carlos... J&H Outlet San Diego... Radio Shack/Mira Mesa San Fernando... San Fernando Electronics San Francisco... Zack Electronics San Jose... Peninsula Elect. Supply San Jose... United Radio and TV San Luis Obispo... Mid State Electronics San Rafael... Electronics Plus Santa Clara... Digital Pacific Santa Cruz... Santa Cruz Electronics Santa Maria... Caps Communications Santa Maria... Electronic Parts Supermart South Lake Tahoe... Calpine Electronics Sunnyvale... Sunnyvale Electronics Torrance... Signal Electronics Torrance... Torrance Electronics Tustin... A.B.C. Electronic Supply Vallejo... Zackit Van Nuys... Thrifty Electronics Westminster... JK Electronics Wentworth... Whiter Electronics Woodland Hills... Heathkit Electronic Center Yuba City... Electronic World</p> <p>COLORADO</p> <p>Boulder... Hapco Colorado Springs... Cabo Digital Equip. Colorado Springs... Centennial Electronics Denver... Fiestel's Electronics</p>	<p>COLORADO (Continued)</p> <p>Denver... Fiestel's Microelectronics Denver... Mountain Coin Machine Lakewood... D.H. Crump Co.</p> <p>CONNECTICUT</p> <p>Avon... Heathkit Electronic Center New Haven... Customized Computer Center Wallingford... Trol Town USA Westport... Computer Works</p> <p>DELAWARE</p> <p>Newark... Computerland New Castle... Delaware Amateur Supply Wilmington... Laraco/Lafayette Radio Wilmington... Micro Products Wilmington... Wholesale Electronics</p> <p>FLORIDA</p> <p>Coral Gables... Olson Electronics Clearwater... Amateur Electronic Supply Fort Lauderdale... Tecktron Enterprises Gainesville... Skoger Electronics Hialeah... Heathkit Electronic Center Hollywood... Eric Inc. Jacksonville... Heathkit Electronic Center Miami... Olson Electronics Orlando... C&S Electronics Orlando... Lafayette Stereo & Elect. Oakland Park... Lafayette Radio Panama City... Bay-Mar Electronics Pensacola... Forbes Electronics Pensacola... Pensacola Electronics Pensacola... Quad Electronics Plantation... Heathkit Electronic Center Tampa... Heathkit Electronic Center</p> <p>GEORGIA</p> <p>Atlanta... A.C.M. Computer Mart Atlanta... Heathkit Electronic Center Dalton... A.C.M. Computer Mart La Grange... Electronic Supply Stone Mountain... Coleman's Electronics Warner Robbins... C&L Electronics</p> <p>HAWAII</p> <p>Hilo... A's Electronics Honolulu... Industrial Electronics Honolulu... Integrated Circuit Supply Pearl City... Heathkit Electronic Center</p> <p>IDAHO</p> <p>Boise... Kimball Electronics Boise... R.J.M. Electronics Caldwell... A-Gem Supply Pocatello... Kimball Electronics Twin Falls... Central Electronics</p> <p>ILLINOIS</p> <p>Addison... Digital World, Inc. Beryn... B.B.&W. Electronics Cape Girardeau... Pak's Electronics Chicago... Heathkit Electronic Center Chicago... Howard Electronic Sales Chicago... Olson Electronics Chicago... University of Illinois Bookstore Decatur... Main Street Computer Deamers Grove... Heathkit Electronic Center Groveand... Moyer Electronics Harvey... George Electronics Metrose Park... Olson Electronics North Prospect... Tri-State Electronic Corp. Niles... Computerland of Niles Pieria... Joseph Electronic Plymouth... Computer and Radio Mies... Warren Radio Co. Rockford... Computer Store of Rockford Rock Island... Team Electronics Skokie... Lillipute Computer South Holland... Union Electronic Dist.</p> <p>INDIANA</p> <p>Angola... Lakeland Electronics Bedford... Elex Mart Bloomington... Stansler Radio Chesterton... Chesterton Electronics Evansville... Hutch & Son Gary... Calumet Electronics Indianapolis... Heathkit Electronic Center Indianapolis... Warren Radio Co. Lafayette... Von's Electronics Muncie... Pierce Electronics Muncie... Genesis Electronics South Bend... TV Supply Co. Terre Haute... Industrial Electronics</p> <p>IOWA</p> <p>Ames... Electronic Supply, Inc. Burlington... Union Supply Co. Clinton... R.J.S. Electronics Ovenport... Warren Radio Co. Des Moines... Gifford Brown Inc. Des Moines... Radio Trade Supply</p> <p>KANSAS</p> <p>Hutchinson... Hutchinson Electronics Kansas City... Electronic Surplus Sales Mission... Heathkit Electronic Center Salina... Electronics Inc. Shawnee Mission... Burstein & Assoc. Topeka... Carroll Radio & TV Supply Wichita... Amateur Radio Equipment Wichita... Lloyd's Radio & Elex Wichita... R.S.C. Supply</p>	<p>KENTUCKY</p> <p>Lexington... Radio Electronic Equip. Co. Louisville... Heathkit Electronic Center Louisville... Peerless Electronic Equip. Paducah... Warren Radio Co.</p> <p>LOUISIANA</p> <p>Baton Rouge... Davis Electronic Supply Baton Rouge... Industrial Elect. Supply Baton Rouge... Menard Electronics Covington... Electronic Mart Gretna... Pelican Electronics Houma... Pelican Electronics Kenner... Heathkit Electronic Center Lake Charles... W.R.E. Inc. Metairie... Pelican Electronic Supply Meridian... Hooper Electronic Supply New Orleans... Wm. B. Allen Supply Co. Shreveport... Electronic Supply of Shreveport Shreveport... Industrial Electronic Supply Shreveport... Southern Electronics Sidell... Electronic Mart</p> <p>MARYLAND</p> <p>Aberdeen... Harco Electronics Annapolis... Computers, Etc. Baltimore... Heathkit Electronic Center Beltsville... Mark Electronics College Park... Electronics Plus Damasoc... Damasoc C.B. Glen Burnie... Revaco of Maryland Laurel... The Comm Center Lavage... J&M Electronics Rockville... Heathkit Electronic Center Rockville... Revaco Electronics Sevens Park... Futronics Inc. Suitland... Suburban Wholesalers Towson... Baynesville Electronics Towson... Computers Unlimited</p> <p>MASSACHUSETTS</p> <p>Danvers... Computer Electronic Consultants Littleton... Tel-Com Inc. Peabody... Heathkit Electronic Center Pittsfield... Pittsfield Radio Equipment Waltham... Computer Mart Inc. Wellesley... Heathkit Electronic Center</p> <p>MICHIGAN</p> <p>Adrian... E&B Electronics Allen Park... Olson Electronics Ann Arbor... Wedemeyer Elect. Supply Battle Creek... Warren Radio Bay City... Kivde Distributing Canton... The Electronic Connection Dearborn... Westside Radio Detroit... A.F. Electronic Parts Detroit... Electronic Parts Co. Detroit... Heathkit Electronic Center Detroit... S&S Electronics East Detroit... Heathkit Electronic Center Fenton... Tri-County Electronics Flint... Shand Electronics Grand Haven... K.S. Electronics Grand Rapids... Miro World Inc. Grand Rapids... Radio Parts Inc. Grand Rapids... T&W Electronics Grand Rapids... Warren Radio Holland... Bits & Bytes Houghton... Technics Jackson... Fulton Radio Supply Kalamazoo... Warren Radio Lansing... Fulton Radio Supply Lansing... Wedemeyer Elect. Supply Livonia... Nowat Electronics Madison Heights... Olson Electronics Madison Heights... Warren Radio Midland... Compuronic Mount Clemens... Olson Electronics Muskegon... H&P Electronics Niles... Niles Radio Supply Owosso... Warren Radio Port Huron... Main TV Radio Electric Saginaw... Electronic Mart Saint Clair Shores... Bell Electronics Co. Sterling Heights... Electronic Supermarket Taylor... Electronic World Taylor... Tel Van Electronic Supply Traverse City... Traverse City Elect. Supply Westland... Olson Electronics</p> <p>MINNESOTA</p> <p>Benjidi... Benjidi Electronics Duluth... Northwest Radio of Duluth Hopkins... Heathkit Electronic Center Livonia... Acme Electronics Saint Paul... Heathkit Electronic Center Winona... Hawatha Electronics</p> <p>MISSISSIPPI</p> <p>Biloxi... Hooper Electronic Supply Jackson... Ellington Electronic Supply Oxford... Oxford Software Pascagoula... Hooper Electronic Supply</p> <p>MISSOURI</p> <p>Bridgeton... Heathkit Electronic Center Kansas City... Show Me Electronics Kansas City... Burstein & Associates Kansas City... Electronic Supply Co. Inc.</p>	<p>MISSOURI (Continued)</p> <p>Kansas City... Walters Radio Rolla... Show Me Electronics Sedalia... Show Me Electronics Springfield... Show Me Electronics</p> <p>MONTANA</p> <p>Billings... Conley Radio Supply Bozeman... Electronic Service & Dist. Great Falls... Art's Electronics Great Falls... Electric City Radio</p> <p>NEBRASKA</p> <p>Grand Island... G.I. Electronics Lincoln... Computer Systems Inc. Lincoln... Scott Electronic Supply Norfolk... Caauwens Gun & Hobby Shop Omaha... Heathkit Electronic Center Omaha... Scott Electronics</p> <p>NEVADA</p> <p>Las Vegas... Century 23</p> <p>NEW JERSEY</p> <p>Edison... William Electronic Supply Fairtown... Heathkit Electronic Center Manaua... Electronic World Ocean... Heathkit Electronic Center Trenton... Lafayette Radio Supply Vineland... Laraco/Vineland</p> <p>NEW MEXICO</p> <p>Alamogordo... Basin Electronics</p> <p>NEW YORK</p> <p>Albany... Greylock Electronics Amherst... Heathkit Electronic Center Buffalo... Olson Electronics Buffalo... Radio Equipment Corp. Commack... Spartan Electronics Hornell... Hornell Electronics Ithaca... Rad-Tronics Jamestown... Warren Radio Jericho... Heathkit Electronic Center Johnson City... Union Electronics Kingston... Greylock Electronics Middleton... Greylock Electronics Newburgh... Action Audio Inc. New York... Manhattan Electronics New York... Tall Electronics Poughkeepsie... Greylock Electronics Rochester... Heathkit Electronic Center Seneca... Olson Electronics Troy... Trojan Electronic Supply Ulica... Central Electronics White Plains... Computer Corner White Plains... Heathkit Electronic Center</p> <p>NORTH CAROLINA</p> <p>Greensboro... Heathkit Electronic Center Winston-Salem... Trayer-Yeverton Inc.</p> <p>NORTH DAKOTA</p> <p>Fargo... Radio & TV Equipment Fargo... S/S Electronics</p> <p>OHIO</p> <p>Akron... Akron Electronic Supply Akron... Warren Radio Bucyrus... Mead Electronics Canton... Electronic Center Inc. Cincinnati... Heathkit Electronic Center Cleveland... Heathkit Electronic Center Columbus... Heathkit Electronic Center Columbus... Olson Electronics Columbus... T.V. Specialties Lima... Warren Radio Massillon... M.H. Martin Co. Mogadore... Olson Electronics Parma... Superior Electronics Reynoldsburg... Universal Amateur Radio Tolado... Heathkit Electronic Center Tolado... Tel Warren Radio Youngstown... Olson Electronics Youngstown... Ross Radio Co.</p> <p>OKLAHOMA</p> <p>Oklahoma City... Trice Wholesale Electronics</p> <p>OREGON</p> <p>Albany... Oregon Ham Sales Beaverton... Norvac Electronics Corvallis... Electronic Super Store Corvallis... Norvac Electronics Dallas... Norvac Electronics Portland... Portland Radio Supply Roseburg... Roseburg Musical Instruments Salem... Computer Specialties Salem... Norvac Electronics</p> <p>PENNSYLVANIA</p> <p>Bradock... Left Electronics Butler... Computer Center Chambersburg... Sunrise Electronic Dist. Drexel Hill... Kass Electronic Dist. Erie... Warren Radio Fairview... Bell Electronics Fazler... Heathkit Electronic Center McGeespport... Barro Radio Norristown... Computer Corner Philadelphia... Heathkit Electronic Center Philadelphia... Spectrum Electronics Phoenixville... Stevens TV & Electric Pittsburgh... Heathkit Electronic Center Pittsburgh... Pittsburgh Computer Store Pittsburgh... South Hills Electronics Pittsburgh... The Computer House York... G.Y.C. Co.</p>	<p>RHODE ISLAND</p> <p>Cranston... Jabour Electronics Pawtucket... Jabour Electronics Providence... Hope Electronics Providence... Heathkit Electronic Center</p> <p>TENNESSEE</p> <p>Bristol... Shields Electronics Concord... National Electronics Cookeville... Wagnon's Stereo Center Dyersburg... Warren Radio Knoxville... Shields's Electronic Supply Memphis... Bluff City Electronics Memphis... Memphis Amateur Electronics Memphis... Warren Radio Murfreesboro... Murfreesboro Radio & Elect. Murfreesboro... Standard Auto Parts Nashville... Eddie Wames Parts Co. Nashville... Becca Dist. Co. Oak Ridge... Mr. Radio Oak Ridge... National Electronics Tussum... Deltek Electronics Tullahoma... H&H Electronics</p> <p>TEXAS</p> <p>Brownsville... George's Electronic Mart Dallas... Heathkit Electronic Center Enid... Trice Electronics Fort Worth... Heathkit Electronic Center Harlingen... George's Electronic Mart Houston... Heathkit Electronic Center Lubbock... Trice Electronics McAllen... Carlos Franco Electronics McAllen... George's Electronic Mart Richardson... Marvin Wholesale Electronics Richardson... Trice Electronics San Antonio... C&K Electronics San Antonio... Heathkit Electronic Center Waco... L&M Wholesale</p> <p>UTAH</p> <p>Midvale... Heathkit Electronic Center Ogden... Carter Supply Co. Provo... Alpine Electronics Supply Salt Lake City... Best Electronics Salt Lake City... Kimball Electronics Salt Lake City... Mountain Con Distributing Salt Lake City... RA-ELCO Inc.</p> <p>VERMONT</p> <p>Burlington... Greylock Electronics Essex Junction... I.E.S. Lafayette Radio</p> <p>VIRGINIA</p> <p>Alexandria... Heathkit Electronic Center Annandale... Arcade Electronics Arlington... Arlington Electronic Wholesalers Charlottesville... Scotty's Radio & TV Charlottesville... Grives Electronics Falls Church... Grassroad Elect. Wholesalers Harrisonburg... Electrical Wholesalers Hopewell... B&G Electronics Lynchburg... Electronic Service Co. Norfolk... A-ve Electronics Norfolk... Cam Electronics Norfolk... Personal Computer Richmond... A-ve Electronics Roanoke... A-ve Electronics Vienna... Electronic Equipment Bank Virginia Beach... Heathkit Electronic Center Woodbridge... E.G.E.</p> <p>WASHINGTON</p> <p>Bellevue... A.B.C. Communications Bellevue... Cascade Electronics Everett... A.B.C. Communications Hoquiam... Harbor Electronics Kennewick... C&J Electronic Kent... Electronic Supermart Moses Lake... Ron's Electronics Olympia... The Electronic Shop Pasco... Radio Shack Palmam... Radio Shack Richland... Radio Shack Seattle... A.B.C. Communications Seattle... Amateur Radio Supply Seattle... Electronic Supply Co. Seattle... Heathkit Electronic Center Spokane... D.S. Sales Spokane... Personal Computer Tacoma... C&G Electronics Tukwila... Heathkit Electronic Center Vancouver... Heathkit Electronic Center</p> <p>WEST VIRGINIA</p> <p>Elkins... Williams Electronics Fairmont... T.P.S. Electronics Morgantown... Computer Corner Morgantown... Elcom Dist. Co. Morgantown... State Electronics Wheeling... Industries</p> <p>WISCONSIN</p> <p>Kenosha... Chester Electronic Supply Milwaukee... Amateur Electronic Supply Milwaukee... Heathkit Electronic Center Milwaukee... Olson Electronics</p> <p>WYOMING</p> <p>Rock Springs... D.C. Electronics</p> <p>FOREIGN</p> <p>Guam... Maranas Electronics Guatemala... Electronica Pan Americana Panama... Sonnet S.A. Panama... Tropico S.A. Puerto Rico... Rio Pedras Macromarket Store Puerto Rico... Rio Pedras... Radio Shack Singapore... Applied Digital Systems West Indies... Trinidad... The Hobby Centre</p>
---	--	--	---	---

For Distributor Information, write or phone JIM-PAK, 1355 Shoreway Road, Belmont, CA 94002 (415) 595-5936

CONNECTORS AND ACCESSORIES

DOUBLE-ROW MALE HEADERS



Solder to PC boards for instant plug-in access • .025" square posts on a .10" x .10" matrix

Part No.	Description
923862R	20 post double row male
923863R	26 post double row male
923864R	34 post double row male
923865R	40 post double row male
923866R	50 post double row male

GENDER CHANGERS



Used to connect 2 cables which have the same gender.

Part No.	Description
JRSM-M	Connects 2 male (DB25P) cables
JRSF-F	Connects 2 female (DB25S) cables

D-SUB CONNECTORS

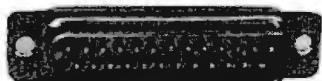

SOLDER-TYPE CONTACTS

Part No.	Description
DE9P	9 Pin Plug
DE9S	9 Pin Socket
DE9H	Hood for DE9 Series Connectors
DA15P	15 Pin Plug
DA15S	15 Pin Socket
DA15H	Hood for DA15 Series Connectors
DB25P	25 Pin Plug (Meets RS232)
DB25S	25 Pin Socket (Meets RS232)
DB25H	Hood for DB25 Series Connectors
DC37P	37 Pin Plug
DC37S	37 Pin Socket
DC37H	Hood for DC37 Series Connectors
DD50P	50 Pin Plug
DD50S	50 Pin Socket
DD50H	Hood for DD50 Series Connectors

MICRO CHARTS



Instant Data on the Most Popular Computer and Microprocessor Parts

- Fully decoded data
- Compact 8 1/2" x 11" size
- Durable credit card plastic
- Clear and concise two-sided tables for: Full instruction set, disassembly, ASCII, base conversion, pinout & much more...

Part No.	Description
MLZ80	Z80 CPU
ML6502	6502 (65XX)
ML7400	5400/7400 TTL Pinouts
MLB080A	8080A/8085A

JE750 4-Digit Fluorescent Alarm Clock Kit



The JE750 Alarm Clock Kit is a versatile 12-hour digital clock with 24-hour alarm. The clock has a bright 0.5" high blue-green fluorescent display. The display will automatically dim with changing light conditions. The 24-hour alarm allows the user to disable the alarm and immediately renewable the alarm to activate 24 hours later. The kit includes all documentation, case and wall transformer. Other features: flashing colon, alarm tone 500Hz once per sec., 10 minute snooze alarm, am/pm indicator. Size: 6 3/4" L x 3 1/4" H x 1 3/4" D.

Part No. JE750 Kit

Insulation Displacement Connectors

Dip Plug Connectors



Part No.	Description
609-14	14 Contact Dip Plug Connector
609-16	16 Contact Dip Plug Connector
609-24	24 Contact Dip Plug Connector
609-40	40 Contact Dip Plug Connector

Socket Connectors



Mates 2 rows of .025" sq. dia. posts on patterns of .100" centers.

Part No.	Description
S20	20 Contact Socket Connector
S26	26 Contact Socket Connector
S34	34 Contact Socket Connector
S40	40 Contact Socket Connector
S50	50 Contact Socket Connector

Card-Edge Connectors



Mates with double-sided 1/16" PC board with contact fingers on .100" centers.

Part No.	Description
C20	20 Contact Card-Edge Connector
C26	26 Contact Card-Edge Connector
C34	34 Contact Card-Edge Connector
C40	40 Contact Card-Edge Connector
C50	50 Contact Card-Edge Connector

D-Sub Connectors

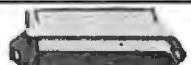

Part No.	Description	FLAT CABLE CONTACTS
CDE9P	9 Contact Plug	
CDE9S	9 Contact Socket	
CDA15P	15 Contact Plug	
CDA15S	15 Contact Socket	
CDB25P	25 Contact Plug	
CDB25S	25 Contact Socket	
CDC37P	37 Contact Plug	
CDC37S	37 Contact Socket	

DATA BOOKS

Part No.	Description
210830	Intel Memo y
210844	Intel Microprocessor
30001	National CMOS
30003	National Linear
30005	National TTL Logic
30009	Intersil Data
30013	Zilog Microprocessor



SPEAKER

1-3/16" Square • 5/32" Thick
8 Ohm • .40 Watt

- Stainless steel diaphragm • Ultra Slim
- For alarms, music sounds, telephone equipment, computers, speech aids, etc.

Part No. TS30S

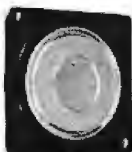

JOYSTICKS

Part No.	Description
JS100K	100K Linear Taper Pots (with knob)
JS150K	1.50K Linear Taper Pots (with knob)
JVC-40	40K Video Controller in case (w/knob)



Jim-pak

DIODES
CRYSTALS
TRANSISTORS
SOCKETS
KITS

SWITCHES
RESISTORS
LEDS
HEAT SINKS
KEYBOARDS
WIRE

SPEAKERS
TOOLS
CORDS
SOLDER
IC'S
BOOKS
CAPACITORS
and more...

CENTRONICS

⇐ Solder Type
Insulation Displacement Type ⇐

Part No.	Description
CEN36M	36 Contact Male-Insulation Displace.
CEN36F	36 Contact Female-Insulation Displace.
57-30360	36 Contact Male - Solder
57-60360	36 Contact Female - Solder

INSULATION DISPLACEMENT CABLE ASSEMBLIES

Part No.	Description
S20-36	20-pin 36" Single-End Socket
S26-36	26-pin 36" Single-End Socket
S34-36	34-pin 36" Single-End Socket
S40-36	40-pin 36" Single-End Socket
S50-36	50-pin 36" Single-End Socket
S20-6-S	20-pin 6" Double-Ended Socket
S20-18-S	20-pin 18" Double-Ended Socket
S26-18-S	26-pin 18" Double-Ended Socket
S50-18-S	50-pin 18" Double-Ended Socket
DB25P-10-P	25-pin male 10' Double-Ended Plug
DB25P-10-S	25-pin male 10' 25-pin female
CEN36M-5	36-pin Centronics 5' male
CEN36M-5-F	36-pin Centronics 5' male to female
CEN36M-5-M	36-pin Centronics 5' male to male

416464K DYNAMIC
200 NS**\$595 TMM2016**2KX8 STATIC **\$415**
200 NS**STATIC RAMS**

2101	256 x 4 (450ns)	1.95
5101	256 x 4 (450ns) (cmos)	3.95
2102-1	1024 x 1 (450ns)	.89
2102L-4	1024 x 1 (450ns) (LP)	.99
2102L-2	1024 x 1 (250ns) (LP)	1.49
2111	256 x 4 (450ns)	2.49
2112	256 x 4 (450ns)	2.99
2114	1024 x 4 (450ns)	8/9.95
2114-25	1024 x 4 (250ns)	8/10.95
2114L-4	1024 x 4 (450ns) (LP)	8/12.95
2114L-3	1024 x 4 (300ns) (LP)	8/13.45
2114L-2	1024 x 4 (200ns) (LP)	8/13.95
TC5514	1024 x 4 (650ns) (cmos)	2.49
TC5516	2048 x 8 (250ns) (cmos)	9.95
2147	4096 x 1 (55ns)	4.95
TMS4044-4	4096 x 1 (450ns)	3.49
TMS4044-3	4096 x 1 (300ns)	3.99
TMS4044-2	4096 x 1 (200ns)	4.49
MK4118	1024 x 8 (250ns)	9.95
TMM2016-200	2048 x 8 (200ns)	4.15
TMM2016-150	2048 x 8 (150ns)	4.95
TMM2016-100	2048 x 8 (100ns)	6.15
HM6116-4	2048 x 8 (200ns) (cmos)	4.75
HM6116-3	2048 x 8 (150ns) (cmos)	4.95
HM6116-2	2048 x 8 (120ns) (cmos)	8.95
HM6116LP-4	2048 x 8 (200ns) (cmos)(LP)	5.95
HM6116LP-3	2048 x 8 (150ns) (cmos)(LP)	6.95
HM6116LP-2	2048 x 8 (120ns) (cmos)(LP)	10.95
Z-6132	4096 x 8 (300ns) (Ostat)	34.95
HM6264	8192 x 8 (150ns) (cmos)	49.95

LP = Low Power Qstat = Quasi-Static

EPROMS

1702	256 x 8 (1us)	4.50
2708	1024 x 8 (450ns)	3.95
2758	1024 x 8 (450ns) (5v)	5.95
2716	2048 x 8 (450ns) (5v)	3.95
2716-1	2048 x 8 (350ns) (5v)	5.95
TMS2516	2048 x 8 (450ns) (5v)	5.50
TMS2716	2048 x 8 (450ns)	7.95
TMS2532	4096 x 8 (450ns) (5v)	5.95
2732	4096 x 8 (450ns) (5v)	4.95
2732-250	4096 x 8 (250ns) (5v)	8.95
2732-200	4096 x 8 (200ns) (5v)	11.95
2732A-4	4096 x 8 (450ns) (5v) (21vPGM)	6.95
2732A	4096 x 8 (250ns) (5v) (21vPGM)	9.95
2732A-2	4096 x 8 (200ns) (5v) (21vPGM)	13.95
2764	8192 x 8 (450ns) (5v)	6.95
2764-250	8192 x 8 (250ns) (5v)	7.95
2764-200	8192 x 8 (200ns) (5v)	19.95
TMS2564	8192 x 8 (450ns) (5v)	14.95
MCM68764	8192 x 8 (450ns) (5v) (24 pin)	39.95
MCM68766	8192 x 8 (350ns) (5v) (24 pin)(pwr dn.)	42.95
27128	16384 x 8 (300ns) (5v)	29.95

5v = Single 5 Volt Supply 21vPGM = Program at 21 Volts

CRYSTALS

32.768 khz	1.95
1.0 mhz	3.95
1.8432	3.95
2.0	2.95
2.097152	2.95
2.4576	2.95
3.2768	2.95
3.579545	2.95
4.0	2.95
5.0	2.95
5.0688	2.95
5.185	2.95
5.7143	2.95
6.0	2.95
6.144	2.95
6.5536	2.95
8.0	2.95
10.0	2.95
10.738635	2.95
14.31818	2.95
15.0	2.95
16.0	2.95
17.430	2.95
18.0	2.95
18.432	2.95
20.0	2.95
22.1184	2.95
32.0	2.95

CMOS

4000	.29	4528	1.19		
4001	.25	4531	.95		
4002	.25	4532	1.95		
4006	.89	4538	1.95		
4007	.29	4539	1.95		
4008	.95	4541	2.64		
4009	.39	4543	1.19		
4010	.45	4553	5.79		
4011	.25	4555	.95		
4012	.25	4556	.95		
4013	.38	4581	1.95		
4014	.79	4582	1.95		
4015	.39	4584	.75		
4016	.39	4585	.75		
4017	.69	4702	12.95		
4018	.79	74C00	.35		
4019	.39	74C02	.35		
4020	.75	74C04	.35		
4021	.79	74C08	.35		
4022	.79	74C10	.35		
4023	.29	74C14	.59		
4024	.65	74C20	.35		
4025	.29	74C30	.35		
4026	1.65	74C32	.39		
4027	.45	74C42	1.29		
4028	.69	74C48	1.99		
4029	.79	74C73	.65		
4030	.39	74C74	.65		
4034	1.95	74C76	.90		
4035	.85	74C83	1.95		
4040	.75	74C85	1.95		
4041	.75	74C86	.39		
4042	.69	74C89	4.50		
4043	.85	74C90	1.19		
4044	.79	74C93	.75		
4046	.85	74C95	1.95		
4047	.95	74C107	.89		
4049	.35	74C150	5.75		
4050	.35	74C151	2.25		
4051	.79	74C154	3.25		
4053	.79	74C157	1.75		
4702	12.95	4060	.89	74C160	1.19
COM5016	16.95	4066	.39	74C161	1.19
COM8116	10.95	4068	.39	74C162	1.19
MM5307	10.95	4069	.29	74C163	1.19
		4070	.35	74C164	1.39
		4071	.29	74C165	2.00
		4072	.29	74C173	.79
		4073	.29	74C174	1.19
		4075	.29	74C175	1.19
		4076	.79	74C192	1.49
		4078	.29	74C193	1.49
		4081	.29	74C195	1.39
		4082	.29	74C200	5.75
		4085	.95	74C221	1.75
		4086	.95	74C244	2.25
		4093	.49	74C373	2.45
		4098	2.49	74C374	2.45
		4099	1.95	74C901	.39
		14409	12.95	74C902	.85
		14410	12.95	74C903	.85
		14411	11.95	74C905	10.95
		14412	12.95	74C906	.95
		14419	7.95	74C907	1.00
		14433	14.95	74C908	2.00
		4502	.95	74C909	2.75
		4503	.65	74C910	8.95
		4508	1.95	74C911	8.95
		4510	.85	74C912	8.95
		4511	.85	74C914	1.95
		4512	.85	74C915	1.19
		4514	1.25	74C918	2.75
		4515	1.79	74C920	17.95
		4516	1.55	74C921	15.95
		4518	.89	74C922	4.49
		4519	.39	74C923	4.95
		4520	.79	74C925	5.95
		4522	1.25	74C926	7.95
		4528	1.25	74C928	7.95
		4527	1.95	74C929	19.95

**EPROM ERASERS
SPECTRONICS CORPORATION**

	Timer	Capacity Chip	Intensity (uW/Cm ²)	
PE-14		9	8,000	83.00
PE-14T	X	9	8,000	119.00
PE-24T	X	12	8,600	175.00
PL-265T	X	30	8,600	255.00
PR-125T	X	25	17,000	349.00
PR-320T	X	42	17,000	595.00

- * Computer managed inventory — virtually no back orders!
- * Very competitive prices!
- * Friendly staff!
- * Fast service — most orders shipped within 24 hours!

UARTS

AY3-1014	6.95
AY5-1013	3.95
AY3-1015	6.95
PT1472	9.95
TR1602	3.95
2350	9.95
2651	8.95
IM6402	7.95
IM6403	8.95
INS8250	10.95

GENERATORS**BIT-RATE**

MC14411	11.95
BR1941	11.95
4702	12.95
COM5016	16.95
COM8116	10.95
MM5307	10.95

FUNCTION

MC4024	3.95
LM566	1.49
XR2208	3.75
8038	3.95

MISC.

UPD7201	29.95
TMS99532	29.95
ULN2003	2.49
3242	7.95
3341	4.95
MC3470	4.95
MC3480	9.00
11C90	13.95
95H90	7.95
2513-001 UP	9.95
2513-002 LOW	9.95

CLOCK CIRCUITS

MM5314	4.95
MM5369	3.95
MM5375	4.95
MM58167	11.95
MSM5832	3.95

KEYBOARD CHIPS

AY5-2376	11.95
AY5-3800	11.95
AY5-3600 PRO	11.95

DYNAMIC RAMS

TMS4027	4096 x 1 (250ns)	1.99
UPD411	4096 x 1 (300ns)	3.00
MM5280	4096 x 1 (300ns)	3.00
MK4108	8192 x 1 (200ns)	1.95
MM5298	8192 x 1 (250ns)	1.85
4116-300	16384 x 1 (300ns)	8/11.75
4116-250	16384 x 1 (250ns)	8/7.95
4116-200	16384 x 1 (200ns)	8/12.95
4116-150	16384 x 1 (150ns)	8/14.95
4116-120	16384 x 1 (120ns)	8/29.95
2118	16384 x 1 (150ns) (5v)	4.95
MK4332	32768 x 1 (200ns)	9.95
4164-200	65536 x 1 (200ns) (5v)	5.95
4164-150	65536 x 1 (150ns) (5v)	6.95
MCM6665	65536 x 1 (200ns) (5v)	8.95
TMS4164-15	65536 x 1 (150ns) (5v)	8.95

5V = single 5 volt supply

6800

68000	49.95
6800	2.95
6802	7.95
6803	19.95
6808	13.90
6809E	14.95
6809	11.95
6810	2.95
6820	4.35
6821	2.95
6828	14.95
6840	12.95
6843	34.95
6844	25.95
6845	14.95
6847	11.95
6850	3.25
6852	5.75
6860	7.95
6875	6.95
6880	2.25
6883	22.55
68047	24.95
68488	19.95

6800 = 1MHZ

68B00	10.95
68B02	22.25
68B09E	29.95
68B09	29.95
68B10	6.95
68B21	6.95
68B40	18.95
68B45	18.95
68B50	5.95
68B00 = 2 MHZ	

6500

6502	4.95
6504	6.95
6505	8.95
6507	9.95
6520	4.35
6522	6.95
6532	9.95
6545	22.50
6551	11.85

2 MHZ

6502A	6.95
6522A	9.95
6532A	11.95
6545A	27.95
6551A	11.95

3 MHZ

6502B	9.95
-------	------

8000

8035	5.95
8039	5.95
INS-8060	17.95
INS-8073	49.95
8080	3.95
8085	4.95
8085A-2	11.95
8086	24.95
8087 CALL	8.95
8088	29.95
8089	89.95
8155	6.95
8155-2	7.95
8156	6.95
8185	29.95
8185-2	39.95
8741	29.95
8748	24.95
8755	24.95

CRT CONTROLLERS

6845	14.95
68B45	19.95
HD46505SP	15.95
6847	11.95
MC1372	6.95
68047	24.95
8275	29.9

2114

450 NS

8/\$995

2114

250 NS

8/\$1095

74LS00

Table listing 74LS00 series components with prices. Includes items like 74LS00, 74LS01, 74LS02, etc.

74S00

Table listing 74S00 series components with prices. Includes items like 74S00, 74S01, 74S02, etc.

VOLTAGE REGULATORS

Table listing voltage regulators with prices. Includes items like 7805T, 78M05C, 7808T, etc.

C, T = TO-220 K = TO-3 L = TO-92

SOUND CHIPS

Table listing sound chips with prices. Includes items like 76477, 76488, 76489, etc.

7400

Table listing 7400 series components with prices. Includes items like 7400, 7401, 7402, etc.

INTERFACE

Table listing interface components with prices. Includes items like 8T26, 8T28, 8T95, etc.

ORDER TOLL FREE 800-538-5000 800-662-6279 (CALIFORNIA RESIDENTS)

DATA ACQUISITION

Table listing data acquisition components with prices. Includes items like ADC0800, ADC0804, etc.



CONNECTORS

Table listing connectors with prices. Includes items like RS232 Male, RS232 Female, etc.

EXAR

Table listing EXAR components with prices. Includes items like XR 2206, XR 2207, etc.

INTERSIL

Table listing Intersil components with prices. Includes items like ICL7106, ICL7107, etc.

9000

Table listing 9000 series components with prices. Includes items like 9316, 9334, 9368, etc.

LINEAR

Table listing linear components with prices. Includes items like LM301, LM301H, LM307, etc.

RCA

Table listing RCA components with prices. Includes items like CA 3023, CA 3039, etc.

TI

Table listing TI components with prices. Includes items like TL494, TL496, TL497, etc.

BI FET

Table listing BI FET components with prices. Includes items like TL071, TL072, TL074, etc.

MICRODEVICES AT MICROPRICES

ALL MERCHANDISE 100% GUARANTEED

2716 16K EPROMS

\$395 EA

4116 250 NS

8/\$795

RF MODULATOR

(ASTEC UM1082) QUANTITIES LIMITED

- * PRESET TO CHANNEL 3
- * USE TO BUILD TV-COMPUTER INTERFACE
- * +5 VOLT OPERATION

NOW ONLY **\$695**

POWER SUPPLIES

IDEAL FOR HOBBYIST, BENCHWORK & DO-IT-YOURSELFERS! 90-DAY WARRANTY! NEW & UNUSED! QUANTITIES LIMITED!

ASTEC AA11190

- * QUAD OUTPUT SWITCHING DESIGN AS USED IN APPLE III
- * +5 @ 4A; -5 @ .25A
- * +12 @ 2.5A; -12 @ .30A; 15.5"x4.5"x2"

NOW ONLY **\$5990**

SIGMA INSTRUMENTS

Model 2PC2241

- * DESIGNED FOR DEC EQUIPMENT
- * FUSE PROTECTED * LINEAR DESIGN
- * AUXILIARY AC OUTLET
- * +5 @ 4A; -15V @ 1.5A; 12.25"x4"x4.75"

NOW ONLY **\$1995**

OUR BUYER BLEW IT... & BOUGHT TOO MANY OF THESE!

4116 250NS **8/7.95**

OPTO-ISOLATORS

4N26	1.00	MCA-7	4.25
4N27	1.10	MCA-255	1.75
4N28	.69	IL-1	1.25
4N33	1.75	ILA-30	1.25
4N35	1.25	ILQ-74	2.75
4N37	1.25	H11C5	1.25
MCT-2	1.00	TIL-111	1.00
MCT-6	1.50	TIL-113	1.75

DIODES

1N751	5.1 volt zener	.25
1N759	12.0 volt zener	.25
1N4148	(1N914) switching	25/1.00
1N4004	400PIV rectifier	10/1.00
KBP02	200PIV 1.5amp bridge	.45
KBP04	400PIV 1.5amp bridge	.55
VM48	Dip-Bridge	.35

NEW UN-USED MUFFIN FANS

4.68" Square	14.95
3.125" Square	14.95

HEAT SINKS

TO-3 style	.95
TO-220 style	.35

SWITCHES

SPDT mini-toggle	1.25
DPDT mini-toggle	1.50
SPST mini-pushbutton	.39

MICRODEVICES AT MICROPRICES

TRANSISTORS

2N918	.50	MPS3706	.15
MPS918	.25	2N3772	1.65
2N2102	.75	2N3903	.25
2N2218	.50	2N3904	.10
2N2218A	.50	2N3906	.10
2N2219	.50	2N4122	.26
2N2219A	.50	2N4123	.25
2N2222	.25	2N4249	.25
PN2222	.10	2N4304	.75
MPS2369	.25	2N4401	.25
2N2484	.25	2N4402	.25
2N2905	.50	2N4403	.25
2N2907	.25	2N4857	1.00
PN2907	.125	PN4916	.25
2N3055	.79	2N5086	.25
3055T	.69	PN5129	.25
2N3393	.30	PN5139	.26
2N3414	.25	2N5209	.25
2N3563	.40	2N6028	.35
2N3565	.40	2N6043	1.75
PN3565	.25	2N6045	1.75
MPS3638	.25	MPS-A05	.25
MPS3640	.25	MPS-A06	.25
PN3643	.25	MPS-A55	.25
PN3644	.25	TIP29	.65
MPS3704	.15	TIP31	.75
		TIP32	.79

CAPACITORS

TANTALUM

	6V	10V	15V	20V	25V	35V
.22uf						.40
.27						.40
.33						.40
.47			.35			.50
.68						.45
1.0		.40	.40	.45	.45	
1.5			.45	.50		
1.8						.75
2.2		.35	.40	.45	.65	
2.7		.40	.45		.90	
3.3		.45	.50	.55	.60	.65
3.9		.45				
4.7	.45	.55		.60	.65	.85
6.8			.70	.75		
8.2						1.00
10	.55	.65	.80	.85	.90	1.00
12	.65		.85	.90		
15	.75	.85	.90			
18			1.25			
22		1.00	1.35			
27			2.25			
39		1.50				
47	1.35					
56	1.75					
100		3.25				
270	3.75					

DISC

50V .05	470	50V .05
50V .05	560	50V .05
50V .05	680	50V .05
50V .05	820	50V .05
50V .05	.001uf	50V .05
50V .05	.0015	50V .05
50V .05	.0022	50V .05
50V .05	.005	50V .05
50V .05	.01	50V .07
50V .05	.02	50V .07
50V .05	.05	50V .07
50V .05	.1	12V .10
	.1	50V .12

MONOLITHIC

.1uf-mono 50V .18	.47uf-mono 50V .25
.047uf-mono50V .15	.01uf-mono 50V .14

ELECTROLYTIC

RADIAL AXIAL

.47uf	50V .14	1uf	50V .14
1	25V .14	4.7	16V .14
2.2	35V .15	10	16V .14
4.7	50V .15	10	50V .16
10	50V .15	22	16V .14
47	35V .18	47	50V .20
100	16V .18	100	15V .20
220	35V .20	100	35V .25
470	25V .30	150	25V .25
2200	16V .60	220	25V .30
		330	16V .40
		500	16V .42
		1000	16V .60
		1500	16V .70
		6000	16V .85

COMPUTER GRADE

26,000uf 30V	3.95
--------------	------

BYPASS CAPS

.01 UF DISC	100/8.00
.01 UF MONOLITHIC	100/12.00
.1 UF DISC	100/8.00
.1 UF MONOLITHIC	100/15.00

IC SOCKETS

	1-99	100
8 pin ST	.13	.11
14 pin ST	.15	.12
16 pin ST	.17	.13
18 pin ST	.20	.18
20 pin ST	.29	.27
22 pin ST	.30	.27
24 pin ST	.30	.27
28 pin ST	.40	.32
40 pin ST	.49	.39
64 pin ST	4.25	call
ST = SOLDERTAIL		
8 pin WW	.59	.49
14 pin WW	.69	.52
16 pin WW	.69	.58
18 pin WW	.99	.90
20 pin WW	1.09	.98
22 pin WW	1.39	1.28
24 pin WW	1.49	1.35
28 pin WW	1.69	1.49
40 pin WW	1.99	1.80
WW = WIREWRAP		
16 pin ZIF	5.95	call
24 pin ZIF	7.95	call
28 pin ZIF	8.95	call
ZIF = TEXT TOOL		
(Zero Insertion Force)		

LED LAMPS

	1-99	100-up
JUMBO RED	.10	.09
JUMBO GREEN	.18	.15
JUMBO YELLOW	.18	.15
LED MOUNTING HARDWARE	.10	.09

LED DISPLAYS

HP 5082-7760	.43"	CC	1.29
MAN 72	.3"	CA	.99
MAN 74	.3"	CC	.99
FND-357 (359)	.375"	CC	1.25
FND-500 (503)	.5"	CC	1.49
FND-507 (510)	.5"	CA	1.49
TIL-311 4x7	.270"	HEX W/LOGIC	9.95

RESISTORS

1/4 WATT 5% CARBON FILM ALL STANDARD VALUES FROM 1 OHM TO 10 MEG OHM	
50 PCS. SAME VALUE	.025
100 PCS. SAME VALUE	.02
1000 PCS. SAME VALUE	.015

DIP SWITCHES

4 POSITION	.85
5 POSITION	.90
6 POSITION	.90
7 POSITION	.95
8 POSITION	.95



JDR Microdevices

1224 S. Bascom Avenue, San Jose, CA 95128
800-538-5000 • 800-662-6279 (CA)
(408) 995-5430 • Telex 171-110

VISIT OUR RETAIL STORE

HOURS: M-W-F, 9-5 T-Th., 9-9 Sat. 10-3

PLEASE USE YOUR CUSTOMER NUMBER WHEN ORDERING

TERMS: Minimum order \$10. For shipping and handling include \$2.50 for UPS Ground and \$3.50 for UPS Air. Orders over 1 lb. and foreign orders may require additional shipping charges - please contact our sales department for the amount. CA residents must include 6% sales tax, Bay Area and LA residents include 6.5%. Prices subject to change without notice. We are not responsible for typographical errors. We reserve the right to limit quantities and to substitute manufacturer. All merchandise subject to prior sale.

© Copyright 1984 JDR Microdevices

2732 32K EPROM

\$495

2764 64K EPROM

\$695

**MICROCOMPUTER
HARDWARE HANDBOOK
FROM ELCOMP — \$14.95**

Over 800 pages of manufacturers data sheets on most commonly used IC's.

Includes:

- * TTL — 74/74LS and 74F
- * CMOS
- * Voltage Regulators
- * Memory — RAM, ROM, EPROM
- * CPU's — 6800, 6500, Z80, 8080, 8085, 8086/8
- * MPU support & interface - 6800, 6500, Z80, 8200, etc.

**BEST SELLING
BOOKS**

OSBORNE/MC GRAW-HILL

- Apple II User's Guide 16.95
- CRT Controller's Handbook 9.95
- 68000 Assembly Language Programming 16.99
- CBASIC User Guide 15.00

SYBEX

- Your First Computer 8.95
- The CP/M Handbook 14.95
- The PASCAL Handbook 18.95
- Microprocessor Interfacing Techniques 17.95

**DISK DRIVES
TANDON**

- TM100-1 5 1/4" (FOR IBM) SS/DD **229.00**
- TM100-2 5 1/4" (FOR IBM) DS/DD **259.00**

SHUGART

- SA 400L 5 1/4" (40 TRACK) SS/DD **199.95**
- SA 400 5 1/4" (35 TRACK) SS/DD **189.95**

PERTEC

- FD-200 5 1/4" SS/DD **179.95**
- FD-250 5 1/4" DS/DD **199.95**

MPI

- MP-52 5 1/4" (FOR IBM) DS/DD **249.00**

NOTE: Please include sufficient amount for shipping on above items.

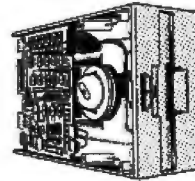

**8-INCH
DISK DRIVE
SALE**

- FD 100-8 SHUGART 801 EQUIV. SS/DD — 10/\$175 EA.
- FD 200-8 SHUGART 851 EQUIV. DS/DD — 10/\$220 EA.

\$18900

\$23900

**EDGE-CARD
CONNECTORS**

- S-100 ST **3.95**
- S-100 WW **4.95**
- 72 pin ST **6.95**
- 72 pin WW **7.95**
- 50 pin ST **4.95**
- 44 pin ST **2.95**
- 44 pin WW **4.95**



CABINETS FOR 5 1/4" DISK DRIVES

CABINET #1 \$29.95

- * DIMENSIONS 8 5/8 x 5 1/2 x 3 1/2"
- * COLOR MATCHES APPLE
- * FITS STANDARD 5 1/4" DRIVES, INCL. SHUGART
- * INCLUDES MOUNTING HARDWARE AND FEET

CABINET #2 \$79.00

- * COMPLETE WITH POWER SUPPLY, SWITCH, LINE CORD, FUSE & STANDARD POWER CONNECTOR
- * DIMENSIONS: 11 1/2 x 5 3/4 x 3 1/2"
- * +5V @ 1 AMP, +12V @ 1.5 AMP
- * FITS STANDARD 5 1/4" DRIVES
- * PLEASE SPECIFY GRAY OR TAN

NOTE: Please include sufficient amount for shipping on above items.

**TRANSFORMERS
FRAME STYLE**

- 12.6VAC 2amp **4.95**
- 12.6VAC CT 2amp **5.95**
- 12.6VAC CT 4amp **7.95**
- 12.6VAC CT 8amp **10.95**
- 25.2VAC CT 2amp **7.95**

PLUG CASE STYLE

- 12VAC 250ma **3.95**
- 12VAC 500ma **4.95**
- 12VAC 1amp **5.95**
- 12VAC 2amp **6.95**

DC ADAPTER

- 6, 9, 12 VDC selectable with universal adapter **8.95**

NOTE: Please include sufficient amount for shipping on above items.

**VISIT DURING
OUR EXPANDED
RETAIL STORE HOURS
SATURDAY 10 to 3**

CENTRONICS

- IDCEN36 Ribbon Cable 36 Pin Male **8.95**
- IDCEN36/F Ribbon Cable 36 Pin Female **6.95**
- CEN36 Solder Cup 36 Pin Male **7.95**

DIP CONNECTORS

DESCRIPTION	HIGH RELIABILITY TOOLED ST IC SOCKETS	COMPONENT CARRIERS (DIP HEADERS)	RIBBON CABLE DIP PLUGS (IDC)
ORDER BY	AUGATxx-ST	ICCxx	IDPxx
CONTACTS 8	.99	.65	
14	.99	.75	1.45
16	.99	.85	1.65
18	1.69	1.00	
20	1.89	1.25	
22	1.89	1.25	
24	1.99	1.35	2.50
28	2.49	1.50	
40	2.99	2.10	4.15

For order instructions see "IDC Connectors" below.

RIBBON CABLE

CONTACTS	SINGLE COLOR		COLOR CODED	
	1'	10'	1'	10'
10	.50	4.40	.83	7.30
16	.55	4.80	1.00	8.80
20	.65	5.70	1.25	11.00
25	.75	6.60	1.32	11.60
26	.75	6.60	1.32	11.60
34	.98	8.60	1.65	14.50
40	1.32	11.60	1.92	16.80
50	1.38	12.10	2.50	22.00

D-SUBMINIATURE

DESCRIPTION	SOLDER CUP		RIGHT ANGLE PC SOLDER		IDC RIBBON CABLE		HOODS	
	MALE	FEMALE	MALE	FEMALE	MALE	FEMALE	BLACK	GREY
ORDER BY	DBxxP	DBxxS	DBxxPR	DBxxSR	IDBxxP	IDBxxS	HOOD-B	HOOD
CONTACTS 9	2.08	2.66	1.65	2.18	3.37	3.69	—	1.60
15	2.69	3.63	2.20	3.03	4.70	5.13	—	1.60
25	2.50	3.25	3.00	4.42	6.23	6.84	1.25	1.25
37	4.80	7.11	4.83	6.19	9.22	10.08	—	2.95
50	6.06	9.24	—	—	—	—	—	3.50

For order instructions see "IDC Connectors" below.

MOUNTING HARDWARE 1.00

IDC CONNECTORS

DESCRIPTION	SOLDER HEADER	RIGHT ANGLE SOLDER HEADER	WW HEADER	RIGHT ANGLE WW HEADER	RIBBON HEADER SOCKET	RIBBON HEADER	RIBBON EDGE CARD
ORDER BY	IDHxxS	IDHxxSR	IDHxxW	IDHxxWR	IDSxx	IDMxx	IDExx
CONTACTS 10	.82	.85	1.86	2.05	1.15	—	2.25
20	1.29	1.35	2.98	3.28	1.86	5.50	2.36
26	1.68	1.76	3.84	4.22	2.43	6.25	2.65
34	2.20	2.31	4.50	4.45	3.15	7.00	3.25
40	2.58	2.72	5.28	4.80	3.73	7.50	3.80
50	3.24	3.39	6.63	7.30	4.65	8.50	4.74

ORDERING INSTRUCTIONS: Insert the number of contacts in the position marked "xx" of the "order by" part number listed. Example: A 10 pin right angle solder style header would be IDH10SR.

FOR APPLE COMPUTER USERS



JDR Microdevices

THOUSANDS SOLD!

JDR 16K RAM CARD FOR APPLE II+

- * Expand your 48K Apple to 64K
 - * Fully compatible with Apple Language System — Use in place of Apple Language card
 - * Highest quality card features: gold edge connector, sockets for all IC's.
 - * 2 YEAR WARRANTY
- Kit with Instructions \$40.95 **\$44.95**
 Bare PC Card \$14.95

GET SLIM IN 1984! JDR HALF-HEIGHT DISK DRIVE

- * 35 Track if used with Apple Controller
- * 40 Track Controller and DOS Available (Call for Price)

\$209.95

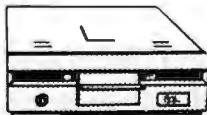

MA SYSTEMS FD-35 DISK DRIVE

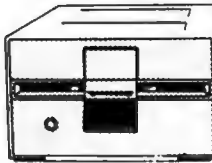

\$199.95

- * Shugart Mechanism — Made in U.S.A.
- * Direct Replacement for Apple Disk II
- * Compatible with Apple Controller or other Apple compatible controllers
- * Specially designed electronics with low power consumption
- * DOS 3.3 and 3.2 compatible
- * One Year Warranty

**CONTROLLER CARD
 \$69.95**



APPLE COMPATIBLE POWER SUPPLY

- * Use To Power Apple-Type Systems
- * +5V @ 5A +12V @ 3A
- * -5V @ .5A -12V @ .5A
- * Instructions Included

\$79.95

BMC BMX-80 PRINTER

- * 80 CPS Dot Matrix Printer
- * Prints Bi-Directional in 40, 80, 71 or 142 Columns in Normal, Double Width or Compressed Text.
- * Print Superscript As Well As Superb Graphics in Character or Bit Image

\$279



micromax

VIEWMAX-80 NOW ONLY \$159.95

- * 80 Column Card for Apple II+
- * Video Soft Switch
- * Inverse Video
- * 2 Year Warranty

VIEWMAX-80e NEW \$129.95

- * 80 Column Card for Apple IIe
- * 64K RAM Expandable to 128K
- * 64K RAM Upgrade \$47.60

GRAPHMAX \$129.95

- * Hi Resolution Graphics
- * Printer Card
- * Centronics Parallel Interface

Graphmax with Color & Zoom Options ... **\$149.95**

NASHUA DISKETTES

5 1/4" WITH HUB RING

MD1 SOFT SECTOR, SS/SD	19.95
MD1D SOFT SECTOR, SS/DD	26.25
MD2D SOFT SECTOR, DS/DD	30.75
MD2F SOFT SECTOR, DS/QUAD DENSITY	45.00
MD110 10 SECTOR HARD, SS/SD	19.95
MD210D 10 SECTOR HARD, DS/DD	30.75
8" WITHOUT HUB RING	
FD1 SOFT SECTOR, SS/SD	24.75
FD1D SOFT SECTOR, SS/DD	30.00
FD2D SOFT SECTOR, DS/DD	36.75

VERBATIM DATALIFE DISKETTES

SS/DD SOFT SECTOR

\$29.95

SS/DD 10 HARD SECTOR

\$29.95

5 1/4" DISKETTE FILE

- * ATTRACTIVE, FUNCTIONAL DISK STORAGE SYSTEM
 - * 75 DISK STORAGE CAPACITY
 - * MOLDED FROM DURABLE SMOKED PLASTIC WITH FRONT CARRYING HANDLE
- \$16.99**

OTHER ACCESSORIES FOR APPLE II

THUNDERCLOCK \$129.95

- * Real-Time Clock Calendar
- * Software Included
- * Mountain Software Compatible
- * BSR Control Options Available

KRAFT JOYSTICK \$39.95

MONITORS

BMC MONITOR STAND MODEL PA-900

Your Display Will Tilt & Swivel **\$29.95**

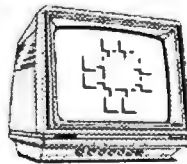

MONOCHROME

BMC BM 12AUW GREEN 12"	\$89.95
BMC BM 12EUY 18 MHZ AMBER	\$139.95
BMC BM 12EUN 18 MHZ HIGH RES GREEN	\$115.00
NEC JB1201M - 20 MHZ GREEN	\$169.00
ZENITH ZVM-121 - 15 MHZ GREEN	\$99.00

COLOR

BMC BM-AU9191U COMPOSITE 13" **\$279.00**

NO C.O.D. ORDERS PLEASE



JDR Microdevices

1224 S. Bascom Avenue, San Jose, CA 95128
 800-538-5000 • 800-662-6279 (CA)
 (408) 995-5430 • Telex 171-110

Apple is a trademark of Apple Computer Corporation

VISIT OUR RETAIL STORE

HOURS: M-W-F, 9-5 T-Th., 9-9 Sat. 10-3

PLEASE USE YOUR CUSTOMER NUMBER WHEN ORDERING

TERMS: Minimum order \$10. For shipping and handling include \$2.50 for UPS Ground and \$3.50 for UPS Air. Orders over 1 lb. and foreign orders may require additional shipping charges — please contact our sales department for the amount. CA residents must include 6% sales tax, Bay Area and LA residents include 6.75%. Prices subject to change without notice. We are not responsible for typographical errors. We reserve the right to limit quantities and to substitute manufacturer. All merchandise subject to prior sale.

© Copyright 1984 JDR Microdevices

Unclassified Ads

WANTED: The Association of Radio Reading Services (ARRS) Inc., an organization representing stations that provide radio broadcasts to the blind and handicapped, seeks tax-deductible TRS-80 Model III or 4. We offer receipt; will pay shipping. Kent Bowers, Treasurer, ARRS, 110B Northeast 36th St., Oklahoma City, OK 73111, (405) 521-3514.

WANTED: Established, nonprofit educational institution seeks tax-deductible gifts of microcomputer, disk drives, monitor and printer. Will pay shipping. Mary Kane Trochim, Community School of Music and Arts, Whiton House, Ithaca, NY 14850, (607) 272-1474.

WANTED: Historic Hudson River church seeks tax-deductible donation of old but functioning personal or small business system for our name list, WP, accounts, etc. We would be happy with almost any disk-based system, such as CP/M, Apple, TRS-80 Models II or III, etc. Christ Church, Elizabeth St., Tarrytown, NY 10591, (914) 631-9194.

WANTED: Newly formed computer club in Philippines seeks correspondence with user's group in America to exchange information on software utilities and applications. Dbrs, Mario Franco Arroyo, 14-D La Salle St., Cubao, Quezon City, Philippines

WANTED: Herbal Investigation of Pharmacology is a computer club seeking to share information and software about botanical medicine. Herbal Investigation of Pharmacology, 2509 North Campbell #9, Tucson, AZ 85719.

NEEDED: Nonprofit appropriate-technology organization in a developing country needs technical, engineering, health service, and bibliographical software for use in Apple/Corvus/Condor system. Botswana Technology Centre, Private Bag 0082, Gaborone, Botswana, Southern Africa.

FOR SALE: Cromemco C-10 with two disk drives and software: \$1000. Jim O'Toole, 422 South Las Palmas Ave., Los Angeles, CA 90020, (213) 933-9806.

FOR TRADE: Unopened Ashton-Tate and Base II for Osborne I. Will trade for printer in good condition or \$350. Gary Watson, R. L. 903 East Mason Rd., Milan, OH 44846, (419) 499-2063.

WANTED: Computers, peripherals, parts, etc. in hopes that I can put together a working system. I will gratefully accept anything; especially interested in DEC or DG minis. Will pay for postage. Bill Donnelly, POB 1978, Oroville, CA 95965.

FOR SALE: Magic Wand. Doesn't work with my operating system. Only slightly used. Will sell for \$120. Br. Brian Kerns, Abbey of the Genesee, Piffard, NY 14533, (716) 243-0660.

WANTED: Parts lists and IC numbers for Redaction (mfgr 1970s) (CPU console) Word Processor with two cassette drives and IBM Selectric #745 I/O. Quote or send and will reimburse. D. Teste, Box 9064, Newark, NJ 07104.

FOR TRADE: Want to swap programs for Apple II Plus. Send your list of programs or games and I'll send mine. Koon-Ping Tong, POB 16274, San Francisco, CA 94116.

WANTED: The Twin City TRS-80 User Group (TCTUG) is seeking to exchange public-domain programs with other groups or individuals. We accept any TRS-80 disk or tape format but prefer TRSDOS 1.3 format. We will return your disk with programs from our library. TCTUG Library, Gary Schlegel, 21581 Creekside Circle, Lakeville, MN 55044.

FOR SALE: Hewlett-Packard HP-85A with 5 1/4-inch dual master flexible disk drive, 32K memory, advanced programming ROM, Assembler ROM, and other required hardware. John L. Brown, 66 Orange St., Brooklyn, NY 11201, (212) 834-9244.

FOR SALE: Sources for: BIOS for CP/M 2.2 on Corvus hard disk and dual floppy for CCS 2210; MP/M II XIOS for systems group 2810; MP/M III XIOS for CCS 2210 floppy-disk system. All MP/M XIOS include LDRBIOS, RESXIOS, and BNKXIOS supplied on 8-inch, single-density floppy disk: \$100 each. Steve Mastrianni, Box 216B, Vernon, CT 06066.

FOR TRADE: Programs for Apple II Plus. Send your list of programs and I will send mine. Roland Forsman, 51 Tower Rd., Brookfield, CT 06805.

FOR SALE: STD BUS Z80 CP/M computers with 16-slot card cage. CPU card, two serial I/Os, four parallel I/Os, hefty power supply; steel cabinet with locking door, all brand name equipment, documentation, guaranteed: \$495. STD BUS 16K EPROM cards with eight 2716 EPROMS: \$55. 8-inch disk drive with enclosure and power: \$150. 5 1/4-inch disk drive Shugart SA-400: \$49. L. H. Gary, 6111 Edgerton Dr., Greensboro, NC 27410, (919) 852-6806 evenings.

FOR SALE: 64K Micro Profesor. Seven program and joysticks included. Has Apple and block graphics, one key basic commands, and accepts programs on tape (cable included). Monitor requires no interface. Cartridges and interfaces for printers and disk drives available. Asking \$395. Francis Hsu, 42-II 149 PL, Flushing, NY 11355, (212) 939-2491.

FOR SALE: Heath IM-4180 FM-deviation meter: \$100. Heath ET-33008 breadboard: \$65. Heath BASIC Programming course: \$25. Analyzer: \$40. Voltmeter: \$100. Amplifier: \$40. HDOS 2.0: \$75. IMSA I motherboard: \$75. EconoRAM II: \$50. Multi I/O board: \$50. Keyboard: \$25. Will trade some for H-89 accessories. Jack Ball, Rt. 2, Box 330, Durham, MO 63438.

FOR SALE: Apple interface cards in language, Integer, FORTH, 16K RAM, CP/M, disk, Epson printer; \$50 each. 80-column (Vindex type); \$80 each. Printer buffers 16K/32K/64K: \$90/\$100/\$120. Our expatriate engineer's computer club is upgrading to IBM compatibles and we have many Apple compatible accessories available. Include \$5 per card for shipping; personal checks OK. Jimmy Menning, 36-90 Da Pei Rd., Kaohsiung 833, Taiwan, Republic of China.

FOR SALE: Atari 800, 48K; dual DSDD Percom drives. 352K each; Atari 850 interface (four serial and parallel); Mannesmann Tally MT160L printer. 160 cps; and two VIC OBOSS joysticks. Software includes OS/A + DOS. All necessary cables and supplies: \$2300 or best offer, or will trade for IBM PC. David Hayes, 92 25th St., Troy, NY 12180, (518) 271-0709 evenings.

WANTED: Used Apple II Plus with Disk II Drive (DOS 3.3) printer and CRT. M. Evangelista, 11128 East Canyon Meadows Dr., Whittier, CA 90601, (213) 627-1642 days and 692-2618 evenings.

FOR SALE: MC68000 single-board computer (OB68KB) by Omnibyte with 128 kilobytes of memory. IEEE-796 Multibus with documentation. Originally \$1900; selling for \$1100. TRS-80 Model III 48K RAM with cassette and green screen, plus many programs and books: \$650. J. Creed, 5 Belaire Court, Old Bridge, NJ 08857, (201) 679-8462.

FOR SALE: BYTE 1976 through 1979. Also, many KiloBaud Microcomputing, '68 Micro Journals, or dobbs journals, etc. Make offer. G. W. March, 210 Country Club Parkway SE, Cedar Rapids, IA 52403.

FOR SALE: BYTE vol. 1, no. 1 through January 1978 (have 2 sets). Many are still in original wrappers. Also, KiloBaud issues no. 1 to 5. All or any part at reasonable prices. Chuck Markham, 362 Commonwealth Ave. #2E, Boston, MA 02115.

NEEDED: I am starting an Adventurer's Club for all computer owners interested in playing adventures or in writing their own. One purpose will be to exchange new adventure program listings through publication in a monthly newsletter. Maurice Dow, 84 Camberley Cres., Brampton, Ontario L6V 3L4, Canada.

FOR SALE: TRS-80 Model I with 48K expansion interface, video monitor, four external disk drives, line printer, cables, system desk, and printer stand. Fully operational: \$1900. Scott Wilson, 71 Jane St., Roslyn, NY 11577, (516) 621-3000.

FOR SALE: Netronics Explorer-85 with 4K RAM and MS-BASIC in ROM with two S-100 slots and RS-232C: \$250. Netronics terminal: 64 by 16 with graphics and internal power supply: \$150, both for only \$350. Centronics 779 printer (if wanted, cable for Exp-85): \$300. Colin Cook, 8112 Ravinia Rd., Ft. Wayne, IN 46825, (219) 489-9401.

FOR SALE: S-100 boards. SD Systems ExpandoRAM II with 16K memory: \$200. Ithaca Audio Z80 CPU: \$80. SSM VBI-B video interface: \$75. SSM MB6B BK static memory: \$65. SSM 104 I/O board: \$80. Tarbell cassette interface: \$60. Jade Double D disk controller: \$200. Wameco Mem-AI BK static memory: \$65. Wameco OMB-12 12-slot motherboard with connectors: \$50. MPI B52 5 1/4-inch 2-sided disk drive: \$200. Bruce Kabernagel, 2047 Finch Dr., Bensalem, PA 19020, (609) 338-3226 days.

WANTED: Apple programs for trade. Please send a list of your games, utilities, etc., and I will send you a list of my extensive software collection. David Sterner, 1281 Bialore Ave., Bethlehem, PA 18017.

FOR SALE: Complete AIM-65, BASIC, Assembler, 4K RAM, and documentation with heavy-duty power supply: \$200 or best offer. David Allen, 184 Avenue A #2, NY, NY 10009, (212) 673-5055.

WANTED: Atari users to buy, sell, or trade software. I have everything made for the Atari PC. Paul Hornung, 104 South 22nd St., La Crosse, WI 54601, (608) 785-2904.

FOR SALE: LNW80 computer board, Z80A processor, has 480 by 192 color resolution, TRS-80 compatible, needs two sockets required, all schematics and manuals are included. I have a Commodore 64, and I will trade for hardware or software, etc. Was \$1995, asking \$350. Jeff Fandl, Box 362, Highland Rd., Orefield, PA 18069, (215) 395-9857.

FOR SALE: Zenith Z-89 with 64K RAM, 10-megabyte hard disk and 8-inch DSDD floppy. Software includes CP/M 2.2, MBASIC (interpreter and compiler), Wrdstar, FORTRAN, COBOL, and communications program. Excellent condition: \$3200 or best offer. R. DeTeresa, 155-18 Locke Ave., Whitestone, NY 11357, (212) 767-1944 evenings, 430-2051 days.

WANTED: Information on computer phreak boards and their numbers. Also, want to trade lode-runner data disks (include postage if trading disks). Eric Kinney, Rt. 1 Box 136, Walla Walla, WA 99362, (509) 525-5887.

WANTED: I have a collection of cassette programs for the TRS-80 Model III. I am interested in swapping games, utilities, and home programs. Also, I am looking for people interested in corresponding. Paulo Pires, Caixa Postal 6125, 13.100, Capinas, SP, Brazil.

FOR SALE: SD Systems 256K 150 ns EXIII: \$600. New MPC-4: \$400. New MP/MLI: \$300. New SA1002 5-megabyte hard disk: \$500. Must sell at asking price or highest bid. Mark E. Hatch, 3961 West 8010 South, West Jordan, UT 84084, (801) 569-1266.

FOR SALE: Four electrical surge protectors to save your data from glitches, and even rfi. All new with warranty never used: \$35 each or all four for \$120. Free shipping. Joseph Cross, POB 3633, Langley Park, MD 20787.

FOR TRADE: Apple games and utilities. I have large list of programs. Please send SASE. Kris Vogelsong, 1108 Kathryn St., Boalsburg, PA 16827.

WANTED: Names, addresses, prices, and information about computer camps or courses near or far for my family. Include description of your experience; would appreciate all information. Matt Beha, 6390 Cheshire, Dimondale, MI 48821.

WANTED: CP/M 2.2 operating system or later version from authorized dealer with BIOS configured for the Sharp PC-3201 with 32K ROM BASIC, 64K RAM plus 48K RAM expansion, two 8-inch DSDD drives, 77 tracks, 26 sectors, cassette interface, and Epson MX-80 serial printer. The CRT display has 80 columns, 25 lines, and is memory mapped. Also, seek correspondence with users of Sharp PC-3201s. Irene Davis, Hamburgo 330-C, Santiago, Chile, South America.

WANTED: Old computer parts, components, and equipment for educational displays. Need not be working! Especially want parts of 1st to 3rd generation computers. Also, items from silicon-chip design and manufacture. Send list of equipment with details and asking price. Jackie Seppy, 19216 Wootton Dr., Poolesville, MD 20837.

WANTED: Anyone interested in starting a users group for the Epson OX-10 is welcome to contact Patric Lee Howley, 454 Barcelona Dr., Satsuma, AL 36572.

FOR SALE: IBM-PC game board, like new: \$35. Also, a Tandon 160K single-sided drive removed from my PC: \$130. George Huribut, 1088 Alderbrook Lane, San Jose, CA 95129, (408) 252-0398.

FOR SALE: Buy my (hopelessly broken) MX70 printer for \$25 or I will pay you \$25 for your hopelessly broken MX70. Bob Wiseman, 1899 Muskegon Dr., Cincinnati, OH 45230, (513) 474-3546.

WANTED: Typewriter or similar daisy-wheel printer. High school student setting up word-processing system. Will consider any reasonably priced, used, and working printer and/or system. Jason Bender, 23855 Southeast 162nd, Issaquah, WA 98027, (206) 392-2698.

FOR SALE: Digital Group System complete 64K Z80 system with two 8-inch DSDD disks, communications board, plus lots of software: \$1400 or best offer. Extra 8-inch DSDD Shugart disk drive: \$125. Disk controller: \$100. Votrax board: \$200. Three BK memory boards: \$40 each, 6800, 6502, and 8080 CPU cards not completely populated: \$25 each. Over 20 original software tapes available and more. All prices are negotiable. Allan Cole, 4758 Fox Hunt Trail, Boca Raton, FL 33431, (305) 994-3535.

FOR SALE: Vector 20-slot mainframe, Microbyte Z80 card (Dart-Parallel I/O), SD Sales ExpandoRAM II with 64K, IMSA I/B-inch dual disk subsystem (IMSA) DIO-C disk controller, SSM I/O 4B: \$1500 or best offer. TV 910 (brand new): \$575 and Epson MX80: \$475. Plus, lots of software. Michael D. Reeves, 6432 Alta Vista Dr., Fort Worth, TX 76148, (817) 498-9020 evenings.

WANTED: TRS-80 Model I owners to trade software. Need Pascal/FORTRAN compilers, DOSs (NEW/DOS80), and arcade games. I have many programs. Send your programs on single density, 35-track disks with DOS and I'll do the same. Also want coin-inventory programs. G. Schofer, 903 Nora Dr., Silver Spring, MD 20904.

FOR SALE: Zenith Z-100 complete system 8 1/2 bit with two DS/DD drives and TPI printer. Lots of software including word processing, spreadsheet, database, high level, and interpretive languages. First \$3000 takes all. Mario Toscano, Bldg. 877 Apt. 602, Governors Island, NY 10004, (212) 825-0150.

FOR SALE: Timex/Sinclair 1000 including complete training course: \$1000. Will consider trade. L. Miller, POB 8183, Rockville, MD 20856, (301) 251-8670.

UNCLASSIFIED POLICY: Readers who have computer equipment to buy, sell, or trade or who are requesting or giving advice may send a notice to BYTE for inclusion in the Unclassified Ads section. To be considered for publication, an advertisement must be noncommercial (individuals or bona fide computer clubs only), typed double-spaced on plain white paper, contain 75 words or less, and include complete name and address. This service is free of charge; notices are printed once only as space permits. Your confirmation of placement is appearance in an issue of BYTE as we engage in no correspondence. Please allow at least three months for your ad to appear. Send your notices to Unclassified Ads, BYTE/McGraw-Hill, POB 372, HancocK, NH 03449.

Unclassified Ads

FOR SALE: Altair 680 with 16K, three I/O, and two each Meca stand-alone RS-232 cassette drives, Micon portable RS-232 terminal, 1 by 32 LED display, Sanyo DMC-6013 color CRT, Hewlett-Packard 5036A Micro-lab, Tektronix 221 portable oscilloscope, Heathkit 6800 Micro-trainer with course and HW-8 with P/S, Cromemco SCC CPU, S-100, and OSI bare boards. B. Pinkerton, Box 2439, Melbourne, FL 32902.

FOR SALE: TRS-80 Model I 16K Level II BASIC computer, good condition, includes CTR-80 cassette deck, and the standard Radio Shack monitor. Must sell, asking \$400; will accept any other reasonable offer. Dan Durachko, 102 Hartranft, University Park, PA 16802, (814) 865-8768.

FOR SALE: Apple II Plus-compatible 48K Syscom Computer with 16K Apple language card, RF modulator, disk-controller card (3.2 or 3.3), Rana Elite I disk drive, and ten disks of software (home finance, utilities, games, etc.). All in super condition: \$1050 takes it. (COD OK with \$100 down payment.) M. C. Smalley, 4793 Gratiot, Saginaw, MI 48603, (517) 791-1233.

WANTED: A Commodore 4040 dual-disk drive. Also, an interface that will let me run a Commodore 64 with a 4040 dual-disk drive (or a 2031 single-disk drive) and a Commodore 4022 printer. Also, numerous Commodore programs for sale. Melvin Billik, 412 Hollybrook Dr., Midland, MI 48640, (517) 631-7607.

FOR SALE: TRS-80 Model I 48K with expansion interface, monitor, lowercase, double-density "floppy" disk drive, LNdoubler, RS-232C, power-line filter, sound interface, joystick, gold plugs, NEWDOS/80, FORTRAN compiler, mu-Math, ICL, Superterm, 30 purchased cassettes, 20 disks, plus much more. Asking \$1300 but will take any reasonable offer. Phil Irey, 102 Hartranft Hall, University Park, PA 16802, (814) 865-8768.

FOR SALE: Racal-Vadic 1200-bps modem, Model VA 1250, 55 P/S/G. Great buy, but half-duplex and uses Bell or Western Electric 202, the original rare protocol or computer interface: \$91 or best offer. Adam Sundor, 4537 Osage Ave., Philadelphia, PA 19143, (215) 748-6463.

FOR TRADE: Apple owners including Microsoft CP/M. Send (air mail) me a list of your software, and I will send mine in exchange. R. Z. Nielson, ARAMCO, POB 4750, Ras Tanura, Via Dhahran, Saudi Arabia.

NEEDED: Word-processing success stories sought by writer. Especially looking for form letters you've written that cut bureaucratic red tape, get jobs, settle grievances, etc. I'll call you. Hugh Deadwyler, POB 419, Newell, NC 28126.

FOR TRADE: Many programs for the Apple available. Send a list of your software and a telephone number. I will send you a list of my software a week before I call you. Eric Podell, 4218 B Guilford Dr., College Park, MD 20740, (301) 779-8543.

FOR SALE: Complete collection of BYTE starting with issue #1 to December 1982. Most in mint condition. Prefer to sell as one unit. Best offer plus shipping. Bob Mitchell, 721 Glenhaven Court, Boulder, CO 80303.

WANTED: Used Apple II or compatible in working order. Send list of components with price. Walt Burkhardt, 12 Azenberg, D-7000 Stuttgart 1, West Germany, tel: 1-49-711-207-8391.

FOR SALE: Digital Group 64K system, 280, six 4-port parallel boards, two Phi Deck controller boards, six Phi Deck drives, Digital Group floppy controller board, Deckmon and Phimon operating systems, and all kinds of documentation and software. I will pay all shipping. No reasonable offer refused. Mel Hagen, (303) 666-6536.

FOR SALE: New DT-8 DSDD disk drive: \$295. New Godbout Interfacer 3-8 with warranty card: \$395. DC Hayes S-100 modem: \$125. R. Van Cleave, 256 South Tucson Circle, Aurora, CO 80012, (303) 340-2955.

WANTED: I am interested in exchanging software and ideas with owners of TRS-80 Color Computers, VIC-20s, and Commodore 64s. Send a list of your programs and I'll send a list of mine. John Van Gorp, Box 15, Ile des Chenes, Manitoba R0A 0T0, Canada.

FOR SALE: VIC-1600 modem for use with the Commodore 64 or VIC-20. I have the terminal program in disk and cassette. Will sell with (\$50) or without (\$45) Compuserve hour. Kevin Rudolph, 7811 Candle Lane, Houston, TX 77071, (713) 778-9973.

FOR TRADE: Zenith Z-100 programs. Send a list or disk of yours and I'll send the same. Nathan Gaffaney, 109 Maple St. Apt. 2, Potsdam, NY 13676.

WANTED: To trade Apple games and utilities programs. Send me a list or disk of your better programs and I'll send you a list or disk of mine. Greg Benfer, 805 Crestview Rd., Milliford, PA 17844, (717) 966-0372.

WANTED: Have SOL-20 programs, will trade. Or if you own a Processor Technology SOL-20, please contact me. I have names and addresses of many SOL owners anxious to trade and talk. Robert Heerdink, 500 Redbud Dr., Forney, TX 75126.

FOR SALE: SwTPC 6800 motherboard and box, MP-A2, 20K RAM, three MP-L cards, two MP-S cards, DC-2 disk controller, AC30, two MP-A, motherboard, MP-M. Also, Heath H-89, 64K, Z67 10-megabyte disk, CP/M, COBOL, BASIC, DS180, printer power/surge projector. Luke Shepherd, 5801 Sagebrush Trail, Greensboro, NC 27409, (919) 855-0108.

BOMB **BYTE's Ongoing Monitor Box**

Article #	Page	Article	Author(s)
1	28	Build a Third-Generation Phonetic Speech Synthesizer	Ciarcia
2	47	User's Column: New Machines, Networks, and Sundry Software	Pournelle
3	81	BYTE West Coast: A First Look at Dayflo	Shapiro
4	95	Computer Simulation: What It Is and How It's Done	Bronson
5	106	Simulating Reality with Computer Graphics	Sørensen
6	138	Simulation of Weighted Voting: The Banzhaf Index	Schrodt
7	157	Queue Simulation	Rasmussen
8	179	A Risky Business—An Introduction to Monte Carlo Venture Analysis	Macaluso
9	194	Simulation and Graphics on Microcomputers	Miller
10	204	Going Further	Pratt
11	214	Compupro's System 816/C and System 68K—the Two and Only	Teja
12	224	Microsoft Flight Simulator	Miastkowski
13	236	The Eagle PC	Wadlow
14	246	STSC APL*PLUS and IBM PC APL: Two APLs for the IBM PC	Bensimon
15	268	Chalk Board's Powerpad and Leonardo's Library	Holden
16	274	Simulated Computer II	Grehan
17	282	Bank Street Writer	Pagnoni
18	288	SPOC: The Chess Master	Flock, Silverman
19	296	M.U.L.E.	Smarte
20	301	The Witness	Barker
21	306	The Tandy TRS-80 Model 2000: A Powerful New MS-DOS Machine	Malloy
22	320	A Closer Look at the IBM PCjr	Vose, Shuford
23	336	The Japan Shows: An Update on the Japanese Computing Scene	Willis
24	352	The User Goes to COMDEX, 1983	Pournelle
25	371	Pascal's Design Flaws: Modula-2 Solutions and Pascal Patches	Johnson, Munro
26	393	Trademarking Software Packages	Sterne, Saidman
27	400	An EPROM Simulator	Woodhull
28	411	Simulation with Electronic Spreadsheets	Matheny

1983's Last Tally

Steve Ciarcia won first place and \$100 with "Keep Power-Line Pollution Out of Your Computer." The second-place winner is Jerry Pournelle with the User's Column, "Buddy, Can You Spare a Door Latch?" Dr. Pournelle wins the \$50 bonus, in third place is Sam Edwards's "Why Is Software So Hard to Use?" Mark Haas's review of the Texas Instruments Professional Computer scored a close fourth and in fifth place is the BYTE West Coast report on Microsoft Windows, written by managing editor Phil Lemmons. Hats off to these authors.

Correspondence

Address all editorial correspondence to the editor at BYTE, POB 372, Hancock, NH 03449. Unacceptable manuscripts will be returned if accompanied by sufficient first-class postage. Not responsible for lost manuscripts or photos. Opinions expressed by the authors are not necessarily those of BYTE. Entire contents copyright © 1984 by McGraw-Hill Inc. All rights reserved. Where necessary, permission is granted by the copyright owner for libraries and others registered with the Copyright Clearance Center (CCC) to photocopy any article herein for the flat fee of \$1.50 per copy of the article or any part thereof. Correspondence and payment should be sent directly to the CCC, 21 Congress St., Salem, MA 01970. Specify ISSN 0360-5280/83. \$1.50. Copying done for other than personal or internal reference use without the permission of McGraw-Hill is prohibited. Requests for special permission or bulk orders should be addressed to the publisher. BYTE® is available in microform from University Microfilms International, 300 North Zeeb Rd., Dept. PR, Ann Arbor, MI 48106 USA or 18 Bedford Row, Dept. PR, London WC1R 4EJ England.

Reader Service

Inquiry No.	Page No.	Inquiry No.	Page No.	Inquiry No.	Page No.	Inquiry No.	Page No.
1	1 SUPER WAREHOUSE 419	78	COMPUPRO 119	166	GIFFORD COMP.SYS 111	257	MTI SYSTEMS CORP. 392
2	1ST PLACE SYSTEMS 426	79	COMPUPRO 410	167	GILTRONIX, INC. 500	258	MUSYS CORP. 123
3	800 SOFTWARE 147	*	COMPUPRO 461	168	GREAT SALT LAKE COMP. 528, 529	259	MYLSTAR ELECTRONICS 363
4	A.S.T. RESEARCH 101	80	COMPUISERVE 129	169	GREAT SALT LAKE COMP. 530, 531	259	MYLSTAR ELECTRONICS 512
413	A-SYSTEMS 468	81	COMPUSHACK 443	170	GTEK INC. 332	164	MYTEK 460
5	AB COMPUTERS 503	400	COMPUTER APPARATUS 502	*	H&E COMPUTRONICS 217	418	NATIONAL COMPUTER GRAPHICS 349
6	ABC COMPUTER LTD 310	82	COMPUTER CHANNEL 356	171	H&M DISK DRIVE SERVICES 414	260	NATIONAL COMPUTER LTD. 220
7	ABC DATA PRODUCTS 380	415	COMPUTER CLUB INC. 468	172	HANDWELL CORP. 24	403	NATIONAL INSTRUMENTS 378
9	ACL INC. 441	83	COMPUTER DISCOUNT PROD. 504	173	HANDWELL CORP. 488	261	NEBS COMPUTER FORMS 469
394	ACORN COMPUTER CORP. 266, 267	84	COMPUTER HANDICAPPING SYS 527	174	HAYES MICROCOMP PROD. 72, 73	262	NEC HOME ELECTRONICS 348
10	ADDMASTER CORP. 342	85	COMPUTER HUT OF N.E. 133	416	HAYES MICROCOMP PROD. 323	263	NEC INFORMATION SYS. 136, 137
11	ADMIT ELECTRONICS, INC. 404	86	COMPUTER INNOVATIONS 467	176	HEWLETT-PACKARD 357	264	NETWORK CONSULTING, INC. 221
13	ADV. COMP. PROD. 494, 495	87	COMPUTER MAIL ORDER 390, 391	175	HITACHI 71	265	NETWORK INC. 285
*	ADV.DIGITAL CORP. 153	*	COMPUTER PLUS 424	177	HITECH INT'L. INC. 508	267	NICOLET PARATRONICS 22
15	ADV.GRAPHIC ENGINEERING 498	88	COMPUTER PRICE CLUB 278	178	HOLLYWOOD HARDWARE 404	*	NORTH HILLS CORP. 404
16	ADV.SYS.CONCEPTS 414	89	COMPUTER SOFTWARE ASSOC. 527	179	HOUSTON INSTR/BAUSCH&LOMB 285	268	NORTH HILLS CORP. 500
17	AIM TECHNOLOGY 428	*	COMPUTER WAREHOUSE 141	181	IBM/SMALL SYSTEMS DIV. 286, 287	268	NORTHWEST DIGITAL SYS. 52
*	ALF PRODUCTS, INC. 448	401	COMPUTERLINE INT'L-A 402	406	IBS 88	75	NOVATION, INC. 455
18	ALPHA OMEGA COMPUTER 208	92	COMPUTERS AND MORE 60	182	IMAGE COMP.PROD. 506	392	NRI SCHOOLS ELECTR.DIV. 97
19	AMDEK CORP. 63	93	COMPUTERS AND MORE 436	183	IMAGING TECHNOLOGY 175	270	O'HANLON COMP.SYS. 173
23	AMERICAN SYSTEMS 512	94	COMPUTERS WHOLESAL 51	184	IN SYNC 516	271	OASIS SYSTEMS 56, 57
*	AMERICAN TOURISTER 273	384	COMPU-MEDIA, INC. 527	186	INTEGRAND 140	272	OCTAGON SYSTEMS CORP. 404
25	AMPRO COMPUTERS INC. 452	95	CONROY-LAPOINTE 244, 245	187	INTERACTIVE MICROWAVE 396	273	OPEN SYSTEMS, INC. 135
26	ANADEX 389	96	CONROY-LAPOINTE 244, 245	188	INTERACTIVE STRUCT. 125	275	ORBYTE SOFTWARE 62
27	ANN ARBOR TERMINALS 155	97	CONROY-LAPOINTE 244, 245	189	INTERDATA SYSTEMS, INC. 508	276	ORyx SYSTEMS 318, 319
28	APPARAT INC 185	98	CONSOLINK 16	190	INTERTEC DATA SYS. 8	276	OZTECH 510
*	APPLE COMPUTER INC. CII, 1	99	CONSOLINK 17	192	JADE COMP.PROD. 517	277	PACIFIC EXCHANGES 310, 342, 404, 496, 498, 500, 508, 516
29	APPLE COUNTRY LTD. 485	417	CONTROL DATA CORP. 90, 91	193	JADE COMP.PROD. 518, 519	278	PACIFIC INFOTECH CORP. 398
30	APPLEWARE, INC. 500	101	CORONA DATA SYS. 392	194	JAMECO ELECTR. 520, 521	279	PAN AMERICAN ELEC. INC. 310
31	APPLIED DIGITAL DATA SYS. 263	102	COSMOS 271	195	JDR MICRODEVICES, INC. 536, 537	280	PANASONIC H.H.C. 315
32	APPLIED SOFTWARE TECH. 419	103	CRE WHOLESAL PROD. 512	196	JDR MICRODEVICES, INC. 538, 539	281	PC PIPELINE 512
33	ARTIFICIAL INT'L. RESEARCH 516	104	CRE WHOLESAL PROD. 512	197	JDR MICRODEVICES, INC. 540	337	PC WARE, INC. 104, 105
367	ASHTON-TATE 113	105	CREATIVITY UNLTD. 508	198	JIM-PAK 534, 535	283	PEOPLE & TECHNOLOGY 314
34	ASHTON-TATE 117	106	CROMEMCO INC. 5	199	JUKI INDUSTRY OF AMERICA 219	285	PERFORM DATA 11
35	ASHTON-TATE 361	107	CUESTA SYSTEMS 404	200	KADAK PRODUCTS 382	392	PERSOFT 516
36	AVATAR TECH. INC. 433	108	CUSTOM COMP.TECH. 511	201	KAYPRO 421	392	PERSONAL COMPUTER NETWORK 149
37	AVOCET 451	109	CYBER ROBOTICS LTD. 508	202	KEYTRONICS CORP. 159	400	PERSONAL COMPUTER USER FEST 222, 223
38	B&B ELECTRONICS 516	111	DATA SPEC 373	203	KNOWLEDGE SYS. 156	286	PHONE 1, INC. 49
39	BASF SYSTEMS 329	112	DATA SPEC 373	204	LABORATORY MICROSYS. 360	287	PIKA-BOX, DIV.APPLIED COMP. 484
40	BAY TECHNICAL ASSOC. 434	115	DATA TECH INDUSTRIES 163	205	LAKE AVENUE SOFTWARE 88	287	PIPELINE COMPUTER 499
41	BELL, JOHN ENGR. 498	116	DATA TRANSLATION INC. 450	206	LEADING EDGE PROD. CIII	288	POPCOMP/PRENTICE CORP. 408, 409
42	BERING INDUSTRIES 154	118	DATAPRODUCTS CORP. 327	207	LIXICOMP DATA SYS. 496	290	PRACTICAL PERIPH. 439
43	BHRT 59	119	DATASOUTH COMP.CORP. 151	208	LIBERTY GROUP INC. 445	291	PRINCETON GRAPHIC SYS. 145
44	BINARY TECHNOLOGY 310	120	DAVIDGE CORP. 496	211	LOGICAL DEVICES 58	292	PRIORITY ONE 532, 533
45	BIZCOMP 183	*	DELUXE COMP. FORMS 422	212	LOGICAL DEVICES 58	293	PRO MICROSYSTEMS 500
*	BORLAND INT'L. 383	121	DIAMOND SFTW.SUPPLY 188	213	LOGITECH INC. 182	294	PROMETHEUS PRODUCTS 121
46	BOTTOM LINE, THE 61	122	DIGITAL EQUIPMENT 394	214	LOMAS DATA PRODUCTS 302	295	PURCHASING AGENT, THE 260
398	BUSINESS SOFTWARE 261	*	DIGITAL RESEARCH COMP. 493	409	LYBEN 506	296	QUADRAM CORP. 55
399	BUSINESS SOFTWARE 261	*	DIRECT SOFTWARE 381	185	LYBEN 527	297	QUADRAM CORP. 78, 79
49	BUSINESS SUPPORT SOFTWARE 510	124	DISCOUNT SOFTWARE 184	215	LYCO COMPUTER 490	298	QUANT SYSTEMS 498
50	BYAD 379	125	DISCWASHER COMP.ACCESS. 259	410	LSI JAPAN 508	299	QUARK INCORPORATED 255
51	BYTCOM 132	127	DISKETTE CONNECTION 424	216	MA SYSTEMS 229	300	QUIBIE DISTRIBUTING 87
266	BYTCOM 506	127	DISKS 'N THINGS 516	218	MACMILLAN BOOK CLUBS 257	302	QUIBIE DISTRIBUTING 312, 313
52	BYTCOM 512	*	DISKWORLD 454	220	MACROTECH INT'L. 465	303	QUESTIONAIRE SERVICE CO. 496
*	BYTE BACK ISSUES 486	*	DISKWORLD 510	221	MARK OF THE UNICORN 165	304	RADIO SHACK CIV
*	BYTE PUBL. INC. 368, 369	128	DISPLAY TELECOMMNTNS. 501	222	MARYMAC INDUSTRIES 527	22	RCA MICRO 316
*	BYTE PUBL. INC. 442	130	DMA 405	223	MAXELL DATA PRODUCTS 210, 211	*	REFLECTONE 192
53	BYTEK COMP. SYS. CORP. 264	131	DOKAY COMP.PROD.INC. 524, 525, 526	224	MAYNARD ELECTRONICS 89	305	RELMS 388
54	BYTEWRITER 6	132	DOW JONES SOFTWARE 178	225	MCT COMPANY 23	306	RIXON 397
123	C.I.M./DIRECTORIES OF INDUSTRY 512	133	DWIGHT CO., INC. 342	226	MC-P APPLICATIONS 355	307	RLC ENTERPRISES 506
*	C-WARE 446	134	DYNACOMP 496	230	MCGRW-HILL BOOK CO. 416, 417	307	ROCKY MTN. SOFTWARE 398, 447
*	C-SYSTEMS 496	135	DYNAX, INC. 239	231	MEMOTECH 25, 26, 27	308	ROGERS LABS 500
55	C.S.D. INC. 174	136	DYNAX CORP. 399	232	MET CHEM INT'L. CORP. 510	414	RPD PRODUCTS 468
385	CABLES BY WORSWICK 506	137	E.T.I. 53	233	METHOD SYS. INC. 496	309	RYDEX INDUSTRIES CORP. 293
56	CALIF. DATA CORP. 496	139	EASTERN ENTERPRISES 425	234	MFJ ENTERPRISES, INC. 395	310	S C DIGITAL 436
*	CALIF. DIGITAL 522, 523	140	EGOSOFT 466	234	MGJ, LTD. 512	311	S-100 DIV. 696 CORP. 497
*	CALIF. MICRO COMP. 454	141	EDUCATIONAL MICROCOMP. 342	235	MICRO AGE COMP.STORES 449	*	SAFWARE 360
57	CAPITAL EQUIPMENT 171	142	EGGHEAD SOFTWARE 466	237	MICRO CRAFT CORP 347	405	SAFT AMERICA 103
58	CDR SYSTEMS 310	143	ELCOMP 310	191	MICRO DATA BASE 265	312	SAGE COMP. TECH. 415
59	CENTENNIAL COMP.PROD. 44, 45	144	ELECTRADE CO. 496	238	MICRO MANAGEMENT SYS. 54	*	SCOTTSDALE SYSTEMS 127
497	CHAMPION SOFTWARE 370	145	ELECTRADE CO. 498	397	MICRO FOCUS 367	314	SEATTLE COMP.PRODS. 498
498	CHAMPION SOFTWARE 370	407	ELECTRALOGICS 472	239	MICRO MART 527	315	SEATTLE COMP.PRODS. 498
60	CHANNEL CONNECTION 487	146	ELECTRONIC SPECIALISTS 467	240	MICRO MINT 457	316	SEQQA COMP.CORP. 7
61	CHECK-DATE 384	147	ELGAR CORPORATION, THE 385	241	MICRO-TAX 227	317	SEMIDISK SYSTEMS 311
62	CHIPS & MALE 500	148	ELLIS COMPUTING INC. 300	47	MICROCENTRE 143	318	SENSIBLE SOFTWARE 98
63	CHRISLIN IND.INC. 431	*	EMPIRICAL RESEARCH GROUP 170	236	MICROCOMP 234, 235	321	SHARP ELECTRONICS 309
411	CHROMOD ASSOC. 508	149	ENRCOMP 20	242	MICRODYNAMICS 500	322	SILICOM INT'L SOFTWARE 86
64	CIRCUITS WORLD ELECTR. 506	151	ENGLISH I COMP. TUTORIALS 500	243	MICROHOUSE 243	*	SILICON SPECIALTIES 68
65	CIRCUITS WORLD ELECTR. 510	*	EPSON AMERICA 84, 65	244	MICROMAIL 489	323	SLICER COMPUTERS 102
66	CLEO 435	154	EXCALIBUR TECH 249	245	MICROPROCESSORS UNLTD. 506	324	SLR SYSTEMS 498
67	CLEVELAND CODONICS 66	155	EXECUTIVE MANAGEMENT SYS. 407	*	MICROSOFT CORP. BUS. BASIC 167	*	SOFTCRAFT 308
68	COGITATE 508	152	EXPERT COMPUTERS 492	*	MICROSOFT CORP. COBOL 199	408	SOFTSMYTHE 277
69	COLORADO COMP. PERIPH. 508	156	EXPOTEK 292	*	MICROSOFT CORP. PASCAL 201	325	SOFTWARE ARTS 527
70	COLUMBIA DATA PROD. 77	157	FLOPPY DISK SERV. INC. 505	*	MICROSOFT CORP. MULTIPLAN 280, 281	326	SOFTWARE AUTOMATION 339
71	COMMAND SERVICES CORP. 342	158	FORMASTER CORP. 375	*	MICROSOFT CORP. WORD 334, 335	327	SOFTWARE BANC 167
72	COMMERCIAL BUSINESS SYS. 486	159	FORMULA INT'L. 491	251	MICROTECH EXPOR'TS 406	328	SOFTWARE PRODUCTS INTL. 202, 203
73	COMMUNICATIONS ELECTR. 328	160	FREEDOM INT'L. 491	252	MICROWARE 152	329	SOFTWARE SERVICES 510
395	COMP. COMPNTS. UNLTD. 513	161	FREEDOM COMP. MART 509	253	MINI MICRO MART 186	330	SOFTWARE SOLUTIONS, INC. 437
396	COMP. COMPNTS. UNLTD. 514, 515	162	FUTJTSU PROFESS.MICROSYS. 209	254	MIRO MICRO MART 186	331	SOFTWARE TOOLWORKS 396
78	COMPAQ COMPUTER CORP. 12, 13	402	FUTECH INT'L. CORP. 284	255	MICRO BUSN. CENTERS 298	*	SORCIM 18, 19
77	COMPETITIVE EDGE 446	163	GENERAL TECHNOLOGY 43	256	MOUNTAIN VIEW PRESS 46	219	SPEECH, LTD. 510
78	COMPUADD 516	166	G&G ENGINEERING 111	256	MPI 453	332	SPERRY COMP.SYS. 80

To get further information on the products advertised in BYTE, fill out the reader service card with your name and address. Then circle the appropriate numbers for the advertisers you select from the list. Add a 20-cent stamp to the card, then drop it in the mail. Not only do you gain information, but our advertisers are encouraged to use the marketplace provided by BYTE. This helps us bring you a bigger BYTE. The index is provided as an additional service by the publisher, who assumes no liability for errors or omissions. *Correspond directly with company.

Reader Service

Inquiry No.	Page No.	Inquiry No.	Page No.	Inquiry No.	Page No.	Inquiry No.	Page No.
345	TELETEK ENTERPRISES, INC. 41	358	TRANSTAR 231	374	VISUAL TECH, INC. 386	388	XOR CORP. 21
346	TELTONE 42	359	TRISTAR DATA SYS. 384	*	VLM COMPUTER ELECTR. 527	*	ZILOG COMP. SYS. 94
347	TERMINALS TERRIFIC 440	361	TYPEQUICK 317	378	WADSWORTH PROFESSNL.SFTW. 279	<i>*Correspond directly with company.</i>	
348	TEXAS COMPUTER SYS. 420	363	U.S. MICRO SALES 507	377	WANG ELECTR.PUB.INC. 172	INTERNATIONAL ADVERTISING SECTION	
349	THOUGHTWARE INC. 74, 75	362	U.S. ROBOTICS 359	*	WANG LABS, INC. 429	; ABTEX COMP. SYS. LTD. 192A	
351	THREE M COMPANY 331	385	UNIFIED SOFTWARE SYS. 527	378	WAREHOUSE SOFTWARE 196	; AMER. BUYING & EXPORT 192C	
150	TIGERTRONICS 508	368	UNIPRESS SOFTWARE, INC. 299	379	WASHINGTON COMP.SYS. 242	* BYTE PUBL. INC. 192D	
352	TINNEY, ROBERT GRAPHICS 193	412	USED PERSONAL COMP.BRKRG 508	380	WCB COMPUTERS 510	NO DOMESTIC INQUIRIES, PLEASE	
353	TITAN TECHNOLOGY 67	388	VANKELL INDUSTRIES 459	381	WHITESMITHS LTD 241		
354	TITAN TECHNOLOGY 69	370	VANTEC 342	382	WILLIAMS, MARK CO. 189		
355	TOSHIBA AMERICA, INC. 376	371	VIDEO GAMES INT'L. 427	383	WINTEK CORP. 516		
358	TOSHIBA AMERICA, INC. 377	372	VISUAL COMPUTER 176, 177	386	WYSE TECHNOLOGY 251		
357	TRANSACTION STORAGE SYS. 341	373	VISUAL TECH, INC. 99	387	XEROX EDUCATION PUBL. 212		

BYTE ADVERTISING SALES STAFF:

J. Peter Huestls, Advertising Sales Manager, 70 Main Street, Peterborough, N.H. 03458 Tel (603) 924-9281

NEW ENGLAND

ME, NH, VT, MA, RI

Paul McPherson, Jr. (617) 262-1160

McGraw-Hill Publications

607 Boylston Street

Boston, MA 02116

ATLANTIC

NJ (NORTH), NY, NYC, CT

Eugene Duncan (212) 512-2096

McGraw-Hill Publications

1221 Avenue of the Americas—39th Floor

New York, NY 10020

Dick McGurk (212) 512-3588

McGraw-Hill Publications

1221 Avenue of the Americas—39th Floor

New York, NY 10020

EAST

PA (EAST), NJ (SOUTH), MD, VA, W.VA, DE, D.C.

Daniel Ferro (215) 496-3833

McGraw-Hill Publications

Three Parkway

Philadelphia, PA 19102

SOUTHEAST

NC, SC, GA, FL, AL, TN

Maggie McClelland (404) 252-0626

McGraw-Hill Publications

4170 Ashford Dunwoody Road—Suite 420

Atlanta, GA 30319

MIDWEST

IL, MO, KS, IA, ND, SD, MN, WI, NB

Jack Anderson (312) 751-3740

McGraw-Hill Publications

Blair Building

645 N. Michigan Ave.

Chicago, IL 60611

GREAT LAKES, OHIO REGION

MI, OH, PA (ALLEGHENY), KY, IN,

EASTERN CANADA

Dennis Riley (313) 352-9760

McGraw-Hill Publications

4000 Town Center—Suite 770

Southfield, MI 48075

SOUTHWEST, ROCKY MOUNTAIN

UT, CO, WY, OK, TX, AR, MS, LA

Alan Morris (214) 458-2400

McGraw-Hill Publications

Prestonwood Tower—Suite 907

5151 Beltline

Dallas, TX 75240

SOUTH PACIFIC

Southern CA, AZ, NM, LAS VEGAS

Page Goodrich (714) 557-6292

McGraw-Hill Publications

3301 Red Hill Ave

Building #1, Suite 222

Costa Mesa, CA 92626

Karen Niles (213) 480-5243, 487-1160

McGraw-Hill Publications

3333 Wilshire Boulevard #407

Los Angeles, CA 90010

NORTH PACIFIC

HI, WA, OR, ID, MT, NORTHERN

CALIF, NV (EXCEPT LAS VEGAS),

W. CANADA

David Jern (415) 362-4600

McGraw-Hill Publications

425 Battery St.

San Francisco, CA 94111

Bill McAfee (415) 964-0624

McGraw-Hill Publications

1000 Elwell Court—Suite 225

Palo Alto, CA 94303

WEST COAST SURPLUS AND RETAIL ACCOUNTS

Tom Harvey (805) 964-8577

3463 State St.—Suite 256

Santa Barbara, CA 93105

Post Card Mailings

National

Bradley Browne (603) 924-6166

BYTE Publications

70 Main Street

Peterborough, NH 03458

International Advertising Sales Representatives:

Mr. Hans Csokor
Publimedia
Relsnerstrasse 61
A-1037 Vienna, Austria

Mrs. Gurit Gepner
McGraw-Hill Publishing Co.
115 Yosephthal St.
Bat Yam, Israel
866 561 321 39

Mr. Fritz Krusebecker
McGraw-Hill Publishing Co.
Liebigstrasse 27C
D-6000 Frankfurt/Main 1
West Germany
72 01 81

Mrs. Maria Sarmiento
Pedro Teixeira 8, Off. 320
Iberia Mart 1
Madrid 4, Spain
45 52 891

Mr. Andrew Karnig
Andrew Karnig & Associates
Kungsholsgatan 10
112 27 Stockholm, Sweden
08 51 68 70

Mr. Ken Davey
McGraw-Hill Publishing Co.
17 rue Georges Bizet
F 75116 Paris
France
720 33 42

Mr. Arthur Scheffer
McGraw-Hill Publishing Co.
34 Dover St.
London W1X 3RA
England
01 493 1451

Mr. Emilio Zerboni
McGraw-Hill Publishing Co.
Via Flavio Baracchini 1
20123 Milan, Italy
86 90 656

Seavex Ltd.
05-49/50 Tanglin Shopping Center
19 Tanglin Rd. Singapore 1024
Republic of Singapore

Seavex, Ltd.
Room 102, Yu Yuet Lal Bldg.
43-55 Wyndham St. Central
Hong Kong

Hiro Morita
McGraw-Hill Publications
Overseas Corp.
Room 1528
Kasumigaseki Bldg.
3-2-5 Kasumigaseki,
Chiyoda-Ku
Tokyo 100, Japan

BYTE READER SERVICE



MARCH 1984
4134

For fastest service transfer mailer label from wrapper to coupon provided at the right. Requests cannot be honored unless zip code is given. This card valid for 90 days only.
NOTE—If label is missing or defaced fill out coupon carefully—**PLEASE PRINT**—this is the only way to get requested material to you.

Name _____

(Title) _____ (Company) _____

Address _____

City _____ State _____ Zip _____

I purchased this copy by Subscription Newsstand, computer store, or bookstore

1	23	45	67	89	111	133	155	177	199	221	243	265	287	309	331	353	375	397	419	441	463	485	507	529	551	573	595	617	639	661	683	705	727	749	771	793
2	24	46	68	90	112	134	156	178	200	222	244	266	288	310	332	354	376	398	420	442	464	486	508	530	552	574	596	618	640	662	684	706	728	750	772	794
3	25	47	69	91	113	135	157	179	201	223	245	267	289	311	333	355	377	399	421	443	465	487	509	531	553	575	597	619	641	663	685	707	729	751	773	795
4	26	48	70	92	114	136	158	180	202	224	246	268	290	312	334	356	378	400	422	444	466	488	510	532	554	576	598	620	642	664	686	708	730	752	774	796
5	27	49	71	93	115	137	159	181	203	225	247	269	291	313	335	357	379	401	423	445	467	489	511	533	555	577	599	621	643	665	687	709	731	753	775	797
6	28	50	72	94	116	138	160	182	204	226	248	270	292	314	336	358	380	402	424	446	468	490	512	534	556	578	600	622	644	666	688	710	732	754	776	798
7	29	51	73	95	117	139	161	183	205	227	249	271	293	315	337	359	381	403	425	447	469	491	513	535	557	579	601	623	645	667	689	711	733	755	777	799
8	30	52	74	96	118	140	162	184	206	228	250	272	294	316	338	360	382	404	426	448	470	492	514	536	558	580	602	624	646	668	690	712	734	756	778	800
9	31	53	75	97	119	141	163	185	207	229	251	273	295	317	339	361	383	405	427	449	471	493	515	537	559	581	603	625	647	669	691	713	735	757	779	801
10	32	54	76	98	120	142	164	186	208	230	252	274	296	318	340	362	384	406	428	450	472	494	516	538	560	582	604	626	648	670	692	714	736	758	780	802
11	33	55	77	99	121	143	165	187	209	231	253	275	297	319	341	363	385	407	429	451	473	495	517	539	561	583	605	627	649	671	693	715	737	759	781	803
12	34	56	78	100	122	144	166	188	210	232	254	276	298	320	342	364	386	408	430	452	474	496	518	540	562	584	606	628	650	672	694	716	738	760	782	804
13	35	57	79	101	123	145	167	189	211	233	255	277	299	321	343	365	387	409	431	453	475	497	519	541	563	585	607	629	651	673	695	717	739	761	783	805
14	36	58	80	102	124	146	168	190	212	234	256	278	300	322	344	366	388	410	432	454	476	498	520	542	564	586	608	630	652	674	696	718	740	762	784	806
15	37	59	81	103	125	147	169	191	213	235	257	279	301	323	345	367	389	411	433	455	477	499	521	543	565	587	609	631	653	675	697	719	741	763	785	807
16	38	60	82	104	126	148	170	192	214	236	258	280	302	324	346	368	390	412	434	456	478	500	522	544	566	588	610	632	654	676	698	720	742	764	786	808
17	39	61	83	105	127	149	171	193	215	237	259	281	303	325	347	369	391	413	435	457	479	501	523	545	567	589	611	633	655	677	699	721	743	765	787	809
18	40	62	84	106	128	150	172	194	216	238	260	282	304	326	348	370	392	414	436	458	480	502	524	546	568	590	612	634	656	678	700	722	744	766	788	810
19	41	63	85	107	129	151	173	195	217	239	261	283	305	327	349	371	393	415	437	459	481	503	525	547	569	591	613	635	657	679	701	723	745	767	789	811
20	42	64	86	108	130	152	174	196	218	240	262	284	306	328	350	372	394	416	438	460	482	504	526	548	570	592	614	636	658	680	702	724	746	768	790	812
21	43	65	87	109	131	153	175	197	219	241	263	285	307	329	351	373	395	417	439	461	483	505	527	549	571	593	615	637	659	681	703	725	747	769	791	813
22	44	66	88	110	132	154	176	198	220	242	264	286	308	330	352	374	396	418	440	462	484	506	528	550	572	594	616	638	660	682	704	726	748	770	792	814

BYTE's BOMB is your direct line to the editor's desk. Each month, the two top-rated authors receive bonuses based on your evaluation. First look at the list of this month's articles and corresponding article numbers (located in the unclassified ads section on the page preceding the Reader Service list), then rate each article you've read as **Excellent**, **Good**, **Fair**, or **Poor**, based on your overall impression of the article, by circling the appropriate number in each column below. Your feedback helps us produce the best possible magazine each month.

Article No.	1	2	3	4	5	6	7	8	9	10	11	12	13	14	15	16	17	18	19	20	21	22	23	24	25
Excellent	1	5	9	13	17	21	25	29	33	37	41	45	49	53	57	61	65	69	73	77	81	85	89	93	97
Good	2	6	10	14	18	22	26	30	34	38	42	46	50	54	58	62	66	70	74	78	82	86	90	94	98
Fair	3	7	11	15	19	23	27	31	35	39	43	47	51	55	59	63	67	71	75	79	83	87	91	95	99
Poor	4	8	12	16	20	24	28	32	36	40	44	48	52	56	60	64	68	72	76	80	84	88	92	96	100

Article No.	26	27	28	29	30	31	32	33	34	35	36	37	38	39	40	41	42	43	44	45	46	47	48	49	50
Excellent	101	105	109	113	117	121	125	129	133	137	141	145	149	153	157	161	165	169	173	177	181	185	189	193	197
Good	102	106	110	114	118	122	126	130	134	138	142	146	150	154	158	162	166	170	174	178	182	186	190	194	198
Fair	103	107	111	115	119	123	127	131	135	139	143	147	151	155	159	163	167	171	175	179	183	187	191	195	199
Poor	104	108	112	116	120	124	128	132	136	140	144	148	152	156	160	164	168	172	176	180	184	188	192	196	200

Comments _____

BYTE READER SERVICE



MARCH 1984
4134

For fastest service transfer mailer label from wrapper to coupon provided at the right. Requests cannot be honored unless zip code is given. This card valid for 90 days only.
NOTE—If label is missing or defaced fill out coupon carefully—**PLEASE PRINT**—this is the only way to get requested material to you.

Name _____

(Title) _____ (Company) _____

Address _____

City _____ State _____ Zip _____

I purchased this copy by Subscription Newsstand, computer store, or bookstore

1	23	45	67	89	111	133	155	177	199	221	243	265	287	309	331	353	375	397	419	441	463	485	507	529	551	573	595	617	639	661	683	705	727	749	771	793
2	24	46	68	90	112	134	156	178	200	222	244	266	288	310	332	354	376	398	420	442	464	486	508	530	552	574	596	618	640	662	684	706	728	750	772	794
3	25	47	69	91	113	135	157	179	201	223	245	267	289	311	333	355	377	399	421	443	465	487	509	531	553	575	597	619	641	663	685	707	729	751	773	795
4	26	48	70	92	114	136	158	180	202	224	246	268	290	312	334	356	378	400	422	444	466	488	510	532	554	576	598	620	642	664	686	708	730	752	774	796
5	27	49	71	93	115	137	159	181	203	225	247	269	291	313	335	357	379	401	423	445	467	489	511	533	555	577	599	621	643	665	687	709	731	753	775	797
6	28	50	72	94	116	138	160	182	204	226	248	270	292	314	336	358	380	402	424	446	468	490	512	534	556	578	600	622	644	666	688	710	732	754	776	798
7	29	51	73	95	117	139	161	183	205	227	249	271	293	315	337	359	381	403	425	447	469	491	513	535	557	579	601	623	645	667	689	711	733	755	777	799
8	30	52	74	96	118	140	162	184	206	228	250	272	294	316	338	360	382	404	426	448	470	492	514	536	558	580	602	624	646	668	690	712	734	756	778	800
9	31	53	75	97	119	141	163	185	207	229	251	273	295	317	339	361	383	405	427	449	471	493	515	537	559											

PLACE
STAMP
HERE

BYTE

READER SERVICE
PO BOX 298
DALTON, MA 01226
USA

PLACE
STAMP
HERE

BYTE

READER SERVICE
PO BOX 298
DALTON, MA 01226
USA

BYTE

SUBSCRIPTIONS



4134

For a subscription to BYTE, please complete this card.

Name _____

Address _____

City _____

State _____ Zip _____ Country _____

Card No. _____

Expiration date _____

Four digits above name—Master Charge only _____

Signature _____ Date _____

Please allow eight weeks for processing. Thank you.

USA

Canada
Mexico

- 1 year \$21 \$23
- 2 years \$38 \$42
- 3 years \$55 \$61

- \$53 Europe (air delivery) payment enclosed
 - \$37 Elsewhere (surface mail) payment enclosed
- (Air mail rates available upon request)

Please remit in US funds drawn on a US bank. Thank you.

- Check enclosed (**Bonus:** [North America only] one EXTRA issue—receive 13 issues for the price of 12)

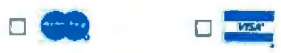

- Bill me (North America only)

BYTE

SUBSCRIPTIONS



4134

For a subscription to BYTE, please complete this card.

Name _____

Address _____

City _____

State _____ Zip _____ Country _____

Card No. _____

Expiration date _____

Four digits above name—Master Charge only _____

Signature _____ Date _____

Please allow eight weeks for processing. Thank you.

USA

Canada
Mexico

- 1 year \$21 \$23
- 2 years \$38 \$42
- 3 years \$55 \$61

- \$53 Europe (air delivery) payment enclosed
 - \$37 Elsewhere (surface mail) payment enclosed
- (Air mail rates available upon request)

Please remit in US funds drawn on a US bank. Thank you.

- Check enclosed (**Bonus:** [North America only] one EXTRA issue—receive 13 issues for the price of 12)



- Bill me (North America only)

Note our special offer! Send cash with your order and receive 13 issues for the price of 12 for each year you subscribe. (North America only, please.)

Don't Miss An Issue!

Have BYTE delivered to your door.

Each month BYTE will bring you the latest in microcomputer technology. DISCOVER and IMPLEMENT new ideas. Don't miss the original information presented in the pages of BYTE.

With BYTE you'll always be among the first to know about the important breakthroughs, worthwhile new equipment, and innovative projects in the world of computing. CHALLENGE US to deliver the very best ideas in microcomputers and advanced technology to you. Return the attached card today! Subscribe to BYTE—the world's leading computer magazine.

PLACE
STAMP
HERE

BYTE SUBSCRIPTIONS
PO Box 590
Martinsville NJ 08836
USA

PLACE
STAMP
HERE

BYTE SUBSCRIPTIONS
PO Box 590
Martinsville NJ 08836
USA

THE DAY THE IBM® PC BECAME OBSOLETE.



It was a Monday in the autumn of '84.

The day they announced the Leading Edge PC—a personal computer that's just plain better than the IBM PC™—at just about half the price.

The Leading Edge PC is faster, it's more than 50% more powerful, more flexible and more dependable (for example, cap. disc drives have a mean time between failures of 20,000 hours versus an 8,000-hour MTBF for IBM's). It's compatible with just about all the software and peripherals that the IBM is.

And unlike IBM's, ours comes complete with a high-resolution monitor, controller, seven expansion slots, serial port, parallel port, a turbo-chip clock, double the standard memory (28K vs. 16K) plus hundreds of dollars worth of software to get you up and running immediately including MS-DOS version 1.25, LAN Base and Leading Edge Word Processing—the most powerful word program ever created to run on an IBM-type personal computer. In short, the basic package comes to you turn-knob and ready to work.

With IBM, on the other hand, you get charged extra for everything. Even for the PC disk disk that makes it run an extra \$40—and \$170 just for the time of day a calendar clock runs standard with Leading Edge. In short, the basic package comes to you as a very expensive 100-pound weight.

It's this simple: The Leading Edge Personal Computer is the first and only serious alternative to the IBM PC—and at only \$295 for the Leading Edge PC. Get serious.

Now at MSJ Leading Edge Dealers across the country. For the one nearest you, call toll-free 1-800-343-6831 or Mass. call collect (617) 828-8866.

LEADING EDGE PRODUCTS, INC., SYSTEM SALES DIVISION, 225 TURNPIKE STREET, CANTON, MA 02021.

IBM is a registered trademark of International Business Machines Corp. MS is a trademark of Microsoft Corporation.



Circle 28 on Reader Card

Get the printer you need at Radio Shack today!

Why Risk Mail Order? At Radio Shack, you can see what you're getting—and there's no wait for delivery! Service and support are available nationwide, too. And we include parallel and TRS-80® Color Computer-compatible serial interfaces for "no-problem" printing.

DWP-210. This low-cost daisy wheel prints with electric typewriter quality at over 200 words per minute (18 cps). Select 10 or 12 characters per inch, or proportional pitch. Uses low-cost interchangeable print wheels.

New! DMP-110. Our lowest-priced, triple-mode dot-matrix printer ever! Features word and data processing, plus dot-addressable graphics modes. Print proportionally-spaced characters at 25 cps or mono-spaced characters at 50 cps. Italic and micro fonts, super/subscripts and underline capacity.

CGP-115. An affordable four-color printer. Create charts, graphs, even computer "doodles" on 4 1/2"-wide paper. Built-in commands simplify drawing and plotting. Measures 21 5/16 x 8 1/4 x 8 1/2".

CGP-220. This whisper-quiet ink-jet printer produces text and high-resolution graphics in seven vivid colors. A screen print utility for the Color Computer and the brand new Tandy TRS-80 Model 2000 personal computer allows multi-color print-outs of graphics screens. Uses easily replaceable ink packs.

Available Nationwide. Find the low-cost solution to any printing need, plus custom forms and replacement ribbons, at your nearby Radio Shack Computer Center, participating store or dealer today.

CGP-220
69900
26-1268
AS LOW AS
\$41 PER MONTH



CGP-115
19995
26-1192
USE YOUR
Radio Shack
CITILINE
Mail Order
54



DMP-110
NEW 39995
26-1271
AS LOW AS
\$28 PER MONTH

Radio Shack Has a Wide Variety of Printers to Choose From—Whether You Need Speed, Graphics or Formed-Character Quality

DWP-210
79900
26-1257
AS LOW AS
\$45 PER MONTH



Radio Shack®

The biggest name in little computers®

A DIVISION OF TANDY CORPORATION

Prices apply at participating Radio Shack stores and dealers.

Circle 304 on inquiry card.