

1249D



# BYTE

MAY 1984 Vol. 9, No. 5  
\$3.50 in U.S.A.  
\$4.25 in Canada/£2.10 in U.K.  
A McGraw-Hill Publication  
0090-6280

the small systems journal



Computers and the Professions



# Introducing Macintosh. What makes it tick. And talk.

Well, to begin with, 110 volts of alternating current.

Secondly, some of the hottest hardware to come down the pike in the last 3 years.

*The garden variety 16-bit 8088 microprocessor.*



*Macintosh's 32-bit MC68000 microprocessor.*



Some hard facts may be in order at this point:

Macintosh's brain is the same blindingly-fast 32-bit microprocessor we gave our other brainchild, the Lisa™ Personal Computer. Far more powerful than the 16-bit 8088 found in current generation computers.

Its heart is the same Lisa Technology of windows, pull-down menus, mouse commands and icons. All of which make that 32-bit power far more useful by making the Macintosh™ Personal Computer far easier to use than current generation computers. In fact, if you can point without hurting yourself, you can use it.

Now for some small talk.

Thanks to its size, if you can't bring the problem to a Macintosh, you can always

bring a Macintosh to the problem. (It weighs 9 pounds less than the most popular "portable.")

Another miracle of miniaturization is Macintosh's built-in 3½" drive. Its disks store 400K—more than conventional 5¼" floppies. So while they're big enough to hold a desk full of work, they're small enough to fit in a shirt pocket. And, they're totally encased in a rigid plastic so they're totally protected.

And talk about programming.

There are already plenty of programs to keep a Macintosh busy. Like MacPaint™,

And with Macintosh BASIC, Macintosh Pascal and our Macintosh Toolbox for writing your own mouse-driven programs, you, too, could make big bucks in your spare time.

You can even program Macintosh to talk in other languages, like Yiddish or Serbo-Croatian, because it has a built-in polyphonic sound generator capable of producing high quality speech or music.

*The Mouse itself. Replaces typed-in computer commands with a form of communication you already understand — pointing.*

*Some mice have two buttons. Macintosh has one. So it's extremely difficult to push the wrong button.*



*The inside story — a rotating ball and optical sensors translate movements of the mouse to Macintosh's screen pointer with pin-point accuracy.*



a program that, for the first time, lets a personal computer produce virtually any image the human hand can create. There's more software on the way from developers like Microsoft,™ Lotus,™ and Software Publishing Corp., to mention a few.

All the right connections.

On the back of the machine, you'll find built-in RS232 and RS422 AppleBus serial communication ports. Which means you can connect printers, modems and other peripherals without adding \$150 cards. It also means that Macintosh is ready to hook in to a local area network. (With AppleBus, you will be able to interconnect up to 16 different Apple computers and peripherals.)

Should you wish to double Macintosh's storage with an external disk



*Macintosh automatically makes room for your illustrations in the text.*



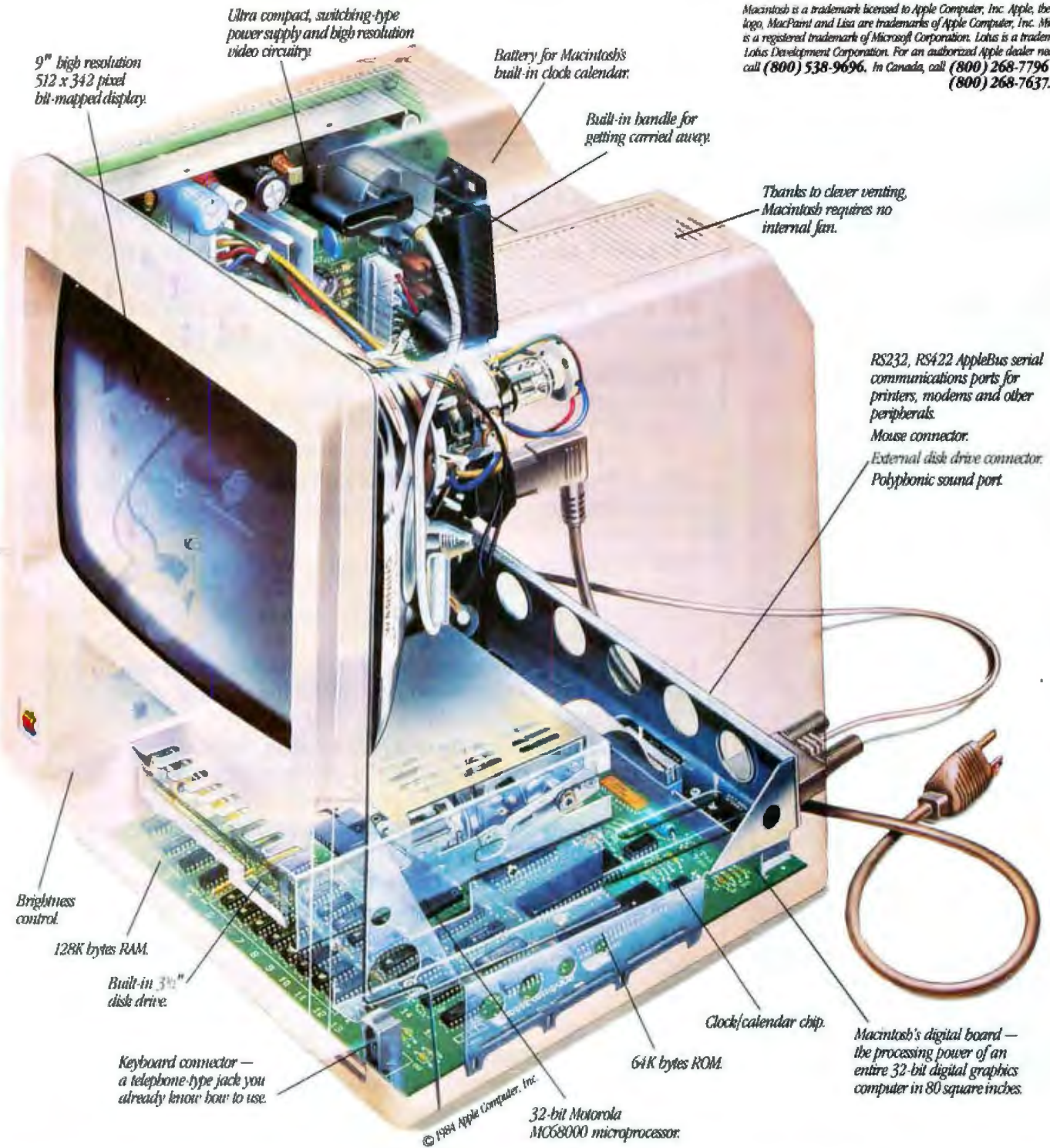
*MacPaint produces virtually any image the human hand can create.*



*Microsoft's Multiplan for Macintosh*



Macintosh is a trademark licensed to Apple Computer, Inc. Apple, the Apple logo, MacPaint and Lisa are trademarks of Apple Computer, Inc. Microsoft is a registered trademark of Microsoft Corporation. Lotus is a trademark of Lotus Development Corporation. For an authorized Apple dealer near you call (800) 538-9696. In Canada, call (800) 268-7796 or (800) 268-7637.



9" high resolution 512 x 342 pixel bit-mapped display.

Ultra compact, switching-type power supply and high resolution video circuitry.

Battery for Macintosh's built-in clock calendar.

Built-in handle for getting carried away.

Thanks to clever venting, Macintosh requires no internal fan.

RS232, RS422 AppleBus serial communications ports for printers, modems and other peripherals.

Mouse connector.

External disk drive connector. Polyphonic sound port.

Brightness control.

128K bytes RAM.

Built-in 3 1/2" disk drive.

Keyboard connector — a telephone-type jack you already know how to use.

Clock/calendar chip.

64K bytes ROM.

Macintosh's digital board — the processing power of an entire 32-bit digital graphics computer in 80 square inches.

© 1984 Apple Computer, Inc.

32-bit Motorola MC68000 microprocessor.

drive, you can do so without paying for a disk controller card—that connector's built-in, too.

There's also a built-in connector for Macintosh's mouse, a feature that costs up to \$300 on computers that can't even run mouse-controlled software.

### One last pointer.

Now that you've seen some of the logic, the technology, the engineering genius and the software wizardry that separates


Macintosh from conventional computers, we'd like to point you in the direction of your nearest authorized Apple dealer.

Over 1500 of them are eagerly waiting to put a mouse in your hand. As one point-and-click makes perfectly clear, the real genius of Macintosh isn't

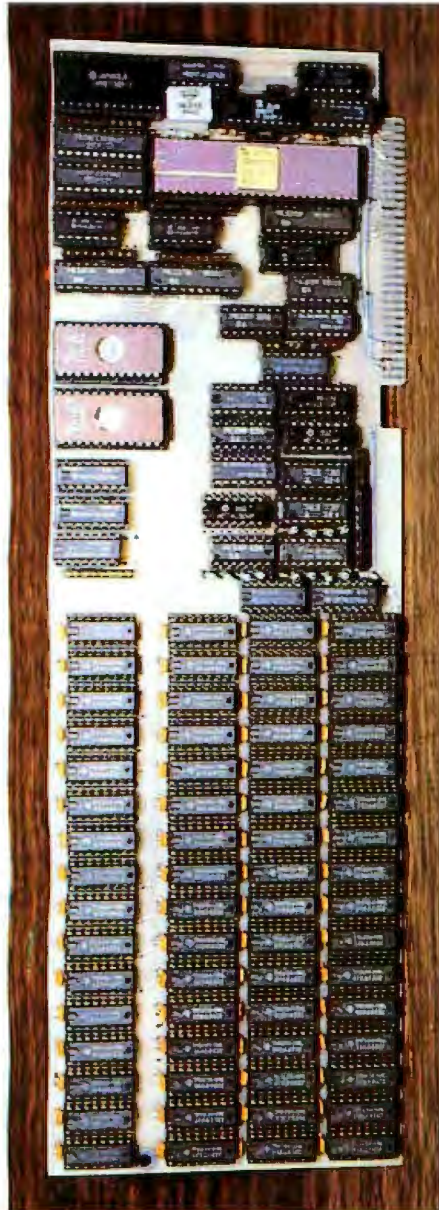
its 32-bit Lisa Technology, or its 3 1/2" floppy disks, or its serial ports, or its software, or its polyphonic sound generator.

The real genius is that you don't have to be a genius to use a Macintosh.

You just have to be smart enough to buy one.

Soon there'll be just two kinds of people. Those who use computers. And those who use Apples. 





Page 40



Page 98

### Columns

**40 Trump Card, Part 1: Hardware** by Steve Ciarcia / Speed up your IBM PC with 16-bit coprocessing power.

**59 User's Column: Chaos Manor's Hard-Disk System** by Jerry Pournelle / Dirty filters, 8/16-land, views of the future, and inevitably more.

**88 BYTE West Coast: Bulletin Boards In Space** by John Markoff / Amateur radio pioneering promises low-cost global communications.

### Themes

**98 Professional Computing** by Stanley J. Wszola / This month's theme articles explore how microcomputers can take on part of the burden of running many types of professional offices.

**101 A Professional's Perspective on User-Friendliness** by William J. Raduchel / New systems are described as user-friendly, but what does that mean?

**108 A Computer in the Doctor's Waiting Room** by George Zucconi / By handling patients' preliminary queries on a particular medical problem, the program described can save a doctor's time for answering more complicated questions.

**122 The Microcomputer as a Decision-Making Aid** by Peter Callamaras / A computer can help you make work decisions, but only if you know what to expect.

**127 Benchmarking Business-Modeling Software** by William Hession and Malcolm Rubel / The guidelines presented can help you compare the functions and speed of business-modeling software.

**137 Expert Systems for Personal Computers** by Milos Konopasek and Sundaresan Jayaraman / The TKISolver approach.

**160 How Lawyers Can Use Microcomputers** by Robert P. Wilkins / Small systems can help cut costs while upgrading legal service.

**171 Computerizing a Medical Office** by Jonathan Javitt / A physician's advice can be useful for other professionals needing tailored applications.

### Reviews

**187 Reviewer's Notebook** by Rich Malloy / BYTE's product-review editor comments briefly on Multiplan, PFS:Write, Infoscope, and more.

**189 Thinktank** by William R. Hershey / Billed as an "idea processor," Thinktank is an outlining and organizing tool.

**196 The QDP-300 Computer** by Edward Joyce / A high-priced but speedy Z80 system.

**206 The Kaypro 10** by Steve McMahon / This hard-disk CP/M portable has a large software bundle and a small price.

**225 Converting the TRS-80 Model III for CP/M** by Mark E. Renne / The author compares Mapper III, Shuffleboard III, and Vid-80.

BYTE is published monthly by McGraw-Hill Inc. Founder: James H. McGraw (1860-1948). Executive, editorial, circulation, and advertising offices: 70 Main St., Peterborough, NH 03458, phone (603) 924-9281. Office hours: Mon—Thur 8:30 AM — 4:30 PM, Friday 8:30 AM — 1:00 PM, Eastern Time. Address subscription questions to BYTE Subscriptions, POB 590, Martinsville, NJ 08836. Postmaster: send address changes, USPS Form 3579, undeliverable copies, and fulfillment questions to BYTE Subscriptions, POB 596, Martinsville, NJ 08836. Second-class postage paid at Peterborough, NH 03458 and additional mailing offices. USPS Publication No. 528890 (ISSN 0360-5280). Postage paid at Winnipeg, Manitoba. Registration number 9321. Subscriptions are \$21 for one year, \$38 for two years, and \$55 for three years in the USA and its possessions. In Canada and Mexico, \$23 for one year, \$42 for two years, \$61 for three years. \$53 for one year air delivery to Europe, 17,100 yen for one year surface delivery to Japan, \$37 surface delivery elsewhere. Air delivery to selected areas at additional rates upon request. Single copy price is \$3.50 in the USA and its possessions, \$3.95 in Canada and Mexico, \$4.50 in Europe, and \$5 elsewhere. Foreign subscriptions and sales should be remitted in United States funds drawn on a U.S. bank. Please allow six to eight weeks for delivery of first issue. Printed in the United States of America.





**236 Robographics CAD-1** by Rik Jadrnicek / Convert an Apple computer into a drafting system.

**246 Two More Versions of C for CP/M** by David D. Clark / A benchmark comparison of Q/C and Eco-C.

**258 LNW-80** by Mahlon G. Kelly / A user reports favorably on this Z80-based, 8-bit TRS-80 work-alike.

**Features**

**275 This Month's Features** by G. Michael Vose / BYTE's features editor gives an overview of the issue's feature articles.

**276 The Apple IIc Personal Computer** by John Markoff / Apple introduces a portable IIc compatible that runs ProDOS.

**288 Inside the Model 100's ROM** by Brian Cameron / Explore the built-in software of the TRS-80 Model 100.

**307 Maximizing Hard-Disk Performance** by Roy Chaney and Brian Johnson / How cache memory can dramatically affect transfer rates.

**339 Update on Apple Macintosh and Lisa 2** by Gregg Williams / The Macintosh turns out to be more expensive than expected.

**340 Fitting Curves to Data** by Marco S. Caceci and William P. Cacheris / The Simplex algorithm is the answer.

**366 Laboratory Data Collection with an IBM PC** by Stephen C. Gates / A versatile hardware/software combination.

**382 Putting the Apple II Work, Part 2: The Software** by Richard C. Hallgren / A high-speed system for the acquisition and analysis of data.

**400 ISIM: A Continuous-System Simulation Language** by Roy E. Crosbie / The structure and features of a simulation language designed to run under CP/M are discussed.

**406 Indexing Open-Ended Tree Structures** by John Snyder / How to "walk" through a "grove" of A-trees in search of hierarchical nodes.

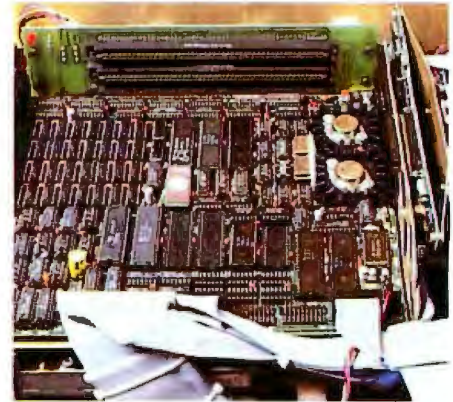
**415 Using Comments to Aid Program Maintenance** by Richard A. Thomas / Complex software can be maintained more easily by the judicious use of remarks embedded in the program code.

**Nucleus**

- 4 Editorial: The BYTE Reader: Who You Are
- 9 MICROBYTES
- 14 Letters
- 426 BYTE's User to User
- 444 Event Queue
- 468, 474 Book Reviews
- 478 Clubs and Newsletters

- 481 Books Received
- 488 Software Received
- 495 Ask BYTE
- 499 What's New?
- 573 Unclassified Ads
- 574 BYTE's Ongoing Monitor Box and BOMB Results
- 575 Reader Service

Cover painting by Robert Tinney



Page 196



Page 206



Page 276

Address all editorial correspondence to the Editor, BYTE, POB 372, Hancock, NH 03449. Unacceptable manuscripts will be returned if accompanied by sufficient first-class postage. Not responsible for lost manuscripts or photos. Opinions expressed by the authors are not necessarily those of BYTE. Copyright © 1984 by McGraw-Hill Inc. All rights reserved. Trademark registered in the United States Patent and Trademark Office. Where necessary, permission is granted by the copyright owner for libraries and others registered with the Copyright Clearance Center (CCC) to photocopy any article herein for the flat fee of \$1.50 per copy of the article or any part thereof. Correspondence and payments should be sent directly to the CCC, 29 Congress St., Salem, MA 01970. Specify ISSN 0360-5208/83 \$1.50. Copying done for other than personal or internal reference use without the permission of McGraw-Hill Inc. is prohibited. Requests for special permission or bulk orders should be addressed to the publisher, BYTE is available in microform from University Microfilms International, 300 North Zeeb Rd., Dept. PR, Ann Arbor, MI 48106 or 18 Bedford Row, Dept. PR, London WC1R 4EJ England.

Subscription questions or problems should be addressed to: BYTE Subscriber Service, POB 328, Hancock, NH 03449





**Editor-in-Chief:** Philip Lemmons

**Managing Editor:** Gene Smarte

**Senior Technical Editors:** Gregg Williams;

Richard Malloy, Reviews; G. Michael Vose,

Features

**Technical Editors:** Richard S. Shuford, Arthur A.

Little, Stanley Wszola, Bruce Roberts, Richard

Krajewski, Jane Morrill Tazelaar, Glenn Hartwig,

Ken Sheldon; Alan Easton, Drafting

**Consulting Editors:** Steve Ciarcia, Jerry Pournelle

**West Coast Editors:** Ezra Shapiro, Technical

Editor, Donna Osgood, Associate Editor.

McGraw-Hill, 425 Battery Street, San Francisco,

CA 94111, (415) 362-4600. John Markoff, Senior

Technical Editor, McGraw-Hill, 1000 Etwell Court,

Palo Alto, CA 94303, (415) 964-0624

**Managing Editor, User News:** George Bond

**User News Editors:** Anthony J. Lockwood,

What's New?; Mark Welch, MICROBYTES

**Copy Editors:** Elizabeth R. Cooper, Chief; Warren

Williamson, Nancy Hayes, Joan V. Roy,

Dennis E. Barker, Anne L. Fischer, Bud Sadler,

Margaret Cook, Paula Noonan

**Assistants:** Faith Kluntz, Beverly Jackson, Lisa Jo

Steiner, Peggy Dunham

**Production:** David R. Anderson, Associate

Director; Virginia Reardon, Production Manager;

Jan Muller, Michael J. Lonsky; Sherry McCarthy,

Chief Typographer; Donna Sweeney, Valerie

Horn, Len Lorette, Nan Fornal

**Advertising:** Deborah Porter, Supervisor; Marion

Carlson, Rob Hannings, Cathy A. R. Drew, Lisa

Wozniak, Jeanne Cilley, Jeanna Reenstierna;

Wai Chiu Li, Quality Control Manager; Linda J.

Sweeney, Advertising/Production Coordinator;

Julie Nelson

**Advertising Sales:** J. Peter Huestis, Sales

Manager; Sandra Foster, Administrative Assistant

**Circulation:** Gregory Spitzfaden, Director;

Andrew Jackson, Subscriptions Manager; Barbara

Varnum, Assistant Manager; Agnes E. Perry,

Louise Menegus, Jennifer Price, Jane Varnum,

Phil Dechert, Mary Emerson; James Bingham,

Single-Copy Sales Manager; Linda Turner,

Assistant Manager; Carol Aho, Edson Ware,

Claudette Carswell

**Marketing Communications:** Horace T.

Howland, Director; Doug Webster, Director of

Public Relations; Vicki Reynolds, Marketing

Associate; Nancy Giacalone, Assistant; Stephanie

Warnesky, Graphic Arts/Production Supervisor;

Sharon Price, Graphic Arts Designer; Michele P.

Verville, Research Manager; Patricia Akerley,

Market Research Analyst; Cynthia Damato,

Reader Service Coordinator

**Business Manager:** Daniel Rodrigues

**Controller's Office:** Kenneth A. King, Assistant

Controller, Mary E. Fluhr, Accounting & D/P

Manager; Karen Burgess, Linda Short, Vicki

Weston, Vern Rockwell, Lyda Clark, JoAnn

Walter, Julie Ferry, Patricia Burke

**Traffic:** N. Scott Gagnon, Manager; Brian

Higgins, Anthony Bennett

**Receptionist:** L. Ryan McCombs

**Personnel/Office Manager:** Cheryl A. Hurd

**Associate Publisher/Production Director:** John

E. Hayes

**Publisher:** Gene W. Simpson;

Doris R. Gamble, Publisher's Assistant

**Editorial and Business Office:** 70 Main Street,

Peterborough, New Hampshire 03458,

(603) 924-9281

Officers of McGraw-Hill Publications Company:

President: John G. Wrede, Executive Vice Presidents:

Paul F. McPherson, Operations; Walter D. Serwatka,

Finance & Services. Senior Vice President-Editorial:

Ralph R. Schulz. Senior Vice President Publishers:

Harry L. Brown, David J. McGrath, James R. Pierce,

Gene W. Simpson, John E. Slater. Vice President

Publishers: Charlton H. Calhoun III, Richard H. Larsen,

John W. Patten. Vice Presidents: Kemp Anderson,

Business Systems Development; Shel F. Aseri,

Manufacturing; John A. Bunyan, Electronic

Information Services; George R. Elsinger, Circulation;

Michael K. Hehir, Controller; Eric B. Herr, Planning

and Development; H. John Sweger, Jr., Marketing,

Virginia L. Williamson, Business Development.

Officers of the Corporation: Harold W. McGraw,

Jr., Chairman; Joseph L. Dionne, President and Chief

Executive Officer; Robert N. Landes, Senior Vice

President and Secretary; Ralph J. Webb, Treasurer.

# The BYTE Reader: Who You Are

We do a lot of research about our readers and your interests, and we thought you might enjoy knowing more about the group you join when you subscribe to BYTE.

You are very well educated. More than 93 percent have gone beyond high school, with about 78 percent completing college, 23.5 percent holding master's degrees, 10 percent holding Ph.D.s, and 2.8 percent holding professional degrees. In all, about 40 percent have some graduate education.

Your fields of study in college are varied. Almost 25 percent of BYTE subscribers majored in electrical engineering, 5.2 percent in mechanical engineering, and 7.8 percent in other engineering specialties. Another 15 percent majored in sciences, 7.8 percent in computer science, and 6.8 percent in social sciences.

Of those BYTE subscribers who did graduate work, 14.8 percent studied business administration, 10.7 percent pursued electrical engineering, and 13.8 percent explored other areas of engineering, while 9.2 percent studied computer science, 13.3 percent physics or chemistry, 7.7 percent mathematics, 4.6 percent social sciences, and 9.2 percent other sciences.

Your occupations reflect your high levels of education and skills. About 15 percent of you are engineers in computers or electronics, 17 percent are engineers in other fields, 5.5 percent are computer scientists, 8 percent are in other fields of science, 13 percent are computer analysts or programmers, 11 percent are managers or administrators, 4.5 percent are students (though this number is growing fast), 4.5 percent are self-employed, and 6 percent are educators.

Some 47.3 percent of you have responsibilities including management and administration, 39 percent have responsibilities in product design and development, 37 percent in research and development, 37 percent in data processing, 14 percent in purchasing.

You use computers in many ways. About 75 percent of you use computers for personal, nonbusiness purposes, and 83.5 percent use microcomputers for business. As to your primary involvements with computers, some 23 percent cite involvement in hardware or software technology, while 20 percent cite use of computers as a management tool or in business applications. Half of you plan to buy a personal computer for nonbusiness purposes in the next year. In personal, nonbusiness use, the leading applications are programming (72 percent), word processing (70 percent), designing hardware or software (68 percent), followed by games, databases, personal finance, and spreadsheets (43 percent). In business, some 80 percent of you or your businesses use microcomputers for word processing, 63 percent for engineering or scientific applications, 63 percent for accounting, 38 percent for industrial control and processing, 37 percent for sales and marketing, 34 percent for electronic mail, 30 percent for investment management, and 28 percent for tax management.

Your favorite articles are about new technology, new hardware, new software, software applications, new peripherals, programming languages, operating systems, telecommunications, and computer graphics. You are also fond of hardware and software reviews.



# 68000-based systems. Just tell us what you need.

## 68000-based systems to fit your application.

Right from the pages of our catalog, we can deliver 68000-based supermicro systems to match virtually any application.

Including yours.

Here's how.

Built on the IEEE-696 (S-100) bus, Cromemco systems offer up to 21 board slots. And a family of 35 boards—CPU, memory and specialized I/O—to fill the slots any way you choose.

At the heart of each system is our 68000/Z-80 dual processor. Backed by as much as 16 Mb of error-correcting RAM. Full multi-tasking capability. I/O to handle up to 16 terminals.

And that's just the beginning. You can select single or dual floppies, 5¼" or 8" A 21 Mb 5¼" Winchester hard disk. And a nine-track tape drive.

We can accommodate your taste for the exotic, too. With boards like our SMD interface that supports up to 1200 Mb of disk storage. An NTSC standard color graphics interface. A TV camera digitizer. A/D and D/A converters. An IEEE-488 bus interface. Communications. And more.

## Intelligent workstations.

Then, if you're designing a distributed processing system, you'll want to take a look at our C-10 personal computer. The Z-80-based C-10 can serve our 68000-based systems

as a powerful intelligent workstation in a distributed processing mode. Or as an independent personal computer with its own floppy storage.

## High-level languages and applications software.

That brings us to software. It starts with CROMIX<sup>®</sup>, our UNIX<sup>™</sup>-like operating system that you're free to tailor to your application.

CROMIX can execute both 68000- and Z-80-based programs. So right along with your 68000-based packages, your system will accommodate a wide selection of CP/M<sup>®</sup> software written for the Z-80.

And our high-level language support is second to none. From a 68000 Macro Assembler. To 68000 FORTRAN 77, PASCAL, GSA-certified high-level COBOL, C and BASIC.

## Cromemco means business. Your business.

You see, when we say, "Just tell us what you need," we're not kidding.

You won't find another family of 68000-based microcomputers that can fit your needs as exactly as ours.

So if you're in the business of providing specialized computing solutions, you really should be doing business with Cromemco.

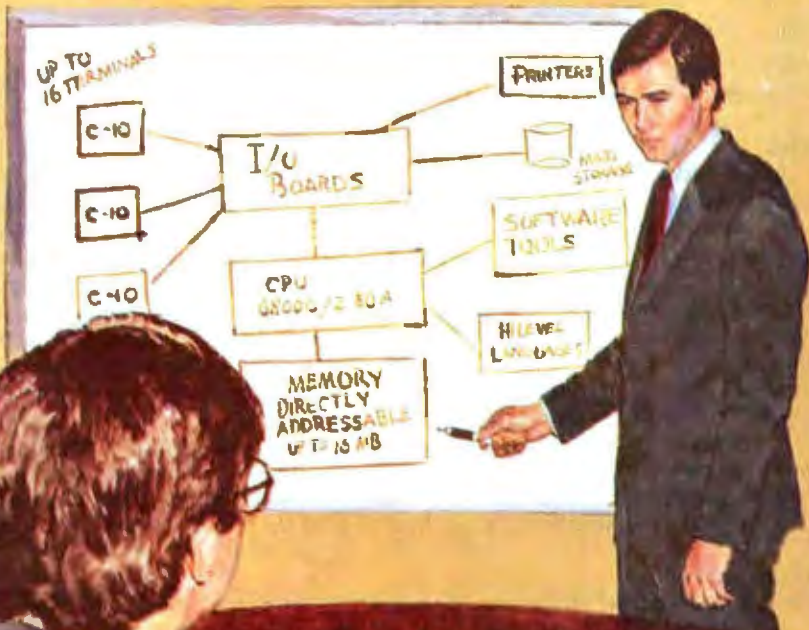
For a copy of our Systems Catalog, contact: Cromemco, Inc., 280 Bernardo Avenue, P.O. Box 7400, Mountain View, CA 94039. (415) 964-7400.

In Europe: Cromemco/GmbH, 6236 Eschborne 1, Frankfurter Str. 33-35, P.O. 5267, Frankfurt Main, Germany or Cromemco Ltd., The Cambridge House, 178-182 Upper Richmond Rd., Putney, London SW15 England.

# Cromemco<sup>®</sup>

\*Cromemco and CROMIX are registered trademarks of Cromemco, Inc. <sup>™</sup>UNIX is a trademark of Bell Laboratories. <sup>®</sup>CP/M is a registered trademark of Digital Research. ©1983, Cromemco, Inc.

Circle 117 on inquiry card.





Not surprisingly, you know a great deal about computers and have valuable information to share (if you want to share your knowledge by writing for BYTE, see the text box below). Almost 50 percent of you describe your skills in personal computing as advanced, and another 40 percent call your skills intermediate; the remaining 10 percent are college students and other bright novices who want to learn a lot fast.

You cite the comprehensiveness and depth of BYTE's coverage of personal computing as distinguishing it from other magazines. We consider that the supreme compliment.

We do research in order to make sure that BYTE continues to focus on your interests and needs. Since our staff shares your interests and matches your profile, we hope not only to do a good job, but also to enjoy it.

### A Note on the BYTE Computer Shows

The first BYTE Computer Show takes place May 10 through 12 (Thursday through Sunday) at McCormick Place in Chicago, with the second to follow on June 14 through 17 (Thursday through Saturday) in Los Angeles. BYTE shows won't be industry exhibitions where manufacturers and distributors make deals, but regional gatherings for users of personal computers, and especially for BYTE subscribers (who get an all-day pass to all exhibits and conferences for \$7.50, as opposed to \$15 for nonsubscribers).

At the BYTE Shows, you will have the chance to meet Steve Ciarcia, Jerry Pournelle, Gregg Williams, Rich Malloy, Mike Vose, Richard Krajewski, and other BYTE editors. You can attend conferences on subjects of greatest interest to personal computer users, such as 32-bit microprocessors, languages, graphics, programming environments, personal robots, notebook computers, idea processing, AI gateways to natural languages, and voice recognition. You can share information with other subscribers (users' report on low-cost 1200-bps

modems, languages forum, homebrew databases, etc.) and get more involved in BYTE by participating in meetings on reviewing and writing for BYTE.

Equally important, the BYTE Shows are not just tempting "don't touch" exhibitions; they are fairs at which you can buy products from exhibitors if you find the machine of your dreams or the board, peripheral, or program you've been living without for too long.

We think the separate elements assembled under one roof—the conferences, the equipment and software on exhibit, the chance to meet fellow subscribers, and the opportunity to shop for a variety of personal computer products—will combine to make the BYTE Shows enjoyable for all BYTE subscribers and others who find personal computers as fascinating as we do.

See you at the Shows.

—Phil Lemmons, Editor-in-Chief

## Writing For BYTE

*BYTE continues to solicit and publish articles and reviews that keep you informed about what's new and important in microprocessor-based technology, and many of our articles are still written by you, the people directly involved with the field we report on. Details on querying us about article, product-review, and book-review ideas are listed below. We also welcome submissions (typed and double-spaced, please) to our Letters to the Editor column. Please contact us, via the appropriate department at:*

BYTE  
POB 372  
Hancock, NH 03449  
(603) 924-9281

*You may also want to call or write us (send a stamped, self-addressed business envelope) for our current author guidelines.*

### Articles

*Because our editorial needs are very specific and subject to change, we prefer receiving query letters instead of completed articles. A query letter should contain one or two pages explaining the subject to be covered, its importance to the BYTE reader, and the focus of the proposed article; it should also contain a one- or two-page outline and a tentative first two pages of the proposed article. Query letters should be addressed to the features editor.*

*If you send us a completed article, we need double-spaced printed versions of the main text (up to 25 numbered pages) and all listings, figures, and tables; please label all items and place all captions on a separate page. Photos should be 35 mm (or larger) transparencies or 5- by 7-inch (or larger) prints. If possible, we would also like to receive magnetic copies of the text, listings, and tables on Apple DOS, IBM PC, Kaypro, or 8-inch CP/M disks; we will pay an additional \$20 for this. The files should be standard ASCII text files and should not contain any nonprintable characters; we prefer files that use carriage returns only at the end of each paragraph. You should also include a stamped, self-addressed return envelope of the appropriate size. Address these to the features editor.*

### Product Reviews

*We frequently need good product reviewers and sometimes accept unsolicited reviews. BYTE product reviews must be fair, accurate, and comprehensive. Reviewers must have considerable experience in the microcomputer field. Writing experience is preferred but not required, and reviewers must have no financial connection to the company whose products are being reviewed. If you are interested in becoming a BYTE reviewer, send a letter to our product-review editor stating what computer products you own, what products you are interested in, and what writing experience you have.*

### Book Reviews

*BYTE is always looking for qualified book reviewers. Submit queries and proposals accompanied by a resume, writing samples, or a list of computer-related interests and expertise to the book-review editor. Unsolicited book reviews also will be considered.*

*We pay competitive rates for articles and reviews and offer you the chance to share your expertise with hundreds of thousands of BYTE readers. Your comments and submissions are always welcome. ■*





Integrated.

Printegrated.

Now, translate your integrated software into integrated hard copy, with the TI OMNI 800™ Model 855 printer. So versatile, it combines letter-quality print, draft-quality print and graphics as no other printer can. **It prints letter-quality twice as fast** as comparably priced daisy wheel printers, yet gives you characters just as sharp, just as clear.

**It prints rough drafts ten times faster** than daisy wheel printers... faster than most any other dot matrix printer. Only the TI 855 has snap-in font modules. Just touch a button; change your typestyle. The 855 gives you more typestyles to choose from than ordinary dot matrix printers. It makes them quicker, cleaner, easier

to access than any other dot matrix or daisy wheel printer.

**The 855's pie charts are rounder...** all its graphics are sharper than on other dot matrix printers, because the TI 855 prints more dots per inch. As for daisy wheel printers... **no graphics.**

## The TI 855 Printer

The printer for all major PC's



For under \$1,000 you get twice the performance of typical dot matrix printers. Or all the performance of a daisy wheel printer, and then some, for half the price.

So get the best of all printers, and get optimum results from your integrated software. With the TI 855. See it at your nearest authorized TI dealer. Or call toll-free: 1-800-527-3500. Or write Texas Instruments Incorporated, P.O. Box 402430, Dept. DPF-182BY, Dallas, Texas 75240.

**TEXAS INSTRUMENTS**   
Creating useful products  
and services for you.

™ OMNI 800 is a trademark of Texas Instruments Incorporated  
Copyright © 1984 Texas Instruments Incorporated. 2763-36



**WORD STAR® AND SUPER CALC 3™ FREE WHEN YOU BUY THE CHAMELEON THROUGH JUNE, 1984.**



**PAYING \$4000 FOR  
AN IBM® PC COULD  
MAKE A TRAMP  
OUT OF ANYONE.**

**PRESENTING THE IBM® COMPATIBLE CHAMELEON FOR JUST \$1995.**

The Chameleon by Seequa lets you run popular IBM software like Lotus® 1-2-3™ and dBASE II.® It gives you a keyboard just like the IBM. A disk drive like the IBM. And a bright 80x25 character screen just like you know who. And it all comes complete at a price that isn't at all like an IBM.

But the Chameleon's \$1995 price tag isn't its only advantage over its famous competitor. The Chameleon also has an 8 bit microprocessor that lets you run any of the thousands of CP/M-80® programs

available. It comes complete with two of the best programs around, Perfect Writer™ and Perfect Calc.™ It's portable. And you can plug it in and begin computing the moment you unwrap it.

So before you spend all your money on an IBM, consider the IBM compatible Chameleon by Seequa.

It's a tool for modern times that won't set you back a fortune.



The Chameleon by



Chameleon shown with optional second disk drive. To learn more about Seequa or for the location of the Seequa dealer nearest you, call (800) 638-6066 or (301) 672-3600.



## **AT&T UNVEILS COMPUTERS**

AT&T announced a line of computers in late March, ranging from a \$9950 multiuser microcomputer to a \$340,000 supermini. The computers use the UNIX System V operating system.

The 3B2/300 microcomputer uses Western Electric's WE 32000 CMOS microprocessor and includes one 720K-byte 5¼-inch floppy-disk drive, a 10-megabyte hard-disk drive, 512K bytes of RAM, four expansion slots, and ports for two users. Optionally, the computer can be expanded to 2 megabytes of RAM and a 32-megabyte hard disk. AT&T's optional I/O expansion card includes a parallel port and four RS-232C serial ports (which use an 8-wire modular jack), so that up to 18 terminals and four printers can be attached. While the base price of \$9950 doesn't include a terminal, AT&T will sell its 5410 "dumb" terminal for about \$600. AT&T's \$6100 5620 terminal, which allows up to six windows to operate concurrently, can also be used, though a maximum of three can access a single 3B2. The 3B2 does not support color graphics.

AT&T also announced a PC interface, allowing the IBM PC to act as a workstation for the 3B2 using RS-232C, Omninet, or Ethernet communications. It also announced that its 3B Net will be available for any of its computers.

While some details and pricing were uncertain at the time of the announcement, AT&T said it would publish the bus and interface information for its computers and would encourage third-party hardware and software development.

AT&T also introduced larger computers. The 3B5 Models 100 and 200 include four to eight WE 32000 microprocessors and are priced from \$57,000 to \$73,000. The 3B20A, 3B20S, and 3B20D superminicomputers, priced from \$230,000 to \$340,000, use a real-time version of UNIX and have microprogrammed CPUs, using WE 32000s only for I/O and memory management.

## **ASHTON-TATE ANNOUNCES INTEGRATED SOFTWARE**

Ashton-Tate, manufacturer of dBASE II, has unveiled an integrated software package called Framework. Using an outline structure with multiple frames (windows), the program allows elements of the outline to be spreadsheets, graphs, databases, text, or other outlines. Numerous functions are available throughout Framework. Print enhancements such as boldface and italic can be used in the spreadsheet or database as well as the word processor. Because the program includes its own programming language, programmers can develop specific applications using Framework. The program was developed by Forefront Corp., but Framework will be distributed by Ashton-Tate, beginning in July, for \$695.

## **OLIVETTI, SORD INTRODUCE NOTEBOOK-SIZE COMPUTERS**

Olivetti Corp. will begin selling its M-10 notebook-size computer in the U.S. With 8K bytes of RAM, a built-in 300-bps modem, and an 8-line by 24-column LCD that tilts for easy viewing, the M-10 will sell for \$799; a 24K-byte version will cost \$999. This computer is made in Japan by Kyocera, which also builds the Radio Shack Model 100 and the NEC 8201. Previously, the M-10 had been available only in Europe, due to a patent dispute among Olivetti, Kyocera, and Radio Shack.

Sord Computer also introduced a notebook-size computer, the IS-11 Consultant, which includes 32K bytes of RAM (expandable to 64K), a CMOS Z80A processor, and an 8-line by 40-character display. Integrated software for word processing, spreadsheets, graphics, communications, and window-management features is included on a 64K-byte ROM chip. The IS-11 will be available this month for \$995; a version with a built-in 300-bps modem will cost \$1095 later this year. Sord plans to offer 64K-byte ROM-pack-based applications software later as well as external monitor and disk-drive options.

## **TWO COMPANIES SEEK TO SELL AI-BASED SOFTWARE TOOLS**

Texas Instruments announced it will license the NaturalLink Software Technology it used to develop software to access Dow Jones News/Retrieval, using plain English instead of complex codes. TI hopes software developers will pay \$8000 to use the natural-language software technology to develop programs for the TI Professional Computer.

Expert Systems Inc., New York, and Jeffrey Perrone & Associates, San Francisco, are selling Expert-Ease, an expert systems generator. After information is entered into the system, the program makes decisions based on that information, ideally simulating the thought process of the "expert" who entered the information. Expert-Ease sells for about \$2000.



### **PLASMA DISPLAY UNVEILED BY FORMER BURROUGHS DIVISION**

Plasma Graphics Corp., Warren, NJ, a joint venture of Burroughs Corp. and Telex Computer Products, has introduced an 80-character by 25-line plasma display. The 3-pound unit has a 7.2- by 3.7-inch display, the equivalent of a CRT display with an 8.1-inch diagonal measure. Plasma Graphics says the display's current \$1795 evaluation price should drop to a volume price of \$300 to \$400 in a few years.

### **CORVUS, AST ANNOUNCE CHANGES TO THEIR LOCAL-AREA NETWORKS**

Corvus Systems Inc. announced Omnishare, a program allowing computers networked with Corvus Omninet to share the hard disk on an IBM PC XT. Previously, Omninet required a separate Corvus hard-disk file server. Corvus also introduced its new OmniDrive line of hard-disk drives with a built-in Omninet connection. Prices range from \$1995 for a 5.5-megabyte drive to \$4995 for 45.1 megabytes, plus \$495 for Corvus Constellation II network software.

AST Research introduced PC-Net II. The twisted-pair network can use an XT or Tallgrass hard disk for shared files and includes a print-spooler feature. A starter kit, with manuals, cables, and two cards for the IBM PC, costs \$1290; additional PC-Net II cards are \$595.

Microsoft is also reportedly developing a new version of its MS-DOS operating system with multiuser/networking features.

### **BASIS GETS NEW DISTRIBUTOR, INTRODUCES LOW-COST VERSION OF 108**

Basis is introducing a lower-cost version of the Basis 108 (reviewed in the January 1984 BYTE). The computer will include 128K bytes of RAM, Z80 and 6502 processors, and two 5¼-inch disk drives for about \$1500. Basis is also preparing a hard-disk version of the Basis 108 as well as 16- and 32-bit systems. (Communicall Inc. [1400 Grant Ave., Novato, CA 94948, (800) 421-6594 or (408) 892-7139] is now the U.S. representative for Basis.)

### **NANOBYTES**

**IBM** announced Displaywrite , a word-processing program for the IBM Personal Computer. An abridged version is available for \$95, or all features are included for \$299. IBM also announced a \$13,000 low-end version of its System 36 computer with a 30-megabyte hard disk . . . Both **IBM** and **Comodore** have been licensed to produce Intel's 8088 processor. . . . **International Data Services Inc.**, San Jose, CA, has announced Unx-II, a \$900 version of UNIX System III for the IBM PC. . . . **Uniform Software Systems Inc.** plans to introduce a version of the UNIX operating system that can run MS-DOS and UNIX software concurrently. . . . **Zilog** has licensed **NEC Corp.** to produce Zilog's Z80000 microprocessor. . . . **IBM** has made a grant to University of New Hampshire professor James Weiner to convert a Prolog interpreter developed at UNH to run on the IBM PC. Weiner predicts the interpreter will be available by August through UNH for less than \$300. . . . **Macrotech International Corp.**, North Hollywood, CA, introduced a \$1395 S-100 processor board using Intel's iAPX286 and Zilog's Z80B. . . . **Casheab**, San Francisco, CA, introduced a music-synthesizer board for the IBM PC. The board will sell for \$795 in late summer. . . . **Daisy Systems Holland**, Torrance, CA, introduced the QuietWrite printer, which it says is quieter than other daisy-wheel printers. . . . **Capitol Data Systems**, a division of Capitol Records, has entered the premium-quality disk business with a line of 5¼-inch floppy disks. Capitol plans to add 3½-inch disks soon. . . . **Synetix Inc.**, Seattle, WA, announced the PC-Handler, an expansion card for the IBM PC, allowing up to four IBM PC or Apple II computers to share files and peripherals. A Z80 processor, two serial ports, four parallel ports, and 64K bytes of RAM are included for \$795. . . . **Information Appliance**, a Palo Alto firm headed by Jef Raskin—originator of Apple's Macintosh—is developing a new product of its own. . . . **Borland International**, Scotts Valley, CA, has introduced a version of its \$49.95 Turbo Pascal compiler for the IBM PCjr. . . . **Atari** has dropped its Atari Program Exchange, through which it sold third-party software. . . . **Apple Computer** will rely on third-party vendors to introduce peripherals for its Applebus low-cost local-area network for the Macintosh and Lisa 2. While Apple plans to introduce shared hard disks and laser printers, it does not presently plan to introduce additional low-cost Applebus peripherals. . . . A number of colleges are now offering course credit for **TeleLearning's** "electronic university" courses, which download and upload course materials, exams, and teacher-student messages. . . . **Workman and Associates** is finally shipping WRITE for CP/M-86. . . . **Creative Solutions Inc.**, Rockville, MD, has announced MacForth for Apple's Macintosh. MacForth Level 1 costs \$149; Level 2, with an assembler and additional functions, is \$249.



# Get A HeadStart<sup>™</sup> On The Other Guys.



## HeadStart Features:

Size: 15" wide, 11" deep, 10 1/2" high.

Weight: 25 lbs.

Processors: Z80A (8 bit) and 8086 (16 bit).

Memory: 128K to 1MB depending on model. All models are expandable.

Disk Storage: 500K to 1MB (unformatted) on a 3 1/2" Micro-Disk.

Display: 12" (diagonal) P31 phosphor, non-glare screen, 25 lines x 80 or 132 columns.

Keyboard: Detachable with 105 total keys. An optional portable version snaps onto the front screen area for easy transportability.

Disk Operating Software: \*CP/M 80 for 8 bit. \*\*MS DOS for 16 bit. LAN DOS for multi-user 8 or 16 bit operation.

Networking: Up to 255 HeadStart VPUs may be connected via coaxial interface into one of 2 optional data storage systems.

Interfaces: One RS449/RS232 compatible serial port. One Centronics compatible parallel printer port. External data bus. Coaxial communications interface. External disk I/O interface.

Optional Data Storage Systems: 2 models available. A 10MB, 5 1/4" system is expandable to 20MB. A 50MB, 8" system (25MB fixed, 25MB removable) is expandable to 200MB.

\*CP/M is a registered trademark of Digital Research.

\*\*MS DOS is a registered trademark of Microsoft.

Intertec's HeadStart is the smallest, smartest, fastest, most powerful business computer money can buy. And the most expandable (it's networkable up to 255 user stations).

## Great Ideas Come In Small Packages.

Instead of three bulky components, HeadStart needs only two—the keyboard and CRT. There's no need for a cumbersome disk and processor cabinet. With HeadStart, it's all in the CRT enclosure.

HeadStart's small but powerful 3 1/2" disk drive offers as much storage as larger 5 1/4" disks. Its 8 and 16 bit processors make software availability no problem.

And HeadStart's small size permits easy transportability with no sacrifice in performance. Each Video Processing Unit (VPU) comes with its

own easy-carrying handle. A portable keyboard option is also available.

## How Fast Is Fast?

HeadStart's RAM Disk, an electronic emulation of the typical second drive, responds up to fifty times faster than conventional microcomputers.

Depress a key and you get a response within a split second. Literally before your finger leaves the key.

And HeadStart is incredibly powerful, too. Up to one megabyte of internal memory can tackle even the most sophisticated applications.

## Some Ideas Are Bigger Than Others.

Because HeadStart is designed to be both a single *and* multi-user computer, you buy only as much computer as you need today.

But as your business grows, it grows with you.

Each HeadStart Video Processing Unit comes with its own memory, processors, disk and multi-user interfaces.

Just add a 10 or 50 megabyte Data Storage System and up to 255 users can share a common data base in an incredibly powerful, multi-user network.

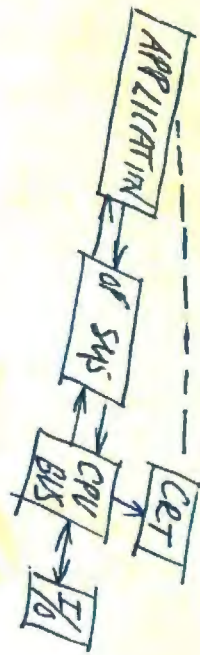
HeadStart is available in three different models. All offer full performance, transportability, and are easily expandable.

Unlike conventional, single-user-only computers, HeadStart is here today with the designed-in technology to be here tomorrow.

So get a HeadStart on the other guys. For more information, call (803) 798-9100 or write: Intertec, 2300 Broad River Road, Columbia, SC 29210.

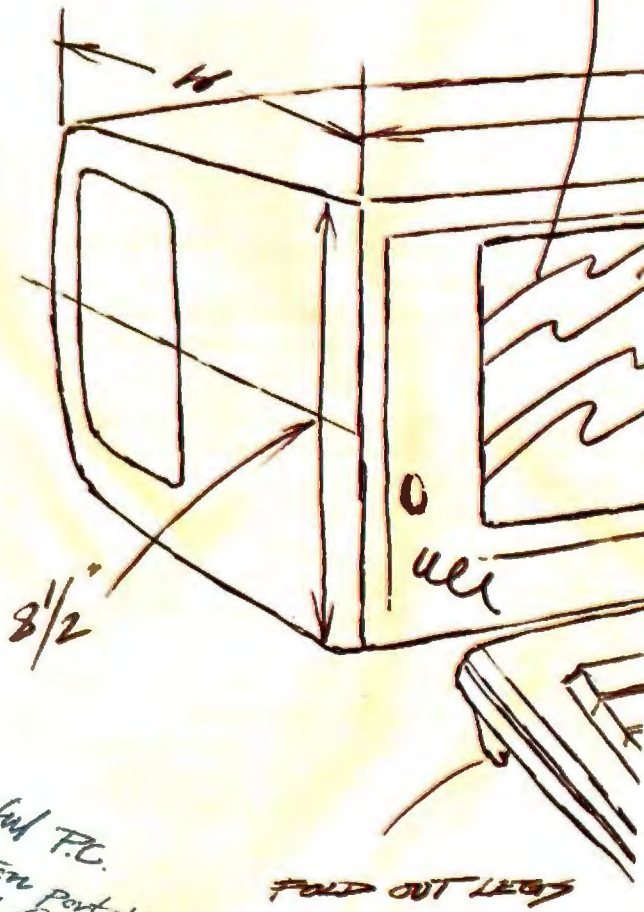
**intertec**<sup>™</sup>





5205 553 0114

9" CRT

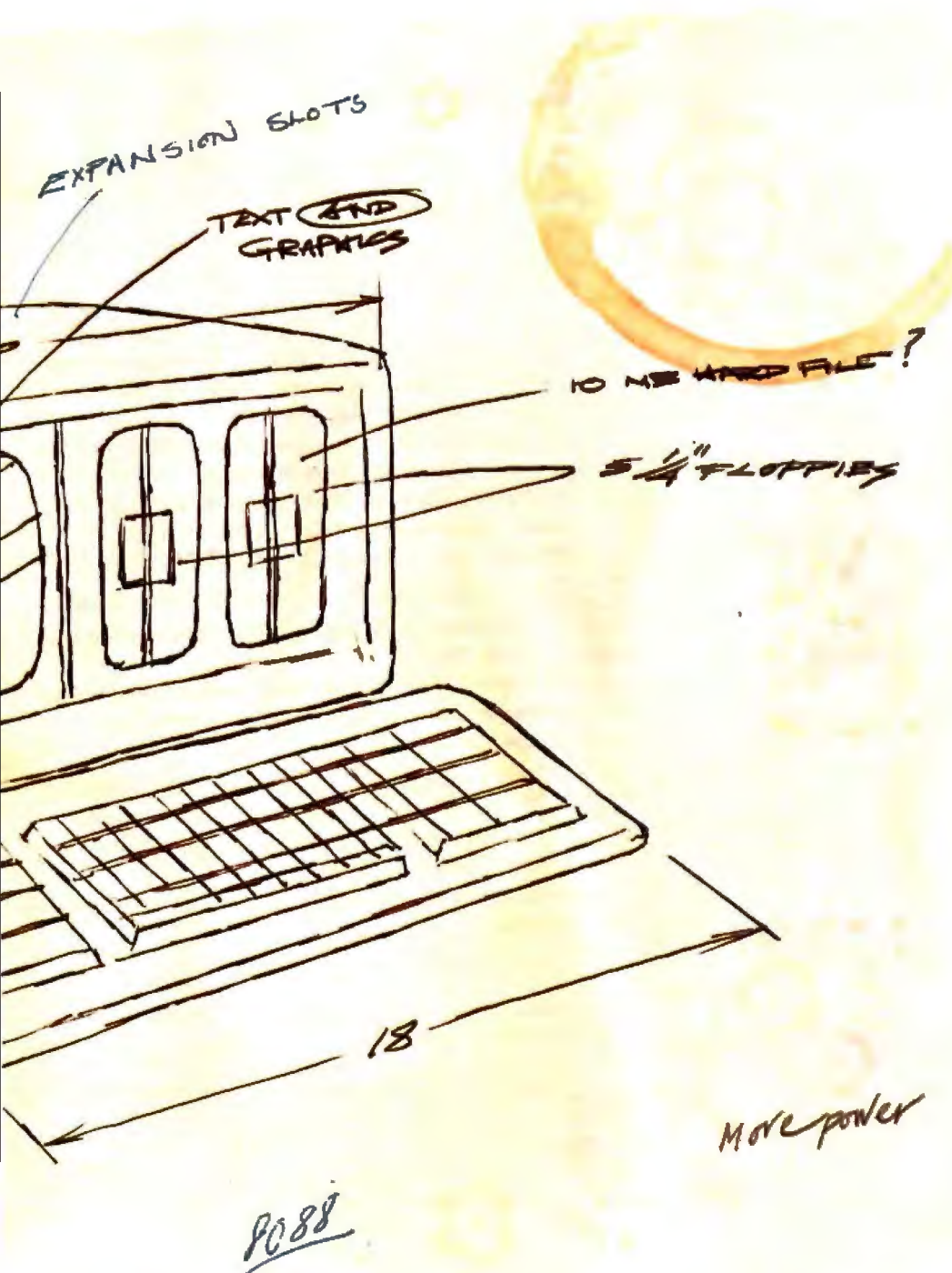


- Most useful P.C.
- (1) Full function portable
  - (2) Truly IBM Compatible
  - (3) Rugged.

FOLD OUT LEGS

A picture worth \$111,000,000.





PC88

More power

Not long ago, three businessmen met in a coffee shop to talk about an idea for a new personal computer. They made a rough design on the back of a place mat.

A lot of companies were already making personal computers, but they thought theirs just might work better.

The next year, they sold \$111 million worth of their new computers, the COMPAQ® Portable and the COMPAQ

PLUS™. No company in America had ever grown that fast. Why?

Simply because they offer, in a rugged, portable package, more capability than most other PCs. They're truly IBM®-compatible, so all the most productive software runs as is. They display high-resolution text and graphics on the same screen. And they grow. Expansion slots take IBM-compatible boards, and a kit converts the COMPAQ

Portable into the COMPAQ PLUS with its integrated ten-megabyte disk drive.

How does the future look? We look at it this way: If we came this far on the back of a place mat, just think of what we can do now.

For the location of your nearest Authorized Dealer, call 1-800-231-0900.

©1984 COMPAQ Computer Corporation. COMPAQ® is a Registered Trademark and COMPAQ PLUS™ is a Trademark of COMPAQ Computer Corporation. IBM® is a Registered Trademark of International Business Machines Corporation.

**COMPAQ**

It simply works better.



## A User Looks at Mac

As an old-school microcomputer person (my first experience with a micro was in December 1977 on a Commodore Pet 2001), I'd like to give a more jaded view of the Apple Macintosh computer.

First, the Mac is an IBM PCjr competitor, not a PC competitor, as Gregg Williams states in "The Apple Macintosh Computer" (February, page 30). Compare both machines' capabilities. The Macintosh has a maximum of 128K bytes of memory, one internal minifloppy drive, and a monitor. It is lightweight and portable, has no hardware expandability, and its software is upwardly compatible to the Lisa 2. The PCjr also has a maximum of 128K bytes of memory and one internal floppy drive. It too is lightweight and portable, has minimal hardware expandability, and its software is upwardly compatible to the PC.

On the other hand, the IBM PC (and variants) have 64K to 128K bytes of memory (expandable to 640K bytes), massive hardware expandability, and multiple floppy and hard disks.

Second, anyone who has worked seriously with computers knows that if speed is the top priority, then tight assembly language is required—but you pay for that speed by having code that is virtually incomprehensible to anyone who did not write it. Forcing software developers to write tight assembly-language code (just to fit memory limitations) will slow the amount of software reaching the market—and raise its price. As Steve Jobs points out ("An Interview: The Macintosh Design Team," February, page 58), once software is developed, it is paid for. So, if Apple plans to sell 10 million Macintosh computers, it obviously expects to sell 10 million copies of Mac BASIC, Mac Paint, and Mac Write. If Apple makes \$50 profit a shot, then the company makes at least an extra \$500 million. (Who said there's no attention paid to quarterly profits at Apple?)

My third complaint is that the Mac is not expandable. What do I do when I outgrow my machine? I would have no choice but to scrap the \$2500 machine and buy a \$3500 system. However, Apple will point out that you get to keep your software.

I know everybody will complain that I am ignoring the wonderful software that

makes Mac the machine it is. But how much are you willing to pay for that software? The Mac is potentially more powerful than the PC, but Apple has so hobbled it that it is not much more powerful than the PCjr.

For the record, I think Mac and Lisa 2 have some wonderful software; but if you really want the software, buy the Lisa 2. At \$3495, it is probably the best mass-produced high-end computer on the market today. For only \$1000 more than you would pay for Mac, you get the expandability that was cut out of Mac (such as large memories and hard disks). In addition, you get another 384K bytes of memory thrown in (the price differential is only what IBM would charge for 384K bytes in chips). As a final bonus, you can get either Mac's or Lisa's operating system. However, you should buy a Lisa 2 quick, because once the differences become evident, Apple will probably raise the Lisa 2's price because of the skyrocketing demand.

**George Snoga**  
1910 Harpers Ferry  
San Antonio, TX 78245

*Gregg Williams replies:*

*Your points about the Macintosh's similarities to the IBM PCjr are well taken; however, I am puzzled by your insistence that the Macintosh is not expandable. My article speaks of the "virtual slot" scheme that makes future peripherals possible and announces the availability of a keypad, a second disk drive (soon), and a 512K-byte memory update (by the end of the year). These alone make the Macintosh more similar to an IBM PC than a PCjr. At the Macintosh announcement date, about 30 third-party vendors announced dozens of software and hardware packages, including two hard disks, two telephone/modems, a printer buffer, and numerous software packages; other vendors have joined since, and some products are already available. Once the Macintosh has 512K bytes of RAM, the powerful operation set of the 68000 and the 128K-byte "toolbox" of routines make it possible to argue that the Macintosh is computationally superior to an IBM PC with 640K bytes of RAM.*

*I agree with you, though, that I'd rather have a Lisa 2 than a Macintosh for my office. Whatever expansion the Mac has, the Lisa 2 will have more, and its ability to run all Macintosh software ensures its vitality.*

## More Mac Reactions

After interminable months of speculation and rumor, the Macintosh has arrived. Apple's "secret weapon" has been released with a flurry of expensive prime-time advertising touting the Macintosh's icon-oriented, mouse-implemented user interface. With the introduction of the Mac has come a plethora of new terminology to be added to the already burgeoning inventory of high-tech buzzwords. In the wake of Macintosh, words such as "icon," "desktop metaphor," and "pull-down windows" are becoming ever more common.

As is to be expected with any new product, especially one that promises to turn the increasingly staid world of personal computing on its ear, the Macintosh has not been uniformly well received. One prominent and oft-repeated criticism is the Macintosh's lack of "compatibility." This indictment, of course, refers to Apple's deliberate choice not to give the Macintosh the capability to run software that is currently in vogue. Several reviewers, most notably Peter McWilliams, have cited this "problem" and stated that the Macintosh is doomed to failure because of it. To dismiss Macintosh for this reason is to sacrifice utility at the altar of uniformity.

It cannot be denied that CP/M and its progeny have carved out a substantial following. Likewise, no one can question that the IBM Personal Computer has become the de facto standard by which all other hardware is measured. Assuming all of this, one nagging question remains: why have these products become so prominent? The answer lies in the meaning of the phrase "de facto." CP/M and the IBM PC have literally stepped into the breach. They have created a standard through blood, sweat, and tears. Quality and performance have been cast aside in the search for conformity. The fear of being different has seized the personal computer industry and has transformed innovators into imitators.

Instead of being ostracized, the Macintosh should be welcomed as a breath of a fresh air in an atmosphere that has become cloistered and stagnant. Were it not for the people involved in developing the Macintosh, personal computer users would still be mired in a swamp of incomprehensible keyboard sequences



# Pick up a SixPakPlus™ for your IBM® PC.

Introducing... SixPakPlus™, the refreshing new 384KB multi-function card! In response to the changing needs of the IBM PC and PC-XT marketplace, AST Research, Inc. is proud to announce the latest addition to our line of multifunction enhancement products, the SixPakPlus! This new product is the result of extensive marketing research into the needs of IBM PC users whether they have the original 64K system board, the newer 256K system board, or the PC-XT. The SixPakPlus has been engineered to meet these needs at a competitive price while main-

taining AST's high standards for quality and reliability.

The SixPak, as we like to call it, could have been named for the six banks of RAM on it. However, we like to think that it was named for the six functions of the card. The features of the SixPak include:

1. RAM memory starting at 64K, user-expandable in 64K increments to 384K. This makes the SixPak ideal for the PC or PC-XT with a 256K system board; 384K on a SixPak added to 256K on the system board yields 640K, the maximum addressable user memory in these systems.
2. One Serial (async) communications port, configurable as either COM1 or COM2, for use with serial printers, modems, a "mouse," and other serial devices. The serial port has on-board jumpers for easy management of the RS-232C lines, simplifying the wiring of cables in many installations.
3. One Parallel (printer) port, configurable as LPT1 or LPT2 (LPT2 or LPT3 when the IBM monochrome card is installed), for use with the IBM/Epson and other compatible printers. The port is compatible with IBM diagnostics.
4. A Clock-Calendar with battery backup, featuring an easily replaceable Lithium battery and a quartz-controlled timebase for a high degree of accuracy.
5. An optional IBM-compatible Game Adapter port, for use with an IBM-type joystick. In conjunction with application programming, this game port may be used for cursor control, in generating graphics or for playing games at the end of your work day!
6. Every SixPak comes with an AST SuperPak utility diskette which includes SuperDrive and SuperSpool, the most powerful disk emulator and print spooler software you can get. These programs will greatly enhance the throughput of your PC or PC-XT by emulating disk drive and printer access at RAM speeds rather than the normal slower speed of mechanical devices. SuperPak is the first of such software to be compatible with both DOS 1.1 and DOS 2.0.

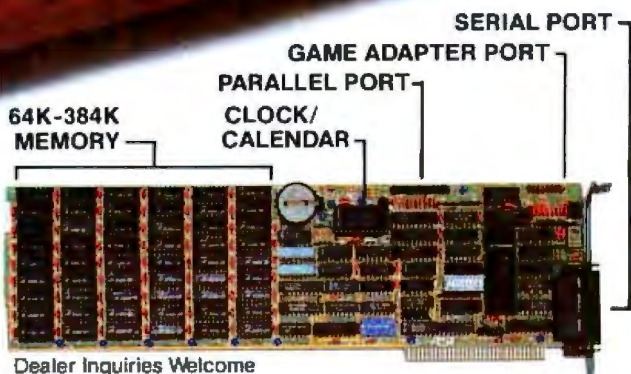
Most important of all, the SixPak comes with the AST "Plus," AST's unsurpassed reputation for quality, reliability, after-the-sale support, and overall design excellence that gives our products the best price/performance ratio in the industry! Hence the name, SixPakPlus!

AST products are available from Computerland, Entre', ComputerMart, and selected dealers worldwide. Call factory if your dealer does not have the AST products you want.

® IBM is the registered trademark of International Business Machines

**AST**  
RESEARCH INC.

2121 Alton Avenue • Irvine, CA 92714  
(714) 863-1333 • TLX 753699 ASTR UR



Dealer Inquiries Welcome



and unintelligible system commands. "Point and click" has become the means by which everyone can enjoy the versatility and power of state-of-the-art micro-processor technology.

Ideally, hardware manufacturers and software developers should be oriented toward a common goal. The goal is simple: to put the greatest amount of information-processing power in the hands of the greatest number of people. This objective will not be achieved without a drastic restructuring of the status quo. To the vast majority of this country's population, personal computing remains a dark art. Perpetuating the existence of this arcane science will only benefit those who seek to monopolize and, therefore, control the flow of information in our society.

When Apple first began to advertise the Macintosh, they used a "1984" theme, with Big Brother obviously being played by IBM. In fact, the theme that was used might not be too far from the truth. With the follow-the-leader approach that is being taken by nearly everyone in the personal computing industry, there is a very real chance that the vitality and creativity of that endeavor may be extinguished.

This cannot be allowed to happen.

Instead of being criticized for refusing to follow the crowd, Apple Computer and the developers of Macintosh should be commended for their efforts. People can only remain a slave to their machines for so long.

J. Edward Chor  
1307 W. Addison St.  
Chicago, IL 60613

The Apple Macintosh, previewed in February, looks like a fine computer with its powerful 68000 microprocessor and sophisticated system software.

However, I think the Macintosh development team committed a fundamental design error when, having exhausted ROM space, they placed their floating-point software in RAM. Software running out of RAM executes approximately 25 percent more slowly on the Macintosh than does software running out of ROM.

It would have been more appropriate for them to have moved some of their user-interface or I/O software to RAM instead. Software that deals with mice,

keyboards, and printers can run more slowly than 6 MHz (the effective RAM-based clock rate) before there is any perceptible loss in speed of a program running on a single-user system.

Obvious as this mistake is, it is also easily corrected. I hope that Apple moves to correct it before the company floods the market with its current system. I discussed this matter over the phone with one of Apple's technical-support people, but I am not certain I got my point across. Your publishing this letter might alert potential users to the problem. The Macintosh, with its excellent graphics and high-speed peripheral interface, looks like it would be a good machine for engineering and scientific applications, as well as for personal and business use. It is a shame to see its computational speed unnecessarily diminished.

As for the floating-point software itself, I inquired whether Apple had implemented the complete IEEE double-precision package. The answer I got—after cross-country phone calls to five different offices—was to send \$150 for a draft copy of Apple's manual *Inside Macintosh*, plus another \$100 for the first bound edi-

UNIX  
TIMESHARE+

*\*UNIX System III POWER and sophistication are yours. Let THE SOLUTION turn your micro into all you dreamed it could be, bringing the Ultimate programming environment as close as your modem. Just a local call from over 300 cities nationwide via Telenet.*

# THE SOLUTION™

- Expansive Software development facilities.
- Berkeley and local enhancements.
- Complete online Unix manuals.
- Extensive Text formatting capability.
- Communication with over 500 UNIX sites on over 150 subjects.
- Interuser mail.
- Online discount shopping for Hardware/Software.
- LOW COST and FAST response time.
- \$24.95 = 1 hr. free system time + SOLUTION Newsletter subscription + BYTE BOOK (Introducing The Unix System 556 pp.).

\*UNIX is a trademark of Bell Labs.



Payment via VISA or Master Card

**Korsmeyer**  
ELECTRONIC DESIGN, INC.

5701 Prescott Avenue  
Lincoln, NE 68506-5155  
402/483-2238  
10a-7p Central



# Sprinter™



## Portable



A new generation printer that combines portability, dependability and quality. **Sprinter** is travel convenience — lightweight and rugged with an easily removable travel cover and plenty of space for storage.



## Personal

A friendly printer that is easy to operate. Ease of operation is top priority for this printer. A **SoftSwitch™ Control Pad** allows the user to control forms' length, print density, tabulations, baud rate and character sets.



## Professional

A fast printer, the 160 CPS **Sprinter** comes standard with a 4K buffer expandable to 68K with MPI's **MemoryMate™** option. It comes equipped with an **EasyLoad™** front paper feed for quick paper insertion and handles everything from letterhead to multi-part forms.



### Travel with the Best!

See the Sprinter at your local computer store or call us for the dealer nearest you. 1 (800) 821-8848

Circle 292 on inquiry card.

**Micro Peripherals, Inc.**

4426 So. Century Dr. • SLC, UT. 84123  
(801) 263-3081



The new 384K Quadboard by Quadram is the most comprehensive board you can buy for the IBM PC or XT. Now with added hardware features and advanced software. But at a very low price.

**NEW EXPANDED QUADBOARD**  
Quadboard now delivers 9 of the most needed PC functions/features. To let you get the most out of your Personal Computer. And help you work better and faster.

**THE WORLD'S BEST SELLING MULTIFUNCTION BOARD IS NOW EVEN BETTER**

All of these features are standard on the new Quadboard:

- **Parallel Port:** With the new Quadboard, you get a Parallel Port. Perfect for operating most printers and other parallel devices.
- **Serial Port:** There's

a Serial Port, too. Fully programmable, use it to connect to plotters, modems, and other serial devices.

- **Chronograph:** And Quadboard's Chronograph (Real-time clock/calendar) keeps your system's clock up-to-date.

- **Game Port:** The new Quadboard has an IBM compatible Game Port. Plug in a joystick or game paddles, and fire away.

- **I/O Bracket:** Quadboard now comes with a special I/O bracket. Use it to organize your expansion port connectors. Snaps right onto the back of the PC.

EXPANDABLE TO  
**384K**

**NEW**

# QUADBOARD®





• **Expandable to 384K:**

The new Quadboard is expandable in 64K increments for up to 384K additional RAM. With full parity checking standard. With the new Quadboard and a fully populated system board, you can take your PC's memory up to the 640K limit.

• **QuadRAM Drive:** Plus, with Quadboard you get advanced QuadMaster Software. Including the QuadRAM Drive program. Use it to set up multiple RAM Drives in Quadboard memory. Solid state drives that let you store and retrieve data quickly and easily. Or take advantage of QuadMaster disk caching. To access frequently

used data whenever you need it.

• **MasterSpool:** QuadMaster Software also includes MasterSpool. Use it to set up a software print buffer quickly and easily. This advanced spooler lets you pause at any time, back up or move forward in a file. Choose just the amount of buffer space you need and stop waiting on your printer.

• **Qswap:** Another feature of QuadMaster Software is Qswap. With Qswap change line printers 1 and 2 back and forth, with just a few keystrokes, as often as you like.

**QUADBOARD STANDS OUT FROM THE PACK**

Now more than ever Quadboard is the first and only board your IBM PC or XT may ever need. No other board even comes close. Because Quadboard is designed for performance. Engineered for dependability.

And built in the continuing tradition of Quadram Quality.



There are many imitators, but only one leader. So make sure you ask for Quadboard by Quadram, the leader in micro computer enhancement products.

Compare. See why more Quadboards are bought than any other multifunction board...

Features/Functions	Quadboard	SixPakPlus
Memory Available	0-384K	0-384K
Parallel & Serial Port	Yes	Yes
Clock/Calendar	Yes	Yes
I/O Bracket	Standard	Optional
Game Port	Standard	Optional
Diagnostic Testing	Yes	Yes
Advanced Spooler	Yes	No
Simple Menu Setup	Yes	No
Disk Cache	Yes	No

SixPakPlus is a trademark of AST Research, Inc.



4355 International Blvd./Norcross, Ga. 30093  
(404) 923-6666/TWX 810-786-4915 (QUADRAM NCR5)

Circle 324 on Inquiry card.

# BY QUADRAM™



# Need a printer?

NOW—get top-notch performance at a rock-bottom price...

star

GEMINI-10

only

\$289



Call for quantity discounts

Word processing... graphics... charts... the advantages of owning a printer are endless. And so are the advantages of purchasing a Star Micronics Gemini-10X from MidWest Micro-Peripherals.

The Gemini-10X is compatible with all major brands of computers. It comes standard with a Centronics compatible printer port (serial optional), plus tractor, friction, and roll feed. With 120 cps bi-directional, logic seeking carriage control and 816 character buffer (expandible to 4K and 8K), you'll get crisp, clean hard copy without having to wait. If you want variety, the Gemini-10X features Epson compatible printer codes. For a wide range of graphic looks, the unit offers six character sets and eight fonts as standard. All this and more at the **guaranteed lowest price**. If you can find a verifiable better price anywhere on any Star printer, **WE WILL BEAT IT**. But besides price, MidWest also offers the best service. We offer same-day shipments on all items in stock. And our experienced staff is ready to help you before, during, and after your purchase. If you purchase NOW, you'll receive absolutely **FREE a deluxe printer cover worth \$16**.

More Star Printers		Sale Price
Gemini-10X	120 cps	\$289
Gemini-15X		409
Delta 10		439
Delta 15	160 cps	589
Radix 10		619
Radix 15	200 cps	719
Power Type	Daisy Wheel	399

Call Toll Free for information and ordering  
1-800-423-8215

In Ohio: 1-800-321-7731

We accept VISA and MASTERCARD (Add 3%), certified checks, money orders, and COD's. **Dealer inquiries are invited.**



## MidWest Micro-Peripherals

(Division of Infotel, Inc.)

135 South Springfield St.

St. Paris, Ohio 43072

100 BY

## Letters

tion (publication date uncertain), plus another \$50 for updates.

Apple is promoting the Macintosh as an "open" system (the meaning of this term seems to be deteriorating with time), but it sure is charging a lot for the key.

Robert Lurie  
8 Tingley Rd.  
Morristown, NJ 07960

I found Mr. Williams's article on Apple's Macintosh disturbing because of the unfettered and naive enthusiasm displayed toward the product and, for that matter, the manufacturer. This material would be expected from a manufacturer or his representative but not from a member of your editorial staff. Journalism of this type severely reduces the credibility of your magazine in presenting unbiased and knowledgeable reviews of new products.

I have 25 years of professional experience as an end user of computer equipment, and I arrived at a considerably different picture of the Macintosh than the one described in your article. Some of the Macintosh's features are more in Apple's corporate self-interest than the user's. Others represent questionable design criteria, and some are just plain "gee-whiz" features with no more substance than tail fins and chrome. Obviously, if I had written the article, a somewhat different story would have been printed.

My negative opinion of the Macintosh may be as unfair as Mr. Williams's positive appraisal. The microcomputer marketplace is a jungle with many pitfalls for both neophytes and pros. It behooves any widely circulated publication like BYTE to make every effort to provide balanced and objective reviews of new products. Your less-sophisticated readers need all the help they can get!

Gerald I. Evenden  
POB 1027  
N. Falmouth, MA 02556

Gregg Williams replies:

Permit me to add some perspective to your evaluation of my article. In many ways, I have an enviable job in that I have been able to review some of the best products our industry has produced. Because of this, they get largely positive reviews (less worthy products would not deserve to be on the cover of BYTE and other magazines). Still, I did point out a number of important areas of dissent: the

single built-in disk drive, the unbundling of Macintosh prices, and the "hyping [of] a machine that easily stands on its own merits" in calling the Macintosh a 32-bit machine. In addition, the article took over six weeks to research and write and contains much technical information and commentary that has not been included in any other Macintosh article. For further perspective on the Macintosh, see my article, "Update on Apple Macintosh and Lisa 2," on page 339.

I was disappointed that your industry-leading magazine missed what nontechnical magazines such as *Time* and *Rolling Stone* reported about the origins of the Macintosh computer. As they pointed out, the Macintosh concept—a low-cost, monochromatic bit-mapped, small, and extremely friendly computer—was my creation.

The original team that I put together to build it included Burrell Smith, hardware designer, Bud Tribble, software designer, and Brian Howard, an unsung hero of the project who contributed to the concept, software and hardware design, and the overall feel of the project. Brian (who, for some reason, was not mentioned in your article) and Burrell are still with Mac, but Bud went back to school and got his M.D. I became C.E.O. of Information Appliance Inc.

I also gave the Macintosh its name. The change in spelling was not an error as you reported, but done deliberately to avoid potential conflict with the electronics manufacturer named "McIntosh."

Interestingly enough, Steve Jobs actively opposed the project at its inception, and only after we had proved the concept did he become the Macbooster that he now is. Reading the BYTE article one might get a very different impression and would not give credit where it is due.

Jef Raskin  
Information Appliance Inc.  
530 University Ave.  
Palo Alto, CA 94301

## Bus Widths

I am writing in regard to "The Apple Macintosh Computer" by Gregg Williams (February, page 30). In his article, Mr. Williams points out that although Apple refers to the MC68000 as a 32-bit processor, he believes that it is generally regarded as a 16-bit processor.

Although no one has been able to come





# THE PRINTER TO PICK WHEN THE PACE QUICKENS.

It's happening all over the PC and micro worlds.

You're getting hit with a ton of increased throughput requirements. Your applications are generating a deluge of paper. You need more printer speed. A lot more.

You're also looking for more professional-looking presentations so you need better print quality. A lot better.

Who's got the best of both worlds for you?

Okidata's Pacemark 2350 and 2410 dot matrix printers.

They'll not only help you *keep* pace with your world, they'll help you set new and exciting ones. In print speed. In print quality. And in vastly increased compatibility and capability.

Take throughput. The 2350 and 2410 can quickly get you out of the waiting game to where you're *really* cranking it out. And with flexibility, too: up to 5 pages per minute.

But wait. Cranking *what* out, you may ask? A single, restrictive printing mode? No way. The 2410 can give you DP, draft,

and a correspondence quality that truly rivals the daisywheel.

And the 2350 and 2410 can both print at up to 350 cps. While producing 120 to 420 lines a minute for you. With bidirectional printing and short line seeking logic. And both high speed horizontal and vertical slew.

## PC COMPATIBILITY. SOFTWARE COMPATIBILITY.

The 2350 and 2410 use industry standard interfaces making them hardware compatible with most mini and micro-systems on the market today. In addition, they are supported on the menus of most of the important software being offered to microsystem users like Visicalc, Lotus 1, 2, 3, DBASE 2, Peachtree 500 and General Ledger, Multi-Mate WP, Wordstar, etcetera, etcetera.

But wait, there's more. Like an outstanding all points addressable graphics capability with 144 x 144 dots per inch resolution.

Two color printing for highlighting. Down line loadable font sets for flexibility.

Subscripts and superscripts so your scientific and technical usage won't bog down. Six-part forms handling. The capability to print 132 columns on eight-inch paper using 17.1 characters per inch to save paper costs and make output easier to handle.

And—so that you can depend on getting all that good stuff, all the time—a mean time between failure of 2200 hours. A mean time to repair of only 30 minutes. An average printhead life of 500,000,000 characters. And an industry low warranty claim rate of less than 2%.

No doubt about it, the quicker the pace at your place, the more you need Pacemark from our place. For more information, call toll free 1-800-OKIDATA. In New Jersey, 609-235-2600. Or write OKIDATA, Mt. Laurel, NJ 08054.



# OKIDATA

an OKI AMERICA company

**We're keeping pace with your business.**

Circle 299 on inquiry card.



# AZTEC MAIN

**NEW FOR '84!**

Quick C	Uni-Tools	C Tutor	Z	Phact DB
<b>C Grafz</b>				
<b>COMMODORE C64 Cross Compilers</b>				
<b>AZTEC C86</b> 8086 / 8088 new release 2.0  <b>PC DOS / MS DOS</b> \$249 <b>CP / M-86</b> \$249 <b>BOTH</b> \$399		<input type="checkbox"/> Full C <input type="checkbox"/> Fast object code <input type="checkbox"/> Basic graphics <input type="checkbox"/> 8087 support <input type="checkbox"/> Large memory model <input type="checkbox"/> Fast I/O <input type="checkbox"/> Overlays <input type="checkbox"/> Relocating assembler <input type="checkbox"/> Linker & library <input type="checkbox"/> Library has I/O, screen I/O, graphics, PC DOS-CP/M 86 <input type="checkbox"/> Interfaces with DRI and MICROSOFT assemblers <input type="checkbox"/> Compatible with AZTEC C for CP/M, APPLE, C64, & TRS-80		
<b>/PRO extension</b> \$249 <b>C Grafz</b> call <b>Uni-Tools I</b> \$ 99 <b>PHACT database</b> call <b>Z</b> \$125 <b>Quick C</b> \$125		/PRO includes optimizer, C86 debugger, and other tools Comprehensive color graphics for use with C or stand alone Tools I has make, diff, grep, & other UNIX inspired tools Phact is a comprehensive set of C database functions Z is a full screen C editor much like the UNIX Vi editor Quick C compiles C source into interpreted code in a flash		
<b>AZTEC C II</b> 8080 Z80 <b>CP / M-80</b> \$199 <b>/PRO extensions</b> \$150		Full C compiler, assembler, linker, library utility, . . . PRO extensions include library source, utilities, ROM libraries, M-80 and RMAC interface		
<b>AZTEC C80</b> TRS-80 <b>MODEL III or 4</b> \$199 <b>/PRO III and 4</b> \$349		The Model 4 system is full AZTEC C II and runs under TRSDOS or DOSPLUS, the Model III system does not support float. PRO has float for III, Z, library source, . . .		
<b>AZTEC C65</b> 6502 <b>APPLE DOS</b> \$199 <b>ProDOS</b> call		A complete C development system for the APPLE II and IIe with assembler, linker, editor, SHELL, library, and library source. Binary files execute under DOS or SHELL.		
<b>C CROSS DEVELOPMENT SYSTEMS</b> C cross compiler, assembler, & linker <b>PDP-11</b> \$2000 other \$750		Cross systems generate modules on a HOST system that are downloaded for execution on a target system. HOSTS include PDP-11 UNIX, 8086 UNIX ports, PC DOS, CP/M-86, CP/M, and APPLE. TARGETS include CP/M, APPLE, COMMODORE C64, & TRS-80.		
<b>AZTEC C TUTOR</b> <b>APPLE or IBM</b> \$99 <b>other systems</b> call		PRENTICE-HALL and MANX SOFTWARE SYSTEMS joined forces to produce an unmatched "hands on" C tutorial. Includes lessons, text, fast compiling student C compiler, and . . .		
<b>Quick C</b> <b>APPLE, CP/M, T-80</b> \$125		Quick C compiles C code into extremely compact interpreted code at blinding speed. Run time system has UNIX functions.		
<b>MANX</b> SOFTWARE SYSTEMS P.O. Box 55 Shrewsbury, N.J. 07701 Order phone 800-221-0440 (outside NJ) 201-790-4004 (NJ and outside USA) Telex (ITT): 4995812 Information: 201-830-7997 Tech support: 201-790-8374 Shipping: per compiler next day USA \$20, 2 days USA \$5, 2 days worldwide \$75, Canada \$10, airmail outside USA & Canada \$20				

## Letters

up with a concrete way to determine the bit size of any given processor, there are two commonly used methods. The first is to rate the processor by the width of the external data bus, and the second is to rate it by the width of the internal data bus. Mr. Williams makes the assertion that the correct way to determine size is to rate the processor by the maximum size of a multiplicand in arithmetic operations. Let me address each of these methods individually.

Determining the size by examination of the external data bus was, until IBM entered the microcomputer marketplace, the most commonly accepted method of rating processor size. It is still probably the best way because most microprocessor systems' speed is limited by the data bus bandwidth (memory accesses per second times size of data bus).

IBM, through its PC advertising, has endorsed rating the processor size by using the internal data bus size. This allows them to call the 8088, which has an 8-bit external data bus, a 16-bit processor. It is interesting to note that Intel, the designer and manufacturer of the 8088, refers to this processor as an 8-bit unit (source: 1982 *IC Master*, page 1083).

Mr. Williams's contention that the size is determined by the maximum multiplicand size is absurd. Rating a processor by this method results in both the 8080A and 6502 processors being 0-bit micros, which I am sure even Mr. Williams will admit is untrue.

Comparing the sizes of some common microprocessors using the above criteria brings about the results shown below.

Processor	Int Width/ Ext Width	Multiplicand Width
8080A	8/8	0
6800	8/8	0
6502	8/8	0
8088	16/8	16
8086	16/16	16
68000	32/16	16

As I stated, I believe that the measure of the external data bus is the most valid method of determining processor size. Using the width of the internal bus results in the 8088 and 8086 being the same size, which, although true from a software point of view, is not true for the hardware. Because most people use the processor size as a relative indicator of computational speed, the external data bus width is the measure that has the most bearing.

Unfortunately, IBM has set the (de

UNIX is a trademark of Bell Labs. CP/M, CP/M-80 and CP/M-86 are trademarks of DRI. PC DOS is a trademark of IBM. MS DOS is a trademark of MICROSOFT. N.J. residents add 6% sales tax.



# What Business Can Afford To Use Fuzzy Information?

**I**n this age of information processing, perhaps the most important information processing occurs between your eyes and your monitor screen. An unclear on-screen image can visually distort the most accurate information, leaving valuable information lost somewhere between the lines.

You won't take that chance with a monitor from Roland DG. For us, clarity is not just a good feature, it's our most important feature.

We designed the Roland DG monitors as if a sharp image was all that mattered. Then we start adding on the extras—like easy plug-compatibility, non-glare screen and other features. Then we styled them so that they look sharp from any angle—not just the front.

Roland DG makes a broad range of monitors, to suit any personal computer and to please any computer's person. From high resolution RGB and Composite Color monitors to Monochrome Composite or TTL signal (IBM-PC) in either Amber or Green.

If accuracy is important to you, you shouldn't settle for anything less than a Roland DG monitor—the clear choice. Because the most important information processor is you.

Roland monitors are available at fine computer dealers everywhere. Roland Digital Group, 7200 Dominion Circle, Los Angeles, CA 90040 (213) 685-5141.

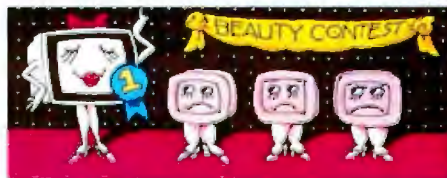


**M O D E L**  
CC1A1



**t**he most important information processing occurs between your monitor and your eyes.

**d**esigned to be as beautiful on the outside as on the inside.



**t**here's a Roland DG monitor for every computer's person!

IBM is a trademark of International Business Machines

**Roland DG**



# Introdu Link Tha

Today, you have to live in two different worlds. One belonging to IBM. The other to everyone else.

With that in mind, companies have come along with a variety of products that attempt

to link the But somewhere line, they all look Enter the PA1000™

converter. It's the most intelligent way to bring personal computers, portable computers, or low-cost ASCII terminals into the IBM coaxial environment. For the first time, overburdened DP/MIS executives can look forward to truly smooth integration, minimal

confusion, and fewer demands on their time. And users can get an affordable, easy-to-use way to tap the riches



two together. along the a little dumb. AVATAR Protocol Con-

verter. It's the most intelligent way to bring personal computers, portable computers, or low-cost ASCII terminals into the IBM coaxial environment. For the first time, overburdened DP/MIS executives can look forward to truly smooth integration, minimal

of their IBM mainframes.

So if you're looking for the best of both worlds, keep reading. And you'll see why the AVATAR PA1000 can out-think any product on the market.

First of all, the AVATAR PA1000 is an almost universal link. With no modification, it connects to virtually any personal or portable computer you have: IBM, Apple, DEC, TRS 80, Kaypro, COMPAQ, NCR, and others.

The AVATAR PA1000 also connects to the DEC VT100, IBM 3101, LSI ADM5,

Televideo 910, ADDS Viewpoint or other compatible terminals.

The PA1000 connects coaxially to an IBM 3274/3276 cluster controller, so whatever personal computer or terminal you use will perform all the functions of an IBM 3278-2. The coaxial connection also means you won't be in for a future shock: ever-changing IBM protocols will be no problem.

	AVATAR PA1000 vs.	IRMALINE™
Easy to install	YES	YES
Q/A installation	YES	NO
English language commands	YES	NO
Help screens	YES	NO
Keyboard types	5	1
Remote dial-in/ security password	YES	YES
Dual host access	YES	NO
Local screen printout	YES	NO
3278 status line modes	3	1
Price	\$995	\$1395
Availability	Immediate	(?)

Two hosts are better than one. So in addition to the coax connection to IBM, the

TRS is a trademark of Tandy Corporation. COMPAQ is a trademark of COMPAQ Computer Corporation. ADM5 is a trademark of Lear Siegler, Inc. ADDS Viewpoint is a registered trademark of Applied Digital Data Systems, Inc. Dow Jones is a trademark of Dow Jones & Company, Inc.



# cing The t Thinks.

AVATAR PA1000 gives you an *extra* RS232 port. That gives you access to other local or remote asynchronous host computers or local printers.

💡 HELP! If you need it (and who doesn't) you have help screens to put you back on track. The PA1000 also has easy-to-use, English language commands.

💡 With a few simple keystrokes, you can switch from your IBM to the extra RS232 port, giving you access to private data networks and public databases like Dow Jones.

And when you switch back, the AVATAR PA1000 is smart enough to *remember* your IBM screen.

💡 In a distributed terminal network, remote dial-in from personal computers or asynchronous devices is increasingly

important. You can dial into your PA1000 at the nearest cluster controller, and reduce communications costs dramatically in the process.

💡 Just by typing "1-2-3" (how much simpler can you get?), the PA1000 *automatically* determines the baud rate of the attached device and is ready to go.

💡 In just five minutes (no kidding) you can install the AVATAR PA1000. And you don't need to be a computer operator.

💡 The AVATAR PA1000 even gives you a file transfer option that lets you transfer information back and forth between your personal computer and an IBM mainframe.

💡 What will AVATAR think of next? The latest news is our PA1500, a link that lets you

print the output from your IBM host on a low-cost ASCII printer. It supports high-speed dot-matrix, letter quality, and line printers. It's very simple to install. And it will save you a bundle.



💡 To find out more about the AVATAR PA1000, our company, our distributors and dealers, or our plans, just call us. In Canada or Massachusetts: 617-435-6872. Everywhere else: 800-828-2004 Ext. 600.

**AVATAR**  
The Link That Isn't Missing Anything.

Avatar Technologies Inc.  
99 South Street, Hophinton, MA 01748





facto) standard for measuring size and has elected to use the internal data bus size for its measurements. Because it would be unfair to measure the Apple by any other criterion, Mr. Williams must concede that the Macintosh is a 32-bit machine.

**Mike Sauve**  
1024 52nd Street, SE  
Kentwood, MI 49508

Gregg Williams replies:

Thank you for your letter. It summarizes discussions that have gone on here at BYTE since I wrote the Macintosh article. We have decided that the situation is too complex to be accurately specified by one descriptor: the multiplicand does not describe the Intel 8080 well, nor does the internal-bus descriptor describe the 8088 (which runs 10 to 40 percent slower than an equivalent 8086—see my article, "Benchmarking the Intel 8086 and 8088," July 1983, page 147) well. In addition, even the external-bus descriptor falls short. Consider the National Semiconductor NS16008; even though it has an 8-bit external data bus, it is a 32-bit architecture internally, including a 32-bit by 32-bit multiply instruction. Surely, this kind of power puts the NS16008 in a different class from, say, the 8080.

Another descriptor that I have just discovered is that of the bus width of the arithmetic logic unit (ALU), that area of the microprocessor chip that performs all the arithmetic and logic functions that the chip allows. The ALU bus width feels intuitively right—it is the ultimate measure of how much

data the microprocessor works on at a time. Does this help us? Hardly, because once we get to this level of detail, the philosophies of chip design muddy the water. The NS16000 family has 32-bit ALU buses. The Motorola family is more complex: the 68000 (16-bit external bus), 68008 (8-bit), and 68010 (16-bit) have three 16-bit ALUs, while the 68032 (with a 32-bit external data bus) has three 32-bit ALUs.

Finally, to complicate the issue even more, let me relate another possible descriptor mentioned by our editor in chief, Phil Lemmons. Things change if you look at the problem of describing the "power" of a computer from a user's point of view. A user doesn't care what operating system is running or whether the microprocessor has an 8- or a 16-bit data bus—this person just wants to know, "Will it run fast enough so I don't have to wait too long?" and "What software does it run?" Computation speed can often be improved by using a chip with a higher clock frequency, but software complexity is determined by the address space of the microprocessor—a feature that is usually fixed, especially on 8-bit chips that are not part of a family of similar products. (We are assuming that software is easier to use if it has Help screens, a sophisticated user interface, and other features that make programs more complex and, therefore, larger.) From this reasoning, we can argue that the address bus, which measures the total amount of memory that a microprocessor can address, is a good descriptor of a microprocessor's power. Many popular programs need more than 64K bytes to run in (the limit of traditional 8-bit microprocessors). As memory gets cheaper and we find ways to fill it up, there may be a very

real difference between microprocessors that can address 1 megabyte of memory (20-bit address bus) and 16 megabytes of memory (24-bit address bus). In addition, if a microcomputer has been designed to use less memory than the microprocessor itself allows, we should make note of that fact as well.

As a result, in BYTE we will state both bus widths—for example, we will describe the 8088 as a "16/8-bit microprocessor (16-bit internal data bus, 8-bit external)" and the 68000 as a "32/16-bit microprocessor." In recognizing that the value of a commercial product is determined by more than just these descriptors, we will try to give all the information that presents a product in the most accurate way. In the "At a Glance" text boxes that accompany our reviews, we will place more emphasis on the internal and external data paths and the maximum amount of memory the computer can address.

### Clock-Time Benchmarks

I generally enjoy benchmark articles and thus found the February BYTE full of interesting comparisons. I feel compelled to comment on one aspect of Avram Tetewsky's article, "Benchmarking FORTRAN Compilers" (page 218). The author goes to great lengths to obtain "true" results for the larger multiuser systems in the comparisons, the VAX 11/780 and the IBM 3081D. Thus, Tetewsky reports only CPU time, runs benchmarks in the early morning hours so there won't be other tasks slowing the system, and

## EPROM PROGRAMMER & UV ERASER FOR THE 80's S15 PROGRAMS OVER 300 DEVICE TYPES

MOS (8K - 256 K, SINGLE & 3 VOLTAGES) BIPOLAR PROMS, 40 PIN MICROS

- Stand Alone
- 256K Buffer (200 ns)
- Integrated keypad
- EPROM simulation
- Fast algorithm
- Power down sockets
- Temp compensated Ref. voltages
- 16 formats & 8 baud rates
- Auto-user friendly-mode



S15F \$995

### OVER 26 FUNCTIONS

- Edit
- CRC check
- Block Move
- Over Program
- Insert
- Delete
- 16 Diagnostic Functions
- And More!



BUV-11A \$95.50

- Heavy duty
- Timer
- Safety switch
- 110/220 voltage

BUV-11B \$66.50

- Heavy duty
- Safety switch
- UV indicator

### OTHER

### COMPLETE SYSTEMS

S15R (remote)	\$695
S15P (4 key)	\$795
S15B (bipolar)	\$895
S15G (gang)	\$1095



COMPUTER SYSTEMS CORP

(305) 994-3520

4089 S. Rogers Circle #7, Boca Raton, FL 33431



# A real fish story.

by Brett Kirk  
Owner  
Poseidon Aquatics

"Our business is wholesaling tropical fish to pet stores. We're not a large-sized company, but we have one whopper of an inventory-control problem. That's where dBASE II® comes in."

## The one that didn't get away.

"We needed a fast program, and dBASE II, the relational database management system from Ashton-Tate, gave us the speed we needed to quickly log in our weekly live-fish shipment in terms of total numbers received, the kind and numbers of each different type, the cost per fish—all critical factors in determining our pricing and being able to pass along savings to our customers whenever possible without hanging us out to dry profitwise.

"We're sure glad we bought dBASE II when we did. I think our customers are glad, too."

**Once you try dBASE II,  
you'll be hooked.**

If you're up to your ears with data



that has to be managed quickly and efficiently, dBASE II can really help you stay afloat.

For all the particulars, contact Ashton-Tate, 10150 West Jefferson Boulevard, Culver City, CA 90230. (800) 437-4329, Ext. 212. In the U.K., call (0908) 568866.

ASHTON · TATE 

Suggested retail price, \$700.  
dBASE II is a registered trademark of Ashton-Tate.  
© Ashton-Tate 1983



# LOOK NO FURTHER! we'll get you low prices and fast service, or else!



## ALPHA OMEGA COMPUTER PRODUCTS

### COMPUTERS

TAVA PC IBM Compatible, 128K, 3-320K Drives, Parallel Port, Monitor	\$1989
SANYO MBC 555 w/software	1049
ROMAR 64K Apple compatible	SAVE
IBM PC Systems	SAVE
KAYPRO II Portable	SAVE

### DISKETTES

SCOTCH 3M SSDD	\$23
MAXELL MD2 DSDD	39

### PRINTERS

C. ITOH 8510 P. 120 cps	SAVE
EPSON FX80 160 cps	\$495
EPSON FX100 160 cps	695
OKIDATA Microline 92 160 cps	445
OKIDATA Microline 93 160 cps	749
DELTA 10 160 cps	SAVE
GEMINI 10X 120 cps	279
GEMINI 15X 120 cps	425
NEC 3550 35 cps L/Q	SAVE
JUKI 6100 L/Q 18 cps	445
PRINTER Pal	24

### MODEMS

HAYES Smartmodem 1200	\$489
HAYES Smartmodem 1200B	425
HAYES Micromodem II	265
ANCHOR A. Mark I 300 BAUD	81
ANCHOR A. Mark XII 300/1200	269

### MONITORS

TAXAN 12" Amber	\$115
GORILLA 12" Green	85
USI P13 12" Amber	145
AMDEK 300G 12" Green	135
AMDEK 300A 12" Amber	145
AMDEK Color I 13"	305
PRINCETON HX-12 RGB	495
BMC 13" Color	219

### APPLE PERIPHERALS & SOFTWARE

VIDEX Videoterm 80C w/software	\$209
VIDEX Ultraterm	279
MICROSOFT 16K RAMcard	69
MICROSOFT 280 Softcard	245
MICROSOFT Premium Pack	479
MICROSOFT Premium Softcard IIE	345
KRAFT & TG Joystick	45

HAYES Mach II Joystick	33
PROMETHIUS 1/2 Height Drives	195
WIZARD IPI Parallel Interface	75
PROMETHIUS Versacard	149
EPS Keyboard	289
KENSINGTON Systemsaver	68
COOL & TIME (fan, surge, clock)	75
KOALA Pad	93
PFS Filing System	81
PFS Report	81
DBase II	389
Wordstar	249
Home Accountant	SAVE
Multiplan	165
DB Master Version 4	249
DB Utility 1 or 2	95
Magic Window II	109
Zaxxon	29
Choplifter	25
Zork I/II/III	28
Wizardry	39
Sublogic Pinball	27

### IBM PERIPHERALS & SOFTWARE

TANDON TM100-2 360K	\$219
TEAC 1/2 Height 360K	195
MICROSOFT Mouse	139
QUADRAM Quadboard w/84K	269
QUADRAM Quadlink	SAVE
QUADRAM Quadcolor I	215
64K RAM Kit 200 ns	55
AST 6-pack plus	SAVE
STB w/64K clock, par, serial, game	295
HAYES Mach II Joystick	35
MAYNARD Int. 10MB Hard Disk	SAVE
Property Management	335
Home Accountant +	SAVE
Multimate	329
PFS Filing System	89
PFS Report	81
Lotus 1,2,3	325
DBase II	389
Friday	189
Wordstar	259
Wordstar Propack w/Mailmrg, Spellstar	359
Multiplan	165
Flight Simulator	33
Deadline	36
Zork I/II/III	28

Hundreds of available items. Call for complete pricing information.

**We do not charge for VISA or MASTERCARD**

(213)  
(818) **345-4422**



18612 Ventura Blvd., Tarzana, CA 91356

All products are in factory sealed packages. We guarantee all items for 30 days. Within this period, defective merchandise returns must be accompanied by RMA number. All other returns will be subject to a 10% restocking fee. For prepaid orders there will be a 3% shipping charge, 5% for UPS Blue Label, \$5.00 minimum, all orders outside U.S. at 15% shipping. There will be an additional \$4.00 surcharge on C.O.D. orders. Cash or Cashiers Check is required on C.O.D. orders. Calif. residents add 6.5% sales tax. Prices subject to change without notice.

## Letters

even removes the I/O time of a slow terminal.

I wish to question the fairness of comparisons in which one class of computers is judged by clock time and another is judged by some mythical "true" time. As a computer user I go by clock time to measure job turnaround. If multiuser systems have a large overhead in dealing with multiple tasks, why shouldn't that be reflected in the benchmark times?

I have a number of Pascal programs that I run on both an IBM 3033 and an Apple II using the UCSD p-System. I typically get results from my Apple 5 to 30 minutes faster than from the IBM. Admittedly, the IBM 3033 runs the programs in several hundredths of a second, but one can spend a long time in both the exec and printer queues.

I suggest that all future benchmark articles that refer to both microcomputers and mainframe systems use the same standard for judging both, namely clock time.

Philip B. Ender, Ph.D.  
UCLA  
Graduate School of Education  
Los Angeles, CA 90024

## Thinktank

I wish to thank Mr. Lemmons for bringing Thinktank to the attention of your readers in "Beyond the Word Processor" (January, page 53).

I used an early version of Thinktank on the Apple II, running under Apple Pascal. FYI, as it was called then, quickly became my most important program (after my word processor and spelling checker). I used it as a reminder program, an outline maker for reports and stories, and as a general aid to thinking. For people who think in headlines and fill in the spaces afterward, it is an idea database without equal. I highly recommend it if you have an Apple, a Macintosh, or an IBM PC.

My only regret is that Living Videotext chose to expand in the direction of MS-DOS, rather than modifying Thinktank to work under UCSD Pascal IV. I miss the program and wish it would run on my Sage II.

Gerald Perkins  
643 Channing Ave.  
Palo Alto, CA 94301



# Rana Systems. Always A Step Ahead.



And it's happening again with our IBM compatible Rana 2000. This 320K double density drive offers a large centering cone for problem-free diskettes and our exclusive silencing mechanism to make it the quietest disk drive you can buy.

At Rana we know the key to our success is providing the highest technology, on the best possible products, while filling the most possible user needs. That is why we spend so much time on research and development. Our world-renowned engineers were the first to offer increased capacity. The first to design a write protect feature. The first to use a metal band positioner and get 100%

data integrity, and a 3 to 4 times improvement in access speed. And, the first to bring you all this performance, quality and dramatic styling.

This is why our Elite One got the #1 rating from Softalk Magazine. And our Atari™ compatible Rana 1000 Slimline has turned a game computer into a sophisticated business tool. And soon we'll have a new Winchester drive and a new series of very high density minifloppies, for both IBM and Apple.\*

So call or write for the nearest Rana retailer or computer store. We're Rana Systems. And we know that to keep a step ahead, we have to put you first.

## RanaSystems



21300 Superior Street, Chatsworth, CA 91311 213-709-5484  
Call toll free 1-800-421-2207 In California only call 1-800-262-1221  
Source Number TCT-654

\* Apple is a registered trademark of Apple Computer, Inc. \* Atari is a registered trademark of Atari, Inc. \* IBM is a registered trademark of International Business Machines, Inc.

© 1983 Rana Systems

Circle 331 on inquiry card.



# ANNOUNCING . . .



## **NOW WE'VE ADDED EVERYTHING TO TURBO PASCAL (EVERYTHING EXCEPT A HIGH PRICE)**

### • **WINDOWING!**

... This is a real shocker. On the IBM PC or PC jr. you'll now have a procedure to program windows. . . . Any part of the screen can be selected as a window and all output will automatically go to this part of the screen only. As many windows as you please can be used from the same program.

### • **AUTOMATIC OVERLAYS!**

... No addresses or memory space to calculate, you simply specify OVERLAY and TURBO PASCAL will do the rest.

### • **GRAPHICS, SOUND AND COLOR SUPPORT FOR YOUR IBM PC OR JR!**

### • **FULL HEAP MANAGEMENT!**

... via dispose procedure.

### • **OPTIONAL 8087 SUPPORT!**

... Available for an additional charge.

If you have a 16 bit computer with the 8087 math chip—your number crunching programs will execute up to 10X faster!

## **EXTENDED PASCAL FOR YOUR IBM PC, PC jr., APPLE CP/M, MSDOS, CP/M 86, CCP/M, OR CP/M 80**

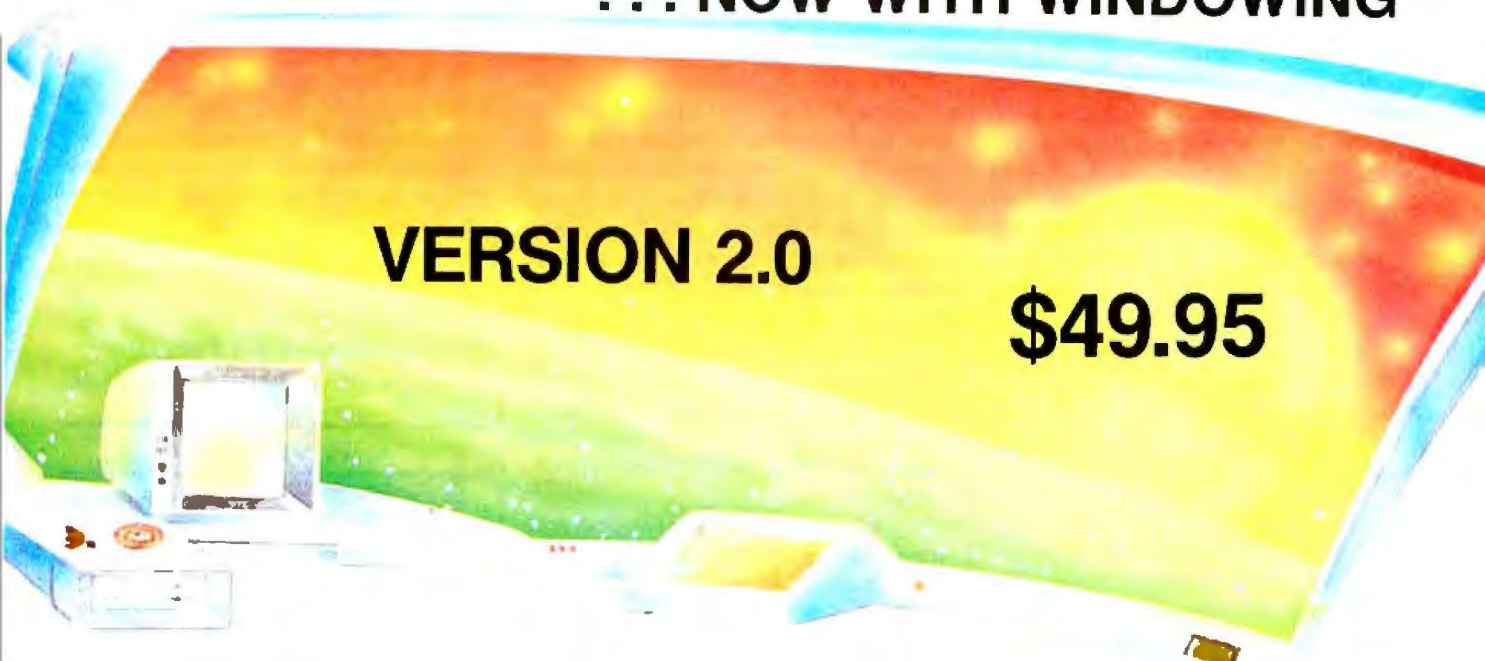
- Full screen interactive editor providing a complete menu driven program development environment.
- 11 significant digits in floating point arithmetic.
- Built-in transcendental functions.
- Random access data files.
- Program chaining with common variables.
- Dynamic strings with full set of string handling features.
- Full support of operating system facilities.
- And much more.



... NOW WITH WINDOWING

VERSION 2.0

\$49.95



HERE'S WHAT THE REVIEWERS HAVE SAID ABOUT TURBO PASCAL

"What I think the computer industry is headed for: well documented, standard, plenty of good features, and a reasonable price."

Jerry Pournelle, *Byte*, February 1984

"Finally, somebody has done it right. A powerful Pascal Z 80 or 8086/88 single pass native code compiler together with a full screen editor and error checking to make a super programming development package."

David Carroll, *Microsystems*, February 1984

"The Perfect Pascal"

Alan R. Miller, *Interface Age*, January 1984

"It is, simply put, the best software deal to come along in a long time."

Bruce Webster, *Softalk IBM*, March 1984

If you already own Turbo Pascal version 1.0, you can upgrade to 2.0 for \$29.95. Just send in your old master with your check. (Manual update included of course).

LEARN TO WRITE A SPREADSHEET

Our offer includes MICRO-CALC, a spreadsheet written in Turbo Pascal. It will be on your disk, and ready to run. And we've included the source code to show you exactly how a spreadsheet is written!

ORDER YOUR COPY OF TURBO PASCAL VERSION 2.0 TODAY

For VISA and MasterCard orders call toll free:

1-800-227-2400 x968

In CA:

1-800-772-2666 x968

(lines open 24 hrs, 7 days a week)

Dealer & Distributor Inquiries welcome

408-438-8400

CHOOSE ONE (please add \$5.00 for shipping and handling for U.S. orders)

- Turbo Pascal 2.0 \$49.95
Turbo Pascal with 8087 support \$89.95
Update (1.0 to 2.0) Must be accompanied by the original master \$29.95
Update (1.0 to 8087) Must be accompanied by the original master \$69.95

Check \_\_\_ Money Order \_\_\_
VISA \_\_\_ MasterCard \_\_\_
Card #: \_\_\_
Exp. date: \_\_\_ Shipped UPS



Borland International
4113 Scotts Valley Drive
Scotts Valley, California 95066
TELEX: 172373

My system is: 8 bit \_\_\_ 16 bit \_\_\_
Operating System: CP/M 80 \_\_\_
CP/M 86 \_\_\_ MS DOS \_\_\_ PC DOS \_\_\_
Computer: \_\_\_ Disk Format: \_\_\_

Please be sure model number & format are correct

NAME: \_\_\_
ADDRESS: \_\_\_
CITY/STATE/ZIP: \_\_\_
TELEPHONE: \_\_\_

California residents add 6% sales tax Outside U.S.A. add \$15.00 (if outside of U.S.A. payment must be by bank draft payable in the U.S. and in U.S. dollars) Sorry no COD or Purchase Orders A14



Phil Lemmons's essay "Beyond the Word Processor" (January, page 53) is an excellent piece of writing/thinking. The comparison to spreadsheets was a crisp and striking illustration of his idea. He targeted the most crucial and relevant limitation and challenge for current text-editing software. What was exciting and valuable about word processing for the writer was the way in which it rendered manageable the physicality of the text—it transformed the "hard" actuality of written work into a "soft" virtual existence and thereby eliminated much of the busy-work involved in preparing a text. But current software is geared to the product rather than the process of writing. The word processor is the writer's secretary. It is interesting to reflect on how the writing process itself is being transformed by what the computer makes possible.

Mr. Lemmons's call for writers to express their needs and dreams is an invitation to experiment with the very process of writing/thinking. Good article!

John Glazer  
616 Pearl St.  
Ypsilanti, MI 48197

**George Orwell and 1984**

I am at a loss to understand why, in an otherwise balanced and penetrating article, G. Michael Vose would choose to "rewrite" the history of George Orwell and his most famous work ("1984 and Beyond," January, page 100). His description of Orwell (Blair) as a fanatic anticommunist conjures up a caricature, a half-mad mixture of Joe McCarthy and Doctor Strangelove. Mr. Vose then limits Orwell's portrait of a dismal future to one dominated by "fascists." All of this implies that Orwell was an unbalanced individual, describing a threat from only one source.

Yet Orwell and his book were no such thing. He was anticommunist certainly, but also an idealist, humanist, and passionate socialist, and one who in no way considered himself part of the "right," fanatical or not. Neither did he take the easy way out in constructing the government of the future, one that would have conveniently ignored the tyranny growing beyond the Elbe. Orwell was opposed to any system that enslaved both the individual and society and labeled such

systems with the more useful and inclusive term *totalitarianism*.

As Mr. Vose correctly notes, the personal computer may prove an aid in preventing such a future. You can bet computers won't be a mass-consumer item in any totalitarian society, fascist or communist.

John C. Ruane  
USS Wabash AOR-5  
FPO San Francisco, CA 96683

**Penny-Wise**

In the February BYTE, Jerry Pournelle's User's Column (page 113) addressed the use of the "Disk Doubler" to enable the use of the back side of disks on single-sided drives. I was glad to see that he recommended against using this tactic, but I feel that he left out the most important reason for not using it.

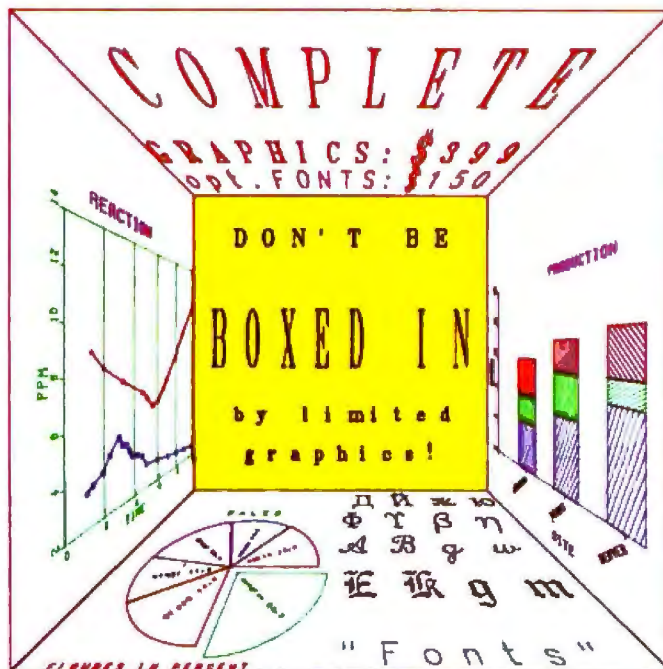
The inside of a disk jacket is lined with a porous material that both lubricates and cleans the disk as it rotates in the jacket. Many small particles are trapped by this material and held out of the way so the

**PLOTWARE-z** This ad was drawn entirely by PLOTWARE-z.

interfaces to most devices: CRT'S, PLOTTERS, DOT MATRIX PRINTERS (at maximum dot resolution), & with "do-it-yourself" custom attachments.

Use with PC DOS, MSDOS, CPM/86, CPM/80, CDOS, etc. (and UNIX in MAY!) Makes all charts with FONTS (several text styles), Greek, italic, Russian, Old English, or different shaded, very stylish ones.

Even Hebrew and math or special symbols - or "Do-it-yourself" fonts. Include LOGO'S and digitized figures. Plus - all pictures can be TRANSMITTED to remote stations. Use with electronic "cut-and-paste", for camera ready copy.



GET PLOTWARE-z : A reliable system with over 3 years of proven usage. Complete with comprehensive manual now with user-written application notes & extensive "walk-thru" help

- DIRECT ACCESS**  
to your data from
1. Word Processors (like WORDSTAR)
  2. DATA BASE files (like dBASE II)
  3. SPREAD SHEETS (Super Calc 2)
  4. Compilers, and Assemblers -even interpretive BASIC
- 5 easy ways to use, from: menu driven to command files to direct library use.
- try the DEMO at your dealer or contact:

**THE ENERCOMP CO.**  
1978 S. Garrison #7  
Lakewood, CO. 80226  
(303) 987-0125  
telex: 499-6325

CPM/86, CPM/80 by Digital Research  
PCDOS by IBM. MSDOS by MICROSOFT  
CDOS-Chromatone WORDSTAR- MICROSOFT  
dBASE II by ACRYON TATE  
SuperCalc 2 by BORCIN



# In the Hard Disk Jungle Tallgrass Clears A Path



In today's hard disk jungle, Tallgrass clears a path by offering high performance, integrated mass storage solutions for the IBM® PC/XT, the T.I. Professional and related computers.

## TALLGRASS INNOVATIVE FEATURES

**MASS STORAGE SYSTEMS** with formatted HardFile™ capacities of 6, 12, 20, 35 and 70 Mb, all with built-in tape backup.

**CONVENIENT INTEGRAL TAPE BACKUP SYSTEM** allows rapid tape "image" streaming, or incremental file-by-file backup and restore on ANSI standard inexpensive data cartridges, instead of the usual floppies, video cassettes, or low-capacity removable Winchester devices.

**NETWORK READY** and fully compatible with networks such as PCnet® and EtherShare™.

**HIGH RELIABILITY** with dual directory and read-after-write verify options. A dedicated landing zone, where the read/write heads reside when the disk is idle, provides data protection during powerdowns and transportation.

Follow the Tallgrass path to your local computer dealer and watch your personal computer transform into a powerful data processing system.

Available from COMPUTERLAND®, Entré® Computer Centers, MicroAge® Computer Stores and other participating computer dealers.

## New! IBM-XT Cartridge Tape Backup

World Headquarters: Tallgrass Technologies Corp., 11100 W. 82nd St., Overland Park, KS 66214 / 913/492-6002 / Telex: 215406 TBYT UR

Canadian Headquarters: Tallgrass Technologies (Canada), 1775 Meyerside Drive Mississauga, Ontario, Canada L4V 1H2 / 416/673-3244

European Distributor: CPS Computer Group, LTD Birmingham, England B276BH / (021) 7073866

Australian Headquarters: Tallgrass Technologies (Australia), Five Dock Plaza, Suite 12/50 Great North Road/Five Dock/Sydney, N.S.W. 2046 / (02) 712-3010



**Tallgrass  
Technologies**  
Corporation



disk will not be harmed. However, when the "Disk Doubler" is used and the disk is inserted in the drive upside down to use the back side, the disk rotates in the reverse direction. Thus, any and all particles that were trapped during the original rotation can be released back onto the disk. Premature failure of the disk, or at least loss of data, is virtually guaranteed.

I have long recommended that this is not a worthwhile savings tactic; the potential of lost data far outweighs the small dollar savings in disks.

Larry C. Hansford  
Creative Computer Consultants Inc.  
POB 66  
New Carlisle, OH 45344

**"In Defense of Luddism"**

I was disappointed to find that you felt the editorial urge to reprint the narrow-minded and reactionary opinion of the *Wall Street Journal* article, "The Luddite Answer to Unemployment," by Bruce Bartlett, in your Editorial on page 4 of the January issue. Mr. Bartlett may be an

economist with impressive credentials, but he is no historian, and he seems to be a poor social analyst as well.

It is a historical cliché, and an inaccurate one, that the Luddites of early 19th century England broke machines because they were "afraid" of technology, or even that they hoped to save jobs of workers. The true mission of the Luddites was pointed out clearly by MIT historian David Noble in a series of articles entitled, "In Defense of Luddism," that appeared in the most recent three issues of the political journal *Democracy*. Noble shows that the Luddites were primarily concerned with the control of the workplace at the point of production. These skilled English craftsmen were resisting the introduction of machine technology that made their skills obsolete, and which forevermore turned over the control of the production of their product to a capitalist owner. The Luddites correctly perceived that the industrial revolution was generating a two-class system of owners of machines and laborers on machines, a system that placed little value in skill or in the relationship between a producer and his product. Noble also pointed out

that the Luddites were not simple-minded "machine-smashers" who bashed looms and other devices out of some irrational, primitive anger. On the contrary, the Luddites chose their targets carefully after some rather sophisticated analysis on the social effects of machine technology.

The issue that the Luddites truly addressed (not what Bartlett would have us believe they represented) is still with us today. The important issue that traces its roots to the Luddites is not fear of technology, but the pressing question of who controls the workplace. Are we to have an economy that persistently excuses its abuses of humans by saying that "technology is neutral" and "we can't stand in the way of Progress"? What is progress if it does not serve human needs? And human needs are not entirely encompassed by employment. The Luddites understood that the battle for control of the workplace necessarily includes a battle for dignity, political rights, equality, and freedom. And they were right—they lost the battle, and the next hundred years of the western world we remember chiefly through the dark writings of

**THE PX-IV AT \$699**  
**The highest performance**  
**RGB COLOR MONITOR**  
**for your IBM PC, IBM PC jr**  
**or even Apple II**

**COMPARE FEATURES**

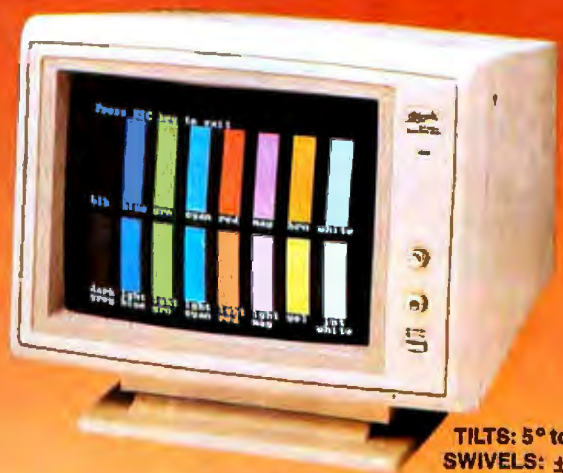
- 80-Column Text
- 13" black matrix tube
- .31mm pitch-720 Horizontal dot resolution
- Swivel base
- Green Text mode-for less eye fatigue
- Cable supplied for IBM PC
- Switchable pos. or neg. synch.
- 6 Months warranty
- Save hundreds of dollars-by ordering direct
- Offer ends June 30, 1984

Send for the PX-IV brochure or to order your PX-IV, send \$499 plus \$15.00 for shipping and handling to:

**LEJ Inc., Suite 210**  
**140 Rt. 17 N.**  
**Paramus, N.J. 07652**

Money orders, MasterCharge, Visa and checks accepted. Discounts available for OEM volume purchases. N.J. residents add 6% sales tax.

If after two weeks of use you are not completely satisfied we will refund your money less shipping charges.



**INCORPORATED**  
**Suite 210**  
**140 Rt. 17 N.**  
**Paramus, N.J. 07652**  
**(201) 871-1112**



# Don't buy Omninet just because it's the #1 network.

## Buy it because it's the best buy.

At under \$500 per node, OMNINET has the lowest cost per station of any local area network.

Because an OMNINET Network uses simple, twisted pair wire. Which means that cabling costs one fifth of the coaxial alternatives, with none of the installation headaches.

Result? OMNINET is both easier and less expensive to install. Or expand.

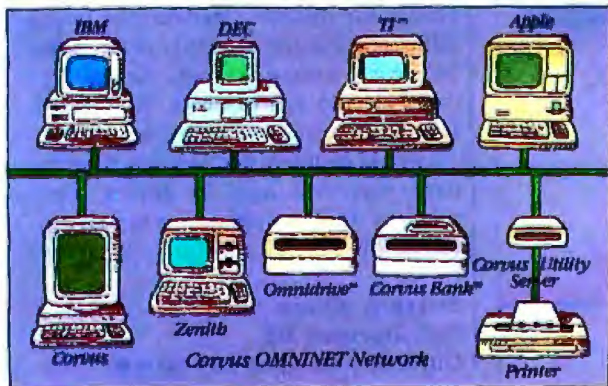
## Buy the system for unmatched flexibility.



From Apples to Zeniths, OMNINET handles more types of micros than any other network. So keep the DEC's in Data Processing and the PC's in Purchasing; OMNINET makes for great working relationships. And starting with

options like electronic mail, your people can choose from over 500 different programs according to their needs. Not their network's limitations.

What's more, CORVUS can handle all your hardware needs. From 6 to 45 MB hard disks through 200MB Random Access backup at an amazing \$11 per megabyte. Both, with OMNINET servers built right in.



## Buy the OMNINET Network for the most expandability.

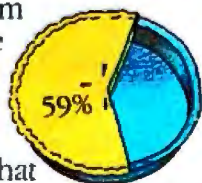
If you're just starting a network, consider OMNISHARE™ Software. It lets your regular PC's or PC-compatibles make full use of the disk space on an IBM PC XT™

When you want to draw on the resources of your central computer, you'll want Corvus' SNA Gateway. It lets your network's micros tap into your mainframe's information.

Whether you have 2 computers or 2,000, OMNINET can get the most out of them.

## Buy us for our experience.

We pioneered local area networking for micros. And we're constantly working on better ways to give you the system you need, with the versatility you want, at a price that makes sense.



With the result that 3 out of every 5 locally-networked micros in the world are connected to a CORVUS network.\*

Give us a call at 800-4-CORVUS to find out more.

Because when it's all said and done, one of the best arguments for going with an OMNINET Network is really very simple.

Buy it for your peace of mind.

# CORVUS

The Networking Company.

\*59% of all locally-networked micros operate in a CORVUS network, according to InfoCorp. CORVUS, THE NETWORKING COMPANY, OMNINET and OMNISHARE are trademarks of CORVUS SYSTEMS INC. IBM PC and PC XT are trademarks of International Business Machines. APPLE is a trademark of APPLE COMPUTER INC. DEC is a trademark of DIGITAL EQUIPMENT CORPORATION. Zenith is a trademark of Zenith Corporation. TI is a trademark of Texas Instruments.



# Softline

FOR YOUR  
BOTTOM LINE.

Lotus 1-2-3 \$319    dBase II \$369    WordStar Professional \$369    Multi Mate \$279

## WORD PROCESSING/EDITORS

Easywriter I System (3 pak)	\$149
Easywriter II System (3 pak)	\$199
Edix/Wordix	\$279
Enstern Writer	\$199
Final Word	\$189
Microsoft Word	\$299
Microsoft Word/Mouse	\$299
Multimate	\$279
PeachText 5000	\$199
Perfect Writer/Speller	\$249
PFS Write	\$ 95
Samna Word II	\$329
Select Word Processor	\$199
Spellbinder	\$249
SSI Word Perfect	\$329
SuperWriter	\$179
Volkswriter	\$129
Volkswriter Deluxe	\$179
The Word Plus (Dosis)	\$109
WordPlus-PC with The Boss	\$329
WordStar	\$249
WordStar Professional (WS/MM/SS/Sl)	\$369
WordStar Options Pak (MM/SS/Sl)	\$189

## ACCOUNTING MODULES

Ask Micro Accounting	\$299
BPI Accounting	\$369
IUS EasyBusiness System	\$319
MBA Accounting	\$369
Open Systems Accounting	\$459
Peachpak 4 (GL/AP/AR)	\$239
Peachtree Accounting	\$399
Real World Accounting	\$469
Star Accounting Partner (GL/AP/AR/PAY)	\$269

## HOME/PERSONAL FINANCE

Dollars and Sense	\$119
Financier II	\$119
Home Accountant Plus	\$ 99
Tax Preparer 84	\$189

## DATABASE SYSTEMS

Alpha Data Base Manager II	\$179
Condor III	\$329
dBase II	\$369
DBplus	\$ 89
Easy Filer	\$219
Friday	\$179
InfoStar	\$269
Knowledgeman	\$309
Perfect Filer	\$159
Personal Pearl	\$199
PFS File/PFS Report	\$169
QuickCode	\$179
R base 4000	\$299
T/Maker III	\$199
11M IV	\$269
Versaform	\$249

## PROJECT MANAGEMENT

Harvard Project Management	\$289
Scitor Project Scheduler	\$229
VisiSchedule	\$199

## GRAPHICS

BPS Business Graphics	\$229
Chartman Combo (II&IV)	\$349
Chartmaster	\$259
dGraph	\$189
Fast Graphs	\$199
Graphwriter Extended	\$429
PC Draw	\$219
PFS Graph	\$ 95
VesTrend/Plot	\$199

## SPREADSHEETS/MODELING

Jack 2	\$Call
Lotus 1-2-3	\$319
Multiplan	\$159
Perfect Calc	\$159
SuperCalc 3	\$239
TKI Solver	\$Call
VisiCalc IV	\$159

## LANGUAGES/UTILITIES

Access Manager	\$239
Digital Research C Compiler	\$219
Display Manager	\$299
Microsoft C Compiler	\$329
MS Basic Compiler	\$249
MS Fortran	\$239
Pascal MT+86	\$249
Norton Utilities	\$ 59

## COMMUNICATIONS/PRODUCTIVITY TOOLS

Crosstalk	\$119
Memory Shift	\$ 79
Move It	\$109
Prokey 3.0	\$ 95

## HARDWARE PERIPHERALS\*

AST Six Pack Plus (64k)	\$ 299
Quadboard (0k)	\$ 229
Hayes 1200B with Smartcom	\$ 439
Hayes Smartmodem 1200	\$ 549
Hercules Graphics Board	\$ 359
Epson FX-100 Printer	\$Call
Comrex II Printer	\$Call
NEC 3550 Printer	\$1899
NEC Prowriter	\$ 399
C Itoh Starwriter	\$1249

\*Add 3% for shipping.

R-base 4000 \$299    Word & Mouse \$299    Microsoft C \$329    AST Six Pack Plus \$299

## EXTRA \$\$\$ SAVINGS

With each order, we offer discount coupons worth up to \$10 on your next order.



## Diskette Library Case

... with your order. This attractive case protects, indexes and stores 10 diskettes for quick retrieval. Normally a \$10 value, it is now available **FREE** to Softline customers

### TERMS

Checks—allow 14 days to clear Credit processing—add 3% COD orders—cash M O or certified check—add \$3.00 Shipping and handling UPS surface—add \$3.00 per item (UPS Blue \$6.00 per item) NY State Residents—add applicable sales tax All prices subject to change

To Order call  
**1-800-221-1260**  
In New York State call (212) 438-6057

For technical support and information call  
(212) 438-6057

Monday thru Friday  
9:00 AM - 7:00 PM  
**Sundays**  
10:00 AM - 4:00 PM

**Softline**  
Softline Corporation  
3060 Bedford Ave., Brooklyn, NY 11210  
TELEX 421047 ATLN UI



## Letters

Dickens and the solemn warnings of Marx.

There are no intellectuals or pundits who are "creating unnecessary fears and anguish among workers," as Bartlett writes, as if workers were frightened children. Workers have legitimate grievances and demands of the system they have built, and they will deal with them as they see fit. They may be, and in some cases are, following the lead of the Luddites by smashing machinery. But this is no more an irrational response to technology than is putting millions out of work without knowing what to do with them. There has been and may always be an overtly *political* battle over the nature of work and its rewards. The Luddites were the opening volley of this battle in our time, and it may be time to listen to what they were really saying.

Gary Chapman  
Department of Political Science  
Stanford University  
Stanford, CA 94305

## X-raying Disks

I am currently part of a team working on a large application project to run on an IBM PC. We have had to do a lot of traveling by air and, consequently, our disks have been sporadically "zapped."

Based on my limited memory of high school physics, I do not think that X rays could have damaged the disks. I believe that the magnetic fields of the X-ray equipment power supplies are the culprits. Although we remove the disks from our carry-on luggage prior to entering the X-ray machines, we still sustain occasional damage. I believe this happens at the entry point to the machines where we stop to unload the disks. That is, the magnetic fields extend a significant distance around the equipment.

Now my tactics are as follows: (1) I put each box of disks in a lead-foil film pouch (although I doubt that this really offers protection against magnetic fields). (2) I carry backup sets of disks. This has allowed me to recover on all occasions.

I would be interested to know how the hard disk will react to airport X-ray systems, and I would appreciate any information on this subject.

Steven A. Green  
2393 Traymore Rd.  
University Heights, OH 44118 ■

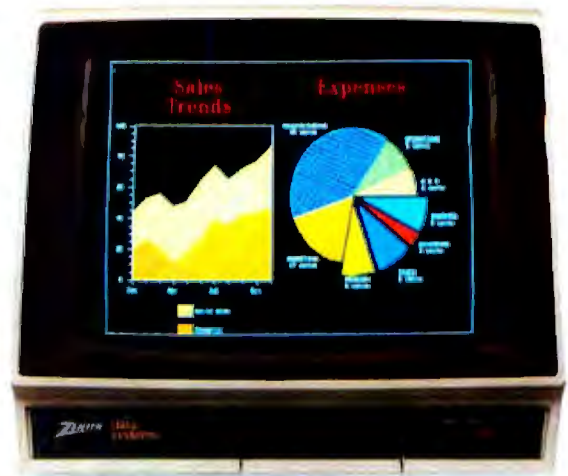


1948



One of the first Zenith television receivers.

1984



ZVM-135: 80 column display. Audio feature. Ideal for expanded IBM PC Jr.

## Only a company with 36 years of TV smarts could make monitors this good.

**Z**enith introduced its first television receiver to a delighted America in 1948. It had single-knob tuning and an 11-inch porthole screen.

Earlier this year, Zenith made its sixty millionth television set. And every one has been built according to this credo: "The Quality Goes In Before The Name Goes On."

Zenith continues this tradition of video excellence with its extensive line of monitors. Monitors that will first dazzle you with their graphic display, then earn your admiration over time with their reliability. And surprise you with their very competitive prices.

There's a Zenith monitor for just about any personal computer, including IBM and Apple, with seven models offering everything from monochrome green or amber to high-resolution color. And some models can also be used with VCR or video disc systems.

Nobody understands video like Zenith. To find out more about their fine monitors, call 1-800-842-9000, ext. 1, for the name of your nearest Zenith Data Systems dealer.



ZVM-122A: Non-glare amber screen. Compatible with most microcomputers.



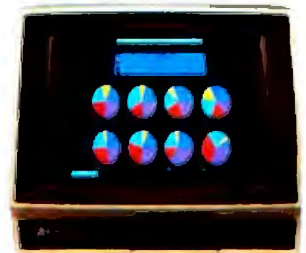
ZVM-123A: Non-glare green screen. Composite video input.



ZVM-124: Super resolution for IBM PC with monochrome adapter.



ZVM-131: 40 column display. Audio amplifier. Ideal for IBM PC Jr. or Adam.



ZVM-133: 80 column display. Ideal for IBM PC and compatibles.

© 1984, Zenith Data Systems



# We wrote the book on portability. In nine different languages.

	8080/8085/286 CP/M MP/M II	8086/8088/8186 CP/M-86 Concurrent CP/M™	8086/8088 IBM PC DOS	8086/8088 MS DOS	MC-68000 CP/M-68K
FORTRAN-77		✓	✓	✓	TBA
C BASIC Computer	✓	✓	✓	✓	✓
Pascal/MT+	✓	✓	✓	✓	✓
Level II COBOL	✓	✓	✓	✓	TBA
PL/I	✓	✓	✓	✓	TBA
C		✓	✓	✓	✓
Assembler Plus Tools	✓	✓	✓	✓	TBA
Access Manager	✓	✓	✓	✓	TBA
Display Manager	✓	✓	✓	✓	TBA
micro/SPF		✓	✓	✓	✓
COBOL Animator	✓	✓	✓	✓	TBA
Personal BASIC		✓			TBA
Dr Logo		✓	TBA		





To every software developer who'd written off portability as an impossible dream, Digital Research humbly announces a few monumental breakthroughs.

We not only offer languages that are portable from 8 to 16 to the 32-bit chips of the future, they're portable across all popular operating systems, too. What's more, we supply the broadest range of quality languages and development tools available today. And will tomorrow.

So rest assured. Whether you design applications at a major corporation, plan to become a major corporation or just qualify as a hobbyist, you only have to write it once.

Simply pick the Digital Research language that's right for you. From Personal BASIC™ to Digital Research FORTRAN-77™. The newest member of our remarkable family.

To complement languages, we offer a complete workshop of development tools. Our Display Manager™ and Access Manager™ simplify the design of screen displays and data bases. So you spend less time and effort.

If you write in COBOL, our Animator™ source level debugger will get your software running in record time.

And for programmers skilled with IBM mainframe SPF, we offer micro/SPF™. An editor that helps turn your invaluable experience into valuable new software applications.

At Digital Research, we work as hard for you after the sale as we do to get the sale. With backup like quality documentation, software updates and a phone line to our technical support team.

With so much productivity and service to draw on, it's small wonder IBM chose our languages for its IBM® PC, XT and the new IBM 3270/PC.

For more information, call your IBM representative.

Or, for the Digital Research retailer nearest you, call 800-227-1617, ext. 400. In California, 800-772-3545, ext. 400.

micro/SPF is a trademark of Fraser Systems, Inc. Animator and Level II COBOL are trademarks of Micro Focus, Ltd. IBM is a registered trademark of International Business Machines Corporation. The Digital Research logo and products are either trademarks or registered trademarks of Digital Research Inc. ©1984 Digital Research Inc. All rights reserved.





# Trump Card

## Part 1: Hardware

*Speed up your IBM PC with 16-bit coprocessing power*

Steve Ciarcia  
Consulting Editor

When asked what computer language I prefer, I generally reply, "Solder." This response is not an effort to be cute but rather to express a preference for dealing in the terms I know best. I don't avoid software. I just try to minimize my involvement.

When it is necessary to write simulation and test programs, I bite

the bullet. Unless the function is time-critical, I most often choose BASIC because it comes closest to being a universal programming language. Virtually all personal and business computers support it, and if I confine my command choices to the more common instructions, the demonstration programs that I compose on an IBM PC should also run on your Cromemco Z2.

With few exceptions, you can compute your accounts receivable or type

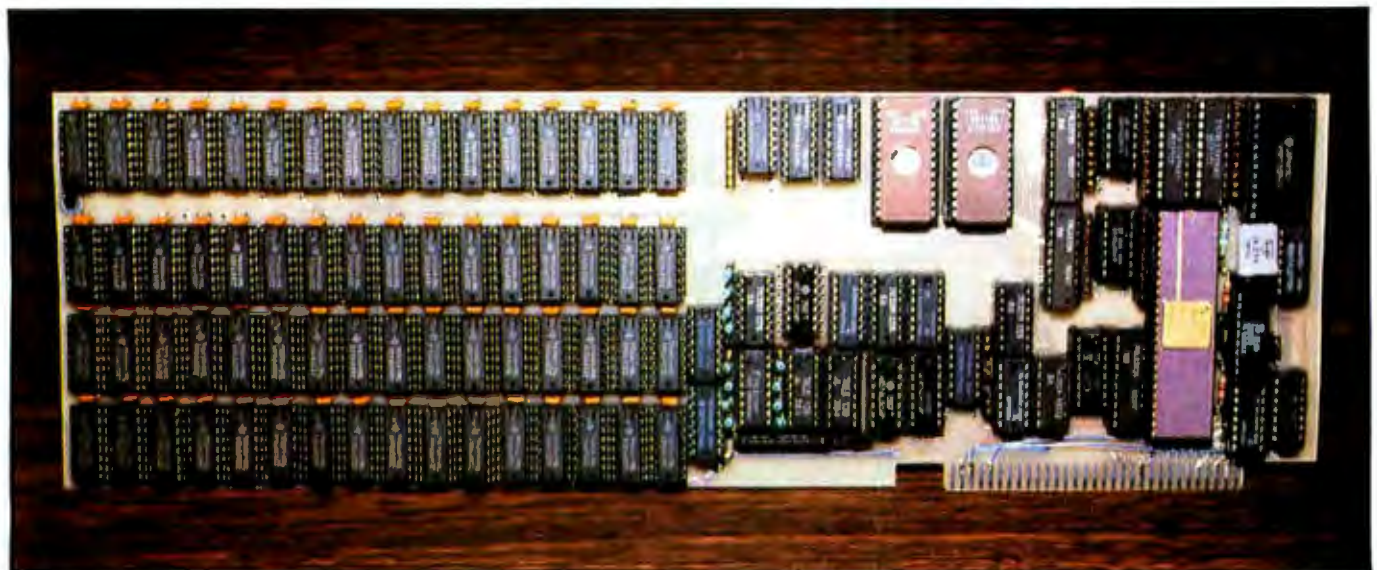
in and play a game equally well with an Apple or IBM PC using BASIC. The fact that one has a 6502 microprocessor and the other uses an 8088 is irrelevant. The output will be the same.

The value of high-level languages is that they isolate the user from microprocessor peculiarities and facilitate transportable software. Unfortunately, the average ROM (read-only memory)-resident BASIC interpreter was never written with perfor-

---

Copyright © 1984 Steven A. Ciarcia.  
All rights reserved.

---



**Photo 1:** The wire-wrapped prototype of the Trump Card, shown from the front. The left side of the board contains 512K bytes of type-4164 dynamic RAM; the right side contains the Zilog Z8001 and an interface to the IBM PC I/O-expansion bus.



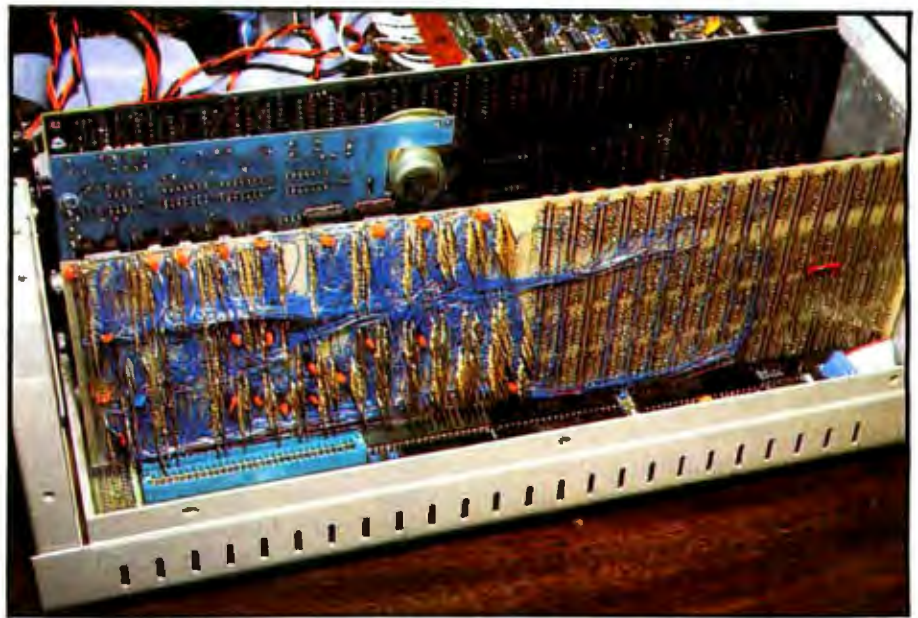
mance in mind. Usually taking 5 to 10 milliseconds (ms) to execute an individual instruction, it can seem like forever when running long programs.

As a writer, I have grown to appreciate the universality of BASIC, even with its shortcomings. By treating the computer as a black box with I/O (input/output) ports and BASIC, I have been able to provide projects that can be implemented on most systems directly. As an engineer/designer, however, I am aggravated by its slowness and feel no animosity toward critics who have converted to languages such as Pascal or C to gain processing speed.

Rather than make further excuses, I decided to solve the problem in classic Circuit Cellar tradition—simply build a black box that improves system throughput and runs BASIC programs faster.

### Processors and Performance

Generally speaking, most people confuse microprocessor benchmarks with system throughput. The comparison of microprocessor-instruction execution speeds is not really indicative of a computer's capabilities. Performance is more often governed by the operating system and magnitude of the application program. It is a false assumption that all software written for a 16-bit microprocessor will necessarily run faster than on an

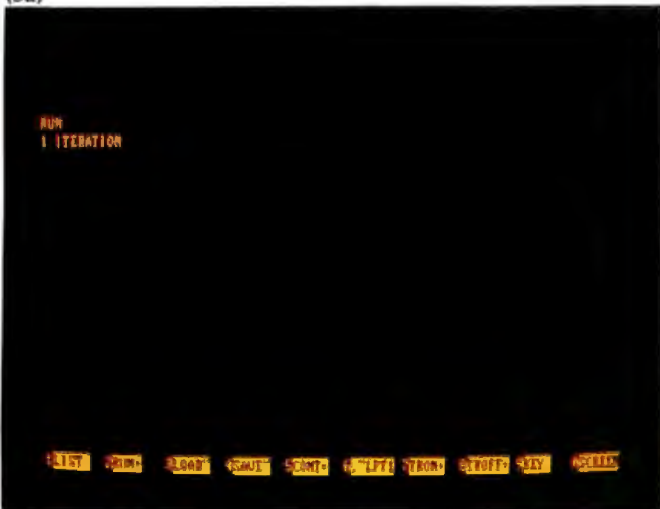


**Photo 2:** The rear of the Trump Card prototype. To save time, the memory section was laid out as a printed-circuit board, with wire-wrapping saved for the processor side. As shown here, the Trump Card is installed for testing in an MPX-16 computer, which has I/O slots compatible with the IBM PC.

8-bit microprocessor. Machine-language fast Fourier transforms (FFT) run quickly on a 6502, but an accounting package that has to constantly interleave a program into and out of disk may be encumbered by 64K bytes of operational memory in the Apple. In all likelihood, large spreadsheets and accounting programs will run more efficiently in the larger memory space provided on an 8088 system such as the IBM PC.

Raising the performance of a high-

level language such as BASIC takes more than raising a microprocessor's clock rate. Instead, it involves a combination of decisions that can ultimately affect the entire system throughput. We can expand the memory available to application programs in an effort to limit repeated disk accesses and configure a portion of memory as a RAM (random-access read/write memory) disk drive to expedite disk operations when they are required. We can optimize the effi-



**Photo 3:** Execution-time visual comparison. (3a) Without Trump Card—a two-second exposure of the display while running the BASICA program in listing 1. The program has executed the PRINT statement and still is dimensioning the arrays. (3b) With Trump Card—the same two-second exposure of the program execution (with PRINT statement added) shows the arrays have been dimensioned and the prime numbers are being overprinted so fast that they blur.



Apple II	Apple III	TRS-80 Model II	IBM PC	IBM PC (with Trump Card)
224	222	189	190	2.4

**Table 1:** A comparison of execution times (in seconds) of the benchmark program in listing 1.

ciency of the high-level language by operating it in a compiled mode rather than as a repeatedly interpreted task. Finally, if the functional throughput of a particular application becomes dependent upon direct microprocessor intervention, for those tasks, substitute a faster microprocessor or help it with a coprocessor.

### A Black Box Called Trump Card

This article is not about building a classic speed-up board for the IBM PC. The word "speed-up" implies replacing the 8088 with an 8086 or 80186. Instead, visualize your PC as a black box with an input, output, and crank. Rather than simply turning the crank faster, think of adding another black box, in the same path between input and output, that performs selective tasks more efficiently and faster than the 8088 alone. To increase the relative throughput of the system, I have designated an alternate path for specific program functions.

I've named this separate box Trump Card. It is a functionally independent 10-MHz Zilog Z8001-based computer with its own 512K bytes of memory. Designed specifically as a compiled high-level-language computer, Trump Card is addressed as an I/O device that communicates through the expansion bus (see photos 1 and 2).

Among the specific functions that Trump Card supports are BASIC, C, CP/M-80, text editing, Z8000 assembly-language programming, and a RAM disk. It does not directly execute programs written in 8088 assembly code, such as Lotus 1-2-3. It instead executes programs written in high-level languages such as BASIC or C (a Pascal compiler and 8088-to-Z8000 translator are in the

works). Alternatively, it can enhance the function of programs such as 1-2-3 by expanding available memory and speeding disk functions. The ultimate purpose of Trump Card is to improve system throughput.

This month, I will outline the basic functions of Trump Card and describe its hardware in detail. This is, of course, a Circuit Cellar construction project, and you are encouraged to build your own Trump Card. More on that later. Next month, I'll describe some of the software in detail and do a little benchmarking.

First, a little about Trump Card and the Z8001.

### Trump Card

Trump Card is a peripheral board that plugs into any expansion slot on an IBM PC or PC-compatible computer. It contains a 10-MHz Z8001 and up to 512K bytes of memory. To use it, you simply load a BASIC, CP/M-80, or C program from PC-DOS and type "RUN." Its memory can also be used as a RAM disk.

Trump Card comes with software that translates existing BASIC and other high-level-language programs to run with reduced overhead. To speed the execution of BASICA, Trump Card compiles the code with a special version of BASIC called TBASIC. Unlike other compilers, this has no separate compiled-code disk files (unless you specifically want them) and no long delays. TBASIC instantly compiles the program in a few tenths of a second when you load the file into Trump Card. In appearance, it looks like any old, slow interpreted BASIC, but it runs with the speed of a compiler.

TBASIC is PC BASICA-compatible. You can use either the Trump Card screen editor or BASICA's editor to

### Listing 1: Size of Eratosthenes prime-number-generator program.

```

5 DEFINT A-Z
10 SIZE = 8190
20 DIM FLAGS(8191)
30 PRINT "Only 1 iteration"
50 COUNT = 0
60 FOR I = 0 TO SIZE
70 FLAGS(I) = 1
80 NEXT I
90 FOR I = 0 TO SIZE
100 IF FLAGS(I) = 0 THEN 180
110 PRIME = I + I + 3
120 K = I + PRIME
130 IF K > SIZE THEN 170
140 FLAGS(K) = 0
150 K = K + PRIME
160 GOTO 130
170 COUNT = COUNT + 1
180 NEXT I
190 PRINT COUNT, " PRIMES"

```

write your programs. Then run the same program using either Trump Card or BASICA. Depending upon the instructions you use, Trump Card provides a tenfold to hundredfold increase in program performance (see photo 3). Table 1 shows typical results of what Trump Card can do with the prime-number Sieve of Eratosthenes program (September 1981 BYTE, page 180) frequently used to benchmark computer systems (see listing 1).

Though I conceived of Trump Card initially as a BASICA enhancement, it didn't take me long to realize that a Z8001 with 512K bytes of memory has some real computing power and deserves proper support. For that reason, the software supplied with this project is much more extensive than usual. With the utilities and languages included, you should have little trouble using the vast software base of Z80 and Z8000 programs.

Trump Card includes the following software:

**BASIC Compiler—TBASIC** is PC BASICA-compatible. The differences between the BASICA interpreter and the TBASIC compiler are minimal. Most instructions are implemented without modification.

**CP/M-80 Emulator—Trump Card** can run your CP/M-80 Z80 assembly-



language programs directly without special disk headers or translation programs. Simply download your Z80 programs and run them.

**C-Compiler—Trump Card** includes the industry standard version of C that is described in *The C Programming Language* by Kernighan and Ritchie.

**Debugger**—Intended to aid in program development. With it, you can examine and replace memory and register contents, set breakpoints, or single-step through programs.

**Screen Editor**—Incorporating many of the features included in word processors, the editor enables you to write or examine ASCII text files for either the PC or Trump Card's use.

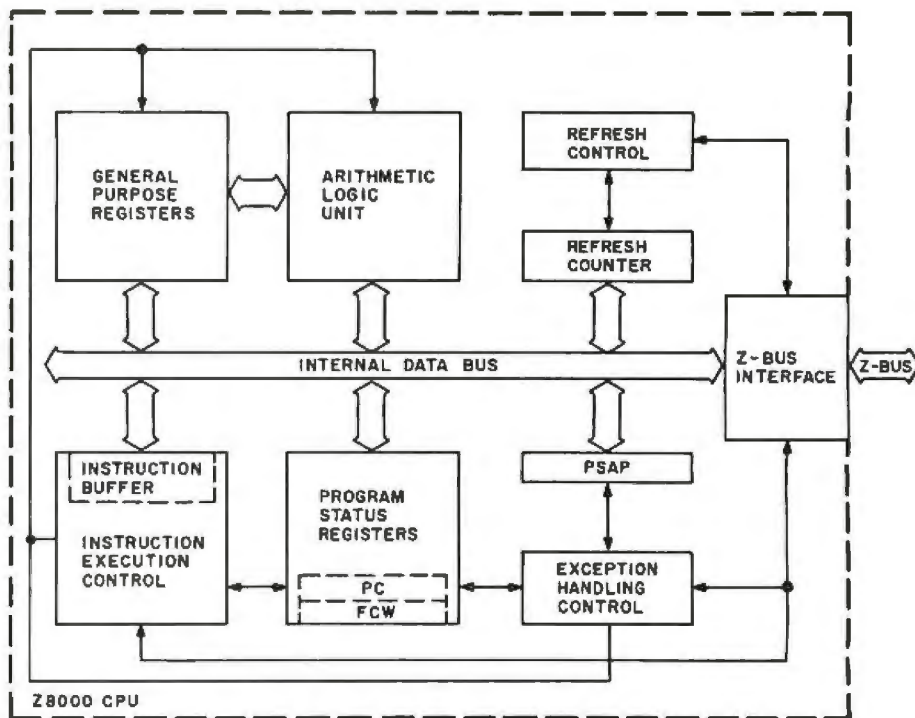
**Multilevel Language Compiler**—This is a structured assembler that allows Pascal-like control and data types, arithmetic expressions with automatic or specified allocations of registers, and procedure calls with parameter passing.

**RAM Disk**—Trump Card can allocate 128K to 387K bytes of its on-board memory to function as an intelligent RAM disk (DOS 2.0 only). This memory is separate from and in addition to any already existing on the PC bus. Trump Card's other functions can run concurrently.

### The Z8000 Microprocessor

A block diagram of the Z8000's internal structure appears here as figure 1. As the programmer sees it, the Z8000 contains sixteen 16-bit general-purpose registers (for addresses or data) that may also be used in groups to form as many as eight 32-bit registers or four 64-bit registers. The low-order halves of the registers may be used for byte operations, thus the Z8000 is able to manipulate data in 8-, 16-, 32-, and 64-bit pieces.

The eight addressing modes are register, indirect-register, direct-address, indexed, immediate, base-address, base-indexed, and relative-address. The instruction set utilizes data types ranging from single bits to a 32-bit-long word. The processor executes 110 distinct instruction types



Z8000 CPU FUNCTIONAL BLOCK DIAGRAM

Figure 1: Block diagram of the internal structure of the Zilog Z8000 family of microprocessors.

that, when permuted by all the addressing modes and data types, create a set of more than 400 instructions.

The Z8000 has two different modes of operation: system and normal. Which mode of operation is in effect is controlled by a bit in the flag-and-control word (FCW). The main dif-

ference between the operating modes is that some of the control/interrupt and I/O instructions work only in the system mode. To simplify the design of the Trump Card, I chose to use only the system mode.

The Z8001 (see photo 4) is the memory-segmented version of Zilog's chip; it comes in a 48-pin DIP (dual-

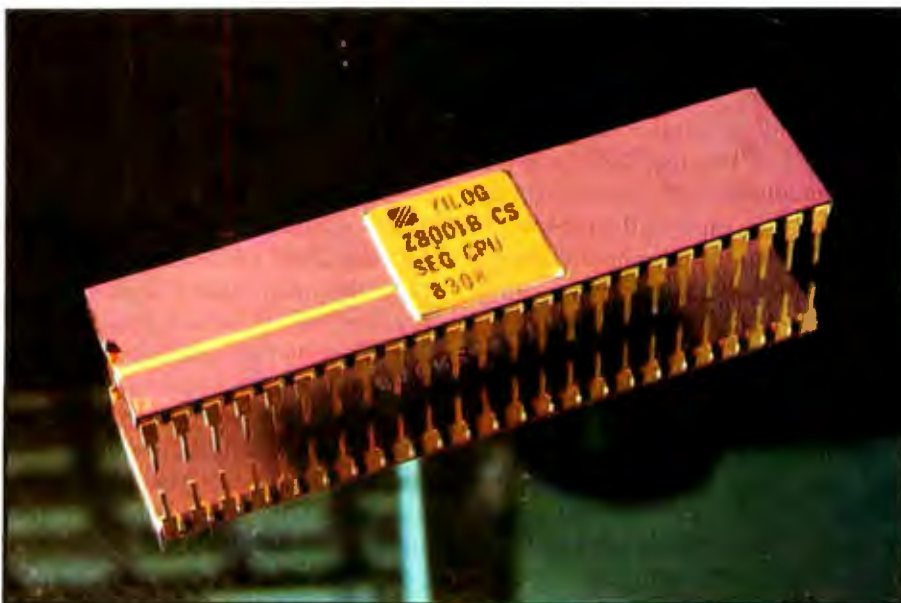


Photo 4: The 48-pin dual-inline package that houses the Zilog Z8001 microprocessor, the heart of the Trump Card.



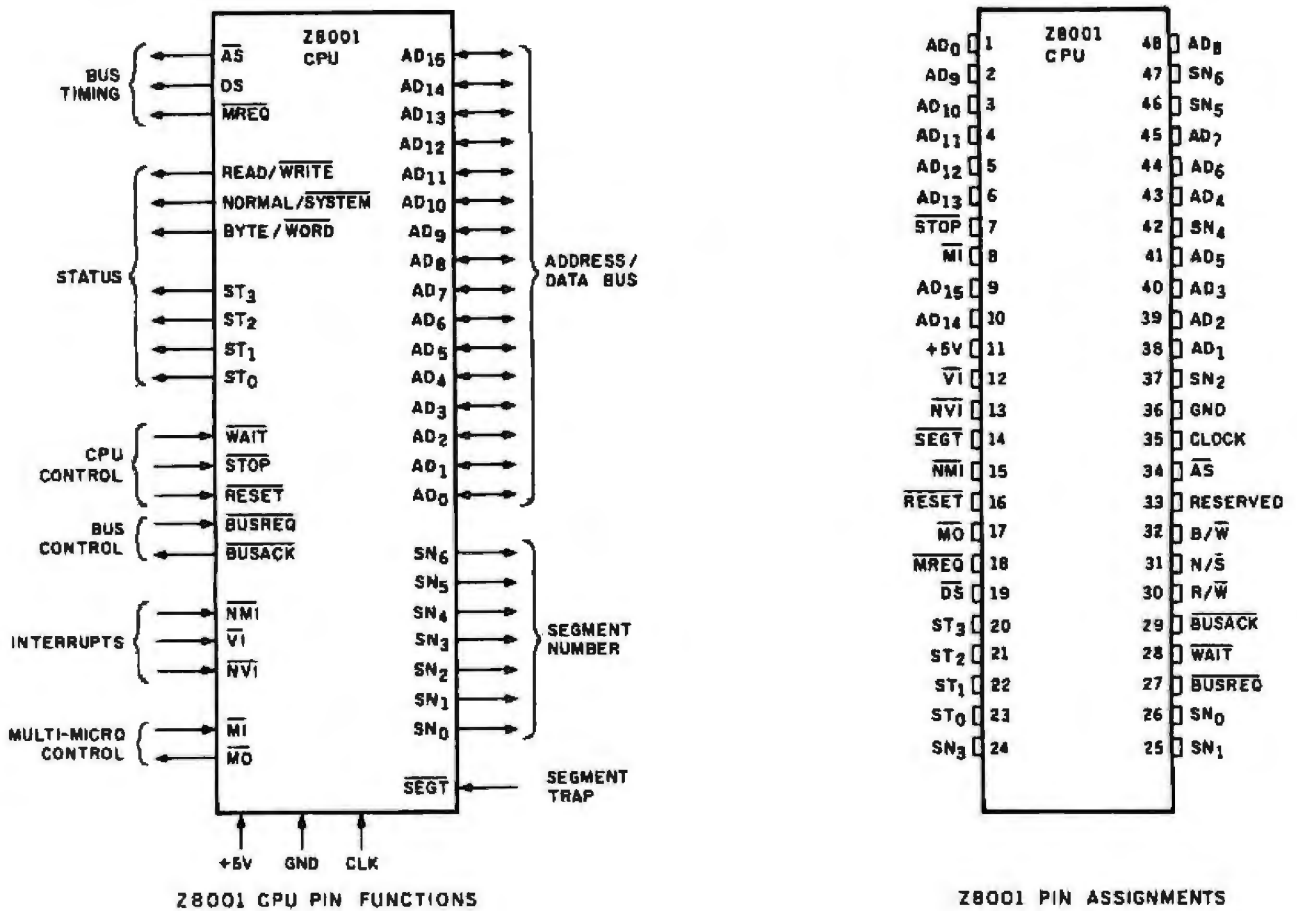


Figure 2: Pinout arrangement of the Z8001 memory-segmented version.

inline package), the pinouts of which are shown in figure 2. (The nonsegmented 40-pin version is called the Z8002.) By memory segmentation, the directly addressable 8-megabyte memory space is divided into as many as one hundred twenty-eight 64K-byte regions. Seven segment-selection lines coming out of the Z8001 control the high-order memory addressing. When the Z8001 is reset, the segment addressing automatically reverts to segment 0, the lowest 64K-byte block of memory. Transfer of control between segments is done by jumps, calls, and returns.

### Inside the Trump Card

The schematic diagram of figure 3 shows the Trump Card's circuitry. It can be plugged into any expansion slot of an IBM PC or into any other computer with compatible I/O slots and operating system.

Five of the Z8001's seven segment-selection lines, SN0 through SN4, are used in the Trump Card to decode

addresses for up to 1 megabyte of RAM (512K bytes fit on the board) and 4K bytes of ROM (read-only memory). Segment line 4 selects between the ROM, mapped into segments 0 through 15, and the RAM, residing in segments 16 through 31. The states of the segment lines are latched by IC3; segment line 4 is named RAM/PROM.

### Address/Data Bus

The address/data lines coming from the Z8001 (AD0 through AD15) are a time-multiplexed address and data bus, which can address a range of 65,536 (64K) bytes of memory or a like number of I/O addresses. Since the Z8001 can form addresses at either word or byte boundaries, the least significant bit AD0 is used in byte operations to determine if the upper or lower byte is to be operated upon. The address on the AD lines becomes valid when the Z8001 asserts the  $\overline{AS}$  (address strobe—active low) line; it remains that way

for a short hold time after  $\overline{AS}$  returns to its idle high state. The address from the Z8001 is latched by two type-74LS373 transparent latches, IC5 and IC6, that are always enabled. The use of transparent latches allows for maximum address-setup time to the memories.

The latched addresses (LA0 through LA15) come out of the 74LS373s with LA0 combined with the signal B/ $\overline{W}$  (byte or word address) to form the EVEN or ODD byte-bank-select signal for memory. When B/ $\overline{W}$  is low, it signifies that a 16-bit memory word is being referenced; this causes the outputs of the two AND gates at IC8 pin 3 and IC8 pin 6 to be active irrespective of the state of LA0. By doing byte operations in this manner, it is possible for the Z8001 to do single-byte memory writes without first reading an entire word location.

The Trump Card contains a pair of type-2716 EPROMs (erasable programmable read-only memories),

*Text continued on page 50*







Figure 3 continued:

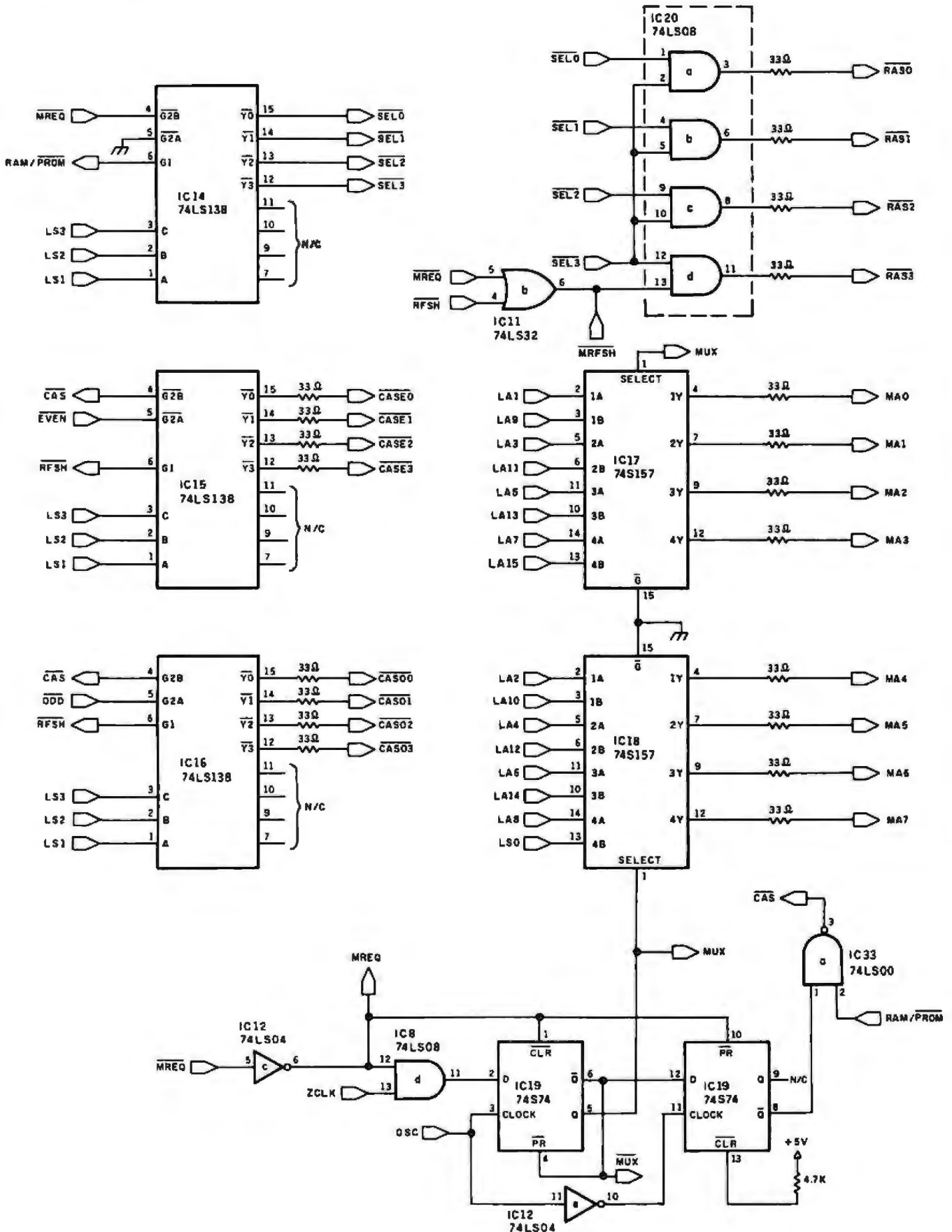


Figure 3 continued on page 47



Figure 3 continued:

NOTE: IC'S IN THIS SECTION ARE CONSECUTIVELY NUMBERED FROM IC36 UPPER LEFT CORNER TO IC99 LOWER RIGHT CORNER. IC'S ARE ALL 4164'S

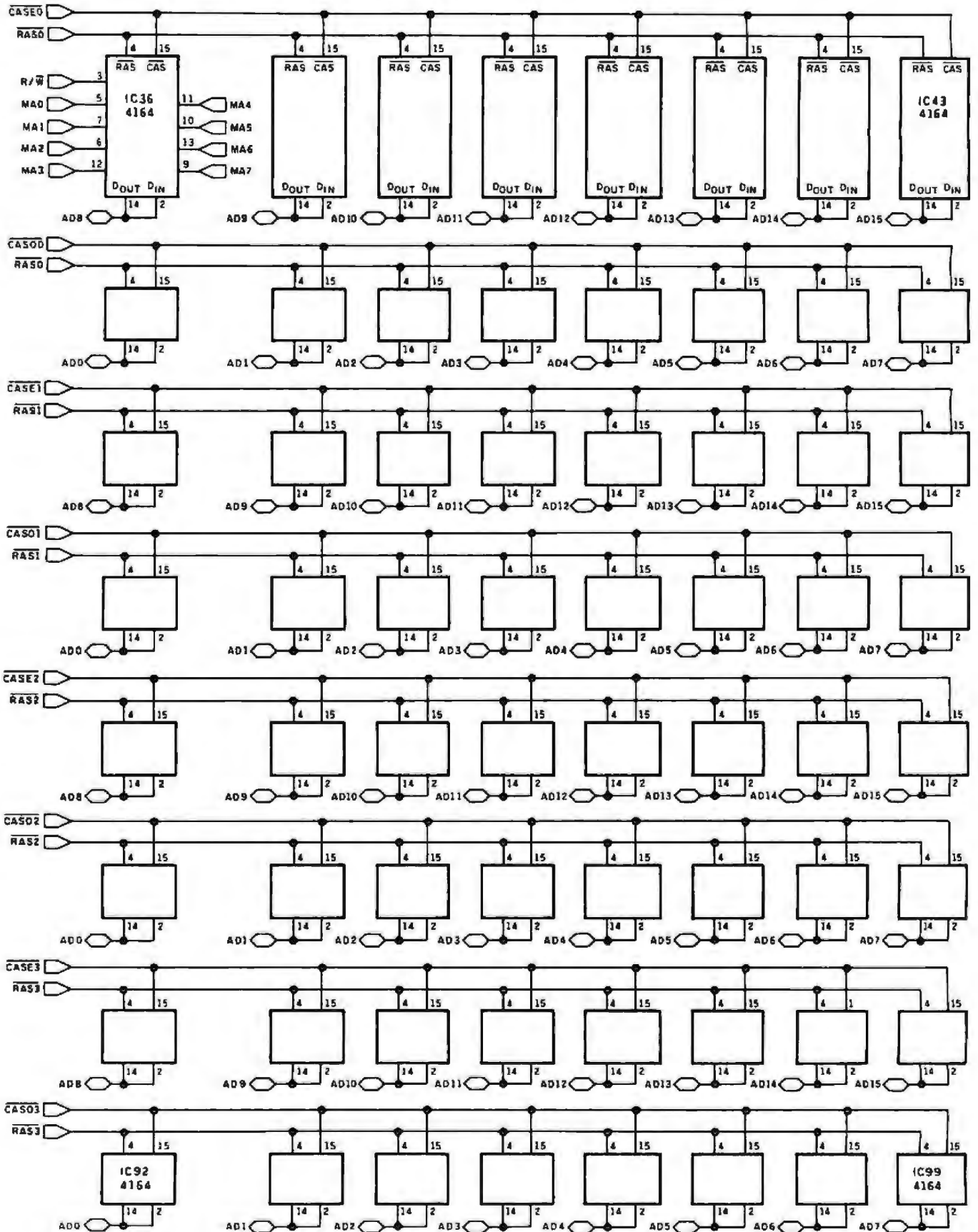


Figure 3 continued on page 48



Figure 3 continued:

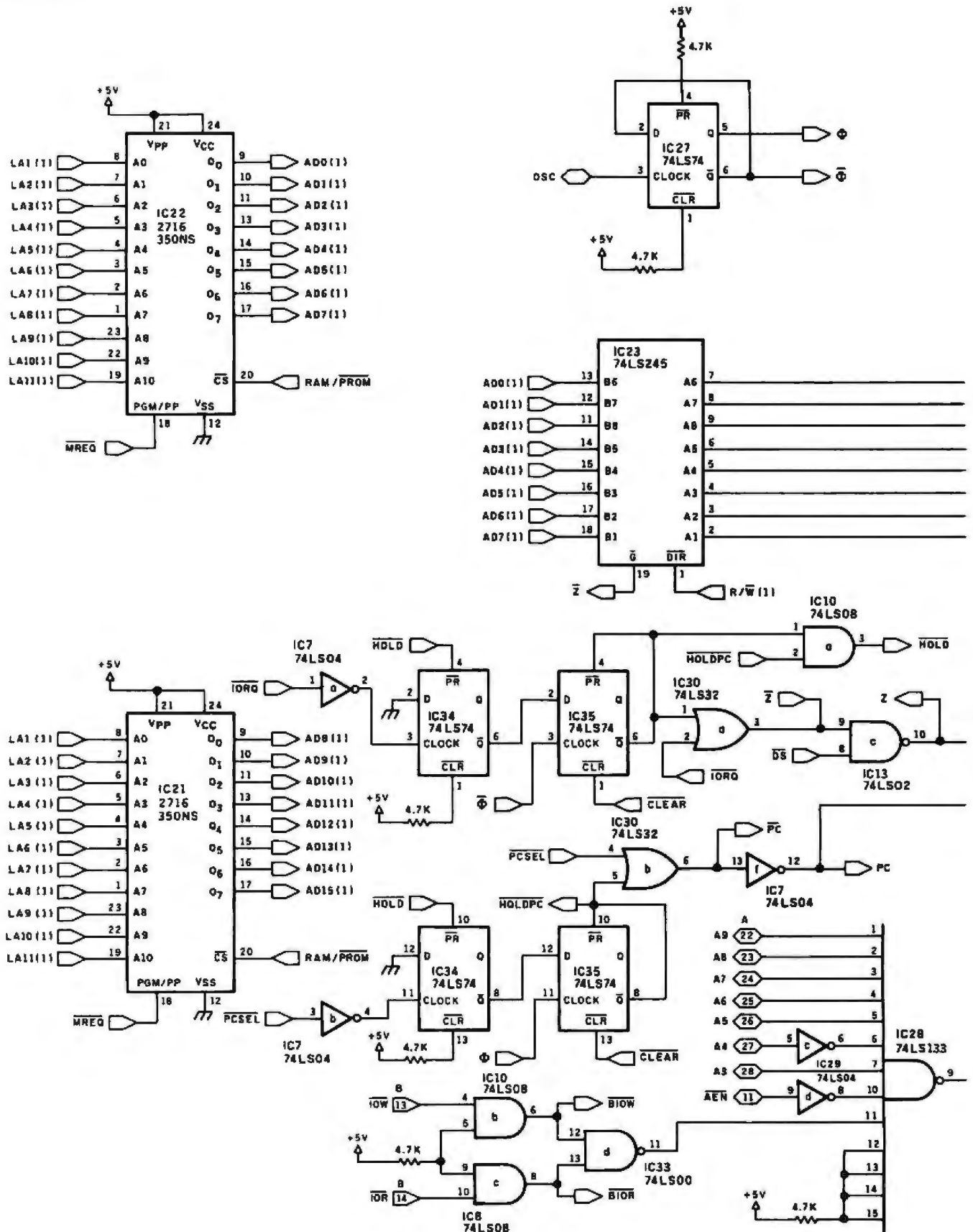
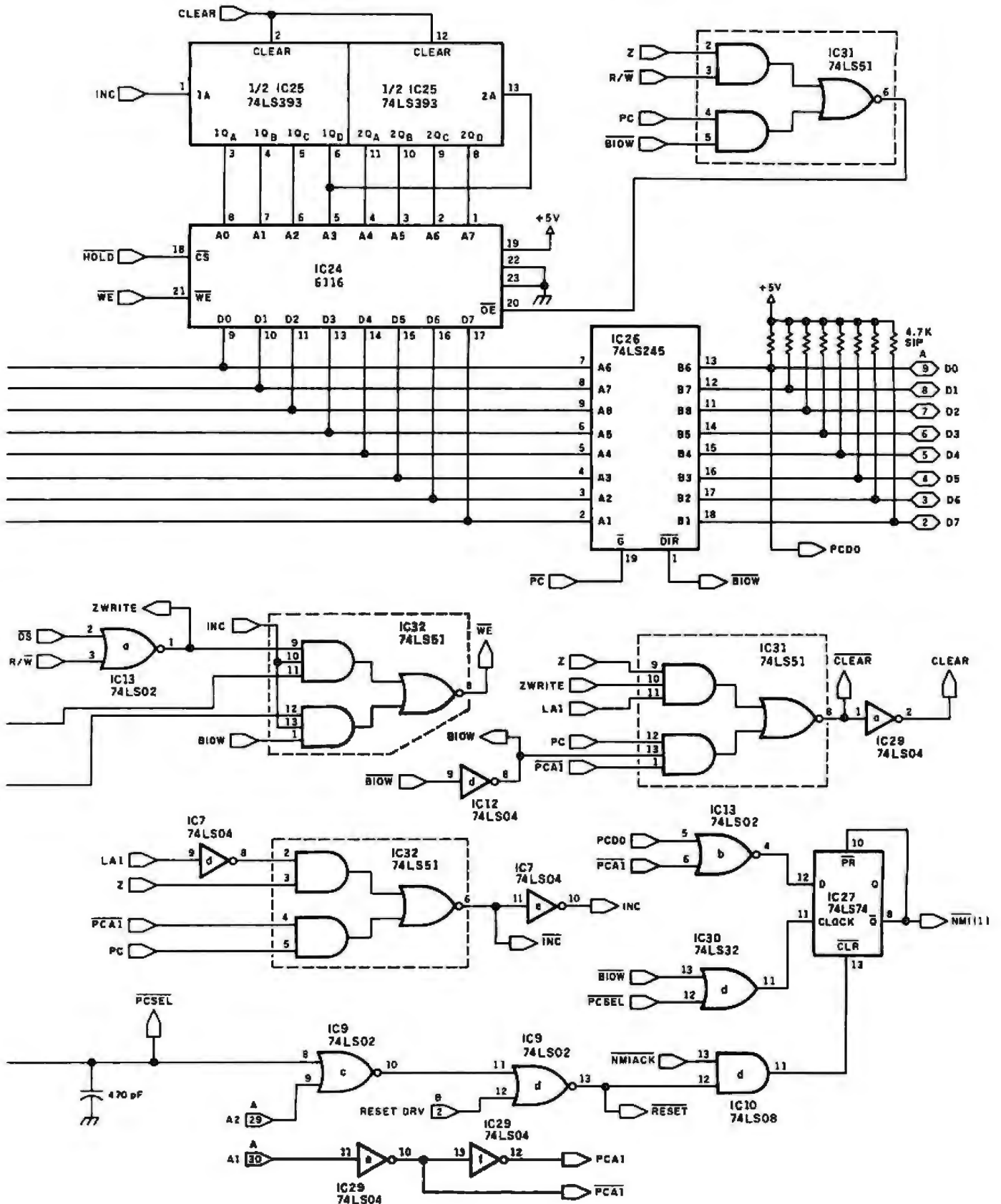


Figure 3 continued on page 49



Figure 3 continued:





Number	Type	+5 V	GND
IC1	Z8001B	11	36
IC2	Z8581	5	14
IC3	74LS373	20	10
IC4	74S138	16	8
IC5	74LS373	20	10
IC6	74LS373	20	10
IC7	74LS04	14	7
IC8	74LS08	14	7
IC9	74LS02	14	7
IC10	74LS08	14	7
IC11	74LS32	14	7
IC12	74LS04	14	7
IC13	74LS02	14	7
IC14	74LS138	16	8
IC15	74LS138	16	8
IC16	74LS138	16	8
IC17	74157	16	8
IC18	74157	16	8
IC19	74S74	14	7
IC20	74LS08	14	7
IC21	2716	24	12
IC22	2716	24	12
IC23	74LS245	20	10
IC24	6116-3	24	12
IC25	74LS393	14	7
IC26	74LS245	20	10
IC27	74LS74	14	7
IC28	74LS133	16	8
IC29	74LS04	14	7
IC30	74LS32	14	7
IC31	74LS51	14	7
IC32	74LS51	14	7
IC33	74LS00	14	7
IC34	74LS74	14	7
IC35	74LS74	14	7
IC36	4164-15 (150 ns)	16	8
IC99	4164-15	16	8

Power wiring table for figure 3.

Text continued from page 44:

which contain a bootstrap loader for cold-start-up and system-diagnostic routines. Address lines LA1 through LA11 are connected to the EPROMs, IC22 (even byte) and IC23 (odd byte). There is no need to use the  $\overline{ODD}$  or  $\overline{EVEN}$  bank-select lines since no data is ever written into the EPROMs. The signal  $\overline{RAM/PROM}$  is connected to the  $\overline{CS}$  pin on the 2716s. The  $\overline{MREQ}$  (memory request) signal from the Z8001 is also connected to pin 18 ( $\overline{OE}$  or output enable) of the 2716s, to inhibit the possibility of bus contention during I/O cycles.

### Status Signals

Various status signals tell the rest of the system about the processor's condition and the type of information that is appearing on the address/data bus. The status signals are as follows:

PC Address	Trump Card Port	Function
03EE	3	A "write" to this port by the processor that has current use of the bucket will cause the 8-bit address counter, IC25, to be reset to 0. It will also release the bucket for use by the other processor. If bit 0 of the data bus is set to a 0 when this write is performed by the 8088 processor, a nonmaskable interrupt (NMI) is also issued to the Z8001. Reading this port allows either processor to see data at the current address of the counter without incrementing the counter. If the bucket is not available, a read operation to this port will return an FF.
03EC	1	A read operation to this port by the processor that has the bucket reserved will return the data at the current address of the counter and increment the counter at the end of the read operation. A read by the processor that does not have the bucket will return a value of hexadecimal FF and will not increment the counter. A write to this port by the processor that has reserved the bucket will enter data at the current address of the counter and increment the counter at the end of the operation. A write by the processor that does not have the bucket will not enter data and the counter will not be incremented.
03E8	x	This port is not used for data transfer by the Z8001. A write to this port by the 8088 will issue a reset to the Trump Card.

Table 2: Communication between the Z8001 and the 8088 is through the "bucket," a FIFO buffer made from a type-6116 static-memory chip and support components. Shown here are the three basic bucket functions and the addresses and codes for each.

**Read/Write:** The  $\overline{R/\overline{W}}$  signal is used to indicate the direction of the current bus transaction. When high, the direction of data is toward the Z8001. Data is clocked into the processor at the occurrence of a positive-going pulse on  $\overline{DS}$  (data strobe). When  $\overline{DS}$  is low, data flows from the processor outward.

**Normal/System:** The  $\overline{N/\overline{S}}$  signal indicates whether the processor is operating in the system (supervisory) mode or normal (user) mode of operation. This control line is used when there is a multitasking and/or multiuser type of environment to segregate system functions and memory. The line is unused in the Trump Card.

**Byte/Word:** The  $\overline{B/\overline{W}}$  line is provided to enable the Z8001 to perform byte operations on memory. When high, it indicates that a byte operation is to take place; a low state indicates word operations. This signal is also used in the  $\overline{ODD}$  or  $\overline{EVEN}$  memory-select logic.

**Status Lines:** Lines ST0 through ST3 are utilized to define the exact type of transaction occurring on the bus. Only 4 of the 16 possible codes are

required for operation of the Trump Card. The first status code, 0000 (Internal Operation), is decoded but unused. The second operation code, 0001 (Memory Refresh), is output by the internal Z8001 memory-refresh timer and is used in refreshing the on-board dynamic RAM. (This signal is ANDed with  $\overline{MREQ}$  and is used as one of the two select signals in the row-address-strobe generation logic.) The third operation, 0010 (Standard I/O Reference), is used in the process of communicating with the host 8088 processor. The fourth operation code, 0011 (Special I/O), denotes I/O associated with the signal  $\overline{SPIO}$  and is reserved for future expansion.

### Clock Generation

The basic clock rate for the Z8001 on the Trump Card is provided by IC2, a Zilog Z8581 clock generator and controller (CGC). The Z8001's clock-input maximum voltage must come within a certain range of the power-supply potential (precisely  $V_{cc} - 0.4$  V) and have a maximum rise and fall time of 10 nanoseconds (ns). Such requirements are difficult to meet with standard oscillators and



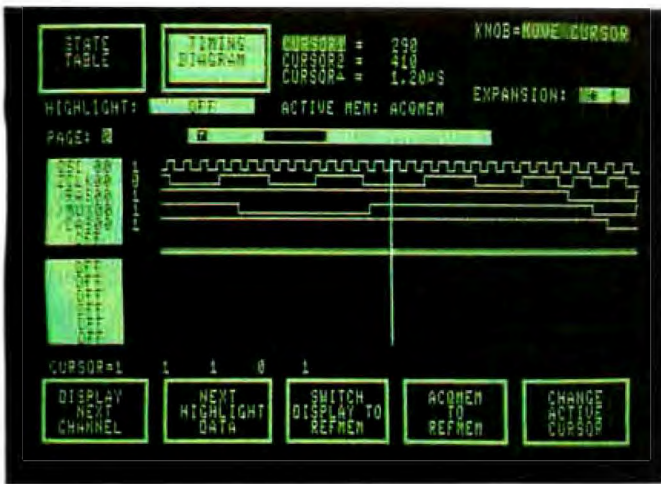


Photo 5: A typical display on the Tektronix 1240 logic analyzer: the column-address-strobe/row-address-strobe timing of the Trump Card.

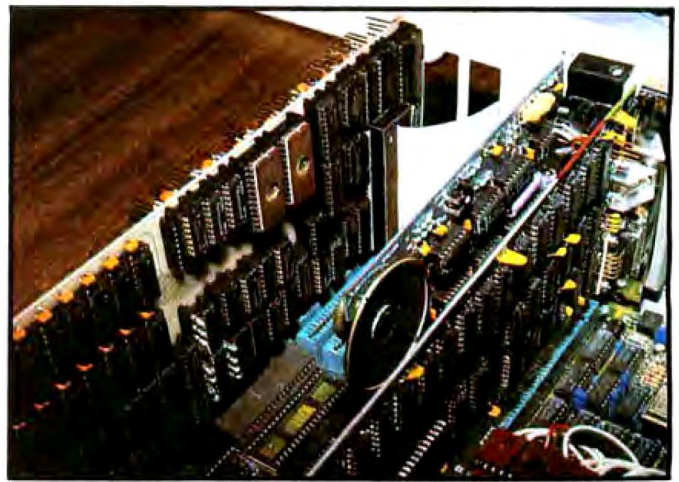


Photo 6: To aid in my initial development, a Zscan-8000 emulator is plugged by a ribbon cable into the Z8001 socket on the Trump Card. In emulation mode, the Zscan-8000 can run diagnostic programs and exercise all functions of the Trump Card at 4 MHz. Hardware debugging is greatly simplified because all sections of the hardware need not be working to use the emulator.

TTL (transistor-transistor logic), but they are easily met by the CGC. The Z8581 also provides an easy and effective means of adjusting the processor's bus cycles to the speed of available memory devices.

The CGC is used on the Trump Card to stretch specific bus cycles. As used on the Trump Card, the Z8001 does three different basic categories of operations: internal operations, memory access, and input/output operations. The timing of the ZCLK signal emitted by the CGC depends on which of these bus activities is taking place. The Z8581 can be configured to add wait states that enable the use of 150- and 200-ns RAM chips.

### Trump Card/Host Communication

The "bucket" is the communications interface between the PC and Trump Card. This FIFO (first-in/first-out)-type dual-port memory configuration consists of a 6116 static memory (IC24), an 8-bit address counter (IC25), two data-bus buffers (ICs 23 and 26), and the necessary control logic to arbitrate access. Programs and instructions are passed between the two computers via this FIFO circuitry. As far as the PC is concerned, the bucket appears as two I/O port addresses. A system of soft-

ware handshaking between the computers determines which has reserved and is using the bucket. Table 2 shows the port addresses and their functions.

It is not possible for both processors to have use of the bucket at the same time. With the processors running asynchronously, arbitration is necessary. It is provided by four D-type flip-flops: two for access requests and two for access reservations. The two access-request flip-flops are clocked by the transition of an access-request signal from either processor ( $\overline{\text{IORQ}}$  for the Z8001 and  $\overline{\text{PCSEL}}$  for the 8088). The preset inputs of these flip-flops are connected to the  $\overline{\text{HOLD}}$  signal, which is active whenever one of the processors has succeeded in reserving the use of the bucket. When  $\overline{\text{HOLD}}$  is active, it prevents the other processor from gaining access.

The Z8001 communicates through the bucket for all its normal I/O by activating the  $\overline{\text{IORQ}}$  line. The 8088 selects the bucket when it performs either an IOW (I/O write) or IOR (I/O read) in the range of the IBM's regular memory-address space from hexadecimal 03E8 to 03EE. Accesses to these addresses are decoded by IC28 to generate the Trump Card's  $\overline{\text{PCSEL}}$  signal.

The two access-reserve flip-flops

sample the output of the request flip-flops 180 degrees out of phase with each other. This is done to prohibit simultaneous requests from being honored. These flip-flops are cleared by a reset command issued from the reserving processor.

The  $\overline{\text{Q}}$  outputs from these flip-flops are combined by a logical AND function with the processor request to form the active select states used by the bucket:  $\overline{\text{Z}}$  ANDed with  $\overline{\text{DS}}$  for the Z8001 and  $\overline{\text{PC}}$  for the 8088. Whenever either request flip-flop is active, the  $\overline{\text{HOLD}}$  signal is active and is used as the chip-select input on the 6116 memory. The FIFO memory, however, is written to by the Z8001 only when a "write bucket with increment" command is used.

The  $\overline{\text{WE}}$  signal, connected to the write-enable input of the 6116 memory, is active during either a Z8001 I/O request (with  $\overline{\text{R/W}}$  low and  $\overline{\text{DS}}$  active) or an 8088-generated write to the bucket (with  $\overline{\text{PC}}$  and  $\overline{\text{INC}}$  active and  $\overline{\text{BIOR}}$  inactive). The  $\overline{\text{INC}}$  signal is active whenever the processor that has control of the bucket sets bit 1 of the address low. The  $\overline{\text{CLEAR}}$  signal is active when bit 1 of the address generated by the selected processor is high and a write operation is occurring.

A nonmaskable interrupt to the Z8001 is generated when the 8088



**Listing 2: Bootstrap initialization program for the Trump Card written in Z8000 assembly language.**

0000	00	DW	- Reserved control word	
0000	02	DW	- Flag and control word	
0000	04	DW	- Segment Register	
0008	06	DW	- Segment Offset	
2100	9E01	08	LD R0, #X9E01	
1404	0003	0001	0C	LDL RR4, #X0003 0001
7D0B		12	LDCTL REFRESH, R0	
3E40		14	OUTB @R4, RHO	
3C40		16	INB RHO, @R4	
AB00		1B	INCB RHO, #1	
E6FC		1A	JR 0 EQ, X0014	
3C40		1C	INB RHO, @R4	
BAB0		1E	CPB RHO, RLO	
EFF9		20	JR NC UGE, X0014	
C803		22	LDB RLO, #X03	
3E5B		24	OUTB @R5, RLO	
B400		26	ORB RHO, RHO	
E6F5		2B	JR Z EQ, X0014	
3C52		2A	INB @R2, @R5	
3C53		2C	INB @R3, @R5	
3C5B		2E	INB @R3, @R5	
3C51		30	INB @R1, @R5	
3C59		32	INB @R1, @R5	
3A50	0120	34	INIRB @RR2, @R5 R1	
F013		3B	DBNZ RHO	
3E40		3A	OUTB @R4, RHO	
AB35		3C	DEC R3, #6	
1E2B		3E	JP @RR2	

performs a write operation to the bucket with address bit 1 and data bit 0 both low. This interrupt is latched in a D-type flip-flop and is not cleared until the Z8001 issues a Nonmaskable-Interrupt Acknowledge (status decode 5) or until the host computer resets the Trump Card. (See table 2 for more detail.)

### Booting Trump Card

When you plug the Trump Card into a slot in the IBM PC and turn on the computer, the Trump Card automatically executes the bootstrap-loader routine contained on board in EPROM. The loader routine is only 31 words (62 bytes) long; its assembly code is shown in listing 2.

I used two 2716 EPROMs instead of bipolar PROMs to store the bootstrap loader because they are both cost-effective and easier to program than bipolar PROMs. Two byte-wide memory devices are required because the Z8001 is a processor with a 16-bit word length. Each machine-language instruction (expressed as four hexadecimal digits) is separated into high- and low-order bytes (or "even" and "odd," if you prefer); the high and low bytes are stored in separate EPROMs. When you examine a particular 16-bit memory location, you are actually viewing the information provided from two 8-bit sources.

### Using Trump Card

Trump Card is transparent to normal PC operation. To start Trump Card, you run a program stored under PC-DOS called LDZSYS. This is the Trump Card communications software that runs on the 8088. If you always want Trump Card features available, you can add this program to your regular AUTOEXEC batch file. When LDZSYS has completed initialization, it returns to the PC-DOS A> prompt to wait further instructions.

At this point, I generally configure part of Trump Card's memory as a RAM disk, using a program called SETRMDSK. This is done as follows:

```
A> SETRMDSK 4
A>
```

SETRMDSK configures the additional C drive to your existing system under DOS 2.0. The number following SETRMDSK determines how many 64K-byte blocks you wish to reserve as a RAM disk. In this case, I set up a 256K-byte drive. The RAM-disk size can be 128K to 387K bytes, depending upon the amount of memory on the Trump Card board. (While you can set a 128K-byte RAM disk in a 256K-byte board, you might have problems running large BASIC or C programs concurrently.)

The memory that I've set as a RAM disk is completely separate and in addition to the regular IBM PC memory. Even if you have a 640K-byte PC, up to 387K bytes of Trump Card's memory would be available as additional RAM-disk configured storage space.

I used the RAM disk to speed up the process of writing these articles. Many word processors, like the Volkswriter I use, make extensive calls to the disk for help files and command-execution files. After a while, the noise and delay get aggravating. To remedy this situation, I run the SETRMDSK 4 sequence just described to create the 256K-byte RAM drive C and then add the following:

```
A> COPY *.* C:
A> C:
C> VW
```

This copies the entire contents of the Volkswriter distribution disk to the RAM disk, sets it as the default drive (C), and starts the word processor. When I now press a function key the action is instant and silent. To guard against power interruptions, drive B is designated as the hard-storage location and periodically I store the article file to it.

Trump Card's other features are equally simple to use. BASIC, C, Z80, and editing files can be stored on the same disk and executed with similar ease. While I'll explain it in greater detail next month, a possible sequence of Trump Card operations is shown in table 3.

### Rewarding Diligence

I've been having a lot of fun with Trump Card. I haven't done much assembly-language or C programming yet, but it has renewed my faith in BASIC.

Trump Card is not an easy project to build. Compared to other Circuit Cellar projects, however, it's manageable. I was surprised at the number of readers who hand-wired the 121-chip MPX-16 PC-compatible computer that I presented last year. Their letters suggested that the motive was neither money nor masochism. In-



# Our Family Tree Is Growing Again

**SBC-II** A two user multiprocessing S-100 slave complete with a Z-80 CPU (4 or 6 MHz), 2 serial ports, 64K RAM, and 2K FIFO buffer for each user! A cost effective way to add users to your multiprocessing system.

**HD/CTC** A hard disk and cartridge tape controller combined together on one board! A Z-80 CPU (4 or 6 MHz); 16K ROM, and up to 8K RAM provide intelligence required to relieve disk I/O burden from host system CPU. Round out your multi-processing system with an integrated mass storage/backup controller.

**Systemaster™**  
The ultimate one board computer; use it as a complete single-user system or as the "master" in a multi-processing network environment. Complete with Z-80A CPU, 2 serial and

**SBC-1** A multiprocessing slave board computer with Z-80 CPU (4 or 6 MHz), 2 serial ports, 2 parallel ports, and up to 128K RAM. Provides unique 2K FIFO buffering for system block data transfers. When used with TurboDOS or MDZ/OS the results are phenomenal!

2 parallel ports, floppy controller, DMA, real time clock, RAM drive disk emulation package, and Teletek's advanced CPM BIOS or TurboDOS.

4600 Pell Drive Sacramento, CA 95838 (916) 920-4600 Telex #4991834 Answer back - teletek

# TELETEK



# WAREHOUSE SOFTWARE

## TECHNICAL INFORMATION (602) 642-1133

Call for programs not listed. We will try to meet or beat any legitimate price for CP/M or IBM PC Software. Most disk formats available.

### DATA BASE MANAGEMENT SYSTEMS

**UNBEATABLE PACKAGE PRICE!!**  
DBASEII + Instruction Book "Using DBASEII", Extra Diskette with Dbase Accounting, Mail list and Inventory Programs. For IBM PC and CP/M. Call for our special price.

Fox and Geller Quickcode .....	<b>\$175</b>
DB+SORT .....	<b>\$89</b>
Condor III .....	<b>\$340</b>
NWA Statpack .....	<b>\$350</b>
TIM IV .....	<b>\$269</b>
Infostar .....	<b>\$259</b>
PFS File .....	<b>\$95</b>
RBASE 4000 .....	<b>\$299</b>
Personal Pearl .....	<b>\$145</b>
Fast Facts for IBM PC .....	<b>\$135</b>

### WORD-PROCESSING

Wordstar, Mail Merge, Spellstar, Index .....	<b>\$359</b>
Wordstar .....	<b>\$245</b>
Mail Merge or Spell Star .....	<b>\$135</b>
Microsoft Word W/Mouse .....	<b>\$295</b>
Word Perfect .....	<b>\$295</b>
Volkswriter for IBM PC .....	<b>\$115</b>
Wang Spellchecker .....	<b>\$36</b>
Metasoft Benchmark .....	<b>\$265</b>
Multimate .....	<b>\$295</b>
Peachtext 5000 .....	<b>\$210</b>

### SPREADSHEETS

Calstar - IBM PC Spec. \$65 .. Others	<b>\$95</b>
Supercalc II .....	<b>\$159</b>
Supercalc III .....	<b>\$199</b>
Microsoft Multiplan .....	<b>\$159</b>

### ACCOUNTING

TCS. Equivalent of Peachtree - Specially Augmented By Warehouse Software Customized For Your IBM PC Terminal and Printer - GL, AR, PA, AP, CP/M, for PC XT, DOS 1.1, 2.0  
Each Module **\$75** For All Four **\$275**

CYMA .....	Call
Peachtree GL, AR, AP .....	<b>\$245</b>
Home Accountant Continental .....	<b>\$95</b>
Real World, GL, AR, AP, PA ..	<b>each \$350</b>

### TRANSFER PROGRAMS

Move-It .....	<b>\$85</b>
Microstuff Crosstalk .....	<b>\$105</b>

**Best Price in U.S. for IBM PC or Clones**  
Multifunction Board—Includes Async Adapter, Parallel Adapter, Clock with battery back-up and Software, 64K Memory Expandable to 384K.  
1 year warranty ..... **\$265** |

### LANGUAGES

Lifeboat C Compiler .....	<b>\$295</b>
Microsoft C Compiler .....	<b>\$335</b>
Microsoft Pascal Compiler .....	<b>\$245</b>
Microsoft Basic Compiler .....	<b>\$285</b>
Microsoft Basic Language .....	<b>\$250</b>
CBASIC 86 for IBM PC .....	<b>\$135</b>
CBASIC CP/M-80 .....	<b>\$95</b>

16 Pounds of IBM PC DOS Compatible Portable Computer-Hyperion-2 Disc Drives - Software.  
List 3690 ..... **Sale \$2665** |

### FOR PC DOS

Norton Utilities .....	<b>\$55</b>
Copy II PC .....	<b>\$34</b>
Prokey V3.0 .....	<b>\$86</b>
Howardsoft Tax Preparer 84 .....	<b>\$215</b>
Microsoft Flight Simulator .....	<b>\$38</b>

### HARDWARE

Hayes 1200 Modem .....	<b>\$495</b>
Hayes 1200B Modem .....	<b>\$435</b>
Anchor Signalman 1200baud Modem .....	<b>\$285</b>
Plantronics Color + Board .....	<b>\$365</b>
Koala pad for IBM PC .....	<b>\$88</b>
Quadram Color I Board .....	<b>\$199</b>
256 K Ram Board .....	<b>\$299</b>
Princeton RGB Hi-Res Monitor .....	<b>\$495</b>
Gemini 15X, 10x Printers .....	Call
Corona Computer - Port. or Desk Top Call	

TERMS: Prices include 3% cash discount. Add 3% for charge orders. Shipping on most items \$5.00. AZ orders +6% sales tax. Prices subject to change.

**TOLL FREE ORDER LINE 1-800-421-3133**

**WAREHOUSE SOFTWARE**  
4935 West Glendale Ave., Suite 12  
Glendale, AZ 85301

A> LDZSYS	(initialize Trump Card)
A>	(return to PC-DOS or use Trump Card)
A>G	(turn over PC operation to Trump Card)
:	(Trump Card prompt)
: EE filename	(edit a file)
or	
: Z80EM	
filename	(emulate CP/M-80 and run Z80 programs)
or	
: C filename	(compile and run a C program)
or	
: Y filename	(compile and run Z8000 assembly language)
or	
: BASIC filename	(compile and run BASICA programs)
::/	(return to PC-DOS)
A>	

Table 3: A Trump Card operating sequence.

stead, building these projects enabled them to experiment with digital circuitry yet be secure in the knowledge that their project would work. I hope this project elicits a similar response, and I'd like to reward such enthusiasm in advance.

Esoteric peripherals such as Trump Card depend a great deal on sophisticated software to fully exercise their capabilities. Unfortunately, when experimenters build rather than purchase boards, they often have to use great ingenuity to obtain software.

More than five man-years of development effort went into the present support packages for Trump Card.

Some, like TBASIC and the RAM disk, were contracted by me, while others, like the C compiler and Y (a Z8000 assembler), were written by Zilog. Combined with the CP/M-80 emulator, Z8000 operating system, and telephone-book-size documentation, it is a formidable package that is difficult to independently price.

I want to encourage you to build your own Trump Card if that is your choice. If you send me a picture of the completed unit, I will send you a copy of the complete software and the documentation (provided it is for personal, noncommercial use) for the cost of duplication and shipping

### The following items are available from

Sweet Micro Systems Inc.  
50 Freeway Dr.  
Cranston, RI 02910  
(800) 341-8001 for orders  
(401) 461-0530 for information

described above and documentation. Software supplied on a PC-DOS 2.0 disk unless otherwise specified.  
512PCC.....\$1325

1. Trump Card, including IC sockets, assembled and tested with 256K bytes of the 512K-byte RAM space populated. Includes TBASIC compiler, C compiler, Z8000 Y assembler, CP/M-80 emulator, RAM-disk driver, and documentation. Software supplied on a PC-DOS 2.0 disk unless otherwise specified.  
256PCB ..... \$995
2. Trump Card, assembled and tested with 512K bytes of dynamic RAM installed. Includes support software

3. Partial kit for Trump Card. Includes fully socketed wave-soldered printed-circuit board, bootstrap EPROMs, 10-MHz Z8001, and Z8581. Includes software and documentation described above. Other integrated circuits not included. Software supplied on a PC-DOS 2.0 disk unless otherwise specified.  
OKPCA.....\$525

Please add \$10 for shipping and handling in the continental United States. Please add \$20 for shipping to other locations. Rhode Island residents please add 6 percent sales tax.



(\$30). The software houses and other parties in this project have waived all royalties as a gesture of support for the Circuit Cellar.

#### Next Month:

In June's article, I'll describe the software in detail and do a little benchmarking. ■

Diagrams pertaining to the Z8000 are reprinted by permission of Zilog Corporation. Z8000 and Z80 are trademarks of Zilog.

Steve Ciarcia (pronounced "see-ARE-see-ah") is an electronics engineer and computer consultant with experience in process control, digital design, nuclear instrumentation, and product development. In addition to writing for BYTE, he has published several books. He can be contacted at POB 582, Glastonbury, CT 06033.

**Editor's Note:** Steve often refers to previous Circuit Cellar articles. Most of these past articles are available in reprint books from BYTE Books, McGraw-Hill Book Company, POB 400, Hightstown, NJ 08250.

Ciarcia's Circuit Cellar, Volume I covers articles that appeared in BYTE from September 1977 through November 1978. Ciarcia's Circuit Cellar, Volume II contains articles from December 1978 through June 1980. Ciarcia's Circuit Cellar, Volume III contains articles from July 1980 through December 1981. Ciarcia's Circuit Cellar, Volume IV, soon to appear, will contain articles from January 1982 through June 1983.

#### References

1. Ciarcia, Steve. "Build the Circuit Cellar MPX-16 Computer System." Part 1, BYTE, November 1982, page 78. Part 2, BYTE, December 1982, page 42. Part 3, BYTE, January 1983, page 54.
2. Majundar, S., K. Kumar, and K. S. Raghunathan. "Interface Unites Z8000 with Other Families of Peripheral Devices." *Electronics*, July 28, 1981, page 156.
3. Rampil, Ira. "Preview of the Z8000." BYTE, March 1979, page 80.
4. Simington, R. B. "The Intel 8087 Numerics Processor Extension." BYTE, April 1983, page 154.
5. Shima, Masatoshi. "Genealogy of the Z8000." *Electronics*, December 21, 1978, page 83.
6. Williams, Gregg. "Benchmarking the Intel 8086 and 8088." BYTE, July 1983, page 147.
7. Zingale, Tony. "Intel's 80186: A 16-Bit Computer on a Chip." BYTE, April 1983, page 132.

To receive a complete list of Ciarcia's Circuit Cellar project kits, circle 100 on the reader service inquiry card at the back of the magazine.

# There's a better way to pack more muscle in your micro.



## The HarDrive™ by QuCeS. More bytes for your buck. In a flash.

If you're looking for a way to get more performance out of your microcomputer, look no further than QuCeS.

With a QuCeS HarDrive subsystem, you can make your micro behave almost like a mainframe. 10 to 114 megabytes of mass storage lets you handle data bases that would make the normal micro blow a fuse. And you can access, update and process data so incredibly fast, you won't believe your eyes. A QuCeS HarDrive with an optional 5 megabyte backup cartridge, also means you won't have to rely on a very unreliable storage medium for your crucial data—namely floppy disks—ever again.

Another QuCeS plus is compatibility. It interfaces with most popular microcomputers like IBM, Radio Shack, Apple, DEC, Epson—you name it. Installation couldn't be easier, our software is easy to use, and each HarDrive is backed by a 1-year warranty.

The QuCeS HarDrive. It will make your micro mightier and faster than ever before.



For complete details, contact

### Quality Computer Services



3 Quces Drive, Metuchen, N.J. 08840 (201) 548-2135  
TELEX 299410 QCS



# The TeleVideo IBM PC

## The best hardware for



TeleVideo versus IBM. Make a few simple comparisons and you'll find there is no comparison.

### **RUNS IBM SOFTWARE.**

With the TeleVideo® IBM Compatible line—PC, XT and portable computers—you'll get the most out of all the most popular software written for the IBM® PC—more than 3,000 programs.

Because every TeleVideo Personal Computer offers the highest level of IBM compatibility on the market

### **THE BEST HARDWARE FOR THE BEST PRICE.**

Features	Tele-PC	IBM PC	Tele-XT	IBM XT
Monitor	YES	OPTIONAL	YES	OPTIONAL
Screen Size	14"	12"	14"	12"
Tilt Screen	YES	NO	YES	NO
Quiet Operation	YES (NO FAN)	NO	YES	NO
Memory	128K	128K OPTION	256K	256K OPTION
Graphics Display (640x200 resolution)	YES	OPTIONAL	YES	OPTIONAL
Printer Port	YES	OPTIONAL	YES	OPTIONAL
Communication Port	YES	OPTIONAL	YES	YES
MS™-DOS/BASIC™	YES	OPTIONAL	YES	OPTIONAL
System Expansion Slot	YES	YES	YES	YES
RGB and Video Port	YES	OPTIONAL	YES	OPTIONAL
<b>Typical System Price</b>	<b>\$2995</b>	<b>\$3843</b>	<b>\$4995</b>	<b>\$5754</b>



# compatibles. the best software.

and has the standard—not optional—features you need to take full advantage of every job your software can do.

Study the chart at the left. It proves that TeleVideo—not IBM—offers the best hardware for the best price.

Note that TeleVideo's ergonomic superiority over IBM extends from fully sculpted keys and a comfortable palm rest to a 14-inch, no glare screen that tilts at a touch.

## THE BEST MICROCHIPS.

What is perhaps most impressive about the TeleVideo IBM PC Compatible can be found deep within its circuitry. We use the same 8088 central processing unit that runs an IBM PC. But we also employ new VLSI (Very Large Scale Integration) microchips that are designed and built exclusively for TeleVideo.

These interface more efficiently with the powerful 8088 and yield numerous benefits.

For example, our tiny custom chips do the work of many of the larger, more expensive circuit boards in an IBM PC. So we can offer a computer system that comes in one attractive, integrated case, is ready to run and occupies less desk space. A computer that edges out IBM's added-cost component system for reliability, ease of service and purchase simplicity.

Fewer circuit boards to cool also allowed us to eliminate the noisy, irritating fan IBM and most other PCs force you to put up with. And TeleVideo compatibles accept



## THE BEST PORTABLE FOR THE BEST PRICE.

Features	TPC II	COMPAQ
High Capacity Storage	YES	NO
2nd Disk Drive	YES	OPTIONAL
Quiet Operation (No Fan)	YES	NO
Ergonomic Display	YES	NO
Communication Port	YES	OPTIONAL
International Power Supply	YES	NO
MS™ DOS 2.11	YES	NO
Graphics Display	YES	YES
<b>Typical System Price</b>	<b>\$2995</b>	<b>\$3710</b>

any IBM hardware options without modification.

## THE BEST LINE.

But the Tele-PC is only one element of the TeleVideo IBM PC Compatible line.

The TeleVideo XT is the best hardware for users of popular IBM XT software who would appreciate an extra 10 megabytes of storage capacity along with the advantages listed on the preceding chart.

As the chart above demonstrates, our portable IBM compatible computer, the TPC II, is far and away better hardware than COMPAQ™. Better hardware—standard—at a better price.

## THE BEST MANUFACTURER.

The TeleVideo IBM PC Compatible line is made by the world leader in multi-user computer systems and the number one independent manufacturer of terminals.

Our compatibles are available at participating ComputerLand and Entré (call 800-HI-ENTRE) dealers or you may call 800-538-8725 for the dealer nearest you. In California, call 800-345-8008.

Before you invest, make a few simple comparisons. You'll find that TeleVideo—not IBM or COMPAQ—has the best hardware for the best software. At the best price.

IBM is a registered trademark of International Business Machines. MS is a trademark of Microsoft Corporation. GW Basic is a registered trademark of MicroSoft Corporation. COMPAQ is a trademark of COMPAQ Computer Corporation.


**TeleVideo®**  
Personal Computers  
● TeleVideo Systems, Inc.

Circle 377 on inquiry card.



# PICK UP WHERE IBM<sup>®</sup> LEAVES OFF.

Portable or desktop, you're way ahead when you pick up a **corona PC**.<sup>™</sup> Because we give you everything you've ever wanted in an IBM<sup>1</sup>-compatible PC and more. For a great deal less.

## COMPATIBLE AND MORE.

Our systems run all software that conforms to IBM PC programming standards. And the most popular software does.

We deliver twice the memory, with room for eight times as much.

We deliver a fast-access 320K floppy drive, a communication port and an improved IBM PC keyboard with indicator lights.

Our systems include high-resolution monitors (12" desktop, 9" portable) for crisper, cleaner displays, and both have built-in high-resolution graphics (640 x 325).

You get a complete system, ready to go to work.



## MORE VERSATILITY.

With all the necessary features built into the main unit, the four expansion slots can be used for your special needs. For example, color or our optional 10MB hard disk.



## MORE SPEED.

Our RAM-disk software gives you temporary disk-type storage that works many times faster than disks.

## PLUS SOFTWARE.

Our systems come with the operating system: MS-DOS.<sup>2</sup> A programming language:

GW BASIC.<sup>2</sup> A training course: PC Tutor.<sup>3</sup> A professional word processor: MultiMate.<sup>4</sup> Plus DOS utilities and demonstration programs. Or you can get the p-System<sup>5</sup> from N.C.I. and write or run portable Pascal packages.

## ALL FOR A GREAT DEAL LESS.

Even with all the extra features and performance, our systems still cost significantly less than the equivalent IBM PC.

Drop by your nearest **corona PC** dealer for a very convincing demonstration. Or contact us at 31324 Via Colinas, Westlake Village, CA 91361. (213) 991-1144 or (800) 621-6746 toll-free. Telex 658212 WSLK, in Europe 76066 CDS NL.



© Corona Data Systems 1983. 1. TM International Business Machines. 2. TM Microsoft. 3. TM Comprehensive Software Support. 4. TM Softword Systems. 5. TM University of California.



**corona**<sup>™</sup>  
data systems, inc.



# Chaos Manor's Hard-Disk System

*Dirty filters, 8/16-land, views of the future, and inevitably more*

Jerry Pournelle  
Consulting Editor

At Chaos Manor everything happens at once. I have 10 pounds of mail set aside because the letters raise questions better answered in this column than in BYTE's User to User; from where I sit I can see a raft of new books; we're getting to know and love the Diser machine; I've heard from the Modula Research Institute; and I've just returned from the Sage Faire, where I learned that the Motorola 68000 chip is alive and well and hiding in Reno, Nevada. Meanwhile, I'm working with the new Compupro 40-megabyte disk and 8/16 operating system, and I have word that Jim Hudson has his 8087 math-chip board for the Z-100. Clearly, the Intel 8086 and follow-ons are as healthy as the 68000 products.

So just where are we going? What will the supermicros look like when they arrive, and how can users be sure they won't invest in dead-end equipment and software? Is it to be the 8086 or the 68000?

I'll get back to that after we look at the latest hardware in Chaos Manor.

### Compupro Hard Disk

For years I've resisted hard disks. Although faster than floppies, they just didn't seem worth the effort. I've heard too many horror stories of how bad software managed to blow a hard

disk's directory, or how a sudden power failure brought on disaster. There seemed to be considerable risk, and the rewards just weren't that great—until recently, hard disks didn't hold *that* much more than my 1.1-megabyte 8-inch floppies, while RAM (random-access read/write memory) disk drives were faster.

From time to time I'd hear about a new hard-disk system and wonder if I ought to install one, but there was always some problem sufficient to keep me away.

That all changed a couple of weeks ago when the Compupro hard disk arrived. I love it, but Chaos Manor has been even more chaotic ever since.

First was the problem of where to put the new disk. The Compupro 40-megabyte system is physically the same size as the Compupro "boat-anchor" system: not small. One natural place to put it is to stack it with the main computer box, and most people will do that. Compupro normally packages an 8-inch double-sided double-density disk in with the hard-disk drive; this provides both backup and a way to get programs into the computer. However, I insist on keeping both of my 8-inch drives, so my hard disk arrived with a blank piece of metal instead of a floppy

drive. Taped to the blank spot was a card that read "Five-inch drive goes here ..."

A story goes with that. Compupro has the 5¼-inch drives, a controller to run them, and software to drive the controller; what it doesn't have just at the moment is the black metal cutout to hold 5¼-inch drives in place. There are plenty of bezels for 8-inch drives, and by the time you read this I should have the 5¼-inch drive running; but for the moment that's in the Real Soon Now category.

There was only one catch to the hard disk: Chaos Manor has become a test site for the new 8/16 software that drives it. Of course, that wasn't supposed to be any real hardship. Tony Pietsch had been running the new software with his hard disk for weeks. I was only supposed to be a sort of final test site, in case there were any minor bugs left.

It's as well that Compupro is thorough. I do a lot of things that Tony doesn't. There definitely were bugs. Some weren't so minor, either; there was a time there when I was muttering that hard disks should be confined to hackers, who undoubtedly deserved them; they weren't for ordinary users. However, as each bug showed up, Tony dug into the BIOS (basic input/output system) and other



esoterica, and pretty soon, Lo!, the system began to work quite well.

There are still some annoyances. Some are fixable, others probably are not. No matter: already the advantages outweigh the disadvantages by a lot.

I now keep my accounting system, editors, address book, mail lists, disk catalog, utility programs, CB-80 compiler, RMAC macro assembler, lots of program sources, spelling checker and dictionaries, and the *entire text* of the new Niven and Pournelle novel *Footfall* in various places on that hard disk. No more getting up to find the right floppy disk. It's all here. Sure, I have to find the right floppy to put safety copies onto—I don't feel my work is safe until I have a copy in a nonmagnetic box in the other room—but I can do that while *The Word Plus* is checking spelling or the compiler is compiling.

I find that I get a lot more done now. Example: I thought of a fast modification to the accounting program. Normally I wouldn't bother, at least not until I had the program sources out. With the source, text editor, and compiler already on line, it took only a few minutes to make the needed changes.

For the first time I find having an on-line address book worth bothering with. Oh, sure: I have always kept mailing lists and stuff like that on disks. Every now and then I get ambitions for new name and address software, and there's a new flurry of activity; but, I blush to say, I've always gone back to a battered green address book held together largely with Sno-Pake and tape. The address book took less time than loading in the data-retrieval program, finding the data disk, and searching for the data. (Larry Niven stores his addresses and phone numbers in a text file and uses the Search function in *WRITE*; that works, but somehow I never got in the habit of it.) With data and the retrieval program all on hard disk, computer retrieval is faster than searching for the address book among the litter on my desk and credenza.

This gives me an idea for a new program: one that searches through

all my electronic-mail files, extracts the names and addresses, and inserts them into a database. The only difficulty would be teaching the machine to recognize what a valid name and address look like. This would be no problem for letter files; now all I have to do is figure out how to tell the machine which files really contain letters and which are something else hiding on the letters' disks.

I may or may not get around to such a program. The point is that the program would be valuable now, and it wouldn't have been without the hard disk.

### Want to Bet?

When Tony installed the new Compupro hard disk and Disk Three controller, my 8085/8088 Dual Processor ceased to work. This caused considerable consternation.

The first supposition was that the disk itself had been damaged in shipment, and examination of the shipping box showed that it had indeed been dropped; some of the tape seams had split. However, it hadn't been damaged. Not only does Compupro lock the disk head in place, but on power-down it's retracted to a dedicated "landing zone" first. Those Quantum disks are rugged.

"We've overloaded the bus," Tony decided. We did, after all, have all 20 slots filled in my Compupro boat-anchor box. In addition, we have Jim Hudson's 8087 math-chip board piggyback on the 8085/8088 Dual Processor's processor board—and that's no ordinary 8087, it's an 8-MHz chip, which gets hot enough to fry eggs on.

Certainly the box was full. There were old memory boards, three different interface boards, and a mess of other stuff; although the Dual Processor has become the main computing machine here, it still retains some residual equipment from the days when it was an experimental system.

Tony removed a number of superfluous boards. A few minutes later Bill Godbout called about something else.

"We finally managed to overload the bus on a boat anchor," I said.

"Nope. Don't believe you," said Dr.

Godbout.

"Eh? Tony says—"

"Tell him I'll bet him the value of his house," Bill said. "And I'll buy the system from you."

"But—"

"Have you looked at the fan filter?"

Sure enough, the filter was clogged with dust. I cleaned it. Just to see, I put all the extra boards back in: no problems.

"We've tried to overload the bus," Dr. Godbout explained. "I suppose you could do it, but the problem is usually the fan filter. Once we had a system failure just before tax time. There was a panic, but it was the filter."

Actually, I expect he doesn't have as much dust, now that Compupro has moved to modern headquarters in Hayward; but when the company was in the old WW II "temporary" buildings at Oakland Airport, I well imagine dust would frequently clog the filters.

We even speculated about modifying the operating system so that on the second Wednesday of each month the system would display a "CLEAN THE FILTER" message, then cease to work for five minutes. After all, there is a real-time clock/calendar on the System Support Board.

I doubt it will ever come to that, but do clean your air filters regularly.

### System 8/16

One of the nice things about the new hard-disk system is CP/M-8/16. My Dual Processor now runs both 8-bit and 16-bit programs. Both varieties are present on the hard disk, and I don't have to worry about which ones are which; I just run the program I want, same as I always did. The computer figures out whether it's supposed to run this as 16-bit software under CP/M-86 or as an 8-bit program under CP/M 2.2, in which case it gets assistance in disk operations from the 16-bit 8088 chip.

There's a large bonus for 8-bit programs. Disk operations are handled by the 8088 chip, leaving a great deal more free memory. In our case, the Temporary Program Area (TPA—the practical workspace for the program)



# HIGH PERFORMANCE

## LONG DISTANCE RACER



You can't win a race when you're not on the road. That's why you need a printer that does more than run fast. You need one that runs *long*. You need a Datasouth.

### MORE CHARACTER

The printhead on a Datasouth printer is rated to live through 500 million characters. Even in the most demanding applications, this means years of service without an overhaul.

### HEAVY DUTY CYCLE

For a Datasouth printer, "100% duty cycle" is something of an understatement. So far, over 35,000 Datasouth printers have hit the hard copy road, and so few have pulled into the garage for repairs, it's hard to say how close to forever any of them will last.

### MORE THAN THE HUM OF ITS PARTS

There's less to go wrong with a Datasouth printer. With sophisticated microprocessor control and unusually

efficient design, Datasouth printers have few moving parts. They also don't need add-on "personality boards" to accommodate different computers.

### TAKE YOUR CHOICE

Datasouth reliability comes in two high performance models. The DS180 is a legendary workhorse that delivers crisp data quality printing at 180 CPS. The new multimode DS220 cruises at 220 CPS for high speed data printing and at 40 CPS for letter-quality word processing. Both models print precision dot-addressable graphics.

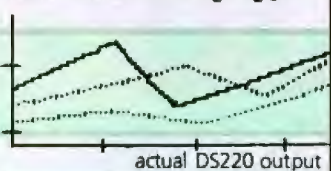
If you have a high performance printing need,

Datasouth has a high performance printer to fill it.

### DRIVE ONE TO WORK

Test drive a Datasouth printer at your nearest showroom today. Then put it to work. With a Datasouth racing beside you, there's no way to lose.

### Data Speed Type Letter Quality Type



# datasouth

H I G H P E R F O R M A N C E M A T R I X P R I N T E R S

Find Datasouth Printers At  
Participating **ComputerLand** Stores  
And Other Fine Dealers.

AVAILABLE NATIONWIDE  
THROUGH OUR NETWORK OF  
SALES AND SERVICE DISTRIBUTORS  
CALL TOLL FREE:  
1-800-222-4528

Datasouth Computer Corporation  
Box 240947 · Charlotte, NC 28224  
704/523-8500 · Telex 6843018 DASOU UW



has increased by 25 to 30 percent. Floppy-disk operations are much faster, too. Meanwhile, hard-disk loads and saves are so fast that although I have a full 2 megabytes of RAM disk, I find that I hardly ever bother to use it. The hard disk is not much slower.

I don't entirely trust the hard disk: every now and then I transfer all the new work to a floppy, and if the work is important enough, I do that again onto a different floppy at the end of the work session. So far I have not

needed those backups, but I'm a firm believer in saving early and often.

### Annoyances

Clearly, I like CP/M-8/16, and I can enthusiastically recommend the new Compupro hard disk and 8/16 operating system. However, it's not all smooth sailing.

Some difficulties are inherent in CP/M. User numbers are vital: without them, you'd never be able to partition a big hard disk into useful areas. That was the trouble with PC-

DOS 1.1 on the Eagle 1620: no directory structure, so that everything was in one interminable directory listing. PC-DOS 2.0 fixed that for the Eagle. CP/M-8/16 doesn't have a tree structure. You have to rely on user numbers, which are vital; but they're not really very convenient.

User numbers control user areas on both floppy and hard disks. Each user area has its own directory. When you first log onto CP/M, the user number is 0, and if you ask for a directory, you'll get the directory for User 0 and no other. Each user area acts as a separate "logical disk," so that disk drive A: can be divided into "drive" A0:, A1:, A2:, etc., up to A15:.

In addition, my hard disk is partitioned into five "logical" disk drives. That is, there's only one actual hard disk, but it acts exactly as if there are five, four of 10 megabytes each and a fifth of something less than 4 megabytes. These are designated drives A:, B:, C:, D:, and E:. Drive M: is the RAM disk. Drives F: and G: will be 5 1/4-inch floppies, and drives I: and J: are 8-inch double-sided double-density 1.1-megabyte floppies. Thus, I could have programs at, say, C12: and B9: in addition to A0:., etc.

Keeping track of just which programs are in which disk area is no easy task, since under CP/M there's no global directory command. That is, if you have files on disk D: under User 13, you'll never be able to list them unless you specifically ask for the D13: directory, and even then you may miss it if you've designated those files as System or "hidden."

When we first installed the hard-disk system, we did a lot of tests, including exercising the random-access capabilities. One program that does very complicated random-access disk I/O is my accounting system, so we went to unused user areas and did a lot of journalizing and posting. When I was done, I had no idea of where we'd put those no longer wanted account files. I was prepared to log onto each logical disk and patiently go from User 0 to User 15 looking for directories, but that seemed a bit tedious. Better, perhaps, to read the instructions.

Alas, the Digital Research CP/M

## GET UP THE RAMP WITH OUR EE/EPROM PROGRAMMERS & UV ERASERS

**R**eliability  
**A**ffordability  
**M**aintainability  
**P**rogram



### NOW AVAILABLE, PAL PROGRAMMERS (call)

**GANGPRO-8™ MULTIPROGRAMMER** ..... \$995.00  
GANGPRO-8™ allows user to program up to 8 EE/EPROMS simultaneously using the latest state of the art programming algorithms. It can test and duplicate a wide variety of devices from 1K to 256K. There are no personality modules to buy. 8 digit alphanumeric display prompts user with messages. This unit is extremely easy to operate and is ideally suited for a production environment.

**QUV-T8™ series UV EPROM ERASERS**  
**QUV-T8/2T (\$97.50)** is an industrial quality eraser designed in a steel enclosure with a 5" wide tray UV indicator lens, anti-static pad, 60 minute rugged timer and safety interlock switch are standard. Capacity is 24 EPROMS. 15-20 minutes erase time for 15 EPROMS.

**QUV-T8 / 2 (\$124.95)** Similar to QUV-T8/2T (with 40% faster Erase Time).

**QUV-T8/2N (\$68.95)** Same as the QUV-T8/2T version without the timer and safety interlock switch.

**QUV-T8/1 (\$49.95)** Economy model in a molded two part plastic case. Erases 15 EPROMS in 15 minutes.

\*MCS-48 is a registered trademark of Intel Co.

**PROMPRO-7™ SERIAL RS-232 STAND-ALONE** ..... \$489.00  
MCS-48™ FAMILY PROGRAMMING WITH PROMPRO-7™ PROMPRO-7™ is an intelligent self-contained unit ideally suited for engineering development or for field service & production. It can program and verify a wide variety of 8K to 128K EPROMS. This unit has a 32K (4K BYTES) internal RAM buffer that could be accessed by the user through a computer or terminal. This unit can also program the micro chips such as the 6478, 8749, 8751, 8741, 8742, 8755. The price includes all modules up to 32K EPROMS & The 8748 & 8749H Micros Upload/download is done by either Motorola or Intel Hex format.

**PROMPRO-8™ SERIAL RS-232 STAND-ALONE** ..... \$689.00  
This extremely versatile programmer has as much as 128K (16Kx8) of internal RAM dedicated to the EE/EPROMS. This RAM buffer can be accessed either through a computer terminal, or by user target system (EPROM emulation). PROMPRO-8 8 digit alphanumeric display prompts user with the system messages. A keypad option is available for stand-alone editing. An impressive range of devices are programmed (as standard feature).

**ORDER TOLL FREE 1-800-EEL-PROM (331-7766)**

AVAILABLE SOFTWARE DRIVERS

1. IBM PC                    2. APPLE II                    3. MDS-ISIS                    4. CPM  
5. TEKTRONICS 8002       6. COMMODORE 64       7. TRS-80 COLOR            8. FLEX

**LOGICAL DEVICES, INC.**

DEPT. 6, 132-E N.W. 65th PLACE, FORT LAUDERDALE, FLORIDA 33309  
INFO. TEL. (305) 974-0967  
DISTRIBUTORS WELCOME FOR QUALIFICATIONS

SEE US AT COMDEX  
SPRING ATLANTA





# PC Owners . . . Reach for Your Phone! This Winchester is Loaded . . . with **UNIX** Software.



That's right, partner. Now is the time to upgrade your PC with the *Sundown*™ disk. Includes controller. Installs right inside your PC in less than 10 minutes. Backed by our full one-year warranty.

But that's only half the story . . . The *Sundown* comes loaded with *VenturCom Venix/386*. This highly-acclaimed operating system is a licensed implementation of AT&T's UNIX and is the only MULTI-USER, MULTI-TASKING UNIX environment available on the IBM PC. Plus you can store and run your MS/DOS programs and files as well!

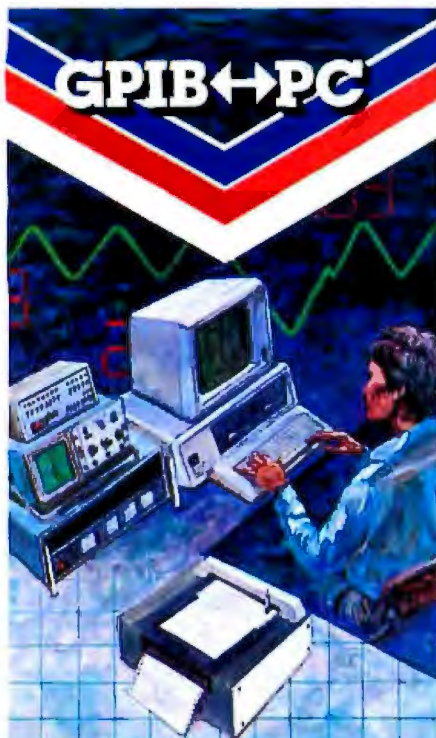
We offer immediate delivery. And our price . . . now that will blow your boots off! Need we say more? Reach for your phone and dial:

## 617-491-1264

Unisource Software Corp., Department 4109  
71 Bent Street, Cambridge, MA 02141

\*UNIX is a trademark of Bell Laboratories.





**IEEE-488**  
High Speed Interfaces  
for Personal Computers

- IBM PC™
- IBM PC Compatibles
- RAINBOW 100™
- Zenith Z-100™
- TI professional

Language Support—BASIC,  
C, FORTRAN, Pascal, Assembly

Operating Systems—PC DOS,  
MS-DOS, CPM 86/80, Z DOS, UNIX

Software Compatible with our  
family of IEEE-488 Interfaces  
for VAX, PDP-11, LSI-11, S-100  
BUS, STD BUS, SBX, and  
Multibus computers.



**NATIONAL  
INSTRUMENTS**

The Leader in IEEE-488  
Computer Interfaces

12109 Technology Blvd.  
Austin, Texas • 78727  
800/531-5066 • 512/250-9119

Rainbow™ is a trademark of Digital Equipment Corp.  
IBM PC™ is a trademark of International Business Machines.

manuals say very little about user areas. There's no discussion, and what information that does exist is scattered through the USER, PIP, and STAT command explanations. The USER command discussion tells you that command STAT USR: will tell you which user numbers have files on a particular disk. Of course, since this is Digital Research documentation, the little *CP/M-86 Command Summary* book doesn't mention USR: in the USER command section, so I'd missed it. It was only when I sat down to write this that I discovered that the full *DR CP/M-86 User's Guide* does mention a command STAT USR:. It would have saved me considerable time if it had been in the *Command Summary* book.

That command is fine, except that apparently you have to log onto each disk in turn to find out which user areas have files. This isn't very convenient. In fact, it's even worse than you think.

CP/M-8/16 has one great feature. Command files that are stored on as System files on disk drive A: under User 0 are accessible to *all* disk drives and *all* user numbers. Thus, I can put XD.COM, WRITE.COM, and other programs I use all the time onto the A: drive, and even though I'm now working with data on the C: drive under User 3, I have immediate access to the A0 command programs.

Alas, the version of CP/M-8/16 that I have has one lousy feature: the "A: User 0" access feature works only with .COM, i.e., 8-bit command files. If I want to use a .CMD (16-bit) command file, it must be present in user area 0 on the disk I'm logged onto. In particular, STAT.CMD must be present on disks B:, C:, D:, and E: if I want to log onto one of those disks and find out which user areas have files stored in them. Moreover, if PIP.CMD isn't on each logical disk, I have to go back to logical disk A: to transfer files from one place to another.

It's no good using PIP.COM and STAT.COM either. They get confused easily in a 16-bit environment. It's best simply to erase them, because you should use PIP.CMD and STAT.CMD.

Sigh. I carefully transferred STAT.CMD to each of the logical disks, then logged onto each in turn and did STAT USR:, which worked fine, although it wasn't very convenient. Then I had an idea. There was no entry under USR: in the index, but careful reading of Digital Research's *User's Guide* entries for STAT turned up the command syntax STAT {d:}USR:. Although there was no example, and I thought B:USR: a very strange command form indeed, when I tried it, I found it worked. Now I have a SUBMIT file called STATUSE.SUB that does STAT USR: for all the logical areas of my hard disk. Wheee!

If I seem a bit sarcastic, BYTE's managing editor has just received a very biting letter from the manager of the Digital Research documentation shop, who says I'll have nothing to write about if I stop unjustly accusing DR of bad documentation. He invites BYTE to require me to look at the Digital Research CP/M-86 documents as a prime example of the new excellent documentation DR now produces. I have just spent several hours experimenting with ways of using PIP with user numbers. Although this is vital to hard-disk management, there are precisely three examples of user-number options with PIP, and one of them contains an unexplained \* in the command option. There is no example of how to transfer files from one disk to another while changing user numbers when you're logged onto yet a third disk under yet a third user number. It turns out that can be done; but I've wasted hours trying to discover what DR could have told me in 10 lines of text, and after that letter it sent, I'm not in a charitable mood.

Aside, for the record: as I've said more than once, Digital Research's documents have shown remarkable improvement. There's room for more. Some of the improvement is said to be due to my flaying of both its old documents and its rather horrible intermediate "improvements" by a group of technical writers. I'm aware DR has put a lot of effort into document improvement, and the com-



# Gifford has a lock on multiuser CP/M® 8-16.

## It's 11:00 P.M. Do you know where your files are?

It's great when multiple local and off site users can run any 8- or 16-bit CP/M or MP/M™ program. It's even better when they can share expensive resources like printers, hard disks, and tape drives. Best of all is when they can share your most precious resource—data. Gifford has been delivering systems with all these features for over two years.

But sometimes data is sensitive. How do you keep people from taking more than their fair share?

## Gifford adds a new dimension to CP/M security.

With our new security features, you can control what resources and data are shared.

Gifford's proprietary security enhancements include user login with encrypted passwords, control over access rights of modem users, secure electronic mail, and the ability to restrict users to specified terminals, programs, and directory areas. Plus, an audit log utility that keeps a permanent record of system activity. And you also get all the standard security features of Digital Research's MP/M-86.™

You select the level of security needed to get the best balance between file sharing and file safety.

## Unleash productivity with Gifford's Virtual Terminals.

With our Virtual Terminals, each terminal on your system can monitor up to four different programs running concurrently. And at the touch of a key you can switch screens instantly from one program to another.

You could look up an address in dBASE II,™ jump over to SuperCalc™ to make some projections, then switch instantly to WordStar® to use this information to update a letter. If you forget what's on a screen, just touch a key to refresh your memory. You won't need to go through the distracting process of loading and unloading programs.

And since your Virtual Terminal can run any 8- or 16-bit CP/M or MP/M program, you can choose the best programs for your job from the biggest software library in the world. It's easier than 1, 2, 3!

## The Gifford Security Blanket: Total Solutions.

Gifford delivers solutions. This means professional pre-sale consultation, expert system integration with 200 hour system burn-in, complete training, and full after sale support.

For example, our three user CompuPro® based system with a 21-megabyte hard disk costs just \$9,990, and can be easily expanded for \$500 per

user. This includes MP/M 8-16, SuperCalc, and dBASE II.

Other Gifford solutions include systems with hard disks that range from 5 to 300 megabytes, 4 and 9 track tape backup, printers, plotters, and modems. Single- and multiuser 8086, 68000, and Z-80 based systems are available for immediate delivery, with 80286 and 16032 systems on the way.

## Two year warranty protection.

In the unlikely event that you encounter a hardware related problem, we'll replace any defective S-100 part within 24 hours FREE for two full years. But chances are, it can be solved on the Gifford service hotline or diagnosed via modem. All at no cost to you.

## Lock in on Gifford Security today.

If total support, training, on site service, obsolescence-proof upgradeable S-100 bus architecture, and complete system security sound appealing, cut the coupon or give us a call. We'll send you a free brochure that tells the whole story. Once you get it you'll see why Gifford has a lock on multiuser CP/M 8-16.

## Gifford Computer Systems is a Full Service CompuPro® Systems Center.



*The powerful Gifford System 321 shown with optional GCS-80 Virtual Terminals.*

**GIFFORD**  
COMPUTER SYSTEMS

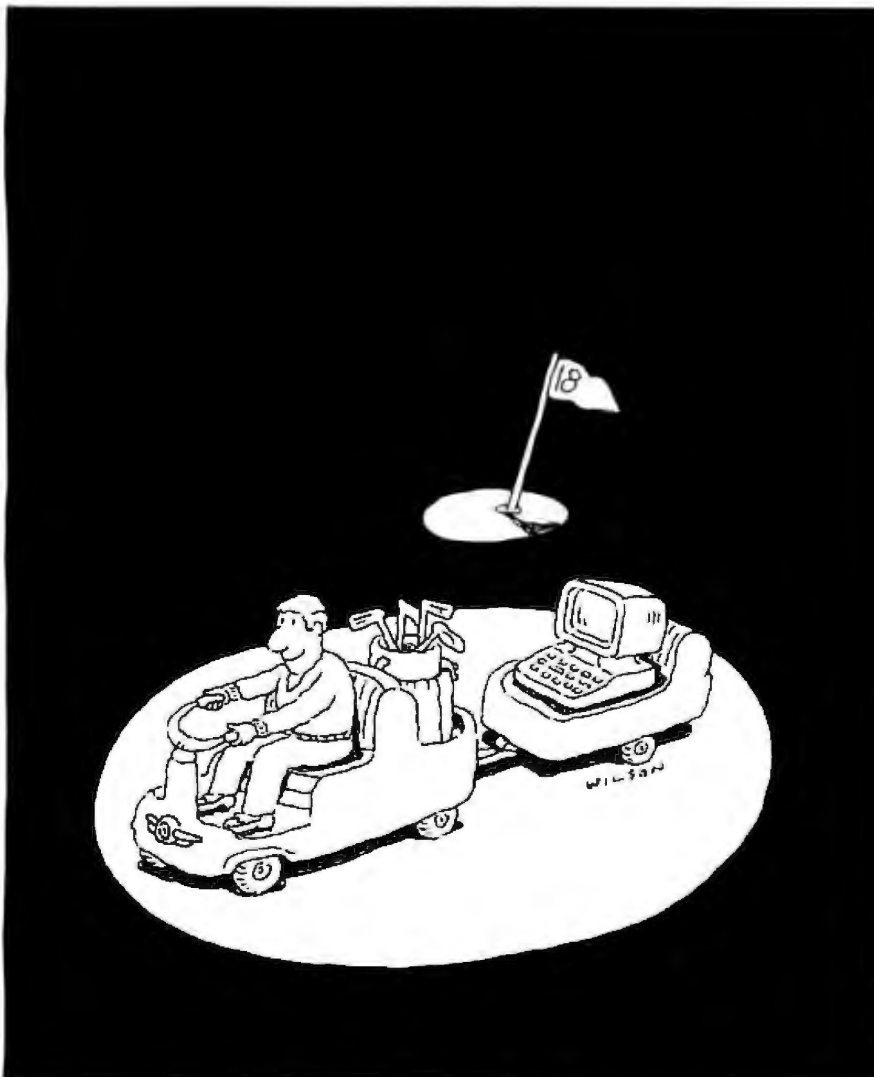
2446 Verna Court, San Leandro, CA 94577  
(415) 895-0798 A division of G&G Engineering  
I'D LIKE THE WHOLE STORY.  
Please send me your brochure.

Name \_\_\_\_\_ Title \_\_\_\_\_  
Organization \_\_\_\_\_ M/S \_\_\_\_\_  
Address \_\_\_\_\_  
City \_\_\_\_\_ State \_\_\_\_\_ Zip \_\_\_\_\_  
Phone \_\_\_\_\_

Please have a representative call me. **BY-S**

GIFFORD COMPUTER SYSTEMS □ San Leandro, CA (415) 895-0798 □ Los Angeles, CA (213) 477-3921 □ Houston, TX (713) 680-1944  
Amherst, NY (716) 833-4758 □ Telex: 704521





## Podunk or Pebble Beach?

Golf at a world famous course is just one of the many rewards of investment success. Improve your chances for that success with Dow Jones News/Retrieval®

Even if you're just starting out in the market, Dow Jones News/Retrieval can help compress hours of research into instantaneous, well-organized, well-timed reports and analyses you can use to pinpoint trends and opportunities and improve your chances for investment success.

Dow Jones News/Retrieval gives you more time to assess more of what you need to know: company and industry activity, economic and

earnings forecasts, Securities and Exchange Commission reports, and electronic stock quotes that are continuously monitored for accuracy by our staff.

The wide variety of high-quality data bases accessible on most personal computers include Dow Jones Current and Historical Quotes, as well as exclusive access to *The Wall Street Journal*, *Barron's* and the Dow Jones News Service.

As smart investors everywhere have discovered, there's only one Dow Jones...and only one Dow Jones News/Retrieval. Invest a few moments right now and discover the difference it can make for you.

# DOW JONES NEWS/RETRIEVAL®

Copyright © 1984, Dow Jones and Company, Inc. All Rights Reserved.  
Dow Jones News/Retrieval® is a registered trademark of Dow Jones and Company, Inc.

**FOR FULL DETAILS, CALL 800-345-8500, EXT. 144**

Alaska, Hawaii and foreign, call 1-215-789-7008, Ext. 144

pany has made great strides. I also realize that documentation is tough, and it's particularly difficult if you're writing for naive users about complex products like operating systems and compilers.

I've also said, repeatedly to the point of nausea, that examples and indexes will cover a myriad of sins. If *USR:* had been an index entry, I might have had a chance. If there had been more examples of how to use PIP with changing user numbers, I'd have saved time. Please, Digital Research: you're much improved since the CP/M 2.2 manuals, but you have not reached perfection yet.

Back to hard disks and 8/16: I'm hooked. There are too many advantages to having that much data on line.

Alas, I don't yet have one of the advantages. That is, I've been using Ward Christensen's wonderful disk-catalog program to keep track of the myriad floppies I've collected since 1976. It's possible to use that program to locate particular files and particular disks, but the catalog-library file the program must search is very large, and on floppies it was just too slow. I wrote a program that prints out the master catalog on paper. (My printer program, Christensen's public-domain catalog program, and a bunch of other useful stuff are available from Workman and Associates as one utility disk.) Christensen unfortunately wrote his catalog program long enough ago that there was no possibility of disks beyond H:. Consequently, I can't catalog floppy disks with it unless I boot up the system under the old CP/M 2.2 BIOS.

However: I can do that. The hard disk is no longer available when I do that, but so what? I can catalog floppies, and when that's all done, reboot under CP/M-8/16, use PIP to put the master catalog onto the hard disk, and keep it on line. The catalog program will search the master file all right; it's only the disk-map utility that won't run.

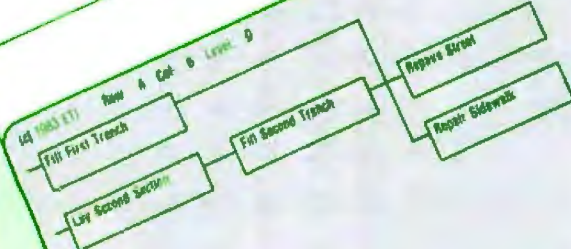
The bottom line on hard disks and 8/16 is that there may be aggravations, but the advantages are high. After all, this is a test setup, and I did volunteer to be a guinea pig. By the

*Text continued on page 70*



# ETI's Four Ways To Better Management

## Project Control System

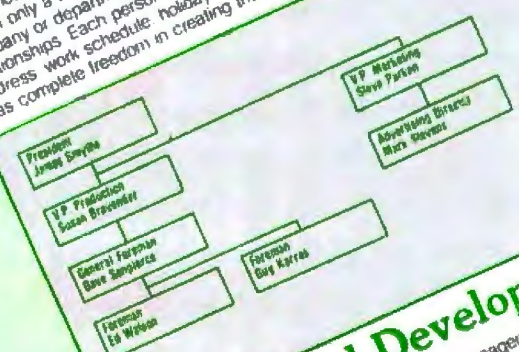


The ETI Project Control System is a visual project management tool. It allows the user to divide large, complex projects into individual tasks and operations. Based on the proven CPM and PERT methodologies, the ETI Project Control System offers uncluttered "what you see is what you get" displays and extensive user flexibility. With a few keystrokes, the ETI Project Control System can draw a task chart to fit nearly any project. Each task may include name, duration, capital cost, labor cost, overhead cost, amount completed, starting and ending dates (including early and late dates) and a narrative description.

Better understanding and control of complex projects is only one result of using the ETI Project Control System. It can also help find schedule threats and test alternatives, or seek the best cost/time tradeoffs. In addition, there are management-aiding displays such as schedule charts, personal schedules, assignment lists and charts that show either budgeted or actual costs.

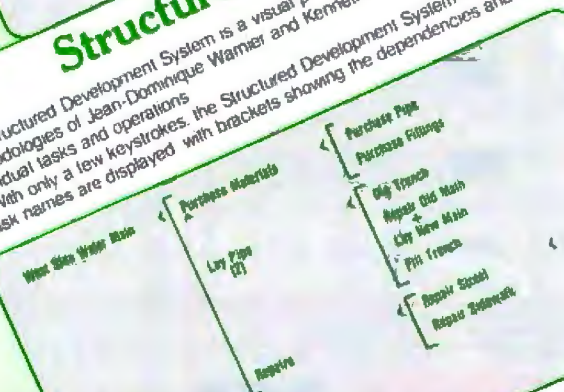
## Personnel System

The ETI Personnel System is a visual personnel management tool. It allows the user to organize a firm's most important resource - its personnel. With only a few keystrokes, the Personnel System can draw an organization chart to fit nearly any company or department. Persons are displayed in boxes, with lines showing the hierarchical relationships. Each personnel record may include the person's name, department, job title and salary. address, work schedule, holiday and vacation schedule, and a narrative description. The user has complete freedom in creating the organization chart. People may be added, removed, or moved anywhere on the organization chart. No additional graphics hardware is required. If you have a printer, what you see is what you get. Reporting of all charts and personnel information transfers your organization chart does not fit on a single page, it will be printed on multiple pages which may be taped together to form a complete chart.



## Structured Development System

The Structured Development System is a visual project management tool. Based on the structured methodologies of Jean-Dominique Warner and Kenneth Orr, it allows the user to divide large complex projects into individual tasks and operations. Each task may include a narrative description in addition to the task name. The user has complete freedom in creating the Warner chart. Tasks may be added, removed, or moved anywhere on the Warner chart. No additional graphics hardware is required. If you have a printer, what you see is what you get. Reporting of all charts and narratives transfers your ideas to paper. If the Warner chart does not fit on a single page, it will be printed on multiple pages which may be taped together to form a complete chart.



## Micro-Reminder

Micro-Reminder is an important tool for anyone who wants to use the computer to organize their time. Even if you have never used a computer, you will feel at ease with Micro-Reminder and quickly learn to use all of its powerful features. With Micro-Reminder, you can use the computer's memory to help remember all the details of your appointments. You can also use Micro-Reminder to write yourself short reminders, and keep track of the tasks facing you. Last, Micro-Reminder allows you to store names, addresses, and phone numbers for easy reference. Micro-Reminder separates these functions into three windows: Calendar, Appointments Reminders, and Addresses. Things To-Do, and you can see any of the information change it, or enter new items.

November 1983

1	2	3	4	5	6	7
8	9	10	11	12	13	14
15	16	17	18	19	20	21
22	23	24	25	26	27	28
29	30	31				

Appointments  
November 8, 1983

- 10:30 Marketing Meeting
- 1:30 Sales Meeting
- Micro-Reminder Presentation

12:30

13:30

14:30

15:30

16:30

17:30

18:30

19:30

20:30

21:30

22:30

23:30

24:30

25:30

26:30

27:30

28:30

29:30

30:30

31:30

Address

James Wilson  
121 E. North  
Greenhouse, MI

Bob Jones  
204 N. East  
Greenhouse, MI

Dave Matthews  
456 S. West  
Easton, MI

F1 Find  
F2 Print  
F3 Insert Line  
F4 Delete Line  
F5 Appointments  
F6 Quit  
F7 Reminders  
Change To-Do

All programs require an IBM Personal Computer with microchannel display (turning PC), DOS, a memory of 128K or more bytes of RAM, and one disk drive with at least 256K byte capacity. No printer is required, but any printer with at least 80 columns may be used. IBM and PC, DOS are trademarks of International Business Machines.

# ETI

ETI • 5848 EXECUTIVE DRIVE  
LANSING, MI 48910 • (517) 887-2480



7400

Number of Pins of each I.C. in many cases

MICROPROCESSOR COMPONENTS

Table listing 7400 series components with columns for Part No., Price, and Pin.

Table listing various microprocessor chips with columns for Part No., Price, and Pin.

Table listing Z80, Z8000, and Z8000 series components with columns for Part No., Price, and Pin.

Table listing dynamic RAMs with columns for Part No., Price, and Pin.

DT1050 - Applications: Teaching aids, appliances, clocks, automotive, telecommunications, language translations, etc.

DT1050 Digtalker... \$34.95 ea. MM54104 Processor Chip \$14.95 ea.

DT1057 - Expands the DT1050 vocabulary from 137 to over 260 words. Includes 2 ROMs and spec. Part No. DT1057 \$24.95 ea.

Table listing Intersil components with columns for Part No., Price, and Pin.

30009 1983 Intersil Data Book (96pp) \$9.95

Table listing 74HC High Speed CMOS components with columns for Part No., Price, and Pin.

Table listing 74C-C/MOS components with columns for Part No., Price, and Pin.

Table listing Linear components with columns for Part No., Price, and Pin.

Table listing CA-LINEAR components with columns for Part No., Price, and Pin.

Table listing CD-CMOS components with columns for Part No., Price, and Pin.

Table listing LOW PROFILE (TIN) SOCKETS with columns for Pin, Price, and Pin.

Table listing SOLDTAIL STANDARD (TIN) components with columns for Pin, Price, and Pin.

Table listing WIRE WRAP SOCKETS (GOLD LEVEL #3) with columns for Pin, Price, and Pin.

MasterCard JAMECO ELECTRONICS VISA 1355 SHOREWAY ROAD, BELMONT, CA 94002



VOICE SYNTHESIZER FOR APPLE AND COMMODORE

NEW!



JE520CM

JE520AP

Over 250 word vocabulary... Built-in amplifier, speaker, volume control, and audio jack...

- APPLICATORS: Security Warning, Teaching, Instrumentation, Handicommunication, Teleprint Aid, Games

The JE520 VOICE SYNTHESIZER will plug right into your computer and allow you to enhance almost any application...

Table with 3 columns: Part No., Description, Price. Includes JE520CM and JE520AP.



NEW! Software for IBM Computers

JE664 EPROM PROGRAMMER

8K to 64K EPROMS - 24 & 28 Pin Packages. Completely Self-Contained - Requires No Additional Supplies for Operation...

The JE664 EPROM Programmer simulates and programs various 8-Bit EPROMs from 8K to 64K...

JE664-A EPROM Programmer

JE664-A EPROM Programmer... \$995.00

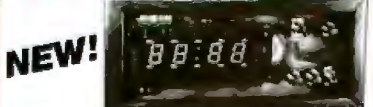
FOR A LIMITED TIME A SAMPLE OF SOFTWARE WRITTEN IN BASIC FOR THE TRS-80 MODEL I LEVEL 3 COMPUTER WILL ALSO BE PROVIDED

JE664-BASER EPROM Prog. w/ JE664 Option

\$1195.00

Table with 4 columns: JE664-BASER Model, Program, Price. Lists various models and their prices.

4-Digit Fluorescent Alarm Clock Kit

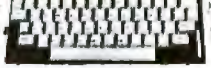


Bright 4-digit 0.5" high display - 10 minute snooze alarm - AM/PM indicator - Automatic display dimmer

The JE750 Clock Kit is a versatile 12-hour digital clock with 24-hour alarm...

JE750 Alarm Clock Kit... \$29.95

Mitsumi 54-Key Unencoded Matrix All-Purpose Keyboard



13 1/2" L x 4 1/2" W x 1 1/2" H

71-Key ASCII Cherry Keyboard



18" L x 7 1/2" W x 1 1/2" H

SPST keyswitches - 20 pin ribbon cable connection - Low profile keys...

KB54... \$14.95

106-Key 8-Bit Serial ASCII Keyboard



21 1/2" L x 9 8/16" W x 3 1/4" H

7 bit parallel ASCII with strobe - 11 key numeric keypad - SPST mechanical keyswitches...

KB1801... \$29.95

Power/Mate Corp. REGULATED POWER SUPPLY



EMAS/BB EMAS/BC

Input 105-125/210-250 VAC at 47-63 Hz - Line regulation: ±0.05% - Three mounting surfaces - Overvoltage protection - UL recognized - CSA certified

EMAS/BB 5V @ 3A/5V @ 2.5A 4 1/2" L x 4" W x 2 1/4" H 2 lbs. \$29.95

EMAS/BC 5V @ 5A/5V @ 5A 5 1/2" L x 4 1/2" W x 2 1/4" H 4 lbs. \$39.95



PS94VDS

Input 115VAC, 50-60Hz @ 3 amp/230VAC, 50% @ 1.8 amp - Fan with power supply control switches (115/230VDC) - Output 5VDC @ 7.6 amp, 12VDC @ 1.5 amp - 9 foot black power cord - Size: 11 1/2" x 12 1/2" x 3 1/4" - Weight: 8 lbs.

PS94VDS... \$39.95



KRP4007

Microprocessor, mini-computer, terminal, medical equipment and process control applications - Input 115/230VAC, 50/60Hz - Output: 5V @ 5 amp, +12V @ 1.8 amp, +12V @ 2 amp, -12V @ 0.5 amp - I.A. recognized - CSA certified

Size 7 1/2" L x 6-3/16" W x 1 1/4" H - Weight: 2 lbs.

KRP4007... \$59.95



FCS-604A

Microprocessor, mini-computer, terminal, medical equipment and process control applications - Input 115/230VAC, 47-63Hz - Output: 5VDC @ 5A, 5VDC @ 1A, +12VDC @ 1A, -12VDC @ 1A - Line regulations: 0.2% - Ripple: 30mV p-p - Load regulation: 1% - Overcurrent protection - Adj. 5V main output 10% - Size 6 1/2" L x 1 1/2" W x 4-15/16" H - Weight: 1 1/2 lbs.

FCS-604A... \$69.95 each



KHP4007

Can drive four floppy disk drives and up to eight expansion cards - Short circuit and overload protection - Fits inside Apple computer

Weight: 2 lbs.

KHP4007... \$79.95



Model FLEXIBLE DISK

DISKETTES AND ACCESSORIES

5 1/4" and 8" Diskettes

ULTRA MAGNETICS - 5 1/4" DISKETTES

Table with 4 columns: Part No., Description, Speed, Price. Lists Ultra Magnetics 5 1/4" diskettes.

SK (ESKIE) - 5 1/4" DISKETTES

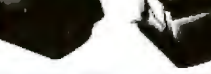
Table with 4 columns: Part No., Description, Speed, Price. Lists SK (ESKIE) 5 1/4" diskettes.

ULTRA MAGNETICS - 8" DISKETTES

Table with 4 columns: Part No., Description, Speed, Price. Lists Ultra Magnetics 8" diskettes.

DISKETTE ACCESSORIES

Disk Minder



Attractive, functional disk storage system - 50 slots for 75 5 1/4" disk storage capacity - Easy filing and retrieving

Part No. Description Price

DM75 Storage 75 (5 1/4") Diskettes \$19.95 each

DM75 Storage 50 (5 1/4") Diskettes \$19.95 each

MAIL PAK

Stores 10 (5 1/4") diskettes - Protects disk from dust contamination - Durable smoked plastic - Size: 6 1/2" x 5 1/2" x 1 1/4" - Weight: 2 lbs.

Part No. Description Price

MP-08 Storage 10 (5 1/4") Diskettes \$2.95 each

MP-08 Storage 5 (5 1/4") Diskettes \$2.95 each

Disquette Envelopes

Saves for Bulk-Purchased Disquettes

Table with 4 columns: Part No., Description, Price. Lists Disquette Envelopes.

Vinyl Pages

For 3-Ring Binders

Table with 4 columns: Part No., Description, Price. Lists Vinyl Pages.

Mail Pak

Stores up to 30 diskettes

Table with 4 columns: Part No., Description, Price. Lists Mail Pak products.

Part No. Description Price

MP-08 Storage 10 (5 1/4") Diskettes \$2.95 each

MP-08 Storage 5 (5 1/4") Diskettes \$2.95 each

MP-08 Storage 10 (5 1/4") Diskettes \$2.95 each

MP-08 Storage 5 (5 1/4") Diskettes \$2.95 each

MP-08 Storage 10 (5 1/4") Diskettes \$2.95 each

MP-08 Storage 5 (5 1/4") Diskettes \$2.95 each

MP-08 Storage 10 (5 1/4") Diskettes \$2.95 each

MP-08 Storage 5 (5 1/4") Diskettes \$2.95 each

MP-08 Storage 10 (5 1/4") Diskettes \$2.95 each

MP-08 Storage 5 (5 1/4") Diskettes \$2.95 each

8" FLOPPY DISK DRIVE



- Single-Sided, 77 Tracks, 400/800K Bytes Capacity, Industry Standard

The FDD100-8" Floppy Disk Drive (Industry Standard) features single or double density Recording mode FM single, MFM double density Transfer rate 250K bits/sec. single density, 500K bits/sec. double density. The FDD100-8 is designed to work with the single sided soft sector IBM Diskette I, or ed. disk cartridge Power 115VAC @ 50-60Hz, ±2VDC @ 1.7 amps max., ±5VDC @ 1.2 amps max. Unit as pictured above (does not include case, power supply, or cables). Size: 6.95" x 14 1/4" x 4 1/4" Weighs 12 lbs. incl. 95pg manual

FDD100-8 .. \$169.95 ea.

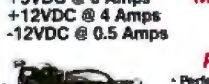
5 1/4" APPLE™ Direct Plug-In Compatible Disk Drive



- Uses Shugart SA3M mechanics - 16K formatted storage - 35 tracks - compatible with Apple controller - Complete with connector and cable - just plug into your 5 1/4" computer - Size: 6 1/2" x 3 1/4" x 5/8" - Weight: 4 lbs.

ADD-514... \$195.95

Microcomputer Power Inc. Regulated Power Supply



- Perfect for computer or disk drive systems - Supply has 4AMP connectors for direct connection to two 5 1/4" disk drives - Cooling fan - Output: 100V/115/200/230VAC, 47-63Hz - Output (above) - Weight: 9 lbs.

13 1/2" L x 8 1/2" W x 5 1/4" H

CP167... \$59.95

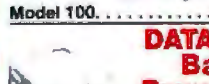
DATASHIELD™ Protect Yourself... Surge Protector



- Eliminates voltage spikes and EMI-RFI noise before it can damage your equipment or cause data loss - 1000 microsecond response - Power dissipation: 1000 microsecond, 1,000,000 watts - 6 sockets - 6 foot power cord - Normal line voltage indicator light - Brown out/black out reset switch - Weight: 2 lbs.

Model 100... \$69.95

DATASHIELD Back-Up Power Source



- Provides up to 30 minutes of continuous 120 VAC 60Hz power to your computer system (load dependent) - Includes battery and battery pack - Voltage sag - Output rating: 200 watts - Six month warranty - Weight: 18 lbs.

Model 200 (PC200)... \$349.95

IBM MEMORY EXPANSION KIT COMPAQ COMPATIBILITY

SAVE HUNDREDS OF \$\$\$ BY UPGRADING MEMORY BOARDS YOURSELF!

Most of the popular memory boards allow you to add an additional 64K, 128K, 192K, or 256K. The IBM/MSX kit will populate these boards in 64K bits increments. It's simple to install - just insert the new 64K RAM chips in the provided sockets and set the two groups of switches. Directions are included.

IBM64K (Nine 200ns 64K RAMs) ... \$49.95

TRS-80 MEMORY EXPANSION KIT

TRS-80 to 18K, 32K, or 48K

Model 1 = From 4K to 18K Requires (1) One Kit

Model 3 = From 4K to 48K Requires (3) Three Kits

Color = From 4K to 16K Requires (1) One Kit

Model 1 equipped with Expansion Board up to 16K Two Kits Required - One Kit Required for each 16K Kit Expansion

TRS-16K3 \*200ns for Color & Model III... \$12.95

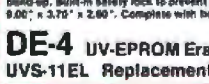
TRS-16K4 \*250ns for Model I... \$10.95

TRS-80 Color 32K or 64K Conversion Kit

Easy to install kit comes complete with 8 ea. 4184-2 (200ns) 64K dynamic RAM's and conversion documentation. Converts TRS-80 color computers with D, E, E.T, F and MC circuit boards to 32K. Also converts TRS-80 color computer to 64K. Flex DOS or OS-9 required to utilize full 64K RAM on all computers.

TRS-64K2... \$44.95

UV-EPROM Eraser



- 8 Chips - 51 Minutes, 1 Chip - 37 Minutes

Erases 2708, 2716, 2732, 2764, 2516, 2532, 2564 Erases up to 8 chips within 51 minutes (1 chip in 37 minutes). Maintains constant exposure distance of one inch. Special conductive floor liner eliminates static build-up. Built-in safety lock to prevent UV exposure. Compact - only 9.00" x 3.75" x 2.60". Complete with holding tray for 8 chips.

DE-4 UV-EPROM Eraser ... \$79.95

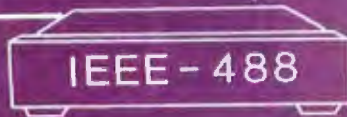
UVS-11EL Replacement Bulb ... \$16.95

Jameco Electronics logo and address: 1355 SHOREWAY ROAD, BELMONT, CA 94002





IBM-PC/XT or PC compatible  
IEEE-488 INTERFACE BOARD



• Implements the entire IEEE-488 standard – transfer commands and data, perform serial and parallel polling.

• A resident firmware interpreter simplifies programming and accepts any ASCII string or code including Tektronix Standard Codes and Formats and IEEE-488 command mnemonics. Interpreter routines support BASIC, PASCAL, C and other languages.

• Supports the PrtSc (print screen) key, and all BASIC print statements for IEEE-488 printers and devices.

• Small size – see BYTE 11/83, p. 314

• Accepts a standard IEEE-488 cable.

• Uses only 16 bytes of RAM and no I/O parts.

• A 116 page Reference Manual provides a tutorial and programming examples for digitizing, interactive bus control, bus diagnostics, and many other applications.

• \$395 complete. There are no extra software or cabling charges.



CAPITAL EQUIPMENT CORP

10 Evergreen Avenue  
Burlington, MA. 01803  
(617) 273-1818

IBM is a trademark of International Business Machines Corp.

Text continued from page 66:

time you see this, much of what annoys me will be taken care of. Even if there were to be no more changes, I'd stay with it. There are enough advantages already.

### Sage Faire

The Sage Computer Faire was held in Reno in early February at the MGM Grand Hotel, where they stage the San Francisco earthquake twice nightly. The MGM dinner show is the most spectacular live stage presentation I've ever seen.

That's not why I went. In the past two years, Sage Computer has taken the same commanding position with development systems based on the Motorola 68000 chip that Compupro holds with respect to the S-100 bus and systems based around the Intel 8086 and follow-ons. Apple will sell a lot more Macintosh 68000 systems, but the Sage is faster, more versatile, and has more software, including advanced languages, *now*. Moreover, I have it on good authority that there's more than one Sage being used to develop Macintosh software.

For those who don't know, we've had a Sage II since the very early days of that machine. It was the Sage and Volition Systems Modula-2 that got me interested in that language. We've never had a glitch with it, and our Sage II is even now being used by Dr. Michael Hyson to develop illustrative programs for the introductory Modula-2 book we are writing.

This year the company brought out the Sage IV, which is faster, has more memory, and has a hard disk. We'll be getting one this month. One reason I went to the Sage Faire was to look at software I might want for the IV.

I saw a lot of it.

Fewer than a thousand people attended the Sage Faire. It reminded me of some of the early micro conventions, the fun ones before they got so large. There was a difference, though: although there were enough hobbyists and hackers to make the conversations interesting, there were also a number of industry heavyweights to make it likely that what was said would have an effect. All told, I don't think I've more enjoyed

a convention since the West Coast Faire in Los Angeles where Carl Helmers, my late mad friend Dan MacLean, and I invented this column.

There's now plenty of software for the Sage: decent text editors, FORTH corresponding pretty well to what's described in Leo Brodie's *Starting FORTH*, what looks like an excellent LISP, and an impressive micro APL (you have to buy a special terminal in order to handle APL's screwy squiggles); there's UCSD Pascal; and of course there's Modula-2 from Volition Systems, with the full Modula-2 compiler and operating system to be available from Modula Research Institute very soon.

There's a small but strong market in add-on packages, such as modems for communications and a rumor of an Omninet retrofix for both IIs and IVs.

There are also application packages: business software that works. In as small a show as the Sage Faire, it's possible to look at everything in some detail. I liked most of what I saw. I was also able to talk to a number of publishers and their programmers, pointing out features I'd like to see and things I didn't care for. Some promised to make changes. We'll see.

I've purposely avoided specifics in the above, because I don't like commenting on things we haven't been able to run here at the Manor. Next month we'll have the Sage IV and whatever software I've been able to collect.

What's important is that the Sage looks to be here to stay. The factory in Reno is quite real, large enough for considerable expansion if the company needs it, and not so expensive that it will go bankrupt paying for it. There's an enthusiastic work force and a lot of in-house use of Sage computers.

I've long thought Sage had the best 68000-based computers on the market. Now I'm certain of it.

### Two Views of the Future

Dr. William Godbout of Compupro and Rod Coleman of Sage are, in my judgment, two of a very small num-



# GET YOUR MESSAGE THROUGH.

## EVEN WHEN YOUR MODEM SENDS IT BY WAY OF THE OKEFENOKEE SWAMP.

When you send data by telephone through nasty environments like this, it can run into problems tougher than just alligators. Problems like impulse noise. Chatter from the switchgear. Static from the atmosphere or bad weather. Distortion due to crosstalk or just plain white noise.

To get your message through, your IBM PC or XT needs the advanced performance features of the PC: IntelliModem.™ It's got the best receive sensitivity available today — actually down below -50 dBm. So now you can achieve a high level of data transmission integrity. Even with bad connections.

### Get patented modem technology.

The PC: IntelliModem is elegantly simple. Its patented design does it all on a single microprocessor chip, with just one crystal. Other modems take

two, four or more  $\mu$ Ps (and even more oscillators), and still accomplish less.

How do we do this? By creating architectural innovations in firmware, and by pushing the chip to its limit, close to 12 MHz. Since it uses fewer parts, the PC: IntelliModem's no-compromise design offers higher reliability, a more compact form factor, and lower costs.



This design elegance leads naturally to more elegant performance. Take line status detection, for example. The PC: IntelliModem's adaptive, decision-directed logic monitors line status more closely than other modems. Even at weak or degraded signal levels. So it can make connections with less chance of error, by detecting signals for dial tone, remote ringback, busy and voice — some of which other modems ignore.

### Plan ahead with integrated voice and data.

For opening up a whole new world of integrated voice and data applications, there's nothing like the PC: IntelliModem. Literally. Its easy-to-use software package — PC: IntelliCom™ — lets you switch repeatedly between talking or listening and sending or receiving data. All at

### Make sure your modem has all these PC: IntelliModem features

#### Integrated Voice/Data

- Switch between voice and data communications
  - Programmable telephone handset jack
- #### Status Reporting
- Line status detection (dial tone, busy, remote ringback, voice answer, modem answer, incoming call)

- Audio monitor
- Programmable status LED

#### PC: IntelliCom™ Software Included

- 99-name on-line telephone directory
- Auto-dial, auto-repeat dial, auto-answer
- Link to another number if busy
- File transfer
- Data capture to diskette
- Programmable auto log-on sequences

#### Compatible with Crosstalk™ and PC-Talk III™

#### Pulse and Tone Dialing

Receive Sensitivity: -50 dBm  
Speeds: 110, 300, 1200 baud

the touch of a single function key. That means now both you and your computer can talk on the same line. Without having to hang up, re-dial or plug and unplug a lot of cables.

So if you're designing microcomputer datacomm products — or just looking for a PC/XT modem for yourself, check out the PC: IntelliModem at your local dealer. You'll get the message. And so will they. Or contact: Bizcomp, 532 Weddell Drive, Sunnyvale, CA 94089; 408/745-1616.

### Bizcomp: A history of innovation.

- 1980 Invented first command-driven modem
- 1981 Introduced proprietary line-status monitoring
- 1983 Designed first single- $\mu$ P 212A-compatible modem
- 1983 Introduced first integrated voice/data modem for IBM PC
- 1983 Granted patent on command-driven modem

# BIZCOMP®

We've got people talking.



**Heart of TEXAS  
COMPUTER SYSTEMS**

**TRS-80**

We carry the full line of TRS-80 computers, plus TCS upgrades. Call for our low discount prices.

- Model 100** Briefcase size. **CALL**
- Model IV Portable:** **CALL**
- Model 12, 16** at discount: **CALL**
- Model 12/16 Accessories/discount.**

**The TANDY-2000**

Check out this terrific new computer from Tandy. It's beautifully designed and very versatile. Four times faster than the IBM-PC and has twice the floppy disk capacity. MSDOS compatible. It's a great machine and we have a great price. **CALL!**

**DISK EXPANSION**

	M-III	M-IV
1 Controller, Pwr.Sup., Hdwr., Instruct.	\$249	\$329
2 Kit 1, plus 1/40-trk. Tandon Dr.	\$429	\$479
3 Kit 1, plus 2/40-trk. Tandon Dr.	\$589	\$649
3a Kit 3 w/2 80 trk.drives (dual sided 40s)	\$699	\$729

Model IV needs 64K to operate. For 64K Kit, **CALL.**

**Tandon**

Quality disk drives—O.E. brand on IBM Available bare and in cabinets.

- TM100-1: \$159**
- TM100-2: CALL** CALL US IF YOU FIND LOWER PRICES!

**CORVUS**

**25% OFF LIST PRICE!**

**OMNINET**— A high speed multi-user network that connects several computers for instant communication up to 4,000 feet away.

Save over \$1,000 on a 20 mg. Corvus Hard Disk system for IBM PC and other computers.

- 5mg. \$1649
- 10mg. \$2279
- 20mg. \$3049

**DAVONG  
Systems, Inc.**

Single user or networking hard disk system for IBM & Apple. Lowest prices anywhere. Priced from \$1375. 10, 15, 21, 32 mg. & cartridge tape backup—**CALL**

**Star PRINTERS**

Fast, dependable, versatile, low price.

- Gemini 10X** 9in., 120cps. Friction/Tractor
- Gemini 15X** 15in., 120cps. Friction/Tractor

**DISKETTES \$1.70**

**CompuDisk**, high quality mini floppy disks from \$1.70. Compare our prices. Disks come complete with hub rings, protective envelopes, write protect tabs, adhesive labels. Fully tested. Certified 100% Error Free. Guaranteed. SSDD or DSDD. Boxed or in Bulk. **CALL.**

**Heart of TEXAS  
COMPUTER SYSTEMS**

P.O. Box 1327 Arlington, TX 76004  
**Toll Free 1-800-433-5184**  
**Texas 1-817-274-5625**

VISA, MC, cashier's check, Money Order. No tax out of state. Texans add 5% Prices subject to change.

ber of key people in microcomputer development. Both sell topflight development equipment. Both have similar ideas about the future of computers. Godbout and Coleman are both after the business market, because that's where the high-volume sales are; but that's marketing strategy, not love.

Their hearts are with the development of high technology, largely for its own sake. Each foresees dramatic increases in computing power per dollar, and each is obsessed with building machines that access huge amounts of memory and work at the fastest possible speeds. The similarity ends there.

**Bill Godbout**

Although Godbout's Compupro company makes a 68000 microprocessor for its S-100 development system, there's little support for the board, and if there are any plans for follow-on developments, such as adding the National Semiconductor 16081 floating-point math chip, it's Compupro's best-kept secret. Dr. Godbout is betting heavily that the future of the micro lies with the Intel iAPX286 and its follow-ons. In addition, he's made some hefty investments in technology based on the National Semiconductor 16032; there's already a Compupro 16032 microprocessor board for the S-100 bus. You might be able to buy one about the time this is in print; about the same time you can probably buy a 286 system, but you'll pay a stiff price for it.

Within a year, though, prices will fall. They always do, and you'll be able to buy working machines with incredible power at reasonable prices. The trend toward more bang for the buck will continue; meanwhile, if you want to develop software for future computers, you can get a machine to develop it on now.

Godbout's development systems are based on the S-100 bus, which he figures will last a few more years before technology irrevocably passes it by. Meanwhile, you can buy a complete development system, with fast memory, disk drives, system support, input/output, etc., and change

microprocessor boards as they arrive; and you can have confidence that Godbout will do his best not to leave his customers hung out to dry.

Dr. Godbout likes to talk about future computer technology. So do I, which is a good thing, since when we get together even on thoroughly social occasions the conversation is likely to get technical, to the extreme boredom of the other guests. I have notebooks full of his speculations about the 16032, memory management, math chips, and the future of operating systems. In brief, he thinks supermicros in the future will be built around either the Intel 286 and follow-ons or the National Semiconductor 16032 and its upgrades; and that the operating system of the future will be multiuser multitasking Concurrent CP/M—which will be compatible with, possibly based on, and look an awful lot like Unix.

**Secrets ...**

Like Bill Godbout, Rod Coleman likes to talk technology, and until very recently his Sage Computer was one of the most open companies going. Almost anyone could call him and get him into a conversation on his view of the future.

Lately, though, his marketing and public-relations people have advised him to be a lot more careful, and he's reluctantly taking that advice: for example, everything said about future Sage products at Sage Faire was not only off the record, but preceded by a formal nondisclosure agreement. Unlike Compupro, Sage doesn't have multiple product lines. The Sage is a great 68000-based development system, but it also has to be Sage's business system; and although the Sage has been profitable from the first month it began shipping computers, the company is critically dependent on shipping machines to maintain its cash flow. There's no big wad of venture capital behind Sage; 90 percent is owned by the three original founders.

Thus, Sage is subject to the "Osborne phenomenon": announcements of future machines killing sales of present ones. I think the company worries too much: the present Sage



# The best ... for peanuts!

Get the most computing power from your IBM/PC Jr. with these exciting Amdex monitors.

The COLOR-1 accepts composite video input for complete compatibility ... and it has a built in speaker and quality resolution. It's the most popular color monitor in the entire world!

The VIDEO-300 with amber or green screen provides 80 column text or graphics display capability ... and its nylon mesh, non-glare screen eliminates distracting reflections.

Both monitors are backed with the best warranty in the business (2 years!) ... and you won't have to shell out a lot of money to own one.

2201 lively Blvd • Elk Grove Village, IL 60007  
(312) 364-1180 • FAX 25-4786

## AMDEK

REGIONAL OFFICES: Southern Calif (714) 662-3949 • Texas (817) 498-2334  
Northern Calif (408) 370-9300 • Denver (303) 794-1497





II and Sage IV are proven systems, with new software coming out every week, which is what business customers want. It's one of Pournelle's rules for users: the best computer to buy is a development system after it has been around a couple of years. You get state of the art with the bugs out.

I didn't really need a confidential briefing to know that Coleman is not standing still, and he was speaking on the record when he said that "the 68000 is a generation ahead of anything Intel is building." Obviously, Sage is going to track new 68000 and follow-on technology, and I must have a dozen letters from readers telling me the virtues of the 68010 and 68020 chips. It's also obvious that any dramatic improvement in 68000 speeds will require some kind of floating-point math chip. In answer to an audience question, Coleman said he expects 256K-bit RAM chips to be available at reasonable prices late in 1984; and everyone knows that really big hard disks are just now coming onto the market.

Put all that together, and lay a french curve through the speed, memory, disk capacity, and price of the Sage II and Sage IV plotted against their date of introduction.

Thus, the only real secrets Sage has are when it will bring out the new stuff and how much it will charge for it: and Coleman gave a clue to that when he said, in a nonrestricted speech, that he doesn't consider a new chip a real part until its price has fallen to 50 percent of the introductory price. "By then it's not only cheaper, it's more reliable. The bugs are shaken out, there's probably been a new mask, and usually there's a second source," Coleman said.

It doesn't take a very large computer to predict what Sage is doing. On the other hand, it doesn't take a market survey to know that business customers aren't interested in state of the art: they're interested in software, service, and reliability. Sage's business sales aren't going to depend on the ability of Coleman's marketing people to shut him up about new Sage products: they're going to de-

pend on Sage's ability to market what I'm now willing to say is the best 68000 computer available.

### Rod Coleman

Coleman believes in the 68000 chip as strongly as Bill Godbout believes in the Intel family. Where Godbout says that "unless you know what you're doing, don't fool around with 68000 machines," Coleman believes the 68000s are the real beginning of the supermicro.

Coleman spends more time worrying about software than Godbout does. Unlike Dr. Godbout—and many 68000 enthusiasts—Coleman rejects Unix as too big, too slow, and too incomprehensible. "Just how different is Unix from Adventure?" he asks. "You get to wander around in the Unix command structure and try to find out if you can make it do anything useful. Once in a while you get hints, like 'Volume not on line.' At least UCSD p-System puts seven words across the top of the screen. That's more than Unix—or CP/M for that matter—ever did."

# MICROMART™ STRICTLY BUSINESS AT A DISCOUNT

## printers

AMDEK AMPLOT II <sup>Supplies 10105 1 2 3</sup> **\$869**  
Houst. Inst. Plotters & Digitizer **CALL!**

**BOT MATRX**  
EPSON FX80 & 100 <sup>(100 cps)</sup> **Best Price!**  
EPSON RX80 & 100 **Best Price!**  
EPSON LQ 1500 <sup>9000 Lines Quality in a Dot Matrix</sup> **Best Price!**  
Mannesman Tally Spirit 80 **\$289**  
ProWriter/MicroPrism 80 **\$275**  
Prism Color <sup>19M x Choice for LESE 127 Cm 1200 cps Color Graphics</sup> **\$1495**  
OKIDATA 92&93 <sup>101 (100 Prints) 1800 cps</sup> **Best Price!**  
OKIDATA ML84 <sup>200 cps</sup> **Best Price!**  
OKIDATA 2410 <sup>Facsimile 1250 cps</sup> **Best Price!**  
TOSHIBA P-1351 & 1340 **Best Price!**  
GEMINI 10X & 15X **\$285/\$425**  
T.J. 855 <sup>24 WIRE P/M HEAD</sup> **Best Price!**  
NEC P2 & P3 <sup>1800 cps</sup> **Best Price!**  
DIABLO P38 <sup>1400 CPS</sup> **Best Price!**

LQ Feeders <sup>Great Cost Saver Feeder for NEC 3500 & C-1700i Stenographer</sup> **SAVE!**  
Grappler <sup>Buffered Model Also Available Postnet Interface for Apple</sup> **CALL!**

## chips IBM\*PC

INTEL 8087 <sup>High Speed Math Coprocessor</sup> **CALL!**  
64K RAMCHIPS **\$55/\$180**  
<sup>16K x 9 Chip Upgrade Kit 1122K 27 Chip Upgrade Kit</sup>  
**CALL FOR QUOTE OR QUANTITY CHIP PURCHASES**

Advertisement prices subject to change without notice. IBM is a registered trademark of International Business Machines.

**LETTER QUALITY**  
NEC SPINWRITERS <sup>7050 7550 & 7720</sup> **Best Price!**  
DIABLO <sup>670 670 670 1CS</sup> **Best Price!**  
C-ITDH <sup>Stenographer 140 Cpm 1000000 150 cps</sup> **\$1055/\$1455**  
QUME <sup>SPRINT 11 40 PLUS SPRINT 11 55 PLUS</sup> **Best Price!**  
BROTHER HR15 & HR25 **\$449/CALL!**

## monitors

PGS-MAX 12 <sup>Amber • Runs off IBM Mono Card • 720h x 350v</sup> **Best Price!**  
PGS-SR-12 <sup>800x400 • Has Interchangeable RGB Modules Text</sup> **Best Price!**  
PGS-HX 12 <sup>16 Pin RGB 2500 Dot RGB</sup> **Best Price!**  
QUADCHROME <sup>16 Pin RGB</sup> **Best Price!**  
AMDEK Color II+ **\$399**  
AMDEK Color IV <sup>720 Dot</sup> **Best Price!**  
AMDEK 300A/300G <sup>12"</sup> **\$149/\$139**  
AMDEK 310A <sup>Amber 12 Improved Alternate to IBM Green Screen</sup> **\$185**

## graphic cards

HERCULES <sup>Manufactures Graphics Supplies 18700 1 1 3</sup> **\$359**  
PLANTRONICS Color <sup>256 Colors 1024 Colors</sup> **CALL!**  
Graphics Master <sup>256 Colors • Mono Graphics Supporting Labels</sup> **Low Price!**  
QUADCOLOR I & II **CALL!**  
Paradise Sys <sup>Color Graphics/Monitors Pen and Printer Port</sup> **\$379**  
STB <sup>Graphics Plus Color & Mono Graphics • Pen Port RAM Disk • Spooler • Low Price Port • Opt. C/C • Opt. C/C</sup> **CALL!**  
Multigraph <sup>132 Cst in Mono With Graphics 720h x 350v Color Graphics to 640h x 400v • Opt. Pen Port</sup> **\$375**

## floppy disk drives

TANDON TM 100-2 <sup>FULLY IBM PC COMPATIBLE</sup> **\$209**  
**CALL FOR QUANTITY PRICING**  
½ HT. DISK DRIVES <sup>TOP NAMES SOUTH'S LARGEST SUPPLY • DEALER INQUIRIES INVITED</sup> **\$189**

## hard disks

Peachtree Peripherals P-10 <sup>Industry's Best Buy • 10 Meg • Auto Spool • Hard Write • Easy Power • Internal or External Installation</sup>

SYSGEN <sup>10 & 20 MEG • 16 Sectors • Top Power Saving & Formatting • IBM TALKBACK</sup> **CALL!**  
TECMAR <sup>3 Meg Removable Internal, also 10 15 20 32 40 48 56 64 80 96 112 128 144 160 176 192 208 224 240 256 272 288 304 320 336 352 368 384 400 416 432 448 464 480 496 512 528 544 560 576 592 608 624 640 656 672 688 704 720 736 752 768 784 800 816 832 848 864 880 896 912 928 944 960 976 992 1008 1024 1040 1056 1072 1088 1104 1120 1136 1152 1168 1184 1200 1216 1232 1248 1264 1280 1296 1312 1328 1344 1360 1376 1392 1408 1424 1440 1456 1472 1488 1504 1520 1536 1552 1568 1584 1600 1616 1632 1648 1664 1680 1696 1712 1728 1744 1760 1776 1792 1808 1824 1840 1856 1872 1888 1904 1920 1936 1952 1968 1984 2000 2016 2032 2048 2064 2080 2096 2112 2128 2144 2160 2176 2192 2208 2224 2240 2256 2272 2288 2304 2320 2336 2352 2368 2384 2400 2416 2432 2448 2464 2480 2496 2512 2528 2544 2560 2576 2592 2608 2624 2640 2656 2672 2688 2704 2720 2736 2752 2768 2784 2800 2816 2832 2848 2864 2880 2896 2912 2928 2944 2960 2976 2992 3008 3024 3040 3056 3072 3088 3104 3120 3136 3152 3168 3184 3200 3216 3232 3248 3264 3280 3296 3312 3328 3344 3360 3376 3392 3408 3424 3440 3456 3472 3488 3504 3520 3536 3552 3568 3584 3600 3616 3632 3648 3664 3680 3696 3712 3728 3744 3760 3776 3792 3808 3824 3840 3856 3872 3888 3904 3920 3936 3952 3968 3984 4000 4016 4032 4048 4064 4080 4096 4112 4128 4144 4160 4176 4192 4208 4224 4240 4256 4272 4288 4304 4320 4336 4352 4368 4384 4400 4416 4432 4448 4464 4480 4496 4512 4528 4544 4560 4576 4592 4608 4624 4640 4656 4672 4688 4704 4720 4736 4752 4768 4784 4800 4816 4832 4848 4864 4880 4896 4912 4928 4944 4960 4976 4992 5008 5024 5040 5056 5072 5088 5104 5120 5136 5152 5168 5184 5200 5216 5232 5248 5264 5280 5296 5312 5328 5344 5360 5376 5392 5408 5424 5440 5456 5472 5488 5504 5520 5536 5552 5568 5584 5600 5616 5632 5648 5664 5680 5696 5712 5728 5744 5760 5776 5792 5808 5824 5840 5856 5872 5888 5904 5920 5936 5952 5968 5984 6000 6016 6032 6048 6064 6080 6096 6112 6128 6144 6160 6176 6192 6208 6224 6240 6256 6272 6288 6304 6320 6336 6352 6368 6384 6400 6416 6432 6448 6464 6480 6496 6512 6528 6544 6560 6576 6592 6608 6624 6640 6656 6672 6688 6704 6720 6736 6752 6768 6784 6800 6816 6832 6848 6864 6880 6896 6912 6928 6944 6960 6976 6992 7008 7024 7040 7056 7072 7088 7104 7120 7136 7152 7168 7184 7200 7216 7232 7248 7264 7280 7296 7312 7328 7344 7360 7376 7392 7408 7424 7440 7456 7472 7488 7504 7520 7536 7552 7568 7584 7600 7616 7632 7648 7664 7680 7696 7712 7728 7744 7760 7776 7792 7808 7824 7840 7856 7872 7888 7904 7920 7936 7952 7968 7984 8000 8016 8032 8048 8064 8080 8096 8112 8128 8144 8160 8176 8192 8208 8224 8240 8256 8272 8288 8304 8320 8336 8352 8368 8384 8400 8416 8432 8448 8464 8480 8496 8512 8528 8544 8560 8576 8592 8608 8624 8640 8656 8672 8688 8704 8720 8736 8752 8768 8784 8800 8816 8832 8848 8864 8880 8896 8912 8928 8944 8960 8976 8992 9008 9024 9040 9056 9072 9088 9104 9120 9136 9152 9168 9184 9200 9216 9232 9248 9264 9280 9296 9312 9328 9344 9360 9376 9392 9408 9424 9440 9456 9472 9488 9504 9520 9536 9552 9568 9584 9600 9616 9632 9648 9664 9680 9696 9712 9728 9744 9760 9776 9792 9808 9824 9840 9856 9872 9888 9904 9920 9936 9952 9968 9984 10000</sup> **CALL!**  
IOMEGA <sup>Cartridges • Single or Double Drive 15 21 25 Available</sup> **CALL!**  
DAYVING 10 MEG <sup>15 Meg</sup> **\$1595**  
SYSGEN IMAGE <sup>Single or Double Drive For Your IBM AT</sup> **CALL!**

## multifunction boards

AST SixPak <sup>64 256K • Check Box & Par Pts Ram Disk • Spooler • Top Game Pts</sup> **Best Price!**  
AST MegaPlus <sup>Max 8 Pts 64 5 1 240 1000s • Game Pts</sup> **Best Price!**  
AST I/O Plus <sup>256K • Ram Disk • Spooler • Top Game Pts</sup> **Best Price!**  
QUADBOARD <sup>New Version 64 256K</sup> **\$279/\$569**  
TECMAR CAPTAIN <sup>64 256K</sup> **\$289**  
SEATTLE RAM + 3 <sup>64 256K • 256K • Par Flash Disk • CB • Spooler</sup> **\$199**  
TALL TREE <sup>128K • RAM • RAM • Drive 64 5 12K</sup> **\$649**  
PROFIT Systems <sup>RAM Plus & 1000 RAM Plus & 1000</sup> **\$299/\$680**  
BABY BLUE II <sup>64 256K • 256K • Par • 2 256K • RAM • Spooler • Par • Game Pts</sup> **Best Price!**  
PC Blossom <sup>128K • 256K • Par • 2 256K • RAM • Spooler • Par • Game Pts</sup> **Best Price!**  
MAYNARD <sup>SANDBAR Paper & Hard Disk Controller Cards</sup> **Best Price!**



He also points out that CP/M was designed to work with a Teletype (TTY), a device that couldn't transfer information with any speed at all. Now we have hardware that can store a lot of information and tell it to us quickly; why are we stuck with operating systems based on obsolete technology?

He also sees the future belonging to multitasking—and to integrated software, huge software projects that tie together spreadsheets, databases, word processors, accounting systems, calendars and all the other tasks we now ask computers to do one at a time. In Coleman's view, future operating systems will do much of the work for the programmer. That means they'll be big, a full megabyte and more—which in turn means that the micro will have to work fast to make use of all that code.

Huge software projects are beyond human capability. Adding more people to the job eventually brings a point of not merely diminishing, but negative return; adding another person to the job requires enough man-

agement and training that the expanded team produces less than it did before the new people were put on the job. Since we will need huge integrated software packages, the only answer is modular software—which is what both Modula-2 and Ada were designed to accomplish.

Coleman's only comment about Ada was that it was designed by a committee. Modula-2, on the other hand, was guided by a single (and brilliant) mind. It can, perhaps, serve as a software bus, with new software making use of previous modules—but only if there's some kind of standardization of the Modula-2 library.

At the founding meeting held in Zurich last March of the Modula-2 Users Association, all the major U.S. and European Modula-2 publishers agreed to work together in standardizing the Modula-2 library. Niklaus Wirth, Modula-2's inventor, pronounced himself very pleased with the meeting.

One thing Coleman is certain of: the future doesn't belong to obscurantists, but to people who can design

systems—hardware and software—accessible to a lot of people. "It has to be simple, like a doorknob," he's fond of saying.

His picture of the future has many of the elements that Larry Niven and I put into the society of *The Mote in God's Eye*. In our novel, everyone carries a pocket computer, which is used by asking questions in ordinary English. (Well, in our novel it's Anglic, since we set this rather far into the future.) The pocket computers are tied into enormous databases; anyone can get the answer to almost any question simply by asking.

In my speech at NCC last year, I said that by the turn of the century, anyone in Western civilization who seriously wants to will be able to get the answer to any question whose answer is either known or calculable. I see no reason to change that prediction. Neither does Rod Coleman.

### So What's Coming?

If you take what Coleman and Godbout say and cancel out their dis-

## THE SERVICE LEADER ★ CORPORATE BUYERS WELCOME

**modems**

**HAYES** SMARTMODM 3000 1200 BPS **CALL!**  
**Access 1-2-3** Windows PC/XT/286/386/486 **CALL!**  
**RIXON** 1200 4800 2400 9600 PC Compatible **CALL!**  
**Signalman Mark XII** 1200 1200 Direct Connect **\$250**  
 Quality at a Low, Low Price

**networking/  
protocol conversion**

**PCnetPlus, PC Turbo** by ORCHID  
 ORCHID TECH'S NEW COMPLETS PRODUCT LINE  
**SNA & BISYNC** • 3780, 5251, 3274  
**SRITEK** 68000 Coprocessor with IBM-COS  
 Convert PC to COBOL emulates, Multi user system  
**BLUE LYNX** 5251/3276 EMULATOR  
**PCterminal** 120 CIST Terminal (8-Bit or 16-Bit & Protocols)  
 Serial and Parallel Ports • Fax Data Sets

**IRMA** STILL A BEAUTY  
 REPLACES 3276 & WITH PC's **JIRMALINE**

**miscellaneous**

**Keytronics 5151** New Improved **CALL!**  
**COLBY Keyboard** Improved Model Over IBM **\$225**  
 to Stack Now  
**MOUSE** Optical Type (XT/AT & Ypsilon Compatible) **\$209**  
 By Mouse Systems  
**CURTIS** Keyboard Protectors **CALL!**  
 Keyboard Extension Cables, Monitor Extension Cables  
**MICROFAZER** 64 12000 64000 64000 **\$139**  
 Backing of  
**BACK UP Power Supply** 200 & 425 Watta **CALL!**  
 Surge Protectors • With Great Filtering the Best  
**ISOBAR** 4 1/2 B Pkg. **\$59**  
 Blasting at

Micro Mart is located in Atlanta, Charlotte, Louisville, Washington D.C., Tampa—Store prices may be slightly higher.

**OpenAccess** Spreadsheet 3-D Graphics Word Processor **CALL!**  
 Time Manager & Communications in One Pkg.  
**JACK 2** Integrated Word Processing Spread Sheet Data **CALL!**  
 Base Management Text in One Screen  
**VisiOn** Applications Manager **CALL!**  
 Calc • Print • Graph • Query  
**KEY II 1-2-3** Outstanding Value for \$159 **\$159**  
 Tracks Information Management  
**SuperCalc III** Superior Spreadsheets to 10785 **\$239**  
 Spreadsheet 3-D Support  
 One Meg RAM on PC  
**Lattice C-Compiler** **\$299**  
**MICROSOFT COMPILERS** **CALL!**  
**DIGITAL RESEARCH COMPILERS** **CALL!**  
**Norton Utilities** A Must for Every IBM PC **\$59**  
**ProKey 3.0** NewSoft **\$95**  
**RELAY** Popular Communications Pkg **\$99**  
**CROSSTALK XVI** HRCOS/UP **CALL!**  
**SMARTCOM II** Hayes **\$109**  
**FINANCIER II** Personal Series **\$119**  
**Dow Jones** Mkt. Analysis Mkt. Manager **\$249/\$219**  
 Call for Price on Mkt. Microscope  
**IUSAR AP G1** Inventory Order Entry, Payroll **\$289**  
 Profitability System  
**BPI Accounting** Personal Systems Series **CALL!**  
**Peachtree Accounting** **CALL!**  
**Open Systems** AR AP BI Payroll Job Cost **CALL!**  
 Inventory Order Processing  
**Multilink** Multi User, Mail List and Package **CALL!**  
 Supports Up to 8 Users Remotely on IBM PC  
**Set-FX** NEW! 1000 FR Service Control Pkg **\$45**  
**Sideways** Inventory Processor **\$49**  
**ATI Training** Critics Choice! **\$59**  
 Software Tutorial  
**Chart-Master/Sign-Master** **CALL!**  
**"CAD Systems"** New Software Available in **CALL!**  
 Computer Aided Design Graphics  
**PC Paint Brush** Windows Software Library **\$139**  
 Windows Software Library

**IBM\* software**

**R:base 4000 or 6000** Microbase **Starts at \$329**  
**Power-base** SMS Systems • Combination of **CALL!**  
 Relational & Hierarchical Data Models  
**Knowledge Man** Use 1.00 Now Available for IBM **\$295**  
 High-Accuracy Data Base  
**dBase III** Version 1.0 **\$389**  
**Multimate** 2.7 WANG Style Word Processor **\$279**  
 With Spelling Checker  
**PFS** Visual File Report Graph Solutions, Status **\$99**  
 W Master/Fourth Generation Word  
**Microsoft Word** Program Use Up to 8 Windows **CALL!**  
**VOLKSWRITER DELUXE** **\$189**  
**WordStar ProPak** New WARE Target! **CALL!**  
 CorrectStar MailMerge, StarIndex  
**WORDPLUS-PC** With the WISES Integrated **CALL!**  
 Spell Check Plus MailMerge  
**WordPerfect** 5.1 Available Now by Popular Demand **CALL!**  
**Easy Writer II** System includes Speller & Mailer **CALL!**  
**Peach Text 5000** **\$199**  
**FRIDAY!** Ashton Tate **\$195**  
**QUICKCODE/dGraph/dUtil** **CALL!**  
**Copyll PC** **\$35**

**ORDERS ONLY**  
**1-800-241-8149**  
 Monday Friday 9:00 AM Midnight, Saturday 9:00 AM 5:00 PM

**MICROMART**  
 TECHNOLOGY CORPORATE CAMPUS  
 3159 Campus Drive • Norcross, GA 30071  
**For Information** 1-404-449-8089  
**Technical Support** 1-404-446-3836



# Printed On An Epson Printer

By The *Fancy Font*<sup>®</sup> System

## Letter Quality

Say goodbye to correspondence quality and hello to *Fancy Font's* high-resolution, proportionally spaced letter quality. *Fancy Font* provides fonts in sizes from 8 to 40 points; styles include Roman, Bold, Italic, Script, Old English, and more. All this on low-cost Epson (MX, RX, FX) and Gemini 10X printers. *Fancy Font* is an easy-to-use software package for CP/M and IBM PC compatible systems; no special hardware or installation is required.

## Create Your Own Characters

You can use over 30 font sets in the *Fancy Font* package and furthermore, can create any new characters or logos you like, up to 1 inch by 1 inch. A database of over 1500 characters is included that makes it possible to print foreign languages and mathematical notations.

## Font Style Samples

small medium **large** Bold *Italic*  
Sans Serif *Script* Old English

$$A = \int_0^a \sqrt{a^2 - x^2} dx$$

Φ Ψ Ω Β € 6 Д Ж ± ÷ ≠ ≤ ≥ ♂ @ § Ω 0 • # 4 b

## Numerous Applications

*Fancy Font* customers, numbering in the thousands, are constantly discovering new applications.

- Business and personal letters
- Custom forms, invoices, labels, signs
- Foreign Languages
- Mathematical Notation, Greek
- Super- and Sub-scripts
- View Graphs
- Custom Letterheads
- Resumés
- Articles for publication
- Newsletters, brochures
- Complete manuals
- Advertisements
- Invitations, place cards

InfoWorld Software Report Card	
Fancy Font	
	Poor Fair Good Excellent
Performance	<input type="checkbox"/> <input type="checkbox"/> <input type="checkbox"/> <input checked="" type="checkbox"/>
Documentation	<input type="checkbox"/> <input type="checkbox"/> <input type="checkbox"/> <input checked="" type="checkbox"/>
Ease of Use	<input type="checkbox"/> <input checked="" type="checkbox"/> <input checked="" type="checkbox"/> <input checked="" type="checkbox"/>
Error Handling	<input type="checkbox"/> <input type="checkbox"/> <input type="checkbox"/> <input checked="" type="checkbox"/>

Copyright, 1983 by Popular Computing, Inc.  
a subsidiary of CW Communications, Inc.  
Reprinted from InfoWorld, 1/2/83

(This ad was printed on an Epson MX-80 printer. Call for an actual sample.)

Highlight: **IBM and CP/M order now - (800) 351-0500 - M/C Visa**

"The quality of print is excellent, and the variety of type styles and sizes is even better."

Pet McKeague, InfoWorld, 5/2/83

Available for Epson FX, MX, RX, Gemini 10X, IBM Graphics Printer, Rileman Inforunner, TI 855/850, Citibank and NEC8023 (IBMPC only)

SoftCraft, Inc., 222 State St. Suite 400, Madison, WI 53703  
 (We've moved from California) phone: (608) 257-3300  
 Fancy Font System \$180.00  
 Fancy Font Demo Disk \$ 10.00<sup>1</sup>  
 Calif. and Wis. residents add sales tax  
 Outside US add \$10 (only \$2 for demo) postage

Diskette Format:  
 8" CP/M  Epson QX10  Osborne  Kaypro  
 IBM PC<sup>2</sup>  Victor 9000<sup>2</sup>  Apple CP/M<sup>3</sup>

<sup>1</sup> \$7.50 applicable towards purchase of Fancy Font  
<sup>2</sup> PC/DOS/MSDOS systems require 128K memory IBM printer works  
<sup>3</sup> Fully transparent 8-bit printer interface required

agreements, you still get a comprehensive picture of the new supermicro. It will have a bit-mapped screen and be able to do high-resolution graphics. There will be a good programming language integrated into the operating system, which will be enormous, Unix-sized even if it's not Unix. The machines will be fast. They'll have several megabytes of memory. They'll do coprocessing, which is to say they'll do several things at once. They'll have access to really large data storage, probably hard disks with 100 megabytes. They'll be able to talk to other machines and do it transparently so the user doesn't really have to know the difference between accessing his own hard disk and accessing one on the other side of the continent.

The operating system will be largely menu driven, and comprehensible to ordinary people. Both Godbout and Coleman have plenty of contacts within the software-development community; Bill Godbout often talks with Digital Research's Gary Kildall, while Rod Coleman's people work closely with Softech, Volition, and the Modula Research Institute. Compupro and Sage are in a position to have major influence over software development.

However, their interests differ. Coleman worries about software development a lot more than Bill Godbout does. Although Compupro is a much larger company than Sage, Sage has more software people and works harder at integrating outside software into its bundle. Compupro tends to have software development done through outside consultants.

Both companies work at the frontiers of microcomputer development—and despite their different approaches, both seem to be headed toward the same place, the world of supermicros.

## To Unix or Not to Unix?

On Mondays and Wednesdays I'm sure Unix is the wave of the future. After all, IBM says Unix. AT&T says Unix. Digital Research is moving in the general direction of Unix and also getting closer to IT&T. There are indications that Microsoft is getting



# NEVADA SOFTWARE

## FOR CP/M. TOP QUALITY, BOTTOM PRICE.

Nevada makes it easy and economical to get the software you want and need. Need a better BASIC? We've got it. Is BASIC not solving your business or engineering problems? Nevada COBOL or FORTRAN will. The media praises Nevada, and it's priced right: just \$39.95—about 1/10 what comparable quality costs. For about half the price of one competitive package, you can own the *entire* Nevada Software library! So don't wait; order one or two or all of our bargains—today.

**NEVADA BASIC™**  
Diskette & 220-page manual  
*For business, education, engineering, science*

Finally, a better BASIC. This straightforward language lets beginners write useful programs without limiting them to simple programs. New Nevada BASIC's interpreter has Prof. Starkweather's great built-in full-screen text editor. You can define single- and multi-line functions. Plus there are full-matrix operations, Random Access and Sequential files, program execution with a simple command, BCD Math—no round-off errors. With Nevada BASIC, micros can run like minis costing thousands more.

**NEVADA COBOL™**  
Diskette & 165-page manual  
*For business*

Whether you do business computing or learn computing for business, COBOL is the language; more business application software is in COBOL than in all other languages combined. Based on ANSI-74 standards, Nevada COBOL offers many advanced features: Random Access

and Sequential files, debugging capability, COPY statement, character string, 16 bit binary and decimal data types. Colleges use the fine documentation as classroom texts. It's field-proven by 10,000+ worldwide business, government and education users. Join them.

**COBOL Application Package—Book I.**  
Superior user documentation that saves even experienced programmers many hours.

**NEVADA FORTRAN™**  
Diskette & 214-page manual  
*For science & engineering*

"If you want to learn or teach someone FORTRAN, this is the package to buy." ACCESS, March/April 1983. For learning and teaching, for scientists and engineers, Nevada is the perfect FORTRAN. Based on ANSI-66 standards (FORTRAN IV), its advanced features include IF...THEN...ELSE constructs, COPY statement, CHAINING with COMMON, TRACE style debugging, and 150 verbal error messages. And you can intermix in-line FORTRAN and Assembly Language statements for special micro needs. Requires 48K RAM. If you're shopping for FORTRAN, look no further.

**NEVADA PILOT™**  
Diskette & 131-page manual  
*For dialogue*

Perfect for training, testing, virtually all programmed instruction, and word puzzles. It's the ideal companion language for BASIC, COBOL, and FORTRAN application packages, because it so quickly solves training and documentation problems. Nevada PILOT meets all PILOT-73 standards and has many new features including a built-in full-screen text editor. Prof. Starkweather's

documentation is exceptional; the manual comes with 10 free programs. See MICROCOMPUTING review, January 1983, and you'll be convinced.

**NEVADA EDIT™**  
Diskette & 59-page manual  
*For text editing*

"A well-thought-out product with excellent documentation and an astoundingly low price." MICRO-COMPUTING, May 1983. Now, high-quality text editing for micros. A character-oriented full-screen display editor, Nevada

EDIT is great for program editing as it's specifically designed to create COBOL, BASIC, and FORTRAN programs. Simple to configure, you customize tab stops, default file type, keyboard layout, and CRT by menu selection.

Nevada EDIT may pay off better than any software purchase you've made.



**EACH ONLY \$39.95**  
*COBOL Applications Package—Book I: \$9.95*

Money back guarantee: you must be completely satisfied, or return the package(s)—in good condition with the sealed diskette(s) unopened—within 30 days, and we'll gladly refund your money.

CP/M is a registered trademark of Digital Research, Inc. TRS-80 is a registered trademark of Tandy Corp. Apple II is a trademark of Apple Computer Inc. Osborne is a registered trademark of Osborne Computer Corp. Xerox 820 is a trademark of Xerox Corp. Raypro is a trademark of Non-linear Sys. Heath Zenith is a trademark of Heath Corp. IBM is a trademark of International Business Machines Corp. Nevada BASIC, Nevada COBOL, Nevada FORTRAN, Nevada PILOT, Nevada EDIT, and Ellis Computing are trademarks of Ellis Computing, Inc. © 1983 Ellis Computing, Inc.



Send to  
**ELLIS COMPUTING, INC.**  
3917 Noriega Street  
San Francisco, CA 94122 Phone 415/753-0186

Please send me: **Software Packages**  
 BASIC  COBOL  FORTRAN  PILOT  EDIT

**Disk Format**

- 8" SSSD (Standard CP/M IBM 3740)
- 5 1/4" Diskette for:
  - Access
  - Apple CP/M
  - DEC VT 180
  - Epson QX-10
  - Heath Hard Sector (Z-89)
  - Heath Soft Sector (Z-90)
  - IBM-PC (Baby blue or big blue card)
  - Kaypro Double Density
  - Micropolis Mod II (Vector Graphic)
  - NEC PC 8001
  - Northstar Double Density
  - Northstar Single Density
  - Osborne (Single Density Disk)
  - Sanyo
  - Superbrain DD, DOS 3.X (512 byte sec)
  - Televideo
  - TRS-80 Model I (Relocated to 4200 hex)
  - Xerox 820 (Single Density)

Send my order for \_\_\_\_\_ packages @ \$39.95 each Total \_\_\_\_\_

COBOL Application package @ \$9.95 each Total \_\_\_\_\_

California residents add 6 1/2% Sales Tax Sales Tax \_\_\_\_\_

Outside North America, add \$6 per package for shipping (Postage paid within North America.) Checks must be in U.S. dollars and drawn on a U.S. bank. Shipping \_\_\_\_\_

Check enclosed  Mastercard  VISA TOTAL \_\_\_\_\_

Card # \_\_\_\_\_ Exp. Date \_\_\_\_\_

Signature \_\_\_\_\_

Ship to: Name \_\_\_\_\_

Street \_\_\_\_\_

City/State/Zip \_\_\_\_\_

The CP/M operating system, an 8080, 8085, or Z-80 microprocessor, and 32K RAM are required. Note: Double Density drives can read Single Density diskettes.



# Less for Your Money

If you do word processing on your personal computer, you probably know that there are many programs for sale to help you with your spelling. But the biggest spelling error you'll ever make is paying too much for your spelling correction software. The Random House ProofReader gives you less for your money — less trouble, that is, and fewer spelling errors. The Random House ProofReader is based on the world famous Random House Dictionary. It contains up to 80,000 words, depending on your disk capacity. You can add new words with the touch of a key. It shows you the error and the sentence it's in. It instantly suggests corrections. It even re-checks your corrections. And it costs half as much as other programs with far less power. The Random House ProofReader is compatible with all CP/M 2.2<sup>®</sup>, MS-DOS<sup>®</sup> and IBM Personal Computer<sup>®</sup> systems.



**The  
Random  
House  
Proof Reader**  
**\$50**

For orders or information, see your local dealer or call 505-281-3371. Master card and VISA accepted. Or write Wang Electronic Publishing, One Industrial Ave., Lowell, MA 01851. Please enclose \$50 and specify your computer model, disk size and memory.

Random House and the House design are registered trademarks of Random House, Inc. CP/M is a registered trademark of Digital Research, Inc. IBM and IBM Personal Computer are registered trademarks of International Business Machines, Inc. MS-DOS is a registered trademark of Microsoft, Inc.

heavily into the Unix game. Thus, the Intel chip family seems headed toward Unix.

Meanwhile, a good part of the 68000 chip community (with the notable exception of Sage's Rod Coleman) believes in Unix and thinks the 68000 has a better architecture for doing Unix-like things than the 8086 family does. It's even possible that Unix will bring about some convergence of software written for the 8086 and 68000 series; at least the source codes in higher-level languages ought to be transportable. It's vital to the micro community that we have as large a software market base as possible, so Unix may be a real boon to us all by allowing software developed on one kind of system to tap another kind of system's market, thus encouraging investment in really elegant programs. By Wednesday evening I can convince myself that Unix is a friend to all.

On Tuesdays and Thursdays I'm certain Unix is dead. It's enormous; Unix for the IBM PC comes on 15 floppy disks. You *must* have a hard disk before Unix even begins to make sense.

Unix is slow. It's designed for a multiuser situation, which violates the first principle of the micro world: One User, One Computer. I fervently believe in that principle, and thus I'm much more partial to communications and networking than to multiuser concepts.

Unix is incomprehensible. It tells you almost nothing and lets you guess what you did wrong. It can be modified, but I haven't yet seen one of those "easily constructed" user-friendly Unix shells that will be out Real Soon Now. By Thursday night I can convince myself that Unix is an enemy of the micro revolution.

The rest of the week I refuse to think about it.

## USUS

If we ever do develop truly modular software, some of the credit should go to outfits like USUS, the UCSD Pascal Users Society. USUS membership costs \$25 a year, and if you've any interest at all in the future of modular languages, you should

join if only to support the outfit.

At the Sage Faire, a number of USUS committees met continually. There was some nattering about USUS business, but most of the discussion was about standards. Since representatives of Apple and Softech, the two largest vendors of Pascal p-code, were present throughout the three days of meetings, there was at least a chance of accomplishing something useful.

A typical problem considered at the USUS meetings was version control for separate compilation.

Separate compilation means that you write and compile your program in little chunks that never have to be recompiled. It saves a lot of time and work.

---

**If we ever develop  
truly modular  
software, some of the  
credit should go to  
outfits like USUS.**

---

Pascal was never designed for separate compilation. Indeed, it wasn't originally designed to be compiled at all; it was intended as a teaching language. After Pascal caught on as a production language, some compiler writers added a kind of separate compilation capability to the language.

Alas, that has its drawbacks. In particular, the "modular" capability additions to Pascal have no provision for version control. This means that you can play holy hell with programs if you make certain kinds of changes and someone else comes along and writes procedures that depend on your *not* having made your changes. It happens more often than you think.

There was a lengthy USUS discussion on how to modify UCSD Pascal to give it version control. Modula-2 has rigid version controls, and Pascal needs them. Implementation would be simple. There are at least a dozen ways to do it—which, of course, is the problem. When I left there'd been no resolution, but they're trying, and that can benefit us all.

You can reach USUS at POB 1148, La Jolla, CA 92038, and you ought to

*Text continued on page 82*





# Key Tronic Creates

## The Deluxe IBM\* PC Keyboard.

Get the most from your IBM\* PC or XT computer system with Key Tronic's new KB 5151 low-profile, plug compatible keyboard . . . and get the "SHIFT" and "RETURN" keys in their proper place.

The KB 5151 offers separate cursor keys, top-row function keys with removable template, and a handy pencil and book holder ridge.

The KB 5151 features familiar typewriter key placement, Key Tronic's reliable, solid-state switch technology, LED status indicators and positive tactile feedback.

If you're purchasing a new IBM\* PC, you can get it without their keyboard, and buy a Key Tronic Deluxe KB 5151 to enhance your system.

Suggested Retail Price: **\$255.00.**

For the retailer closest to you or information on Model KB 5151, call Toll Free 1-800-262-6006, (7 am - 3 pm Pacific Time). Warranty information may be obtained by writing to the address below.

\*IBM is a registered trademark of IBM Corporation

 **key tronic**

Come see us at Comdex Booths #'s 4848, 4850

THE RESPONSIVE KEYBOARD COMPANY • DEPT. E5 • P. O. BOX 14677 • SPOKANE, WA 99214 • USA

RETAILERS: For the Distributor in your area, call Toll Free 1-800-262-6006, Department D (7 am - 3 pm Pacific Time)



# TOP SELLERS

1. Week of Jan. 30, 1983. Lotus 1-2-3. No. 1.
2. Week of Feb. 6, 1983. Lotus 1-2-3. No. 1.
3. Week of Feb. 13, 1983. Lotus 1-2-3. No. 1.
4. Week of Feb. 20, 1983. Lotus 1-2-3. No. 1.
5. Week of Feb. 27, 1983. Lotus 1-2-3. No. 1.
6. Week of March 6, 1983. Lotus 1-2-3. No. 1.
7. Week of March 13, 1983. Lotus 1-2-3. No. 1.
8. Week of March 20, 1983. Lotus 1-2-3. No. 1.
9. Week of March 27, 1983. Lotus 1-2-3. No. 1.
10. Week of April 3, 1983. Lotus 1-2-3. No. 1.
11. Week of April 10, 1983. Lotus 1-2-3. No. 1.
12. Week of April 17, 1983. Lotus 1-2-3. No. 1.
13. Week of April 24, 1983. Lotus 1-2-3. No. 1.
14. Week of May 1, 1983. Lotus 1-2-3. No. 1.
15. Week of May 8, 1983. Lotus 1-2-3. No. 1.
16. Week of May 15, 1983. Lotus 1-2-3. No. 1.
17. Week of May 22, 1983. Lotus 1-2-3. No. 1.
18. Week of May 29, 1983. Lotus 1-2-3. No. 1.
19. Week of June 5, 1983. Lotus 1-2-3. No. 1.
20. Week of June 12, 1983. Lotus 1-2-3. No. 1.
21. Week of June 19, 1983. Lotus 1-2-3. No. 1.
22. Week of June 26, 1983. Lotus 1-2-3. No. 1.
23. Week of July 3, 1983. Lotus 1-2-3. No. 1.
24. Week of July 10, 1983. Lotus 1-2-3. No. 1.
25. Week of July 17, 1983. Lotus 1-2-3. No. 1.
26. Week of July 24, 1983. Lotus 1-2-3. No. 1.
27. Week of July 31, 1983. Lotus 1-2-3. No. 1.
28. Week of Aug 7, 1983. Lotus 1-2-3. No. 1.
29. Week of Aug 14, 1983. Lotus 1-2-3. No. 1.
30. Week of Aug 21, 1983. Lotus 1-2-3. No. 1.
31. Week of Aug 28, 1983. Lotus 1-2-3. No. 1.
32. Week of Sept. 4, 1983. Lotus 1-2-3. No. 1.
33. Week of Sept. 11, 1983. Lotus 1-2-3. No. 1.
34. Week of Sept. 18, 1983. Lotus 1-2-3. No. 1.
35. Week of Sept. 25, 1983. Lotus 1-2-3. No. 1.
36. Week of Oct. 2, 1983. Lotus 1-2-3. No. 1.
37. Week of Oct. 9, 1983. Lotus 1-2-3. No. 1.
38. Week of Oct. 16, 1983. Lotus 1-2-3. No. 1.
39. Week of Oct. 23, 1983. Lotus 1-2-3. No. 1.
40. Week of Oct. 30, 1983. Lotus 1-2-3. No. 1.
41. Week of Nov. 6, 1983. Lotus 1-2-3. No. 1.
42. Week of Nov. 13, 1983. Lotus 1-2-3. No. 1.
43. Week of Nov. 20, 1983. Lotus 1-2-3. No. 1.
44. Week of Nov. 27, 1983. Lotus 1-2-3. No. 1.
45. Week of Dec. 4, 1983. Lotus 1-2-3. No. 1.
46. Week of Dec. 11, 1983. Lotus 1-2-3. No. 1.
47. Week of Dec. 18, 1983. Lotus 1-2-3. No. 1.
48. Week of Dec. 25, 1983. Lotus 1-2-3. No. 1.
49. Week of Jan. 1, 1984. Lotus 1-2-3. No. 1.
50. Week of Jan. 8, 1984. Lotus 1-2-3. No. 1.
51. Week of Jan. 15, 1984. Lotus 1-2-3. No. 1.
52. Week of Jan. 22, 1984. Lotus 1-2-3. No. 1.

In the world of business software, there's only one number one: "1-2-3" from Lotus.

And it's been that way almost from day one. Since January of 1983, 1-2-3 has consistently been at the top of the software best sellers lists.

And it's the best selling PC software in the world, for one very good reason. It's the very best PC software.

## The PC software that simply does more for you.

1-2-3 gives you the most powerful productivity software available today. An analytical tool that combines spreadsheet, graphics and information management into one incredibly fast, easy-to-use package.

With 1-2-3, you can analyze, interpret and report information in seconds with just the touch of a key.

And because it's all one program, you not only work faster and smoother, you work smarter.

## But don't just take our word for it.

Take the word of the experts.

*The New York Times* heralded 1-2-3 as "the wave of the future in business software."

And recently they wrote, "In scarcely a year, the Lotus Development Corporation has done for the world of personal computer software what International Business Machines has done for personal computers: it has created a product so wildly successful that scores of other companies are scrambling to imitate or improve on it."

*Software News* said, "1-2-3 has more capabilities than any other program in its class."

"It is the one product that without doubt has single-handedly changed the face and direction of the personal-computer-software industry," was the way *Info-World* put it.

*Softalk* simply wrote, "Lotus's 1-2-3 is so dominant, it doesn't seem as though there's room for other software." And in 1983, 1-2-3 from Lotus was good enough to be named a "Product of the Year" by both *Fortune* and *Info-World*.

## It's the difference between getting by and getting ahead.

What can 1-2-3 do for you?

What it's already done for hundreds of thousands of PC users. Give you a proven business software that can dramatically increase productivity for you and everyone in your company.

After all, when it comes to looking out for number one, going with number one is the only way to go.

To find out what 1-2-3 from Lotus can do for you just visit your local computer store, or call 1-800-343-5414. (In Massachusetts call 617-492-7870.)



The hardest working software in the world.

1-2-3 and Lotus are trademarks of Lotus Development Corporation. \*Based on Softsel, Softalk Best Selling Software Lists, 1983.



**1-2-3  
from Lotus.**

**Maybe the best  
way to look  
out for number  
one is to  
go with  
number one.**





## Borland Turbo

I have nearly a dozen letters from satisfied users of Borland's Turbo Pascal—and not one complaint. I also know three people who bought Turbo by mail and received it much sooner than they thought they had any right to expect; the evidence is that Borland really does ship on the same day it gets the order.

Our own experiences have also been positive. Borland's Pascal certainly rivals Digital Research's Pascal MT+ in speed, compactness of code, and ease of use—and it sure costs a

lot less. It's almost certainly better than IBM's Pascal for the PC.

It's also the only Pascal, including IBM's, that runs on the PCjr—and its built-in editor is nearly as powerful as IBM's Homeword.

Recommended.

## Games . . .

I always look forward to Avalon Hill computer games, largely because I've liked its board games for so many years. I'm also particularly interested in classical war games (I've got several *banda* of super-heavy cataphract

miniatures). Thus, I was eager to get Avalon Hill's Legionnaire.

We received it with two other games; one would not work with Rana drives and Avalon Hill's copy-protection system. However, A-H will honor its lifetime disk guarantee, so if you get a game that won't work on your system, write the company. It will make the game work or give you your money back.

Another, Parthian Kings, has been really popular with the boys. It appears to be a form of chess, with "Hammurabi" economics, combat, and magic thrown in. I haven't had time to play it, but I note that the boys have spent a good bit of time playing, both against each other and against the machine. I expect I'll like it; I know they do.

Legionnaire gets mixed reviews. I hated it. It appears to be a game of strategy, but it takes place in real time, which in practice means that it's an arcade game masquerading as a game of strategy. You're supposed to give orders to your various Roman combat units, in much the same way that you might issue written orders to units in a miniatures game. It takes time for the units to get the orders, and meanwhile something may have happened to make the orders obsolete.

A miniatures game has rules concerning just how you might be able to cancel inappropriate orders and send in new ones and how much initiative the units are allowed to take. In Legionnaire, you have to move the cursor to the unit using a *terrible* control system if you have the Apple version; there's an Atari version that's said to use the joystick, which might not be quite so bad. Once you have the cursor over the unit, it no longer carries out orders, but you can cancel old ones and give new ones. About the time you do that, something has happened on the other side of the board, and you must race the cursor over there, at which point another unit is in trouble, and so forth. There's no time for strategy and not much time for tactical decisions.

I suppose this is intended to produce some kind of realistic "fog of war" effect, but it doesn't, because it

**What do you get when you cross 1200 baud, free on-line time, and extra features at a price Hayes can't match?**

### Data Rate?

The MultiModem gives you a choice—either 1200 or 300 bits per second. So you can go on-line with the information utilities. Check out bulletin boards. Dial into corporate mainframes. Swap files with friends.

### On-Line Time?

With the MultiModem you get CompuServe's DemoPak, a free two-hour demonstration of their service, and up to seven more free hours if you subscribe. You also get a \$50 credit towards NewsNet's business newsletter service.

### Features & Price?

Of course, the MultiModem gives you automatic dial, answer, and disconnect. Gives you the Hayes-compatibility you need to support popular communications software programs like Crosstalk, Data Capture, our own MultiCom PC, and dozens of others. Gives you a two-year warranty, tops in the industry.

### But Better?

Yes. The MultiModem gives you features the Hayes Smartmodem 1200™ can't match. Features like dial-tone and busy-signal detection for more accurate dialing and redialing. Like a battery-backed memory for six phone numbers. All at a retail price of just \$549—compared to \$699 for the Smartmodem.

What do you get? The new MultiModem, from Multi-Tech Systems. Isn't this the answer you've been looking for?

For the name of your local distributor, write Multi-Tech Systems, Inc., 82 Second Avenue S.E., New Brighton, MN 55112. Or call us at (612) 631-3550.

# MultiModem.



**MultiTech** Systems

*The right answer every time.*

Circle 283 on inquiry card.

Trademarks — MultiModem, MultiCom PC, Multi-Tech Systems, Inc. — CompuServe, CompuServe Information Services are H & R Block company — NewsNet, NewsNet, Inc. — Crosstalk, MicroSoft, Inc. — Data Capture, Southeastern Software — Smartmodem, Hayes Microcomputer Products, Inc.



# AMERICA'S HIGH TECH WAREHOUSE

SHOP AND SAVE...

Circle 423 on Inquiry card.

## PRINTERS

DOT MATRIX	
STAR MICROWMS	
Gamma-10X	\$ 299.00
Delta-10	Call
OKIDATA	
OKIDATA-824	Call
OKIDATA-834	Call
OKIDATA-92	Call
OKIDATA-93	Call
OKIDATA-84	Call
PLUG N PLAY	Call
C. ITOH	
PROWRITER I	\$ 379.00
PROWRITER I (IBM)	Call
PROWRITER 8	Call
LETTER QUALITY	
TTX-1014	\$ 529.00
Juki-E100	\$ 549.00
Juki-Tractor Feed	Call
Starwriter (40CPS)	\$1079.00
Starwriter-Tractor Feed	Call

## SOFTWARE

	IBM PC's	Apple Franklin
Lotus 1-2-3	Call	-
Software Publishing		
pls File	\$ 94.00	\$ 94.00
pls Report	\$ 94.00	\$ 94.00
pls Graph	\$ 94.00	\$ 94.00
pls Write	\$ 94.00	\$ 94.00
Software		
Multimate	Call	-
Microsoft		
Fight Simulator	\$ 35.00	-
Multiplex	\$165.00	\$165.00
Word w mouse	\$249.00	-
InfoCom		
Zork I & II	\$ 29.00	\$ 29.00
Continental		
Home Accounting	\$ 99.95	\$ 49.95
Memogram		
Doctors & Sense	\$ 89.00	\$ 89.00
Seiblogic		
Fight Simulator II	-	\$ 39.00
Broderbund	-	\$ 49.95
Bank Street Writer		
Lightning		
Tractor Type	\$ 35.95	\$ 29.95
Spinneraker		
Story Machine	\$ 25.00	\$ 25.00
Face Maker	\$ 25.00	\$ 25.00
Alphabet Zoo	\$ 29.00	\$ 21.00

NOTE: This is only a selected sample of our software inventory. If we have not listed your particular need, call and we will get it for you at our fantastic prices.



## COLUMBIA MPC 1600

The enhanced IBM Alternative  
TRULY IBM COMPATIBLE

IBM Hardware & Software compatibility in a Multi-User 16 bit computer. 128K, two serial ports, one parallel port and 8 expansion slots. Monochrome Color Graphics.  
Plus over \$3,000 of Software FREE: MS-DOS, CPM-86, Tutor Diagnostics, Macro-Assembler, Basica-Perfect Writer, Speller, Calc, Filter, Link/ Home Accountant +, FAST GRAPHS, T.J.M./V. Space Commanders.

- COLUMBIA MPC 1600
- COLUMBIA VP PORTABLE

CALL for fantastic prices!!

## PRODUCTS FOR YOUR IBM PC/XT AND COLUMBIA

<b>QUADRAM CORP.</b>	<b>HERCULES</b>	
Quadboard Multifunction Board	Graphics Card	\$389.00
Full Expandability From 64K to 384K		
Par Printer Port, Serial Port, c.c		
Ram Disk Drive	<b>AMDEK</b>	
Quadline-Apple On A Card	Multiple Adapter Interface	Call
Microfizer Print Spooler	<b>PARADISE SYSTEMS</b>	
Print Buffering From 8K to 512K	Multidisplay Card	Call
Why Was For Your Printer?	IBM Mono And Colorgraphics	
	And Par Port	Call
<b>AST</b>	<b>Plantronics</b>	
6-Pack Plus 64K to 384K	Color Plus	Call
One Ser One Par c.c (starts at	<b>KEYTRONICS</b>	
10 Plus	Enhanced Word Processing Keyboard	
Clock Cal. One Ser Port	Model KB 5150	\$199.00
	Model KB 5151	Call
<b>STB</b>	<b>KRAFT</b>	
"Super Rio" Card 64K to 256K	Joystick	\$ 46.00
Two Ser. One Par Port. Clock Cal.	Paddles	\$ 35.00
Ram Disk. Cables included w 64K	Call	
STB Graphic Plus	<b>T &amp; G</b>	
	Joystick	\$ 43.00
<b>TECMAR</b>	Paddles	\$ 29.00
1st Mate w 64K	<b>KOALA</b>	
Graphics Master	Graphics Tablet	\$169.00
2nd Mate		
Captain w 64K		

## PRODUCTS FOR YOUR APPLE/FRANKLIN COMPUTER

<b>ORANGE MICRO</b>	<b>KENSINGTON</b>	
Grappler -	System Saver	\$ 72.00
Buffered Grappler	<b>KRAFT</b>	
<b>MICROTEK</b>	Joystick	\$ 46.00
FV-611C Par Interface	Paddles	\$ 35.00
SV-522C Ser	Call	
Apple Dumping 16K	<b>T &amp; G</b>	
BAM 16K Ram Expansion	Joystick	\$ 43.00
<b>MICROSOFT</b>	Paddles	\$ 28.50
16K Ram Expansion	Serial-A-Port	\$ 43.00
Soft Card	Trail-Ball	\$ 47.00
<b>ALS</b>	<b>PRACTICAL PERIPHERALS</b>	
Smarters II 80 Col Card (Apple only)	Micro-Buffer II 16K	\$159.00
<b>VIDEX</b>	<b>KOALA</b>	
Ultratara	Graphics Tablet	\$ 89.00
Vidotechs 80 Col Card		
PSI O Card		

## MONITORS

<b>PRINCETON GRAPHICS</b>	
HC-12	\$489.00
RX-12	Call
<b>AMDEK</b>	
300G 12" Green	\$139.00
300A 12" Amber	\$149.00
310A IBM Compatible	\$175.00
Color I Composite	\$299.00
Color I +	\$339.00
Color II +	\$449.00
<b>BBC</b>	
12" Green	\$ 89.00
15" Color Composite	\$249.00

## FLOPPY DISK DRIVES

<b>TANDON</b>	
TM 100-2 5 1/4 DS-DD 320K (IBM)	\$235.00
<b>MICRO SCI</b>	
A2 (Apple)	\$219.00
Controller (Apple)	\$ 75.00

## HARD DISK DRIVES

<b>TECMAR</b>	
Complete Line	Call
<b>DAVONG</b>	
Complete Line	Call

## MODEMS

<b>U.S. Robotics-Auto Dial 212A</b>	\$499.00
<b>U.S. Robotics-Password</b>	\$379.00
<b>Signalman-Mark XII 1200 Baud</b>	\$279.00
<b>Signalman-Volkmodem</b>	Call
<b>Novation-J-Gat</b>	\$109.00
<b>Novation-Smart Car 100/212</b>	\$429.00
<b>Novation-PC 1200 B w Cross Talk XCV</b>	Call
<b>Hayes-Smartmodem 1200</b>	\$499.00
<b>Hayes-Smartmodem 1200 B</b>	\$439.00
<b>Hayes-Micromodem RE w Smartcom II</b>	\$241.00

## DISKETTES

<b>Memorex</b>	10 per box 5 1/4 SS DD	\$ 25.95
	10 per box 5 1/4 DS DD	\$ 35.95
<b>Elephant</b>	10 per box 5 1/4 SS DD	\$ 19.95
	10 per box 5 1/4 DS DD	\$ 26.95
<b>Verbatim</b>	10 per box 5 1/4 SS DD	\$ 25.95
	10 per box 5 1/4 DS DD	\$ 36.95
<b>Wabash</b>	10 per box 5 1/4 SS DD	\$ 19.95
	10 per box 5 1/4 DS DD	\$ 26.95

YOUR SATISFACTION IS OUR BEST ADVERTISING

NO CREDIT CARD FEE



# CENTENNIAL Computer Products, Inc.

NATIONAL ORDER DESK

1-800-862-7819 ORDERS ONLY

Discount on Disk Case Lots (Buy with a group)

TERMS AND CONDITIONS: NO CREDIT CARD FEE. Payment in cash or by check. All orders subject to credit review. Minimum order \$50.00. Shipping and handling charges extra. All prices are in U.S. dollars. Prices are subject to change without notice. © 1988 Centennial Computer Products, Inc. All rights reserved. Printed in the U.S.A. 10/88

IN COLORADO CALL (303) 371-2432  
10890 E. 47th Ave. (Near I-70 & HAYANA)  
DENVER, COLORADO 80239

VISIT OUR WAREHOUSE

OPEN 9 am - 6 pm M-F  
10 am - 4 pm SAT.



happens too darned fast. In the real world it takes minutes, not seconds, for a legion to turn and march. If you were to try to match *actual* real time, the game would take too long; but speeding it up the way the company has doesn't work either. Alas, there's no provision for changing the time-scale factor.

In addition, for reasons I don't understand, all the action takes place on a very small part of the screen. You see only a portion of the screen and have to scroll the map up and down and sideways in order to see

the entire playing area.

The graphics are lousy, too. All the units look alike; the only way you can figure out which ones are which is to put the cursor over one, at which point the unit is "frozen" in movement and combat, but you can read its designation and strength until you take the cursor away.

Legionnaire has neither history nor realism nor playability to recommend it. Oddly enough, though, Phillip, who wants to be a navy jet pilot and has the family record for arcade game scores, likes it, largely because of its

defects: it's really difficult to win, because not only must you be a good arcade game player, but also a good strategist. I notice, though, that he's taken to Parthian Kings again, and Legionnaire sits in its box.

### Hide That BYTE

I have written a long piece of advice for minicomputer establishment managers who want to get along with micros. Alas, there's no room this month, but it's at the top of my notes.

However, I can't resist telling this story.

It seems that the manager of the electronic data processing (EDP) shop of a Fortune 500 company decided to buy a bunch of micros. (Smart move; micros can do things that minicomputers can't, not because the micro is more powerful, but because there's better software due to the larger micro customer base.) He made his choice and put in an order for about a hundred machines.

Naturally the supplier asked why he'd chosen its product.

"Read about it. Guy named Pournelle, writes in one of the computer magazines."

"Oh, you read it in BYTE."

There was a stunned silence from the EDP man. Then he said, "Uh, look, uh, no, I didn't see it there—"

It turns out there's considerable prejudice against BYTE in certain circles. This chap was supposed to be reading *Datamation* or some other "professional computer" magazine, not BYTE for corn's sake . . .

I expect there's a moral to that story, but I'll leave it as an exercise for the reader. ■

*Jerry Pournelle is a former aerospace engineer and current science-fiction writer who loves to play with computers.*

*Jerry Pournelle welcomes readers' comments and opinions. Send a self-addressed, stamped envelope to Jerry Pournelle, c/o BYTE Publications, POB 372, Hancock, NH 03449. Please put your address on the letter as well as on the envelope. Due to the high volume of letters, Jerry cannot guarantee a personal reply.*

## Items Reviewed

<b>Compupro Hard Disk</b>	\$5495
CP/M-8/16 and BIOS	\$250
Compupro 3506 Breakwater Court Hayward, CA 94545 (415) 786-0909	
<b>CP/M Utilities</b>	\$32.50
Workman and Associates 112 Marion Ave. Pasadena, CA 91106 (818) 796-4401	
<b>CP/M-86</b>	\$250
Digital Research POB 579 Pacific Grove, CA 93950 (408) 649-3896	
<b>Legionnaire</b>	\$35 cassette, \$40 disk
<b>Parthian Kings</b>	\$25
Avalon Hill Game Corporation 4517 Harford Rd. Baltimore, MD 21214 (301) 254-5300	
<b>Modula-2 Operating System</b>	\$40
Modula Research Institute 950 North University Ave. Provo, UT 84604 (801) 375-7402	
<b>Sage II</b>	\$3900
<b>Sage IV</b>	\$7300
Sage Computer 4905 Energy Way Reno, NV 89502 (702) 322-6868	
<b>Turbo Pascal</b>	\$49.95
Borland International 4807 Scotts Valley Dr. Scotts Valley, CA 95066 (408) 438-8400	
<b>8087 Math Board</b>	without memory \$595
James Hudson Associates POB 2957 Santa Clara, CA 95055-2957 (408) 554-1316	
	just memory \$595
	with memory \$995



SHARP INTRODUCES

# COMPUTERS TO GO

With Sharp's PC-5000 you can take your entire office with you, wherever you go. Do word processing on the train, order entry from a customer's office or spread sheet analysis in your hotel room. It goes anywhere.

It's small.

It weighs under 10 lbs.\* and fits in a standard briefcase.

It prints. Quietly, with an optional correspondence-quality printer.

It comes with software. Word processing and communications. Also available are spread sheeting, executive planning and scheduling.

It remembers over 80 (128K) typewritten pages. And can be expanded to handle over 500 (896K).

It's compatible with a wide array of 16-bit IBM® software.

It communicates with other computers and databases.

It's AC/DC with rechargeable 6-hour batteries.

It all means travel time and commuter time no longer have to be downtimes.

For more information call toll-free now 1-800-BE SHARP or send in the coupon.

\*Without optional printer and modem.  
IBM® is a registered trademark of International Business Machines Corporation.  
Sharp Electronics Corp., Paramus, NJ 07652



FROM SHARP MINDS  
COME SHARP PRODUCTS

Sharp Electronics Corp., 1909 E. Cornell, Peoria, IL 61614

Please send me more information about Sharp's PC-5000.

Please set up a demonstration.

Name \_\_\_\_\_ Title \_\_\_\_\_

Company \_\_\_\_\_

Street \_\_\_\_\_ City \_\_\_\_\_

State \_\_\_\_\_ Zip \_\_\_\_\_

Phone (\_\_\_\_) \_\_\_\_\_

Dept. S-B-5-7-4



# Epson. For those who need it, simplicity.

One computer.

Two points of view.

The Epson QX-10 personal computer.

To many, the Epson represents the ultimate in simplicity.

Just press a single key for the function you require: word processing, scheduling, business graphics, address book or file management. One key-stroke produces your program. There are no rigamaroles to remember. No disks to change.

The result: you start to work immediately. And you start being productive, immediately. With step-by-step prompts. In plain English, not computerese.

Simplicity itself.

Or is it?

The plain fact is that the ease of operation the Epson offers today is accomplished with a degree of technological sophistication most other computers can only promise for tomorrow — specifically, fully integrated software, operating in an interactive environment.

The few other computers offering such "simplicity" cost \$5,000 to \$15,000 more. And most other computers can't offer it at any price. Which makes one wonder exactly what they do offer, in terms of either simplicity, or performance.

---

## HOW MUCH CAN YOU DO ON THE EPSON? HOW MUCH ARE YOU READY TO DO?

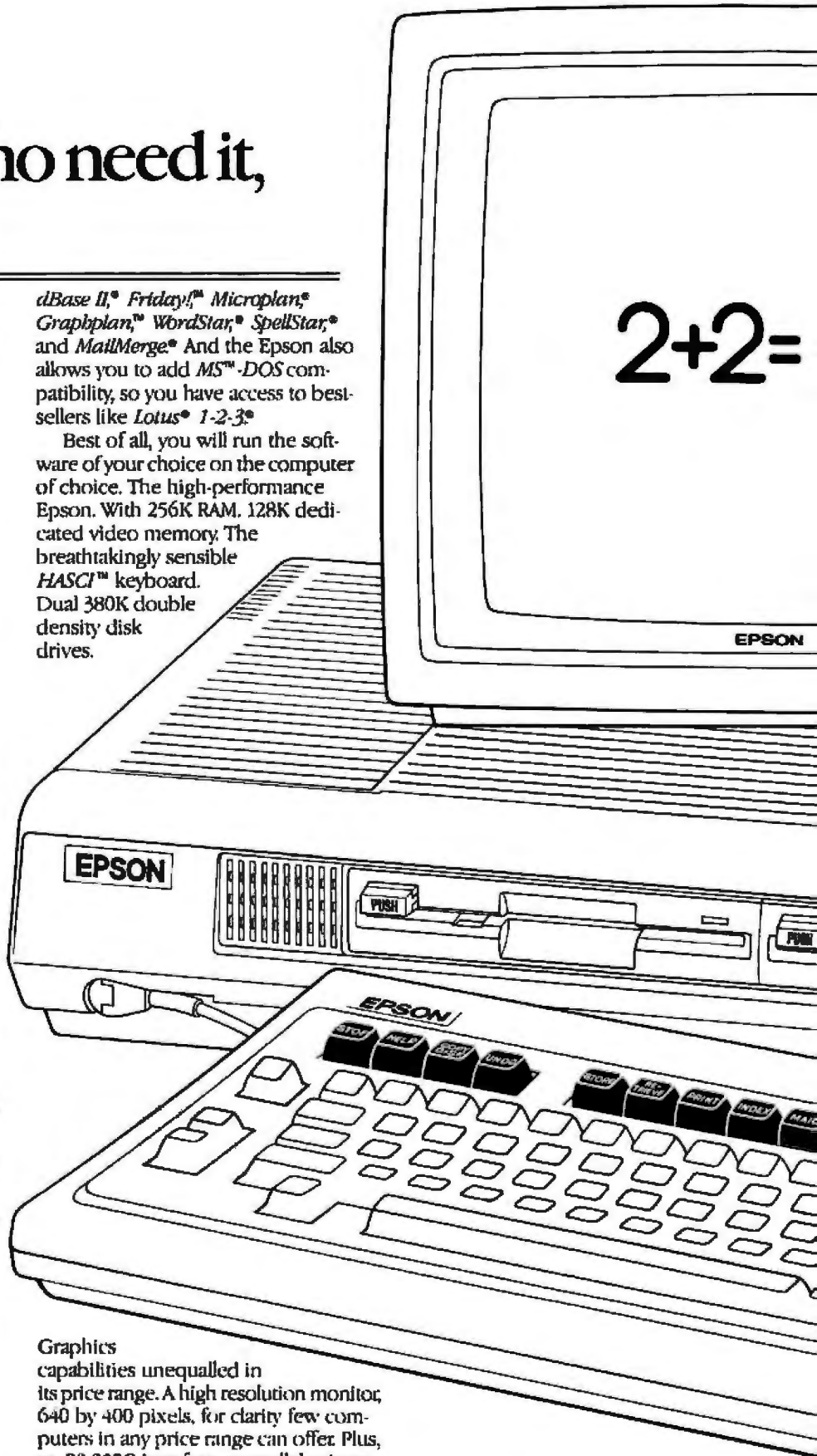
---

The Epson's ease of operation may spoil you, but it certainly won't limit you.

Case in point: every Epson comes complete with an integrated software system — *Validocs*® — to effortlessly provide the basic functions for which most people buy computers. The Epson also comes with *CP/M*® 80 2.2, so you can choose from the hundreds of programs in the CP/M library. And only Epson offers an exciting new collection of seven best-selling programs now specially enhanced to give you every powerful feature, plus Epson one-button simplicity. Included are

*dBase II*®, *Friday!*™, *Microplan*®, *Graphplan*™, *WordStar*®, *SpellStar*®, and *MailMerge*®. And the Epson also allows you to add *MS*™-DOS compatibility, so you have access to best-sellers like *Lotus*® 1-2-3®.

Best of all, you will run the software of your choice on the computer of choice. The high-performance Epson. With 256K RAM. 128K dedicated video memory. The breathtakingly sensible *HASCI*™ keyboard. Dual 380K double density disk drives.



Graphics capabilities unequalled in its price range. A high resolution monitor, 640 by 400 pixels, for clarity few computers in any price range can offer. Plus, an RS-232C interface, a parallel printer interface, and internal space for up to five peripheral cards so you can expand your Epson as your needs require.

One further point: all these features, and quite a few more, are included in the Epson's \$2,995 price. Some com-



# Epson. For those who can handle it, performance.

puter companies ask you to pay extra for features like these. Most can not offer them at any price.

That, too, is performance. The kind of performance that can make choosing a personal computer very simple, indeed.

**EPSON QUALITY. OR, WHY  
WONDER WHAT TERRIBLE  
KLUDGES LURK IN WHICH  
SLEEK BOXES.**

If you know computers, you know Epson. Epson printers set the industry standard for quality, reliability and value. Rest assured, the same can be said for the Epson personal computer.

The satisfying silence of the slim, Epson-designed disk-drives is one way for you to judge or, for an inside-out perspective, here is an excerpt from a review by Jim Hanson in the April, 1983 issue of *Microcomputing*\*

"The Epson QX-10 is soundly designed and executed. I looked hard and found no evidence of kludging or shorting out anything in the name of economy. All the connectors have gold on them and are of quality manufacture. The printed circuit boards are heavy, with soldermarks on both sides of double-sided boards. The circuit boards are completely silk-screened with component labels, and the layout is as professional and clean as you will find anywhere."

Isn't this what you expect? After all, it's an Epson.

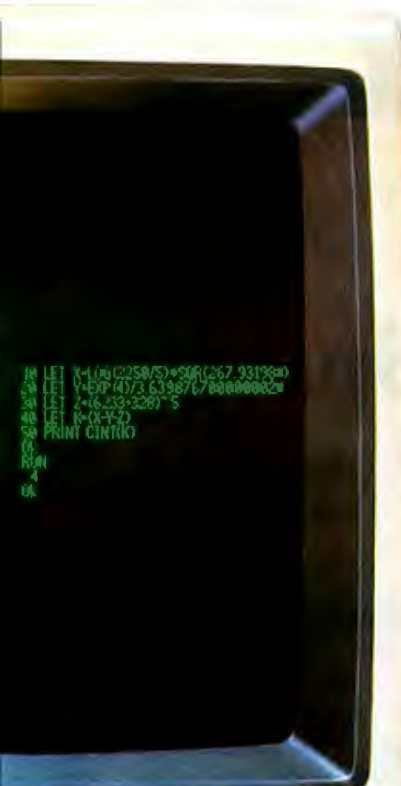
**A WORD TO THE WISE:  
GET YOUR HANDS ON  
THE EPSON.**

Is the Epson a simple, easy-to-use computer for beginners? Or a sophisticated high-performance computer for the experienced? The answer is "yes." And when you think about it, aren't those two computers the one you need now?

**For technical specifications, and the complete, 3-part *Microcomputing* review, along with the name of your nearby Epson dealer, call toll-free (800) 421-5426. California residents, call (213) 539-9140.**

\*Excerpt reprinted by permission of *Microcomputing Magazine*. All rights reserved.  
CP/M, dBase II, Microplan, WordStar, SpellStar, MailMerge, Lotus, 1-2-3 are registered trademarks of Digital Research, Ashton-Tate, Chang Labs, MicroPro (3), and Lotus Development (2) Valldocs, Graphplan, MS, and HASCI are trademarks of Rising Star, Chang Labs, Microsoft, and Rising Star, respectively.

**EPSON**  
STATE-OF-THE-ART...SIMPLICITY.



*Richard Cook*



## Bulletin Boards in Space

*Amateur radio pioneering promises low-cost global communications*

**John Markoff**  
BYTE Senior Technical Editor

The recent explosion of interest in personal computer communications using electronic bulletin-board systems (BBS) has been paralleled by a rise in interest in data communications among radio amateurs. Unlike their earthbound personal computer counterparts, hams are now raising the data communications ante both literally and figuratively.

Amateurs are seeking approval to be on board a space-shuttle mission to be launched from Vandenberg Air Force Base in Southern California sometime in 1986. If all goes well, the shuttle will carry an experimental amateur satellite system called PACSAT (packet radio satellite) into a low-earth polar orbit. Midway through the mission, a shuttle astronaut will push a series of switches ejecting PACSAT through the open shuttle payload bay.

PACSAT will be placed into orbit at the bargain-basement price of \$10,000 as part of the National Aeronautics and Space Administration's (NASA) "Get-Away Special." This program was devised by NASA to interest organizations that might not otherwise be able to participate in the space program. PACSAT will be contained in a 5-cubic-foot package weighing no more than 200 pounds.

When it reaches orbit, PACSAT will be the world's first space-based multiuser BBS. With several CMOS (complementary metal-oxide semiconductor) Z80-based (NSC800) microcomputers and 4 megabytes of RAM (random-access read/write

memory) disk storage on board, PACSAT will herald the arrival of a new era of global data communications.

PACSAT will allow licensed radio amateurs anywhere to transmit packet-switched digital messages at 9600 bps (bits per second) for delivery within a 12-hour time period. As the satellite circles the globe at an altitude of 250 miles, inexpensive earth-based gateway communications stations will be able to transmit electronic messages on several ham-band uplink communications channels. These messages will be stored for later retransmission by PACSAT to other hams around the world.

The architecture of the PACSAT communications network looks much like baseband LANs (local-area networks) that use a carrier-sensing, multiple-access (CSMA) scheme to share a single wire in an office setting. However, in this case, digital-data packet communications will share a part of the RF (radio frequency) spectrum using a set of packet-switching protocols that are, in effect, an extension of the X.25 protocols used in commercial packet-switching computer networks.

To make the PACSAT network more efficient, the satellite will communicate directly with network nodes rather than with all amateurs.

"The ultimate goal is for you to be able to connect your packet-radio (printed-circuit) board to a local-network node," says Harold Price, NK6K, an amateur-radio operator

with a computer-science background who is serving as PACSAT's full-time project manager.

"You could probably build messages off line," he adds. "You could use Wordstar to build your message and then tell your computer which amateur to send it to. What will actually happen is that your computer will connect up to the local network, put that message on there and say 'forward this,' and the network itself will take care of routing the message the best way. If the person the message is intended for happens to be local, it will keep it locally until there is a check-in. Or it will be sent by satellite if the person is located farther away."

Price admits, however, that the amateurs still have several years of development work before such a sophisticated network is in place.

Two aspects of the project will be of great interest to personal computer users interested in data communications. First, the PACSAT project will offer the first truly low cost global communications network. PACSAT will be visible to every portion of the globe each six hours, meaning that it will function as an electronic-mail carrier in the sky, taking data up on one side of the earth and transmitting it down to another point during a subsequent orbit.

The Radio Amateur Satellite Corporation (AMSAT) is now designing PACSAT earth stations that will cost less than \$700. The stations will consist of a simple digital transceiver de-



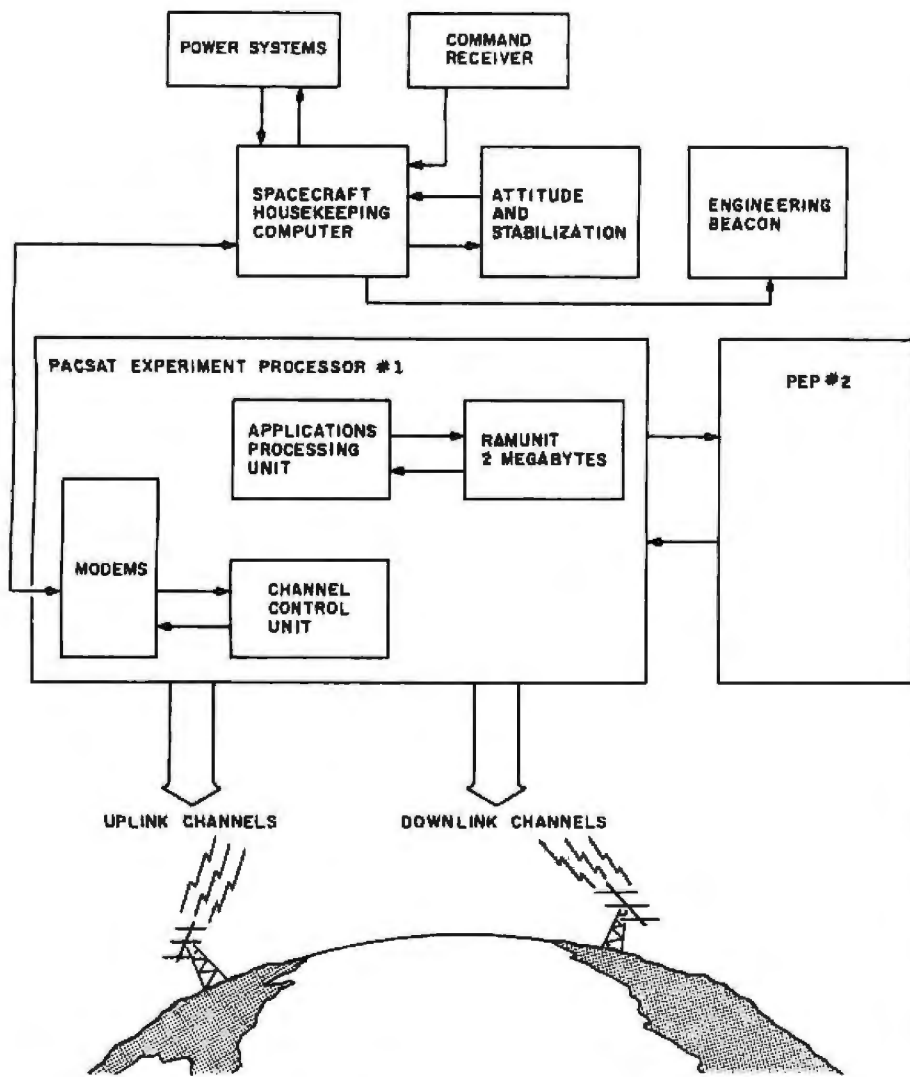


Figure 1: PACSAT system architecture.

signed to operate at the 70-centimeter (435-MHz) and 2-meter (146-MHz) amateur-radio frequencies, a terminal node controller (TNC) used to convert an asynchronous data-communication stream into synchronous digital packets, and a quarter-wave ground-plane antenna. These stations can be connected to virtually any personal computer.

"The antenna is extremely simple," says Price. "In my case, it is simply two bent coat hangers located in a high place out of the way of trees and other objects."

The second aspect is that the work radio amateurs are doing in satellite and packet-radio communications areas may ultimately find application in earthbound data-communications networks. Hams have begun implementation of several levels of the International Organization for Stan-

dardization's (ISO) open system interconnection model designed to standardize communications systems.

PACSAT is a joint project of AMSAT and Volunteers in Technical Assistance (VITA), a nonprofit organization spreading science and technology to poor countries. Inquiries have been received in most scientific areas. VITA will be the second PACSAT user, greatly accelerating the speed of communications between its projects around the world.

PACSAT will, in fact, have two separate BBSes, each with a series of data uplink and downlink channels that will be able to handle communications with multiple earth stations. AMSAT and VITA will each use a separate communication computer, known as a PEP (for PACSAT experiment processor), on board the

spacecraft (see figure 1).

Each PEP consists of an applications processing unit (APU), a channel control unit (CCU), and 2 megabytes of system RAM, accessed by a bank-switching scheme, that will function as an electronic mass-storage system. A serial connection exists between the two PEPs to provide redundancy and to permit AMSAT to reconfigure the experiment if one unit fails.

The APU provides microprocessor-based control for the PEP. It is based on an NSC800 (a version of the Z80 microprocessor implemented in low power consumption CMOS) running at 4 MHz. This processor controls the BBS software and handles I/O (input/output) between two CCUs, each containing the modem hardware required to move data between the RF links and APU. Each CCU is also controlled by an NSC800 and supports two uplink and one downlink communications channels. The CCUs function independently and each contains its own programs in 2K bytes of PROM (programmable read-only memory) and 2K bytes of RAM. This is done to keep the communications channels as separate as possible and to avoid having large numbers of data and address lines being strung throughout the satellite.

"What we'll have up there is a multitasking, multiprogrammed operating system," notes Price. "There will be many earth stations connected to PACSAT simultaneously, and PACSAT will have to keep track of multiple users."

To conserve processing power aboard PACSAT, ground stations will be able to request a file directory from the PEP on board the spacecraft and then search the directory for files on earth. Once a file is located, it can be requested and sent to the ground station at the same time new messages are being uploaded.

The spacecraft itself will be controlled by a microcomputer called the integrated housekeeping unit (IHU), which will keep the spacecraft healthy by handling navigation and attitude control, monitoring the solar cells, and collecting telemetry and sending it to the ground control sta-



# ERG/68000 MINI-SYSTEMS

- Full IEEE 696/S100 Compatibility

## HARDWARE OPTIONS

- 8MHz, 10 MHz, or 12 MHz  
68000/68010 CPU
- 68451 Memory Management
- Hardware Floating Point
- Multiple Port Intelligent I/O
- 64K/128K Static RAM (70 nsec)
- 256K/512K/1MB Dynamic RAM (150 nsec)
- Graphics-Digital Graphics  
CAT-1600
- DMA Disk Interface
- SMD Disk Interface
- 1/4" or 1/2" Tape Backup
- 5 1/4" or 8" Floppy Disk Drives
- 5MB-474MB Hard Disk Drives
- 7/10/20 Slot Back Plane
- 20 or 30A Power Supply
- Desk Top or Rack Mount Encl.

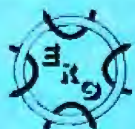
## SOFTWARE OPTIONS

- 68KFORTH<sup>1</sup> Systems Language
- CP/M-68K<sup>2</sup>O/S with C, 68K-BASIC<sup>1</sup>,  
68KFORTH<sup>1</sup>, FORTRAN 77, EM80  
Emulator, Whitesmiths' C, PASCAL
- IDRIS<sup>3</sup> O/S with C, PASCAL,  
FORTRAN 77, 68K-BASIC<sup>1</sup>, CIS  
COBOL<sup>4</sup>, INFORMIX<sup>5</sup> Relational  
DBMS
- UNIX<sup>6</sup> SYS V O/S with C, PASCAL,  
FORTRAN 77, BASIC, RM COBOL<sup>7</sup>,  
ADA<sup>8</sup>, INFORMIX<sup>5</sup>, Relational DBMS
- VED 68K Screen Editor
- Motorola's MACSBUG and FFP  
Package

Trademark <sup>1</sup>ERG, <sup>2</sup>Digital Research,

<sup>3</sup>Whitesmiths, <sup>4</sup>Micro Focus, <sup>5</sup>RDS,  
Inc., <sup>6</sup>Bell Labs, <sup>7</sup>Ryan McFarland,  
<sup>8</sup>U.S. DoD

30 Day Delivery - OEM Discounts



since 1974

Empirical Research Group, Inc.  
P.O. Box 1176  
Milton, WA 98354  
(206) 872-7665

tion. On other amateur satellites, this function has been performed by a military-grade RCA 1802 microprocessor using a special Sandia CMOS radiation hardening process that is very rare and expensive.

Price notes that the PACSAT designers will confront special problems outside the earth's atmosphere. Little hard information is available on how the system will fare in a high-radiation environment. Low power consumption semiconductors are relatively susceptible to radiation-induced errors. To work around this problem, instead of using heavy, expensive shielding systems or less vulnerable high-power semiconductors, each PEP will contain software-based error-checking algorithms that will protect the contents of the RAM. Special error-checking hardware circuitry will protect program and operating-system software held in a separate 48K-byte section of memory in each PEP.

Weight and power constraints are also forcing PACSAT's designers to create an extremely low power consumption hardware architecture for the spacecraft. The entire PACSAT spacecraft will run on less than 35 watts of power. On UOSAT B, launched in March, a smaller experimental communications processor that served as a prototype for the PACSAT PEP experiment used 0.75 watt.

"They said they could give us 1 watt," says Price. "They said that if we used a watt they would have to turn us off every once in a while. So we fought to keep the power real small so they would leave us on all the time." For reference, he points out that a standard non-CMOS Z80 microprocessor draws 150 milliamperes at 2 MHz. This is roughly equivalent to the power consumption of an entire PEP on board PACSAT.

The ground-station component of the PACSAT network is built around a simple TNC controller created by a group called Tucson Amateur Packet Radio (TAPR). The group has designed and made available in kit form a TNC that has software and hardware architecture organized in accordance with the ISO layered-

network communication model. The TAPR TNC currently implements the first two layers of the ISO model: the physical layer and the data-link layer. The TAPR TNC, which is based on the 6809 microprocessor, can hold a total of 48K bytes of RAM and ROM on the printed-circuit board. It uses the Western Digital 1933 HDLC (high-level data-link control) chip (an LSI [large-scale integration] device that implements much of the ISO level-two standard in hardware) and has both serial and parallel ports. The TAPR TNC is a second-generation design that is an outgrowth of an earlier board built by a group of hams in Vancouver, British Columbia. (For more information on the TNC kit, available for \$240, contact Tucson Amateur Packet Radio, POB 22888, Tucson, AZ 85734.)

Amateur packet radio is just beginning to come into its own in the United States. The first digital packet-radio repeater (called digipeaters by the Canadians) was established at the end of 1980 by Dr. Hank Magnuski, KA6M, a data-communications professional and amateur-radio operator in the San Francisco area. Since that time, communities of interest have sprung up around the country as more radio amateurs begin experimenting with radio and personal computers. Currently, several amateurs are experimenting with packet radio in California.

Digital repeaters enable amateurs to send information over a wide geographic region. Several amateurs have set up repeater-based CP/M systems hooked into the network that function as packet-radio bulletin-board systems and permit file transfers as well. In this case, according to Harold Price, no error-checking software (such as the Christensen Protocol) is used at the personal computer level because that function is handled by the TNC.

"When a frame comes in, the TNC board error-checks it; if it doesn't pass, then the frame doesn't get acknowledged," Price says. "The sending station times out and then re-sends the packet. For file transfer, you do not need a higher-level error-checking protocol like Modem7 be-



# LOOK WHO BUYS SOFTWARE FROM US!

IBM • XEROX • NCR  
 CHEVRON • GTE • SPERRY  
 JFK SPACE CENTER • ARAMCO  
 AT&T • BENDIX • PRICE WATERHOUSE  
 HEWLETT PACKARD • GENERAL ELECTRIC  
 GENERAL DYNAMICS • TRW • ARTHUR ANDERSEN & CO.

If you order software from us, you're in good company. You see, some of our best customers are America's biggest corporations.

Maybe they're attracted by our low, low prices (big companies are price-conscious too!).

Or maybe when you're an "IBM", you're looking for something extra. Like the personal service, giant inventory, and in-depth technical support you'll

find at 800-SOFTWARE.

You see, when you call us, we'll take care of you like our business depends on it. Because it does. Which means when you place an order, you can be sure we'll fill it promptly. And that our unique Order Tracking System™ is keeping tabs on your order every step of the way.

Most important, we'll be there if you need us after your software arrives. We'll make

sure that you'll receive the finest technical support and customer service in the industry. And that's a promise.

Next time you're looking for low price and great service, do what IBM, General Electric, and a lot of other big companies do. Pick up the phone and give us a call.

We'll show you why some hard-headed companies buy their software from us.

## CHECK OUT ALL OUR INCREDIBLE BUSINESS SOFTWARE PRICES:

WordStar™ PROF PAK \$389	Lotus™ 1-2-3 \$329	SuperCalc 3™ \$259	dBASE II \$399	
WordStar™ \$269	InfoStar™ \$289	SuperCalc 2™ \$169	Crosstalk \$119	
ANDERSON BELL™ Abstral \$339	All Other Products CALL	MAXELL™ DISKETTES CALL	Interface \$299	
ASHTON-TATE™ dBase II \$399 dBase II User's Guide \$ 20 Friday! \$219	HAYES™ Smartmodem 300 \$249 Smartmodem 1200 \$549 Smartmodem 1200B \$489	MEMOREX™ DISKETTES CALL	MICROSOFT™ Fortran \$269 Multiplan™ \$149 Word™ \$289 Word™ w/Mouse \$359 All Other Products CALL	ROSESOFT™ Pro Key \$ 99
ATI™ TRAINING PRODUCTS CALL	HERCULES™ Color Graphics Card \$409	MICROPRO™ WordStar (w/Training Mod.) \$269 WordStar Prof. Pak (WS/MMS/SS) \$389 WordStar/MailMerge \$369 InfoStar \$289	MICROSTUF™ Crosstalk \$119	SOFTWARE PUBLISHERS™ PFS File \$105 PFS Graph \$105 PFS Report \$ 95 PFS Write \$105
CDEX™ TRAINING PRODUCTS CALL	HOWARDSOFT™ Tax Preparer \$229	WordStar/MailMerge \$369 InfoStar \$289	NORTON™ UTILITIES \$ 59	SOFTWARE SYSTEMS™ Multimata \$349
CONDOR™ 3 \$269	HUMANSOFT™ OB Plus \$ 79	Options Pak (MM/SS/SS) \$169 MailMerge \$139 PlanStar \$339 ReportStar \$229 Star Index \$129 All Other Products CALL	PEACHTREE™ PEACHTEXT 5000 \$239	SORCIM™ Supercalc 2 \$169 Supercalc 3 \$259 All Other Products CALL
CONTINENTAL™ Home Accountant \$105	IMSI™ 4-Point Graphics \$129 All Other Products CALL	PlanStar \$339 ReportStar \$229 Star Index \$129 All Other Products CALL	PERFECT SOFTWARE™ Perfect Writer \$209 Perfect Link \$119 All Other Products CALL	VISICORP™ Visicalc Advanced (Apple IIe) \$269 Visicalc \$189 Visi-On Products CALL All Other Products CALL
DIGITAL RESEARCH™ CPM 86 CALL Concurrent CPM 86 CALL CBasic 86 CALL All Other Products CALL	IUS™ EasyWrites II System \$229 EasyWriter I System \$140 IUS Accounting \$299/mod. All Other Products CALL	MICRODRIM™ RBase 4000 \$369 RBase Extended Report Writer \$109 RBase Program	QUADRAM™ Quadboards 64K/256K \$329/\$489 Quadlink \$559	
FOX & GELLER™ Quickcode \$199 dGraph \$199 dUtil \$ 65	LIFETREE™ Volkswriter Deluxe \$179	LOTUS™ 1-2-3 \$329		

## WE ALSO CARRY HUNDREDS OF OTHER PRODUCTS!

WRITE:  
 800-SOFTWARE, INC.  
 940 Dwight Way, Suite 14  
 Berkeley, CA 94710  
 CA residents  
 add sales tax.

**800-SOFTWARE**

TO ORDER CALL TOLL FREE:  
 800-227-4587 or 415-644-3611

- ✓ We guarantee our products against manufacturing defects.
- ✓ Quantity discounts available through our National Accounts Program
- ✓ Purchase orders accepted. Please call in advance.
- ✓ Prompt U.P.S. or Federal Express shipping. Overnight delivery available. Call for shipping charges.
- ✓ Call for free catalog and other low software prices.
- ✓ We do not add surcharge for credit card purchases.
- ✓ Prices may change.
- ✓ International orders welcome. Telex: 75173 800-SOFTWA KK 11D



# FREE SHIPPING

WEST OF MISSISSIPPI  
EAST — 1/2 UPS CHARGES

CALL FREE  
1-800-841-2748

## COMPUTERS

ALTOS 580-20 . . . . .	\$3645
ALTOS 586-20 . . . . .	\$5565
ATARI . . . . .	SCALL
APPLE LOOK-A-LIKE . . . . .	SCALL
SANYO 550-555 . . . . .	SCALL

## TELEVIDEO

803 . . . . .	\$1789	1603 . . . . .	\$2019
PORTABLE . . . . .			SCALL

## NORTHSTAR

ADVANTAGE . . . . .	\$2135
---------------------	--------

## PRINTERS

BROTHER HR18P . . . . .	\$479
DAISYWRITER 48K . . . . .	\$975
DATASOUTH 180 . . . . .	\$1125
DATASOUTH DS220 . . . . .	\$1575
GEMINI . . . . .	\$275
JUKI 6100 . . . . .	\$459
OKIDATA (LOW PRICES) . . . . .	SCALL
QUME 1140+ . . . . .	\$1275
QUME 1155+ . . . . .	\$1475

## CITOH

8510 . . . . .	\$339	1550 . . . . .	\$559
F10-40C PS . . . . .	\$970	F1055 . . . . .	\$1299

## DIABLO

620 . . . . .	\$860	630 . . . . .	\$1689
---------------	-------	---------------	--------

## NEC

3550 . . . . .	\$1699	8025 . . . . .	\$659
7710 . . . . .	\$1849	2030 . . . . .	\$799

## TERMINALS — MONITORS

ALTOS II . . . . .	\$875
QUME 102G . . . . .	\$529
TELEVIDEO 914 . . . . .	\$640
TELEVIDEO 924 . . . . .	\$689
TELEVIDEO 950 . . . . .	\$929
TELEVIDEO 970 . . . . .	\$975

AMDEK 300G . . . . .	\$129
AMDEK 300A . . . . .	\$145
AMDEK COLOR I+ . . . . .	\$275
AMDEK COLOR II+ . . . . .	\$429
B.M.C. GREEN . . . . .	\$89
B.M.C. COLOR . . . . .	\$245
N.E.C. 1216 . . . . .	\$429

## DISK DRIVES — MODEMS

INDUS APPLE . . . . .	\$259
MICRO SCI A2 . . . . .	\$229
ATARI 1050 . . . . .	\$365
INDUS ATARI . . . . .	\$345
RANA 1000 . . . . .	\$310
HAYS SMART MODEM . . . . .	\$199
SMARTMODEM 1200 . . . . .	\$485
SMARTMODEM 1200B . . . . .	\$429
MICROMODEM II E . . . . .	\$235
RIXON 212A . . . . .	\$449
U.S. ROBOTICS PASSWORD . . . . .	\$349

# 1st PLACE

COMPUTER SYSTEMS  
13422 N. CAVECREEK RD.  
PHOENIX, AZ. 85022

OTHER INFORMATION: 602-867-9897



Free shipping is on UPS ground only.

Send cashier's check or money order... all other checks will delay shipping two weeks.

Prices & availability subject to change without notice.



## OSCAR: The Amateur-Radio Satellite Tradition

PACSAT isn't the first amateur-radio satellite to be launched into space. Since 1961, OSCARs (orbiting satellites carrying amateur radio) have been hitchhiking into space aboard rocket boosters carrying commercial satellites.

On December 12, 1961, OSCAR 1 was launched and operated for 18 days. Its communications system was simple. A beacon continually transmitted the message "Hi" in Morse code. The number of "Hi's" transmitted within a 10-second interval was a function of the internal spacecraft temperature.

Since then, nine other satellites carrying communications and other scientific experiments have been launched by amateurs based in different countries. One recent OSCAR included a video camera intended to beam television pictures of earth back to amateurs with special television reception equipment.

Like their commercial counterparts, radio amateurs also have occasionally been plagued with errant satellites. OSCAR 4, launched on December 21, 1965, was the amateurs' first failure. It was supposed to attain a sun-synchronous orbit, but the third stage failed to ignite, leaving it in a highly elliptical orbit instead.

In recent years, OSCARs have been the

product of international cooperation among radio amateurs. AMSAT-OSCAR 8, launched as a passenger on a LANDSAT C booster on March 5, 1978, was a joint project of amateurs in the U.S., Japan, and West Germany.

In June of 1983, AMSAT-OSCAR 10 was sent into orbit by the European Space Agency. It was a combined effort by volunteers in the U.S., West Germany, Hungary, Argentina, Japan, Canada, and New Zealand. This satellite, which is in an orbit that opens a window of communications between amateurs in North America and Europe, is powered by solar panels that generate 40 watts of power.

The next amateur launch, known as UOSAT-B, occurred in March. Designed as a small prototype of PACSAT, it carried scientific experiments on radio propagation and the magnetic and radiation environment in low-earth orbit. The satellite was constructed by scientists at the University of Surrey in England. It carried a "Digital Communications Experiment" that is a precursor of the PACSAT system. It will permit ground stations around the world to gain experience with an orbiting digital store-and-forward device. The UOSAT-B orbiting BBS included 196K bytes of storage and a single 2400-bps path.

cause the ACK function is taken care of at a lower level. I just spew data out. If my system doesn't get an acknowledgment to the packet, the system determines that either the packet didn't get through or there must have been a collision. One way or another, it retransmits the packet after waiting a random period of time for the channel to clear again."

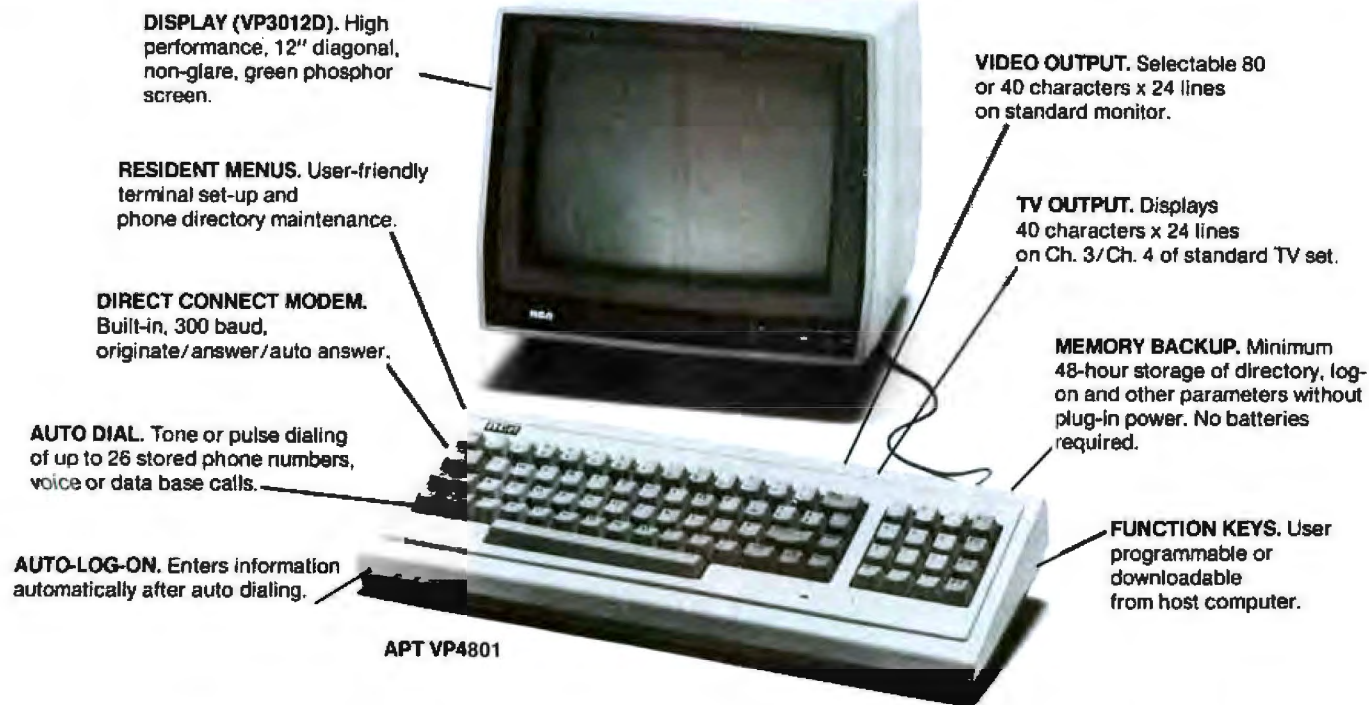
Amateur operators already have begun experimenting with linking ground-based packet-radio networks via satellite. Recently, a data file was sent from Washington, DC, to Los Angeles via the OSCAR 10 satellite. OSCAR 10 (see the "OSCAR: The Amateur-Radio Satellite Tradition" text box) is a voice and data repeater in high-earth orbit. Shortly, Price and Dr. Tom Clark, W3IWI, an amateur in Washington, DC, and president of AMSAT, plan to see if Clark is able to log onto a C/P/M system in California routing via OSCAR 10 and digi-

tal-repeater stations. Several stations in North America and a station in New Zealand already have exchanged data files.

To implement level two of the ISO model on board the TNC, amateur packet communications utilize a protocol known as AX.25. This protocol, agreed on at an AMSAT national meeting in 1982, is a variant of the X.25 packet-switching standard. AX.25 differs from X.25 principally in the structure and size of its address field. The AX.25 protocol includes both source and destination addresses while X.25 contains only a single address. This results in optimizing the protocol for "many-to-many" data communications, which is characteristic of amateur-radio digital networks. The selection of the format of the address under AX.25 is simple. Each amateur's packet address is his or her unique ham call sign.



# You don't need a computer to talk to another computer.



**DISPLAY (VP3012D).** High performance, 12" diagonal, non-glare, green phosphor screen.

**RESIDENT MENUS.** User-friendly terminal set-up and phone directory maintenance.

**DIRECT CONNECT MODEM.** Built-in, 300 baud, originate/answer/auto answer.

**AUTO DIAL.** Tone or pulse dialing of up to 26 stored phone numbers, voice or data base calls.

**AUTO-LOG-ON.** Enters information automatically after auto dialing.

**VIDEO OUTPUT.** Selectable 80 or 40 characters x 24 lines on standard monitor.

**TV OUTPUT.** Displays 40 characters x 24 lines on Ch. 3/Ch. 4 of standard TV set.

**MEMORY BACKUP.** Minimum 48-hour storage of directory, log-on and other parameters without plug-in power. No batteries required.

**FUNCTION KEYS.** User programmable or downloadable from host computer.

APT VP4801

## The new RCA APT (All Purpose Terminal) expands your data communications capabilities for a lot less money.

For business, professional and personal data communications, you'll find more user-friendly features and greater communications capabilities in the RCA APT than in other terminals selling for up to three times the price.

The new APT terminals are ideally suited to multi-data base time sharing and dedicated, direct computer-connected applications. They feature menu-controlled operation and a programmable "personality" to match specific communications requirements for your data bases.

A single keypress can dial a stored number, send the log-on sequence on the host computer, and return terminal control to the user. Password protection prevents unauthorized access to designated numbers. APT can also be used as an auto-dialer for voice communications.

### OTHER FEATURES

RS232C port for direct computer connections at data rates to 9600 baud, or for connecting high speed modems and other accessories. Parallel printer port for hard copy. Numeric keypad, can dial phone numbers not in terminal directory. Built-in speaker with adjustable volume control for audio monitoring of phone line. Smooth scroll display. Automatic screen blanking to reduce possibility of burn. Briefcase size: 17" x 7" x 2". Weight: under 4 lbs.

Quite simply, matching features with price, there is no other professional quality terminal available today that can do as much at such low cost.

APT terminals list for \$498, in your choice of full stroke or membrane keyboard versions. Either style is also available with a display monitor for \$697 list. The data display monitor alone, VP3012D, \$199 list.

For more information—or to order—call 800-722-0094. In Penna., call 717-295-6922. Or write for fully descriptive brochure to RCA Data Communications Products, New Holland Avenue, Lancaster, PA 17604. OEM and dealer pricing available. The new RCA APT. Expansive. Not expensive.



**APT VP3801.** Flexible membrane keyboard version designed for travel and hostile environments.

# RCA



# Graphics for Zenith Terminals



## Graphics-Plus transforms Z19 into super terminal

The GRAPHICS-PLUS enhancement board installs easily into your Zenith Z19 terminal to give you powerful graphics capability as well as expanded user features. For a small investment, your Z19 now rivals the horsepower of very expensive terminals.

You get Tektronix 4010 compatibility to run industry standard graphics software. In the text mode, you get DEC VT100 compatible 80 and 132 column formats and 24/49 line

displays. Plus seven pages of off-screen scrolling memory. A "plain English" Set-up mode. Sixteen programmable function keys. And many more convenience features.

### Printer Port Option

To capture your graphs and text on hardcopy, you will also want our printer interface board for popular dot matrix printers. Specify if you need serial or parallel compatibility.

\*Ask about GRAPHICS-PLUS for the Z-29

## Northwest Digital Systems

P.O. Box 15288  
Seattle, WA 98115  
(206) 524-0014

<input type="checkbox"/> Enter my Order		Quantity
<input type="checkbox"/> Send literature only		
<input type="checkbox"/> GRAPHICS-PLUS (GP-19) board	\$ 849	
<input type="checkbox"/> Z19 Terminal with GP-19 installed	1495	
<input type="checkbox"/> Printer I/O board	195	
<input type="checkbox"/> Serial I/O	<input type="checkbox"/> Parallel I/O	Total \$
Name _____		
Company _____		
Address _____		
City _____ State _____ Zip _____		
Telephone _____		

According to Price, AMSAT members also are working on an inexpensive transceiver that will transmit in the 70-centimeter range and receive on 2 meters as well as contain high-speed modem circuitry capable of exchanging data at 9600 bps. The receiver will be designed to handle only data communications by converting RF frequencies to the intermediate-frequency (IF) stage of 10 MHz.

"We are planning to build a receiver with just the RF and IF stages and no bells and whistles for less than \$100," says Price. "We are going to come up with plans for a kit. You'll feed RF into it from an antenna, and you'll get a digital stream out. Data will never get translated to audio frequencies."

VITA is also considering its own low-cost, portable earth stations, currently planning between 6 and 20 of them. These stations will be fully portable and able to operate from solar power.

Today, low-cost satellite-communications technology is still in its infancy, yet the radio amateurs are exploring frontiers that may one day fundamentally change the basis of our communications practices.

"It's very significant," says Dr. Magnuski. "Here are individuals who now have their own satellite-communications ground stations. In the past, these have cost a minimum of \$70,000 to \$80,000.

"Now for the first time you have the potential for global person-to-person communication not based on commercial offerings. It's a tremendous equalizer. A person who lives in the mountains in the most remote area of the country has, in principle, as much access to information as someone like myself living in the heart of Silicon Valley." ■

**Author's Note:** For more information on PACSAT, send a stamped, self-addressed envelope to the Radio Amateur Satellite Corporation, POB 27, Washington, DC 20044.

John Markoff is a senior technical editor at BYTE's West Coast bureau. He can be reached at McGraw-Hill, 1000 Elwell Court, Palo Alto, CA 94303.



# Score another first for ACE.



A lot of people who've never heard of ACE's impressive record of firsts in multiprocessing are about to sit up and take notice. Why?

It's our latest wonder: Multiprocessor CP/M Plus\*.

ACE has developed a linkup between its powerful multiuser micro-computer, the Discovery, and the fastest and most powerful version of CP/M\* ever marketed.

The result is a multiprocessor that does more than just emulate CP/M or rely on a lesser operating system that's "CP/M compatible." It actually delivers pure CP/M (either CP/M-86\* or CP/M Plus) to any of Discovery's up to 16 on-line users.

With easy command line editing, quick file accessing through user-defined automatic search paths and comprehensive "help menus," CP/M Plus is as friendly as they come — and with big performance extras.

Like large files, directory hashing, data buffering, time and date stamping, and an extensive utility set that can accept English words.

All of which means that ACE's linkup with CP/M Plus will continue to give Discovery owners access to the largest selection of applications software in the world for years to come.

That's something to think about. Because who wants a multiuser system that's friendly and powerful today but unfriendly tomorrow when new software using CP/M

## Multiprocessor CP/M Plus.™

Plus features hits the scene?

Our latest triumph is just one of a line of firsts.

ACE pioneered multiprocessing for microcomputers back in 1979 when we introduced a Discovery featuring what was then the revolutionary concept of dedicating a CPU to each on-line user.

Two years later, we moved further ahead of the pack with our next singular feat: the first user-processor on a single board, the dpc-180\*. Everything was there: memory, CPU, serial I/O.

Nice.

Which made our 1982 breakthrough — the amazing 16-bit dpc-186\* mated with CP/M-86 — seem like business-as-usual to us even though it caught the competition flat-footed.

With room to grow from 128K to 1MB of expansion memory, and designed for systems also using our 8-bit board, this breakthrough let individual users tap into either 8- or 16-bit computing power with one

central Discovery unit.

And because each Discovery system is controlled by our own dpc/os\*, tried and proven in more than 10,000 Discovery and OEM installations around the world, any user on line can take advantage of interprocessor communication, file and record locking, fully managed multiple printers, private directories, plus many other features.

So what little wonder does ACE have up its sleeve now? Stay tuned. Because soon you'll hear the news about our Concurrent CP/M-86\* which will give the owners of our Discovery all the benefits of 16-bit computing power, CP/M's comprehensive software selection, and efficient multi-tasking capabilities. So each user can get several projects underway with a few quick taps on the keyboard.

Meanwhile, it'll be business as usual for ACE, keeping ahead of the crowd while turning out the best multiuser multiprocessor micro on the market, backed by one of the best nationwide service networks you could hope for.

So if you're a computer dealer, distributor, or systems house who wants to join the group that scores high with a multitude of users, just give us a call at (800) 821-6596. (In California, it's (213) 351-5451.)

And do us a small favor. Tell us you've heard of us.



**ACTIONCOMPUTERENTERPRISE**  
The Multiprocessing Company.

Action Computer Enterprise, Inc. (Corporate Headquarters): 430 No. Halstead St., Pasadena, CA 91107, TWX 910-588-1201 ACTION PSD  
ACE/Europe: Boschdijk 189, Box 1275, 5602 BG, Eindhoven, Netherlands, Tel. 040-452658, Telex 51767 ACE E NL ACE/Asia, G/Floor Lee Wah Mansion, 171-177 Hollywood Rd, Hong Kong.  
Tel. 5-441692 or 5-442310, Telex 75332 PACIC HX Canada: Future Electronics, Inc., 237 Hymus Blvd., Pt. Claire, Quebec H9R5C7, Canada, Tel. (514) 694-7710, Telex 05-823554.

\*CP/M Plus, CP/M, CP/M-86, and Concurrent CP/M-86 are either trademarks or registered trademarks of Digital Research, Inc. / \*dpc-180 and dpc / os are registered trademarks of Action Computer Enterprise, Inc.  
Serviced nationwide by Bell & Howell Company



Now A 16-Bit  
Microcomputer  
Designed To  
Expand Your  
Knowledge.





# Here's How You Can Learn 16-Bit Technology. And Graduate To One Of Today's Most Powerful And Advanced Microcomputers.

Now you can master 16-bit technology with an all-new Advanced Microprocessor course. And build hands-on experience with the only 16-bit microcomputer specifically designed for the hobbyist, working engineer and student.

## Advanced Microprocessor Course

This all-new self-study course (EE-8088) provides in-depth coverage of 16-bit, state-of-the-art technology.

You will gain a thorough understanding of microprocessors from this 1200 page course. In 10 easy-to-understand units, starting with microcomputer basics, you'll cover all phases of 16-bit micro-processing. Assembly language. Program writing. Addressing modes. Dynamic and static RAM. And hardware interfacing.



And by using your 16-bit Trainer/Learning Computer for hands-on experiments (over 60 included), you'll gain actual circuit interface and software programming experience with an

8088 microprocessor system.

## Trainer/Learning Computer

A unique combination of design features makes this versatile microprocessor system much more than a "teaching machine." Use it as a trainer with the Advanced Microprocessor course. Use it as an experimental design computer. And use it to run a wide variety of 16-bit software—including Z-Dos, Multiplan, Z-Basic, Condor File Manager, and much more.



In its most basic form, the Trainer/Learning Computer is a 16-bit,

cassette-based microcomputer.

Its unique design features access ports and solderless breadboards to allow you to build interfaces, design and modify circuits, or simply experiment with the inner workings of the microprocessor system.

The basic system has an 8088 processor, 32K ROM (including assembler, editor and debugger) and 16K RAM.

The unit also features a serial I/O printer port, cassette interface and a detached 95-key keyboard (including 16 function keys and a numeric keypad) which generates a full ASCII character set. It's available either in kit form or factory assembled.

And you can take advantage of the system's H/Z-100 computer design heritage by easily upgrading it to a disk-based, 16-bit microcomputer that will run H/Z-100 series software and many other forthcoming programs.

## Fully Upgradeable

The powerful upgrade package and variety of accessories allow you to make the basic 16-bit system more powerful and versatile. You can add 128K or 192K bytes

of RAM. Floppy disk controller. 48TPI double-sided, double-density, single or dual floppy disk drive. Bit-mapped video graphics or full-color graphics. Two RS-232 ports. Programmable timer. And a Centronics-compatible printer port.

**Learn on it. Design with it.  
Use it as a 16-bit computer.**

It's the only 16-bit microprocessor system specifically designed to integrate theory with a hands-on understanding of how 16-bit computers work. And it's from Heathkit/Zenith Educational Systems, the world-leader in problem-solving courses, trainers and accessories to help you learn state-of-the-art technology.



**Heathkit**  
Heath  
Company

Circle 195 on inquiry card.

A subsidiary of Zenith Radio Corporation



Get more information in the  
**FREE  
HEATHKIT CATALOG**

Mail to: Heath Company, Dept. 334-174  
Benton Harbor, MI 49022

Name \_\_\_\_\_

Address \_\_\_\_\_

City \_\_\_\_\_

State \_\_\_\_\_ Zip \_\_\_\_\_

ED-199R1







# Professional Computing

In a future scenario, you might walk into a doctor's office, explain your medical problems to a computer, and get a diagnosis. The state of the art in microcomputers hasn't reached that level yet. But microcomputers are starting to take on part of the burden of running many types of professional offices.

Yet integrating a microcomputer into a professional work environment can be a particularly frustrating experience. Potential users raise questions concerning the dependability of software and hardware, the usefulness of available software, and how to select the best software to serve their needs. Our theme for this issue, Professional Computing, examines the problems and offers some solutions for introducing a microcomputer into a critical and demanding office setting.

Two articles cover the use of microcomputers in legal and medical practices. Robert P. Wilkins, a practicing attorney, discusses the advantages of using a microcomputer in a legal office and how to select available software to handle an attorney's particular needs. Dr. Jonathan Javitt tackles the herculean task of how to computerize a typical medical office. His article helps the medical practitioner define his or her needs to make selection of the best hardware and software a less risky proposition.

William Hession and Malcolm Rubel describe a benchmarking approach to quantifying the performance of business-modeling software. The authors present an objective method for evaluating software. Peter Callamaras offers his ideas on how a businessperson can develop a decision-support system for assistance in making critical decisions.

William J. Raduchel strips away some of the confusion about the term "user-friendly" and explains what it really means for the purchaser of business software. Milos Konopasek and Sundaresan Jayaraman explain how the TKISolver program can be used to develop the framework for an expert system for use in business and engineering.

Rounding out the theme is Dr. George Zucconi's description of how he installed a microcomputer in his waiting room. This is his practical response to providing medical information to his patients.

—Stanley J. Wszola, Technical Editor

---

**101 A Professional's Perspective on User-Friendliness** by William J. Raduchel

---

**108 A Computer in the Doctor's Waiting Room** by George Zucconi, M.D.

---

**122 The Microcomputer as a Decision-Making Aid** by Peter Callamaras

---

**127 Benchmarking Business-Modeling Software** by William Hession and Malcolm Rubel

---

**137 Expert Systems for Personal Computers** by Milos Konopasek and Sundaresan Jayaraman

---

**160 How Lawyers Can Use Microcomputers** by Robert P. Wilkins, J.D.

---

**171 Computerizing a Medical Office** by Jonathan Javitt, M.D.

---



# SYSTEMS OR BOARDS, YOU CHOOSE!



The S100-PC is a cost effective high performance floppy based system ideally suited to business and scientific applications.

**The S100-PC by LOMAS DATA PRODUCTS:**  
Offering high performance at a "low" price . . .  
and it's IBM-PC compatible.

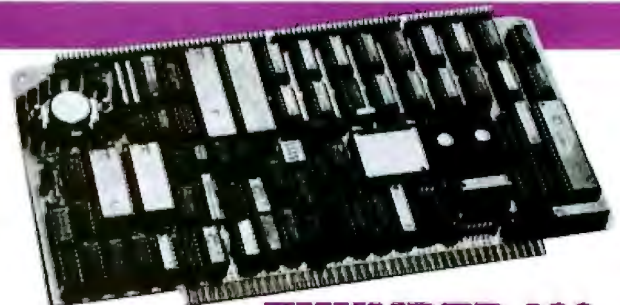
The system offers the following standard features:

- 8 MHz 8086 CPU (8087 optional)
- 128K byte RAM (expandable to 1 megabyte)
- 2 RS232 serial ports and 2 parallel ports
- Battery protected clock/calendar
- CONCURRENT CP/M-86\* version 3.1, PERSONAL BASIC, CP/M 2.2 emulator and communications program.
- 2 double sided 5 1/4" floppy drives (720K bytes)
- Attractive 15 slot desktop enclosure

In addition to the above standard features many options are available: Winchester disk drives 10 to 40 Mbyte, 80286 microprocessor, and IBM-PC compatible graphics support (JUN84). If you're using an IBM-PC or other compatible and you want to improve the performance of your software, LOMAS DATA PRODUCTS is the solution.

## S100 BUS boards products & support for the system integrator

- **LIGHTNING ONE \*\*\* 8086/8088 CPU**  
8086 or 8088, with 8087 and 8089 coprocessors. Up to 10 MHz operation . . . . . **PRICES start at \$425.00**
- **HAZITALL SYSTEM SUPPORT BOARD**  
2 serial, 2 parallel ports, battery protected clock/calendar, Hard disk controller host interface . . . . . **PRICE \$325.00**
- **LDP 128/256K DYNAMIC RAM**  
Advanced dynamic RAM with LSI controller for failsafe operation, parity . . . . . **PRICE 128K—\$495.00, 256K—\$795.00**
- **RAM67 HIGH PERFORMANCE STATIC RAM**  
High speed (100ns) low power CMOS static RAM. 128K bytes, extended addressing . . . . . **PRICE \$995.00**
- **LDP12 FLOPPY DISK CONTROLLER**  
Single/double density, single/double sided disks, both 8" and 5 1/4" inch drives simultaneously . . . . . **PRICE \$275.00**
- **LDP88 8088 SINGLE BOARD COMPUTER**  
8088 CPU, 1K RAM, 8 K EPROM, Monitor RS232 serial port, 8 vectored interrupts . . . . . **PRICE \$349.00**
- **LIGHTNING 286—80286 CPU BOARD**  
Offers 4 times the performance of a 5MHZ 8086 CPU while maintaining software compatibility. . . . . **PRICE \$1395.00**
- **OCTAPORT 8 PORT SERIAL BOARD**  
8 serial ports 0 to 19200 baud operation real time clock interrupt. Ideal for multi-user systems such as MP/M-86.\* . . . **PRICE \$395.00**



### THUNDER 186

THUNDER 186 is the only complete S100 BUS, 16 bit single board computer available today. This board comes complete and ready to plug into an enclosure and run. It comes with the most advanced microprocessor operating system CONCURRENT CP/M-86, which in addition to running CP/M-86 programs also runs MS-DOS programs. This board offers the perfect combination of performance and cost. Price with 256K bytes of RAM only . . . . . **\$1595.00**

All of LDP boards are fully tested to exacting standards and carry a one year warranty. We specialize in 16-bit products & support the four major operating systems for 16-bit processors: CP/M-86\*, MP/M-86, CONCURRENT CP/M-86\*, and MS-DOS (PC-DOS).

Dealer inquiries invited.



LOMAS DATA PRODUCTS, INC. □ 66 Hopkinton Road, Westboro, MA 01581 □ (617) 366-6434 □ Telex: 4996272

Circle 240 on inquiry card.

\*CP/M-86, MP/M-86 and CONCURRENT CP/M-86 are trademarks of Digital Research  
\*\*MS-DOS is trademark of Microsoft  
\*\*\*Lightning One is trademark of Lomas Data Products, Inc.



# A Professional's Perspective on User-Friendliness

*New systems are described as user-friendly—  
but what does that mean?*

William J. Raduchel  
McGraw-Hill Inc.

Computer software, to be commercially viable, must be user-friendly. And yet nobody can define what user-friendly means, although many claim to know it when they see it. One prominent software developer noted that since every piece of software is presumably friendly to its author, every piece of software can be described as user-friendly. It is primarily a problem of defining the user.

Is "user-friendly," therefore, a tautology? At the other end of the logical spectrum, is it another equally useless "I don't know how to define it but I know it when I see it" phenomenon? I would like to bring more rigor to this problem by offering a tentative definition of user-friendliness and then considering its implications for software development.

## The Problem

Computers have a dramatic impact on the way we work and live. Raising the productivity of service industries and white-collar professionals is the management challenge of the 1980s. Personal computers and office automation are widely seen as the means of achieving this. For productivity to rise, millions of workers must accept computers as an integral part of their daily routine. Computers affect jobs in three primary ways.

First, they perform the often tedious and detailed text and data

manipulations vital to modern business. Consider for a moment a world without computers. The airline and financial-services industries as we know them would not exist. Multinational corporations and large organizations would have to survive with primitive information systems covering only the most aggregate of concepts. Many routine transactions would cost significantly more than they do today.

Second, because they work rapidly and accurately, computers permit the use of new algorithms to solve problems. Trend forecasting with statistics has been understood for decades, but until computers became commonplace, these techniques were impractical and generally infeasible. Controlled-capacity airline seating is but one example of computers creating new commodities from old. And now, world weather models await even larger and faster computers.

Third, computers represent a watershed event that has irrevocably altered expectations. Computers can provide precise answers where before there was only vagueness, so precision becomes the norm whether or not each question actually deserves such careful consideration. (I have termed this Gresham's Law of Answers; see "Economic Policy in a Media Age," *Journal of Business and Economics* 13 (1982): 1-14.)

Personal computers are important because their low price permits computerization of tasks that are too small to be done on a mainframe but are tedious and time-consuming nevertheless. Because they can be tailored to individual needs and are priced low, personal computers are justifiable on a presumption of increased productivity.

Microcomputers have made significant changes in three areas. First, they can handle such tedious work as recalculating spreadsheets. Second, they permit broader use of such esoteric tools as graphics. Third, they have permanently altered our ideas on managing information. Timesharing had the same kind of impact when it made computers more accessible in the 1970s.

Mainframe computers have had massive influence despite the fact that only a fraction of workers understand them. But for microcomputers to have the same effect, at least half of all white-collar workers will eventually have to become familiar with them. The personal computer and office-automation industries are staking their futures on making this happen.

The ostensible issue is price: costs have fallen and will continue to fall. Nevertheless, personal computers involve much more than microelectronics, and many of their components are not dropping in cost. The



# Quantifying "User-Friendly"

We can quantify a definition of user-friendly as follows. Define  $F(j,k)$  as the probability that a user of group  $j$  can solve problem  $k$  of  $n$  problems in the set  $Q(j)$  in one execution of the set of steps  $S(j,k) = s_i(j,k), i=1$  to  $n(j,k)$ . The probability that the user can perform steps  $s_i(j,k)$  successfully is  $p_i(j,k)$ . This probability refers to logical steps rather than keystrokes and includes the user correcting input on the basis of system feedback (error messages). Finally, define  $p_0(j,k)$  as the probability that the user can specify  $S(j,k)$  accurately. (A more general model would recognize that most problems have multiple solutions, and we should average over these. However, little but complexity seems to be gained by explicitly incorporating this now.) Obviously, as  $n(j,k)$  increases,  $p_0(j,k)$  decreases. Then,  $F(j,k) = P_0(j,k) p_1(j,k) \dots p_{n(j,k)}(j,k)$ .

For simplicity and with little loss of generality, let's assume that

$$p_1(j,k) = p_2(j,k) = \dots = p_n(j,k) = p(j,k)$$

so that

$$F(j,k) = P_0(j,k) (p(j,k))^{n(j,k)}$$

Furthermore, we generally will not need the  $(j,k)$ , so we can use  $F = P_0 p^n$ .

Now, define  $F_0(j,k)$  as the probability that a user in group  $j$  can solve problem  $k$  using the best alternative system in terms of elapsed time and cost. Then, the system is user-friendly for group  $j$  if and only if

$$F(j,k) > F_0(j,k), \text{ for all } k$$

for some prespecified set of  $F_0(j,k)$ . The value of each  $F_0(j,k)$  depends on the frequency and complexity of the problem. Each  $F_0(j,k)$  reflects expectations; for each generation of system, each  $F_0(j,k)$  must be at least as large as in the prior

Standard PC $P_0 = 0.9$		Script $P_0 = 1.0$		Lisa $P_0 = 0.95$	
Task	$p_i$	Task	$p_i$	Task	$p_i$
1. "term"	0.995	1. Select item	0.995	1. Select Pro File	0.995
2. 1 (CR)	0.995	2. Restore form	0.995	2. Open	0.995
3. 0 (CR)	0.995			3. Select Lisa Term	0.995
4. 5 (CR)	0.995			4. Tear Off	0.995
5. F1	0.99			5. Open	0.995
6. 4	0.995			6. "Assumed"	0.995
7. 2	0.995			7. Range	0.995
8. Stocks. txt (CR)	0.99			8. Cut	0.995
9. E	0.99			9. Set Aside	0.995
10. F5	0.98			10. Select Lisa Calc	0.995
11. I	0.98			11. Tear Off	0.995
12. F1	0.99			12. Open	0.995
13. 0	0.995			13. Range	0.995
14. Y	0.995			14. Paste	0.995
15. "convert"	0.995			15. Calculate	0.995
16. ISP (CR)	0.995			16. Range	0.995
17. Load	0.98			17. Cut	0.995
18. Retrieve	0.98			18. Set Aside	0.995
19. Recalculate	0.995			19. Select Lisa Graph	0.995
20. Graph	0.995			20. Tear Off	0.995
21. Exit	0.995			21. Open	0.995
				22. Range	0.995
				23. Paste	0.995
				24. Set Aside	0.995
				25. Select Lisa Term	0.995
				26. Erase	0.995
				27. Select Lisa Calc	0.995
				28. Erase	0.995
				29. Select Lisa Graph	0.995
				30. Erase	0.995
$p_i = 0.856$		$p_i = 0.990$		$p_i = 0.880$	
$F = 0.770$		$F = 0.990$		$F = 0.817$	

Table 1: Once created, the script approach yields the highest probability of a user completing a task successfully. However, script creation is complex and illustrates the difference between systems that are easy to use and those that are easy to learn. (CR), in the Standard PC column, designates a carriage return.



generation. Finally, each  $F_0(j,k)$  reflects the reliability, time, and cost of alternative solutions. Thus, the range of  $F_0(j,k)$  is probably between, say, 0.2 and 0.99, but users will surely be interested in replacement systems as long as  $F_0(j,k)$  is below 0.9.

We can now assess whether or not a system is user-friendly with the following six steps:

1. Define the target user group  $j$ .
2. Define the set of  $n$  problems  $k$  to be solved for that group.
3. For each problem, define the solution  $S(j,k)$  to be supplied by the system.
4. For each problem, assess the appropriate  $F_0(j,k)$  given its complexity and frequency relative to the alternative solutions.
5. For each  $s(j,k)$ , assess the probability  $p_s(j,k)$ .
6. Evaluate the set of  $F(j,k)$ .

In principle, this methodology can be made operational in a controlled experiment. The table on the preceding page is an illustration of a standard personal computer application: connect to a remote database, retrieve stock prices for a fixed portfolio, insert into a spreadsheet to evaluate the portfolio values, and then graph the results in a pie chart. The user is assumed to be inexperienced and the application is assumed to be the product of a skilled programmer. Three cases are presented.

Standard PC employs a terminal package with autodial, automatic log-on and macros, and an integrated spreadsheet and graphics package (ISP) with a previously created spreadsheet. One specially created software package

(Convert) is assumed to make the necessary format and file conversions.

Script employs a fully integrated software package with a macro capability so all the user has to do is specify the task and, from a file, restore the specifications of the portfolio.

Lisa employs a variant of the Apple Lisa with three stationary pads for terminal, spreadsheet, and graphics invocation. One extra step is assumed to make the format conversions; in practice, this is not easy.

I have made certain assumptions to simplify the process. An upper bound of 0.995 for any  $p_i$  is assumed, and the other values reflect the subjective assessment of difficulty. Two commonly claimed attributes of a Lisa-type environment are accepted in setting  $P_0$  to 0.95 and all  $p_i$  to 0.995. The results are instructive, in any case.

Once created, nothing can claim to be more user-friendly than a properly completed exhaustive script. Some of the benefits of the Lisa environment are lost because of the multiplicity of steps, but with the numbers assumed, it receives a slightly higher  $F$  score. Slightly clearer prompting in the Standard PC approach would eliminate this edge, however.

These examples are intended to help make explicit how sensitive user-friendliness is to the application. For a one-time task to be done by an experienced user, the script approach is unassailable, and the Lisa environment has many strengths. The most important point is that no single approach dominates.

price of power supplies, electric motors, and precision machine parts is partially responsible, but personnel—as represented by software, documentation, training, and support—is the major inflationary cost component.

For the personal computer and office-automation industries to achieve their goals, systems must be not only affordable but also sufficiently user-friendly. This is the real challenge, as is shown by all the press attention to the Apple Lisa, Visicorp Visi On, and Microsoft Windows. These products attempt to introduce the "desktop" metaphor to replace the "spreadsheet" metaphor that has propelled the industry to this point. Both Apple and Visicorp pose an implicit definition of user-friendly: 30 minutes (or less) of training is required for the software to be usefully applied.

### A Paradigm

Pure technology is abstract and sterile. It is of no value until it helps solve problems. Users employ word

processors to communicate, not to ogle technology. This suggests the following definition of a user-friendly system: A user-friendly system helps produce accurate solutions in less time and at less expense than alternative systems.

Three important implications of this definition need special emphasis:

- the interface for the nontechnical user is only one factor in user-friendliness
- user-friendliness is relative to both the group of users and to the alternative methods; no software can be user-friendly across the board
- user-friendly relates to solutions, not to tools

Together, these three points imply that no system can be user-friendly *except in the context of specific problems for specific users.*

Another implication is less apparent. A system that is easy to learn may not be easy to use; every user-

friendly system faces a trade-off between these two goals. Visicalc is easy to use but not particularly easy to learn. After an application becomes routine, ease of use becomes more important than ease of learning. Thus, user-friendliness in one case may not be user-friendliness in another.

The text box entitled "Quantifying 'User-Friendly'" (beginning on the preceding page) presents an illustrated definition of user-friendliness, but I'll summarize the formal logic here. A system is user-friendly if it solves problems reliably. (This is an admittedly less comprehensive definition than the earlier one.) The probability of the solution,  $F$ , is above some (high) threshold.  $F$  can be the result of three factors:

- $P_0$  — the probability that the user will find the set of steps to solve the problem
- $p$  — the probability that the user can successfully ex-



# Make your spooling network sing in six-port harmony.

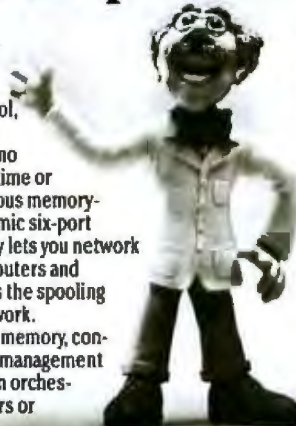
**Add MultiSpool—the hardware spooler that's truly flexible.** Now, thanks to MultiSpool, there's no more need to buy individual spoolers, no more wasted computer time or memory. With its enormous memory-sharing power, this dynamic six-port switching device not only lets you network any combination of computers and printers; it also provides the spooling function within that network.

With its 60K of buffer memory, controlled by 4K of memory management firmware, MultiSpool can orchestrate up to five computers or

five printers simultaneously. Only this degree of flexibility can meet the ever-changing port-expansion needs of today's multiuser environment.

Note, too, that MultiSpool mixes four serial and two Centronics-compatible ports. It also handles X-on, X-off protocols and DTR. So, with the unit's dipswitch, you can configure each port to accommodate either a computer or printer; and you can define the discipline of that port.

Best of all, MultiSpool sells for just \$995.00—even less if you don't need all six ports. And that, we're sure, is music to your ears.



**Digital Laboratories Inc.**

600 Pleasant Street, Watertown, MA 02172. (617) 924-1680

ecute each step  
 $n$  — the minimum possible number of steps in the solution

Formally,  $F = P_0 \times p^n$ . The requirement of being user-friendly is that  $F$  be at or above some threshold probability value  $F_0$ , determined by the characteristics of the alternative systems.

## The Implications

The preceding definition has implications for software developers. User-friendliness becomes a function of  $P_0$ ,  $p$ , and  $n$ . The ideal system has both  $P_0$  and  $p$  as close to 1.0 as possible, with  $n$  as small as possible (at a lower bound of 1.0 step). Unfortunately, software developers cannot freely choose these values.

Why not? Because  $P_0$  has to fall as  $n$  increases, while  $p$  generally increases as each step is made smaller. The classic easy-to-learn system guides the user through hierarchical menus. As long as the user can easily identify where to begin,  $F$  will be very high for problems solved by that system. Such a system is inherently limited to the problems selected by the menu builders. Other types of problems may be solved by the system, but if they are not enumerated in the menus, their "F score" is likely to be very low.

The cost of increasing the number of steps is very high, even if  $p$  is 0.995 (an error only once in every 200 attempts). For example,  $p^n$  would be 0.975 for 5 steps, 0.951 for 10 steps, 0.905 for 20 steps, and 0.818 for 40 steps. This is where ease of use and ease of learning conflict. The user progresses from one level of ability to another through training and experience, and the steps can then be reduced but made more complex with little decrease in  $p$ . A user eventually will consider a system with fewer, but natively more complex, steps to be more user-friendly.

The problems a user has change from day to day, and a user-friendly system must be able to easily accommodate this change. Therefore, the fundamental tools must be strong.

Because people make mistakes,  $p$

# BYTEWRITER®

## DAISY WHEEL PRINTERS



- Praxis 35 portable BYTEWRITER ..... \$495
- Praxis 40 office BYTEWRITER ..... \$595
- Model 900 (no keyboard) 900 day warranty ..... \$649
- Serial and parallel input. Tractor and friction feed.
- Interface only - wired and tested for Praxis 30, 35 and 40 .... \$165
- for ET-111 ..... \$195

**BYTEWRITER**

125 NORTHVIEW RD., ITHACA, N.Y. 14850  
 (607) 272-1132



When you visit your dealer and compare the Princeton IBM-compatible HX-12 side-by-side with the IBM color monitor, your eyes will see the difference.

The HX-12 gives you higher resolution and finer dot pitch (.31mm) than the IBM 5153's medium resolution (.43mm) for a cleaner, sharper image.

Compare our full range of colors and our crisp whites without red bleed. You'll also see a difference in

our non-glare screen—a feature your eyes will really appreciate in a long work session.

The Princeton HX-12 comes with a cable that plugs directly into the IBM PC, ready to burst forth into 16 superb colors. All at a suggested retail price (\$695) that's a pleasure for sore eyes and overworked budgets.

**Apple IIe users:** call us to learn how you, too, can now enjoy the visible superiority of the Princeton HX-12.

Ask your local dealer for a demonstration and let your eyes decide. Or call us at 800-221-1490 for more information and the name of your nearest dealer.

If you're ready to move up to color, graduate to the Princeton HX-12. It's right at the head of its class.



**Princeton  
Graphic  
Systems**

1101-1 State Road Princeton New Jersey, 08540  
609 683-1660 TLX:6857009 PGS Prin.  
800-221-1490

Circle 317 on Inquiry card.

## DON'T COMPROMISE:



**OURS:** .31 mm dot pitch, 80 column text.



**THEIRS:** .43 mm dot pitch, 80 column text.

### THE PRINCETON HX-12 HIGH RESOLUTION RGB COLOR MONITOR

for the image  
your eyes deserve





has an upper limit regardless of the computer skills of the user group (probably not far above the 0.995 used in the preceding example). Although their computer skills cannot raise  $p$  much beyond a certain level, more training may help a user group to execute substantially more complex steps with the same  $p$ .

This is a critical point. Any system designed for a mass market can be user-friendly only for relatively simple problems. If the problems to be solved are not simple, it is unlikely that any general, mass-market system can be user-friendly. Resolving this dilemma involves reeducating the user group. With better training and documentation, software vendors can increase the computer sophistication of their users (i.e., raise  $p$  and lower  $n$ ). In so doing, they also can increase the scope and complexity of problems for which their systems are user-friendly. Alternatively, by customizing the software to fit specific needs, software vendors can build user-friendly systems for users who have little computer sophistication.

Are integrated systems user-friendly? The answer is clearly "sometimes." Let's consider four major limitations:

1. There are limits to spoon-feeding. Lisa and Visi On succeed exceptionally well in packaging their capabilities in easily recognized, highly robust capsules. The effect of this is to raise both  $p$  and  $n$  by requiring many steps to do anything. These systems are user-

friendly in much the same way as Tinkertoys. They provide easy-to-use building blocks, but you cannot create large, stable applications with them. This is fine because the goal of these systems is to let more people use personal computers and not necessarily to expand the scope of problems that can be solved with personal computers.

2. Current technology does a poor job of telling the user what to do as opposed to how to do it. Lisa and Visi On make spreadsheets, graphics, word processors, and similar tools easier to use. Unfortunately, they also assume that the user knows what data to obtain and from where, what transformations should be made, what other processing is required, and which report format or graphics should be used. In the real world, the user may need more help making these choices than using the software. This is the problem "expert systems" and artificial intelligence seek to address.

3. Much of the day is spent doing routine tasks, but it's not necessarily these tasks that are simplified by using integrated systems. Lisa and Visi On may simplify each step of a task, but the user still has to remember, and then execute, each step individually. The user would much rather select one choice, supply the parameters, and then let the computer step through the various tasks. The popularity of keyboard macro packages, such as Pro Key, derives from the fact that they let users

store their most common key-stroke sequences.

4. Any integrated computer system is still but a component of a total business system. Merging integrated applications with existing applications likely will prove more difficult than many people expect because the businessperson's tasks are so varied and the tools are so diverse. Meetings, telephone conversations, correspondence, publications, memoranda, calculation and dictation machines, as well as pencil and paper, are used every day; not all work can be done at a workstation. Moreover, professionals travel and go home—and they take their work with them. Integrated workstations can create as many problems as they solve by providing the user with so much power in an isolated environment. Lap-sized computers will help reduce this isolation, however.

To achieve their stated market goals, integrated systems must be perceived as user-friendly and cost-effective. Without question they achieve their integration at double or triple the cost of component-oriented alternatives, so the burden on user-friendliness is extreme. The challenge is great. Training, in-person support, and customization seem essential, yet their price may make these systems no longer cost-effective. ■

*William J. Raduchel is vice-president of product development support at McGraw-Hill Inc. (1221 Avenue of the Americas, New York, NY 10020).*



**FUTECH 2000 SERIES**  
**ADVANCED INDUSTRIAL GRADE**  
**S-100 MAIN FRAMES**

*The most advanced industrial grade high-tech, high quality, sleek style S-100 bus main frame.*

- Front panel LED display for TIME/DATE and temperature of internal system air flow...
- Heavy duty power supply meeting today's standards for multi-user multi-tasking high speed CPU applications...
- A variety of front panels for floppy and winchester configurations...
- Synthesized warning voice indicator...



2100 N. Hwy. 360, Suite 1807, Grand Prairie, Texas 75050, (214) 660-1955, Telex 703033





## All the C compiler support you need, from one place.

### CROSS TO:

HOST:	CP/M-80	CP/M-68K	MS/PCDOS CP/M-86	P/OS-11
IBM 370				
VAX VMS				
VAX UNIX (4.1 BSD)				
PDP-11 UNIX (V6, V7, III)				
IDRIS/R11				
RT-11				
RSX-11M/M+				
MC68000 UNIX (UNIPUS+)				
IDRIS/S68K				
MS/PCDOS				
CP/M-86				

HOST ONLY: CP/M-80\*, CP/M-68K,  
VERSAdos, P/OS-11  
(\*2.1 Cross Compilers  
are Available)



- C and Pascal for 6 machine architectures: PDP-11, 8080, 68000, 8086, VAX, 370
- Full C language implementation
- All of the most popular operating systems supported
- Optional cross support for: CP/M-80, CP/M-68K, CP/M-86, MS/PCDOS, P/OS-11
- Field-proven reliability since 1979
- New UNIX-compatible library for non-UNIX operating systems

# Whitesmiths, Ltd.

97 Lowell Road, Concord, MA 01742, (617) 369-8499, Telex 750246 SOFTWARE CNCM

UNIX is a trademark of Bell Laboratories; PDP-11, P/OS, RSX-11M, RT-11, VAX, VMS are trademarks of Digital Equipment Corporation; CP/M is a trademark of Digital Research Co.; MC68000 and VERSAdos are trademarks of Motorola Inc.; IBM, PCjr, MVS, VM/CMS and PCDOS are registered trademarks of International Business Machines Corporation; MS is a trademark of Microsoft; UNIPUS+ is a trademark of Unisoft Systems of Berkeley; Idris is a trademark of Whitesmiths, Ltd.



# A Computer in the Doctor's Waiting Room

*An Atari program that offers some of the capabilities of an "expert system" for one physician's patients*

George Zucconi, M.D.  
Private Practice

For the past year I've kept an inexpensive computer in my office waiting room for my patients to use. The computer, an Atari 400, runs programs that impart medical information to the user. Instructions appear on the screen so that anyone can use the system without any aid from the office staff. The three programs I have developed answer the medical questions most frequently asked by the patients in my obstetrical-gynecological practice.

One program elicits information concerning symptoms of abnormal uterine bleeding. According to the user responses, it will diagnose the seriousness of the condition and will recommend what course of action the patient should take.

The other two programs are somewhat different in nature. One contains information about birth control methods, including the effectiveness, advantages, disadvantages, and risks of each. The remaining program, *Drugs in Pregnancy*, presented in this article, outlines 15 classifications of commonly available drugs and their effects on the various stages of pregnancy.

Though not meant as a substitute for doctor-patient interaction, the pa-

tients' use of these programs saves time for more complicated questions by eliminating basic preliminary queries. My patients take readily to the computer and have found the programs to be helpful. For one thing, using the computer avoids any feelings of embarrassment when inquiring about intimate matters. Furthermore, the computer is tireless and never scoffs at seemingly dumb questions. Even computerphobes overcome their hesitancy after watching someone else use the machine. In fact, it's unusual to see the computer sitting idly when anyone is in the waiting room.

## The Genie in the Lamp

The educational use of computers promises to open up the possibilities for conveying information to others. With the proliferation of small, inexpensive computers, many more people will be able to afford these instruments and experiment with devising new applications for them. No longer the exclusive tool of the few, the power of the computer has been released like the genie from the lamp, waiting to grant us whatever wishes we command. In order to effectively develop the powers of the

microcomputer "genie," a concerted effort and sharing of knowledge are necessary.

The beauty of putting so many people in touch with computers is that by merely increasing the number of users, we will attain a "critical mass" wherein a breakthrough in learning is inevitable. Each new kernel of knowledge leads to another, building on the impetus of the previous one, all multiplying exponentially and cascading in a chain reaction.

This concept has long been the tradition in the medical profession. Scientific progress would be nonexistent without the dissemination of discoveries and information. Following in this tradition, I would like to share some efforts I have made toward devising medical applications for this versatile tool. I've provided the BASIC listing of the *Drugs in Pregnancy* program so that interested readers can use it or learn from its construction (see listing 1).

## When the Doctor's Not In

You may not be anxious to expose a valuable computer to inexperienced hands or to children's sticky fingers. However, even if you do not give

*Text continued on page 116*



Listing 1: The source code for *Drugs in Pregnancy*, a program written in Atari BASIC that explains the effects of various types of commonly available drugs on pregnancy.

```

1000 REM INTRODUCTION
1010 CLR :DIM K$(1)
1020 GRAPHICS 2+16:POKE 77,0
1025 SETCOLOR 2,4,0:SETCOLOR 4,7,0
1030 ? #6:? #6;" please feel free"
1040 ? #6:? #6;" to come over"
1050 ? #6:? #6;" and see what"
1060 ? #6:? #6;" this computer"
1070 ? #6:? #6;" can do"
1080 FOR J=1 TO 1000:IF PEEK(53279)=6 THEN 3000
1090 NEXT J
1100 GRAPHICS 2
1105 SETCOLOR 4,7,0:SETCOLOR 2,3,2
1110 ? #6;" YOU CAN ASK"
1120 ? #6:? #6;" THE COMPUTER"
1130 ? #6:? #6;" ABOUT THE"
1140 ? #6:? #6;" EFFECTS OF DRUGS"
1145 ? #6:? #6;" IN PREGNANCY"
1150 PRINT " PRESS YELLOW <START> PANEL BELOW"
1152 PRINT " RED LIGHT ON RIGHT SIDE OF KEYBOARD"
1154 PRINT " TO ASK ABOUT DRUGS AND PREGNANCY ";
1160 FOR J=1 TO 2000:IF PEEK(53279)=6 THEN 3000
1170 NEXT J:GOTO 1010
2000 REM SUBROUTINES
2120 PRINT :PRINT
2122 PRINT " ENTER NUMBER OF TOPIC"
2123 PRINT " Your Choice is ";
2130 FOR J=1 TO 3000
2140 IF PEEK(764)=31 THEN POKE 764,255:K$="1":PRINT K$:RETURN
2150 IF PEEK(764)=30 THEN POKE 764,255:K$="2":PRINT K$:RETURN
2160 IF PEEK(764)=26 THEN POKE 764,255:K$="3":PRINT K$:RETURN
2170 IF PEEK(764)=24 THEN POKE 764,255:K$="4":PRINT K$:RETURN
2172 IF PEEK(764)=29 THEN POKE 764,255:K$="5":PRINT K$:RETURN
2180 NEXT J:GOTO 1010
2220 IF (ASC(K$)<49) OR (ASC(K$)>50) THEN PRINT " USE NUMBERS 1 TO 2 ";K$="N":PR
INT :RETURN
2230 IF (ASC(K$)<49) OR (ASC(K$)>51) THEN PRINT " USE NUMBERS 1 TO 3 ";K$="N":PR
INT :RETURN
2240 IF (ASC(K$)<49) OR (ASC(K$)>52) THEN PRINT " USE NUMBERS 1 TO 4 ";K$="N":PR
INT :RETURN
2250 IF (ASC(K$)<49) OR (ASC(K$)>53) THEN PRINT " USE NUMBERS 1 TO 5 ";K$="N":PR
INT :RETURN
2280 RETURN
2290 PRINT :PRINT :PRINT " ENTER C TO MAKE A CHOICE"
2292 PRINT " ENTER R TO RETURN TO THE PREVIOUS"
2294 PRINT " LIST TO MAKE ANOTHER CHOICE"
2300 PRINT " ENTER Q TO QUIT ";
2320 FOR J=1 TO 3000
2330 IF PEEK(764)=40 THEN POKE 764,255:K$="R":PRINT K$:PRINT :RETURN
2340 IF PEEK(764)=18 THEN POKE 764,255:K$="C":PRINT K$:RETURN
2345 IF PEEK(764)=37 THEN POKE 764,255:K$="M":PRINT K$:RETURN
2350 IF PEEK(764)=47 THEN POKE 764,255:GOTO 1010
2360 NEXT J
2370 GOTO 1010
3000 REM DRUG LIST "
3010 GRAPHICS 0:SETCOLOR 2,9,4
3020 PRINT :PRINT " Copyright 1983 G.R.Zucconi M.D.":PRINT
3030 PRINT " ANY DRUG SHOULD BE AVOIDED"
3032 PRINT " DURING PREGNANCY UNLESS ABSOLUTE-"
3034 PRINT " LY NECESSARY. YOU CAN SEE WHAT"
3036 PRINT " EFFECT EACH DRUG HAS BY CHOOSING"
3038 PRINT " ONE FROM THE LIST.":PRINT
3090 PRINT " 1. ALCOHOL"
3100 PRINT " 2. EPILEPTIC OR SEIZURE DRUGS"
3110 PRINT " 3. BLOOD THINNERS"
3120 PRINT " 4. LITHIUM"
3130 PRINT " 5. HORMONES AND BC PILLS"
3131 PRINT :PRINT " FOR MORE DRUGS, ENTER M"
3132 GOSUB 2290:IF K$="R" THEN 3000
3133 IF K$="M" THEN 3160
3134 GOSUB 2120:GOSUB 2250

```

Listing 1 continued on page 110



**Your Key To  
Microcomputer Software!**



**More  
software  
for more  
computers  
...and more.**

Whatever your software needs, all you need to know is Westico. We have hundreds of business and professional software programs in formats to fit more than 120 microcomputers, including IBM PC, MS DOS and CP/M-compatible systems. Our large inventory means you get the software you want, when you want it. Plus, our after sales service is designed to keep you smiling. Westico helps you get the most from your microcomputer.

Find out more with our new directory. Detailed descriptions of all our programs help you select the correct software to fit your needs. Start getting more with Westico.

**— Order Your Copy Today —**

Rush me the brand new Westico software directory.

Name \_\_\_\_\_

Firm \_\_\_\_\_

Address \_\_\_\_\_

City \_\_\_\_\_ State \_\_\_\_\_ Zip \_\_\_\_\_

Mail to:



25 Van Zant Street • Norwalk, CT 06855  
(203) 853-6880 • Telex 64-3788

© Copyright 1984 Westico, Inc. WES-37

Listing 1 continued:

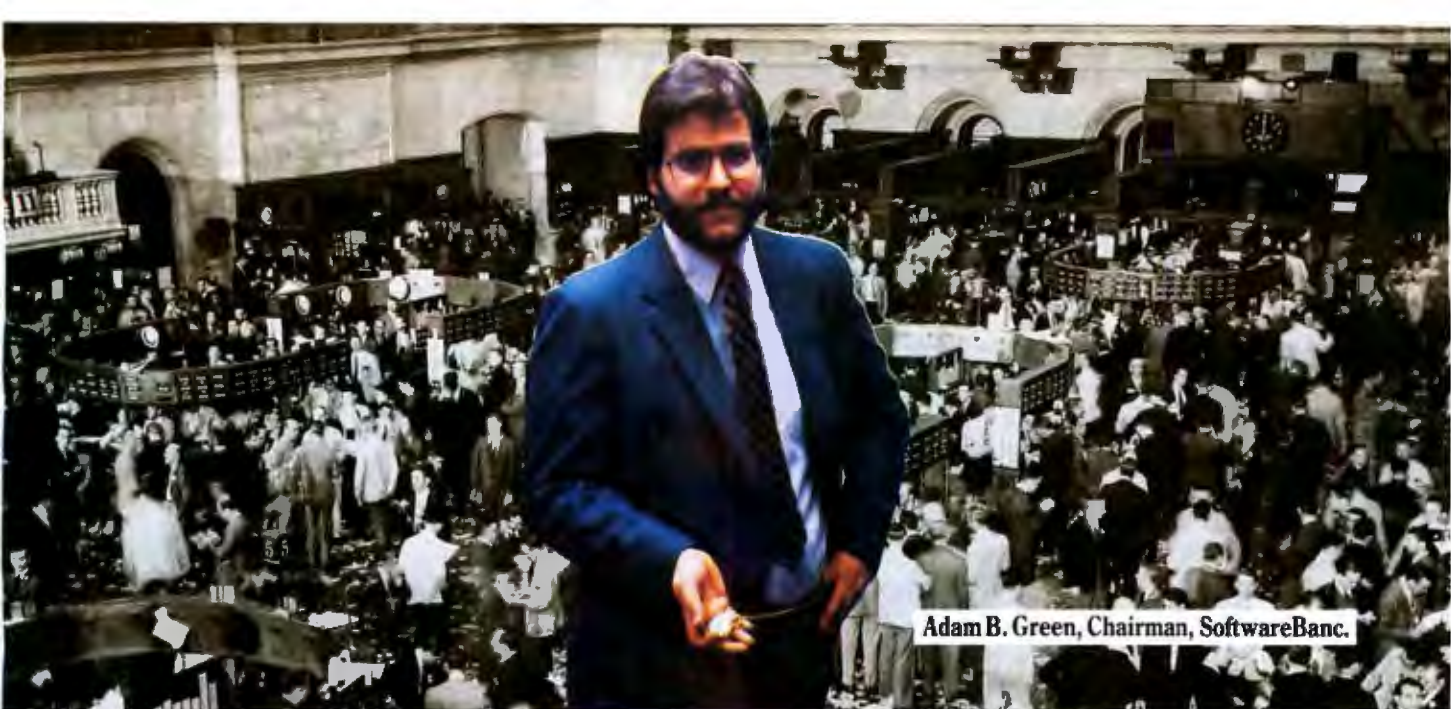
```

3140 IF K$="N" THEN 3000
3150 ON VAL(K$) GOSUB 3390,3500,3640,3740,3840
3160 PRINT "):PRINT :SETCOLOR 2,3,2:SETCOLOR 4,11,4
3170 PRINT " DRUG LIST CONTINUED":PRINT
3180 PRINT " 1. ANTIBIOTICS"
3190 PRINT " 2. ANESTHETICS"
3200 PRINT " 3. DRUGS FOR NAUSEA"
3210 PRINT " 4. TRANQUILIZERS, SEDATIVES"
3220 PRINT " 5. ASPIRIN"
3230 PRINT :PRINT " FOR MORE DRUGS, ENTER M"
3240 GOSUB 2290:IF K$="R" THEN 3000
3250 IF K$="M" THEN 3280
3260 GOSUB 2120:GOSUB 2250
3270 IF K$="N" THEN 3160
3275 ON VAL(K$) GOSUB 3960,4080,4190,4330,4440
3280 PRINT "):PRINT :SETCOLOR 2,6,2:SETCOLOR 4,15,6
3290 PRINT " DRUG LIST CONTINUED":PRINT
3300 PRINT " 1. DRUGS TO BE AVOIDED NEAR"
3302 PRINT " THE END OF PREGNANCY"
3304 PRINT " 2. SMOKING"
3310 PRINT " 3. X-RAYS"
3320 PRINT " 4. FACTORS KNOWN TO CAUSE"
3330 PRINT " DEFORMITIES IN THE FETUS"
3335 PRINT " 5. STREET DRUGS"
3340 PRINT :PRINT " THIS IS THE END OF THE DRUG LIST"
3350 GOSUB 2290:IF K$="R" THEN 3160
3360 GOSUB 2120:GOSUB 2250
3370 IF K$="N" THEN 3280
3375 ON VAL(K$) GOSUB 4590,4690,4820,4960,5150
3380 REM
3390 PRINT "):PRINT
3400 PRINT " ALCOHOL ":PRINT :PRINT
3410 PRINT " RISK OF MALFORMATION INCREASES"
3420 PRINT " WITH THE AVERAGE DAILY INTAKE.":PRINT :PRINT
3430 PRINT " THERE IS ONE CHANCE IN TEN OF A"
3440 PRINT " DEFORMITY IF YOU HABITUALLY HAVE"
3450 PRINT " MORE THAN ONE OR TWO DRINKS PER"
3460 PRINT " DAY FOR MOST OF THE PREGNANCY.":PRINT :PRINT
3470 PRINT " HEAVY DRINKERS HAVE ONE CHANCE IN"
3480 PRINT " FOUR OF HAVING A DEFORMED BABY."
3490 GOSUB 2290:IF K$="R" THEN 3000
3500 PRINT "):PRINT
3510 PRINT " EPILEPTIC OR SEIZURE DRUGS ":PRINT
3520 PRINT " THERE IS A 2 TO 3 PER CENT RISK"
3530 PRINT " OF MALFORMATION IN WOMEN TAKING"
3540 PRINT " THESE DRUGS.":PRINT
3550 PRINT " PHENOBARBITAL,AND BARBITURATES IN"
3560 PRINT " GENERAL,HAVE BEEN USED FOR A LONG"
3570 PRINT " TIME, AND IT SEEMS UNLIKELY THAT"
3580 PRINT " THEY HAVE ANY IMPORTANT EFFECT.":PRINT
3590 PRINT " DILANTIN HAS A LOWER RISK THAN"
3600 PRINT " TRIDIONE AND PARADIONE.":PRINT
3610 PRINT " THE RISKS OF THE NEWER DRUGS LIKE"
3620 PRINT " TEGRETOL AND DEPAKENE ARE UNKNOWN."
3630 GOSUB 2290:IF K$="R" THEN 3000
3640 PRINT "):PRINT
3650 PRINT " BLOOD THINNERS ":PRINT
3660 PRINT " COUMARIN SHOULD NOT BE USED IN"
3670 PRINT " PREGNANCY. IT CAN CAUSE FETAL AB-"
3680 PRINT " NORMALITIES EVEN LATE IN THE PRE-"
3690 PRINT " GNANCY. IT CAN ALSO CAUSE BLEED-"
3700 PRINT " ING IN THE FETUS AND THE NEWBORN.":PRINT
3710 PRINT " IF AN ANTICOAGULANT IS NEEDED,THE"
3720 PRINT " DRUG OF CHOICE IS HEPARIN."
3730 GOSUB 2290:IF K$="R" THEN 3000
3740 PRINT "):PRINT
3750 PRINT " LITHIUM ":PRINT :PRINT
3760 PRINT " THE EVIDENCE CURRENTLY AVAILABLE"
3770 PRINT " SUGGESTS THAT LITHIUM IS PROBABLY"
3780 PRINT " A CAUSE FOR MALFORMATIONS.":PRINT
3790 PRINT " THE EVIDENCE IS SUFFICIENT TO"
3800 PRINT " JUSTIFY AVOIDING LITHIUM DURING"

```

Listing 1 continued on page 113





Adam B. Green, Chairman, SoftwareBanc.

# TIME IS MONEY

Do you want to spend your time as intelligently as you spend your money? The decision may be yours, but your concerns are ours. We know you don't want to spend more time learning business software than you do using it. So we provide the productivity tools you can bank on to INVEST IN YOURSELF, time and time again.

It's no wonder over 50% of our business comes from repeat customers and referrals. For quality seminars, videotapes, books and software, you can count on SoftwareBanc for a guaranteed return on your investment.

## \$ SEMINARS

As a full service organization, we provide fine professional training. Adam B. Green, well known dBASE II educator, uses a custom video presentation to highlight these invaluable lectures. **\$200/day**

dBASE II Fundamentals  
dBASE II Programming  
Advanced dBASE II Techniques

Problem Solving with 1-2-3  
Exploring UNIX

Atlanta  
May 14-18

\*Boston/Waltham  
June 18-21

Toronto  
July 9-13

New York  
August 13-17

Costa Mesa/Orange County  
September 17-21

\* In cooperation with Bentley College, Waltham, MA

## \$ VIDEOTAPES

Learn the basics of dBASE II in three hours with this professionally produced training package. We give you everything you need to reproduce Adam B. Green's popular dBASE II seminar in your own home or office. You receive everything but the lunch!

dBASE II Demo	\$ 25.00
dBASE II Fundamentals (VHS or BETA)	\$295.00
dBASE II Fundamentals (U-MATIC)	\$395.00

## \$ BOOKS

Built on years of practical experience in testing, supporting and teaching dBASE II, we take pride in offering you our accumulated knowledge. Interest adds up with new tips and techniques never before published!

dBASE II User's Guide	\$29.00
Advanced dBASE II User's Guide	\$29.00
Report Writing in dBASE II	\$15.95
101 Questions in dBASE II	Soon

## \$ SOFTWARE

As an authorized dealer of every product we sell, you are assured of expert technical support, knowledgeable salespeople and fast, dependable service with a smile!

dBASE II with free dBASE II User's Guide	\$439
WordStar	\$269
1-2-3 with free 123 Trans	\$399

(Available at SoftwareBanc Seminars)

Take stock in SoftwareBanc! Call or write for the free catalogs which include our complete product line, seminar curriculum and unique services.

**At SoftwareBanc, a wise investor is our best customer.**

To order, call (800) 451-2502 or (617) 641-1241 in Mass. Hours are 9 a.m. - 8 p.m. EST Monday - Friday and 9 a.m. - 5 p.m. EST on Saturday.

Payment may be made by: MC/VISA, MO, check or COD. Terms available to qualified customers. MA residents add 5% sales tax. Add \$5 for S&H. Prices subject to change without notice. Dealer inquiries invited. Ask about our Discount Savings Plan.

dBASE II is a registered trademark of Ashton-Tate  
1-2-3 is a registered trademark of Lotus Development Corp.  
WordStar is a registered trademark of MicroPro  
UNIX is a registered trademark of Bell Laboratories



## SoftwareBanc

661 Massachusetts Avenue, Arlington, MA 02174

**(800)-451-2502**  
**(617) 641-1241 in MA**



# Your computer's telephone.

# Hayes



What are the adverse effects of this compound?



Gary: The pedigrees for next week's auction are as follows...



Sold 1000 shares at 33 for net profit of 6000. Richard.

Wouldn't it be great if you could use your IBM\* PC to tap into vast resource libraries across the country? To transfer files to your partner, upstate? Or from your broker, down the street?

It's possible. All you need is a modem, to connect your computer to others. Down the hall. Or thousands of miles away.



**Hayes Smartmodem. Think of it as your computer's telephone.** Hayes Smartmodem 300™ and the faster Smartmodem 1200™ allow you to communicate over ordinary phone lines.

But any modem will send and receive data. Hayes Smartmodems

also dial, answer and disconnect calls. Automatically. And without going through the telephone receiver, making them far superior to acoustic coupler modems.

**Choose your speed; choose your price.** The lower-priced Smartmodem 300 is ideal for local data swaps and communicates at 300 bps. For longer distance and larger volumes, Smartmodem 1200 operates at baud rates of 300 or 1200, with a built-in selector that automatically detects transmission speeds.

Both work with rotary dials, Touch-Tone® and key-set systems; connect to most time-sharing systems; and feature an audio speaker.

Smartmodem 1200B™ is also available as a plug-in board. Developed specifically for the PC, it comes packaged with Hayes' own communications software, Smartcom II™

**Smartcom II. We spent a lot of time developing it, so you can spend less time using it.** Smartcom II prompts you in the

simple steps required to create, send, receive, display, list, name and re-name files. It even receives data completely unattended—especially helpful when you're sending work from home to the office, or vice versa.

If you need it, there's always "help." This feature explains prompts, messages, etc. to make communicating extra easy.

With Smartcom II, it is. Case in point. Before you communicate with another system, you need to "set up" your computer to match the way the remote system transmits data. With Smartcom II, you do this only once. After that, parameters for 25 different remote systems are stored in a directory on Smartcom II.

Calling or answering a system listed in the directory requires just a few quick keystrokes.

You can store lengthy log-on sequences the same way. Press one key, and Smartcom II automatically connects you to a utility or information service.



**Hayes**



Smartmodem 300, 1200, and 1200B are FCC approved in the U.S. and DOC approved in Canada.

Smartmodem 1200B. (Includes telephone cable. No serial card or separate power source is needed.)



Smartcom II communications software.

NOTE: Smartmodem 1200B may also be installed in the IBM Personal Computer XT or the Expansion Unit. In those units, another board installed in the slot to the immediate right of the Smartmodem 1200B may not clear the modem; also, the brackets may not fit properly. If this occurs, the slot to the right of the modem should be left empty.

And, in addition to the IBM PC, Smartcom II is also available for the IBM Personal Computer XT, COMPAQ Portable, Corona Portable PC, Columbia MPC, DEC Rainbow 100, Xerox 820-II, and Kaypro II personal computers.\*

**Backed by the experience and reputation of Hayes.** A solid leader in the microcomputer industry, Hayes provides excellent documentation for all products. A limited two-year warranty on all hardware. And full support from us to your dealer.

So see him today. Break out of isolation. Get a telephone for your Personal Computer. From Hayes.

**Hayes Microcomputer Products, Inc.,** 5923 Peachtree Industrial Blvd., Norcross, GA 30092. 404/441-1617.

Smartmodem 300, Smartmodem 1200, Smartmodem 1200B and Smartcom II are trademarks of Hayes Microcomputer Products, Inc. \*Trademarks of International Business Machines Corporation, Compaq Computer Corporation, Corona Data Systems, Columbia Data Products, Inc. Digital Equipment Corporation, Kenex Corporation, and Kaypro Corporation. Touch Tone is a registered service mark of American Telephone and Telegraph. ©1984 Hayes Microcomputer Products, Inc.

Listing 1 continued:

```

3810 PRINT " THE FIRST THREE MONTHS OF THE"
3820 PRINT " PREGNANCY."
3830 GOSUB 2290:IF K$="R" THEN 3000
3840 PRINT "}"
3850 PRINT "          HORMONES AND BC PILLS ":PRINT :PRINT
3860 PRINT " THE SMALL AMOUNTS OF PROGESTOGEN"
3870 PRINT " IN BIRTH CONTROL PILLS ARE NOT"
3880 PRINT " LIKELY TO CAUSE MALFORMATIONS.":PRINT
3890 PRINT " STUDIES HAVE BEEN CONTRADICTORY"
3900 PRINT " AND CONFUSING,BUT IF THERE IS ANY"
3910 PRINT " RISK, IT MUST BE SMALL.":PRINT
3920 PRINT " EXPDSURE TO DIETHYLSTILBESTEROL"
3930 PRINT " CAN CAUSE CANCER OF THE VAGINA IN"
3940 PRINT " FEMALE OFFSPRING."
3950 GOSUB 2290:IF K$="R" THEN 3000
3960 PRINT "}"
3970 PRINT "          ANTIBIOTICS ":PRINT
3980 PRINT " ALMOST ALL DRUGS USED TO TREAT"
3990 PRINT " INFECTIONS ARE SAFE IN PREGNANCY.":PRINT
4000 PRINT " DRUGS CONTAINING TRIMETHOPRIM AND"
4010 PRINT " PYRIMETHAMINE MAY CAUSE MALFORMA-"
4020 PRINT " TIONS.BRAND NAMES FOR THESE DRUGS"
4030 PRINT " ARE: BACTRIM, SEPTRA, PROLOPRIM,"
4040 PRINT " TRIMPLEX AND DARAPRIM.":PRINT
4050 PRINT " TETRACYCLINE CAN CAUSE STAINING"
4060 PRINT " OF TEETH, AND SHOULD BE AVOIDED."
4070 GOSUB 2290:IF K$="R" THEN 3160
4080 PRINT "}"
4090 PRINT "          ANESTHETICS ":PRINT :PRINT
4100 PRINT " ANESTHETICS FOR SURGERY OR DENTAL"
4110 PRINT " WORK DO NOT INCREASE THE RISK FOR"
4120 PRINT " HAVING A DEFORMED INFANT.":PRINT
4130 PRINT " WOMEN WHO WORK IN THE OPERATING"
4140 PRINT " ROOM OR ARE EXPOSED TO GAS ANES-"
4150 PRINT " THETICS,ESPECIALLY NITROUS OXIDE,"
4160 PRINT " OVER A LONG PERIOD OF TIME, ARE"
4170 PRINT " AT INCREASED RISK FOR ABORTION."
4180 GOSUB 2290:IF K$="R" THEN 3160
4190 PRINT "}"
4200 PRINT "          DRUGS FOR NAUSEA ":PRINT
4210 PRINT " MANY STUDIES INVOLVING MANY HUN-"
4220 PRINT " DREDS OF WOMEN HAVE FAILED TO"
4230 PRINT " SHOW AN INCREASED INCIDENCE OF"
4240 PRINT " MALFORMATIONS.":PRINT
4250 PRINT " IN SPITE OF OVERWHELMING SCIENTI-"
4260 PRINT " FIC EVIDENCE AND 27 YEARS OF USE,"
4270 PRINT " A RECENT COURT JUDGEMENT HAS CAU-"
4280 PRINT " SED PUBLIC ALARM OVER THE SAFETY"
4290 PRINT " OF THE MOST EFFECTIVE OF THESE"
4300 PRINT " DRUGS IN PREGNANCY, BENEDCTIN,"
4310 PRINT " AND ITS MANUFACTURE HAS BEEN"
4315 PRINT " DISCONTINUED."
4320 GOSUB 2290:IF K$="R" THEN 3160
4330 PRINT "}"
4340 PRINT "          TRANQUILIZERS, SEDATIVES ":PRINT :PRINT
4350 PRINT " TWO MAIN STUDIES HAVE PRODUCED"
4360 PRINT " CONFLICTING RESULTS, BUT RISK, IF"
4370 PRINT " IT EXISTS, IS SMALL.":PRINT
4380 PRINT " THE SAME THING CAN BE SAID ABOUT"
4390 PRINT " MOOD ELEVATORS OR ANTIDEPRESSANTS,"
4395 PRINT " WITH THE EXCEPTION OF LITHIUM.":PRINT
4400 PRINT " BARBITURATES HAVE BEEN IN USE FOR"
4410 PRINT " A LONG TIME AND ARE CONSIDERED"
4420 PRINT " SAFE DURING PREGNANCY."
4430 GOSUB 2290:IF K$="R" THEN 3160
4440 PRINT "}"
4450 PRINT "          ASPIRIN ":PRINT
4460 PRINT " THERE IS NO ASSOCIATION BETWEEN"
4470 PRINT " ASPIRIN AND MALFORMATIONS.":PRINT
4480 PRINT " HOWEVER,ASPIRIN SHOULD BE AVOIDED"
4490 PRINT " AFTER THE FIRST THREE MONTHS OF"
4500 PRINT " PREGNANCY BECAUSE IT CAN CAUSE"
4510 PRINT " THE PREGNANCY TO BE PROLONGED IF"

```

Listing 1 continued on page 114



# The p-System Improvement You've Been Waiting For...

## A Lower Price!

Compatible with the IBM PC, XT,  
Corona, Columbia, Compaq, Colby,  
Eagle, Hyperion and Texas  
Instruments' Professional

We've taken \$245 off the price of the NCI p-System, the newest, fastest and most complete p-System for the IBM PC and compatibles. For only \$595 the NCI p-System offers far more features than the comparably-priced version marketed by IBM. It uses the latest implementation and has been recognized by major software developers and reviewers as being the best version available.\*

The NCI p-System runs up to five times faster than IBM's and is the only p-System that lets you move files from PC DOS to the p-System and vice versa. You also get many exclusive utilities and the widest range of hardware support and compatibility. Only the NCI p-System includes technical support and new, easy-to-reference documentation.

Special discounts are available for users who have already purchased the IBM version and want to upgrade to the NCI p-System. For full details clip this coupon and send it to:



**Network Consulting Inc.**  
Ste. 110 - 3700 Gilmore Way  
Burnaby, B.C. Canada V5G 4M1  
Phone (604) 430-3466

- I want to know more about NCI's p-System  
 I own an IBM version  
 Please send me dealer information

Name \_\_\_\_\_

Title \_\_\_\_\_

Company \_\_\_\_\_

Address \_\_\_\_\_

State \_\_\_\_\_ Zip \_\_\_\_\_

\*Endorsements and reviews available from NCI. The p-System is a trademark of SoftTech Microsystems, Inc. IBM PC and XT are trademarks of International Business Machines Corporation.

Listing 1 continued:

```

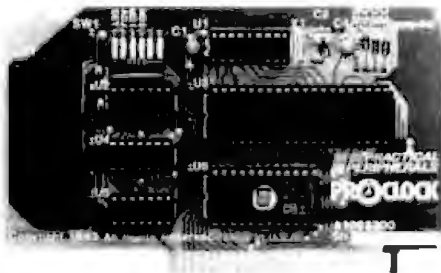
4520 PRINT " TAKEN IN HIGH DOSES.":PRINT
4530 PRINT " ASPIRIN MAY ALSO PROLONG LABOR,"
4540 PRINT " AND IF TAKEN WITHIN ONE WEEK OF"
4550 PRINT " DELIVERY, CAN CAUSE BLEEDING PROB-"
4560 PRINT " LEMS IN THE MOTHER AND INFANT."
4570 GOSUB 2290:IF K$="R" THEN 3160
4590 PRINT "}"
4600 PRINT " DRUGS TO BE AVOIDED "
4610 PRINT " NEAR THE END OF PREGNANCY ":PRINT :PRINT
4620 PRINT " SULFA DRUGS AND ASPIRIN CAN LEAD"
4630 PRINT " TO JAUNDICE IN THE NEWBORN.":PRINT
4640 PRINT " THE FOLLOWING DRUGS CAN LEAD TO"
4650 PRINT " RUPTURE OF THE BABY'S RED BLOOD"
4660 PRINT " CELLS CAUSING ANEMIA; DRUGS FOR"
4670 PRINT " MALARIA, PHENACETIN (APC), SULFA"
4675 PRINT " AND NITROFURANTOIN."
4680 GOSUB 2290:IF K$="R" THEN 3280
4690 PRINT "}"
4700 PRINT " SMOKING ":PRINT
4710 PRINT " SMOKING IS KNOWN TO BE A POSSIBLE"
4720 PRINT " CAUSE OF PREMATUREITY, AND IT MAY"
4730 PRINT " ALSO INCREASE THE RISK OF SPONTA-"
4740 PRINT " NEOUS ABORTION.":PRINT
4750 PRINT " CHEWING TOBACCO AND NICOTINE CHEW-"
4760 PRINT " ING GUM SHOULD NOT BE USED DURING"
4770 PRINT " PREGNANCY.":PRINT
4780 PRINT " CUTTING BACK ON THE NUMBER OF CI-"
4790 PRINT " GARETTES SMOKED WILL HELP, IF YOU"
4800 PRINT " CANNOT STOP ALTOGETHER."
4810 GOSUB 2290:IF K$="R" THEN 3280
4820 PRINT "}"
4830 PRINT " X-RAYS ":PRINT :PRINT
4840 PRINT " THE AMOUNT OF RADIATION ABSORBED"
4850 PRINT " FROM CHEST OR DENTAL X-RAYS IS"
4860 PRINT " TOO SMALL TO HAVE ANY EFFECT ON"
4870 PRINT " FETAL DEVELOPMENT. EVEN X-RAYS TO"
4890 PRINT " THE PELVIS IN EARLY PREGNANCY DO"
4900 PRINT " NOT PRODUCE ENOUGH RADIATION TO"
4910 PRINT " CAUSE ANY MALFORMATION.":PRINT
4920 PRINT " DURING PREGNANCY, HOWEVER, A LEAD"
4930 PRINT " SHIELD OR APRON SHOULD BE USED AS"
4940 PRINT " A PRECAUTION."
4950 GOSUB 2290:IF K$="R" THEN 3280
4960 PRINT "}"
4970 PRINT " FACTORS KNOWN TO CAUSE "
4980 PRINT " DEFORMITIES IN THE FETUS ":PRINT
4990 PRINT " MORE THAN 65% OF MALFORMATIONS"
5000 PRINT " HAVE UNKNOWN CAUSES, BUT PROBABLY"
5010 PRINT " MOST HAVE MULTIPLE CAUSES, ONLY"
5020 PRINT " 10% OF WHICH MAY BE ATTRIBUTED TO"
5030 PRINT " DRUGS. THE OTHER 25% ARE DUE TO"
5040 PRINT " CHROMOSOME OR GENETIC PROBLEMS.":PRINT
5050 PRINT " EVEN THALIDOMIDE PRODUCES DEFECTS"
5060 PRINT " IN LESS THAN 25% OF EXPOSED OFF-"
5070 PRINT " SPRING.":PRINT
5080 PRINT " CYTOTOXIC DRUGS USED FOR CANCER"
5090 PRINT " TREATMENT ARE THE OTHER CLASS OF"
5100 PRINT " DRUGS THAT CAUSE MALFORMATIONS."
5140 GOSUB 2290:IF K$="R" THEN 3280
5150 PRINT "}"
5160 PRINT " STREET DRUGS ":PRINT
5170 PRINT " PREMATUREITY AND LOW BIRTH WEIGHT"
5180 PRINT " ARE COMMON AND INFANT MORTALTIY"
5190 PRINT " IS INCREASED WITH USE OF HEROIN.":PRINT
5200 PRINT " WITHDRAWAL EFFECTS AFTER DELIVERY"
5210 PRINT " OR EVEN WHILE IN UTERO CAN CAUSE"
5220 PRINT " FETAL DISTRESS AND DEATH.":PRINT
5230 PRINT " NONE OF THE COMMON STREET DRUGS,"
5240 PRINT " INCLUDING MARIJUANA, ARE KOWN TO"
5250 PRINT " CAUSE ANY FETAL MALFORMATIONS."
5260 GOSUB 2290:IF K$="R" THEN 3280
5270 PRINT " YOU HAVE REACHED THE END "
5280 PRINT " OF THE PROGRAM "
5290 GOSUB 2290:IF K$="R" THEN 3280
5300 GOTO 1010

```



# A TIMELY ANNOUNCEMENT FOR ProDOS™ USERS:

**C**ongratulations! You not only have a powerful new operating system in Apple's\* ProDOS, you can now get an incredibly versatile Clock/Calendar card to use with it. PROCLOCK™.



PROCLOCK is the first Clock/Calendar designed for ProDOS-based systems as well as other Apples running DOS 3.3, CP/M\*\*, Pascal, Applesoft\*, and BASIC.

What's more, PROCLOCK fully emulates Superclock II, Thunderclock Plus and Apple Clock\*. So programs written for these products can be used without any modification.

Of course, PROCLOCK will time- and date-code files. And consider how much money you could save by timing your modem to transmit when the phone rates are cheapest. You can even use PROCLOCK as part of an automatic appliance control system.

Plus, PROCLOCK's powerful interrupt capabilities are invaluable to programmers working with time-sensitive routines and multi-tasking. It can generate interrupts at intervals of 1 millisecond, 1 second, 1

minute, 1 hour, or any combination of those. And all interrupts are software-controlled and handled through PROCLOCK's on-board PIA.

Speaking of software, you also get a diskette full of sample programs, utilities and applications like our Time-Clock II job/time logging program.

PROCLOCK even includes one feature we don't expect anyone to take advantage of—a 10-year lithium battery that keeps the clock running even if your computer is left off for long periods of time.

But just try to keep away from your Apple long enough to put that to the test! With PROCLOCK, you'll have a whole new world of applications to explore. And plenty of time to explore it. Because PROCLOCK is a reliable, well-built piece of hardware. So well-built, it's backed by a five-year warranty.

Ask your dealer about PROCLOCK. It's perfect timing for ProDOS users!

Another practical product from Practical Peripherals—makers of MICROBUFFER™, PRINTERFACE™, GRAPHICARD™, and SERIALL™.

**PRACTICAL  
PERIPHERALS**

31245 La Baya Drive, Westlake Village, CA 91362  
(818) 991-8200 • TWX 910-336-5431

\*ProDOS, Apple, Applesoft and Apple Clock are registered trademarks of Apple Computers, Inc. \*\*CP/M is a registered trademark of Digital Research, Inc.



your patients access to the computer, you may find this type of program useful in another way; it can be used by your staff to answer questions posed by patients.

Letting a nurse or receptionist handle simple medical questions is a common practice, but the aptness and correctness of the response may vary considerably depending on the training and experience of the person answering the questions. A program such as listing 1, used by the office staff to answer patient queries, can, in effect, make use of the expert knowledge and judgment of a physician, even in his or her absence.

In essence, the program and not the staff person supplies the answers. Through the program, the logic and rules of the expert applied to the base of medical knowledge control the response to the questions. The patients receive the answers you would have given, just as if you were speaking to them directly. Full diagnostic programs for large computers are already in operation in some medical centers. These programs, known as "expert" systems, function in much the same way. By interrogating for signs and symptoms and acting on these with rules devised by professionals, the systems arrive at the most likely diagnoses.

### **Adaptability to Other Computers**

The Drugs in Pregnancy program was written in Atari BASIC and requires less than 13K bytes of memory. I chose the Atari because of its inexpensive price and rugged construction, and because it could be used without difficulty by anyone in the waiting room. The program can be easily rewritten in versions of BASIC for other computers. Instructions helpful for such conversions are given in the next section of this article.

The program structure is not limited to any particular field or topic. By changing the wording of the choices and the responses, you can change the topic to heart disease, exercise physiology, or any other area. By retaining its structure, the program will continue to operate as before, adapted to the new subject.

### **Converting an Atari Program**

If you are converting this program for use on a computer other than the Atari, you need to change or eliminate some of the Atari-specific statements and commands. These are mostly graphic commands and symbols that differ from those of other computers. In the program listed, they serve to change the colors of the background and the borders of the screen display. You could delete all the graphic statement lines in the program, and it would still convey the information.

---

### **I chose the Atari because of its inexpensive price and rugged construction.**

---

In designing this program, I devoted particular attention to making it user-proof. Envisioning the user as someone with no previous experience in operating a computer, and considering the environment for the program's intended use, I attempted to make it as difficult as possible to crash the program. The program had to continue operation, or right itself, if the user committed a mistake. This goal was achieved to a point.

Practically all the keys are rendered inoperable except the few that are needed for the user to make choices in the program. Because the office computer does not operate with a disk system, I found no practical way to disable the Break or the System Reset keys other than to cover them with the message, "Do NOT press this key." All responses to the user choices are segregated into timed loops so that if a preset time limit is exceeded, the program will automatically restart at the beginning. This prevents the program from freezing at a particular place if the user abandons it before its conclusion.

Most of the PEEK and POKE statements are used to carry out the fool-proofing. Since the PEEKs and POKEs are peculiar to the Atari, if you need this kind of crash prevention, you will have to devise methods

for your own computer. The following Atari commands and functions are explained in detail so that you can convert them to the equivalent functions on your computer.

The SETCOLOR statement chooses a particular hue and luminance. The question mark (?) is an abbreviated form of the PRINT statement. PRINT #6 is a graphic statement that produces enlarged characters on the screen. The GRAPHICS command selects one of various graphic modes. Since the Atari GRAPHICS command also clears the screen, whenever you see this command in the program you should substitute your computer's command to clear the screen. Another Atari command also clears the screen: a PRINT statement followed by an arrow between double quotes. However, since most printers cannot print this arrow character, another symbol for the clear-screen command appears in the printout of the program listing. That symbol is "}" (right brace). Wherever you come across PRINT "}" in program listing 1, you should also substitute your computer's clear-screen code.

### **Explanation of the Program**

Atari BASIC requires dimensioning all string variables for the maximum length of the string. The DIM statement, line 1010 CLR :DIM K\$(1), reserves a certain number of memory locations for the string variable K\$. Each character in a string requires 1 byte in memory. CLR clears the memory of all previously dimensioned strings, arrays, and matrices.

Ordinarily, luminescence is reduced and the colors are rotated to protect the screen if no one accesses the keyboard after nine minutes. The POKE command, line 1020 POKE 77,0, disables this function since the keyboard frequently goes unused for this period of time. Instead, the program changes screens automatically every 15 to 20 seconds while unattended, so this protection feature is not needed.

Line 1080 sets up a loop to keep the display on the screen for 15 seconds and allows the user to break out of the loop to start the main program by



# THE WHOLE ENCHILADA

## \$1575

Now 320/360K Drives!

Compare this system to any offered by any manufacturer, any dealer. A 16-bit, 128K 8086 MS-DOS system (which by happy coincidence runs some IBM PC-DOS programs): The PC Deluxe™ includes the Sanyo MBC-555 computer with dual disk drives, MS-DOS, Sanyo Color Graphics Basic, Wordstar, Calcstar, Mailmerge, Spellstar, Infostar, PC File, a 12" green phosphor Sanyo display with a 640x200 resolution, a printer cable, and your choice of a Mannesmann Tally Sprint 80, Gemini 10X, or Scottsdale Systems' new LTR-1 letter quality printer. All for \$1575.

Of course you may not want the whole Enchilada, in which case we have other system packages based on the Sanyo 550 computer that may be more to your taste.

If you're thinking about buying the hottest micro of 1984 give us a call. Find out why our prices, inventory, product knowledge, and an insatiable appetite for Mexican food have made us Sanyo's largest U.S. dealer.

**PC PLUS™** ..... \$1099  
**PC DELUXE™** ..... \$1575

The Sanyo Plus includes MS-DOS, Sanyo Basic, Wordstar, Calcstar, Easywriter I, a CRT-36, and dual 160K drives.

No dealers please.

**SANYO**



### TELEVIDEO



The single user 803's now include CP/M and Graphplan from Chang Labs. You can save money by buying your multi-user TeleVideo system from us, and we can have it installed at your site through our agreement with T.R.W. (additional charge).

TPC-dual drive ..... \$1709  
 803 ..... \$1849  
 1605 ..... New, Coll  
 802H ..... \$4319  
 806/20 mb. .... \$4859  
 816/40 mb. .... \$9275

### ALTOS

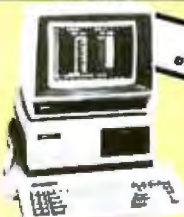


"Free Altos II terminal w/586-20.40

From the lowest-priced dual-floppy multi-user systems to true 16-bit 10Mhz, multi user systems. Local service available via TRW. We will configure, test and install your systems for an additional charge (call for prices).

580-2 ..... \$1998  
 580-10 ..... \$3629  
 586-20 ..... \$6539  
 586-40 ..... \$7995  
 8000-10 ..... \$4679  
 8000-14 ..... \$8118

### ZENITH



25% off List

Now you can go beyond IBM compatibility with a name you can trust. The Z-150's run virtually all software written for the IBM-PC but feature a new modular design so that they can be easily upgraded. Each ZF-151-22 comes with 128K of RAM with parity, dual 360K drives, four unpopulated compatible slots, color video, a small footprint and a big return key. The ZF-161-22 is a dual drive portable and, in addition, includes a built-in 9" CRT.

ZF-151-22 ..... \$3999  
 ZF-161-22 ..... \$3999  
 ZW-151-22 ..... \$3799

### COLUMBIA



Each Columbia comes with Basica (with IBM-PC compatible color graphics), Perfect Writer™, Perfect Speller™, Perfect Calc™, Perfect Filer™, Fast Graphs, Home Acc't Plus, Space Commanders, Diagnostics and the Columbia Tutor. The VP is a 38lb, portable, the 1600-1 is the desktop unit. Both have dual 320K drives and are backed nationwide by Bell and Howell. The VP has a 9" CRT, the 1600-1 price includes CRT controller and keyboard.

VP ..... \$2295  
 1600-1 ..... \$2569  
 1600-4 ..... \$3849

### TERMINALS



**ADDS Viewpoint 3A+**, now emulates the Viewpoint 1A and 2A, along with the ADM 3A. (New model due April)

Viewpoint 60 ..... \$589  
 Wyse 50 ..... \$508  
 Wyse 100 ..... \$694  
 Televideo 914 ..... \$559  
 Televideo 924 ..... \$689  
 Televideo 970 ..... \$1044  
 Altos II ..... \$724  
 Zenith Z-29 ..... \$656  
 Zenith ZT-1 ..... \$449  
 Gume 102 ..... \$544

**HOUSTON INSTRUMENTS**  
 DMP-29 ..... \$1795  
 DMP-40 ..... \$745  
 DMP-41 ..... \$2340

### Sanyo 8-bit Systems ..... new lower prices.



**Scottsdale Systems Ltd.**  
 617 N. Scottsdale Road, Suite B, Scottsdale, Arizona 85257

(602) 941-5856

Call 8-5 Mon.-Fri.



We participate in arbitration for business and customers through the Better Business Bureau of Maricopa County.



### SERVICE/ORDERING

**INTEGRATION:** Prices listed are for new equipment in factory sealed boxes with manufacturer's warranty. We will pretest your equipment, integrate your system, configure your software, provide special cables, etc., for an additional charge. Call for prices.

**ORDERING: MAIL ORDER ONLY.** Prices listed are for cash. No C.O.D.'s. We sell on a Net 30 basis to Fortune 1000 companies and Universities with good credit. P.O.'s add 2%, charge cards add 3%. Az. residents add 6%. Prices subject to change, product subject to availability. Personal checks take 3 weeks to clear. 0-20% restocking fee for returned merchandise. Shipping extra - products are F.O.D. point of shipment. CP/M and MP/M are registered trademarks of Digital Research. Wordstar is a registered trademark of MicroPro International. IBM and IBM PC are registered trademarks of International Business Machines Corporation. TeleVideo® is a registered trademark of TeleVideo Systems, Inc. SOFTWARE: Sold only w/systems, not warranted for suitability.

### PRINTERS



Tally Sprint ..... \$298  
 Tally 160L/trac ..... \$584  
 Tally 180L/trac ..... \$799  
 Oki 92 ..... \$174 Off  
 Oki 93 ..... \$290 Off  
 Gemini 10X ..... \$115 Off  
 Gemini 15X ..... \$140 Off  
 Prism 132 ..... \$1449  
 all opis ..... \$1449  
 Transtar 315 ..... \$469  
 Toshiba 1031 ..... \$1515  
 Rifeam ..... new low prices

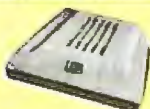
### LETTER QUALITY

Silver Reed 500 ..... \$409  
 Silver Reed 550 ..... \$559  
 Diablo 630 ..... \$1669  
 NEC2030 ..... \$799  
 NEC 3550 ..... \$1771  
 NEC 7710 ..... \$1949  
 DTC 360Z ..... \$995  
 Juki's ..... Call

### PASSWORD 300/1200

The best price on the best selling auto dial/auto answer, 300/1200 baud, auto speed, auto mode full/half duplex, modem. Price includes power phone, and RS-232 cables.

\$329



### OKIDATA

Now you can have twice the "Letter Quality" resolution of an Okidata 92 for about the same price. Let us install an Ok-Writer to an Okidata 82 or 83 and you'll get a remarkable 16 x 17 resolution, dot graphics, and 2400 baud serial port. Call for print sample.

Ok 82 w/Ok-Writer ..... \$409





pressing the Start key. The PEEK command in this line monitors the Atari console switches. When the Start key is pressed, the program branches to line 3000. If the Start key is not activated within 15 seconds, the loop terminates and the program goes on to the next statement.

Line 1160 performs the same function for the second screen display, and line 1170 returns to the first screen if the Start key is not activated.

Lines 2000 to 2370 are subroutines and will be discussed in the sections of the program that call them.

Line 3000 is the beginning of the main program. A brief explanatory message is displayed on the screen followed by a menu of five drugs and an option to go on to a list of additional drugs.

Line 3132 calls subroutine 2290. (This input subroutine ends at 2370 unless an exit is made at one of the earlier lines.) The subroutine displays a menu of choices. A timing loop is set up as before, while the PEEK 764 statements read the value of the last key pressed. This function is similar to that of the INKEY statement in other versions of BASIC. The computer responds when the key is pressed; the user need not hit the Return or Enter key. The POKE statement restores the PEEK location to its normal value of 255, and the character entered is stored in the string

variable K\$. If the character "C" is entered, indicating that the user wishes to choose one of the drugs listed, the program returns to line 3132 and falls through the next two statements to line 3134, where the program control shifts to the subroutine starting on line 2120.

The subroutine at line 2120 prompts the user to enter a number and sets up another timed loop. The PEEK 764 statements that follow again scan the keyboard for the numbers 1 through 5, store the chosen number in the string variable K\$, and then return the program to line 3134. Lines 2140 to 2172 will not respond to any entry except the numbers 1 through 5. This is a further safeguard against the program's being crashed by an incorrect keystroke. Line 2180 restarts the program if keys 1 through 5 are not pressed within 15 seconds.

The second statement on line 3134 calls the subroutine at line 2250. This subroutine checks to see if the keyboard entry was a number from 1 to 5. If not, line 2250 displays an error message and sets an error flag in variable K\$; this returns the user to the menu again for another input in line 3140.

If all has gone well up to this point, K\$ contains the number associated with the drug of choice. The conversion of this string value to a numerical value with the VAL function in

line 3150 causes the program to branch to the appropriate routine with the ON GOSUB statement. If "R" was entered as a choice, the program will return to the previous menu. If "M" was the choice, the program will display the names of more drugs by branching to the next list of drugs.

The many subroutines, nested several layers deep, may make following the logic of the program difficult. However, the memory stack keeps track of all the subroutine calls and returns each one to the proper address. The advantage of such a method is that the user can move from the beginning of the program to the end in sequence, or jump back and forth anywhere in between, without being restricted to a one-way path.

The remainder of the program contains the text for the choices available to the user and further information on the topic chosen. By changing the textual content but retaining the form, structure, and logic of the program, you can rewrite the contents to deal with any topic that lends itself to a list of choices with a response for each one. ■

*George Zucconi, M.D., has a private OB/GYN practice in San Diego, California. He has written numerous articles and delivered lectures on the topic of computers and medicine. He can be reached at 7808 El Cajon Blvd., La Mesa, CA 92041.*

## a message to our subscribers

From time to time we make the BYTE subscriber list available to other companies who wish to send our subscribers material about their products. We take great care to screen these companies, choosing only those who are reputable, and whose products, services, or information we feel would be of interest to you. Direct mail is an efficient medium for presenting the latest personal computer goods and services to our subscribers.

Many BYTE subscribers appreciate this controlled use of our mailing list, and look forward to finding information of interest to them in the mail. Used are our subscribers' names and addresses only (no other information we may have is ever given).

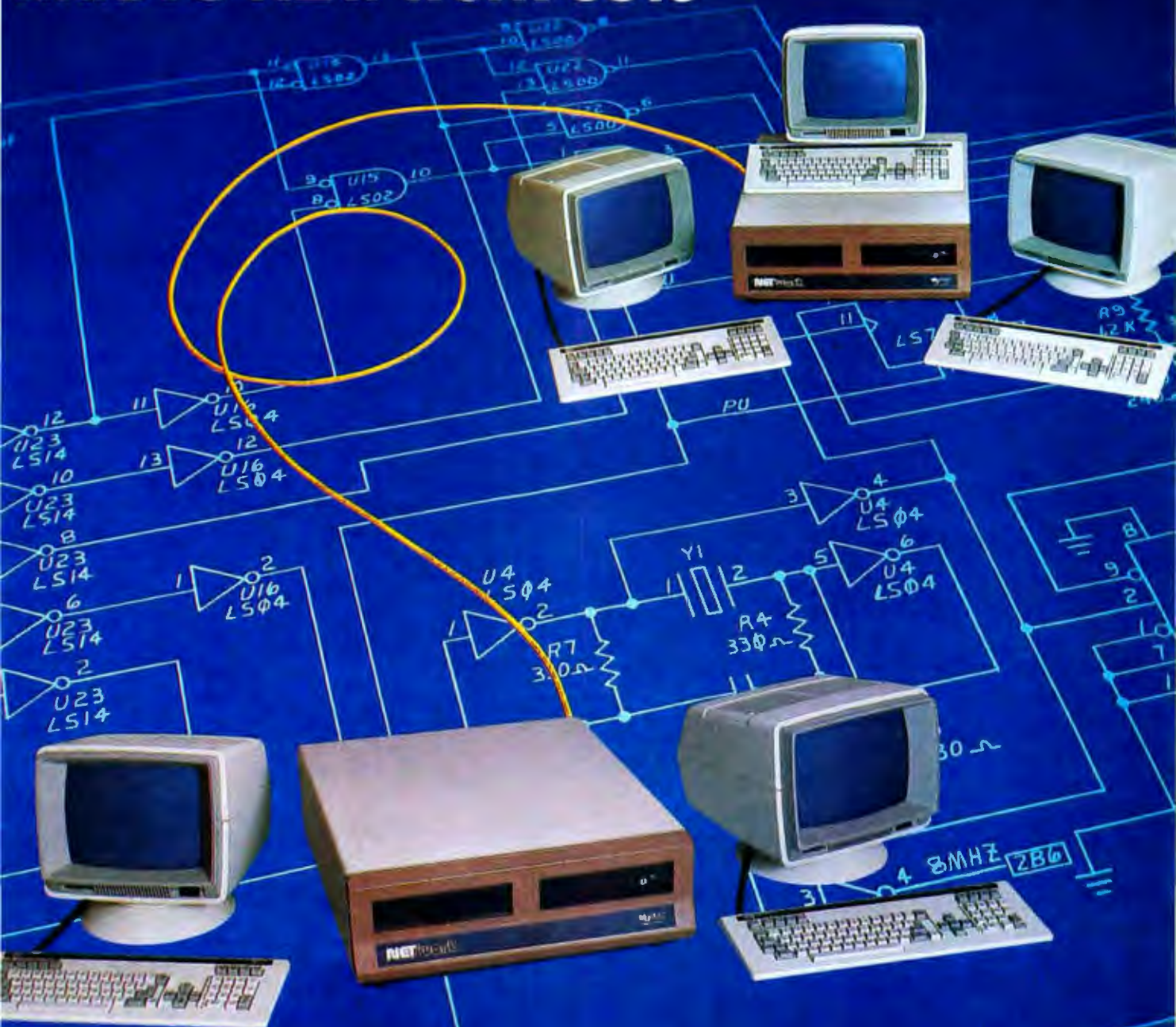
While we believe the distribution of this information is of benefit to our subscribers, we firmly respect the wishes of any subscriber who does not want to receive such promotional literature. Should you wish to restrict the use of your name, simply send your request to the following address.

BYTE Publications Inc  
Attn: Circulation Department  
70 Main St  
Peterborough NH  
03458



# THE SMALL BUSINESS MAINFRAME

## MuSYS NET/work 8816



### Large Multi-user Capability

The NET/work 8816 is an 8/16 bit Multi-user, Multi-processor small business computer system that affords "Mainframe Power at a Micro Price". The major features of the system are:

- Expandable from 2 to 8 users, with **18 to 242 formatted Megabytes** of reliable high speed storage. Each user has their own computer with a minimum of 128K RAM and access to a common database of information.
- **Runs over 3,000 CP/M and MP/M software packages.** The NET/work 8816 operates under an enhanced version of the TurboDOS operating system, providing each user with **one of the industry's largest TPAs** (minimum 63 KB).
- You won't outgrow this system! **Room for growth** without costly changes. Networking via ETHERNET links up to 16

systems to accommodate 256 users with 3.8 GIGABYTES of high-speed online disk storage.

- **Easy to install**, boots from the hard disk with a Menu-driven System Configuration Program, **and even easier to use.**
- Plus, Cartridge or 9 Track Tape Back Up Subsystems are available.

Call toll free 1-800-852-5362 for literature (sent in 24 hours), inside California (714) 662-7387. Or write MuSYS Corporation, 1752-B Langley, Irvine, California 92714. TWX 910-595-1967. Cable MUSYSIRIN.

DEALER and OEM INQUIRIES WELCOME

NET/work is a trademark of MuSYS Corporation. TurboDOS is a trademark of Software 2000, Inc. CP/M is a trademark of Digital Research, Inc. Ethernet is a trademark of Xerox Corporation.





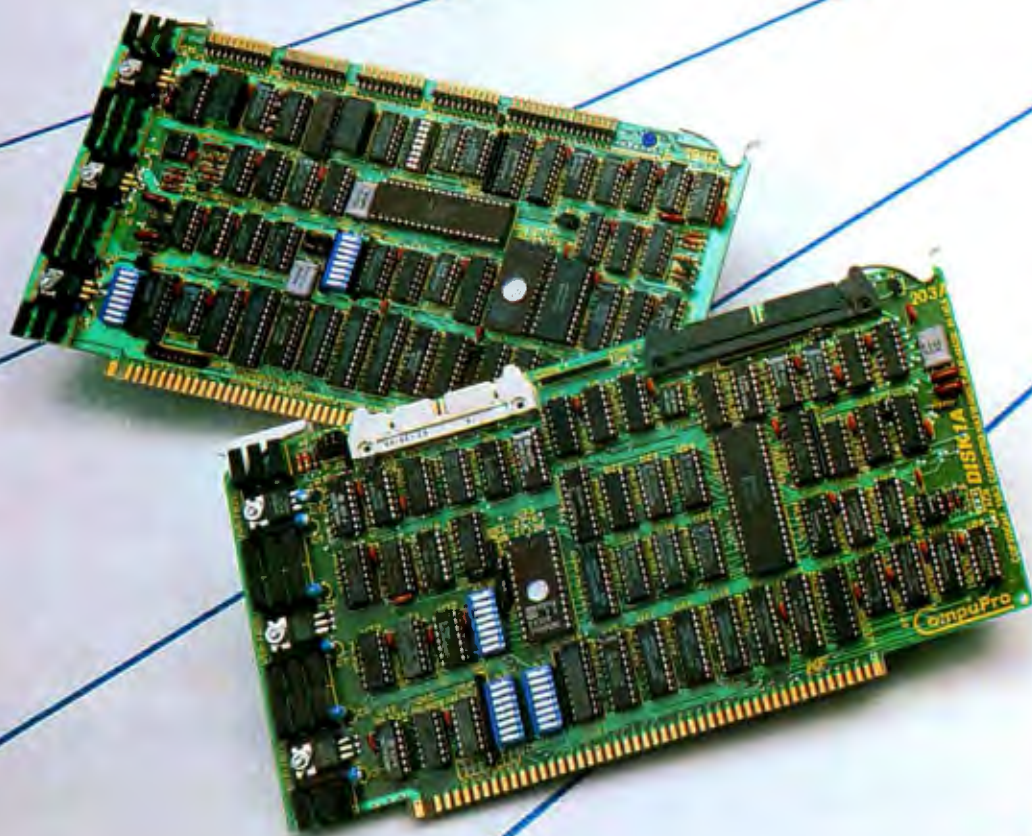
# THE ESSENTIALS

## The CompuPro H40 Disk Subsystem

When it comes to answering your data storage needs, CompuPro has the essential components. Like our H40 Hard Disk Subsystem with Disk 3™ controller and our Disk 1A™ controller. They're the IEEE 696/S-100 products that will keep you and your system on the cutting edge of computing for years to come. Each reflects the most advanced technology available. And that's what you've come to expect from CompuPro. Because we've built our reputation on quality components like these for more than a decade.

**DISK 1A™:** Our high-performance floppy disk controller handles any combination of up to four 8" or 5¼" drives. The Disk 1A is perfectly suited for the highest level single or multi-user microcomputer system. It features state-of-the-art LSI architecture, high-speed DMA interface, and complete compatibility with CP/M-80™, CP/M-86®, CP/M-68K™, CP/M®8-16™, MP/M™8-16™, and Concurrent CP/M™8-16™ operating systems.

**DISK 3™:** Our hard disk controller, which supports as many as four 5¼" Winchester drives, achieves new levels of performance for multi-tasking systems. The Disk 3's many features include transfer of each disk sector using high speed "burst mode" DMA, and a channel processor for independent seeking, reading and writing, as well as the capability to transfer large blocks of data between disk and memory with a single command. Compatible with the same operating systems as Disk 1A.





# OF DATA STORAGE



## HARD DISK SUBSYSTEM:

Here's the essential peripheral for your microcomputer. The H40 has a single 8" floppy drive—a Qume Trak 842™ that's double-sided double-density with 1.2 Mbytes of formatted capacity—and a Quantum Q540™ 5¼" hard disk with 40 Mbytes of unformatted storage, allowing both floppy disk and hard disk operation in a single unit. Assembled in our famous disk enclosure, the H40 is compatible with the IEEE 696 standard.

**You can learn even more about making the most of your microcomputer by sending for our free catalog. In it, you'll find components and systems that can improve the way you work. And why CompuPro is essential to you.**

## The Essential Computer™

See us at COMDEX/Spring '84, booth #8010.

# CompuPro®

A GODBOUT COMPANY

3506 Breakwater Court, Hayward, CA 94545

(415) 786-0909

CP/M and CP/M-86 are registered trademarks and CP/M-80 and CP/M-68K are trademarks of Digital Research Inc. CP/M 8-16, MP/M 8-16 and Concurrent CP/M 8-16 are compound trademarks of Digital Research Inc. and CompuPro. Disk I/A, Disk 3 and The Essential Computer are trademarks of CompuPro. Qume Trak 842 is a trademark of Qume Corporation. Quantum Q540 is a trademark of Quantum Corporation. Prices and specifications subject to change without notice. ©1984 CompuPro

Circle 90 on Inquiry card.

For Dealer locations, see pg. 435



# The Microcomputer as a Decision-Making Aid

*A computer can help you make decisions at work, but only if you know what to expect*

**Peter Callamaras**  
U.S. Air Force

The phrase "decisions, decisions, decisions," used either in jest or in response to real frustrations, bears special significance. It has come to be a common, sometimes satiric, way of identifying one source of our problems. In this case, the source of irritation is the fact that the decisions we have to make have a way of piling up, demanding our time and attention, and seemingly never becoming manageable. The average person takes for granted the ability to make complex decisions. From the time we get up (what to wear today?), through the morning (which route to work?), afternoon (what's for lunch?), and evening (more dessert?), we are presented with choices, and we constantly make decisions. Throughout the day we make simple decisions about our personal well-being, even while we are engaged in professional activities. At some point this constant decision making can cause "decision overload." We get tired, our concentration suffers, and we start making mistakes.

## **The Problems**

The combination of being overburdened with decisions and making a series of bad choices will frustrate most of us. More important, when we're at work this problem can have consequences far beyond its effect on

our emotional state. A classic example of decision overload and its possible dangers is a doctor's misdiagnosis.

A second problem related to decision making is the amount of time it takes. Assimilating all the information relevant to a decision can slow the whole process. Add to that the fact that the volume of information keeps growing. In fact, things change too quickly for many of us to keep up, especially in a busy work environment.

With the need to make more and better decisions, and because of the time involved in wading through so much data, we obviously need some way to reduce the burdens of professional decision making. Microcomputers provide a means of satisfying these needs.

Microcomputers can simplify decision making, speed up the process of choosing between alternatives, and help ensure the accuracy of each decision.

## **Levels of Decision Making**

There are three levels of decision making: operational, managerial, and strategic. Microcomputers can be of great value at all three levels.

Most operational-level decisions involve the specific needs of the decision maker. These decisions make up

the majority of our routine choices. They usually are standardized in our daily activities. Operational-level decisions require detailed information, but the data is readily available and its conversion into decision-making information is often subconscious. We have a set of "canned" responses for these decisions and we often can delegate their execution. The typical advice to a cold sufferer, "take aspirin and drink plenty of liquids," is a delegated canned decision.

Managerial-level decisions require a broader base of information. The decision maker must rely on his prior experience, training, and instincts. Managerial-level decisions cannot be delegated, but they can be substantially speeded up. For instance, a lawyer about to accept a new case may have a general idea of what it concerns. However, the lawyer can't give his client any legal advice until all the data concerning the case is in. The client can help the lawyer by giving him detailed and specific information.

Strategic-level decisions require a wide range of information. These decisions usually are made after long periods of thought and planning and they often require the generation of completely new data. For example, the chief space-shuttle program



engineer probably had to "imagine" some of its aspects from technology that was either immature or still speculative when the program began. Thus, the majority of strategic decisions are heuristic (trial and error) and cannot be standardized, canned, or delegated. (For a more detailed discussion of the three levels of decision making, see *Information Processing Systems for Management*, Chapter 20, by D. Hussain and K. Hussain, Homewood, IL: Richard D. Irwin Inc., 1981.)

### **Time and the Microcomputer**

Work time is one of our most precious resources and also one of the most difficult to conserve. Microcomputers can help us reduce the time we have to spend on the decision-making process by gathering data and converting it into usable information. Once we have all the information we need, we can concentrate on our most prudent course of action.

Computers can bound a problem and ensure that we have the information we need to make a decision at our fingertips. If the decision is routine, computers can provide a canned response and you can get on with more important matters. However, it will take time to integrate a computer into your professional life.

First, you have to decide whether you really want to add a computer to your set of professional tools. Then you have to decide what to buy.

Next, you have to learn how to operate the hardware and interact with the software. Current literature, particularly advertisements, can lead you to believe that you can become proficient at operating a microcomputer in a few hours. This is not so. While you can learn to manipulate the keyboard and turn out some useful products in short order, you will not get the full benefit of the microcomputer until operating it becomes second nature to you. Compare this to oil painting. Until you master the basic techniques of applying the paint to the canvas, shading, mixing, etc., you will not have complete freedom of creativity. The same holds true for a computer system.

It also takes time to enter necessary background information into your computer. Many ads for financial-management programs, for example, only describe the output you can generate and don't dwell on the time it takes to input the information you need to get those impressive printouts. If it took you an entire year to spend the money you are now trying to account for, you can expect that it will take a great deal of time and effort to put your spending history into the computer.

### **Some Helpful Solutions**

In the past, two data-processing disciplines aimed at satisfying the needs of decision makers have been

---

**Any professional who has to work with finances and is not using a computer system is wasting valuable time.**

---

management information systems (MIS) and decision support systems (DSS). An MIS is a large data-gathering system. You define your data needs and set up a method of gathering it. The DSS is a refinement of the MIS applied to an individual's decision-making needs. An analogy can be found to a microcomputer if you imagine starting with a database management system (MIS) and then designing a set of tailored reports (DSS) based on the MIS data.

For another example, look at your annual tax return and your checkbook as an MIS and a DSS, respectively. Your tax return should contain all your financial data in one handy form. You can use it to gauge your financial health and make plans for the coming year. You use this MIS to create budget categories for the following year (checkbook/DSS). You then use these budget categories for specific financial decisions. Balancing your checkbook at the end of the month tells you how much you spent in relation to how much you had. You can then break out the totals for each budget category and take a detailed

look at your spending for the month. Then, if necessary, you can make adjustments for the next month.

In the past, both MIS and DSS systems had to be implemented on large computers. Today, most professionals can obtain the benefits of an MIS/DSS with a good microcomputer system.

### **How the Microcomputer Helps**

Any professional who has to work on finances and is not using a computer system is wasting valuable time. This applies particularly to professionals in business for themselves. When reviewing financial activities, the computer makes it easy to compare the money that is coming in with the money that is owed. If there are discrepancies, a computerized financial-management system allows you to go back and locate the source of the problems. If things are going well, you can use a spreadsheet program to speculate on possible future directions. A microcomputer also can make tax planning an easy, ongoing exercise that maximizes income and minimizes payments.

A computerized inventory system can also be of help to the professional. For example, you can establish a set of routine procedures for ordering supplies. If it takes a week to receive a high-consumption item, you can use the computer to determine when to place the order. One way this can be done is through the application of the economic order quantity (EOQ) method. With EOQ you create a model of your consumption patterns and compare them with your ordering/receiving patterns. The result is an indication of the best time to place orders. Accurate and timely order placement ensures that a minimum amount of inventory will be on hand to satisfy operating needs and that you will never run out of something. The stock stays fresh and storage costs decline. This also turns inventory control into a set of operational-level decisions that then can be delegated to a subordinate.

Microcomputers can perform complex statistical analyses. Engineers routinely perform statistical analyses of the failure rates of materials or



components they want to use. The results allow them to accept or reject the materials. Once the acceptance/rejection criteria are determined, materials selection can be reduced to a canned routine.

For professionals who travel a great deal, trip planning can be made easier with a transportation model (TM). The TM can also determine the most economical route for product deliveries. For those whose business it is to move people or things around the country, the decision again can be converted into a set of canned control types and delegated.

Another type of software can aid planning and scheduling by providing a pictorial representation of the task at hand. Once the necessary events are determined, the computer generates a graph of the events along a time line. As time passes, the completion of a specific task can be tracked against the graph and corrective action can be taken as needed. One of the better known of these time-line graph programs is the critical-path method (CPM).

Teleprocessing through the phone system opens a whole new world to the microcomputerized decision maker. For those who need a great deal of information, the growing number of on-line data services can be a godsend. An on-line data service can be viewed as a specialized library in a computer. There are several medical libraries, for example, that allow doctors to make more accurate diagnoses or prescribe more effective medication.

On-line data services for lawyers, such as Westlaw, contain a vast body of judicial decisions. These services can reduce the drudgery of wading through all the material that is potentially applicable to a legal question. The search capability allows a lawyer to put in a set of key words and anything relating to those words is returned.

### Conclusion

The more decisions you reduce, standardize, and delegate, the less time decision making will take. The more data you gather, the more in-

formation you will have available to make the best possible decisions. The microcomputer's ability to play "what if" gives you trial-and-error results without forcing you to live with the consequences of poor decisions.

The cost of microcomputers now is generally low enough to be affordable to most professionals. Learning to use one properly takes time, but it is worth the investment. The documentation that accompanies most hardware and software is getting better. With clearer instructions, it takes less time to get "up to speed." There is plenty of software available to support decision making, and there are more decision-making packages coming out all the time. The key question is, Can you afford *not* to start using a computer to aid in your decision making? ■

*Peter Callamaras, an Air Force officer, can be reached at AFCC/EPPB Scott AFB, IL 62225. He recently received his master's degree in systems management. He has been interested in computers since 1966 and was the service-department manager of a computer store.*

**FREE SHIPPING**  
Order line: 800-354-7330

### SANYO SUPER SYSTEMS

#### SYSTEM #1 \$1195

- SANYO MBC-550
- SANYO GREEN MONITOR
- GEMINI 10 X • SOFTWARE •

Sanyo MBC-550 Single Drive Computer • Sanyo CRT-36 Monitor • Star Micronics Gemini 10X • Cabling • WordStar • CalcStar • Easywriter • MS-DOS • Sanyo Basic •

#### SYSTEM #2 \$1525

- SANYO MBC-555
- SANYO GREEN MONITOR
- GEMINI 10X • SOFTWARE •

Sanyo MBC-555 Dual Drive Computer • Sanyo CRT-36 Monitor • Star Micronics Gemini 10X • Cabling • WordStar • CalcStar • SpellStar • InfoStar • Mail Merge • Easywriter • MS-DOS • Sanyo Basic •

#### PRINTERS

##### C. ITOH

A10-20 \$505

F-10 Serial or Parallel \$940

Praxwriter 8510 \$335

8510 SP \$460

8510 SCP \$530

8510 BP1 \$420

##### COMREX

CR-2 \$450

Keyboard \$150

##### DIABLO

620 RD \$860

630 RD \$1715

630 ECS/IBM \$2090

S-11 \$560

P-11 \$560

##### EPSON

All models \$AVE

##### JUKI

6100 \$480

##### NEC

2010 \$780

2050 \$905

3510 \$1370

3550 \$1715

8023A \$385

8025 \$675

#### OKIDATA

All models

##### QUME

11/40 w/Interface \$AVE

11/55 w/Interface \$1370

Letter Pro 20P \$1570

Letter Pro 20S \$609

SILVER REED \$609

##### EXP400

EXP500P \$AVE

EXP500S \$390

EXP550P \$425

EXP550S \$485

EXP550S \$500

##### STAR MICRONICS

Gemini 10X & 15X \$AVE

Delta 10 \$AVE

##### TALLY

MT 160L w/tractors \$AVE

MT 180L w/tractors \$AVE

Spirit \$299

Spirit 80 \$AVE

##### TOSHIBA

1340 \$AVE

1350 Serial or Parallel \$1450

1351 Serial or Parallel \$1550

##### TRANSTAR

130P \$675

120P \$450

T315 \$450

#### SAVE

#### TERMINALS

##### TELEVIDEO

910 + \$AVE

914 \$1370

924 \$609

925 \$609

950 \$AVE

970 \$390

##### ZENITH

Z-29 \$425

#### COMPUTERS

##### SANYO

MBC-550 System \$AVE

MBC-555 System \$AVE

##### TELEVIDEO

801 \$1799

##### ZENITH

Z-100 Low Profile \$2635

Z-100 All-In-One \$2815

#### MODEMS

##### HAYES

1200 \$490

1200B \$435

300 \$205

Micromodem IIe \$240



#### DISK DRIVES

##### RANA

Elite 1 \$555

Elite 2 \$540

Elite 3 \$670

1000 w/DOS (for Atari) \$705

\$905

\$980

##### MONITORS

##### TAXAN

12" Amber \$125

##### ZENITH

12" Green \$95

12" Amber \$120

Prices reflect 3% to 5% cash discount.

Product shipped in factory cartons

with manufacturer's warranty.

Free shipping is on UPS ground

only. Prices & availability

subject to change with-

out notice. Send cash-

ier's check or money

order...all other

checks will

delay ship-

ping two

weeks.

**SILICON SPECIALTIES**  
2024 WEST SOUTHERN  
MESA, ARIZONA 85202  
602-969-0909



## **WHY DEC AND INTEL CHOSE THE MARK WILLIAMS C-COMPILER.**

DEC and INTEL wanted the best C technology available, with excellent code density, supporting the full C language and their specific operating environments—all at a competitive price.

They found it all at Mark Williams.

## **WHY YOU SHOULD CHOOSE THE MARK WILLIAMS C-COMPILER.**

Our C-compiler supports the dominant 16-bit microcomputers—68000, PDP-11, Z8000, 8086—with a proven reliable, high-technology product. We are shipping versions of C for a large number of environments including CP/M and PC DOS. Both cross and native compilers are available.

Call us for the distributor nearest you. OEM's should contact us directly about their specific requirements.

Mark Williams Company,  
1430 West Wrightwood, Chicago, Illinois 60614,  
312/472-6659.





# The Wang PC. The hardware that brings out the best in software.

The Wang Professional Computer runs hundreds of the most common business applications.

And almost all of the most popular software programs—including Visi On,<sup>™</sup> Lotus 1-2-3,<sup>®</sup> TK!Solver,<sup>™</sup> Multiplan<sup>™</sup> and Peachtree.<sup>™</sup>

And because the Wang Professional Computer is more powerful than most other personal computers—including the IBM PC—it runs all of these programs better. Applications are more responsive.

Screens are faster.

The graphics are sharper.

In fact, many software companies have told us they prefer to see their software demonstrated on the Wang Professional Computer.

Which is only natural. Everybody likes to look their best.

For a demonstration of the Wang Professional Computer, call 1-800-225-9264. Or write to: Wang Laboratories, Inc., Business Executive Center, One Industrial Avenue, Lowell, MA 01851.

Visi On is a trademark of VisiCorp. Lotus 1-2-3 is a registered trademark of Lotus Development Corp. TK!Solver is a trademark of Software Arts Inc. Multiplan is a trademark of Microsoft Corp. Peachtree is a trademark of Peachtree Software Inc.



## WANG

**The Office Automation  
Computer People.**



# Benchmarking Business-Modeling Software

*These guidelines will help you compare  
the functions and speed of business-modeling software*

**William Hession and Malcolm Rubel  
Performance Dynamics Associates**

When you want to fasten two boards together, you usually use a nail. To drive the nail through the boards you need a tool—preferably a hammer. The heel of a shoe might sometimes work, but it is hardly satisfactory where many nails are involved. You use a hammer because it is the best tool to perform the required tasks.

The process of selecting computer software, specifically business-modeling software (such as spreadsheet programs), can be likened to the hammer and nail problem. The software is your tool, but you need to have the right program to suit your modeling needs. Business-modeling software is a general-purpose tool; the added features of a specific program make it either more or less suited to different modeling tasks. Selecting business-modeling software is therefore complicated and prone to error. Benchmarks, or standard references, can simplify your evaluation of individual programs.

## **Alternative Selection Procedures**

There are four distinct approaches to selecting software; each has its own strengths and weaknesses.

1. *The "Dealer Demonstration" Approach.* This involves going to a dealer for product demonstrations. While you can view excellent demonstra-

tions at reputable dealers, you will be exposed only to the programs the dealer stocks and sells. These demonstrations will not necessarily be specific to your individual needs. When you go to a demonstration it is essential that you have a clear and concise idea of your needs, so that you can ask the salesperson to show you products that can meet your requirements.

One drawback to this approach is that the salesperson may be unfamiliar with all but one or two products. Thus the salesperson may try to "force fit" your needs to the products he is familiar with. If the salesperson can't tell you about alternative products, you may make a poor purchase decision.

You also should not be afraid to ask the salesperson questions. Although you may think your questions are unimportant, they can be vital. Unasked, they go unanswered.

2. *The "Talk to a Friend" Approach.* Probably the most common way to choose software is on a friend's recommendation. Usually the person making the recommendation has no incentive to sell you something but is well versed in the uses of the product and can recommend it with authority. If you are lucky enough to know someone with the same software needs as you, this approach can

be of some value. Problems arise if the person recommending the product did not make an optimal purchase decision or has task requirements that are substantially different from yours.

3. *The "Read the Reviews" Approach.* Many people evaluate business-modeling software by reading reviews on the different programs available. Most reviewers spend a considerable amount of time using the program they are reviewing and are truly knowledgeable about the type of software involved. However, the writer cannot help bringing personal bias into the review.

Each reviewer has preconceived ideas about what a specific type of software should include, and has his own approach to reviewing a product. A reviewer also has a set of problems that he wants the product to solve. Consequently, it is difficult to get an unbiased and comparable set of evaluations by reading a series of reviews by different authors.

One factor that reviewers tend to overemphasize is a product's "user-friendliness." To one person, "friendliness" could mean that the program prompts the operator at every command and asks for confirmation on every move. To another, this same "friendliness" could mean hours of tedium and frustration. "User-



# CARD TRICKS.



## (Or how to add six functions to your IBM PC/XT with just one multifunction card)

It's not magic. And it isn't sleight of hand. It's ConsoCard from Consolink...the multifunction card for your IBM PC OR PC/XT that performs six tricks from a single slot space.

- Up to 384K expansion memory for larger in-memory data bases.
- Printer spooling for computing even when the printer is printing.
- RAM disk emulator for fast access to frequently used files.
- TWO asynchronous RS-232 ports for communication with other computers.
- Battery powered chronograph for accurate time keeping.

One Card. Six Tricks.



Visit us at Comdex,  
Booth D-217.

**ConsoCard**  
Without it, your IBM  
isn't playing with a full deck.

Circle 108 on inquiry card

**CONSOLINK**  
CORPORATION

1880 Industrial Circle • Longwood, CA 95040

(916) 881-2018 • Toll Free: (800) 625-4705

Industry's Most Comprehensive Support Services Available

friendly" is not an absolute term; it is relative to the user's experience, temperament, and environment.

The first three approaches to selecting software draw your attention to the product's capabilities, simplicity of operation, utilities, special features, and the number of tasks it can perform. Unfortunately, they do not take into consideration the tasks you need to perform and whether the product can accomplish them.

The fourth method of product evaluation and selection, benchmarking, enables you to consider your needs first.

### The Benchmark Approach

To use the benchmark approach to choose your business-modeling software, start by defining the jobs you want done and then describe what you need in a product to perform these tasks. Once your needs are defined and you develop a suitable set of benchmarks, you can compare products based on your own specifications.

We use the term "benchmark" when evaluating software with a defined standard against which each software package is compared. Our benchmark is also split into two separate sections: functional comparisons and speed comparisons.

Functional comparisons, by far the most important, deal with the capabilities of a specific program to perform a specific task. Speed comparisons deal only with the individual program's speed and efficiency in performing a defined operational task. Speed comparisons are important only if the tasks defined involve massive data manipulations, substantial internal calculations, and/or many iterations. In general, this criterion becomes inconsequential when compared to the program's functional benchmarks and its simplicity of operation.

It is important to differentiate benchmarking from more traditional product-review techniques. Conventional reviews are characterized by implicit, rather than explicit, standards. You may not know why a reviewer gave a high or low mark to a specific capability of a program, you

just know that he did. You are left to rely on the reviewer's judgment.

Conventional reviews traditionally cover only one product and, if any comparisons are made, they are usually ad hoc and do not have a valid foundation. Also, although reviewers' biases do exist, they are not annotated in the review.

Because different reviews are done by different people, it is virtually impossible to make comparisons of the products.

Benchmarking, on the other hand, is characterized by explicit standards. You may or may not be interested in the tasks being benchmarked, but you can at least see what the tasks do and weigh their importance.

Benchmarks make it easy to compare products and evaluate their differences in functionality and speed. Biases in a benchmark (which are certain to exist because the benchmark represents only one perception of what is important) are evident in the required modeling task. If the problem set does not adequately represent your individual needs you are free to ignore the comparisons.

Benchmarks are goal oriented. They are set up to determine whether a product can perform a predefined series of tasks. They are not set up to find out everything a product can do. As such, they are limited, but they are comprehensive within their own problem set.

To benchmark business-modeling software you must develop the benchmark and apply it to a specific product.

### Benchmark Development and Use

You should begin your benchmark development process with a thorough examination of the broad spectrum of business-modeling software. Pay attention not only to what is being modeled but also to how it is being modeled; also note who created the software and for what purpose.

Business modeling can be broken into several different categories. These categories represent the different tools, or capabilities, the software makes available to you. To select software properly you have to be able to define the tasks to be performed.



The software *must* be able to perform those that are required.

A business-modeling tool kit comprises several groups of tools: simple models, advanced simulation models, statistical tools for analysis and forecasting, special mathematical and business functions for modeling and analysis, and a generalized programming capability for user-developed functions and applications.

Elementary applications using ledger-sheet formats for the analysis of business performance require basic spreadsheet-modeling capabilities. The spreadsheet model, with its row/column modeling and basic arithmetic functions, provides the tool for the "quick and dirty" analyses so often required in business. When combined with an ability to link or consolidate sheets, this tool proves useful in report and simple accounting consolidations.

More sophisticated applications, based on large, complex equation systems, require modeling tools explicitly designed for developing and solving these types of problems. Modeling software for these tasks should include the capability to automatically order equations for a solution and the ability to solve both recursive and more complex circular or simultaneous model relationships. In addition, "what-if?" and "goal-seeking" features should be supported to aid model analysis. A sensitivity analysis (what-if?) feature allows you to vary assumptions and provides the means to examine the model's reactions to alternative assumptions. Goal seeking, also called backward solution, lets you determine what actions are necessary to achieve specified model outcomes.

To analyze past business patterns and to forecast future results, a basic statistical ability is required in modeling software. Minimum features should include basic statistics for analysis—mean, variance, standard deviation, simple correlation, forecasting tools such as linear regression, and simple time-series analysis functions such as moving averages or exponential smoothing routines.

Applications in business or financial analysis—for example, invest-

ment evaluation, capital budgeting, or profitability studies—are facilitated by special business mathematics functions. The calculation of net present values, internal rates of return, and depreciation and amortization schedules are a few of the more important business and financial functions. These functions may be tested directly in the problem set but must also be covered completely in a benchmark's questionnaire section to ensure that they are properly highlighted.

Developing custom business models and modeling applications sometimes requires the use of special formulas and procedures not always available in business-modeling packages. To meet this need, modeling software often provides a high-level programming capability. The modeling language should provide a full range of conditional functions and the usual programming constructs. Features permitting user-definable functions and subprograms are helpful for the larger tasks.

If it is to be useful, the benchmark problem set must address all different types of modeling applications. Simplify the models you are testing to their bare minimum to ensure that you test only the program's ability to perform a specific function, not its ability to perform a big job. If you keep the program simple you will also be able to apply it to your own needs more easily. The text box, "A Simple Financial Modeling Problem," on page 130, shows an example of one problem from the benchmark problem set designed simply to test a program's abilities.

From the range of business-modeling software that is available you can select those tools that are of primary importance to your work. From this list, you also can determine if there are other modeling tools you would like to have, given their availability. You can then go through the list of products available to you and discard those that do not meet your criteria. This reduces the list of possible purchases to a reasonable length.

At this point, you can examine each program's support of its tools. The benchmark problem set and ques-

# WAIT-LESS COMPUTING



With MicroSpooler from Consolink, your computer is free for use even when your printer is printing. There's no downtime, or waiting around time. So your computer is back on the job in seconds... **working** instead of waiting.

Standard features include:

- **16K memory**—expandable to 64K
- **Status readout**—displays amount of data stored or number of copies left to run (up to 99)
- **Internal power supply**—eliminates extra cost and bulky adaptors

**MicroSpooler™**  
MicroSpooler from Consolink.  
Why you want your computer  
to wait less... and work more.

Visit us at Comdex Booth D-217

**CONSOLINK**  
CORPORATION

11140 Industrial Circle • Livingston, CA 94550  
(415) 651-2014 • Toll Free (800) 575-4200  
TWX 910-320-0798

Subsidiary of Consolink • A Division of Consolink

Circle 109 on inquiry card



## A Simple Financial Modeling Problem

The Universal Products Corp. wishes to develop a simple financial model of a pro forma income statement. The model will be simulated for five periods.

### Exercise A

Develop and run the model, generating the pro forma income statement shown below. Please attempt to replicate the report format as closely as possible. Save the report to disk and print it. Save the command file to disk and print it. Label the model and printed output EXA.1. Label the command file and output EXA.2.

#### UNIVERSAL PRODUCTS INC. Projected Income Statement

	1984	1985	1986	1987	1988
	Revenue	Revenue	Revenue	Revenue	Revenue
Operating and other revenue	120,000	144,000	172,800	207,360	248,832
Cost of goods sold	96,000	115,200	138,240	165,888	199,066
Earnings before interest and taxes	24,000	28,800	34,560	41,488	49,766
Interest expense	30,000	10,000	10,000	10,000	10,000
Earnings before taxes	(6,000)	18,800	24,560	31,488	39,766
Taxes	0	9,400	12,280	15,744	19,883
Net income	(6,000)	9,400	12,280	15,744	19,883
	=====	=====	=====	=====	=====

The relationships on which the model is based are given below:

$$REV = 1.2 \times \text{lagged } REV$$

$$CGS = 0.8 \times REV$$

$$EBIT = REV - CGS$$

$$INT = \$30,000 \text{ in period \#1, } \$10,000 \text{ thereafter}$$

$$EBT = EBIT - INT$$

$$TAX = 0.5 \times EBT \text{ if } EBT \text{ is } > 0, \text{ otherwise } TAX = 0$$

$$NET = EBT - TAX$$

Notes: Period 0 is 1983, period 1 is 1984 and so on. All lags are one-period lags. Initial revenue is assumed throughout the exercise to be \$100,000. That is, REV for Period 0 = \$100,000.

### Exercise B

Assume now that revenue growth is 30 percent in years 1984, 1985, and 1986 and 50 percent in 1987 and 1988. Retrieve the model from disk, run it, and generate a new income statement in the same report format. Save the new report to disk and print it. Label this EXB.1. Save the command file to disk and then print it. Label these EXB.2.

### Exercise C

Assume now that interest expenses are \$20,000 per year for 1984-1988. Alter the model to reflect this new assumption (while maintaining the assumptions of exercise B). Run the model and generate an income statement similar to the one above. Save the report to disk and output it to the printer. Label these files EXC.1. Save the command file to disk and print it. Label these files EXC.2.

### Exercise D

This question tests your product's ability to perform goal seeking, or the backward solution of the model. Use the model saved in exercise A. Find out what revenue would have to have been in 1984 if the net income will be \$25,000 in 1985. Run the report, save it to disk, and print it. Label these files EXD.1. Save the command file to disk and print it. Label these files EXD.2.

tionnaire should address a series of questions on how well each program works to support its problem-solving abilities.

You should design the benchmark's questionnaire to answer these important questions: who is doing the modeling, and for what purpose? You must ask questions about the documentation and output presentation. If you want the product to be a personal productivity tool, you will not ask the same benchmark questions as you would if the product is to be used by several people of differing skill levels. Your questionnaire should consider the following:

- Documentation—Is it complete, easy to read, and indexed? Does it give operator instructions for novices? Is there a tutorial or a reference card? Does it offer on-screen help?

- Data Input—Can data input into a model be simplified so that it can be done by a third party? Can forms be designed for input on screen? What is data editing like?

- Data Management—Can specific information be changed, modified, or copied? How? Is information easily retrieved? Can models easily access data?

- Functions and Utilities—What tools, both arithmetic and statistical, are available to assist you in developing and running your models? Some programs provide many specific functions such as net present value or variance. Others may require the operator to define the functions with many lines of code.

- Report Writing—What capabilities does the program have to output the finished report?

- Graphics—Does the program have the ability to present your information graphically? If so, in how many ways? What output devices are supported? Can you do color work?

An example of part of a function questionnaire is given in table 1. The set of questions that you ask should be comprehensive. The more points of differentiation between the varying programs, the easier it will be to reduce the set of possible choices to a final few.



# CONTROL 16 S-100 USERS WITH 1 ADIT BOARD



ADIT. There's nothing else like it on the market. It's an intelligent I/O board with its own operating system that lets you control up to 16 different terminals, modems or printers. Or link your local network up to four other systems simply and inexpensively. And all this from a single slot in your S-100 bus. Now that's efficient!

ADIT gives you many extras. It allows you to upgrade to a multi-user system and expand as your needs grow—without performance degradation. The on-board 6MHZ Z80B supports DMA operations to off-load the host CPU. Multi-tasking firmware supports UNIX, MP/M and AMOS operating systems. It complies fully with IEEE 696.

There's much more to tell you about ADIT than space allows. And it is only one of Macrotech's products designed to maximize the performance of your S-100 system. The MAX Dynamic Memory, for instance, gives you up to 1 Mbyte of memory for all your system memory and virtual disk applications—again from a single slot. And our newly developed dual-processor, CPU board. It uses a 16-bit 80286 and an 8-bit Z80B to provide unprecedented speed and power from a single slot. That's efficiency, too.

Call or write us today, and ask about these products.



**Macrotech  
International Corp.**  
9551 Irondale Avenue  
Chatsworth, CA 91311  
Phone: (818) 700-1501

Circle 247 on inquiry card.

Dealer/Distributors: Priority One Electronics, (800) 425-5922, (213) 709-5111 / John D. Owens Assoc., (212) 448-6298

In England: Fulcrum (Europe) (0621) 828-763

UNIX is a registered trademark of Bell Laboratories, Inc. / MP/M is a registered trademark of Digital Research / AMOS is a registered trademark of Alpha Microsystems





## Narrowing the Field

Once you have discarded programs that do not meet basic tool and function criteria, you must subject the remaining programs to "test drives." At this point, you can profitably consult a dealer or friend who has the program.

When consulting a dealer about a targeted product, it is important that you ask specific questions about it and that you set up and solve specific problems. If the salesperson is reluctant to do this, ask if you can conduct your own demonstration. At this point, you should determine how well the programs you have selected work for you. Get as much hands-on experience as you can before making a purchase.

It may seem like we have made the process of selecting a business-

modeling program overly complicated, but when you consider your investment in a program, not only in actual but also in implied dollars (learning the program, setting up data files and models, and getting used to working with the program), your time and effort spent researching and selecting it is insignificant. The benchmark process can help you compare programs objectively and arrive at the proper purchase decision. ■

*Malcolm Rubel is president and William Hession is executive vice-president of Performance Dynamics Associates (305 Madison Ave., New York, NY 10165), a marketing-consulting firm specializing in software marketing. They are also the authors of The Performance Guides to Business Software, a series of books benchmarking word-processing, business-modeling, and database-management software. The books will be published by McGraw-Hill in 1984.*

### Sample Product Function Questions

Does the product have any of these Boolean and control functions:

EQUALS (=)? \_\_\_\_\_  
 GREATER THAN (>)? \_\_\_\_\_  
 LESS THAN (<)? \_\_\_\_\_  
 GREATER THAN OR EQUAL TO (≥)? \_\_\_\_\_  
 LESS THAN OR EQUAL TO (≤)? \_\_\_\_\_  
 NOT EQUAL TO (≠)? \_\_\_\_\_  
 AND? \_\_\_\_\_  
 OR? \_\_\_\_\_  
 NOT? \_\_\_\_\_  
 IF ... THEN ... ELSE? \_\_\_\_\_  
 NESTED IF ... THEN? \_\_\_\_\_  
 TRUE? \_\_\_\_\_  
 FALSE? \_\_\_\_\_

Does the product have any of the following business functions:

NET PRESENT VALUE? \_\_\_\_\_  
 FUTURE VALUE? \_\_\_\_\_  
 INTERNAL RATE OF RETURN? \_\_\_\_\_  
 PAYBACK PERIOD? \_\_\_\_\_  
 AMORTIZATION? \_\_\_\_\_  
 DEPRECIATION:  
 STRAIGHT LINE? \_\_\_\_\_  
 DOUBLE DECLINING BALANCE? \_\_\_\_\_  
 SUM OF THE YEARS DIGITS? \_\_\_\_\_

Does the product have any of the following statistical functions:

MAXIMUM? \_\_\_\_\_  
 MINIMUM? \_\_\_\_\_  
 MEAN? \_\_\_\_\_  
 MODE? \_\_\_\_\_  
 MEDIAN? \_\_\_\_\_  
 VARIANCE? \_\_\_\_\_  
 STANDARD DEVIATION? \_\_\_\_\_  
 CORRELATION COEFFICIENTS? \_\_\_\_\_  
 SIMPLE LINEAR REGRESSION? \_\_\_\_\_  
 MULTIPLE LINEAR REGRESSION? \_\_\_\_\_  
 MOVING AVERAGE? \_\_\_\_\_  
 EXPONENTIAL SMOOTHING? \_\_\_\_\_  
 RANDOM-NUMBER GENERATOR? \_\_\_\_\_

Indicate any additional functions that are included in the product

Table 1: Part of a questionnaire for evaluating business-modeling software.

## Enter CompuServe's Electronic Mall™ and shop at your convenience in these exciting departments.

The Micro Mart  
 The Department Stores  
 The Travel Agent  
 The Book Bazaar  
 The Record Emporium  
 The Photo Booth  
 The Software Shop  
 The Financial Market  
 The Magazine Kiosk  
 The Gardening Shed  
 The Newsstand

## A sample of the companies participating in CompuServe's Electronic Mall™ includes:

Amdek  
 American Airlines  
 American Express  
 AST Research  
 Bantam  
 CBS Publishing  
 CDEX  
 Colonial Penn  
 Commodore  
 Computer World  
 Digital Equipment  
 dlithium Press  
 800 Software  
 Heath  
 Hertz  
 E.F. Hutton  
 Inmac  
 Innovative Software  
 Magazine Supply House  
 Manufacturer's Hanover Trust  
 McGraw-Hill  
 Metropolitan Life  
 Microsoft  
 Miracle Computing  
 Misco  
 Newsnet  
 Official Airline Guide  
 Pan American Electronics  
 Peachtree Software  
 Practical Peripherals  
 Program Store  
 Professional Color Labs  
 RCA Record Clubs  
 Record World  
 Sears  
 Select Information Exchange  
 Sim Computer Products  
 Software Advisor  
 Stark Brothers  
 Supersoft  
 Max Ule  
 Vanguard  
 VisiCorp  
 Ziff-Davis

Merchants and manufacturers who want to participate in the Electronic Mall™ may contact: Stephen A. Swanson, L. M. Berry & Co., P.O. Box 6000, Dayton, OH 45401, (513) 296-2015.





# BY THE YEAR 2000, THE WORLD MAY CATCH UP WITH THE WAY COMPU SERVE'S NEW ELECTRONIC MALL<sup>™</sup> LETS YOU SHOP TODAY.

## Introducing the first computer shopping service that brings you convenience, savings and enjoyment.

Here's your chance to expand the practical uses of your personal computer.

Sign up for CompuServe and shop in our new Electronic Mall. It's easy to use. It tells you more about the products you're buying. It lets you order faster. And it's totally unique.

### CompuServe's new Electronic Mall<sup>™</sup> offers you all these shopping innovations.

- It's enormous! So it gives you in-depth information on thousands of goods and services, and lets you buy even hard-to-find merchandise. - Its unique "Feedback" service lets you ask the merchants themselves specific questions. - It's incredibly efficient in ordering the products and services you want.

- Its special discount opportunities make it economical, purchase after purchase. - And its name-brand merchants assure you of top-quality merchandise.

#### Make the CompuServe Electronic Mall 15-Minute Comparison Test.

*What you can do in 15 minutes shopping the Electronic Mall way.*

- Call up on your computer screen full descriptions of the latest in computer printers, for instance.
- Pick one and enter the order command.
- Check complete descriptions of places to stay on your next vacation.
- Pick several and request travel brochures.
- Access a department store catalog and pick out a wine rack, tools, toys... any thing!
- Place your order.

*What you can do in 15 minutes shopping the old way.*

- Round up the family and get in the car.

### The Electronic Mall, a valuable addition to the vast world of CompuServe.

CompuServe's Consumer Information Service brings you shopping information, entertainment, personal communications and more.

You can access CompuServe with almost any computer and modem, terminal or communicating word processor.

To receive your illustrated guide to CompuServe and learn how to subscribe, call or contact...

## CompuServe

Consumer Information Service  
P.O. Box 20212  
5000 Arlington Centre Blvd.  
Columbus, OH 43220

**800-848-8199**

In Ohio call 614-457-0802

Circle 91 on inquiry card.



# Apple's® new baby has



Microsoft BASIC  
on Apple's new Macintosh

It's called Macintosh™. And it has our brains and a lot of our personality.

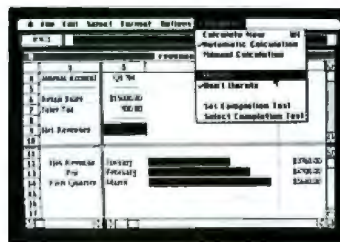
We're called Microsoft®. And our part of Macintosh is five new programs that are bright, intuitive, outgoing, understanding and born to perform.

**Our pride, your joy.**

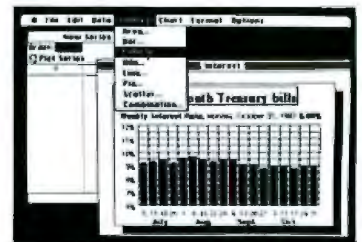
Taking advantage of Macintosh's mouse and rich graphics, we've designed software that works like you, even thinks like you.

All our programs share the same plain English

commands. So what once took days to learn, now takes hours or minutes to learn with Macintosh.



Microsoft Multiplan



Microsoft Chart

**Meet the family.**

Our financial whiz is MULTIPLAN®, an electronic spreadsheet that actually remembers how you work. Even offers suggestions on spreadsheet set-up.

When it comes to writing, nothing travels faster



# our best features.

than our WORD. Using the mouse, it lets you select commands faster than you can say "cheese."

Our most artistic child is CHART. It gives you 40 presentation-quality chart and graphic styles to choose from.

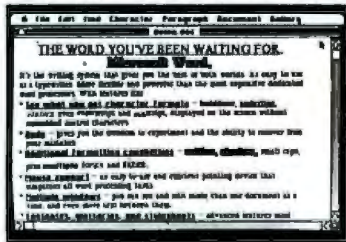
FILE is our most manageable child, an advanced personal record management program. **MICROSOFT**  
The High Performance Software

And BASIC, the language spoken by nine out of ten microcomputers worldwide, is the granddaddy of them all. Now enhanced to take advantage of the

Macintosh mouse, windows and graphics.

We'll be adding more to the family soon. So call 800-426-9400 (in

Washington State call 206-828-8088) for the name of your nearest Microsoft dealer.



Microsoft Word



Microsoft File

# MICROSOFT



# Now... Draw On Your Imagination



## Introducing The Gibson Light Pen System.™

The link between mind and machine has arrived. Suddenly you're free... free to translate your every thought into professional quality computer graphics... just by touching your screen.

The Gibson Light Pen System software features *icon* menus that offer easy access to powerful graphics tools such as symbol libraries, geometric shapes, mirror-imaging, magnification and complete color and pattern editing. Even if you're not a graphic artist, you can design, diagram and draw with precision at high-speed, in high-resolution, and in full-color... right on your screen.

### COMPLETE WITH FIVE SOFTWARE SYSTEMS TO MAXIMIZE YOUR CREATIVE OPTIONS.

The Gibson Light Pen System comes complete with all you need to draw, paint, design, score music and learn animation.

#### DRAW FREEHAND WITH PENPAINTER.™

A full range of drawing tools, shapes, patterns and colors to draw or paint virtually anything on your screen.

#### DESIGN PRECISION DIAGRAMS WITH PENDESIGNER.™

Turn your computer into your own graphic design studio. A complete selection of templates make perfect business and architectural diagrams, technical drawings and engineering schematics a snap.

#### CREATE COMPUTERIZED ANIMATION WITH PENANIMATOR.™

All that you need to learn the basics of animation. Develop your own animation sequences, and bring your screen to life.

#### COMPOSE MUSIC WITH PENMUSICIAN.™

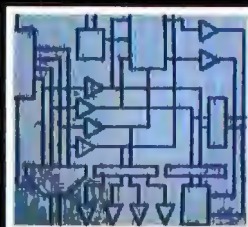
Score computerized melodies with incredible ease at the touch of your pen.

#### CREATE YOUR OWN LIGHT PEN APPLICATIONS WITH THE PENTRAK LANGUAGE SYSTEM.™

Take advantage of the software features, and customize your own light pen programs.

### NOW AVAILABLE FOR THE APPLE II® SERIES

Coming soon for the IBM PC™ and PCjr.™





# Expert Systems for Personal Computers

## *The TK!Solver Approach*

Milos Konopasek and Sundaresan Jayaraman  
Software Arts Products Corp.

Although some question the possibility of implementing expert systems on today's personal computers, the authors of this article wish to present a counterexample. This article will show that many characteristics of expert systems are present in TK!Solver and will describe a framework for building a variety of expert systems with *quantifiable* knowledge bases.

### Historical Note

Early research in artificial intelligence (AI) was aimed at producing domain-independent reasoning techniques. General Problem Solver (GPS), a classic example, could prove theorems and solve a variety of problems and puzzles; however, it was inadequate for larger real-world problems. By the mid-1960s research efforts had shifted to the building of expert systems with large stores of domain-specific knowledge, such as Dendral at Stanford University and Macsyma at the Massachusetts Institute of Technology. This marked the beginning of increased research in the development of applied AI systems and into the philosophy behind them (the bibliography on page 154 refers you to publications concerning artificial intelligence and its history).

The fundamental issue of problem representation became more important in the context of these expert systems. Efforts were directed at determining the proper structures to efficiently represent the knowledge applicable to the problem domain, with

the difficulty increasing as the domain broadened. These efforts represented a paradigm shift in AI during the 1970s.

The knowledge bases for the expert systems were hand-assembled—requiring many man-years of effort and mediation of a knowledge specialist. Some observers felt that this was the principal bottleneck in the development of expert systems (see reference 4), and that Tiersias was the first step toward the elimination of this bottleneck (see reference 2). Although it was limited to helping debug and fill out the knowledge base of Mycin, Tiersias separated the two basic components of an expert system—the knowledge base and the problem-solving or inference part. This also was a step toward domain independence, i.e., realization of the idea of removing the current knowledge base and “plugging in” a different one.

More recently, with expert systems development and experimentation costs increasing, a trend toward developing design tools to build expert systems is emerging. These tools also are designed to facilitate easy modifications of and experimentation with expert systems. Emycin, Ops, Age, Expert, and Hearsay III are some examples of this trend. TK!Solver is another.

TK!Solver is aimed at realizing many concepts expounded in AI research, human-computer interface design, and human problem solving. It has no built-in knowledge of any particular discipline, but it provides

a framework to make it easier for the user with such knowledge to construct expert systems. The knowledge engineer—the bottleneck we mentioned earlier—is eliminated.

There are strong links between the prehistory of TK!Solver and developments in AI. Before detailing these links we have to mention the efforts outside the mainstream of AI aimed at creating special-purpose languages/frameworks for computer-assisted problem solving in specific areas. Ices, for civil engineering, SPSS, a statistical package, and GPSS, a simulation package, are typical examples. These programs lacked “knowledge” in the AI sense but they simplified the noncomputer professional's use of computers. They reflected the then state of the art in commercial hardware and software. Yet a large amount of domain-specific and mathematical knowledge went into the design of constituent subprograms and command structures. Running these programs was equivalent to accessing the embedded knowledge and using it for solving a variety of problems.

The development of these and scores of similar packages (for computer-aided design (CAD), operations research, forecasting, etc.) was facilitated by the application programmer's grasp of particular fields of expertise coupled with the expert's grasp of programming in high-level languages. The utility of these packages, their complexity, and their relative efficiency still present a challenge to mainstream AI tech-



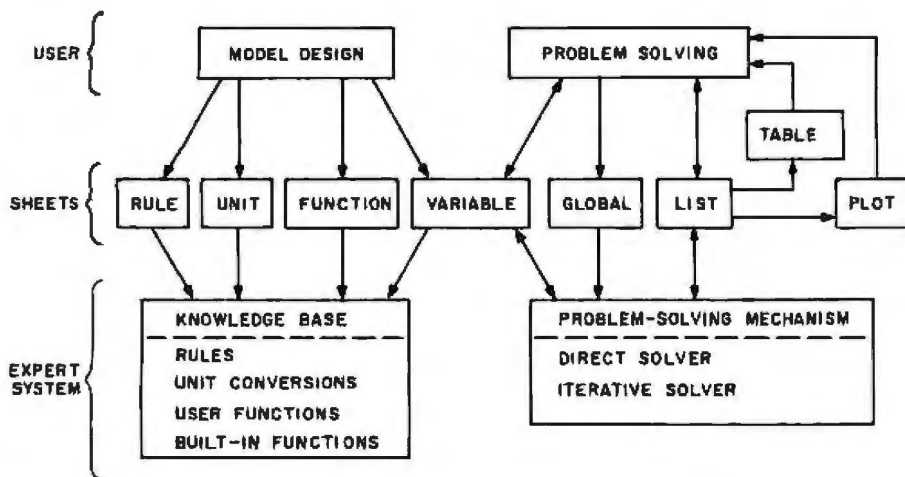


Figure 1: A functional diagram of the TK!Solver user interface. The arrows indicate the predominant flow of information but all links are bidirectional.

```

===== RULE SHEET =====
S Rule
-----
I = V / R           " Ohm's Law
I^2 = P / R        " Joule's Law
P = V * I
U = P * t
rho = fun(MC)
R / rho = L / A
A = pi()/4 * D^2

```

Figure 2: The "laws of electricity" knowledge base: rule sheet.

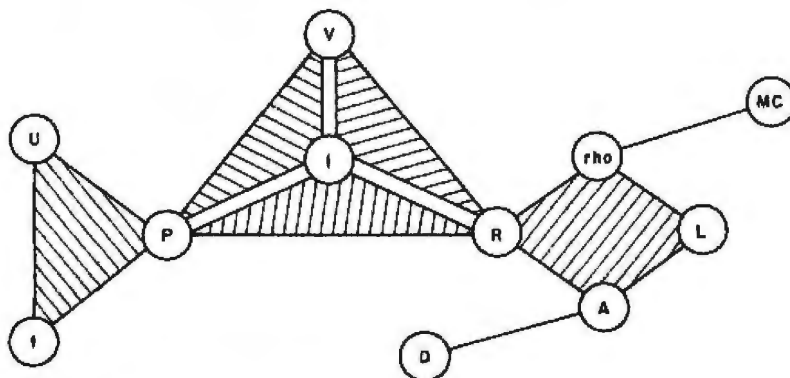


Figure 3: The R-graph for the equations in figure 2.

niques and to the methodology of expert-system design.

In the late 1960s, one of the authors of this article (Milos Konopasek, then at the University of Manchester Institute of Science and Technology) was assigned the task of developing what in present terminology would be equivalent to an expert system for textile engineers. The knowledge base for this system included (but

was not limited to) components from mechanical, industrial, and chemical engineering. He faced a dilemma: on one hand, the nature of the knowledge base did not justify or require the Ices/GPSS/SPSS approach; on the other hand, the AI approach looked promising but was unlikely to yield quick results because of the lack of practical tools at that time.

Most of the knowledge under con-

sideration dealt with relationships that could be described in terms of algebraic equations and empiric functions. This fact, and the desire to quantitatively and qualitatively increase the computer's share in the problem-solving process, led to the idea of making the user communicate with the computer at the level of relationships (represented by equations), rather than at the level of sequential programs and assignment statements. In 1972 a QAS, limited in scope but suitable for solving a large variety of real-world problems inexpensively, was developed. It was called "Question Answering System on mathematical models and related databases," or QAS. It was implemented first on PDP-10 and some other mainframe time-sharing systems and much later on microcomputers.

In QAS the expert sets up (types in or loads) the domain-specific knowledge as a "model" consisting of a set of relationships in the form of equalities

<expression> = <expression>

and empiric functions defined by lists of pairs

(<argument value>,  
<function value>)

The expert then assigns the values of any combination of variables as input and lets the computer find a way to solve for the unknowns using either the consecutive-substitution procedure or iteration.

Interestingly enough, the intended role of QAS as an expert system brought about the separation of the knowledge base and control strategy—a key factor in the design of expert systems.

QAS's strong points were its fast response to any question, high power/resources ratio, and knowledge-carrying potential. Its weak point, especially in light of recent developments in human-computer interface, was the line-oriented dialogue.

TK!Solver is essentially an enhanced implementation of the QAS system. Its development was made



# More For Your Micro

**Qubie' offers a few select products at low prices, with service and support not available elsewhere.**

## 1. Digital Signal Processing Modems

The Qubie' modems provide a high level of performance and quality at a price unmatched by competing modems. This is made possible by four microprocessors which measure the tones being transmitted digitally, eliminating the need for expensive analog filtering devices. Both modems are Bell 212A compatible, and are capable of transmitting and receiving at 300 and 1200 baud. These auto-dial and auto-answer modems recognize the Hayes software commands. If you already are using a software package written for Hayes modems, like CROSSTALK or even Hayes' SMART-COM, you can use it on the Qubie' modems.



**PC212A/1200  
Internal Modem  
for IBM PC<sup>®</sup>  
and XT<sup>®</sup>**

Includes: internal modem, modular phone cable, card edge guide, instruction manual, and the highly rated PC-TALK III communications software. Its low profile design allows it to fit in just one slot, even on an XT. For just \$20 we can add an external serial port connector. This lets you use the serial port circuitry on the modem card to address external serial devices when you are not using your modem. PC212A/1200 \$299.



**The 212A  
1200E  
Standalone  
Modem.**

The most economical way to get high speed data communications for any personal computer with a serial port. It supports all Hayes commands and can use any Hayes compatible software package. It comes standard with its own cable to connect it to your computer, a modular phone cable, and manual. \$329.

Copyright Qubie' 1984

## 2. More Than Just Graphics on a Monochrome Monitor

Now you can get graphics on an IBM PC monochrome monitor along with parallel port, serial port, and battery powered clock/calendar. It is the ideal solution for those who wish to do graphics using Lotus 1-2-3™ The 720X348 Hercules compatible resolution of the MonoGraphPlus eliminates the eyestrain caused by the IBM graphics adapter with its lower 640x200 resolution.

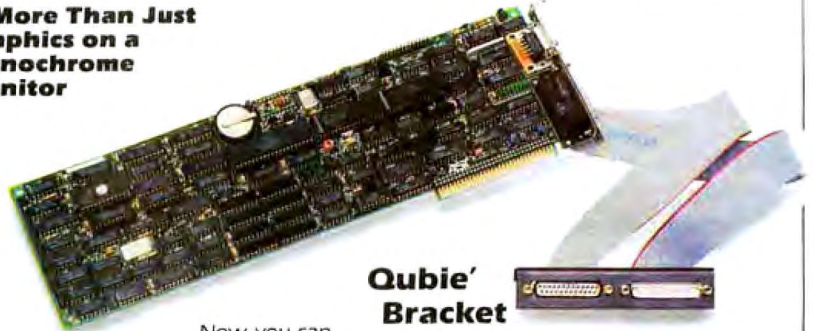
Graphics is just the beginning. We have added some popular features from the AST<sup>®</sup> family of multifunction boards. Standard features include a parallel printer port, and a battery powered clock/calendar for automatic loading of the time and date. You can even order an optional serial port for a serial printer, plotter mouse, or modem. All functions are 100% IBM compatible. And of course there is a one year factory warranty from AST Research and the Qubie' Acid Test backing it all up. MonoGraphPlus \$449. Optional serial port, \$35.

## 3. 30 Minutes of Standby Power, with Surge and EMI Protection Tool

Have you ever had the misfortune to have the power fail or the lights blink right in the middle of doing something really important? You could have missed out on the frustration of losing all that work if your micro had a Qubie' SB200 Standby Power Supply. It is ready on just 1/100th of a second notice to run your PC for up to 30 minutes after a power failure. It will also go into action should the power dip below the minimum required (a "brown-out"). An audible alarm warns you to save your work to a disk and shutdown in an orderly manner. The SB200 also provides filtering of Electromagnetic Interference (EMI), and surge protection which can wreak havoc on your PC's internals or your data without you even noticing. SB200 200 watt standby power, \$329.

IBM, IBM PC and XT are registered trademarks of IBM Corp

New from **AST**  
RESEARCH INC.



**Qubie'  
Bracket**

**The Acid Test.** If within 30 days of purchase you are not completely satisfied with our products you may return them for a complete refund including freight to ship it back. Each product is warranted for one year parts and labor. Should service be required during this period our inhouse service department will fix the problem within 48 hours or we replace the item.

## Order Today!

All prices include UPS surface freight and insurance. Add \$5 for two day air on modems and AST, \$15 on SB200. For fastest delivery send certified check or credit card. Personal checks take 18 days to clear. Calif. residents add 6% sales tax. Corporations & Institutions call for purchase order details.

**(800) 821-4479**

Toll Free outside California

**(805) 987-9741**

Inside California

**QUBIE'**

4809 Calle Alto  
Camarillo, Ca. 93010

Tempo House, 15 Falcon Road  
London SW11 2PH, United Kingdom



**SB200  
Standby Power Supply**

AST is a registered trademark of AST Research

UNIT SHEET			
From	To	Multiply By	Add Offset
hour	min	60	
min	sec	60	
kW	W	1000	
J	cal	.239	
W	cal/sec	.239	
kWh	J	3600000	
hp	W	746	
m	cm	100	
m <sup>2</sup>	cm <sup>2</sup>	10000	

Figure 4: The "laws of electricity" knowledge base: unit sheet.

USER FUNCTION: fun		
Comment:	Electrical Properties of Matter	
Domain List:	material	
Mapping:	Table	
Range List:	resistivity	
Element	Domain	Range
1	'aluminum	.0000000263
2	'copper	.0000000162
3	'gold	.0000000222
4	'iron	.000000011
5	'platinum	.0000000111
6	'silver	.000000016

Figure 5: The "laws of electricity" knowledge base: user function subsheet.

possible by the rapid proliferation of inexpensive microcomputers with direct memory to screen mapping that facilitated screen-oriented dialogues and resulted in an improved human-computer interface. We view TK!Solver as an attempt to create expert systems to fit the mass-produced professional-class personal computers.

## Overview

Figure 1 shows the architecture of TK!Solver. The domain-specific knowledge responsible for system performance is contained in the knowledge base. The problem-solving tools that contain the control strategy—the Direct and Iterative Solvers—use the knowledge base when solving particular problems. For interaction (or I/O (input/output)) TK!Solver provides "sheets" displayed through one or two windows on the screen.

The explicit division between the

knowledge base and the control strategy is this architecture's main feature. Consequently, the expert/user deals only with issues of domain-specific knowledge and is insulated from the details of control-strategy implementation.

In the following paragraphs we will describe the four components of the knowledge base, the characteristics of a mode, and the problem-solving mechanism. We will try to illustrate these concepts with examples from a knowledge base of basic information about Ohm's law, Joule's law, and resistivities of materials. Obviously, the kind of interaction shown here is not restricted to this particular knowledge base.

## Rules

Rules are the basic component of domain-specific knowledge. They express mathematical relationships in terms of the equality between left-hand and right-hand expressions.

Equations, constraints, or definitions can all be represented as rules. Figure 2 shows the rule sheet for our sample knowledge base. The set of rules can be represented as a network of relationships called the R-graph (for relationships graph) as shown in figure 3. A variable is represented as a node and each polygon-shaped subgraph represents a rule.

## Unit Conversions

Units of measurement are associated with most measurable quantities. Conversions between them are frequently encountered in problem solving and have to be defined in the knowledge base. Figure 4 shows the unit sheet with the unit conversions in our example's knowledge base.

## Function Definitions

Empiric relationships between sets of values are expressed as (user-defined) functions and make up the third component of the knowledge base. Figure 5 shows the user function subsheet, with materials and their resistivities, in our sample knowledge base.

## Built-in Knowledge

Irrespective of the domain-specific knowledge, TK!Solver is designed to solve problems involving basic arithmetic operations and built-in mathematical functions. Standard varieties of those are supplemented by special ones such as "element" (for retrieving list components) and "apply" (for associating empiric functions with arguments). TK!Solver may, for example, associate the function defin-

VARIABLE SHEET				
St Input	Name	Output	Unit	Comment
4	I		amp	current
110	V		volt	voltage
	R	27.5	ohm	resistance
	P	440	W	power
	U	3168000	J	energy
2	t		hour	time
	MC			material of conductor
	rho		ohm-m	resistivity of material
	L		m	length of conductor
	D		m	diameter of conductor
	A		m <sup>2</sup>	cross-sectional area

Figure 6: A variable sheet with a list of variables used in the rules in figure 2. It shows the solution of a problem concerning the energy supplied to a motor drawing 4 A (ampere) from a 110-V (volt) line over two hours.

Text continued on page 144



When You Turn  
this Page  
You'll be Leaving  
the World of  
Ordinary  
Microcomputers

---

CH

\$  
5%  
0

# Introducing the MTX 512

## A World Apart from the Ordinary.

It begins with the sense of touch.

With the sleek black metal housing. Cool to the touch. Cool to the advanced circuitry and components contained within.

And the solid feel of people-sized keys set up in a field that gives you room to work and space in which to think.

But the difference only begins with what you see and feel. Where it ends...well, that's really up to you.

In a very practical sense, the only limits you'll experience with the MTX512 are those you choose to accept.

### 64K To 512K RAM – A Look On The Inside

Take a close look at the MTX512.

We could tell you it offers the greatest performance and versatility of any micro in its price range, but we think you're smart enough to draw your own conclusions.

The design is elegant in its simplicity. Remarkable for the power and complexity it represents. 64K RAM built in, with total expansion to 512K. And that doesn't include 16K of video RAM controlled by its own processor.

Speaking of video, keep in mind this is no ordinary monochromatic, single screen system. The MTX starts off where other micros end up. Delivering vivid screen capabilities with 256 x 192 pixels that crisply define interference-free high resolution graphics. 16 brilliant colors that can be displayed simultaneously. In a format powered by 32 easily movable, user-defined graphics characters. Graphics capabilities you'd find impressive in a system that gives you a single screen to work in. With the MTX, you have eight.

Yes, eight.

Eight definable windows to operate independently or in tandem. And still maintain full screen capabilities. Thus, you can manipulate spread sheets on the MTX and see the impact of changing variables in graphics at the same time. Eight separate windows on the world. We call them Virtual Screens. You'll call them extraordinary.

Far from ordinary as well are the built-in system outputs that come standard on the MTX. The Centronics parallel printer port. The two industry-standard joystick ports. The uncommitted parallel I/O port. The Cassette port with 2400 baud. Separate TV and Video Monitor Ports. The 4-channel sound hifi output. We've even installed a ROM cartridge port for word processing and other dedicated programs.

### Interactive Languages And Routines – A Look At The Way All Micros Will One Day Perform

Forget the way all other micros perform. This is the way they should.

Interactively.

With the MTX, you can create and manipulate programs using four different languages in dynamic interaction, all coordinated through the FRONT PANEL DISPLAY. Interweaving elements as you would in creating a symphony.

And take a serious look at the languages housed in the MTX's 24K ROM. MTX BASIC, a more powerful form of BASIC that allows you to use all standard BASIC programs. MTX GRAPHICS, with straight forward commands, eliminates the tedium and difficulty of creating complex graphics programs. NODDY, an 11-command "easy learn" language that can transform real world programming into a child-friendly activity. And MTX ASSEMBLER, which enables sophisticated programming in assembly language. Something else the advanced programmer will appreciate is our ASSEMBLER/DISASSEMBLER, tied to BASIC, which provides unprecedented display and keyboard access to Z80 CPU storage locations, memory and program.

If you're hungry for more, PASCAL and FORTH are also available as add-on ROM packs.

On the keyboard side of things, you'll find a number of operator-oriented features that speed up and ease up the operation of the MTX. The separate numeric pad with quadri-directional cursor control and full editing functions. The eight dual function keys.







The auto repeat function on all alpha-numeric keys. Add to this such programmer-saving features as the use of abbreviated BASIC commands, a built-in syntax verifier, automatic cursor-honing to errors, auto-line numbering and automatic scrolling, and you begin to see the MTX not only opens a lot of doors that other micros leave closed, but speeds you through them as well.

### The 160 Megabyte Connection – A Look At The System

To build a good system, quality must be designed in at every level.

We designed the MTX and its complete line of system peripherals using proven, standard components. Striking a strategic balance between power, versatility and dependability. Our Z80A processor, running at 4MHz, gave us the high performance characteristics we were striving for, plus the ability to expand into the MTX Hard Disc, MTX Silicon and Floppy Disc CP/M operated systems. Systems that could provide up to 160 megabyte storage capacity. More power than you'll probably ever need, unless you take full advantage of the MTX's impressive system capabilities.

Systems hookup is as simple as every other MTX procedure. By merely plugging in the twin RS232C Serial interfaces and the Node software, sold optionally, you're ready to create a disc-driven interactive communications network (OXFORD RING®) that can link up to 255 units.

Software? You'll never worry about software availability with the MTX. Dozens of MTX-dedicated programs have already been created, supplementing the vast landscape of CP/M applications software currently available. And advance word of the MTX's technical capabilities has precipitated an MTX software "push" on the part of many leading software manufacturers.

### Word Processing For \$999 – A Look At A Great Deal

Look first at the capabilities, then at the price.

This is word processing the way it should be. Quick. Easy. Professional. A package that includes the MTX512; the powerful New Word™ word processing ROM cartridge; and the Memotech DMX80 correspondence quality printer.\* An exceptional value!

And that brings us to the bottom line.



### A Look At The Price

There's a very simple equation that covers the pricing of the MTX512.

The more engineering you put in a system, the less it will cost to produce. As you've already seen, the MTX is a pure product of advanced, innovative engineering.

Which is why we can sell it for \$595.\*\*

And why we can confidently back it up with a full one-year warranty.

Make no mistake. When you turn this page, you'll be returning to a world very different from this one.

A world in which all microcomputers will suddenly seem very different.

Suddenly very ordinary.

For more information about the MTX512, or to find out the location of the MTX dealer nearest you, contact Memotech Corporation, 99 Cabot Street, Needham, MA 02194; or phone (617) 449-6614

# MEMOTECH CORPORATION

CP/M is a trademark of Digital Research, Inc.

New Word™ is a trademark of New Star Software, Inc.

\*DMX80 correspondence quality printer suggested retail price \$395.

\*\*Suggested retail price.

(3s) Status: > Inconsistent

```

===== VARIABLE SHEET =====
St Input      Name      Output      Unit
-----
      4         I         amp
     110        V         volt
          R         27.5       ohm
      >         P         440        W
     > 1.25      U         kWh
     > 2         t         hour
  
```

===== RULE SHEET =====

S Rule

```

-----
I = V / R
I^2 = P / R
P = V * I
> U = P * t
* rho = fun(MC)
* R / rho = L / A
* A = pi()/4 * D^2
  
```

Figure 7: What must have been the current if, in the example in figure 6, the energy supplied was 1.25 kWh? (See text for the explanation of the inconsistency.) The solution, after removing the value of I from input, is I=5.68 A, R=19.36 Ω (ohms) and P=625 W (watts).

```

===== VARIABLE SHEET =====
St Input      Name      Output      Unit      Comment
-----
          I         10         amp        current
          V         1.5        volt       voltage
     .15      R         ohm        resistance
     15      P         W          power
          U         .0075      kWh        energy
     30      t         min        time
  'copper  MC
          rho      1.62E-8   ohm-m     resistivity of material
          L         7.2722052 m      length of conductor
     .1      D         cm         diameter of conductor
          A         .00785398 cm^2   cross-sectional area
  
```

Figure 8: The variable sheet with the solution of the following problem: What would be the current and the voltage across a 0.15 Ω copper resistor producing 15 W of heat? What is the energy supplied in 30 minutes if the wire diameter is 0.1 cm (centimeter)?

Text continued from page 140:

ing the stored load-deformation characteristics with a given type of material.

### Model

The model encompasses the first three components of the knowledge base in figure 1 (rules, unit conversions, user functions) as contained in the rule, variable, unit, and user function sheets. It can be viewed as a compact, high-level representation of domain-knowledge structure, organization, and content. The model's content and structure allow for a control strategy that we feel is both sim-

ple and powerful. The model is also intended to serve as a user-friendly guide during problem solving.

The model usually reflects a specific part of a particular discipline's knowledge base. Different models may be merged later by loading some or all of their components into TK!Solver, thereby creating larger models capable of addressing more complicated problems. There are commercial versions of model sets, called TK!SolverPacks, for such disciplines as mechanical engineering, financial analysis, and building design.

### Problem-Solving Mechanism

The Direct Solver is the workhorse of the problem-solving mechanism. It manipulates equations depending on the problem's formulation and solves for unknowns. The solution process goes through the R-graph and "fires" all polygons with only one unknown node. It continues until as many unknowns as possible are evaluated. This "propagation of solution" strategy simulates the consecutive-substitution procedure. If an inconsistency error or an illegal operation is detected, the solution process is terminated and the rule causing the problem is flagged with the appropriate error message. Because a problem's formulation dictates the solution path, the control strategy may be regarded as forward chaining or data-driven.

Whenever the Direct Solver cannot match the nature and complexity of a given problem, the Iterative Solver can be used. The heart of the Iterative Solver is a modified Newton-Raphson procedure that handles sets of simultaneous linear and nonlinear equations. It either can be invoked explicitly or automatically called when the Direct Solver fails to produce a solution.

### Examples

Figures 6 through 8 show variable sheets with formulations and solutions for a few problems concerning our sample knowledge base. The "calculation units" (i.e., units implied in figure 2's rules) are specified and used in figure 6 for all variables except t. In the next two figures the units for U, D, and A were changed respectively to kWh, cm, and cm<sup>2</sup>, and the values were changed accordingly.

In figure 7 the user overconstrained the model by assigning U=1.25 without releasing I from the set of input variables. The partial view of the variable and rule sheets shows the offending rule and related variables marked by >. Bringing the cursor over the > mark in the rule sheet causes the error message "Inconsistent" to be displayed in the status line.

The asterisk (\*) in front of the last three rules in figure 7 indicates that



# "The office automation I bought for everyone in the corporation doesn't incorporate everyone."

Stop the shock...with the new Exxon Business Support System.



An office automation system that can't support everyone in your corporation can lead to some very shocking experiences.

## The right power to the right people

That's why Exxon Office Systems now offers more practical office automation solutions that help everyone in the corporation to be more productive. With the Business Support

System, Exxon extends its fully integrated line of office automation products to support managers, professionals, administrators, and secretarial staff.

## Office automation for those who shape the corporation

The Exxon Business Support System features the new EXXON 750 Professional Workstation, designed with powerful, integrated software that lets you move instantly from

text to graphics to data processing — without changing programs.

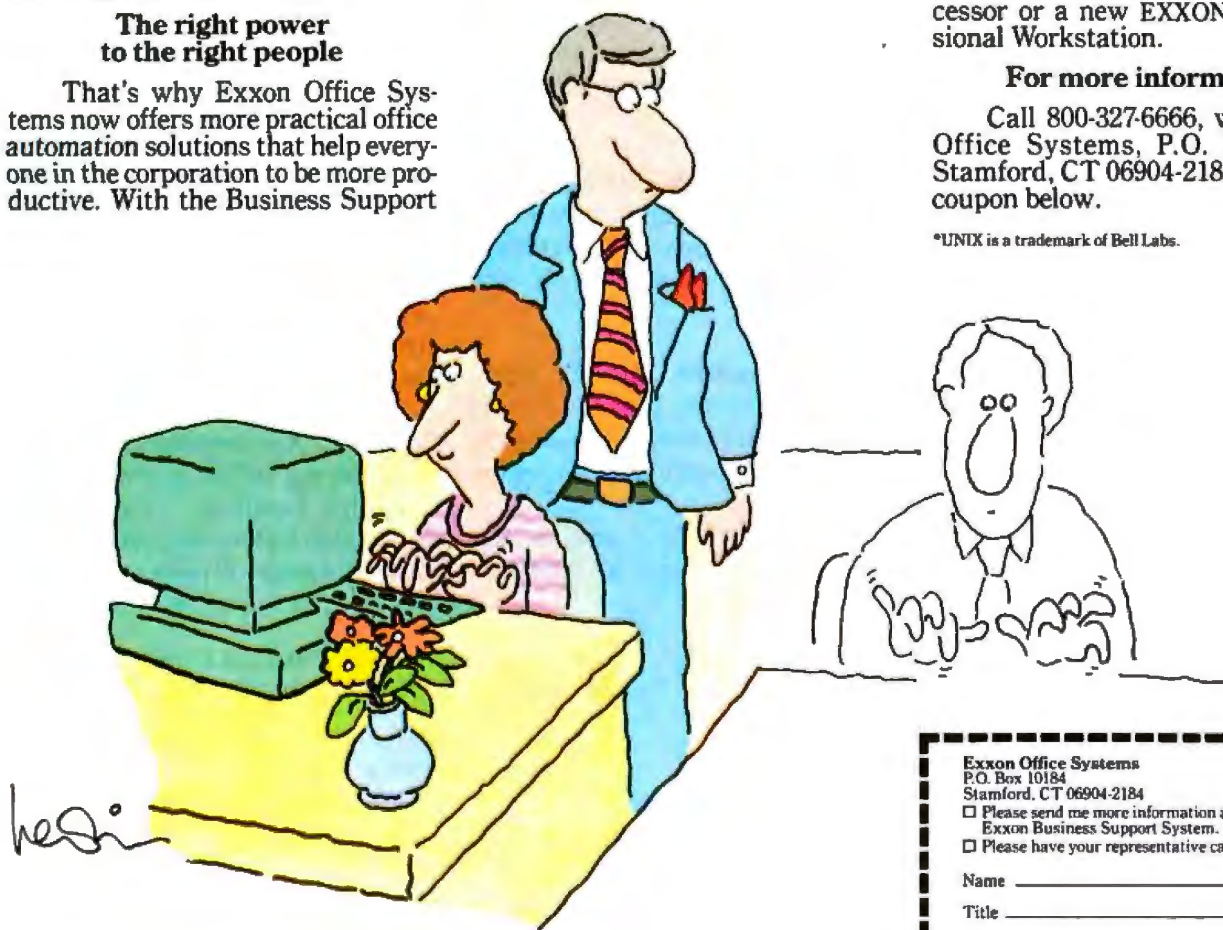
## Tying everyone together

At the core of the Business Support System is the EXXON 8400 Series controller. With its UNIX\*-based operating system, it can integrate all levels of workstations to share information and programs. Everyone can keep track of schedules and meetings with time management and calendaring functions, whether their workstation is an EXXON 500 Series Information Processor or a new EXXON 750 Professional Workstation.

## For more information

Call 800-327-6666, write Exxon Office Systems, P.O. Box 10184, Stamford, CT 06904-2184, or use the coupon below.

\*UNIX is a trademark of Bell Labs.



Exxon Office Systems  
P.O. Box 10184  
Stamford, CT 06904-2184

Please send me more information about the Exxon Business Support System.  
 Please have your representative call.

Name \_\_\_\_\_  
Title \_\_\_\_\_  
Company \_\_\_\_\_  
Address \_\_\_\_\_  
City \_\_\_\_\_ State \_\_\_\_\_ Zip \_\_\_\_\_  
Telephone \_\_\_\_\_

800-327-6666 (In CT, 800-942-2525)

**EXXON** OFFICE SYSTEMS

The future...without the shock.

```

===== VARIABLE SHEET =====
St Input      Name      Output      Unit      Comment
-----
              alpha    36.869898  deg      angle opposite to side a
              beta    53.130102  deg      angle opposite to side b
              gamma   90         deg      angle opposite to side c
3             a         side a
4             b         side b
5             c         side c
              P         12        perimeter
              A         6         area
===== RULE SHEET =====
S Rule
-----
* alpha + beta + gamma = pi()           " sum of angles equals pi
* a^2 = b^2 + c^2 - 2*b*c*cos(alpha)    " cosine theorem
* a / sin(alpha) = b / sin(beta)        " sine theorem
* P = a + b + c                          " perimeter
* A = a * b * sin(gamma)/2              " area

```

Figure 9: The variable and rule sheets for the triangle model showing the solution of a right-angle triangle with sides 3, 4, and 5.

those rules were not used in the attempted solution. The solution to the problem in figure 8 involved all the rules, the function relating the type of material and resistivity, and the unit conversions.

The procedure for changing the knowledge base is demonstrated in figure 9. To solve problems concerning the elements of a triangle (after finishing with electrical properties of matter), the user types /RA (for Reset All) and loads the "Triangle" model.

Somewhat more complicated situations are exemplified in figures 10 through 13. The results (in figures 11 and 13) had to be arrived at using the Iterative Solver. Figure 12 shows an impromptu modification of the knowledge base: the desire to solve for an isosceles triangle is expressed simply by adding the rule  $a = b$  to the rule sheet.

In figure 14 the knowledge base is changed again to deal with simple projectile problems.

In short, we feel that TK!Solver's power comes from the ease with which a particular knowledge base may be set up or selected, problems formulated, assumptions varied, and results generated.

### TK!Solver and Expert Systems

TK!Solver was designed to be an expert system primarily in the area of numerical problem solving. As such it

- (1) parses entered algebraic equations and generates a list of variables
- (2) solves sets of equations using the consecutive-substitution procedure (Direct Solver)
- (3) solves sets of simultaneous algebraic equations by a modified

Newton-Raphson iterative procedure when the consecutive-substitution procedure fails (Iterative Solver) (4) searches through tables of data and evaluates either unknown function values or arguments when required in the process of (2) or (3) (5) performs unit conversions (6) detects inconsistencies in problem formulation and domain errors (7) generates a series of solutions for lists of input data and outputs results in tabular and graphic forms

However, we also consider TK!Solver to be a general framework for setting up expert systems in a whole class of disciplines. A class is defined by the heavy dependence of human experts on the use of mathematical and logical skills. See the text box "Attributes of Expert Systems" on page 152 for a comparison of TK!Solver and the typical characteristics of an expert system.

We experimented with TK!Solver by using it to build expert systems in a variety of disciplines. For example, we were able to set up models and use them for solving whole sets of problems in Schaum's Outline Series books on physics, chemistry, finance, etc.

We also feel that the TK!Solver concept is useful in covering well-structured knowledge as embodied, for example, in *The Engineer's Manual* (see reference 5) consisting of 1029 "chunks" of knowledge and 30 accompanying tables of empiric relationships, functions, constants, unit conversion factors, etc. (with the exclusion of about 10 percent of the text

*Text continued on page 152*

```

===== VARIABLE SHEET =====
St Input      Name      Output      Unit
-----
              alpha
              beta
              gamma
G 3           a
G 4           b
              c
              P
              A
              7

```

Figure 10: What would be the elements of a triangle given angle beta = 55 degrees, side c = 5, and area A = 7? Direct Solver failed. This partial variable sheet shows a and b set as guesses for Iterative Solver.

```

===== VARIABLE SHEET =====
St Input      Name      Output      Unit
-----
              alpha    42.652161  deg
              beta    82.347839  deg
              gamma   82.347839  deg
              a         3.4181688
              b         4.1325618
              c         5
              P         12.550731
              A         7

```

Figure 11: The solution to the problem in figure 10.



Announcing  
the sudden obsolescence  
of the floppy disk.

# NEW HELIX PC BUBBLE DISK™

HALF-MEGABYTE MEMORY BOARD

The first bubble memory board for  
IBM PC/XT and compatible computers.

- NON-VOLATILE: You don't lose data when there is no power.
  - Eight times faster than a floppy disk.
  - For fixed or portable use without need for back-up storage.
  - Impervious to dust, dirt, humidity, cold— as reliable in the North Sea, the Sahara, a Space Station, as in your office.
  - Mean time between failure (MTBF) more than 20 years.
  - Rugged enough to withstand vibration and shock up to 200Gs.
- For complete details, see us in L.A.  
at Comdex/Winter '84, Booth #1526.  
Or contact:



Helix Laboratories, Inc. Marketing Division—Suite 720  
11601 Wilshire Blvd., Los Angeles, CA 90025  
(213) 477-8221—outside California, 800-468-0004  
Dealer Inquiries Welcome

© 1984, Helix Laboratories, Inc.



# THE VICTORY FACTOR. MICROCOMPUTER ARCHITECTURE WITH NO END IN SIGHT.

## Real UNIX™ Power. Real-Time Speed.

Victory Computer Systems announces the FACTOR—the first 16-bit multi-CPU computer that gives you pure UNIX programming power with real-time response. We did it with a system architecture that simultaneously implements an entire array of 16-bit single board computers. Each SBC has its own MC68000™ CPU, 256 kilobytes of dual-ported RAM, and VRTX™—a rugged, real-time software-on-silicon operating system that switches

tasks in as little as 100  $\mu$ sec. So now you can run several UNIX programs at once. Or use your FACTOR to monitor automated equipment while simultaneously processing words and data for up to 24 fully supported users.

## The VMEbus. Faster by a factor of 10.

The FACTOR's CPUs communicate over the VMEbus—an advanced new backplane design with 6 card slots, 4 bus arbitration levels and 32-bit address and data paths. At 20 megabytes per

second, the non-multiplexed VMEbus is *an order of magnitude faster* than the bus implemented in today's most popular microcomputer systems. Even if you don't run a factory, the FACTOR's speed will mean faster throughput as your computing needs grow. And growth is what the Victory FACTOR is all about.

## Exponential Growth. FACTORED-In.

The FACTOR's expansion-oriented architecture will take you far beyond today's performance horizons. In pro-





cessor power. In multi-channel industrial I/O flexibility. In on-board memory. In built-in mass storage options. In the number of fully supported users. And there's no end in sight.

In designing a multi-user system with real-time speed, you've always had many factors to consider.

Now there's just one.

We've got more to tell you about the Victory FACTOR. To get the whole story, give us a call today.

**System Hardware:**

- Each single board computer with 16-bit MC68000 CPU, 256 Kb dual ported RAM, VRTX real-time executive in PROM, 8 RS-232C serial ports, and a Centronics-compatible parallel port
- New international standard 20 Mb/sec VMEbus
- Optional 1 Mb RAM expansion board.
- Mass storage: Hard disk, floppy disk, and removable cartridge hard disk built-in (29-104 Mb UF)
- Fully supports Motorola 2 MHz I/O bus and industrial control interface cards
- Alphanumeric terminals in green, international amber, or color
- Graphics terminals in monochrome or color
- Optional coprocessor board for concurrent execution of CP/M™ on four Z80's, each with its own 64Kb RAM

**System Software:**

- UNIX (UNIPLUS™) operating system (includes "C" language)
- VRTX real-time operating system standard in PROM
- Available languages: SMC Basic, Fortran '77, Pascal (IEEE Standard), RMCOBOL ANSI '74 Standard (Ryan-McFarland)
- Ethernet™ local area network interface
- 3760, and 3270 data communications protocols

Outside CA: 1-800-221-2419  
 Inside CA: 408-259-7370

Or TELEX 176-431 ANS; VICTORY SNJ  
 OEM QUANTITY DISCOUNTS AVAILABLE



1610 BERRYESSA ROAD  
 SAN JOSE, CALIFORNIA 95133

Circle 394 on inquiry card.

**THE ARCHITECTURE OF INTELLIGENT COMPUTING.**

# My Programs Always Compile the *FirstTime*™

## Yours can too!

*FirstTime* is an intelligent editor that knows the rules of the language being programmed. It checks your statements as you enter them, and if it spots a mistake, it identifies it. *FirstTime* then positions the cursor over the error so you can correct it easily. *FirstTime* will identify all syntax errors, undefined variables, and even statements with mismatched variable types. In fact, any program developed with the *FirstTime* editor will compile on the first try.

### Unprecedented

*FirstTime* has many unique features found in no other editor. These powerful capabilities include a zoom command that allows you to examine the structure of your program, automatic program formatting, and block transforms.

If you wish, you can work even faster by automatically generating program structures with a single key-stroke. This feature is especially useful to those learning a new language, or to those who often switch between different languages.

**Other Features:** Full screen editing, horizontal scrolling, function keys labeled on screen, help screens, inserts, deletes, appends, searches, and global replacing.

Programmers enjoy using *FirstTime*, because its powerful features allow them to concentrate on the program logic without having to worry about coding details. Debugging is reduced dramatically, and deadlines are more easily met.

The *Spruce FirstTime* editor is immediately available for PASCAL (\$245) and C (\$295) on the IBM Personal Computer and its compatibles. A demonstration disk is available for \$25. (N.J. residents please add 6% sales tax.)

For programs that compile the *FirstTime*.

To order, or for more information, contact:

# Spruce

**Technology Corporation**  
110 Whispering Pines Drive  
Lincroft, N.J. 07738  
(201) 741-8188 or (201) 663-0063

Dealer enquiries welcome. Custom versions for computer manufacturers and language developers are available.

*FirstTime* is a trademark of Spruce Technology Corporation.



```
===== VARIABLE SHEET =====
St Input   Name      Output    Unit
-----
           alpha   42.652161 deg
           beta   82.347839 deg
           gamma
G 3.7753653 a
           b      4.1325618
           5      c
           7      P      12.550731
           A

===== RULE SHEET =====
S Rule
-----
* alpha + beta + gamma = pi()
* a^2 = b^2 + c^2 - 2*b*c*cos(alpha)
* a / sin(alpha) = b / sin(beta)
* P = a + b + c
* A = a * b * sin(gamma)/2

* a = b
```

Figure 12: What are the elements of an isosceles triangle if side  $c$  and area  $A$  are the same as in figure 11 and no angle is given? Constraint  $a = b$  is added to the rule sheet. Guess the value for  $a$  arrived at by typing in  $(a + b)/2$  (rationale: the expected value must lie between previous values of  $a$  and  $b$ ). Values in output field left from previous solutions don't count.

```
===== VARIABLE SHEET =====
St Input   Name      Output    Unit
-----
           alpha  48.239700 deg
           beta  48.239700 deg
           gamma  83.520599 deg
           a      3.7536649
           b      3.7536649
           5      c
           7      P      12.507330
           A
```

Figure 13: The solution to the problem in figure 12.

```
===== VARIABLE SHEET =====
St Input   Name      Output    Unit      Comment
-----
100        V0         m/sec     initial velocity
30         alpha     deg       angle of departure
32         a         ft/sec^2  accln. due to gravity
           time     10.252625 sec  time taken
           maxht   128.15781 m    maximum height reached
           range   887.90334 m    horiz. dist. travelled

===== RULE SHEET =====
S Rule
-----
maxht = V0^2 * sin(alpha)^2 / (2 * a)
range = V0^2 * sin(2*alpha) / a
time = sqrt(8 * maxht / a)
(range/time)^2 = V0^2 - 2*maxht*a
```

Figure 14: The variable and rule sheets for the projectile model with the solution of the following problem: A baseball is thrown with an initial velocity of 100 m/s (meters per second) at an angle of 30 degrees. How far does it travel and how long does it take before it hits the ground?



# In the world of emulating terminals... VISUAL is a world apart.



## VISUAL EMULATION CAPABILITY

**VISUAL 50/55 are low cost smart terminals.** The VISUAL 50 emulates DEC VT52, Lear Siegler ADM3A, Hazeltine Esprit and ADDS Viewpoint. VISUAL 55 emulates the same plus Hazeltine 1500/1510 and VISUAL 200/210.

**VISUAL 102 is 100% compatible with the DEC VT100/VT102\* and also emulates the VT52.** A Graphics Option Card provides Tektronix 4010/4014 compatible graphics.

**VISUAL 300/330 are versatile terminals that can be easily customized.** The VISUAL 300 emulates the DEC VT100 and VT52. VISUAL 330 emulates the DEC VT52, ADM3A, Hazeltine 1500 and Data General D200.

**VISUAL 500/550 are low cost, high resolution graphic terminals with powerful alphanumeric capabilities.** The VISUAL 500 emulates the VT52, ADM3A, Hazeltine 1500, D200 and Tektronix 4010/4014. The VISUAL 550 emulates the VT100, VT52 and Tektronix 4010/4014.

VISUAL terminals feature extended ergonomics including tilt and swivel non-glare 12" and 14" screens, detached keyboard, large character size, menu-style setup, sculptured key caps and more.

VISUAL has earned for itself an exclusive place . . . a solitary niche . . . in the arena of emulating terminals. Four great terminal series offer a combination of advanced features found on no other terminals anywhere in the world. Each series delivers higher performance at lower cost for its particular market segment. And nobody else gives such a wide choice of emulations as VISUAL . . . the pioneer in the field.

So check the chart before you choose your next terminal. See for yourself why VISUAL stands alone as the first choice for emulating terminals.

Service available in principal cities through Sorbus Service, Division of Management Assistance, Inc.

# VISUAL

See for yourself\*

Visual Technology Incorporated  
540 Main Street, Tewksbury, MA 01876  
Telephone (617) 851-5000. Telex 951-539

\*Registered trademark of  
Visual Technology Incorporated



dealing with concepts beyond the scope of the control strategy of the current version of TK!Solver). This experience compares favorably with the domain limitations of systems like Mecho or Newton; the latter also faced difficulties in interfacing the quantitative knowledge with the mathematical expertise provided by Macsyma.

### Further Developments

TK!Solver in its present form provides a general framework for building expert systems in scientific, engineering, and other disciplines. In this sense it falls in the category of knowledge-representation languages like KRL, NETL, Klon, or Prolog.

It may be argued, however, that TK!Solver falls short of learning capabilities, analogical reasoning, reasoning under conditions of uncertainty, and some other features stipulated by the theoreticians of expert systems or proclaimed for the Japanese fifth-generation computers. There are also other AI "standards" for the design of expert systems that TK!Solver seems to ignore: natural-language interface, restriction to problems that are "not algorithmic or totally understood" (see reference 3), and "representation of symbolic knowledge for use in machine inference" (see reference 4). Finally, there is the implicit notion of the need to use a list-processing language for AI work (incidentally, TK!Solver is implemented in a LISP-like language).

Although in fact all these advanced attributes are present in TK!Solver to

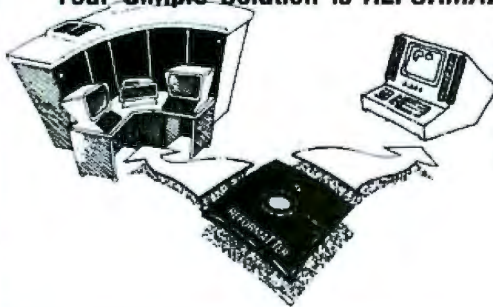
### Attributes of Expert Systems

Readers are invited to test TK!Solver against each of the expert system characteristics listed here.

- The expert system has separate domain-specific knowledge and problem-solving methodology and includes the concepts of the Knowledge Base and the Inference Engine.
- The expert system should think the way the human expert does.
- An expert system tells the computer "what" the problem is rather than "how" to solve it.
- Its dynamic knowledge base should be expandable, modifiable, and facilitate "plugging in" different knowledge modules.
- The interactive knowledge transfer should minimize the time needed to transfer the expert's knowledge to the knowledge base.
- Addition of a new rule should result in a new competency for the system, and conversely, the absence of the rule should mark the absence of the related ability.
- The expert system should interact in the language "natural" to the domain expert; it should allow the user to think in problem-oriented terms. The system should adapt to the user and not the other way around. The user should be insulated from the details of the implementation.
- The principal bottleneck in the transfer of expertise—the knowledge engineer—should be eliminated.
- The control strategy should be simple and user-transparent, the user should be able to understand and predict the effect of adding new items to the knowledge base. At the same time it should be powerful enough to solve complex problems.
- Expert systems should be computationally fast and not demanding of resources, avoiding situations where interactive intelligent systems suffer from a basic conflict between their computationally intensive nature and the need for responsiveness to a user.
- There should be an inexpensive framework for building and experimenting with expert systems.
- Human engineering aspects are important for making the system understandable and for keeping experts interested and making users feel comfortable.
- The expert system should have provision for help and English-language dialogue.
- The system should have a display-oriented interface.
- It should be able to reason under conditions of uncertainty and insufficient information, and should be capable of probabilistic reasoning.
- An expert system should be able to explain "why" a fact is needed to complete the line of reasoning and "how" a conclusion was arrived at.
- Pragmatic systems are needed; they should be robust, general, and efficient for routine use.
- The expert system should be available to users in properly sized, properly packaged combinations of hardware and software; chronic absence of cumulation of AI techniques in the form of software packages that can achieve wide use; proliferation should lead to expert systems at everyone's disposal.
- The system should be useful, i.e., responsive to the practical needs of professional communities; real-world systems.
- Expert systems should be capable of learning from experience.

## DATA TRANSFER PROBLEMS?

Your Simple Solution is **REFORMATTER®** Diskette Conversion Software



- Avoids serial communication protocols.
- Needs only one system to transfer data.
- Converts source code and data files.
- Allows 2-way transfer.
- Quick, reliable, and inexpensive.



### VERSIONS

Runs On	Reads/Writes
CP/M	↔ IBM 3740
CP/M	↔ DEC RT-11
CP/M-86	↔ IBM 3740
CROMIX	↔ DEC RT-11
DEC RT-11	↔ CP/M
MS-DOS	↔ IBM 3740
TRSDOS II*	↔ CP/M
TRSDOS II	↔ DEC RT-11
PRICE:	\$350 *\$249

Requires 8" floppy drive.

(415) 324-9114 TWX: 910-370-7457

467 Hamilton Avenue, Suite 2, Palo Alto, Calif. 94301



# Better Business BASIC.

Finally! A BASIC compiler that means business.

Microsoft® Business BASIC Compiler allows you to create professional applications for MS™-DOS systems that are so fast your users will never know they were written in BASIC.

Because the compiler produces native code, your software will run three to ten times faster than the same interpreted programs.

But speed isn't everything. Microsoft's Business BASIC also has business savvy. Based on the de facto standard Microsoft BASIC, it includes a rich set of extensions:

Decimal floating point arithmetic (14-digit precision-BCD format) for extremely accurate dollars and cents calculations.

Two types of arrays provide maximum program flexibility: static arrays for speed, dynamic arrays for expandability.

Over twenty string handling functions provide sophisticated character manipulation capa-

bilities. Strings can be up to 32K bytes.

Multi-line functions and subprograms allow you to define routines with local or globally defined variables.

Separate module compilation means complex programs can be broken down into smaller units. Coupling multiple modules together permits creation of very large programs, up to one megabyte.

Call 800-426-9400 to order  
the better Business BASIC.  
\$600\*

In Washington State, call 206-828-8088. Ask for operator A5, who will rush you your order, send you more information, or give you the name of your nearest dealer to see Microsoft Business BASIC in action.



# CPM / 80 MACRO ASSEMBLERS

We've been selling these industrial-quality assemblers to the development system market since 1978. They are now available for the CP/M market.

## FEATURES:

- Fully relocatable
- Separate code, data, stack, memory segments
- Linker included
- Generate appropriate HEX or S-record formatted object file
- Macro capability
- Most 5¼" and 8" diskette formats supported
- Conditional assembly
- Cross reference
- Supports manufacturer's mnemonics
- Expanded list of directives
- 1 year free update

Assemblers now available include:

Chip	Price	Chip	Price
1802/1805	1495	8085	1495
8051	495	NSC800	495
6500/01/02	495	F8.3870	495
6800/01/02	495	Z8	495
6803/08	495	Z80	395
6804	495	9900/9995	595
6805	495	Z8000	695
6809	495	68000	695
6811	495		

Take advantage of leading-edge technology. Get your own *Realms* assembler today. Use your *Mastercard* or order by phone: (408) 729-3011.

Or call toll free (800) 448-4880

Relational Memory Systems, Inc.  
1650-B Berryessa Road  
San Jose, CA 95133-1082  
TWX: 910-379-0014

65 different diskette formats available. A signed object Code License Agreement required prior to shipping. Prices subject to change without notice. Software distributor inquiries invited.

# realms®

a small or embryonic extent, it would serve no purpose to argue to what extent they have to be present in order to classify the system one way or another. We would rather point to what TK!Solver can do in its present form and stress the fact that it provides a basis for implementing additional features and capabilities as the hardware permits and as the mass user requires.

In its future development TK!Solver should look two ways: first, at concepts and tools emerging from research in AI, and second, at the time-proven "non-AI" program packages that have become a part of human experts' lives. ■

## References

1. Buchanan, B.G. "New Research on Expert Systems." *Machine Intelligence*, volume 10, 1982, pages 269-299.
2. Davis, R. *Applications of Meta-Level Knowledge to the Construction, Maintenance, and Use*

of Large Knowledge Bases (Ph.D. thesis). Stanford, CA: Stanford University, 1978.

3. Davis, R., and D.B. Lenat. *Knowledge-Based Systems in Artificial Intelligence: Two Case Studies*. Hightstown, NJ: McGraw-Hill Inc., 1982.
4. Feigenbaum, E.A. "The Art of Artificial Intelligence: Themes and Case Studies of Knowledge Engineering." *Proceedings IJCAI-77*, pages 1014-1029.
5. Hudson, R.G. *The Engineers' Manual*, 2nd ed. New York: John Wiley & Sons, 1917.
6. Konopasek, M., and S. Jayaraman. *The TK!Solver Book: A Guide to Problem-Solving in Science, Engineering, Business, and Education*. Berkeley: Osborne/McGraw-Hill, 1984.
7. Ross, S.S. *McGraw-Hill's TK!SolverPack to Accompany Hicks: Standard Handbook of Engineering Calculations*. New York: McGraw-Hill, 1984.

Milos Konopasek holds a Ph.D. from the University of Manchester, Manchester, England. Sundaresan Jayaraman is completing a Ph.D. program at North Carolina State University in Raleigh, North Carolina. Both authors currently work at Software Arts Inc., 27 Mica Lane, Wellesley, MA. Konopasek is senior scientist and Jayaraman is a product manager.

## Bibliography

1. Amarel, S. "On Representation of Problems of Reasoning about Actions." *Machine Intelligence*, volume 3, 1968, pages 131-171.
2. Amarel, S., B. G. Buchanan, C. Kulikowski, and H. Pople. "Reports of Panel on Applications of Artificial Intelligence." *Proceedings IJCAI-77*, pages 994-1006.
3. Balzer, R., L. Erman, P. London, C. Williams. "Hearsay-III: A Domain-Independent Framework for Expert Systems." *Proceedings of 1980 AAAI Conference*.
4. Barr, A., and E. A. Feigenbaum. *The Handbook of Artificial Intelligence*, volume 2. Los Altos, CA: William Kaufmann Inc., 1982.
5. Bobrow, D. G., and I. Winograd. "An Overview of KRL, a Knowledge Representation Language." *Cognitive Science*, volume 1, 1976, pages 3-46.
6. Brachman, R. J. "On the Epistemological Status of Semantic Networks." *Associative Networks: Representation and Use of Knowledge by Computer* (N. V. Findler, ed.), New York: Academic Press, 1979, pages 3-50.
7. Brachman, R. J. and H. J. Levesque. "Competence in Knowledge Representation." *Proceedings of 1982 AAAI Conference*, pages 189-192.
8. Bundy, A., L. Byrd, G. Luger, C. Mellish, and M. Palmer. "Solving Mechanics Problems Using Meta-Level Inference." *Proceedings IJCAI-77*, pages 1017-1027.
9. Clark, K. L., and F. G. McCabe. "Prolog: A Language for Implementing Expert Systems." *Machine Intelligence*, volume 10, 1982, pages 455-470.
10. Carbonell, J. R., and A. M. Collins. "Natural Semantics in Artificial Intelligence." *Proceedings of 3rd IJCAI*, 1983, pages 344-351.
11. Davis, R. "Interactive Transfer of Expertise: Acquisition of New Inference Rules." *Proceedings IJCAI-77*, pages 321-328.
12. de Kleer, J. "Multiple Representations of Knowledge in a Mechanics Problem-Solver." *Proceedings IJCAI-77*, pages 299-304.
13. Duda, R. O., J. G. Gaschnig, P. E. Hart, K. Konolige, R. Reboh, P. Barrett, and J. Sloum. "Development of the Prospector Consultation System for Mineral Exploration" (final report). SRI Projects 5821 and 6415, Artificial Intelligence Center, SRI International, Menlo Park, CA, 1978.
14. Duda, R. O. and J. G. Gaschnig. "Knowledge-based Expert Systems Come of Age." *BYTE*, September 1981, pages 238-281.

Bibliography continued on page 156



# Capable COBOL.

For over twenty years, COBOL has proved it can handle the most awesome data handling requirements of the business world.

And Microsoft® COBOL brings this power to the MS™-DOS environment in an even more flexible version. It's the ideal choice for transporting and adapting the thousands of mainframe and minicomputer programs now on the market.

Microsoft COBOL was designed after the ANSI COBOL standard. Its quality and performance has been fully certified by the GSA.

Microsoft COBOL includes a complete set of file handling facilities including support for sequential, line sequential, relative and B+ tree indexed sequential (ISAM) files.

The advanced screen handling features, compatible with Data General®, make it easy to create forms and menus for interactive user programs. Direct cursor positioning, highlighting, automatic format conversion, projected

fields, and automatic field skip are just some of the capabilities.

An interactive source code debugging tool allows you to step through your program in symbolic form. There is no need to wade through object code and addresses in memory to see what is going on. It's a complete development package.

Applications developed with the compiler can be distributed without a runtime support charge.

Like all Microsoft languages, the standard linking interface makes it easy to combine assembly language subroutines.

**Call 800-426-9400 to order the capable COBOL. \$700\***

In Washington State, call 206-828-8088. Ask for operator A5, who will rush you your order, send you more information, or give you the name of your nearest dealer to see Microsoft COBOL in action.



\*Price exclusive of handling and Washington State sales tax.  
Microsoft is a registered trademark and MS is a trademark of Microsoft Corporation.  
Data General is a registered trademark of Data General Corporation.

**FOR TRS-80 MODELS 1, 3 & 4  
IBM PC, XT, AND COMPAQ**

**Train Your Computer  
to be an  
EXPERT!**

Expert systems facilitate the reduction of human expertise to simple, English-style rule-sets, then use them to diagnose problems. "Knowledge engineers" are developing many applications now.

EXPERT-2, Jack Park's outstanding introduction to expert systems, has been modified by MMS for MMS-FORTH V2.0 and up. We supply it with full and well-documented source code to permit addition of advanced features, a good manual and sample rule-sets: stock market analysis, a digital fault analyzer, and the Animal Game. Plus the benefits of MMSFORTH's excellent full-screen editor, super-fast compiling, compact and high-speed run-time code, many built-in utilities and wide choice of other application programs.

(Rule 1 - demo in EXPERT-2)  
IF YOU WANT EXPERT-2  
AND NOT YOU OWN MMSFORTH  
THEN YOU NEED TO BUY  
MMSFORTH PLUS EXPERT-2  
BECAUSE MMSFORTH IS REQUIRED

**EXPERT-2**  
in  
**MMSFORTH**

Another exciting tool for our alternative software environment!

- **Personal License (required):**  
MMSFORTH System Disk IBM PC . . . . . \$249.95  
MMSFORTH System Disk TRS-80 1, 3 or 4 . . . \$129.95
- **Personal License (optional modules):**  
FORTHCOM communications module . . . . . \$39.95  
UTILITIES . . . . . \$39.95  
GAMES . . . . . \$39.95  
EXPERT-2 expert system . . . . . \$69.95  
DATAHANDLER . . . . . \$59.95  
DATAHANDLER-PLUS (for PC only) . . . . . \$99.95  
FORTHWRITE word processor . . . . . \$176.00
- **Corporate Site License Extensions** . . . . . from \$1,000  
Shipping/handling & tax extra.

Ask your dealer to show you the worlds of MMSFORTH, or request our free brochure.

**MILLER MICROCOMPUTER SERVICES**  
81 Lake Shore Road, Natick, MA 01780  
(617) 653-6138

*Bibliography continued from page 154:*

15. *Fahlman, S. E.* NETL: A System for Representing and Understanding Real-World Knowledge. Cambridge, MA: MIT Press, 1979.
16. *Feigenbaum, E. A.* "Artificial Intelligence Research: What Is It? What Has It Achieved? Where Is It Going?" *Invited paper, Symposium on Artificial Intelligence, Canberra, Australia, 1974.*
17. *Forgy, C., and J. McDermott.* "Ops, A Domain-Independent Production System Language." *Proceedings IJCAI-77, pages 933-939.*
18. *Gerring, P. E., E. H. Shortliffe, and W. van Melle.* "The Interviewer/Reasoner Model: An Approach to Improving System Responsiveness in Interactive AI Systems." *The AI Magazine, Fall 1982, pages 24-27.*
19. *Goldstein, I., and S. Papert.* "Artificial Intelligence, Language and the Study of Knowledge." *Cognitive Science, volume 1, 1977.*
20. *Gordon, G.* System Simulation. Englewood Cliffs, NJ: Prentice-Hall, 1969.
21. *Hammond, P.* "Appendix to Prolog: A Language for Implementing Expert Systems." *Machine Intelligence, volume 10, 1982, pages 471-475.*
22. *Konopasek, M.* "An Advanced Question-Answering System on Sets of Algebraic Equations." *Proceedings of the European Conference on Interactive Systems (D. Lewin, ed.). Uxbridge, England: Online Publications, 1975.*
23. *Konopasek, M., and M. Kazmierczak.* "A Question Answering System on Mathematical Models in Microcomputer Environments." *Proceedings of The First West Coast Computer Faire Conference, 1977, pages 182-186.*
24. *Konopasek, M., and C. Papadostadopoulos.* "The Question Answering System on Mathematical Models (QAS): Description of the Language." *Computer Languages, volume 3, 1978, pages 145-155.*
25. *Luger, G. F.* "Mathematical Model Building in the Solution of Mechanics Problems: Human Protocol and the Mecho Trace." *Cognitive Science, volume 5, 1981, pages 55-77.*
26. *Mark, W. S.* "The Reformulation Approach to Building Expert Systems." *Proceedings IJCAI-77, pages 329-335.*
27. *Michalski, R. S., J. G. Carbonell, and T. M. Mitchell.* Machine Learning: An Artificial Intelligence Approach. Palo Alto, CA: Tioga Publishing Company, 1983.
28. *Nau, D. S.* "Expert Computer Systems." *Computer, February 1983, pages 63-85.*
29. *Newell, A., and H. A. Simon.* "GPS, A Program that Simulates Human Thought." *Computers and Thought (E. A. Feigenbaum and J. A. Feldman, ed.), Hightstown, NJ: McGraw-Hill, 1963.*
30. *Newell, A., and H. A. Simon.* Human Problem Solving. Englewood Cliffs, NJ: Prentice-Hall, 1972.
31. *Nie, N. H., C. H. Hull, J. G. Jenkins, K. Steinbrenner, and D. H. Bent.* Statistical Package for Social Sciences. Hightstown, NJ: McGraw-Hill, 1975.
32. *Nii, H. P., and N. Aiello.* "Age (Attempt to Generalize): A Knowledge-Based Program for Building Knowledge-Based Programs." *Proceedings IJCAI-79, pages 645-655.*
33. *Novak, G. S.* "Representations of Knowledge in a Problem for Solving Physics Problems." *Proceedings IJCAI-77, pages 286-291.*
34. *Pople, H. E.,* "The Formation of Composite Hypotheses in Diagnostic Problem Solving and Exercise in Synthetic Reasoning." *Proceedings IJCAI-77, pages 1030-1037.*
35. *Ross, D.* Ices Systems Design. Cambridge, MA: MIT Press, 1967.
36. *Shortliffe, E. H.* Computer-Based Medical Consultations: Mycin. New York: American Elsevier, 1976.
37. *Stefik, M., J. Aikin, R. Balzar, J. Benoit, L. Birnbaum, F. Hayes-Roth, and E. Sacerdoti.* "The Organization of Expert Systems: A Tutorial." *Artificial Intelligence, volume 18, 1982, pages 135-173.*
38. *Tesler, L.* "The Smalltalk Environment," *BYTE, August 1981, pages 90-147.*
39. *Treleaven, P. C., and I. G. Lima.* "Japan's Fifth-Generation Computer Systems." *Computer, August 1982, pages 79-88.*
40. *van Melle, W.,* A Domain-Independent System that Aids in Constructing Knowledge-based Consultation Programs (Ph.D. thesis). Stanford, CA: Stanford University, 1980.
41. *Weiss, S., and C. Kulikowski.* "Expert: A System for Developing Consultation Models." *Proceedings IJCAI-79, pages 942-947.*



# Potent Pascal.

Microsoft® Pascal may be the most powerful software development environment available for the MS™ DOS system. It combines the programming advantages of a structured high-level language with the fast execution speed of native code compilation.

And it exceeds the proposed ISO and ANSI standards with logical extensions that make the language more powerful and versatile. For example, programming capabilities even allow you to manipulate data at the system and machine level.

It gives you single and double precision IEEE floating point arithmetic. Numeric operations take advantage of the 8087. Or automatic software emulation is

provided if the coprocessor is not installed.

Support for long heap allocation and separate module compilation gives you the flexibility to create large programs up to one megabyte.

And the standard linking interface makes it easy to combine Microsoft FORTRAN or assembly language subroutines.

**Call 800-426-9400 to order the potent Pascal. \$300\***

In Washington State, call 206-828-8088. Ask for operator A5, who will rush you your order, send you more information, or give you the name of your nearest dealer to see Microsoft Pascal in action.



# How to move with and take your

## Introducing the IBM *Portable* Personal Computer.



It's a complete PC. In a case. With a handle.  
And a welcome addition to the family.

The IBM *Portable* Personal Computer is the first IBM PC system you can pick up and take with you. Across town or across the hall. Or put away easily for another day.

It's a powerful system, with 256 KB of user memory (expandable to 512 KB) and a slimline double-sided 5¼" diskette drive (and room for another). Plus a built-in



# modern times PC with you.



9" monitor with easy-to-read amber characters. Text and graphics capability. And an 83-key keyboard.

All fitted into a sturdy, transportable case that's easy to handle. And park.

**The IBM® of portable personal computers.** Make no mistake about it, this is a true IBM PC.

Which means it is part of the same dependable family as the IBM Personal Computer, the IBM PC/XT and the new IBM PCjr. And that means you can use many IBM Personal Computer Software

programs to help you reach your goals.

All this and five expansion slots, ready to accept expanded memory, printers and other useful IBM Personal Computer options. Which should keep you rolling far into the future.

**Pick one up at a store near you.** You can see the new IBM *Portable* Personal Computer at any authorized IBM PC dealer or IBM Product Center.

To find the store nearest you, call 1-800-447-4700. In Alaska or Hawaii, call 1-800-447-0890.

**IBM®**

Circle 204 on Inquiry card.

# How Lawyers Can Use Microcomputers

*Cutting costs while upgrading legal service with the aid of microcomputers*

Robert P. Wilkins, J.D.  
R.P.W. Publishing Company

Microcomputers are a mystery to many lawyers because, too often, they try to learn about them in terms of BASIC programming, RAM (random-access, read/write memory), ROM (read-only memory), bps (bits per second), and other foreign, often unnecessary technical terms. All lawyers need to know is how computers can improve the efficiency of a legal practice.

Reviewing the firm's needs is the first step in this analysis. Work in law offices is generally divided between administrative and substantive tasks—those relating to the actual practice of law.

Administrative tasks in the law office are similar to those in any other small business: bookkeeping, bank account reconciliation, payroll, calendar control, file management, information retrieval. One legal administrative task uncommon to most small businesses is timekeeping and billing. Most lawyers keep time records and either submit bills based on them or use them in determining what they will bill. This may be the most important administrative reason to acquire a computer.

Generally, legal services can be divided into broad categories. Lawyers prepare letters, opinion let-

ters, memoranda of law, briefs, deeds, wills, agreements, and other documents. When everything else fails, they may go to court on the client's behalf. Before going to court, pleadings must be prepared, witnesses interviewed, depositions taken, and the paper associated with the lawsuit managed. In addition, there are some critical court-proceedings deadlines that must be followed and observed. In complex litigation many exhibits must be tracked.

Although some lawyers spend the majority of their time in court, most usually spend it in the office. Lawyers research and analyze problems, give advice, prepare documents, make mathematical projections, prepare tax returns, gather data, and analyze the information gathered. The practice of law involves much paperwork and includes a substantial amount of document preparation. Because of this, many lawyers have become interested in the use of computers. For the most part, however, lawyers have been slow to take advantage of new technology. Most lawyers in America practice in small firms; 70 percent practice in firms of five or fewer lawyers. Until recently, word

processing was relatively expensive, and many small-firm lawyers did not feel they could afford it. The cost of a single, dedicated word-processing system dropped from the \$12,000 to \$20,000 range. Today, the cost can be as low as \$2100. A very powerful microcomputer with letter-quality word-processing capability can be purchased for between \$2100 and \$7000. As a result, many lawyers are now using microcomputers, not for computing, but for low-cost word processing. Once they acquire the computer for word processing, they realize the tremendous potential of the computer to help in other ways.

It is interesting to note that the smaller firms have seemed to lead the way in the microcomputer explosion. Initially, many large firms with minicomputers and mainframes turned up their noses at microcomputers. Now, large firms are waking up to the potential of microcomputers, and many are now buying them for their individual lawyers. The computers are usually used both as freestanding units and as terminals into the mainframe.

For the lawyer who has a microcomputer for word processing or one who is considering a first purchase, it is important to understand what a



computer does. Generally speaking, a computer can be used for: word processing; number crunching (including bookkeeping, payroll, tax projections); information or data management; communications; electronic spreadsheets; and specialized tasks to help in specific areas of the law. Let's look at each category and explore it as it relates to the practice of law.

### Word Processing

The practice of law is ideally suited for word-processing equipment, and without a doubt, word processing is the legal profession's most common use of the microcomputer. The use of the word processor in the law office can be broken down into three major categories:

- routine daily correspondence
- long documents that require extensive editing
- repetitive documents

It is important to understand that most lawyers are under pressure to cut costs and to price services reasonably. Because labor can be the highest single cost in a law office, efficiency is important. In the first two categories listed above the benefit of word processing is largely that it improves staff efficiency. The long documents may include agreements, briefs, and memoranda of law. In almost every case a draft of the document is prepared and input is received from other lawyers and the client. In some cases, such as a negotiated contract, input will also be received from the opposing lawyer and that lawyer's client. By using a word processor you will benefit by quick document turnaround after editing or preparation.

In the third category, where repetitive documents can be recalled from magnetic media and modified to meet a particular client's needs, a major benefit is the time saved. Examples of these documents are: wills and trust agreements; property settlements; pleadings in court cases; pension and profit-sharing plans; and leases. These do not have to be prepared from scratch and since the new draft of the document requires

a minimum of keyboarding, another major benefit is increased productivity.

Merging variables and assembling separate paragraphs into one document are capabilities that make word processors especially useful in the legal profession. The footnote capability is especially helpful to lawyers who file a large number of briefs.

### Number Crunching

I first began using word-processing equipment in 1964 when I bought a paper-tape Royal Typer, which used folded paper tape punched much like the scrolls of music for a player piano. Since that time, I have used word processors employing cassettes and disks, and I presently use a CPT 8000.

---

## Next to word processing, timekeeping and billing software probably represents the most common reason a lawyer might want a computer.

---

Having thus taken a personal interest in electronics technology, when I acquired my first full-capability computer I intended to learn all I could about it.

The first software I used was a general ledger package. All of my bookkeeping had previously been done by hand, and the final numbers often were not put together until well after the end of the year. I almost never had the luxury of a monthly financial statement.

With my general ledger package, which was relatively inexpensive (\$199), I was able to set up account numbers for my income and expense items and key in my checks and deposits once a month. The computer automatically produced: a list of all posted documents; a ledger of these entries sorted by account number; a trial balance; an income statement for the month showing percentages and year-to-date balances; and a balance sheet for the month show-

ing percentages and year-to-date balances. When the December entries were posted, I immediately had a printout of my year-end financial information and could complete my tax return on time.

The second software program I added was payroll. Year-end W-2 preparation had generally been completed amid turmoil on or near January 31. With the payroll package, which cost about \$499, I only had to input the employee information once. Thereafter, checks for salaried employees and quarterly returns could be produced. The process for hourly employees only required key-boarding of each employee's hours for a particular pay period.

Next to word processing, the need for timekeeping and billing software is probably the most common reason a lawyer might want a computer. There are more than 120 companies offering software for timekeeping and billing, and this large number creates more of a problem than it solves. (For a list of them, see the March 1, 1984 issue of *The Lawyer's PC*, or contact POB 1108, Lexington, SC 29072, (803) 359-9941.)

Lawyers do not all keep time the same way, nor do we render statements the same way. There are many variations of timekeeping and billing techniques, as well as many differences between software packages and what they accomplish. Trying to match the two is a problem of some magnitude.

Before acquiring a timekeeping and billing package, it is extremely important to see the program up and running. It can be helpful to talk with a peer at a comparably sized firm who bills in a similar fashion and is using the program. Timekeeping and billing programs range in price from about \$500 to \$5000. The difference in quality is not necessarily represented by the difference in price. The size of the firm in many cases will be the determining factor. Packages designed for use by five or fewer lawyers probably will not work effectively for larger firms, and those designed for 15 lawyers may not be what the smaller firm needs.

Although we are discussing time-

**FREE**  
Backup Diskette With Your Order  
"CALL FOR FREE CATALOG!"

# DISCOUNT SOFTWARE

## Ad #52

### SOFTWARE FOR CP/M, IBM, APPLE\*

---

<p><b>ASHTON-TATE</b> dBASE II.....\$449 Friday!.....\$265 <b>DIGITAL RESEARCH</b> DR Assembler &amp; Tools.....\$179 CPM 2.2 Intel MDS.....\$135 TRS 80 Model II (P&amp;T).....\$189 Pascal MT+ (Compiler).....\$315 SPP Package.....\$175 CBasic.....\$119 <b>FOX &amp; GELLER</b> Quickcode.....\$265 DGraph.....\$265 D-Util.....\$ 75 Quickscreen.....\$135 <b>IANSYST</b> lankey (Typing Tutor).....\$ 59</p>	<p><b>MICROPRO</b> Wordstar.....\$289 Mailmerge.....\$179 Infostar Plus.....\$429 WordStar Professional.....\$549 Option Pack.....\$265 <b>MICROSOFT</b> MultiPlan.....\$175 Fortran.....\$399 Macro 80.....\$159 Basic 80.....\$275 Word &amp; Mouse.....\$399 <b>MICROSTUF</b> Crosstalk.....\$149 <b>OSBORNE (McGRAW/HILL)</b> Enhanced Osborne.....\$249</p>	<p><b>SORCIM</b> SuperCalc II.....\$265 SuperCalc III.....\$355 <b>STAR</b> Accounting Partner.....\$349 <b>VISICORP</b> VisiCalc.....\$219 VisiPlot/Trend.....\$259 Visi On.....CALL <b>WOOLF</b> Move-It.....\$ 99 <b>OTHER GOODIES</b> R:Base 4000.....\$444 Adv DB Master.....\$535 Smart Key II.....\$ 81 Punctuation &amp; Style.....\$112</p>
---	--	--

*We carry many more software packages and formats than listed, so give us a call if you don't see what you need.*

ORDER TOLL FREE VIA VISA/MASTERCARD  
1-800-421-4003  
CALIF: 1-800-252-4092  
These are order taking lines only — M-F, 8AM-5PM PST

FOR: • Customer Service • Information  
• Technical Support  
(213) 837-5141 — M-F, 8AM-5PM PST

MAIL ORDERS 6520 SELMA AVE.  
WELCOMED: LOS ANGELES, CA 90028

Add \$3.50 postage & handling per each item. Blue Label \$3.00 additional per item. C.O.D. \$3.00 extra. California residents add 6 1/2 % sales tax. Outside Continental U.S.—add \$10 plus Air Parcel Post. Allow 2 weeks on checks. Prices subject to change without notice. All items subject to availability. \* Mr. trademark. CPM is a registered trademark of DIGITAL RESEARCH, INC.

keeping and billing systems as they apply to number crunching, a lawyer familiar with database managers can design a very simple timekeeping and billing system for a small firm.

In the number-crunching category, a system is also needed for keeping track of other people's money held in a trust. Under the Code of Professional Responsibility, a client's funds cannot be commingled with the law firm's, and the firm must be able to account for any client's funds held in a trust account. Software packages to handle trust accounts can be purchased or designed to include such features as: the ability to enter checks and deposits at random with an item description and an account number for the client; the ability to receive a printout at least monthly of the transactions in the entire bank account, with a total balance, together with an individual printout of each client's transactions and a balance of the client's account; and the ability to confirm that all clients' accounts equal the total amount in the bank account. This seems to be a relatively simple accounting procedure, but it is amazing how little software is available to accomplish it.

### Information Management

Another category of computer use that is tremendously beneficial to people in the legal profession is information management. Database management programs fall into this category, as do a number of specialized information programs.

Information management, as I use the term, means the ability to keyboard certain information once and then sort, select, and use it effectively without having to rekeyboard. The most common uses of this technique are: maintaining client records, keeping a calendar and docket control system, file management, and litigation support.

There are many other information-management needs specific to a law firm's practice. Any of these can be handled with a database manager. For lawyers who use the IBM Personal Computer (PC) or compatibles, dBASE II is popular. For lawyers who use Radio Shack computers, Profile

## Powerful Z80 emulation, priced well within your grasp. That's NICE.™

NICE may be only 3" square and 1/2" thick, but it hands you full speed, real time emulation for the Z80—over 50 emulation functions, software breakpoints, all memory addresses and all I/O ports.

Just plug NICE directly into the target Z80 socket and any RS232 terminal for system development, troubleshooting, debugging or testing... at home, in the lab or in the field.

And NICE hands you all this performance, portability and versatility for only \$498\*... the best emulator price/performance ratio on the market, hands down.

Call in your order today using

your VISA or Mastercard number: (800) NICOLET outside CA, or (415) 490-8300 in CA.

Or send your check or money order to NICE, Nicolet Paratronics Corporation, 201 Fourier Avenue, Fremont, CA 94539.

\*Payment by check, money order, VISA or MasterCard.

NICE is a trademark of Nicolet Paratronics Corporation.

\*Z80 is a trademark of Zilog, Inc.



**Nicolet**



Plus is probably the most commonly used.

With a program of this type, you can visualize how it works by imagining a page organized in vertical columns of information with horizontal lines representing a particular file. The vertical columns are called fields. Each field contains the same kind of information for every client. For example, last names would be in the same field for every client.

The horizontal lines that represent one client's information are called records. Once the information has been keyboarded, it can be massaged in many different ways without having to be keyed again. For example, if the client record consists of a name, address, telephone number, court in which the action is pending, and lawyer responsible, then by using the sort and select technique of the database manager the lawyer can print an alphabetical list of all clients by last name. It is also possible to sort, select, and print a sublist that, instead of including all clients, will only include those for a particular lawyer in a particular court.

The information in the database can be merged with form letters so that, for example, you can use the will-retrieval database to select the names and addresses, salutation, and date of the last will executed by the client. This information can be merged into a letter to the client indicating that the will needs review. These letters can then be printed automatically on continuous-run paper.

In larger firms, database managers can be used to manage records that only need to be keyboarded once and then accessed by using sort and select techniques. For example, the client database can be searched as each new client is accepted to make certain there is no conflict if a suit is begun against some other person. Firms with many clients and several lawyers must take this precaution to avoid suing one of their own clients.

"Where is it? Why can't we find it?" is a familiar cry in the law office. Lawyers manage a lot of paper and, therefore, filing is frequently a problem. The filing problem relates not

only to where a particular document might be but, more importantly, where to find research information. We almost always can find material in a client's file. The question is, in which case did we last handle a matter involving a similar dispute, e.g., the eviction of a tenant for damage to the premises?

Softshell (POB 18522, Baltimore, MD 21237, (301) 686-1213) offers a program called Mindex and Search that costs \$25 and will solve most information-retrieval problems. Under the Mindex and Search program, entries of 255 characters are possible (about three typewritten lines). Each of these entries is considered a separate record. The 255 characters, of course, must contain the location of the basic information and the keywords to let you find it. In the previous matter, we would enter "eviction of tenant for damage or destruction of the premises" and the name or number of the file in which the research data and pleadings for that particular matter are located. We might (since we have not used the entire three lines) want

to include the kind of research material to be found in that file. We can make thousands of entries of this type at random and then, using the Search program, search for any three characters in a row. In most cases, we use the actual keyword; we might choose "eviction" or we might choose "tenant". If we have a large number of eviction and tenant cases, we might want to search a combination of words connected by "and," e.g., "eviction and destruction." We can also search by using "or" as the connector, which will result in the program finding all records containing either word.

### Communications

A lawyer can use the computer for electronic mail, bulletin-board reading, and access to on-line databases.

When lawyers think about on-line databases, the first that come to mind are Westlaw and Lexis. These two legal-research databases have been available for many years. Only recently, however, could we access them via microcomputers. Westlaw

## IBM protects disks in sleeves of TYVEK.



### Here's why.

Quality disks deserve a quality sleeve. Sleeves of TYVEK<sup>®</sup> spunbonded olefin provide unsurpassed data protection because

1. TYVEK is strong—won't tear like paper.
2. TYVEK does not lint.
3. TYVEK is smooth, non-abrasive.
4. TYVEK is chemically clean, has a neutral pH.
5. TYVEK reduces static problems.
6. TYVEK is unaffected by water.

Take the first step to maximum disk data protection. Call 800-44 TYVEK for the names of manufacturers who rely on sleeves of TYVEK.

TYVEK is DuPont's trademark for spunbonded olefin. DuPont makes TYVEK, not sleeves.





# THE FORTH SOURCE™

## MVP-FORTH

Stable - Transportable - Public Domain - Tools  
 You need two primary features in a software development package a stable operating system and the ability to move programs easily and quickly to a variety of computers. MVP-FORTH gives you both these features and many extras. This public domain product includes an editor, FORTH assembler, tools, utilities and the vocabulary for the best selling book "Starting FORTH". The Programmer's Kit provides a complete FORTH for a number of computers. Other MVP-FORTH products will simplify the development of your applications.

### MVP Books - A Series

- Volume 1, All about FORTH** by Haydon MVP-FORTH glossary with cross references to fig-FORTH, Starting FORTH and FORTH-79 Standard. 2nd Ed. \$25
- Volume 2, MVP-FORTH Assembly Source Code.** Includes CP/M®, IBM-PC®, and APPLE® listing for kernel \$20
- NEW**  **Volume 3, Floating Point Glossary** by Springer \$10
- NEW**  **Volume 4, Expert System** with source code by Park \$25
- NEW**  **Volume 5, File Management System** with interrupt security by Morelon \$25

### MVP-FORTH Software - A Transportable FORTH

- MVP-FORTH Programmer's Kit** including disk, documentation, Volumes 1 & 2 of MVP-FORTH Series (All About FORTH, 2nd Ed. & Assembly Source Code), and Starting FORTH. Specify  CP/M,  CP/M 86,  CP/M+,  APPLE,  IBM PC,  MS-DOS,  Osborne,  Kaypro,  H89/Z89,  Z100,  TI-PC,  MicroDecisions,  Northstar,  Compupro,  Cromenco,  DEC Rainbow,  NEC 8201,  TRS-80/100 \$150
- MVP-FORTH Cross Compiler** for CP/M Programmer's Kit. Generates headerless code for ROM or target CPU \$300
- MVP-FORTH Meta Compiler** for CP/M Programmer's kit. Use for applications on CP/M based computer. Includes public domain source \$150
- MVP-FORTH Fast Floating Point** Includes 9511 math chip on board with disks, documentation and enhanced virtual MVP-FORTH for Apple II, II+, and ILe. \$450
- MVP-FORTH Programming Aids** for CP/M, IBM or APPLE Programmer's Kit. Extremely useful tool for decompiling, callfinding, and translating. \$150
- MVP-FORTH PADS (Professional Application Development System)** for IBM, or APPLE. An integrated development system with complete documentation for PC, XT or PCjr and Apple II, II+ and ILe. Will run on most IBM and Apple look-alikes. \$500
- NEW**  **MVP-FORTH Floating Point & Matrix Math** for IBM or Apple \$85
- NEW**  **MVP-FORTH Graphics Extension** for IBM or Apple \$65
- NEW**  **MVP-FORTH MS-DOS file interface** for IBM PC PADS \$80
- MVP-FORTH Expert System** for development of knowledge-based programs for Apple, IBM, or CP/M. \$100

### FORTH COMPUTER

- Jupiter Ace** \$150
  - 16K RAM Pack \$50
  - 48K RAM Pack \$125

**FORTH CROSS COMPILERS** Allow extending, modifying and compiling for speed and memory savings, can also produce ROMable code. \*Requires FORTH disk.

- |                                |       |                                       |       |
|--------------------------------|-------|---------------------------------------|-------|
| <input type="checkbox"/> CP/M  | \$300 | <input type="checkbox"/> IBM*         | \$300 |
| <input type="checkbox"/> 8086* | \$300 | <input type="checkbox"/> Z80*         | \$300 |
| <input type="checkbox"/> 68000 | \$300 | <input type="checkbox"/> Apple II/II+ | \$300 |

**Ordering Information:** Check, Money Order (payable to MOUNTAIN VIEW PRESS, INC.), VISA, MasterCard, American Express. COD's \$5 extra. Minimum order \$15. No billing or unpaid PO's. California residents add sales tax. Shipping costs in US included in price. Foreign orders, pay in US funds on US bank, include for handling and shipping by Air. \$5 for each item under \$25, \$10 for each item between \$25 and \$99 and \$20 for each item over \$100. All prices and products subject to change or withdrawal without notice. Single system and/or single user license agreement required on some products.

## FORTH DISKS

FORTH with editor, assembler, and manual.

- |   |       |   |       |
|---|-------|---|-------|
| <input type="checkbox"/> <b>APPLE</b> by MM               | \$100 | <input type="checkbox"/> <b>Z80</b> by LM                         | \$100 |
| <input type="checkbox"/> <b>APPLE</b> by Kuntze           | \$90  | <input type="checkbox"/> <b>8086/88</b> by LM                     | \$100 |
| <input type="checkbox"/> <b>ATARI®</b> valFORTH           | \$60  | <input type="checkbox"/> <b>68000</b> by LM                       | \$250 |
| <input type="checkbox"/> <b>CP/M®</b> by MM               | \$100 | <input type="checkbox"/> <b>VIC FORTH</b> by HES, VIC20 cartridge | \$50  |
| <input type="checkbox"/> <b>HP-85</b> by Lange            | \$90  | <input type="checkbox"/> <b>C64</b> by HES Commodore 64 cartridge | \$60  |
| <input type="checkbox"/> <b>HP-75</b> by Cassidy          | \$150 | <input type="checkbox"/> <b>Timex</b> by HW                       | \$25  |
| <input type="checkbox"/> <b>IBM-PC®</b> by LM             | \$100 |   |       |
| <input type="checkbox"/> <b>NOVA</b> by CCI 8" DS/DD\$175 |       |   |       |

**Enhanced FORTH** with: F-Floating Point, G-Graphics, T-Tutorial, S-Stand Alone, M-Math Chip Support, MT-Multi-Tasking, X-Other Extras, 79-FORTH-79, 83-FORTH-83.

- |   |       |   |       |
|---|-------|---|-------|
| <input type="checkbox"/> <b>APPLE</b> by MM, F, G, & 83   | \$180 | <input type="checkbox"/> <b>Extensions</b> for LM Specify IBM, Z80, or 8086 |       |
| <input type="checkbox"/> <b>ATARI</b> by PNS, F,G, & X.   | \$90  | <input type="checkbox"/> Software Floating Point                            | \$100 |
| <input type="checkbox"/> <b>CP/M</b> by MM, F & 83  | \$160 | <input type="checkbox"/> 8087 Support (IBM-PC or 8086)                      | \$100 |
| <input type="checkbox"/> <b>Apple, GraFORTH</b> by I  | \$75  | <input type="checkbox"/> 9511 Support (Z80 or 8086)                         | \$100 |
| <input type="checkbox"/> <b>Multi-Tasking FORTH</b> by SL, CP/M, X & 79   | \$395 | <input type="checkbox"/> Color Graphics (IBM-PC)                            | \$100 |
| <input type="checkbox"/> <b>TRS-80/II or III</b> by MMS, F, X, & 79   | \$130 | <input type="checkbox"/> Data Base Management                               | \$200 |
| <input type="checkbox"/> <b>Timex</b> by FD, Iape G,X, & 79   | \$45  | <input type="checkbox"/> Requires LM FORTH disk.                            |       |
| <input type="checkbox"/> <b>Victor 9000</b> by DE,G,X   | \$150 |   |       |
| <input type="checkbox"/> <b>fig-FORTH Programming Aids</b> for decompiling, callfinding, and translating. CP/M, IBM-PC, Z80, or Apple | \$150 |   |       |

### FORTH MANUALS, GUIDES & DOCUMENTS

- |   |      |   |      |
|---|------|---|------|
| <input type="checkbox"/> <b>ALL ABOUT FORTH</b> by Haydon. See above.                                       | \$25 | <input type="checkbox"/> <b>1980 FORML Proc.</b>  | \$25 |
| <input type="checkbox"/> <b>FORTH Encyclopedia</b> by Derick & Baker  | \$25 | <input type="checkbox"/> <b>1981 FORML Proc 2 Vol</b>   | \$40 |
| <b>NEW</b> <input type="checkbox"/> <b>The Complete FORTH</b> by Winfield                                   | \$16 | <input type="checkbox"/> <b>1982 FORML Proc.</b>  | \$25 |
| <input type="checkbox"/> <b>Understanding FORTH</b> by Reymann  | \$3  | <input type="checkbox"/> <b>1981 Rochester FORTH Proc.</b>                                    | \$25 |
| <input type="checkbox"/> <b>FORTH Fundamentals, Vol. I</b> by McCabe  | \$16 | <input type="checkbox"/> <b>1982 Rochester FORTH Proc.</b>                                    | \$25 |
| <b>NEW</b> <input type="checkbox"/> <b>FORTH Fundamentals, Vol. II</b> by McCabe                            | \$13 | <input type="checkbox"/> <b>1983 Rochester FORTH Proc.</b>                                    | \$25 |
| <b>NEW</b> <input type="checkbox"/> <b>FORTH Tools, Vol.1</b> by Anderson & Tracy                           | \$20 | <input type="checkbox"/> <b>A Bibliography of FORTH References, 1st. Ed.</b>                  | \$15 |
| <b>NEW</b> <input type="checkbox"/> <b>Beginning FORTH</b> by Chirlian                                      | \$17 | <input type="checkbox"/> <b>The Journal of FORTH Application &amp; Research Vol. 1, No. 1</b> | \$20 |
| <input type="checkbox"/> <b>FORTH Encyclopedia Pocket Guide</b>   | \$7  | <input type="checkbox"/> <b>Threaded Interpretive Languages</b>                               | \$23 |
| <input type="checkbox"/> <b>And So FORTH</b> by Huang, A college level text.                                | \$25 | <input type="checkbox"/> <b>META-FORTH</b> by Cassidy   | \$30 |
| <input type="checkbox"/> <b>FORTH Programming</b> by Scanlon  | \$17 | <input type="checkbox"/> <b>Systems Guide to fig-FORTH</b>                                    | \$25 |
| <input type="checkbox"/> <b>FORTH on the ATARI</b> by E. Floegel  | \$8  | <input type="checkbox"/> <b>Invitation to FORTH</b>   | \$20 |
| <input type="checkbox"/> <b>Starting FORTH</b> by Brodie. Best instructional manual available. (soft cover) | \$18 | <input type="checkbox"/> <b>PDP-11 User Man.</b>  | \$20 |
| <input type="checkbox"/> <b>Starting FORTH</b> (hard cover)   | \$23 | <input type="checkbox"/> <b>FORTH-83 Standard</b>   | \$15 |
| <b>NEW</b> <input type="checkbox"/> <b>68000 fig-Forth</b> with assembler                                   | \$25 | <input type="checkbox"/> <b>FORTH-79 Standard</b>   | \$15 |
| <b>NEW</b> <input type="checkbox"/> <b>Jupiter ACE Manual</b> by Vickers                                    | \$15 | <input type="checkbox"/> <b>FORTH-79 Standard Conversion</b>                                  | \$10 |
| <input type="checkbox"/> <b>Installation Manual for fig-FORTH,</b>  | \$15 | <input type="checkbox"/> <b>Tiny Pascal fig-FORTH</b>   | \$10 |
|   |      | <input type="checkbox"/> <b>NOVA fig-FORTH</b> by CCI Source Listing                          | \$25 |
|   |      | <input type="checkbox"/> <b>NOVA</b> by CCI User's Manual                                     | \$25 |

**Source Listings of fig-FORTH**, for specific CPU's and computers. The Installation Manual is required for implementation. Each \$15

- |                                |                                  |                               |  |
|--------------------------------|----------------------------------|-------------------------------|--|
| <input type="checkbox"/> 1802  | <input type="checkbox"/> 6502    | <input type="checkbox"/> 6800 | <input type="checkbox"/> AlphaMicro    |
| <input type="checkbox"/> 8080  | <input type="checkbox"/> 8086/88 | <input type="checkbox"/> 9900 | <input type="checkbox"/> APPLE II      |
| <input type="checkbox"/> PACE  | <input type="checkbox"/> 6809    | <input type="checkbox"/> NOVA | <input type="checkbox"/> PDP-11/LSi-11 |
| <input type="checkbox"/> 68000 | <input type="checkbox"/> Eclipse | <input type="checkbox"/> VAX  | <input type="checkbox"/> Z80           |

# MOUNTAIN VIEW PRESS, INC.

PO BOX 4656

MOUNTAIN VIEW, CA 94040

(415) 961-4103



can be accessed by almost any micro-computer. At this writing, Lexis can only be accessed by the IBM PC. These database services are relatively expensive, but accessing them through your own microcomputer gives you greater control over the costs.

There are a number of other on-line databases of possible interest to lawyers. The American Bar Association recently announced ABA/net. Using this service, electronic mail and bulletin boards can be accessed, in addition to the UPI news wire, the Official Airline Guide, and financial news from Unistox, for as little as \$12 per hour. The American Bar Association publication and information database, Ambar, will go on line with ABA/net in the near future and will cost \$32 per hour in prime time and \$22 per hour in nonprime time. (For details on ABA/net write: ITT Dialcom, 1109 Spring St., Silver Spring, MD 20910 or call (800) 323-1717 and ask for operator 129. In Illinois, call operator 129 at (800) 942-8211.)

Dialog is probably the largest non-legal database of interest to lawyers. It actually consists of more than 200 databases. The most common is the Legal Resources Index, which contains more than 660 legal periodicals, newspapers, and magazines published since January 1980. Other databases on Dialog include the Federal Register and a number of technical databases involved with medicine and other technical subjects. (For information write: Dialog Information Services, 3460 Hillview Ave., Palo Alto, CA, or call (800) 227-1927. In California, call (800) 982-5838.)

The General Electric database contains tax projection and other business accounting projection programs. Some of these programs were prepared by Arthur Andersen & Company, some by J. H. Cohn & Company, and some by Coopers & Lybrand. (For details write: General Electric Information Services Company, 401 N. Washington St., Rockville, MD 20850, or call (800) 638-8730. In Maryland, call (800) 492-8470.)

In time, the most frequent use of the microcomputer's communications feature may be electronic mail.

By using electronic mail, you can transmit a document to another lawyer's computer for almost instant review and input. The document can then be retransmitted to you with changes. If acceptable, it can be printed out in final form at both locations. A third lawyer can review the document, since either office can send it anywhere over the telephone network. All the traveling lawyer needs is a portable computer (such as the Radio Shack Model 100) with a modem. This lawyer can make changes and send the document back to either office.

Communications make it possible for a branch office to function with limited support staff. Much of the heavy document preparation can take place at the home office and then be transmitted to and printed out at the branch.

Bulletin boards are available for almost any subject. ABA/net is expected to provide bulletin boards of specific interest. With a bulletin board, you can call the number and, by keyboarding instructions, select a

substantive area to review. For example, you can call a bulletin board and review the particular substantive area on medical malpractice. If you see any information or inquiries of interest, you can write a response on the bulletin board or communicate directly to the other lawyer if a telephone number or address has been left.

Messages can also be left for others who read the bulletin board. For example, a lawyer can ask for information from other lawyers with experience in specific fields.

The introduction of ABA/net may have more influence on the use of databases by lawyers than any other event of recent years. The American Bar Association plans to actively solicit lawyers to join ABA/net. Since this database is relatively inexpensive, it gives lawyers a chance to overcome fears or hesitations at a low cost and for a useful purpose.

Many law book publishers are exploring the possible use of on-line databases to furnish their services. Looking far into the future, it is quite

## DYSAN® protects disks in sleeves of TYVEK.



### Here's why.

Quality disks deserve a quality sleeve. Sleeves of TYVEK® spunbonded olefin provide unsurpassed data protection because

1. TYVEK is strong—won't tear like paper.
  2. TYVEK does not lint.
  3. TYVEK is smooth, non-abrasive.
  4. TYVEK is chemically clean, has a neutral pH.
  5. TYVEK reduces static problems.
  6. TYVEK is unaffected by water.
- Take the first step to maximum disk data protection. Call 800-44 TYVEK for the names of manufacturers who rely on sleeves of TYVEK.

 **Dysan.**

\*TYVEK is DuPont's trademark for spunbonded olefin. DuPont makes TYVEK, not sleeves

Dysan is a registered trademark of Dysan Corporation



# Accounting software so perfect you'll want to change it immediately.

It's perfect because you *can* change it.

Which is one thing you can't do with canned accounting programs. Instead, you're stuck doing bookkeeping their way.

Well, rather than let your accounting software run your business, we suggest you run our business accounting software: Sensible Solution Management.

Straight out of the box, it's ready to get down to business with single-entry general ledger,

accounts payable and receivable, payroll, inventory control and order entry.

Language so you can modify the program to take into account your needs.

Canned Accounting vs. The Sensible Solution		
	The Typical Accounting Package	Sensible Solution Management
Can the program be changed to suit special needs?	No	Yes
Can you use your business's existing forms?	No	Yes
Is source code included in the program's price?	No	Yes
Can you easily transfer your data when you buy a new computer?	No	Yes

You can change it to use your business forms and checks. Work in your company's commission rates. Add space for your product codes. Or do just about anything else your way.

So if you've got accounting software you can't change, change to the Sensible Solution.

And kick the canned forever.

But instead of locking you in to our way of accounting, we also supply you with source code and The Sensible Solution

## The Sensible Solution™

The Sensible Solution Programming Language for most single and multi-user operating systems is \$695 (single-user) or \$995 (multi-user) with Accounting Modules at \$250 each. For more information, write or call: O'Hanlon Computer Systems, 11058 Main Street, Bellevue, WA 98004. Phone (206) 454-2261. Telex 152974. Dealer and distributor inquiries welcome.



possible that most legal-research needs will be met by on-line databases. Competitive pricing may speed this occurrence.

### Electronic Spreadsheets

Use of electronic spreadsheets will depend on the kind of law practiced by the firm. Electronic spreadsheets allow mathematical projections to be made and manipulated. They can be useful in preparing budgets and cash-flow projections. They can be used to project earnings in damage cases, to perform a blood alcohol analysis in drunk driving cases, and many other tasks requiring mathematical projections and "what if" calculations. (For a template of the blood alcohol analysis program, see *The Lawyer's PC*, November 1, 1983, page 4, or write POB 1108, Lexington, SC 29072.)

Many publishers are producing inexpensive electronic spreadsheet templates that take much of the drudgery out of using these powerful programs. Quite a number of these templates can be useful to lawyers, since they deal with business calculations.

### Specialized Software Packages

There are several specialized software packages that lawyers should know about. These software packages can be purchased and run immediately to accomplish specific tasks. For example: a long-distance analyzer is designed to allow the development of a directory of calls, date called, and amount of call, so this out-of-pocket expense can be charged to clients (Long Distance Analyzer, \$195, Golden Braid Software, 1450 Ranchero Dr., Sarasota, FL 33582, (813) 371-0388).

Estate tax projections are designed to allow lawyers to enter details about the client and get projections of different estate plans. Two common ones are: Estate Tax Plan, \$750, Aardvark/McGraw-Hill, 1020 N. Broadway, Milwaukee, WI 53202, (414) 225-7500; and ESTAX, \$295, Professional Data Corp., 6449 Goldbranch Rd., Columbia, SC 29202.

Real estate closing packages are designed to allow for the input of the

basic information. The program then produces all the documents necessary for a HUD real estate closing (RESPA Resolver, \$250, Electronic Law Publishing Company, POB 1027, Buies Creek, NC 27506).

Programs for the preparation of immigration and naturalization forms are designed to allow keyboarding of the basic information and have the program prepare the necessary forms (Immigration Program, \$350, Hudson Computer Bureau Inc., 6135 Bergenline Ave., West New York, NJ 07093, (201) 868-6134).

Income tax projections allow for the input of information about the client's tax circumstances to make "what if" calculations. An example of this type program is Cal-Q-Tax (Cal-Q-Tax, \$595, Tax Management, a subsidiary of Bureau of National Affairs Inc., 1231 25th St. NW, Washington, DC 20037).

There are numerous other income tax preparation packages. A list and analysis of them appeared in *The Journal of Taxation*, A Guide to the Practitioner's Selection of Tax Soft-

ware for the Microcomputer, December 1983. The November 1983 issue contained a comparison of software vendors. For information, write *The Journal of Taxation*, 1633 Broadway, New York, NY 10019. The list is growing every day as new programs for lawyers are developed.

The computer is going to make the most significant change in the way law is practiced since the invention of the telephone and the typewriter. There is resistance, but strange as it may seem, there was also resistance to the telephone and typewriter.

In the long run, economic issues will prevail. There is no question that those of us who use the computer efficiently can practice law more effectively and, therefore, can provide legal services to the client at reasonable cost. That is the name of the game. ■

---

*Robert P. Wilkins (POB 729, Lexington, SC 29072) is a lawyer and the editor of The Lawyer's PC and The Lawyer's Microcomputer newsletters for lawyers using the IBM PC and compatibles and Radio Shack computers, respectively.*

---

## 3M protects disks in sleeves of TYVEK.



### Here's why.

Quality disks deserve a quality sleeve. Sleeves of TYVEK™ spunbonded olefin provide unsurpassed data protection because

1. TYVEK is strong—won't tear like paper.
2. TYVEK does not lint.
3. TYVEK is smooth, non-abrasive.
4. TYVEK is chemically clean, has a neutral pH.
5. TYVEK reduces static problems.
6. TYVEK is unaffected by water.

Take the first step to maximum disk data protection. Call 800-44 TYVEK for the names of manufacturers who rely on sleeves of TYVEK.

\*TYVEK is DuPont's trademark for spunbonded olefin. DuPont makes TYVEK, not sleeves.

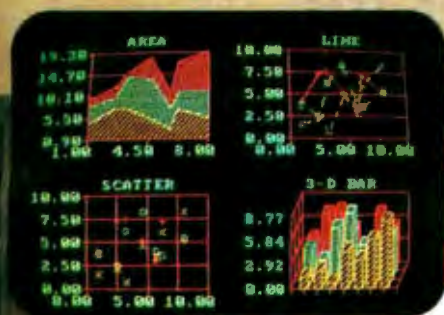








For people who just can't  
get enough of  
a good thing



**intricate...or somewhere in between**

**Reliable and Comprehensive**

The Knowledge Manager is built to last. You can start with the Beginner's Guide, or run right through the instruction manual to advanced data management commands.

Chances are you won't find a job the Knowledge Manager can't do.

**Dealer inquiries invited.**



KnowledgeMan is a trademark of Micro Data Base Systems, Inc.; SQL/DS of IBM. Circle 263 on inquiry card.

Please send me:

- Free feature-by-feature comparison
- Forms painter and graphics information and pricing\*
- Run-time package information and pricing\*
- \*Forms painter, graphics and run-time package are available as optional components.
- Please accept my order for the Knowledge Manager \$500.00
- Shipping and Handling† 10.00 (Indiana residents must add 5% sales tax—\$25.00)

Machine: \_\_\_\_\_

Operating Systems:  
 PC DOS  MSDOS  CP/M-86

Disk Format:  
 8" IBM-3740 SS/SD

- 5¼" IBM PC SS
- 5¼" Victor/Sirius
- 5¼" DEC Rainbow
- †Add \$20.00 if outside U.S., Canada or Mexico

192K RAM required, 500K mass storage suggested.


- Check or money order enclosed (must be drawn from U.S. bank in U.S. currency)

MasterCard No. \_\_\_\_\_  
VISA No. \_\_\_\_\_  
American Express No. \_\_\_\_\_  
Expiration Date \_\_\_\_\_  
Bank No. (if M.C.) \_\_\_\_\_  
Signature \_\_\_\_\_

VISA, MasterCard and American Express orders may be placed by phone (317) 463-2581.

Name \_\_\_\_\_  
Title \_\_\_\_\_  
Company \_\_\_\_\_  
Phone (\_\_\_\_) \_\_\_\_\_  
Address \_\_\_\_\_  
City \_\_\_\_\_  
State \_\_\_\_\_ Zip \_\_\_\_\_

Send To:

 **MDBS/Consumer Products**  
P.O. Box 248  
Lafayette, IN 47902  
Phone: (317) 463-2581  
Telex: 209147 ISE UR

Or Contact Your Local Dealer.  
PRICES SUBJECT TO CHANGE WITHOUT NOTICE  
Current release is 1.06 as of 4/1/84.



# Tek's best-selling 60 MHz scopes: Now 25 ways better for not a penny more!

Now Tek has improved its 2213/2215 scopes with brighter displays. Greater accuracy. And more sensitive triggering. At no increase in price.

The 60 MHz 2213 and dual time base 2215 have been the most popular scopes in Tektronix history. Now, Tek introduces an "A" Series update with more than 25 specification and feature enhancements — things you have asked for such as single sweep — all included at no added cost.

**A brighter display and new vertical amplifier design provides sharp, crisp traces.**

That makes the 2213A/2215A a prime candidate for tasks like TV troubleshooting and testing, where fast sweeps are typical.

**New features include 10 MHz bandwidth limit switch, separate A/B dual intensity controls (2215A only), and power-on light:** additions customers have suggested for



giving these scopes the final measure of convenience.

**Triggering, sweep accuracy, CMRR and many more major specifications are better than ever.** Check the performance chart: not bad for scopes already considered the leaders in their class!

**The price: still \$1200\* for the 2213A, \$1450\* for the 2215A.** Or, step up to the 100 MHz 2235 for just \$1650\*! You can order, obtain literature, or get expert technical advice, through Tek's National Marketing Center. Direct orders include operator manuals, two 10X probes,

15-day return policy, world-wide service back-up and comprehensive 3-year warranty.

**Talk to our technical experts.  
Call toll-free:  
1-800-426-2200  
Ext. 157.**

In Oregon call collect:  
(503) 627-9000 Ext. 157.



Specification enhancement	2213/2215 "A" Series	2213/2215
CRT brightness	14 kv accel. potential	10 kv accel. potential
Vertical accuracy	3% 0° to 50°C	3%, +20° to 30°C
Chop rate	500 kHz	250 kHz
Input capacitance	20 pF	30 pF
CMRR	10 to 1 at 25 MHz	10 to 1 at 10 MHz
Channel isolation	100:1 at 25 MHz	Not specified
A Trigger sensitivity (int)	0.3 div at 5 MHz	0.4 div at 2 MHz
TV triggering	1.0 div compos. sync	2.0 div compos. sync
Sweep accuracy (in 10X)	4%, 15° to 35°C	5%, 20° to 30°C
Delay jitter	20,000 to 1 (2215A) 10,000 to 1 (2213A)	10,000 to 1 (2215) 5,000 to 1 (2213)
Holdoff Range	10:1	4:1

\*Price F.O.B. Beaverton, OR  
All scopes are UL Listed and CSA approved. 3-year warranty includes CRT and applies to 2000 family oscilloscopes purchased after 1/1/83



# Computerizing a Medical Office

*A physician's advice can be handy for other professionals needing tailored applications*

Jonathan Javitt, M.D.

Computer Consultant for Medical Applications

As of July 1983, only 5 percent of the physicians in the United States owned microcomputers. Nevertheless, I believe physicians will no longer be able to maintain an uncomputerized office. Perhaps by the end of the decade all medical practices will have a computer. [Editor's Note: The trend may extend to other professional offices with an extensive but specific clientele. The following advice for physicians may well apply to any professional needing a tailored computer system.]

## Why Computerize?

As medical practice costs rise and the supply of physicians increases, practices will need to pay increasing attention to economics and marketing. Most good office-management programs can generate productivity reports by practitioner, by procedure, or even by piece of equipment. Determining whether the practice is running a piece of diagnostic equipment at a profit or a loss then becomes a simple matter.

One of the most difficult aspects of practice management is patient follow-up and recall. With a computerized record-keeping system, however, mailing one or more reminder letters

to patients and tracking those who don't respond can be done with ease. Such a system might also allow you to generate patient newsletters and health alerts. This contact can make a significant difference in a patient's satisfaction with your service.

A computer in a medical office can also be an instant link to a world of information, from the hospital records of one's patients to the extensive database of the National Library of Medicine. Up-to-the-second conferences on a variety of topics are available to anyone with a computer and a telephone. Within the next few years, electronic mail will be the most efficient way for physicians to share information about patients. Ordinary mail will then be as useful as blood-letting.

## How to Computerize Successfully

The selection of a computer system for a medical office need not be painful, protracted, or even inordinately expensive. When done logically and systematically, it may even be enjoyable and informative. If at all possible, find a consultant who is experienced in medical office systems. I believe that the cost of mistakes in

system selection is far more expensive than any consultant's fee.

By a consultant I mean someone who is familiar with the medical-management programs on the market and with the computer systems needed to run those programs, rather than a programmer who offers to write a program for running your office. Custom software is not an ideal solution to medical-management needs because if you have a problem with the software, you have only the original programmer to rely on. If he or she is no longer available, then you're stuck, with no one else able to help you. With commercial software, however, you will have the support of a large company and access to successive revisions.

Seven steps for selecting a computer system for a medical office are listed below:

1. needs assessment
2. system specification
3. software survey and selection
4. hardware survey and selection
5. vendor selection
6. office task assignment
7. software support

While these stages may seem obvious

at first, each one is crucial, and by-passing any of them is an invitation to disaster. If at all possible, do not change their order. Especially try to avoid allowing the vendor to be the determining force in system selection; the vendor's priorities are clearly different from yours.

### Needs Assessment

Involving all office staff in needs assessment from the outset is imperative. A computer system is only as capable as those who use it. If the staff is unenthusiastic about the system, the chances of a successful transition are minimal. All too frequently, the office staff first encounters a computer system when it shows up in boxes. The other side of this caveat is equally important. Often the office staff knows far more about work flow than the physicians in the practice and will be able to spot inadequacies in a system while they can still be corrected with an eraser and notepaper. "If only I'd known . . ." is an expensive utterance when it comes to computerizing a medical office.

### System Specification

What jobs do you expect the computer to do? Your answer should state exactly what information the system will be expected to store on any given patient, which report functions the software must be able to write, and so on. With this information, you will be able to choose software that will do the job that you want done.

How expandable should the system be? If the system cannot grow, then you will have to stunt your practice or get a new computer system—a costly way to do business.

How will the flow of information in and out of the computer be managed, and how many users will be on the system at once? These factors will determine the hardware that you'll need.

How much can you afford? The only intelligent approach to budgeting for this project is to sit down with the practice's financial advisers and determine the monthly cost of the system versus the projected return. In all likelihood, the calculations will justify a system large enough to han-

dle the office's needs. Once all the above questions are answered, you can start choosing the software.

### Software Survey and Selection

Currently, there are no microcomputer-based office-management programs that can store detailed clinical information for each patient. While the concept of a paperless office with all patient data stored electronically is highly attractive, it is not yet practical on microcomputer-based systems. At present, that level of data management is available only on minicomputers.

The reason for this situation is twofold. First, software development is driven by market demand. At this time, relatively few medical offices have state-of-the-art microcomputers, so why would programmers bother writing a complex clinical information-management system for such a small market? Second, the nature and structure of clinical information vary greatly from one medical specialty to the next. It is simply not possible to design a clinical database

## 8087 SUPPORT and FORTRAN for your PC

**87FORTRAN/RTOS™** - our adaptation of the Intel Fortran-86 Compiler generates in line 8087 code using all 8087 data types including 80-bit reals and 64-bit integers. The compiler uses the Intel large memory model, allowing code/data structures of a full megabyte, and supports overlays. Includes RTOS and support for one year. **\$1350**

**87PASCAL/RTOS™** is Intel's ISO-Standard Pascal with 8087-8088 exceptions. These make it possible to use all the 8087 data types directly, while generating modules in one of the three Intel Memory Models. Includes RTOS and support for one year. **\$1350**

**RTOS DEVELOPMENT PACKAGE** includes 87FORTRAN, 87PASCAL, PL/M-86, Utilities, TX Screen Editor and RTOS. **\$2500**

**RTOS—REAL TIME MULTI-TASKING/MULTI-USER EXECUTIVE**  
RTOS is a Micro Ware configured version of iRMX-86. Includes ASM-86, LINK-86, LOC-86, LIB-86, and the ROM Hex Loader. **\$600**

**OBJ→ASM™** - a multipass object module translator and disassembler. Produces assembly language listings which include public symbols, external symbols, and labels commented with cross references. Ideal for understanding and patching object modules for which source is unavailable. **\$200**

**PC TECH JOURNAL REVIEW:**  
"The Micro Ware package is preferable ... it executes the basic operations more rapidly and Micro Ware provides a free update service."

**87BASIC™** includes patches to the IBM Basic Compiler and both runtime libraries for USER TRANSPARENT and COMPLETE 8087 support. Provides super fast performance for all numeric operations including trigonometrics, transcendentials, addition, subtraction, multiplication, and division. **\$150**

**87MACRO™** -our complete 8087 software development package. It contains a "Pre-processor," source code for a set of 8087 macros, and a library of numeric functions including transcendentials, trigonometrics, hyperbolics, encoding, decoding and conversions. **\$150**

**87DEBUG™** - a professional debugger with 8087 support, a sophisticated screen-oriented macro command processor, and trace features which include the ability to skip tracing through branches to calls and software and hardware interrupts. Breakpoints can be set in code or on guarded addresses in RAM. **\$150**

**FOR→BAS™** - a library of interface routines which allow MS Fortran programs to call the IBM Basic Compiler library and access features such as the RANDOM NUMBER GENERATOR, SOUND, PLAY, DRAW and SCREEN commands. **\$150**

**8087-3 CHIP \$175**  
- with 180-day warranty and 8088 exchange.

**64K RAM Upgrade** ..... **\$50**

**87/88GUIDE** - an excellent tutorial on writing 8087 code and interfacing it with compilers. Full of code that runs. **\$30**

**MATRIXPAK™** manages a MEGABYTE!  
Written in assembly language, our runtime package accurately manipulates large matrices at very fast speeds. Includes matrix inversion and the solution of simultaneous linear equations. Callable from MS Fortran 3.2, MS Pascal 3.2, and Micro Ware 87MACRO, 87BASIC, and RTOS compilers. **each \$150**

**MICROSOFT FORTRAN 3.2**  
**MICROSOFT PASCAL 3.2** These new IEEE compatible compilers support both double precision and the 8087. **each \$259**

**MICROSOFT C COMPILER** includes Lattice C and the MS Librarian. **\$350**

**XENIX**  
LOGITECH Modula-2/86 ..... **\$445**  
FLOAT87 for MS C Compiler ..... **125**  
Multitool Word ..... **269**  
SuperSoft Fortran 66 ..... **299**  
SSS 8087 Support ..... **50**  
Computer Innovations C86 V 2.04 ..... **345**  
STSC APL★PLUS/PC ..... **545**  
87BASIC+ ..... **75**  
HALO Graphics ..... **125**  
GRAPHMATIC ..... **125**  
ENERGRAPHICS ..... **295**  
Professional BASIC ..... **295**  
Kidger Optical Design Program ..... **3000**  
COSMOS REVELATION ..... **CALL**  
dBASE II ..... **CALL**  
SuperCalc III ..... **CALL**  
MAYNARD Electronics Boards ..... **CALL**

**Micro Ware**  
P.O. Box 79  
Kingston, MA  
02364  
(617) 746-7341

**You Can Talk To Us!**



# computers wholesale

# 315-472-3055

Box 150 Brewerton, N.Y. 13029

Circle 104 on Inquiry card.

## We pay UPS shipping charges on prepaid orders.

### -PRINTERS-

**ANADEX**  
DP-9501B .....\$1049  
DP-9620B .....1099  
DP-9625B .....1199  
DP-6500 .....2399  
WP-6000 .....2159

**TEXAS INSTRUMENTS**  
TI 850 Par. ....499  
TI 855 .....Call

**C. ITOH**  
Prowriter 8510A Par. ....\$345  
Prowriter 8510A Ser. ....499  
Prowriter II Par. ....565  
Prowriter II Ser. ....699

**EPSON**  
RX-80 .....Call  
RX-80FT .....Call  
FX-80 .....Call  
FX-100 .....Call

**GEMINI**  
10X .....\$295  
15X .....435

**MANNESMAN TALLEY**  
MT-160I .....\$529  
MT-160L .....579  
MT-180L .....859

**DIABLO**  
620 RO 25 CPS .....\$919  
630 RO 40 CPS .....1769

**OKIDATA**  
ML-82A .....Call  
ML-83A .....Call  
ML-92 Par. ....Call  
ML-92 Ser. ....Call  
ML-93 Par. ....Call  
Pacemark 2350 .....Call  
Pacemark 2410 .....Call

**PANASONIC**  
KX-P1090 .....\$319

**NEC NEW/NEC 2050** .....979  
3510 .....\$1399 3530 .....\$1490  
3550 .....1849 7710 .....1899  
7715 .....1949 8023 .....399

**QUME**  
Sprint 11/40 .....\$1299  
Sprint 11/55 .....1499

**RITEMAN Inforunner** .....\$299

**SILVER REED**  
EXP 500 Par. ....\$459  
EXP 560 Par. ....529  
EXP 770 Par. ....939

Advertised prices reflect a cash discount on prepaid orders only. Most items are in stock for immediate delivery in factory sealed cartons with full factory warranties.

### -MONITORS-

**AMDEK**  
Color I .....\$275  
Color I+ .....319  
Color II (RGB) .....399  
Color III (RGB) .....349  
300 G (12" green) .....135  
300 A (12" amber) .....145  
310 A (IBM PC) .....169

**BMC**  
12 AU (12" green) .....\$79

**NEC**  
JB-1201 (12" green) .....\$155  
JB-1205 (12" amber) .....155  
JC-1212 (12" color) .....339  
JC-1216 (12" RGB) .....439

**PANASONIC**  
12" Green Monochrome .....\$169  
12" Amber Monochrome .....179  
13" RGB .....389

**SAKATA**  
SG-1000 12" Green .....\$99  
SC-100 13" Color .....269  
SC-200 13" RGB .....499  
SC-300 13" RGB .....659

**TAXAN**  
KG 12N (12" green) .....\$129  
210 (13" color) .....299  
400 (13" RGB color) .....299  
410 (13" RGB color) .....379

**ZENITH**  
Z-122 (12" amber) .....\$139  
Z-123 (12" green) .....109

### -HARD DISKS-

**CORVUS**  
Omninet 6 .....\$1695  
Mirror Back-up .....670  
Print Server .....839

**TALLGRASS TECHNOLOGIES**  
20MB Hardfile Disk for IBM-PC .....2695  
70MB Hardfile Disk for IBM-PC .....Call

### -DISKETTES-

**Maxell**  
5 1/4" MD1 .....\$22.95  
5 1/4" MD2 .....32.95

**3M/Scotch**  
5 1/4" SSDD .....\$21.95  
5 1/4" DSDD .....30.95

**Educator Lifetime Warranty**  
5 1/4" SSDD .....\$16.95  
5 1/4" DSDD .....21.95  
Flip 'n' File/holds 60 Disks .....17.95

### -BOARDS-

**IBM PC BOARDS**  
Amdek MAI Graphics Board .....\$479  
AST Sixpak plus 64k .....299  
AST Megapak 256k .....569  
CCS 132 Column Board .....589  
Microsoft 256k RAM Board .....299  
Plantronics Color + Board .....399  
Quadram New Quadboard .....Call  
Quadram Quadlink Board .....Call  
Tecmar 1st MATE Board .....229  
Tecmar Graphics Master Board .....569  
PC Peacock Graphics Board .....299  
64k Chip Kit (9 Chips) .....Call

### -SYSTEMS-

**COLUMBIA**  
VP Portable .....Call  
MPC 1600-1 .....Call  
MPC 1600-4 .....Call

**CROMEMCO**  
CS-1 .....3195  
CS-2 .....3755  
CS-3 .....5595  
64 FDC .....475  
TUART .....255

**EAGLE**  
II E Series PC Series  
II E-1 II E-2 PC-2 PC-1 +  
II E-3 II E-4 PC-2 + PC-XL +  
1600 Series SPIRIT  
1620 1630 Portable  
- Call us today for the best prices -

**BMC If800** .....1395  
COMPLETE BUSINESS SYSTEM!

**MORROW**  
New Portable w/2 Drives & Software .....Call  
MD11 w/H Disc & Software .....Call

**NEC**  
PC-8201 Portable .....Call  
PC-8800 Small Business System .....1689  
PC-8800 16-Bit System .....1999  
PC-8800 System w/8-in. Drives .....2299

**NORTHSTAR**  
Advantage .....Call

**SANYO**  
MBC 1200 .....1299  
MBC 550 .....Call  
MBC 555 .....Call  
CRT-36 .....159

**TELEVIDEO**  
TS-803 .....\$1989  
Portable .....Call

**ZENITH**  
151-22 w/2 Drives .....\$2495  
151-22 w/Hard Disk .....3995  
161-22 Portable .....Call

### -TERMINALS-

**ESPRIT SYSTEMS**  
Esprit .....\$489  
Esprit II .....499  
Esprit III .....649  
Exec. 10/102 .....799  
Exec. 10/102G .....1249

**New!**  
Televideo Personal Terminal  
Personal Terminal .....\$399  
w/300 baud modem  
Personal Terminal .....529  
w/1200 baud modem

**TELEVIDEO**  
910 .....\$439  
914 .....579  
924 .....695  
925 .....699  
950 .....865  
970/50 .....949

**QUME**  
102 .....\$659  
108 .....715

**WYSE**  
50 .....Call  
75 color .....Call

**ZENITH**  
Z-29 .....\$659  
ZTX-10 .....319  
ZTX-11 .....389

### -MODEMS-

**HAYES**  
Smartmodem 300 .....199  
Smartmodem 1200 .....498  
Smartmodem 1200B .....Call

**NOVATION**  
D-Cat .....\$149  
J-Cat .....99  
Apple Cat II .....269  
103 Smart Cat .....179  
103/212 Smart Cat .....399  
212 Auto Cat .....549  
Access 1-2-3 .....449

**SIGNALMAN**  
Mk I .....\$75  
Mk XII .....279 Volks-  
Mk VII .....95 modem .....59

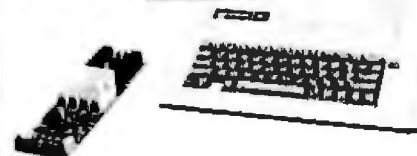
**U.S. ROBOTICS**  
300 Baud Password .....\$149  
1200 Baud Password .....339  
PC 1200 Baud Modem .....329  
S 100 1200 Baud Modem .....329

N.Y. residents, add appropriate sales tax. We accept VISA and Master Card. Personal and company checks, allow 2 weeks to clear. C.O.D.'s require a 25% deposit. All prices and offers may be withdrawn without notice.



## What to do with your Apple II/IIe® after you're through playing games —

- Machine Tools with 2 or More Axes of Positioning Controls
- Robotic Development
- Laboratory Experiments
- Machinery Controls
- Process Controls



### ALSO AVAILABLE — APPLE COMPATIBLE

- Half height direct drive disc drive
- 9" or 12" metal case monitors, green or amber
- Bubble memory board 128K - Helix ABM with software

### 16 OPTO-ISOLATED I/O PLUG-IN BOARD (A16 I/O) \$270

- Individually configurable I/O
- Compatible with solid state relay
- Interrupt inputs
- Software

### 2 AXIS STEPPER MOTOR DRIVER INTERFACE BOARD (A6 T/D) \$215

- Compatible with translators
- Accepts encoder pulse inputs
- Positioning software with ramping

### 2 AXIS (35 oz. in.) PRIME MOVER SYSTEM (PMS 23) \$365

- R2D23 dual axis stepper driver
- (2) size 23 stepper motors
- A6 T/D plug-in interface board
- Software, cable

- 32 opto-isolated I/O board (A32 I/O)
- Power supply for PMS 23 system 12/24V-2A/5V-1A reg. (PS 23)
- 2 axis (220 oz. in.) prime mover system (PMS 34)

**ROGERS LABS (714) 751-0442**  
2710 SO. CRODDY WAY, SANTA ANA, CA 92704

that is generic enough to be useful to a large segment of the market and yet specific enough to be perfect for the specialist.

However, packages have been created that accommodate specific items of clinical information. These programs allow a practice to designate 10 or 20 items that must be recorded for each patient and to configure data fields to store those items. Similarly, the programs enable a practice to store lists of diagnoses, medications, and allergies for each patient. Some packages allow visit notes to be entered as free text in addition to the structured data. In the long run, what is needed is a relational database that is able to track clinical parameters over time and correlate them with other parameters. This level of sophistication has not been developed under current microcomputer operating systems and is currently available only under Unix. As the base of computer users within the medical world enlarges and more powerful operating systems become available on microcomputers, undoubtedly specialty-specific clinical databases will be designed to run on microcomputers.

Even today, a microcomputer can do a vast amount of work in a medical practice. For instance, any good management program can maintain a general ledger for each patient. (But be sure that the program you select lets you perform a complete audit trail for each account.) By storing the insurance carriers for each patient, one or more carriers can be automatically billed for each account payable. Another major way the computer will rapidly earn its keep is by its ability to track and age accounts receivable. Further, by billing on a staggered basis rather than monthly, a practice can maintain a smoother cash flow. The availability of this ledger information makes it simple to develop management reports to determine the economics of the practice's fee structure, particular pieces of equipment, or procedures. Look for a software package that not only offers these reports, but will allow you to devise your own reports as you go along.

## BASIC Discovers Shorthand.

Programming in BASIC just got smarter, easier, faster . . . and five great reviews. Before you write another program in BASIC, you might be wise to start with a little reading.

Five major computer publications have something good to tell you. About the BASIC Development System (BDS). And about making your programming in BASIC more efficient than you ever dreamed.

BDS is a powerful, integrated set of software tools that quickly gets you beyond the BASIC basics. It gives you everything from Cross-Referencing to Scrolling Keys that let you scroll by page or line. It gives you Compress and Uncompress commands, Variable Dump, Single Step Trace and more.

BDS also gives you something else. A 30-day money back guarantee.

Finally, BDS gives you great references. From reviewers who've lived with it and loved it. For example: "I wonder how I ever got along without it." John M. Woram, PC Magazine, September 1983.

We'll send you the reviews just for writing us. Or, for only \$79, we'll send you BDS itself. And a 30-day money back guarantee.

BETA TOOL SYSTEMS  
**BTS**

8972 E. Hampden Ave. • Suite 179  
Denver, Colorado 80231 • 303/793-0145

BDS is available for IBM PC and COMPAQ computers. VISA/MC accepted. Please add \$3 for shipping.



# People are going for Friday!™ like there's no tomorrow.

Friday! is the new electronic file handling system that has become an instant best-seller because it's so revolutionary.

Within two weeks, it broke into the Top 20 on the sales chart of Softsel, one of the country's leading computer software distributors.

And it's now well on its way to the top.

## The Friday! phenomenon is simple.

Friday! uses simple menus and talks to you in plain English, so almost anybody can use it.

It's great for sales and commissions, clients and portfolios, mailing lists and labels, invoices, inventories, paychecks, reports and more. And it works with other microcomputer software like 1-2-3™ and dBASE II® (our own advanced database management system).

It comes with a complete, step-by-step tutorial, but you can set up an "electronic file" without even looking at the manual, then use it at the touch of a few keys.

Friday! finds any filed information in seconds. Computes totals, subtotals, commissions, etc. Prints form letters and mailing labels. Gives you quick reports from all or part of a file with a few key-strokes. Or if you need a special report for



your bank or board of directors, just "paint" the format on your screen, then have Friday! do all the work.

And while Friday! does more than file handling systems selling for as much as \$495, it's yours for just \$295 (suggested retail price)!

For more information, contact Ashton-Tate, 10150 West Jefferson Boulevard, Culver City, CA 90230. (800) 437-4329 ext. 202. In Colorado, (303) 799-4900. In the U.K., call (0908) 568866.

Or for the name of your nearest dealer, just call 1-800-4-FRIDAY, ext. 202.

## ASHTON · TATE

©Ashton-Tate 1983. Friday! is a trademark and dBASE II is a registered trademark of Ashton-Tate. 1-2-3 is a trademark of Lotus Development Corp.

Well-designed software can be an enormous asset in enhancing communication with patients. By combining scheduling functions with automatic patient recall, systematically sending reminder notices to patients before an appointed visit, test, or procedure is possible. This application makes it much easier to periodically recall patients with chronic conditions, such as hypertension or diabetes, for the appropriate clinical tests. This type of follow-up is nearly impossible using manual methods. The mail-merge functions of these packages also make it simple to generate a patient newsletter to report new services offered, important medical news, or other information of interest.

The program you consider should contain a good word processor or interface with one. If it doesn't, changing a form letter or recall notice will be difficult.

A major consideration in choosing software packages is that they be easy to use. Unfortunately, many packages on the market are adaptations of hospital mainframe computer packages. The mainframe programs usually run in batch mode, which means they are designed to run one function at a time on a large group of data, such as generating bills for all of your patients. This system doesn't work well if you want to run several functions on just a handful of data, such as entering a patient's account, posting a single charge, and generating one bill. Select a package that is primarily record oriented so that you are not constantly switching from one batch program to another.

On the other hand, batch mode is excellent for certain tasks. To be able to post the hospital charges for an entire hospitalization in one step or the charges for one day's rounds with a single command can be extremely useful. Similarly, printing all outstanding insurance forms at once is important. Therefore, look for a software package that can also operate in batch mode.

In evaluating software, pay little or no attention to the advertising for the product—the only valid data is provided by current users. Many soft-

ware packages have attractive demonstration programs that dealers are only too happy to show. These demo programs accommodate a small number of patients, run fast, and never lose data. The story may be quite different when the software is loaded with information on 2000 to 5000 patients. Any reputable company should be willing to provide you with the names of colleagues who are successfully using its software. If it is not willing to do this, look elsewhere.

Installation of medical-management packages is time-consuming, and the length of time can vary greatly from one package to another. In the initial phase, the personal data on

---

**When buying a microcomputer, do not be concerned about whether it will ever break. I promise that sooner or later it will.**

---

each physician in the practice must be entered as well as the particulars of each insurance carrier with which the practice deals. A complete list of diagnoses and procedures used in the practice must then be entered along with the appropriate procedure charges and standard diagnostic codes. The most painless way to do this part of the installation is to maintain a list of all diagnoses and procedures encountered during the month prior to installation. Try to find a program that can learn new diagnostic codes and procedures as it comes across them.

Instead of spending a lot of time designing billing forms and insurance forms, look for a program that has predesigned forms. Even better, choose a program that comes with the paper on which those forms must be printed. Predesigned forms can save 20 hours of installation time in a busy practice.

One misleading feature of several packages is that of electronic claims submission, that is, submission of claims via modem. Since insurance carriers have no standard electronic

communications system, it isn't likely that your package will be able to communicate with all of the different carriers. As electronic claims submission becomes a reality, the big software publishers will update their packages to include this feature. In other words, when shopping for software, do not be influenced by bells and whistles that you cannot use today. If the product is stable, these features will be added as they become practical.

### **Hardware Survey and Selection**

Only after the software has been chosen is it reasonable to consider hardware. In a single-station, single-user system running under CP/M or MS-DOS, hardware selection is straightforward. More likely, however, a system will have several workstations—the issue then becomes complicated. The problem centers around the lack of standardization in multiuser or network operating systems. Software designers are struggling to keep their products compatible with these continually evolving operating systems.

Although I prefer not to make strong hardware recommendations in a topical essay, I have observed that medical-management software is currently easier to marry to network systems than to true multiuser systems. The distinction I am drawing is between a system in which each user is connected to a separate, dedicated microprocessor, sharing only mass storage, versus a system in which all users share time on one microprocessor. Examples of the first approach range from freestanding microcomputers linked together in a network to a micro/mini arrangement in which all microprocessors are housed in one box and each is connected to a dedicated remote terminal. Standard CP/M software tends to run exceptionally well in the micro/mini type of system but none as yet run MS-DOS. If you are committed to MS-DOS software and want to support several users, the only alternative is networked MS-DOS-based personal computers with a common file server. Be sure that the software publisher will support this



# Changing our ribbon is a snap.

Most printers make you fool with a messy ribbon.

But with Digital's Letterprinter 100, all you have to do is snap in one of our replacement cartridges.

You'll instantly get at least 5 million more characters' worth of ink.

Easy, isn't it?

The fact is, everything about the Letterprinter 100 is easy.

For example, with just a flick of a finger you can select

up to five different typefaces. Or let your

computer do it for you, automatically.

If you can't find a typeface you like,

we'll customize one for you.

Now why would the world's second

largest computer company go to

such lengths to make the

Letterprinter 100 so

accommodating?

Simply so it can spend more

time doing what you bought it

to do in the first place.

And that's printing crisp, clear

manuscripts and graphics. From letter-

quality like you see here for word processing,

to high speed printing so you can get a draft

page in only 10 seconds.

The Letterprinter 100 works with any of

Digital's personal computers or video terminals. And it's a snap to use.

See the whole family of Digital's Printers, including the

daisy-wheel LQP02 and the low cost Personal Printer, the LA50.

For the distributor nearest you, call 1-800-DIGITAL, extension 700.

Or write Digital Equipment Corporation, Terminals Product Group,

2 Mt. Royal Avenue, UP01-5, Marlboro, MA 01752.



digital

network system before you make the commitment. A little bit of checking will tell you that the micro/mini approach is far cheaper than linking freestanding personal computers.

Before you buy a computer, you should determine the quantity of information to be stored on it. You can do this by multiplying the number of patients by the amount of information you need to store on each one. A practice that fills up its mass storage in two years and is then faced with a major financial expenditure for more disk space has clearly made some mistakes at an early stage of the selection process. The only intelligent solution is to determine the actual number of bytes needed per record stored and to multiply that by the projected number of patients over the next five years. One of the advantages of micro/mini computers is that they tend to support much larger hard disks than linked personal computers.

The companion question to how much mass storage is needed is how will it be backed up. The cost to a

medical office of an unprotected hard-disk crash is incalculable. Discipline is required on the part of the office staff. Murphy's law guarantees that when backup is not performed the disk will crash. The only safety lies in iron-clad rules about daily backup, preferably with a tape streamer. Similarly, invest in a backup power supply in case the failure is on the part of the local electric company. In this environment the investment in security is well worth it.

In evaluating hardware, be somewhat conservative. The tested product is generally a safer bet than the newer release with that added feature. No shortage exists of maturing products that will provide all the power any office needs. Only through a year or two of experience in field situations can a manufacturer work out the final bugs that develop under the pressure of daily use.

Don't fall short when you choose the simplest and cheapest hardware device—the printer. Dot-matrix printers are getting less expensive and more reliable by the day. A

medical practice needs to print on several types of paper, including insurance forms, demand statements, and letterhead or bond paper. A sensible approach is to purchase enough printers so that the office staff is not continually installing and aligning different types of forms in one over-worked printer. The equipment cost is rapidly offset by the savings in staff time.

## Vendor Selection

Although most vendors are honest and have good intentions, vast discrepancies appear in their abilities to follow through on promises regarding installation, training, and support. Because of the high cost of inventory in computer dealerships, cash-flow problems can be fatal, as is demonstrated by the rate of dealership failures. Carefully evaluate the business record of the dealer with whom you plan to undertake the project. Ask for bank references and for the names of satisfied customers. By all means, call the manufacturer's sales division and say that you are

# Modula-2. Simply Better.

More and more software developers are finding a new language simply better than C or Pascal. They're finding Modula-2, by Niklaus Wirth, the creator of Pascal. For professional programmers, it's simply a better language.

Modula-2. Simple like Pascal (if you know Pascal, you can be writing Modula programs in hours) but with much more power and flexibility. Power to handle any professional application, so there's no need for extensions.

Modula-2. Better than C because it gives you strong typing and superior separate compilation facilities. That means you write cleaner programs, faster.

Only LOGITECH's Modula-2/86 system translates directly into high-speed native code for PC-DOS™, MS-DOS™ and CP/M-86™.

No other system speeds your Modula programs along faster than our native code compiler. And our high-level, symbolic debugger ensures your programs arrive in flawless running condition.

Multi-level overlays, 8087 support, ROMable code, and a full library of standard modules make Modula-2/86 the perfect system for every professional application.

We also offer the only VAX/VMS™ resident and cross compiler for the 8086.

For VAX mainframes to PCs, look to LOGITECH's Modula-2 software development systems. For professional programmers, it's simply a better choice.



## LOGITECH

805 Veterans Blvd., Redwood City, CA 94063  
415-365-9852

LOGITECH SA (in Europe), CH-1143 Apples, Switzerland  
LOGITECH Srl., Corso Nigra 60, 10015 IVREA TO, Italy

PC-DOS is a TM of IBM, MS-DOS is a TM of Microsoft, CP/M-86 is a TM of Digital Research. VAX/VMS is a TM of Digital Equipment Corp.



# BYTE WORLD

**WE WILL BEAT ANY ADVERTISED PRICE**

**IBM® AND IBM® PC-COMPATIBLE PRODUCTS**

## IBM PERSONAL COMPUTER

64K w/1 Drive .....	\$ call
64K w/2 Drive .....	\$ call
128K PC-XT .....	\$ call

## IBM PC COMPATIBLE

Sanyo MBC 550 .....	\$ call
Sanyo MBC 555 .....	\$ call
Chameleon w/2 Drives ....	\$ call

## DISK DRIVES

Tandon 100-2 .....	\$210
Control Data DS/DD .....	\$215
Slimline DS/DD .....	\$185
Davong 10mb .....	\$1675
10 MB Subsystem.....	\$995

## PERIPHERALS AND ACCESSORIES

IBM Monochrome Monitor	\$325
IBM Monochrome Adapter Card	\$295
IBM Color Monitor	\$620
IBM Color Card	\$220
IBM Parallel Card	\$140
IBM DOS 2.0	\$55
64K Upgrade Kits (set of 9) ..	\$55
Parallel Cable IBM	\$39.95
Serial Cable IBM	\$39.95
DC Hayes Smart Modem 1200B	\$450

**SPECIAL** PC PEACOCK  
Color Graphics Adapter  
• Medium and High Resolution  
• Parallel Printer Port • 2 year warranty  
**\$295**

## IBM SOFTWARE

Wordstar Pro. PAC .....	\$378
Wordstar .....	\$238
Multiplan MS-DOS .....	\$158
Home Acct. + .....	\$83.95
Lotus 1-2-3 .....	\$315
PC Tudor .....	\$40
DBASE II .....	\$375
Supercalc 2 .....	\$158
Crosstalk .....	\$108
Volkswriter .....	\$112

## COLOR CARDS

Plantronics Color Plus ...	\$369.50
Quadram Color Plus I .....	\$225

**APPLE® PRODUCTS FOR ALL COMPUTERS**

## APPLE IIe COMPUTER STARTER KIT

**SPECIAL PRICE**

## OMNIGRAPH

Intelligent Graphics Printer Adapter

- Prints pictures, designs, graphs on all popular dot-matrix printers
- Versatile selection of dazzling effects — zoom graphics, inverse graphics, 90° picture rotation, hi-res screen reproduction and many more!

**\$79.00**

**Monitor: Green & Amber**

**Hi Res 20 MHz  
USI Lookalike  
ONLY \$99**



## APPLE PERIPHERALS

Hayes Smart Modem 1200	\$469
ST 6 PAL + w/64K .....	\$269
ST I/O w/Game Port ...	\$169
Apple Disk Drive .....	\$285
Apple Compatible D/D ...	\$160
CG Joystick IIe .....	\$35.25

## APPLE SOFTWARE

Wordstar Pro. PAC .....	\$388
Home Acct. .....	\$44.95
Apple Quick File .....	\$85
Apple Writer IIe .....	\$150
Bankstreet Writer .....	\$46
Visicalc IIe .....	\$168

## PRINTERS

Epson RX-80 .....	\$ call
Epson FX-80 .....	\$525
Epson FX-100 .....	\$679
Tractor Feed/FX-80 .....	\$50
Okidata 92-P .....	\$420
Tractor 82/92 .....	\$55
Okidata 93-P .....	\$700
Okidata 84-P .....	\$968

## DISKETTES

Verbatim 5¼ SS/DD . (10)	\$22.90
(100)	\$220
Verbatim 5¼ DS/DD . (10)	\$34.00
(100)	\$330
Syncom 5¼ SS/DD . (10)	\$15.50
(100)	\$150

## MONITORS

Amdek Color II+ .....	\$425
Amdek 310-A .....	\$165
Princeton HX-12 .....	\$465

Circle 254 on inquiry card.

1. All items subject to availability.
2. All prices subject to change.
3. Software sales are final.
4. Shipping: min. \$4.00 shipping charge.

5. We accept VISA, MC, Am. Exp. = 3%. Personal and company checks, allow 2 weeks to clear. California residents add 6½% sales tax.

6. Customers must call for RMA# before returning any merchandise. Any goods returned for restocking are subject to 15% restocking fee at our discretion. Cancelled orders are subject to 20% charge at our discretion.

074 Crosswind Court, San Jose, CA 95126 (408) 263-1515, (408) 263-1516

**WE WILL BEAT ANY ADVERTISED PRICE**



**Lower Price!**



**We make C easy ...**

**... and work!**

Whether you're a seasoned pro or just getting started with C, our Eco-C C compiler has everything you need.

- A full C compiler, including long, float and double.
- A library of more than 100 functions for faster program development.

- The compiler generates assembler output (Zilog mnemonics) for processing with Microsoft's MACRO 80 assembler and linker, both of which are included in the price.
- Extremely efficient code (e.g., Knuth's "seive" executes in 15.8 seconds).
- For a limited time, we include a copy of the **C Programming Guide**. The Guide and the Eco-C compiler provide an excellent environment for learning C.

Perhaps the best news is that we've lowered the price of Eco-C to \$250.00 and it includes a user's manual, the Guide and MACRO 80. Eco-C requires a Z80 CPU and CP/M (an 8088 version in the 2nd quarter). To order, call or write:



6413 N. College Ave.  
Indianapolis, IN 46220  
(317) 255-6476



Trademarks: Eco-C (Ecosoft), MACRO 80 (Microsoft), CP/M (Digital Research), Z80 (Zilog)

considering buying the company's product through a specific dealer. Often, you will get a between-the-lines impression of the dealer's reputation and stability.

Any promises regarding installation, staff training, and support must be included as part of the initial sales contract. Installation work and staff training to be provided must be specified in terms of both hours and personnel. If service is furnished by the dealership, find out if the technicians are employed full-time or if service is being subcontracted.

When buying a microcomputer, do not be concerned about whether it will ever break. I promise that sooner or later it will. The essential question is how fast will it be fixed and by whom. Repair turnaround must be promised to you in terms of working hours, not days. An obvious point is not to consider operating without a service contract with a firm willing to make this commitment.

All your hardware should be serviced under the same contract. You do not want to find yourself in the position of having the computer serviced by one party and the printer by another. They will quickly start to argue about whose equipment is causing any problem, leaving you in the middle.

**Office Task Assignment**

All too often, office personnel come in one morning to be confronted with a stack of ominous-looking boxes filled with equipment that they are told to learn how to use. Effectively integrating a computer system will take some time, and provisions should be made for staff overtime and a temporarily reduced workload.

One person in the office must take overall responsibility for system installation, training, and maintenance, ideally, someone who is enthusiastic about the project in the first place and is likely to remain on the staff for some time. Installation planned for in advance will be a smooth process.

**Software Support**

Determine ahead of time who, if not the dealer, is going to support the software and to what extent. It is

**SAVE 60% & MORE**

SEE APRIL/JUNE "BYTE" FOR FULL LISTING OF OUR PRODUCTS

**FREE MONITOR NEC-8800 at unheard of prices!** Buy these

- quality systems at fraction of original cost, and receive a NEC green monitor (1410 or 1201) FREE!
- NEC-8800 w/ 2 5 1/4" drives, incl. CP/M, Basic, WordStar, MultiPlan ..... **\$1,299**
  - for 8" drives in place of 5 1/4" drives ..... add **\$ 299**
  - for 16-bit board (8086) w/128K RAM & 16-bit Basic MS/DOS ..... add **\$ 349**
- full NEC warranty and support!

**ZORBA Portable Computer \$995**

Sold last year for \$2,495

Most sophisticated 8-bit CP/M portable ever made!  
64K RAM, 2 drives d.s.d.d. 800 KB read/write IBM-PC, Xerox 820, KayPro, Osborne, DEC Formatel (And with CO-POWER 88 you can even execute PC software!) Standard Interfaces, serial, parallel, IEEE-488! Software included CP/M 2.2, CBasic, WordStar, MailMerge, CalcStar. New in factory carton, full factory warranty & nationwide service  
INTERNATIONAL ORDERS WELCOME! Shipped immediately air-freight Collect!  
SWP CO-PROCESSOR W/256K RAM-DISK RUN IBM SOFTWARE ON ZORBA **\$499**



**HURRY!**  
QUANTITIES VERY LIMITED!

**NEW HEWLETT-PACKARD INK JET PRINTER**  
160 cps approaching laser-printer quality! Limited supply List \$499 **\$CALL**

**TAVA** Fully IBM-compatible, incl. video card (specify whether color or hi-resolution monochrome) **\$1,799**

**NASHUA** 5 1/4" s.s.d.d. FLOPPY DISKETTES **\$1.49**

**SOFTWARE SPECIALS**

- LOTUS 1-2-3 ..... **\$339**
- WordStar Propak (W/S, SpellStar, MailMerge, StarIndex)..... **\$429**
- Condor III w/ReportWriter **\$299**

**ROMAR-II** the ONLY APPLE-compatible computer approved by US-Customs..... **\$399**

**ZENITH Z-132** 1 floppy and internal 10 MB hard disk..... **\$3,995**

**BHRT-NEVADA** (800) **845-5555** Mon-Fri 7:00 AM-5:30 PM PST  
P.O. BOX 50020, HENDERSON, NV 89016  
INFORMATION LINE: (702) 451-3305  
ORDER STATUS: (702) 451-1361





# GenTech



## THIS MONTH'S SPECIALS

- BROTHER/DYNAX HR-25 ..... \$749
- C-TOH Prowriter 1 8510AP..... \$369
- C-TOH Prowriter 2 1550P ..... \$659
- NEC Spinwriter 2030 (Centronics)..... \$869
- U.S. ROBOTICS Password Modem (1200 Baud) ..... \$359
- TAXAN KG-12N (12" Green Monitor).... \$125
- BASIS 108 (128K, 2 Drives, CP/M 3.0). \$1695
- TANDON Drive (IBM Compatible, 320K). \$239
- FOURTH DIMENSION Super Drive (Apple) \$219
- GREAT LAKES 10 MB IBM Internal..... \$1075
- QCS 10 MB External ..... \$1975
- TALLGRASS TECHNOLOGIES
  - 12 MB Hard Disk..... \$2249
  - 20 MB Hard Disk ..... \$Call
- RANA ELITE I (Apple Compatible, 163K). \$245
- RANA 1000 (For ATARI) ..... \$319
- MICROSOFT Multiplan (Apple II) ..... \$139
- HERCULES Graphics Board For IBM-PC. \$369
- MA SYSTEMS PC Peacock ..... \$309
- ORCHID PC Network Kit ..... \$Call
- Color Graphics Board ..... \$Call
- PLANTRONICS ColorPlus..... \$419
- TECMAR
  - 1st Mate Board For IBM (No RAM) .. \$239
  - Graphics Master..... \$549
- ORANGE MICRO
  - Buffered Grappler+ 16K/64K . \$179/\$239
  - Grappler CD (Commodore) ..... \$Call

### CUSTOMER SERVICE & TECH. SUPPORT

**401-273-2420**

### ORDERS ONLY

**800-843-4302**

150 Broadway, Suite 2212, N.Y. NY 10038

Money Order, Cashier's Chk, Personal Chk (3 Weeks to Clear)  
 Add 3% MC/VISA 5% AMEX Charge. Add 2% On COD Orders  
 APO Orders Add 6% Add 3% For Net Terms  
 All Returned Non-Defective Merchandise Are Subject To 20% Restocking Charge  
 GenTech Reserves the Right to Change Advertised Prices



### COMPUTERS

- ALDOS**  
 586-10 Bus (8086), 512K, 5 Users, XENIX/RT, 12 MB Hard Disk & 1 Floppy) ..... \$Call  
 986-40 Bus (8 Users, 42 MB) ..... \$Call
- COLUMBIA**  
 1600-1 (128K, 2 Drives) ..... \$Call  
 1600-4 (10 MB Hard Disk) ..... \$Call  
 1600-VP (Portable) ..... \$Call



- COMPUPRO All Models** ..... \$Call
- CORONA**  
 Desktop & Portable PC's ..... \$Call
- EAGLE**  
 PC-2 /PC-XL /Spirit-XL ..... \$Call  
 IIE Series All Models ..... \$Call
- FRANKLIN**  
 ACE 1000 w/ Color ..... \$799  
 ACE PRO PLUS System ..... \$Call  
 ACE 1000 PLUS FAMILY PAK ..... \$Call  
 ACE 1200 (8502/2808) ..... \$1399  
 ACE OMS (2 Drives) ..... \$Call

- INTERTEC**  
 Head Start, CompuStar ..... \$Call
- MORROW DESIGNS**  
 MD2 (64K, 2 SSD Drives, WordStar, Correct-It, LogiCalc, etc.) ..... \$Call  
 MD3 (Same as Above except w/ 2 DSD Drives & QUEST Accounting) ..... \$Call  
 MDH (128K, 1 1/2 MB Hard Disk & 1 DSD Drive, Same Software as MD3) ..... \$Call  
 MDH w/ MDT-60 Terminal ..... \$2549  
 Multi-User DECISION Series ..... \$Call
- NEC PC-8201A (w/ 16K RAM)** ..... \$Call

- SANYO**  
 MBC 550, (IBM-Compatible, 8088, 128K, 1 SSD Drive, WordStar, CalcStar, EasyWriter) ..... \$799  
 MBC 555 (550 Plus 1 Add. Drive, MailMerge, SpellStar, InfoStar) ..... \$Call
- SWP Micro Computer Products For Kaypro**  
 Co-Power-88 Board For Kaypro II & IV (8088 w/ 128K OR 256K) ..... \$Call

- TELEVIDEO**  
 1805 (IBM Compatible, 8088, 128K, 2 Drives, MS-DOS 2.0) ..... \$Call  
 TPC-II (Portable Version of Above) ..... \$Call  
 Multi-User Systems ..... \$Call

### FOR IBM PC

- AST RESEARCH INC.**  
 MEGA PLUS II (64K, Ser & Ck) ..... \$295  
 MEGAPAK 256K Module ..... \$299  
 SIX PACK PLUS (64K, Ser/Par, Ck) ..... \$295  
 COMBO PLUS (64K, Ser/Par, Ck) ..... \$295  
 I/O PLUS II (Serial Port, Clock/Cal) ..... \$129

- \*\*OPTIONS\*\***  
 Each 64K Increment For Expandable AST Boards Are \$65.  
 Serial Port. \$45 Parallel Port. \$45  
 Game Port. \$45

- QUADRAM**  
 QUARDBOARD (Serial/Parallel, Clock/Cal) 64K ..... \$279 256K ..... \$419
- QUAD 512+** (Serial Port, Maximum 512K) 128K ..... \$299 256K ..... \$399
- QUADCOLOR I** (Video Board) ..... \$239
- QUADLINK** (5502 w/ 64K) ..... \$489

- MICROFAZER**  
 Parallel/Parallel  
 8K ..... \$125 16K ..... \$139 64K ..... \$199  
 128K ..... \$289 256K ..... \$589 512K ..... \$899  
 Serial/Serial, Serial/Par, Par/Serial  
 8K ..... \$145 16K ..... \$159 64K ..... \$219
- STB SYSTEMS Graphix Plus** ..... \$379

- CCS SuperVision** (132 Column) ..... \$599  
**KEYTRONIC IBM Keyboard** (1510) ..... \$199  
**MA SYSTEMS PC Peacock** (RGB & Composite, Parallel Port) ..... \$309
- \*\* SPECIAL PRICES ON HERCULES, \*\***  
**\*\* TECMAR, MICROLOG (BABY BLUE) \*\***  
**& PLANTRONICS PRODUCTS \*\***

### FOR APPLE II/IIe, Franklin Ace

- ALS CP/M Card** ..... \$299  
 Smarterm II (80 Column Card) ..... \$145  
 Printer Mate (Printer Card) ..... \$59  
 EPD Surge Protectors ..... \$Call  
**FOURTH DIMENSION 16K RAM Card** ..... \$49  
 80 Column Card w/ 64K (Ile Only) ..... \$189  
**INTERACT.STRU.** PKASO Universal ..... \$125  
 Shuffle Buffer (32K) ..... \$229  
**KOALA TECH.** Koala Pad ..... \$95  
**MICROSOFT Premium Softcard** (Ile) ..... \$289  
**MICROTEK Dumping-16** ..... \$159  
**ORANGE MICRO Grappler+** ..... \$119  
**PROMETHEUS Graphith** ..... \$89

### HARD DISK

- COMREX ComFiler** (FOR QX-10, 10MB) ..... \$1995
- CORVUS**
- |       |        |       |        |
|-------|--------|-------|--------|
| 8 MB  | \$1695 | 10 MB | \$1645 |
| 11 MB | \$2350 | 15 MB | \$2095 |
| 20 MB | \$3150 | 21 MB | \$2495 |
- CTI 11 MB Internal Hard Disk w/ 64K For DEC Rainbow** ..... \$1995

- PEGASUS (GREAT LAKES)**  
 10 MB Internal For IBM ..... \$1075  
 23 MB External (w/ Controller) ..... \$1845
- TECMAR Removable Cartridge Winchester** (n PC (5 MB) ..... \$1495

**CALL FOR PRICES ON CAMEO, DSS, FOURTH DIMENSION, FRANKLIN, GORDNA, QCS, QUADRAM, SANTA CLARA, TALLGRASS & XCOMP**

### DOT MATRIX PRINTERS



- ANADEx DP9625B** (60 CPS HLD) ..... \$1199
- EPSON**  
 FX-80 ..... \$499 FX-100 ..... \$709  
 RX-80 ..... \$299 RX-80 F/T ..... \$379  
 RX-100 ..... \$529 LQ-1500 ..... \$Call

- MANNESMANN TALLY**  
 MT 160L ..... \$599 MT 180L ..... \$839  
 Spirit-80 ..... \$329 1602 ..... \$Call

- OKIDATA**  
 ML 92 ..... \$439 ML 93 ..... \$729  
 ML 84(P) ..... \$979 ML 84(S) ..... \$1079

- STAR MICRONICS**  
 Delta 10 ..... \$469 Radix 10 ..... \$659

- DATASOUTH All Models** ..... \$Call  
**PANASONIC KX-P1090** ..... \$319  
**TOSHIBA P1340/1350** ..... \$819/\$1579  
**TRANSTAR T315 Color Printer** ..... \$469

### LETTER-QUALITY PRINTERS

- BROTHER/DYNAX**  
 DX-15 (13 CPS, Diablo Compal.) ..... \$Call  
 HR-25 (23 CPS, 3K Buffer) ..... \$749
- DAISYWRITER**  
 2000 EXP (25 CPS, 48K Buffer) ..... \$999
- DIABLO 630 ECS/IBM** ..... \$Call  
**JIUKI 5100** (17 CPS, Diablo Compal.) ..... \$Call  
**NEC All Spinwriter Models** ..... \$Call  
**OLYMPIA Compact II** (Typewriter) ..... \$Call

- QUME Sprint 1140** ..... \$1345  
 Sprint 1155 ..... \$Call
- SILVER-REED**  
 EXP 550(P) ..... \$569 EXP 770(P) ..... \$899  
 EXP 500(P) ..... \$418 EXP 500(S) ..... \$459
- TRANSTAR T120, T130 & T140** ..... \$Call

- AMDEK DXY-100, Amplot II** ..... \$Call  
**ENTER COMPUTERS Sweet-P** ..... \$Call
- HOUSTON INSTRUMENTS**  
 DMP 40 ..... \$839  
 DMP 29 (8 COLOR 11x17 PAPER) ..... \$1845  
 DMP 41 (SINGLE PEN 22x17 INCH) ..... \$2495  
**MANNESMANN TALLY Pixy-3** ..... \$645  
**ROLAND, STROBE** ..... \$Call

### MONITORS



- AMDEK**  
 Video 300/300A/310A ..... \$139/149/169  
 Color I+ ..... \$Call Color II+ ..... \$449
- COMREX Color, Green, Amber** ..... \$Call
- GENTECH 9"/12" Green** ..... \$99/\$109
- PRINCETON GRAPHICS HX-12** ..... \$489  
 RGB Interface For Apple Ile ..... \$159  
 SR-12, MAX-12 (New!) ..... \$Call
- ROLAND, SAKATA All Models** ..... \$Call

- TAXAN**  
 RGBvision 210 (380x262) ..... \$299  
 RGBvision 420 (640x262) ..... \$489

### TERMINALS



- LIBERTY Freedom 100/200** ..... \$Call  
**QUME 102/102A** ..... \$559/\$579  
 103/108 ..... \$879/\$729
- TELEVIDEO All Models** ..... \$Call  
 Personal Terminal (All Models) ..... \$Call  
**VISUAL All Models** ..... \$Call  
**WYSE WY-75 (VT-100 Compat.)** ..... \$639

### MODEMS

- ANCHOR**  
 Mark VI (IBM) ..... \$189  
 Mark XII ..... \$279
- HAYES**  
 Micromodem IIe (w/SmartCam I) ..... \$249  
 Smartmodem 300 ..... \$Call  
 Smartmodem 1200 ..... \$Call  
 Smartmodem 1200CB (IBM) ..... \$439

- NOVATION**  
 Access 1-2-3 ..... \$Call  
 J-Cat (Auto Orig/Answer, 300 Baud) ..... \$109  
 Apple Cat II (300 Baud) ..... \$259  
 212 Apple Cat II (1200 Baud) ..... \$575  
 103 Smart Cat (300 Baud) ..... \$175  
 103/212 Smart Cat (1200 Baud) ..... \$409

- TRANSEND** (Formerly SSM)  
 Modemcard w/ Source (For Apple) ..... \$239  
 PC Modem Card 300 (For IBM) ..... \$289

- U.S. ROBOTICS**  
 Password (1200 Baud) ..... \$359  
**VEN-TEL MD212-3E** (1200 Baud) ..... \$399

### SOFTWARE

- LOTUS 1-2-3** ..... \$349  
**MBSI, STAR Accounting Software** ..... \$Call  
**MICROPRO WordStar** (IBM, CP/M) ..... \$319  
 WordStar w/ Applicard (For Apple) ..... \$349  
**PS WordPlus-PC w/ BOSS** ..... \$349  
**SOFTWARE SYSTEMS Multimate** ..... \$319  
**SORCIM SuperCalc 3** ..... \$269

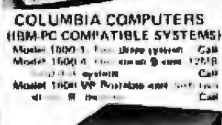




**IBM PC & XT Computers** - Call  
**SOFTWARE FOR IBM PC**  
 Multiple SCALL  
 BASIC 2.0 SCALL  
 Lotus 1-2-3 SCALL  
 Home Accounting Plus SCALL  
 Peach Tree Series 4 (A/R, A/P, G/L) \$225  
 Peach Tree 5000 SCALL  
 PFS: File SCALL  
 PFS: Report SCALL  
 PFS: Graph SCALL  
 PFS: Word SCALL  
 SuperCalc II SCALL  
 SuperCalc III SCALL  
 TBI Sales SCALL  
 VisiForm SCALL  
 Wordstar Professional SCALL  
 Word with Mouse SCALL



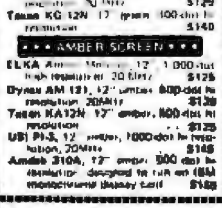
**COMPAQ**  
 Compaq 128K 1 drive SCALL  
 Compaq 256K 2 drives SCALL  
 Compaq 386 1 drive, 10MB hard disk SCALL  
 Compaq Plus 286K, 1 drive, 10MB hard disk SCALL



**COLUMBIA COMPUTERS**  
**IBM PC COMPATIBLE SYSTEMS**  
 Model 1001 1.44 diskette system Call  
 Model 1002 4 diskette 2 drive 12MB hard disk system Call  
 Model 1003 WP Notebook 4 diskette 1.44 diskette system Call



**SANYO**  
**DESK-TOP BUSINESS COMPUTERS**  
 SBC-630 1.2M 1 drive, new software SCALL  
 SBC-630 1.44M 1 drive, new software SCALL  
 SBC-630 1.44M 2 drive, new software SCALL  
 SBC-630 1.44M 2 drive, new software SCALL  
 SBC-630 1.44M 2 drive, new software SCALL  
 SBC-630 1.44M 2 drive, new software SCALL



**MONITOR SALE**  
 FREE software, cables included  
 ••• RGB COLOR •••  
 Precision 1K 12" 1000-dot high resolution monitor, 16K memory, 10 cables included \$479  
 Amtek AQR Color II Plus 1000-dot high resolution, 16K memory, 10 cables included \$499  
 ELKA Invert Monitor 12" 1000-dot high resolution, 20K memory \$519  
 Dyrpe DM-120 12" green high resolution 1000-dot, 20K memory \$529  
 Reikon OG AM 1200 12" green, 16K memory, 16K resolution, 20K memory, 10 cables included \$549  
 MSI P12 12" green, 1000-dot high resolution \$549  
 Tame KC 120 12" green, 1000-dot high resolution \$549  
 ••• AMBER SCREEN •••  
 ELKA Amber Screen 12" 1000-dot high resolution, 20K memory \$529  
 Dynax AM 121 12" amber, 1000-dot high resolution, 20K memory \$529  
 Teton RA-1224 12" amber, 1000-dot high resolution \$529  
 UBI P13 12" amber, 1000-dot high resolution, 20K memory \$548  
 Amtek 3104 12" amber, 500 dot high resolution, designed for IBM (IBM monochrome display card) \$549

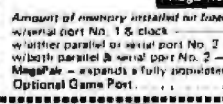
**Highest Quality Shielded Cables**  
 Parallel SCSI for IBM PC \$35  
 Serial monochrome cable for IBM PC \$35



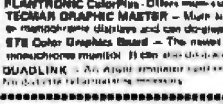
**QUADMASTER II** - 9-Function memory expansion card for IBM PC  
 8 Up to 384K 8 Compact disk out-put 8 Game port 8 put to LPT-1, 2 or 3 8 Changeover 8 QuadRAM drive 8 Parallel port 8 Mouse port 8 Serial port 8 HD bracket  
 Amount of memory installed - OR 64K 128K 192K 256K 320K 384K  
 w/serial port No. 1 & 2 \$276 \$325 \$375 \$425 \$475 \$535



**STE**  
 RIO PLUS Manufacture of memory expansion cards for IBM PC XT  
 64K 128K 192K 256K 320K 384K  
 \$288 \$339 \$388 \$438 \$489 \$539  
 memory installed - 64K 128K 192K 256K 320K 384K  
 \$288 \$339 \$388 \$438 \$489 \$539



**JRAM BOARD** by Tall Tree Systems  
 The JRAM board integrates totally memory onto the 640K boundary with the unique software controlled hardware system. Add a JRAM board and doubling the memory capacity in 2 MB. \$12K. JRAM board software \$499



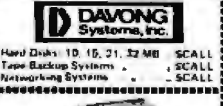
**AST**  
**Multi-Function Cards for IBM PC and XT**  
 (Each card now comes w/ SuperDrive & SuperSoft)  
 Memory installed on card - None 64K 128K 192K 256K 320K 384K  
 w/serial port No. 1 & 2 \$227 \$267 \$317 \$367 \$417 \$467 \$517  
 w/serial port & serial port No. 2 \$252 \$292 \$342 \$392 \$442 \$492 \$542



**MegaPlus II Cards**  
 Amount of memory installed on board - None 64K 128K 192K 256K  
 w/serial port No. 1 & 2 \$226 \$266 \$316 \$366 \$416 \$466 \$516  
 w/serial port & serial port No. 2 \$251 \$291 \$341 \$391 \$441 \$491 \$541  
 MegaPlus - expands a fully populated MegaPlus card (256K) to 512K. \$209  
 Optional Game Port. \$100



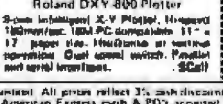
**HERCULES GRAPHICS CARDS** - Upgrade hardware graphics to the IBM monochrome \$349  
 Amtek IBM Board - for IBM monochrome & color graphics, but 512K max resolution \$309  
 Universal Research Color Card - no built-in card and no software shipping, no parallel port \$309  
 Vanta Data Master - 2K max resolution, but 512K & 1K alt. IBM PC XT compatible \$199



**Special Purpose Cards**  
**FLUORONIC ColorPlus** - Offers more colors in 640x480 resolution, parallel port \$379  
**TECHNIGRAPH MASTER** - Multi-resolution board for built-in VGA color or monochrome displays and can display on IBM \$349  
**STB Color Graphics** - offers 640x480 resolution, parallel port \$349  
**Video Data Master** - 2K max resolution, but 512K & 1K alt. IBM PC XT compatible \$199



**QUADLINK** - An Apple expansion card for IBM PC in full Apple II software. For details information necessary \$489



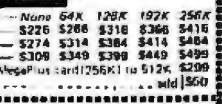
**IBM compatible**  
**5 1/4" DISK DRIVES**  
 Tandon TM-100 1.44 diskette, 5 1/4" floppy, 160K formatted, 1000 RPM, 1000-dot high resolution, 20K memory, 10 cables included, \$218  
 Tandon TM-100 2 diskette, 5 1/4" floppy, 160K formatted, \$218  
 Tandon TM-100 4 diskette, 5 1/4" floppy, 160K formatted, \$235  
 Central Data (equivalent model), 5 1/4" floppy, 160K formatted, 1000 RPM, 1000-dot high resolution, 20K memory, \$275



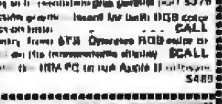
**QUADRAM**  
**QUADMASTER II** - 9-Function memory expansion card for IBM PC  
 8 Up to 384K 8 Compact disk out-put 8 Game port 8 put to LPT-1, 2 or 3 8 Changeover 8 QuadRAM drive 8 Parallel port 8 Mouse port 8 Serial port 8 HD bracket  
 Amount of memory installed - OR 64K 128K 192K 256K 320K 384K  
 w/serial port No. 1 & 2 \$276 \$325 \$375 \$425 \$475 \$535



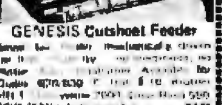
**STE**  
 RIO PLUS Manufacture of memory expansion cards for IBM PC XT  
 64K 128K 192K 256K 320K 384K  
 \$288 \$339 \$388 \$438 \$489 \$539  
 memory installed - 64K 128K 192K 256K 320K 384K  
 \$288 \$339 \$388 \$438 \$489 \$539



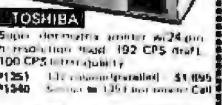
**JRAM BOARD** by Tall Tree Systems  
 The JRAM board integrates totally memory onto the 640K boundary with the unique software controlled hardware system. Add a JRAM board and doubling the memory capacity in 2 MB. \$12K. JRAM board software \$499



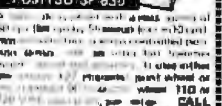
**AST**  
**Multi-Function Cards for IBM PC and XT**  
 (Each card now comes w/ SuperDrive & SuperSoft)  
 Memory installed on card - None 64K 128K 192K 256K 320K 384K  
 w/serial port No. 1 & 2 \$227 \$267 \$317 \$367 \$417 \$467 \$517  
 w/serial port & serial port No. 2 \$252 \$292 \$342 \$392 \$442 \$492 \$542



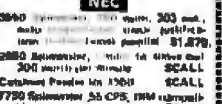
**MegaPlus II Cards**  
 Amount of memory installed on board - None 64K 128K 192K 256K  
 w/serial port No. 1 & 2 \$226 \$266 \$316 \$366 \$416 \$466 \$516  
 w/serial port & serial port No. 2 \$251 \$291 \$341 \$391 \$441 \$491 \$541  
 MegaPlus - expands a fully populated MegaPlus card (256K) to 512K. \$209  
 Optional Game Port. \$100



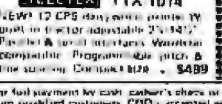
**HERCULES GRAPHICS CARDS** - Upgrade hardware graphics to the IBM monochrome \$349  
 Amtek IBM Board - for IBM monochrome & color graphics, but 512K max resolution \$309  
 Universal Research Color Card - no built-in card and no software shipping, no parallel port \$309  
 Vanta Data Master - 2K max resolution, but 512K & 1K alt. IBM PC XT compatible \$199



**Special Purpose Cards**  
**FLUORONIC ColorPlus** - Offers more colors in 640x480 resolution, parallel port \$379  
**TECHNIGRAPH MASTER** - Multi-resolution board for built-in VGA color or monochrome displays and can display on IBM \$349  
**STB Color Graphics** - offers 640x480 resolution, parallel port \$349  
**Video Data Master** - 2K max resolution, but 512K & 1K alt. IBM PC XT compatible \$199



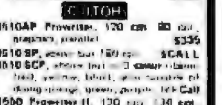
**QUADLINK** - An Apple expansion card for IBM PC in full Apple II software. For details information necessary \$489



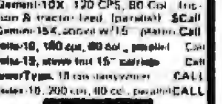
**IBM compatible**  
**5 1/4" DISK DRIVES**  
 Tandon TM-100 1.44 diskette, 5 1/4" floppy, 160K formatted, 1000 RPM, 1000-dot high resolution, 20K memory, 10 cables included, \$218  
 Tandon TM-100 2 diskette, 5 1/4" floppy, 160K formatted, \$218  
 Tandon TM-100 4 diskette, 5 1/4" floppy, 160K formatted, \$235  
 Central Data (equivalent model), 5 1/4" floppy, 160K formatted, 1000 RPM, 1000-dot high resolution, 20K memory, \$275



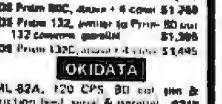
**EPSON**  
 FX-80, 80 CPS, 80 Col. Fraction B tractor feed, parallel Call  
 FX-100, 100 CPS, 132 Col. Fraction B tractor feed, parallel Call  
 MX-80FIT, 80 cps, 80 col. tractor and fraction feed, parallel Call  
 MX-100FIT, 100 cps, 132 col. tractor and fraction feed, parallel Call  
 RX-80FIT, 80 cps, 80 col. tractor feed only, parallel Call  
 RX-100FIT, 100 cps, 132 col. tractor and fraction feed, parallel Call



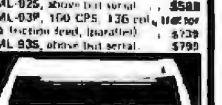
**CITOH**  
 B110AP, Parallel, 120 cps, 80 col., fraction feed, parallel \$235  
 B110P, Parallel, 120 cps, 80 col., fraction feed, parallel \$235  
 B110SCP, Parallel, 120 cps, 80 col., fraction feed, parallel \$235  
 B110SP, Parallel, 120 cps, 80 col., fraction feed, parallel \$235  
 B110SP, Parallel, 120 cps, 80 col., fraction feed, parallel \$235  
 B110SP, Parallel, 120 cps, 80 col., fraction feed, parallel \$235



**STAR GEMINI**  
 Gemini-10X, 120 CPS, 80 Col. Fraction B tractor feed, parallel \$235  
 Gemini-15K, 150 CPS, 132 Col. Fraction B tractor feed, parallel \$235  
 Gemini-18, 180 cps, 80 col., parallel Call  
 Gemini-18, 180 cps, 132 col., parallel Call  
 Gemini-18, 180 cps, 132 col., parallel Call



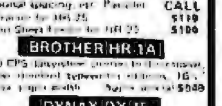
**RITEMAN**  
 120 CPS, 80 col. matrix, tractor/fraction feed, compact size, only 2.75" by 4.5" in cartridge, (optional) \$289



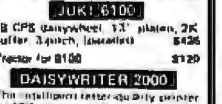
**IDS PRISM**  
 IDS Prism 80, 200 cps, 80 col., fraction B tractor feed, parallel \$1,150  
 IDS Prism 80C, 200 cps, 80 col., fraction B tractor feed, parallel \$1,150  
 IDS Prism 132, 200 cps, 132 col., fraction B tractor feed, parallel \$1,300  
 IDS Prism 132C, 200 cps, 132 col., fraction B tractor feed, parallel \$1,450



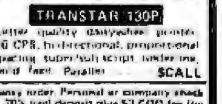
**OKIDATA**  
 ML-82A, 120 CPS, 80 col. dot, fraction B tractor feed, parallel \$218  
 ML-83A, 120 CPS, 132 col. dot, fraction B tractor feed, parallel \$235  
 ML-84P, 200 CPS, 132 col. dot, fraction B tractor feed, parallel \$289  
 ML-84S, 200 CPS, 132 col. dot, fraction B tractor feed, parallel \$289  
 ML-82P, 100 CPS, 80 col. dot, fraction B tractor feed, parallel \$218  
 ML-82S, 100 CPS, 132 col. dot, fraction B tractor feed, parallel \$235  
 ML-83P, 100 CPS, 132 col. dot, fraction B tractor feed, parallel \$235  
 ML-83S, 100 CPS, 132 col. dot, fraction B tractor feed, parallel \$235



**CITOH F-10**  
 40 CPS, 80 col. dot, fraction B tractor feed, parallel \$235  
 55 CPS, 80 col. dot, fraction B tractor feed, parallel \$235  
 Tractor for F-10 \$225



**BROTHER HR-25**  
 Model 23 CPS, 80 col. dot, fraction B tractor feed, parallel \$218  
 Model 25 CPS, 80 col. dot, fraction B tractor feed, parallel \$218  
 Model 25 CPS, 80 col. dot, fraction B tractor feed, parallel \$218



**BROTHER HR-1A**  
 40 CPS, 80 col. dot, fraction B tractor feed, parallel \$218  
 55 CPS, 80 col. dot, fraction B tractor feed, parallel \$218  
 Tractor for HR-1A \$218

unrealistic to expect a dealer to know as much about a package as the company that developed it. Similarly, if the dealer does not sell more than a few copies of a product, he or she cannot afford the time to learn it inside and out, and your problems can further be compounded by the tendency of dealers to reorganize, restructure, and go out of business. Therefore, unless the product is directly and completely supported by the publisher, that software is a risky investment. Regardless, the dealer should know the software well enough to install it competently and train your staff to use it. Ask him or her to supply you with the names of people to whom this particular product has been sold and make sure to call those people.

To expect full software support for free would be unreasonable; no company can afford to provide it. A company that guarantees to keep your software running, even if it has to put a support person on an airplane to do it, is entitled to charge a monthly fee. Any company that provides this level of service without charge is trying to lose money and is likely to be headed for serious financial trouble. More often, however, the company simply does not promise. Full software support and revision is worth the price. Too many users have learned that lesson the hard way.

**Conclusion**  
 Although some warnings are expressed in this article, the process of office computerization is ultimately worthwhile and likely to be highly successful. If the above guidelines are followed, the chance of untoward surprises will be minimized and the most probable question to arise will be "Why did we wait so long to do this?"

Jonathan Javitt, M.D., M.P.H., is a Kellogg Fellow in Health Management at the Harvard School of Public Health. He has been a consultant in medical microcomputer and information systems for the past two years. He can be reached at 207 Park Drive, Boston, MA 02215. In July, Dr. Javitt will be joining the staff of Wills Eye Hospital, in Philadelphia, Pennsylvania.



# APPLE

Compatible

# IBM-PC

Compatible

# S-100

Compatible

### • DOT MATRIX PRINTERS •

Okidata		Epson	
ML-80.....Call	RX-80.....Call	ML-82A.....Call	RX-80FFT.....Call
ML-83A.....Call	MX-100.....Call	ML-84 Par.....Call	FX-80.....Call
ML-92 Par.....Call	FX-100.....Call	ML-93 Par.....Call	<b>Star Micronics</b>
	Gemini 10X.....\$299		Gemini 15X.....499
<b>NEW! Riteman</b>	Delta 10.....Call	Inforunner.....\$319	Radix 10.....Call
<b>NEW! Panasonic</b>	<b>Mannesman Tally</b>	KX-P1090.....\$339	160L.....\$579
	160L......639		180L......849
<b>Anadex</b>	Spirit......339	DP9620B.....\$1195	
DP9625B.....1295		WP6000......2195	
DP6500......2495			
CITOH		Texas Instruments	
8510AP.....\$399	850.....\$499	1550P......719	855......Call
CX-4800 (color).....579	Font Modules......35		

### • DAISYWHEEL PRINTERS •

NEC		Diablo	
2010 (Ser).....\$879	620.....\$898	3510 (Ser).....1499	630 R-155.....1899
7710 (Ser).....Call	630 ECS/IBM.....2195		
Olympia		Qume	
Compact RO.....\$479	11/40.....\$1399	Compact II......449	11/65......1599
CITOH		Silver Reed	
Starwriter.....\$1219	Exp 550.....\$569	Printmaster.....1569	Exp 770......Call

We have cables, printwheels, ribbons, paper surge protectors, and other accessories for your printer in stock at outstanding prices.

### • MONITORS •

Amdek		Zenith	
300G 12" Gr.....\$139	123 12" Gr.....\$118	300A 12" Amber.....159	122 12" Amber.....145
310A 12" Amber.....189	131 Med. Res. RGB 319	Color I......299	135 High Res. RGB 549
Color II +......449		Color III......385	
Panasonic		BMC	
12" Green.....\$169	JB1201.....\$159	12" Amber.....189	JB1205.....169
13" RGB......399	JC1216......469		
Taxan		Sakata	
210 (13" Color).....\$299	SA-1000 Amber.....\$119	415 (13" RGB)......Call	SC-100 (13" Color) 269

### • MODEMS •

D.C. Hayes		Novation	
<b>Smartmodems</b>	D-Cat.....\$155	300 Baud.....\$219	J-Cat.....\$110.00
1200 Baud......529	Apple Cat II......279	1200B (IBM-PC)......499	212 Smartcat......429
Micromodem II......289	Access 1-2-3......Call		
Signalman		U.S. Robotics	
MK VII......Call	Password 300.....\$169	Volksmodem......59.95	300/1200......349

### • TERMINALS •

TeleVideo		Esprit Systems	
910.....\$499	Esprit.....\$499	914......619	Esprit II......549
924......739	Esprit III......669	925......749	Esprit III (color).....Call
950......945	Exec 10/102......Call	970......1099	Exec 10/25......Call
TeleVideo Personal Terminal			
Personal Terminal			
w/300 baud Modem......559			
Personal Terminal			
w/1200 baud Modem......899			
Zenith			
Z-29.....\$699	ZTX-11.....\$399		
Qume		Wyse	
102.....\$595	WY-50.....\$569	102A......610	WY-60......675
103......Call	WY-75......679	108......759	WY-100......845

### • CROMEMCO •

Introducing the C-10MP Package. This new system couples the popular C-10 hardware and software developed by Cromemco with the most popular software offered by MicroPro. **Word Star - Info Star - Calc Star - Mail Merge**

List Price \$2195 Our Low Price - Call

— Other Cromemco Systems from Mini Micro Mart —

C-10 Super Pack.....\$1599  
 CS-1 with Z-80A, 64KZ, 2DS/DD 5 1/4 Drives 3389  
 CS-1 with DPU, 256KZ, 2DS/DD 5 1/4 Drives 4239  
 CS-1HD with DPU, 256KZ, 21MB hard disc 6789

We also carry the entire Cromemco line of S-100 board level products and software  
 Cromix.....\$499 CDOS.....\$79

### • EAGLE PC •

Simply, a better PC! 128k RAM (expandable to 512 on the main CPU board), DS/DD 320k disc drives, serial ports, 1 parallel port, MS-DOS, Eagle Calc and Eagle writer included.

The EAGLE SPIRIT portable w/10 MB hard disk is now available.

### • COLUMBIA VP PORTABLE •

Featuring IBM-PC compatibility teamed with the most comprehensive software package in the industry. Includes 126k RAM, 2 5 1/4, 320k drives, and a 9 inch 80x25 display.

### • SANYO MBC550 •

Not only is the Sanyo MBC550 priced less than one-third that of a comparably equipped IBM-PC, it is also less expensive than most 8 bit computer packages. Includes a 160k drive, 128k RAM, M5-DOS, Word Star and Calc Star.

### • IBM-PC BOARDS •

Amdek MAI Graphics Board.....\$499	
AST Research Six Pak Plus 64k......299	
AST Research Mega Plus......289	
AST Research Extender Card......55	
Hercules Graphics Card......389	
IRMA 3278/79 Terminal Emulator......995	
Microsoft 256k RAM Board......299	
Microsoft 64k System Board......275	
Plantronics Color Plus......Call	
Quad Ram Quadboard......239	
QuadRam Quadvue card......289	
Quibe 1200 baud modem card......299	
Tecmar 1st MATE Board......249	
Tecmar Graphics Master......589	
64K Memory Chip Kit (9 chips, 150 NS)......Call	

### Color Graphics Special

PC-Peacock color graphics board + 4-Point Graphics CAD Software

**BOTH FOR \$449.95**

### • DISKETTES •

IBM		Maxell	
5 1/4" SSDD.....\$29.95	5 1/4" MD1.....\$23.95	5 1/4" DSDD.....\$36.95	5 1/4" MD2.....\$33.95
8" DSDD.....\$47.95	8" SSDD.....\$36.95		
3M/Scotch		Best Buy	
5 1/4" SSDD.....\$20.95	5 1/4" SSDD 48TPI	5 1/4" DSDD.....\$27.95	Brand of our choice
8" SSSD.....\$23.95			<b>\$16.95</b>

Save an extra 10% when you buy 10 boxes

### • DISC DRIVES •

Tandon 100-2 DSDD 5.25".....\$249
Tandon 848-2 8" DSDD......Call
Mitsubishi 8" DSDD......Call
Mitsubishi 5.25 1/2 height DSDD......175

### • HARD DISC SYSTEMS •

Tailgrass Technologies	
GMB Hardfile Disk for IBM-PC.....\$1895	
20MB Hardfile Disk for IBM-PC......2795	
70MB Hardfile Disk and Tape Backup......Call	

### Corvus Omninet

An easy, low cost way to make personal computers part of a powerful information management network.

Corvus Omninet Disc Server.....\$829
Corvus GMB Hard Disc......1695
Mirror Card Backup for IBM-PCXT......412
Corvus Print Server......839
The Bank 200MB Tape Drive......1895



All prices F.O.B. shipping point, subject to change. All offers subject to withdrawal without notice. Advertised prices reflect a 2% cash discount (order prepaid prior to shipment). C.O.D. credit card orders 2% higher.

# Mini Micro Mart

943 W. Genesee St. Box 2991 Syracuse, N.Y. 13220

(315) 422-4467 TWX-710-541-0431



# 3¼-inch computing is ready when you are.

**Media, drives, software.  
Everything you need is here now.**

**Dysan 3¼" Flex Diskettes." Reliability refined.** Personal computing is getting more personal. Smaller, lighter, more portable.

How small will it get? Frankly, we don't know. But we're confident that 3¼" is the next step on the way down.

Why?

Because everything you need to get the most out of 3¼" computing is here now. In spades.

The story starts with our 3¼" one megabyte Flex Diskettes. They're built on the same reliable technology as the larger Dysan diskettes you use today. But with some very interesting innovations.

Like a durable metal hub that provides long-term read/write stability and accuracy.

A flexible combination of media and jacket, free from rigid metal shutters and fragile plastic parts. So both diskette and data will survive the bending that comes with normal handling.

And our 3¼" Flex Diskettes are packaged with hard plastic carrying pouches that hold and secure as many as five diskettes. So you can carry your work home. Or mail it across the country. Safely.

And, of course, all the quality you expect from Dysan has come down to 3¼", too. Like our jacket liner material that cleans the diskette surface. Our

superior magnetic coating. And our advanced burnishing techniques.

What does all this add up to?

Reliability. Dysan 3¼" Flex Diskettes are guaranteed to be 100% bit error-free. And durability. They're backed by a five-year limited warranty.

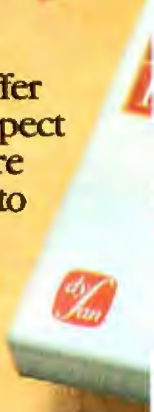


**3¼" Floppy Drives. Plug in a smaller size.** 3¼" floppy drives offer all the reliability you've come to expect from 5¼" drives. Simply put, they're 5¼" drives refined. And cut down to size.

They're generally ¼ the size and ½ the weight of 5¼" drives. And they use less than half the power.

Yet the 3¼" drives plug right into today's personal computers. All that's required is less space.

**Dysan Series Software." Best-selling programs in 3¼".** There's just one last thing necessary to turn 3¼"





diskettes and drives into 3 1/4" computing. Software.

And Dysan has solved that problem by licensing and converting scores of best-selling programs to 3 1/4". Programs from DRI, Microsoft, Sorcim, Peachtree, Pearlsoft, ADS, ADI America and more.

We call it Dysan Series Software. And it's here right now.

**It's where personal computing is going.** We'd be remiss if we didn't point out that 3 1/4" computing isn't just Dysan's good idea.

3 1/4" diskettes are being manufactured by several suppliers. So you're always assured of an abundant supply of quality media for your personal computer.

3 1/4" floppy drives are being built by a number of leading manufacturers. Including Tabor, Seikosha, MPI and, soon, Seagate.

To ensure the serviceability of 3 1/4" computing, Dysan has developed simple, portable tools to test and align 3 1/4" drives.

And we provide a duplication service to convert software from other formats to 3 1/4".

That's the 3 1/4" story. Quality diskettes, reliable drives and a great selection of software.

It's where personal computing is going. And it's ready when you are.

**Call Toll-Free (800) 551-9000 for complete information about 3 1/4" computing.**

Dysan Corporation  
5201 Patrick Henry Drive  
Santa Clara, CA 95050  
(408) 988-3472

Dysan is a registered trademark. Flex Diskette and Dysan Series Software are trademarks of Dysan Corporation. Copyright 1984, Dysan Corporation.

Circle 149 on inquiry card.



**Dysan®**



# I/O PROCESSOR™

## Takes Your IBM PC™ A Step Beyond By Adding a New Dimension of Productivity and Convenience

I/O PROCESSOR increases your productivity by increasing your PC's capabilities. And I/O PROCESSOR offers you the convenience no other expansion board can.

I/O PROCESSOR is a multifunction board offering 2 parallel ports, 1 serial port, a 64K printer buffer and a chronograph. The key to I/O PROCESSOR's unique abilities is its on-board Z-80 computer.

### INCREASED PRODUCTIVITY

I/O PROCESSOR's 64K buffer eliminates wasted hours of waiting for your printer to finish printing before you can use your computer. The buffer frees the computer for your use while the printer continues printing. You save time and increase productivity.

You can even use the buffer for TWO printers. Simply initiate printing instructions and I/O PROCESSOR's computer does the rest.



### ADDED CONVENIENCE

With other buffer boards (spoolers), you must tediously enter programs or load disks to activate the printer buffer. Not only is this a time consuming hassle, but it also ties up your PC's processor.

I/O PROCESSOR eliminates this inconvenience. The on-board computer handles the complete operation of the buffer. And you can use the buffer with all of your PC software — it's fully compatible. No special programs, disks or modifications required.

And I/O PROCESSOR's buffer doesn't tie up your PC's processor. It works independently, using the on-board computer, to increase computing speed and provide full software compatibility.

I/O PROCESSOR will provide you with years of reliable performance and is backed with an exceptional TWO YEAR warranty.

Let I/O PROCESSOR make your computing more productive and convenient. Isn't that why you had your computer in the first place?

I/O PROCESSOR is available now at your local computer dealer.

**MA SYSTEMS**  
INCORPORATED

Circle 246 on inquiry card. An Encore Company

2015 O'Connell Avenue, San Jose, California 95131 (408) 943-0596



# Reviewer's Notebook

Rich Malloy

BYTE Senior Technical Editor

Last month I mentioned the Panasonic Sr. Partner, a good, new IBM PC compatible. Since then, however, the prices I quoted have been changed. The two-drive version with 128K bytes of memory, a printer, and a good software bundle (Wordstar, Visicalc, PFS:File, Graph, and Report) now costs \$2945. This is still a fairly good price, but it's not as great as the original one.

## Multiplan and PFS:Write

There are a number of good products out there that somehow take a long time to get reviewed in this magazine. Two of the best in this category are Multiplan, a spreadsheet program from Microsoft, and PFS:Write, a word processor from Software Publishing Corp.

Multiplan is very easy to use, fairly powerful, available for many systems, and reasonably priced (\$195). It will probably replace Visicalc as the standard to which other spreadsheets are compared.

PFS:Write is also very easy to use and fairly dependable. It lacks some fancy features, but it has all of the essentials. And although the program is copy protected, it costs only \$150. PFS:Write is currently at the top of my list of recommended word processors.

## The Leading Edge Word Processor

One of the programs just behind PFS:Write on my list is the one by Leading Edge. It's very easy to use and loaded with features. One of the nicest of these is the ability to "undelete" material, a feature that comes in very handy when, thanks to the IBM's keyboard buffer, you delete more than you intended to. The program is a bit expensive (\$295), but it's a lot cheaper than Wordstar, and it's not copy protected.

Unfortunately, the Leading Edge word processor has a peculiar way of storing files on disk. Every file, no matter how small, uses up at least 6K bytes of disk space (12K if you don't turn off the backup provision). You can eat up a lot of disk space very fast. Also, files are stored in a very unusual format. An "end of text" character appears in the beginning of the files, which makes it impossible to get the operating system to TYPE out a file. And the filenames look like this: "F01D0002." If you accidentally alter one of this program's directory files, vast quantities of text may become relatively inaccessible. There is a way to access these lost files, but you'll have to call Leading Edge to find out.

## Infoscope

The folks at Microstuf, who brought us the Crosstalk communications program, have recently come out with an impressive database manager for the IBM PC called Infoscope. For \$225, this program has a lot of very novel features. First, it has the fastest sort capability I have seen. Second, it's one of the few programs that make full use of the IBM PC's memory. Third, it has its own windows. Fourth, it has a powerful "focus" command to focus in on data records that fit particular conditions. And Infoscope has a spelling checker that tries to guess what command you would have typed if you hadn't made a typing mistake.

Infoscope is not going to replace dBASE II or Microrim, but it is going to fill a big niche in the software market. A review of the program should appear in these pages very soon.

## PC-Talk

The best communication programs are also usually the cheapest. For

example, the series of MODEM programs originated by Ward Christensen for CP/M systems has set the standard for data transfer. Best of all, MODEM7 and XMODEM are available for free from several bulletin boards around the country.

For the IBM PC, a BASIC program called PC-Talk is available from a company called Freeware. Users are encouraged to copy the program and pass it on to their friends. There is no charge, but Freeware encourages customers to contribute \$35 to the company.

PC-Talk version 3 is one of the best programs I have seen for any price. Some very good communication programs for the IBM PC cost much more and have more features. But for general-purpose communication, PC-Talk is hard to beat.

## This Month

This month we're reviewing two Z80 machines. The first is the Kaypro 10, the economical Z80 machine with a 10-megabyte hard disk. Another Z80 machine with a hard disk, the QDP 300, is a high-priced, high-performance machine with a 192K-byte disk cache.

Last August we reviewed a group of compilers for the C programming language. This month we take a look at two more C compilers for Z80 systems.

We also review a computer-aided design system called CAD-1 from Robographics.

For TRS-80 Model III enthusiasts, we take a look at three CP/M boards and the LNW-80 microcomputer system. And for the IBM we have a review of Thinktank, a program that's supposed to help people write more clearly and coherently. ■

---

*Rich Malloy is BYTE's product-review editor. He can be reached at POB 372, Hancock, NH 03449.*

# Have we got an ear-full for you.

**Votrax voice synthesizers let your computer talk to you in a world of sound.**

Now your ears are as important as your eyes when working with your computer. With a **Votrax** voice synthesizer your computer talks, and it talks to you in a world of sound you never thought possible.

**Votrax** was one of the first pioneers in the field. The **Votrax SC-01A** speech chip is state of the art, the one many other manufacturers use in their own equipment.

What it means to you is unparalleled speech capability. **Votrax** voice synthesizers pronounce words by using their basic building blocks rather than utilizing a vocabulary of a few hundred words. It assures you of an unlimited vocabulary. And an unlimited range of sounds: from jet planes to an advanced musical range.

Best of all, **Votrax** speech synthesizers are "smart," requiring no computer memory for operation. Your computing capacity stays free for other tasks. Small in size yet surprisingly economical, **Votrax** voice synthesizers are sophisticated pieces of equipment that hook-up in seconds.

Mix speech or sound, program sound frequencies or amplitude levels, or compose your own music with either the **Votrax Type 'N Talk™** or **Personal Speech System**.

Ideal for business, school, handicapped use or the home, **Votrax** voice synthesizers put a world of sound in your computer.

See your local computer retailer or call toll free for more product, warranty or ordering information: 1-800-521-1350 (in Michigan call 313-588-0341). Dealer inquiries welcome.



**Votrax<sup>®</sup>, INC.**

1394 Rankin • Troy, Michigan • 48063-4074

Circle 399 on Inquiry card.



## Thinktank

### *An outlining and organizing tool*

William R. Hershey  
MITRE Corporation

In the same way that Pascal and other structured programming languages encourage a top-down approach to programming, outlining encourages a top-down approach to writing. The benefits are the same. The investment of a little time planning and organizing saves time in the long run and results in a more efficient final product. It's not surprising, therefore, that a couple of Pascal programmers, David Winer and Jonathan Llewellyn, have come up with a clever program for outlining: Thinktank, billed as the first "idea processor."

In the first part of this review, I'll discuss Thinktank's capabilities, its similarity to word processors, and some of its unique features. Many of Thinktank's commands are, after all, word-processing commands: INSERT, DELETE, COPY, MOVE, XCHANGE, etc. In the second part, I'll describe what it's like to use Thinktank. Learning and using the program is generally very easy. The documentation is top-quality but the program has some shortcomings. Thinktank also has several potential applications beyond organizing and writing text.

#### What Is an Idea Processor?

My first big question about Thinktank was, "What does this program do that a good word processor doesn't?" Thinktank's advantage is in its ability to display an outline at different levels of detail without modifying the contents. You can display the level of detail you need with two commands, COLLAPSE and EXPAND. These commands help you visualize how your writing fits together. You can see relationships you might have missed if you tried to absorb all the headings in a long outline.

Thinktank also lets you alphabetize the subheadings beneath a given heading at any level, which is very handy for certain file-management tasks. And it offers the options of generating section numbers and tables of contents with page numbers.

#### The Thinktank Environment

Thinktank reserves the bottom four lines of the screen for menus, prompts, and error messages. The top 20

lines constitute a text area that serves as a window into your outline. Headlines appear in the text area with pluses or minuses preceding them. A plus means additional subordinate headlines exist at deeper levels, and a minus means the headline has no subheadings. Thinktank automatically generates the pluses and minuses and indents the headlines appropriately on the screen. A headline can also have an optional block of text, called a paragraph, of up to 2048 characters in any format. The paragraph follows the headline in the outline; any subheadings follow the paragraph.

A bar cursor highlights an entire headline at a time. Move it up and down through your outline with the arrow keys; the location of the cursor determines where a command is to take effect.

The manipulation of headlines and paragraphs is similar to the manipulation of text with a word-processing program. Because headlines follow a structure, however, the commands are probably slightly more complex than the ones in a word processor. When you want to create or edit material, you have to specify whether you want to edit a headline or a paragraph. When creating a new headline, you need to indicate if it's to be positioned directly above the one highlighted, directly beneath it, beneath it at a higher level (to the left), or beneath it at a lower level (to the right). Similarly, moving a headline from one place to another in an outline can be an involved process, sometimes requiring multiple steps with several level changes. The DELETE command also operates in several different ways. You can delete a single character, an entire headline or paragraph, or a selected portion of a paragraph. You can also restore a previously deleted block of text.

In Edit mode, the bar cursor disappears, and a blinking character cursor indicates where the action is. To edit headlines, which is more limited than editing paragraphs, you enter Insert mode; the left arrow functions as a destructive backspace, and Ctrl-D deletes the character under the cursor. Paragraph editing includes automatic word wraparound, a Typeover mode, the capability to exchange one pattern for another, a FIND com-

## At a Glance

### Name

Thinktank

### Type

Idea processor

### Manufacturer

Living Videotext Inc.  
1000 Elwell Court  
Palo Alto, CA 94303  
(415) 964-6300

### Price

\$150

### Computer

64K-byte Apple II, II Plus, or IIe; 96K-byte Apple III, IBM Personal Computer; Apple Macintosh version slated for the second quarter of 1984

### Language

Pascal and Assembly

### Format

Apple II, II Plus, and IIe: two 5¼-inch floppy disks (p-System); Apple III: three 5¼-inch floppy disks (p-System); Apple Macintosh: one 3½-inch disk; IBM Personal Computer: one 5¼-inch floppy disk (PC-DOS)

### Documentation

Users manual (228 pages, spiral-bound) with tutorial and reference guide; reference card; data disk to accompany tutorial; technical notes available separately for \$5 each

### Audience

Writers and others who need to organize their thoughts

insignificant at first, but I recently found them invaluable in writing about a mazy systems-engineering problem. I ended up rearranging that outline many times.

## Other Handy Features

Alphabetizing a list can be a tedious chore even with a word processor, but if your program has sorting capability, it's a snap. Fortunately, Thinktank can sort. When you issue the ALPHA command, the program arranges all the subheadings beneath the bar cursor in alphabetical order. You can also sort a list of numbers or numbered headlines or alphabetize the subheadings at any level. You can manage a simple database, like an address file, with the ALPHA command.

The PORT command directs Thinktank's output to a printer or to text files. Sixteen format settings offer lots of flexibility for printed listings. In addition to the usual capabilities for specifying line spacing, margins, page length, headers, footers, number of copies, and printer control codes, you can have Thinktank assign section numbers to your headlines (see figure 1).

You can also control indentation and the level to which headlines and paragraphs are printed, which enables you to generate one listing of just your outline (with the paragraphs suppressed) and another that shows only the major headings with all paragraphs. (Figures 2 and 3 illustrate these alternatives.)

Thinktank can be used to generate a final written product. If you need a table of contents, Thinktank will generate it, automatically inserting the proper page number for each headline. However, if you would rather use a word-processing program to polish up your final version, you can PORT the document to a Pascal text file and read it from there into your word processor. It is preferable if your word processor reads Pascal text files, but the utilities to translate them to text files for other operating systems are available from Living Videotext.

## Learning Thinktank

Thinktank is easy to learn and use. A slash (/) produces a main command menu at the bottom of the screen, which is very helpful while learning the program. But after you learn the commands, you can optionally evoke each one with a single keystroke (M moves a headline, for example) without pressing / first. A hierarchy of menus leads you through all the choices, and the Escape key consistently operates as an exit from all menus. (If you are distracted by the clicking and squirting sounds, simply turn them off with Ctrl-Q.)

The 228-page manual, by John Unger Zussman, is well written and well constructed. The book starts with an introduction that describes Thinktank's philosophy and then covers the differences between the versions available for various Apple computers—the 64K-byte Apple II, II Plus, or IIe, or 96K-byte Apple III. (Your system must have two disk drives because Thinktank accesses program segments periodically from one disk while updating the outline file on a different drive.) Other chapters in part I deal with how to start using the

mand, and SELECT, which highlights a section of text that you may then copy or delete.

Depending on the capacity of your disk (hard or floppy), you can create up to 10,000 levels of headlines with Thinktank. This permits a fairly robust outline. Each level is indented to the right of the next higher level, and the display automatically scrolls left and right to let you see all 80 characters in a headline.

If you don't want to see all the deeper levels in an outline, you can make them disappear by issuing the COLLAPSE command. EXPAND brings them back to any level you wish. The < and > keys represent EXPAND and COLLAPSE, respectively; the shapes of these symbols suggest the operations invoked. In their simplest form of usage, these two commands apply to both the paragraph and the subheadings beneath the highlighted headline; however, you can COLLAPSE or EXPAND just the paragraph or just the subheadings.

These two commands make Thinktank unique and give it capabilities not available in word-processing programs. You can experiment with how your ideas relate and test how each detail contributes to the whole. I like to COLLAPSE an outline so that just the highest-level headings show, then step down the subheadings and EXPAND each one to see how it relates to the whole piece. I can determine if a subheading really belongs where I put it and then COLLAPSE it again before proceeding to the next one.

The COLLAPSE and EXPAND commands may seem



NOW ONLY  
**\$1599.00**

**NEC**

# You come first.

With NEC's PC-8800 personal computer, you don't have to ask yourself which comes first, the hardware or the software.

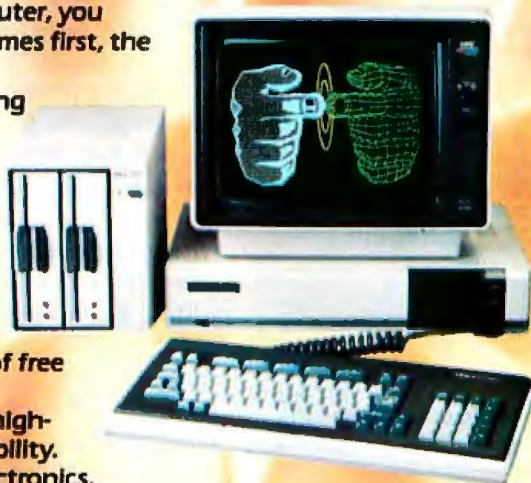
It's designed to be uncompromising in both areas. So you come first. In the office or at home.

The hardware lets you select from NEC's state-of-the-art processors, disk drives, printers, and monitors.

For \$1,599 you get an 8-bit processor, 5 1/2" dual disk drive, an NEC high-quality monitor and lots of free CP/M software.

You come first again with NEC's high-quality graphics and ultra-high reliability.

The PC-8800 from NEC Home Electronics. It puts you first. So you can break out of your shell and grow.



**Also available:**

- 16-bit processor with MSDOS operating system
- 8" dual disk drive
- High-speed dot matrix or letter-quality printer

**Free software with complete system:**

- WordStar<sup>®</sup> word processing
- MailMerge<sup>®</sup>
- Multiplan<sup>™</sup> spread sheet
- BASIC (two versions)
- CP/M<sup>®</sup>

**NEC**

NEC Home Electronics (U.S.A), Inc.  
Personal Computer Division  
1401 Estes Avenue  
Elk Grove Village, IL 60007

NEC Corporation, Tokyo, Japan  
Circle 280 on inquiry card.

```

1:   the screen
1.1:   command area
1.2:   text area
1.2.1:   headlines
1.2.2:   paragraphs
2:   bar cursor
3:   manipulating headlines and paragraphs
3.1:   creating and editing
3.1.1:   apply to headline or paragraph?
3.1.2:   where?
3.2:   moving
3.2.1:   involved process
3.3:   deleting
3.3.1:   several forms
4:   edit mode
4.1:   blinking character cursor
4.2:   headline and paragraph editing different
4.3:   some commands
4.3.1:   insert
4.3.2:   delete character
4.3.3:   typeover
4.3.4:   find
4.3.5:   exchange
4.3.6:   select
4.3.7:   copy
4.3.8:   delete select

```

**Figure 1:** A Thinktank outline with automatically generated section numbers. You can specify the number of levels to print and the amount of indentation.

```

the screen
  command area
  text area
    headlines
    paragraphs
bar cursor
manipulating headlines and paragraphs
  creating and editing
    apply to headline or paragraph?
    where?
  moving
    involved process
  deleting
    several forms
edit mode
  blinking character cursor
  headline and paragraph editing different
  some commands
    insert
    delete character
    typeover
    find
    exchange
    select
    copy
    delete select

```

**Figure 2:** A Thinktank outline with the headlines only. This is helpful in organizing your thoughts when you're just getting started.

```

the screen
Thinktank reserves the bottom four lines of the screen for menus,
prompts, and error messages. The other 20 lines form a text area that
is a window into your outline. Headlines appear . . .

bar cursor
A bar cursor highlights an entire headline at a time. Move it up and
down through your outline with the arrow keys. The position of the
bar cursor determines where commands will take effect.

manipulating headlines and paragraphs
The manipulation of headlines and paragraphs is similar to the
manipulation of text with a word-processing program. Because
headlines follow a structure, however, the commands are probably
slightly more complex than the ones in a word processor. When you
want to . . .

edit mode
In edit mode the bar cursor disappears, and a blinking character
cursor determines where the action is. Editing headlines is more
limited than editing paragraphs. With headlines . . .

```

**Figure 3:** A Thinktank outline with major headlines and paragraphs. In this mode, the final product starts to emerge. You can insert a paragraph beneath a headline at any level.

program. A tutorial uses a sample outline supplied on a separate disk. A chapter entitled "Notes and Suggestions" offers shortcuts; a glossary defines all the terms used in the manual; and appendixes cover an introduction to the Pascal operating system, disk management, and other technical information.

Part II contains a reference guide with all the commands listed in alphabetical order. A section on error messages describes where an error may occur, the possible causes, and some suggested solutions. There's an extensive index at the end of the manual.

Technical notes describing how to link Pascal programs to Thinktank are available from Living Videotext for \$5 each. Telephone support is excellent. When I called with questions, I received very helpful advice from one of the program's authors. Also, Thinktank's lack of copy protection makes it easy to create backups.

## Annoyances

Some of my complaints relate to command logic and are unique to the type of program Thinktank is. The MOVE command needs improvement. You can't move groups of headlines without moving the higher-level headline and all the subheadings under it. If, for example, you want to move 5 out of 10 subheadings to a different headline, you must move them one at a time. If you want to move a subheading so it falls under a different headline, you can't simply move it up or down: you have to move it left, then up or down, then right to get it back to the proper level. It is also difficult to move a piece of a paragraph so it falls under a different headline.

The COPY command is similarly limited. You can copy only one headline at a time, and the copy goes directly beneath the original. You then have to move the copy to where you want it.

Certain keystrokes should work at different menu levels, not just at the main menu. These keystrokes that are restricted include the up and down arrows for moving the bar cursor (Ctrl-O and Ctrl-K on the Apple II and the Apple II Plus) and the < and > keys when used for the EXPAND and COLLAPSE commands. It would be very helpful to have these operations available in the New, Edit, and Move modes. Such improvements would save many keystrokes and unnecessary menu changes.

Differences in the sequence of commands for creating and editing paragraphs is bothersome. Within the same paragraph, the New mode, for example, requires a different set of cursor moves than the Edit mode (which you can use after entering the text for the new paragraph). And why does SAVE require an extra step? Elsewhere, the program saves headlines automatically. After a save, you must answer the question, "Are you finished editing this paragraph?" Since the limit on paragraphs is only 2048 characters, repeated paragraph saves are a waste of time.

I originally intended to write this review entirely with Thinktank. But the editing routine for Thinktank paragraphs is so cumbersome that I decided to use the Word



# PRO-MODEM 1200



## It's about time.

Time for your computer to make the telephone connection – with an intelligent, full 212A 300/1200 baud modem – with a real time clock/calendar – and with the capability to expand into a complete telecommunications system. It's time for PRO-MODEM 1200. Much more than just a phone modem.

When you're on-line, time is money. PRO-MODEM telecommunication systems help you save. By monitoring the duration and cost of your phone calls. And by sending and receiving messages, unattended, at preset times when the rates are lower. . . with or without your computer.

Compare the \$495 PRO-MODEM 1200 with any other modem on the market. For example, you'd have to buy both the Hayes Smartmodem 1200 plus their Chronograph for about \$950 to get a modem with time base.

PRO-MODEM 1200 is easy to use. A convenient "Help" command displays the Menu of operating command choices for quick reference whenever there's a question about what to do next. Extensive internal and remote self-diagnostics assure that the system is operating properly. Some of the other standard features include Auto Answer, Touch Tone and Pulse Dialing, and Programmable Intelligent Dialing.

PRO-MODEM does more. It lets you build a full telecommunications system with features like Auto Dialer, Incoming and Outgoing Message Buffering, Business/Personal Phone Directory, Programmable Operating Instructions, a 12-Character Alpha-Numeric Time and Message Display, and versatile PRO-COM Software. PRO-MODEM commands are Hayes compatible so you can use most existing telecommunications software without modification.

There's much more to the PRO-MODEM story. See your local dealer for complete details. He'll show you how to save time. And money.

Prometheus Products, Inc., 45277 Fremont Blvd., Fremont CA 94538, (415) 490-2370



# PROMETHEUS

Juggler program from Quark (2525 West Evans, Suite 220, Denver, CO 80219, (303) 934-2211), which now has me spoiled. I still believe, however, in the value of Thinktank for organizing information and writing outlines.

My remaining complaints have to do with Thinktank's implementation on the Apple III. Despite the 256K bytes of memory available, you must wait interminably for disk accesses—both for program segments and for data—because the program is really designed for a 64K-byte machine. It takes 5 to 10 seconds for most disk accesses, but I timed one at 25 seconds—25 seconds to delete just one headline.

You can redefine edit keystrokes with Thinktank, so I tried to make them the same as the Word Juggler commands, which are input with the Apple III's numeric keypad. Unfortunately, I found that the program did not have the logic to distinguish between the keypad keys and their main-keyboard counterparts.

### Databases and Trees

Thinktank has database-management capabilities, thanks to the ALPHA command, and the ability to hide what you don't need to see. The manual has an extensive list of applications, including "to do" lists, telephone directories, and catalogs of collections. I've used the program to keep a list of publications that I need to refer to in my work. The table of contents lists the names of the publications (sorted alphabetically, of course) and their page numbers. The actual listing page contains a

brief description of the publication, the author, and the date.

A topologist will tell you that Thinktank's data structure is called a *tree*, a convenient device for lots of mathematical endeavors. Computers use trees all the time in their internal workings. Users, however, are seldom aware of them because programs reveal only the forest. Sorting and other database-management operations, for example, use trees extensively. With Thinktank's tree structure out in the open, we can expect to see some very interesting uses made of this program (genealogy is one), and we can hope for improvements that will enhance its mathematical potential.

### Conclusion

Thinktank is a refreshing new program, friendly to use and well documented. Because it is very important to organize ideas before writing, an idea processor can be as useful as a word processor. With a few improvements, Thinktank could be a *total* word processor that integrates the process of organizing thoughts with the art of writing. ■

*William R. Hershey (MITRE Corp., 1820 Dolley Madison Blvd., McLean, VA 22102) is a systems engineer with a B.S. in engineering from Princeton and an M.A. in computer and communication sciences from the University of Michigan. He is chairman of an Apple III users group in the Washington, DC, area and an instructor in computer literacy at the University of Maryland's University College.*

# SATISFY YOUR DRIVES!

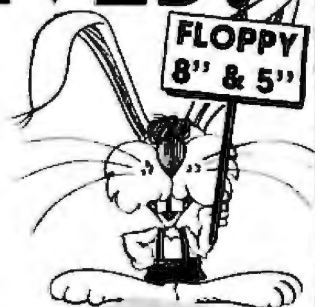


**800D2F**  
5" Floppy Main/Frame  
(10 cards) **\$392**

## 70 MAIN/FRAMES & DISK ENCLOSURES FROM \$100



**2215**  
5" Floppy Winchester  
Main/Frame (7 cards) **\$380**



**2905**  
5" Disk Enclosure **\$100**



Write or call for our brochure which includes our application note: "Making micros, better than any ol' box computer"

**INTEGRAND**

8620 Roosevelt Ave./Visalia, CA 93291  
209/651-1203

We accept BankAmericard, Visa and MasterCard



# Now Taxan for IBM

RGBvision 420 features 640 horizontal line resolution with .38mm dot pitch, non-glare black face picture tube, 18 MHz bandwidth. Includes cable.

TAXAN Model 121 (Green) or 122 (Amber) are TTL, 800 horizontal line resolution, 20 MHz bandwidth.

The optional tilt and swivel base with LCD clock, model 110-12, is also available for Models 121 / 122.

Ask your dealer about TAXAN model 505, 256K RAM expansion card for the IBM PC.

Circle 387 for Dealer inquiries.  
Circle 388 for End-User inquiries.



Image on Model 420  
Created by  
Visual Data Enterprises

**TAXAN** manufactures monitors for nearly every personal computer.

**TAXAN** Corporation, 18005 Cortney Court, City of Industry, California 91748, (818) 810-1291

See your local **TAXAN** dealer or call us for details



## The QDP-300 Computer

*A speedy Z80 at a premium price*

Edward Joyce  
Free-lance Writer

Line end to end all the Z80 systems on the market and you could almost circle the earth. From this conglomeration, eliminate the ones that run at less than 6 MHz and you narrow the field considerably. Of this group, isolate the systems costing more than \$6000 and you'll probably

end up with one machine—the QDP-300 from Quasar Data Products (QDP).

The speed and price of the QDP-300 distinguish it from most Z80 systems. The microprocessor hums at 6 MHz, compared with to 2 to 4 MHz for most Z80s. The price



Photo 1: The QDP-300 with a 10-megabyte hard-disk drive and one 8-inch floppy-disk drive.





Photo 2: The back of the QDP-300. Two RS-232C serial ports and two Centronics-compatible parallel ports come standard with the system.

of \$6395 buys 192K bytes of memory, including cache. Take away 64K bytes and replace the hard disk with a floppy disk and you're looking at QDP's least expensive system—\$3995. The QDP is intended for business users who can afford to pay a premium for more horsepower to crank through packages like Wordstar, Multiplan, dBASE II, and other software heavyweights of the CP/M-80 environment.

Photo 1 shows the \$6395 hardware package. The top cover of the cabinet is attached to the body at the two strips of real wood that run the length of the chassis. Besides adding an aesthetic touch to the package, the wood slats provide a convenient handhold.

The single floppy-disk drive accepts 1.2-megabyte, double-sided, double-density, 8-inch disks. The drive also reads and writes single-sided, single-density disks.

Photo 2 shows the back panel. Serial ports A and B, which are driven by a Z80 SIO (serial input/output) device, connect to the system terminal and printer. A Z80 PIO (parallel input/output) device handles the bit-banging on the two Centronics-compatible parallel ports. The other seven ports are inactive stubs. Serial ports C, D, E, and F are for attaching terminals in an MP/M multi-user environment. (This article reviews the single-user version only.) The auxiliary ports, labeled "Aux. A and B," are available for user devices that may be plugged into the two open slots on the S-100 bus. Finally, the port labeled "Aux. Disk" seems to be designed to enable daisy-chaining of disk drives; however, QDP offers no hardware configurations other than the one-cabinet unit.

On the left side of the back panel is the fan. There must be an axiom in the computer-design cookbook that says "cool a powerful computer with a powerful fan." The QDP rivals the Digital Equipment Corporation (DEC) Rainbow as a candidate for generating jet streams in the wind tunnels of General Motors research laboratories. Any hard-working machine needs protection from overheating, but a system that generates the exhaust sound and thrust of a small turbine engine won't find widespread acceptance as a desktop computer. A smaller fan should be able to handle the cooling load at a fraction of the noise.

While I'm offering free advice to the designers on the physical aspects of the computer, I'll put in my two cents regarding the power switch. As seen in photo 1, the switch protrudes prominently from the left side of the front panel, a little too prominently for my liking. Every time I saunter past the machine, I worry about accidentally bumping the switch and possibly flushing a 180-cell spreadsheet down the tubes. To avoid electronic disaster, I've unconsciously developed the habit of executing a quick side step when I pass the computer. My choreography would make Michael Jackson jealous. The designers wisely recessed the reset switch; why they left the power switch sticking out like a sore thumb is anyone's guess.

The inside of the cabinet is shown in photo 3. Most of the system logic fits neatly on one board. For instance, a Z80 DMA (direct memory access) chip, which manages disk-data transfers and memory-to-memory block moves, is on this board. Additional circuits and memory

Benchmark	Execution Time	Compilation and Link Time	Compilation and Link Time with List Option on
Pascal Sieve (with cache)	16	25	27
Pascal Sieve (without cache)	18	36	38
MBASIC Sieve	1197	—	—

**Table 1:** Sieve of Eratosthenes benchmarks were executed on the QDP-300 using Pascal/MT+ version 5.5 and Microsoft BASIC version 5.2. All times are in seconds. The Pascal compilations were executed with and without the 128K-byte cache buffer to demonstrate its effect on system throughput. Both compilations were performed on the 10-megabyte hard disk.

## At a Glance

### Name

QDP-300 Model 300FIH10

### Manufacturer

Quasar Data Products  
10330 Brecksville Rd  
Cleveland, OH 44141  
(216) 526-0838

### Dimensions

19.5 by 18 by 8.25 inches; 50 pounds

### Computer

Zilog Z80B microprocessor, 6-MHz clock; 192K bytes of RAM; three-slot S-100 bus (two expansion slots); two RS-232C serial ports; two Centronics-compatible parallel ports; real-time CMOS clock with battery backup

### Disk storage

One 10-megabyte fixed hard disk; one 1.2-megabyte, double-sided, double-density, 8-inch floppy-disk drive

### Software Included

CP/M-80 version 2.2 (uses 128K bytes for disk buffering), Perfect Writer, Perfect Speller, Perfect Filer, Perfect Calc

### Hardware options

256K-byte RAM disk (\$995), 512K-byte RAM disk (\$1395)

### Documentation

200-page Users Manual and Osborne CP/M User Guide by Thom Hogan

### Prices

Dual floppy, 128K-byte RAM system	\$3995
Single floppy, 10-megabyte hard disk, 192K-byte RAM system	\$6395
Single floppy, 15-megabyte hard disk, 192K-byte RAM system	\$6895
Dual floppy, 10-megabyte hard disk, 192K-byte RAM system	\$7145
Dual floppy, 15-megabyte hard disk, 192K-byte RAM system	\$7645

can be placed in the two empty slots of the three-slot S-100-bus motherboard, which is shown toward the back in photo 3.

At the very bottom of photo 3, barely visible, is the top of a 10-megabyte hard-disk drive manufactured by Miniscribe Corporation. The drive interfaces to the computer through a Western Digital WD1000 controller. The

floppy-disk drive is just above the hard-disk drive; a NEC D765AC chip controls the floppy-disk drive.

A battery keeps the CMOS (complementary metal-oxide semiconductor) MM58167 real-time clock ticking when the power is turned off. It was a nice feeling to have the QDP-300 greet me with the correct time and date when I unpacked it and typed in the CLOCK command. A voltage selector lets you choose between a 115-volt or 220-volt power source.

QDP provides a 12-month, on-site warranty, managed by General Electric Apparatus and Engineering Services, which has 50 service locations in the U.S.

## Software

The QDP-300 first awakes under the control of an 8K-byte ROM (read-only memory) monitor. The monitor provides the lowest level of housekeeping, including booting, system routines, and debugging support. The boot logic loads CP/M-80 version 2.2 from either the hard or the floppy disk.

Although the CP/M implemented is version 2.2, QDP's programmers have incorporated several features of CP/M Plus (or CP/M 3.0). The most outstanding feature, a cache BIOS (basic input/output system), divides the 192K bytes of total memory into a 128K-byte cache region and a 64K-byte CP/M region. The cache region contains much of the BIOS, a fresh copy of the CCP (console command processor) and the BDOS (basic disk operating system) for quick warm booting, and a cache or LRU (least recently used) buffer for disk sectors. The cache buffer stores disk sectors in memory as they are read. When an applications program requests a sector, the BIOS checks the cache first. If the sector is in memory, that is, in the cache, it is transferred to the applications program without performing a disk read. Transferring a sector from memory versus reading it from disk is like delivering a transcontinental message over the telephone versus sending it by horse. Programs running in a cache environment can increase throughput significantly.

With much of the BIOS residing in the cache region, CP/M's transient program area (TPA) weighs in at a healthy 55K bytes without overlaying the CCP, a generous allotment that few CP/M 2.2 systems can match. Another CP/M Plus feature inherent in QDP's enhanced CP/M is the ability to search for command files on other than the current drive. If a command file is not found on the current drive, the operating system automatically searches drive A for the command. This obviates the need to place copies of commonly used utility programs on each drive.

QDP supplements CP/M's standard repertoire with several utility programs, the most notable of which are HELP, MENU, HCONFIG, FORMAT, SECURE, HARD-BACK, and RESTORE. HELP adds a little hand-holding to CP/M's terse command structure. It supplies on-line assistance for the utilities. HCONFIG provides the tool for fine-tuning the system. It configures logical drive assignments, protocol for the I/O (input/output) ports, and the cold-boot auto-load command.



# STRATEGIC

Videotex may be more important to business than personal computers.

Reach new customers through the consumer medium of the 1980's.

Telidon/NAPLPS Companies pioneered the videotex standard and a kaleidoscope of services.

They're still leading the way in these markets.

# WIZARDRY

Let us help you plan your videotex strategy.

Send us your business card and we'll send you the strategic wizardry you need to stay ahead!

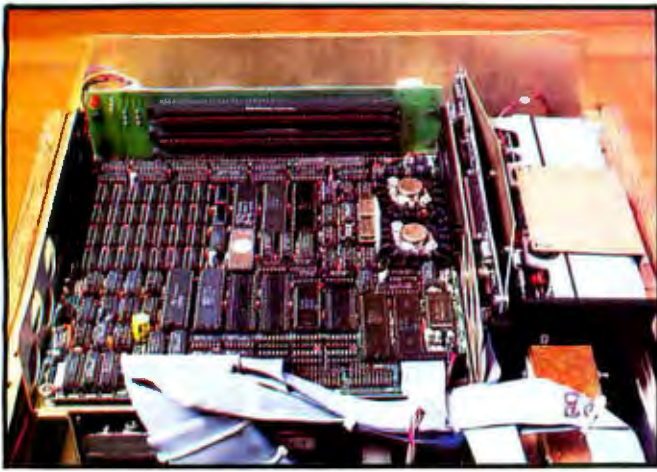
Telidon/NAPLPS Companies  
External Affairs Canada (TIS)  
125 Sussex Drive  
Ottawa, Ontario  
Canada  
K1A 0G2



Telidon/NAPLPS.

# TELIDON NAPLPS





**Photo 3:** The inside of the QDP-300. The hard-disk drive is on the right. Two S-100 bus connectors are in the left rear.

At first glance, **FORMAT** appears to be a typical program that writes track and sector-header information to a floppy disk in single- or double-density mode. You can select 128-, 256-, 512-, or 1024-byte sectors. QDP apparently believes that the variety of options enables customization of disk formats for optimal performance. I think that providing anything more than the usual single and double density (128- and 256-byte sectors) is overkill, but the flexibility might suit some discerning users.

**SECURE** wins the Strange Program of the Month award. According to the documentation, **SECURE** directs the Winchester hard-disk read/write heads to a safe "landing zone" and "should always be run before powering down the computer." As sure as the sun rises in the east, there will be times when either operator forgetfulness or an act of nature will cause the voltage to drop to zero before **SECURE** is executed. QDP claims that failing to run **SECURE** at power-down will probably result in loss of data on the hard disk. This is the first I've heard of such a limitation with a Winchester. Certainly there's a risk of data destruction if power is lost during a read or write operation; however, while the disk is idle, the heads shouldn't go diddling-bopping on the platter when the current is turned off. It sounds fishy; **SECURE** makes me feel insecure.

The **HARDBACK** and **RESTORE** utilities enable the hard disk to be conveniently backed up on eight double-sided, double-density disks.

QDP has added several systems features that make its CP/M more than just another plain implementation. All serial I/O ports are buffered up to 128 bytes. With a buffer that size, exceeding the type-ahead capacity of the keyboard is virtually impossible. System software automatically logs hard and soft disk errors. A utility program called **SYSTAT** can be used to display error counts. This feature is invaluable for earmarking marginal media or drives. Worn or deteriorating disks, for example, would post an inordinate number of errors.

## Benchmarks

Now that I've whetted your appetite with an overview of the QDP's innards, I'd like to discuss its most impressive feature—speed. Table 1 lists the results of the traditional Sieve benchmark (see "Eratosthenes Revisited: Once More through the Sieve," by Jim Gilbreath and Gary Gilbreath, January 1983 **BYTE**, page 283). The QDP clocks in at 16 seconds in Pascal/MT+, about 16 percent faster than the fastest Z80 Pascal listed in the aforementioned article. In Microsoft BASIC, the QDP-300 runs the benchmark about 19 percent faster than a Z80 machine running at 4 MHz.

Table 1 also shows the increased throughput attributable to the system's cache buffer. With the cache buffer enabled, the Pascal compilation and link run about 30 percent faster than without the cache.

To determine how the QDP-300 fares in word processing, I fed a 3600-word document into the Oasis Systems Word Plus spelling checker. Then, for a gross comparison, I ran the same document through Word Plus on a 2.5-MHz Z80 system with 64K bytes and dual, single-sided, single-density, 8-inch disk drives. The QDP knocked the socks off the disk-based system, processing the document in 30 seconds, one-tenth the time of the slower, albeit older and less expensive, computer.

Although benchmarks provide salient statistics, true appreciation of the QDP's speed comes only when you sit down at the terminal with your favorite software. Programs execute swiftly. On my old computer, I typically fill up the keyboard type-ahead buffer, then daydream while the processor catches up. But on the QDP-300, there's nary a moment between pressing the Return key and seeing the cursor flashing on the screen, awaiting your next command. Adjusting to the speed of the QDP-300 is a pleasurable experience. It's like flying to a distant city instead of taking the bus. You get to read fewer magazines, but you arrive at your destination faster.

## Documentation

The QDP-300's greatest weakness surfaces in its documentation. The 200-page users manual describes the hardware and software poorly. It chalks up demerits for its lack of organization, clarity, and comprehensiveness. The critical procedure of running the **SECURE** program before powering down mysteriously pops up on page 38 in a subsection describing the **MENU** utility. The text of the manual betrays its Wordstar origins in sentences like this: "Taking good care of your disks is essential, and you will be rewarded with minimum problems..PA." A word such as "optionnumber8willnotappear" indicates that several pages were treated with something bigger than a fine-tooth comb.

The most annoying attribute of the users manual is its self-congratulatory, backslapping tone. For example, the section entitled "Computer Error Messages" starts out saying, "One of the most important features of the QDP-300 is its unique error handling, both human and computer types. QDP was the first microcomputer com-



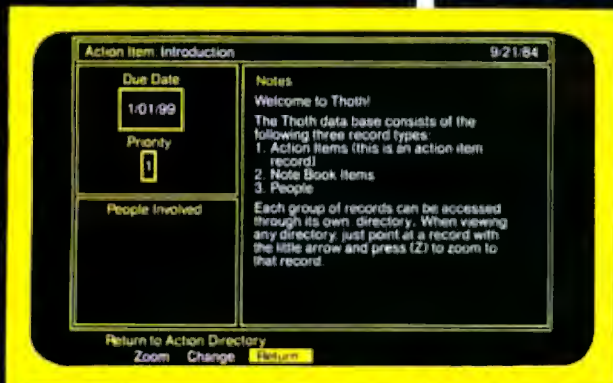


PERSONNEL DATA BASE  
MANAGER

# THOTH

TELLS YOU HOW TO  
ADDRESS PEOPLE

Designed for everyone from first time PC users to old pros, Thoth provides you with a confidential facility for personnel records organized and sorted in alphabetical order. Rapid interaction between three data bases, onscreen help and a fool-proof escape route help you to create records quickly and easily.



ACTION LIST DATA BASE  
MANAGER

## SO MAKE AN APPOINTMENT WITH THOTH

You'll never miss a deadline or an important meeting again — organize and sort by due date and priority. There's no better way to keep up-to-date than with Thoth.

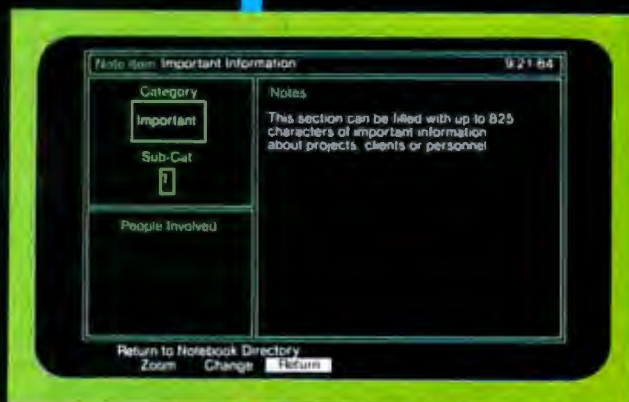
Thoth has been designed with your busy schedule in mind; with a friendly suggested retail price of \$99.95.

Thoth requires IBM® PC with DOS 1.1 or 2.0, 128K memory. Color/graphics adapter and color monitor suggested.

# THOTH

THROWS AWAY  
THE CABINET AND  
KEEPS THE FILES

Thoth also helps you keep important information in an organized fashion for easy access. File all your vital facts under Thoth. Organized and sorted by category and sub-category, they will always be at your fingertips.



NOTEBOOK DATA BASE  
MANAGER

# XOR CORPORATION

FIRST CLASS SOFTWARE

For the IBM® PC and compatibles

IBM is a registered trademark of International Business Machines Corporation

5421 Opportunity Court

Mnettonka MN 55343

(612) 938-0005

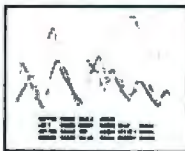


## VERSATILE DATA REDUCTION, DISPLAY AND PLOTTING SOFTWARE FOR YOUR APPLE\* II

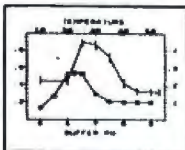
**STRIPCHARTER** — Turns your APPLE and Epson MX series printer into an economical 4-pen chart recorder. Prints and displays continuous 1 to 4-channel strip-charts of any length. Ideal for large data sets. Numerous user-selectable graphics options enhance output quality. Includes 5 demos on disk with 37-page manual \$100



**VIDICHART** — Proven tool for lab data management. Fast plots of 4 data sets with scrolling in 4 directions, zoom scaling on X and Y axes, 2 types of graphic cursors and on-screen STATUS REPORT, even plots A/D input while sampling. ADD, SUBTRACT, MULTIPLY, DIVIDE, INTEGRATE, DIFFERENTIATE, AVERAGE or NORMALIZE data sets with SIMPLE COMMANDS. Ideal for spectra, chromatograms, rate curves, etc. Includes SAMPLE DATA on disk with 28-page manual ..... \$75

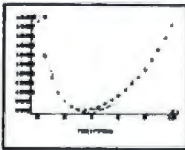


**SCIENTIFIC PLOTTER** — Draws professional-looking graphs of your data. You choose data format, length and position of axes, 20 symbols, error bars, labels anywhere in 4 orientations. Includes 5 demos on disk plus 30-page manual ..... \$25



(For DIF file and Houston Instrument or H-P 7470A plotter adaptations, add \$25 for each option selected.)

**CURVE FITTER** — Select the best curve to fit your data. Scale, transform, average, smooth, interpolate (3 types), LEAST SQUARES fit (3 types). Evaluate unknowns from fitted curve. Includes 5 demos on disk with 33-page manual ..... \$35



**SPECIAL: VIDICHART, SCIENTIFIC PLOTTER, CURVE FITTER on 1 disk ..... \$120**

Add \$1.50 shipping on all U.S. orders. VISA or MASTERCARD orders accepted.

\*Trademark of Apple Computer, Inc.



**INTERACTIVE MICROWARE, INC.**  
P.O. Box 771, Dept. 3 State College, PA 16801  
CALL (814) 238-8294 for IMMEDIATE ACTION

pany to introduce this feature." The manual goes on to describe how the BIOS traps disk errors and enables the operator to retry, ignore, or reboot instead of just returning to BDOS. "In our nasty scenario above things were looking pretty bleak," the text continues, "but now comes QDP to the rescue!!!" Yuk.

The description of the configuration program, HCONFIG, begins in a similar vein. "QDP has instituted a revolutionary utility program that changes the way our microcomputer operating system can be modified by end users." Come on, QDP. Any decent implementation of CP/M offers disk error trapping in the BIOS and a configuration program for modification of system parameters. Does the company really believe that its system, which was first sold in 1983, inaugurated these "revolutionary" features? Statements such as these remind me of Detroit's annual claims of revolutionary new automobiles.

To its credit, QDP supplements the documentation with a copy of *Osborne CP/M User Guide* by Thom Hogan. Jerry Pournelle recommends Hogan's guide as a "good introduction" to CP/M. It's definitely better than the standard documents distributed by Digital Research.

### Conclusions

If asked to summarize the QDP-300 in one sentence, I would paraphrase a statement from Peter McWilliams's *The Personal Computer Book*: "All things considered, I'd rather have a good computer with poor documentation than good documentation with a poor computer." In my experience, this hardware breaks all speed records for CP/M-80 programs. And the extra utilities and better-than-average BIOS earn the software a gold star.

The documentation falls short by any measure, but QDP's customer representative patiently guided me through the gray areas. The information he supplied over the phone, coupled with addendums sent a week later, filled many gaps in the original users manual.

Some people may be concerned about investing their computing future in a five-year-old company that, quite frankly, holds less than the lion's share of the market. This risk applies to many technological ventures, but on the brighter side, QDP has not retired its development staff after one system. The company recently announced the QDP-400, a six-slot, S-100 bus, Z80B system that includes the TurboDOS operating system from System 2000. A 16-bit coprocessor, which will open a path to the world of MS-DOS software, is in the works.

The complexity of the QDP-300 extends far beyond the needs of casual and first-time users. The computer's largest audience will be shops that employ professional programmers and systems houses that specialize in packaging hardware and software for small businesses. These sophisticated users should have no difficulty justifying the top-dollar price tag of this Z80 screamer. ■

*CP/M user Edward Joyce (Rt. 9, Box 149, Charlottesville, VA 22901) received his baptism in microcomputers at the Department of Computing and Information Sciences at Trinity University in San Antonio, Texas.*

## High Quality!

NDC SERIES  
100/200



## 5 1/4" DISK CONTROLLER

### KEY FEATURES

- Full sector buffering
- Logical sector addressing
- Multiple sector, cylinder operation
- 11 bit burst ECC
- Self-diagnostic capability
- Automatic sector alternation for the defective sectors
- Automatic Error Retry
- Industry Standard SASI I/F

### National Computer Ltd.

LIASON OFFICE IN CALIFORNIA  
PHONE:(408)734-1006 FAX:(408)744-0708

AKEBONO BLDG. 2-6-12 NIWAMOTO-CHO  
CHIVODA-KU, TOKYO, JAPAN  
PHONE:(03)863-6706 TLX:J27542  
FAX:(03)864-4581



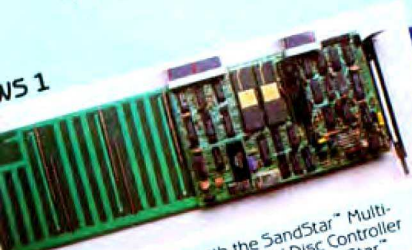
# NOW! Choose From 3 Hard Disc Drive Systems That Convert Your IBM\* PC To Perform Like The PC XT!

Our Winchester Hard Disc Drive Systems offer 10 Mega-bytes of formatted capacity, are internally installed and use available power!

Maynard Electronics introduces three Winchester Hard Disc Drive Systems — the only drive systems to offer you 10 Mega-bytes of formatted capacity with complete internal installation! These systems offer the user countless benefits and features: capability of booting off the hard disc; additional functions while requiring only **one** card slot in your PC; and, use of available power, thereby preventing overheating problems which have affected other drives. Handling heavyweight data was never easier.

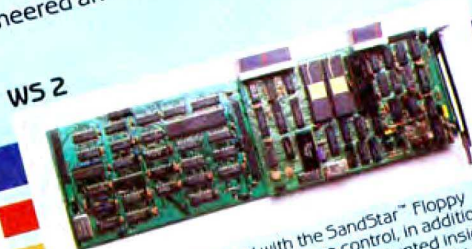
Each system is equipped with a low-power hard disc drive, complete software, cable, a SandStar™ Card and Hard Disc Controller Module. SandStar™ is the first family of modular peripherals created for the IBM\* PC. Simple instructions for easy installation are included and all components are backed by an Unconditional One Year Parts and Labor Guarantee.

All three systems are quality engineered and work with DOS 2.0 without any special software drivers and also run with other operating systems designed to make use of the XT hard drive ready to run!



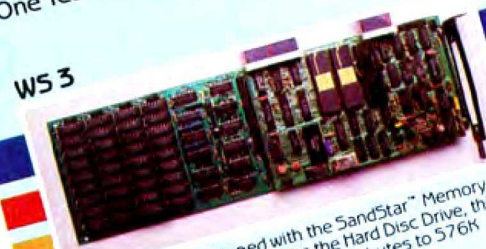
WS 1

This System is equipped with the SandStar™ Multi-function card. In addition to the Hard Disc Controller Module, you can add up to three other SandStar™ Modules while using only **one** card slot. The following modules are available: Serial Port, Parallel Port, Clock Calendar, Game Adaptor, and Prototyping Module.



WS 2

This System is equipped with the SandStar™ Floppy Drive Controller Card. The Card can control, in addition to the Hard Disc Drive, two floppy drives mounted inside your PC and optionally two additional 5¼" or 8" drives mounted externally. This leaves three system slots for other expansion boards.



WS 3

This System is equipped with the SandStar™ Memory Card. In addition to controlling the Hard Disc Drive, the Memory Card allows you to add 64K bytes to 576K bytes of memory using only one card slot.

To expand your PC to perform like the PC XT, one of our Winchester Hard Disc Drive Systems is right for you. And if you have already made the wise decision to install any of Maynard's SandStar™ Cards, the SandStar™ Hard Disc Controller Module may be purchased separately.

TO ORDER, CONTACT YOUR LOCAL DEALER OR DISTRIBUTOR.



**MAYNARD**  
400 East Semoran Blvd.  
Casselberry, Florida 32707  
305/331-6402

We make modern times better.

ELECTRONICS



Circle 252 on inquiry card.

\*IBM is a trademark of the International Business Machines Corporation.  
\*\*COMPAQ is a trademark of the COMPAQ Computer Corporation.





## **On IBM® PC compatibility, the portable computer, and you.**

### ***What is IBM PC compatibility and why is it important in a personal computer?***

IBM PC compatibility refers to a computer's ability to perform like an IBM Personal Computer. Its importance can be explained in one word: software. You see, the overwhelming success of the IBM PC has created a booming IBM compatible software industry. As a result, some of the most advanced and innovative software packages available today have been written specifically for the IBM PC. So no matter what your business problem, it is most likely that the software to solve it already exists. But only a truly IBM PC compatible computer can take immediate advantage of these hundreds of state-of-the-art programs. As well as future IBM PC software breakthroughs.

### ***Why are some computers more compatible than others?***

IBM PC compatibility can be a very relative term.

For example, a computer featuring the same 8088 microprocessor as the IBM PC, but without the necessary compatible disk operating system is not IBM PC compatible. Nor are computers advertised as IBM compatible that use 3 1/2" floppy disks (the IBM PC's are 5 1/4") or magnetic bubble memories. While these computers claim IBM PC compatibility, they will not run software written for the IBM PC without modification.

To make certain of a system's IBM PC compatibility, see if it can run popular software written for the IBM PC: Business programs like Lotus 1-2-3,™ VisiCalc,™ or WordStar.™ Games like Flight Simulator.™ Or educational software from Spinnaker.™

For true compatibility, you need a computer that can run all this IBM PC software right off the shelf. A computer like the Visual Commuter.™



# VISUAL

Visual Computer Incorporated

## ***The Visual Commuter: think of it as an IBM PC to go.***

Commuter offers you a level of IBM PC compatibility unsurpassed in a portable or desk-top computer. With the MS-DOS™ operating system, GW Basic.™ A full 83 key IBM PC identical keyboard. And unlike many so-called IBM PC compatibles, Commuter can run virtually all of the software written specifically for the IBM PC. Commuter's 5 1/4" floppy disks are interchangeable with the IBM PC. It also features IBM compatible color graphics and monochrome support. There's even a port for the IBM expansion chassis built right in.

## ***16 pounds of power at a very compatible price: \$1995.***

If you've ever lugged around a 35 pound computer with a handle, you'll appreciate the beauty of Commuter's design. At only 16 pounds (about half the weight of other portables in its class), Commuter has solved the weight problem that has plagued other full-function portables. Whether at work, home, or on a business trip, with Commuter you're travelling light. And at only 3 1/2" x 18" x 15" with built-in handle and carrying case, you can take it anywhere you can take a briefcase.

Commuter. With desk-top computer power including a 16 bit 8088 processor, 128K of memory (expandable to 512K), and a full 16 line by 80 column optional flat panel display. And built-in expansion capabilities for printers, hard disk, communications, and external monitors, including your television set.

Best of all, Commuter is priced at only \$1995. Now what could be more compatible than that?

For more information, call **1-800-847-8252** (in MA call **1-800-462-5554**), or write Visual Computer Incorporated, 135 Maple Street, Marlboro, MA 01752. Or visit your local Commuter dealer today.

## ***Commuter. It can take your business places it's never been.***

Visual Computer Incorporated is a wholly owned subsidiary of Visual Technology Incorporated. COMMUTER is a trademark of Visual Computer Incorporated. IBM is a registered trademark of International Business Machines Corporation. MS-DOS, GW Basic, and Flight Simulator are registered trademarks of Microsoft Corporation. Lotus and 1-2-3 are registered trademarks of Lotus Development Corporation. VisiCalc is a trademark of VisiCorp. WordStar is a trademark of MicroPro International Corporation. Spinnaker is a trademark of Spinnaker Software Corporation.

Circle 396 on Inquiry card.



**COMMUTER**<sup>™</sup>  
THE PORTABLE COMPUTER



## The Kaypro 10

*A hard-disk CP/M portable with a large software bundle and a small price*

Steve McMahon  
Independent Software Developer

Kaypro's hard-disk portable computer, the Kaypro 10, like its siblings, the Kaypro II and 4, is not a technologically innovative machine. Kaypro has taken existing single-board computer and Winchester hard-disk technology, combined with a monitor, keyboard, and floppy-disk drive and wrapped it all up in a simple bent-metal case.

On another score, though, the Kaypro 10 is very innovative. The equipment and power delivered for the price are outstanding. At \$2795 the Kaypro 10 costs less than many stand-alone hard-disk drives. And along with its 10-megabyte hard-disk drive comes a sturdy and serviceable CP/M microcomputer, a high-quality, built-in terminal, and an astonishingly large software bundle (see photo 1).

So, while the Kaypro 10 may have little to teach us about electrical engineering or systems programming, and nothing to teach about aesthetics or ergonomics, it offers many lessons about what kind of value is available for a limited budget.

### Hard Disk or 16 Bits?

The appearance of this hard-disk computer with software for under \$3000 will present many computer buyers with a dilemma: will they get better performance from an 8-bit machine with a hard-disk drive or a comparably priced 16-bit machine with floppy disks?

The answer, of course, will depend on the principal purposes for which the computer will be used. Large

spreadsheet applications, graphics work, high-precision computation, and heavy statistical analysis will likely be served better by the expandable RAM (random-access read/write memory) resources of a 16-bit machine.

But if you're doing a lot of word processing or database management, you'll probably find that the 8-bit machine with the hard disk is faster and more convenient than the 16-bit machine with only floppy disks.

A reliable hard-disk computer system like the Kaypro 10 is a joy to work on if you're used to floppy-disk-only systems. The advantages are speed and capacity. The Kaypro 10 reads and writes material to and from the hard disk at a rate two to four times faster than the floppy disk. Programs run faster and records are found more quickly (see table 1).

The difference in capacity adds up principally to great advantages in convenience. Working with the 10, I found I could keep all my current projects on the hard disk along with all the tools I needed to do the work, such as word processors, spelling checkers, compilers, and database programs. I could switch easily and quickly among projects and tools. Floppy-disk handling, and the subsequent likelihood of damaging disks, was cut to a small fraction of what it was on a floppy-disk-only system. I got a lot more done in the same time because I spent less time with the logistics of getting the right files onto the right floppy disks at the right moment.

For people doing a lot of database-management work, the added capacity of the hard disk may be not only con-





**Photo 1:** The Kaypro 10 and its documentation. Even glancing through all the documentation for the extensive software bundle is a major chore.

venient but necessary. It enables rapid access by more than one index to records that previously had to be stored on separate disks.

### The Winchester

A Winchester-type fixed hard disk is what makes all of this possible in an inexpensive portable. The two-platter, 10-megabyte drive manufactured by Tandon is sealed in its own container and double shock-mounted inside the 10. The sealing of the drive protects it from a possibly dusty or moist environment. Because there is only one drive, which cannot practically be removed, the drive must be backed up by copying its contents to floppy disks. The floppy disks can then be removed and protected.

### Safety

Included with the Kaypro 10 is a safety program that is an important part of the portability of the machine. The safety program must be run before the 10 is turned off. The program causes the hard-disk read/write heads to be withdrawn to a data-free "landing zone" where the heads can do no damage if they accidentally strike the disk surface during movement of the computer.

The 10 also automatically deselects the hard disk whenever it is not in use for more than a few seconds. While this probably slows the 10 down some on hard-disk access, it cuts the chances of damage to the disk if power is interrupted.

BASIC Benchmarks	Time (Seconds)	
	Kaypro 10	IBM PC XT
Disk Write (64K bytes)		
Floppy Disk	65	29
Winchester	15	8
Disk Read (64K bytes)		
Floppy Disk	17	23
Winchester	9	8

**Table 1:** Disk read and write speed comparisons of the Kaypro 10 and the much more expensive IBM PC XT. The comparison mainly serves to highlight the slow speed of the Kaypro's floppy- and hard-disk write routines. The Kaypro test was made with Microsoft's BASIC-80, which is included with the 10. BYTE's benchmarks are listed in the January 1982 BYTE, page 54.

### Transporting the 10

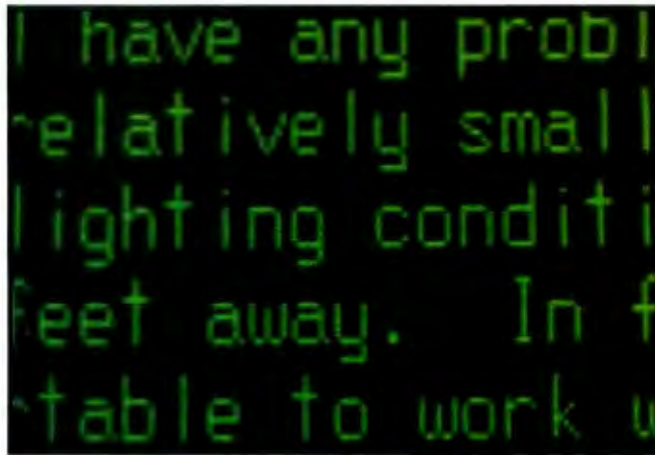
Calling the 10 a portable is pushing the definition of portable. At 30 pounds, it's a hefty burden to carry for more than a block or so. Anyone doing that will also discover that the carrying handle is quite uncomfortable.

Nonetheless, the 10 folds up into a neat package that can be carried easily to a car parked nearby, or it can be moved from room to room. The 10 fits under most major-airliner seats—a popular benchmark for portability—as long as you avoid the window seats. You won't have any leg room left over, but it's much preferable to





**Photo 2:** The complete character set of the Kaypro 10. The 10 includes a good collection of graphics characters.



**Photo 3:** A close up of the Kaypro 10's display. Note the very high resolution and the fact that character spacing is a bit uneven.

checking the computer as luggage (a Kaypro technical-support hotline employee told me this would constitute abuse of the computer).

If you carry the Kaypro around much you should definitely get a cover of some sort for it. Even folded up for transport, all the Kaypro 10's ventilation slots are completely open to dust and moisture.

The 10 I tested survived my carrying it around from day to day with no difficulty at all. While I didn't deliberately drop it, I did bump it around some, and nothing went wrong. The machine also survived being shipped across the country twice without accumulating any bad spots on the hard disk in the process.

By this measure, Kaypro's shock-mounting system for the Winchester seems to be a success. Despite this, I have

one complaint: the *Kaypro 10 User's Guide* offers no guidelines at all on how to transport the machine safely or what kind of shocks it can be expected to survive. Presuming that the hard disk is vulnerable, I found this to be a distressing omission.

### The Display

The folks at Kaypro have certainly packed a beautiful monitor into this metal box. The 9-inch non-glare screen holds a full 25 rows (only 24 easily available to the user) and 80 columns of very clear green-phosphor characters. The characters are composed of 14 dots vertically by 7 horizontally, with 3 of the 14 vertical dots used as true descenders (see photo 2). The screen's resolution is much better than the Kaypro II's and the characters are a lot

## At a Glance

### Name

Kaypro 10

### Manufacturer

Kaypro Inc. (formerly Non-Linear Systems)  
533 Stevens Ave.  
Solana Beach, CA 92075  
(619) 755-1134

### Dimensions

19 by 17 by 9 inches (when closed for transport); 30 pounds

### Components

Processor: 4-MHz Z80; Memory: 64K bytes RAM; Display: built-in, high-resolution 9-inch green-phosphor; 80 by 25 display with underline, reverse-video, half-intensity, blinking, or in combination. Graphics Format: 160- by 100-pixel graphics-plus-character graphics. Keyboard: 75 full-ASCII keys in Selectric-style layout; 14-key numeric keypad and 4-key cursor vector pad double as user-definable function keys

### Mass storage

1 shock-mounted 10-megabyte (8944K bytes available) fixed hard-disk drive subdivided into two logical drives; 1 half-height double-sided, double-density 390K-byte floppy-disk drive

### Interfaces

1 Centronics-type parallel printer port; 2 RS-232C serial ports; 1 light-pen port

### Software

CP/M version 2.2 with enhancements for easier employment of user areas. Word Processors: Wordstar version 3.3, Perfect Writer version 1.20. Spreadsheets: Perfect Calc version 1.10. Chang Lab's Microplan. Spelling Checkers: The Word Plus, Perfect Speller. Database: Perfect Filer. Programming Languages: Microsoft BASIC, CBASIC, and Topaz Programming's S-BASIC. Communications: Superterm, a smart-terminal program with XMODEM protocol option. MUFBAR disk-backup system. Assorted games

### Options

Kaylink mainframe-to-microcomputer synchronous communications package. Kaynet networking system. Contact Kaypro for prices and availability

### Documentation

*Kaypro 10 User's Guide*, approximately 150 pages, from Kaypro. Manuals for all software items (except games). Reference cards for Wordstar and all the Perfect Software. A current copy of Kaypro's magazine *Profiles*

### Price

\$2795



# A printer should complement your computer, not compromise it.



It's a simple fact that your small computer can compute a lot faster than your printer can print. A problem that becomes even more frustrating in business, when your computer is tied up with your printer while you're ready to move on to other work.

Of course, the only thing more frustrating than waiting on a slow printer is waiting on a printer that's down. And unfortunately, chances are the initial printer you purchased with your computer system just isn't designed to work on continuous cycle high volume printing.

More than likely, you've already experienced one, if not both of these frustrations. But now, you can turn printer frustration into printing satisfaction with the new Genicom 3014, 3024, 3304 or 3404. Professional printers for personal computers...price/performance matched.

Designed and built to increase productivity and maximize the value of your personal computer, the range of 3000 PC printers offers 160-400 cps draft, 80-200 cps memo, and 32-100 cps NLQ printing...performance for both high productivity and high quality printing.

The 3014/3024 models print 132 columns, while the 3304/3404 models give you a full 136 column width. The 3304 and 3404 models even offer color printing.

Each printer is easy to use, lightweight, functionally styled and attractive. And you can choose options from pedestals and paper racks to document inserters, sheet feeders and 8K character buffer expansion, plus more.

Genicom 3000 PC printers feature switch selectable hardware, dual connectors and dual parallel or serial interfaces, plus software emulations for Graftax Plus and Okidata Microline 84 Step II. So your current system is most likely already capable of working with these Genicom printers without modification.

Most important, the Genicom 3000 PC printers are quality-built, highly durable printers designed for rapid, continuous duty cycle printing.

So why wait? And wait. And wait. Get a Genicom 3000 PC printer now.

Genicom Corporation, One General Electric Drive, Dept. C411, Waynesboro, VA 22980.

# GENICOM

## The New Printer Company.

For the solution to your printing needs call

**TOLL FREE 1-800-437-7468**

In Virginia, call 1-703-949-1170.

See us at  
**COMDEX/SPRING**  
Booth 3650



# WANTED

"Buyers," & "We'll pay the shippin'"

• CALL FREE (800) 654-4058 •

"Call For Reduced Prices At Various Quantities"

Verbatim	Dysan CORPORATION	3M Scotch
5 1/4" sin-side dbl-den. 2 40	5 1/4" sin-side dbl-den. 3 20	5 1/4" sin-side dbl-den. 2 20
5 1/4" dbl-side dbl-den. 3 45	5 1/4" dbl-side dbl-den. 4 20	5 1/4" dbl-side dbl-den. 3 20
5 1/4" sin-side quad 3 20	5 1/4" sin-side quad 4 45	8" sin-side sin-den. 2 35
5 1/4" dbl-side quad 4 40	5 1/4" dbl-side quad 4 95	8" sin-side dbl-den. 2 95
8" sin-side sin-den. 2 75	8" sin-side sin-den. 3 45	8" dbl-side dbl-den. 3 90
8" sin-side dbl-den. 3 05	8" sin-side dbl-den. 4 45	
8" dbl-side dbl-den. 3 40	8" dbl-side dbl-den. 4 95	
Head Cleaning Kits... 5 20	We Stock "Bulk-Packed" Diskettes	Disk Minder • Smoked Plastic • Holds 75 Disks 16 75 ea
Refills . 955		Dealer Inquiries Welcomed

Prices per ea.  
10 per box

the **Diskette Connection**<sup>™</sup>

P.O. Box 1674  
Bethany, OK 73008

VISA

\* (Continental U.S. only. Add 3% on orders under 40%)

more readable than the II's (see photo 3).

I don't think most people will have any problems reading this display, despite its relatively small size. It was quite readable under a variety of lighting conditions and at distances from very close to 5 feet away. In fact, I found this screen to be a lot more comfortable to work with for extended periods than many 12-inch monitors on nonportable computers.

The only advantage these larger, separate monitors have over the Kaypro's is that some may be easily adjusted for height and angle. Adjusting the Kaypro's monitor position or angle involves moving the whole machine laterally and propping things under it. It would have been nice if Kaypro had provided an adjustable stand to compensate for users' preferences and working conditions.

The 10's monitor is versatile as well as readable. It offers reverse video, half-intensity, underlining, blinking, and any combination of these video effects. Most of the 10's users won't see much of this versatility, though; only a small number of the programs included with the 10 make use of even the reverse video.

The reverse-video effect was very irritating to my eyes when it occupied more than a tiny portion of the screen. Unfortunately, Kaypro chose to make Wordstar's menus and status line appear in reverse video. The result is a glaring screen that makes it hard to concentrate on the text at hand. I was able to solve this problem by patching Wordstar to use half-intensity type rather than reverse video for its menus. Users who don't know how to patch Wordstar and don't have a sympathetic dealer won't be so lucky.

There shouldn't be any trouble getting applications software that will operate acceptably on the 10's screen because Kaypro imitated the popular Lear-Siegler ADM-3A methods for clearing the screen and addressing the cursor. Getting commercial software to use the previously mentioned video effects, though, will require some extra work on either the user's or the software vendor's part, because Kaypro went its own way in determining the codes to invoke these features.

## Graphics

Ultrahigh resolution for text does not mean high resolution for graphics. The 10 offers bit-mapped pixel (picture element) graphics, but the resolution is only 160 by 100 pixels. These plump pixels can be used for bar charts if there aren't too many bars and there certainly will be a few games written to make use of them. But my guess is that there won't be a whole lot of use made of the 10's pixel graphics by applications programmers. If you're thinking of purchasing the 10 rather than another computer because of the 10's graphics, you should think again unless you're only after a taste of graphics programming.

The 10 also offers a good set of graphics characters that should prove marvelous for drawing up sharp menus or such. The graphics characters aren't documented in the manual, but Kaypro includes the source code for the

**SPAN THE PRESENT AND FUTURE**

Keep in touch with your IBM PC or APPLE II through our new compatible peripherals

KEYBOARDS, FLOPPY DISK DRIVES, HARD DISK DRIVES, MONITORS, PRINTERS, SWITCHING POWER SUPPLIES . . .

SKB-000

WINCHESTER HARD DISK DRIVE  
8 1/2" 10 MB

FLOPPY DISK DRIVES 3 1/2"

HALF HEIGHT FULL HEIGHT

SKB-400

SKB-300

IBM COMPATIBLE HARD DISK CONTROL BOARD

SKB-2000

**SUPERCOM**

SUPERTRON ELECTRIC CO., LTD.  
P.O. Box 55-1326, Taipei, Taiwan, R.O.C. Telex: 24317 SUPEROHM  
Cable: "SUPEROHM" Taipei Tel: (02) 541-7401/2, 713-3492



# THE BUFFER DID IT.

## Who Stole The 1500 Letters From The Computer?

Let's just say you've got to send a letter to 1500 different people. Would you like to spend 22.5 hours\* or 60 seconds of computer time?

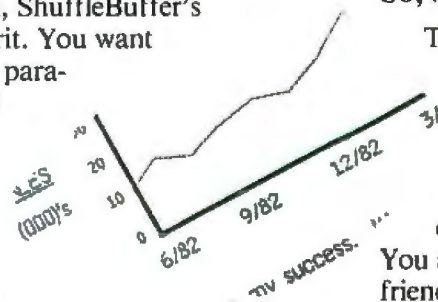
With a garden-variety buffer, the computer has to mix, merge and send 1500 addresses and 1500 letters to the buffer. Trouble is, most buffers only store about 32 letters. So after 32 letters, the computer's down until the printer's done. Altogether, you're talking 22.5 hours.

In the case of our new (not to mention amazing) ShuffleBuffer, computer time is 60 seconds flat. Just give

ShuffleBuffer one form letter and your address list, and it takes care of the mixing, the merging, and the printing. But that's not all ShuffleBuffer's stolen from the computer. Oh, no.

## Who Changed and Rearranged The Facts?

Again, ShuffleBuffer's the culprit. You want to move paragraph #1 down where #3 is? Want to add a chart or picture? No problem. No mystery, either. Any buffer can give you FIFO, basic first-in, first-out printing. And some



buffers offer By-Pass; the ability to interrupt long jobs for short ones. But only ShuffleBuffer has what we call Random Access Printing — the brains to move stored information around on its way to the printer. Something only a computer could do before. Comes in especially handy if you do lots of printing. Or lengthy manuscripts. Or voluminous green and white spread sheets. And by the way, ShuffleBuffer does store up to 128K of information and gives you a By-Pass mode, too.

## And Who Spilled The Beans 239 Times?

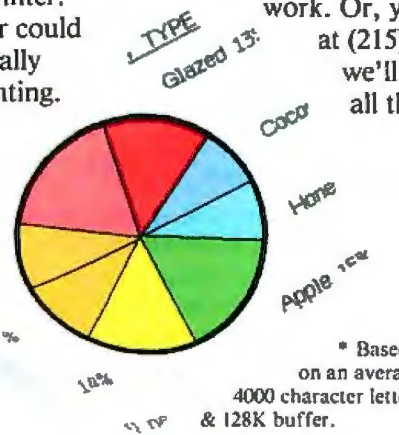
Most buffers can't tell the printer to duplicate. If they can, they only offer a start/stop switch, which means you're the one who has to count to 239. Turn your back on your buffer, and your printer might shoot out a room full of copies. ShuffleBuffer, however, *does* control quantity. Tell it the amount, and it counts the copies. By itself.

## So, What's The Catch?

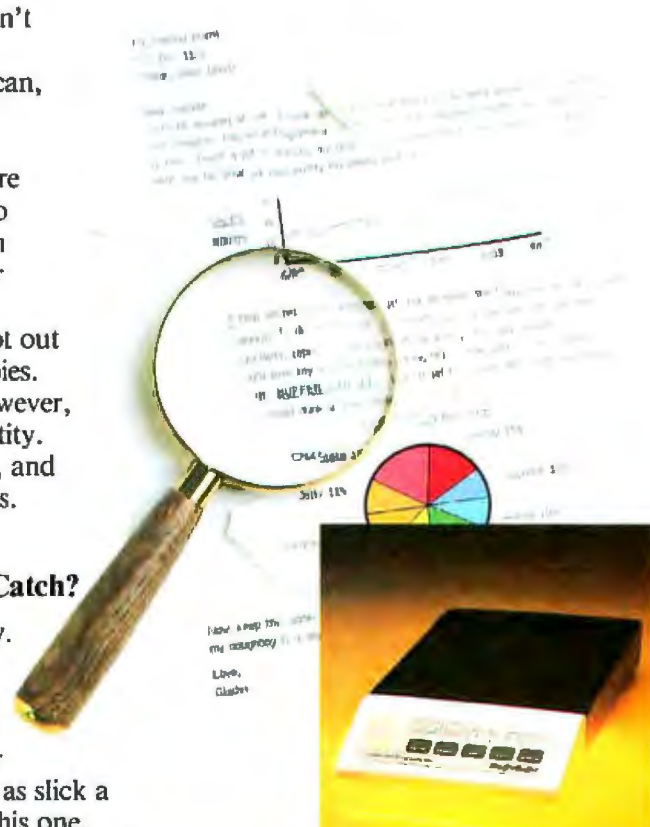
There isn't any. Sleuth around. You won't find another buffer that's as slick a character as this one. You also won't find one that's friendly with any parallel or serial computer/printer combination. This is the world's only universal buffer. With a brain.

## Who Wants You To Catch A ShuffleBuffer In Action?

You guessed it. We do. Just go to your local computer dealer and ask him to show you a ShuffleBuffer at work. Or, you can call us at (215) 667-1713, and we'll clue you in on all the facts directly.



Now, keep it. Love, Gladys



**ShuffleBuffer**  
The Buffer with a Brain  
Interactive Structures Inc.  
146 Montgomery Avenue  
Bala Cynwyd, PA 19004



## Peripheral Networking Now



### Buy ASCII Intelligent Port Expanders

- Eliminate Manual Switching by Remote Control
- Improve Productivity and Reliability
- Share Printers, Modems or Plotters
- Expand Computers or Terminals
- Use Matrix Switching for Multiple Transmission or Security
- Supports Polling and Queuing

INSTANT COMPATIBILITY with new computer devices and MAJOR OEM PRODUCTS:

Allos — Burroughs — Data General — DEC  
H.P. — IBM — NCR — Northstar — Victor  
and other key manufacturers.

Call 213-793-8979 to EXPAND YOUR SYSTEMS TODAY.



**Advanced Systems Concepts Inc.**  
435 N. Lake Ave., Dept. B5  
Pasadena, CA 91101  
800-824-7080 Telex: 701 215

## THE PURCHASING AGENT

We can buy any microcomputer product for you from our 299 participating wholesalers. Here are the net prices on a few of the 7,000 products we can buy for you, acting as your purchasing agent.

COMPUTERS		COMPUTERS		MONITORS	
Altos 580 10	4,199	Northstar Advantage w/Dual Floppies w/5 meg	2,107	Amdak RGB II	450
586-20 w/o term	5,725	Onys C5002A, 256K, 14M	3,249	1410 RGB	532
986-40	9,027	Sage II, w/2.540K	9,022	Princeton RGB w/cable	780
Compupro Godbout -		IV, w/12 meg	5,830	All others	485
Sys 816A RAM 17*	4,065	IV, w/40 meg	7,985	Houston Instr., DMP 41	2,321
Sys 816A RAM 21*	4,179	Sanyo 555, w/2-160K	1,100	Strobe M 100	481
Sys 816C*	6,459	Televideo TS-1605PC	2,356	All others	CALL
Sys 816CH*	8,482	Zenith ZF-100-21	2,157	ZF-110-22	2,685
Sys 816D*	8,856	ZW-120-32	4,245	All others	CALL
Sys 816E*	9,887	All others	CALL	Anadax 9625B car	1,190
Sys 816Z*	3,722			C. Roh A 10-20	534
*Completely Assembled				Diablo 930 API	1,615
M-Drive-H	1,100			NEC 771D	1,900
RAM 21, 128K, 14 Mhz	788			Okidata	CALL
RAM 22, 256K	1,222			Toshiba P 1340	798
Pragmatic 20 meg.	2,990			All others	CALL
Pragmatic 40 meg.	4,888			IBM PERIPHERALS	
Columbia Sys. 2-320K	2,779			IBM PC, mono, 2 320K	2,950
Sys. 12 meg.	4,119			Keytronics 5150 Keyboard	189
Sys. portable	2,339			MODEMS	
Corvus Concept, 256K	2,999			Hayes 1200	499
Eagle 1630	4,699			US Robotics Paseword	349
Molecular SM 8 10 meg.	4,848			TAX SOFTWARE	
NEC APC-H03	2,999			Microtax	CALL
APC-H12 Col. Graph	6,118				
APC-H26 10 meg	2,172				

CALL US FOR THE NET PRICE ON ANY OF THE 7,000 OTHER PRODUCTS WE CAN BUY FOR YOU AS YOUR PURCHASING AGENT.

Since 1980

F.O.B. shipping point. Prices subject to change without notice.

B-84-5

**THE PURCHASING AGENT, INC.**  
574 Weddell Drive, Suite 5  
Sunnyvale, CA 94089  
(408) 744-0646



10's menus, all of which make use of the special characters. (You'll have to hunt for these, though, as the *User's Guide* doesn't tell you where to look.)

### The Keyboard

The 10's detached keyboard covers the monitor and floppy-disk-drive opening when the machine is packaged for travel. In use, the keyboard is connected to the back of the computer by a curly cord similar to the one that connects most telephones with their handsets (in fact, the modular jacks and connectors are exactly the same). The cord allows you about 3 feet of play without stretching it too far, so I had no trouble finding a comfortable place to put it for typing.

The touch of the keyboard is smooth and consistent, but extremely light. Even though I am accustomed to light keyboards (I use a Kaypro II), I still make a lot more errors than usual when working with the 10. Presumably, if you type only on this keyboard you'll get used to the light feel, but it might be difficult to switch back and forth between the 10 and other keyboards.

The keys themselves are well designed and conveniently arranged; for instance, the Return and Shift keys are large and placed where most touch-typists expect them. The keyboard makes a noise that sounds like a cross between a squeak and a click when keys are pressed or when they repeat. The sound is not adjustable, but the manual does tell you how to turn it off.

All the keys repeat when held down for more than a fraction of a second—unless you are holding down the Control key at the same time. Control characters don't repeat. I found that to be quite a problem, particularly when using Wordstar and Perfect Writer, until I learned how to use the function-key facility to put frequently used control characters on the numeric keypad, where they can repeat. This worked well, but it would have been better if the control characters repeated when used normally.

The function-key facility is one of the nicest but also most poorly documented of the 10's facilities. Each of the 14 keys on the numeric keypad and the four additional cursor-control keys can be redefined to produce the equivalent of up to four keystrokes when pressed. A program, Config.com, included to accomplish this redefinition is well designed and also lets you change the default printer port and the data-transmission rates of both serial ports. The problem is that there is only a brief and very incomplete mention of this important program in the *User's Guide*. Many users will never discover that they have function keys.

### The Operating System

When using nearly 10 megabytes of storage, it's critically important to be able to subdivide the directory so that the whole multiscreen mess doesn't appear every time you ask for a directory. CPM versions 2.0 and later (the Kaypro's is 2.2) solve this problem by allowing each drive to be logically broken into as many as 16 user areas. Each of these user areas is invisible to each other area, even



INTERFACE IT.....PUT IT IN PRINT

# JUKI<sup>®</sup> MODEL 6100

THE  
LETTER QUALITY  
DAISYWHEEL  
PRINTER HAS PC  
COMPATIBILITY

**\$599\***



If word processing has become increasingly important in considering the growth of your personal computer system, then your choice in selecting a printer should be a major decision, not a major investment. If PERFORMANCE, COMPATIBILITY and PRICE are significant factors in determining your decision, then the Juki Model 6100 Letter Quality, Daisywheel Printer will benefit you. Here's why...

## PERFORMANCE

Engineered for precision performance, the Juki Model 6100 has been field tested and proven for accuracy, reliability and versatility. It prints bi-directionally at 18 cps, has proportional spacing, 10/12/15 pitch and performs the latest word processing functions including superscript, subscript, bold/shadow printing, double strike, underlining and graphics. It houses over 40 built-in control commands, has a buffer memory expandable to 8k, and operates on a linear induction motor ensuring accurate positioning. Also, the Juki Printer is lightweight and conventional in design, has a low noise level and is available with a Tractor Feed. \*Tractor Feed optional.

## COMPATIBILITY

Interface it... the Juki Letter Quality, Daisywheel Printer is compatible with all major personal computers and is equipped with Centronics Parallel interface as standard equipment and is available with the RS-232C Serial connection as well. It conveniently uses IBM Selectric™ ribbons and 100 character Royal/Adler™ daisywheels with a variety of type styles to choose from.

## COST BENEFIT

With all the advanced features of a higher priced unit combined with convenience and dependability, the low cost of the Juki Model 6100 adds up to one thing... hard copy at a soft price.

At \$599.00 the Juki Model 6100 Letter Quality, Daisywheel Printer will complement your personal computer system with a minimum investment.

Contact your local  
Juki Distributor for  
further details.



## JUKI INDUSTRIES OF AMERICA, INC.

ACORN DATA PRODUCTS  
7304-L South Alton Way  
Englewood, CO 80112  
303/779-6844  
Serving:  
MT, WY, CO, UT, NM

BUTLER ASSOCIATES, INC.  
82A Winchester Street  
Newman, MA 02181  
617/864-5270  
Serving:  
ME, NH, VT, CT, RI, MA

COMPUTER SERVICES  
INTERNATIONAL CORP.  
560 Sylvan Avenue  
Englewood Cliffs, N.J. 07632  
201/569-8300  
Serving: METRO NY, E. PA, NJ

DENTY ASSOCIATES, INC.  
7695 Currency Drive  
Orlando, FL 32809  
305/858-7450  
Serving:  
TN, NC, SC, MS, LA, AL, GA, FL

INFORMATION SYSTEMS, INC.  
2430 E. Oakton Street, Unit H  
Arlington Heights, IL 60005  
312/228-5488  
Serving:  
WI, IL, MN, IA, MO, NE, ND, KS, SD

INTERNATIONAL BUSINESS  
SYSTEMS CENTER  
7023 Little River Turnpike  
Annandale, VA 22003  
703/750-3085  
Serving: MD, DE, DC, VA

OSSMANN COMPUTER  
TECHNOLOGIES, INC.  
6880 Old Collierville Road  
E. Syracuse, NY 13057  
315/437-6666  
Serving: UPSTATE NY

SIGMA DISTRIBUTING  
2110 116th Ave. N.E.  
Bellevue, WA 98005  
206/454-8307  
Serving:  
WA, OR, ID, AK

SOUTHERN MICRO  
DISTRIBUTORS  
8780 Royal Lane  
Irving, TX 75063  
214/258-8638  
Serving: TX, OK, AR, LA

STAR-TRONIC  
DISTRIBUTOR CO.  
23978 Fromway Park Drive  
Farmington Hills, MI 48024  
313/477-7908  
Serving: MI, IN, OH, KY, W. PA, WV

TECHNOLOGY MARKETING CORP.  
2300 Valley View Lane  
Suite 108  
Dallas, TX 75234  
214/243-7084  
Serving: TX, OK, AR, LA

VITEK  
830-B Boardwalk Avenue  
San Marcos, CA 92069  
619/744-8385  
Serving:  
S. CA

WESTERN MICRO  
TECHNOLOGY  
10840 Bubb Road  
Cupertino, CA 95014  
408/725-1880  
Serving: N. CA, NV, AZ

NATIONAL HEADQUARTERS,  
JUKI INDUSTRIES OF AMERICA, INC.  
DA DIVISION  
298 Market Street  
Saddle Brook, NJ 07642  
201/388-3666

WEST COAST  
JUKI INDUSTRIES OF AMERICA, INC.  
CALIFORNIA DIVISION  
3555 Lomita Boulevard  
Torrance, CA 90509  
213/325-3083





Photo 4: The Kaypro 10's main menu.

though they take up space on the same disk. Size of user areas is flexible; each could potentially contain nothing or utilize the entire disk.

Kaypro made a couple of modifications to the CP/M's CCP (console command processor) that make a world of difference in the usefulness of the user-area feature. The modified CCP displays the current user area along with the current drive letter whenever it prompts the user for a command line. So the usual CP/M A> prompt is replaced with A0>, A1>, . . . , A15>, depending on which user area you're logged to. Also, whenever a command file is asked for that can't be found in the current user area, the CCP searches user area zero for the program. This means you can place most of your utilities in user area zero and they'll be available no matter what area you're logged to. (Unfortunately, programs like Wordstar can't find their overlays in different user areas, so there are still problems.) These little changes save a lot of time and trouble in day-to-day work.

## Hard-disk Backup

Hard-disk backup should be easy and reliable. Winchester drives may be more reliable than floppy disks, but they still make errors. With the capacity of a hard disk, a directory error or a hard-disk failure can make a real mess.

Fortunately, Kaypro has included a quite workable hard-disk backup system with the 10. The MUFBAR (multi-floppy backup and recovery) system will back up anything, from an entire user area to individual files, from the hard disk onto floppy disks.

MUFBAR will automatically break up very large files onto multiple floppy disks if necessary. This capacity is an important one if you're thinking of keeping a large database on the 10. This backup program also gives you the ability to "stamp" backup disks with a note about the time and contents of the backup.

What the program won't do is tell you which files need backing up. As provided by Kaypro, CP/M offers no facility for marking files that have been changed so that

just the changed files may be backed up. This means that either you'll have to keep a list of what files have been altered since the last backup or you'll have to back up all the files every time. Because the hard disk contains the equivalent of about 23 floppy disks, the latter would be a burdensome task.

In an environment where several people use the machine and each can't be disciplined to keep records of files changed, a floppy-disk backup system could mean courting disaster, no matter how convenient the backup program is. Such users would be well advised to look for a hard-disk computer with a better backup system, even though it is likely to be a far more expensive system than the 10.

## Menus

The Kaypro 10 includes a set of menus extensive enough that many users may be able to completely avoid learning CP/M if they wish.

The master menu (see photo 4), which automatically runs when the 10 is turned on (this auto-load feature may be turned off easily by running a program called Nomenu.com), enables you to run any of the major programs provided with the Kaypro. All you have to do is move the cursor to the program desired and press the Return key. Brief explanations of what each program can do are provided in an information area on the right side of the menu. The explanations change depending on where you have positioned the cursor.

The main menu chains into a set of subsidiary menus in cases where there are more decisions to be made. These special-purpose menus follow exactly the format of the main menu. All are quick to use and intelligible.

I liked these menus a lot better than any of the other menu systems I've seen on inexpensive microcomputers. The reason the Kaypro menus worked, though, didn't have as much to do with the menu design as with the hard disk. Most microcomputer menu systems break down because all the applications you might want to run are not available on the same disk. Thus, the menus lead you through disk changes in a way that necessarily leaves room for errors the menu system can't deal with well. This problem goes away when the menu can immediately run the desired application.

The hard disk also eases up the space constraints that hinder the designers of a menu system. The 100 or so kilobytes an adequate menu system might require is a big sacrifice on smaller-capacity, floppy-disk-only computers.

The 10's menus, though generally very useful, do have some annoying flaws: chief among these is that there are some important omissions from the menus. For example, the hard-disk backup system is completely menu-driven, except for the fact that you can't format a floppy disk from the menu. So backing up disks requires you to leave the menu system. Anything that makes the backing-up process harder or more confusing is a real problem.

Also, there is no easy way for you to customize the



# NOVATION OUT SMARTS HAYES

Take a look at both and you'll discover the Novation Smart-Cat™ modems give you everything you get with the Hayes Smart-modem—plus some extras.

#### Off-the-shelf software

It's a draw. There's a lot of software for both.

For the Smart-Cats, there's ASCII Express™, The Pro™, Crosstalk XVI™, Transend™ and more that let you do virtually anything you'd like. No compromises.

#### Only on the Cats:

##### Instant status report

Place a call and your Smart-Cat knows what's going on every microsecond. Fail to get a dial tone? Your Smart-Cat tells you right now. With Hayes, you can wait through an entire call-answer cycle—then wonder what went wrong.

##### Dial tone detect on long distance

With special long distance telephone services, you must wait for dial tone part way through a long dialing sequence. The Hayes modem relies on a pause—which works if things go just right. Smart-Cat waits, detects the tone, then completes dialing. It always works.

##### True, automatic "redialing"

The Hayes modem gives you a simple Repeat of the last command. Enter another command since you last dialed and you've lost the number.

Smart-Cats give you both Redial and Retry. Redial calls the last number dialed no matter what has happened in between.

Retry keeps retrying on a busy signal. A handy time-saver.

##### Easy on-line commands

With Hayes, you need escape and re-entry codes when on-line. With the Cats, just enter a single command—or even string a bunch together. Smart-Cats follow them,

then go back on-line. No lost contacts. No lost data.

#### Test everything

The Hayes modem has only internal self-testing. But the Cats do more.

They also test the rest of the communications loop. At

1200 baud, the Cats can automatically run data over the line, through the other

modem and back. You know if your modem is right. You

know if the rest of the loop is right, too.

#### Novation LSI vs. Hayes discrete

##### components

Large Scale Integrated (LSI) circuits—more and more logic on a smaller and smaller chip—is today's technology. It's the breakthrough that has made personal computers possible. It eliminates all kinds of parts and adds all kinds of logic. Our LSI does something else extremely logical. It cuts costs.

#### \$595\* (Novation) vs. \$695\* (Hayes)

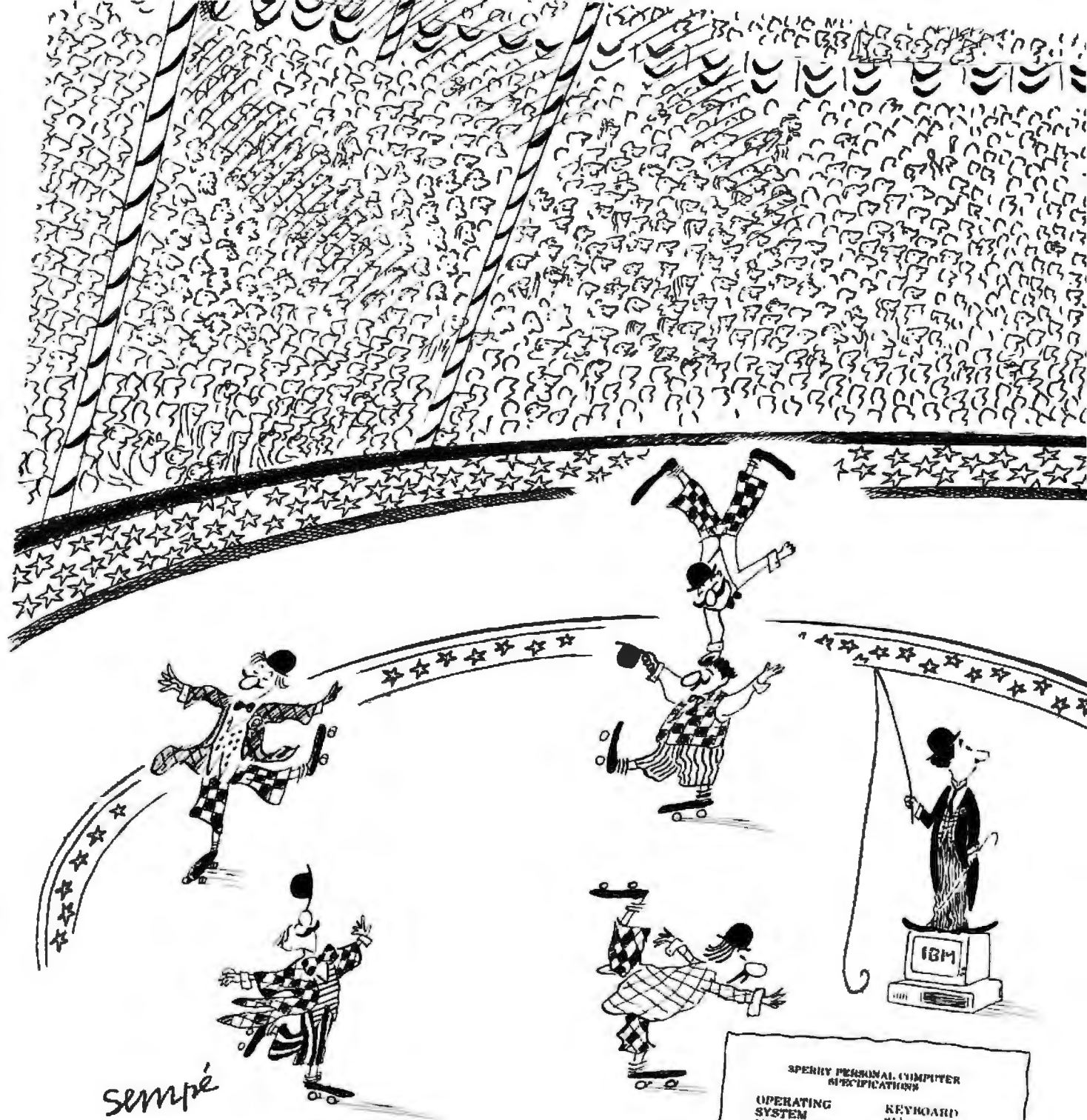
The Smart-Cat 1200 is \$100 less than the Hayes Smartmodem 1200. Now that's a lot smarter.

Lower price, LSI technology, lots of software—and no waiting. You can see them now at your computer store and let your computer out tonight.

Novation, Inc., 20409 Prairie Street, Box 2875  
Chatsworth, CA 91311 • (800) 423-5419  
In California: (818) 996-5060



## NOVATION

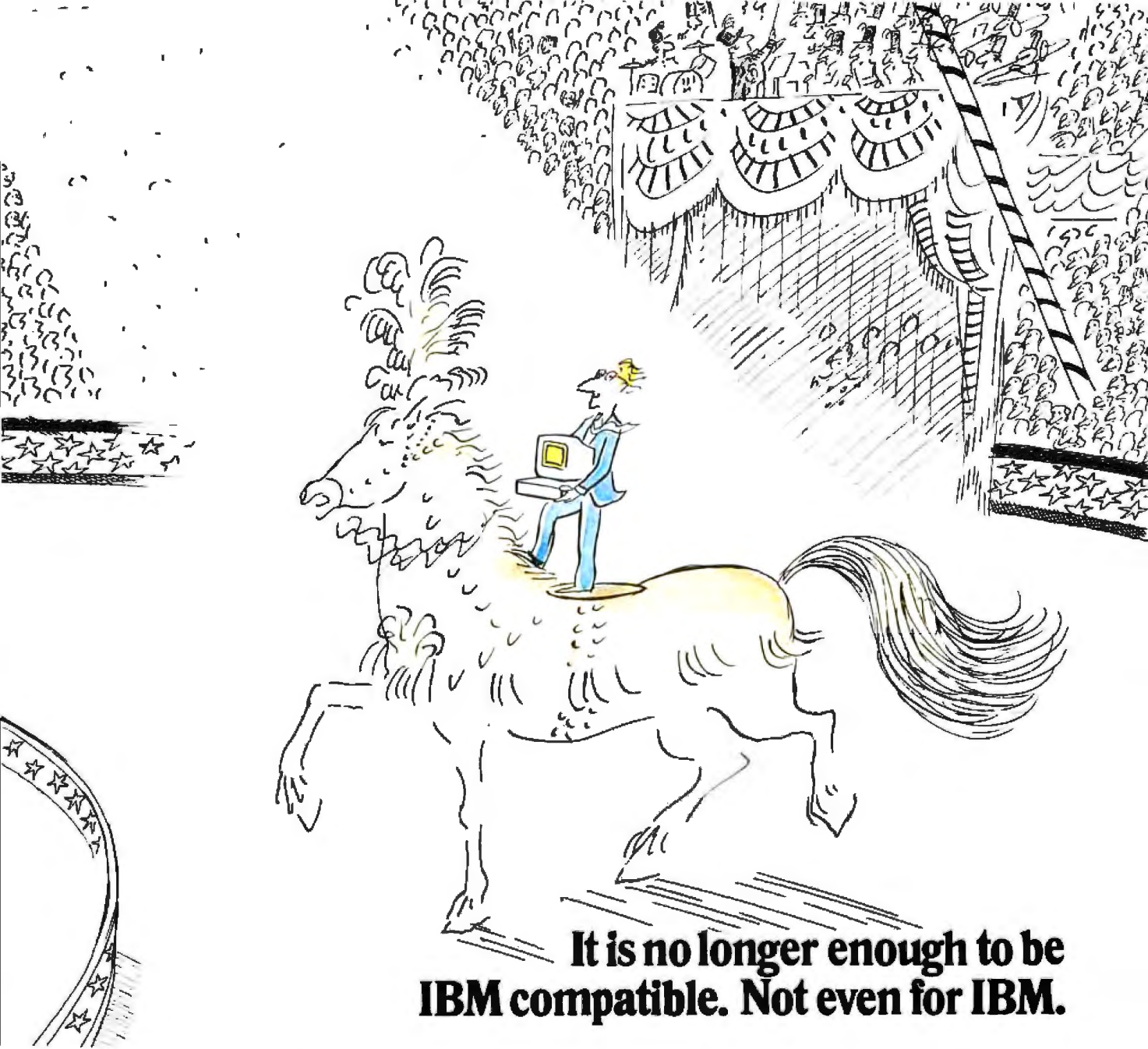


sempé

**SPERRY PERSONAL COMPUTER SPECIFICATIONS**

<b>OPERATING SYSTEM</b> MS DOS Version 1.25 or 2.0 with G.W. BASIC MICRO-PROCESSOR High-Speed 16-bit 8088	<b>KEYBOARD</b> 64 keys, 6 ft. cord
<b>DISPLAY SCREENS</b> High Definition monochrome display. High resolution color display. IBM compatible graphics.	<b>AUXILIARY MEMORY</b> Up to two internal 5 1/4" diskettes 1MB internal fixed disk when configured with single diskette.
<b>COMMUNICATIONS</b> Both In Asynchronous	<b>USER MEMORY</b> Standard 128K bytes, expandable to 640K
	<b>DIAGNOSTICS</b> Power-on self test CLICK Time-of-day with battery back-up





## It is no longer enough to be IBM compatible. Not even for IBM.

It was the personal computer circus.

And it had gone on too long.

The crowd grew restless as each new act continued to perform varying degrees of IBM compatibility.

Suddenly, the crowd gasped. It was the unexpected finale — the arrival of Sperry, with a performance no one could have imagined possible.

Ladies and gentlemen, it was the Sperry PC. It ran IBM compatible software.

But that wasn't the show stopper.

Because it soon became quite clear the Sperry PC didn't just *run* the IBM programs, it ran them *better*.

Better because it ran them faster — up to 50% faster.

It ran them with breathtaking

graphics, far more dramatic than the IBM PC could provide.

And it ran them from a keyboard that drew roars of approval, for it was not only easier to operate, but far more comfortable than IBM's.

And as the crowd cried out for more, that's just what Sperry gave them: the ability to plug right into a company's main computer, whether that system was IBM or Sperry. Or both.

As the crowd sat stunned by this final flourish, Sperry left all with a most provocative question. Was it possible that the Sperry PC could do all of this and yet cost less?

Again, the crowd gasped.

Could it be?

Come see for yourself. Hands-on, side-by-side. Call 800-547-8362, toll-free. Or write us. Sperry Corporation, Computer Systems, Department 100, P.O. Box 500, Blue Bell, PA 19424.

 **SPERRY**



**The Sperry PC.**  
**What the personal computer**  
**should have been in the first place.**

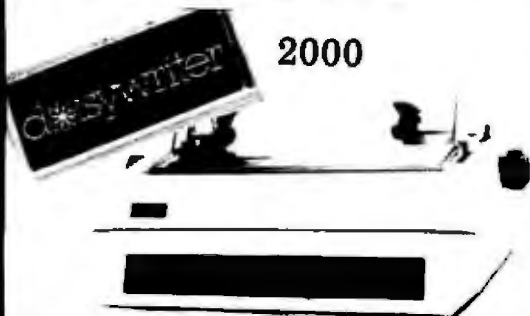
Circle 360 on Inquiry card.

# LIBERTY GROUP, Inc.

4221 Winfield Scott Plaza · Scottsdale, Az 85251

Introducing . . .

2000



**Increases Printing Efficiency  
& Productivity!!**

Simple Design      Built-in Buffer Memory  
Low Cost            CRT Hard Copy Printout

COMPUTERS

PRINTERS

TERMINALS

MODEMS

AND MANY OTHER COMPUTER PRODUCTS!

ALSO . . .

The terminal that emulates  
with Televideo

Freedom 1001



FOR TECHNICAL INFORMATION & AZ ORDERS

**602-949-8218**

FOR PRICE QUOTES & ORDERING:

**1-800-328-8905**

menus. Kaypro provides the S-BASIC source code for the menus, but this isn't enough. Customization should be possible without having to program. It certainly shouldn't require having to program in an unusual hybrid language available only with the Kaypro 10.

### Documentation

It's helpful that the menu programs that Kaypro provides to move you around the hard disk are so good, because the *Kaypro 10 User's Guide* provided with the machine is a positive hindrance.

This manual must be rated unacceptable for several reasons. Its description of the organization of the 10's software bundle is not only incomplete, but very often incorrect. Vital information on system software utilities is missing or also incomplete. Very important documentation, such as the description of the hard-disk backup utility, is stuck in the back, without so much as a note at the beginning of the manual to indicate it's there. There is no index.

The information presented in the manual also fluctuates between user-friendly and cryptic. The first few pages of the manual constitute a very gentle "shake hands with your Kaypro 10" introduction, complete with simple illustrations. They are followed by explanations of a few important CP/M utilities rendered in such a way that only someone already familiar with CP/M stands much chance of understanding them. This sudden change in tone is characteristic of the manual as a whole. The *Kaypro 10 User's Guide* will satisfy neither new nor accomplished users.

The *User's Guide* is only one of a small shelf's worth of manuals that come with the 10. Most of the other manuals are for one or more of the many programs bundled with the machine. All of these manuals (even Digital Research's improved CP/M manuals) are much better than the Kaypro manual.

One very welcome piece of documentation included with the 10 I reviewed was the second issue of *Profiles*, a slick magazine published by Kaypro for Kaypro owners (*Profiles*, POB N, Del Mar, CA 92014). Many outfits offering software and hardware add-ons specifically designed for the Kaypro have ads in *Profiles* that are enlightening.

### Software

One of the advantages occasionally touted for the practice of bundling software with a computer is that it eliminates the problem of choice for the buyer new to the computer world. The manufacturer makes the software choices for the average user by making appropriate software part of the bundle purchased. Because the computer manufacturer usually has great buying and bargaining power, bundling also often provides a software package that would add up to more than the price of the computer system if each software item were purchased separately.

Kaypro apparently has tremendous buying and bargaining power. But while the company may have used





# New Qantex 7020. It speaks their language.

If you buy any printer without considering the Qantex 7020, you could make a serious mistake. This multi-mode workhorse is compatible with nearly all of today's PCs and software. So no matter which programs or PCs you use now or in the future, the 7020 can handle them. Lotus® 1-2-3.™ VisiCalc.™ Wordstar.™ dBASE II.™ BPS.™ Business Graphics.™ Perfect Writer.™ Apple.™ IBM.™ Epson.™ DEC.™ — you name it.

As a high density graphics printer, the 7020 is fully dot addressable with resolution to 144 x 144 dots per inch and handles your most

complex applications. Quickly and quietly.

As a single pass NLQ word processor (75cps), the 7020 gives you a choice of fonts along with proportional spacing, justification, auto underline, bold and more. Data processing is a breeze with bidirectional printing at 180 or 150 cps. User defined formats and 6-part forms capability are both standard.

It even provides built-in variable bar code capability and an operator-initiated test mode. And with industrial quality construction and a 500-million-character printhead

life, the 7020 will be around for years of hard use.

The 7020 costs just \$1,495 and is backed by the most comprehensive support in the industry. Find out how compatible it can be with your business. Contact Qantex for details or a demo, 60 Plant Avenue, Hauppauge, NY 11788. Call toll-free 800-645-5292; in New York State 516-582-6060.

 **north atlantic**  
**Qantex**

this power to provide great value, it hasn't exactly eased the novice's burden of choice.

Indeed, the Kaypro 10 comes bundled with an astounding quantity of software. Unfortunately, many a novice user will prefer to substitute the adjective "stupefying" for "astounding." There is far more software included with the 10 than anyone is likely to find useful.

Experienced computer users will likely be happy to make the appropriate choices between two word processors, two spelling checkers, two spreadsheets, two communication programs, and three versions of BASIC. But without guidance from a friend or dealer, people new to word processing will likely flounder trying to choose whether first to learn Wordstar or Perfect Writer. It would be very difficult to learn both at the same time. The same will hold for spreadsheet-users-to-be faced with both Perfect Calc and Chang Lab's Microplan or novice programmers confronted with M, C, and S BASIC.

To the well-guided user, though, the only problem with this over-bundling will be the embarrassment of riches. There are several first-rate, tremendously useful programs in the Kaypro's bundle.

While I can't possibly describe all the software in this review (most of it has been extensively reviewed on its own previously), a few items deserve particular note.

### **Word Processing**

Micropro's Wordstar version 3.3 is a fine enhancement of an already excellent product. While users of version 3.0 will not notice any particular changes in Wordstar itself, the manual and installation program have been markedly improved. Wordstar's manual is no longer scandalously difficult to read and there is even a good tutorial booklet included. I wish that Wordstar had accomplished this without inserting so many self-congratulatory cartoons and text passages in the process, but the new manual still makes me feel much better about recommending Wordstar to new users.

The installation program can now be used to easily change such variables as the justification method and the degree of help displayed when the editor is first entered. Previously, only persons able to use the difficult patching facility were able to customize these features. (Yes, the patching facility still exists and is also much improved.)

If you've given up on Wordstar as slow and awkward, you may be in for a pleasant surprise when you try it on the 10. First, the inherent speed of the hard disk allows it to run a lot more smoothly and quickly. There are no more agonizing pauses while program overlays or the next page of text loads from disk into memory. Second, Kaypro has implemented a function-key system that makes use of the redefinable numeric keypad keys to trim down several multikeystroke Wordstar commands to single keystrokes.

Perfect Writer provides an interesting and useful contrast to Wordstar. This Perfect Software product is not nearly the text-formatting tool that Wordstar is, but it is

a far better writing tool. Anyone who does (or wishes to do) a lot of actual writing at the keyboard should take a careful look at Perfect Writer.

Perfect Writer's principal advantage for writing is its ability to split the screen into two text windows. This feature allows me to work on one portion of text while having another portion in view (that portion may even be in another file). It often saves me from having to print out a draft just to be able to look at a piece of text while writing a reference to it. All this is great for writing and nearly indispensable for programming. Imagine being able to look at a function declaration while writing the function call.

Add to the split screen a very fast block-move feature, a deletion "undo" command, the capacity to have up to seven files open for editing (and passing text back and forth among them), and a good search-and-replace facility, and you have a very good editor.

What you don't have, though, is a very workable text formatter. Perfect Writer is not a "what you see is what you get" editor. This is not necessarily bad. When working on a long manuscript, I'd rather not do my formatting while I do my writing. Instead, I'd like to pass it through a formatting program, one that would do the hard work for me, when I finish. This is what Perfect Writer attempts to provide, but the program fails to allow even adequate formatting control. Only through a very awkward process of multiple formattings is it possible to avoid such formatting disasters as section headings alone at the bottom of pages. Getting a good format of a long (75 double-spaced pages) academic manuscript took me a good part of a day.

### **Spelling Checkers**

Kaypro has provided what is, in my opinion, the *crème de la crème* of 8-bit spelling checkers: Oasis Software's The Word Plus. The Word Plus not only checks spelling against a 50,000 word dictionary, but shows suspected errors in context and suggests alternative spellings. The dictionary can be easily updated, and special-purpose supplementary dictionaries can be assembled. Best of all, though, The Word Plus consistently identifies fewer correctly spelled words as potentially misspelled than other checkers I've tried. This may, of course, just mean that the folks at Oasis Software and I share about the same vocabulary.

Perfect Speller runs a good bit faster than The Word Plus, but I found that it frequently missed my typographical errors. This spelling program is one of those that tries to make a small dictionary file seem big by using prefix/suffix rules to expand on it. If you don't mind having words like "whyed" and "whileor" in your correspondence, this might not bother you as much as it did me.

### **Spreadsheet Programs**

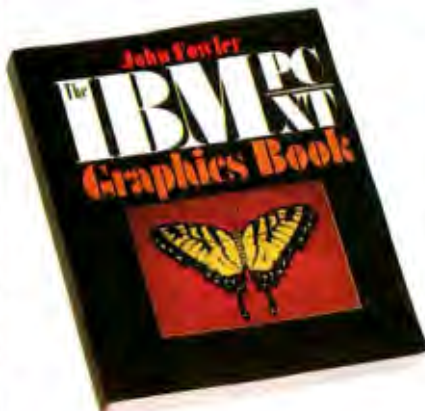
One strong point in favor of the Perfect Software is that once you've learned one of the programs, the others are a lot easier to learn. This is because each member program of the Perfect series shares a similar command



# Prentice-Hall speaks a language other publishers have forgotten. English.\*



**IBM PC BASIC PROGRAMMING** by Richard Haskell and Glenn A. Jackson. A see-as-you-do approach to beginning programming. Loaded with step-by-step screen illustrations and fascinating graphics examples. \$13.95



**THE IBM PC/XT GRAPHICS BOOK** by John Fowler. Ph.D. An example-packed IBM BASIC graphics tutorial. Covers both simple and advanced concepts for business and pleasure. \$16.95



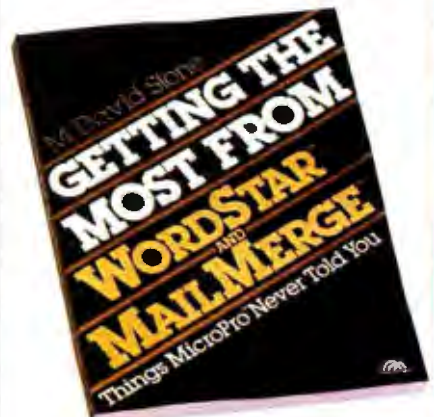
**LSF: THE LEAST SQUARES CURVE FITTER: A Problem Solving Aid for the IBM PC** by The Sumar Corporation. A software package that explains what *Least Curve Fitting* is and how engineers, social scientists, and data analysts can use it to solve problems on the IBM-PC. \$39.95



**SOFTWARE SOLUTIONS FOR THE IBM PC: A Practical Guide to dBase II, Lotus 1-2-3, VisiCalc, WordStar, and More** by Thomas H. Willmott. Uncomplicated answers to a common question: "What can a microcomputer software system do for my business and how to I get started?" \$14.95



**TELECOMMUNICATIONS FOR THE IBM PCjr** by David W. Carroll. How to use the new IBM PCjr as a home communications terminal for gaining access to data-bases, sending and receiving electronic mail, and communicating with other computers all over the world. \$15.95



**GETTING THE MOST FROM WORDSTAR® AND MAILMERGE™** Things MicroPro Never Told You by M. David Stone. Exciting new ways to take full advantage of these two highly popular word-processing programs. \$14.95

## PRENTICE-HALL/THE LEADER IN COMPUTER PUBLISHING

For more information about our computer books and software, write to us at the address below. Dealer inquiries welcome.  
Prentice-Hall, General Publishing Division, Englewood Cliffs, N.J. 07632

\*We guarantee that all our guides are easy to read and simple to apply without the aid of a reference library, a computer salesperson, or a niece who just graduated from M.I.T.



## QUELO 68000 Assembler Package

# 68000

New 5.0 Release

First Commercial  
Release - January, 1983

The Quelo portable 68000 assembler conforms to the Motorola resident assembler, publication M68KMASM[D4].

### Quelo 68000 Assembler Package Features:

Input file concatenation, include function, macros, global parameter substitution from command line, listing date-time stamp, up to 31 character symbols, conditional assembly, structured programming directives, instruction optimization, 68010 instructions, relocation and linking, complex expression linking (all operators), DB-DW-DL directives for Z80 byte order data generation, object library utility, software configuration tracking, conditional linking, options for assembler and linker to write complete symbol table to a file, detailed symbol table listings, assembler symbol cross-reference, linker global symbol symbol cross-reference, object library symbol cross-reference, superb linker load map, various HEX load formats produced by linker, error messages in English (not meaningless numbers), extensive typeset manual with index, readily transported to any system with a C compiler and "UNIX like" system interface for command line and file access.

Ready to run in various disk formats for CP/M-80, CP/M-86, CP/M-68K, MS-DOS and PC-DOS	\$300 early bird price, good until June 30, 1984. \$595 after June 30.
--	---

Portable version with detailed installation and testing instructions.	\$750 and license agreement.
---	------------------------------

For more information or to order write or call:	<b>Adams Custom Software</b> 2464 33rd Ave. W., Suite #173 Seattle, WA 98199 (206) 285-2528
---	--

COD, Visa, MasterCard.

CP/M-80, CP/M-86, CP/M-68K TM DRI, UNIX TM Bell Labs. MS-DOS TM Microsoft. PC-DOS TM IBM.

structure. Typing Control-X 2 splits the screen in Perfect Calc as well as Perfect Writer. Such small advantages are not to be scoffed at when trying to find your way through a software bundle as extensive as the Kaypro 10's.

Perfect Calc was a lot easier to learn after learning Perfect Writer. It is a complicated spreadsheet program with a thick manual and a nearly useless Help function. It is also a very powerful spreadsheet, and the thick manual is a good one with lots of tutorial lessons.

Like Perfect Writer, Perfect Calc enables you to edit multiple files with free interchange of information between them (two of these spreadsheet files may even be on the screen at the same time). Perfect Calc also enables you to construct some very large spreadsheets because it uses the disk as a buffer to expand available memory. This works only poorly on a floppy-disk system: large spreadsheets become horribly slow spreadsheets. It works better on the 10, so much better that it seems to take spreadsheets right to the limit of what's possible on an 8-bit 64K-byte computer. Perhaps it takes them past the limit: Perfect Calc lost information more than once on large spreadsheets I built.

Microplan, also included with the 10, is Perfect Calc's opposite: it is simple to use, but not particularly sophisticated. Unfortunately, Microplan's manual is also the opposite of Perfect Calc's: instead of making a difficult program simpler, the Microplan manual makes a simple program more difficult.

### Database

Anyone interested in keeping databases with the 10 should know that Perfect Filer may not meet your needs. While the program's preconfigured mailing-list databases worked very well and were easy to use, Perfect Filer proved aggravating when I tried to do much more.

The Perfect Filer manual provided with the 10 was noticeably the weakest of the Perfect series. After warmly greeting me with easy tutorials when I wanted to do easy things, it coldly abandoned me the moment I wanted to do something other than create a sample database of current members of Congress. The problem was that I tended to make mistakes. Apparently the authors of the tutorials were not so error-prone, because an explanation of how to make corrections was not included.

Perfect Filer was just as poor on error handling. Its response to that likely database error, filling the disk, was to let me go on merrily making entries. (I tried this on a floppy disk, as I didn't have the time nor the patience to fill the hard disk with a mailing list.) The manual didn't explain error messages and the program's on-screen messages were cryptic at best, particularly when it didn't like my attempts at form-letter generation.

### Floppy-disk Translation

While reviewing the 10, I had the opportunity to try out a wonderful \$49.95 disk-format translation program from Micro Solutions.

Uniform, which is available in different forms for the Kaypro II, 4, and 10, enables you to read, write, and for-



**NOT  
ANOTHER  
BLACK  
BOX—**

## A Software Implementation within Your Product Hardware

If you manufacture a computer system or a computer based product, allow it to EMULATE COMMUNICATE by installing one or more of Systems Strategies "C" Language based communication packages.

- 3270 SNA SDLC Emulation
- 3270 BSC Emulation
- 2780 3780 HASP Emulation
- X.25 Levels 1, 2, 3 Communication

You can purchase these "C" Language packages with source code and license to distribute in your hardware product. Each package is available either "Port it Yourself" with instruction manual and training or ported to your hardware by Systems Strategies' communications staff

**Systems Strategies/Advanced Technology Division  
Specialists in Data Communications Software**



**Systems Strategies Inc.**  
225 West 34th Street  
New York, New York 10001  
(212) 279-8400



# RUN VIRTUALLY ANY SOFTWARE ON ONE POWERFUL PERSONAL COMPUTER.

Here's the compatibility you have been waiting for. Dimension. A single personal computer able to handle Apple<sup>®</sup>, IBM<sup>®</sup>, TRS-80<sup>®</sup>, UNIX<sup>™</sup> and CP/M<sup>®</sup> based software.

The Dimension 68000 Professional Personal Computer does it all. It's designed to emulate virtually any popular microcomputer and software combination today. Or tomorrow.

Dimension provides the incredible power of a 32 bit MC68000 microprocessor with up to 16 megabytes of random access memory.

And it lets you add future innovations as they develop.

Dimension. Compatibility and expandability with all the power of a mainframe. At a personal computer price, it's obviously the best value you can find. For more information ask your dealer or call us at (214) 630-2562 for the name of your nearest dealer.

**dimension™**



**68000**

A product of  
Micro Craft Corporation  
4747 Irving Blvd., Suite 241  
Dallas, Texas 75247. ©1983

Dealer Inquiries Invited



(CRT NOT INCLUDED)

Apple is a registered trademark of Apple Computer, Inc.; IBM is a registered trademark of International Business Machines Corporation; TRS-80 is a registered trademark of Radio Shack, a Tandy Corporation company; UNIX is a trademark of Bell Laboratories, Inc.; CP/M is a registered trademark of Digital Research Corporation.

**THE MOST POWERFUL, MOST COMPATIBLE PERSONAL COMPUTER YOU CAN BUY.**



mat 5¼-inch disks for a variety of different microcomputers. The version of Uniform for the Kaypro II can, of course, only translate single-sided disk formats; the versions for the 4 and the 10 can handle most of the major double-sided formats as well. Televideo, NEC, Osborne, Xerox, Epson, Otrona, Cromemco, Hewlett-Packard, Zenith, Morrow, and Radio Shack CP/M microcomputers are just a few of the many different machines listed on Uniform's easy to use menus.

Most impressive of all, Uniform on the 4 and 10 also provides a facility for translating CP/M and PC-DOS directory formats. This enables you to transfer data files between PC DOS 1.0 (160K bytes) and 1.1 (320K bytes) disk formats. I was able to use this feature to move a friend's Wordstar-format text files from NEC 8001 format disks to disks for use on an IBM PC in only a few quick steps.

Having Uniform on the 10 gives you a hard-disk computer that is data-compatible with the IBM for under half the price of the IBM PC XT. As PC format disks become the de facto standard for disk information exchange between microcomputers, this data compatibility will be very important. Some writers already are offered incentives by their publishers to furnish their prose on a PC-readable disk.

## Revisions

The Kaypro 10 had been on the market about five months when I wrote this review. The machine I re-

viewed (a late November 1983 model) was very different in both the software bundle and implementation of the operating system from what Kaypro was shipping in July of 1983. The software bundle had gone through several major changes, the BIOS (basic input/output system) was in revision "F" and the monitor EPROM (erasable programmable read-only memory) and the hard-disk interface board had each been changed. Several system utilities for use with the hard disk had been revised to work with the new EPROM and interface.

The BIOS, EPROM, interface board, and utility changes were necessitated, a Kaypro spokesperson said, to rectify a problem that only a few machines might have: incorrectly reporting hard-disk errors. In addition to preventing inaccurate reports of read faults, the changes also appeared designed to prevent a possible hard-disk reset error, an independent comparison of the old and new interface card suggested.

Kaypro is shipping kits to all its dealers that are necessary to fix any 10s already sold that might have the hard-disk difficulties, and no charge will be made for the repairs whether in or out of warranty, the Kaypro spokesperson said.

## Conclusion


The drawbacks of the Kaypro 10 are definitely overshadowed by its many advantages; for instance, the 9-inch, high-resolution, non-glare screen has the problem of inflexibility, yet is much more readable than the 12-inch (and larger) screens of many desktop computers. In addition, the software varies in quality—but there is a lot of it bundled with the system. And while the *User's Manual* is poorly organized and incomplete, the menu system and enhancements to CP/M will aid both novice and experienced CP/M users in mastering the tremendous storage capacity of the hard-disk drive. Furthermore, the floppy-disk backup may not meet the needs of all users, but on the other hand, the system's hard-disk drive has advantages in speed and convenience over comparably-priced, floppy-disk-only computers. Overall, the machine reviewed was reliable and fairly easy to transport. Despite a few rough spots, the Kaypro 10's many advantages make it an exceptional value for the money. It should be considered by anyone interested in hard-disk capacity or performance at an excellent price. ■

## Author's note:


I would like to thank the staff of Technika Computer Center in Berkeley, California, for their assistance in preparing this article.

Steve McMahon (2208 Martin Luther King Jr. Way, #6, Berkeley, CA 94704) is an independent software developer working particularly on small newspaper business systems. He is also a graduate student in sociology at the University of California at Berkeley.


**EVEN LOWER PRICES**  
for SERVICE,  
SAVINGS, and SATISFACTION  
Call for May Specials !!



**apple**  
//e  
64K CPU, 2 Drives,  
Controller, 80-Col  
\$ SAVE \$  
NEW ARRIVAL !!  
MACINTOSH... Call



**SAVE**  
BROTHER HR-25  
\$729  
WHILE THEY LAST !!




PC 84K  
2-Drives, Controller  
Color & Monochrome,  
Parallel Port  
\$2495  
IBM XT \$4295  
Call for Special Deals !


PRINTERS	ACCESSORIES	MODEMS
Dynax 15X.....439	Microsoft Software //e...299	Hayes 1200.....478
Epson FX-100.....Call	Chalk Board.....79	1200B.....399
FX-90.....489	Grappier.....119	MM //e.....239
Gemini 10K.....284	Grappier+ Workalike.....79	Novation Apple Cat 2...Call
Juki 6100.....459	Kensington Fan.....59	Password 300/1200...329
NEC 3550.....1839	Koala Pad Apple.....79	Pro-modem 1200.....Call
3030.....Call	Hayes Joystick.....35	Signalman Mark XII...269
Okidata 82P.....429	Micro Sci A2.....205	Volks Modem 300 baud...59
Prowriter.....349	Microsoft Mouse.....129	<b>IBM MODULES</b>
<b>MONITORS</b>	Mockingboard.....Call	AST 8 Pak.....279
Amdel 310A.....169	Rana Elite I.....219	Mega.....279
300.....135	Sony 3 1/2 Drive.....Call	Graphis Plus.....299
Composita Color.....249	Teac 55B.....189	Quadboard.....249
Princeton MX12.....469	Thin Line Drive //e or IBM...189	84K Ram Board.....159
Taxan Amber.....129	Videx VT 802 80 Col.....149	87B RIO.....249
Vision 3.....449	Maxell SS/DD.....22	Super RIO.....279

**SOFTWARE SPECIAL — LOTUS 1-2-3 \$299**

**WE SUPPORT THESE FINE SYSTEMS:**  
Alto, Apple, Columbia, Compaq,  
Corona, DEC, Epson, IBM, KayPro,  
Sanyo, TeleVideo, Zenith, Zorba, and  
many more.  
Orders over \$500.00 receive a free  
gift.  
**NO CLUB FEE**  
PRICES SUBJECT TO CHANGE WITHOUT NOTICE  
CALL PRICE 1



**Computer Price  
Club**  
**714 841-6160**  
16783 Beach Blvd.  
Huntington Beach, CA 92647



A-184



**Dow Jones  
means  
business.<sup>SM</sup>**

# The leading name in business information is now the leading name in business software.

The Wall Street Journal. Barron's. Dow Jones News/Retrieval.\* Dow Jones has set the standard for business information for over 100 years. Now Dow Jones introduces a full range of business and financial software for personal computers. Many of these programs manage information from Dow Jones News/Retrieval, the nation's leading online news and information service. All programs entitle you to a News/Retrieval password.\* All set standards for business and financial software.

\*Telephone and modem required for News/Retrieval.

## Accounting

New from Dow Jones, the accounting series is designed to meet all the accounting needs of small businesses. It offers power and flexibility, yet is easy to learn and use. When you purchase Dow Jones General Ledger, Accounts Receivable or Accounts Payable, you are eligible for a free training seminar designed by Arthur Young, one of the nation's foremost accounting firms.\* This seminar covers computerized accounting and bookkeeping principles.

**Dow Jones General Ledger™** is the heart of the accounting series. Using *Generally Accepted Accounting Principles*, the General Ledger allows you to define the structure of your chart of accounts and establish account ranges for assets, liabilities, capital, income and expenses. It offers double-entry bookkeeping that's

never out of balance, and allows you to post entries "in pencil" for easy error checking and correction. When you are satisfied, you can close your books and the General Ledger posts your entries "in ink" and freezes a full audit trail. When you print financial reports, the General Ledger formats them to reflect the structure of your chart of accounts.



The screenshot shows a computer terminal window with a blue border. The title bar reads "DOW JONES INC. GENERAL LEDGER". The main window displays a "Sales Journal" for "1984". It lists several entries with columns for "Date", "Account", "Description", "Debit", and "Credit". The entries include "Sales - Computers", "Sales - Peripherals", "Sales - Software", "Sales - Misc", and "Sales - Jones Payable". The total debit and credit amounts are both 7,812.38.

Date	Account	Description	Debit	Credit
		Sales - Computers		4,175.00
		Sales - Peripherals		1,125.00
		Sales - Software		1,125.00
		Sales - Misc		2,000.00
		Sales - Jones Payable	7,812.38	
			7,812.38	7,812.38

Journal Entry, Dow Jones General Ledger

**Dow Jones Accounts Receivable™** and **Dow Jones Accounts Payable™** complete the basic accounting system. Programs for Sales Order Entry, Purchase Order Entry, Management Analysis and Inventory will be available early in 1985.

By Trademark Software, Inc. and Dow Jones & Company, Inc.  
Available for the IBM® XT.  
\*Seminars and product may not be available in all areas.

## Investment

Dow Jones investment software was introduced in 1982 and rapidly became the leader in the field. These best-selling programs, expressly designed for investors, money managers and business planners, allow you to analyze and manage your investments using financial information from Dow Jones News/Retrieval. You also have easy access to business news and headlines, economic updates and forecasts.

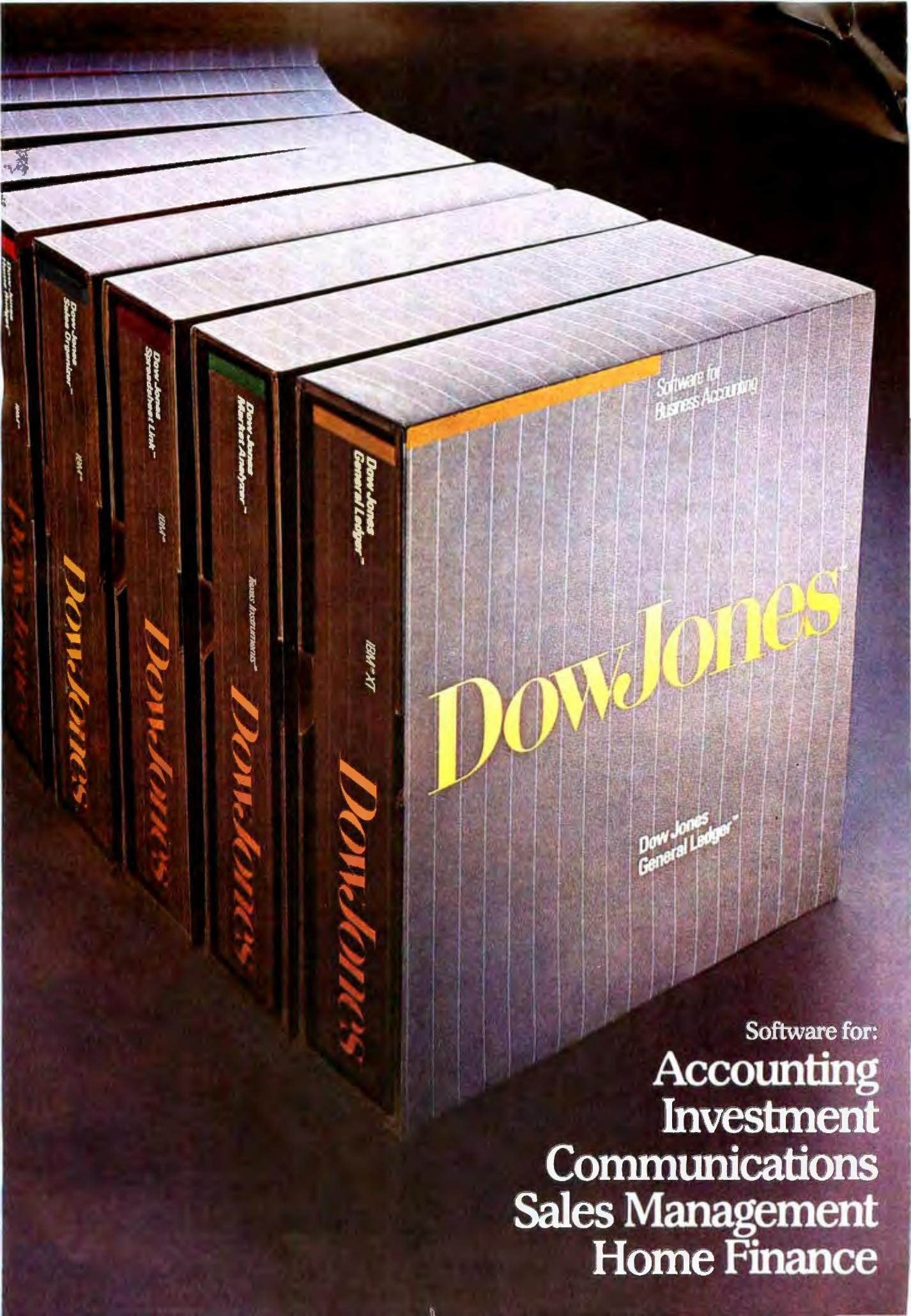
**Dow Jones Market Analyzer™** is an integrated technical analysis and communications program that can increase the effectiveness of your

investment decisions. The Market Analyzer collects and stores historical quotes from Dow Jones News/Retrieval, and automatically updates daily data on stocks, bonds, mutual funds and options. It then calculates and constructs price and volume charts, trend lines, moving averages, support/resistance lines and many other charts.

By RTR Software, Inc. and Dow Jones & Company, Inc.  
Available for the IBM® PC, IBM XT, T1 Professional and Apple® II computers.

**Dow Jones Market Manager™** provides you with a powerful investment information system for maintaining single or multiple portfolios.





Software for  
Business Accounting

# Dow Jones

Dow Jones  
General Ledger™

Software for:  
**Accounting**  
**Investment**  
**Communications**  
**Sales Management**  
**Home Finance**



Dow Jones Sales Director™ automatically consolidates information from the other two programs in the sales system, performs analysis and produces management reports that can then be distributed throughout the organization. Scheduling, word processing, graphics and spreadsheet capabilities are also included.

(Available summer/fall 1984) By P/E Software, Inc. and Dow Jones & Company, Inc. Available for the IBM PC and IBM XT.

## Home Finance

Dow Jones software for the home helps you organize and control your personal finances. The products in this series keep track of how your money is earned, spent and invested. In addition, your Dow Jones News/Retrieval password brings you and your family news and information, encyclopedia articles, sports, weather reports and movie reviews.

Dow Jones Home Budget™ helps you plan and control your financial situation. It keeps track of your income, expenses, assets and liabilities to help you in financial planning, budgeting and tax preparation. You can program the Home Budget to flag tax-deductible expenses and automatically account for recurring transactions such as mortgage payments and telephone bills. The Dow Jones Home Budget allows

you to produce reports about specific accounts and transactions, and provides you with a net worth statement that gives you a clear picture of your personal finances.

By Decision Support Software, Inc. and Dow Jones & Company, Inc. Available for the IBM PC, and Apple II computers.



List of Accounts, Dow Jones Home Budget

Dow Jones Investment Evaluator™ is a personalized system for managing your portfolio. It maintains one or more portfolios of up to 50 securities each, and automatically updates your stocks with the latest quotes from Dow Jones News/Retrieval. The Investment Evaluator displays or prints

reports showing purchase value, current value and gains and losses, so you can evaluate your position at a glance.

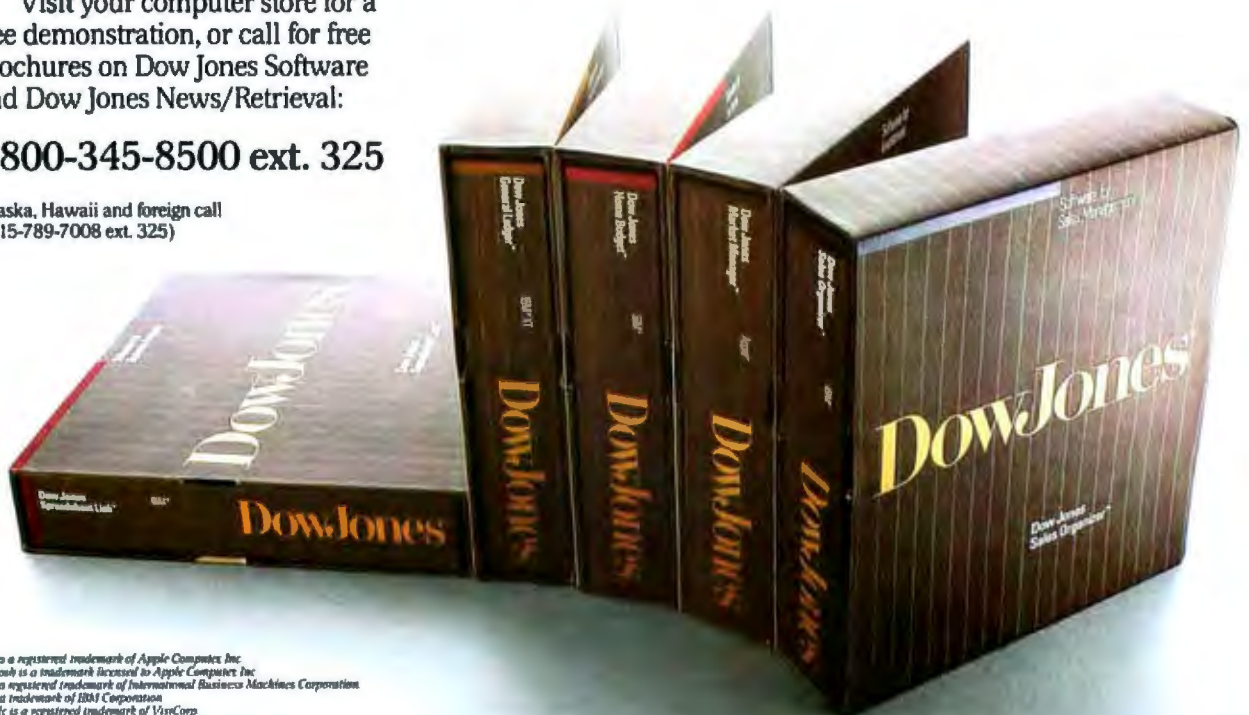
By Dow Jones & Company, Inc. Available for the IBM PC and TI Professional.

All Dow Jones Software™ is fully supported by a sixty-day warranty, thorough documentation and a toll-free Customer Service hotline.

Visit your computer store for a free demonstration, or call for free brochures on Dow Jones Software and Dow Jones News/Retrieval:

**1-800-345-8500 ext. 325**

(Alaska, Hawaii and foreign call 1-215-789-7008 ext. 325)



Apple is a registered trademark of Apple Computer, Inc.  
Macintosh is a trademark licensed to Apple Computer, Inc.  
IBM is a registered trademark of International Business Machines Corporation.  
PCjr is a trademark of IBM Corporation.  
VisiCalc is a registered trademark of VisiCorp.  
Multiplan is a registered trademark of Microsoft Corporation.  
Lotus and 1-2-3 are trademarks of Lotus Development Corporation.



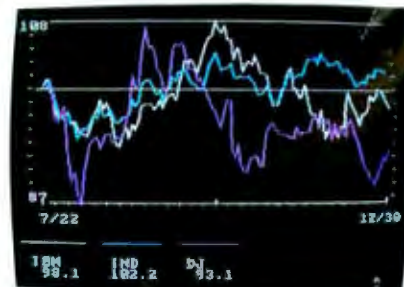
The Market Manager automatically values your existing position in the stock market. Its tax lot accounting system records all your securities transactions and matches your sell transactions to existing positions in the market, to minimize tax liability. You can also generate reports for individual accounts and an overall securities holdings report.

By TELEWARE, Inc. and Dow Jones & Company, Inc.  
Available for the IBM PC and Apple II and Apple III computers.

**Dow Jones Market Microscope™** is a fundamental analysis program for money managers, business planners and investors. It allows you to

produce reports that screen industries and companies using Media General and Corporate Earnings Estimator™ financial indicators. A Price Alert routine tells you which stocks have reached your critical levels for buying and selling.

By National Software and Dow Jones & Company, Inc.  
Available for the IBM PC, TI Professional and Apple II computers.



Comparison Chart, Dow Jones Market Analyzer

## Communications

Dow Jones communications software is designed to meet the business analysis needs of executives and investors. These programs allow you to collect, store, and organize timely information from Dow Jones News/Retrieval. You have access to financial information on companies and industries, current and historical quotes, and exclusive news from The Wall Street Journal, Barron's and the Dow Jones News Service.

**Dow Jones Spreadsheet Link™** is an efficient and accurate way to collect and transfer up-to-date financial information from Dow Jones News/Retrieval

to Lotus™ 1-2-3™, VisiCalc® or Multiplan® spreadsheets. Spreadsheet Link saves you time by eliminating manual data entry, and requires a minimum of memory. Now you have immediate access to the information you need, and can enter it into your customized template with just a few keystrokes.

By Solutions, Inc. and Dow Jones & Company, Inc. Available for the IBM PC, IBM XT, IBM® PCjr, IBM® PC 3270, Apple II systems and Apple® Macintosh.™

**Dow Jones News Link™** allows you to follow and analyze the latest business news—easily and quickly. You can retrieve text and statistics from News/Retrieval and create your own personal data base. Then, offline, it is easy to read, edit, index and store information. With News Link, the summaries and reports you produce can be transmitted to other locations using computers and modems. An expanded version of News Link includes additional communications features.

(Available fall 1984) By Gaia Communications and Dow Jones & Company, Inc. Available for the IBM PC, IBM XT and IBM PCjr.



Main Menu, Dow Jones Spreadsheet Link

## Sales Management

Dow Jones sales management software enables sales professionals and their organizations to sell more effectively. These powerful new programs can be used as an integrated system. They produce reports that give you information about all phases of your sales cycle. All three programs feature in-depth tutorials and easy-to-follow menus.

**Dow Jones Sales Organizer™** is designed for sales representatives and managers. It tracks prospects throughout the customer relationship, and automates scheduling. The Sales Organizer produces budget, forecast, commission, lead capture rate, expense and call reports, along with quotation, order and product summaries. It has graphics and spreadsheet capabilities that allow you to analyze data the way you want, and includes word processing and order tracking.

**Dow Jones Prospect Organizer™** enables sales support staff to track prospects from initial lead through assignment to sales territories. The Prospect Organizer allows you to create a data base of updated prospect information and to analyze media and promotion effectiveness. You can generate reports that show the geographic distribution and current status of your prospects. Word processing capabilities simplify correspondence, telemarketing, survey and direct mail functions.



Call Reporting, Dow Jones Sales Organizer



# Dow Jones News/Retrieval means information.

Included in any Dow Jones Software program, your Dow Jones News/Retrieval password brings you a world of electronic information on your personal computer (via telephone and modem). There is only one Dow Jones, and Dow Jones News/Retrieval provides you with exclusive news and information from The Wall Street Journal and Barron's, stock quotes direct from the floor of the exchange, and a wide range of information and services for you, your business and your family. Dow Jones Investment and Communications software is specifically designed for easy access and management of information from News/Retrieval. Here are some of News/Retrieval's data bases:

## Dow Jones Business and Economic News

- News from The Wall Street Journal, Barron's and the Dow Jones News Service
- Online headlines and summaries of major stories
- Text search of Dow Jones News
- Weekly economic update
- Full text of The Wall Street Journal

## Dow Jones Quotes™

- Current quotes 15 minutes from the floor
- Historical quotes covering a full year
- Historical Dow Jones Averages™

## Financial and Investment Services

- Earnings forecasts from Corporate Earnings Estimator™
- DISCLOSURE II—SEC filings and company profiles
- Detailed corporate financial information from Media General Financial Services
- Economic and foreign exchange survey
- Forbes rankings of U.S. corporations and industries
- Airline schedules and fares
- Merrill Lynch Research Service

## General News and Information

- Academic American Encyclopedia
- Foreign and national news
- Sports
- Movie reviews
- Wall Street Week Online™ transcripts
- Comp-U-Store™ electronic shopping service

## MCI Mail Service and Free Customer Newsletter



## Converting the TRS-80 Model III for CP/M

*Comparing Mapper III, Shuffleboard III, and Vid-80*

Mark E. Renne  
Free-lance Writer

When Radio Shack announced CP/M compatibility for the Model 4, it became another of the many manufacturers to make the CP/M operating system available for its computers. But should Model III owners rush down to their Radio Shack stores and shell out \$799 for a Model 4 upgrade kit, or should they look into the many CP/M conversions available for the Model III? This article will briefly explain some of the basics of CP/M and then examine three different conversions that are available.

The so-called control program for microcomputers (CP/M) designed by Digital Research of Pacific Grove, California, has become the standard operating system for 8-bit microcomputers. It is used by more manufacturers than any other system. Some people would like to have you believe that CP/M is the answer to all your problems, but it has a few bugs of its own.

### Myths about CP/M

Either on purpose or by ignorance, many salespeople insist that CP/M allows programs to be used on any other computer as long as it uses CP/M. Although there is some truth to this, CP/M is not as transportable as many people think. In fact, for a program to be transported from one brand of computer to another, several things have to be true depending on the program. For example, if it's a machine-language program, the computers must have the same central processing unit. CP/M Apple Visicalc will *not* work on a TRS-80 under CP/M.

For other programs, the same language—including version—must be available on both computers. Also, the same version of CP/M usually will be required on both computers. TRS-80 users are familiar with this from Radio Shack's upgrade of TRSDOS from 1.1 to 1.3. In this article we will talk primarily about CP/M version 2.2. Note, however, that some new programs for CP/M version 3.0 may not run on CP/M 2.2.

Another problem is screen compatibility. Most people write CP/M programs with an 80-character by 24-line screen in mind; the Model III has a 64 by 16 screen. Some CP/M conversions for the Model III also change the format of the III's screen, but that increases cost. Because most microcomputers at one time had 64 by 16 screens, many programs work well in this mode. Other programs work on different brands and have an Install program that allows the user to adjust screen size.

Also, each computer formats the disks used in its system differently. The 8-inch, single-density format is standard, but 5¼-inch disk formats are chaotic. Don't be misled into believing you can simply take a disk from your neighbor's North Star and insert it in your TRS-80 because they both use CP/M. (Actually, you could insert it—it just wouldn't work!) Some CP/M systems, however, do allow this type of interchangeability, and I'll discuss that later.

For a program to be totally transportable, then, even under CP/M, it must be written for the same processor.

## At a Glance

### Name

Mapper III

### Use

To convert the Radio Shack TRS-80 Model III to operate under the CP/M operating system as well as TRSDOS

### Manufacturer

Omikron  
1127 Hearst St.  
Berkeley, CA 94702  
(415) 845-8013

### Size

6 by 3½ by ½ inches

### Weight

4 ounces

### Features

16K bytes of RAM; Omikron utilities and enhancements available

### Hardware required

Radio Shack TRS-80 Model III, 48K bytes of RAM, disk

### Software supplied

CP/M 2.2, MBASIC

### Documentation

8½- by 11-inch, three-hole punched, 6-page installation manual, 15-page users manual, 150-page MBASIC manual, and 249-page CP/M manual

### Price

\$199



Photo 1: Mapper III from Omikron.

use the same language (including version), be set up for the same screen size, and be formatted in a way that can be read by the conversion.

## The Advantages of CP/M

Why then, would you convert to CP/M? The principal advantage for users is the great number of programs available that run under CP/M. There are also a great number of users groups that support CP/M, providing public-domain software and also assistance for modifying CP/M for different machines.

The greatest advantage of CP/M for manufacturers is that it is hardware independent. In other words, only a small part of CP/M—specifically, the BIOS (basic input/output system)—has to be changed to work on different computers. This flexibility enables manufacturers to include an operating system for their computers with relatively little effort. It also makes it possible for programs written on one computer to be used on other computers because they have an operating system in common.

## The Disadvantages of CP/M

Because of its flexibility, CP/M doesn't take advantage of any of the special features of a particular machine. For example, there's no way to access the graphics capabilities of the TRS-80. Also, CP/M works with only one drive at a time. If you want to execute a program, you

must be "logged on" the correct drive; it does not search all drives for the program as TRSDOS does. There is no password protection on any files, but because any password eventually can be broken, maybe that isn't a drawback. Also, to copy a disk you must use three separate programs. The last problem with CP/M is the quality of error messages—there are only a few, and all are non-descriptive. It's hard to believe, but this operating system reports more cryptic messages than TRSDOS.

## Converting the TRS-80 to CP/M

Let's look at some CP/M conversions available for the TRS-80 Model III. First, this machine requires a hardware conversion rather than just software because the Model III uses the first 14K bytes of memory for ROM (read-only memory) BASIC, while CP/M expects that memory to be empty and available for operating system use. This conflict can be resolved only by a hardware modification. Of course, all modifications still allow you to use TRSDOS for your existing software.

The conversion procedure is similar in all cases. Remove the cover of the TRS-80 as well as the heat shield covering the central processing board. Remove the Z80 chip and replace it with a circuit board that plugs into the Z80 socket. Then plug the Z80 chip into the circuit board. Some modifications also require a RAM (random-access read/write memory) chip to be removed and replaced by a plug connected to the CP/M board. The en-



As your terminal needs accelerate, move to Ann Arbor. We make the CRTs used by hard-driving professionals from M.I.T. to Stanford.

Take our Ann Arbor Ambassador, for instance. Nothing about it slows you down. The editing commands use line pointers to virtually eliminate the need for pad characters. The ANSI coding lets you put parameters in your commands to speed up execution.

And that's just for starters. The Ambassador does what no

other alphanumeric terminal can: it gives you a 60-line display with zoom. You choose the format best suited to your software and your comfort—24 lines, 30 lines, 48 lines. Whatever. Then instantly zoom up to 60 to see what a printout will look like. Recapture something that scrolled by too fast. Or simply check for context.

Like all Ann Arbor products, the Ambassador uses a large, easy-to-read screen—either portrait or landscape. The case can

be tilt/swivel or rack mounted. And the detached keyboard provides dozens of programmable keys to save you time.

Of course, starting at \$1595, the Ambassador isn't for everyone. Just for the thousands of professionals who really want to move.

For more information, call 313/663-8000. Or write us at Ann Arbor Terminals Inc., 6175 Jackson Road, Ann Arbor, Michigan 48103. But don't wait too long—the Ambassadors are going fast!

## **ANN ARBOR** TERMINALS

Circle 37 on Inquiry card.

*Once you've worked with them, you won't work without them.*

# **0 to 60 in less than a second.**



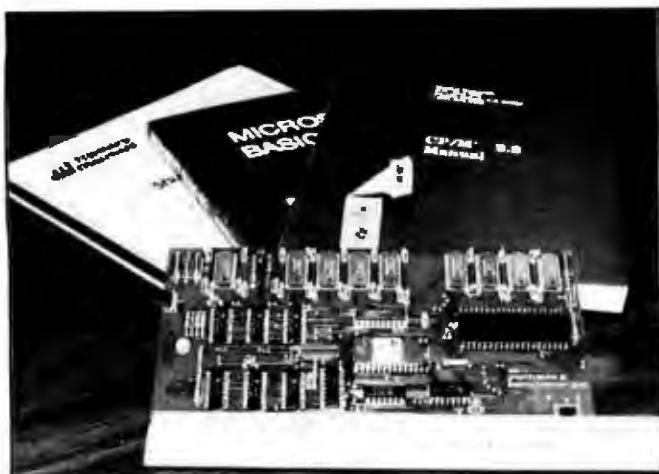


Photo 2: Shuffleboard III from Memory Merchant.

### At a Glance

**Name**

Shuffleboard III

**Use**

To convert the Radio Shack Model III to operate under the CP/M operating system as well as TRSDOS

**Manufacturer**

Memory Merchant  
14666 Doolittle Dr.  
San Leandro, CA 94577  
(415) 483-1008

**Size**

8 by 3 3/4 by 1/2 inches

**Weight**

4 1/2 ounces

**Features**

High-density disk format, 16K bytes of RAM, direct cursor addressing, virtual-drive concept, 15-day free trial

**Hardware required**

Radio Shack TRS-80 Model III, 48K bytes of RAM, disk

**Software supplied**

CP/M 2.2, MBASIC

**Documentation**

7- by 9-inch perfect-bound 77-page users and installation manual, 184-page MBASIC manual, and 214-page Digital Research manual

**Price**

\$299

ture procedure takes about a half-hour and is easy even for those who have had only a casual acquaintance with electronics.

Because the Model III lacks a number of ASCII (American National Standard Code for Information Interchange) characters on the keyboard (braces, brackets, control key, etc.), CP/M modifications must also reconfigure the keyboard to generate all the ASCII characters. Usually this involves a combination of keys, such as the Up-Arrow and another key. I'll discuss each modifica-

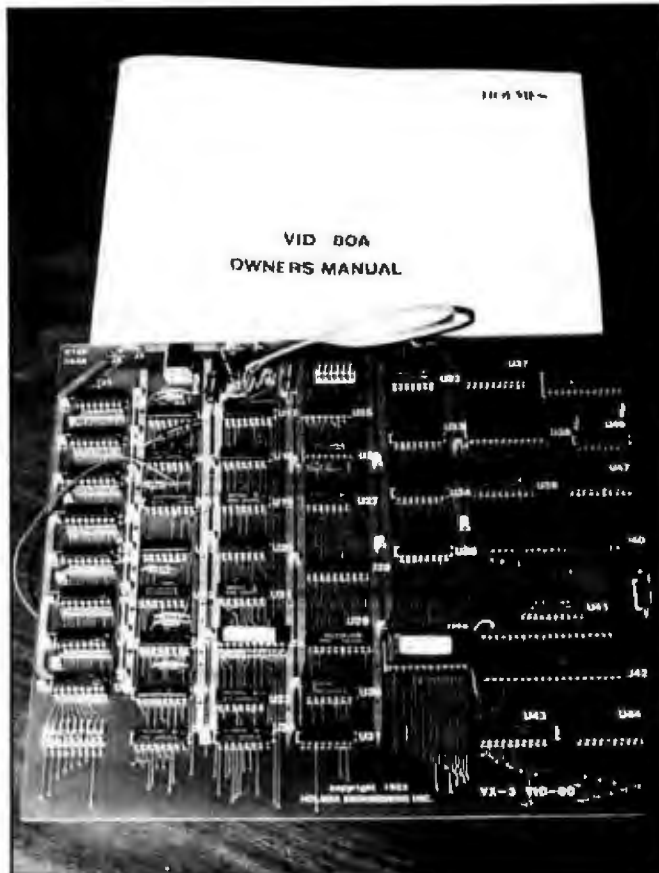


Photo 3: Vid-80 from Holmes Engineering.

### At a Glance

**Name**

Vid-80

**Use**

To convert the Radio Shack TRS-80 Model III to operate under the CP/M operating system as well as TRSDOS. Also, converts screen to 80 by 24 under both operating systems.

**Manufacturer**

Holmes Engineering Inc.  
5175 Green Pine Dr.  
Salt Lake City, UT 84107  
(801) 261-5652

**Size**

9 1/2 by 9 by 1/2 inches

**Weight**

14 ounces

**Features**

16K bytes of RAM, 80-character by 24-line board included

**Hardware required**

Radio Shack TRS-80 Model III, 48K bytes of RAM, disk

**Software supplied**

CP/M 2.2, utilities

**Documentation**

8 1/2- by 11-inch 30-page users and installation manual; 320-page CP/M Handbook (with MP/M) by Rodney Zaks

**Price**

\$399



Name	Control Key	Software Included	Disk Formats	Price	Able to use CP/M 3.0	Auto Repeat
Mapper III	Down-Arrow	CP/M 2.2 MBASIC	See text	\$199	no	yes
Shuffleboard III	Up-Arrow	CP/M 2.2 MBASIC	Osborne, Xerox, IBM	\$299	no	no
Vid-80	Clear	CP/M 2.2	Kaypro, Xerox	\$399	yes*	yes

\*optional at extra cost

Table 1: A comparison of the CP/M conversion boards.

tion separately, but I've also summarized conversion features in table 1.

### Mapper III

The least expensive board evaluated was the Mapper III from Omikron. Although the board lists for \$199, it functions well and most of its limitations should be eliminated by the time you read this.

The board I evaluated was an early prototype board that Omikron was shipping to its customers. This board is single-density, uppercase only. The manufacturer indicated that double-density should be available very soon, which would be a must for any serious user of CP/M. Omikron indicated that this will be a free upgrade for its customers and will contain a number of enhancements I'll cover later.

The Mapper III uses the Down-Arrow key for the Control key and Shift-Break for escape. It emulates the SOROC IQ120 terminal for video addressing and screen display. Installation is easy and requires the removal of only one chip, the Z80. The board contains all chips in sockets for easy repair and upgrade. It's also the smallest board that was tested.

The Mapper III that I tested could read only disks formatted for the Mapper III. Omikron indicated that the production board will read a number of formats with the previously mentioned software upgrade.

Omikron also expects to release a number of very useful utilities that will be standard with the production of the Mapper III, or free to owners of earlier Mapper IIIs, in the near future. These include programs to check memory, check disk condition, emulate a dumb terminal, and transfer programs from TRSDOS to CP/M. The last program will be most useful for long BASIC programs that you don't want to retype. Programs written under TRSDOS probably won't run under CP/M without modification.

For another \$199, Omikron offers an additional software package to go with the Mapper III. The package, which includes CBASIC-II, Wordstar, and Microproof, represents a substantial savings over retail prices of these packages and gives you a good start on CP/M software. Omikron also has a special user's purchase group, Cougar, that enables owners to buy additional software at greatly reduced prices.

The installation instructions are well written and I encountered no problems with the board. Also, Omikron offers a lifetime warranty on the Mapper III. Although the software for the version I tested was not as sophisticated as the other boards, even in its preliminary form, the Mapper III offers a good value for those interested in CP/M. You should check with Omikron, however, to verify current capabilities for a particular application.

### Shuffleboard III

The Shuffleboard III from Memory Merchant is a moderately priced (\$299) yet excellent conversion that contains an additional 16K bytes of memory, for a total of 64K under CP/M with a 48K-byte Model III. It includes both CP/M 2.2 and MBASIC, Microsoft's BASIC interpreter for CP/M, similar to the TRS-80 standard BASIC. A 77-page users manual and 398 pages of Digital Research documentation for MBASIC and CP/M 2.2 provide necessary documentation.

This conversion features an "auto-sense" boot that automatically determines what type of operating system is contained on the disk in drive zero. In other words, once installed, the conversion boots in the proper mode automatically; you can disable this feature if desired. The system normally boots from drive zero, but this also can be disabled, allowing you to boot from any drive for CP/M. (TRSDOS, of course, always boots from drive zero.)

The Up-Arrow key functions as a control key, and all other ASCII characters may be generated from the keyboard. The cursor may be set for either blinking or non-blinking, and linefeeds for the printer may be disabled or enabled easily to accommodate different printers.

A special function allows a remote terminal to be hooked up to the RS-232C port to allow for graphics, an 80 by 24 display, or any other special function. A SET-COM command, similar to that found in TRSDOS, is used to set the data rate, parity, character length, and stop bits. Direct cursor addressing is implemented, and console control characters are equivalent to a Lear-Siegler ADM-3A control set.

Perhaps one of the most unique features of the Shuffleboard III is its *virtual drive function*. Although difficult to explain in this limited space, virtual drive means that it may appear to the system that you have more drives

EMACS  
FOR THE  
IBM PC

UniPress is pleased to announce the availability of MS-DOS EMACS to supplement our

existing UNIX and VMS versions. MS-DOS EMACS is full-function Gosling EMACS, including compiled MLISP, macros, command undo and much more.

**UniPress Gosling EMACS:** The famous multi-window full-screen editor. Edit several files at once. Interprocess communication on UNIX and VMS. Extensible via macros and the built-in compiled MLISP language.

**UniPress Gosling EMACS:** The ultimate programmer's tool: C, Pascal and MLISP language assist. EMACS manages execution of Unix makefiles, and automatically points to lines containing errors in the source code. Keys can be bound as desired, macros can be named, customized MLISP routines can supplement the many included packages, and much more!

**UniPress Gosling EMACS:** Use EMACS as your session manager — Divide your screen into a "shell window" to run commands, and one or more source file windows.

**ALSO NEW! MINIMACS** — Special efficiency-conscious EMACS. Faster and smaller; includes all standard editing features, keybinding, and multiple windows.

PRICES: UNIX: \$395/Binary; \$995/Source  
VMS: \$2500/Binary; \$7000/Source  
MS-DOS: \$375/Binary; \$995/Source  
(Requires at least 384K)

### UNIPRESS OFFERS A FULL LINE OF SOFTWARE FOR UNIX, VMS AND MS-DOS.

**Lattice® C compilers to the 8086-family;** both native and cross. Write programs on your mainframe for execution on the IBM-PC, etc. (Cross compilers for UNIX and VMS.)

**Q-CALC** — extraordinary UNIX spreadsheet.

**LEX** — Powerful interactive UNIX word processor.

**PHACT** — Multi-keyed ISAM database record manager for UNIX and MS-DOS.

### OTHER UNIPRESS PRODUCTS:

Full UNIX System V operating system for the Apple LISA, /RDB The Menu System, UniCalc, and more.

Call or write for more information.

## UniPress Software, Inc.

2025 Lincoln Highway, Suite 312, Edison, NJ 08817  
201-985-8000 • Order Desk: 800-222-0550 (outside NJ)  
Telex: 709418

Mastercard and Visa

Unix is a trademark of Bell Laboratories • VMS is a trademark of Digital Equipment Corp. • MS-DOS is a trademark of Microsoft • Lattice and UniCalc are registered trademarks of Lattice Inc. • IBM-PC is a trademark of IBM

than you actually do. For example, the operating system may believe that you have two double-density and two single-density drives even though you have only two double-density configurations. This makes some difficult operations easy. A high-density format routine also increases disk capacity by about 11K bytes.

I strongly believe that any good conversion should include the ability to read many disk formats because very little CP/M software comes in the TRS-80 format. The Shuffleboard III will read *and format* Osborne, IBM, and Xerox disks. Superbrain, Kaypro, and Televideo should be ready soon. Of course, IBM programs won't run on the TRS-80 because IBM uses different central processors, but this conversion does make data transfer possible. Please note that I said Shuffleboard III would also *format* these disks. This enables you to prepare a disk directly on your computer for a friend who owns a different computer, a very nice feature that is well implemented on the Shuffleboard III.

The warranty is good for one year, and Memory Merchant offers a 15-day trial period. Installation instructions are well written and clear. I installed the board quickly and without board or documentation problems. The Shuffleboard III offers a conversion with the features most users require for a reasonable price.

### Vid-80

The \$399 Vid-80 by Holmes Engineering is the one board that not only converts the TRS-80 to CP/M but also converts the screen to 80 by 24. As mentioned earlier, most software is formatted for an 80 by 24 screen, and this conversion makes the Model III compatible with almost all CP/M software. For video and screen formatting, the Vid-80 emulates the Lear-Siegler ADM-3A terminal.

The conversion for 80 by 24 also works in TRSDOS with some limitations. Software, especially machine language, will not work without conversion in the 80 by 24 mode. The board also redefines graphics from 127 by 47 to 159 by 71, slightly improving resolution. Locations for the PRINT@ command are also redefined from 0 through 1024 and 0 through 1919. It would take a separate review to evaluate the board for its use in TRSDOS, but it does function under both operating systems.

The latest version of the board has the ability to read and write several 5¼-inch disk formats, including those of the IBM PC, Kaypro II, Xerox 820 (single- and double-density), Osborne-I, Zenith Z-100, Freedom Tech, and Morrow Micro Decision. Maximum storage using the Kaypro standard is 191K bytes. Considering that CP/M uses quite a bit of disk overhead, this is amazing. You end up with more storage capability than TRSDOS.

After the board is installed, the Model III automatically recognizes which operating system is on the disk and boots up in the 80-character mode. If you want a 64-character mode, you hold down a "6" during booting. Installation requires the removal of two integrated circuits and their replacement on the Vid-80 board. Two solderless jumper cords and two power cords must be at-



## The all new Freedom™ 110 VDT has just two things going for it.

**The price, \$595.** The new Freedom 110 Video Display Terminal is without question the price leader of all low-end smart terminals. And it doesn't stop there. In fact, the price is only the beginning.

**The performance.** It starts with distinctive styling, including a tilt and swivel screen, and a sculptured, detached European DIN-standard keyboard. We paid a little extra for the green phosphor (amber optional) non-glare high resolution screen so you get the best in crisp, easy to read characters. We've packed the ergonomic Freedom 110 with a long list of user-relevant features, too.

- 24 x 80 display with user-accessible 25th status line.
- 10 programmable non-volatile function keys (20 with shift) and 20 pre-programmed codes.
- Flexible non-volatile set-up modes (full page or status line).
- 15 thin-line graphic characters.
- Non-embedded character attributes.
- 9 cursor control and 8 editing keys.
- Screen time-out.
- Block, conversation, monitor and local communication modes.
- Bidirectional buffered auxiliary port.
- 8 standard foreign character sets.
- Self-test mode.
- TeleVideo 910, ADDS Regent 25, Lear Siegler ADM 3A/5 and Hazeltine 1420 emulation.
- Chassis-mounted PC board for the same easy serviceability and add-on board capability as the advanced Freedom™ 200 VDT.

You get all this, plus our industry leading six-month warranty and comprehensive third-party service. To find out more about what price and performance leadership really means, contact your nearest Liberty dealer or distributor. Or call Liberty direct at (415) 543-7000.

**See us at COMDEX in Atlanta. Booth 3432, West Hall.**

Circle 231 on inquiry card.

 **LIBERTY**

© 1984 Liberty Electronics.

TeleVideo 910 is a trademark of TeleVideo Systems, Inc. Regent 25 is a trademark of Applied Digital Data Systems, Inc. ADM 3A/5 is a trademark of Lear Siegler, Inc. WordStar, MailMerge and SpellStar are trademarks of MicroPro International Corp.



tached. All this is done without any soldering or permanent change to your TRS-80.

In addition to the CP/M operating system and its utilities, two other programs are included. A Sap utility sorts and packs the directory to conserve space and alphabetize. An Unerase utility lets you restore files that may have been accidentally erased. Auto-repeat capabilities for each key are also standard with the Vid-80.

The Vid-80 RAM can be increased through expansion modules to nearly 1 megabyte. A CP/M 3.0 version should be available by now for Holmes's 64K-byte memory option (112K bytes total), which sells for \$524.

For technical assistance and updates, Holmes maintains both a phone number and a computer bulletin board. This bulletin board, Connection-80, enables Holmes to pass on patches and other technical information and allows the user to leave questions about Vid-80 for Holmes. When I contacted Holmes with technical questions, both as a reviewer and customer, the company was courteous, quick, and correct each time.

Both Omikron and Memory Merchant indicated that they will be marketing an 80 by 24 conversion for their CP/M boards in the future. The Vid-80 already has this feature, which makes the Model III very competitive with the Model 4. The Vid-80 is a complete CP/M conversion and enables you to enter the world of CP/M without reservation.

#### What about the Model 4?

What advantages does the Model 4 have over the Model III? Well, the most significant are a higher speed processor, an 80 by 24 screen, ASCII character generation, a new (TRSDOS 6.0) operating system, and CP/M compatibility. If you're only interested in CP/M, you should consider one of these boards for your Model III. Holmes also sells a speed-up kit for the Model III for about \$100. Converting this way allows you to add one piece at a time, instead of all in one big costly chunk.

#### Conclusions

Each of the conversions is targeted at different users. You should decide which you need for your individual

use. All the conversions worked without major problems and are easy to install following the instructions included with each.

The Omikron Mapper III is aimed at the low-budget user who intends to purchase his software from Omikron. Omikron's Cougar club allows owners to purchase major programs at very low cost. The company has a track record with the Model I Mapper and should have several enhancements included in the future.

The Memory Merchant Shuffleboard III is a full-featured CP/M conversion that meets the needs of most users. It reads three disk formats, and three more will be ready soon. The virtual-drive idea is exciting and very useful to two-drive owners. I was most impressed with this board and its implementation. I have used this board for several months without a single bug.

The Vid-80 from Holmes Engineering is the only conversion I tried that also converts the screen to 80 by 24. Sooner or later all computer users will want this size screen for some application, and Holmes solved that problem. I give Holmes four stars for this conversion. I know that \$400 is quite a bit to spend, but that's a very low price for CP/M, an 80 by 24 display, and accommodation of a wide variety of disk formats. Holmes has been in the TRS-80 business for many years and has a good record with the dealers with whom I spoke. If you can afford to do the conversion all at once, the Holmes board is a good choice.

All in all, the TRS-80 user has a number of conversions from which to choose. With Radio Shack turning to CP/M, it may not be many years before TRSDOS is gone forever. I think all serious users should start looking into CP/M and what it has to offer. ■

#### Author's Note:

*I'd like to thank all the manufacturers for their cooperation and answers to my questions. I'd also like to thank Bob Byars at Mountain Data in Havre, Montana, for the use of his equipment and time.*

*Mark E. Renne (53 Glacier Ct., Bozeman, MT 59715) is a free-lance writer and full-time student at Montana State University in Bozeman.*

**IT'S SIMPLE. . .CALL AND SAVE MONEY!**

**Since 1978**

**1-800-841-0860**

**GA. & INFO  
912-377-7120**

**DIRECT MARKETING  
COMPUTERS AND  
EQUIPMENT  
TO SAVE YOU MONEY!**

**FREE UPON REQUEST**

\*DISCOUNT PRICE LIST AND INFORMATION KIT  
\*COPY OF MFR'S WARRANTY  
PRICES AND PRODUCTS ARE SUBJECT TO CHANGE  
WITHOUT NOTICE.

**TRS-80  
COMPUTERS**

**EPSON**

**star**  
REPRODUCIBLE

**IBM PC Compatibles**  
Call For Your Choice

**Columbia PC Tandy  
Model 2000**

Other Products

**\$CALL**



**MicroManagement  
Systems, Inc.**

2503 Thomasville Road East  
Cairo, Georgia 31728

TELEMARKET DEPT. 1



# DRAWING YOUR OWN CONCLUSIONS



## ... Is Easy With The Versatile HIPAD™ DT-114 From Houston Instrument.

Enter a whole new universe of graphics, made possible by programs tailored to the HIPAD digitizer.

Exciting new applications in computer-aided drafting are now available, allowing you to create subdivision plats, machine drawings, schematics, architectural elevations and circuit-board artwork . . . with your micro-computer . . . at your desk . . . with no training as a draftsman.

Use of the HIPAD in medicine is increasing. With currently available software, physicians and dentists can prepare graphics of anatomical features for diagnosis and correction.

Artistic efforts are complemented by the HIPAD. With customized software, free-form renditions can be created quickly and precisely. Colors to fit the moment can be selected . . . and easily changed at a later time. The

HIPAD provides access to the realm of high technology graphics.

The HIPAD features a full-size 11" x 11" digitizing area, and is both UL listed and FCC approved.

## The Conclusions You Draw Are Clearly Correct. The HIPAD will open the door to a universe of form and color . . . and creativity.

For the name, address and phone number of your nearest representative, write Houston Instrument, P.O. Box 15720, Austin, TX 78761. Phone 512-835-0900, or 800-531-5205 if outside Texas for the name and location of your nearest representative. In Europe contact Bausch & Lomb Belgium NV., Rochesterlaan 6, 8240 Gistel, Belgium. Tel. 059-27-74-45, Tlx. 846-81399.

## houston instrument

HIPAD is a trademark of Houston Instrument



DayFlo announces  
a major revision  
of the fundamental  
law of computing.





Garbage in, garbage out.

Since computers were invented, the conventional wisdom has held that input that doesn't conform to the computer's highly structured needs will result in unintelligible output.

Which meant that you had to learn to think like a computer in order to use one.

Trouble is, the world isn't organized to suit computers. Data is never collected in the way you want to retrieve it. That's why traditional, rigidly structured databases often wind up hindering your work more than they help.

DayFlo offers a new approach to database management needs. It's a Fluid Format™ Personal Information Manager. Which means it approaches the world the same way you do: taking in unorganized data and organizing it into meaningful information.

DayFlo is a powerful tool for your IBM® PC XT. It accepts both structured and unstructured data. When you want to extract information, just type in the key words you're looking for. Instantly, DayFlo organizes the data according to your criteria. And reorganizes it according to new criteria whenever you wish.

Information from other programs, spreadsheets, word processing or accounting files, virtually any data in the system can be assimilated by DayFlo. And once the information is at hand, DayFlo lets you manipulate it at will to produce letters, memos, reports and much more. You can work at your computer the same way you work at your desk, even switching quickly from task to task, without ever losing your place.

DayFlo's concept is as simple as it is revolutionary. You no longer have to think for the computer. Instead, it can help you think better for yourself. Which leads, inevitably, to a brand-new version of computing's fundamental law.

**DAYFLO**  
Software™

**Garbage in. Information out.**



# The \$14.95 Peripheral

## That Puts Your Computer's Commands Where They Belong And Your Manuals On The Shelf.

Now, you can command new computer productivity. Discover how much easier your personal computer is to use when the commands are at your fingertips. PC-DocuMate keyboard templates can save you time and frustration. You can recall needed commands, options and formats. Quickly. Professionally designed and comprehensive. Each PC-DocuMate template has been designed by a software expert. Commands are logically and functionally organized so you can get the most from your software. And our templates are comprehensive reference aids which use both sides to document a product or a system. Completely.

Durable and guaranteed, PC-DocuMate templates are silk-screened onto durable, non-glare plastic to our exacting specifications. Each template is printed on both sides and color-coordinated to complement your PC. And your satisfaction is guaranteed. Fully. Or your money back. Save time and enjoy greater productivity. Order your PC-DocuMate without delay. Lower prices for better design. With PC-DocuMates, you get two-sided templates for less than a single-sided template from other manufacturers. And you get a better designed template. Order direct or ask your local dealer.

### PC-DocuMates now available... IBM PC/XT & COMPAQ — \$14.95

- DOS/BASIC 2.0 & 2.1 • DOS/BASIC 1.1 • Lotus 1-2-3 • WordStar • dBASE II • MultiMate 3.20 • VisiCalc • Multiplan 1.00 or 1.06 • Volkswriter • SuperCalc<sup>2</sup> • PeachText 5000 • EasyWriter II • Do-It-Yourself

### COMMODORE 64 — \$12.95

- BASIC & more • Calc Result • EasyScript • Quick Brown Fox • Do-It-Yourself (CBM 64 templates are printed on one side only)

### IBM PCjr. — \$12.95

- DOS/BASIC 2.1 • MultiMate • dBASE II • Do-It-Yourself

### APPLE IIe — \$14.95

- WordStar • VisiCalc • dBASE II • AppleWriter II • Quickfile • Do-It-Yourself

If your favorite software package is not shown here, you can order our "Do-It-Yourself" template (which includes a special pen and eraser) and develop your own custom keyboard template.

**Our Guarantee.** Use your template for 20 days. If you are not completely satisfied return it to us (undamaged) for a full refund.

**HOW TO ORDER:** Send personal check, money order or MasterCard/VISA credit card information. Please add \$1.50 for shipping and handling per order; foreign orders must add \$5.00 per unit (except Canada). US funds only. Sorry, but no COD's. NC residents add 4% sales tax. Corporate quantity discounts available. Dealer inquiries invited. And for faster service on credit card orders...

Call Toll Free  
**1-800-762-7874**  
 (In North Carolina) 919-787-7703

**SYSTEMS MANAGEMENT ASSOCIATES**  
 3700 Computer Drive, Dept. Y-1  
 Raleigh, North Carolina 27609

Circle 370 on inquiry card.

The following trademarks are acknowledged.. IBM Corp., IBM, IBM PC/XT & PCjr, Ashton-Tate, dBASE II, Information Unlimited Software, Inc., EasyWriter II, Lotus Development Corp., Lotus 1-2-3; SoftWorld Systems, Inc., MultiMate; Microsoft Corp., Multiplan, PeachTree Software, Inc., PeachText 5000, Sorcom Corp., SuperCalc<sup>2</sup>, Lifetime Software, Inc., Volkswriter, MicroPro International Corp., WordStar, QuikText; Quick Brown Fox, Herdic Software, etc; Calc Result, Commodore Business Machines, Inc., EasyScript, VisiCorp, VisiCalc, Apple Computer, Inc., Apple IIe, AppleWriter II, Quickfile.



## Robographics CAD-1

*Convert an off-the-shelf Apple into a drafting system*

Rik Jadrnicek  
Micro Flow Company

There are more and more CAD (computer-aided design) packages coming out all the time. In fact, trying to keep up with them becomes a job in itself. Out of necessity, I find myself picking one or two outstanding characteristics from each to separate it from the rest. Robographics CAD-1 stands out for its use of libraries—the way it enables you to assemble large drawings with complete disregard for the amount of available RAM (random-access read/write memory)—and for its zooming abilities—the way it allows you to draw in much greater detail than the graphics monitor can show.

CAD-1 is a computer-aided design software package for the Apple II and Apple IIe computers. Using CAD-1, you can draw a wide variety of pictures with great accuracy and plot the image precisely on various output devices. For example, you may draw simple block diagrams, flowcharts, or a more complex schematic; you may design a personal computer circuit board or do some mechanical drawing on a valve; or you may do some space planning or architectural design.

How well a CAD system performs these tasks depends on software quality, the central processor, the graphics processor and monitor, and the hard-copy output device. Within the limitations of Apple's 6502 processor and graphics resolution, CAD-1 performs very nicely. Written in assembly language with high-precision floating-point math, the program is lightning fast and seems to implement fully the processing power available.

### Hardware

With this software, you can convert an off-the-shelf Apple computer into a drafting system. You need the CAD-1 software, the joystick supplied with the software, an Apple II or IIe with 64K bytes of RAM, a suitable video display, and two Apple II DOS 3.3 disk drives with controller cards.

CAD-1, with its special input device (a hardware box with three buttons, a rotating dial, and a joystick) retails for \$1095. With it you can make the most of the entries necessary to run the program. You can draw accurately with the joystick and rotate and scale objects with the dial. More on this device later.

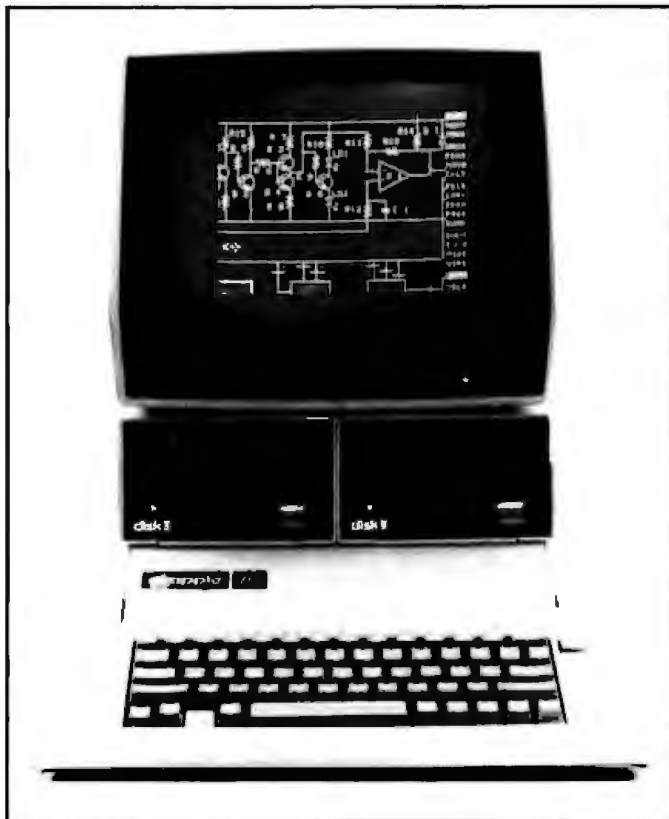


Photo 1: An Apple IIe displaying a typical CAD-1-created drawing.

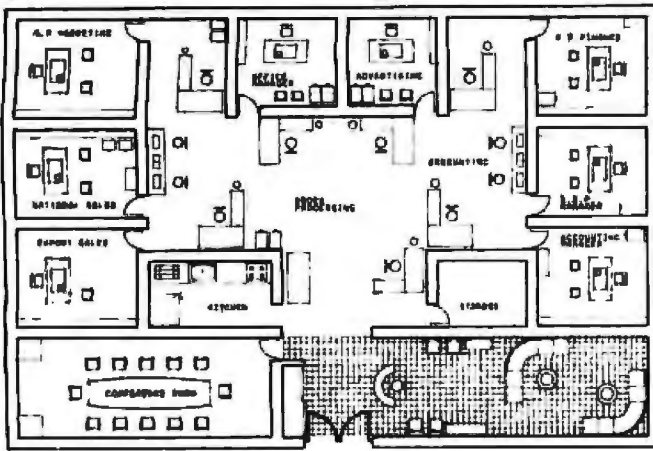


Figure 1: A sample floor plan prepared with CAD-1. This drawing is made easy by manipulating different user-defined library drawings of standard office furnishings.

Optionally, CAD-1 also supports the Robographics and Apple Graphics 11 by 11 digitizing tablets to make drawing easier. These devices simulate a drafting table and come in all sizes. You can trace existing drawings or simply draw from scratch on the digitizer surface. A stylus or cursor (sometimes called a puck) serves as an electronic pencil for entering data points at the press of a button.

To produce low-resolution, hard-copy plots of your drawings, you can use a dot-matrix printer. The software supports a variety of interface cards and you can configure the software yourself if a particular card is not directly supported. You can use a variety of quality plotters capable of producing A to D size plots (USA) or A1 to A4 size plots (Europe). These currently include Bausch & Lomb (Houston Instrument DMP 40 through 42), Calcomp (models 81, 84), Gould Bryans Colorwriter, Hewlett-Packard (7470A, 7580A/B, 7585A) and Watanabe Digiplot (all B or A3 sizes).

### Monitor Drawing Resolution

A variety of graphics monitor options are available in addition to the standard Apple graphics capability. Herein lies the major limitation of most CAD systems including CAD-1. The software is capable of producing a large drawing (e.g., 24 by 36 inches) in detail, and a large format plotter is fully capable of plotting the same detail. However, the graphics display device can't accurately represent the image you see while you are creating and editing your drawing.

The resolution of the graphics processor and monitor determines the accuracy with which a display can represent an image. These devices have only a certain number of pixels (picture elements) with which to describe an image. The lower the number of pixels available, the lower the resolution and the more jagged the image.

For example, the resolution of the Apple is 280 horizontal pixels by 192 vertical pixels. The Robographics CAD-1 system uses the rightmost 24 columns of pixels

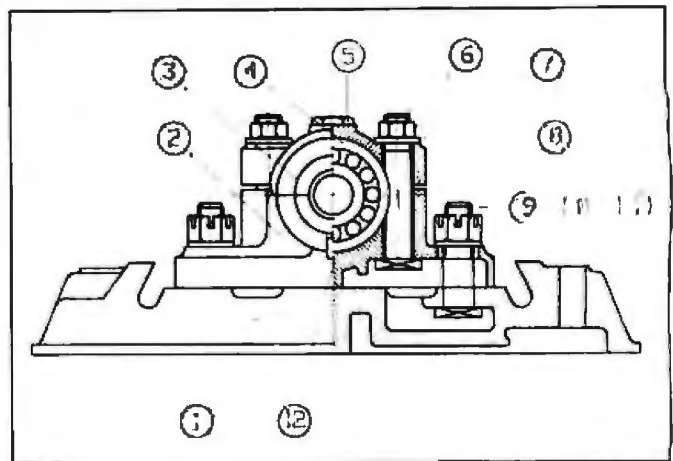


Figure 2: A mechanical drawing created with CAD-1 showing the potential accuracy of the software and the use of line types, arc, circles, and crosshatching.

for on-screen menus (see photo 1), leaving a workspace of 256 by 192 pixels. This area is used to represent your image no matter how large it is. It stands to reason that a 24- by 36-inch drawing appears very crude.

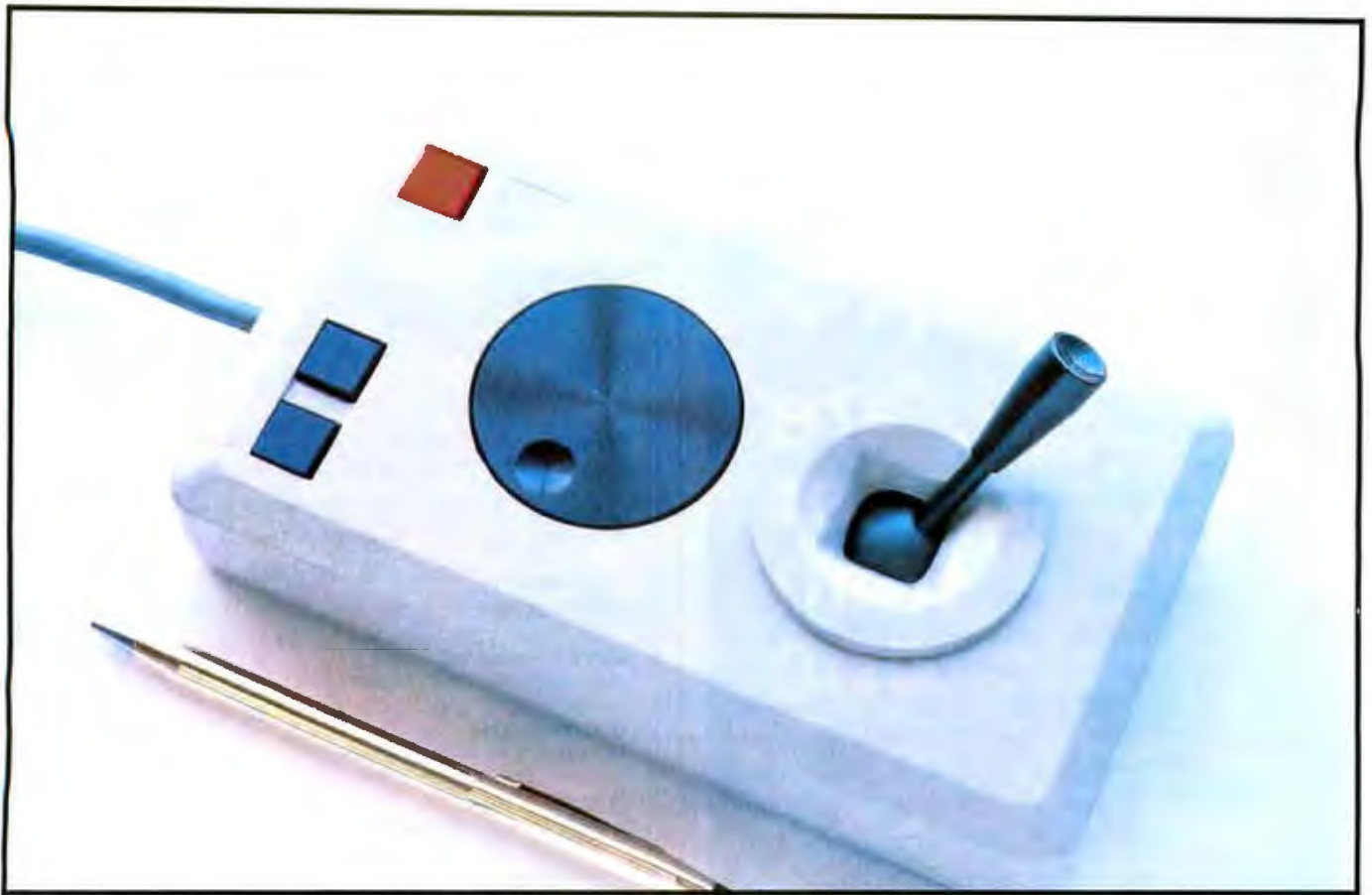
On the other hand, the actual drawing database is very accurate. The output device resolution provides the only limitation on the quality and resolution of the hard-copy output. For example, a dot-matrix graphics printer produces a low-resolution image while a high-resolution plotter reproduces the drawing accurately. These differences in actual, display, database, and output resolution are important to understand when configuring CAD systems.

### Let's Draw

To begin drawing with CAD-1, you hook up the input device to your Apple, insert the program disk in the drive, and load the program. Then you insert a library disk in drive A and a buffer disk in drive B. There is a lot of disk swapping with CAD-1. When you use a plotter, an additional disk must be swapped. The system really needs a hard-disk version developed for serious applications.

Once the proper disks are in place and the system is loaded, the system presents you with a clear screen to draw on—clear except for a menu area down the right-hand side of the screen and a function area at the bottom. Using the joystick on the input device, you move a small cursor (an "x" on the screen) around the drawing area and place it on menu choices. Pressing a combination of the device's three buttons, you choose commands and functions from the menu and create drawings on the monitor screen. For example, if you move the cursor to the function area at the bottom of the screen, you can choose a primitive type (e.g., line, arc, circle, etc.), a color, and a line type (e.g., dotted). Then if you choose DRAW on the monitor menu, you can draw images on the screen with the joystick (or digitizer) and the buttons. You can freehand sketch, trace lines of





**Photo 2:** The Robographics CAD-1 specially designed input device, consisting of a hardware box with three buttons for selecting and de-selecting points and menu options, a joystick for positioning the cursor on the display screen, and a rotating dial for controlling such things as the radius length of a circle, or an arc, or the rotation of objects on the screen.

different widths, fill areas temporarily or permanently, insert text, erase objects, zoom, and pan (scroll from one area to another). See figures 1 and 2.

Since the program is written in assembly language, the cursor movements and placement of lines and shapes are instantaneous. You can freely manipulate lines, arcs, and circles while you watch them stretch and shrink on the screen before you. You can turn on a grid system and lock your drawing to the grid points (your drawing points snap to the nearest grid point—standard or user-defined) to produce precision drawing. You can have different *x*- and *y*-axis values and you can rotate the grid if you want to work on isometric images.

### Commands

Several cursor lock modes are available for drawing precision. You can lock the cursor to move in only two fixed directions from its current position. The axes of these two directions can be set at different angles providing tremendous help in constructing isometric images. A NORMAL-TANGENT lock mode automatically senses the slope of the last line drawn then sets an orthogonal axis (at right angles) lock at the end of the line. I find this helps to create a smooth continuation of a previous line with an arc—a good way to construct a fillet (the concave transition surface between two other-


wise intersecting surfaces).

You can determine the location of a specific point with the FIND command, snap the current grid to that point with SHIFT-GRID, and rotate the grid using NORMAL-TANGENT. You can even skew the grid for more variety. These are very powerful features for precision work. You can draw isometric projections in true scale or, if this is too confusing, call up two preset standard grids to restore your sanity.

The scale of the CAD-1 system is metric but the database units could just as well be feet or inches with decimal fractions. By the time you read this, CAD-1 expects to have automatic dimensioning with feet and inches (requiring a Saturn RAM expansion board to boost the Apple to 192K bytes of RAM), but currently dimensioning must be done manually.

With the NIB command you can determine the spacing between, and the direction of, the fill elements. This allows you to shade objects, giving dimension to your drawings.

There are some software limitations in CAD-1. I did not see a provision for entering data-point coordinates manually from the keyboard, either relative to the origin (0,0), relative to the current point, or using polar coordinates (angle and distance from a point). The ability to draw on layers, turning them on and off to display dif-



# 2 chips are better than one

Is your Apple's 6502 processor chip a little overworked lately? Have you been eyeing one of those new, 16-bit systems? But you don't want to give up all your Apple programs ...

Add the powerful 16-bit 8088 processor to your Apple with ALF's Processor Card. Let the 6502 and 8088 work together to tackle your toughest problems—like speeding up your Applesoft and Apple Pascal programs. With the Processor Card, you can use the CP/M™ 86 or MS-DOS™ operating system to run the latest 16-bit software, including many IBM PC programs.

64K or 128K of high-speed memory is available for ALF's Processor Card. Use the Processor Card with 128K as a fast disk emulator or to view sixteen hi-res images in under a second. Or run Basic, C, COBOL, or Pascal with 16-bit performance!

The ALF Processor Card is just \$395 (Applesoft speed-up software included). See your Apple dealer today, or contact ALF for more information.

Trademarks: "Apple": Apple Computer, "CP/M": Digital Research, "MS-DOS": Microsoft.

# ALF

ALF Products Inc.  
1315F Nelson St., Denver, CO 80215  
(303) 234 0871 Telex: 4991824

## At a Glance

### Name

Robographics CAD-1

### Type

Computer-aided design (CAD) software

### Manufacturer

Chessell-Robocom Corporation  
111 Pheasant Run, Suite 2B  
Newtown, PA 18940  
Mr. Peter Kendall  
(215) 968-4422

### Format

Apple DOS 3.3 5¼-inch floppy disks

### Language

Assembler

### Computer

Apple II or Apple IIe

### Software required

None other than the program

### Documentation

167-page, 6- by 9-inch manual

### Price

\$1095 including hardware input device

### Comments

CAD-1 provides fast, powerful, and easy-to-use computer-aided design capability on an Apple II or Apple IIe

ferent elements of your drawing, is also missing. In addition, only one text font is provided and it is only adequately attractive.

## Zooming

CAD-1's ability to zoom into an area of the drawing helps to overcome the display monitor's limitations. For example, when you zoom into (or window) a particular room of a floor plan you are drawing, that room will fill the entire monitor screen. You can see more detail and you can draw with greater precision. The width of the screen could represent, for example, 1 inch, 1 foot, or 1 mile.

The concept of zooming is important to understand. CAD-1 provides a window into your drawing. Consider a 24- by 36-inch drawing. With CAD-1, you can see as much of that area as you want at a time. You can draw a border on the drawing and then zoom in to a 9- by 12-inch area to do some detailed work. You can zoom in further to a 1-inch square and draw at 0.001-inch precision. In effect, you are scrolling a window (often called a viewport) over the surface of a larger drawing. Zooming back to the full-size drawing condenses all that detail into a relatively small area on the screen. This doesn't have any effect on the final plot, however; the full 24- by 36-inch image is plotted to scale depending on output device capability.



# MOST ACCOUNTING SOFTWARE TURNS WORK STATIONS INTO BATTLE STATIONS.

When you have Champion Accounting Software, your personnel can leave the combat zone. Because Champion\* gives you the performance you need, without a fight.

Champion is written in dBASE II\*\* on one convenient disk. And its features make conventional accounting software obsolete.

## PERFORMANCE YOU CAN SEE.

Other software dealers will tell you what they think their product will do. Only Champion dealers will show you how the software performs:

- Help function provides users with clear, concise, on-line answers to questions about Champion.

- Unparalleled recovery program automatically puts the user's books back in balance in the event of a crash.
- Real time updating. All files are simultaneously updated when data is entered.

## PRaised BY EXPERTS.

*"It performs extremely well... If you are looking for a good, competitively priced, fully integrated accounting package... take a close look at this one."*

Amanda Hixson  
INFOWORLD, 9/83

*"... users will find this to be a very comprehensive software package with several attractive features that make it superior to its competition."*

Carl Heinz, CPA  
INTERFACE AGE, 8/83

For more about Champion performance, see the Champion dealer nearest you. And get the accounting software system that lets you work in peace.

\*Champion is a registered trademark of Champion Software Corporation  
\*\*dBASE II is a registered trademark of Ashton-Tate

Champion Software Corporation  
Formerly:  
Data Base Research Corporation  
66 South Van Gorden, Suite 155  
Lakewood, CO 80226 (303) 987-2588

# CHAMPION

**BUSINESS ACCOUNTING SOFTWARE**

Circle 497 for Dealer Inquiries.  
Circle 498 for End-User Inquiries.



# NOW AVAILABLE FOR IBM P.C.

CALL (303) 987-2588 FOR A FREE DEMONSTRATION

## Drawing Size

Each drawing holds up to 3000 bytes of information. For example, a line takes 10 bytes, an arc 15, a circle 8, a nib fill pattern 18, text 10 (plus 1 byte per letter). When the workspace fills up, the system notifies you with a beep. This is where CAD-1 gets creative. It is obvious that 3000 bytes is not much room for a detailed drawing. CAD-1 lets you store the work you have done in a library on disk. Within one library file you are allowed three pages of drawings. The number of drawings you can keep on each page varies from 4 to 64. Put simple images like letters on the 64-division page and more complex drawings on the 4-division page where you can save more detail.

Once you store your drawing in a library slot, you can return to the drawing editor, clear the screen, and draw another 3000-byte image. You can also store this drawing in a library and return to do another and so on until the memory is used up. Then you can copy back the stored library images to your current drawing. As the images come in, you can freely scale them by  $x$  and  $y$  and rotate them in increments of 5 degrees (by turning the rotating dial on the input device). Once copied, they are treated as one entity and occupy only 20 bytes in your current drawing. You can assemble about 150 of these drawings within the new drawing and then save that drawing as a library image. When copied into another drawing, this image also takes only 20 bytes of memory. This procedure can go on until the disk space is used up.

Developing large drawings with CAD-1 is a process of assembling smaller drawings that have been stored in the library. A certain amount of preorganization is, therefore, required to do complex drawings. You can even copy library items from different library disks into your current drawing. When the current screen is full, simply save the increasingly complex image to an available library slot and continue, incorporating it in another drawing. Animation effects can be developed by creatively interacting with the library images and the drawing-regeneration process.

There are some limitations associated with using library images that ought to be mentioned. When you copy a complex drawing in from the library, you can't edit it in detail. However, you can edit the original library image after which all references to it reflect the revisions. You can also print/plot your library pages for reference in assembling your drawings. Needless to say, this is a clever way of overcoming the RAM limitations of the Apple. The real drawing size limitation becomes the available disk space.

Since the regeneration of your drawing slows down in proportion to the drawing size, it makes more sense to assemble large drawings by overlaying a series of smaller drawings onto your plotter rather than by trying to fit everything into one drawing. Nevertheless, significant capability is available and one Apple disk will store several 24- by 36-inch plots with an average amount of detail.

## Packaging

CAD-1 documentation consists of one 6- by 9-inch manual with typeset pages printed on one side. The manual contains three sections, Getting Started, Basic Drawing, and Precision Drawing, and eight appendixes covering subjects like library archives, constructing lines with a given angle and length, creating symmetrical drawings with the mirroring function, discussion of the plotting utility and the options available, and others. The manual is well illustrated with a good tutorial. It needs double-sided pages and a good section on CAD basics, though.

The package includes an intelligent plot utility on a separate disk with a variety of options. You can search the library pages for the image you want to plot and window the appropriate area. You can change line types or colors, choose predefined zoom and plot scales, and plot with dimensions in metric or English units (in decimals). The program automatically selects different pens on multipen plotters, and you can stop or pause the plot at any time—very handy if you need to change a pen.

The software is copy protected with one backup of the program disk supplied. There is a 90-day warranty against defects in material and workmanship after which disk replacement costs \$10. Enhanced versions seem to be on the horizon, so check the company's update policy.

## Conclusions

CAD-1 makes good use of the Apple computer. I am amazed at how much is possible with the processing power of the 8-bit 6502 chip. The accompanying hardware input device provides a very friendly interface; however, it is nice to see that a selection of digitizer devices and plotters is also supported.

CAD-1 is written in fast assembly language and uses floating-point math for very high precision capability. The drawing library is a very strong feature. The ability to copy library drawings into the current drawing with minimal RAM overhead makes large drawings possible within the limitations of addressable RAM. Automatic dimensioning in feet and inches will be a welcome addition.

Like all CAD systems, this package needs a graphics processor/monitor combination with higher resolution to take full advantage of its capabilities. Running the program requires too much disk-shuffling, especially for more complex drawings. A hard-disk version is needed along with more addressable RAM and an MS-DOS version. Currently the program runs on the IBM PC with a Quadlink card installed. A true MS-DOS version is planned for release in 1984.

This software appears as somewhat of a sleeper, like a Ferrari engine in a Volkswagen. It is worth checking out, especially if you plan some serious drawing with an Apple computer. ■

---

*Rik Jadrnicek is president of Micro Flow (POB 1147, Mill Valley, CA 94942), a microcomputer consulting firm. When he isn't writing or playing with microcomputers, Rik likes sailing and traveling.*

---









Formerly **Computer Exchange**



© 1984 by Conroy-LaPointe Inc. All Rights Reserved

LOW PRICES TO PROFESSIONALS WHO KNOW WHAT THEY WANT AND KNOW HOW TO USE IT!

## SUPPLY CENTER for IBM-PC or XT

**256K IBM-PC or XT**  
320/360K Disk Drives by CDC  
90 Day Warranty By Us  
Call for Details



Coming soon — products for the PC Jr  
© 1984 Service Mark of Conroy-LaPointe Inc.

**AMDEK** MM 4-in-1 Multitask Board, Color Graphics, Mono 128K \$ 599 \$ 519

**AST** CombiPlus, 64K S/P/C \$ 395 \$ 279  
CombiPlus, 256K S/P/C \$ 625 \$ 495  
MegaPlus II, 64K, 25/P/C \$ 495 \$ 375  
MegaPlus II, 256K, 25/P/C \$ 795 \$ 595  
256K MegaPlus II Expansion \$ 395 \$ 295  
SuPaPlus, 64K, S/P/C +S/W \$ 395 \$ 295  
SuPaPlus, 256K, S/P/C +S/W \$ 695 \$ 495  
SuPaPlus, 384K, S/P/C +S/W \$ 895 \$ 595  
For SuPa w/ Game Port, 4M 1.0 Plus II, S/P/C \$ 50 \$ 39  
1.0 Plus II, S/P/C \$ 215 \$ 180  
1.0 Plus II, S/P/C/G \$ 265 \$ 185

**CCS** SuperBoard, 132 col. mono board \$ 799 \$ 599  
Z Plus 64, fast 280K, 64K game port \$ 875 \$ 695

**Chalkboard**, Power Pk, Reg. Kit \$ 100 \$ 73

**ComX** 256K RAM Card with Fasttrak™ RAM disk emulator and spooler software \$ 495 \$ 325

**CURTIS** LMS I, Monitor til & swivel base \$ 50 \$ 39  
3 to 9 foot keyboard cable \$ 40 \$ 30  
Vertical CPU "System Stand" \$ 25 \$ 19  
Microchrome Girl, Cable Pan \$ 50 \$ 35

**HERCULES** Microchrome Board \$ 499 \$ 349

**Key Tronic** KB5150 Std keyboard \$ 209 \$ 159  
KB5151 Std keyboard NEW \$ 255 \$ 209

**Koala** Floppy Pad™ w/PC Design Programmer's Guide \$ 150 \$ 109  
\$ 15 \$ 12

**MAYNARD SANDSTAR** Multitasking (B) Card, MFC \$ 80 \$ 79  
Memory Card no RAM \$ 230 \$ 169  
Memory Card 256K \$ 498 \$ 395  
Modules for Sandstar in stock Call

**MICROSOFT** RAMCard 256K \$ 550 \$ 385  
SystemCard 256K \$ 625 \$ 469  
SystemCard 64K \$ 395 \$ 295  
Mouse \$ 195 \$ 145  
MOUSE SYSTEMS, PC Mouse w/Software \$ 225 \$ 195

**ORCHID** PCnet™ Starter Kit, LAN \$ 1490 \$ 1190  
PCnet™ Circuit Board Kit \$ 695 \$ 545

**PLANTRONICS** Color Board & Colormagic, 16 color w/Para \$ 550 \$ 395  
Color Board & Dreamman, 16 color, w/Para \$ 550 \$ 395

**QUADRAM**  
• Quadram NEWEST VERSION \$ 680 \$ 485  
Quadboard, no RAM, expand to 384K \$ 295 \$ 219  
Quadboard 64K, expand to 384K \$ 395 \$ 279  
Quadboard 256K, expand to 384K \$ 675 \$ 525  
• Quadboard, 384K \$ 795 \$ 625  
Quadboard II, no RAM, expand to 256K Call Call  
Quadboard II, 64K, expand to 256K \$ 395 \$ 285  
Quadboard II, 256K, 6 function \$ 595 \$ 395  
Quad 512 \* 64K plus serial port \$ 325 \$ 265  
Quad 512 \* 256K plus serial port \$ 550 \$ 420  
Quad 512 \* 512K plus serial port \$ 895 \$ 625  
Quadboard I, board, 16 colors \$ 295 \$ 219  
• Quadboard II, board, use with Quadboard I \$ 275 \$ 209  
• Quachrome, 12" RGB Monitor \$ 795 \$ 499  
Quatscreen 17" 963 \* 512 Monitor \$ 1985 \$ 1595

**Tecmar** Int MATE, 64K \$ 389 \$ 295  
Int MATE, 256K \$ 589 \$ 439  
Captain, 64K S/P/C/Prog \$ 424 \$ 324  
Captain, 256K S/P/C/Prog \$ 795 \$ 595  
Boss, 256K short brd. \$ 499 \$ 369  
Boss, S/P/C short brd. \$ 1395 \$ 1145  
Graphics Master \$ 685 \$ 575

**Titan** Accelerator PC (3086 \* 128K) \$ 995 \$ 790

**TG PRODUCTS** Keytrich \$ 60 \$ 40  
WICO, IBM PC Mouse \$ 100 \$ 69



Prices and availability subject to change. Call.

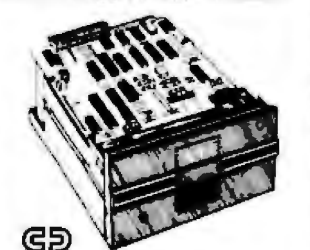
**\$55**  
★ 9 Each 4164, 200ns, MEMORY CHIP KIT  
90 Day Warranty by us

**\$325** \$295 Two or more.  
★ ComX 256K RAM BOARD

Fully Compatible 1 Year Limited Warranty by ComX  
With Fasttrak RAM Disk Emulator and Spooler Software  
Works on DOS 1.1, 2.0 or 2.1

★ MEANS A BEST BUY

### DRIVES AND ACCESSORIES



320K/360K DS/DD DISK DRIVES  
With Detailed Installation Instructions  
30 Day Warranty by Factory Authorized Distributor

Same as now installed by IBM \$219 \$279 For One

**HALF \$199 HEIGHT**

ComX Y™ Disk Drive Power Cable \$ 3 \$ 6

**AMDEK** Amadek V - height external, 320/360K \$ 329 \$ 249  
Amadek III Dual 3" Micro Floppy, 320/360K \$ 589 \$ 529  
Cable Amadek III to IBM-PC interface Call

**MAYNARD** Happy Drive Control Brd - up to 4 drives \$ 215 \$ 189  
same with Parallel Port \$ 300 \$ 239

### 8" CP/M-80 SOFTWARE

**MUCH MORE IN STOCK**

	LIST PRICE	OUR PRICE
ASHTON-TATE, dBase II	\$ 700	\$ 385
INFOCODA, Starbase, Zork I, II or III, each	\$ 50	\$ 34
Deadline or PlanSheet, each	\$ 60	\$ 40
MICROPRO, WordStar™	\$ 495	\$ 285
MultiStar™	\$ 250	\$ 145
WordStar ProL, 4Pak/Call	\$ 995	\$ 429

## SOFTWARE for IBM-PC or XT

**BUSINESS**

	LIST PRICE	OUR PRICE
ALPHA, Database Manager II	\$ 295	\$ 185
ASHTON-TATE, dBase II, 163 PC-DOS & 128K	\$ 700	\$ 385
dBase II User's Guide (Book)	\$ 30	\$ 20
Everyman's DB Primer (Book)	\$ 15	\$ 12
The Financial Planner	\$ 700	\$ 395
Friday	\$ 295	\$ 199
APPLIED SOFT. TECH., Versatorm	\$ 385	\$ 265
ASK MICRO, GLARAP, INV or PR, each	\$ 495	\$ 295
BRODERBUND, Bank Street Writer	\$ 80	\$ 56
BPI, Gen'l Acctg/ARAP or PR, each	\$ 595	\$ 395
CHANG LABS, Micro Plan	\$ 495	\$ 335
CONTINENTAL, Home Accountant	\$ 150	\$ 89
Tax Advantage	\$ 70	\$ 45
FCM (Filing, Cataloging, Mailing)	\$ 125	\$ 89
Property Management	\$ 495	\$ 329
DOW JONES, Market Analyzer	\$ 350	\$ 279
Market Manager	\$ 300	\$ 239
Market Microscope	\$ 700	\$ 525
FOX & GELLER, Quickcode, rGraph, Grator or Qz, each	\$ 295	\$ 195
dUnit (MSDOS or CP/M/86, each)	\$ 99	\$ 59
HAYDEN, IBM Pen Writer	\$ 200	\$ 135
Pen Speller or Sargan II, each	\$ 50	\$ 34
HOWARDSON, Tax Preparer, 1984 for 1983 year	\$ 295	\$ 220
HUMAN ENG, Management or Sales, vs I/UB, EasyWriter II System	\$ 350	\$ 259
EasySpeller II	\$ 225	\$ 149
Business System: GL + AR + AP	\$ 485	\$ 395
GLARAP or INV, each	\$ 395	\$ 295
INSOFT, Data Design Easy to use (DBMS)	\$ 225	\$ 169
GRAORTH (formatted 3D graphics)	\$ 125	\$ 95
LIFETIME, Volkswrtr	\$ 285	\$ 195
LOTUS, 1-2-3	\$ 495	\$ 329
QUE, Using 1-2-3 (Book)	\$ 15	\$ 12
MICRO LAB, Tax Manager for 1983	\$ 250	\$ 169
MICROPRO, WordStar™	\$ 495	\$ 238
MultiMerge™	\$ 250	\$ 129
SpellStar™	\$ 250	\$ 129
WordStar Professional, 4 Pak	\$ 895	\$ 395
Options Pak, SS/AM/SI	\$ 295	\$ 175
StarIndex	\$ 195	\$ 109
MultiStar™	\$ 250	\$ 145
MICROFORM, R-base, Series 4000	\$ 495	\$ 335
MICROSOFT, Multiplan	\$ 250	\$ 169
Word	\$ 375	\$ 259
Word with Mouse	\$ 475	\$ 325

**BUSINESS**

	LIST PRICE	OUR PRICE
MICROSOFT, Financial Statement	\$ 100	\$ 60
Budget	\$ 150	\$ 99
MONOGRAM, Dollars & Sense	\$ 495	\$ 110
OPEN SYS, GLARAP, INV or PCL, each	\$ 695	\$ 429
OSBORNE/CBMX, (Book & Business, Statistics & Math Programs on DOS/2.00 Disk)		
Some Common Basic Programs (70 ea.)	\$ 100	\$ 60
Practical Basic Programs (40 each)	\$ 100	\$ 60
PBL, Personal Investor I, I	\$ 145	\$ 99
PEACHTREE, Peach Pak (GLARAP)	\$ 395	\$ 239
Peach Test 5000	\$ 395	\$ 239
PEARLSOFT, Personal Pearl (DBMS & MIS)	\$ 295	\$ 195
PERFECT, Perfect Writer™	\$ 349	\$ 219
Writer & Speller, 2 Pak	\$ 399	\$ 249
Perfect File™ or Perfect Calc, each	\$ 249	\$ 149
Perfect Writer, Speller, File, Calc (4)	\$ 989	\$ 499
SATELLITE, Word Perfect	\$ 495	\$ 285
SOFTWARE ARTS, IN/Editor	\$ 399	\$ 299
SOFTWARE PUBLISHING, PFS File	\$ 140	\$ 84
PFS Report	\$ 125	\$ 84
PFS Write	\$ 140	\$ 95
PFS Graph	\$ 140	\$ 95
SOFTWORD SYSTEM, Multimate	\$ 495	\$ 395
SOFCIM, SuperCalc 2	\$ 295	\$ 195
SuperCalc 3	\$ 395	\$ 265
SSI/SATELLITE, WordPerfect	\$ 495	\$ 375
Personal WordPerfect	\$ 185	\$ 149
STC/SOFTEC, The Creator	\$ 300	\$ 195
STONEWARE, Advanced DB Master	\$ 395	\$ 395
SYNAPSE, File Manager	\$ 100	\$ 67
SYNCRISTIC, Data Reporter	\$ 250	\$ 169
T/MAKER, T/Maker III	\$ 375	\$ 169
VISICORP, VisCalc III	\$ 250	\$ 179
VisFile or VisSchedule	\$ 300	\$ 219
Desktop Plan I	\$ 300	\$ 219
VisWord with VisSpell (128K)	\$ 375	\$ 269

**UTILITY & SYSTEM**

	LIST PRICE	OUR PRICE
DIGITAL RESEARCH, Concurrent CP/M-86™	\$ 350	\$ 225
Concurrent CP/M-86™ w/windows	Call	Call
CP/M-86™	\$ 60	\$ 40
CBASIC 86™	\$ 200	\$ 135
CBASIC Compiler (86 or MSDOS), each	\$ 600	\$ 369
Pascal/MT™ - CP/M-86	\$ 400	\$ 285
Pascal/MT™ - MSDOS	\$ 500	\$ 389
FL/1 (MSDOS or CP/M-86, each)	\$ 750	\$ 499
Access Mngt (MSDOS or CP/M-86), each	\$ 400	\$ 179
Display Mngt (MSDOS or CP/M-86), each	\$ 500	\$ 339
Speed Prog. Pkg. (CP/M-86)	\$ 200	\$ 135
CIS COBOL-86	\$ 850	\$ 529
DR LOGO-86	\$ 100	\$ 69
HAYES, Smartcom II (Data Com)	\$ 119	\$ 89
INSOFT, GrafORTH (formatted 3D graph)	\$ 125	\$ 95
MICROSTUFF, CrossTalk IV (Data Com)	\$ 195	\$ 129
MICROSOFT, multiMail/Win/Temp	\$ 300	\$ 199
Business BASIC Comp	\$ 600	\$ 399
Pascal Compiler	\$ 350	\$ 250
C Compiler	\$ 500	\$ 339
BASIC Compiler	\$ 395	\$ 269
FORTRAN Compiler	\$ 350	\$ 259
COBOL Compiler	\$ 750	\$ 495
NORTON, Utilities 2.0, 14 programs	\$ 80	\$ 65
ROSEFT, Prokey	\$ 75	\$ 50

**HOME & EDUCATIONAL**

Alert, Campcode, PacMan or Donkey K. ea.	\$ 35	\$ 28
Bleagle Bros., Beagle Bag	\$ 30	\$ 22
Blocktop, Millionaire	\$ 60	\$ 40
Broderbund, Chopchop or Lode Runner, each	\$ 35	\$ 25
Arcade Machine	\$ 60	\$ 40
Apple Pac	\$ 30	\$ 21
BudgetCo., Printal Conso Set	\$ 40	\$ 27
Comnetal, Home Accountant	\$ 75	\$ 48
Dataseq, Atlas or Zaxxon, each	\$ 40	\$ 27
Davidson, Math Blaster™	\$ 50	\$ 34
Edu-Ware, (Large inventory)	Call	Call
Hayden, Sargon II (Chess)	\$ 35	\$ 29
Sargon III (Chess)	\$ 50	\$ 34
InfoComm, Zork I, II, III, or Starcross, each	\$ 40	\$ 27
Koala, Full line in stock, CALL Learning Co., (Large Inventory)	Call	Call
Micro Lab, Miner 2048	\$ 40	\$ 27
Microsoft, Typing Tutor	\$ 25	\$ 17
Monogram, Dollars and Cents	\$ 100	\$ 69
Origit, Ultra II	\$ 60	\$ 40
Scarborough/Lightning, MexiType™	\$ 40	\$ 27
Sherra/On-Line, Ultra II	\$ 60	\$ 40
Sir-Tech, Wizardy	\$ 50	\$ 39
Spinnaker, Katercomp (others in stock)	\$ 30	\$ 20
Sub Logic, Flight Simulator II	\$ 50	\$ 37

### UTILITY & SYSTEM

**1983 CL SOFTWARE AWARD:**  
Copy II PC by Central Point Software is still the best software buy of 1984. It will copy more copy protected software and makes than any other backup system. Unlike other copiers it makes an exact duplicate of your original and it does 100% verification of copy. Documentation is excellent.

• CENTRAL POINT, Copy II PC Backup	\$ 40	\$ 30
• COMX, Fasttrak™, RAM/Disk emulator and spooler program. Works on any PC./DOS version or RAMCard. Menu Driven	\$ 100	\$ 59

OUR AD #B4  
NO SALES TAX

NATIONAL ORDER DESK TOLL FREE (800) 547-1289  
Order Desk Hours, 6AM to 6PM PST  
Oregon TOLL FREE (800) 451-5151  
Not Line For Information On Your Order  
Print (503) 570-067

FREE GIFT  
Use of our order forms qualifies you for a free gift with your order. Get on our mailing list now for order forms, and our new newsletter and sales specials announcement. Our customers are already on our list.

MAIL TO: 12060 Garden Place, Portland, OR 97223

NAME \_\_\_\_\_  
ADDRESS \_\_\_\_\_  
CITY \_\_\_\_\_ STATE \_\_\_\_\_ ZIP \_\_\_\_\_

**COUPON**

## Two More Versions of C for CP/M

*A benchmark comparison of Q/C and Eco-C*

David D. Clark  
Pennsylvania State University

In recent years the C programming language has generated a great deal of interest. Small, concise, fast, powerful, and offering many operators, it provides both systems-implementation and applications-programming capabilities. C compilers for microcomputers have virtually exploded onto the marketplace in the past two years. I reviewed two of the newer releases: Q/C, written by Jim Colvin and distributed by The Code Works, and Eco-C from Ecosoft.

### Q/C Version 3.0

Q/C is a fairly complete implementation of the C compiler unless you require floating-point capabilities. It comes in two basic forms: 8080, which requires either Digital Research's RMAC assembly language or Microsoft's M80 assembly language, and Z80, which works only with the M80 assembly language. It is a single-pass, recursive-descent compiler that takes its input from a file, passes it through a "window," and produces an assembly-language file.

Originally derived from Ron Cain's small-c compiler (see reference 1) and tremendously increased in power through several major revisions, Q/C 3.0 is now a subset of the Unix Version 7 C compiler from Bell Laboratories. It lacks:

- variable types—long, float, and double
- bit fields
- casts
- sizeof
- typedef

- local declarations in compound statements
- parameterized #define statements
- type specifiers on function declarators (all functions return integers)

The Z80 package includes an excellent paperback user's manual and a disk containing an executable version of the compiler, a program to change the defaults, a relocatable version of the function library, and *the source text for the compiler and the library*. You must buy the M80 (or the RMAC) assembly language separately.

The manual first explains how to compile, assemble, and link a small program. Then it goes into more detail, explaining the command-line options (see table 1), redirection, assembly-language interfacing, the standard library, and the internal workings of the compiler itself. The manual is readable and complete.

### Eco-C Version 1.52

Eco-C from Ecosoft has a three-pass compiler. First, the preprocessor accepts a C program as input and writes an intermediate token file to disk; then the C parser program writes an intermediate code file; finally, the code-generation pass reads the intermediate code file and generates an assembly-language output file. If the parser pass detects a bug, it calls an error-handling program to print a message telling where the error occurred and to abort the compilation.

The Eco-C compiler attempts to adhere strictly to standard C's syntactic and semantic rules. It is a very complete implementation lacking only:



## At a Glance

### Name

Q/C C compiler

### Version

3.0

### Manufacturer

The Code Works  
POB 6905  
Santa Barbara, CA 93160  
(805) 683-1585

### Price

\$95

### Computer needed

8080- or Z80-based CP/M with at least 56K bytes of memory and at least one disk with a capacity of 240K bytes (two are recommended)

### Documentation

136-page paperback manual

### Audience

Systems and application-software developers, hobbyists

## At a Glance

### Name

Eco-C C compiler (including M80 assembly language)

### Version

1.52

### Manufacturer

Ecosoft Inc.  
POB 68602  
Indianapolis, IN 46268-0602  
(317) 255-6476

### Price

\$350

### Computer needed

Z80-based CP/M or MP/M 2.0 or later versions, with at least 56K bytes of memory and at least one disk with a capacity of 240K bytes (two are recommended)

### Documentation

61-page loose-leaf manual; a 186-page loose-leaf manual also is included describing Microsoft's Utility Software Package, included with the compiler

### Audience

Systems and application-software developers

- bit fields
- initializers
- parameterized #define statements
- the #line preprocessor directive
- macro expansion in a compound expression following an #if preprocessor directive
- redirection of standard I/O (input/output) (This is the responsibility of the operating system, not the compiler. However, many versions of C for CP/M provide the function in a library routine.)

- a Generate an assembly-language file for Digital Research's RMAC assembly language. This option is not available with the Z80 version.
- c Generate a commented assembly-language file.
- d Send output to the console rather than a disk file. This is useful for debugging.
- i Toggle initialization of large arrays. When turned off, arrays larger than 128 bytes will not be initialized to zeros.
- l Do a library generation. Each function encountered will be written to a separate file.
- m Generate an assembly-language file for Microsoft's M80 assembly language. This option is not available with the Z80 version.
- o Specify a name for the output file.
- r Toggle the inclusion of redirection capability into the compiled program. When turned on, a larger version of the run-time initialization routine is included that allows redirection of standard I/O from the command line.
- s Generate ROMable code with an optional specification of the stack starting address.
- t Generate trace messages in the compiled program. When turned on, code is generated to print a message of the form ">function-name" on entry to each function and "<function-name" on exit.
- v Toggle the compiler between verbose and terse mode. In verbose mode, the compiler displays progress messages as it proceeds.

Table 1: The Q/C compiler command-line options.

The Ecosoft package consists of a loose-leaf user's manual and a disk containing the software. Microsoft's Utility Software Package, a standard software component, is included. It contains the M80 relocating macro assembly language, L80 linking loader, LIB80 library-management program and CREF80 cross-reference utility. Because the M80 assembly language comes with the compiler, you don't need any additional software to use the system.

The manual for Eco-C contains instructions on how to get started, command-line options (see table 2), some programming hints, a description of the standard library, and various details on how to work with the system. Some packages also come with a copy of the *C Programming Guide*, an easy-to-understand introduction to C by Jack Purdum, Ecosoft's president.

## Benchmarks

To compare the relative performances of various implementations of the C programming language, I ran benchmarks on a "generic" CP/M-based system consisting of a Teletek Systemmaster with a 4-MHz Z80A, a Heath H19A terminal, and two 8-inch, double-density, double-sided Mitsubishi disk drives. The CP/M 2.2 operating

-b	Turns off most of the progress messages normally displayed by the compiler during its operation.
-c	Uses the library in which <code>getchar()</code> and <code>putchar()</code> do direct BDOS calls to CP/M for console I/O rather than passing through <code>getc()</code> and <code>putc()</code> . The code generated is slightly smaller.
-i	Tells the compiler to use the version of <code>printf()</code> for integers. If the program does not need to print floating-point numbers, this option should be used.
-o	Specify a name for the output file.
-snnn	Select the system libraries <code>nnn</code> at link time. There are 10 reserved system libraries. The only one implemented at the time of this writing is <code>SLIB0</code> , which contains the transcendental library.
-unnn	Select the user libraries <code>nnn</code> at link time. This option is similar to the <code>-s</code> option. User libraries may contain whatever the user wishes.
-ns or -nu	Variations of the last two options. These options allow selection of a range of libraries. For example, <code>-5u</code> would search from <code>ULIB5</code> down to <code>ULIB0</code> .

**Table 2:** The Eco-C compiler command-line options.

system had a 56K-byte TPA (transient program area) and the BIOS (basic input/output system) used 256-byte disk buffers.

I am including the BDS C compiler in some of the benchmark results to allow you to indirectly compare Q/C and Eco-C with other C compilers previously benchmarked against the BDS compiler. (The BDS compiler is one of the most popular and intensively examined versions of C for microcomputers.) (See reference 2.)

To measure the speed of compilation, assembly, and linkage, timing started when the Carriage Return was tapped at the end of the command line and stopped when the CP/M prompt line reappeared on the screen. Because of this, the times listed include the time required to load the compiler, assembly language, or linker and the time required to warm-boot CP/M (a total of 4 to 12 seconds depending on the program). To measure execution speeds, timing started when the first program message line appeared on the screen and stopped with the display of the program termination message. All timing, reported to the nearest half-second, was done on a hand-held stopwatch.

The Q/C programs were compiled with the `-i` option, which directs the compiler not to initialize large arrays to zero. This results in a tremendous reduction in the size of some assembly-language files and the time required to assemble them. When you invoke this option, the system uses a `DS` (define space) assembly-language directive to allocate array space rather than a series of `DB 0` (define byte 0) directives. If you don't require zero initialization, this option makes a great deal of sense.

With the exception of the floating-point benchmark, the Eco-C programs were compiled with the `-i` and `-c` options. The `-i` option says to use a version of the `printf()`

function that doesn't format real numbers, resulting in smaller code size and slightly greater speed. The floating-point benchmark needs to perform output of real numbers so the `-i` option is inappropriate. The `-c` option tells the compiler to use the direct console I/O procedure in the CP/M BDOS (basic disk operating system) instead of passing console I/O characters through the file handlers. Because Ecosoft doesn't supply the source of the `printf()` function, it is impossible to know how it handles character I/O.

The BDS versions were compiled with the `-o` and `-e` options. The `-o` option optimizes speed for some processes while it sacrifices space. The `-e` option gives the compiler the address where "external" variables should start. This allows direct reference to the variables (rather than indirect through a table), saving time and space. The BDS versions used the L2 linker from Mark of the Unicorn (222 Third St., Cambridge, MA 02142), which offers some advantages over the standard linker, CLINK (such as linking very large files by swapping part of the linkage tables to disk and replacing indirect table references with direct references, eliminating the tables, reducing code size, and moderately increasing speed). The L2 linker is included with the BDS compiler.

### The Sieve of Eratosthenes

One of the most difficult parts of benchmarking is selecting the programs to use in the tests. Jim and Gary Gilbreath proposed what has since become a standard for comparing microcomputer compilers and interpreters—the "sieve" program (see reference 3). Listing 1 shows the standard version of the sieve program.

The benchmark used a variety of different compiler options to check how small variations in the code would affect program performance. Figures 1 and 2 and table 3 present the results of the sieve program.

The BDS C compiler doesn't support register or static allocation; therefore, those results are missing from the table. In the `setmem` examples, in addition to making the variables external, a call to the library routines to fill the array with the value `TRUE` replaces the following statement:

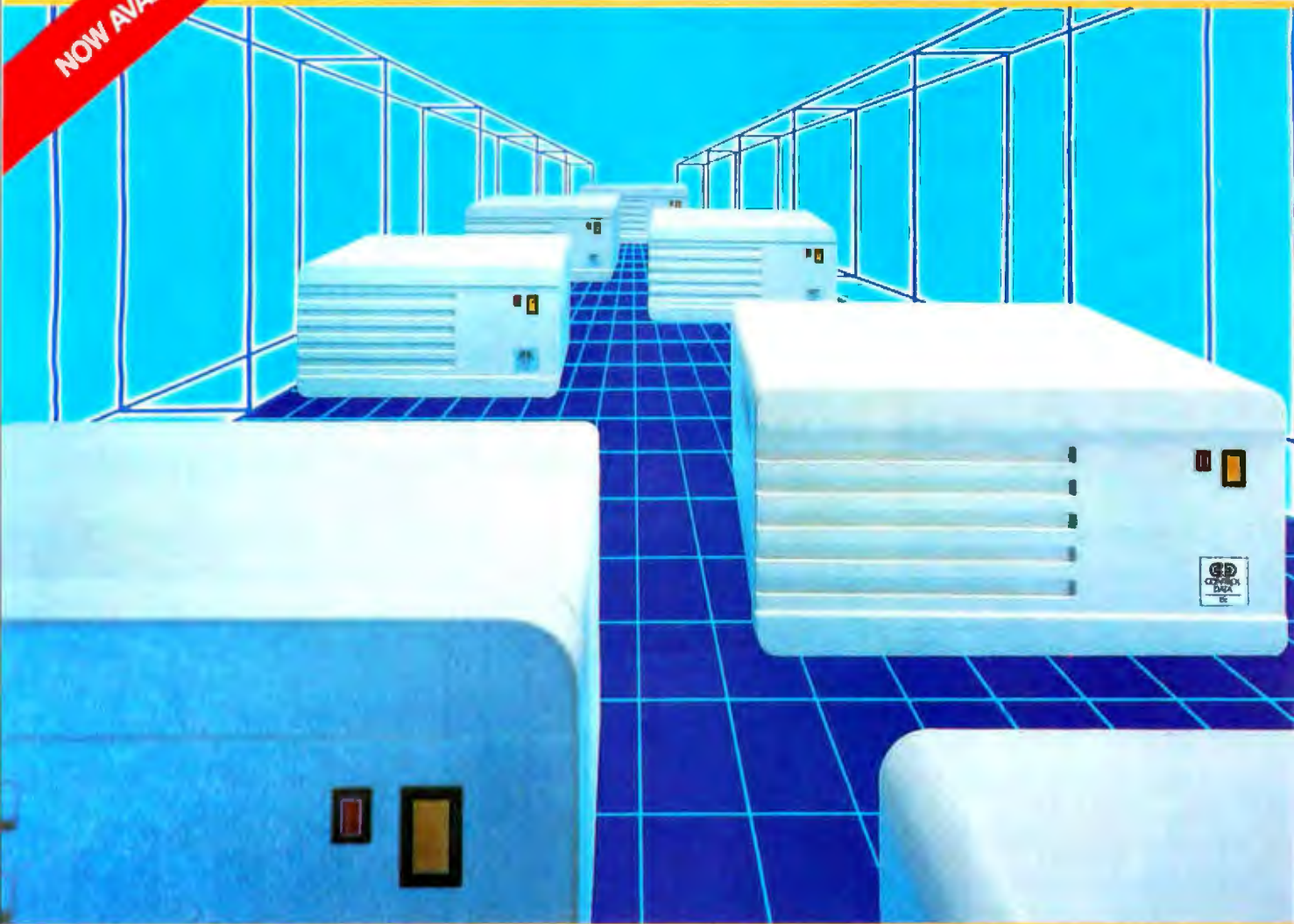
```
for (i = 0; i = SIZE; i++)
    flags[i] = TRUE;
```

This saves a substantial amount of time. So does the *improved algorithm* program supplied with Eco-C—proof that an intelligent programmer can usually create a quicker program than an intelligent compiler can.

The Eco-C and Q/C compilers require larger file sizes to hold their code because they include data space in the code files (see figure 3). The BDS C compiler places a pointer to the external variables' location in the code file and calls a runtime routine to initialize the external variables to zero when the program executes. Thus, the code file doesn't store the sieve program's flags array so the code size is about 8K bytes smaller for the BDS C compiler, which, therefore, doesn't support initializers.



NOW AVAILABLE!



## StorageMaster™ Fixed Disk builds stronger PCs three ways.

If you own an IBM PC, the new StorageMaster 500 Series Fixed Drives from Control Data give you three great advantages.

- Larger capacity than IBM's fixed disk drive. The StorageMaster 518 offers up to 18 megabytes of storage; the StorageMaster 530 capacity of 30 megabytes is the equivalent of 15,000

double-spaced typewritten pages.

- You can boot\* (start up) from StorageMaster 500 Drives—no need to boot up from a flexible disk as with other drives.
- More byte for the buck. Dollar for dollar, StorageMaster gives you more bytes of storage than IBM's fixed disk drive.

There's more. The 500 Series Drives have an average seek time of only 45 milliseconds—about twice as fast as most other drives. They store your information in a sealed, contamination-free environment. They require no cleaning or preventive maintenance. And they

come ready to plug into your PC\*

Look for the 500 Series Drives at your local computer store. Or give us a toll-free call at 800/232-6789 (in Minnesota, call 612/921-4400, ext. 41) and we'll tell you where you can find our whole family of StorageMaster products.

\*This capability requires the use of a StorageMaster 301 Controller.

Circle 110 on inquiry card.



**CD**  
CONTROL  
DATA

**Listing 1:** The sieve prime-number generator benchmark program. This is the same program as originally presented in "Eratosthenes Revisited" (see reference 3). This version is slightly different from the version presented in Christopher Kern's comparison of five versions of C for CP/M (see reference 2) in that there is no preprocessor directive to include the header file "stdio.h."

```

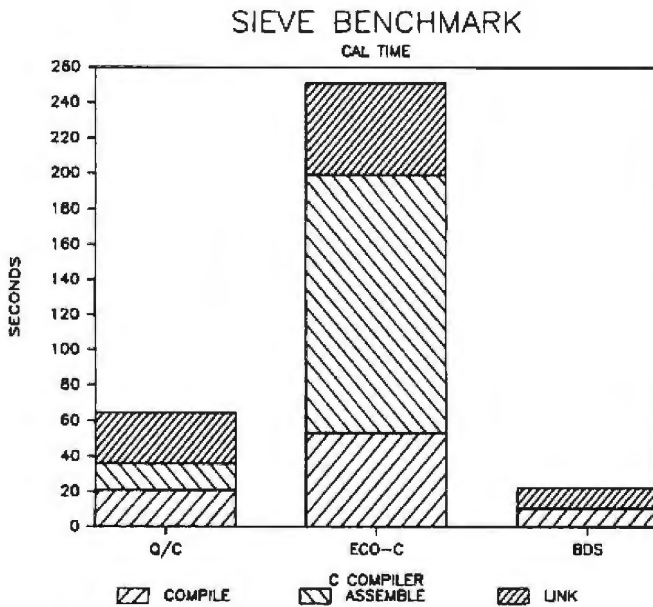
/* Eratosthenes Sieve Prime Number Program in C */
#define TRUE 1
#define FALSE 0
#define SIZE 8190

char flags[SIZE+1];

main()
{
    int i, prime, k, count, iter;

    printf("10 iterations.\n");
    for (iter = 1; iter <= 10; iter++) {
        count = 0;
        for (i = 0; i <= SIZE; i++)
            flags[i] = TRUE;
        for (i = 0; i <= SIZE; i++) {
            if (flags[i]) {
                prime = i + i + 3;
                for (k = i + prime; k <= SIZE; k += prime)
                    flags[k] = FALSE;
                count++;
            }
        }
    }
    printf("%d %d\n", prime, count);
}

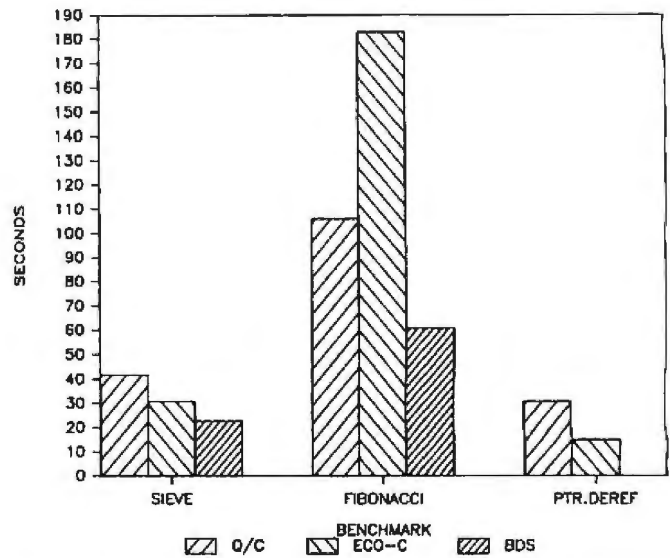
```



**Figure 1:** A comparison of the cumulative program CAL (compile, assemble, and link) times for the sieve benchmark. (All figures were drawn with a Hewlett-Packard 7475A plotter.)

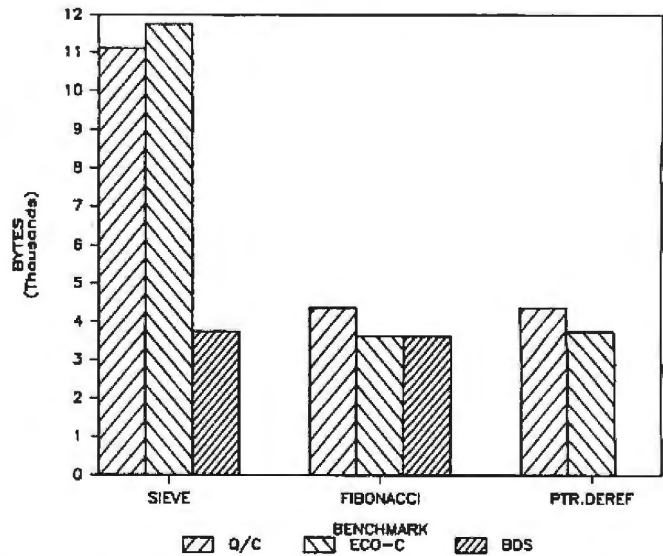
The long assembly and link times for Eco-C are the result of its method of initializing external arrays. The definition of C says that all external variables not initialized explicitly will be set to zero (see reference 4); therefore, the sieve program must initialize the external array flags to zeros before the program starts. In Eco-C the assembly language expands a macro containing the statement "DB 0" the required number of times, resulting in fairly small assembly-language files but very slow assembly.

## VANILLA EXECUTION TIMES



**Figure 2:** Comparative execution times for the various benchmarks.

## AMOUNT OF CODE GENERATED



**Figure 3:** Comparative code sizes for the various benchmarks.

## Fibonacci Numbers

Another important measure of performance of any block-structured language is the speed at which it performs function calls. The calculation of Fibonacci numbers (1, 1, 2, 3, 5, 8, 13 ...) is naturally recursive (obtainable by a finite number of computations), and thus provides an excellent way to examine the speed of function calls. Christopher Kern presented a benchmark program (see reference 2), shown in listing 2, that calculates Fibonacci numbers recursively. Because Q/C doesn't allow type declarators on functions, I modified the program slightly to do that compilation.

Figures 2 and 4 present the results from the Fibonacci number benchmark program. There is a wide variation in execution speed for this program—a factor of three.



# COMPUTERS and more. . . is your place to buy for SELECTION, SERVICE and SAVINGS. We know that your needs are not the same as everyone's, so we don't treat you "just like everyone else." Your needs are special. That's why COMPUTERS and more. . . is your place to buy for. . .



## ... SCHOOL

### COMPUTERS

<b>IBM</b>	<b>EAGLE</b>
64KPC w/2-320 drives 2295	PC-XL ..... 3395
PC XT w/256KRAM 4795	Spirit II ..... 2699
PCJR 128K ..... CALL	
<b>APPLE</b>	<b>CORONA</b>
The Macintosh ..... call	DeskTop w/2 drives ... 2369
Apple Starter System 1299	Portable w/2 drives ... 2195
Apple IIe ..... 899	
New Apple Products ..... call	
<b>COLUMBIA</b>	<b>TELEVIDEO</b>
1600-1 w/1 year w.r. 2495	TS 1505 ..... CALL
1600-1 Pack w/1 yr w. 2795	Teletext ..... SALE
1600-4 CPU only ..... 3454	Multi-User Systems ... CALL
VP Portable ..... 2349	
<b>DEC</b>	<b>ZENITH</b>
Rainbow 100 ..... 2295	Z150 ..... ON SALE
Rainbow 100+ ..... 4495	Z160 ..... CALL NOW
<b>KAYPRO</b>	<b>SHARP</b>
Keypco II ..... 115	PC-5000 ..... 1529
Keypco II + or 4+ ..... CALL	
<b>FRANKLIN</b>	<b>NEC</b>
Aca 1000 ..... 799	We sell and service all
Aca OMS ..... CALL	Nec Micras ..... CALL
<b>COMPAQ</b>	<b>LEADING EDGE</b>
Compaq 2-drive 128K 2599	PC ..... 2199
Compaq Plus ..... 3995	

For our complete selection call for our line card and price list for all computers.

### ACCESSORIES

<b>IBM</b>	<b>APPLE</b>
Access I-2-3 ..... 389	80 Col 64K for file ..... 116
Keytronic 5150 ..... 189	Pax Interface ..... 54
Keytronic 5151 ..... 219	Serial Card ..... 79
Hercules Card ..... 349	Buffered Grappler + ..... 159
AST 6-Pack ..... 265	Z-80 Card ..... 97
AST PC Net ..... CALL	
Plantronic Color Bd ..... 369	
Z-Plus by CCS ..... 679	
Graphix Plus by STB ..... 319	
256K cd by STB ..... 379	
<b>RIO-Plus 64K ..... 269</b>	<b>294 K by Syntex ..... 499</b>
<b>R10 64K + 1/0 cd ... 249</b>	<b>Micromodem IIe w/5ft 239</b>
<b>SR10 by STB ..... on sale</b>	<b>Koala Pad ..... 79</b>
<b>Optical Mouse by Visi 199</b>	<b>AppitCards ..... call</b>
<b>Quadboard Ex 64K ... 319</b>	
<b>Quadboard II 64K ... 249</b>	
<b>Quadvue ..... 289</b>	
<b>Orchid Tech ..... CALL</b>	
<b>1200B w/5ft ..... 429</b>	
<b>Tecmar Access ... CALL</b>	



### 1 Year Warranty Available

TO ORDER: Phone orders invited using Visa, MasterCard, or bank wire transfer. Visa, MC, service charge of 2%. Mail orders may send charge card number (include expiration date), cashiers check, money order, or personal check (allow 10 business days for personal or company checks to clear). Please add 3% (\$5.00 minimum) for UPS shipping, handling, and insurance. All equipment is in factory cartons with manufacturer warranty. Opened products not returnable. Restocking fee for returned merchandise. Equipment subject to price change and availability. Retail prices differ from mail order prices. Calif. residents add 8% State Tax. Company and school P.O.'s accepted on approval. IBM & Apple are registered trademarks. International inquiries welcomed. Telex 697120, Datamatix Airtel Dept. 322

## ... HOME

### PRINTERS

<b>JUKI</b>	<b>TOSHIBA</b>
6100 18 cps ..... 419	P1351 P ..... 1599
Tractor ..... 109	P 1351 S ..... 1599
Cut-Sheet Feeder ..... 529	P 1340 P ..... 799
	P 1340 S ..... 799
<b>EPSON</b>	<b>RITEMAN</b>
Fx-100 ..... CALL	Riteman Plus ..... 329
LQ-80 ..... CALL	Riteman Blue ..... 359
LQ-1500 ..... NEW	
<b>ABATI</b>	<b>MANN-TALLY</b>
LQ-20 Parallel ..... 389	We carry all
LQ-20 Serial ..... 429	Mann-Tally Printers CALL
<b>DAISYWRITER</b>	<b>SIEMANS</b>
Daisy 2000 w/48 K Buf. 949	PT 88 Ink Jet ..... 759
Tractor for 2000 ..... 119	Pt 89 Ink Jet ..... 994
Cut-Sheet Feeder ..... 659	
<b>RICOH</b>	<b>ANADEX</b>
RP-1300 35 cps ..... 979	9500 B ..... 995
RP-1600 45 cps Ser. 1395	9625 B ..... 1195
RP-1200 20 cps L/Q ..... 589	9000 B ..... 989
Tractor-All Models ... 219	
<b>TRANSTAR</b>	<b>STAR</b>
Transfer 120P ..... 399	Power Type - New CALL
Transfer 120S ..... 399	Delta 10 & 15 ... CALL
Transfer 130P ..... 579	Gemini 10x & 15x . CALL
Transfer 130S ..... 579	Radix 10 & 15 ... CALL
Tran 130 Sheet Feeder 329	
	<b>OKIDATA</b>
	Call for our low sale prices
	on all OKI Printers

## FREE \* SHIPPING

### PLOTTERS

<b>AMDEK</b>	<b>HOUSTON-INST</b>
Amplot-4 Color ..... 719	DMP-40-2 ..... call
Amplot II Digital ..... 899	DMP-40 P ..... 959
X-Y 6-Color ..... 949	
<b>ENTER</b>	<b>C-ITOH</b>
Sweet-P for Apple ..... 729	Cx-4800 ..... \$49
Sweet-P for IBM ..... 789	
Sweet-P Model 100 ..... 529	<b>STROBE</b>
	M100 I-Pen ..... 489
	M260 8-Pen ..... 779

### DISK DRIVES

Tandon 100-2 ..... 219  
 CDC for IBM (320 K) ..... 229  
**SPECIAL NOTE TO OUR CUSTOMERS:**  
 Because Hard Disk Drive companies are rethinking their prices downward, please call for lowest prices for: QUADRAM, TECMAR, DA-VONG, CORVUS, PEGASUS AND OTHERS.

## ... OFFICE

### SOFTWARE

<b>IBM PC, XT &amp; JR.</b>	<b>APPLE</b>
Easywriter I ..... 189	Friday ..... 169
Lotus 1-2-3 ..... 319	C Dex (each) ..... 36
Lotus Symphony ..... call	Quick Code ..... 179
Filewriter 2 ..... 67	Micro Pro ..... on sale!
R:Base 4000 ..... 119	PFS: File ..... 83
Des Q ..... 339	PFS: Report ..... 83
MultiMate ..... call	PFS: Graph ..... 83
Volkswriter DeLux ..... 199	Visicalc 3.3 ..... 169
Wordstar ..... on sale!	Visicalc Enhanced ..... 179
Home Accountant Plus ..... 99	Letter Perfect w/Mail ..... 99
Concurrent CP/M 86 ..... 239	dBase II ..... call
CP/M 86 ..... CALL	Tax Prepare '84 ..... 179
T.I.M. ..... 329	Save New York ..... 24
Q Base ..... 139	
Verse Form ..... 279	
Ask Micro (ea package) .389	
Smartcom II ..... 99	
Inview ..... 219	
Micro Terminal ..... 69	
<b>MICRO</b>	
Friday ..... 199	
dBase II ..... 499	
Micro Soft Basic ..... 119	
MultiPlan ..... 159	
Chart ..... 99	
Call for our free price list	
of software	

### MONITORS AND TERMINALS

Princeton Hx-12 ..... 464	Zenith 131 ..... 319
Princeton SR-12 ..... on sale!	Zenith 135 ..... 487
Princeton Max-12 ..... 179	Zenith 122 ..... 109
Taxan 420 ..... 467	Amdelk 310 A ..... 159
Taxan Amber ..... 119	Amdelk Color II ..... 429
Taxan Kx-122 ..... 159	Amdelk Color IV ..... 799
Quadram Quadchrome 499	NEC 1216 ..... 419
Quadram Color II ..... 449	
<b>TERMINALS</b>	
WYSE 300 ..... 989	Televideo 914 ..... 539
WYSE 100 ..... 689	Televideo 924 ..... 687
QUME 102A ..... 534	Televideo 9104 ..... 549
QUME 103A ..... CALL	Televideo 950 ..... 895

### SERVICE

EXTENDED WARRANTIES AND FAST REPAIR BY QUALIFIED TECHNICIANS FOR OUR ENTIRE PRODUCT LINE. CALL FOR MORE INFORMATION.



# COMPUTERS and more. . .

3620 30TH ST., SAN DIEGO, CA 92104



TO ORDER (619) 291-1442



"SE HABLA ESPAÑOL"

\$50 to \$200 rebate on system purchases  
 CALL FOR MORE INFORMATION.

P.O.'S ACCEPTED ON APPROVAL

\* On All Pre-paid Cash Orders In Cont. U.S.



Compiler Execution Times (in seconds)

	vanilla	register	static	external	setmem	Improved algorithm
Q/C	42	26	26	26		
Eco-C	31	31	22	22	17	11
BDS	23			15	13	

vanilla — the program compiled exactly as shown in the article "Eratosthenes Revisited"  
 register — the auto variables declared as register integers  
 static — the auto variables declared as static integers  
 external — the auto variables moved outside the main() function  
 setmem — the library routines used to fill large blocks of memory with a specified value  
 improved algorithm — the improved version of the published algorithm used

Table 3: The results of running the sieve benchmark program with various options and definitions of those options.

Listing 2: The Fibonacci number-generator benchmark. This is the same program that originally appeared in Christopher Kern's article (see reference 2).

```
#include <stdio.h>

#define NTIMES 10 /* number of times to compute Fibonacci value */
#define NUMBER 24 /* biggest one we can compute with 16 bits */

main() /* compute Fibonacci value */
{
    int i;
    unsigned value, fib();

    printf("%d iterations: ", NTIMES);

    for (i = 1; i <= NTIMES; i++)
        value = fib(NUMBER);

    printf("Fibonacci(%d) = %u.\n", NUMBER, value);
    exit(0);
}

unsigned fib(x) /* compute Fibonacci number recursively */
{
    int x;
    {
        if (x > 2)
            return (fib(x - 1) + fib(x - 2));
        else
            return (1);
    }
}
```

Eco-C has a tortuous function-calling protocol. My opinion on this is based on the assembly-language interface description and the file produced. The compiler puts all sorts of stuff in the code file and on the stack and then calls a library routine to perform the function call. When control returns from the function, Eco-C calls another library routine to put the returned values in the right places—not an efficient way to do things. Eco-C is the most costly of the three in execution time while Q/C is intermediate between BDS C and Eco-C.

The similarity of the code-file sizes in this benchmark is interesting. The Fibonacci program doesn't contain a large array like the sieve program does; therefore, the program sizes for Q/C and Eco-C are comparable to BDS C's (see figure 3).

FIBONACCI NUMBER

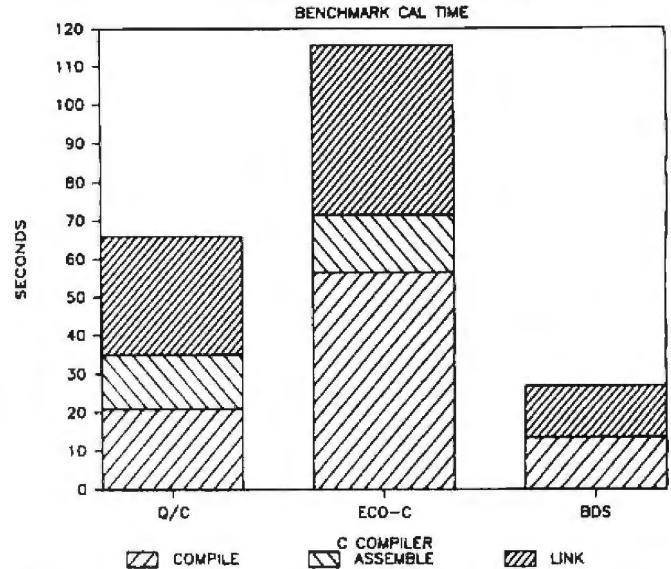


Figure 4: A comparison of the cumulative program CAL times for the Fibonacci benchmark.

### Pointer Dereferencing

Because most sizable C programs make extensive use of pointers, a good compiler should generate efficient code for dereferencing them. The program in listing 3 attempts to test the capabilities of Q/C and Eco-C in this area. It declares a "structure" containing a single member with 20 levels of indirection (indirect addressing). The main program then declares a pointer to the structure through an additional 20 levels and repeatedly references the character located through these 40 levels of indirection. To compile this program with Q/C, you must increase the size of the compiler's "type table" from 35 to 50 entries using the included QRESET program.

Figures 2 and 5 show the results of the pointer-dereferencing program. BDS C can't parse the structure declaration and, therefore, is omitted from the results. Here Eco-C shines, producing a smaller, faster program (see figure 3).

It was more difficult than expected to create this benchmark. My first attempts produced programs that executed too quickly to be accurately measured. The program shown in the listing executes two million dereferencing operations and both compilers are fairly good at it.

### Floating-Point Calculations

One nice feature of Eco-C is that it includes floating-point variables. The matrix-multiplication program presented by Jerry Pournelle (see reference 5) was rewritten in C to test floating-point speed. Listing 4 shows the resulting program. Because all arrays in C start with an index of 0, some changes occur in the for loops, the final answer changes to 383740.00000, and the implicit data type conversions in Dr. Pournelle's program become explicit with the use of casts. Because C does all its floating-point calculations in double-precision, the matrices are



# There are a lot of powerful reasons to write software for HP systems.



## You're looking at two of them.

An enhanced UNIX™ operating system. And the cash bonuses you'll earn when you sell your UNIX-compatible applications with an HP system.

Those are compelling reasons to participate in HP's special program for software companies.

We have a whole range of products that can run UNIX, from our popular line of MC 68000-based machines to our powerful 32-bit systems. And we'll be expanding that range all the time.

While we're giving you a wider choice of products for your programs, we're also making it even easier for you to write them.

We've developed an especially powerful version of the industry standard UNIX, called HP-UX. Its enhancements provide for graphics, data base management and networking, to name just a few.

When you team up with HP, you have our full service organization behind you. Our factory and field support teams are dedicated to problem-

solving. So, if you or your customers have any questions about HP-UX, just give us a call. We're ready to help.

And we're ready to make your efforts very rewarding. When your customer buys an HP system because of your application, we'll give you a cash bonus of 30% of your software's sales price — up to 6% of the net HP system's price. Our only restriction is that, to qualify for the bonus, your software must sell for at least \$10,000.

There are lots of other good reasons to write HP-compatible software for UNIX or any of our other operating systems. To find out all about them, write to Hewlett-Packard, Attn: Gwen Miller, Dept. 57190, 19447 Pruneridge Avenue, Cupertino, CA 95014. In Europe, contact Henk van Lammeren, Hewlett-Packard Nederlands B.V., Dept. 57190, P.O. Box 529, 1180 AM Amstelveen, The Netherlands.



UNIX is a trademark of Bell Laboratories.

9002315



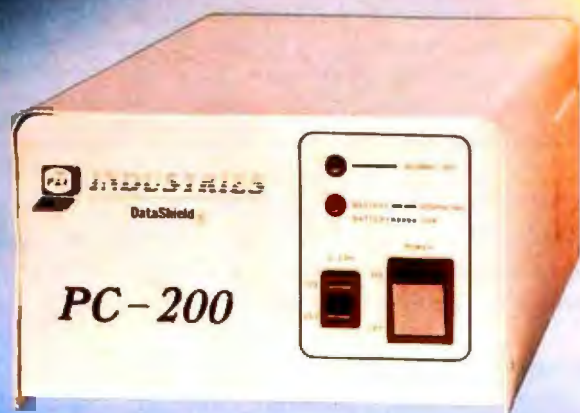


# YOU COULD LOSE EVERYTHING IN A SPLIT SECOND

Blackouts, Brownouts, Power Drops, Surges, Noise —  
They Can Alter Data, Wipe Out Memory,  
or Damage Equipment.

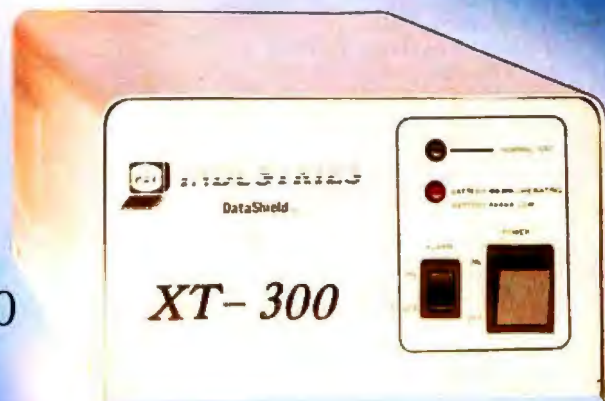
**PROTECT** your personal  
computer with the finest  
price/performance back-  
up power source on the  
market.

*What Was Once  
An Expensive Luxury  
Is Now An  
Affordable Necessity!*



200 Watts  
Now Only... **\$359<sup>00</sup>**

300 Watts  
Now Only... **\$499<sup>00</sup>**



**DataShield . . . The Quiet Necessity . . .**  
is a rechargeable, battery-operated power  
source which takes over within 10 milliseconds  
whenever the power drops or goes  
out completely. It also boasts a built-in surge  
protector to guard against peaks, surges,  
and line noise.

Technologically, there is no compa-  
rable product on the market that is more  
advanced. That's a fact. It's been tested

and proven. Economically, nothing comes  
close to the low price of the DataShield.  
Period.

If you have begun to realize the need  
for back-up power source insurance, but  
you were waiting until the quality and the  
price were right . . . well, stop waiting.

**Contact your local computer dealer  
or contact the manufacturer for more  
details.**



**INDUSTRIES**

320 River Street, Santa Cruz, CA 95060  
(408) 429-6881 TELEX 176841

Circle 124 on inquiry-card.

**Listing 4: A C-language version of the matrix-multiplication benchmark originally proposed by Jerry Pournelle (see reference 5).**

```

/*
** matmult.c -- a benchmark based upon the matrix multiplication
** program given by Jerry Pournelle in Byte October 1982 p. 254.
**
** Type conversions have been made explicit with casts. Array
** and loop indices now start at 0.
*/

#define N      20
#define M      20
#define BELL   ?

char gup;
double sumb, a[N][M], b[M][M], c[M][M];

main()
{
    sumb = 0.0;
    printf("Hit any character to start\n");
    gup = getchar();

    filla();
    printf("\nA filled\n");
    fillb();
    printf("\nB filled\n");
    fillc();
    printf("\nC filled\n");

    matmult();
    printf("\nMultiplied\n");
    submit();

    printf("The sum is: %20f\n", sumb);
    putchar(BELL);
}

filla()
{
    int i, j;

    for (i = 0; i < N; i++)
        for (j = 0; j < M; j++)
            a[i][j] = (double) i + j;
}

fillb()
{
    int i, j;

    for (i = 0; i < M; i++)
        for (j = 0; j < M; j++)
            b[i][j] = (double) (int) ((i + j)/j);
}

fillc()
{
    int i, j;

    for (i = 0; i < M; i++)
        for (j = 0; j < M; j++)
            c[i][j] = (double) 0;
}

matmult()
{
    int i, j, k;

    for (i = 0; i < M; i++)
        for (j = 0; j < M; j++)
            for (k = 0; k < M; k++)
                c[i][j] = c[i][j] + a[i][k]*b[k][j];
}

submit()
{
    int i, j;

    for (i = 0; i < M; i++)
        for (j = 0; j < M; j++)
            sumb = sumb + c[i][j];
}

```

### Xtra, Xtra ...

Since this article was written, some changes have been made to Q/C and Eco-C. I have not, however, received review copies of the revisions.

Eco-C has a new version that supports initializers and parameterized macros that allow it to handle most programs written for Unix Version 7. Ecosoft also answered some of my questions concerning the source code for library functions. It seems that the source was distributed for a while but some bugs that were eventually traced to modified versions of the library were reported. Because of this, Ecosoft stopped distributing the source with the system. Advertising copy has presumably been changed but publishing lead times dictate that some of the old copy is still appearing in some magazines. Those who bought the compiler expecting the source code can get it by requesting it from Ecosoft. They must, however, state in their request letter that they understand no support for the library, therefore, will be offered by Ecosoft.

A new version of Q/C has also been announced by The Code Works. The new version (3.1) includes typedef, sizeof, type casts, function typing, and library functions to support large file buffers. These features should make Q/C one of the most complete C compilers available for nonnumerical applications.

screen fills as fast as the terminal can accept characters. Eco-C takes twice as long and generates twice as much code as Q/C. This is apparently the result of the slow procedure-calling process.

### Summary

As you may have guessed, I like Q/C and have mixed feelings about Eco-C.

Q/C, a large subset of the standard language and a good introduction to it, has a portable library and produces good code quickly. If you want to learn compiler construction techniques or modify the standard language, Q/C is the obvious choice.

Eco-C does everything claimed in its manual. It has the long, float, and double variable types required for many calculation-intensive programs—possibly the purpose behind its development. Eco-C also includes Microsoft's M80 assembly language—a nice extra for use with other packages. ■

### References

1. Cain, R. "A Small-C Compiler for the 8080s." *Dr. Dobbs Journal*, May 1980, page 5.
2. Kern, C. O. "Five C Compilers for CP/M-80." *BYTE*, August 1983, page 110.
3. Gilbreath, J., and G. Gilbreath. "Eratosthenes Revisited: Once More through the Sieve." *BYTE*, January 1983, page 283.
4. Kernighan, B. W., and D. M. Ritchie. *The C Programming Language*. Englewood Cliffs, NJ: Prentice-Hall Inc., 1978, page 198.
5. Pournelle, J. "A BASIC and Pascal Benchmark, Elegance, Apologies, and FORTH." *BYTE*, October 1982, page 254.

*Dr. David D. Clark (246 South Fraser St., #2, State College, PA 16801) is a post-doctoral research scholar in the department of chemistry at Pennsylvania State University. He has a B.A. in chemistry from Indiana Central University and a Ph.D. in biological chemistry from the University of Nebraska.*



# One of Japan's leaders would like to go to work for you.



Fujitsu, Japan's largest computer company, sends you their best. The new Micro 16s personal business computer. A combination of thoughtful planning, innovative thinking and quality craftsmanship. Just what you'd expect from a Japanese company that's been making computers for three decades.

The Micro 16s is a complete computer system. The options of other computers are our standards. For example, its price includes the CP/M-86<sup>®</sup> operating system, SuperCalc<sup>2™</sup> electronic spreadsheet, WordStar<sup>®</sup> word processing, a high resolution color graphics monitor, and two microprocessors, the Z80<sup>®</sup>A 8-bit and 8086 16-bit.

The Micro 16s will run any of the more than 3,000 CP/M<sup>®</sup> software programs on the market today. Optional operating systems for the Micro 16s include MS<sup>™</sup>-DOS and the

multi-tasking Concurrent CP/M-86<sup>™</sup>.

The Micro 16s also comes with a detachable keyboard, dual built-in 5¼" floppy disk drives, 128 kilobytes of internal memory expandable to over one megabyte, and expansion slots for future growth.

The unique and flexible design of the Micro 16s makes it easy to add advanced microprocessors of tomorrow, hard disks, mainframe communications or local area networking when the time is right.

Put a Japanese leader to work for you. Fujitsu's Micro 16s. For more information or the name of your nearest dealer call toll free 1-800-MICRO 16. Or write Fujitsu Microelectronics, Inc., Professional Microsystems Division, 3320 Scott Blvd., Santa Clara, CA 95051.



## Fujitsu's Micro 16s.™

# Hardware Review



Photo 1: The LNW-80 Model II microcomputer.

## LNW-80

### *One user's glowing report*

Mahlon G. Kelly  
University of Virginia

The LNW-80 Model II is a Z80-based, 8-bit microcomputer that evolved gradually from the old TRS-80 Model I. It is capable of running virtually all software and operating systems for the TRS-80 Models I, III, and 4 better than the TRS-80s do and of supporting a full-featured CP/M with 96K bytes of RAM (random-access read/write memory). Please note that this is not an objective review. I happen to believe that the LNW is the best 8-bit microcomputer you can buy. I'll try to tell you why.

While I'm an avid admirer of the TRS-80 Model I's basic design, the machine itself had a lot of faults. The Model III solved many of the severe problems but it didn't go far enough—no high resolution or color and only a 16 by 64 screen, for example. The Model 4 is better but it still doesn't provide color, Model I and III programs won't run in Model 4 mode, there's little flexibility in the types of disk drives supported, and CP/M and high-resolution graphics cost extra.

The LNW-80 Model II (see photo 1) lacks the limita-



tions of the TRS-80 Model 4. It has the excellent basic design of the TRS-80 Model I, none of its hardware problems, all the important features of the Model 4, and more. Like the Model 4, it has an 80 by 24 screen, high-speed operation (4 megahertz), and compatibility with CP/M.

But unlike the Model 4, it has high-resolution graphics, excellent color capabilities, and good compatibility with Model I, III, and 4 software, including all of the popular operating systems. It can also use almost any disk-drive configuration (including 8-inch and hard disks); its CP/M can read the most popular disk formats including IBM PC (Personal Computer), Osborne, Kaypro, Xerox, and industry standard 8-inch; and it's built better than any microcomputer I have seen.

In addition, the LNW comes with an incredible array of software, including several integrated small-business programs, a spreadsheet program, a word processor, a smart-terminal program, a TRS-80-compatible operating system, and a well-tailored version of CP/M. The software also includes an enhanced BASIC that supports the color and high-resolution features. The software alone, if purchased separately, would cost nearly the price of the whole package. While Osborne and Kaypro have been praised for their software, the LNW provides much more. LNW Research, the manufacturer, is planning an add-on board to provide software and hardware compatibility with the IBM PC. (They already produce add-on boards for the IBM.)

## The Company

The LNW-80 started life as a series of kits: the first one was for an improved TRS-80 expansion interface; the second, for a group of improvements over the TRS-80; and the third, an assembled board allowing double-density operation of both 5- and 8-inch disk drives. (The kits have been severely criticized for being complex and hard to build. If you're thinking of building the kit, buy the documentation and look it over first.) Eventually, these kits were combined in an assembled package that was completely compatible with TRS-80 hardware and software. The LNW Model I was similar to the TRS-80 Model I without its hardware problems and with high-resolution graphics, an 80 by 24 screen, color displays, upper- and lowercase, and flexible support for different disk drives.

The Model II introduced CP/M compatibility, 96K bytes of bank-selected RAM, an improved BASIC, and a number of other features. It also included an internal loudspeaker, the use of gray tones to represent colors on a black-and-white monitor, and joystick ports. With the IBM compatibility will come even more flexibility and performance. Even with all these changes and additions, the LNW is extremely well integrated and as reliable as any microcomputer I have used.

LNW Research provides inexpensive upgrades to the owners of earlier models. For example, I recently paid \$299.50 to add CP/M to my LNW Model I. The upgrade included the hardware installed by the factory and the

## At a Glance

### Name

LNW-80 Model II

### Type

8-bit microcomputer supporting nearly all TRS-80 Models I, III, and 4 software and CP/M; color display, high-resolution graphics, 96K RAM, and 16K ROM with paging

### Manufacturer

LNW Research Inc.  
2620 Walnut St.  
Tustin, CA 92680

### Price

\$1195

### Supplied Software

DOSPLUS, CP/M 2.2, LNW/BASIC (enhanced BASIC with graphics support and more), Electric Pencil, Electric Spreadsheet, Microterm (smart-terminal program), Chartex (business-oriented plotting program), Microsoft (Level II) BASIC, integrated small-business package with general ledger, accounts receivable, accounts payable, payroll, and more

### Hardware

Z80 microprocessor, RS-232C, parallel printer, joystick, tape recorder, bus and disk drive ports, full keyboard, internal speaker

### Disk-Drive Support

Radio Shack and nearly all CP/M formats; both 5¼-inch and 8-inch single- and double-density; Radio Shack and Appar hard disks

### Documentation

Large, easy-to-use operations and technical manuals and manuals for all software supplied with the computer; more than 9 inches in thickness; oriented to beginners, technical users, and programmers

### Audience

Anyone looking for a top-of-the-line microcomputer with great flexibility and continued upgrades

CP/M software with LNW additions. Future upgrades are promised at very small prices.

The company also provides excellent software support. When LNW began including a lot of free software with the Model II, the company made it available to previous owners for only \$299—almost a thousand dollars worth of software.

Although it's not available as I write this, the upgrade from CP/M 2.2 to CP/M Plus (a costly upgrade on most machines) is expected to cost \$25. LDOS, giving TRS-80 Model III compatibility, is planned soon, and a version of DOSPLUS, for compatibility with the TRS-80 Model 4, is in the works. The IBM and 16-bit add-ons, which will plug into the bus and provide slots for a number of IBM cards, are also expected at a very reasonable price.

## Physical Description

The LNW-80 measures 16.5 inches wide by 3.5 inches high and 22 inches deep (see photo 1). It weighs 26 pounds, most of it in the attractive 16-gauge steel case, a symbol of LNW Research's commitment to physical quality. A friend of mine who designs electronic equip-

The Little Board®

## Quantity One... \$349\*

The world's simplest and least expensive single board computer



\*Substantial Quantity discounts available

- 4MHz Z80A<sup>1</sup> CPU, 64K RAM
- Two RS232 serial ports
- Mini floppy controller
- Parallel printer port
- On-board -12V converter
- Only 5.75 x 7.75 Inches
- Power Requirement: +5VDC @ .75A; +12VDC @ .05A
- Screws directly onto a mini floppy drive

**All this...  
and CP/M<sup>††</sup> 2.2 also!**

**AMPRO**  
COMPUTERS INCORPORATED

<sup>1</sup> Z80A is a registered trademark of Zilog, Inc.  
<sup>††</sup> CP/M is a registered trademark of Digital Research

67 East Evelyn Ave. • Mountain View, CA 94041 • (415) 962-0930

ment for the Navy looked over the machine's components and said it could survive on a battleship during combat. All edge connectors are gold-plated, all components are first quality, and most are soldered to the boards. (There are few loose connections with soldered joints.) There's a very quiet cooling fan and all connections (printer, disks, modem, etc.) are on the back of the case, which is open to provide easy access to the printed-circuit boards.

As a result the LNW is extremely reliable. It has an excellent power supply that seems to be immune to power fluctuations. Turned on almost continuously for 3 months, the only failures were due to a complete loss of power, and it can operate with line voltages from 90 to 130 volts.

The keyboard is excellent. It is mechanically like that of a Model I and thus needs software debounce (a timing loop that solves the problem of extra characters on the screen), but all operating systems now provide that. It has a numerical keypad like the Models I, III, and 4 with several additional keys for a total of 74. One is a control key for Electric Pencil or for Newsprint that acts like a true control key when used with CP/M. Others are Caps Lock (which puts the computer into upper-case-only mode), Shift (which acts as if the Shift key were pressed), and High/Low (which chooses 1.7- or 4.0-megahertz operation). The four arrow keys are in a logically arranged cluster on the right-hand side of the keyboard, and there are three function keys that are LNWBASIC programmable. You may redefine nearly all of the keys using the CP/M mode or LNWBASIC. Finally, two widely separated reset keys reboot the machine when you press them simultaneously. Their placement keeps you from accidentally rebooting the system but may be a problem for some handicapped users.

The LNW has a Z80 processor and 96K bytes of RAM. In TRS-80 mode 48K is directly addressable by the user; the rest may be bank-selected. In CP/M mode the user has almost 61K of RAM available; various drivers use the rest. I believe 61K is more RAM than any other 8-bit CP/M-compatible machine provides. You may add another six 4164-byte memory chips to give you three more screens of graphics display.

There are four boards in the case: the keyboard substrate, the main processor board, an expansion board analogous to the TRS-80's expansion interface, and a disk controller board. There's also a small loudspeaker and a joystick port that is hardware-compatible with Apple joysticks. A small muffin fan cools the machine, but the case becomes perceptibly warm after about an hour's use.

### Graphics Features

The LNW has excellent color and high-resolution graphics. There are four modes: 0 is like the TRS-80; 1 provides high-resolution black and white (480 by 192 points) and an 80 by 24 character screen (if you use the proper software drivers); 2 gives you 8-color graphics with 160 by 192 resolution (much more than is available

## DECADES OF SERVICE

FROM THE NATION'S LARGEST NEC DEALER

Where Do You Turn To Solve Your Computer Puzzle?



### TURN TO US!

We'll show you the easiest way to put the pieces together.

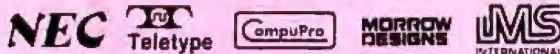
Matched. Compatible. Proven—  
Use Someone Else's Engineering to Supplement Yours.

Our professional applications specialists are happy to assist you in configuring business and scientific computer systems from the thousands of hardware and software products we regularly handle.

Our specialties include:

- CAD/CAM Graphics
- Multi-user Databases
- Foreign Language Processing
- Communications

Our GSA Contracts.



## Washington Computer Services

97 Spring Street (212) 226-2121  
N.Y., N.Y. 10012

an affiliate of  
**WASHINGTON ELECTRIC COMPANY**  
est. 1922

HOURS: 9 AM - 5 PM / Monday-Friday TELEX: 12-5606 CABLE: WASHCOMP NYK

**PLEASE!** Do not confuse us with mail order dealers. We are a full service distributor serving the data processing & installation needs of business and industry from micros to mainframes. System houses, educational institutions & governmental agencies given special consideration. Dealer and international inquiries welcome.



# A few smart reasons to buy our smart modem:

Features	Ven-Tel 1200 PLUS	Hayes
1200 and 300 baud, auto-dial, auto-answer	Yes	Yes
Compatible with "AT" command set	Yes	Yes
Can be used with CROSSTALK-XVI or Smartcom II software	Yes	Yes
Regulated DC power pack for cool, reliable operation	Yes	<b>No</b>
Eight indicator lights to display modem status	Yes	Yes
Speaker to monitor call progress	Yes	Yes
Attractive, compact aluminum case	Yes	Yes
Two built-in phone connectors	Yes	<b>No</b>
Compatible with The Source and Dow Jones News Retrieval	Yes	Yes
Unattended remote test capability	Yes	<b>No</b>
Phone cable included	Yes	Yes
Availability	Now	
<b>Price</b>	<b>\$499</b>	<b>\$699</b>

The Ven-Tel 1200 PLUS offers high speed, reliable telecommunications for your personal computer or terminal. Whether you use information services or transfer data from computer to computer, the Ven-Tel 1200 PLUS is the best product around. Available at leading computer dealers and distributors nationwide.

Also from Ven-Tel: internal modems for the IBM and HP-150 Personal Computers with all of the features of the 1200 PLUS.

**You choose. The Ven-Tel 1200 PLUS—the smartest choice in modems.**

## Ven-Tel Inc.

2342 Walsh Avenue  
Santa Clara, CA 95051  
(408) 727-5721



<b>BLINK</b>	- switch blinking cursor on and off	<b>PAINT</b>	- fill in a bounded graphics space with color
<b>CALL address</b>	- execute a machine language program	<b>PCLS</b>	- clear the graphics memory or fill it with a specified color or value
<b>CIRCLE</b>	- produce a circle, ellipse, or arc	<b>PGET</b>	- save a part of the video display to an array
<b>COLOR</b>	- specify the color of the next graphics command	<b>PLOAD</b>	- load the graphics memory from a disk file
<b>CONV</b>	- convert between various hexadecimal and decimal expressions	<b>PLOT</b>	- specify dot and dash patterns in a plotted line
<b>DEFKEY</b>	- define a string assigned to a key	<b>POFF</b>	- turn off the echo from video to printer
<b>DESPOOL</b>	- send the contents of a file to a printer while continuing computation	<b>POINT</b>	- test a graphics point for color
<b>DISKEY</b>	- show the defined keys	<b>PON</b>	- turn on the echo from video to printer
<b>DLOAD filespec</b>	- load a machine-language program	<b>PPUT</b>	- put array specifications on the video screen
<b>DO...UNTIL</b>	- do a loop until a condition is met	<b>PRESET</b>	- erase a specified pixel or point
<b>DRAW string</b>	- draw a figure specified by "string"	<b>PSET</b>	- turn on a specified pixel or point
<b>DRUN</b>	- exit LNW BASIC and run a command-level program	<b>PSAVE filespec</b>	- save the hi-res memory to a disk file
<b>FLS</b>	- fill the screen with a character or color	<b>QUICKEY</b>	- switch the abbreviated key entry on and off
<b>GSUB name</b>	- go to a named or numbered subroutine	<b>REPEAT</b>	- switch the keyboard repeat and beep on and off
<b>GTO</b>	- branch to a named or numbered routine	<b>REST</b>	- restore a data pointer to the start of a line
<b>HIMEM</b>	- set the high memory limit	<b>RS232</b>	- initialize the RS-232C interface
<b>JOY</b>	- support use of joysticks	<b>RSIN</b>	- turn on (or off) input from the RS-232C interface
<b>LABEL</b>	- name a line for a branch by name	<b>RSOUT</b>	- turn on (or off) output from the RS-232C interface
<b>LCASE</b>	- switch lowercase on or off	<b>SAVEKEY filespec</b>	- save defined keys to a disk file
<b>LINE</b>	- draw a line between specified points	<b>SOUND</b>	- produce a tone of specified pitch, character, and duration
<b>LOADKEY</b>	- load a file of defined keys	<b>SPOOLOFF</b>	- turn off spooling of printer output
<b>LOC</b>	- locate a string in the program text	<b>SPOOLON</b>	- turn on spooling of printer output
<b>MODE</b>	- set the graphics mode (see text)	<b>XSTRS(string)</b>	- execute a string as a BASIC statement (see text)
<b>MOVE</b>	- move a block of memory	<b>ZGET</b>	- similar to PGET but faster
<b>NTROFF</b>	- turn off the new trace facility	<b>ZPUT</b>	- similar to PPUT but faster
<b>NTRON</b>	- turn on the trace facility		
<b>PAGE</b>	- bank-select graphics displays from extended memory to the video display		

**Table 1:** A summary of LNW BASIC commands and statements.

in the normal black-and-white TRS-80); and 3 is a color-graphics mode providing the same resolution as Mode 1 but in eight colors without alphanumeric (an RGB monitor is needed). The graphics in Mode 1 are in 12K bytes of RAM that is bank-selected into lower memory; while graphics changes are made you can overlay them on the screen with a normal alphanumeric display, you can independently erase either the graphics or the alphanumeric overlay, and you can call graphics pages via LNW BASIC. This allows an unusual combination of graphics and printed output. If you use the color modes with a monochrome monitor, the colors appear as different intensities of gray. You may easily use all of the graphics modes with LNW BASIC; it has a syntax similar to the Radio Shack Color Computer's but it's much more powerful.

## Software

I believe the LNW-80 comes with more software than any other microcomputer. The two operating systems available are DOSPLUS (TRS-80 Model I compatible) and CP/M 2.2. By the time you read this, a version of LDOS to work with Model III disks, CP/M Plus, and a version of DOSPLUS to make the LNW act like a TRS-80 Model 4 should be available. Electric Pencil (a good word-processing program), Electric Spreadsheet (a Visicalc clone), Microterm (a smart-terminal program including 80-character lines for the LNW), and Chartex (a plotting program for bar graphs, etc.) all come free with the machine. An integrated small-business accounting system that includes general ledger, accounts receivable, ac-

counts payable, and payroll is also provided. All of that software (except Chartex and the small-business programs) has been widely reviewed and is first quality. (The business software is an extensive, complete system that comes on six double-density disks with a manual almost two inches thick.) The most important piece of software, however, is LNW BASIC, which supports the LNW's advanced features, particularly color, graphics, and the additional memory.

## Some Features of LNW BASIC

The LNW BASIC commands are summarized in table 1. The graphics commands are similar to those for the TRS-80 Color Computer, but are more extensive. They include: DRAW, which produces a shape defined by a string and gives you a variety of options on how to present it on the screen; CIRCLE, which draws circles and ellipses or arcs; and LINE, which draws a line between two points on the screen. PAINT fills a bounded figure with a specified color, while PLOT specifies dot-dash patterns for all of the graphics commands. Once you have produced a plot, PSAVE saves it to disk and PLOAD recalls it to the screen. PGET and ZGET save the graphics within a specified rectangle to an array, and PPUT and ZPUT retrieve them. You can erase graphics and alphanumeric displays separately, allowing flexible plot labeling. Other commands, like PCLS, FLS, COLOR, and so on, support the machine's color abilities.

The graphics software is extremely flexible. It's at least as good as many packages I have seen on mainframe computers. Listing 1 gives you a very short program



..SORRY CHARLIE  
FOR LEAVING  
YOU OUT!



**FEATURES  
INCLUDE:**  
16 Bit CPU  
With 128K RAM Memory  
Expandable to 256K,  
Two 320KB Slimline  
Disk Drives,  
Floppy Disk Controller,  
Monochrome Monitor and  
Adapter, Parallel and  
Serial I/O's.

**BEST OF ALL!  
TEN DAYS FREE TRIAL!  
ALL YOU PAY IS  
SHIPPING!**

**FOR MORE DETAILS  
CALL OR WRITE  
TO: TAVA CORPORATION  
16861 Armstrong,  
Irvine, California 92714  
714/261-0200  
Headquarters/Telex: 181667  
Answer Back COMPDSHACK IRIN**

# IBM® COMPATIBILITY AFFORDABLE PRICE TAVA PC

**THE SMART COMPUTER USER  
WANTS REAL VALUE WITH  
IBM COMPATIBILITY!**

Circle 375 on inquiry card.

**THE TAVA PC.** The ultimate Personal Computer. It gives you IBM PC® Compatibility at a fraction of the cost. Choosing a personal computer is a difficult decision. But, when your decision is a TAVA PC, it's not hard at all! The TAVA PC runs under DOS 1.1, 2.0, CP/M86®, and p-System®. You can choose from a large library of all the most popular IBM PC software products such as dBaseII®, Lotus 1-2-3®, Visicalc® and thousands more.

CP/M86 is a registered trademark of Digital Research, Inc.  
UCSDp is a registered trademark of Softech Microsystems

IBM PC is a registered trademark of IBM Corp.  
Visicalc is a registered trademark of Visicorp



©TAVA CORPORATION 1983  
trademark of ASHTON-TATE, Inc.

\*California residents add 6% sales tax.

dBASE II is a registered  
LOTUS 1-2-3 is a registered trademark of Lotus Development





# Inside Apple

Vol. 1, No. 4

## A dot matrix printer that will improve your image.

Meet the Apple® Imagewriter, the newest dot matrix printer for your Apple Personal Computer.

And with all that it has going for it, just maybe the best dot matrix printer on the market.

Take legibility, for instance.

The Imagewriter crams 140 x 160 dots into each square inch. So you get text that's highly readable and high resolution graphics, besides.

And it is fast.

The Imagewriter cruises at an unbelievable 120 characters per second. And that's just in the text mode. It's even faster printing graphics. 180 characters per second, to be exact.

What's more, the graphics dump is up to 60% faster than other comparably priced dot matrix printers. And that makes the Imagewriter fast enough to handle the Lisa™

Yet it's just as at home with an Apple III or Apple IIe. Thanks to Apple software experts who designed the control electronics to give the Imagewriter perfect compatibility. Not to mention some special capabilities

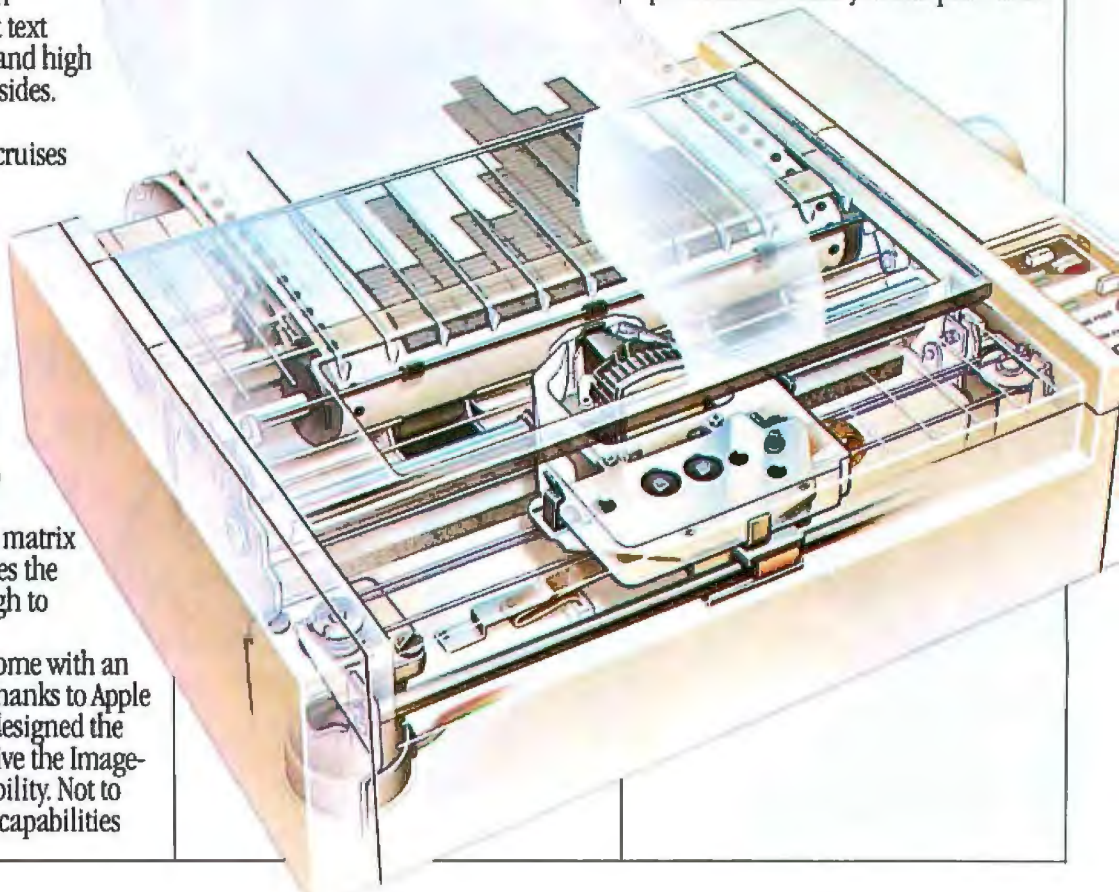
like superscript and subscript, to name just two.

Now, with all this high-speed performance, you'd expect the Imagewriter to make the Devil's Own Noise. It doesn't. In fact, the Imagewriter is specially constructed — with overlaid seams and special sound-deadening materials — to achieve a remarkable 53 dB. How loud is a remarkable 53 dB? You'd make more noise if you read this aloud.

The Imagewriter even has quiet good looks, since we designed it to look like the rest of the Apple Family.

Yet even with all its improvements, the Imagewriter is a better deal than any other dot matrix printer with comparable performance. And you can print that.

**APPLE PRESENTS THE  
E IMAGewriter APPLE PR  
ESENTS THE IMAGewriter APPLE PRESENT  
S THE IMAGewriter APPLE PRESENTS THE IMAGewriter APPLI**







## Charge!

Go out there and get the Apple Personal Computer System you really want. Now. Without laying out your extra cash. Without tying up your other lines of credit. With the Apple Card. The only consumer credit card reserved exclusively for the purchase of Apple Computers, peripherals and software.

Like all our products, it works simply:

Fill out an application (short, to the point and annotated in English) at an authorized Apple dealer honoring the Card. Your salesperson will call in the application and in most cases get an approval for you right on the spot.

You can then take your Apple system home. You don't even have to wait for the Card; we'll mail it out to you. And by the time you get it, you'll probably be well into doing whatever you bought your Apple system to do.

There is no annual fee for the Card, although a couple of restrictions do apply. The first purchase must include an Apple Personal Computer and you have to put 10% down. And subsequent purchases need to be at least \$100 if made with the Card. Oh, yes — you'll also have a credit limit.

When you use the Apple Card to make additional purchases, all you have to do is show the Card and sign the invoice. As long as it's within your credit limit, of course. Our dealers get a little nervous when someone signs for half their inventory. You understand.

You'll also receive monthly statements that include the latest purchases, credit available, and the minimum payment due. You'll also be happy to know Apple Card credit terms are affordable and the payments can be spread out. It's all

spelled out for you at the time your Card is approved.

So stop by a participating authorized Apple dealer and get an Apple Card. Just think of it as credit where credit is due.

## Give your floppy disks the boot.

We call it the "floppy disk shuffle." It happens when you have two or more software programs on floppies and you need to work with both. What do you do? You put one disk in, boot it, do your work, take it out, put the other disk in, boot it, do your work — you get the idea.

Well, you can stop shuffling any time now.

Thanks to a unique new software program called Catalyst™ from Quark, Inc. Specially designed for your Apple III and ProFile™ hard disk.

Catalyst allows you to take a wide variety of software programs and store them on your ProFile. Once they're on your ProFile, you just select the program you want from the Catalyst menu that appears on your monitor — then Catalyst does the rest. You'll never have to boot those programs again.

What kinds of programs will work with ProFile and Catalyst?

Almost anything written for the Apple III including copy-protected programs like VisiCalc®, Quick File™ and Apple Writer III. Or languages like Pascal, BASIC, or COBOL.

And once you've loaded these programs into your ProFile, the only diskette you may ever need is the Catalyst.

So if you have an Apple III and a ProFile and more floppies than you care to flip through, get yourself a Catalyst. And boot those disks for good.





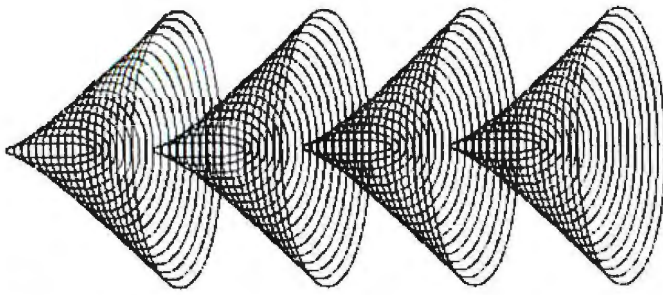


Figure 1: The image produced by listing 1 as sent to a Centronics 739 printer.

Listing 1: The program that produces the image shown in figure 1.

```

10 CLS: PCLS: MODE 1
20 J=0
30 FOR I=5 TO 90 STEP 5
40 CIRCLE J+30+I,100,30,I
50 NEXT I
60 J=100+J
70 IF J>300 GOTO 70
80 GOTO 30

```

whose result is shown in figure 1. (The figure is actually the image as sent to a Centronics 739 printer and is nearly identical to the screen image.)

LNWBASIC has many abilities that are only indirectly related to the LNW. You can redefine various keys (including but not restricted to the programmable keys) to produce a string; for example, "Shift-@" could produce "CMD"DIR:0 or perhaps a string of graphics characters (in Mode 0). You can enter BASIC commands with a single keystroke using QUICKKEY. For example, "G" produces GOSUB—and there's an excellent trace and debugging facility. You can send screen output simultaneously to a printer and disk file. (A spooler sends printer output to a disk file and prints from the disk file while the machine does other things.) You can exchange input and output with the RS-232C port (and the printer and disk), creating the possibility of writing specialized smart-terminal programs in BASIC. Perhaps the most remarkable command is XSTR\$(string) where "string" could be a function like  $A = \sin(B)$ ; you can enter this function from the keyboard or the disk and execute it as if it were a statement written from the program.

LNWBASIC resides in low memory. It doesn't compete with any high memory routines you may want to use, and it's compatible with many existing programs that live in upper RAM. It pushes your programs and data higher up and doesn't leave much room. To get around the memory problem there's a program called CREATOR that lets you assemble customized versions of BASIC with only the necessary functions. LNWBASIC is better than any of the enhanced BASIC packages I have seen for TRS-80 compatible machines.

The compiler, ACCEL3, can compile most LNWBASIC

programs and is particularly compatible with LNW software; the few things that are not compatible are found only by trial and error. ACCEL3 can also compile HIRES graphics (see below) and is a particularly important piece of LNW software.

There is other software available and more is being developed all the time by the manufacturer, users groups, and independent programmers. For example, LNW Research sells a program called CHARM that allows a user to define an independent character set. Another program called AUTOPLLOT plots data on the screen in a versatile set of formats and can send the output to various printers. HIRES is a BASIC-compatible graphics driver that's much faster than LNWBASIC but not as extensive. (It's sold by E&H Software, 11814 Coursey Blvd., Suite 249, Baton Rouge, LA 70816.) A graphics printer driver (sold by Excellonix, 637 No. Bristol St., Santa Ana, CA 92703) will send a high-resolution plot from the screen to various dot-addressable printers, and a variety of drivers for different alphanumeric screen displays are available from LNW Research. A Tektronix emulator, a perspective plotting routine, and other packages are public-domain software and are available from two LNW-oriented bulletin boards (see text box at end).

### CP/M for the LNW

Using the LNW with CP/M is like having a second computer. By the time you read this, CP/M Plus should also be available, but I've not seen it so my comments are on CP/M 2.2. Be aware that I strongly dislike CP/M: it's slow, cumbersome, difficult to use, not suited to graphics, and has few features of the more advanced TRS-80-compatible operating systems. It seems ironic that many people consider CP/M to be the professional's operating system while it is really the kludged outgrowth of a hobbyist's product; most TRS-80 operating systems were written by professionals and are of much better quality. In my opinion the only reason to use CP/M on the LNW is to read disks written on another machine or to run a CP/M program; however, I have yet to find a program I needed that was unavailable in a TRS-80 version.

The LNW version of CP/M is excellent, having all of the features of the normal 2.2 version with some important enhancements. It provides a full 80 by 16 or 80 by 24 screen, the control key is a true control key, and it follows the protocols of the ADM 3A terminal (in setting up word-processing programs, for example).

Two programs are particularly important: LNW.COM and SET.COM. LNW.COM lets you set disk-drive configurations to almost any standard—5¼-inch or 8-inch, 40-track, 80-track, double-sided, and so on. You can set up drives to read and write the 5¼-inch disks compatible with several other machines, including the Kaypro, Osborne, IBM PC, and Xerox 820. The program SET.COM allows even more specialized disk configurations. You can set the various parameters, such as skew tables, sector length, and so on, to custom-configure drives so they work with the disk format from almost





# STOP STRUGGLING WITH SPREADSHEETS!

## THERE'S AN EASIER WAY TO DO YOUR BUSINESS PLANNING: PROFIN.

If you don't have days, or even hours, to do projections with a spreadsheet, consider this:

There is now a highly specialized software tool expressly for the business person who needs the answers more than the workout.

### TIME-CONSUMING WORK ALREADY DONE FOR YOU

If you want to do forecasts and budgets, return on equity, discounted cashflows, net present values, capital expenditure analysis, interest calculations, depreciation comparisons or taxation scheduling without setting up the mathematical calculations or laying out a spreadsheet, you need Profin.

Profin is an easy-to-use (menu driven) program which leads you through your business analysis step by step. You simply answer the questions as they appear on the screen.

### REPORTS AUTOMATICALLY LAID OUT

Once you've completed entry, you'll be able to see any or all of the following reports laid out for you:

- income statements
- tax schedules
- interest schedules
- returns on equity
- capital expenditures
- discounted cashflows
- and balance sheets.

You can then make any changes to any of the information already entered and look at revised reports.

And you can automatically load your Profin reports onto a Multiplan, VisiCalc, SuperCalc or Lotus 1-2-3 screen (or any other spreadsheet that reads D.I.F. files) to carry out further manipulations.

### SPECIALIZED HELP FOR BUSY PEOPLE

Think of it this way: spreadsheets are great for the hobbyist who gains satisfaction from hours in front of the screen. But if you're a business person with little computer experience and even less spare time, you need the specialized tool: Profin.

Available under \$300 for CP/M-80, MS-DOS, and IBM PC-DOS from your local retailer.

Also available: PLANFIN. For sales, marketing and other executives who just want simple forecasts and budgets, Planfin gives you operating income statements plus net income and discounted cashflow reports in less than 15 minutes. Under \$200.

**BUSINESS™  
SOFTWARE**



Please send me more information about how Profin and Planfin beat the spreadsheets for budgets and forecasts.

Name \_\_\_\_\_

Address \_\_\_\_\_

City/State/Zip \_\_\_\_\_

Computer Brand Owned or Planned to Buy \_\_\_\_\_

Mail to: Business Software, Inc. 875  
12021 Wilshire Blvd., #194 Los Angeles, CA 90025



Circle 427 on Inquiry card.

# THE WAREHOUSE

1421 Carlisle, Alb., NM  
87110  
(505) 255-3360



## TO ORDER CALL 1-800-222-1494

ORDER DESK HOURS 8 A.M. to 5 P.M. MST Monday through Friday and 10 to 4 Saturday.

### COMPUTERS



- ZF 101-21 ..... \$2,199
- ZFA 121-22 ..... \$2,799
- ZF 121-22 ..... \$2,899
- F 111-32 ..... \$4,100
- ZF 121-32 ..... \$4,379

FREE

MS-DOS & Lotus 1, 2, 3  
Included with each  
computer!

### MONITORS



- ZVM 123-2  
swivel base .... \$ 15.00
- ZVM 123 (C) .... \$115.00
- ZVM 122 (A) .... \$115.00
- ZVM 124 (A) .... \$169.00
- ZVM 131  
med. res. co. .... \$299.00
- ZVM 435  
high res. co. .... \$475.00

### PRINTERS

#### INFOSCRIBE

- 500 ..... \$940.00
- 700 ..... \$1345.00
- 1000 ..... \$1130.00
- 1100 ..... \$1230.00
- 1200 ..... \$1395.00

#### MPI

- MPI-99 ..... \$ 599.00
- MPI-150 ..... \$ 995.00

#### BLUE CHIP

- BDC 40/15 ..... \$1,899.00
- BDC 20/15 ..... \$ 899.00

Manufactured by CGK, a wholly owned subsidiary of Selmans

### TERMINALS



- ZT-10 ..... \$379.00
- ZT-11 ..... \$449
- Z-29 ..... \$649

SOFTWARE ALSO AVAILABLE.  
PLEASE CALL FOR QUOTES.

## GUARANTEE

We guarantee every item in this advertisement for 30 days. We will replace or exchange any item damaged or otherwise inoperable at our expense. Sorry, software must be excluded from our policy due to copyright laws.

**ORDERING INFORMATION AND TERMS:** All items usually in stock. Cashiers Checks, Money Orders, Fortune 1000 Checks and Government Checks, we immediately honor. Personal or other Company Checks allow 20 days to clear. No C.O.D. Prices reflect 3% cash discount so ADD 3% to above prices for VISA or MC. For U.S. Mainland, add 3% for shipping, insurance and handling (S&H) by UPS with \$5 minimum for S&H. UPS ground is standard so add 3% more for UPS Blue with \$10 minimum for S&H. Add 12% total for S&H for US Postal, APO or FPO with \$15 minimum for S&H. For Hawaii, Alaska and Canada, UPS is in some areas only, all others are Postal so call, write or specify Postal. Foreign orders except Canada for S&H add 18% or \$25 minimum for S&H except for monitors add 30% or \$50 minimum for S&H. Prices subject to change and typo errors, so call to verify.

any machine. I have, for example, read Superbrain disks on the LNW.

One utility that I would like to see is missing: the ability to transfer ASCII (American National Standard Code for Information Interchange) files from CP/M disks to TRSDOS-compatible disks.

When the LNW uses CP/M, it bank-selects out the normal TRS-80-compatible ROM (read-only memory). In addition it places several drivers in the bank-selected extra RAM giving the user nearly 61K bytes of directly addressable RAM space. I believe that's more than any other 8-bit machine provides. If you need CP/M, the LNW version is as good as you'll find anywhere.

### Documentation

The manuals now provided with the LNW-80 are excellent; yet LNW's most criticized feature has been its documentation. The kits and the early machines were shipped with very inadequate instructions. It is surprising that the early kit customers managed to build working machines. Most of the LNW's published reviews and word-of-mouth information came from kit builders; luckily, those who bought the assembled machine had a much different experience.

LNW Research is very aware of its documentation problem, and now there's an excellent user's manual (called an "operations manual") and an equally good technical manual. There are also manuals for DOSPLUS, Level II BASIC, and LNWBASIC; all three are excellent. You must use the user's manual (116 pages) with the BASIC, LNWBASIC, and operating system manuals, but it is usable by both the expert and the complete novice. It may be necessary to shift between several different books, but learning to use the LNW is made easy by the many examples and cross-references.

The technical manual (179 pages) is also excellent and contains complete circuit diagrams. It should enable anyone experienced with hardware to repair and modify the LNW. The CP/M documentation is a thin but clear summary of the CP/M procedures and the LNW enhancements. That manual is not enough for a programmer, however, and if you intend to use the product, you should buy one of the more detailed descriptions of CP/M available. Very complete documentation for the rest of the software (Electric Pencil, and so on) is also included.

My greatest criticism of the documentation is that the user's manual and technical manuals were written for the Model I and only a barely adequate addendum is provided for the Model II. This addendum would make a high school English teacher cringe and a high school typing teacher ill. What is worse, the obscure descriptions of some features are so difficult to understand, even an expert will have problems. It's a good thing you can effectively use the LNW without reading the addendum.

### Service

There are relatively few LNW dealers at this time and local service is usually impossible. Therefore, there are



# Build The Ideal PC Network

IBM Compatible



Digital Microsystems opened up the world of shared micro computer resources with its HiNet™ Local Area Network in 1980. Now, 3000 HiNet LAN systems later, comes the DMS-816, the cost-effective solution to the need for multiple IBM-compatible PCs.

Up to 63 DMS-816 work stations can be interconnected to share common data and expensive peripherals. Cost per user can be half that of stand-alone PCs. And if you



software, as well as existing CP/M-80™ and CP/M-86™ programs. Standard 256K RAM memory means you

already own IBM PCs™ connect them to HiNet™ with low cost HiNet/PC Adapter cards. Conserve your investment while expanding the utility of your system.

With the DMS-816 you take advantage of the wealth of PC-DOS™



can handle large, data-intensive applications immediately without the expense of purchasing added memory.

Your network is controlled by an extremely fast and reliable master station. And your communication pathways are unlimited—HiNet gateways let you talk to mainframes and public data networks.

As part of an international communications company—Exel group PLC—Digital Microsystems is the dependable

supplier for everything you need on your HiNet LAN: large hard disk servers, network software, cabling and connectors, intelligent work stations, optional local storage. This translates into easy installation, training and support.



For a view of the world you never had before, call or write today.

## DD Digital Microsystems

HiNet is a trademark of Digital Microsystems, Inc. IBM PC is a trademark of International Business Machines. PC-DOS is a trademark of International Business Machines. CP/M-80 and CP/M-86 are trademarks of Digital Research, Inc. Corporate Offices: U.S. 1840 Embarcadero, Oakland, CA 94606. Tel. (415) 261-1034. TWX 910-366-7310. U.K.: Tel. (0734) 793131. Telex 851849925. Hong Kong: Tel. 3-7237962. Telex 78041153. Germany: Tel. 610234036/7/8. U.S. Sales Offices: California: (415) 261-1034. New York: (516) 829-4772. Texas: (214) 234-4940. Washington D.C.: (301) 837-6700.

International Distributors: Australia, Daro Systems, (02) 699-3877 • Belux, Digital Systems, (2) 384-80-82 • Denmark, Data APS (1) 780 141 • India, American Components, (01) 222999 • Ireland, DigiCom, (0001) 604544 • Israel, Oshat Computers, (3) 492122 • Italy, Condor Informatics, (2) 4987549 • Norway, Nor Sales, (2) 680555 • Portugal, Monteiro, (1) 322500 • Saudi Arabia, EECC, (2) 6690221 • South Africa, Digital Computer (11) 706 7182 • Spain, MDS, (3) 239 3604 • Sweden, Macrotek, (8) 870190 • Switzerland, Compuserve (42) 366155

Circle 433 on Inquiry card.



only two recourses for a user with hardware problems: find a competent local technician or send it back to LNW Research. The technical documentation is good enough that a competent technician should be able to work on the machine. If you must send it back, LNW Research has excellent support. It can usually repair a machine and have it back in the owner's hands within three weeks—a better response time than many local dealers.

LNW Research also has a very knowledgeable technical support staff that can and will gladly answer most questions. My problems have always been solved by phone. If you buy an LNW, you have the particular advantage of working with a small company—personal and friendly service.

### Problems

I have few criticisms of the LNW-80. Mine didn't work when it first arrived, but that was due to UPS, not LNW Research, which helped me fix it quickly.

For several reasons I don't find it easy to use the 80 by 24 screen with the various drivers available. The drivers need upper memory that I want to use for other purposes; they slow up screen scrolling; and they're not compatible with my two most frequently used programs: a text editor (Newsprint) and a smart-terminal package (ST80-III).

I would prefer a small separate keyboard—the LNW's design should allow this. The case soils easily, and the paint wore off the corners of mine after about 3 months.

However, the worst problem is that LNW Research's high standards for documentation fell again with the Model II. Its initial product documentation does not match the quality for subsequent releases. Let's hope that the company follows its own lead and publishes a high quality second release of Model II documentation.

### Overall

The LNW's greatest advantage is its compatibility with other machines—much of the TRS-80 line and most CP/M-compatible products. Second is its graphics capability followed by its use of 96K bytes of memory. The manufacturer's upgrade policy is equally important. I

expect IBM-compatible hardware and software to be coming soon. The LNW's price is comparable to or better than its competition's, and its quality of construction is outstanding. Then too, it comes with as much or more software than any other 8-bit computer I know of. . . . It's hard to choose which one of the LNW's advantages is most important.

Yet the LNW is not very popular. Why? For one thing, large firms like Apple, Radio Shack, and IBM can afford large advertising budgets, while LNW Research cannot. But LNW Research faces a special public relations problem: it is known as a kit manufacturer. LNW is just not commonly known. Whenever I tell someone I own one, I have to explain what it is and then defend it against the "Trash-80" reputation. I don't know what LNW should do to improve its image, but for the sake of anyone who wants to buy an outstanding computer, I hope that it succeeds. In my opinion the LNW is the best 8-bit microcomputer available. ■

### For More Information

#### Newsletters

LNW News

244 Mill Rd.

Yaphank, NY 11980

*contains a lot of advertisements but useful material as well*

The LNW USER Group Newsletter

4345 Manchester Rd.

Grand Island, NB 68801

*mostly for kit builders and those with hardware experience, but something for everyone*

#### Bulletin Boards

(516)924-8115

Yaphank, NY

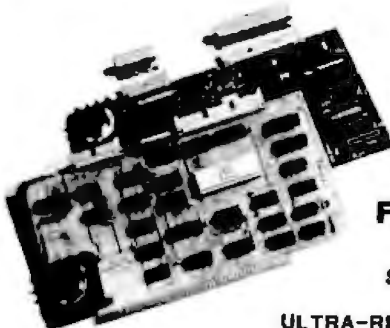
*run by Info Inc.; lots of free software and help*

(504)291-8115

Baton Rouge, LA

*run by E&H Software; also has lots of free software and help; especially graphics programs supporting HIREs*

*Mahlon G. Kelly (268 Turkey Ridge Rd., Charlottesville, VA 22901), an associate professor of environmental sciences at the University of Virginia, is involved in research into the character of lakes.*



## ULTRA-RES™ GRAPHICS

IEEE-696 S-100

IBM-PC

- 1 X 512 X 512 \$495

- 1 X 512 X 512 \$495

- 3 X 512 X 512 \$1250

- 1 X 1024 X 1024 \$995

- 1 X 1024 X 1024 \$995

- CONSOLE EMULATOR \$50

- PLOT 10 \$150

### FEATURES

Software drivers, Hardware zoom, Programmable Display Resolution, Windowing, Multi-Controller Capability, NEC UPD7220 Graphic Controller

### Starting Prices

ULTRA-RES Trademark CSD Inc.

IBM-PC Trademark IBM

**C.S.D. Incorporated**  
**P.O. BOX 253 Sudbury, MA 01776**  
**(617) 443-2750**



# Self-dFENSE™ for EDP managers.

The micro invasion has begun. And, chances are, you've now got a lot of different people in a lot of different departments using a lot of different micros.

Now there's a way for you to control and maximize the benefits of all the different micros in your domain.



## Fight back with dBASE II.®

dBASE II is the relational database management system from Ashton-Tate that enables you to manage your micro-based corporate data resources with the high level of consistency and sophistication you've enjoyed with mainframe and minicomputer systems.

Armed with dBASE II and the dBASE II RunTime™ program development module, you can write programs which will enable micro users in each department to "do their own thing" while creating complete database consistency throughout the company.

dBASE II is a powerful, flexible way for you to effectively manage the micro proliferation.

## Help is here.

If you'd like to know more about how dBASE II and RunTime can help you win the micro management battle, contact Ashton-Tate today. 10150 West Jefferson Boulevard, Culver City, CA 90230. (800) 437-4329, ext. 212. In Colorado (303) 799-4900. In the U.K. (0908) 568866.

ASHTON · TATE ™

dBASE II is a registered trademark and RunTime is a trademark of Ashton-Tate  
Suggested retail price for dBASE II is \$700.  
© Ashton-Tate 1984



**Era one.**





One saw the personal computer increase the productivity of the business executive dramatically. Yet for all their power, personal computers have not fulfilled their potential. Because the different makes have been unable to communicate reliably with one another and with the various public data networks.

But now, Microcom moves the personal computer into a new era of communications compatibility with Era 2—the first Personal Computer Communications System with the industry-standard communications protocol MNP. Era 2 finally enables dissimilar personal computers to communicate with one another reliably and cost effectively. It also allows the personal computer to access public data networks easily and error-free.

#### closer look at Era 2.

Era 2 with MNP is a 1200 baud Communications System (software and inboard modem) designed to operate with the IBM PC, PC XT, compatibles and PCjr; Apple IIe, Apple II Plus and Apple II. Its features include IBM 3101, Digital T-100 and VT-52 terminal emulations. Era 2 executes multiple functions with a single keystroke. Offers a virtually unlimited number of telephone numbers — each one up to 31 digits. Era 2 is Bell 2A compatible, works with Pulse or Touch-tone™ dialing. Its speaker alerts you to busy signals, wrong numbers, etc. Era 2 gives your personal computer error-free compatibility with other personal computers, data bases, mainframes, almost any information source that can be reached by telephone line.

A new era in dependability. Era 2's electronics are so well put together we're able to offer a four-year warranty—twice the term of protection you get from yesterday's products.

## Era two.

On top of that our product support is outstanding. Our 800 number operates 9AM to 8PM (EST), Mondays through Fridays, 9AM to 5PM Saturdays with experts available to solve any problem or answer any question.

#### The state of the price of the state of the art.

We're able to offer Era 2 for an amazing \$429. By any standard the price/value ratio of Era 2 is outstanding.

Move your personal computer forward into a new era of communications. Visit your Era 2 dealer soon. Call 800-322-ERA2 (in MA, 617-762-9310) for the name of one nearest you. Or write us, Microcom, Inc., 1400A Providence Highway, Norwood, MA 02062. We'll send you a brochure with complete information on Era 2. **Only from Microcom: The Personal Computer Communications System with MNP.**

Circle 261 on inquiry card.

# Era 2



# EQUATIONS PROCESSED

## NO PENCIL. NO PAPER. NO MANUAL LABOR.

The TKISolver® program will take on your toughest problems—linear, quadratic, simultaneous equations, whatever. Then stand back. Because TKISolver turns your personal computer into a simple, yet powerful, desktop equation processor.

Whether your problem is a simple formula or a model consisting of many equations, TKISolver can help improve your productivity. Once the equations are written, enter the known values, press the ! key, and TKISolver gives you the answer.

Engineers, scientists, architects, financial analysts and planners, educators, researchers, and other professionals who use equations and mathematical models can work more creatively with TKISolver.

### TK!SOLVER GIVES YOU: BACKSOLVING

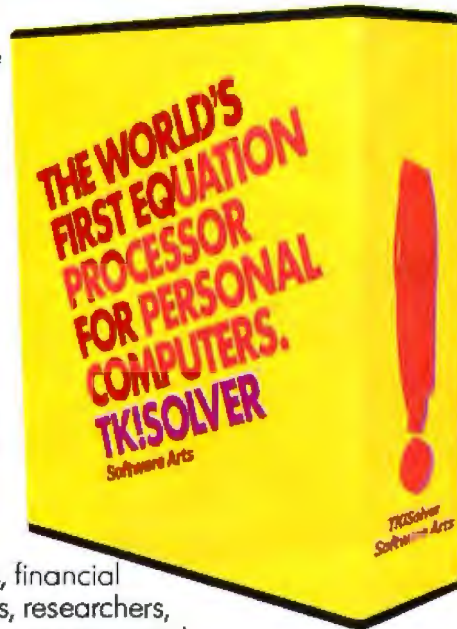
If the programs you use now require you to rewrite the same equation to solve for different unknowns, TKISolver can dramatically improve your productivity. Enter your problem once and then solve for the unknowns no matter where they are in your equation.

### ITERATIVE SOLVING

If TKISolver can't solve an equation directly, take an educated guess at the answer. Type the ! key and the TKISolver program starts with your guess and performs repeated approximations to converge on the answer.

### LIST SOLVING

Given a list of input values, TKISolver automatically calculates the equation for every value in



your list. For example, if you want to know how different interest rates will affect monthly loan payments, enter a list of interest rates and let TKISolver calculate the payment amount for each value.

### UNIT CONVERSIONS

Any type of unit conversion—Fahrenheit to Celsius, meters to feet, dollars to deutschemarks, newtons to dynes—can be made without altering your equations. Just define the numerical relationship between two units of measurement and the TKISolver program automatically converts the variable value to the unit you specify.

### TABLES AND PLOTS

Quickly generate tables and plots of your results on your screen or printer.

### AVAILABLE NOW

You can run the TKISolver program on the IBM® PC and XT and compatible machines, the Digital™ Professional™ 350, the Digital™ Rainbow™ 100, the Wang Professional Computer, Apple® IIe, and on the following personal computers using MS™-DOS: TI Professional Computer, GRID Compass Computer,™ Canon AS-100, Eagle® 1600, Toshiba T300, and the Zenith Z-100.™

### SEE IT TODAY

There's more. Lot's more. But you'll have to see it to believe it. And that's easy. Bring your own equations into your nearest computer retailer and ask to see the TKISolver program in action.

The world's first equation processor for personal computers.

**TK!Solver®**  
By Software Arts,™ creators of VisiCalc®  
27 Mica Lane, Wellesley, Massachusetts 02181 617-237-4000

Copyright © 1984 Software Arts, Inc. All rights reserved.



# This Month's Features

**A** sneak preview of Apple's newest computer, the Apple IIc, is the highlight of this month's features. The new IIc is examined by West Coast Senior Technical Editor John Markoff and he reports that, with the icon character generator in ROM and a disk drive running under ProDOS, this lightweight, Apple II-compatible, transportable computer delivers a lot of bang at a price less spectacular than expected. Nevertheless, Cupertino's grown-up garage operation continues to be fruitful.

Like those classic science-fiction journeys into the human body, Brian Cameron tours the lap-portable TRS-80 Model 100's ROM. You can access ROM routines that'll make your Model 100 programs shorter and more efficient, using the information you'll gather from this excursion. Cameron, who has written a lot about his findings from mucking about inside Radio Shack computers, has once again proven that there are rewards for those willing to dig a little.

Speed and efficiency are key concerns of Drs. Roy Chaney and Brian Johnson. Here they explore a technique for realizing the true performance potential of Winchester disk drives. Memory caches and some sophisticated algorithms for prefetching data allow hard disks to move data at the megabit (and higher) speeds they were designed for.

Gregg Williams updates the Macintosh/Lisa story that appeared in February's *BYTE* with new information on models and prices. Authors Caceci and Cacheris explore the subject of fitting curves to data.

Following on the heels of April's Real-World Interfacing theme, Stephen Gates takes us into the laboratory to put an IBM to work collecting data, while Richard Hallgren offers up the software portion of his two-part series on using an Apple II for data acquisition.

Next, Roy Crosbie offers an explanation of ISIM, a language designed for writing computer simulations. As Crosbie reveals, a continuous-system simulation language running on micros under CP/M can add a new dimension to computer modeling. For those of us trying to glimpse the forest through a tangle of branches, John Snyder offers assistance with an article on a method for indexing open-ended trees. Finally, Richard Thomas illuminates the gains to be made in program maintainability by using intraprogram remarks to document software.

—G. Michael Vose, Senior Technical Editor

- 
- 276 The Apple IIc Personal Computer** by John Markoff
- 
- 288 Inside the Model 100's ROM** by Brian Cameron
- 
- 307 Maximizing Hard-Disk Performance** by Roy Chaney and Brian Johnson
- 
- 339 Update on Apple Macintosh and Lisa 2** by Gregg Williams
- 
- 340 Fitting Curves to Data** by Marco S. Caceci and William P. Cacheris
- 
- 366 Laboratory Data Collection with an IBM PC** by Stephen C. Gates
- 
- 382 Putting the Apple II Work, Part 2: The Software** by Richard C. Hallgren
- 
- 400 ISIM: A Continuous-System Simulation Language** by Roy E. Crosbie
- 
- 406 Indexing Open-Ended Tree Structures** by John Snyder
- 
- 415 Using Comments to Aid Program Maintenance** by Richard A. Thomas
-

# The Apple IIc Personal Computer

*A portable IIe compatible that runs ProDOS*

John Markoff

BYTE Senior Technical Editor

In an industry that sees dozens and dozens of personal computers introduced each year, and despite the fact that the venerable Apple II is rooted in seven-year-old technology, it's remarkable that Apple Computer has succeeded in keeping its II product line alive and even thriving. Now, in the face of stiff competition from both foreign and U.S. manufacturers and in the wake of its own introduction of two significantly more powerful desktop computers (Lisa and Macintosh), Apple Computer has introduced the fourth version of the Apple II product line, the Apple IIc (see photo 1).

### Evolving Apple II Technology

While the IIc will remain highly compatible with the Apple II product line from a software perspective, it is clearly not just "old wine in new bottles."

The IIc is what Apple Computer refers to as a "focused product." It is designed to fit into a market niche that places it in head-to-head competition with the IBM PCjr at the high end of the home market for personal computers. However, a great deal of flexibility is evident in both the IIc software and hardware architecture and peripherals. As such, you can expect to see the IIc appearing in a variety of other markets, including business and educational applications.

The IIc represents an evolution of Apple II hardware and software tech-

nology in a number of areas. First, it is truly portable. The system unit weighs just 7½ pounds and occupies a space of approximately 11½ by 12 by 2¼ inches. Its carrying handle folds into the backplane. A built-in half-height 5¼-inch disk-drive unit is accessed from the right-hand side of the case. The IIc and its optional 9-inch monochrome monitor are shown in photo 2.

Later this year, Apple intends to enhance the portability of the IIc when it introduces a full-screen, high-resolution flat-panel display (see photo 3). I'll discuss the flat-panel display later. Although a battery pack will not be available upon introduction, the IIc runs on virtually any 12-volt (V) power supply. The AC-to-DC converter has been isolated from the system, and, because the IIc has no slots, the power-supply capacity has been reduced from 45 to 35 watts. A small briefcase-size carrying case is available to hold the computer, flat-panel display, and other peripherals.

The IIc is based on the 65C02, a new CMOS (complementary metal-oxide semiconductor) implementation of the 6502 microprocessor. The 65C02 is an extension of the 6502's instruction set (with 27 new instructions) and offers faster graphics and arithmetic operations. The 65C02 runs virtually all existing Apple II software; however, software written to take advantage of the new instruction set will not be compatible with

the IIe and II Plus. The new micro-processor has a clock speed of 1.023 MHz and will perform up to 500,000 eight-bit operations per second, performance figures that match the 6502's.

The IIc extends the use of custom-designed ICs (integrated circuits) beyond what was used in the original IIe design. In addition to the input/output unit (IOU) and memory-management unit (MMU), the IIc contains a custom timing-generator (TMG) chip that generates several time and control signals, a general logic unit (GLU) that provides miscellaneous logic control required by the system, and the disk-controller unit, which is referred to as the IWM (Integrated Woz Machine). The IWM is also used as a disk controller on the Macintosh. It is a one-chip LSI (large-scale integration) of the disk controller originally designed by Steve Wozniak for the Apple II.

The increased use of custom LSI ICs has permitted Apple to further lower the chip count of the IIc (see photo 4). In addition to its sixteen 64K-bit RAM (random-access read/write memory) chips (the computer comes with a standard 128K bytes of RAM), the IIc has only 21 chips. This is particularly striking when you consider that this is three chips fewer than the number of non-RAM ICs in the IIe, despite the fact that many functions performed by additional cards (disk controller, two serial interfaces, 80-column video circuitry)



are now integrated into the IIc design.

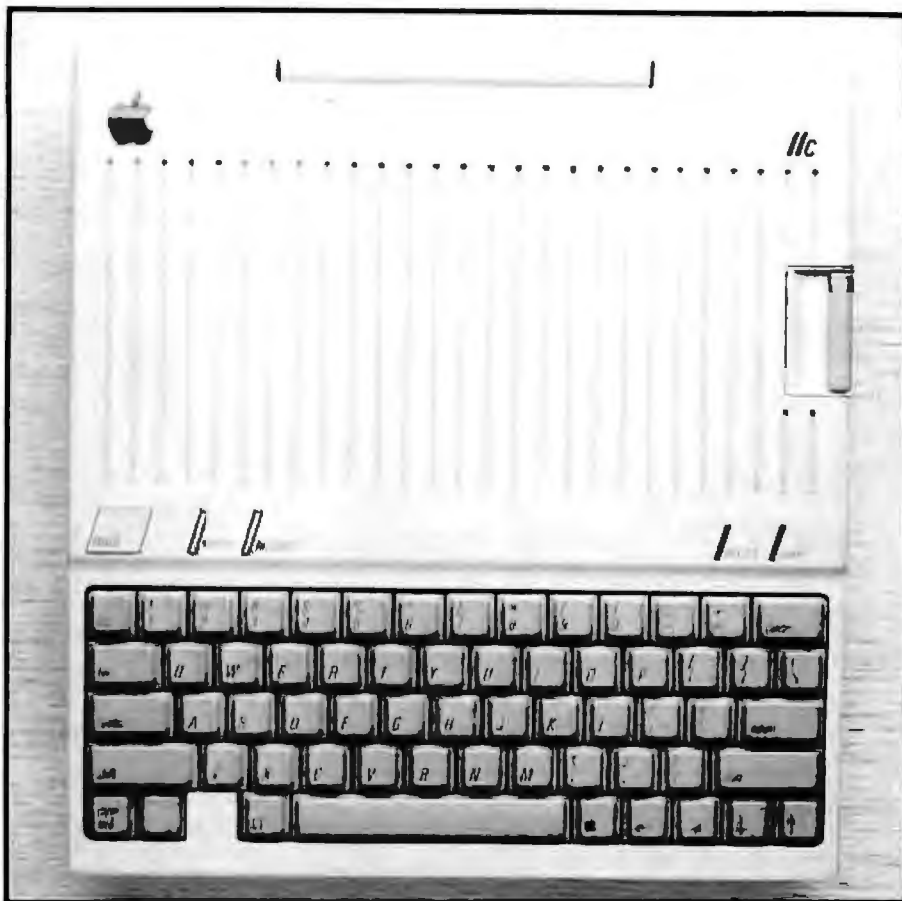
Finally, the design of the IIc is based on a closed-hardware architecture giving the user no direct access to the system bus. However, in return for taking away the II's expandability, Apple included many of the features that have in the past required slots.

A quick look at the back of the IIc reveals connectors for two RS-232C serial ports, two video ports, an external disk-drive port, and a combination mouse/joystick port (see photo 5). Thus, in the slotless version of the IIc, users will have access to the functions that traditionally have taken as many as five of the computer's seven slots. While the Macintosh's relatively closed hardware architecture has created some controversy, the decision to restrict hardware expansion appears to be more clear-cut in the case of the IIc.

Portability and ease of use have clearly been gained at the expense of expandability. Apple has decided to market the IIc to a novice computer user who, it is argued, will have no desire to get inside the hardware, but instead will be interested in a computer that can be set up and run as simply as a stereo system. Toward that end Apple has separated the documentation into a setup guide and reference manual.

The software evolution of the IIc is more subtle, yet it may prove to have far-reaching consequences. The IIc will come with Apple's recently released ProDOS operating system, which offers a significant increase in performance over DOS 3.3. ProDOS includes Unix-like hierarchical file structures that are compatible with the Apple III SOS operating system.

Although the Apple IIc ROM (read-only memory) will appear very similar to the IIe ROM to programmers, it actually was redone almost completely. The ROM went through a dramatic "code crunch" according to Peter Quinn, manager of the IIc design team. Additionally, several bugs in the IIe ROM were removed and other features added, including improved interrupt-handling capability, a built-in windowing function, and a series of 32 graphics characters



*Photo 1: A top view of the Apple IIc. It has a lower profile (2½ inches) and weighs less (7½ pounds) than the Apple IIe computer. The keyboard is the same in size and functional layout but is designed around a low-cost key switch that provides tactile and auditory feedback. The Reset key has been moved from one side of the keyboard to the other, and switches for 40/80-column mode and Dvorak and QWERTY keyboard arrangements have been added.*



*Photo 2: An optional 9-inch monochrome monitor is available for the IIc. When separated from the monitor, the system can be carried in a briefcase-size carrying case that includes room for the flat-panel display.*

## At a Glance

### Name

The Apple IIc Computer

### Manufacturer

Apple Computer Inc.  
20525 Mariani Ave.  
Cupertino, CA 95014  
(408) 996-1010

### Dimensions

Width: 11½ inches; depth: 12 inches; height: 2¼ inches

### Weight

7½ lbs.

### Power Requirements

9 to 20 volts DC, 35 watts

### Processor

1-MHz 65C02 8-bit CMOS microprocessor

### Memory

128K bytes of RAM; 16K bytes of monitor in ROM (includes self-test, Applesoft BASIC, 80-column routines, Mousertext icons, and interrupt-handling routines)

### Keyboard

63 keys capable of generating the 128 ASCII characters; features auto-repeat and two-key rollover

### Mass Storage

Built-in Alps half-height 5¼-inch disk drive that is fully compatible with the Apple Disk II: single-sided, 35-track, 16-sector disks

### Video Display

Optional 9-inch monochrome monitor; flat-panel LCD will be introduced before the end of the year. RGB adapter to be offered at an unspecified future date. Video-display modes: 40-column text; 80-column text; low-resolution color graphics (40 horizontal by 48 vertical, 16 color); high-resolution color graphics (280 horizontal by 192 vertical, 6 color); double-high-resolution color graphics (560 horizontal by 192 vertical, 16 color). Text capacity: 24 lines by 80 columns. Character set: 96 ASCII (uppercase and lowercase). Display formats: Normal, Inverse, Flashing, Mousertext

### Other Features

RF modulator; external AC-to-DC power converter; two RS-232C serial ports; video expansion port; external disk port

### Hardware Options

Second disk drive; mouse; joystick; flat-panel LCD, carrying case

### Operating System

ProDOS: single-user, single-task operating system; includes hierarchical directory structures, predefined and user-definable file types, file sizes up to 16 megabytes; compatible with DOS 3.3

### Available Software

Includes almost all existing Apple II software. Specially designed packages from Apple: Appleworks integrated database management, word processing, and spreadsheet analysis; Access II communications program; Apple Logo II (requires 128K bytes of RAM); Apple Education Classics

### Prices

Basic system unit: under \$1300; other prices to be announced

found in the character-generator ROM. These characters, called Mousertext by Apple, are a series of icons designed to offer programmers access to a user interface that appears similar to that found on the Lisa and the Macintosh. They can be called

directly and thus moved around on the screen faster than bit-mapped characters.

At the time of this writing, Apple was planning to price the IIc at "less than \$1300." While this price is higher than some expected, Apple clearly

has decided to go after the same market that IBM is trying to reach with the PCjr and has priced the IIc accordingly. Still, given equivalent features with the IIe, the IIc represents some price savings. But the trade-off for that price saving is the IIc's lack of an expansion slot. The amount of the price saving may determine the IIc's ultimate importance.

## A Computer for the Home

Apple has styled the IIc to reach a group of potential buyers that heretofore have been afraid or uninterested in personal computers. The IIc is, according to senior product designer Rob Gemmell Jr., "the cuddliest computer we have ever designed."

This is reflected in the IIc's case, which has a significantly lower profile than that of the IIe. Apple also has chosen a lighter, white color called "Apple Fog" for the case. The new color scheme is part of a general redesign effort that will affect all new Apple products. Originally code-named Snow White, the project led to a worldwide search for a design consultant. Ultimately, Apple settled on German designer Hartmut Esslinger, the designer of the Sony Walkman portable stereo. Esslinger set down the aesthetic design guidelines for the IIc and has since been retained by Apple to consult on future products.

The back panel of the case also reflects Apple's attempt to simplify system installation. Connectors are labeled with icons that represent modem, printer, and other ports. Frequently used interface cables make use of easy-to-fasten connectors. For example, Apple has chosen to use standard DIN 5-pin connectors to fasten the serial cables to the IIc.

Other external design features include a new door design for the internal disk drive (see photo 6), a miniphono headphone jack and volume-control knob that are recessed on the left side of the computer, and two switches set just behind the keyboard that control 40/80-column display and selection of a Sholes or Dvorak keyboard layout. The Dvorak option was available on the IIe, but it had to be accessed with



jumpers and printed-circuit board trace cuts. The technical reference manual points out that you can change the key caps yourself, but it warns that if you break the switch stems you will void your warranty.

The IIc keyboard itself is functionally a duplicate of the IIe keyboard; it has 63 keys capable of generating the 128 ASCII (American National Standard Code for Information Interchange) characters. The actual mechanical design of the keyboard, however, is significantly different from keyboards on other Apple products. The IIc keyboard is laid out in a flatter fashion, in part because the IIc is designed to be used tilted up at a slight angle while resting on the handle, which folds down to serve as a stand. Although the keyboard is physically the same size as that of the IIe, the keys themselves are based on a new low-cost key switch that Apple has developed. The switch is not "full travel" (i.e., the keys don't depress deeply), but instead offers what Apple claims is improved tactile and auditory response.

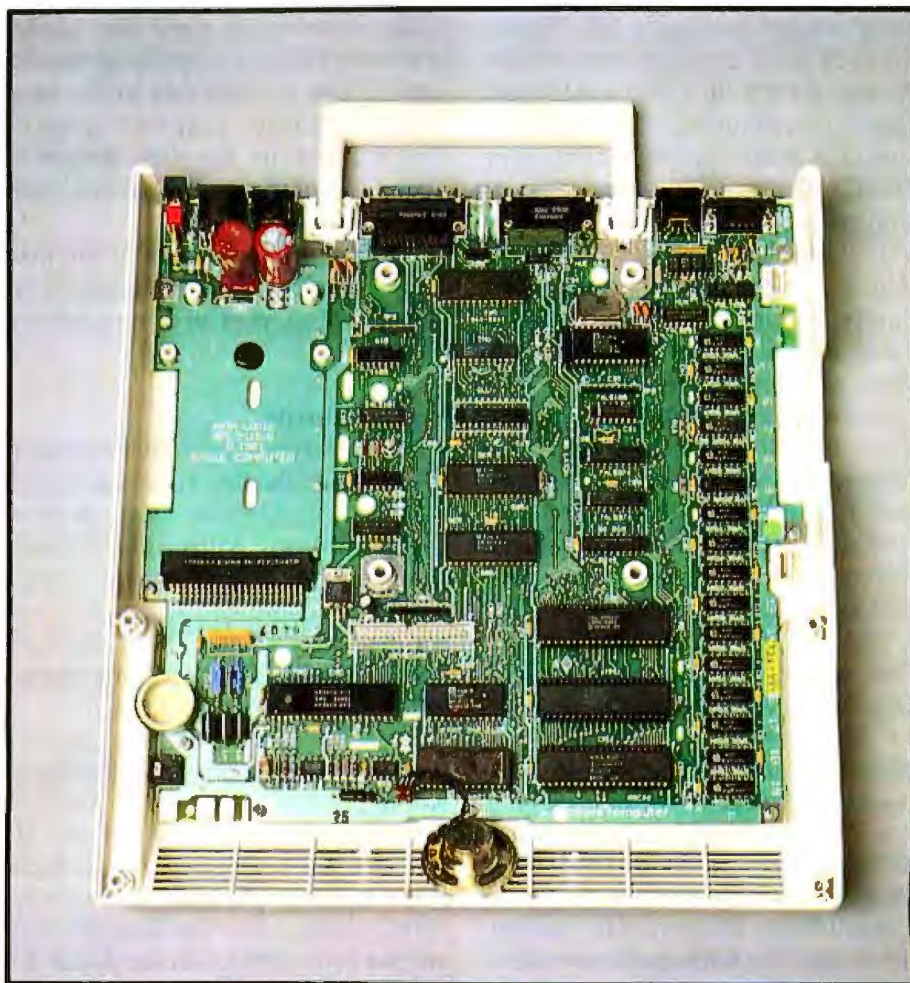
It seems that no new version of the Apple II would be complete without altering the placement of the Reset key. This time it is placed just above and to the rear of the keyboard on top of the system case. As with the IIe, there are two levels of Reset. Holding down the Control key and the Reset key will cause a warm-start procedure with some programs. This leaves the resident program intact. Simultaneously holding down the open-apple key (to the left of the space bar) with the Control and Reset keys forces a cold start, which has the same effect as turning the power off and back on again.

### Display Options

Although the video output of the IIc is similar to that of the IIe, Apple has attempted to generalize the output options of the IIc as much as possible. The back panel offers two connectors: a standard RCA pin-plug jack for a video monitor and a 15-pin D-type connector for video expansion. The latter interface is designed to support a number of display options, including RGB (red-green-

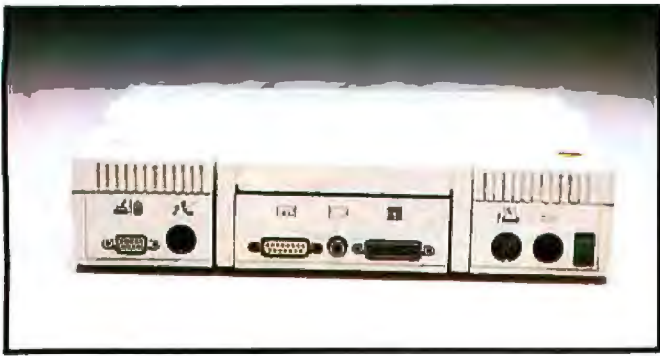


*Photo 3: Apple has announced that a full-screen (560- by 192-pixel) flat-panel LCD will be available for the IIc before the end of 1984. The flat-panel display will support all the IIc's text and graphics modes and draw its power from the video expansion port.*



*Photo 4: The main circuit board of the Apple IIc. The IC count is now down to 21 (excluding RAM), including two serial ports, video circuitry, and a disk controller. By comparison, the IBM PCjr has more than 90 ICs.*





**Photo 5:** The rear panel of the IIc. The panel consists of seven connectors and a main power switch. From left to right: a 9-pin D-type miniature connector for hand controls or a mouse; a 5-pin DIN (Deutsche Industrie Norm) connector for serial I/O (input/output) (port 2, normally for a modem); a 15-pin D-type connector for video expansion; an RCA pin-plug jack for a video monitor; a 19-pin D-type connector for linking a second disk drive; another 5-pin DIN connector for serial I/O (port 1, normally for a printer or plotter); a special 7-pin DIN connector for 9–15-volt DC power input; and the main power switch.



**Photo 6:** View of the IIc's internal 5¼-inch disk drive. The drive was initially designed to face backward but in the final design faces the side of the case. The drive is heavily shielded and ventilated.

blue) displays, the forthcoming flat-panel display, and a variety of European display standards. All 15 pins are used and signals include a video-text signal from the GLU, a 1-V sound signal to permit television speaker sound, a power source, a composite NTSC (National Television System Committee) video signal from the VID (video interface device) hybrid IC, a color-reference signal, and others. The intent is to let designers easily access all the hooks for both serial and composite data.

The basic system unit comes with a standard RF modulator designed to connect to the video expansion port, and an optional 9-inch monitor is available. An RGB adapter still is necessary, and Apple plans to have one available in the future.

Like the IIe, the IIc can produce both 40- and 80-column text displays. However, if you use an ordinary color or black-and-white television set, 80-column text will be too blurry to read. For a clear 80-column display, you must use a high-resolution video monitor with a bandwidth of 14 MHz or greater.

In addition to text-display modes, the IIc also has three graphics modes: low-resolution (40 horizontal by 48 vertical), 16 color; high-resolution (280 horizontal by 192 vertical), 6 color; and double-high-resolution

(560 horizontal by 192 vertical), 16 color.

The double-high-resolution mode is achieved by bit-mapping the lower-order 7 bits of the bytes in the two high-resolution graphics pages. These bytes in the two graphics pages are interleaved to provide 560 dots per line.

When the flat-panel LCD (liquid-crystal display) is available later this year, it will support all three graphics modes.

### Compatibility

As it did during the transition from the II Plus to the IIe, Apple has made a significant effort to ensure software compatibility. Although it has switched to a half-height drive, Apple has continued to employ the 5¼-inch disk size for the II product line. The IIe also will continue to use 140K-byte single-sided drives.

In recent months, Apple has undertaken a major program of testing Apple II software on the IIc and informing software publishers if changes are needed to make their software compatible. Currently, Apple believes that the IIc is 90 to 95 percent compatible with the Apple II.

Compatibility problems, where they arise, may come from the ROM, the 65C02 microprocessor, unorthodox protection schemes, or illegal

memory addresses. For example, programs that enter the monitor ROM at unpublished locations will not work. A more intriguing but apparently rare problem emerges from the fact that some programmers have discovered and used undocumented instructions for the 6502 microprocessor. These instructions no longer exist in the 65C02.

### Software

Apple has made the decision to endorse selected third-party software that has been specially designed for the IIc. Of the 21 products that Apple is introducing with the IIc, 17 are published by independent software publishers. The programs fall into the broad categories of education, entertainment, and productivity and come from such publishers as Microsoft, Software Publishing, The Learning Company, and Brøderbund Software. Apple itself is offering Appleworks, an integrated database-management, word-processing, and spreadsheet program; Apple Logo (see photo 7), redesigned to take advantage of the 128K bytes of RAM available in the IIc; Apple Education Classics; and the Apple Access II communication program.

Apple's endorsement is not an exclusive one. More than 100 other companies also are developing their





## WITH THE PASSWORD™ MODEM AND TELPAC™ BEN FRANKLIN COULD HAVE PUBLISHED THE FRIDAY EVENING POST.

**T**he Password™ modem and Telpac™ software deliver text fast, far, cheap, and letter-perfect. Fast? Ten times faster than an expert typist (and four times faster than most other modems). Far? Crosstown or crosscountry. Letter perfect? Multiple accuracy checks of your text are just one editorial benefit. Cheap? Thousands of words by phone lines, for less than express mail. And if the text is to be typeset,

the cost will be half or less—the proofreading zero!

Password is USR's virtually automatic modem: 300/1200 baud, auto dial/answer, auto mode/speed select, two-year warranty. \$449.\* Telpac, the USR friendly telecommunications software package, \$79. Write or call for complete descriptions—both Telpac and Password do far more than this!



**U.S. ROBOTICS INC.**

1123 WEST WASHINGTON • CHICAGO, ILLINOIS 60607  
(312) 733-0497

Circle 389 on Inquiry card.

\*Suggested list for Password complete with power adapter, phone cable, RS232 interface.

Password, Telpac, and USR logo are trademarks of U.S. Robotics Inc.





**Photo 7:** Part of the Apple Logo tutorial. Apple has limited the amount of printed documentation and increased the interactive on-line tutorials available with the IIc. The basic system comes with four disks of tutorials designed to offer 10 to 12 hours of instruction.

software for the IIc. A software developers toolkit and a technical reference manual will be available to software publishers.

### Peripherals

Several peripherals designed to work with the IIc represent significant technological advances.

Apple has gone to the Japanese manufacturer Sharp for a full-screen flat-panel display that Apple hopes to have ready for introduction later this year. Several Japanese LCD manufacturers now are on the verge of introducing 80-character by 24-line flat-panel displays. Significantly, most of them will have an aspect ratio of 640 by 200 (width to height), corresponding to the IBM monochrome display. However, Apple has persuaded Sharp to manufacture a display for the IIc with an aspect ratio of 560 by 192. Apple currently has several working prototypes of the display. Recently, BYTE was shown a demonstration of one of these prototypes. The display differs from a CRT (cathode-ray tube) in appearance because of the square shape of individual pixels. (Individual pixels on an Apple monitor are twice as high as they are wide.) This makes

characters on the display appear somewhat flattened; however, characters in 80-column display mode appeared quite crisp, and the display also produced remarkable high-resolution graphics.

The Scribe printer, which is being announced simultaneously with the IIc, is an impressive plain-paper thermal-transfer printer with color capabilities. Although the final price of the Scribe has not been set, it is likely to be in the \$300 range. Apple is taking some pains to separate the Scribe thermal-printing technology from other thermal-printing techniques that require specially sensitized or coated papers. By contrast, the Scribe will print on virtually any paper surface, ranging from Xerox copier paper to continuous form-feed paper. The Scribe also will print on projection transparencies.

Although the Scribe is being announced with the IIc, it is designed as a printer to function with the entire Apple product line, including the Macintosh and the Lisa. BYTE was shown printing samples of graphics screen dumps from the Macintosh that appeared to exceed the ImageWriter in quality. The Scribe has two resolution modes and can operate at

either 80 cps (characters per second) in draft mode or 50 cps in letter mode.

Scribe technology is based on a proprietary print head that consists of 24 resistance elements that are arrayed in a vertical column. While printing, the head is pressed against a ribbon that consists of a polyester backing and a carbon-filled paraffin ink. The resistance elements are pulsed briefly, heating them and melting the ink to deposit it on paper.

The design of the print head permits a resistance element to rise to a temperature above 300°F and then drop to below 95°F (below the melting point of the wax in the ribbon) within the space of several hundred microseconds. The dot resolution of the Scribe can range as high as 160 horizontal by 144 vertical dots per inch in letter mode.

Color printing can be achieved by inserting a color ribbon that has different colors laid out in serial bands; the Scribe skips intermediate colors when printing in a particular color.

While the Scribe is a low-cost printer to purchase, the cost of printing will be high. Ribbon cost for an 80,000-character black ribbon will be in the neighborhood of \$5, and color ribbons may cost as much as \$8. Apple claims that the Scribe will be most compatible with "low duty cycle" applications such as those associated with students, homes, or executive workstations.

### Questions and Comments

Now that we've seen what the Apple IIc has going for it, what does it lack? First, there are the obvious shortcomings, such as its inability to run CP/M software. This is not an insubstantial omission, since Z80 cards are one of the most common additions to the Apple II beyond 80-column cards, serial cards, and disk controllers.

Second, Apple has chosen not to include a built-in modem. It seems reasonable to expect that a modem should be an integral part of any computer that is designed to be readily transportable. Apple's response is that it decided to leave the modem out for reasons of time, cost,



# 4

## It's Fast In Any Language.

When it comes to software development, the difference between a Sage IV computer and other micros is like day and night.

With the Sage Computer it'll take you fewer days and nights to finish your program.

Speed is the reason. Speed resulting from the fast MC68000 microprocessor, fast architecture, fast operating systems, and blinding transfer rates.

The fact is, even we are surprised by the amount of software that's developed on Sage Computers.

So if you're a programmer, maybe you should spend some time learning how much time you could save using a Sage IV.

### The Hottest Languages And Operating Systems.

Programs in nearly all of the important languages can be written on the Sage computer.

Included in the price is the **p-SYSTEM** operating system which supports **Pascal**, **BASIC**, and **FORTRAN**.

Other operating systems are optional. For **UNIX** fans there's **IDRIS**, which runs up to twice as fast (even without a Sage computer). **IDRIS** conforms to /usr /Group Standards Committee

standards and programs written under it are highly portable to other micros.

**CP/M** advocates please note that Digital Research has developed **CP/M-68K** for Sage hardware, providing a truly complete software development environment. Versions of **Pascal**, **BASIC**, **C-BASIC**, **C**, and **FORTRAN 77**, as well as a very fast **APL**, may be used under this operating system.

The Sage IV is also blindingly fast when

if you found your language here, you just found your computer. The 16-bit, 2-million operation/sec Sage IV micro with up to one MByte RAM and 18-MByte internal hard disk.

For more information and the name of your nearest SAGE dealer, call us today. And be sure to ask about our new software catalog describing over 200 application programs for Sage computers.

Sage Computer Corporate Office,  
4905 Energy Way, Reno, Nevada  
89502. Phone (702) 322-6868  
TWX: 910-395-6073/SAGE RNO

Eastern United States  
Sage Computer  
15 New England  
Executive Park  
Suite 120, Burlington, MA  
01803 (617) 229-6868



running **hyperFORTH** with its extended programmer and user interfaces.

Besides **IDRIS**, other **Multi-User** operating systems that run on the Sage Computer are **PDOS**, **MBOS**, and **MIRAGE**.

A lot of excitement has been brewing in the Pascal World over Niklaus Wirth's new **MODULA 2**—and it's available for Sage computers. So is **ADA**, for the record.

© 1983 Sage Computer Technology all rights reserved Sage & Sage IV are trademarks of Sage Computer Technology



# THE SMART WAY TO CONNECT YOUR EQUIPMENT.



There's only one cable on the market that allows you to hook your computer to virtually any peripheral. It's the Smart Cable. Its on-board logic matches any RS-232 port to another. Instantly. And automatically. No other cable can do it. So don't face the problem of needing a new cable for every new connection. Buy the only cable you'll ever need to buy. The Smart Cable. Suggested retail \$89.95.



**IQ TECHNOLOGIES, INC.**  
11811 N.E. First Street  
Bellevue, WA 98005

## Smart Cable™

and space. However, since lap-size computers selling for as little as \$700 now include integral 300-bps modems, this may be the IIc's most significant design flaw.

Less obvious, perhaps, are problems associated with the decision to maintain media compatibility between the IIc and earlier versions of the Apple II. Certainly Apple is the only company that can get away with introducing a personal computer with just one 140K-byte single-sided drive.

Even in its half-height form, it seems that the 5¼-inch disk standard is not an ideal one for a truly portable computer. The drive adds considerably to the weight and size of the computer and, in fact, the Apple design team admitted that the internal drive created major headaches in terms of cooling the IIc. (The critical element in the cooling equation is the jacket of the 5¼-inch disk.)

The obvious alternative would have been to switch to the Sony 3½-inch disk drive used by the Macintosh. That drive is lighter and more compact and has more than twice the storage capacity in its single-sided version. The problem of transferring software from one medium to another doesn't seem insurmountable, particularly because Apple seems intent on marketing the IIc to first-time computer users.

Also less clear is the question of open- versus closed-hardware architecture. It seems obvious that, in the case of the IIc, expandability had to be sacrificed to achieve a genuinely portable computer. Peter Quinn, the director of engineering for the IIc, insists that, while Apple's two most recently released products have been slotless, the company has not backed away from its commitment to the principle of open architectures: "I think that within this division we're still very sold on open architecture, open slots, and I think any of our new products will ultimately reflect this, once we evolve into a new architecture," he says. ■

*John Markoff is a senior technical editor at BYTE. He can be contacted at 1000 Elwell Court, Suite 225, Palo Alto, CA 94303, (415) 964-0624.*



## Check Our Services

We'll supply you with the best values, at the best prices, delivered when you need them. Everytime.

### PRESSURE SENSITIVE LABELS

Price per Thousand 5-55 60-115 120+

3½" x 15/16" Single \$2.99 \$2.84 \$2.56

4" x 17/16" Single \$5.55 \$5.27 \$4.74

### CARTRIDGE RIBBONS

Designed to fit the IBM PC Printers

1-11 12-23 24+

MX, FX-80 \$6.99 \$6.29 \$5.66

MX, FX-100 \$9.95 \$8.96 \$7.96

Call or write for our free catalogue.

Toll free: 1-800-343-7706.

In Massachusetts: 617-963-7694.

P.O. Box 103, Randolph, MA 02368



# CHECK-MATE

COMPUTER SUPPLIES INC.



# THE WY-50. PRETTY SMALL

A NEW GENERATION OF LOW-COST TERMINALS FROM WYSE.



Never before has anyone put so much into something so small. The WY-50 gives you big terminal features without occupying your entire work-space. This took revolutionary design. Design a lot of people couldn't accomplish for the price. But we did.

In fact, the WY-50 introduces a new standard for low-cost terminals. You get a compact, full-featured design that meets the most advanced European ergonomic standards. 30% more viewing area than standard screens. And a price tag as small as they come.

The WY-50 sells for only \$695.00.

#### FEATURES:

- 14" screen.
- 80/132 column format.
- Soft-set up mode.
- High resolution characters.
- Low-profile keyboard.
- Industry compatible.
- Only \$695.00.

For more information on the revolutionary design, outstanding features and unique good looks of the new WY-50,

contact WYSE and we'll send you a brochure filled with everything you need to know. The WY-50. The full-featured terminal with the small price.

## WYSE

Circle 409 on Inquiry card.

Make the Wyse Decision.

WYSE TECHNOLOGY 3040 N. First St., San Jose, CA 95134, 408/946-3075, TLX 910-338-2251. Outside CA call toll-free, 800/421-1058, in So. CA 213/340-2013.



# The Texas Instruments makes the best software

Best-Seller List.



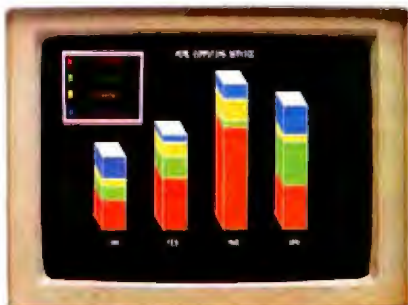
These best-sellers are among the most popular business software programs for microcomputers as reported in Inc. magazine, September, 1983.



# Professional Computer perform even better.

See the difference TI can make with these best-sellers and hundreds more software packages.

Word processing, data base management, advanced integrated programs...the Texas Instruments Professional Computer can help you meet virtually every business and professional need. But before you consider software alone, consider the hardware too.



*Our sharp, 8-color graphics give your displays even more visual impact.*

**The better the hardware, the more you get from your software.**

The TI Professional Computer's outstanding monitor resolution and 8-color graphics make best-selling programs like Lotus 1-2-3™ sharper, easier to work with.

You can put three times the graphic information on screen—in both color and monochrome—so you'll be able to take even greater advantage of the best graphics programs. For best-selling word processing packages like WordStar,™ TI's comfortable, typewriter-style keyboard is a natural. Anyone familiar with a standard typewriter keyboard can start to work immediately, without re-learning key positions.

**TI offers all the software you need.**

So whatever your business needs, the TI Professional Computer runs the programs



*Our easy to use keyboard makes word processing easier.*

you need now, and the ones you'll want tomorrow. Thirty to forty programs each month are being developed by over 200 software manufacturers. You'll find them among hundreds of other software packages listed in the TI Software Journal.

So get more from your software with the best hardware, the Texas Instruments Professional Computer. For more information, call 1-800-527-3500.

Or visit the dealer nearest you.



## TEXAS INSTRUMENTS

Creating useful products and services for you.

1-2-3 is a trademark of Lotus Corporation.  
WordStar is a trademark of MicroPro International Corp.  
Copyright © 1984 Texas Instruments

2773-04 SW-R2



# Inside the Model 100's ROM

*Explore the built-in software in the TRS-80 Model 100*

**Brian Cameron**  
Free-lance Writer

The TRS-80 Model 100 is still a relatively new machine with not much software or information available for it yet. This probably will change, as it did for the original TRS-80 Model I and other early microcomputer systems. I hope to shorten the time it takes you to get information contained within the Model 100 by taking you on a walk through its ROM (read-only memory) chips, stopping at addresses you may find useful in your own BASIC or machine-language programs. I will show you the locations of the systems directory and your files and explain their formats. Finally, I will describe a program I wrote called DIR.CO. This program addresses a shortcoming of the Model 100 in that it shows the location and size of the files in the machine. DIR.CO will list each directory entry, even if the file has been erased, and give the starting address and length of each file. In some cases DIR.CO will provide even more information, such as the execution and entry addresses of a command file.

## The Directory

The file directory starts at hexadecimal location F962. Each directory entry is 11 bytes long. The first byte is a flag byte that describes the status of the file. The bits defined in the status byte are:

7—tells that the file really exists

- 6—identifies the file as a text (.DO) file
- 5—identifies the file as a command (.CO) file
- 4—shows that the program is in ROM if this bit is on
- 3—shows that the program is invisible if this bit is on
- 2—not used
- 1—not used
- 0—not used

The status byte is followed by a 2-byte starting address for the program and an 8-byte address containing the filename. The directory starts with the system entries. These are what the user is accustomed to seeing displayed in the main menu. The familiar system files are BASIC, TEXT, TELCOM, ADDRSS, and SCHEDL. Each of these files contains a status-flag byte of hexadecimal B0. The status-byte list, above, shows that this means the files are command type and that they are resident in ROM. The next two directory entries refer to programs called SUZUKI and HAYASHI. Both these filenames are preceded by a zero. The status flags for SUZUKI and HAYASHI are hexadecimal 88 and C8, respectively. In each case the invisible bit is on for these files. The user directory entries start at hexadecimal address F9AF.

## About Erased Files

An erased file has a status-flag byte

of zero. All other files have the high-order bit of the status byte turned on. If you accidentally erase a file, you may be able to recover it. Start at the beginning of the user directory and move through it 11 bytes at a time until you come to the file you erased. Store a hexadecimal 80 in the first byte of the directory entry and the file will reappear. This, however, does not ensure that the file will be restored; to be recoverable it must have been the last file stored. The Model 100 ROM routine not only changes the flag to 00 when a file is erased, but it also closes any holes in the file structure. For example, if three files exist, F1.DO, F2.DO, and F3.DO, and you erase F2.DO, file F3.DO will close the gap that F2.DO left. This can be demonstrated with the DIR.CO program. Create several files and display their start and end addresses, then erase one of the files and invoke the DIR.CO program again. As long as the program erased was not the last directory entry, you will notice that the file previously listed after the erased file will now begin at a new address. Because of this file movement you cannot be assured that a file can be restored after a KILL command has been entered. It is unfortunate that the authors of the Model 100 ROM routines did not choose to simply mark a file as erased and then clean up any missing gaps at the next file save. Be careful if you attempt to recover a lost



# Compute and print client tax returns in minutes

on your microcomputer with **MICRO-TAX**

That's right, in just minutes you can have a client's completed tax return in your hand. Think about it... you increase client volume, you increase your profits. Plus, you save the cost of your computer service bureau—and you have complete client security.

**FEDERAL AND STATE PACKAGES TO MEET EVERY NEED** MICRO-TAX<sup>®</sup> offers four Federal tax packages and 25 state packages (fully integrated with the Level II Program), so you can select the programs that best meet your needs:

**Level I—Federal Individual Package:** for individuals preparing their own taxes.

**Level II—Federal Professional Individual Package:** for accountants, registered agents, tax attorneys, and other tax professionals.

**Level III—Federal Partnership/Corporate Package:** for those who prepare Federal Partnership, Corporate, and Subchapter S returns.

**Level IV—Overseas Tax Package:** addresses the unique tax situations of United States Expatriates.

Levels II, III, and IV have a depreciation module and automatically compute underpayment penalties and minimum tax. In addition, Levels II and III automatically compute self-employment taxes, and Level II computes income averaging.

**FLEXIBLE DATA ENTRY.** With MICRO-TAX<sup>®</sup> you can organize data entry in a sequence similar to that of manual tax preparation, or you can choose another sequence. The menu driven system makes data entry simple.

**MULTIPLE PRINTING OPTIONS.** You can input client tax information at the time of interview and produce forms immediately, or enter data during the day and batch print returns at night. MICRO-TAX<sup>®</sup> prints your returns on IRS forms, IRS approved substitute forms, or with transparent overlays.

**TAXNET<sup>®</sup>—TELETEXT SUPPORT NETWORK.** MICRO-TAX<sup>®</sup> customers can now have access to an electronic mailbox and instantaneous memoboard through the TAXNET<sup>®</sup>

teletext support network. With TAXNET<sup>®</sup> you can send information, ask questions, get answers and updates—directly through your computer and a modem.

**TAX ORGANIZER.** Now MICRO-TAX<sup>®</sup> offers a Tax Organizer. You get both the software and the forms, so each year, you can send your clients an organizer with the prior year's client data printed on it.

**HARDWARE COMPATIBILITY.** MICRO-TAX<sup>®</sup> is compatible with your IBM PC/XT, DEC Rainbow, Radio Shack, or any other personal computer with CP/M-80, PC DOS, or MS DOS—from Apple to Zenith.

So, take the tedium out of tax preparation—save time and money—*Call Micro-Tax<sup>®</sup> for complete details, or call your local dealer.*

FULL FEDERAL MICRO-TAX <sup>®</sup> PERSONAL COMPUTER SYSTEMS	1983 FEDERAL FORMS AND SCHEDULES INCLUDED																				PRINTS					
	1040	1041	1042	1043	1044	1045	1046	1047	1048	1049	1050	1051	1052	1053	1054	1055	1056	1057	1058	1059	1060	Substitutive Forms	IRS Forms	Blank Padroll	Continuous	Reprinted Forms
Level I, Individual \$195.	•	•	•	•	•	•	•	•	•	•	•	•	•	•	•	•	•	•	•	•	•	•	•	•	•	•
Level II, Professional Individual \$1000.	•	•	•	•	•	•	•	•	•	•	•	•	•	•	•	•	•	•	•	•	•	•	•	•	•	•
Level III, Partnership/Corporate \$1000.	•	•	•	•	•	•	•	•	•	•	•	•	•	•	•	•	•	•	•	•	•	•	•	•	•	•
Level IV, Overseas \$2000.	•	•	•	•	•	•	•	•	•	•	•	•	•	•	•	•	•	•	•	•	•	•	•	•	•	•

• All forms and schedules subject to final IRS changes for 1983 tax year.  
 • 25 Integrated state returns available • Orders taken for yearly update packages  
 • Transparencies: Level I, \$150; Levels II, III, IV, \$250 each.



\*C/P/M—trademark of Digital Research, Inc. DEC Rainbow—trademark of Digital Equipment Corp. MICRO-TAX and TAXNET—trademarks of Microcomputer Taxsystems, Inc. MS DOS—trademark of Microsoft Corp. PC DOS, IBM PC, and IBM XT—trademarks of IBM; Apple—trademark of Apple Computers; Zenith—trademark of Health Company and Zenith Radio Corp. Radio Shack—trademark of Tandy Corp.

**MICRO-TAX<sup>®</sup> MICROCOMPUTER TAXSYSTEMS, INC.**  
 6203 Variel Avenue, Suite A Woodland Hills, CA 91367, Dept. 1B Phone (213) 704-7800  
 (Area code changes to (818), effective January 1984)

Circle 270 on inquiry card.



BASIC Command	Internal Code (all hexadecimal)	ROM Entry Address (all hexadecimal)	BASIC Command	Internal Code (all hexadecimal)	ROM Entry Address (all hexadecimal)
ABS	E1	33F2	LET	87	09C3
ASC	F9	294F	LINE	92	0C45
ATN	ED	2F71	LIST	A5	1140
BEEP	B1	4229	LLIST	A7	113B
CALL	B9	1DFA	LOAD	9B	4D70
CDBL	F4	35BA	LOG	E8	3FCF
CINT	F2	3501	LPOS	E4	10C8
CLEAR	A7	40F9	LPRINT	A0	0B4E
CLOAD	A8	2377	MAX	B7	1D9B
CLOAD?	(same as CLOAD)	2456	MENU	BA	5797
CLOADM	(same as CLOAD)	24A7	MERGE	9C	4D71
CLOSE	9A	4E28	MOTOR	B6	1DEC
CLS	B0	4231	NAME	BC	2037
COM	AD	1A9E	NEW	BF	20FE
CONT	A4	40DA	NEXT	82	4174
COS	EA	2EEF	ON	97	0A2F
CSAVE	A9	2280	OPEN	99	4CCB
CSAVEM	(same as CSAVE)	22DD	OUT	96	110C
CSNG	F3	352A	PEEK	EE	1284
CSRLIN	CA	1D90	POKE	A2	128B
DATA	83	099E	POS	E5	10CE
DATE	AB	1924	POWER	B8	1419
DAY	AC	1955	PRESET	B5	1C66
DEF	A1	0872	PRINT	A3	0B56
DIM	85	478B	PSET	B4	1C57
DSKI	C8	5073	READ	86	0CD9
DSKO	98	5071	REM	8E	09A0
EDIT	93	5E51	RESTORE	8B	407F
END	80	409F	RESUME	95	0AB0
EOF	EF	1889	RND	E7	313E
ERROR	94	0B0F	RUN	89	090F
EXP	E9	30A4	SAVE	9E	4DCF
FILES	9D	1F3A	SAVEM	(same as SAVE)	22CC
FIX	F5	3645	SCREEN	BE	1E22
FOR	81	0726	SGN	DF	3407
FRE	E2	2B4C	SIN	EB	2F09
GOSUB	8C	091E	SOUND	B2	1DC5
GOTO	88	0936	SPACE	FB	298E
HIMEM	CC	1DB9	SQR	E6	305A
IF	8A	0B1A	STOP	8F	409A
INKEYS	C9	4BEA	STR	F7	273A
INP	E3	1100	STRING	C6	296D
INPUT	84	0CA3	TAB(	C0	0C01
INPUT#	(same as INPUT)	0C99	TAN	EC	2F58
INT	E0	3654	TIME	AA	1904
IPL	BB	1A78	USING	C2	4991
KEY	AF	1BB8	VAL	F8	2A07
KILL	BD	1F91	VARPTR	C3	0F7E
LCOPY	B3	1E5E	WIDTH	90	1DC3
LEN	F6	2943			

**Table 1:** The BASIC command entry points and internal codes. For an explanation of the abbreviations, see September 1983 BYTE, page 154.

file—if the files have been shifted after the erase command the results may be unpredictable.

### File Formats

Three types of files can exist on the Model 100: BASIC files (.BA), command files (.CO), and document files (.DO). A BASIC file starts at the address specified in the directory and continues through memory until

three zeros are encountered. A document file also starts at the address specified in the directory, but it continues until a Control-Z hexadecimal 1A is encountered. A command file is a little more complicated because it must provide such information as the start address and the length of the program. At the address specified in the directory, you will find where the command file is stored. This is

not where it is executed. The program, when invoked from the main menu, will be moved to its execution address and control will then be passed to it. The first two bytes of the file contain the start address, or the address where the file will be moved to in memory. The next two bytes contain the length of the program. This is the program proper and does not include the start-address bytes,



# INDUSTRIAL GRADE IEEE-696/S-100 BOARDS

Dual Systems designs and manufactures a variety of IEEE-696/S-100 boards for 16-bit microprocessor systems running under UNIX and other operating systems. These boards bring high performance and three years of field-proven experience to your computing environment.

Each board is rigorously tested and burned-in for 168 grueling hours. If it can't bear the heat, it won't bear our name.

## High Performance System Boards

**Model WDC-SMD** The WDC-SMD Hard Disk Controller\* is specially designed for high throughput in large, heavily-loaded multi-user UNIX systems. All sectors on a track are transferred essentially within a single disk rotation regardless of where the head first settles or the order in which sectors are encountered.

The controller offers 16-bit throttled DMA data transfers and disk transfers up to 10 Mb/sec. Also features dual-ported, full-track, look ahead cache, and on-board microprocessor. Interfaces with one or two SMD drives. \$2195.

**Model SIO4-DMA** The most advanced, intelligent, 4-port serial I/O board available for the IEEE-696/S-100 bus, this module features 256 bytes of FIFO buffer for input characters and provides DMA transfers for output. A built-in 8085A processor greatly reduces system overhead. \$695.

\*Patent Pending

**Model DMEM** Features 256K bytes of memory and either 8 or 16-bit data paths. 24-bit addressing, and parity checking on each byte. DMEM has no S-100 wait states. \$1395.

**Model EPROM** Capable of either 8 or 16-bit data transfers, this 32/64K EPROM offers the versatility of running with 68000, Z-8000, 8086, 16000, and other 16-bit processors. It accepts industry-standard 2732 and 2716 EPROMs. 64K RAMS may be mixed with 2716 EPROMs for use as a RAM/EPROM board. \$345.

**Model CPU-68000M** High-performance CPU board with 16-bit data path, 10 MHz CPU operation, and MC68451 MMU for multi-tasking applications. \$1195.

**Model CPU-68000** Similar to 68000M, but features 8K bytes of on-board ROM with Motorola's MacsBug monitor instead of the Memory Management Unit. \$895.

**Models M/BD-15 & 20 Back Planes** These premium quality motherboards feature four-layer construction with two internal ground planes, and Schottky-diode termination. They provide high-speed operation with true transmission line characteristics and minimum noise. M/BD-15: \$495, M/BD-20: \$545.

**Model CMEM** This non-volatile CMOS memory board provides easy-to-use 8 or 16-bit data paths and 32K bytes of memory with dynamically movable write/protect window. On-board lithium battery holds data for 3-10 years with power off. \$725.

## Data Acquisition and Control Boards

**Model CLK-24C** Clock-calendar features a LSI CMOS chip and on-board, long-life lithium battery. \$325.

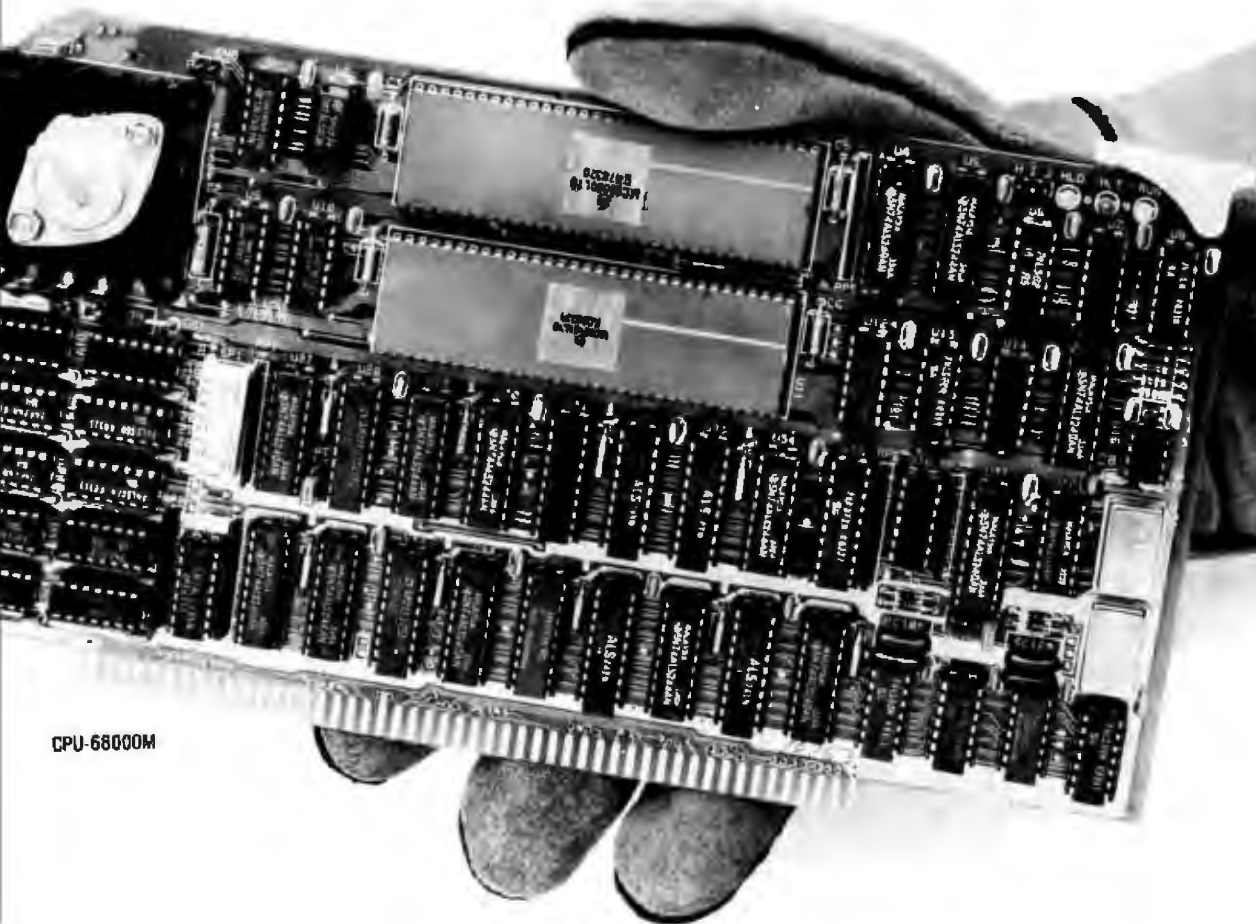
**Model AIM-12** A highly reliable A-to-D converter with 35msec. maximum conversion time, 12-bit resolution and accuracy, and 32 channels single-ended/16 channels differential. \$725.

**Model AOM-12** This D-to-A converter offers I/O-mapped port address, 12-bit  $\pm 1/2$  L.S.B. accuracy (0-70°C), and voltage outputs of 0 to 10 volts,  $\pm 5$  volts, and  $\pm 10$  volts. \$675.

**Model VIC 4-20** Converts voltage outputs from AOM-12 into four separate 4-20MA current outputs. Module also provides overvoltage protection on all current output, plus transient protection per ISA standards. \$600.

For more information, call (415) 549-3854. Dual Systems Corp., 2530 San Pablo Avenue, Berkeley, CA 94702

THERE'S ONLY ONE  
**DUAL**



CPU-68000M



# New dimensions in Bible study.



**THE WORD**  
processor  
the complete KJV Bible on  
disks \$199.95 \*  
**TOPICS**  
an index to over 200 Scripture  
subjects \$49.95 \*  
\* plus \$3 postage/handling

Requires APPLE II+, IBM PC  
and compatibles, TRS80,  
CP/M 2.2 (Z-80), KAYPRO,  
OSBORNE, COMMODORE 64,  
Z-100.

For information contact:  
**Bible Research Systems**  
9415 Burnet, Suite 208  
Austin, TX 78758  
(512) 835-7981

"Software for personal Bible study."

length bytes, or the entry bytes in its calculated length. The two bytes following the length contain the entry address of the program. This is where the program will start executing from, once control is passed to it. The entry address is not necessarily the same as the start address, but they can be the same if the program is to start at the first byte specified in the start address.

## ROM Routines

By understanding parts of the Model 100 ROM routines you will be able to shorten your programs and use the 32K bytes of ROM space that would normally be useless to your program. For example, there is no point in writing the code to clear the screen or home the cursor if these routines already exist in the machine. Because the Model 100 clears the screen when it leaves the menu, you should be able to use this function, as well as other routines (providing you can find them in ROM) and understand what each routine requires. To prove this capability, enter the BASIC command CALL 16945. This is the entry point for the BASIC CLS command. After you enter this command your screen will be blank. Table 1 gives a list of BASIC command entry points, as well as their internal representation.

Many other useful ROM routines are available in the Model 100. Table 2 is a list and description of addresses I discovered in the ROMs using a disassembler on an IBM 4341. You can easily incorporate these routines into your machine-language programs.

## The DIR.CO Program

The DIR.CO program in listing 1 is an extended version of the BASIC FILES command, but it provides much more information than just the names of the current files. If a directory entry exists for an erased file, its name will also appear in the list of files, with the comment \*ERASED\* beside it. Each file appears by itself on the screen. Pertinent information also appears with the filename. You move through the system files by pressing the Enter key, at which point the screen is cleared and the next file

**IBS** **IBM® COMPATIBLE**  
**\$2295** List Price  
Nation Wide Service

**MAXIMUM IBM®  
COMPATIBILITY**



**CARDS N DRIVES  
for OEM**

Maximum IBM PC/XT Compatible System • Multi-Layered Board (Made in U.S.A., 1 Year Warranty) • 128K RAM Expandable to 256K • 96 Key detachable keyboard • 2 TEAC DS/DD Slim Drives • Drive Controller • Color Graphics Card • Monochrome Monitor • 2 Serial Ports • Printer Port • Operates under MS-DOS 1.1, 2.0, 2.11, 3.1, CP/M-86, and p-System • Runs LOTUS 1-2-3, Flight Simulation, and thousands more • **CALL FOR DEALERS IN YOUR LOCAL AREA.**

# POWER SUPPLY

**FOR IBM PC HARD DISK SYSTEM**

**65 W** REG. \$199 SPECIAL \$159    **100 W** REG. \$249 SPECIAL \$189    **130 W** REG. \$299 SPECIAL \$219

**\*QUANTITY DISCOUNTS FOR OEM AND DEALERS**

714-630-6361 • 630-6362 • TELEX: 783197

2732 E. MIRALOMA AVE. • ANAHEIM, CA. 92806

IBM is a trademark of IBM Corporation. Quinx is a trademark of Quantum Software.  
MS DOS is a trademark of Microsoft Corporation. CP/M is Digital Research's trademark.



# KNOWLEDGE SYSTEMS INC.

Information Processing Components, Selected for Performance and Value.

FREE SHIPPING — NO EXTRA CHARGE FOR MASTER CARD AND VISA  
 PREPAID PRICES INCLUDE SHIPPING AND INSURANCE, UPS Ground Continental USA only.

## MONITORS

<b>Amdek</b>	
143	133
175	
<b>Dynax</b>	
127	138
<b>Taxan</b>	
446	534
<b>PGS</b>	
485	196
<b>Sony</b>	
1211HG-Profeel, the best	725
<b>USI</b>	
2 12" Green	125
3 12" Amber	142
<b>Sanyo</b>	
2 Hi/Res	195
<b>NEC</b>	
1201	162
1205A	172
1410	817

## MODEMS

<b>Hayes</b>	
207	493
408	432
romodem IIe W/T	242
<b>US Robotics</b>	
340	460
<b>Novation</b>	
ess 1,2,3	473
ble Cat II	277
<b>Prometheus Products</b>	
modem 1200	385
Options Processor	78
Memory \$30 per 16K up to 64K	64K
Alphanumeric Display	78
Procom Software-Apple, IBM	78
<b>Rixon</b>	
212A	415
2A	415

## IBM ACCESSORIES

<b>Ast Research</b>	
ack	225
ambo Plus	225
ga Plus	225
K Ram Set	55
<b>Micro Graphics</b>	
B, Monochrome, Printer	398
<b>Plantronics</b>	
lor Plus	375
<b>Hercules Computer</b>	
rcules Graphics Card	350
<b>Amdek</b>	
al	477
<b>Koala</b>	
ala Graphic Tablet	Call

## PRINTERS

<b>C. Itoh</b>		
Prowriter 8510P	120 cps	353
Prowriter 8510SP	180 cps	495
Prowriter 8510SPC	180 cps color	589
Prowriter 1550P	120 cps	581
Prowriter 1550SP	180 cps	Call
Prowriter 1550SPC	180 cps color	Call
New CX4800 plotter		610
New A10 18 cps Daisy Wheel		549
Starwriter F10 40 cps Daisy Wheel		997
Printmaster F10 55 cps Daisy Wheel		1323
We Know How to Make Your Prowriter IBM Compatible		
<b>Okidata</b>		
92p	160 cps	427
93p	160 cps	705
IBM Printer Rom		45
2350	350 cps	2000
2410		2380
<b>Star Micronics</b>		
Gemini 10X	120 cps	285
Gemini 15X	120 cps	423
Delta 10	160 cps	448
Delta 15	160 cps	633
<b>NEC</b>		
3550	40 cps	1767
7710	55 cps	1963
<b>Brother</b>		
HRI	16 cps	569
HR25	23 cps	765
HR35	34 cps	Call
<b>Dynax</b>		
DX15	14 cps	453
Keyboard		149
<b>IDS</b>		
Prism 132 color		1535
Prism 80 color		1419
<b>Transtar</b>		
315 color		450
<b>Silver Reed</b>		
550		595
500		431
<b>Juki</b>		
18 cps		487
<b>Teletex</b>		
12 cps		455
<b>Mansman Tally</b>		
Spirit	80 cps	315
160	160 cps	641

## DISK DRIVES

<b>For IBM</b>	
Tandon TM100-2	238
Teac 55B 1/2 Height	199
Panasonic/Shugart 1/2 Height	194
CDC	220
<b>For Apple</b>	
Super 5 1/2 Height	203
Quentin Ap 100-Y	242
Quentin Ap 105-Y 1/2 Height	213
Quentin Controller	48
Rana 1	255
Rana 1 with Controller	325
"C"	Call

### HAVE IT YOUR WAY



18 Slot Chassis  
 125 Watt Power  
 and  
 IBM Compatible CPU

### IMP SYSTEM — \$1,300

The S-100 Concept for IBM Compatible Systems  
 You want a computer. You like the flexibility and options of the IBM PC. EXCEPT there are some things that you want your way. YOU:

- Don't like the funny keyboard.
- Want 1/2 height drives so you can add a hard disk later.
- Want a powerful supply that is adequate for disk expansion.
- Want more than three additional slots.
- Want a faster or different CPU.
- Want higher resolution graphics.
- Want Dvorak or other keyboard layout.

TIME SPECTRUM	395	Call
APSTEK	369	Call
CRAMBO	359	Call
BIG BLUE	600	Call
EASIBOARD + 15 functions	350	Call
Maynard Sandstar	230	Call
PC CT 80186 8MHz	1195	Call
Scion	1595	Call
Halo-Intlgnt High Res Graphics	150	Call
PROTIUM	1195	Call
Keytronics Keyboard QWERTY	169	Call
Keytronics Keyboard DVORAK	169	Call
Keytronics Keyboard 5151	255	Call
Lotus 1-2-3 users, you need this keyboard		Call

## COMPUTERS

Franklin OMS 1200	1709
Columbia 1600-1	2750
TAVA PC	1900
Eagle I	1650
Eagle II	2050
Eagle III	2270
Eagle IV	3500
Eagle PC-2	2730
Eagle 1620	3400
Eagle 1630	5270
Eagle 1640	6400

## TERMINALS

<b>Televideo</b>	
914	563
925	717
950	914
<b>Wyse</b>	
50	569
<b>Teletex</b>	
3000	460

## SOFTWARE

<b>Ashton Tate</b>	
dBase II	389
Friday	184
<b>Software Arts</b>	
TK Solver	215
Solver Pac	88
<b>Seasoned Systems</b>	
Sure Stroke Dvorak Tutor	48
<b>Sorcim</b>	
Super Calc III	230
<b>Micro Pro</b>	
Wordstar	258
Mail Merge	131
Spellstar	131
Pro Pack	475
<b>MBSI</b>	
Realworld GI	533
Realworld AR	533
<b>ATI</b>	
For Most Software Programs	69
<b>Hayes</b>	
Smart Com	72
<b>Micro Stuff</b>	
Crosstalk	134
<b>Micro Rim</b>	
RBBase	372
<b>S-100</b>	
<b>Sierra Data Sciences</b>	
SBC-100 Master	750
SBC-100S Slave	650
CPM	110
Turbo Dos Multi-user	630

California Residents add 6.5% State Sales

Shipping extra for outside USA, FPO and

use include an address reachable by  
 no P.O. boxes, and your phone number  
 where you can be reached during the day.

(213) 344-4455

Circle 224 on Inquiry card. ORDERING TERMS

Knowledge Systems Inc.  
 19707 Ventura Blvd.  
 Woodland Hills, CA 91364

Prepaid: Money Orders, Cashier's Checks, Cer-  
 tified Checks, Bank Wire Transfers, Master Card,  
 Visa, AMEX (add 3% for AMEX) and Personal  
 Checks (allow 15 banking days for all personal  
 checks). Please include Valid Driver's License #  
 and Major Credit Card for Identification.

- 12CB — Get a Character from Keyboard**  
This routine will wait for a character from the keyboard and return it in the A register. The carry flag will be set if it is a special character.
- 13DB — Check Keyboard**  
This routine checks to see if any characters are pending from the keyboard. The zero flag is set if no character is found. The zero flag is reset if there are keys waiting.
- 1470 — Print a Character**  
The character in the A register will be printed when this routine is called.
- 14A8 — Turn On Cassette**  
This routine will turn on the cassette motor.
- 14AA — Turn Off Cassette**  
This routine will turn off the cassette motor.
- 14B0 — Get a Character from the Cassette**  
A character is read from the cassette and returned in the A register. Upon entry to this routine, the C register must contain the current checksum. Upon exit, the C register will contain the updated checksum.
- 14C1 — Write a Character to the Cassette**  
This routine is similar to the cassette-read routine. The character to be written to the cassette must be in the A register, and the checksum must be in the C register. Upon return, the C register will contain the updated checksum.
- 190F — Get Time**  
Upon entry, the HL register pair must point to an 8-byte data area that will receive the system time. The format of the time returned is HH:MM:SS.
- 192F — Get Date**  
Upon entry, the HL register pair must contain the address of an 8-byte data area to receive the system date. The format of the date returned is MM/DD/YY.
- 1962 — Get Day**  
A call to this routine will return a 3-byte representation of the day of the week. Upon entry, the HL register pair must contain the address of the 3-byte area to receive the day.
- 1BE0 — Display Printable Characters**  
This routine displays the characters pointed to by the HL register pair, for the length contained in the B register. Only printable characters are displayed. If the value is greater than 7F or less than 20, then a blank is displayed in place of the character.
- 1E5E — Print LCD [liquid-crystal display] Screen**  
This routine will print the contents of the screen on the printer. This is the same entry point for the BASIC LCOPY command.
- 1FBE — Erase a .DO File**  
A call to this address will result in erasing a text file from the system. The HL register must contain the address of the files directory entry. The DE register pair must point to the start of the file. The start of file can be obtained from a call to 5AE3.
- 220F — Save a .DO File**  
This routine will create a directory entry for a text file. The filename must have previously been stored in RAM (random-access read/write memory) at location FC93.
- 2542 — Move from Address in HL to Address in DE**  
The data pointed to in the HL register is moved to the address specified in the DE register, for a length contained in the B register. This is a forward movement of data because HL and DE are both incremented.
- 27B1 — Display a String**  
This routine will display, on the LCD screen, the characters pointed to in the HL register. The display of characters is terminated when a zero is discovered in the string.
- 290C — Move from Address in BC to Address in DE**  
The data pointed to in the BC register is moved to the address specified in the DE register, for a length contained in the L register. This is a forward movement of data.
- 2EE6 — Move from Address in HL to Address in DE**  
The data pointed to in the HL register is moved to the address specified in the DE register, for a length contained in the C register. This is a backward movement of data because the HL and DE registers are decremented before each character moved.
- 3469 — Move from Address in DE to Address in HL**  
The data pointed to in the DE register is moved to the address specified in the HL register, for a length contained in the B register. This is a forward movement of data.
- 3472 — Move from Address in DE to Address in HL**  
Same as the call to address 3469 except that this is a backward movement of data.
- 39D4 — Convert and Display**  
The hexadecimal value in the HL register pair will be converted to a decimal number and will then be displayed at the current cursor position. (See the DIR.CO program listing for an example.)

**Table 2: The ROM routines. (All numerical values are in hexadecimal notation.)**



# THE BEST THING NEXT TO AN IBM PC IS A SPINWRITER.



Put a Spinwriter® next to your IBM® PC, or XT, and get the best letter-quality printing available anywhere. Spinwriter is totally IBM plug-compatible and works with every piece of IBM PC software. It also works with all popular third party applications packages.

Depending on your needs, you can choose between our popular 350 wpm model 3550, or our new 200 wpm model 2050.

Both give you world famous Spinwriter printing quality and reliability. And both were made for the IBM. That's why 55% of the letter-quality printers used with IBM PC's are Spinwriters.\*

Spinwriter gives you over 60 different type styles. Each with up to 128 characters.

\*PC WORLD Magazine, July 1983

Spinwriter is a registered trademark of NEC Corp. IBM is a registered trademark of International Business Machines Corp.

Circle 291 on inquiry card.

And there's a forms handling option for every paper and forms handling need. Which means no matter what form your business takes, Spinwriter can handle it.

So, if you want to get the most out of your IBM, get a Spinwriter. For more information, just call 1-800-343-4419; in Massachusetts call (617) 264-8635.

Also available at: Entré, 1-800-HI ENTRE, Computerland stores (in California) 1-800-321-1101; (outside California) 1-800-423-3008, Sears 1-800-228-2200 and IBM Product Centers.

Find out why most IBM PC users are saying, "NEC and me."

Yes! I want only the best for my IBM PC.

Please send me more information on:

spinwriter 3550  spinwriter 2050

Name \_\_\_\_\_ Title \_\_\_\_\_

Company \_\_\_\_\_

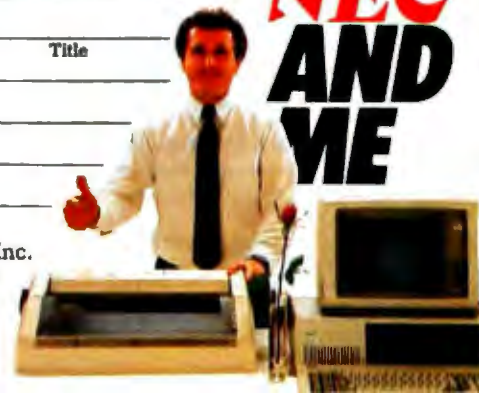
Address \_\_\_\_\_

City \_\_\_\_\_

State \_\_\_\_\_ Zip \_\_\_\_\_

NEC Information Systems, Inc.  
1414 Massachusetts Avenue  
Boxborough, MA 01719

**NEC  
AND  
ME**



**40F1 — Check HL for Character**

The byte at the address pointed to by the HL register is checked to see if it is a valid uppercase letter. If it is not valid then the carry flag is set.

**40F2 — Check A for Character**

This is similar to the call to address 40F1, except that the A register is checked for a valid uppercase letter A-Z.

**4222 — Display CR LF**

Calling this address results in a carriage return and a line feed being displayed on the screen. The A register is destroyed.

**4229 — Beep**

This routine gives a short beep on the speaker. The A register is destroyed.

**422D — Home Cursor**

This routine does the same as the call to address 5D6A, except that the HL register is not touched. This probably is a better choice.

**4231 — Clear Screen**

This routine is also the same as the BASIC command CLS. The A register is destroyed.

**4235 — Protect the Bottom Line**

After calling this routine you are unable to write into line eight. The system uses this to protect the function-key displays.

**423A — Unprotect the Bottom Line**

This routine undoes a call to address 4235.

**423F — Scroll Lock**

After a call to this routine the screen will be locked. A line feed cannot cause the top line to disappear or a fresh line to appear on the bottom.

**4244 — Scroll Unlock**

This routine reverses the effect of a call to 423F, allowing a line-feed character to move lines of data, off the top of the screen.

**4249 — Turn Cursor On**

This routine causes the familiar block cursor to appear at the current cursor position.

**424E — Turn Cursor Off**

This routine will cause the block cursor to disappear.

**4253 — Erase Line**

This routine will erase the entire contents of the current screen line.

**4258 — Insert Line**

This routine will insert a blank line on the screen below the current cursor position.

**425D — Erase to End of Line**

This routine will clear the current line starting from the cursor position.

**4269 — Reverse Video**

After a call to this routine, characters typed on the screen will appear white with black backgrounds.

**426E — Normal Video**

This routine restores normal black characters on a white background.

**4270 — Send Escape Code**

Upon entry, the A register contains the escape code.

**427C — Move Cursor to (row, col)**

This routine can be used to position the cursor anywhere on the screen. Upon entry, the HL register points to the destination of the cursor

H = ROW

L = COLUMN

The A register is destroyed.

**428A — Erase Function Display**

This routine will remove the function-key display from the bottom of the screen.

**42A5 — Set (and display) Function Keys**

This routine will set the function keys according to the table pointed to by the HL register and display them. This routine is the same as a call to address 5A7C to set the keys, followed by a call to address 42A8 to display the setting.

**42A8 — Display Function Keys**

As stated in the routine above, this routine will display the settings.

**4644 — Get a Line from Keyboard**

This routine will get a line of input from the keyboard and exit back to the calling routine when the Enter key is pressed. The data can be found in the keyboard input buffer, located at address F685.

**4B44 — Display a Character**

The character in the A register is displayed on the LCD screen.



***"My IBM® PC XT" writes monthly billings and statements to Maxwell & Sons' 1,893 customers, and tells me who owes what."***

When you work with a lot of information, you can't afford to re-enter every file when your hard disk fails. And no hard disk is fail-safe.



***"My Sysgen Image" backs up the whole lot in less than five minutes. 10 megabytes on a single cassette..."***

The Sysgen Image backs up the hard disk in your IBM PC XT. So you can protect your files in minutes—instead of spending hours re-entering them.



***"For just \$995. That's cheap insurance. It lets me sleep at night."***

The Sysgen Image for just \$995. It's the most affordable insurance you can buy for your two most important assets: Your information. And your time.



## **Sysgen. Because a hard disk without tape just doesn't make sense.**

Sysgen products for the IBM® PC, PC XT, and other personal computers: Economical, 10- and 20-Megabyte hard disk systems with tape back-up. Or 10-Megabyte

tape back-up for the IBM PC XT.

Go to your local computer dealer. Ask for a demonstration of Sysgen back-up systems. And find out how to make sense of your storage.  
47853 Warm Springs Blvd., Fremont, CA 94539  
(415) 490-6770 Telex 4990843



# **SYSGEN**

INCORPORATED



IBM is a registered trademark and PC XT is a trademark of International Business Machines Corporation. Sysgen Image is a trademark of Sysgen, Incorporated.

Circle 369 on inquiry card.

**4B55 — Print a Character (expand tabs)**

This routine will print the character that is in the A register, unless it happens to be a tab character, in which case the tab is expanded out two spaces.

**52B8 — Drop Phone Line**

This routine will terminate the phone connection.

**52D0 — Connect Phone Line**

**532D — Dial a Number**

This routine will dial the specified phone number pointed to by the HL register.

**5791 — Display Message on New Line**

This routine will display a message pointed to by the HL register. The message must be terminated with a zero. If the cursor is not at the beginning of the line then a carriage return is done before the message is displayed.

**5797 — Main Menu**

This is the address of the main-menu routine.

**5970 — List Files**

This routine is called from the main menu to display the files on the LCD screen.

**59AD — Display Filename**

This routine is called to build a filename. The DE registers must point to a string of characters containing the filename. The HL registers must contain the address of a work area large enough to contain the filename, file type, the period separator, and a trailing zero. After the call the HL register no longer points to the start of the string so it is advised to PUSH the HL register before the call, and then POP the register before calling off to the routine to display the filename. For an example, see the routine called PUTFN in the DIR.CO program listing.

**5A58 — Display String of Characters**

Upon entry to this routine, the HL register must contain the address of a string of characters to be displayed on the screen. The string must be terminated with a 00. The A register is destroyed and HL points to the end of the string.

**5A79 — Clear Function Keys**

This routine clears the function-key table.

**5A7C — Copy Function Keys**

The HL register must contain the address of the function table that will be copied into the system function-key settings.

**5A9E — Display the Function Table**

**5AA9 — Find a Directory Entry**

The DE register pair must point to the address of the file you wish to search for. A zero must terminate the name. Upon exit, the HL register contains the start address of the file. If the file is not found, the zero flag will be set.

**5AE3 — Get Start of File**

Upon entry, the HL register must contain the address of the directory entry. Upon exit, the HL register will contain the start address of the file.

**5D6A — Home Cursor**

This routine will move the cursor to upper left corner of the screen. Registers A and HL are destroyed. (Also see address 422D.)

**5F2F — Wait for Space Bar**

This routine waits until the space bar is pressed, then returns.

**6CD6 — Cold Start Address**

**6CE0 — Warm Start Address**

**6D3F — Print a Character**

The character in the A register will be sent to the printer. The carry flag will be set if the print operation is canceled by break.

**6D6D — Return Number of Characters on RS-232C**

This routine will return the number of characters pending on the RS-232C queue. The results are returned in the A register. If there are no characters pending, the zero flag will be set.

**6D7E — Get Character from RS-232C**

Upon return, the A register will contain a character from the RS-232C queue. The zero flag will be set if all is OK. The carry flag will be set if the Break key was pressed.

**6E0B — Send XON**

This routine will send an XON character (Control-Q) across the communication line. This character resets the XOFF code to stop the flow of data.

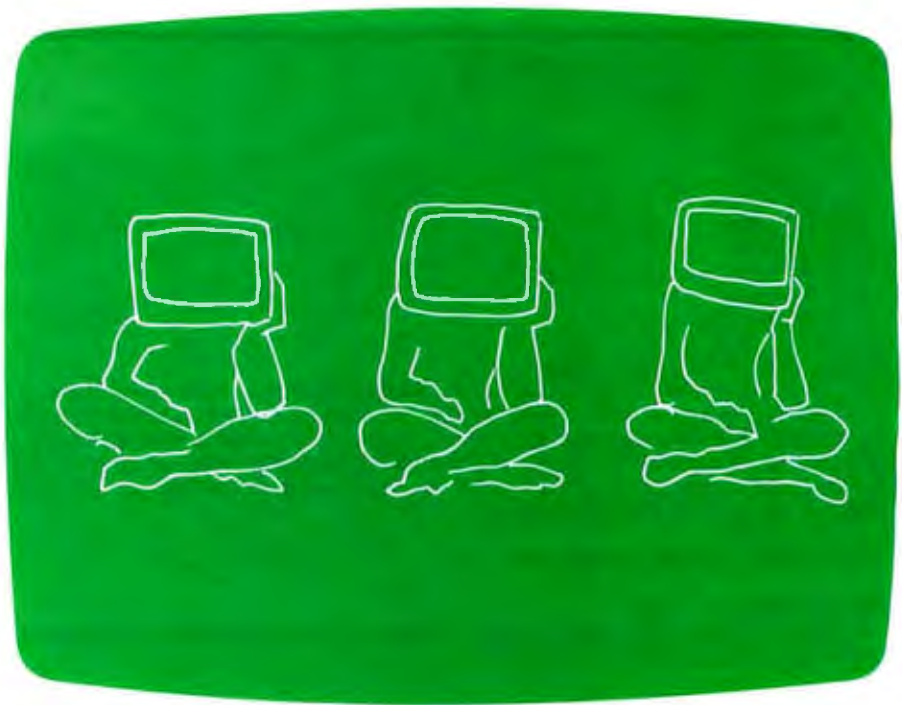
**6E1E — Send XOFF**

This routine will transmit an XOFF character (Control-S) across the communication line. This code is used to stop the flow of data to the Model 100. Data flow will resume only when you send an XON.

**6E32 — Send Character to RS-232C**

The character in the A register is sent to the RS-232C.





## WAITING FOR SOFTWARE INTEGRATION?

Vendor X's word processing software looks great, but Vendor Y's spreadsheet program is number one, and Vendor Z has the communications package you really need. Wouldn't it be great if they were integrated?

With APX Core™ your personal computer gains the power to drive several different programs—from Vendors X, Y, and Z—at the same time. Coordinate them through overlapping windows that you define, and optimize keystrokes to save effort. APX Core™ even lets you “cut and paste” data among the different programs automatically.

Let APX Core™ integrate your choice of software. Our demo package can show you how.

Dealer inquiries invited.

### APX Core™ Technical Specifications:

**Format:** Software on 5¼" diskette with User Manual.

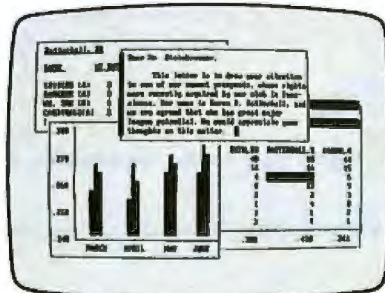
**Minimum Hardware Required:** IBM PC with DOS, 30K RAM plus memory required for resident application software, 1 Diskette Drive, and either monochrome or color display. (Call for availability on other hardware.)

**Commands:** Switch Task, Window, Transcribe, and Keysave.

**Standard Features:** Concurrent processing selectable per task, with automatic file and device allocation.

**Qty. 1 Price:** \$195

Circle 424 on inquiry card.



# APX

**Application Executive Corporation**  
600 Broadway  
Suite 4C  
New York, NY 10012  
(212) 226-6347

Table 2 continued:

**6E75 — Set RS-232C bps [bits per second]**

The H register contains the code from 1 to 9.

- 1 = 75 bps
- 2 = 110 bps
- 3 = 300 bps
- 4 = 600 bps
- 5 = 1200 bps
- 6 = 2400 bps
- 7 = 4800 bps
- 8 = 9600 bps
- 9 = 19200 bps

**6EA6 — Initialize RS-232C or Modem**

This routine will initialize the RS-232C port or the modem, depending on the setting of the carry flag. If it is set then the RS-232C is initialized. If it is reset the modem is initialized. The H register setting is the same as the address 6E75 call (see above). The L register contains the settings for the remaining UART parameters. Bit 0 of the L register specifies the number of stop bits. If this bit is off then one stop bit is set. If the bit is on then two stop bits are set. Bits 1 and 2 are used to specify the parity setting. A 00 means no parity. A setting of 01 means even parity. A setting of 10 means odd parity. Bits 3 and 4 are used to specify the word length. A 00 means a 6-bit word length. A 01 means a 7-bit word length. A 10 means an 8-bit word length.

**6ECB — Deactivate the RS-232C Port**

**6EEF — Check for Carrier**

This routine will return a 00 in the A register, as well as the zero flag being set, if the carrier is detected. If there is no carrier the A register will contain an FF and the zero flag will be reset.

**6F46 — Write Header to Cassette**

Writes the header and sync byte to the cassette.

**6F5B — Write to Cassette**

This routine writes the character contained in the A register to the cassette. This routine differs from the cassette-write routine at address 14C1 in that it does not perform a checksum.

**6F85 — Read Header from Cassette**

Reads the header and sync byte from the cassette.

**702A — Read from Cassette**

This routine reads a character from the cassette. No checksum is performed. The character is returned in the D register.

**7242 — Scan Keyboard**

This routine checks the keyboard for a character and returns with the status set. The A register contains the character, if one was found. The zero flag will be set if no character was found. The carry flag will also be set if the character found is not a normal character, for example, a function key. In the case of a special key being pressed, the A register will contain the following HEX code to represent the key pressed:

- 0 = function key 1
- 1 = function key 2
- 2 = function key 3
- 3 = function key 4
- 4 = function key 5
- 5 = function key 6
- 6 = function key 7
- 7 = function key 8
- 8 = Label key
- 9 = Print key
- A = Shift-Print key
- B = Paste key

**7270 — Check for Character or Break**

The zero flag will be set if no characters are waiting. The carry flag will be set if Break has been pressed.

**7283 — Check for Break or Pause**

The carry flag is set if Break or Pause has been pressed.

**72C5 — Play Tone on Speaker**

This routine will sound a tone on the speaker. The DE register must contain the frequency, while the B register must contain the duration.

**744C — Turn LCD Pixel On**

This routine will turn on a screen pixel at the location specified in the DE register pair. Register D must contain the X coordinate, and register E must contain the Y coordinate.

**744D — Turn LCD Pixel Off**

Similar requirements to the call at address 744C except the pixel will be turned off.

**7EAC — Display Memory Free**

This routine calculates the amount of free memory and displays it on the screen, along with the message "BYTES FREE." This familiar message appears in the main menu and at the startup of BASIC.



Listing 1: The DIR.CO directory program.

8085 MACRO ASSEMBLER, VER 2.0 ERRORS = 0 PAGE 1

```

E000      ORG      0E000H
12CB     WAITCR EQU 12CBH
4272     PUTCR  EQU 4272H
4B44     PUTC   EQU 4B44H
;
;-----
; DIR.CO
;
; WRITTEN BY BRIAN CAMERON
;
; A PROGRAM TO DISPLAY ALL TRS100 FILES
; (EVEN ERASED FILES) AND SHOW SUCH ATTRIBUTES
; AS THE FILE LOCATION, SIZE, EXECUTION ADDRESS
; AND ENTRY ADDRESS, WHERE APPROPRIATE
;-----
DIR      EQU      $
E000     118AF9  LEI      D,0F9BAH ;POINT TO USER DIR
E001     TOPDIR EQU      $
E002     CALL    12311H ;CLEAR SCREEN
E003     CALL    PUTCR ;GET TO NEXT LINE
E004     LDA    D ;GET CODE INTO A
E005     CPI    0 ;IS FILE ERASED?
E006     JZ     ERASED ;YES
E007     INR    D ;POINT TO ADDR
E008     PUSH  D ;SAVE FOR LATER
E009     PUSH  D ;AND AGAIN
E010     LDA    D ;GET FIRST BYTE OF ADDR
E011     CPI    0 ;POSSIBLY END OF DIR?
E012     JZ     NO ;NO
E013     JNZ  NO ;POINT TO SECOND BYTE OF ADDR
E014     INR    D ;GET IT
E015     LDA    D ;POINT BACK ONE
E016     OCK  D ;IS IT END OF DIR?
E017     CPI    0 ;YES
E018     RZ
;
; NOTED EQU      $
E019     1J     INR    D ;POINT TO SECOND BYTE OF ADDR
E020     1J     INR    D ;POINT TO THE FN FT
E021     CALL  PUTFM ;DISPLAY IT
E022     POP   D ;GET BACK ADDR
E023     MOV   A,E ;MOVE FOR ADD
E024     ADI   8 ;ADD PT OFFSET
E025     MOV   E,A ;MOVE IT BACK
E026     MVI  A,' ' ;LOAD A BLANK
E027     CALL  PUTC ;SHOOT IT
E028     LDA    D ;GET FT CHAR
E029     CPI    'B' ;IS IT BASIC?
E030     JZ     YES ;YES
E031     CPI    'C' ;IS IT CODE?
E032     JZ     YES ;YES
E033     CPI    'D' ;IS IT A DOC FILE?
E034     JZ     YES ;YES
;
;-----
E035     CAP800  JZ     DOC ;YES
E036     81     POP   E ;CLEAR THE STACK
E037     1J     INR    D ;POINT TO ...
E038     1J     INR    D ;THE NEXT DIR ENTRY
E039     JP     MORE ;CARRY ON
;
; WE GET HERE AFTER IT IS DETERMINED THAT THE
; FILE WE ARE LOOKING AT HAS BEEN ERASED
; WE MAKE A SECOND CHECK FOR A ZERO BYTE IN THE
; ADDRESS FIELD TO MAKE SURE WE ARE NOT AT THE
; END OF THE DIRECTORY
;-----
ERASED EQU      $
E040     D5     PUSH  D ;SAVE FLAG BYTE ADDR
E041     1J     INR    D ;POINT TO ADDR
E042     LDA    D ;LOAD IT
E043     CPI    0 ;END OF DIR?
E044     JZ     NO ;POINT TO PART 2
E045     INR    D ;POINT TO ADDR
E046     JNZ  NO ;END OF DIR?
E047     INR    D ;LOAD IT
E048     CPI    0 ;END OF DIR?
E049     JZ     NO ;NO
E050     JNZ  NO ;RESTORE STACK
E051     RET
;
; NOB002 EQU      $
E052     1J     INR    D ;POINT TO FN
E053     CALL  PUTFM ;SHOW IT
E054     LRI  H,MSG ;POINT TO MSG
E055     CALL  SASH ;SHOW IT
E056     POP   D ;POINT TO FLAG BYTE
E057     MOV   A,E ;GET ADDR
E058     ADI  11 ;OFFSET TO NEXT DIR ENTRY
E059     MOV   E,A ;SAVE IT BACK
E060     JMP  MORE ;CARRY ON
;
; WE ENTER HERE WHEN WE DETERMINE THAT WE ARE
; LOOKING AT A BASIC FILE. WE DISPLAY THE
; ADDRESS THAT THE FILE IS STORED AT FOLLOWED BY
; THE SIZE OF THE FILE. THE END OF FILE IS
; MARKED BY THREE ZERO BYTES IN A ROW
;-----
BASIC  EQU      $
E061     D1     POP   D ;POINT TO ADDR
E062     LRI  H,STMSG ;POINT TO STORED MSG
E063     CALL  SASH ;SHOW IT
E064     CALL  PFFL ;POINT TO FILE
E065     CALL  CHVD ;DISPLAY ADDR
E066     CALL  PUTS ;GET TO NEXT LINE
;
;-----
E067     2130E1  LRI  H,STMSG ;POINT TO STORED MSG
E068     CALL  SASH ;SHOW IT
E069     CALL  PFFL ;POINT TO FILE
E070     CALL  CHVD ;DISPLAY ADDR
E071     CALL  PUTS ;GET TO NEXT LINE
;
;-----
E072     21DAE1  LRI  H,ENDADR ;END ADDRESS MSG
E073     CALL  SASH ;SHOW IT
E074     MVI  R,0 ;CLEAR HL ...
E075     MVI  L,0 ;FOR SIZE COUNT
;
; BALOOP EQU      $
E076     1A     LDA    D ;GET A CHAR
E077     CPI    0 ;END OF FILE?
;

```

8085 MACRO ASSEMBLER, VER 2.0 ERRORS = 0 PAGE 2

```

E078     21DAE1  LRI  H,ENDADR ;END ADDRESS MSG
E079     CALL  SASH ;SHOW IT
E080     MVI  R,0 ;CLEAR HL ...
E081     MVI  L,0 ;FOR SIZE COUNT
;
; BALOOP EQU      $
E082     1A     LDA    D ;GET A CHAR
E083     CPI    0 ;END OF FILE?
;

```

Listing 1 continued on page 302



# OPTIMIZING C86™ controls Charlie... LIKE A PUPPET ON A STRING!

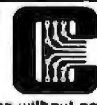


The IBM/PC can dance—Use C86.

Serious programmers use Optimizing C86 to control the IBM PC and MS-DOS computers. Features include 30% + more speed and:

- Full and Standard version of the C language—balance portability with control.
  - Standard MS-DOS Linker support and option to produce MASM from C86.
  - A rich set of libraries includes source for K&R functions, string handling, graphics, sorting, floating point (8087 and 8086/8088), "Large" model (1,000K RAM), "Small" memory model, MS-DOS 1.1, 1.25, 2.0, 2. + +
  - Support for numerous add-on libraries including: HALO Graphics, C Tools, PHACT for ISAM.
- Pull Charlie's strings with our fast, complete, reliable C Compiler —the leading compiler for serious programmers of MS-DOS and CPM-86 systems. Still \$395.

INQUIRIES AND ORDERS  
**800-922-0169**  
 Technical support:  
 (201) 542-5920



Computer Innovations  
 980 Shrewsbury Avenue  
 Suite J-504  
 Tinton Falls, NJ 07724  
 Visa MC

C86 is a trademark of Computer Innovations, Inc. CPM-86 is a registered trademark of Digital Research. MS-DOS is a trademark of Microsoft. PC DOS is a trademark of International Business Machines.

# SUPPLIES FORMS & STATIONERY

## for Apple, IBM PC, TRS-80 & other Desk-Top Computers

- Continuous checks, statements, or invoices... 500 for \$49.95 or less.
- Compatible with 350 software publishers.
- Diskettes, printer ribbons, Micro-perf™ letterheads, labels, work station aids.
- High quality, low prices, small quantities.
- Money-Back Guarantee.
- Next day shipment of supplies ordered by TOLL FREE phone.
- Send today for your FREE CATALOG

Please rush my FREE NEBS Computer Forms Catalog.

Name \_\_\_\_\_ Phone \_\_\_\_\_

Company Name \_\_\_\_\_ Your Line of Business \_\_\_\_\_

Street Address \_\_\_\_\_

City, State and Zip \_\_\_\_\_

Use computer for: (Check as many as apply)

Home  Business  Word Processing  Accounting

Apple  TRS-80  Plan to purchase  Have a printer?

IBM PC  Other \_\_\_\_\_ within \_\_\_\_\_

NEBS  
**Neb's Computer Forms**  
 12 South Street, Townsend, MA. 01469  
 A Division of New England Business Service, Inc.

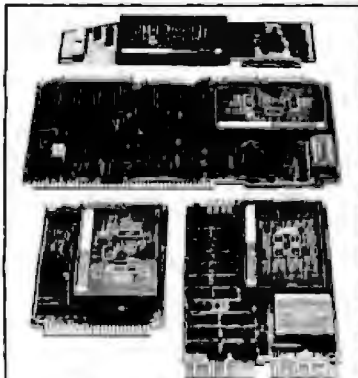
GAA 84.3 CODE 11010

# "Looking for bus compatible data acquisition boards? You've come to the right guy."

Left to right, Fred Molinari, President



This isn't just a line. Data Translation offers the most complete line of analog I/O boards available. Anywhere. We have LSI-11™ Bus, MULTIBUS™, UNIBUS™, IBM PC™ Bus, STD Bus, and Apple™ Bus. You'll never have to change buses to get the analog compatibility you need.



Data Translation is the leading supplier of microcomputer compatible analog I/O boards.

## DATA ACQUISITION BOARDS

BUS	A/D	D/A	DIGITAL I/O	REAL TIME CLOCK
STD	X	X		
MULTIBUS	X	X		
UNIBUS	X	X		
LSI-11	X	X	X	X
IBM PC	X	X	X	X
APPLE II	X			

And you won't be left stranded for help... our user manuals and thorough diagnostics guide you through any technical road blocks. All for the same low fare.

So whether you're in scientific research or industrial control, call us.

We're the world's leading supplier of analog I/O boards, systems and software.

We'll have you up, and on line, in no time. Call (617) 481-3700.

# DATA TRANSLATION

World Headquarters: Data Translation, Inc., 100 Locke Dr., Marlboro, MA 01752 (617) 481-3700. Telex 951 646. European Headquarters: Data Translation, Ltd., 430 Bath Rd., Slough Berkshire SL1 68B England (06295) 3412. The B49 862 in Canada (416) 625-1907.

LSI-11 and UNIBUS are registered trademarks of Digital Equipment Corp. MULTIBUS is a registered trademark of Intel Corp. IBM PC is a registered trademark of IBM.

## Listing 1 continued:

```

E0B3 CABB80 JZ BASEND ;YES
E0B4 13 BALP2 EQU $ ;
E0B5 23 INX D ;POINT TO NEXT CHAR
E0B6 33 INX H ;ADD 1 TO COUNT
E0B7 C3B070 JNP BALOOP ;DO IT AGAIN

E0B8 BASEND EQU $ ;
E0B9 CDAAB0 CALL CRDOP ;IN ORDER TO SHOW ...
E0BA CDAAB0 CALL CRDOP ;ITS END OF FILE
E0BB 05 PUSH H ;SAVE IT FOR LATER
E0BC 05 PUSH D ;MOVE ADDR TO
E0BD 01 POP H ;HL REGISTER
E0BE CD6BE1 CALL CONVD ;CONVERT AND SHOW IT
E0BF CD75E1 CALL PUTS ;MOVE OVER ROVER
E0C0 21C9E1 LXI H,LENGMSG ;POINT TO LENGTH MSG
E0C1 CD585A CALL SASHN ;SHOW IT
E0C2 01 POP H ;RESTORE THE COUNT
E0C3 CD6BE1 CALL CONVD ;CONVERT AND DISPLAY
E0C4 CD51E1 CALL POPDR ;RESTORE DIR POINTER
E0C5 C339E1 JNP MORE ;GET NEXT FILE

E0C6 CRDOP EQU $ ;
E0C7 13 INX D ;POINT TO THE NEXT BYTE
E0C8 23 INX H ;ADD ONE TO THE COUNT
E0C9 1A LDAX D ;GET THE CHAR WHERE WE CAN LO
E0CA FB00 CPT 0 ;POSSIBLE EOP?
E0CB CB RZ ;LOOKS GOOD
E0CC C1 POP B ;CLEAR THE STACK
E0CD C3B650 JNP BALP2 ;CARRY ON

;
; WE ENTER HERE WHEN WE HAVE FOUND A .CD FILE *
; THE FILE ITSELF CONTAINS THE INFORMATION THAT *
; DESCRIBES THE LOAD ADDRESS, SIZE OF FILE AND *
; ENTRY ADDRESS *
;
E0CE CODE EQU $ ;
E0CF 01 POP D ;POINT TO ADDR
E0D0 21B0E1 LXI H,STMSG ;POINT TO STORED MSG
E0D1 CD585A CALL SASHN ;SHOW IT
E0D2 CD48E1 CALL PTPL ;POINT TO THE FILE
E0D3 CD6BE1 CALL CONVD ;CONVERT AND SHOW IT
    
```

R005 MACRO ASSEMBLER, VER 3.0 ERRORS = 0 PAGE 4

```

E0E1 CD75E1 CALL PUTS ;GET TO NEXT LINE
E0E2 21BCE1 LXI H,STMSG ;POINT TO START MSG
E0E3 CD585A CALL SASHN ;SHOW IT
E0E4 CD48E1 CALL PTPL ;POINT TO START OF FILE
E0E5 CD6BE1 CALL CONVD ;CONVERT AND DISPLAY
E0E6 01 POP D ;RESTORE FILE POINTER
E0E7 CD75E1 CALL PUTS ;GET TO NEXT LINE
E0E8 21C9E1 LXI H,LENGMSG ;POINT TO LENGTH MSG
E0E9 CD585A CALL SASHN ;SHOW IT
E0EA 13 INX D ;POINT TO ...
E0EB 13 INX D ;LENGTH
E0EC CD48E1 CALL PTPL ;GET THE LENGTH
E0ED CD6BE1 CALL CONVD ;CONVERT AND DISPLAY
E0EE 01 POP D ;RESTORE FILE POINTER
E0EF CD75E1 CALL PUTS ;GET TO NEXT LINE
E0F0 21D2E1 LXI H,ENMSG ;ENTRY MSG
E0F1 CD585A CALL SASHN ;SHOW IT
E0F2 13 INX D ;POINT TO THE ENTRY
E0F3 13 INX D ;ENTRY
E0F4 CD48E1 CALL PTPL ;GET THE ENTRY
E0F5 CD6BE1 CALL CONVD ;CONVERT AND DISPLAY
E0F6 01 POP D ;RESTORE FILE POINTER
E0F7 CD63E1 CALL POPDR ;
E0F8 C339E1 JNP MORE ;DO NEXT FILE

;
; WE ENTER HERE WHEN WE DETERMINE THAT WE HAVE *
; FOUND A .DO FILE. WE DISPLAY THE STARTING *
; LOCATION OF THE FILE AND THEN DETERMINE THE *
; LENGTH BY SEARCHING FOR A CONTROL Z (1A) *
;
E0F9 DOC EQU $ ;
E0FA 01 POP D ;POINT TO ADDR
E0FB 21B0E1 LXI H,STMSG ;POINT TO STORED MSG
E0FC CD585A CALL SASHN ;SHOW IT
E0FD CD48E1 CALL PTPL ;POINT TO FILE
E0FE CD6BE1 CALL CONVD ;CONVERT AND DISPLAY
E0FF CD75E1 CALL PUTS ;GET TO NEXT LINE
E100 21DAE1 LXI H,ENDADR ;END ADDRESS MSG
E101 CD585A CALL SASHN ;SHOW IT
E102 2600 HV1 H,0 ;CLEAR HL FOR ...
E103 7E00 HV1 L,0 ;SIZE COUNT
    
```

R005 MACRO ASSEMBLER, VER 3.0 ERRORS = 0 PAGE 5

```

E104 DOCOSP EQU $ ;
E105 05 PUSH H ;SAVE
E106 05 PUSH D ;MOVE ADDR TO
E107 01 POP H ;HL REGISTER
E108 CD6BE1 CALL CONVD ;CONVERT AND DISPLAY
E109 CD75E1 CALL PUTS ;GET TO NEXT LINE
E10A 21C9E1 LXI H,LENGMSG ;POINT TO THE LENGTH MSG
E10B CD585A CALL SASHN ;SHOW IT
E10C 01 POP H ;RESTORE COUNT
E10D CD6BE1 CALL CONVD ;CONVERT AND SHOW
E10E CD51E1 CALL POPDR ;RESTORE DIR POINTER
E10F C339E1 JNP MORE ;DO NEXT FILE

E110 MORE EQU $ ;
E111 CD2242 LXI H,PUTCR ;POINT TO MSG
E112 21BAE1 LXI H,MOREMSG ;POINT TO MSG
E113 CD585A CALL SASHN ;SHOW IT
E114 CDC812 CALL WAITCR ;WAIT FOR A CHAR
E115 C33E0 JNP TOPDR ;RESET AND CARRY ON

E116 PPPL EQU $ ;
    
```

Listing 1 continued on page 303



Listing 1 continued:

```

E146 E1      POP  H      ;GET RETURN
E149 D9      PUSH D      ;SAVE
E14A E5      PUSH M      ;SAVE RETURN ADDR
E14B 1A      LDAX D
E14C 6F      MOV  L,A      ;SAVE TOP PART OF ADDR
E14D 13      INX  B      ;POINT TO NEXT BYTE
E14E 1A      LDAX D      ;GET SECOND PART OF ADDR
E14F 67      MOV  H,A      ;SAVE BOTTOM PART OF ADDR
E150 E5      PUSH H
E151 01      POP  D      ;MOVE FILE START ...
E152 C9      RET          ;TO DE REG

;
E153      ;
E153 E1      POPDH EQU  S      ;GET RETURN ADDR
E154 D2      POP  D      ;RESTORE DIR POINTER
E155 E5      PUSH H      ;RESTORE RETURN ADDR
E156 78      MOV  A,E      ;GET CURRENT POINTER
E157 C60A    ADI  10      ;POINT TO NEXT ENTRY
E158 3F      MOV  H,A      ;RESTORE IT
E15A C9      RET

;
E15B      ;
E15B D5      PUSH D
E15C E5      PUSH H
E15D 218BE1  LKI  H,PHBUF ;POINT TO WORK BUFFER
E15E E5      PUSH H      ;SAVE START POINTER
E15F CDAD59  CALL 59ADH ;BUILD THE FN, FT
E160 E1      POP  H      ;POINT BACK TO START OF BUFF
E161 CDAD59  CALL 59ADH ;DISPLAY FN, FT
E162 E1      POP  H
E163 CD585A  CALL 5A8BH
E164 E1      POP  H
E165 E1      POP  H
E166 E1      POP  H

8085 MACRO ASSEMBLER, VER 2.0 ERRORS = 0 PAGE 6

E169 D1      POP  D
E16A C9      RET

;
E16B      ;
E16B C5      CONV D EQU  S
E16C D5      PUSH D
E16D E5      PUSH H
E16E CD0429  CALL 1904H ;CONVERT AND DISPLAY
E16F E1      POP  D
E170 D1      POP  D
E171 D1      POP  D
E172 D1      POP  D
E173 C3      POP  B
E174 C9      RET

;
E175      ;
E175 E5      PUTE  EQU  F
E176 CD2242  CALL 2242H ;PUTCH

E179 2181E1  LKI  R,BLKS
E17C CD585A  CALL 5A8BH
E17F E1      POP  H
E180 C9      RET

E181 20202020 BLKS: DB 0
E185 20202020
E189 00      DB 0
E18A 50524553 HOREMSG: DB 'PRESS ENTER TO CONTINUE...'
E18E 3320454E
E192 54455220
E196 544F2041
E19A 4F4E5449
E19E 4E545228
E1A2 2E2E
E1A4 00      DB 0
E1A5 202A4552 HMSG: DB 'ERASED*'
E1A9 41534544
E1AD 2A20
E1AF 00      DB 0
E1B0 2053544F STMSG: DB 'STORED AT'
E1B4 52454620
E1B8 415420
E1BB 00      DB 0
E1BC 20535441 STMSG: DB 'START ADDR'
E1C0 52542041
E1C4 44445220
E1C8 00      DB 0
E1C9 204C454E LENMSG: DB 'LENGTH'
E1CD 47544820
E1D1 00      DB 0
E1D2 20454E50 ENMSG: DB 'ENTRY'
E1D6 525920
E1D9 00      DB 0
E1DA 20454E44 ENADDR: DB 'END ADDRESS'

8085 MACRO ASSEMBLER, VER 2.0 ERRORS = 0 PAGE 7

E1DE 20414444
E1E2 52455353
E1E6 20
E1E7 00      DB 0
E1E8 20202020 PHBUF: DB 0
E1EC 20202020
E1F0 20202020
E1F4 00      DB 0

;
END

NO PROGRAM ERRORS

```

Text continued from page 292:

appears. A BASIC or document file shows its start address and length. A command file shows the address where it is stored in the file system, followed by its start address at execution time. The length and entry address are also provided for a command file.

To get the program into your machine, you can enter DIR.CO into the TEXT program and then run it through a resident assembly language. This can present problems, however, because there are not many assembly languages available for the Model 100 yet. Even Radio Shack has not addressed this problem.

I took another approach. I entered the program on a system that supports an 8080 or 8085 cross-assembly language and then loaded the machine code generated by the cross-assembly language into the Model 100. You could even use a Z80 cross-assembly language if you keep in mind that all instructions must be of the 8080 subset. The language that I used was on an IBM mainframe. Most large timesharing systems sup-

port a library of cross-development software and this approach may be an alternative to a resident assembly language.

Another possibility is to enter the hexadecimal codes at the side of the DIR.CO program listing via the BASIC POKE command, although this is probably the most error-prone method.

To run the program, move the block cursor over the DIR.CO entry and press the Enter key, as you normally would to run a program. The system will make an obnoxious "beep" sound and return to the main menu because it thinks that the DIR.CO program is going to tread on unused memory. To run this program (or any other command-type program), you must move the high-memory pointer down to an address below the one in which the program is going to execute. You can enter BASIC and issue the command: CLEAR 512,57340, after which the DIR.CO program will execute properly, at least until another BASIC program resets the high-memory

pointer. Another way to run this program from the main menu is to create a three-line BASIC program called DIR.BA, which will reset the high-memory pointer and run the DIR.CO program. This program looks like this:

```

10 CLEAR 512,57340
20 RUNM "RAM:DIR.CO"
30 MENU

```

Line 30 will return you to the main menu rather than leave you in BASIC. You could run this program instead of the DIR.CO program. The DIR.CO program incorporates several of the ROM routines that are found in table 2.

### Conclusion

The Model 100 is full of interesting little secrets. It will only be a matter of time until more is revealed about this versatile machine. ■

*Brian Cameron (Box 37, Ste. 2, RR 1, Elora, Ontario, Canada N0B 1S0) is a systems programmer at the University of Waterloo.*

# HOW VISICORP SEES SEGMENTED ARCHITECTURE.

**MEMO**  
 Insert Page 1 Line 9 Text Document:  
 TO: All Department Managers  
 SUBJECT: Cash Flow Forecast  
 Based on the year end financials reported to this office last Wednesday afternoon (shown below) highlights  
 select start point in te  
 graph clear-all done.

**TREND**  
 4 14.77%  
 3 17.06%

**FORECAST**

	A	B
1		
2		
3		
4		January
5		
6		
7	Cash on Hand	63,450
8	Receipts	335,000
9	Disbursements	265,484
10	Interest	555
11	Taxes	10,001
12	-----	-----
13	Cash Flow	\$60,069
14		
15		
15	)	Value: 107960

Services  
 Calc  
 Graph  
 Word  
 Query  
 Archives  
 Services  
 start install

HELP CLOSE OPEN FULL FRAME OPTIONS TRANSFER



"Just beautiful."

That's what Bill Coleman of VisiCorp\* calls our iAPX 86 architecture. He should know. He and his staff of over 50 people spent three years with it. Writing VisiOn,\* the application software destined to become a multitasking

industry standard.

The key to creating VisiOn was memory management. Allowing Coleman and his team to create an efficient concurrent processing environment, where different processes are active all at once.

As Bill puts it, "The real beauty of this architecture is that you don't have to keep an entire program in memory at any one time. Just the active segments of code actually being run."

In the 8086 architecture, those memory segments are variably-sized and mapped as needed. So loading is very fast. And the resulting performance is very high, because you can load the exact memory you need. Which then gives you the highest performance from any given memory size.

That means some significant runtime advantages. Like faster switching from task to task and window to window. While keeping your mice from running wild.

Another advantage of the 8086 is its extended family, the members of which are perfectly compatible. So your product, and your investment, are protected longer.

The 8087 coprocessor, for example. It adds float-

ing point power, with calculations running up to 100 times faster than normal.

Or the new iAPX 286 microprocessor. In Coleman's words, "an optimal VisiOn machine."

The 286 handles some of VisiOn's multitasking chores in hardware, setting the software free for more powerful functions. Plus, it has on-chip memory management which protects one task from another and even helps prevent system crashes.

Best of all, you can experience all this for yourself. Because VisiOn is an open applications system. And VisiCorp is sharing information to encourage independent software development.

Which means you've got a wonderful opportunity to share in the forthcoming wealth.

But before you start building, study a little architecture. Call (800) 538-1876. In California, (800) 672-1833. Or write Intel, Lit. Dept. F-7, 3065 Bowers Ave., Santa Clara, CA 95051.

Who knows? You might find yourself looking at your own work in a whole new way.



*William T. Coleman, VisiCorp's  
Director of Product Development*



**intel**<sup>®</sup>



# "My Datec PAL has a lot of pals."



I've made a lot of new friends through my Datec PAL Plus Modem. Now I have friends who can deliver mail immediately. Confirm my reservations. Quote stock prices. Research my reports. Entertain me. Even keep me up-to-date on the latest scores.

With my PAL Plus Modem, I just call a friend whenever I need a favor. After all, what else are friends for?

To learn more about our friendly Personal Access Link modems, or for the name of your nearest Datec dealer, call 919-929-2135.

PAL Plus features: • 0-300 or 1200 bits per second • Touch-Tone or rotary pulse dialing • Autodial/Autoanswer • On-board monitor speaker with volume control • One-slot-only, no-hassle fit in the IBM PC or XT • Independent RS-232C port • CROSSTALK XVI communications software included free.

**DATEC**<sup>®</sup>  
*Your Best Connection*<sup>™</sup>

Datec, Incorporated  
200 Eastowne Drive, Suite 116  
Chapel Hill, NC 27514

Datec, Datec PAL and Your Best Connection<sup>®</sup> Datec, Inc.  
IBM<sup>®</sup> International Business Machines Corporation  
CROSSTALK XVI<sup>®</sup> Microsoft, Inc.



# Maximizing Hard-Disk Performance

*How cache memory can dramatically affect transfer rate*

Roy Chaney

University of Texas at Dallas

and

Brian Johnson

Percom Data Corporation

Many personal computer users are looking for ways to increase both the disk-storage capacity and the performance of their computers. One popular approach is through the use of a Winchester hard-disk drive. Although this is a valid approach for increasing disk-storage capacity, the performance may not necessarily meet all of your expectations. At first glance, the performance specifications of typical Winchester disk drives give the impression that there will be a large performance increase, relative to floppy-disk drives. In fact, this is often only partially true. In this article, we'll try to explain why this is so, what memory caching is, and why it can help provide the high performance that most personal computer users desire.

Three main parameters affect the speed performance of any disk drive. The first is the instantaneous data rate while actually reading or writing disk data. The second is the rotational latency, or the time required for the disk to rotate into the correct position to begin transferring the desired data. The third parameter is the seek time, the time required to move the disk head into the proper position on the disk.

The tracks on a disk are concentric circular paths around the recording

surface of the disk, similar to the grooves on an audio record except that they are not in a spiral form. To provide access to the desired data, the heads on the drive must be moved to the track where the data is to be found. On most floppy-disk drives, and on many Winchester drives, this technique of moving the heads from track to track is implemented by the use of a stepping motor. Both the rotational latency and the seek time are determined by electromechanical factors in the physical design of the disk drive and tend to be very expensive to improve. Each track on a disk surface is broken up into smaller units of information, sometimes called sectors, but we'll refer to them as *blocks*. These blocks are the smallest units of information that can be read or written on a disk. This terminology is compatible with that of PC-DOS 2.0 as used with the IBM Personal Computer (PC). For the IBM PC, one disk block corresponds to 512 bytes of data.

A manufacturer's performance specifications for a typical Winchester disk drive might report a disk transfer rate of about 490K bytes per second. This can be compared with a transfer rate of about 23K bytes per second for a 5¼-inch double-density floppy-disk drive like that used in the IBM PC.

On the basis of this data, you might expect that the purchase of a Winchester disk drive would not only increase the disk capacity of the computer system but also would speed up the file transfers by as much as a factor of 21. These estimates, however, are not realized in practice. One reason for this is that the data is transferred from the drive faster than the computer can receive it. Few personal computers can accept a sustained data-transfer rate this high for very long. As a result, the data must be buffered in the disk controller, and the disk must be read only intermittently so that the average data-transfer rate between the disk and the computer is acceptable. The blocks in a disk track are frequently interleaved, or placed in a particular non-sequential order to match the average disk transfer rate to the speed of the computer. A typical interleave factor for a Winchester disk drive is 5. This means that when reading two logically sequential blocks, four blocks are skipped in between. Under these circumstances, the effective speed advantage for a typical Winchester disk system is frequently of the order of 3 or 4 over that of a 5¼-inch floppy-disk drive, providing transfer rates in the range of 60K to 90K bytes per second. Floppy-disk drives are also fre-

quently interleaved, but not for the IBM PC.

At the same time, there are systems for the IBM PC that use excess computer RAM (random-access read/write memory), usually 64K to 320K bytes. These RAM-disk systems usually are pure software products that store disk data by simulating a disk drive, and they typically have a transfer rate of about 350K bytes per second. This rate is determined primarily by the processor speed and the bandwidth of the computer bus; having no electromechanical factors involved is an indication of the maximum possible data-transfer rate of the computer. This number is thus the approximate maximum transfer rate achievable on any disk subsystem attached to the IBM PC. The best you can hope for under any condition is a speed advantage of about 15 times over the floppy-disk drive. But this is still considerably higher than the advantage usually achieved with a real disk drive, so our first task is to understand why this is so.

So far, we have discussed what the data-transfer rate would be when the disk head was already at the correct position on the disk and the disk had already rotated into the correct position for the desired data. Our model gets more complex when the mechanical factors are included. For a real disk system (*not* a RAM disk), there always is a delay between the time when a data-transfer request is made and the time when the transfer actually starts. This delay is termed the access time and is the sum of two delays: rotational latency and seek time. Neither of these times is a fixed value; they are instead statistically derived times that are averaged over a range of common circumstances. Normally, 5¼-inch floppy-disk drives rotate at 300 rpm (revolutions per minute), or 5 revolutions per second. On the average, one-half of the revolution, or 100 ms (milliseconds), is required to get to the appropriate position to transfer the desired data. For a Winchester disk rotating at 3600 rpm, the corresponding time for one-half of a revolution is 8.3 ms. This time, normally referred to as the average rotational

latency of a disk, indicates the average delay time that is encountered between the time of a request for a data transfer and the time the transfer actually begins, assuming that the head is already correctly positioned on the desired track.

The other mechanically determined delay is the seek time, the time required for the stepping motor to move the heads from the current track to the desired track; this is always a major portion of the access time. This time obviously depends on the distance between the respective tracks and the speed with which the heads can be moved. A disk manufacturer typically publishes an average seek time for a given drive, which is based on a track-to-track movement of an average distance. For statistical reasons, this average distance usually is taken to be one-third of the distance between the innermost and outermost tracks. For most floppy-disk drives, the head moves at a constant speed; therefore, the seek time is approximately proportional to the seek distance. For many Winchester drives, the head moves at a higher velocity for longer movements than for shorter movements. For a typical 5-inch Winchester disk drive, this average seek time is approximately 70 ms; for the IBM PC floppy-disk drive, it is approximately 125 ms.

As mentioned previously, the access time for a disk transaction is the sum of the rotational latency and the seek time. These figures are approximately 80 ms for a Winchester disk and approximately 225 ms for a floppy disk. These numbers are, of course, averages based on a completely random pattern of data requests, with all blocks on the disk considered equally likely to be accessed. This situation is not really typical of normal use, but the fact that the ratio of the access times is only about a factor of 3 in favor of the Winchester disk turns out to be remarkably indicative of the actual typical performance.

Now consider the impact of these numbers on the actual data-transfer rate to be expected. If we assume an average access time for each disk

transfer, and if we assume that a typical disk transfer corresponds to 512 bytes of data, the transfer rate of the Winchester would be 6.4K bytes per second, and that of the floppy would be 2.3K bytes per second. Moving large contiguous blocks of data increases both of these numbers, but they illustrate why the actual average data-transfer rate is well below the peak rate for real disks. The reason behind this is that for both types of real disks, the access time dominates the data-transfer time. RAM disks, on the other hand, have no mechanical components and have essentially zero access time. The average data-transfer rate of 350K bytes per second is the same as the peak data-transfer rate, independent of the sequence or size of requested data transfers. This explains the enormous popularity of the RAM-disk concept today.

In actuality, the use of the average times previously calculated generally reflects pessimism about the time required for head movement between disk transfers. This is a result of the fact that the operating system (OS) usually does its best to try to keep the disk data blocks for a given file on the same or adjacent tracks. By doing this, head movement is minimized; when a single sequential file is being read or written, the real access time is much smaller than the average time specified by the disk-drive manufacturer. The OS, however, can do little to benefit certain types of programs that have several large files all opened simultaneously for random access. Thus you might see a transfer rate similar to the average one just described for a database-management system that transfers data to or from several large disk files, or for a compiler reading a large source file while generating both an object file and a listing file.

Multitasking also has a significant degrading effect on disk performance because there is no reason why files being accessed by different tasks would be near each other on the disk. In these cases, it is much more difficult for the OS to reduce the amount of head movement. It is common in multitasking systems to see



*"Kaypro 2... \$1295... Complete..."*



Oh, mentor of highest wisdom, help all mystified first-time buyers discover the ultimate truth about personal business computers.

Tell them that, unlike other computer companies, Kaypro does not advertise a low "starter system" price, then charge extra for so-called "options" like a monitor, software, disk drives or peripheral interfaces.

Tell them that Kaypro 2 has become the fourth largest-selling personal business computer because we sell it complete. For \$1295.

Tell them that Kaypro 2 comes with a highly readable, 9" green-screen monitor. A 64K RAM, Z-80 microprocessor. Two built-in disk drives with a 400K capacity. A more complete keyboard than Apple IIe. Interfaces for both a printer and a telecommunications modem. And a full complement of CP/M software to handle the overwhelming majority of Word Processing, Data Base Management and Financial Spreadsheets needs, with top quality programs such as Wordstar.

All for \$1295.

Then, tell them to call 800-447-4700 for their nearest dealer, or call Kaypro at 619-481-4318.



**KAYPRO**

The \$1595 computer that now sells for \$1295.

disk heads executing continual large seeks as the various tasks make data requests from files located at diverse places on the disk. In this case, the average access time can be much longer than that indicated by the average times presented earlier. File servers for a LAN (local-area network) are an extreme case of the same problem.

## Caching

The technique of caching is often the solution to this problem. The objective of caching is to economically provide both the high performance of a fast, small, expensive memory (such as a RAM disk) and the large capacity of a large, slow, cheap memory (such as a Winchester disk). The technique of caching has been used successfully in memory systems for many large mainframe computers and minicomputers for several years. Examples include the IBM 370, the Data General (DG) Eclipse, the Digital Equipment Corporation (DEC) PDP-11/70, and many others. Let us discuss the use of caching in computer memories first, then we will generalize it to disk applications. For the moment, we will consider only "read" accesses to the memory, that is, those accesses that require data to be moved from memory to processor.

The word *cache* in French means "to hide" or "hidden," thus it is used in the context of computers to refer to a transparent memory. In the computers just mentioned, there are two types of memory. One is a small amount of high-speed, very expensive (cache) memory; the other is a large amount of slower, less expensive (main) memory. Copies of data located in certain parts of main memory are stored in cache memory. Whenever data accessed by the processor can be found in cache memory, it can be read at the fast speed; otherwise, it is read at the usual slower speed of the main memory. When the processor is successful in accessing data from the cache memory, it is referred to as a *hit*; otherwise, it is called a *miss*. If the fraction of the time that memory access results in a hit is high, the average time required to access data from

memory is reduced, and the average performance is enhanced. All caching schemes depend on this one fundamental concept.

In the design of a cache-memory scheme, there are two technical problems that must be solved before you can effectively use this fast memory. The first is how to quickly determine whether the fast memory contains the information required by the processor. This problem is a serious one for memory caching primarily because the time for making this decision is very small (much less than 1 microsecond) in order to gain any advantage from the cache. This fast timing restriction does not affect disk caching. The more critical problem is determining the best algorithms to use to maximize the chances that the information required by the process will be available in fast memory. It is not, in general, possible to do this perfectly because it would be necessary to predict all future memory accesses. In effect, you would have to look into a crystal ball and predict what data the processor would need to access next so that the data could be moved from slow memory into fast memory before it was requested. If this could be done perfectly, all accesses would be fast-memory accesses.

Basically, two classes of algorithms attempt to provide an optimum choice of what data to keep in cache memory and when to move it there from slow memory. These algorithms attempt to partially predict future data accesses, given some information about current and past accesses, under the assumption that the future is likely to be an extrapolation of the past and the present.

One class of algorithm is called a *prefetch* algorithm. This type is based on the assumption that much data access is sequential in nature, and that access of some particular piece of data implies a strong likelihood that the next piece of data sequentially following the first will soon be wanted.

The second class of algorithm is called a *replacement* algorithm. This type is based on the premise that any data brought into the fast memory

must displace data that is already there. The key here is to displace that data judged least likely to be needed again in the near future, based on some assumptions about the relationship between past usage and future usage of a particular piece of data. In effect, prefetch algorithms try to determine what data to bring into the cache before it is requested, and replacement algorithms try to determine what data to keep in the cache once it has been brought there. Of course, these two algorithms interact with each other because bringing in new data always requires the displacement of old data previously in the cache. A great deal of time and effort has been spent by computer manufacturers to determine effective prefetch and replacement algorithms. We will discuss details of these algorithms later.

Another important decision that must be made in the design of any cache-memory scheme is a choice of the amount of cache memory to be provided, relative to the size of the main memory that is to be cached. It also is frequently desirable to perform caching on blocks of data that are larger than the elementary units of information (bytes, for instance) because then the overhead of cache decision-making can be amortized over larger amounts of data, and the decisions do not need to be made as frequently. This unit of caching is frequently referred to as a *page* or a *cluster*.

## Disk Caching

We now turn from caching in general to the specific case of disk-performance enhancement through the use of the caching technique. Let's begin with a brief discussion of disk-file access. This discussion somewhat favors PC-DOS 2.0—that was the target OS that motivated most of our work.

When an application program requests transfer of data to or from a disk file, a series of operations that is essentially invisible to the user must be performed by the OS. That is, the user program does not know how they happen. These operations, however, do have a significant effect

*Text continued on page 314*



# Something no modem has ever said before.



If you're looking for a premium modem without a premium price, here's a word of advice: Apple.

Introducing the Apple® Modem 300. And, to keep up with the business world, our faster Apple Modem 1200.



*As you'll notice, the Apple Modem is hardly noticeable under a desk phone.*

Inside, they're packed with all the technical wizardry you would want in an intelligent modem. Auto-dial. Auto-answer. Built-in error diagnostics.

And compatibility with all the latest advanced communications software.

But the real message is located outside, due north of the little green light.

That one familiar symbol tells you as much as a gigabyte of specs. It says Apple quality. Apple technology. And in the unlikely event you should need it, Apple service.

It also means total compatibility with whatever Apple you own. Particularly since we include the right accessory kit to get any system in our line on line. Immediately.

We even give you a subscription offer to THE SOURCE™ and a free demonstration of CompuServe.\* Together, they let you access almost any subject known to mainframes.

News reports. Dow Jones averages. Sports scores. Closing prices on pork bellies.

You can send electronic mail. Play games. Bank at home. Make friends. Influence people. Find the lowest air fares for business trips. Or do almost anything else you like.


And since the computer age happens to coincide with the plastic age, you can charge your Apple Modem with an Apple Credit Card.

Which, along with the low price, makes buying an Apple Modem as much fun as using one.

That's something no modem has been able to say before, either.



*The cable, phone cord and power supply are all included. And we offer a serial interface card for the Apple IIe at an unusually reasonable price.*

Soon there'll be just two kinds of people. Those who use computers. And those who use Apples. 

You're traveling through 140°





terrain at 300 rpm.

**Only one disk  
guarantees safe passage  
through the torrid zone  
of drive heat.**

**Maxell.**

A lifetime warranty. And manufacturing standards that make it almost unnecessary. Today and in the long run, you'll be glad you chose Maxell.

Consider this: Every time you take your disk for a little spin, you expose it to hazardous drive conditions. Temperature build-up can sidetrack data. Worse, take it to the point of no return. Maxell's unique jacket construction defies heat of 140°F. And keeps your information on track.

And Maxell runs clean. A unique process impregnates lubricants throughout the oxide layer. Extending media and head life. How good is Gold? Maxell's the disk that many drive manufacturers trust to put new equipment through its paces. It's that bug-free.

So you can drive a bargain. But in accelerated tests, Maxell floppys lead the industry in error-free performance and durability. Proving that if you can't stand the heat you don't stand a chance.



**maxell®**  
IT'S WORTH IT.

Maxell Corporation of America  
60 Oxford Drive, Moonachie, N.J. 07074  
201-440-8020

Circle 251 on inquiry card.

Text continued from page 310:

on the implementation of caching algorithms and need to be discussed in that context.

First, let us describe what happens when an application program needs to read information from a file on the disk. The program requests that the OS open the file on the disk. The part of the OS that receives and dispatches all requests then forwards that request to a set of routines collectively called the file manager, which then goes to work to perform this operation. The file manager first looks into a special file (commonly called the directory) that contains the names of all of the files currently stored on the disk to see if the requested file is contained on the disk.

Assuming that the file is there, the file manager then looks into another section of the disk (commonly called the file-allocation table) to determine where the various parts of that particular file are physically stored on the disk. Some information is then returned to the application program that will be used when actually reading data from this file. In subse-

quent calls to the file manager, the program requests the actual transfer of data from the file now open, and it eventually makes a final call to the file manager to close the file.

The sequence of actions for a write operation is similar unless the file manager does not find the file already present; in this case, it updates the directory to contain the name of the new file and looks into the file-allocation table to find locations on the disk in which no data is currently stored, so that it can write the data onto empty portions of the disk. The important point in this discussion is that there is little, if any, direct relationship between the location of a logical block of data required by the program and the physical location of that data on the disk. The file-manager component of the OS is responsible for keeping track of the logical/physical relationship in a way that is invisible to the user.

The actual operations of reading and writing physical blocks of data to or from disk involves another component of the OS called the disk

driver. The file manager tells the disk driver which physical blocks are required to be transferred, and the disk driver performs the actual data transfer. Done in this way, the disk driver does not need any knowledge of the nature or structure of files on the disk. This hierarchical relationship among the various components of the OS is very common; one file manager can work with multiple different disk drivers, and each disk driver need not duplicate the file-management function. As far as disk caching is concerned, the particular caching algorithms used will be very different depending on whether the caching is done at the level of the file manager (see figure 1a) or at the level of the disk driver (see figure 1b). The reason for this is that the file manager has a great deal more information about the organization of the files on the disk than does the disk driver. For example, it is easy for the file manager to know which blocks of data on the disk correspond to logically sequential data in a particular file, or part of the directory, or



# SAVE MORE THAN EVER ON...

## 3M Scotch® DISKETTES

### AND OTHER COMPUTER NEEDS!



### 3M Scotch® Diskettes

are boxed in 10's with labels, envelopes and reinforced hubs on 5 1/4" diskettes. **LIFETIME WARRANTY!**

**\$185** ea. 5 1/4" SSDD (744)  
Qty. 20

5 1/4" DSDD (745) **\$235** ea.  
Qty. 20

5 1/4" SSQD-96TPI (746) \$2.60 ea.  
5 1/4" DSQD-96TPI (747) \$3.25 ea.  
8" SSDD (740) \$2.05 ea.  
8" SSDD (741) \$2.50 ea.  
8" DSDD (743) \$3.10 ea.



### DISK CADDIES

...the original flip-up disk holder for 10 diskettes. Beige or grey only.

5 1/4" \$165 ea. + .20 Shpng. 8" \$229 ea. + .20 Shpng.

### RIBBONS! at bargain prices.

EPSON MX-70/80	\$3.58 ea. + .25 Shpng.
EPSON MX-100	\$6.99 ea. + .25 Shpng.
Okidata Micro 84	\$3.58 ea. + .25 Shpng.
Diablo 830 Mylar	\$2.60 ea. + .25 Shpng.
Diablo 830 Nylon	\$2.93 ea. + .25 Shpng.

WE WILL BEAT ANY NATIONALLY ADVERTISED PRICE!  
**Nationwide: 1-800-621-6827**  
**Illinois: 1-312-944-2788**  
Hours: 9 AM-5 PM Central Time  
Minimum Order: \$35.00

### DISKETTE 70 STORAGE



The best buy we've seen! Dust-free storage for 70 5 1/4" diskettes with six dividers.

**\$1495** + \$3.00 Shpng.

### FLIP 'N FILE

Redesigned for better appearance and greater ease of use. FLIP 'N FILE 25 holds 25 5 1/4" diskettes; FLIP 'N FILE 50 holds 50 5 1/4" diskettes.

FLIP 'N FILE 50  
Retail \$39.95  
...DW Price  
**\$26.95**  
+\$5.00 Shpng.



Shipping: 5 1/4" DISKETTES—Add \$3.00 per 100 or fraction thereof. 8" DISKETTES—Add \$4.00 per 100 or fraction thereof. OTHER ITEMS: Shipping charges as shown in addition to diskette shipping charges. Payment: VISA or MasterCard. COD orders only, add \$3.00. Taxes: Illinois customers, please add 8%.

# DISK WORLD!

SUITE 4806  
30 EAST HURON STREET  
CHICAGO, ILLINOIS 60611

Authorized Distributor  
Information Processing Products





# MicroAge<sup>®</sup>


**"THEY GAVE US THE BEST  
OF BOTH WORLDS"**

**...OWNERSHIP...AND THE STRENGTH OF  
AN INTERNATIONAL CORPORATION!"**

"We wanted to offer Indianapolis something different; not just another computer store. The MicroAge idea of selling solutions really made sense to us...and with MicroAge, we're making it happen!"

"When we started in 1981, we had just three people working for us. Today, we're the largest computer store in Indiana. We've tripled our store to 7000 sq. ft. and increased our staff to 15."

"MicroAge...They're committed to excellence: The hardware shows it, the software shows it, the support for the store and customers shows it, and our solutions prove it!"



*G. Michael Gunason*

G. Michael Gunason  
Franchise Owner

*D. Susan Wisely*

D. Susan Wisely  
Franchise Owner

Building your own professional computer sales organization with MicroAge requires an initial investment of \$200,000 to \$300,000, which includes \$80,000 in liquid assets. Write to:

**MicroAge<sup>®</sup>**  
**COMPUTER STORES**  
*"The Solution Store"<sup>®</sup>*

1457 West Alameda • Tempe, Arizona 85282

**(602) 968-3168**

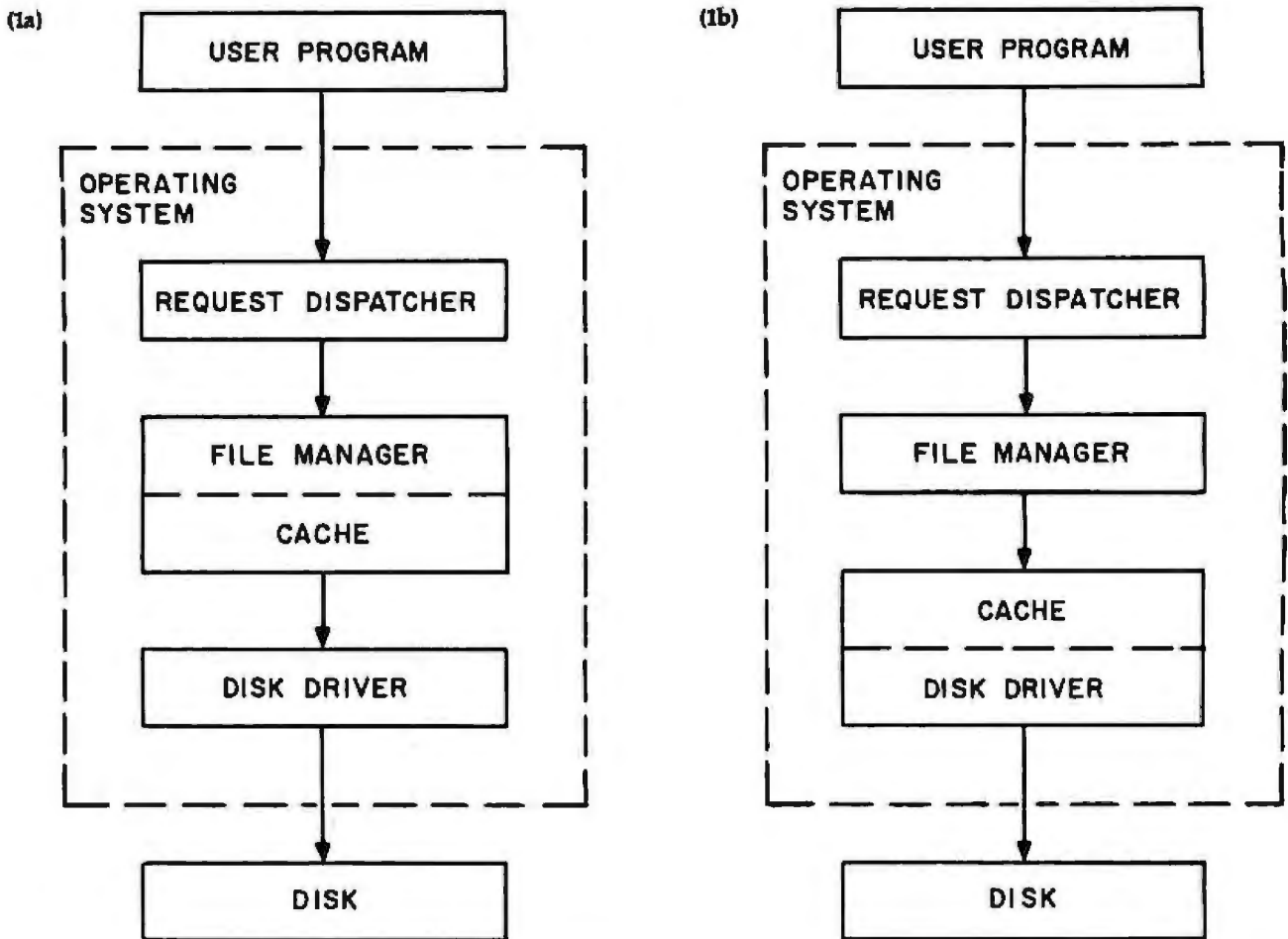


Figure 1: A block diagram of the structure of a typical operating system and its interaction between a user program and the disk. Figure 1a shows the operation when the cache is implemented as part of the file manager; 1b shows the operation when the cache is implemented as part of the disk driver.

part of the allocation tables. As a result, the file manager can make better guesses as to what to keep and what to displace in the cache. Disk caching at the file-manager level can therefore lead to somewhat more efficient cache algorithms because they are based on more knowledge of the structure of the files on the disk. The *problem* we face with the implementation of caching at the file-manager level is that the file manager is an integral part of the OS, and any disk caching at this level must be done by extensive modification to the OS. On the other hand, disk drivers are more loosely connected to the OS and frequently can be modified or replaced without direct changes to the system itself. In some cases, as in PC-DOS 2.0, disk drivers can be loaded separately from the OS when the system is booted.

Now let us discuss how memory-

caching techniques can provide faster apparent data-transfer rates for Winchester disk drives. If we substitute references to the disk drive for all references to the slow main memory and references to main memory for references to the fast memory in the previous discussion on caching, then we can consider the disk to be the large slow memory and (part of) the computer main memory to be the cache memory. For a specific example, let us assume that we have a small amount (perhaps 256K bytes) of main memory that we would like to use as a cache for a Winchester disk with a capacity of 10 megabytes. Now, it is impossible for all of the data on the disk to be simultaneously stored into the cache because the disk is 40 times as large as the cache. However, if the amount of data actually needed from the disk is a small fraction of its total capacity (over

some reasonable period of time), then it could be made to appear to a user's program that all of the data needed was available from the Winchester disk. We would like for that information already to be contained in the cache so that we will have a hit on the cache memory. Whenever we have a hit, we expect to achieve a data-transfer rate close to that of a RAM disk (350K bytes per second), because a cache is very similar to a RAM disk in its internal construction. A convenient way to understand the effect of cache memory on the disk drive is to plot the effective transfer rate of the disk versus the ratio of hits to misses on the cache memory. This plot is given in figure 2 for various values of disk-access times, assuming 1024-byte transfers and a cache-memory transfer rate of 350K bytes per second. It is clear from the plot that it is impossible to achieve the max-

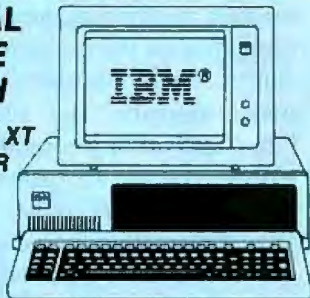


# COMPUTER HUT™

COMPARE  
OUR  
SERVICE & PRICE!

## SPECIAL OF THE MONTH

IBM-PC & XT  
CALL FOR  
PRICE



## HARDWARE FOR IBM-PC DISK DRIVES

### Tandon

TM100-2 DS/DD	\$229
PANASONIC JA 551	\$189
SHUGART SA-455 half-high	\$189
TEAC FD-55B Slimline	\$209

### MAYNARD ELECTRONICS

Floppy Disk Controller	\$169
FDC w/Par. Port	\$219
FDC w/Ser Port	\$239

SANDSTAR SERIES CALL

### QUADRAM

Quadboard-PP,SP,C/C,Mem + s/w	Expandable to 384K	CALL
Quad 512 + SP,Mem with s/w	64K	\$249
Quadcolor	512K	\$639

### AST RESEARCH

MegaPlus II 4-Funct 64K + s/w	\$279
6-Pack 5-Funct 64K + s/w	\$279
I/O Plus	\$135

### TECMAR

Graphics 720 x 400 16 colors	\$539
------------------------------	-------

### HERCULES

Hi Res Graphics 720 x 348	\$359
---------------------------	-------

### FREDRICKS ELECTRONICS

COLORPLUS 640 x 200, 16-Color + s/w	\$399
--	-------

### MA SYSTEMS

PC Peacock w/Par Port	\$295
-----------------------	-------

### AMDEK

MAI Graphics 640 x 400	\$479
------------------------	-------

### MICROLOG

Baby Blue	\$359
Baby Blue II 64K	\$575

### PARADISE

Multidisplay	\$395
--------------	-------

## HARD DISK - IBM-PC & XT

### MOUNTAIN — External Syst.

5MB	\$1539	10MB	\$1839
15MB	\$2309	20MB	\$2549
20M Tape back up	\$1775		
MAYNARD	CALL		

## PRINTERS

### EPSON

FX80	CALL	FX100	CALL
------	------	-------	------

### brother

HR1 A Par	\$599
HR-15 Par	\$459
HR-25	\$649

### DYNAX

DX-15 Par	\$459	Ser	\$489
-----------	-------	-----	-------

### C-ITOH

STARWRITER A-10	CALL
STARWRITER F-10 P	\$1095
PROWRITER 8510 SP 180 CPS	\$649

### star MICRONICS

Gemini 10X	\$299	15X	\$399
------------	-------	-----	-------

### OKIDATA

82A	CALL	83A	CALL
84P	BEST	84S	BEST
92P	PRICES	92S	PRICES
93P		93S	

### NEC

3510	\$1485	7710	\$1995
3515	\$1479	7715	\$2039
3530	\$1575	7720	\$2495
3550	\$1695	7730	\$1995
2000 Series	CALL		

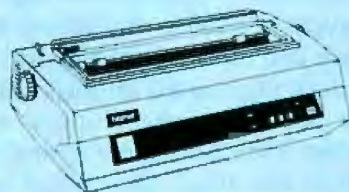
### TOSHIBA

P1350	\$1549
-------	--------

IDS, DAISYWRITER... CALL

### SILVER-REED

EXP 500 Par	\$429	Ser	\$459
EXP 550 Par	\$639	Ser	\$679



## MODEMS

### HAYES

Smartmodem 1200	\$499
Smartmodem 1200B	\$429

NOVATION, US ROBOTICS CALL

## COMPUTERS

### EAGLE

CALL

### COLUMBIA DATA PRODUCTS, INC.

CALL

### CORONA

CALL

### PLA TAVA PC

CALL

## MONITORS

### AMDEK

Video 300G	\$139	300A	\$149
Video 310A	\$189		
Color II	\$429	Color II +	CALL

### PGS

HX12 Hi Res RGB monitor	BEST
MAX-12 Hi Res Mono	PRICES
SR-12 Super Hi Res RGB	



## SOFTWARE FOR IBM-PC

LOTUS 123	\$329
Word Perfect	\$299
WordStar	CALL
DBase II	\$399
VisCalc	\$189
Multipan	\$175
Multimate	\$299
MICROSOFT Word	\$269

## AND MORE

## CANADIAN COMPUTER HUT

AUTHORIZED DEALER

MICROCONTEXT INC.

5253 AVE DU PARC

MONTREAL

QUE H2V4P2.

(514) 279-7291

Published Prices are for U.S.A. Only  
Please call for Canadian Prices

ANY PRODUCT NOT LISTED? CALL

**COMPUTER HUT**  
OF NEW ENGLAND INC.  
101 Elm St., Nashua, NH 03060

ORDERS & INFORMATION  
**(603) 889-0666**

ORDER-LINE ONLY  
PLEASE  
**(800) 525-5012**

All products usually in stock for immediate shipment and carry full manufacturers' warranty. Price subject to change — this ad prepared two months in advance. You get the lowest price. We honor personal checks — allow 10 days to clear. COD up to \$200 add 3%. Visa, MasterCard add 3%. For shipping & insurance add 3% or \$5.00 min. for small items and \$8 min for monitors, printers, etc. APO & FPO orders add 12%. Include phone number.



TRANSFER RATE VERSUS  
HIT/MISS RATIO

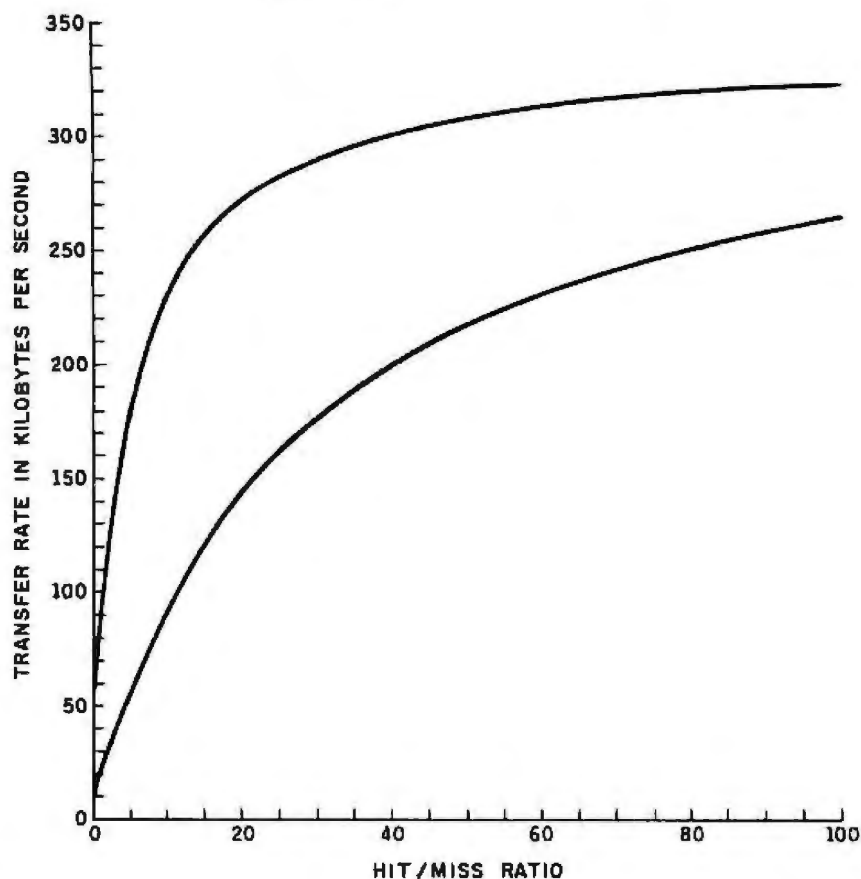


Figure 2: A plot of the improvement in the transfer rate for a Winchester disk drive as a function of the hit/miss ratio for the cache memory. The upper curve is the case where the head is already positioned on the proper track, and the only delay is rotational latency. The lower curve is the average access time, including the average time needed for a seek.

imum transfer rate of 350K bytes per second. However, for hit/miss ratios of 10 and greater, it is possible to achieve a significant improvement in the transfer rate over that of the disk without caching.

The improved-performance factor is plotted versus the hit/miss ratio in figure 3, which shows that it is possible to achieve an improvement of 3 by using a disk cache, relative to a disk operating at its maximum transfer rate (head always near the desired track). The improvement might be around 8 over a disk that is performing operations requiring a great deal of head movement. And all this can be done with a hit/miss ratio of 10. The design goal for a disk-cache scheme is to use some of the extra addressable memory available in 16-bit processors (typically of the order of 64K to 320K bytes) as cache space for the Winchester disk. By utilizing pre-

fetch and replacement algorithms for transferring data into and out of the cache memory to maximize the number of hits, you can hope to achieve a hit/miss ratio of at least 10. Of course, the size of the cache memory also is an important parameter, and enlarging the size of the cache always increases the hit/miss ratio but adds extra cost.

Let us examine specific techniques that might be used to implement the prefetch and replacement algorithms to achieve the desired hit/miss ratio. There are two quite distinct approaches to the design of caching algorithms for disks. The choice between these two approaches is not simple, and it depends on how much the cache system knows about the file system. If the cache is implemented as part of the operating-system file manager, then the cache can make decisions based on knowledge of

which files are open and of the relationships between physical disk locations and logical file structure. Frequently, caching at the file-manager level enables the cache to make special arrangements about caching the disk directory, the file-allocation table, and other frequently accessed global disk-data structures, and to attempt to decide what other data should be cached, based on educated guesses about the probable usage. If the cache is implemented as part of the disk driver, then the cache must make all decisions without any knowledge of file structure or logical data structures. The first approach can deliver higher performance at the cost of higher complexity; the second approach is always simpler but may require more care in the choice of the algorithm details because of its poorer knowledge base. Either approach is capable of delivering good performance, and some caching systems use both, providing directory caching in the file manager but doing most of the high-volume data caching at the driver level.

Now we will discuss prefetch algorithms in these two cases. As stated before, the prefetch methods are developed to anticipate the data needs of the processor and to attempt to place the data into the cache memory before it is actually requested by the processor. In the case of disk caching, it is much easier to anticipate the requirements of the processor than it is in the case of memory caching. The reason for this is that so many disk files are processed partially or wholly in a sequential manner. By assuming that the processor is soon going to need data in the region on the disk corresponding to data immediately following previously requested data, it is possible to predict with a high percentage of accuracy what data to prefetch in order to anticipate further requests from the processor.

There is one problem with this scheme: in most operating systems, sequential files are not placed on the disk in contiguous sequential locations. When a sequential file is written to the disk, the OS writes the information in clusters. Typically, these



# We've Earned The Right To Be #1 By Being First So Often

When it comes to being **FIRST** with technology-leading products, **Advanced Digital** wears its #1 button with pride. We were **FIRST** to introduce an 8-Bit, single board S-100 computer... We were **FIRST** to introduce a 6MHz, 128KByte single board computer... We were **FIRST** to introduce a 6MHz, 128KByte Slave Processor board. And our record for being **FIRST** continues with...

- The introduction of **SUPER EIGHT** - an 8MHz master with Winchester and Floppy disk controller on one board.
- The introduction of **SUPER SLAVE II** - A dual slave processor that will support two users under TurboDOS.
- The introduction of our new **SUPER 186** - the **FIRST** 16-Bit, single board S-100 computer that performs at twice the speed of older technologies. Loaded with features such as on-board floppy disk controller and up to 1MByte of RAM, the **SUPER 186** is designed to function as a bus Slave or Master. Advanced Digital's **SUPER 186** permits you to take advantage of vast libraries of sophisticated applications software.

Advanced Digital boards are IEEE 696 compatible, run under a variety of operating systems such as CP/M 2.2,\* CP/M 3.0, Concurrent CP/M, MP/M,\* OASIS,\* and TurboDOS\*

Top row L to R: Super Slave 128, HDC-1001, Super Slave 64,  
Bottom row L to R: Super Quad, Super 186, Super Six)

and are available with CPU speeds of 4, 6, or 8MHz. On-board memory capacities range from 64KBytes to 1 MByte.

When it comes to selecting your S-100 boards, go with Advanced Digital - The Company that earned the right to be #1.

See your local computer dealer or contact Advanced Digital today... We'll help you become #1.



**Leading the Microcomputer Technology**

**Advanced Digital**

5432 Production Drive, Huntington Beach, CA 92649  
Tel. (714) 891-4004 • Telex 183210 ADVANCED HTBH

**In Europe:**

**Advanced Digital U.K. Ltd.**

27 Princess St., Hanover Square  
London W1R8NQ • United Kingdom

409-0077 • 409-3351 Telex 265840 FINEST



CP/M is a trademark of Digital Research.  
TurboDOS is a trademark of Software 2000.  
MP/M is a trademark of Digital Research.  
Oasis is a trademark of Phase One Systems.

COMDEX Atlanta/Booth 7010



IMPROVEMENT VERSUS  
HIT/MISS RATIO

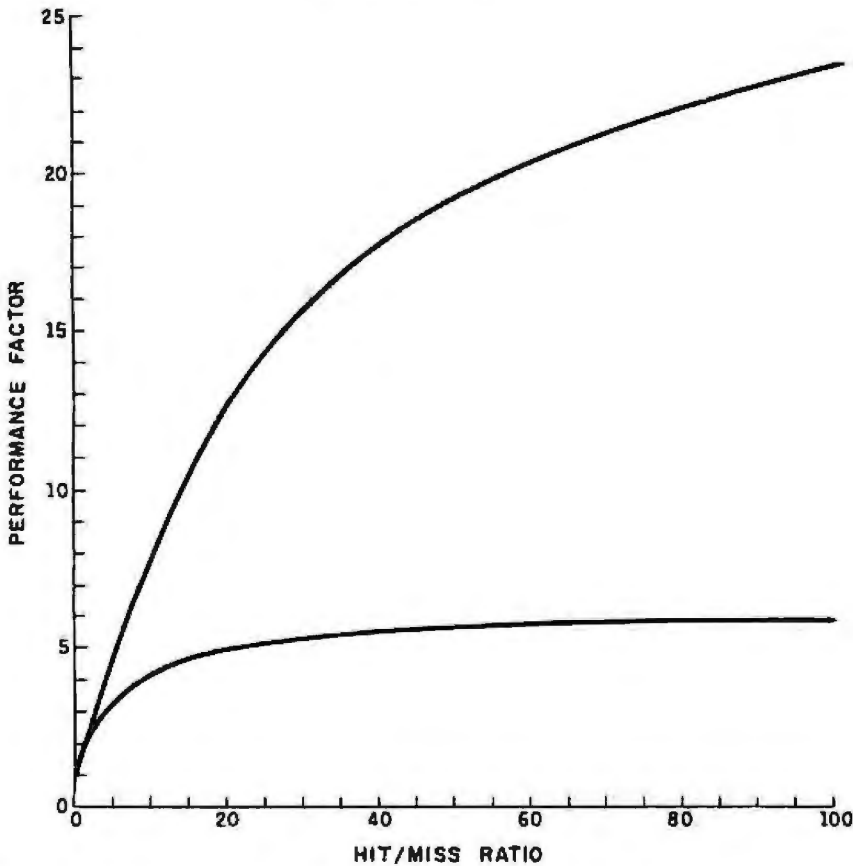


Figure 3: A plot of the ratio of the effective transfer rate of the Winchester drive with the cache versus the uncached drive as a function of the hit/miss ratio. As in figure 2, the upper curve corresponds to rotational latency only, and the lower corresponds to average access time with a seek.

clusters are composed of one or more contiguous disk blocks. The information is contiguous within a cluster. However, logically sequential clusters that correspond to sequential data in a file may not be physically contiguous, and physically contiguous clusters may not even correspond to the same file. For a freshly initialized disk (containing no files) onto which all of the files have just been copied, the file manager usually makes sure that the clusters for the files are physically contiguous and in sequential order. But after the disk has been used for a while and many files have been added, deleted, or modified, the disk becomes somewhat fragmented and adjacent clusters no longer necessarily correspond to adjacent data in a file. This fragmentation effect must be considered in the evaluation of the prefetch algorithm.

One of two similar prefetch algo-

rithms is commonly used, depending on the implementation level of the cache. If the cache is part of the file manager, the prefetch algorithm is usually designed so that whenever some data is accessed from a particular file, the next cluster of the file is to be placed into the cache if it is not already there. This is done regardless of whether the access request is a hit or a miss. This algorithm is intended to ensure that after an initial miss on the first access to the file, the rest of the file accesses will have hit access to the cache.

The second algorithm is simpler and is usually used when the cache is part of the disk driver. Whenever a cache miss occurs, the required block, plus several other blocks occupying physically adjacent positions on the disk, are read from the disk under the assumption that physically contiguous data is likely to

be logically contiguous data, i.e., the fragmentation is fairly low. In the first case, it is necessary for the cache system to know the physical arrangement of particular files on the disk. In the second case, that knowledge is unnecessary, and caching can be performed more mechanically, usually as part of the disk-driver software. The cache system need not be part of the OS or know anything about the nature of file storage. In this simpler driver-based case, fragments will occasionally be fetched from other, not-needed files unnecessarily if the read prefetch cluster is different from the OS cluster used to store the files. This is especially true if the disk is highly fragmented.

One standard version of the second algorithm always reads an entire track from the disk whenever any part of that track is accessed. It is possible to improve on that by not reading the part of the track preceding the requested block. Another version might use a cluster size that corresponds to those used by the OS. All of these algorithms are ultimately based on the notion that once the time has been spent to move the head into position to read some requested data, it is beneficial to read as much data from that area as seems likely to be wanted later.

Replacement algorithms are concerned with the decision of what data to displace from the cache when a data request requires new data to be cached. Three techniques that have been examined for use in mainframe memory caching are random replacement, first-in/first-out (FIFO), and least recently used (LRU). The names of these techniques give a strong indication of their operation.

The random-replacement technique picks the data to be displaced in a random manner without regard to any knowledge about the likely usefulness of that data. The FIFO method keeps a counter to indicate the order in which data has been brought into the cache and always displaces the oldest data that is in the cache. The LRU algorithm is a variation of the FIFO, but it remembers the order in which the cached data has been used by the processor.



# How to make your IBM run 2½ to 4 times faster.



## Just plug in the Accelerator PC™ and watch your IBM\* PC or XT take off.

Yes, Titan's done it again. The innovators who speeded up the Apple® now bring similar performance advantages to IBM users. Imagine running Lotus® 1-2-3™, VisiCalc®, or Multiplan™ without long delays. With the Titan Accelerator PC, your IBM PC or XT can run all your software faster. Data bases, word processors, spreadsheets, graphics, and much more will speed up by a factor of 2½ to 4 (average around 3).

The Accelerator PC has a 10 MHz 8086 processor and 128K of high-speed RAM, expandable to 640K with the memory upgrade piggyback option. It's compatible with your present hardware and software, and designed to be ready for future enhancements.

Get your work done in a third of the usual time.

See your computer dealer today or contact: Titan Technologies, Inc., P.O. Box 8050, Ann Arbor, MI 48107; Telephone (313) 662-8542.

 **Titan**  
TECHNOLOGIES, INC.  
FORMERLY SATURN SYSTEMS OF MICHIGAN

Sales and Marketing by The MARKETING RESOURCE GROUP, Fountain Valley, CA.

IBM is a registered trademark of International Business Machines Corporation. Lotus and 1-2-3 are trademarks of Lotus Development Corporation. Multiplan is a trademark of Microsoft Corporation. Apple is a registered trademark of Apple Computer Inc. VisiCalc is a registered trademark of VisiCorp, Inc. Accelerator PC is a trademark of Titan Technologies, Inc.

Using the LRU method, data that has been *unused* the longest is displaced. The LRU method depends on the premise that data used frequently by the processor should remain in cache and should displace data used infrequently.

Some evidence from research conducted by mainframe manufacturers indicates that for the case of memory-to-memory caching, performance is not strongly dependent on which replacement algorithm is chosen. The manufacturers, therefore, sometimes choose random replacement as being the easiest to implement. We felt, however, that for memory caching of disks, the LRU algorithm would be the most effective. Certain areas of the disk, such as the directory and the file-allocation table, are used extensively and frequently by the processor. Thus, it is particularly important to ensure that these areas are in the cache memory at all times. The fact that they are used frequently causes the LRU algorithm to make sure they remain in cache memory, making the LRU the most efficient replacement algorithm. If the cache is implemented within the file manager of the OS, such frequently used disk-data areas often are given special treatment so they are always in memory and not at the mercy of the replacement algorithm.

So far, we have been talking only about the use of the cache to enhance the transfer rate of the read operations from the disk. We also must consider how the cache is affected by writes from processor to disk. We should consider if the cache should even be involved in write operations. The answer is that the cache must at least be involved to the extent that it faithfully represents the data on the disk. If new data were written to a location on the disk that had previously been read to the cache, and this was not known to the cache, then the next read access to that data would be from the cache and the processor would receive old (erroneous) data.

One of the absolute requirements of any cache scheme is that it must be an exact duplicate of that part of the disk it represents. If data on the

disk is modified by writing to the disk, then it is necessary to check whether that part of the disk also is in the cache. If the written part also is cached, there are two options. One option is to declare the part of the disk just written no longer in the cache, which prevents the processor from getting a hit on the old erroneous data; the second option is to update the cache copy of the data to reflect the modifications produced by the write onto the disk. One of these two options must be chosen to ensure that the processor receives the updated version of the data during a subsequent read operation.

---

### **An absolute requirement of any cache scheme is that it must be an exact duplicate of that part of the disk it represents.**

---

Another question that should be asked is whether there is any advantage in caching write operations in a manner similar to that of read operations, or whether data should be transferred first from processor to cache and then from cache to disk. In fact, the answer is yes.

Now let us see how caching can be used to greatly enhance the effective transfer rate on write operations. We have shown that the cache must be involved in the write operation to disk, at least to the extent that it makes sure all data in the cache agrees exactly with the data on the disk. Let us look at one way this could be performed.

Suppose that when the processor needs to write information onto the disk, it writes the information into the cache and then immediately requests the transfer of that part of the cache memory to the disk. This algorithm is known as *write-through*. Assuming we are using an interrupt-driven disk driver, once the transfer is started, the processor does not need to be held up waiting for the write operation to complete and can proceed doing other useful work. Because the write operation is interrupt-driven, it can proceed independently of user tasks to perform

the write to disk. This implementation on a user task makes the effective write performance of the disk essentially the same as for a RAM disk (350K bytes per second) because the user task is held up only for the length of time needed to transfer the data into the cache memory, after which regular processing may be resumed.

One minor penalty is paid for this greatly enhanced write throughput: a short duration of time during which the user task thinks that the data has been written successfully to the disk, but in fact the transfer has not actually taken place. Prior to the completion of the write operation, the cache memory and the disk do not contain identical copies of the data. This is not a problem for future read requests because the cache responds to all processor read requests for this data with the updated result. The problem could occur if the computer were turned off very quickly after the completion of a program, resulting in the cache not having time to flush its contents to disk.

Another difficulty that is more of a nuisance than a serious problem is that the transfer from cache to disk occurs after the user task thinks it has successfully completed its write to disk. Any disk errors detected during the transfer from cache to disk must therefore be handled in the cache or in the OS because the user task thinks it already has completed a successful write to disk before the disk error occurs. This might be a serious problem for disks with high error rates. However, our experience has been that the reliability of a Winchester disk drive is much higher than that of a floppy-disk drive, and that the only error you might get with any frequency from a Winchester disk drive occurs when the drive is not turned on. The improvement obtained by the RAM-disk equivalent performance on disk-write operations greatly outweighs the minor inconveniences of handling disk-write errors.

A second feature that can be implemented in the cache software with essentially no loss in transfer rate is performing automatic verify on write. Again, because the write operation



into cache is complete and the user task has resumed, verification of the integrity of the disk-data write can be done essentially independently, in parallel with the user task, and does not adversely affect the transfer rate of the write requests. The user task still loses the time required to transfer the data, but the disk-access time is not lost because the access overhead is concurrent with execution of the user task. There also is a cluster effect in writing; it is more efficient to write large contiguous groups of blocks than it is to write widely separated single blocks. However, writing is determined by the user task, so there is not a great deal you can do in this area to improve efficiency other than to choose an optimum sequence for writing the blocks to disk. The average access time for writes can be reduced by choosing a sequence that minimizes the average head motion required.

At this point, let us note that when this form of write caching has been adopted, there is a choice of the timing of the actual cache-to-disk transfers. In some cases, particularly in transaction processing for database-management systems, there may be a tendency for a particular piece of data to be written several times in a short time span. In this case, it is wasteful to repeatedly update the disk copy of the data. It would be more efficient to wait until all writes were finished, then update the disk copy. This is usually accomplished by adopting what is called a *write-back* algorithm.

When write-back is used, the cache is not copied to disk until the replacement algorithm determines that the data should be displaced, because that part of the cache is needed for other data. Usually a *dirty* flag is kept for each cluster of the cache, which indicates that the data has been modified but not copied to disk. If the replacement algorithm decides to displace the data, and if the dirty flag is set, the data is "written back" to the disk. Frequently, a timer also is used, so that after some interval of time, while the disk is not too busy, that data is written back anyway. If this were not done, it would be

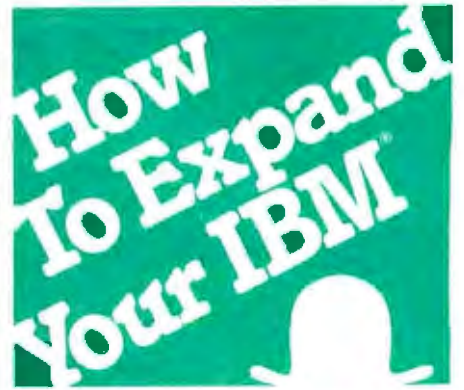
necessary to do something special to flush the cache before powering down the computer; otherwise, the system would lose the updated contents of the cache. A long interval between writing the cache and updating the disk also makes the system more vulnerable to data loss in case of a system crash, unless the system crashes gracefully enough to remember to finish the update first. This grace is rare in small computers.

### Experimental Results

In order to determine experimentally the actual performance potential of a Winchester disk cache as a function of the various parameters discussed, we developed a cache driver for a Percom PHD-10 Winchester disk drive with 10-megabyte capacity, operating on an IBM PC with PC-DOS 2.0. Because PC-DOS 2.0 can use boot-time loading of disk drivers, it was particularly convenient to design the cache as part of the disk driver and not as part of the operating-system file manager. We used the write-through algorithm for all write operations to disk. The prefetch algorithm that we used is the cluster method but uses much larger clusters than the 2 to 4 blocks that are typical cluster sizes in PC-DOS 2.0. We used a cluster size equal to one track of the disk drive (16 blocks). Our choice was based on the hardware performance characteristics of the Winchester drive and its controller.

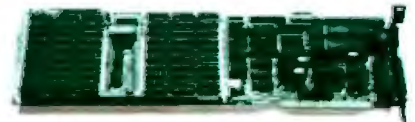
The data is organized on the disk, by interleaving, to optimize the transfer of an entire track of data. For this reason, we decided to transfer an entire track of data into the cache whenever a miss occurred. This may not be the optimal value for the cluster size because it is larger than the file-system cluster size, but we felt that this large cluster size would result in better overall performance for the cache-disk subsystem. This algorithm performs very well on relatively unfragmented disks.

The driver was constructed so that it would keep count of the number of read hits and misses on the cache memory. But first we must spend a little time quantifying what we mean



### Exclusive six-function card expands workspace, increases speed, and boosts memory up to 576K.

The TITAN™ is the only expansion card that gives your IBM PC or XT both hard disk SASI interface and a parallel printer port. This advanced package also includes a pair of RS-232C serial ports, real-time clock/calendar with battery back-up, plus a choice of memory expansions. And everything slips into a single slot!



Pick a TITAN with parity-checked dynamic RAM from 64K to 576K. Each comes ready to run, complete with four super software selections. PSEUDO-DISK™ makes the RAM act like an exceptionally fast disk drive. PSEUDO-PRINT™ print spooler lets your computer calculate while the printer is running. WHATIME™ keeps track of date and time so you don't have to enter them at each system restart. HARDISK™ makes a 10MB Winchester addition plug-in easy.

Yes, it's a lot for one slot. And it's available now to add new utility to your IBM system.

Let us help you expand your IBM's productivity. For information on our multi-function boards and other Titan microcomputer products, see your computer dealer or contact: Titan Technologies, Inc., P.O. Box 8050, Ann Arbor, MI 48107; Telephone (313) 662-8542.

Sales and Marketing by The MARKETING RESOURCE GROUP, Costa Mesa, CA.



IBM PC and XT are registered trademarks of International Business Machines Corp.  
TITAN, PSEUDO-DISK, PSEUDO-PRINT, WHATIME, and HARDISK are trademarks of Titan Technologies, Inc.

## EFFECT OF CACHE SIZE

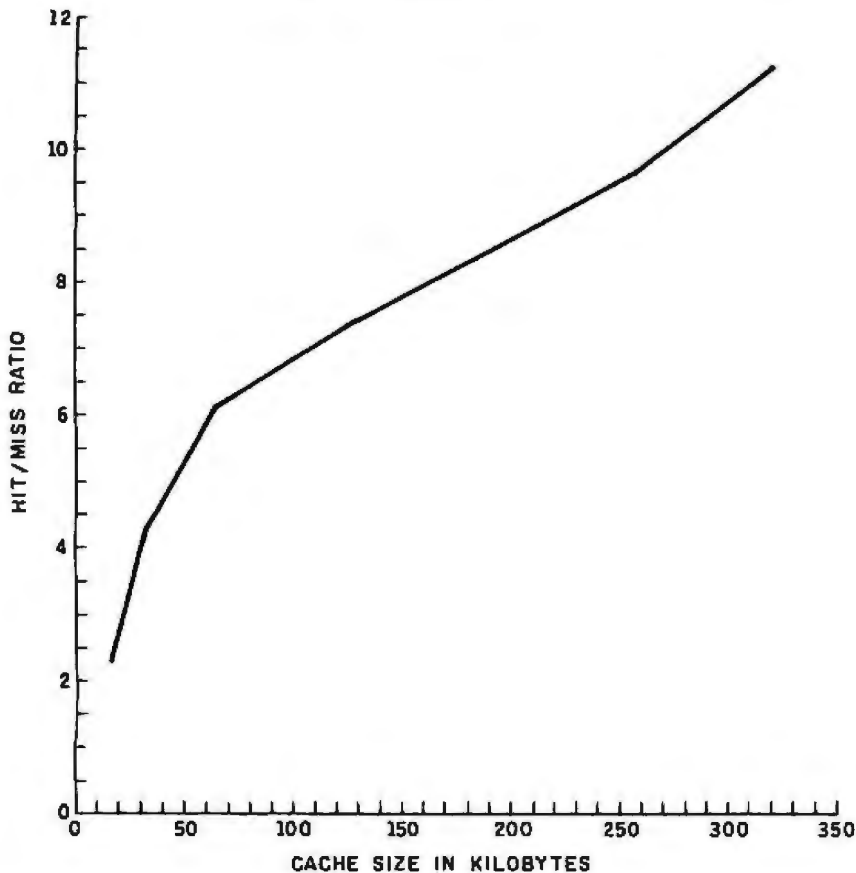


Figure 4: A plot of the effect on the hit/miss ratio of changing the amount of computer memory allocated to caching. This plot corresponds to a mix of programs with little repetitive usage of the same files.

by a hit and a miss.

Suppose the processor makes a read request for four blocks of data from the cache driver. We assume here that all four of the blocks either are contained in cache memory or are not (they are not part in and part out). We also will assume that all four blocks are located on the same track

of the disk. These are not the assumptions made in the actual implementation of the hit/miss computation algorithms, but they make the algorithms easier to describe.

If the four blocks are contained in the cache, the hit count is incremented by 4 to indicate that we had a hit of four blocks. If they are

not contained in cache, the first impression is that you should increment the miss count by 4 to indicate that we had a miss of four blocks. The problem with doing this is that the access time for the first missed block is much slower than the access time for the next three blocks, once the first block has been read.

In order to transfer the first block of data, the heads must move to the correct position on the disk. This, according to the drive manufacturer, requires an average of 80 ms. However, once the head is at the correct position on the track, the transfer of a single block requires only about 5.2 ms. Therefore, blocks 2, 3, and 4 can be transferred with a much smaller time penalty than that of the first block (this is the same premise on which the prefetch algorithm is based).

In order to take this effect into account fairly, we constructed the driver so it kept two miss counters. The first counter is called the hard-miss counter and is incremented by 1 for this example. The second is called the soft-miss counter and is incremented by 3 for this example. In the computation of the hit/miss ratios, the soft-miss count was multiplied by 0.065 ( $5.2 / 80.0$ ) and added to the hard-miss count to get the effective miss count. This data then was used to directly compute the hit/miss ratio as a figure of merit of the efficiency of various cache sizes and replacement algorithms. We considered only the hit/miss ratio for reads because a user task is held up waiting for the transfer to take place

# IN LESS THAN 3 MINUTES

Your IBM Model 50, 60, 65, 75, 85 or 95 Electronic Typewriter can be an RS232C **PRINTER** or **TERMINAL** using our Model 5060 Interface. Our Model 300 Interface can even connect your IBM Electronic typewriter directly into a phone connector to send or receive **ELECTRONIC MAIL**.

**Both Versions can be easily installed and require NO modifications to the typewriter.**

**CMC CALIFORNIA MICRO COMPUTER**  
9323 Warbler Ave., Fountain Valley, CA 92708 (714) 848-3947





# COMPUTER WAREHOUSE

CALL TOLL FREE **1-800-528-1054**

## PRINTERS

<b>Blue Chip</b>	
M120/10 W/Commodore Interface	\$279
M120/15 W/Commodore Interface	\$349
<b>C-Itoh</b>	
A10-20	\$499
F-10-Parallel or Serial	\$935
53 CPS Serial or Parallel	\$1319
8510 Parallel (Prowriter)	\$329
8510 SP	\$455
8510 SCP	\$525
8510 BPI	\$415
<b>Computer International</b>	
Daisywriter 2000 w/48K	\$985
<b>Comrex</b>	
CR-2	\$449
CR-2 Keyboard	\$150
<b>Datasouth</b>	
DS180	\$1150
<b>Diablo</b>	
820	\$850
630 API	\$1699
630 ECS/IBM	\$2075
P-11	\$559
P-11	\$559
<b>Epson</b>	
All Printer Models	Call
<b>Inforunner</b>	
Relaman	\$329
<b>IDS</b>	
Microprism 480	\$375
Prism 132	\$1310
Prism 132 Color	\$1500
<b>Juki</b>	
6100	Call
<b>NEC</b>	
PC-8023A	\$385
PC-8025	\$635
2010	\$775
2015	\$775
2050	\$899
3510	\$1365
3550	\$1710
7710	\$1900
<b>Okidata</b>	
82A	Call
83A	Call
84P	Call
84S	Call
82	Call
93	Call
2350P	Call
2410P	Call
<b>Panasonic</b>	
1090	\$299
<b>Qume</b>	
11/40 w/interface	\$1369
11/85 w/interface	\$1569
Letter Pro 20P	\$609
Letter Pro 20S	\$609
<b>Silver Reed</b>	
EXP400	Call
EXP900P	\$385
EXP500S	\$420
EXP550P	\$480
EXP550S	\$499
<b>Star Micronics</b>	
Gemini-10X	Call
Gemini-15X	Call
Delta 10	Call
Delta 15	Call
Radix	Call
<b>Tally</b>	
MT 180L w/Tractors	Call
MT 180L w/Tractors	Call
Spirit 80	Call
<b>Toshiba</b>	
P1350 Serial or Parallel	\$1445
1351 Serial or Parallel	\$1545
1340	\$775
<b>Transtar</b>	
120 Serial or Parallel	\$395
130 Serial or Parallel	\$549
T315	\$449

## SANYO\* EPSON SYSTEMS

### DUAL DRIVE SYSTEM \$1525

SANYO MBC-555 • SANYO CRT-36  
HI-RES GREEN MONITOR  
EPSON RX-80 WordStar • CalcStar  
• Mailmerge • InfoStar • Spell Star  
• Easywriter • MS-DOS • Sanyo Basic

Above with Sanyo CRT-70  
Color Monitor **\$1939**

### SINGLE DRIVE SYSTEM \$1175

SANYO MBC-550 • SANYO  
CRT-36 HI-RES GREEN  
MONITOR • EPSON RX-80  
WordStar • CalcStar • Easywriter  
• MS-DOS • Sanyo Basic

Above with Sanyo CRT-70  
Color Monitor **\$1629**

## VIDEO TERMINALS

### ADDS

A-2 Green \$490  
Viewpoint 80 \$519

### Altos

Smart II Call

### Hazeltine

Esprit I \$475  
Esprit II \$485  
Esprit III \$575

### Qume

QVT 102 Green \$535  
QVT 102 Amber \$550  
QVT 103 Green \$840  
QVT 103 Amber \$850  
QVT 108 Green \$680  
QVT 108 Amber \$699

### Televideo

910+ \$550  
914 \$515  
924 \$635  
925 \$700  
950 \$900  
970 \$985

### Wyse

Wyse 50 \$489  
Wyse 100 \$880  
Wyse 300 \$1020

### Visual

Visual 50 Green \$619  
Visual 55 Green \$709

### Zenith

Z-28 \$644

## QUADRAM

Quadlink \$449  
Quadboard 64K \$265  
Quadboard 256K \$389  
Quadboard II 64K \$265  
Quadboard II 256K \$389  
Microfazer (ME16) 16K \$129  
Microfazer (ME32) 32K \$149  
Microfazer (MSS16) 16K \$149  
Microfazer (MSS32) 32K \$179

## MONITORS

### Amdek

Video 300 \$130  
Video 300A \$145  
310A \$160  
Color I Plus \$275

### Princeton Graphic

HX-12 \$499  
Taxan 12" Amber \$125

### Zenith

12" Green Screen \$95  
12" Amber Screen \$95

## DISK DRIVES

### Rana

Elite 1 \$215  
Elite 2 \$345  
Elite 3 \$410  
Controller (w/Drive only) \$65  
1000 w/DOS (for Atari) \$305

## DISKETTES

### Maxell

MD-1 (Qty 100) \$189  
MD-2 (Qty 100) \$295

### Scotch

744-D (Qty 100) \$200

### Elephant

S/B S/D (Qty 100) \$155  
D/S D/D (Qty 100) \$235

## MODEMS

### Hayes

Smartmodem \$199  
Smartmodem 1200 \$485  
Smartmodem 1200B \$430  
Micromodem IIe \$235

### US Robotics

212A Autodial \$420  
Passwork 1200 \$310  
IBM PC Modem \$320

## COMPUTERS

### Altos

All models Call

### Columbia

Corona Call

### Eagle

PC-2 w/Monochrome Monitor \$2699  
Spirit-2 \$2525  
Spirit-XL \$3675

### NEC

PC-8201A CPU \$589  
PC-8206A 32K Ram \$289  
PC-8221A Thermal Printer \$129  
PC-8261A Recorder \$89  
PC-8201A-90 Battery Pack \$15

### Sanyo

MBC-550 System \$1175  
MBC-555 System \$1525

### Televideo Systems

802 H \$4210  
803 \$1765  
803H Call  
1603 \$2150  
806/20 \$4599  
800 A (user station) \$975  
TPC-1 \$1525

### Zenith

Z-100 Low Profile \$2625  
Z-100 All-In One \$2800  
Z-150 Single Drive \$1949  
Z-150 Dual Drive \$2349  
Z-150 10 Megabyte \$3449  
Z-160 Single Drive \$2099  
Z-160 Dual Drive \$2399

Order Line: 1-800-528-1054

Order Processing & Other Information: 602-954-6109



2222 E. Indian School Rd.  
Phoenix, Arizona 85016

Store Hours: Mon-Fri 10-5:30 Saturday 9-1  
Order Line Hours: Mon-Fri 8:30-5:30 Saturday 9-1



Prices reflect 3% to 5% cash discount. Product shipped in factory cartons with manufacturer's warranty. Please add \$8.00 per order for shipping. Prices & availability subject to change without notice. Send cashier's check or money order...all other checks will delay shipping two weeks.

## REPLACEMENT ALGORITHMS

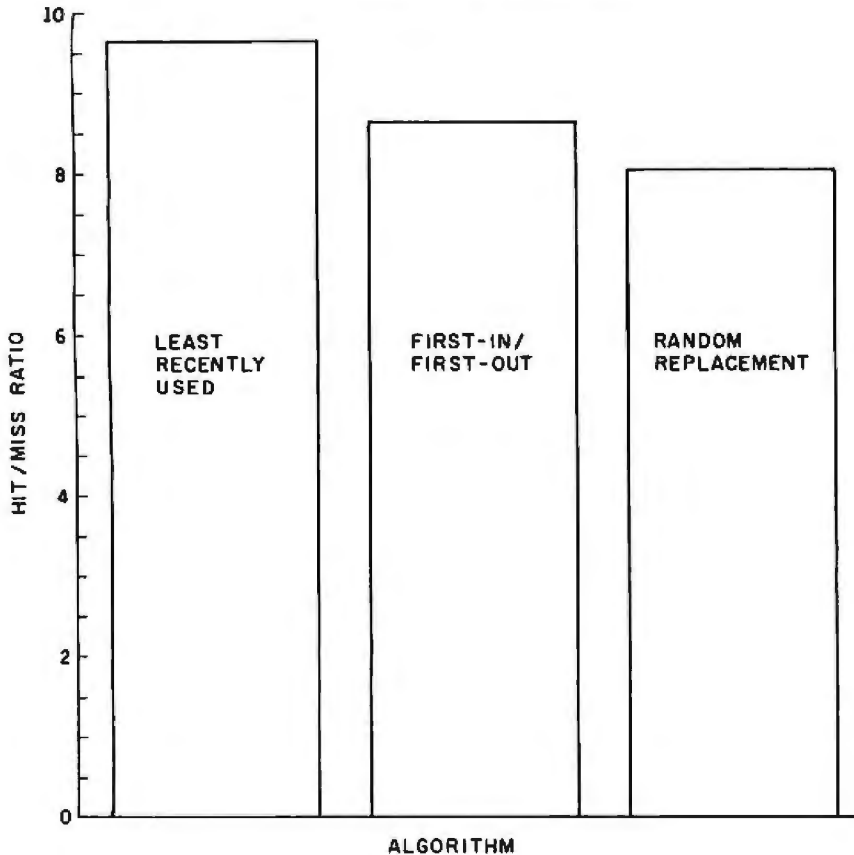


Figure 5: A bar chart of the effect of the hit/miss ratio of using different replacement algorithms to determine which part of the cache to discard.

only in the case of a read. All writes are automatically hits by this definition.

The hit/miss ratio depends very strongly on the I/O (input/output) characteristics of the particular tasks using the disk. To see why this is the case, imagine that we are repetitively performing operations that involve disk transfers totally contained in the

cache memory. The hit/miss ratio continues to increase as we repeat operations on the same disk data.

You might ask, however, what conditions would correspond to repeated operations on the same files. Examples of this include running the same program several times (for instance, in a spreadsheet or a BASIC program), repeated editing or word

processing of the same text file, or repeated editing and compiling using a language processor.

Our first choice for the mix of tasks was selected as a worst-case test of the advantages of caching. We picked a class of jobs that would use the disk extensively and would have the minimal repetitive usage of the same files. Our mix of tasks consisted of a C compilation of a medium-size program (350 lines) followed by a Pascal compilation of a long program (1000 lines). The compiled Pascal program was then linked to form an executable load module. The total number of blocks requested to be read by the processor was about 2000. We ran this same sequence of programs for each of the tests so that the effect of the mix of programs would not bias the conclusions for the relative efficiency of the various algorithms. In each case, the cache started empty.

Figure 4 shows the hit/miss ratio as a function of the cache size for the LRU replacement algorithm and a prefetch value of 16 blocks (whenever a miss occurs, one full track of data is prefetched). Notice that even for this worst-case mix of programs, the effective hit/miss ratio is almost 10 by the time you get to 256K bytes of caching memory and becomes greater than 10 for 320K bytes of caching memory. We may expect to achieve our goal of a hit/miss ratio of 10 using 256K bytes of dedicated caching memory for a better mix of programs.

We'll now look at the effect of various cache replacement algorithms on the hit/miss ratio. To do

*Text continued on page 330*

IBM Apple Z-100



## Statistics + Data Plotting Software

This book/disk package contains 18 programs in BASIC for processing and plotting data. They uniquely combine statistics with computer graphics to give you data plotting capabilities found only in programs costing many times more - and they're all fully documented in BASIC so you can modify and combine them for special applications.

Programs plot histograms with mean and standard deviation, sort and draw pie charts, linear plots, log plots, barcharts, running averages, stock market charts, 3D views of surfaces. Special features include curve fitting, regression, data management, automatic scaling and axis labeling, automatic replotting when data changes. Send check or Visa/Mastercard no. with expiration date. Call for faster delivery. All items in stock and ready to go. Book with Disk \$52.00. Please specify IBM, Apple or Z-100.

Kern International, 433 Washington St  
PO Box 1029MB, Duxbury, MA 02331 (617)934-0445

Send for free SOFTKIT catalog



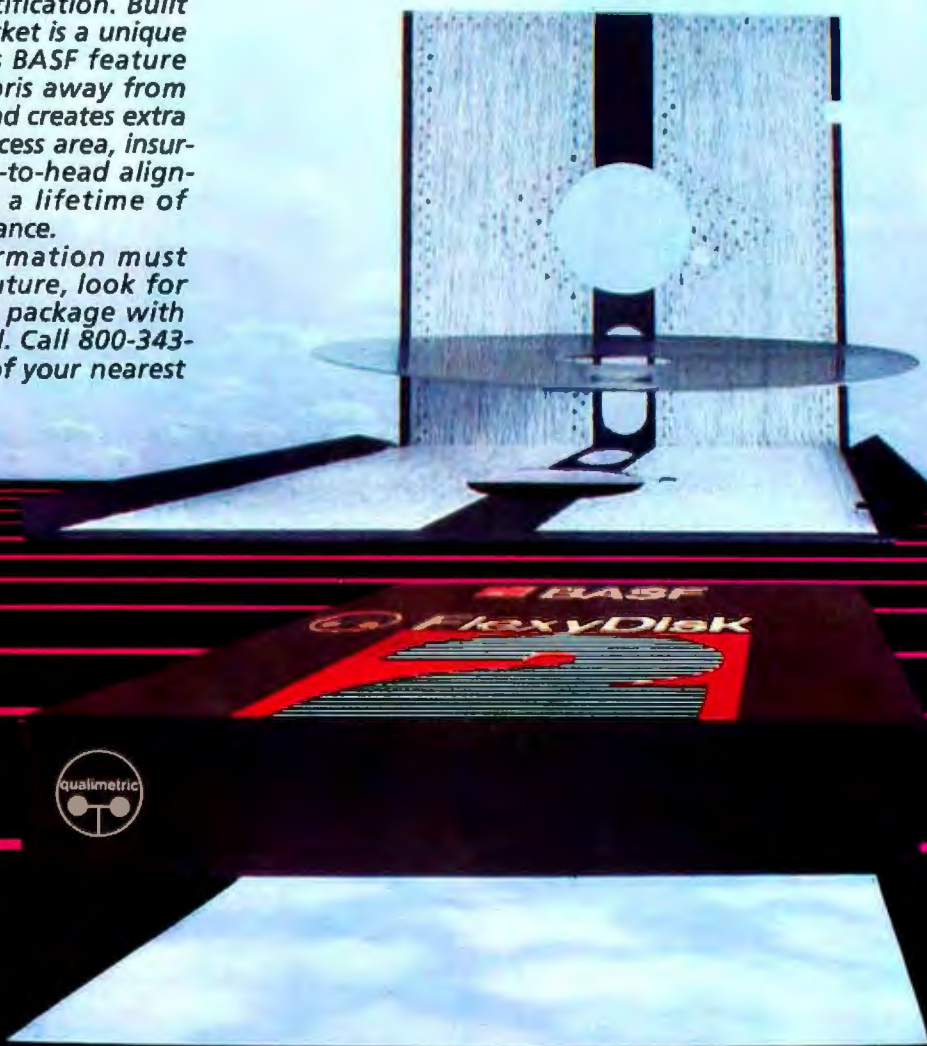
# BASF QUALIMETRIC™ FLEXYDISKS® BUILT FOR ETERNITY - WARRANTED FOR A LIFETIME.

*BASF Qualimetric FlexyDisks® offer you more...an extraordinary new lifetime warranty.\* The BASF Qualimetric standard is a dramatic new international standard of quality in magnetic media...insurance that your most vital information will be secure for tomorrow when you enter it on BASF FlexyDisks today.*

*We can offer this warranty with complete confidence because the Qualimetric standard reflects a continuing BASF commitment to perfection...a process which begins with materials selection and inspection, and continues through coating, polishing, lubricating, testing, and 100% error-free certification. Built into our FlexyDisk jacket is a unique two-piece liner. This BASF feature traps damaging debris away from the media surface, and creates extra space in the head access area, insuring optimum media-to-head alignment. The result is a lifetime of outstanding performance.*

*When your information must be secure for the future, look for the distinctive BASF package with the Qualimetric seal. Call 800-343-4600 for the name of your nearest supplier.*

Circle 54 on inquiry card.



ENTER TOMORROW ON BASF TODAY



**BASF**

\*Contact BASF for warranty details. © 1982, BASF Systems Corporation, Bedford, MA



# It Reads, Writes and It Paints in 3-D, Keeps and Talks to

It's called "OPEN ACCESS," and it's the result of 60 man-years of effort to create a truly do-it-all, super-program—one that can perform virtually every task you're ever likely to encounter.

The beauty of it is, all that capability resides on a single program. You don't have to re-enter data. Or spend time trying to get unmatched programs to work together.

OPEN ACCESS takes its name from the source of its power—a relational data-base manager that gives you access to more data in more ways than any comparable software.

OPEN ACCESS includes an electronic spreadsheet, 3-D graphics, word processor, appointment scheduler and telecommunications module—all revolving around the powerful information manager.

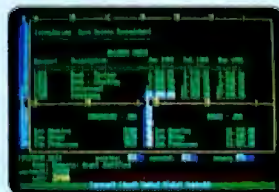


1



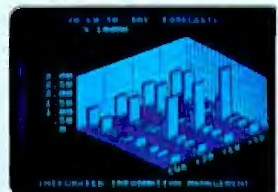
**INFORMATION MANAGEMENT—THE MASTERMIND.** This advanced data-base manager stores and retrieves multiple files quickly, easily and reliably. What's more, it shares all information with the other programs, so you never have to re-enter the same data twice.

2



**ELECTRONIC SPREADSHEET—NUMBER CRUNCHING AND GOAL SEEKING.** It helps you produce forecasts, cost estimates and "break-even" points—in seconds, instead of hours or days. Best of all, it allows "goal seeking." Ask, for example, "What sales must I have the rest of the year to net \$1 million?" and OPEN ACCESS will figure it out.

3



**3-D GRAPHICS—NOT JUST PRETTY PICTURES.** These graphics distill raw data into trends that can be instantly visualized, helping you discern the important facts from a wealth of information.



# Does Arithmetic. Your Appointments the World.

Because they do not have a dedicated relational data-base manager that can quickly direct massive amounts of data, other programs simply can't do what OPEN ACCESS can. Some don't have a communications program, others no dedicated word processor. None have a time management program.

There's just one conclusion: At \$595\*, OPEN ACCESS can do more for you than any other comparable business program on the market. Bar none. But the only way for you to be convinced is for you to see OPEN ACCESS work its magic on your work load. So call your local software dealer today, or call us at SPI, at 619-450-1526.

\*Introductory price

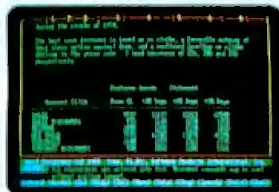


## SPI

SOFTWARE PRODUCTS INTERNATIONAL

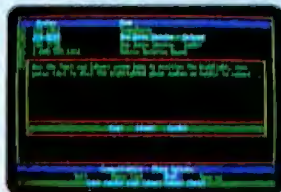
10240 Sorrento Valley Road  
San Diego, CA 92121

# 4



**WORD PROCESSING—EDITOR**  
(TRAORDINAIRE! Superior word processors make it easy to correct typos, change words, shuffle paragraphs and format documents. This is one of that breed. Use it to write efficient memos, letters, proposals and reports.

# 5



**TELECOMMUNICATIONS—YOUR LINK WITH THE WORLD.** This program gives you access to virtually any other computer system in the world. Not only can you transmit and receive reports from your colleagues, you can also subscribe to special data banks that know everything from GM's stock price to the relative humidity in Genoa. Now that's power!

# 6



**TIME MANAGEMENT—CONSERVING YOUR MOST PRECIOUS RESOURCE.** This module helps you keep track of all your appointments, hour by hour, day in and day out. It alerts you to standing obligations, automatically coordinates meeting times with other busy professionals, and lists all your associates on a Rolodex™-like file.

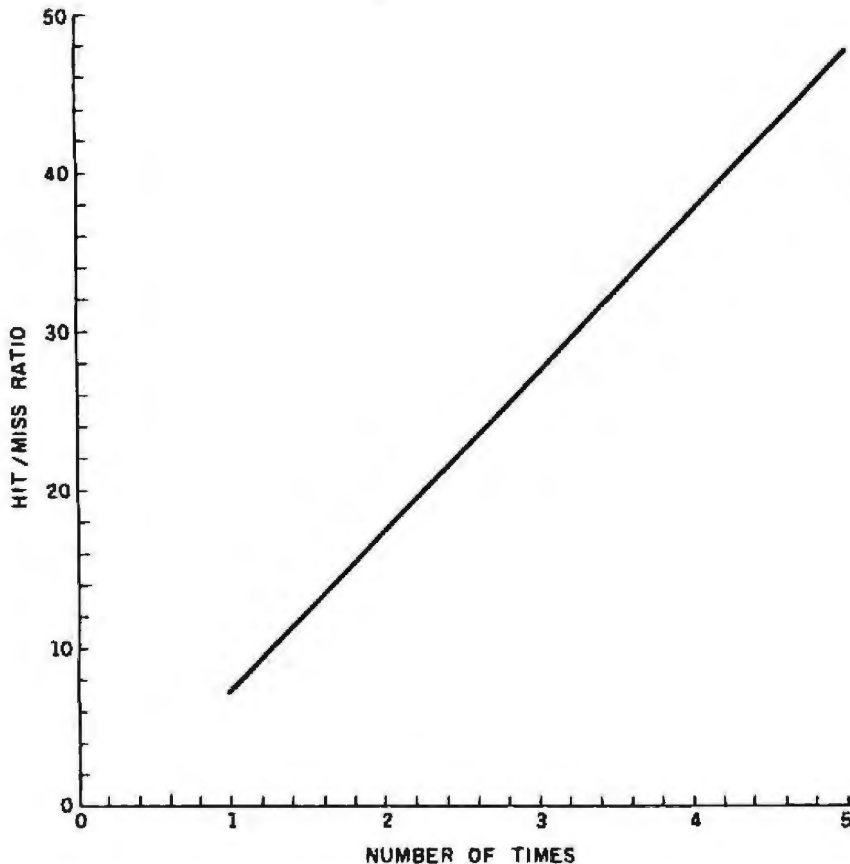


Figure 6: A plot of the change in the hit/miss ratio produced by multiple I/O operations on the same set of files. This plot is for repetitive word processing on part of the text for this article, and it is typical of fully cached operation.

Text continued from page 326:

this, the disk driver was modified to let us use any of the three algorithms in the cache module. Figure 5 shows the measured hit/miss ratios of the three different replacement algorithms. This data was collected using a cache memory allocation of 256K bytes. Notice that, as predicted, the LRU algorithm produces a slightly higher hit/miss ratio than either the FIFO or the random-replacement algorithms. Although the effect is not too large (10 to 20 percent), we thought it significant enough to justify the use of this algorithm even though it is somewhat more complex to implement.

To show how the caching driver might achieve an even greater hit/miss ratio for a more fortunate mix of programs, for our next example we took the text editing of this article, and we plotted the hit/miss ratio as a function of the number of times the word processor was executed for the purpose of writing part of this text.

These results, also corresponding to a cache size of 256K bytes, are plotted in figure 6.

---

### **Programs that are heavy on file access can show large improvement factors with the use of caching.**

---

The large increase in the hit/miss ratio from 7 to almost 50 when the word processor is used on the text file needs some explanation. When the word processor is first run, the files containing both it and the text file are loaded into the cache memory, then passed through to the processor. Unless they were previously in the cache, this results in a certain miss count that depends on the size of the word processor and the size of the text file. When the editing of the file is completed, the updated file is written out to the cache and then auto-

matically transferred to the disk, but if the cache memory is sufficiently large, both the word processor and the updated text file also will remain in the cache. When the word processor is again used to edit the same text file, the cache will contain both. The second and all subsequent modifications to the file result in nothing but hits on the cache memory. In this case, which is referred to as being *fully cached*, you can therefore expect the hit/miss ratio to continue upward in a manner proportional to the number of times the word processor is used on the same file. Because word processing and computer programming frequently entail this sort of cyclic use of a small set of files, the benefits from disk caching for this type of computer usage are obvious from the plot. Of course, this speed-up effect does not mean that all processing is speeded up; it only applies to time that would otherwise be lost during inefficient disk transfers. If a program is computation intensive, with little file access, its execution speed is largely unaffected. Programs that are heavy on file access can show large improvement factors.

In general, "tuning" the cache memory allocation consists primarily of trying to get the cache size large enough to hold virtually all of the files in use over some reasonable period of time. This situation may be compared with a RAM disk where the size choice is made in much the same way.

In some systems, attempts have been made to use small caches of 64K bytes or less. Our experience is that attempting to use too small a cache frequently degrades performance rather than enhances it, so it is important to accurately assess the needs and provide adequate memory for this purpose. At the same time, using a larger cache size than is needed for the normal mix of tasks done is simply wasteful and expensive. A larger than average utilization of disk data would necessitate a larger disk cache; a frugal user of disk data might get by with less.

It is useful to compare the cache concept with that of the RAM disk. The big advantage of disk caching



# SPSS/PC™

**NEW!**  
IBM PC and  
DEC PRO 350

## Statistical and Reporting Software

SPSS Inc. a leading producer of statistical software for over 15 years, with more than a half million manuals sold in 80 countries, is making micro waves with SPSS/PC and SPSS/Pro.™ Two powerful new statistical and reporting programs which were designed for the IBM Personal Computer and the DEC Professional 350.

### POWERFUL STATISTICS

- Crosstabulations
- Analysis of variance
- Multiple regression
- Over 25 integrated procedures

### TOTAL INTEGRATION

- File management of large or small data sets
- Input & output to popular PC programs
- Flexible data transformations

### CUSTOM DISPLAYS

- Automatic or custom reports
- Fully labeled tables
- Plots & graphs

### EASY TO LEARN

- Simple English commands
- Tutorial & demonstration diskette included
- Comprehensive documentation for all levels of users

**SPSS inc.**

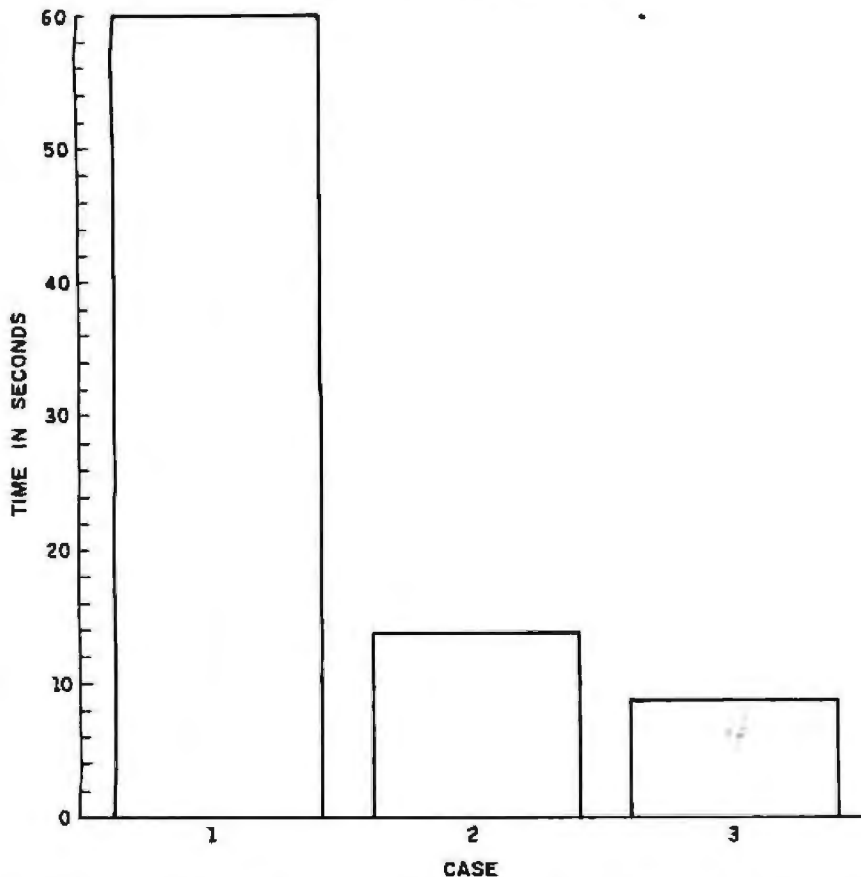
444 N. Michigan Avenue  
Chicago, Illinois 60611  
(312) 329-2400

For the DEC Professional 350, and soon for the IBM PC with hard disk. To discover how SPSS can help you make waves, call us for the full story. (312) 329-2400.

SPSS, SPSS/PC and SPSS/Pro are trademarks of SPSS Inc. for its proprietary computer software. IBM PC is a trademark of IBM Corporation. DEC and DEC Professional are trademarks of Digital Equipment Corporation.

© Copyright 1983. SPSS Inc.

## TIME FOR FILE TRANSFER



**Figure 7:** A bar plot of the time required for a program to read a file of 100K bytes, perform minor processing on the data, and write the file back to disk. Bar 1 was obtained using a driver with no caching. Bar 2 was obtained using caching, but with the cache initially empty so that file and program data had to be read into the cache. Bar 3 was obtained under the fully cached condition where all of the required disk data was already contained in the cache.

over a RAM disk is that the selection of which files are to be placed into the "fast disk" is completely automatic rather than manual, and the cache approach provides automatic, read-verified backup to the nonvolatile physical disk; consequently, it is unnecessary to remember to write the files back manually, and the risk of data loss due to power failure is minimized. The adverse effect of disk fragmentation can be overcome by occasionally performing a full backup and restore of all files on the disk. Doing this results in a completely compacted disk with all files completely contiguous. Thereafter, only those files that are modified will become fragmented, and the average fragmentation will be small. Besides the value of performing regular backup, this practice is beneficial even without caching.

Finally, to demonstrate that caching does produce a substantial improvement in overall system speed, we ran timing tests on two typical programs.

---

### **The time spent in caching algorithms was insignificant compared with the time spent performing the actual data transfer.**

---

The first task is a file copy. This program reads a file one block at a time, performs some processing on the data, and writes the resulting data back to the disk into a different file. The two files were moderately far apart on the disk. Figure 7 shows the time required to carry out this task in three cases. In the first case, no

caching was used. In the second case, caching was used, but the program and files were not already in the cache. The third was the fully cached case, with the program and files already in the cache from the second test. By using the caching driver, this test exhibits improvement, by more than a factor of four, in the total execution time for this program.

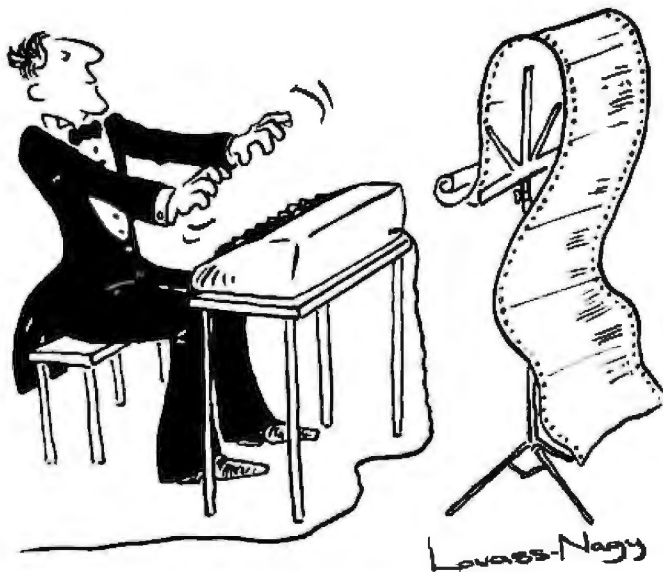
Figure 8 shows the time required to compile and link the program used to collect the data presented in figure 7. The improvement is not as dramatic in this example because these tasks are more computation intensive, with less time spent in disk operations. Nevertheless, there is a decrease of 30 percent in total execution time.

You might well ask whether you should consider the degradation in the transfer rate produced by using the more complex algorithms in the cache system. That is, are we slowing down the transfer rate by spending too much time in determining if the data is in cache memory, or in sophisticated prefetch and replacement algorithms? We found, at least in the case of PC-DOS 2.0, that the time spent in the various caching algorithms was insignificant in comparison with the time spent performing the actual data transfer. It therefore turns out that the cache memory has a transfer rate almost equal to a RAM-disk system whenever it contains the requested data. We have, of course, implicitly assumed this fact in our previous plots of transfer rate versus hit/miss ratio. In this regard, disk caching has an advantage over memory caching. In disk caching, the various algorithms are executed once, at most, for every block that is transferred; in memory caching, some of the algorithms are executed once for each byte or word that is transferred.

### **Conclusion**

We have determined that you can utilize the added addressable memory afforded by 16-bit processors in a very useful way to improve the overall effective transfer rate of Winchester systems and to provide apparent, sometimes dramatic, performance increases. For the case of cach-





Before Johann Sebastian Bach developed a new method of tuning, you had to change instruments practically every time you wanted to change keys. Very difficult.

Before Avocet introduced its family of cross-assemblers, developing micro-processor software was much the same. You needed a separate development system for practically every type of processor. Very difficult and very expensive.

But with Avocet's cross-assemblers, a single computer can develop software for virtually any microprocessor! Does that put us in a league with Bach? You decide.

## The Well-Tempered Cross-Assembler

### Development Tools That Work

Avocet cross-assemblers are fast, reliable and user-proven in over 3 years of actual use. Ask NASA, IBM, XEROX or the hundreds of other organizations that use them. Every time you see a new microprocessor-based product, there's a good chance it was developed with Avocet cross-assemblers.

Avocet cross-assemblers are easy to use. They run on any computer with CP/M\* and process assembly language for the most popular microprocessor families.

5¼" disk formats available at no extra cost include Osborne, Xerox, H-P, IBM PC, Kaypro, North Star, Zenith, Televideo, Otrona, DEC.

### Turn Your Computer Into A Complete Development System

Of course, there's more. Avocet has the tools you need from start to finish to enter, assemble and test your software and finally cast it in EPROM:

**Text Editor VEDIT** -- full-screen text editor by CompuView. Makes source code entry a snap. Full-screen text editing, plus TECO-like macro facility for repetitive tasks. Pre-configured for over 40 terminals and personal computers as well as in user-configurable form.

CP/M-80 version ..... \$150  
 CP/M-86 or MSDOS version ..... \$195  
 (when ordered with any Avocet product)

**EPROM Programmer** -- Model 7128 EPROM Programmer by GTek programs most EPROMS without the need for personality modules. Self-contained power supply ... accepts ASCII commands and data from any computer through RS 232 serial interface. Cross-assembler hex object files can be down-loaded directly. Commands include verify and read, as well as partial programming.

PROM types supported: 2508, 2758, 2516, 2716, 2532, 2732, 2732A, 27C32, MCM8766, 2564, 2764, 27C64, 27128, 8748, 8741, 8749, 8742, 8751, 8755, plus Seeq and Xicor EEPROMS.

Avocet Cross-assembler	Target Microprocessor	CP/M-80 Version	CP/M-86 IBM PC, MSDOS** Versions
XASMZ80	Z-80	\$200.00 each	\$250.00 each
XASM85	8085		
XASM05	6805		
XASM09	6809		
XASM18	1802		
XASM48	8048/8041		
XASM51	8051		
XASM65	6502		
XASM68	6800/01		
XASMZ8	Z8		
XASMF8	F8/3870		
XASM400	COP400		
XASM75	NEC 7500		\$500.00
Coming soon: XASM68K...68000			\$300.00 each

(Upgrade kits will be available for new PROM types as they are introduced.)

Programmer ..... \$429  
 Options include:  
 Software Driver Package - enhanced features, no installation required.  
 CP/M-80 Version ..... \$ 75  
 IBM PC Version ..... \$ 95  
 RS 232 Cable ..... \$ 30  
 8748 family socket adaptor ... \$ 98  
 8751 family socket adaptor ... \$174  
 8755 family socket adaptor ... \$135

**G7228 Programmer by GTek** -- baud to 2400 ... superfast, adaptive programming algorithms ... programs 2764 in one minute.

Programmer ..... \$549  
 Ask us about Gang and PAL programmers.  
**HEXTRAN Universal HEX File Converter** - Converts to and from Intel, Motorola, MOS Technology, Mostek, RCA, Fairchild, Tektronix, Texas Instruments and Binary formats.  
 Converter, each version ..... \$250

### Call Us

If you're thinking about development systems, call us for some straight talk. If you don't have what you need, we'll help you find out who does. If you like, we'll even talk about Bach.

**CALL TOLL FREE 1-800-448-8500**  
 (In the U.S. except Alaska and Hawaii)

VISA and Mastercard accepted. All popular disc formats now available -- please specify. Prices do not include shipping and handling -- call for exact quotes. OEM INQUIRIES INVITED

\*Trademark of Digital Research \*\*Trademark of Microsoft



**AVOCET SYSTEMS INC.**  
 DEPT. 584-B  
 804 SOUTH STATE STREET  
 DOVER, DELAWARE 19901  
 302-734-0151 TELEX 467210

## SPECTACULAR OFFERS

### wabash

6 YEAR WARRANTY

M11	5 1/4"	SINGLE SIDE SINGLE DENSITY	1.49*
M13	5 1/4"	SINGLE SIDE DOUBLE DENSITY	1.89*
M14	5 1/4"	DOUBLE SIDE DOUBLE DENSITY	2.39*
M16	5 1/4"	DOUBLE SIDE QUAD DENSITY	3.49*
F111	8"	SINGLE SIDE SINGLE DENSITY	1.89*
F1312	8"	SINGLE SIDE DOUBLE DENSITY	2.59*
F144	8"	DOUBLE SIDE DOUBLE DENSITY	2.99*

### maxell.

LIFETIME WARRANTY

MD1	5 1/4"	DOUBLE SIDE DOUBLE DENSITY	2.09*
FD1-128	8"	DOUBLE SIDE DOUBLE DENSITY	3.49*

### BASF

7 YEAR WARRANTY

54968	5 1/4"	ss,dd	1.79*
53428	8"	ss,dd	1.89*

### BASF

LIFETIME WARRANTY

54974	5 1/4"	ss,dd	2.09*
54998	8"	ss,dd	2.29*

### TDK

LIFETIME WARRANTY

2501	5 1/4"	ss,dd	2.19*
2801	8"	ss,dd	3.59*

### Memorex

1 YEAR WARRANTY

3481	5 1/4"	ss,dd	1.99*
3062	8"	ss,dd	2.09*

### 3M

LIFETIME WARRANTY

744D-0	5 1/4"	ss,dd	1.99*
740-0	8"	ss,dd	2.30*

### FUJI

LIFETIME WARRANTY

MD1D	5 1/4"	ss,dd	2.14*
FD1S	8"	ss,dd	3.09*

WE ALSO STOCK AT FANTASTIC LOW PRICES

**OPUS**  
Floppy, Tape, Drum Cartridges, Data Cartridges and Disk Packs

**Dynan**  
Microfilm

**ULTRA**  
Microfilm

\* QUANTITY 100. SMALLER QUANTITIES ADD 5%

#### DISK DRIVE HEAD CLEANING KITS

5% 15.95

#### C-10 CASSETTES

Get 6 cassettes, and Cassette/Library Album 8.00

#### SNAP-IT POWER CENTER

Turn one outlet into six!  
Power Surge Control  
RFI Filtration  
15 Amp Circuit Breaker 59.95

#### LIBRARY CASES

5" KAS-4510/10 2.99  
5" MINI KAS-5610/10 2.49

#### BOOK VALUES

FULL SELECTION, DISCOUNT PRICES  
on hundreds of titles published by ALFRED, HAYDEN, DILITHIUM, SAMS, TAB, McGRAW HILL and many others.

#### SOFTWARE

AT FANTASTIC PRICES SAVE UP TO 50% on thousands of software packages for all systems, including Business, Language, Engineering, Games, Graphics, Utility, and many more.

\* Write-in purchase orders accepted from government agencies and well rated firms for net 30 day billing • International orders accepted with a 15.00 surcharge for handling, plus shipping charges. • C.O.D. requires a 10% deposit. • We accept Visa, MasterCard, Money Order, and Certified checks. • Checks require bank clearances. • All shipments F.O.B. San Diego • Maximum shipping and handling 2.00, minimum order 10.00. • California residents add 6% sales tax. Prices and terms subject to change without notice. • All sales subject to availability, acceptance and verification. • All sales are final. • Satisfaction guaranteed or full refund.

We also offer printer ribbons, printwheels, type elements, equipment covers, power consoles, paper supplies, storage and filing equipment, furniture and many other accessories for word and data processing systems. Write for our free catalog.

Orders Only  
**800-854-1555**

Information  
**619-268-3537**

MasterCard (Anytime)  
**619-268-4488**

Exclusive Monthly Specials

# ABC

DATA PRODUCTS

ITT TELEX 4992217  
8865 CLAIREMONT MESA BLVD  
SAN DIEGO, CALIFORNIA 92123

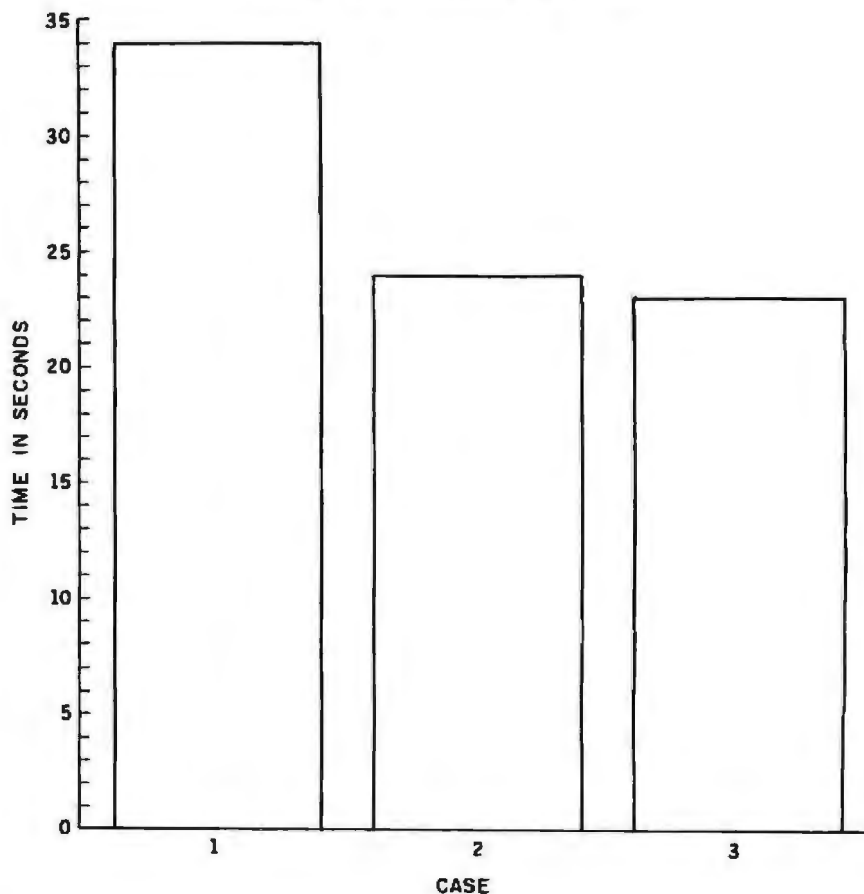


Figure 8: A bar plot of the time required to compile and link a C program. As in figure 7, bar 1 was obtained with no caching, bar 2 was obtained with an empty cache, and bar 3 was obtained with fully cached operation.

ing within the disk driver, the cluster prefetch method does a good job. We chose the cluster size based on characteristics of the disk hardware.

It appears that the LRU replacement algorithm delivers the best hit/miss ratio and should be used because the time spent in the actual transfer dominates the computation overhead. We also found that the complexity of the various algorithms had a negligible effect on the transfer rate.

On the basis of the example of the extremes between little repetitive usage and significant repetitive usage, we feel that the average single-user system can expect an overall hit/miss ratio greater than 10 for a cache size of 256K bytes. We generally attain hit/miss ratios of 20 to 50. These high ratios lead to an overall improvement in the disk transfer rate of 5 to 15, depending on the amount of head movement that occurs in the un-

cached disk. The effect of caching for the case where all of the files accessed are fully cached is that the transfer rate after the files first have been brought into cache is equal to that of a RAM disk. The improvement produced by utilizing a disk cache is significant for the case of single-tasking operating systems. It should be almost indispensable for a multitasking system, or for a Winchester disk drive used as a file server by several computers in a local-area network. ■

Roy C. Chaney holds a Ph.D. in solid-state physics and is an associate professor of physics at the University of Texas at Dallas.

Brian W. Johnson holds a Ph.D. in electrical engineering. He is on leave from the University of Texas at Dallas, where he is an associate professor of physics and computer science. Johnson was a vice-president of research at Percom Data Corporation when this article was written.

The authors can be reached at the Department of Physics, POB 688, University of Texas, Dallas, TX 75080.



# Introducing the Most Powerful Business Software Ever!

TRS-80™ (Model I, II, III, or 16) • APPLE™ • IBM™ • OSBORNE™ • CP/M™ • XEROX™



## The VERSABUSINESS™ Series

Each VERSABUSINESS module can be purchased and used independently, or can be linked in any combination to form a complete, coordinated business system.

**VERSARECEIVABLES™** \$99.95  
**VERSARECEIVABLES™** is a complete menu-driven accounts receivable, invoicing, and monthly statement-generating system. It keeps track of all information related to who owes you or your company money, and can provide automatic billing for past due accounts. **VERSARECEIVABLES™** prints all necessary statements, invoices, and summary reports and can be linked with **VERSALEDGER II™** and **VERSAINVENTORY™**.

**VERSAPAYABLES™** \$99.95  
**VERSAPAYABLES™** is designed to keep track of current and aged payables, keeping you in touch with all information regarding how much money your company owes, and to whom. **VERSAPAYABLES™** maintains a complete record on each vendor, prints checks, check registers, vouchers, transaction reports, aged payables reports, vendor reports, and more. With **VERSAPAYABLES™**, you can even let your computer automatically select which vouchers are to be paid.

**VERSAPAYROLL™** \$99.95  
**VERSAPAYROLL™** is a powerful and sophisticated, but easy to use payroll system that keeps track of all government-required payroll information. Complete employee records are maintained, and all necessary payroll calculations are performed automatically, with totals displayed on screen for operator approval. A payroll can be run totally, automatically, or the operator can intervene to prevent a check from being printed, or to alter information on it. If desired, totals may be posted to the **VERSALEDGER II™** system.

**VERSAINVENTORY™** \$99.95  
**VERSAINVENTORY™** is a complete inventory control system that gives you instant access to data on any item. **VERSAINVENTORY™** keeps track of all information related to what items are in stock, out of stock, on backorder, etc., stores sales and pricing data, alerts you when an item falls below a preset reorder point, and allows you to enter and print invoices directly or to link with the **VERSARECEIVABLES™** system. **VERSAINVENTORY™** prints all needed inventory listings, reports of items below reorder point, inventory value reports, period and year-to-date sales reports, price lists, inventory checklists, etc.

**VERSALEDGER II™** \$149.95  
**VERSALEDGER II™** is a complete accounting system that grows as your business grows. **VERSALEDGER II™** can be used as a simple personal checkbook register, expanded to a small business bookkeeping system or developed into a large corporate general ledger system **without any additional software**.

- **VERSALEDGER II™** gives you almost unlimited storage capacity (300 to 10,000 entries per month, depending on the system),
- stores all check and general ledger information forever,
- prints tractor-feed checks,
- handles multiple checkbooks and general ledgers,
- prints 17 customized accounting reports including check registers, balance sheets, income statements, transaction reports, account listings, etc.

**VERSALEDGER II™** comes with a professionally-written 160 page manual designed for first-time users. The **VERSALEDGER II™** manual will help you become quickly familiar with **VERSALEDGER II™**, using complete sample data files supplied on diskette and more than 50 pages of sample printouts.

### SATISFACTION GUARANTEED!

Every **VERSABUSINESS™** module is guaranteed to outperform all other competitive systems, and at a fraction of their cost. If you are not satisfied with any **VERSABUSINESS™** module, you may return it within 30 days for a refund. Manuals for any **VERSABUSINESS™** module may be purchased for \$25 each, credited toward a later purchase of that module.

To Order: **Write or call Toll-free (800) 431-2818**  
 (N.Y.S. residents call 914-425-1535)

- \* add \$3 for shipping in UPS areas
- \* add \$5 to CANADA or MEXICO
- \* add \$4 for C.O.D. or non-UPS areas
- \* add proper postage elsewhere

DEALER INQUIRIES WELCOME

All prices and specifications subject to change. Delivery subject to availability.



# COMPUTRONICS!

50 N. PASCACK ROAD, SPRING VALLEY, N.Y. 10977

\* TRS-80 is a trademark of the Radio-Shack Division of Tandy Corp. • APPLE is a trademark of Apple Corp. • IBM is a trademark of IBM Corp. • OSBORNE is a trademark of Osborne Corp. • CP/M is a trademark of Digital Research • XEROX is a trademark of Xerox Corp.



# Does your Apple leave you hungry?



We've got speed, performance and 3,000 new applications to satisfy that appetite.

Introducing the Digital Research CP/M Gold Card.™ The pick of the hardware crop for your Apple® Computer

Just plug it into any slot in your Apple II, II+ or IIe, and you get a new generation machine that runs CP/M Plus™ and all those programs it could never handle before.

Impressive, but not surprising. After all, who better than the creators of CP/M® to perfect it for your Apple?

And if you thought your Apple was a bit slow, chew on this.

We combined CP/M Plus, the Z80B microprocessor and optional Disk Cache to push your Apple to perform up to three times faster than any of the competition.

With the speed to handle programs like dBase II™ in half the time. And we've included CBASIC® so you can write customized programs.





It even boosts your monitor's CP/M output to full 80 column video. And those are just the basics.

For serious programmers we also included a macro-assembler and symbolic debugger. Explaining it all in two complete manuals.

It all comes down to this. Soon

there will be two kinds of Apple users. Those with the CP/M Gold Card. And those who are still hungry for one.

The products and corporate logos referred to herein may be trademarks or registered trademarks of the companies indicated. The Digital Research logo and products are either trademarks or registered trademarks of Digital Research Inc. ©1984 Digital Research Inc. All rights reserved.

Circle 134 on inquiry card.

 **DIGITAL  
RESEARCH**<sup>®</sup>  
We make computers work.<sup>SM</sup>





# Design & Conquer!



When Fox & Geller set out to conquer the world of Management Control software they met with key managers from Fortune 500 companies. They studied the demands made on managers, and the demands those managers made on their software. And they learned the reason many of them used the programs they were using was not because it was the right software for the job, but because there was nothing better to choose from. Well, now there is! Introducing OZ: MANAGEMENT CONTROL!

Designed by managers for managers! OZ is more than a spread-sheet. OZ is the first fully integrated Management Control System designed to bring highly sophisticated management technique to today's business manager.

OZ does everything a manager does, like: forecast revenues and expenses, compare actuals to forecast, pinpoint and understand variances. OZ can even perform 3-dimensional analysis of your data. And at the touch of a key, OZ will graph anything you call to the screen, in color!

OZ is complete financial reporting and information control with fully integrated graphics. OZ talks to you in plain English. And is so fully automatic, so easy to use, that most functions are performed by touching only one key!

OZ is the most advanced software ever developed for the personal computer.

Call us at (201) 794-8883 and discover the difference the right software can make in controlling your business.

You need control!

**OZ: MANAGEMENT CONTROL.**  
by FOX & GELLER.



**FOX & GELLER**

Fox & Geller, Inc. 604 Market Street, Elmwood Park, N.J. 07407 (201) 794-8883 U.K. 17 Wigmore Street, London W1, England: 011 441-580-5816



# Update on Apple Macintosh and Lisa 2

Gregg Williams

BYTE Senior Technical Editor

The Macintosh and Lisa 2 are out, although a few unpleasant surprises occurred between the deadline for my articles appearing in the February BYTE (pages 30 and 84, respectively) and Apple's formal announcement on January 24. In a word, the Macintosh (or Mac) is more expensive than we thought it would be. At one time, Apple had decided on a \$1995 price for the basic Macintosh, but the company changed this to \$2495. Other changes include: Imagewriter (reported at \$495), \$495 if bought with a Mac, \$595 otherwise; numeric keypad, \$129 (up from \$99); second disk drive, \$495 (up from \$395). Apple also announced a 300-bps (bits per second) modem for \$225 and a 1200-bps modem for \$495.

Apple has also formed the Apple University Consortium (AUC) to "further the use of computers in higher education" by making "commitments to supply large numbers of its new Macintosh personal computers to 24 leading universities," including Yale, Stanford, Dartmouth, Brown, and the University of Michigan. Apple requires member universities to create courseware and meet regularly together. Faculty and students will be able to buy Macintoshes at reduced rates; a source close to the University of Utah, an AUC member, said that the prices were \$1200 for students and \$900 for faculty.

Apple also announced three members of the Lisa 2 family: the Lisa 2, at \$3495; the Lisa 2/5, at \$4495; and

the Lisa 2/10, at \$5495. All units have 512K bytes of memory and one 3½-inch microfloppy-disk drive. The Lisa 2/5 adds an external 5-megabyte Profile hard disk, and the Lisa 2/10 adds an internal 10-megabyte hard disk. Lisa 1 owners can upgrade to a Lisa 2/5 for free until June 1, \$595 afterward, or to a Lisa 2/10 for \$2495. A 512K-byte memory upgrade is \$1495. The Macintosh operating system (needed for a Lisa computer to run Macintosh software) comes free with the Lisa 2 computer and is available at extra cost for buyers of the Lisa 2/5 and 2/10. Apple also announced Apple Bus, a low-cost local network that will allow Macintoshes, Lisas, and (later) Apple II-family computers to share common peripherals.

## Commentary

Initial reaction to the Macintosh has been strongly, but not overpoweringly, favorable. A few traditional computer users see the mouse, the windows, and the desktop metaphor as silly, useless frills, and others are outraged at the lack of color graphics, but most users are impressed by the machine and its capabilities. Still, some people have expressed concern about the relatively small 128K-byte RAM (random-access read/write memory) size, the lack of any computer language sent as part of the basic unit, and the inconvenience of the single disk drive. Although Apple has said nothing officially, it is widely be-

lieved that Apple will offer a 512K-byte Macintosh upgrade by the end of 1984; since the Macintosh memory chips are soldered onto the printed-circuit board, this will not be a simple upgrade that most users will want to do at home. The Macintosh is largely a computer of unparalleled vision on Apple's part; however, that vision failed when the Mac was limited to 128K bytes of memory. It took no vision to see the need for a larger memory; much existing software (for the IBM PC, for example) already makes use of 256K- and 512K-byte memory spaces.

At the current prices, a usable system (Macintosh with one language, Mac Paint/Mac Write, Imagewriter printer, and second disk drive) will now cost \$3879 (\$100 less if you buy the Imagewriter with the system). This is considerably more than the \$2984 possible package price quoted in my February article. Marketing decisions have compromised Steve Jobs's vision of "something really inexpensive so that everyone can afford it." Also, the higher price will probably decrease the influence of the machine on the market; this may make the difference between the Macintosh being just another successful computer rather than being the computer that is popular enough to be a surviving alternative to the looming IBM monopoly. ■

---

*Gregg Williams is a senior technical editor at BYTE. He can be reached at POB 372, Hancock, NH 03449.*

---

# Fitting Curves to Data

*The Simplex algorithm is the answer*

Marco S. Caceci and William P. Cacheris  
Florida State University

Fitting functions to data is a frequent task in science and wherever you need to superimpose complex mathematical models on data. Most curve-fitting programs presently running on microcomputers are either locally written, brute-force stepping procedures, or Newton-Raphson algorithms in BASIC and FORTRAN that have passed hands dozens of times. The Simplex algorithm we use is relatively recent (1965) and has been applied to curve-fitting problems only in the past few years, mostly in academic circles.

Consider a set of number pairs,  $x_1, y_1; x_2, y_2; \dots; x_n, y_n$ . It is easy to implement a linear fit, computing the parameters  $a$  and  $b$  of the "best" straight line,  $y = a + bx$ , passing through the points. Some pocket calculators have the necessary routines in firmware. And there are programs available that can fit any set of points to a polynomial or some "well-behaved" function. It would be convenient, however, to be able to fit sets of data points to more complicated

functions, or, for that matter, to find an algorithm capable of fitting a set of data points to any function, no matter how complex.

Within the speed and memory limitations of the computer on which it runs, the program *Simp* is capable of computing the parameter values that best fit a particular set of data points given an analytical function with any number of variables and parameters. The program utilizes the Simplex algorithm and is written in Pascal/Z version 4.0.

## Problem Definition

It is easier to understand curve fitting if you start with an example. As a typical case of experimental data that provides useful information through a complex function, consider the Michaelis-Menten kinetic theory of enzyme action. The Michaelis-Menten equation has the form  $y = a \times x / (b + x)$ . Experimentally, you measure the initial reaction rates:  $y$ , for different substrate concentrations;  $x$ , in order to determine the value of

constants;  $a$  and  $b$ . The  $a$  represents the maximum initial reaction rate and  $b$  the enzyme's affinity for the substrate. The problem lies in determining the best values of  $a$  and  $b$  for a given set of  $x$  and  $y$  data.

Figure 1 represents a set of six experimental data points,  $x_i, y_i$ , and the curve described by the Michaelis-Menten function that best fits them. The points do not fall exactly on the curve because they are affected by experimental error, and they are redundant. Two would be enough to define the curve, but by providing a larger number, the errors tend to cancel and possibly can be estimated. A further assumption that simplifies the mathematics (and is usually true) is that the  $x$  values are virtually error free; the only significant errors are in the experimental determination of the  $y$  values.

In the equation  $y = a \times x / (b + x)$ , constants  $a$  and  $b$  do not vary within a set. Variables  $x$  and  $y$  do. The experimenter varies  $x$ , the independent variable, freely during the experi-



ment;  $y$ , the dependent variable, is measured by the experiment, and its value (hopefully) depends on  $x$ . The Michaelis-Menten equation forms a model when applied to an experiment, and the constants in the equation become the model's parameters. This model has, therefore, one independent variable and one dependent variable and it is described by an equation with two parameters. To fit the curve you must estimate the "best" values for these parameters.

You can use two strategies to obtain a fit: linear and nonlinear parametric fit. If the model contains only linear equations (integral powers of the variables), you can use a linear algorithm. The great advantage of linear methods is that the solution is often immediate, i.e., they don't require an indefinite number of iterations. The main disadvantage is that many functions are not, and cannot be reduced to, linear equations.

The Michaelis-Menten equation in the example is not a linear equation, although you can manipulate it into a linear form. It is easy to prove that if you plot  $1/y$  versus  $1/x$ , the result is a straight line whose slope is  $b/a$ , whose intercept is  $1/a$ , and whose equation is  $1/y = 1/a + b/a \times 1/x$ . You can find good values for  $a$  and  $b$  by drawing or computing the "best" straight line through the "manipulated" experimental points according to the least-squares criterion.

You can extend this approach by properly using matrix algebra to handle more than two parameters and/or polynomial expressions. It is generally not a good practice to transform nonlinear systems into linear ones even when it is possible. Not only is it somewhat cumbersome, since you must handle each different function in a different way, but the error distribution and the statistical weight of the data points change after such transformations. If you don't deal with this properly, it can result in substantial inaccuracies.

In general, to handle nonlinear functions you need nonlinear parametric fits. Unfortunately, all general-purpose, non-linear, curve-fitting algorithms developed to date have one annoying feature—namely, they

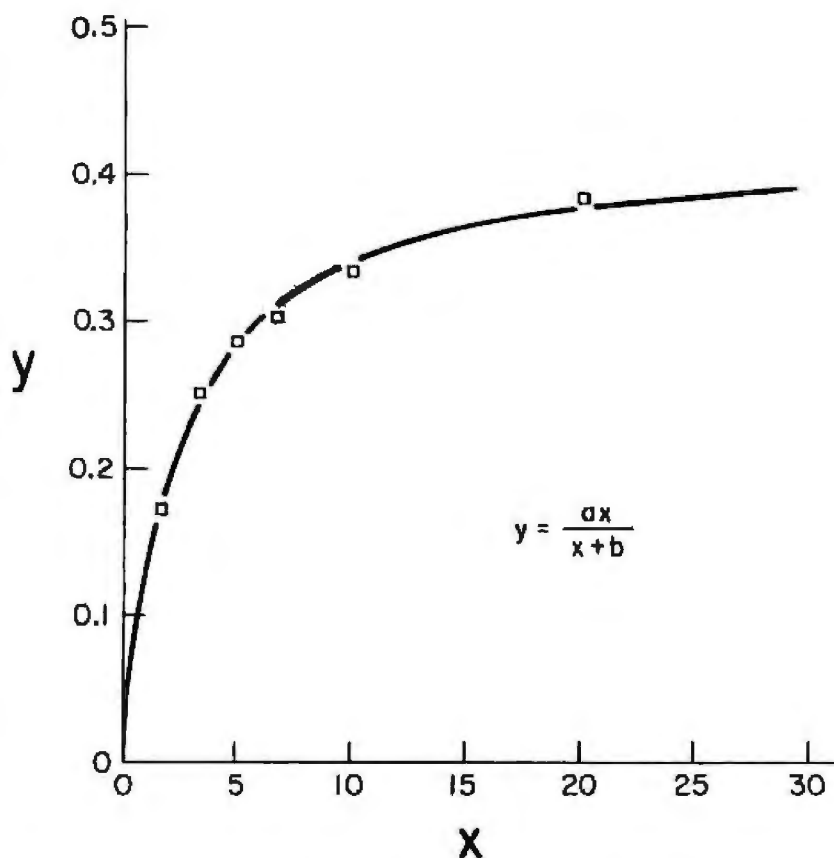


Figure 1: Plot of experimental data: initial reaction rates ( $y$ ) versus substrate concentration ( $x$ ). The data obeys the Michaelis-Menten equation:  $y = a \times x / (b + x)$ . Note: the best-fit curve is also drawn.

are recursive. You must adjust the parameters in an iterative way with no idea of how many repetitions you will need to achieve convergence or even, for that matter, if you can. Non-linear parametric fits also require initial estimates of the values sought.

### The Response Surface

Getting back to the example, you need a method for finding the best values of  $a$  and  $b$  for a set of  $x$  and  $y$  data using a nonlinear approach. And you must be able to generalize this method for any kind of function.

First, you need a new representation of the data. If you choose arbitrary values for  $a$  and  $b$ , you can determine the corresponding values of  $y$  for each experimental  $x$  from the equation. Good values for  $a$  and  $b$  can adequately predict  $y$  values that are close to those experimentally measured.

Quantitatively, if you have  $n$  data points, label each value of the independent variable as  $x_1, x_2, \dots, x_n$

and each value of the dependent variable as  $y_1, y_2, \dots, y_n$ . Also, label your  $n$  predicted values (as calculated by the equation using certain values for  $a$  and  $b$ ) for the dependent variable  $y'_1, y'_2, \dots, y'_n$ . Any pair of  $a$  and  $b$  values thus produces a set of  $y'_i$  predicted values corresponding to the experimental  $x_i$  set.

The sum  $(y_1 - y'_1)^2 + (y_2 - y'_2)^2 + \dots + (y_n - y'_n)^2$  is called the sum of the squared residuals ( $SS_R$ ) and can be written  $\sum_i (y_i - y'_i)^2$ . The lower this sum is, the better the curve fits. This is called the least-squares criterion. For random errors randomly distributed (usually a reasonable assumption), this is the best criterion of all.

If the error distribution is not random but known, you can usually assign a statistical weight  $w_i$  to each data point. The least-squares criterion will then minimize the sum:  $SS_R = \sum_i w_i (y_i - y'_i)^2$ .

Thus, the problem of finding the best values for a function's unknown

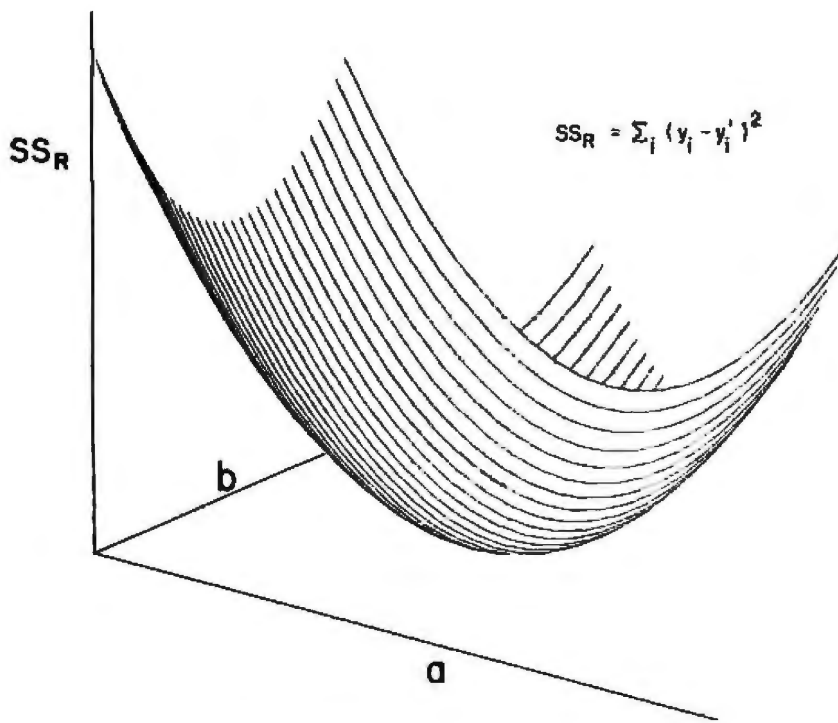


Figure 2: Representation of the response surface,  $SS_R$  versus  $a$  and  $b$ . The best values for  $a$  and  $b$  are those where the  $SS_R$  value is the lowest. If you have poor  $a$  and  $b$  values, you will get large values for  $SS_R$ .

parameters becomes the problem of finding the minimum of a new function,  $SS_R$ . In this example, we can picture  $a$  and  $b$  as the independent variables and  $SS_R$  as the dependent one (figure 2). In general, if you have a function with  $n$  parameters to be optimized,  $SS_R$  describes an  $(n+1)$ -dimensional surface, called the response surface. If you have very bad parameter values, the surface point values are high. As you move toward better values, the response surface dips toward a minimum.

### Searching for the Minimum

The best values of  $a$  and  $b$  lie at the minimum of the function  $SS_R = \sum_i w_i (y_i - y'_i)^2$ , and you need to find this minimum. Before discussing the Simplex algorithm, let's consider the most common alternatives.

The stepwise descent strategy consists of adjusting one parameter at a time, sequentially, until you find a minimum along that parameter, and then repeating the process until all values are stable. This algorithm is relatively easy to program and will converge virtually all the time, but it can be extremely slow to run, especially if there is a large number of

parameters or any appreciable correlation between them.

Steepest descent methods adjust the parameter values along the direction of the response surface's fastest decrease. They involve fewer iterations, but they require knowledge or computation (by numerical differentiation) of  $SS_R$ 's first derivatives.

---

**A simplex is a geometric figure that has one more vertex than the space in which it is defined has dimensions.**

---

The Newton-Raphson algorithm (and its many descendants) is the most popular nonlinear, least-squares fitting algorithm today. Although it is mathematically complex and always prone to divergence, it is fast (especially where the hardware supports matrix and floating-point operations), and speed is the most important consideration with computer time as expensive as it is.

Basically, the algorithm varies the parameters until the partial deriva-

tives of  $SS_R$  are all sufficiently close to zero. At each iteration, it computes the amount by which the parameters are changed, creating a square matrix that contains all the second derivatives of  $SS_R$ , then inverting this matrix and multiplying the result by the previous values of the first derivatives.

This approach often gives rapid convergence, but it also suffers substantial drawbacks. The program can diverge if it starts from inaccurate initial guesses. Considerable truncation errors can occur in the partial derivatives' calculations and in the matrix inversions, particularly when the installation does not support double-precision formats. Also, the numerical calculation of all the partial derivatives at each repetition requires massive amounts of computations.

The Marquardt algorithm and other more recent methods are mathematically equivalent to a mixture of the Newton-Raphson and the steepest descent algorithms. It avoids the divergence problems of Newton-Raphson without the unacceptable losses in speed. The amount and complexity of code generated in this way can, however, become substantial.

The Simplex method is relatively new; it was first proposed by J. A. Nelder and R. Mead in 1965. They used it to find mathematical function minimums. Since then, various applications to fitting problems have been developed.

A simplex is a geometric figure that has one more vertex than the space in which it is defined has dimensions. For example, a simplex on a plane (a two-dimensional space) is a triangle; a simplex in three-dimensional space is a tetrahedron, and so on.

The basic idea in the Simplex method is to build a simplex in the  $M+1$ -dimensional space described by the parameters you want to fit. For example, in the Michaelis-Menten equation above, there are two parameters,  $a$  and  $b$ . You can consider them as axes in a plane on which we create a simplex (a triangle). Each vertex is then character-



# SemiDisk™ and SemiSpool:™ SURE-FIRE WAIT-REDUCTION!



## 512Kbyte SemiDisk™ I \$1095

Time was, you thought you couldn't afford a SemiDisk. Now, you can't afford to be without one.

	256K	512K	1Mbyte
SemiDisk I, S-100	\$895	\$1095	\$1795
IBM PC		\$1095	\$1795
TRS-80 Model II		\$1095	\$1795
SemiDisk II, S-100		\$1395	\$2095
Battery Backup Unit	\$150		

Time was, you had to wait for your disk drives. The SemiDisk changed all that, giving you large, extremely fast disk emulators specifically designed for your computer. Much faster than floppies or hard disks, SemiDisk squeezes the last drop of performance out of your computer.

Time was, disk emulators were afraid of the dark. When your computer was turned off, or a power outage occurred, all your valuable data was lost. But the SemiDisk changed all that. Now, the optional Battery Backup Unit helps take the worry out of power interruptions. It keeps the SemiDisk powered for up to 5 hours during a power failure.

Time was, you had to wait until your printer finished printing to use your computer. That's changed, too. Now, the SemiSpool print buffer in our Version 5.0 software, running under CP/M 2.2, frees your computer for other tasks while your data is printing. With a capacity up to the size of the SemiDisk itself, you could implement an 8 Mbyte spooler!

But one thing hasn't changed. That's our continuing commitment to supply the fastest, highest density, easiest to use, most compatible, and most cost-effective disk emulators in the world.

### SemiDisk.

It's the disk the others are trying to copy.

*still*

## SemiDisk Systems, Inc.

P.O. Box GG Beaverton, OR 97075 (503) 642-3100

Call 503-646-5510 for CBBS®/NW, a SemiDisk-equipped computer bulletin board. 300/1200 BAUD  
SemiDisk trademarks of SemiDisk Systems, Inc. Copyright © 1983 SemiDisk Systems, Inc. CP/M Trademark Digital Research

Circle 344 on Inquiry card.



NO WAITING

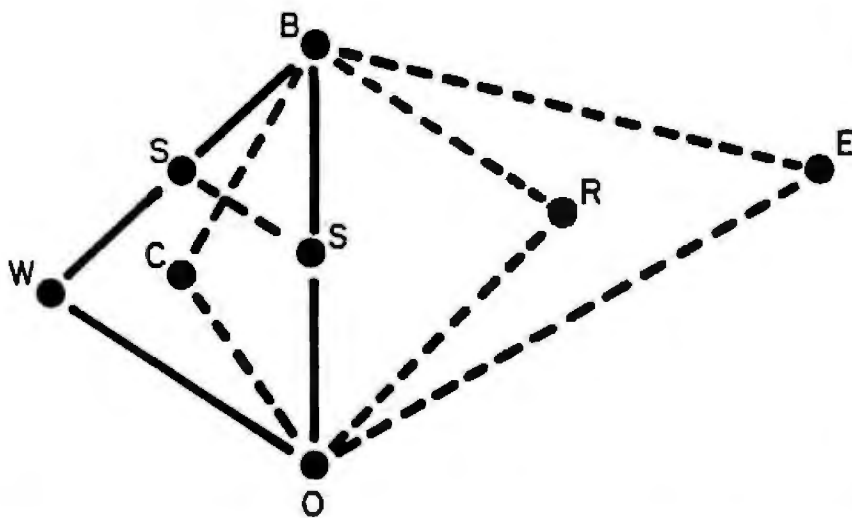


Figure 3: Two-dimensional simplex BWO illustrating the four mechanisms of movement: reflection, expansion, contraction, shrinkage. B = vertex, W = worst vertex, R = reflected vertex, E = expanded vertex, C = contracted vertex, and S = shrunken vertexes.

ized by three values:  $a$ ,  $b$ , and the response  $SS_R$ .

To reach the lowest value of  $SS_R$ , the program moves the simplex "downhill", accelerating and slowing down as needed. It follows the rule: find which vertex has the highest (worst) response and which has the lowest (best), then reject the highest and substitute another one for it. The program computes the new vertex according to one of these mechanisms: reflection, expansion, contraction, and shrinkage.

If you want to create a reflected vertex, call  $d$  the distance from the worst vertex to  $M$ , the midpoint of all the other vertexes. For the triangle this is the distance from the vertex to the center of the line that connects the other two vertexes. The reflected vertex is located at a distance  $d$  from  $M$  on the line continuation that joins the rejected vertex to  $M$ .

If the response of the reflected vertex is neither worse than the rejected one nor better than the best one in the simplex, then the program accepts it. If the reflected vertex has a lower (better) response than the previous best, the program tests an expansion by reflecting twice the distance  $d$ . The expanded vertex is accepted if it has a lower response than the rejected one; otherwise, the program accepts the reflected one.

If the reflected vertex has a higher (worse) response than the rejected

vertex, the program tests a contraction by moving the rejected one a distance of one-half  $d$  toward the midpoint. This contracted vertex is accepted if it produces a better (lower) response than the rejected one; otherwise, a shrinkage occurs and all vertexes, except the best one, move directly toward it by half of their original distance from it.

Figure 3 illustrates these four mechanisms and figure 4 gives the rules of simplex movement in flow-chart form. Figure 5 shows an example of a simplex moving on  $SS_R$ 's contour plot for a two-parameter fit.

It is possible to make various modifications to the present algorithm. One common variant substitutes the shrinkage with a contraction beyond the point  $M$ . And you can change the coefficients for the reflection, expansion, and contraction within certain limits.

The rules given above show clearly the advantages of the Simplex strategy:

- Divergence is impossible.
- You need to compute the response value only once or at most a few times for each iteration.
- You don't need any knowledge of derivatives or numerical differentiation. This avoids rounding-off errors and allows the handling of non-continuous functions.
- No matrix operation is involved.

## Where to buy Toshiba's P1351 and P1340 printers:

### EASTERN

R & D/CAMELOT ASSOCIATES, INC. Northampton, MA	(413) 253-7378
DIGITAL ENTRY SYSTEMS Waltham, MA	(617) 899-6111
MICROAMERICA Frammingham, MA	(800) 343-4411 in MA (617) 877-8500
CYBER/SOURCE Southfield, MI	(313) 353-8660
GENERAL BUSINESS COMPUTERS, INC. Cherry Hill, NJ	(809) 424-8500
MONROE DISTRIBUTING COMPANY Cleveland, OH	(216) 781-4600
ROBEC DISTRIBUTORS Lisle Lexington, PA	(215) 822-0700

### SOUTHERN

SYSPRINT, INC. Sarasota, FL	(813) 924-8278
MICROAMERICA Tampa, FL	(813) 623-8526 in FL (800) 282-3385
Norcross, GA	(800) 241-8566 in GA (404) 441-0515
Rockville, MD	(800) 638-6621 in MD (800) 492-2949

### CENTRAL

TEK-AIDS INDUSTRIES, INC. Arlington Heights, IL	(312) 870-7400 or (800) 323-4138
KALTRONICS DISTRIBUTORS, INC. Northbrook, IL	(312) 291-1220
MICROAMERICA Schaumburg, IL	(800) 323-6827 in IL (800) 942-4690
Richardson, TX	(800) 527-3261 in TX (800) 442-5847

GENERAL MICROCOMPUTER South Bend, IN	(219) 277-4972
MIDTEC ASSOCIATES dba CRYSTAL COMPUTERS Lenexa, KS	(813) 541-1711
B & W DISTRIBUTORS St. Louis, MO	(314) 569-2450
SMC INTECH SYSTEMS CORP Carrollton, TX	(214) 446-9055
COMPU SHOP Richardson, TX	(214) 783-1252
SYSPRINT, INC. Richardson, TX	(214) 669-3666

### WESTERN

PG I. CORPORATION Tempe, AZ	(602) 967-1421 or (800) 528-1415
MICROAMERICA Carson, CA	(800) 421-1485 in CA (800) 262-4212
BYTE INDUSTRIES, INC. Hayward, CA	(415) 783-8272 or (800) 972-5948 outside CA (800) 227-2070

PREMIER SOURCE DISTRIBUTING Irvine, CA	(714) 261-2011
CYPRESS DISTRIBUTING COMPANY, INC. San Jose, CA	(408) 297-9800
MICROWARE DISTRIBUTORS, INC. Aloha, OR	(503) 642-7679
Bellevue, WA	(206) 451-8588
ANACOMP, INC. Salt Lake City, UT	(801) 539-0158
Redmond, WA	(206) 881-1113 or (800) 426-6244

### CANADA

IRWIN ELECTRONICS Etobicoke, Ontario	(416) 826-8800
---	----------------

### OR THESE TOSHIBA AMERICA, INC. REGIONAL OFFICES:

177 Madison Avenue, Post Office Box 2331R Morristown, NJ 07960	(201) 328-8777
662 Office Parkway, The Colonnade Building St. Louis, MO 63141	(314) 991-0751
18017 Sky Park Circle, Suites P and Q Irvine, CA 92714	(714) 250-0151

# TOSHIBA

Circle 385 on inquiry card.



# Two ways to show off your IBM PC.™



There's no better way to show off your IBM PC – or any other micro – than with the new line of Toshiba printers. They offer state-of-the-art features, high reliability and low price.

#### **P1351**

The new Toshiba P1351 printer has a unique high-density 24-pin dot-matrix print head. It lets you print crisp, clean letter copy at 100 cps, draft copy at 192 cps. And with the software-selectable downloading fonts, you get to pick from a variety of type styles.

The P1351 has more stuff to show. Like 180 x 180 dots-per-

inch high-resolution graphics, 132-column-width platen (great for spreadsheets and Lotus™ 1-2-3™ data processing and graphics), Qume SPRINT 5™ emulation, and a choice of either a forms tractor or automatic sheet feeder.

#### **P1340**

For considerably less, the new P1340 gives you just a little less. But it still has the same high-density 24-pin dot-matrix print head, the 180 x 180 dots-per-inch graphics resolution, and the Qume SPRINT 5 emulation. In addition to true proportional spacing and a

built-in forms tractor. Whichever printer you choose, you also get nationwide service within 24 hours by Western Union technicians.

So the choice is yours. But when you choose Toshiba, you know you're putting on the best show possible.

For more information, call one of the distributors listed on the adjacent page.

IBM PC to P1340 and P1351 graphics utilizes PaperScreen and the IBM PC with color graphics adapter. IBM PC is a trademark of International Business Machines. Lotus and 1-2-3 are trademarks of Lotus Development Corporation. SPRINT 5 is a trademark of Qume Corporation.

©1984 Toshiba America, Inc.

In Touch with Tomorrow

## **TOSHIBA**

Information Systems Division, TOSHIBA AMERICA, INC.

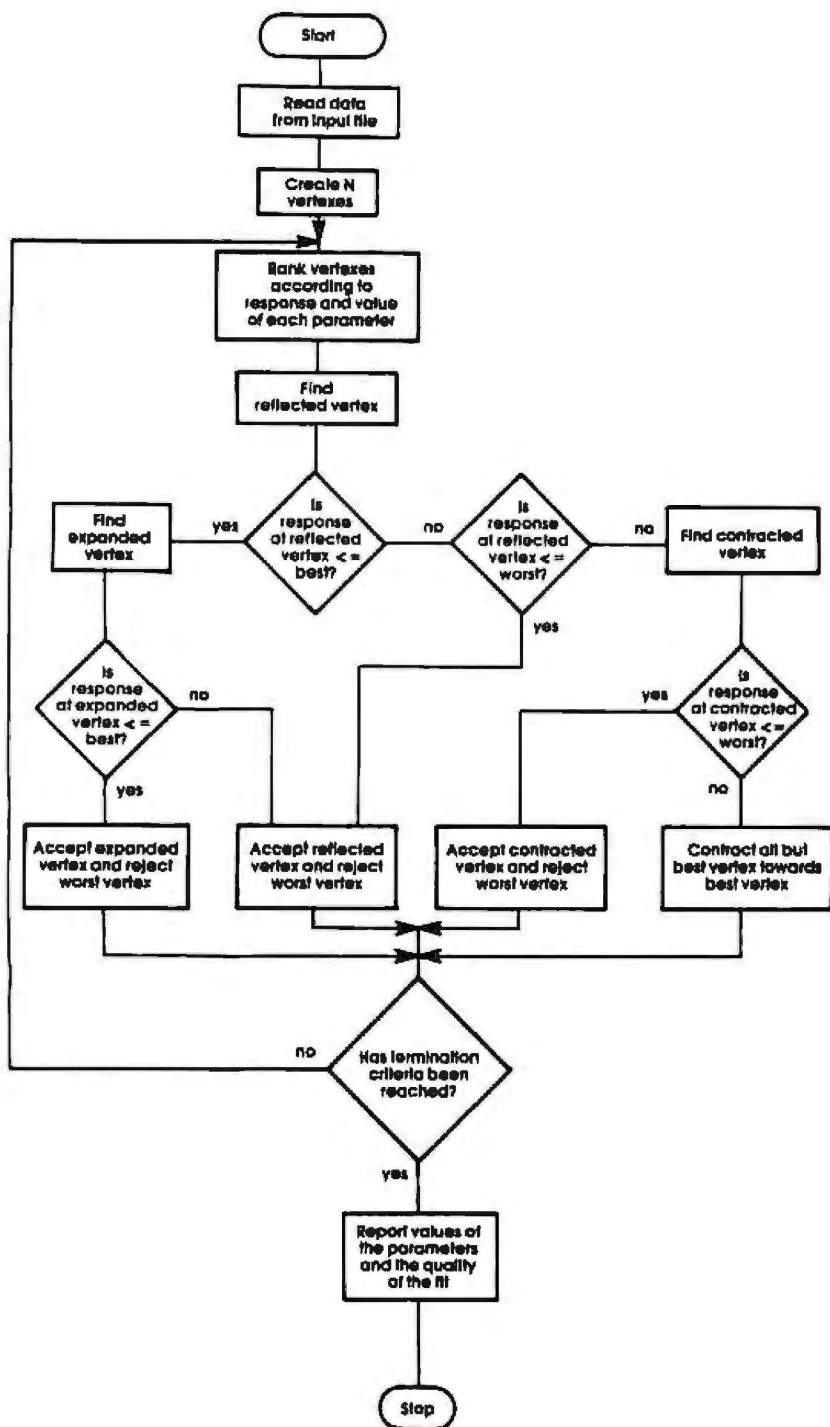


Figure 4: Flowchart of the Simplex algorithm.

Every function that you can write as computer code, you can optimize with the Simplex algorithm. In particular, to implement contour conditions, such as "parameter  $r$  must be positive, parameter  $s$  must be between one and ten, etc.," you assign very high values to  $SS_R$  points corresponding to out-of-boundary parameter values to prevent the simplex from ever entering these regions.

### Program Description

Simp (listing 1) is written in Pascal/Z (Ithaca Intersystems) version 4.0 to run under the CP/M-80 operating system. This example contains about 200 statements and compiles into 19K bytes. Despite the care taken to try to avoid any nonstandard (Jensen and Wirth) expressions, some I/O (input/output) expressions are not standard, and you should be

cautious about transporting Simp to other compilers. A version running on a Control Data Cyber-76 mainframe (Pascal 6000.34.0 compiler) is also presently available, and a BASIC translation for the Atari microcomputer is coming soon. To date, Simp has been used to fit functions with up to nine adjustable parameters, up to 200 data points, and two independent variables. The speed and memory limitations of the machine on which the program runs define the upper limit on these numbers.

To operate the program, you need only modify the function declaration and, in some cases, the constants' assignments and the I/O procedures. The only constants you must modify to accommodate different models are:  $m$ , the number of parameters to be fit; possibly  $nvpp$ , the total number of variables per data point; and  $mnp$ , the maximum number of data points. In the present example,  $nvpp$  is 2 (1 independent variable,  $x$ , and 1 dependent one,  $y$ ) and  $mnp$  is 200.

The program input is in a disk file whose name is appended to the CP/M command. Procedure *enter* reads the input file. Simp directs *enter* to produce a screen output. If any error exists in the input file, you can easily detect it at this stage. If there are no errors, Simp redirects the output to the printer and invokes *enter* again. If you need additional data input or preprocessing of the data, you must modify procedure *enter* accordingly.

Next, Simp computes the starting simplex values, represented as a square matrix  $n \times n$ , where  $n$  is the number of parameters you want to fit plus one. Each matrix row is a different vertex, for which the first  $n-1$  columns are the individual parameter values, and the  $n$ th column stores the response value to be minimized from the procedure *sum\_of\_residuals*.

Procedure *sum\_of\_residuals* receives a set of parameter values, and from these, combined with the experimental data, computes the response surface value at the corresponding point. That is, it computes the sum of the squares of the differences between individual experimental dependent variable values and those



ORDER DESK ONLY  
**(800) 292-3360**  
 TOLL FREE OUTSIDE CALIF.

**"WHY PAY MORE"**  
**COMPARE THESE PRICES**

**MC-P APPLICATIONS**  
 Brings Software & Hardware  
 At Unbeatable Prices

**(800) 272-3360**  
 TOLL FREE IN CALIFORNIA

**SOFTWARE**

	LIST	OUR
<b>APPLIED SOFTWARE TECHNOLOGY</b>		
VersaForm	\$389	\$269
<b>ASHTON TATE</b>		
Financial Planner	700	452
Friday	295	199
<b>BPI ACCOUNTING SYSTEMS</b>		
GL/AP/AR (Each)	395	285
<b>CONTINENTAL</b>		
Property Management	495	327
<b>FOX &amp; GELER</b> Quick Code	295	174
<b>FUNK SOFTWARE</b> Sideways	60	45
<b>HOWARD SOFT</b>		
Real Estate Analyzer II Apple	199	135
Tax Preparer Apple	199	135
Apple	199	175
IBM	250	199
<b>HUMAN SOFT DB Plus</b>		89
<b>LATTICE C Compiler</b>	500	325
<b>LIFETREE</b> Volkswriter Deluxe		179
<b>METASOFT</b> Benchmark	499	295
<b>MICROSTUFF</b> Crosstalk	195	129
<b>MICROPRO</b> Spell Star	250	162
Word Star w/Applicard	495	349
Mail Merge	250	162
Super Sort	250	149
Calc Star	145	86
Info Star	495	320
Word Star Pro	695	395
<b>MICRORIM</b>		
R Base 4000	495	339
<b>MICROSOFT</b>		
Flight Simulator (IBM)	50	35
Flight Simulator (Apple) Sublogic		29
Multitool Word W/Mouse	475	339
Multitool Financial	100	69
Multitool Budget	150	99
Pascal Compiler	350	245
C Compiler	500	345
<b>PBL CORPORATION</b>		
Personal Investor	145	98
<b>PETER NORTON</b>		
Peter Norton Utility	80	57
<b>PEACHTREE</b>		
Peach Pack (AR, AP, GL)	595	249
Peach Text 5000	395	245
<b>ROSESOFT</b> Prokey	75	57
<b>SOFTWARE ARTS</b> T.K Solver	299	219
<b>SOFTWARE DIMENSIONS</b>		
Accounting Plus		
GL, AR, AP, PR, INV - Each	495	295
<b>SOFTWARE PRODUCTS INTERNATIONAL</b>		
Open Access	575	415
<b>SATELLITE SOFTWARE</b>		
Word Perfect	495	325
<b>SOFTWARE PUBLISHING</b>		
Pfs File		
Apple	125	85
IBM	140	95
Pfs: Report	125	85
<b>SOFTWORD SYSTEM</b>		
Multimate	495	299
<b>SORCIM</b> SuperCalc II	295	185
SuperCalc III	395	275
<b>SYNPSE</b> File Manager	150	97
<b>WOLF</b> Move-It	199	125
<b>VISICORP</b>		
Visicalc IV	250	175
Visifile (Apple)	250	187
Visifile (IBM)	300	195
VisiSchedule	300	195
VisiWord w/free VisiSpell	375	285
Visitrend/Plot	300	195

NO PHONE ORDERS FOR LOTUS 1-2-3

**LOTUS 1-2-3**  
**\$316<sup>00</sup>**

**LOTUS + VOLKSWRITER**  
**\$475<sup>00</sup>**

**DUTIL + QUICK CODE**  
**\$215<sup>00</sup>**

**WORD STAR**  
**\$275<sup>00</sup>**

**DBASE II**  
**\$399<sup>00</sup>**

**EDIX/WORDIX**  
**\$129<sup>00</sup> each**

**MULTIPLAN**  
**\$168<sup>00</sup>**

**HOME ACCOUNTANT**  
**\$ 52<sup>00</sup>**

**BANK STREET WRITER**  
**\$ 49<sup>00</sup>**

**TANDON TM1000-2**

**\$225<sup>00</sup>**

**OKIDATA 92**

**\$459<sup>00</sup>**

**AMDEK COLOR II**

HI RES RGB

**\$435<sup>00</sup>**

**AST MEGA PLUS 64K**

**\$275<sup>00</sup>**

**NOVATION J-CAT**

**\$105<sup>00</sup>**

**EPSON FX 100**

**\$735<sup>00</sup>**

**HERCULES GRAPHICS CD.**

**\$359<sup>00</sup>**

**KOALA TOUCH PAD**

**\$ 95<sup>00</sup>**

**HARDWARE**

	LIST	OUR
<b>HAYES MICROCOMPUTER PRODUCTS</b>		
Hayes 300 Baud	\$289	\$199
Smart Modem 1200B	599	429
Smart Modem 1200	699	495
<b>ADVANCED LOGIC SYSTEM (Apple II)</b>		
Z-Card	169	115
Printer Mate (Parallel)	99	55
CP/M Card (W CP M 3.0)	399	315
<b>MICROSOFT</b>		
64K Ram Card (IBM)	350	249
<b>MPC PERIPHERALS (Apple)</b>		
Parallel Interface Card (w Cable)	90	68
<b>MOUSE SYSTEMS</b>		
PC Mouse w/Software	295	219
<b>NOVATION</b>		
Apple - Cat II	389	275
212 Auto Cal	695	595
Smart-Cat 103/121	595	445
Smart-Cat 103	249	187
<b>PEGASUS</b>		
Hard Disk 10 mgb		1399
<b>PERSONAL COMPUTER PRODUCTS</b>		
Applicard 6 Mhz	375	280
<b>KRAFT &amp; TG Joystick</b>		
IBM	70	49
Apple	65	45
<b>TALL GRASS Hard Disk 10 mgb</b>	3495	2995
<b>VERBATIM DISC</b>		
S/S D/D 10 Pk	49	24
D/S D/D 10 Pk	71	38
<b>AMDEK MAI BOARD</b>	599	495
<b>ELECTRONICS PROTECTION DEVICES</b>		
Orange	140	99
Peach	98	69
<b>QUADRAM</b>		
Quadboard II 64K	395	285
Quadcolor I	295	219
Quadlink	680	525
<b>MEMORY CHIP SET</b>		
(64K, 9 chips)	95	55
<b>PRINTERS</b>		
NEC 7730 RO Parallel	2595	2295
Daisey Writer 2000	1395	1185
Qume 1140	1685	1525
<b>MONITORS</b>		
Amdek 12" 310A	230	175
Quadchrome 17"	695	525
Princeton RGB Hi Res	795	495

**CALL FOR SOFTWARE & HARDWARE PRICES NOT LISTED HERE**

**USED PCs & APPLES BOUGHT & SOLD**

**"International Dealer Enquiries Welcomed"**

Circle 253 on inquiry card.

**MC-P APPLICATIONS, INC.**

111 W. St. John St., Suite 307  
 San Jose, CA 95113 Phone (408) 293-3360

Telex: 821398 MCPA UD

HOURS: 8 a.m. to 5:30 p.m. — Mon. - Sat.

Call for prices in AUSTRALIA

at 02-929-8468

**TERMS:** All prices subject to change. Cashier's check/MO/Bank Transfer. Allow time for company or personal checks to clear. Prices reflect cash prepaid discount. VISA/MASTER CARD/COD/PO's -3%. California residents add sales tax. **SHIPPING:** \$4 per item for UPS surface (\$8 for Blue Label) Monitors \$20. Printers \$25. within continental USA.

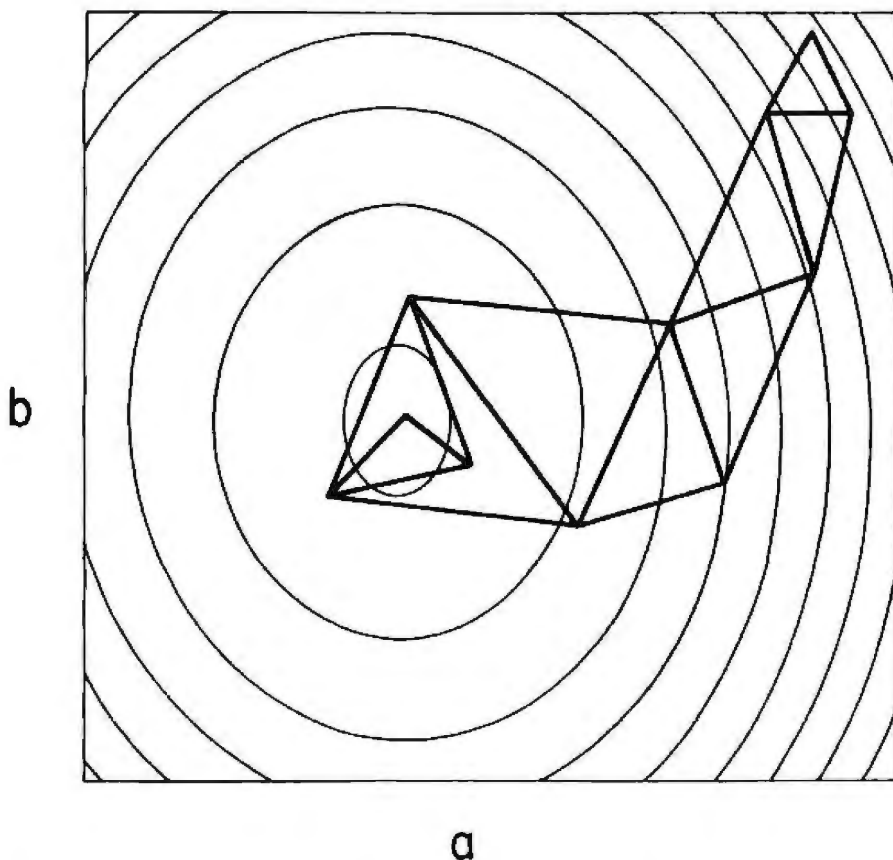


Figure 5: An example of the simplex moving on the response surface's contour plot.

calculated for the same independent variable values using the parameters being tested.

In this example, procedure *sum\_of\_residuals* gives identical statistical weight to all data points. In circumstances where the data points' statistical weight is not constant, you should modify the procedure.

Function *f* computes a single dependent variable value,  $y'$ , from the parameters and a given independent variable value. The program spends most of its time in this function, and you should be extremely careful to optimize its speed.

Simp calls procedure *order* to identify the highest and lowest values of the parameters and the response surface from among all the vertexes. It uses this information to compute the errors and make the decisions for the simplex's next movement. After Simp computes the vertexes of the first simplex from your initial guesses and their increments, procedure *first* outputs the values to the printer and then to the screen, as directed by the main part of the program.

The main program loop moves the simplex according to the rules previously given. Procedure *new\_vertex* substitutes the rejected vertex with a new one. Simp exits the loop when the error (the percent difference between the extreme values) for all parameters falls below the necessary limits or reaches the maximum number of iterations. At each repetition *new\_vertex* displays the new accepted vertex's values on the screen.

Once the program exits the main loop, procedure *report* directs the results to the screen and the printer. It also creates two files on the default disk drive, FIT.DAT and ERR.DAT. FIT.DAT contains the fitted points, that is, the  $(x_i, y'_i)$  data points, where Simp copies the input  $x_i$  values and computes their corresponding  $y'_i$ 's using *a* and *b*'s estimated values. ERR.DAT contains the  $(x_i, dy'_i)$  data points, where the  $x_i$ 's are from the input and the  $dy'_i$ 's are from the computed residuals (the quantities  $y_i - y'_i$ ). Both files begin with a series of six separated ones

followed by the number of data points and then the data points themselves. If you need to post-process the data or if you change *nopp*, procedure *report* will require modifications.

### Program Operation

You must create an executable file, SIMP.COM, from the source file, SIMP.PAS. In Pascal/Z, this is done by executing:

```
A> pascal56 simp
    This creates SIMP.SRC.
A> pasopt simp
    Optional optimizer. It saves a few bytes.
A> asmb1 main, simp/rel
    Creates SIMP.REL relocatable file.
A> link simp/n:simp/e
    Creates SIMP.COM object code file.
```

The command `A>simp <infile>` invokes the program where `<infile>` is a valid CP/M filename. The disk input file, `<infile>`, is organized as follows:

- the maximum number of iterations (integer). Zero gives an infinite loop. Very generally speaking, the program usually converges in less than  $20 \times m^2$  repetitions.
- your initial parameter guesses ( $m$  floating points).
- your initial parameter increments ( $m$  floating points). 0.0 blocks the corresponding parameter. The recommended values are one-tenth to one-half of your initial guesses.
- the maximum errors allowed ( $m + 1$  floating points—one for each parameter and one for the sum of the squares of the residuals). The recommended values are  $1E - 4$  to  $1E - 6$ .
- the data  $(x_n, y_n; x_n, y_n; \dots; x_n, y_n)$ .

The program tolerates different input formats and any separator (space, tab, carriage return, line feed) should work. It is essential, though, to terminate the input file without any

Text continued on page 360



# THE PERSONAL COMPUTER NETWORK

## Buy Hardware/Software at Wholesale, And Save On Software Rentals, As A NETWORK™ Member Only!

Save hundreds of dollars when you buy DIRECT from America's Number 1 Computer Buying Service at just 8% above DEALER WHOLESAL PRICES, plus shipping.

Members receive The Personal Computer NETWORK's Giant Catalog featuring over 10,000 products and the lowest prices on the widest selection of computer software and hardware in the nation!

**RENT BEFORE YOU BUY—Members are eligible to join The NETWORK's Business and Game Software Rental Libraries for a much smaller fee than other software rental services. And The NETWORK's rental charges are far less—just 20%-25% of the Member WHOLESAL PRICE.**

Listed below are just a few of the over 10,000 products available at our EVERYDAY LOW PRICES!

Low prices, fast home delivery and two software rental libraries are only the beginning! The NETWORK is your source for everything from memory chips to mainframes—and it's all just 8% above wholesale, plus shipping.

### HARDWARE

Monitors (color and monochrome)  
Printers  
Complete Systems  
Disk Drives (full/half height, add-on/add-in)  
Multi-Function Boards  
Graphics Boards  
Modems  
Local Area Networks  
Memory Chips (all speeds available)  
S-100 Components

### SOFTWARE (rent or buy!)

Available in most major system formats.  
Business  
Recreational  
Compilers  
Word Processors  
Utilities  
Scientific  
Data Bases  
Educational  
Graphics  
CP/M-MS/DOS  
CPM-80  
CPM-86  
MS-DOS  
PC-DOS  
Apple-DOS  
TRS-DOS  
And More!

### SUPPLIES & ACCESSORIES

Blank Diskettes (all formats)  
Paper Stock  
Ribbons  
Print Wheels  
Cables  
And More!

Choose hardware and software from hundreds of manufacturers, including:

- Altos
- Amdek
- Apparat
- AST
- Ashton-Tate
- Atari
- CDC
- Coleco
- Columbia
- Commodore
- Corona
- Cromemco
- DEC
- Digital
- Research
- Eagle
- Epson
- Franklin
- Hayes
- IBM
- IUS
- Lotus
- MicroPro
- Microsoft
- Morrow
- Motorola
- NEC
- Northstar
- Okidata
- Peach Tree
- Princeton
- Quadram
- Sanyo
- Sierra
- On-Line
- Software Publishing
- Softword
- Tandon
- Tecmar
- Texas Instruments
- Toshiba
- Visicorp
- Xerox
- Zenith

### GAMES & EDUCATIONAL SOFTWARE

Please add \$1 shipping and handling for each title ordered from below

Wholesale Price		Wholesale Price	
Infocom Zork I	\$23.00	Spinmaker Alphabet Zoo	\$17.00
Infocom Zork II	23.00	Spinmaker Delta Drawing	29.00
Infocom Zork III	23.00	Spinmaker Facsimile	23.00
Infocom Dinosaur	29.00	Spinmaker Holy Octole Dodge	17.00
Infocom Wendel	29.00	Spinmaker Kender Comp	17.00
Lightening MasterType	29.00	Spinmaker Rhythms & Puddles	17.00
Microsoft Flight Simulator	29.00	Spinmaker Snoopers Troops #1	26.00
Orion Jibers	22.50	Spinmaker Snoopers Troops #2	26.00
Orion PCMan	21.00	Spinmaker Story Machine	20.00
Sierra On-Line Frogger	21.00	Spinmaker Most Amazing Thing	23.00
Sierra On-Line Crossade	18.00	CBS Mastering the SAT	90.00
Sublogic Night Mission Package	24.00	CBS Goren-Bridge Made Easy	48.00

### BUSINESS SOFTWARE

Please add \$2.50 shipping and handling for each title ordered from below

Wholesale Price		Wholesale Price	
ATI How To Use MultiMate	\$45.00	Monogram Dollars & Sense	\$85.00
ATI How To Use Microsoft Word	45.00	Oasys The Word Plus	90.00
Context Concept MBA	417.00	Peter Norton Norton Utilities	48.00
Conceptual Instr. Desk Organizer	150.00	Rosesoft Prosey Version 3.0	79.00
Digital Research CP/M-86	33.00	Rogue Micro SPP	76.00
Funk Software Soverays	36.00	Software Publishing PFS File	82.00
Lotus Development Lotus 1-2-3	CALL	Software Publishing PFS Organ	88.00
MDBS Knowledge Man	275.00	Software Publishing PFS Report	82.00
Micro Rim II Base 4000	260.00	Software Publishing PFS Write	260.00
Microsoft C Compiler	300.00	Softword Systems MultiMate	217.00
Microsoft Pascal Compiler	319.00	Sorcim SuperCalc III	217.00
Microsoft Word with Mouse	250.00	SPI Open Access	260.00

### HARDWARE

Please add appropriate shipping and handling charges (at night in parentheses) to each item ordered from below

Wholesale Price		Wholesale Price	
Amdek Video 300	\$115.00 (13.00)	NEC Spinwriter 3550 35 CPS letter-quality printer	\$1,604.00 (132.00)
Amdek Video 300A	130.00 (12.00)	NEC 2050 Spinwriter 20 CPS	685.00 (117.00)
Amdek Video 310A	140.00 (12.00)	Okidata ML92P	CALL
Amdek MAJ multiple 4-in-1 display device	415.00 (12.50)	Okidata ML92P	CALL
Another Blank 8 1/2 Inset Diskette	220.00 (15.00)	Okidata IBM to Okidata Cable	20.75 (11.00)
Apparat 312H HAM Card w/OK	92.00 (12.50)	Paradyne (UNIV. RESCH.) Multi-Display Card	206.50 (12.50)
AST Sir-Paca Plus-OK	210.00 (12.50)	Perfection Graphics MK12	CALL
AST Magazines II-OK	210.00 (12.50)	Quadram Dual Color 1	181.00 (12.50)
AST I/O Plus II	99.00 (12.50)	Qume Half Height OS DD	350.00 (17.00)
AST Any Port Option (MG II, SPK, I/O)	30.00 (11.00)	Disk Drives IBM Portable equiv 1	1,229.00 (24.00)
Epson FX-80	CALL	Qume Spinnt II 55 CPS	1,358.00 (27.18)
Epson FX-100	CALL	Qume Spinnt II 40 CPS	1,229.00 (24.00)
Epson FX-80	CALL	Qume IBM iCPE w/ cable	72.00 (12.50)
Epson Epson to IBM printer cable	21.00 (11.00)	Qume Daisy Wheel	8.00
Hayes Smartmodem 300	183.00 (13.00)	Qume Ribbons	8.00
Hayes Smartmodem 1200B	399.00 (12.50)	STB Graphics Plus	297.00 (12.50)
Hercules Graphics Card	220.00 (12.50)	STB Clock Option	30.00 (11.00)
IBM Pasm 120C (color w/ all 4 options)	1,380.00 (130.00)	Tandon TM100-2 (OS DD IBM equiv.)	200.00 (14.00)
IBM Pasm to IBM cable	20.00 (11.00)	Tallgrass 2040 Hwtable	3,310.10 (140.20)
Kraft Analog joystick	29.97 (12.50)	Teva Teva PC IBM Compatible (complete system)	1,890.00 (12.00)
Maynard Floppy Disk Controller	155.00 (12.50)	Transfer 120P 15 CPS letter-quality printer	387.00 (18.36)
Maynard WSJ 10MB Internal Hard Disk Multifunction	665.00 (117.00)	USB P-3 Monitor (17" amber)	132.00 (13.00)
Maynard WSJ 10MB Internal Hard Disk Floppy Controller	990.00 (119.20)		
Maynard WSJ 10MB Internal Hard Disk Sanistar Memory w/OK	990.00 (119.20)		
NEC Notebook Computer	559.00 (111.18)		

\*PC NETWORK Members pay just 8% above the wholesale price plus shipping. All Prices Cash. On credit card orders there is a 3% service charge.

1. REAL BUYING CLOUT—Buy at just 8% above DEALER WHOLESAL PRICES, plus shipping
2. SHOP-AT-HOME CATALOG
3. KNOWLEDGEABLE CONSULTANTS
4. INSURED FAST HOME DELIVERY
5. OPTIONAL BUSINESS SOFTWARE RENTAL LIBRARY—Rent business software at just 20%-25% of the NETWORK's low prices for a 7-day period (plus a 3-day grace period for return shipping). 100% of your rental fee applies towards purchase.
6. OPTIONAL GAME SOFTWARE RENTAL LIBRARY—All the same conditions apply as for benefit five.
7. SPECIAL SAVINGS BULLETINS
8. DISCOUNT BOOK LIBRARY
9. MEMBERSHIP GUARANTEE
10. PRODUCT GUARANTEE

When ordering be sure to provide us with your type of computer, amount of memory number and type of disk drives and type of monitor (color or monochrome)

**CALL TOLL FREE 1-800-621-S-A-V-E**  
In Illinois call (312) 280-0002

Your Membership Validation Number: **8600**  
You can validate your membership number and, if you wish, place your first money-saving order over the phone by using your VISA, MASTERCARD or AMERICAN EXPRESS. Our knowledgeable service consultants are on duty Mon-Fri 8 AM to 7 PM Sat 9 AM to 5 PM CST

**Call now...Join the NETWORK and start saving today!**  
**PERSONAL COMPUTER NETWORK**  
320 West Ohio  
Chicago, Illinois 60610

All items subject to availability. Prices subject to change without notice. Copyright 1984 PC NETWORK INC.

### THE NETWORK MEMBERSHIP APPLICATION

YES! Please enroll me as a member of The NETWORK and rush my catalog featuring thousands of computer hardware and software products all at just 8% above DEALER WHOLESAL PRICES. I will also receive all the other exclusive money-saving services available to Members. I am under no obligation to buy anything. My complete satisfaction is guaranteed.

Please check (✓) all boxes that apply.

- Basic Membership**
- One-year membership for \$8
  - Two-year membership for \$15 (SAVE \$1)
  - Business Software Rental Library for \$30 add'l per year—members only
  - Games Software Rental Library for \$10 add'l per year—members only
- Special V.I.P. Membership 800**  
Includes advance notification of special limited-quantity merchandise
- One-year membership for \$15
  - Two-year membership for \$25 (SAVE \$5)
  - BOTH Business and Game Software Rental Libraries for \$35 add'l per year—Extended 10-day rental to V.I.P. members only

Bill my credit card  VISA  MasterCard  American Express

Account Number \_\_\_\_\_ Exp. Date \_\_\_\_\_ (mo/year)

Check or money order enclosed for \$ \_\_\_\_\_

Name \_\_\_\_\_

Address \_\_\_\_\_ Apt. No. \_\_\_\_\_

City \_\_\_\_\_ State \_\_\_\_\_ ZIP \_\_\_\_\_

Telephone (\_\_\_\_\_) \_\_\_\_\_

My computer(s) is  IBM PC  Apple II  TRS-80

Altan  Commodore Other \_\_\_\_\_

Signature \_\_\_\_\_ (Signature required to validate membership)

**Listing 1: Compiled listing of the program, Simp. It is written in Pascal/Z (Ithaca Intersystems) version 4.0 to run under the CP/M operating system.**

```

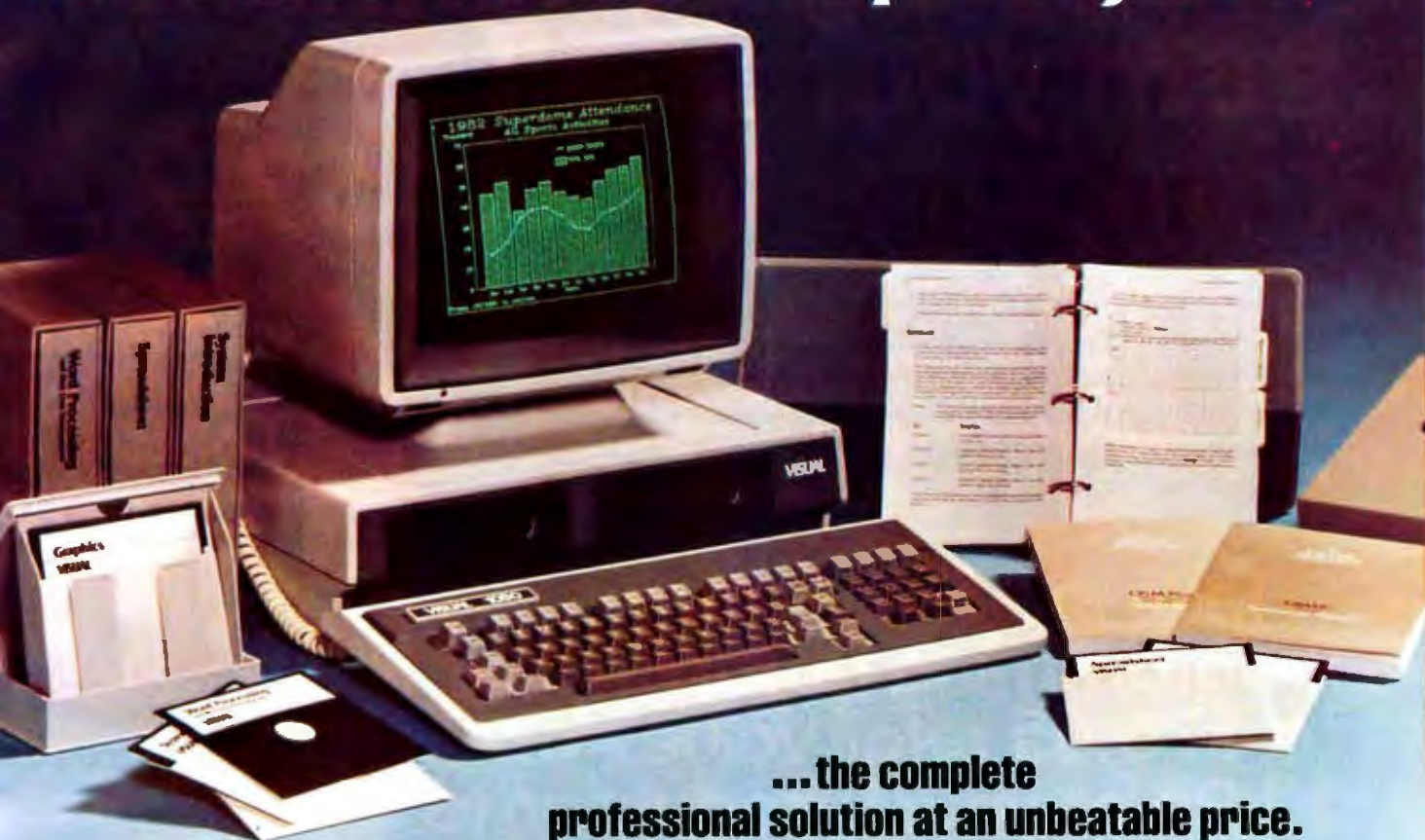
Line Stmt Level
 1 1 0 program simp; {curve fitting with the simplex algorithm}
 2 1 0 {this example fits data to a Michaelis-Menten function}
 3 1 0
 4 1 0 {by Marco Caceci, with help from William Caceris. 1983}
 5 1 0 {Chem. Dept. Florida State University Tallahassee FL32306}
 6 1 0 {no copy-right. BSSD floppy disk copies on request}
 7 1 0
 8 1 0 {see Nelder J.A. & R. Mead, Computer J. 7, 308 (1965) and }
 9 1 0 {L.A. Yarbrow & S.N. Deming, Anal. Chim. Acta 74, 391 (1974)}
10 1 0
11 1 0 const date = ' 5/22/83';
12 1 1 memo =
13 1 1
14 1 1 ' fit of a Michaelis-Menten function : y=ax/(b+x)';
15 1 1
16 1 1 m = 2; {number of parameters to fit}
17 1 1 nvpp = 2; {total number of vars per data point}
18 1 1 n = m + 1; {some compilers don't like this}
19 1 1 mnp = 200; {maximum number of data points}
20 1 1
21 1 1 alfa = 1.0; {reflection coefficient, >0}
22 1 1 beta = 0.5; {contraction coefficient, 0 to 1}
23 1 1 gamma = 2.0; {expansion coefficient, >1}
24 1 1
25 1 1 lw = 5; {width of line in data fields+1}
26 1 1 page = 12;
27 1 1 root2 = 1.414214;
28 1 1 type vector = array[1..n] of real;
29 1 1 datarow = array[1..nvpp] of real;
30 1 1 index = 0..255;
31 1 1 var done : boolean; {convergence}
32 1 1 i, j : index;
33 1 1 h, l : array[1..n] of index; {number high/low params}
34 1 1 np, : number of data points}
35 1 1 maxiter, : {max number iterations}
36 1 1 niter : integer; {number of iterations }
37 1 1 next, : {new vertex to be tested}
38 1 1 center, : {center of hyperplane described
39 1 1 by all vertexes of the simplex excluding the worst}
40 1 1 mean, error,
41 1 1 maxerr, : {maximum error accepted}
42 1 1 p, q, : {to compute first simplex}
43 1 1 step : vector; {input starting steps}
44 1 1 simp : array[1..n] of vector; {the simplex}
45 1 1 data : array[1..mnp] of datarow; {the data}
46 1 1 fname : array[1..14] of char; {filename}
47 1 1 din, dout: text; {input, output}
48 1 1
49 1 1 {~~~~~}
50 1 1
51 1 1 function f (x : vector; d: datarow) : real;
52 1 1 {x(1..m) the parameters, d has the data}
53 1 1 begin
54 1 2 f := x[1] * d[1] / (x[2] + d[1])
55 2 2 end;
56 2 1
57 2 1 {~~~~~}
58 2 1
59 2 1 procedure sum_of_residuals (var x : vector);
60 2 1 {computes the sum of the squares of the residuals}
61 2 1 {x(1..m) passes parameters. Result returned in x(n)}
62 2 1 var i : index;
63 2 2 begin

```

Listing 1 continued on page 354



# VISUAL 1050 Personal Computer System



... the complete professional solution at an unbeatable price.

**Complete Solution** The VISUAL 1050 is an advanced personal computer system designed especially for managers and professionals. It comes complete with top-rated software and high-performance hardware... all fully configured for easy set-up and simple operation. The VISUAL 1050 costs much less than other full-feature personal computers and comes with everything you need to tackle important professional jobs, right out of the box.

**Words, Numbers and Graphics** The VISUAL 1050 solves more professional problems than any other computer in its class. Whether you work with words, numbers, or graphics, the VISUAL 1050 speaks your language. You get *WordStar*,<sup>™</sup> *MailMerge*,<sup>™</sup> *Multiplan*<sup>™</sup> and Digital Research's *DR Graph*<sup>™</sup>... leading software packages for word processing, spreadsheet and graphics. And all have been specially adapted to share data and perform as an integrated software family.

**Communications, BASIC and More**... You get *Terminal Emulation* software which turns your VISUAL 1050 into a powerful ASCII terminal for dial-up access to remote computer resources. And you get *CBASIC*<sup>™</sup> for custom programming applications. *CP/M Plus*,<sup>™</sup> a new and improved release of CP/M, allows your VISUAL 1050 to support hundreds of popular third-party packages.

**Unbeatable Value** \$2,695 is the total retail price for the VISUAL 1050. You get the best and most popular software packages, ready to run on hardware which offers the features and quality you should demand. Two high capacity disc drives. 128K memory standard. Fast, bit-mapped graphics. Full size green screen.

	VISUAL 1050	IBM <sup>®</sup> PC	Apple <sup>®</sup> IIe	DEC Rainbow <sup>™</sup>
Base System Price <sup>1</sup>	\$2,695	\$2,750	\$2,390	\$3,495
Serial Port (RS232)	STANDARD	\$119	\$195	2 STANDARD
Parallel Port	STANDARD	\$119	\$180	STANDARD
Bit-Mapped Graphics	STANDARD	\$240	STANDARD	\$845
Word Processing Software	STANDARD	\$200-\$500	\$200-\$500	\$200-\$500
Spreadsheet Software	STANDARD	\$200-\$300	\$200-\$300	\$200-\$300
Business Graphics Software	STANDARD	\$200-\$400	\$200-\$400	\$200-\$400
Communications Software	STANDARD	\$100-\$200	\$100-\$200	STANDARD
<b>COMPLETE SOLUTION PRICE</b>	<b>\$2,695</b>	<b>\$3,928-\$4,628</b>	<b>\$3,465-\$4,165</b>	<b>\$4,940-\$5,540</b>
Dual Drive Capacity	800 KB	640 KB	280 KB	800 KB
Graphics Resolution	640 x 300	640 x 200	280 x 192	800 x 240
Keys on Keyboard	93	83	63	105
Standard Memory	128K	64K	64K	64K
Optional Winchester	YES	YES	YES	YES
Tilt and Swivel Display	YES	NO	NO	NO

1—Includes CPU, Standard Memory, Keyboard, Display, Two Disc Drives, and Operating System  
Based on manufacturers' information available February, 1984. VISUAL 1050 includes 128K User Memory standard.

Standard printer and communication ports. Rugged 93-key keyboard with special *WordStar* engravings. You can't buy a more complete hardware and software solution at anywhere near the price.

**VISUAL** See for yourself<sup>®</sup>

Visual Technology Incorporated  
540 Main Street, Tewksbury, MA 01876  
Telephone (617) 851-5000. Telex 951-539

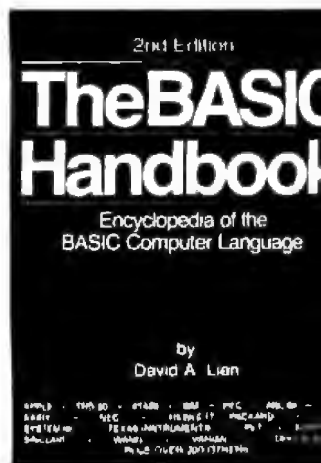
<sup>®</sup>Registered trademark of Visual Technology Incorporated

# Get big performance from your small computer for just \$2.95!

...with the latest information on *Interactive computing, Incompatibility, New BASIC applications, Computer simulations, Data file development and maintenance, CP/M and its uses, Writing more advanced programs, Algorithms, and more.*

Take this 5-volume Programming Library (a \$76.65 retail value) for \$2.95 as your introduction to the Small Computer Book Club.

You simply agree to buy 3 more books—at handsome discounts—within the next 12 months.



In the ever changing computer field, new techniques and applications seem to happen overnight...developments in software, design modifications in hardware, innovative programming techniques, and more!

Keeping current on the latest trends is essential...but it can be almost a full-time job. That's why we created the Small Computer Book Club. With books by some of the most respected authors in the field, we'll keep you up-to-date with the rapidly changing world of computers. You'll get steady training that will both refine and broaden your small computer talents...talents that will help you get more out of the time you spend "on-line."

A division of The Library of Computer and Information Sciences—the oldest, largest, and most respected computer book club in the world—the Small Computer Book Club gives you access to virtually every important computer topic.

## What can the Programming Library do for you?

The 5-volume Programming Library will challenge your knowledge and expand your capabilities...teaching you to get more from your small computer than you ever thought possible!

### Master virtually every BASIC application.

1. **THE BASIC HANDBOOK: Encyclopedia of the Basic Computer Language**, by David A. Lien, is an invaluable

tool, whether you operate a "bottom-of-the-line" pocket micro or a megabyte system.

You'll learn all there is to know about the uses of BASIC, as well as what to do about the problem of incompatibility.

Plus, **THE BASIC HANDBOOK** explains virtually every significant BASIC language feature of practically every BASIC-speaking computer in the world. It is the most complete collection of BASIC words ever, with strategies programmers can use to convert the many different "dialects" to their computers. Publisher's Price: \$19.95.

### Make your ideas become reality.

2. **BASIC AND THE PERSONAL COMPUTER**, by Thomas A. Dwyer and Margot Critchfield, gives you the resources you need to really take advantage of your computer's full capacity.

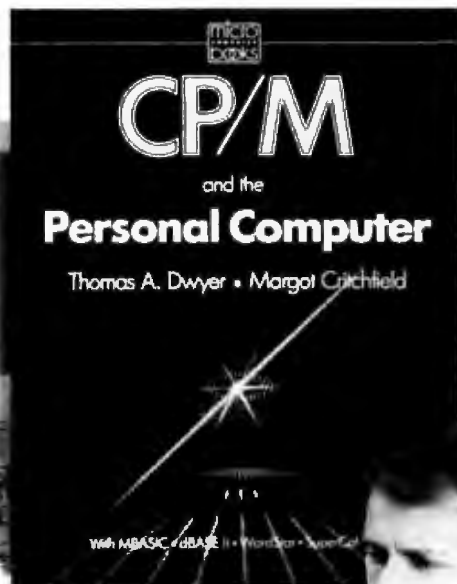
The best introduction to programming in BASIC and extended BASIC, this book will enable you to learn BASIC within eight hours, and to do almost anything else you want—write programs, sort data, and much more...all with step-by-step examples.

There are also sections on computer graphics, program development, data bases, word processing, computer simulations, and more. Publisher's Price: \$15.55.

### Understand CP/M and its uses.

3. **CP/M AND THE PERSONAL COMPUTER**, by Thomas A. Dwyer and Margot Critchfield, is an informative overview of how CP/M works and how to apply CP/M to profes-





**EXAMINE  
FREE  
FOR 10 DAYS**

**THE  
LITTLE BOOK  
OF  
BASIC STYLE**



sional and personal computing.

You'll get down-to-earth explanations that break CP/M into basic components for easy mastery of filing, debugging, editing, information flow, and more. The volume functions as a complete guide to this microcomputer disk operating system. There's even coverage of how to use popular commercial CP/M application programs in four major areas: word processing, spread sheets, database management, and accounting systems.

Publisher's Price: \$19.95.

**Write programs you can read.**

4. **THE LITTLE BOOK OF BASIC STYLE: How to Write a Program You Can Read**, by John Nevison, challenges the reader to go beyond computer literacy to fluency, teaches you how to write programs of less than one page, encourages thoughtful program organization, and more.

Covering everything from algorithms and games to problem solving and programming, **THE LITTLE BOOK OF BASIC STYLE** is a comprehensive guide that not only will teach you the rules to follow, but explain *why* they are necessary.

Publisher's Price: \$8.25.

**Use data files on microcomputers.**

5. **DATA FILE PROGRAMMING IN BASIC: A Self-Teaching Guide**, by LeRoy Finkel and Gerald R. Brown, is the first self-instructional manual in clear, non-technical language, for both hobbyists and professionals who want to add data file programming to their computing capabilities.

Data files are the key to using microcomputers effectively—whether for business or personal applications. Yet, being able to set up and maintain data files is beyond most people's capabilities. But with **DATA FILE PROGRAMMING IN BASIC**, you'll grasp the necessary techniques quickly and easily. Includes step-by-step instructions for programming, data file maintenance, and modification of commercial programs.

Publisher's Price: \$12.95.

**4 Good Reasons to Join**

1. **The Finest Books.** Of the hundreds of books submitted to us each year, only the very finest are selected and offered. Moreover, our books are always of equal quality to publishers' editions, never economy editions.
2. **Big Savings.** In addition to getting the Programming Library for \$2.95 when you join, you keep saving substantially—up to 30% and occasionally even more. (For example, your total savings as a trial member—including this introductory offer—can easily be over 50%. That's like getting every other book free!)
3. **Bonus Books.** Also, you will immediately become eligible to participate in our Bonus Book Plan, with savings up to 70% off the publishers' prices.
4. **Convenient Service.** At 3-4 week intervals (16 times per year) you will receive the Book Club News, describing the Main Selection and Alternate Selections, together with a dated reply card. If you want the Main Selection, do nothing and it will be sent to you automatically. If you prefer another selection, or no book at all, simply indicate your choice on the card, and return it by the date specified. You will have at least 10 days to decide. If, because of late mail delivery of the News, you should receive a book you do not want, we guarantee return postage.

If the reply card has been removed, please write to: the Small Computer Book Club, Dept. Y-AF6, Riverside, N.J. 08075 to obtain membership information and an application.

Byte 5/84

## Listing 1 continued:

```

64 2 2      x[n] := 0.0;
65 3 2      for i := 1 to np do
66 4 3          begin
67 5 4              x[n] := x[n] + sqr(f(x,data[i]) - data[i,2])
68 6 4                  end
69 6 3          {loop}
70 6 1          {sum_of_residuals}
71 6 1      {~~~~~}
72 6 1
73 6 1
74 6 1      procedure enter;          {enters data from disk file fname
75 6 1          file must terminate with EOF
76 6 1          immediately after last number.
77 6 1          data in the order:
78 6 1              -maximum number iterations,
79 6 1              -starting point coordinates
80 6 1              -starting increments
81 6 1              -maximum errors
82 6 1              -data)
83 6 1
84 6 1      begin                      {enter}
85 6 2          write(dout,' SIMPLEX optimization version ');
86 7 2          write(dout,date);
87 8 2          writeln(dout,' @ MC/BC FSU');
88 9 2          writeln(dout,memo);
89 10 2         writeln(dout,' accessing file ',fname);
90 11 2         read(din,maxiter);
91 12 2         writeln(dout,' max number of iterations is := ',maxiter:5);
92 13 2         write(dout,' start coord.:');
93 14 2         for i := 1 to m do
94 15 3             begin
95 16 4                 read(din,simp[1,i]);
96 17 4                 if (i mod lw) = 0 then writeln(dout);
97 19 4                 write(dout,simp[1,i])
98 20 4             end;
99 20 2         writeln(dout);
100 21 2        write(dout,' start steps: ');
101 22 2        for i := 1 to m do
102 23 3            begin
103 24 4                read(din,step[i]);
104 25 4                if (i mod lw) = 0 then writeln(dout);
105 27 4                write(dout,step[i])
106 28 4            end;
107 28 2        writeln(dout);
108 29 2        write(dout,' max. errors: ');
109 30 2        for i := 1 to n do
110 31 3            begin
111 32 4                read(din,maxerr[i]);
112 33 4                if (i mod lw) = 0 then writeln(dout);
113 35 4                write(dout,maxerr[i])
114 36 4            end;
115 36 2        writeln(dout);
116 37 2        writeln(dout,' data:');
117 38 2        writeln(dout,' x':14,'y':14);
118 39 2        np := 0;
119 40 2        while not eof(din) do
120 41 3            begin
121 42 4                np := succ(np);
122 43 4                write(dout,' #',np:3);
123 44 4                for j := 1 to nvpp do
124 45 5                    begin
125 46 6                        read(din,data[np,j]);
126 47 6                        write(dout,data[np,j])
127 48 6                    end;
128 48 4                writeln(dout);
129 49 4            end

```

(while)

Listing 1 continued on page 355



Listing 1 continued:

```
130 50 3      end;                                {enter}
131 50 1
132 50 1      {~~~~~}
133 50 1
134 50 1      procedure report;
135 50 1          var    y, dy,
136 50 2              sigma    : real;
137 50 2              d1, d2    : text;          {disk out files}
138 50 2          begin
139 50 2              rewrite('FIT.DAT',d1);      {fitted y's}
140 51 2              rewrite('ERR.DAT',d2);     {residuals }
141 52 2              writeln(d1,' 1 1 1 1 1 1',np); {dummy arguments}
142 53 2              writeln(d2,' 1 1 1 1 1 1',np); {for PLOT program}
143 54 2              writeln(dout,' program exited after',niter:5,' iterations ')
144 55 2              writeln(dout,' the final simplex is');
145 56 2              for j := 1 to n do
146 57 3                  begin
147 58 4                      for i := 1 to n do
148 59 5                          begin
149 60 6                              if (i mod lw) = 0 then writeln(dout);
150 62 6                              write(dout,simp[j,i]:10)
151 63 6                              end;
152 63 4                              writeln(dout)
153 64 4                          end;                {do j}
154 64 2              writeln(dout, ' the mean is');
155 65 2              for i := 1 to n do
156 66 3                  begin
157 67 4                      if (i mod lw) = 0 then writeln(dout);
158 69 4                      write(dout,mean[i])
159 70 4                      end;
160 70 2              writeln(dout);
161 71 2              writeln(dout,' the estimated fractional error is');
162 72 2              for i := 1 to n do
163 73 3                  begin
164 74 4                      if (i mod lw) = 0 then writeln(dout);
165 76 4                      write(dout,error[i])
166 77 4                      end;
167 77 2              writeln(dout);
168 78 2              writeln(dout,' #':4,'x':10,'y':15,'y''':15,'dy':15);
169 79 2              sigma := 0.0;
170 80 2              for i := 1 to np do
171 81 3                  begin
172 82 4                      y := f(mean,data[i]);
173 83 4                      dy:= data[i,2] - y;
174 84 4                      sigma := sigma + sqr(dy);
175 85 4                      writeln(dout,i:4,data[i,1]:15,data[i,2]:15,y:15,dy:15);
176 86 4                      writeln(d1,data[i,1],y);
177 87 4                      writeln(d2,data[i,1],dy)
178 88 4                  end;
179 88 2              sigma := sqrt(sigma / np);
180 89 2              writeln(dout,' the standard deviation is',sigma);
181 90 2              sigma := sigma / sqrt(np - m);
182 91 2              write(dout,' the estimated error of the');
183 92 2              writeln(dout,' function is',sigma);
184 93 2          end;                                {report}
185 94 1
186 94 1      {~~~~~}
187 94 1
188 94 1      procedure first;
189 94 1          begin
190 94 2              writeln(dout,' starting simplex');
191 95 2              for j := 1 to n do          {vertexes}
192 96 3                  begin
193 97 4                      write(dout,' simp['',j:1,'']');
194 98 4                      for i := 1 to n do
195 99 5                          begin                                {dimensions}
```

Listing 1 continued on page 356

## Listing 1 continued:

```

196 100 6          if (i mod lw) = 0 then writeln(dout);
197 102 6          write(dout,simp[j,i])
198 103 6          end;                                {dimensions}
199 103 4          writeln(dout)
200 104 4          end;                                {vertexes}
201 104 2          writeln(dout)
202 105 2          end;                                {first}
203 105 1
204 105 1 {~~~~~},
205 105 1
206 105 1 procedure new_vertex; {next in place of the worst vertex}
207 105 1 begin
208 105 2   write(dout,' --- ',niter:4);
209 106 2   for i := 1 to n do
210 107 3     begin
211 108 4       simp[h[n],i] := next[i];
212 109 4       write(next[i])
213 110 4     end;
214 110 2   writeln(dout)
215 111 2   end;                                {new_vertex}
216 111 1
217 111 1 {~~~~~},
218 111 1
219 111 1 procedure order; {gives high/low in each parameter}
220 111 1 {in simp. caution: not initialized}
221 111 1   var i, j : index;
222 111 2
223 111 2   begin
224 111 2     for j := 1 to n do {all dimensions}
225 112 3       begin
226 113 4         for i := 1 to n do {of all vertexes}
227 114 5           begin {find best and worst}
228 115 6             if simp[i,j] < simp[l[j],j] then l[j] := i;
229 117 6             if simp[i,j] > simp[h[j],j] then h[j] := i;
230 119 6           end {i loop}
231 119 5         end {j loop}
232 119 3       end; {order}
233 119 1
234 119 1 {~~~~~},
235 119 1
236 119 1 begin {simplex}
237 119 1   read(fname); {input file in CP/M command line}
238 120 1   reset(fname,din); {fname is on disk}
239 121 1   rewrite('con:',dout); {output goes to console}
240 122 1   enter; {get the data}
241 123 1   reset(fname,din); {reset in file}
242 124 1   rewrite('lst:',dout); {output goes to printer}
243 125 1   enter;
244 126 1
245 126 1   sum_of_residuals(simp[l]); {first vertex}
246 127 1
247 127 1   for i := 1 to m do {compute offset of the vertexes}
248 128 2     begin {of the starting simplex}
249 129 3       p[i] := step[i] * (sqrt(n) + m - 1) / (m * root2);
250 130 3       q[i] := step[i] * (sqrt(n) - 1) / (m * root2)
251 131 3     end;
252 131 1
253 131 1   for i := 2 to n do {all vertexes of the}
254 132 2     begin {starting simplex}
255 133 3       for j := 1 to m do simp[i,j] := simp[l,j] + q[j];
256 135 3       simp[i,i - 1] := simp[l,i - 1] + p[i - 1];
257 136 3       sum_of_residuals(simp[i]) {and their residuals}
258 137 3     end;
259 137 1
260 137 1   for i := 1 to n do {preset}
261 138 2     begin

```

Listing 1 continued on page 357



## Listing 1 continued:

```

262 139 3          l[i] := 1; h[i] := 1
263 141 3          end;                                {before calling}
264 141 1  order;
265 142 1
266 142 1  first;                                       {pass to printer}
267 143 1  rewrite('con:',dout); {and}
268 144 1  first;                                       {to screen}
269 145 1
270 145 1  niter := 0;                                   {no iterations yet}
271 146 1
272 146 1  repeat                                       {keep iterating}
273 147 2  done := true;                                 {wish it were...}
274 148 2  niter := succ(niter);
275 149 2
276 149 2  for i := 1 to n do center[i] := 0.0;
277 151 2  for i := 1 to n do                            {compute centroid}
278 152 3      if i <> h[n] then                        {excluding the worst}
279 153 3          for j := 1 to m do
280 154 4              center[j] := center[j] + simp[i,j];
281 155 2
282 155 2  for i := 1 to n do                            {first attempt to reflect}
283 156 3      begin
284 157 4          center[i] := center[i] / m;
285 158 4          next[i] :=
286 159 4              (1.0 + alfa) * center[i] - alfa * simp[h[n],i]
287 159 4              {next vertex is the specular reflection of the worst}
288 159 4      end;
289 159 2  sum_of_residuals(next);
290 160 2
291 160 2  if next[n] <= simp[l[n],n] then
292 161 2      begin                                     {better than the best ?}
293 162 3          new_vertex;                             {accepted !}
294 163 3          for i := 1 to m do                     {and expanded}
295 164 4              next[i] :=
296 165 4                  gamma * simp[h[n],i] + (1.0 - gamma) * center[i];
297 165 3          sum_of_residuals(next); {still better ?}
298 166 3          if next[n] <= simp[l[n],n] then new_vertex
299 168 3      end                                       {expansion accepted}
300 168 2
301 168 2  else                                         {if not better than the best}
302 168 2      begin
303 169 3          if next[n] <= simp[h[n],n] then
304 170 3              new_vertex;                         {better than worst}
305 171 3          else                                     {worse than worst}
306 171 3              begin                                 {then: contract}
307 172 4                  for i := 1 to m do
308 173 5                      next[i] :=
309 174 5                          beta * simp[h[n],i] + (1.0 - beta) * center[i];
310 174 4                  sum_of_residuals(next);
311 175 4                  if next[n] <= simp[h[n],n] then
312 176 4                      new_vertex;                 {contraction accepted}
313 177 4                  else                             {if still bad}
314 177 4                      begin                         {shrink all bad vertexes}
315 178 5                          for i := 1 to n do
316 179 6                              begin
317 180 7                                  for j := 1 to m do
318 181 8                                      simp[i,j] :=
319 182 8                                          (simp[i,j] + simp[l[n],j]) * beta;
320 182 7                                  sum_of_residuals(simp[i])
321 183 7                              end                             {i loop}
322 183 6                          end                             {else}
323 183 4                      end                             {else}
324 183 3                  end;                             {else}
325 183 2
326 183 2  order;
327 184 2  for j := 1 to n do                            {check for convergence}

```

Listing 1 continued on page 358

Listing 1 continued:

```
328 185 3      begin
329 186 4        error[j] :=
330 187 4          (simp[h[j],j] - simp[l[j],j]) / simp[h[j],j];
331 187 4        if done then
332 188 4          if error[j] > maxerr[j] then
333 189 4            done := false
334 190 4        end
335 190 3      until (done or (niter = maxiter));
337 190 1
338 190 1      for i := 1 to n do          {average each parameter}
339 191 2        begin
340 192 3          mean[i] := 0.0;
341 193 3          for j := 1 to n do
342 194 4            mean[i] := mean[i] + simp[j,i];
343 195 3          mean[i] := mean[i] / n
344 196 3        end;
345 196 1
346 196 1      report;                  {to console}
347 197 1      rewrite('lst:',dout);   {and do it again}
348 198 1      report;                  {to the printer}
349 199 1      writeln(dout,chr(page))
350 200 1    end                      {of simplex}
351 200 1    .
```

A>

Listing 2: An example of a *Simp* input file. This file contains experimental data obeying the Michaelis-Menten equation.

```
100
0.2 3
0.1 1
1e-4 1e-4 1e-4
1.68 0.172
3.33 0.250
5.00 0.286
6.67 0.303
10.0 0.334
20.0 0.384
```

Listing 3: An example of the printer output from *Simp* for the Michaelis-Menten example. The computed values of *a* and *b* are given in "the mean is ..." line. The  $a = 4.238157E-01$  and  $b = 2.451927E+00$ . The equation is  $y = 0.4238157 \times x / (x + 2.451927)$ .

```
SIMPLEX optimization version 5/22/83 @ MC/BC FSU
fit of a Michaelis-Menten function : y=ax/(b+x)
accessing file MM
max number of iterations is := 100
start coord.: 1.999999E-01 3.000000E+00
start steps: 9.999999E-02 1.000000E+00
max. errors: 9.999998E-05 9.999998E-05 9.999998E-05
data:
      x          y
# 1  1.679999E+00  1.719999E-01
# 2  3.329999E+00  2.500000E-01
# 3  5.000000E+00  2.859999E-01
# 4  6.669999E+00  3.029999E-01
# 5  1.000000E+01  3.339999E-01
# 6  2.000000E+01  3.839999E-01
starting simplex
simp[1] 1.999999E-01 3.000000E+00 1.607578E-01
simp[2] 2.965924E-01 3.258818E+00 6.597012E-02
simp[3] 2.258818E-01 3.965925E+00 1.520970E-01
```

Listing 3 continued on page 360



# See Software.

Dick is a programmer. Dick is bored. Harried. Dick struggles with trace chores. Debugging routines. Nonexistent documentation. Hidden bugs. So Dick is four months behind schedule. And customers are upset when bugs slip through. They yell and make Dick upset. They make Dick's boss upset. Nobody is very happy.



# See Software Run.

Jane is a happy programmer. She uses ANIMATOR™. It's a VISUAL PROGRAMMING™ aid for MICRO FOCUS™ LEVEL II COBOL™. It runs on a micro. It makes child's play of test and debugging tasks.

With ANIMATOR Jane sees a picture of the program explaining itself. In real time. In COBOL source code. ANIMATOR tracks the program's exact execution path. Including sub-routine branches. Jane can have the program run fast. Or slow. Or stop. With one key. This makes it easy to spot problems. Insert fixes. Set breakpoints. Instantly.

Jane's programs are best sellers. They're delivered on time. With no hidden bugs. Jane's boss likes this about Jane. Because he doesn't like customers to yell at him.

# Run, Software, Run.

This software vendor just went public. Because he doubled productivity. Eliminated bugs. Cut costs. Produced terrific applications. Beat the competition to market. And customers don't yell at him anymore. All thanks to ANIMATOR.



## See ANIMATOR now.

Let ANIMATOR help you do better work. And speed your applications to market. Write for more information. Or call (415) 856-4161. Right now.

### **MICRO FOCUS**

2465 E. Bayshore Rd., Suite 400, Palo Alto, CA 94303

© 1984 Micro Focus Inc. All Rights Reserved.  
LEVEL II COBOL ANIMATOR, VISUAL PROGRAMMING, MICRO FOCUS and the MICRO FOCUS Logo are trademarks of Micro Focus Ltd.

2465 East Bayshore Rd., Suite 400, Palo Alto, CA 94303  
I'd like more information

Name \_\_\_\_\_ Title \_\_\_\_\_

Company \_\_\_\_\_ Phone \_\_\_\_\_

Address \_\_\_\_\_

City \_\_\_\_\_ State \_\_\_\_\_ Zip \_\_\_\_\_

BY 5/84

Listing 3 continued:

```

program exited after 43 iterations
the final simplex is
4.238141E-01 2.451970E+00 1.675719E-04
4.238193E-01 2.451966E+00 1.675727E-04
4.238136E-01 2.451845E+00 1.675722E-04
the mean is
4.238157E-01 2.451927E+00 1.675723E-04
the estimated fractional error is
1.321987E-05 5.095140E-05 5.036683E-06
#           x           y           y''           dy
1  1.679999E+00  1.719999E-01  1.723191E-01  -3.191828E-04
2  3.329999E+00  2.500000E-01  2.440892E-01  5.910783E-03
3  5.000000E+00  2.859999E-01  2.843664E-01  1.633465E-03
4  6.669999E+00  3.029999E-01  3.098962E-01  -6.896257E-03
5  1.000000E+01  3.339999E-01  3.403615E-01  -6.361544E-03
6  2.000000E+01  3.839999E-01  3.775317E-01  6.468236E-03
the standard deviation is 5.284775E-03
the estimated error of the function is 2.642387E-03

```

Text continued from page 348:

character between the last digit and the EOF (end of file) mark to avoid a "read beyond EOF" error.

Listing 2 gives the input for this example. If you use a dedicated program to write *<infile>*, you can avoid many problems with inexperienced operators.

The printer output (listing 3) consists of the input data followed by:

- the number of iterations
- the values of the parameters and  $SS_R$  at the vertexes of the last simplex
- the final mean values of the parameters and  $SS_R$
- the estimated errors on those mean values
- for each data point: the experimental and the computed dependent variable values and the difference between the experimental and calculated values
- the standard deviation of the experimental points from the fitted function
- the estimated standard deviation of the "true" function points from the fitted ones

### Problems

Simp never diverges but this does not guarantee that no problems will develop. Programming or input errors are easily corrected while others are not.

Failure to converge and premature conclusion are usually the result of using the wrong input parameters along with truncation/round-off

errors in the machine's arithmetics. Very large initial guesses and/or very small initial increments create a starting simplex with virtually identical responses at the vertexes. In cases like this, the program often ends prematurely.

If the acceptable errors are exceedingly large, the program may emerge while the simplex is still far from the minimum response, possibly along a saddle. If the acceptable errors are too small, on the other hand, the simplex can keep bouncing around the minimum until the maximum number of iterations is completed. This is due to the simplex's inability to contract further because of "quantum" round-off errors in the machine's arithmetics.

In many instances the results are largely insensitive to one or more of the fitted parameters. In these cases, the simplex travels great distances along these coordinates before coming to rest. When you know that a parameter is of only marginal significance in the fit (i.e., its value scarcely affects the results), it is a good idea to give it a large acceptable error. If you don't, Simp keeps changing that parameter, without noticing any effects on the response surface.

Last, sometimes the program gives results far from the expected, but the fitted curve matches the experimental data excellently. This happens when a particular function can be equally satisfied with more than one set of parameters (the response surface has more minima). When you suspect more than one solution

exists, good starting guesses and small increments usually help. It is always a good practice to verify the uniqueness and precision of your results by running the program with different starting guesses.

Simp does not provide an estimate of the computed parameter errors. A good way to evaluate them is with the following Monte Carlo or sensitivity analysis:

- from the parameters *a, b, etc.*, produced by Simp, compute the set,  $x_1, y_1; x_2, y_2; \dots; x_n, y_n$ , consisting of the independent variable's experimental values and the dependent variable's "expected" values. (Simp writes these points in FIT.DAT.)
- to this set, add random numbers with a Gaussian distribution mean = 0 and a standard deviation equal to the experimental data's computed by Simp to create a sufficiently large number, *m*, of simulated experimental point sets:

$$\begin{array}{l}
 x_1, y^1_1; x_2, y^1_2; \dots; x_n, y^1_n \\
 x_1, y^2_1; x_2, y^2_2; \dots; x_n, y^2_n \\
 \dots \\
 x_1, y^m_1; x_2, y^m_2; \dots; x_n, y^m_n
 \end{array}$$

- run Simp on each of these simulated experimental sets.
- the new computed parameter values should approach the experimental data's. Their standard deviation is a reasonable estimate of the error in the computed parameters. A statistically significant difference between the mean value of the simu-





## Sheet Feeders By Rutishauser.

*Swiss-Made Quality. Competitive Prices.*

**R**utishauser. Remember the name. Our precision sheet feeders save you time. And Money. Rutishauser products are made to exacting standards of Swiss craftsmanship. Built to perform. Built to last. Time after time after time. Rutishauser. The very best in document and forms handling equipment... electronic or mechanical... for word and data processing systems.

### MECHANICAL SHEET FEEDER (2:00)

Automatic feeding. Simple and easy to install and load. No special software, switches, controls, or adjustments needed.

### PROGRAMMABLE DOUBLE BIN FEEDER (11:00)

Flexible control and consistently reliable performance — with or without electronic commands. Operator programmable, with remote/local modes. Also reacts to mechanical or electrical bin selection.

Circle 339 on Inquiry card.

### BI-DIRECTIONAL FORMS TRACTOR (9:00)

Trouble-free handling for accurate continuous forms feeding. Fits any standard word/data processing printer.

### SINGLE BIN SHEET FEEDER (3:00)

One of the most widely used single bin feeders in the world. Automatic. Compact. Lightweight. A powerful microprocessor controls paper position and insertion.

### DOUBLE BIN SHEET FEEDER (12:00)

Interchangeable and software compatible with our demand sheet feeder model. Each sheet fed upon command. Ample capacity with room for 450 sheets.

### DEMAND SHEET FEEDER (10:00)

Feeds sheets upon command by printer system. Accommodates virtually any size paper or type of form.

### FRONT FEED DEVICE (1:00)

Programmed insertion of forms for complex applications. Handles preprinted forms, ledger cards and other single or multipart documents.

Rutishauser sheet feeders are available for leading letter-quality printers. Rutishauser. Swiss standards of lasting value. Call us at (214) 343-9154 (USA) or (00-41-1) 926 46 00 (International). Isn't it... about time?

Rutishauser of America, Inc.  
10345 Brockwood Rd.  
Dallas, Texas 75238

(An affiliate of Rutishauser Data AG.)

See us at COMDEX Spring, #1074.

**Rutishauser**

SWISS QUALITY

Swiss-Made Quality You Can Afford.





for 6809  
8080, Z80  
8088, 8086

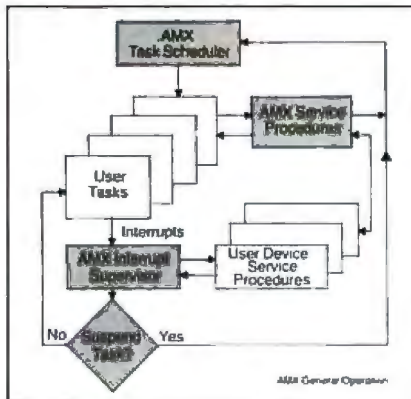
## Real-Time Multitasking Executive

- ROMable (< 3K)
- No royalties
- Source code included
- Language interfaces
- Low interrupt overhead
- Inter-task messages

Options:

- C, Pascal, PL/M, Fortran i/f
- Extended memory (> 64K)
- Configuration Builder Utility
- Resource (semaphore) Manager
- Buffer Manager
- Integer Math Library
- Real-Time C Library

AMX (for 8080) \$800 U.S.  
manual only \$ 75 U.S.



AMX Real-Time Core™ of KADAK Products Ltd  
Z80 is TM of Zilog Corp

### KADAK Products Ltd.

206-1847 W. Broadway Avenue  
Vancouver, B.C., Canada V6J 1Y5  
Telephone: (604) 734-2796  
Telex: 04-55670

lated data's parameters and the real data's is a strong indication that the function being fitted is not an adequate model of the system, or at least, that systematic errors are present in the data.

### Conclusion

Curve fitting is a very frequent task, at least in the scientific environment. The big advantages of the Simplex algorithm are not only its remarkable speed and the fact that the program can never diverge, but also the compact and elegant flow-chart, which makes it ideal for didactics and for Pascal implementations. Simp uses no matrix operation and no knowledge of calculus is necessary to understand the purely geometrical description of the simplex movements given.

The program Simp provides a curve-fitting algorithm capable of handling virtually any function, no matter how complex, with any number of variables and parameters. It is a very handy tool for scientists and statisticians because of its remarkable speed, simplicity, and reliability. ■

### References

1. Adby, P. R., and M. A. H. Dempster. *Introduction to Optimization Methods*. London: Chapman and Hall, 1974.
2. Box, G. P., J. Hunter, and W. Hunter. *Statistics for Experiments*. New York: John Wiley and Sons, 1978.
3. Marquardt, D. W. "An Algorithm for Least-Squares Estimation of Non-Linear Parameters". *Journal of the Society of Industrial and Applied Mathematics*, 11, 431, 1963
4. Nedler, J. A., and R. Mead. "A Simplex Method for Function Minimization". *Computer Journal*, 7, 308, 1965.

**Authors' note:** We would like to thank the Office of Basic Energy Sciences of the United States Department of Energy, which supported our work.

Marco S. Caceci (1322 N. Bronough St., Tallahassee, FL 32304) is a research associate in the Department of Chemistry at Florida State University in Tallahassee. His interests range from photography and reading to swimming, skiing, and scuba diving.

William P. Cacheris (2616 Mission Rd., Apt. 175, Tallahassee, FL 32306) is a research assistant in the Department of Chemistry at Florida State and is currently seeking his doctorate in the same department. He enjoys sports, playing the piano, and exploring the capabilities of home computers.

# TOTAL CONTROL:

FORTH: FOR Z-80®, 8086, 68000, and IBM® PC

Complies with the New 83-Standard

GRAPHICS • GAMES • COMMUNICATIONS • ROBOTICS  
DATA ACQUISITION • PROCESS CONTROL

- FORTH programs are instantly portable across the four most popular microprocessors.
- FORTH is interactive and conversational, but 20 times faster than BASIC.
- FORTH programs are highly structured, modular, easy to maintain.
- FORTH affords direct control over all interrupts, memory locations, and i/o ports.
- FORTH allows full access to DOS files and functions.
- FORTH application programs can be compiled into turnkey COM files and distributed with no license fee.
- FORTH Cross Compilers are available for ROM'ed or disk based applications on most microprocessors.

Trademarks: IBM, International Business Machines Corp., CP/M, Digital Research Inc., PC/Forth+ and PC/GEN, Laboratory Microsystems, Inc.

**FORTH Application Development Systems** include interpreter/compiler with virtual memory management and multi-tasking, assembler, full screen editor, decompiler, utilities and 200 page manual. Standard random access files used for screen storage. extensions provided for access to all operating system functions

Z-80 FORTH for CP/M® 2.2 or MP/M II, \$100.00.  
8080 FORTH for CP/M 2.2 or MP/M II, \$100.00.  
8086 FORTH for CP/M-86 or MS-DOS, \$100.00.  
PC/FORTH for PC-DOS, CP/M-86, or CCPM, \$100.00. 68000 FORTH for CP/M-68K, \$250.00

FORTH+ Systems are 32 bit implementations that allow creation of programs as large as 1 megabyte. The entire memory address space of the 68000 or 8086/88 is supported directly

PC FORTH+ \$250.00  
8086 FORTH+ for CP/M-86 or MS-DOS \$250.00  
68000 FORTH+ for CP/M-68K \$400.00

**Extension Packages** available include: software floating point, cross compilers, INTEL 8087 support, AMD 9511 support, advanced color graphics, custom character sets, symbolic debugger, telecommunications, cross reference utility, B-tree file manager Write for brochure

**Laboratory Microsystems Incorporated**  
Post Office Box 10430, Marina del Rey, CA 90295  
Phone credit card orders to (213) 306-7412





# Your IBM<sup>®</sup> PC is smarter than you think.

It's really a terrific computer once you get the hang of it. But getting through the IBM manuals can really hang *you* up.

Unless you do it the smart way. Using Ashton-Tate's Reference Encyclopedia for the IBM Personal Computer.

## The IBM PC Reference Encyclopedia.

Authors Gary Phillips and Karen Phillips took everything you might even *think* you'd want to know about your IBM PC and compatible products, and assembled it all in one place.

This Second Edition of our Encyclopedia is two volumes jam-packed with information that gives you the meanings behind the manuals and keeps you current on compatible software and hardware products.

Inside, you'll find several thousand quick-reference entries and over a hundred in-depth "how-to" items.

We'll tell you everything you need to know about DOS (including 2.0). We thoroughly cover the PC and the XT.<sup>™</sup> Detail topics like disk organization, printer control and more. Describe IBM and non-IBM programs and add-ons realistically, so you don't get trapped in the software/hardware jungle. And show you dozens of other ways to get the most out of your PC.



We've compiled tables and reviews you won't find anywhere else. Gathered hundreds of practical tips and techniques from magazines, newsletters and dozens of experienced users, so you won't have to learn them the hard way.

### It's easy to take.

We've made all this information easily accessible, because the Encyclopedia is efficiently indexed and thoroughly cross-referenced.

It's all explained in plain English with enough depth for both novice and intermediate users.

We update it twice a year, to keep you up to speed on all the new developments.

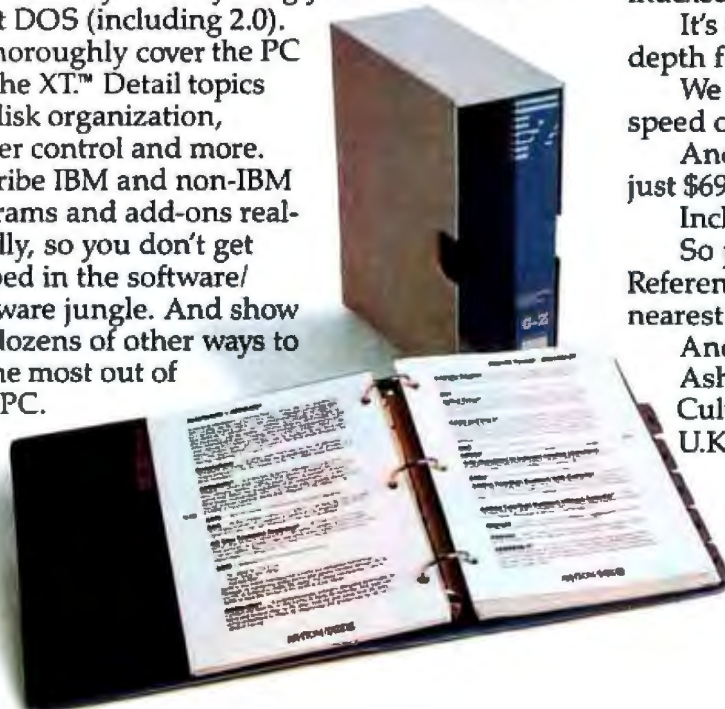
And it's all yours for a suggested retail price of just \$69.95.

Including two free updates.

So pick up a copy of the Ashton-Tate IBM PC Reference Encyclopedia (Second Edition) at your nearest computer or software store.

And stamp out manual labor today.

Ashton-Tate, 10150 West Jefferson Boulevard, Culver City, CA 90230. (213) 204-5570. In the U.K., call (0908) 568866.



ASHTON · TATE  <sup>TM</sup>

IBM and XT are trademarks of International Business Machines.  
© Ashton-Tate 1984

Circle 425 on inquiry card.

# Undo.Windows.

New Microsoft® Word. It makes your IBM Personal Computer think it's better than a \$10,000 word processor.

With Microsoft Word, what you see on the screen is what you get on the paper. So it's easy to spot mistakes. **Boldface**, underline, and *italics* look like this, not this: ^Bboldface^B, ^Sunderline^S, ^Iitalics^I.

And, when you make changes, paragraphs are automatically reformatted. Flush right, flush left, centered or justified. It even gives you several columns on a page, like a newspaper.

**Word forgives and doesn't forget.**

There's an "uh-oh" command called Undo. Make a mistake? Or just want to experiment? Hit Undo.





# Mouse. Finally.

Word undoes your last change and remembers things the way they were.

Word does windows. Up to eight, to be exact. So you can transfer or edit between eight different documents. Or between eight different pieces of the same document.

## Word travels fast.

Word has a Mouse, a handy little critter that lets you move copy, select commands and edit faster than you can say "cheese."



Word also lets you create your own style sheets, so you can standardize your documents, memos, files and letters.

It's not surprising that Microsoft has a way with Word. We designed the MS™-DOS operating system that tells the IBM® PC how to think. And we pioneered the first microcomputer BASIC, the language spoken by nine out of ten micros worldwide.

For a few final words, call 1-800-426-9400 (in Washington State call 206-828-8088) for a free Word brochure and the name of your nearest Microsoft dealer.

**MICROSOFT**  
The High Performance Software

# Laboratory Data Collection with an IBM PC

*A versatile hardware/software combination*

Stephen C. Gates  
Illinois State University

You have a new IBM Personal Computer (PC) and you want to use it in the laboratory to collect data from a scientific instrument. How do you do that with a small investment of time on your part and still get a product that is a powerful, useful tool in the laboratory?

I faced that same problem almost two years ago when our chemistry department received its first IBM PC, and I wanted to interface it to a variety of chemical laboratory instruments. We had only one of each type of instrument, so I was faced with the possibility of designing a custom interface for each of 10 or more instruments.

Fortunately, I had interfaced single instruments to a DEC LSI 11/23 and to an Apple, so I knew from my own previous mistakes that a little advanced planning would make this a much simpler project. Specifically, I realized that interfacing can be made much easier by using two simple concepts: first, buy commercially available hardware where possible, and, second, develop general-purpose software that can be used for almost any instrument.

By utilizing these two concepts, I found that even undergraduate chem-

istry students with little previous computer experience can produce research-quality interfaces, with complete software, in less than one week. If you follow the suggestions provided here, you should be able to design and implement an interface to the instrument of your choice in less time. All you need to do is be able to program in BASIC, FORTRAN, or some other language that allows the use of assembly-language subroutines.

The essential elements of this system are a commercially available data-collection board that fits in one of the slots of the IBM PC, a preamplifier and filter for conditioning the signal from the instrument, and a set of BASIC and assembly-language routines to perform tasks common to all of the instruments to be interfaced.

The utility of this approach arose fairly naturally from some initial design decisions. My major criteria for selection of equipment and software were ease of development and ease of use. Therefore, I judged it to be not cost-effective to spend time developing special-purpose A/D (analog-to-digital) converters, timers, or other equipment. Similarly, I

chose to use BASIC for all purposes except the data-collection process itself because of the ease of programming, even for novices; when the programs are completely tested, they are converted to compiled BASIC to greatly increase their execution speed.

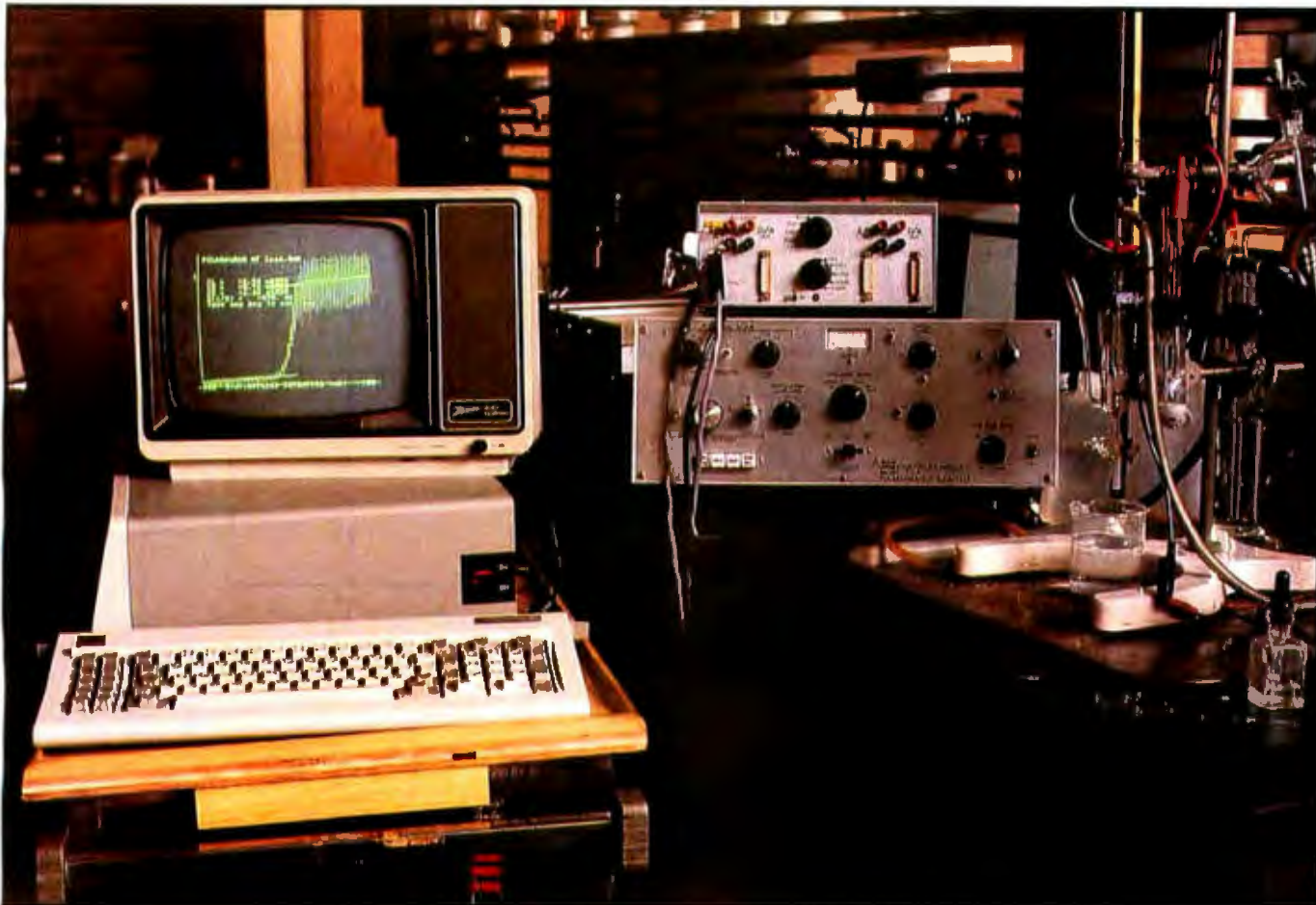
In order to encourage a variety of users, I put the (now several) IBM PCs on carts so that the computers can be wheeled from experiment to experiment. Each cart contains a 64K- or 128K-byte IBM PC with a color-graphics monitor adapter and green monitor; dual 320K-byte disk drives; a combination board containing an A/D converter, D/A (digital-to-analog) converter and programmable clock; and a preamplifier and filter combination. A typical system in use is shown in photo 1.

Each of the components on the cart is designed to accommodate interfaces to a variety of instruments. If you are attempting to develop a similar system, it may help to have a description of why I selected each component.

## Data-Acquisition Board

Several different manufacturers now market general-purpose data-





**Photo 1:** The general-purpose laboratory interface station can be moved easily from instrument to instrument because it is on a laboratory cart. The IBM PC contains a color/graphics monitor board and a Tecmar Lab Master interface board. The preamplifier box is perched on top of the larger control device for the polarograph, in the center. The electrodes for the polarograph are at the right side of the photo.

acquisition boards (see reference 4). These usually include a multi-channel A/D converter, one or more D/A converters, and a programmable clock as standard features, with options such as programmable gain, higher acquisition rates, and DMA (direct memory access). For most scientific applications, a 12-bit A/D conversion is necessary; 8-bit A/D converters simply do not provide adequate resolution.

In addition, most laboratories now use nonintegrating A/D converters rather than integrating types because of the slow speed of the latter. The primary advantage of the integrating A/D converter is the reduction of noise; however, this can be accomplished instead through appropriate software used with the nonintegrating type. The A/D converters on almost all of the general-purpose data-collection boards now available are of the nonintegrating type.

While not essential, a programmable clock is highly recommended. Although timing can be controlled by carefully timed program loops, usually in assembly language, it is much more easily and accurately achieved in hardware.

For these reasons, I chose to use a Tecmar (6225 Cochran Rd., Cleveland, OH 44139, (216) 349-0600) PC-Mate Lab Master board with a 16-channel, 12-bit nonintegrating A/D converter with no programmable gain and a general-purpose clock/timer. The board also contains two D/A converters and a digital I/O (input/output) section that I do not routinely use, but which you may need if you plan to control the operation of your instrument as well as collect data from it.

### Connecting the Interface

In order to use the hardware interface in your lab, you must first con-

nect the interface to the instrument. If the instrument has a recorder output, this is very easy to do; simply connect the A/D converter input to the recorder output wires. For signals below 1 volt maximum, the preamplifier should be interposed between the A/D converter and the instrument.

Often, particularly on more recently designed instruments, both a recorder output and a BCD (binary-coded decimal) or other computer-compatible output exist. If there is a computer output, no A/D converter is needed; instead, a digital I/O board, serial interface, or other hardware is required. Unfortunately, I found that the documentation provided by Tecmar on the digital I/O section of the interface board is almost no help to those who are not already familiar with this type of hardware.

Alternatively, if no suitable output

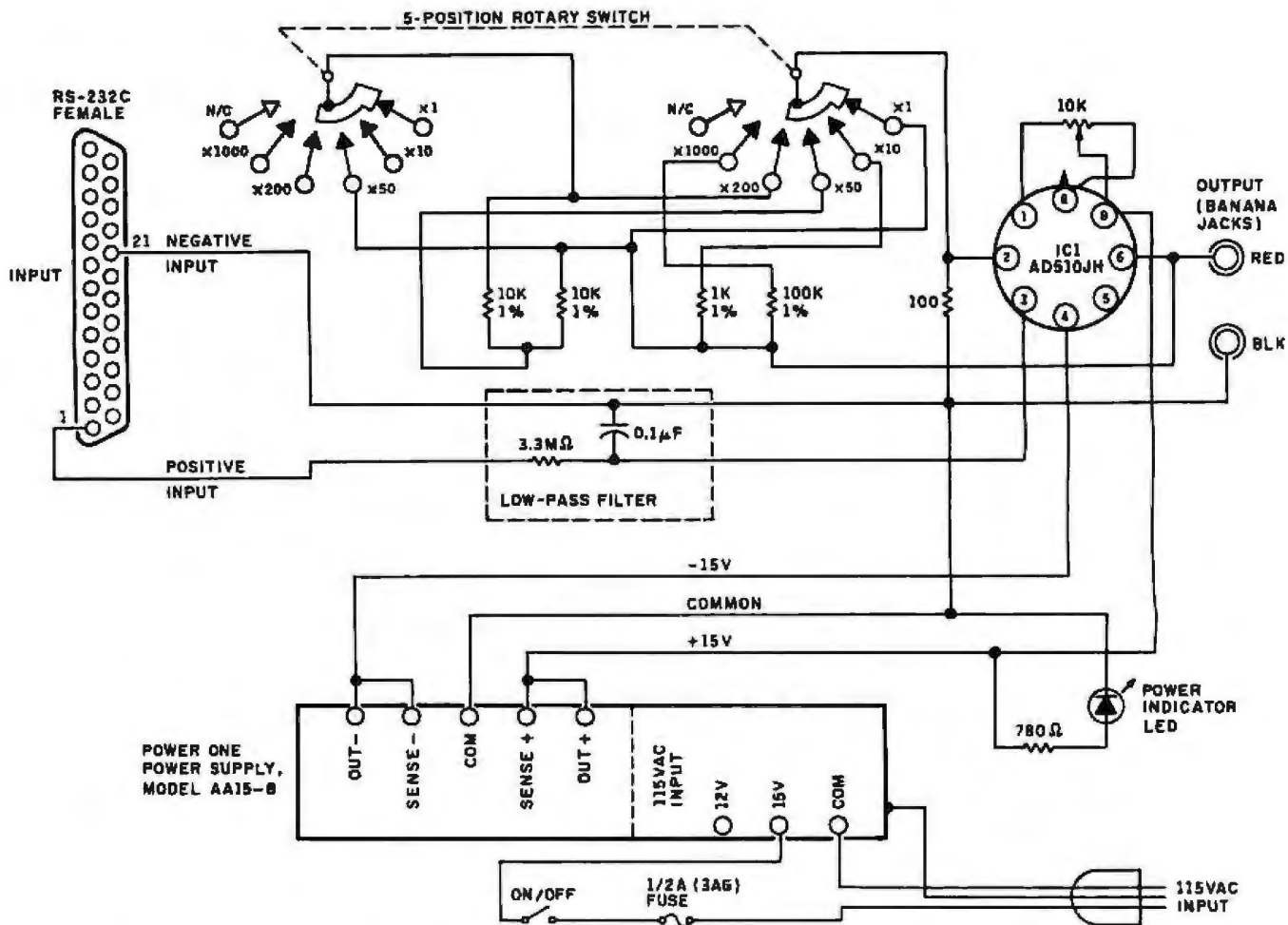


Figure 1: The schematic diagram for the preamplifier described in the text. The low-pass filter is optional.

is provided, it may be necessary for someone with knowledge of the electronics of the instrument to locate for you the portion of the circuitry needed to provide a suitable voltage output to the A/D converter. Where possible, this voltage should be in the volt range, rather than in millivolts (mV) or microvolts ( $\mu$ V). Fortunately, most instruments have recorder outputs and consequently are very easy to interface.

### Preamplifier

Depending upon the instrument being interfaced and the A/D board being used, varying amounts of pre-amplification are needed. I designed our system to accommodate a wide variety of possible inputs; hence, a simple amplifier circuit was included to permit five different gains between 1 and 1000. The amplifier schematic is shown in figure 1.

Alternatively, a programmable-gain A/D board may be desirable, al-

though that option is usually much more expensive than a separate amplifier. There is another reason for separate preamplifiers, however. Instruments with full-scale outputs of under 10 mV are common in scientific laboratories because of the widespread availability of 10-mV strip-chart recorders. For these instruments, your best alternative is to build the preamplifier into the instrument itself, or at least to connect it so that it is as near as possible to the instrument. This reduces the amount of noise picked up by the low-level signal lines that, in effect, act as antennas to the various sources of electronic noise in the environment. In general, the shorter the distance between the instrument and the A/D board, the better the signal-to-noise ratio will be in the final data.

### Filter

The most general solution to noisy signals is software filtering, because

the filter can be varied to best match the noise level. However, particularly for low-level signals and low data-collection rates, e.g., 1-mV signals at 60 Hz (hertz), I have found it useful to have a hardware filter because of the large amount of computation time required for extensive software-based filtering. For such instruments, I use the simple, passive, low-pass filter included in figure 1. This filter has a cutoff frequency of approximately 0.5 Hz, which is adequate for filtering out the most common noise signals that are 60 Hz or higher in frequency. More expensive filters, including active and notch filters, may be desirable for specific applications. Almost any "electronics for scientists" text can be consulted for more details.

### Data Collection

One aspect of interfacing that texts often neglect is the need for general-purpose programs to collect, plot, and process the instrumented data.



QUARK COMBINES

# WORD JUGGLER<sup>TM</sup> AND LEXICHECK<sup>TM</sup>

FOR HALF THE PRICE.

Now you can have the power of Quark's Word Juggler word processor. And the convenience of the Lexicheck spelling checker, with its 50,000 word dictionary and special Word Guess Plus<sup>TM</sup> feature. All in one package. For virtually half the price.

The new suggested retail for Word Juggler IIe is only \$189. Word Juggler for the Apple III and III Plus is only \$229\*.

Ask for a demonstration today. For the name of the Quark dealer nearest you, call 1 (800) 543-7711. And be sure you look into Quark's other popular office automation tools for the Apple IIe, Apple III and Apple III Plus. Especially the Catalyst<sup>TM</sup> program selector.

\*Previous list prices: Word Juggler IIe, \$239; Lexicheck IIe, \$129; Word Juggler for the Apple III, \$295; Lexicheck for the Apple III, \$149. All prices suggested U.S. retail.

Quark, Word Juggler, Lexicheck, Word Guess Plus and Catalyst are trademarks of Quark Incorporated. Apple is a registered trademark of Apple Computer, Inc.

Circle 328 on inquiry card.

**Quark**<sup>TM</sup>  
INCORPORATED

Office Automation Tools  
2525 West Evans, Suite 220  
Denver CO 80219

However, by having a suitable library of general-purpose routines, you can shorten the development time for your specific interface considerably. By using the general-purpose data-collection, smoothing, and display routines described here, you can concentrate all of your efforts on developing the device-specific portion of the software and end up with a higher quality product in a much shorter time than if you "reinvent the chip" for each new interfacing project.

In order to provide high data-collection rates and a real-time plot, I wrote a data-acquisition routine in assembly language. The routine illustrated in listing 1 provides rates up to 2400 Hz with a real-time plot, and up to 20 kHz without plotting. Even faster rates are possible with special hardware settings of the standard Tecmar board, and rates up to 125 kHz are available as an optional feature. However, very few instruments will require higher rates than 20 kHz.

The routine in listing 1 assumes the use of the Tecmar Lab Master data-acquisition board, so that some of the code is device-specific and would need to be modified for use on other systems.

Although the listing is fully documented, several comments are required. First, using the excellent procedure suggested by Rollins (see reference 2), the routine begins with a header section to enable it to be converted by EXE2BIN to a binary file that can be loaded into memory with a BASIC BLOAD command. Second, high-resolution plotting is done using the BIOS VIDEO\_IO routine, which is invoked with interrupt 16 (10 hexadecimal).

Three different clock rates are used, depending upon the desired data-collection rate. This is done to achieve maximum precision. For high data rates, the 1 MHz clock in the Tecmar board is used directly. For rates below 31 Hz, a 10-kHz subfrequency of the clock is used; to use the 1-MHz clock directly would require chaining several of the counters together. Rates of less than 1 Hz are counted with a 100-Hz subfrequency.

At very high data rates, it is possible that a conversion may take place

Listing 1: An assembly-language data-collection routine for use with the IBM PC and the Tecmar Lab Master board.

```

TITLE TIMER
; S.C. GATES DEPARTMENT OF CHEMISTRY, ILLINOIS STATE
; UNIVERSITY, NORMAL, IL 61761
; SUBROUTINE TO DO TIMED DATA COLLECTION FROM TECMAR BOARD
; CALL FROM BASIC WITH CALL OF FORM:
; CALL TIMER (A%{1},FA,PA,MA,CA,SA)
; WHERE
; A% IS ARRAY WHERE DATA ARE TO BE STORED
; PA IS OVERRUN FLAG--SET TO ZERO UPON NORMAL EXIT
; OTHERWISE SET TO VALUE OF CX REGISTER TO GIVE
; NUMBER OF POINTS NOT COLLECTED
; PA IS 0 TO OMIT REAL-TIME PLOT, OTHER TO PLOT
; MA IS NUMBER OF POINTS TO BE COLLECTED
; CA IS CHANNEL NUMBER OF A/D
; SA IS NUMBER OF DATA POINTS PER SECOND
; SA MUST BE = SPEED OF A/D
; IF SA < 0 THEN MEANS WANT THAT MANY SEC/POINT
;
CSEG SEGMENT
ASSUME CS:CSEG, DS:NOTHING
HEADER:
DB 0FDH ;CODE FOR BLOAD FILE
DW 0
DW 0
DW RTN_LEN
TEMP DW ? ;TEMP. STORAGE
PLOT DW ? ;PLOT FLAG
TEMP51 DW ? ;TEMP STORAGE FOR SI REGISTER
OVRUN DW ? ;OVERRUN OF A/D FLAG
;DEFINITIONS:
ADD0 =1808 ;BASE OF TECMAR BOARD
ADD4 =ADD0+4 ;A/D CONTROL BYTE
ADD5 =ADD0+5 ;A/D CHANNEL NUMBER
ADD6 =ADD0+6 ;A/D START
ADD8 =ADD0+8 ;CLOCK DATA PORT
ADD9 =ADD0+9 ;CLOCK CONTROL PORT
;
TIMER PROC FAK
PUSH BP ;SAVE BP
MOV BP,SP ;SET BASE PARAMETER LIST
DI,[BP]+6 ;GET DATA POINTS/SEC
MOV AX,[DI] ; INTO BX REGISTER
MOV BX,AX
MOV DI,[BP]+8 ;GET CHANNEL NUMBER
MOV AX,[DI] ; AND STORE AS AX
MOV DX,ADD5 ; AND OUTPUT TO A/D
OUT DX,AL ; (USE ONLY LOWER BYTE)
DI,[BP]+10 ;GET NUMBER OF DATA POINTS
MOV CX,[DI] ; STORE IN CX REGISTER
DI,[BP]+12 ;GET PLOT FLAG
MOV AX,[DI] ; STORE IN MEMORY
MOV PLOT,AX
MOV AL,128 ;SELECT A/D MODE (DISABLE AUTOINCREMENT,
MOV DX,ADD4 ; EXTERN. START CONVERSION, ALL INTERRUPTS
OUT DX,AL ; GAIN=1)
MOV AX,0 ;SI IS X-VALUE OF POINT TO BE
MOV TEMP51,AX ; PLOTTED--SAVE FOR LATER
MOV AX,6 ;SET UP HIGH-RES GRAPHICS MODE
INT 10H
MOV DX,ADD6 ;RESET DONE FLIP-FLOP OF A/D
IN AL,DX
MOV DX,ADD9 ;SET DATA POINTER TO MASTER MODE REGISTER
MOV AL,23
OUT DX,AL
MOV DX,ADD6 ;SET MASTER MODE REGISTER FOR SCALED CONTROL
MOV AL,0 ; BCD DIVISION, ENABLE INCREMENT, 8-BIT
OUT DX,AL ; FOOT ON, DIVIDE BY 16, SOUPCE=F1,
MOV AL,128 ; COMPARATORS DISABLED, TOD DISABLED
OUT DX,AL
MOV DX,ADD9 ;SET DATA POINTER TO COUNTER MODE OF
MOV AL,5 ; REGISTER 5
OUT DX,AL
MOV DX,ADD8 ;SET COUNTER 5 FOR COUNT REPETITIVELY,
MOV AL,33 ; BINARY COUNT,COUNT DOWN, ACTIVE HIGH
OUT DX,AL ;TC, DISABLE SPECIAL GATE, RELOAD FROM LOAD,
CMP BX,31 ;CHECK IF >= 31 POINTS/SEC
JGE FAST ;IF SO, JUMP TO FAST
CMP BX,0 ;CHECK IF > 0 POINTS/SEC
JG MED ;IF SO, JUMP
; BRANCH TO HERE IF POINTS/SEC < 0, MEANS THAT WANT LESS THAN
; ONE POINT/SEC.
SLOW: MOV AL,15 ;SET TO 100 HZ (NO GATE, RISING EDGE
OUT DX,AL ; OF P5)
NEG BX ;GET ABSOLUTE VALUE OF BX
MOV AX,BX ;AND MULTIPLY BY 100 TO GET COUNT
MOV CX,100
MUL DI
JMP GO
;BRANCH TO HERE FOR 31 TO 20,000 POINTS/SEC--USE 1 MHZ CLOCK
FAST: MOV AL,11 ;COUNT AT 1 MHZ (NO GATE, RISING
OUT DX,AL ; EDGE OF P1)
MOV AX,10000 ;DIVIDE 1,000,000 BY PTS/SEC BY
MOV DI,100 ; GETTING 10E6 INTO DX*AX
MUL DI
DIV BX ;BX=PTS/SEC; RESULT IN DX*AX, BUT
; IGNORE DX, SINCE DX=0

```

Listing 1 continued on page 371



Listing 1 continued:

```

CMP     AX,200           ;DISABLE INTERRUPTS IF >=5000
JG      FAST2           ; POINTS/SEC
CLI
FAST2: JMP     GO
;BRANCH TO HERE FOR 1 TO 30 POINTS/SEC--USE 10 KHZ CLOCK
HED:    MOV     AL,13     ;COUNT AT 10 KHZ (NO GATE, RISING
OUT     DX,AL           ; EDGE OF F3)
MOV     AX,10000        ;CALCULATE NUMBER OF TICKS OF 10,000 HZ CLOCK
CWD
DIV     BX              ; PER DATA POINT BY DIVIDING
; 10,000 BY POINTS/SEC
;START CLOCK TICKING AT DESIRED RATE
GO:     MOV     DX,ADD6   ; AND LOAD COUNTER 5 WITH TICKS
DEC     AX              ; (COUNT TO ZERO, SO DECREMENT AX
OUT     DX,AL           ; FOR CORRECT COUNT)
MOV     AL,AH
OUT     DX,AL           ; 8 BITS AT A TIME
MOV     DI,[BP]+14      ;GET OVERRUN FLAG ADDRESS
MOV     WORD PTR [DI],0 ;ZERO THE FLAG
MOV     OVRDN,DI        ;AND STORE THE FLAG ADDRESS
MOV     DI,[BP]+16      ;GET ADDRESS OF DATA ARRAY
MOV     DX,ADD9         ;LOAD COUNTER 5 FROM LOAD REGISTER
MOV     AL,112          ; AND ARM (START COUNTING)
OUT     DX,AL
MOV     DX,ADD4         ;ENABLE EXTERNAL START (PINS 3 + 4 OF
MOV     AL,132          ; CONNECTOR J2 MUST BE CONNECTED)
OUT     DX,AL
;BEGIN DATA COLLECTION; COLLECT UPON EXTERNAL START TRIGGER
DONE:   MOV     DX,ADD4   ;CHECK IF DATA READY
IN      AL,DX
CMP     AL,128          ;BY CHECKING READY BIT (BIT 7)
JB      DONE           ;LOOP UNTIL READY
TEST    AL,64          ;SEE IF DATA OVERRUN FLAG SET
JNE     ERRMESS        ;IF SO, NOTIFY BASIC PROGRAM AND EXIT
MOV     DX,ADD5         ;YES, DONE, SO GET LOW BYTE OF DATUM
IN      AL,DX
MOV     [DI],AL        ;AND STORE IT
INC     DI              ;GO TO NEXT LOCATION IN ARRAY (1 BYTE LATER)
MOV     DX,ADD6         ;GET HIGH BYTE AND STORE IT
IN      AL,DX
MOV     [DI],AL
INC     DI
CMP     PLOT,0          ;DON'T PLOT IF PLOT FLAG=0
JZ      NOPLOT
;PLOT ROUTINE STARTS HERE
MOV     TEMP,CX         ;SAVE CX FIRST
MOV     AH,AL           ;GET HIGH BYTE JUST TAKEN
MOV     AL,[DI-2]       ;AND LOW BYTE FROM STORAGE SO AX=DATUM
ADD     AX,2047         ;CALCULATE Y-VALUE TO PLOT =
; 199-((DATUM+2047)/21)
MOV     BX,21           ;DIVIDE BY 21--QUOTIENT IN AX
DIV     BX
MOV     DX,AX           ;RESULT INTO DX
NEG     DX              ;NEGATE AND ADD TO 199
ADD     DX,199
MOV     SI,TEMPSI       ;GET X-VALUE OF LAST POINT ON SCREEN
INC     SI              ;GO TO NEXT LOCATION ON SCREEN
CMP     SI,640          ;TEST IF AT RIGHT EDGE OF 640 X 200
; SCREEN
MOV     SI,0            ;IF SO, GO TO LEFT EDGE TO PLOT
MOV     CX,SI           ;GET X-VALUE INTO CX
MOV     TEMPSI,SI       ;SAVE X VALUE
MOV     AX,3073         ;AH=12,AL=1 TO WRITE DOT TO SCREEN
INT     10H            ;PLOT POINT
MOV     CX,TEMP         ;RESTORE CX
NOPLOT: LOOP DONE      ;DECREMENT CX AND LOOP IF >0
;BRANCH TO HERE UPON FINISH OR OVERRUN
NOGO:   MOV     DX,ADD4   ;TURN OFF A/D
MOV     AL,0
OUT     DX,AL
STI
POP     BP              ;RESTORE INTERRUPT SERVICE
RET     12              ;RESTORE BP
;6 ARGUMENTS IN CALL X 2=12
ERRMESS: MOV DI,OVRRUN ;SET OVERRUN FLAG SINCE A/D GOING
MOV     WORD PTR [DI],CX ;TOO FAST
JMP     NOGO
TIMER  ENDP
RTN_LEN EQU $-TEMP ;LENGTH OF ROUTINE FOR HEADER
CSEG   ENDS
END     HEADER          ;NEEDED FOR A .BIN FILE CONVERSION

```

Listing 2: General-purpose data-collection, graphing, and smoothing program in IBM PC BASIC (DOS 1.10).

```

10 REM GENERAL PURPOSE DATA COLLECTION PROGRAM
20 REM S. GATES, DEPARTMENT OF CHEMISTRY, ILLINOIS STATE UNIVERSITY, NORMAL, IL
30 REM
40 REM Some FOR...NEXT loops are compressed to speed execution
50 CLEAR,31000: BLOAD "TIMER.BIN",31000: TIMER=31000 'Get timer routine
60 DIM A$(1000),B$(1000),SG$(9)
70 WIDTH 80:CLS
80 INPUT " Do you wish to process data that have already been collected?";Y$
90 IF Y$="Y" OR Y$="y" THEN Y=4: GOTO 300
100 INPUT "Enter your name, please"; NAMS
110 OS-DATES: T$=TIMES: INPUT "Enter the sample identification, please."; S$

```

Listing 2 continued on page 372

before the previous data point has been read from the A/D converter. This is referred to as an overrun. Thus the program must check for the occurrence of an overrun. Upon finding one, the assembly routine sets a flag that can be read by the BASIC program once the data collection is finished.

At very high data-collection rates, interrupt-driven processes occurring in the computer, such as interrupts by the system clock, may interfere with data collection. Indeed, initially this program was limited to 6 kHz until I realized that the interrupts from the system clock were taking too much time. For this reason, at rates above 5 kHz, the subroutine turns off interrupts with a CLI (clear interrupt flag) instruction; when data collection is completed, the interrupts are again enabled by using an STI (set interrupt flag) instruction.

At low-to-moderate data-collection rates, it is useful to have a real-time plot. This is done for each data point collected by loading the low and high bytes of the data point into a register and converting it so that the screen displays a -10-volt A/D reading at the bottom and a +10-volt reading at the top—i.e., so that the full screen is used for the display.

When this assembly-language routine is linked to a higher level program, such as a compiled BASIC or FORTRAN program, only minor changes are required. The Header section must be removed, so that the code starts at Temp. The Timer procedure must be made Public, and the last line of the routine must include an End statement instead of an End-Header statement. After assembly, the subroutine is linked to the calling program using Link in the normal fashion; EXE2BIN does not need to be run in that case.

### Sample BASIC Program

A short interpreter BASIC program for the IBM PC that uses the assembly-language routine is shown in listing 2. The program sets aside a region of memory for the routine; the location chosen in line 30 may vary depending upon the amount of memory available in the system. The

For low-cost RS-232C port expansion, BayTech has...

# THE RIGHT STUFF

SERIAL PORT EXPANDERS



- Increase I/O ports to 4, 8 or 16.
- Mix & match peripheral devices.
- Port selection through software control; all ports can run with different configurations.
- Models for most applications.

## NETWORKING

With its host port and eight peripheral ports capable of any-port-to-any-port interconnection, networking applications with this unit are virtually unlimited.

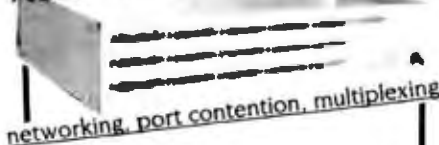
## MULTI-PLEXING

This unit allows four lines of data to be multiplexed and sent sequentially over a single line, then demultiplexed by a 2nd 524E with automatic distribution to the corresponding peripheral ports.

## PORT CONTENTION

This unit maximizes utilization of available ports. Among other configurations, 6 terminals can contend for 3 ports or 7 terminals for 2 ports.

Need 16 ports... \$1595



To place your order or discuss your expansion needs...

1-800-523-2702

**BIA** BAY TECHNICAL ASSOCIATES, Inc.  
 HIGHWAY 803, P.O. BOX 387  
 BAY ST. LOUIS, MISS 39520  
 (501) 467-8231

value 31500 is correct for a 64K-byte system using Advanced BASIC.

After the data has been collected, the overrun flag is checked, and the data is displayed in the high-resolution graphics mode. The data is

scaled to fill the entire screen.

Once the data has been collected and displayed, you usually will need to remove high-frequency noise. A simple method for doing this in software is shown in listing 2. It uses a

Listing 2 continued:

```

120 PRINT "Please enter 3 lines of experimental description, including":
    PRINT "Sample preparation, instrument settings, etc."
130 FOR I=1 TO 3: LINE INPUT LS(I): NEXT I
140 INPUT "Enter the channel number (0 to 15)": C%
150 INPUT "Enter the number of data points to collect.":N%
160 INPUT "Enter the number of data points/second desired. ": S
170 S% = S: IF S < 1 THEN S% = 1/S 'Convert to proper format for timer routine
180 PRINT "Type any key to start count-down for data collection."
190 IS=INKEY$:IF IS="" THEN 190
200 CLS: FOR I=10 TO 0 STEP -1: LOCATE 12,40 : PRINT I: FOR J=1 TO 500:NEXT J:
    NEXT I 'Count down; J loop is delay between counts
210 P% = 0 'Initialize overrun flag
220 P% = 1: IF S% > 2000 THEN P% = 0 'Plot if < 2000 pts/sec
230 CALL TIMER(A%(1),P%,P%,N%,C%,S%) 'Collect data; all variables MUST be
    INTEGER!

240 IF P% = 0 THEN PRINT "Warning--data taken too fast": N% = N% - P%
250 FOR I=1 TO N%
260 IF A%(I) = 32767 THEN A%(I) = A%(I) - 65535!
270 A%(I) = A%(I) / .2047: 'Store input as mV, assuming -10 to 10V range
280 NEXT I
290 CLS: PRINT "Enter a 1 to plot data on the screen":
    PRINT "A 2 to store the data in a file.": PRINT "A 3 to smooth the data":
    PRINT "A 4 to get another file":PRINT "A 5 to exit": INPUT Y
300 ON Y GOSUB 340,510,670,770,890
310 GOTO 290
320 ***** SUBROUTINES *****
330 REM Screen plotting routine
340 SCREEN 2 :KEY OFF
350 DEF FNSCALE(Z%) = 190 - 190 * (Z% - YMIN) / (YMAX - YMIN)
360 INPUT "Enter the label for the graph",LAB$
370 CLS:YMAX = A%(1): YMIN = A%(1)
380 FOR I=1 TO N%
390 IF A%(I) < YMIN THEN YMIN = A%(I) ELSE IF A%(I) > YMAX THEN YMAX = A%(I)
400 NEXT I
410 YPLOT = FNSCALE(A%(1))
420 PSFT (60,YPLOT),0 'Go to first point
430 FOR I=2 TO N%: XPLOT = 60 + 579 * (I - 1) / (N% - 1): YPLOT = FNSCALE(A%(I)):
    LINE - (XPLOT,YPLOT): NEXT I
440 LOCATE 25,40 : PRINT LAB$; LOCATE 1,1 : LINE (60,0)-(639,190),,B 'label
    and box plot
450 LOCATE 25,8 : PRINT "1": LOCATE 25,75 : PRINT N%: LOCATE 1,1 :
    PRINT YMAX; LOCATE 24,1 : PRINT YMIN; 'Label axes
460 LOCATE 6,1: PRINT "Type any key to continue";
470 Y$ = INKEY$:IF Y$="" THEN 470
480 RETURN
490 REM *****
500 REM Subroutine to store data in a file
510 INPUT "Enter the name of the file in which the data are to be stored.":FILN$

520 OPEN FILN$ FOR OUTPUT AS #2
530 WRITE #2,NAMS,DS,TS 'Save name, date, time
540 WRITE #2, S$ 'Save sample description
550 FOR I=1 TO 3: WRITE #2,LS(I): NEXT I 'and conditions
560 WRITE #2,N%,S% 'number of points, sampling rate
570 FOR I=1 TO N%: WRITE #2,A%(I): NEXT I
580 CLOSE #2: RETURN
590 REM *****
600 REM Subroutine to compute second-order 9-point Savitzky-Golay smooth
610 REM including smooths at both beginning and end of data
620 REM It computes a "smoothed" value for each point by adding together
630 REM the 4 points on either side of it, plus itself, each multiplied
640 REM times the corresponding coefficient.
650 REM It then computes the "smoothed" value for each successive point
660 REM using the original data array.
670 DATA -21,14,39,54,59,54,39,14,-21: 'Savitzky-Golay coefficients
680 RESTORE
690 FOR I=1 TO 9:READ SG%(I):NEXT I 'Get coefficients
700 FOR I=1 TO N%: B(I) = 0:DF% = 0: FOR J=-4 TO +4: IF I+J < 1 OR I+J > N% THEN 720
710 B(I) = B(I) + A%(I+J) * SG%(J+5):DF% = DF% + SG%(J+5)
720 NEXT J: B(I) = B(I) / DF%:NEXT I 'Divide by sum of coefficients used
730 FOR I=1 TO N%: A%(I) = B(I): NEXT I 'Store back in original array
740 RETURN
750 REM *****
760 REM Subroutine to read previously collected data from disk file
770 INPUT "Enter the name of the file to be processed. " : FILN$
780 OPEN FILN$ FOR INPUT AS #2
790 INPUT #2, NAMS,DS, TS
800 INPUT #2,S$
810 FOR I=1 TO 3: LINE INPUT #2,LS(I): NEXT I
820 INPUT #2,N%,S%
830 PRINT NAMS,DS,TS: PRINT S$: FOR I=1 TO 3: PRINT LS(I): NEXT I
840 PRINT "Number of points=" : N%, "Points/sec=" : S
850 FOR I=1 TO N%: INPUT #2,A%(I): NEXT I
860 CLOSE #2: PRINT "Type any key to continue"
870 Y$ = INKEY$: IF Y$="" THEN 870
880 RETURN
890 END
    
```



# All the hits your computer is missing.



If you thought you'd never find fun games for your hardworking home computer, happy days are here. Because now ATARISOFT™ has all the great hits... Pac-Man<sup>1</sup>, Donkey Kong<sup>2</sup> by Nintendo<sup>3</sup>, Centipede<sup>4</sup>, Defender<sup>5</sup>, Joust<sup>1</sup>, Jungle Hunt<sup>1</sup>, Moon Patrol<sup>1</sup>, Pole Position<sup>1</sup>, Galaxian<sup>1</sup>, Ms. Pac-Man<sup>1</sup>, and Battlezone<sup>1</sup>.

And we've got them for all the hit computers ... Apple, IBM, Commodore 64, Vic-20, Colecovision<sup>\*</sup>, and TI 99/4A. We've got Pac-Man, Centipede and Defender for Intellivision too.

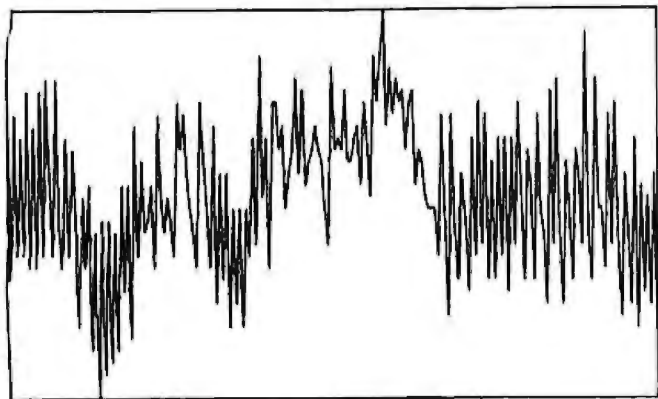
So dust off your joystick and ask your dealer for all the ATARISOFT hits. It's the software your hardware's been waiting for.

## ATARISOFT.™

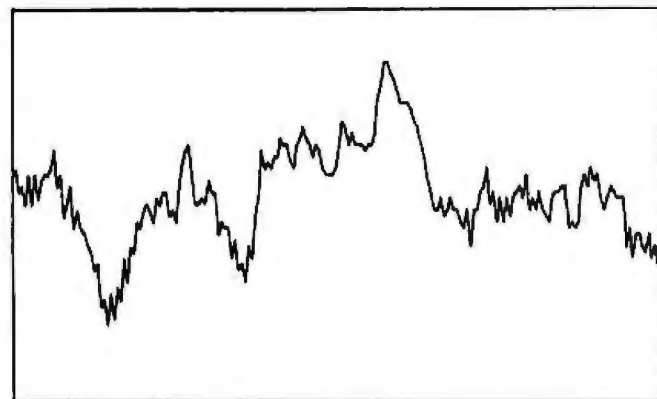
All the hits your computer is missing.

ATARISOFT™ products are manufactured by Atari, Inc. for use with various computers and video game consoles. ATARISOFT products are not made, licensed or approved by the manufacturer(s) of these computers and video game consoles. \*Donkey Kong and Battlezone not available on Colecovision. 1. Trademarks of Bally Mid. Co. Sublicensed to ATARI, Inc. by Namco-America, Inc. 2. Trademarks and © Nintendo 1981, 1983. 3. Trademarks and © Williams 1980-1982, manufactured under license from Williams Electronics. 4. Trademark and © of Iateo America Corporation 1982. 5. Engineered and designed by Namco Ltd., manufactured under license by ATARI, Inc. Trademark and © Namco 1982. Atari™ © A Warner Communications Co. © 1984 ATARI, Inc. All rights reserved.

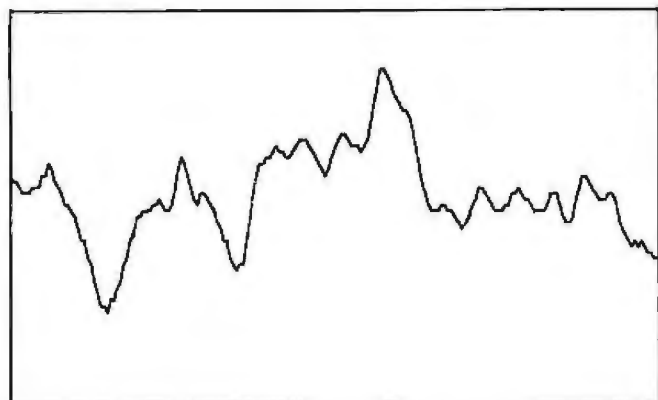
(2a)



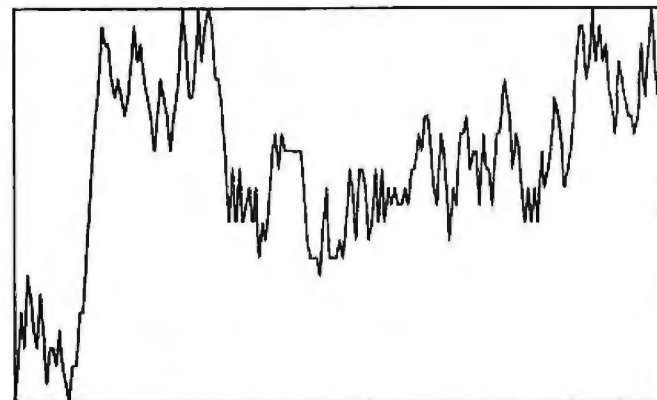
(2b)



(2c)



(2d)



**Figure 2:** The effect of filtering on noise levels can be very significant. Figure 2a shows 200 data points taken from an instrument over a period of 20 seconds. Ideally, the signal should be a straight line, but instead shows both long-term and short-term noise. In figure 2b, data from the same instrument is passed through a digital (software) filter once; in figure 2c, it is passed through the filter twice. In figure 2d, data from the same detector is passed through a hardware low-pass filter.

"Savitzky-Golay" type smoothing algorithm (see reference 3), which is a rapid, easily implemented smoothing technique that is equivalent to fitting a least-squares line through the data. The order of the fit and the number of points included in the fit can be modified to provide varying amounts of smoothing. A second-order, 9-point smooth is the one most often used in my lab. In picking which software filter to use, you may find an article by Cram et al. quite useful (see reference 1). For severe noise problems, other techniques such as ensemble averaging or filtering using fast Fourier transforms may prove useful.

The usefulness of the filtering process is illustrated in figure 2. Figure 2a shows data collected from the detector of a high-performance liquid chromatograph, without filtering. In figure 2d, data was collected from the same detector, but with the low-pass

hardware filter being used. In figure 2b, the data is exactly the same as the unfiltered data (figure 2a), except that it has been passed through the Savitzky-Golay second-order, 9-point filter contained in listing 2. In figure 2c, the data from figure 2a has been passed through the Savitzky-Golay filter twice; the reduction in the noise is striking. I often use a combination of hardware and software filtering for optimum results.

#### Examples of Use

I offer a four-week course to science students that teaches them to interface to a variety of scientific instruments using the techniques described in this article. Students spend one week learning BASIC, two weeks learning the concepts of interfacing and writing simple programs, and one week interfacing the computer to a specific chemical laboratory instrument.

Although the students learn to write data-collection and display routines in BASIC, for their final project they use the Timer routine in listing 1. Using the standardized interfacing system, in one week's time they have written complete data-collection and analysis programs for a number of different instruments, including a pH meter, a UV (ultraviolet)-visible spectrophotometer, a differential scanning calorimeter, a high-performance liquid chromatograph (HPLC), and a polarograph. Even though these programs were written in one week's time, each of these programs is now in routine use in our teaching or research laboratories.

I'll use two examples to show how quickly and easily instruments can be interfaced using this approach.

One student interfaced an IBM PC to a polarograph, using the circuitry shown in figure 1. The polarograph already has a sophisticated preampli-



# WORK SMARTER - NOT HARDER

WITH THE SMART-CARD™ MANAGEMENT SYSTEM™ \*  
FROM EXEC-U-PLAN™

**GET MORE DONE IN LESS TIME**  
Control 20-50—even hundreds of projects at a time with the smartest, easiest, most flexible method ever developed for planning and monitoring activities, schedules, appointments, performance, details and deadlines. The SMART-CARD Management System helps busy executives accomplish more in less time—by freeing the mind's memory banks and thought processes to focus where it counts! No matter how well organized you are, The SMART-CARD Management System will give you a better return on your time investment. **We guarantee it!**

## CONTROL HUNDREDS OF PROJECTS WITH COMPUTER-LIKE EFFICIENCY

The SMART-CARD Management System is designed to function in many ways like a personal data processing center, but, with much greater flexibility and ease. Simply record all important information directly onto color-coded SMART-CARDS. Then insert them in the system's exclusive see-through panels—for visual control of hundreds of entries at-a-glance. Merge cards into the system after meetings. Move cards as projects are completed or priorities change. Retrieve information instantly. The SMART-CARD Management System's unique features and six special purpose cards help you plan and manage more effectively than ever before.

## QUALITY CRAFTSMANSHIP

Individually crafted of the finest genuine leathers or rich leather grained vinyls, each SMART-CARD System comes personalized with your name or initials on the cover. Take the handsomely styled, highly portable EXEC-U-PLAN System with you to meetings, on business trips, or for a more productive daily commute.

## WORKS FOR EVERYONE

Available in three styles to satisfy a wide range of needs and preferences, The EXEC-U-PLAN SMART-CARD Management System is ideal for all executives and professionals. With the system you're always so well organized, the time you save won't just be your own—it will increase the productivity of everyone around you. So, to Work Smarter, Not Harder, put the remarkable new EXEC-U-PLAN SMART-CARD Management System to work for you, and those around you, today!

**\*PATENT PENDING**

## SPECIAL BONUS

Now—for a limited time only—receive a handsome, matching Pocket Organizer **FREE** with any model shown at left. This compact tuck-away version of the SMART-CARD Management System puts key data in your pocket—and lets you easily make new entries on-the-go. Retail value \$15.00.



### DELUXE

Our most popular model

- Manages 288 projects: 2 panels—72 SMART-CARDS per side. Expands to 1440 w/purchase of extra panels
- 750 asst'd SMART-CARDS
- Color-coded signals
- Name or initials on cover
- Pen, tablet and business card storage
- Deluxe lock Plus the SMART-CARD Management System Manual



### SUPER DELUXE

Our premier model

- Manages 576 projects: 4 panels—72 SMART-CARDS per side. Expands to 1440 w/purchase of extra panels
- 4 tabbed dual pocket dividers
- 1,000 asst'd SMART-CARDS
- Multi-function calculator
- Digital time piece and alarm
- Calendar-phone-address book
- Color-coded signals
- Name or initials on cover
- Pen, tablet and business card storage
- Deluxe lock Plus the SMART-CARD Management System Manual

Leather grained vinyl **\$105.00**

Genuine leather **\$155.00**

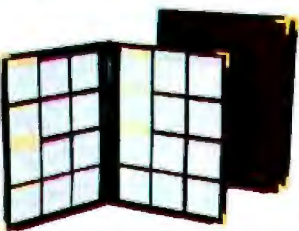
Plus \$4 shipping and handling



Leather grained vinyl **\$44.50**

Genuine leather **\$84.50**

Plus \$4 shipping and handling



### THE TRAVELER

Our streamlined model

- Manages 144 projects
- 500 asst'd SMART-CARDS
- Color-coded signals
- Name or initials on cover
- Pen holder
- Plus the SMART-CARD Management System Manual

Leather grained vinyl **\$27.50**

Genuine leather **\$52.50**

Plus \$4 shipping and handling

All Models Available in:

#### LEATHER GRAINED VINYL

Chestnut Brown (dark), Willow Brown (medium), Black, Burgundy and Natural Tan Suede.

#### GENUINE LEATHER

Black, British Tan and Burgundy.

### SATISFACTION GUARANTEED

If for any reason you are not completely satisfied with your EXEC-U-PLAN SMART-CARD System, simply return it within 30 days of purchase for a full and prompt refund.

CREDIT CARD ORDERS  
PHONE TOLL FREE

**1-800-USA-0700**

OR WRITE: **EXEC-U-PLAN™ DEPT. 184**

31-17 QUEENS BLVD., LONG ISLAND CITY, N.Y. 11101

Circle 170 on Inquiry card.

add \$7.50 per model for shipments to Canada, Alaska, Hawaii and Puerto Rico, \$12 to Mexico and \$18 to all other countries

Copyright 1983, Executive Management Systems, Inc. U.S. and International patents pending. EXEC-U-PLAN™ SMART-CARD™ SMART-CARD Management System™ and the products named herein are trademarks of Executive Management Systems, Inc.



## Using the Tecmar A/D Board

The Tecmar board can be given instructions, and have information read from it, in one of two ways: either the I/O (input/output) mode or the memory-mapped mode can be used. In the I/O mode, various functions of the board are accessed through ports, which are addressed with INP and OUT instructions in BASIC, or IN and OUT instructions in assembly language. In the memory-mapped mode, the functions are accessed at a series of consecutive memory locations; this requires PEEK and POKE instructions in BASIC, or any memory-addressing instruction in assembly language, such as MOV or TEST.

The choice between these two modes is largely a matter of personal preference. The memory-mapped mode is slightly faster but the board is configured at the factory for the I/O mode, which is probably the simpler mode to program. In either mode, you must select the base address, which is the first of 16 consecutive addresses used to communicate with the various functions on the board. The base I/O address set at the factory is 1808. However, other base addresses, as well as the memory-mapped mode, may be selected using the appropriate jumpers or switches.

Other options available on the board include auto-incrementing of the A/D (analog-to-digital) converter (automatically switching the channel from which data is being taken), and the range of the signals coming from or going to the instrument. In addition, three types of inputs to the A/D converter are selectable by appropriate jumper settings: single-ended, pseudo-differential, and true differential. The single-ended setting is normally used, but the differential modes are particularly useful with low-level signals in environments with large amounts of electromagnetic noise. It is also possible to use interrupts to signal the computer when the A/D board has data ready for storage.

The system described in the text uses a

-10-V to +10-V bipolar range for the A/D board, clock triggering of the A/D board, and a single-ended input. Only one instrument is normally connected, so the auto-incrementing feature is disabled, as are interrupts. Timer 5 is used to trigger the A/D board.

The clock portion of the Tecmar board provides a general-purpose mechanism for timing various events or for providing timed pulses for triggering various events. At least 18 different modes of operation are possible, each with several options. To the average user, this number of possibilities can prove highly confusing at best.

For triggering the A/D board at specific intervals, however, the process is fairly straightforward. The clock circuitry contains a 1-MHz clock, which is further subdivided either by powers of 10 (BCD scaling) or by powers of 16 (binary scaling), depending upon the option selected. Any one of five counters can be loaded with a count, which is then either incremented or decremented every time the clock "ticks."

For example, with a BCD scaling of divide-by-100, the clock provides a 10-kHz output. Assuming the count is in a downward direction, then the 16-bit counter can be loaded with a value of 99 to provide an output pulse to the A/D board every 0.01 second (i.e.,  $10 \text{ kHz} \div 100 = 100 \text{ Hz}$ ). Note that the counter provides an output to the A/D board when it attempts to go below zero (called the "terminal count"); hence, the counter is set to 99 rather than to 100.

To connect the counter pulses to the A/D converter, the output from the specific counter must be directed to the trigger input of the A/D converter. Because of the pin placement on the Tecmar board, the easiest method for doing this is to connect the output of counter 5 to the A/D converter by jumpering pins 3 and 4 of connector J2.

All of the functions of the clock are con-

trolled using two I/O ports accessible to any program. Although these ports are termed control port and data port, both ports are needed to set up the correct timing sequence. In a typical use of the timer, the control port is first directed to point to an internal register called the master mode register. You then select the various control options by loading a 16-bit word into the master-mode register via the data port; this selects options such as whether an 8- or 16-bit I/O bus is being used, what is to be used as a source of the clock frequency, and so forth.

Most of the information, however, is loaded into another internal register, the "counter-mode register." There is one such register for each of the five counters. Hence, the program uses the control port to select which counter-mode register is to be used; in this case, the one for register 5 is selected. The counter-mode register is then loaded, through the data port, with the various options selected for that register. Options include whether to count up or down, whether to count in binary or BCD, and which subfrequency of the clock is to be used. Special options are available if the counters are to be used as a time-of-day clock.

When the program is ready to begin collecting data, the appropriate counter must be loaded with the correct count and "armed," i.e., started counting. Assuming that the A/D converter has been set to recognize the signal from the clock as a trigger by enabling the external start bit, the A/D converter will automatically initiate a conversion (data collection) every time the counter register goes to zero. Hence, the program only needs to wait until the A/D converter signals that it has completed a conversion and then store the data; no timing loops need to be written. The A/D converter will continue to be triggered by the clock until the clock output is turned off by the program.

fier system, so a 10-volt signal could be readily obtained. Hence, the student set the preamplifier on the interface cart to a gain of 1, attached it to the recorder output of the polarograph, used no filtering, and set the Timer routine to collect data for a period of time determined by the potential range scanned.

The major task of the student, then, was to understand the theoret-

ical basis of the instrument readings and to design a program in BASIC to analyze the data. In order to accomplish this, the student had to fit a least-squares line to a sawtooth wave function, determine the inflection point in the curve, and calculate the distance between the two least-squares lines at the inflection point. The A/D readings were then converted to current values in micro-

amperes and the time scale was converted into the applied potential in millivolts.

Students in the analytical chemistry class now use data collected with this system from a series of standard lead samples to calculate the amount of lead in leaded gasoline. Photo 2 shows data collected by a group of students for a standard sample of lead.

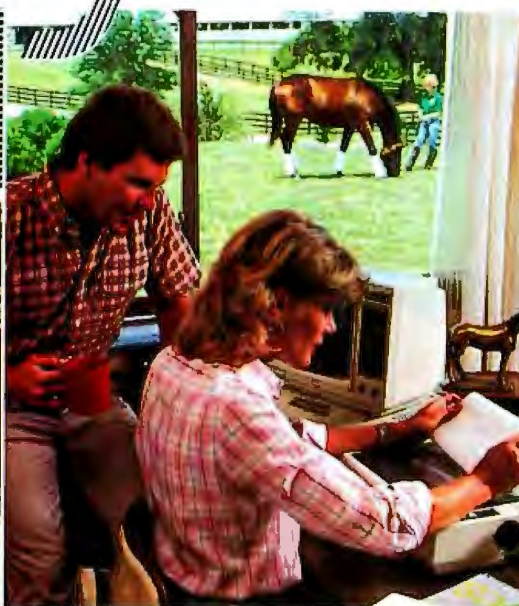


# Hayes

Your Apple's telephone.



"Thanks for the prompt reply. Sure was a lot faster than waiting for the mail!"



"Gary: The pedigrees for next week's auction are as follows..."



"Attn. Prod., Sales, Purch.; Recommend 50% blue, 30% red screen for closest match!"

A complete plug-in communications system for Apple® computers. From Hayes, the established telecomputing leader: the simple but sophisticated Micromodem II® plug-in board modem and its companion software, Smartcom I.™ Everything you need to expand the world of your Apple II, IIe, II Plus and Apple III. In one, convenient communications package.

With Micromodem IIe and Smartcom I, you can access data bases, bulletin boards, and the varied resources of information services. Plan your travel itinerary via computer, including flight numbers, hotel and rental car reservations. Retrieve and analyze daily stock and options prices. Work at home and send reports to your office. You can even do your gift shopping by computer!

**Micromodem IIe. Think of it as your Apple's telephone.** It allows your computer to communicate with any Bell-103 type modem over ordinary telephone lines, at 110 or 300 bits per second. Micromodem IIe installs easily in an expansion slot, and requires no outside power source. It connects directly to either a single or multiline modular phone jack, to perform both Touch-Tone® and pulse dialing.

Micromodem IIe dials, answers and disconnects calls automatically. And, unlike some modems, it operates in full or half duplex, for compatibility with most time-sharing systems.

A built-in speaker lets you monitor your



calls when dialing. That way, you'll know if a line is busy. With Smartcom I, Micromodem IIe automatically redials your last number.

Discover how Micromodem IIe can help maximize the capabilities of your Apple. While Smartcom I software will minimize your efforts.

**Smartcom I companion software. For effortless communications.**

Whether you're a newcomer to personal computing or a seasoned professional, you'll appreciate the ease and speed with which you can perform any communications function. Thanks to Smartcom I!

Let Smartcom I guide you through a few easy-to-answer questions to tailor the program to your particular needs. Then you're ready to go!

Make a selection from the Smartcom I menu to manage your communications, files or printer. Program prompts guide you along the way. And menu selections let

you easily make a call, end a call, or answer a call. When you're on the receiving end, your Micromodem IIe answers automatically, even if you're not there!

Convenient! And so is the Smartcom I memory for phone numbers. Smartcom I stores three of your most frequently called telephone numbers and one prefix. Plus, it also remembers the last number dialed.

Smartcom I also provides a directory of the files stored on your disk. And lets you create, list, name, send,

receive, print or erase files right from its menu.

Smartcom I is as versatile as you need it to be. It accepts DOS 3.3, Pascal, CP/M™ 3.0 or CP/M Plus™ operating systems. And accommodates up to six disk drives and several printer interface cards.

Like all our products, Smartcom I and Micromodem IIe are backed by excellent documentation and full support. Including a two-year limited warranty on Micromodem IIe and a 90-day warranty on Smartcom I!

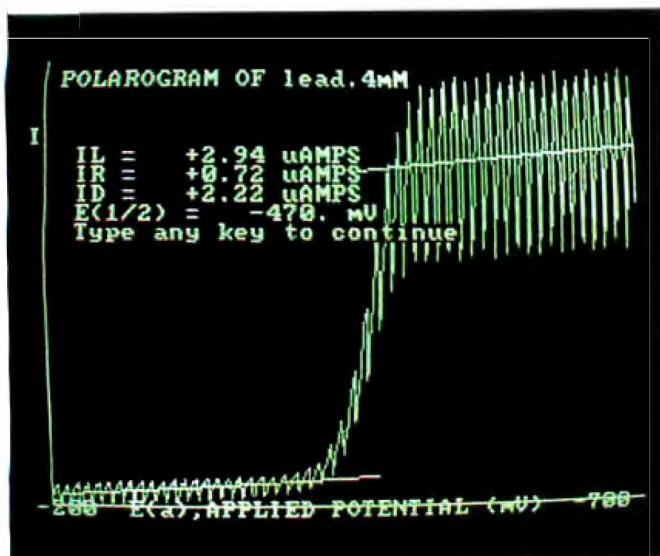
See your dealer today. Then plug into the exciting world of telecomputing.

**Hayes Microcomputer Products, Inc.,** 5923 Peachtree Industrial Blvd., Norcross, Georgia 30092. 404/441-1617.



FCC approved in U.S.A. Micromodem IIe is a registered trademark of Hayes Microcomputer Products, Inc. Smartcom I is a trademark of Hayes Microcomputer Products, Inc. Apple is a registered trademark of Apple Computer, Inc. Touch-Tone is a registered service mark of American Telephone and Telegraph. CP/M is a trademark of Digital Research, Inc. CP/M Plus is a trademark of Advanced Logic Systems. ©1981 Hayes Microcomputer Products, Inc.





**Photo 2:** Students taking our analytical chemistry laboratory course analyze the amount of lead in gasoline using the interface described in the text. The diffusion current (ID on the display) is proportional to the concentration of the lead in the sample.

A second example of an instrument that students have interfaced is a high-performance liquid chromatograph. The normal output of the HPLC is a 10-mV signal displayed on a strip-chart recorder; hence, the pre-amplifier was set to a gain of 1000 to provide a 10-volt signal to the A/D converter.

The student writing the program divided it into two sections: a data-collection portion and a data-analysis portion. In the data-collection portion, all of the parameters of the instrument and the sample to be analyzed are recorded, thus providing a permanent record of the conditions of the analysis. The program also asks for the names of the substances being analyzed, if known, and whether an internal standard is being used.

The data collection is done using the assembly-language routine, with a real-time plot of the data. If more than a predefined number of points are collected, the data is "bunched," or averaged, together. The Savitzky-Golay smooth is then performed, and the smoothed data and identifying information are stored in a disk file.

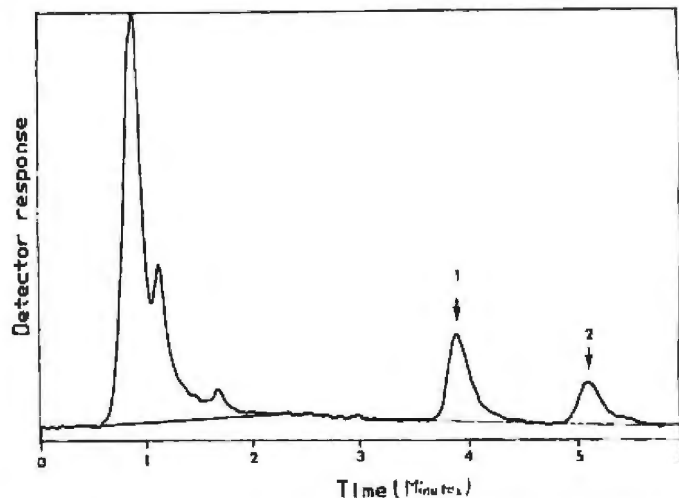
In the second section of the program, the peaks in the data are in-

tegrated, and the area of each peak is compared to that of an internal standard. Proper integration involves deciding where each peak starts and stops and then selecting the appropriate baseline to be subtracted from each peak. The results of this process are shown in figure 3. Again, the program is used routinely in our analytical laboratory course; figure 3 shows an analysis of caffeine in coffee performed by a group of students in that course.

### Conclusions

One of the many advantages of the revolution in "home" computers is that powerful but inexpensive computers can be used in scientific or industrial laboratories, even by those with relatively limited computer skills. Utilizing off-the-shelf components and simple programming languages, extremely sophisticated data-collection and data-processing systems can be developed very rapidly.

The system described here represents a hardware and software solution to the problem of data collection and analysis in a wide variety of commonly encountered laboratory situations. By making only minor modifications, you should be able to adapt



**Figure 3:** A common problem in chemical laboratory work is to measure the areas of peaks. Each peak in this figure is integrated by the computer program; the peaks of interest are peaks 1 and 2, which are caffeine and benzyl alcohol, respectively. The benzyl alcohol peak serves as an internal standard for measuring the caffeine. The straight lines under each peak are the baselines determined by the computer during the integration process. The large initial peak is a group of unidentified substances. The sample is a cup of instant coffee.

it to other types of hardware and to other types of instrumentation with an extremely wide range of applications, not only in chemistry, but in other scientific and industrial areas as well. ■

### References

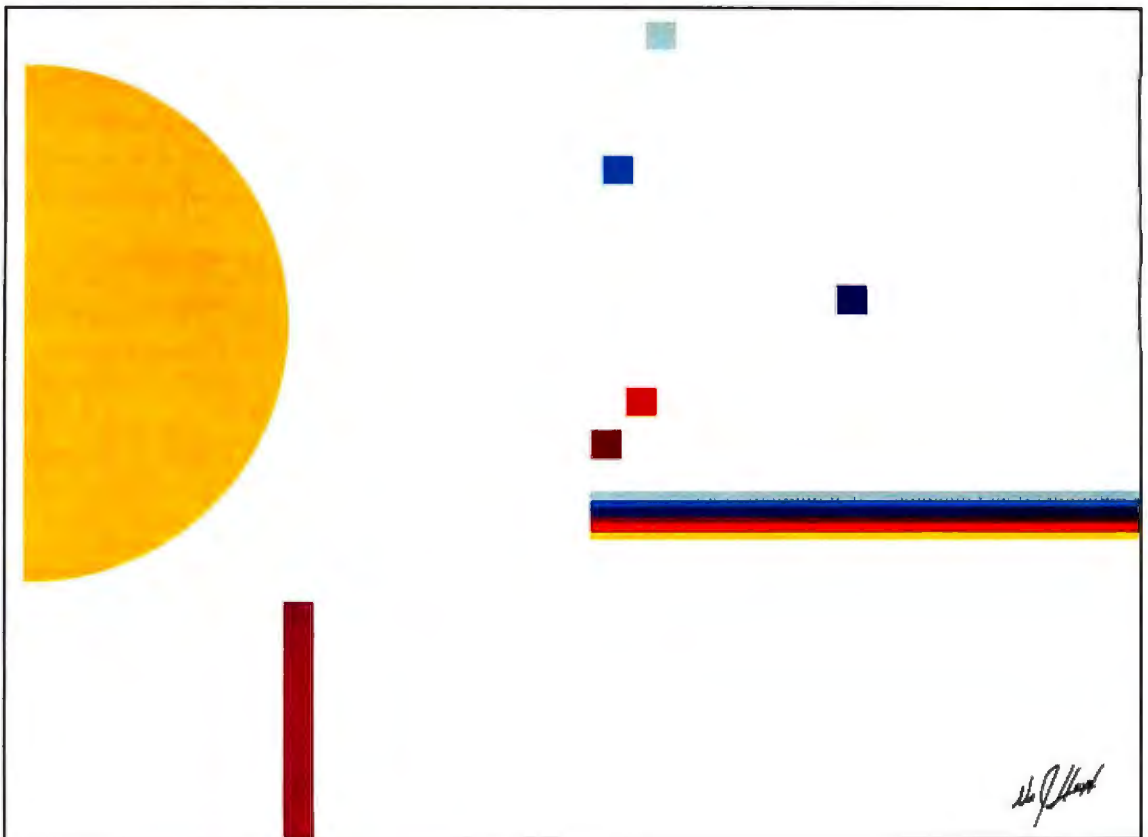
1. Cram, Stuart P., S. N. Chesler, and A. C. Brown III. "Effects of Digital Filters on Chromatographic Signals." *Journal of Chromatography*, volume 126, Amsterdam, Netherlands: Elsevier Scientific Publishing Company Inc., 1976, page 279.
2. Rollins, Dan. "The 8088 Connection." *BYTE*, July 1983, page 398.
3. Savitzky, Abraham and Marcel J. E. Golay. "Smoothing and Differentiation of Data by Simplified Least Squares Procedures." *Analytical Chemistry*, volume 36, Washington, DC: American Chemical Society, 1964, page 1627. Minor corrections were also published in *Analytical Chemistry*, volume 44, 1972, page 1906.
4. Welch, Mark J. "Expanding on the PC." *BYTE*, November 1983, page 168.

*Stephen C. Gates, Ph.D. (Department of Chemistry, Illinois State University, Normal, IL 61761), is assistant professor of biochemistry. He teaches a course in computer interfacing and does research on computerized chemical analysis of biological samples.*

**Program Available:** A disk with copies of the programs described in the article is available. Write to the author for information.



Bringing Information to light.™



## Would da Vinci have settled for a Crayon?

A great artist must command his tools and his medium to fully express his creativity...to solve his design problems. To solve information problems, you need to command an information management system that allows you the flexibility to design solutions tailored to your needs.

Data Spectrum™, is a comprehensive and powerful information management system for business and personal use that goes beyond "user friendly" to downright "people affectionate."

Data Spectrum is the master work of information management. It allows you to customize the organization of information to your specific needs. To search, sort, analyze, edit, evaluate and merge files as you want. And even to generate forms, reports, labels and standard letters.

All menu driven. All built in. With special features like "RAPID TRANSIT": A new file management approach that processes smaller files at blinding speed and automatically switches to "LARGER FILE ORIENTATION" to handle larger files.

Destined to set a new standard in the industry, Data Spectrum's on-screen tutorial blends text,

graphics, humor, sound and animation to lead the user through the concepts, uses and operating techniques of this innovative software package.

On-screen tutorial and powerful program functions make Data Spectrum the universal information management system and problem solver. And a work of art. Our program up-date service and information "Hot-Line" will keep it that way.

So if you are looking for solutions rather than just software, Data Spectrum will bring them to light.

Write or call us for your nearest computer dealer carrying Apple or IBM versions of Data Spectrum. If there is no dealer in your area, you can order Data Spectrum directly from us...with a full money back guarantee. 1-800-323-6902 Illinois Residents 312-298-0997. Advanced Business Computing, Inc. 1580 N. Northwest Highway, Park Ridge, IL 60068-1471.

Apple is a registered trademark of Apple Computer Inc.  
IBM is a registered trademark of International Business Machines Corporation





# DON'T PAY CASH USE YOUR COMPUCARD™

The Computer Line believes that it is important to be competitive by offering low prices, however we regard service as the most important asset of a mail-order organization. All our lines are available so that you (the customer) are able to talk to fully qualified computer specialists trained to answer all your questions pertaining to our line of microcomputers. We are renowned for our excellent after-sales support and our promptness for delivery. Peace of mind and excellence in service is our pledge to all our customers.

## NEW FRANKLIN SYSTEMS

Compatible with the Apple computer!

### 1000 Pro Pack Plus:

#### Featuring:

- 1000 CPU
- Franklin Monitor
- 80 Column Card
- Ace 10 Disk Drive + Controller
- Ace Calc.
- Ace Writer
- Data Perfect
- Welcome Package

**TOO LOW  
TO PUBLISH**

### 1200 OMS Package:

#### Featuring:

- 1200 CPU
- 80 Column Card
- 2 Disk Drives + Controller
- CP/M Card + Software
- Parallel & Serial Interfaces
- Wordstar
- Mailmerge
- Ace Calc.
- Welcome Package

**TOO LOW  
TO PUBLISH**

## COLUMBIA DATA PRODUCTS

- IBM PC Compatible
- 128K Main Memory
- 8 Expansion Slots
- 2 Serial and One Parallel Port Built In
- 2 Double Sided/Double Density 320K Drives
- Over \$3000 Free Software including:

- Perfect Writer/Speller
- Perfect Filer/Calc.
- Home Accountant
- Fast Graphs
- MS DOS/CP/M and more!

**Too Low  
To  
Publish**

### VP

#### PORTABLE UNIT

- Same as 1600-1  
except this unit is  
truly portable

### MPC-1600-4

#### HARD DISK UNIT

- Compatible to IBM PCXT  
- Includes 12 megabyte  
hard disk

## HAVOC

### Great First Computer

- Apple Compatible
- Detached Keyboard
- Built-In Disk Drive
- Built-In Parallel Port
- Built-In Serial Port

**SUPER  
LOW  
PRICE  
\$769.95**

### APPLE IIe STARTER SYSTEM

#### Complete System Includes:

- Apple IIe w/64K
- Disk Drive w/Controller
- 80 Column Card
- Monitor
- DOS Disks & Manuals

**CALL FOR  
OUR  
LOW LOW  
PRICE**

## IBM PERSONAL COMPUTERS

Take A Demonstration on the IBM PC. Our System Includes:

- Two Double-Sided Drives
- 256K of Memory
- Color Graphics Adaptor

**ONLY \$2899.00**

Maximum of 4 weeks delivery on all IBM systems.

## CORONA

- 128K Expandable to 512K
- 2 DS/DD 320K Disk Drives
- 4 Expansion Slots
- 1 Parallel Port
- 1 Serial Port
- Hi Res Monitor

	Green	Amber
Desk Top	\$2695.00	\$2725.00
Portable	\$2579.95	\$2595.00

**EPSON QX-10**  
State of the Art Simplicity-  
Complete Software Package  
w/VALDOCS & CP+ CP/M  
**SCALL**

### TAVA PC

- IBM Compatible
- 2 DS/DD 320K Disk Drives
- Serial Port
- Parallel Port
- Hi-Res Monitor

**PANASONIC**  
Portable with Built in Printer  
**CALL FOR  
LOW PRICE**

**\$1995.00**

## PRINTERS

C. ITOH	
NEW HOT DOT	Too Low
180 CPS Excellent Quality	To Publish
Printer I	
8510 Parallel 120 CPS	\$359.95
8510 Serial 120 CPS	\$479.95
Printer II	
1550 Parallel	\$599.95
1550 Serial	\$679.95

### SUPER SPECIAL

#### F-10 Letter Quality Printer

- Fast 40 CPS
- Parallel or Serial **\$999.95**

F-10 Tractor Feeds Now In Stock!

EPSON	
FX 80 160 CPS, Corr. Qual	SCALL
FX 100 160 CPS 15 Wide	SCALL

## OKIDATA

OKIDATA 82A	\$319.95
- 120 CPS 80 Col	
- Parallel/serial inter	
OKIDATA 92P	\$449.95
- 160 CPS 80 Col	
- Excellent Corr Quality	
- Parallel	
OKIDATA 93P	\$739.95
- 160 CPS 132 Col	
- Same as 92P	
OKIDATA 84 Par/ or Ser	SCALL
PACEMARK 2410	\$2499.95
OKIDATA Plug & Play	\$43.95
OKIGRAPH	\$39.95

## STAR MICRONICS

### GEMINI-10X

- 120 CPS
- Graphics, 80 Col
- Tractor and friction

**TOO LOW TO PUBLISH**

### GEMINI-15X

- 15" Wide (132 Col)
- Same features as 10X

**TOO LOW TO PUBLISH**

**NEW DELTA 10X SCALL**

**CABLES & INTERFACE  
AVAILABLE**

## LETTER QUALITY PRINTERS

JUKI	
Juki 8100 Letter Quality	\$ 469.95
BROTHER	
Dynax DX-15	\$ 469.95
Tractor for DX-15	\$ 89.95
Keyboard	\$ 149.95
Dynax DX-25	\$ 779.95
INTERGRAL DATA SYSTEMS	
Micro Prism	\$ 499.95
Color Prism 132, 4-color	\$1499.95
TOSHIBA	
Toshiba 1350 Dot Matrix	\$1599.95
NEC SPINWRITER	SCALL
PAPER	
9 1/2"x11 Lazer cut 3000 Sheets	\$29.95
11 1/2"x15" Lazer Cut	\$38.95



## FOR IBM

<b>QUADRAM</b>	
Quadcolor 1 color & graphics board	\$249.95
Quadboard 1 w/64K, Ser, Par, Clock	\$279.95
Quadlink Apple Emulation System	\$479.95
Microfazer P/P, P/S, S/P, S/S	\$CALL
<b>TECMAR</b>	
Captain	\$CALL
1st Mate	\$CALL
2nd Mate	\$CALL
Graphics Master	\$CALL
<b>AMDEK</b>	
MAI-Monochrome & RGB	\$499.95
<b>KEYTRONICS KEYBOARD</b>	\$229.95
<b>MICROSOFT SYSTEMS BOARD</b>	\$CALL
<b>AST</b>	
6-PAK plus w/64K (384K max), Ser, Par, Clock	\$289.95
Mega plus w/64K (512K), 2 Ser, Par, Clock	\$389.95
Combo plus w/64K Ser, Par, Clock	\$289.95
I/O plus 2 Ser, 1 Par, Clock	\$249.95
<b>MAYNARD</b>	
Disk Drive Controller Card	\$CALL
Controller w/Parallel Port	\$CALL
Controller w/Serial Port	\$CALL
<b>BABY BLUE CP/m card w/z-80</b>	\$CALL

## DISK DRIVES

FOR IBM	FOR APPLE
<b>PANASONIC/NATIONAL</b> 320K 1/2 height \$199.95	<b>ALPS</b> 1/2 height for Apple \$169.95
<b>TANDON</b> TM 100-2 DS/DD 320K \$219.95 TM 85-2 1/2 height \$219.95	<b>RANA ELITE</b> Elite I \$CALL Elite III \$CALL
<b>CDC</b> CDC 320K DS/DD \$239.95	<b>RANA 1000</b> For Altair \$CALL MICRO SC) \$CALL
<b>WINCHESTERS</b> 10 MEG Internal or External for IBM \$1195.00	<b>MAYNARD W8-2</b> Hard Disk For IBM 10 MEG Internal 1/2 height Controller & Power Supply BONUS—\$70 trade-in on your IBM controller card ONLY \$1299.95 COMPLETE
<b>DAVONG CORVUS</b>	
<b>QUENTIN TALLGRASS</b> Hard Disk Drives	

## SOFTWARE

BUSINESS	APPLE	IBM
Lotus 1-2-3	—	\$319.95
DB Master (version 4)	\$269.95	\$399.95
DBASE II	\$449.95	\$449.95
Friday	—	\$199.95
Multiplan	\$189.95	\$189.95
The General Manager	\$159.95	—
TK Solver	\$CALL	\$CALL
BPI-Gen Acct/Inv/Payrol	\$279.95	\$419.95
-Job Costing	\$419.95	—
Word w/Mouse	—	\$339.95
Wordstar Professional	\$439.95	\$439.95
Screenwriter II	\$ 89.95	—
Sensible Speller	\$ 89.95	—
PFS: Write/File/Report	\$ 84.95	\$ 99.95
PeacoteX 5000	—	\$269.95
Supercalc 3	—	\$279.95
Visicalc IV	\$CALL	\$CALL
<b>HOME/GAMES/EDUCATION</b>		
Home Accountant	\$ 49.95	\$109.95
Dollars and Sense	\$ 74.95	\$129.95
Micro Cookbook	\$139.95	\$139.95
Bank Street Writer	\$ 49.95	\$ 46.95
Tax Advantage	\$ 46.95	\$ 46.95
Zaxxon	\$ 29.95	—
Lode Runner/Choplifter	\$ 24.95	—
Zork I, II, III	\$ 27.95	\$ 27.95
Deadline/Witness/Planet	\$ 35.95	\$ 35.95
Flight Simulator	\$ 34.95	\$ 34.95
Sargon III	\$ 34.95	—
Frogger	\$ 26.95	\$ 26.95
Temple of Apathal	\$ 29.95	\$ 29.95
Master Type	\$ 29.95	\$ 35.95
Kinder Comp/Alphabet Zoo	\$ 23.95	\$ 23.95
Story Machine/Facemaker	\$ 24.95	\$ 24.95
Snooper Troops Case #1/#2	\$ 34.95	\$ 34.95

## Special of the Month QUENTIN

**DISK DRIVES FOR YOUR APPLE/FRANKLIN COMPUTER** **\$199.95** limited quantities

## FOR APPLE COMPUTERS

<b>MICROSOFT</b>	
Softcard 2 80	\$249.95
Ram Card 16K	\$ 77.95
<b>ORANGE MICRO</b>	
Grappler+ printer inter	\$109.95
Buffered Grappler+	\$159.95
<b>VIDEX</b>	
Video Term 600/601	\$CALL
Function Strip	\$ 64.95
Display Enhancer II	\$ 99.95
<b>MICROTEK</b>	
Apple Dumping	\$CALL
Dumping w/16K	\$CALL
<b>PRACTICAL PERIPHERALS</b>	
Micro-Buffer II (16K plus)	\$169.95
*****	
<b>GRAPHICS INTERFACE</b>	
For Apple/Franklin	
Just Like Grappler	only \$89.95
*****	
<b>KOALA TABLET</b>	
HAYES	\$ 89.95
Mach III Joystick	\$ 39.95
<b>T&amp;G</b>	
Joystick	\$ 44.95
Paddles	\$ 29.95
Select a Port	\$ 44.95
<b>KENSINGTON</b>	
System Saver	\$ 89.95

## MONITORS

<b>AMDEK</b>	
Video 300 Med-Res Green	\$139.95
Video 300A Med-Res Amber	\$149.95
Video 310A Hi-Res Amber	\$179.95
Color I+ Composite	\$299.95
Color II+ RGB	\$399.95
Color III+ Hi-Res Composite	\$419.95
Color IV+ Hi-Res RGB	\$CALL
<b>USI</b>	
Pt-2 Med-Res Green	\$135.95
Pt-3 Med-Res Amber	\$149.95
<b>NEC</b>	\$CALL
<b>ZENITH ZVM-123</b>	\$109.95
*****	
<b>PRINCETON GRAPHICS</b>	
HX-12 Hi-Res RGB	\$469.95
for IBM PC	while they last
*****	
<b>LEADING EDGE</b>	
Gorilla Hi-Res Green	\$ 89.95
Gorilla Hi-Res Amber	\$ 95.95
<b>TAXAN</b>	
KG-12N Hi-Res Green	\$139.95
KG-12N-UY Hi-Res Amber	\$149.95
KX-121 Hi-Res Green for IBM	\$169.95
KX-122 Hi-Res Amber for IBM	\$179.95
420 Hi-Res RGB	\$559.95
Tilt Swivel Base w/Clock	\$ 49.95

## MODEMS

<b>NETWORKER™</b> Plug in single slot direct connect modem for Apple II family & Franklin computers with communications software. Includes subscription to the SOURCE™	<b>APPLE MODEM</b> w/everything for \$119.95
<b>NETMASTER™</b> software package w/purchase of NETWORKER™	\$39.95
<b>D.C. HAYES</b>	
Smartmodem 300 BAUD	\$219.95
Smartmodem 1200 BAUD	\$479.95
Smartmodem 1200B W/SCII	\$419.95
Smartmodem Ite W/SC II	\$249.95
Chronograph	\$169.95
<b>U.S. ROBOTICS</b>	
300 BAUD	\$169.95
Auto Dial 1200	\$449.95
Password 1220 BAUD	\$339.95
<b>NOVATION</b>	
J-Cal	\$119.00
Apple-Cal II	\$CALL
<b>COMPUTER FURNITURE</b>	
<b>BUSH</b>	
Desk Oak Veneer	\$109.95
Hutch Oak Veneer	\$ 64.95
Printer Stand Oak Veneer	\$ 59.95

## DISKS/SUPPLIES

Verbatim SS/DD 5 1/4 floppy	\$23.95
Verbatim DS/DD 5 1/4 floppy	\$31.95
Dysan SS/DD 5 1/4 floppy	\$27.95
Dysan DS/DD 5 1/4 floppy	\$36.95
ESK SS/DD 5 1/4 floppy	\$19.95
ESK DS/DD 5 1/4 floppy	\$27.95
Elephant SS/DD 5 1/4 floppy	\$CALL
Elephant DS/DD 5 1/4 floppy	\$CALL
Control Data SS/DD 5 1/4 floppy	\$22.95
Control Data DS/DD 5 1/4 floppy	\$CALL
Library cases holds 10 disks	\$ 1.95
Disk Storage Box holds 70 disks	\$19.95
Flop-n-file 25 holds 25 disks	\$CALL
Flop-n-file 50 holds 50 disks	\$19.95
Flop-n-file 70 holds 70 disks	\$23.95

**64K RAM MEMORY UPGRADE FOR IBM PC**  
\$53.95

## SURGE SUPPRESSORS

<b>EDP</b>	
Lemon	\$ 46.50
Lime	\$ 57.00
Peach	\$ 76.00
Orange	\$105.00

**NEW 48 HOUR SERVICE**



## THE COMPUTER-LINE™

Committed to bringing computers within the reach of all Americans

CALL (800) 255-4659 (Outside California)  
CALL (800) 541-4300 (Inside California)

When in California, please visit us at:

21054 SHERMAN WAY  
CANOGA PARK, CA 91303  
CALL: (818) 716-1812

17781 FITCH ST.

IRVINE, CA 92714

CALL: (714) 863-9944

General/Mailorder (714) 863-9988

CUSTOMER SERVICE AND ORDER INQUIRY (714) 863-8931

When in Colorado, please visit us at:

1136 COLORADO BLVD.

DENVER, CO 80222

CALL: (303) 758-3261

TERMS: All prices reflect a 2.9% cash discount. All goods acknowledged faulty on receipt by the customer will be repaired or replaced at our discretion. Customers must call for an RMA number before returning any goods. This facilitates our quick attendance to faulty goods. We reserve the right to repair or return to the manufacturer for repair all goods becoming faulty within the specified warranty period. Any goods (hardware or software) returned for restocking are subject to a 15% restocking fee at our discretion. The charge for cancellation of orders is 20% at our discretion. No returns on software. We accept no responsibility for any false claims made by manufacturers. Prices quoted for stock on hand and subject to change without notice. Specialists in APO and international deliveries. Please add 3% (minimum \$3.00) for shipping. APO add to all prices 5% for shipping (minimum \$5.00). We will calculate exact freight. Please allow a minimum of 2 weeks plus mail time (if an order is mailed in) for receipt of all UPS delivered goods. All goods (other than APO or international) delivered UPS ground. All items listed available for 48 hour service provided products are readily available from the manufacturer.

ALL BRANDS ARE REGISTERED TRADEMARKS

Circle 102 on inquiry card.

# Putting the Apple II Work

## Part 2: The Software

### *A high-speed system for the acquisition and analysis of data*

Richard C. Hallgren  
Michigan State University

Last month, I described the overall system approach and provided you with construction details and preliminary testing. In this concluding part, I'll discuss the software I've developed that makes the system operational.

#### System Software

The software that enables the computer to collect and display the data can best be visualized by breaking down the total program set into a number of subroutines:

1. A main routine written in Applesoft BASIC is responsible for calling all machine-language subroutines, displaying the data on the high-resolution graphics screen, and storing the data on disk.
2. A machine-language routine that controls the digital section of the analog-to-digital (A/D) converter and provides high-speed transfer of the binary data into the Apple II.
3. A machine-language routine that scrolls the displayed data horizontally across the video display.
4. A machine-language routine that enables you to mix text with the data displayed on the high-resolution graphics screen.

The Applesoft program expects the

machine-language routines to be stored on disk drive 1 and to have the following names:

A/D — routine that controls the digital section of the A/D converter  
Shift — routine that scrolls the data  
Hires — routine that writes text onto the high-resolution graphics screen  
Table — graphics character look-up table

After you have loaded these programs and stored them onto a disk initialized with the Hello routine, execute the Applesoft routine. If the program jumps to the A/D routine but never returns, you probably have one of two problems:

1. The program did not enter the A/D routine correctly. Usually, you will get strange characters appearing on the screen, and/or the keyboard will not respond without turning the power off and then back on.
2. Absolutely nothing happens. Make sure that the  $\overline{IRQ}$  signal is getting to pin 30 on the interface connector.

Once you get the program to go to the A/D routine and to return, the end is in sight. If the data does not plot correctly, check the section in

the Applesoft routine that supports this. For example, if you try to scroll the data and the computer does strange things, take a close look for mistakes in the scroll subroutines.

#### Applesoft Routine

Listing 1 gives the program with comments. This BASIC routine first loads all the machine-language routines and then loops until the operator is ready to digitize data. Once the operator indicates that data is to be taken, the program jumps to the machine-language A/D routine that proceeds to digitize and store a predetermined quantity of data. Program control then returns to the Applesoft routine. The data is then plotted on the high-resolution graphics screen, and text is added to the plots. You then have the option of reviewing the data by scrolling it back and forth across the video display. If the data is "good," you can store the data on disk. If the data is not good, you can initiate the acquisition of a new block of data.

#### A/D Machine-Language Routine

The machine-language A/D converter subroutine is called from the BASIC program by executing CALL -28656. This forces the computer to execute the subroutine stored at memory location 9010 hexadecimal.



(Unless otherwise indicated, all addresses are hexadecimal.) Listing 2 gives the program with comments. Upon entering this subroutine, the contents of the accumulator, the contents of the X and Y registers, and the processor status are saved. The subroutine then clears the Y register and loads the X register with the 8 most significant bits (MSBs) of the memory address defining the upper limit of the block of memory reserved for data storage. The memory address for the lower limit of the block reserved for data storage is loaded into memory locations 0A (least significant bits or LSBs) and 0B (MSBs). These two memory locations serve as a pointer to the current location in memory in which a byte of data is to be stored.

The system interrupt logic is disabled while the 8 MSBs of the current data-storage address (the contents of memory location 0B) are compared with the 8 MSBs of the maximum allowable address (the contents of the X register). If the maximum limit has not been reached, the program jumps to memory location 9038. If the maximum limit has been reached, the subroutine restores the contents of the accumulator, the contents of the X and Y registers, and the processor status. After that, the return from subroutine (RTS) command forces the computer to return to the BASIC calling routine.

At memory location 9038, the subroutine enables the system interrupt logic and waits a few machine cycles to see if it is time to take another sample. The sampling rate is determined by connecting the output of the crystal-controlled oscillator and frequency-divider logic to the interrupt request line (IRQ) going to the 6502. If it is not time to take another sample, the subroutine returns to memory location 9026, where the interrupt logic is disabled. If it is time to take another sample, the interrupt logic forces the computer to jump to memory location 9040. This address was determined by the Hello program, which was executed when the DOS (disk operating system) was initially booted.

At memory location 9040, the three

Listing 1: A/D converter main routine written in Applesoft BASIC.

```

10 REM HIGH SPEED A/D CONVERTER
20 D$ = ""
22 PRINT D$;"BLOAD A/D.D1"
24 PRINT D$;"BLOAD HIRES.D1"
25 PRINT D$;"BLOAD TABLE.D1"
26 PRINT D$;"BLOAD SHIFT.D1"
32 UTAB 10: PRINT "PRESS THE SPACE BAR WHEN YOU ARE": PRINT "READY TO DIG
    ITIZE DATA."
40 GET K$
42 IF K$ < > CHR$(32) THEN GOTO 40
44 GOTO 2100
100 REM SCROLL DATA TO THE LEFT
102 IF K1 > 28600 THEN RETURN
112 POKE - 30875,230: POKE - 30869,227: POKE - 30751,0: POKE - 30744,
    232: POKE - 30742,28: POKE - 30865,26: CALL - 30876
130 HCOLOR= 1: FOR I = 1 TO 14
132 Y = ( PEEK (K1 + DI * I)) / 1.5
134 HPLLOT 195 + I,175 - Y: NEXT I
136 K1 = K1 + DI * 14
140 HCOLOR= 2: FOR I = 1 TO 14
144 Y = ( PEEK (K2 + DI * I)) / 1.5
146 HPLLOT 195 + I,175 - Y: NEXT I
148 K2 = K2 + DI * 14
150 HCOLOR= 3: FOR I = 1 TO 14
154 Y = ( PEEK (K3 + DI * I)) / 1.5
156 HPLLOT 195 + I,175 - Y: NEXT I
158 K3 = K3 + DI * 14: SL = 1
199 RETURN
200 REM SCROLL DATA TO THE RIGHT
202 IF K1 < 25230 THEN RETURN
212 POKE - 30875,227: POKE - 30869,230: POKE - 30751,27: POKE - 30744
    ,202: POKE - 30742,255: POKE - 30865,254: CALL - 30876
221 IF SL = 0 THEN GOTO 230
222 K4 = K1 - 210 * DI: K5 = K2 - 210 * DI: K6 = K3 - 210 * DI
230 HCOLOR= 1: FOR I = 14 TO 1 STEP - 1
234 Y = ( PEEK (K4 - DI * I)) / 1.5
236 HPLLOT 14 - I,175 - Y: NEXT I
238 K4 = K4 - DI * 14: K1 = K4 + 210 * DI
240 HCOLOR= 2: FOR I = 14 TO 1 STEP - 1
244 Y = ( PEEK (K5 - DI * I)) / 1.5
246 HPLLOT 14 - I,175 - Y: NEXT I
248 K5 = K5 - DI * 14: K2 = K5 + 210 * DI
250 HCOLOR= 3: FOR I = 14 TO 1 STEP - 1
254 Y = ( PEEK (K6 - DI * I)) / 1.5
256 HPLLOT 14 - I,175 - Y: NEXT I
258 K6 = K6 - DI * 14: K3 = K6 + 210 * DI
299 RETURN
2100 REM DIGITIZE DATA
2102 HOME : TEXT : UTAB 10: PRINT "DATA IS BEING DIGITIZED."
2132 POKE - 28643,112: POKE - 16143,0: CALL - 28656
2200 K1 = 24576: K2 = 24577: K3 = 24578: DI = 3: GOSUB 3000: GOSUB 10000
2250 GET K$
2254 IF K$ = CHR$(8) THEN GOSUB 100
2256 IF K$ = CHR$(21) THEN GOSUB 200
2258 IF K$ = CHR$(32) THEN GOTO 2100
2260 IF K$ = CHR$(27) THEN GOTO 4000
2299 GOTO 2250
3000 REM PLOT DATA
3010 HCOLOR= 1: HGR2
3030 FOR I = 0 TO 209: Y = ( PEEK (K1 + DI * I)) / 1.5
3032 HPLLOT I,175 - Y: NEXT I
3034 K4 = K1: K1 = K1 + 210 * DI
3036 HCOLOR= 2
3038 FOR I = 0 TO 209: Y = ( PEEK (K2 + DI * I)) / 1.5
3040 HPLLOT I,175 - Y: NEXT I
3041 K5 = K2: K2 = K2 + 210 * DI
3042 HCOLOR= 3
3044 FOR I = 0 TO 209: Y = ( PEEK (K3 + DI * I)) / 1.5
3046 HPLLOT I,175 - Y: NEXT I
3048 K6 = K3: K3 = K3 + 210 * DI
3049 RETURN
4000 REM ESCAPE SUBROUTINE
4002 TEXT : HOME
4010 UTAB 4: PRINT "PRESS THE KEY CORRESPONDING TO YOUR": PRINT "CHOICE:"
4014 UTAB 10: PRINT "R TO RETURN TO CURRENT DATA"
4016 UTAB 12: PRINT "S TO SAVE CURRENT DATA ON DISK"
4018 UTAB 14: PRINT "D TO DIGITIZE NEW DATA"
4019 UTAB 16: PRINT "H TO STOP"
4020 UTAB 20: GET K$
4022 IF K$ = "0" THEN GOTO 2100
4023 IF K$ = "R" THEN POKE - 16304,0: POKE - 16299,0: POKE - 16297,0:
    GOTO 2250
4024 IF K$ = "R" THEN POKE - 16304,0: POKE - 16299,0: POKE - 16297,0:
    GOTO 2250
4026 IF K$ = "H" THEN END
4028 IF K$ = "S" THEN GOTO 4050
4029 GOTO 4020
4050 HOME

```

Listing 1 continued on page 384

AD7570 A/D converters are simultaneously instructed to begin the conversion of their respective input signals. The subroutine then loops until all three units have finished their conversion cycles. The subroutine then proceeds to load the digitized signal from the first AD7570 into the accumulator. The contents of the accumulator are then transferred into the memory location determined by the contents of memory locations 0A (containing the 8 LSBs) and 0B (containing the 8 MSBs) and the contents of register Y (which are added to the contents of memory location 0A).

After the data has been stored, the Y register is incremented. The subroutine tests the Y register to see if the increment caused the register to be equal to zero (a transition from #FF to #00). Such a transition indicates that memory location 0B then needs to be incremented. The subroutine then proceeds to load and store data into successive memory locations until all three converters have been serviced. A return from interrupt (RTI) command then forces the computer to return to the point in the program where the interrupt request was detected. The subroutine ultimately ends up back at memory location 9026, where the interrupt logic is again disabled and a test is made to see if the maximum allocated data-storage address has been exceeded.

Once the data has been digitized and stored, program control returns to the BASIC routine. The first 209 data samples from each input channel are displayed on the high-resolution graphics screen. Differentiation of the data is achieved by using a unique color for each input channel. The full width of the graphics display is not utilized for data so that reference text can be added on the right-hand side of the screen.

### High-Resolution Text Generator

The text-generator software is used to write textual information on the high-resolution graphics screen. This capability lets you identify data points and display the magnitude of selected data points along with the data. The character set for the graphics generator was purposely limited

### Listing 1 continued:

```

4060 UTAB 10: PRINT "ENTER THE NAME OF THE DATA FILE"
4064 UTAB 14: INPUT K$
4070 D$ = ""
4072 PRINT D$;"BASE " ;K$;" ,A$1000,L$1000,D1"
4099 GOTO 4000
10000 REM IDENTIFY PLOTS AND ADD TEXT
10002 POKE 54,0: POKE 55,143: POKE - 16299,0
10010 UTAB 23: HTAB 1: PRINT "PRESS ← OR → TO SCROLL THE DATA."
10050 UTAB 24: HTAB 1: PRINT "PRESS SPACE BAR TO DIGITIZE MORE DATA."
10052 UTAB 14: HTAB 32: PRINT "PRESS ESC"
10054 UTAB 15: HTAB 32: PRINT "TO EXIT."
10060 HCOLOR= 1
10062 HPLOT 215,12 TO 219,12: HPLOT 215,20 TO 219,20: HPLOT 217,12 TO 217,20: HPLOT 223,20 TO 223,12 TO 227,20 TO 227,12: HPLOT 231,20 TO 231,12 TO 235,12 TO 235,16 TO 231,16
10064 HPLOT 239,12 TO 239,20 TO 243,20 TO 243,12: HPLOT 249,20 TO 249,12 TO 247,12 TO 251,12
10066 HPLOT 257,20 TO 261,20 TO 259,20 TO 259,12 TO 257,14
10070 HCOLOR= 2
10072 HPLOT 216,32 TO 220,32: HPLOT 216,40 TO 220,40: HPLOT 218,32 TO 218,40: HPLOT 224,40 TO 224,32 TO 228,40 TO 228,32: HPLOT 232,40 TO 232,32 TO 236,32 TO 236,36 TO 232,36
10074 HPLOT 240,32 TO 240,40 TO 244,40 TO 244,32: HPLOT 250,40 TO 250,32 TO 248,32 TO 252,32
10076 HPLOT 258,32 TO 262,32 TO 262,36 TO 258,36 TO 258,40 TO 262,40
10080 HCOLOR= 3
10082 HPLOT 216,52 TO 220,52: HPLOT 216,60 TO 220,60: HPLOT 218,52 TO 218,60: HPLOT 224,60 TO 224,52 TO 228,60 TO 228,52: HPLOT 232,60 TO 232,52 TO 236,52 TO 236,56 TO 232,56
10084 HPLOT 240,52 TO 240,60 TO 244,60 TO 244,52: HPLOT 250,60 TO 250,52 TO 248,52 TO 252,52
10086 HPLOT 258,52 TO 262,52 TO 262,56 TO 258,56 TO 262,56 TO 262,60 TO 258,60
10099 RETURN

```

### Listing 2: This routine provides high-speed data transfer from the A/D converter to the Apple II.

9010	8D 00 90	STA	\$9000	Save accumulator
9013	8E 01 90	STX	\$9001	Save X register
9016	8C 02 90	STY	\$9002	Save Y register
9019	08	PHP		Save processor status
901A	A0 00	LDY	\$500	
901C	A2 63	LDX	\$70	Load X register with maximum data storage address
901E	A9 00	LDA	\$500	
9020	85 0A	STA	\$0A	Memory locations \$0A and \$0B contain the start address for data storage
9022	A9 60	LDA	\$60	
9024	85 0B	STA	\$0B	
9026	78	SEI		Disable interrupt
9027	E4 0B	CPX	\$0B	Compare current data storage address with maximum address
9029	D0 0D	BNE	\$9038	
902B	AD 00 90	LDA	\$9000	Restore accumulator
902E	AE 01 90	LDX	\$9001	Restore X register
9031	AC 02 90	LDY	\$9002	Restore Y register
9034	28	PLP		Restore processor status
9035	60	RTS		Return to calling routine
9036	EA	NOP		
9037	EA	NOP		
9038	58	CLI		Enable interrupt
9039	EA	NOP		
903A	4C 26 90	JMP	\$9026	
903D	00	BRK		
903E	00	BRK		
903F	00	BRK		
9040	A9 01	LDA	\$501	Start A/D conversion
9042	8D F0 C0	STA	\$C0F0	
9045	A9 00	LDA	\$500	
9047	8D F0 C0	STA	\$C0F0	
904A	AD 61 C0	LDA	\$C061	Check and see if all conversions are complete
904D	2A	ROL		
904E	80 FA	BCS		
9050	AD F1 C0	LDA	\$C0F1	Load data from input #1
9053	91 0A	STA	(\$0A),Y	Store data
9055	C8	INY		Increment LSD of data storage address
9056	D0 02	BNE	\$905A	Branch on result not zero
9058	E6 0B	INC	\$0B	Increment MSD of data storage address
905A	AD F2 C0	LDA	\$C0F2	Load data from input #2
905D	91 0A	STA	(\$0A),Y	Store data
905F	C8	INY		Increment LSD
9060	D0 02	BNE	\$9064	Branch on result not zero
9062	E6 0B	INC	\$0B	Increment MSD

Listing 2 continued on page 386



# The Computer Book Club®

Recognized as the authoritative source for micro users!

## Superior Performance, Practical Price!

More programs, projects, ways to use your micro for home, hobby, education, and business!

Select 5 Books  
for Only \$2<sup>95</sup>

worth up to  
\$105.25



1496  
List \$17.95



1050  
List \$13.95



1710  
List \$18.95



1062  
List \$14.95



1488  
List \$16.95



1423  
List \$10.95 (paper)



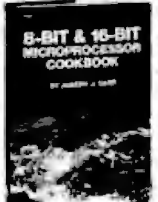
1276  
List \$15.95



1567  
List \$18.95



1295  
List \$16.95



1643  
List \$19.95



1513  
List \$19.95



1633  
List \$19.95



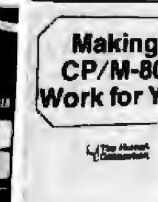
1205  
List \$16.95



1873  
List \$13.95



1160  
List \$14.95



1764  
List \$16.95



1479  
List \$19.95



1556  
List \$21.95



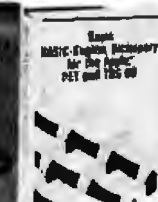
1389  
List \$16.95



1506  
List \$7.95 (paper)



1640  
List \$21.95



1521  
List \$17.95

Free guide to  
**BASIC Statements  
& Commands**



Plus FREE For Joining →

## 7 very good reasons to join The Computer Book Club®

- **Big Savings.** Save 20% to 75% on books sure to increase your computer know-how
- **No-Risk Guarantee.** All books returnable within 10 days without obligation
- **Club News Bulletins.** All about current selections—mains, alternates, extras—plus bonus offers. Comes 13 times a year with hundreds of up-to-the-minute titles you can pick from
- **"Automatic Order."** Do nothing, and the Main selection will be shipped automatically! But . . . if you want an Alternate selection—or no books at all—we'll follow the instructions you give on the reply form provided with every News Bulletin
- **Bonus Books.** Immediately get a Dividend Certificate with every book purchased and qualify for big discounts of 60% to 80%
- **Extra Bonuses.** Take advantage of added-value promotions, plus special discounts on software, games, and more
- **Exceptional Quality.** All books are first-rate publisher's editions selected by our Editorial Board and filled with useful, up-to-the-minute information

## The Computer Book Club®

P.O. Box 80, Blue Ridge Summit, PA 17214

Please accept my membership in The Computer Book Club® and send the 5 volumes circled below, plus my FREE copy of *BASIC Statements, Commands and Functions*, billing me \$2.95 plus shipping and handling charges. If not satisfied, I may return the books within ten days without obligation and have my membership canceled. I agree to purchase 3 or more books at reduced Club prices (plus shipping/handling) during the next 12 months, and may resign any time thereafter.

1050 1062 1160 1195 1205 1276 1295 1389 1423  
1455 1466 1473 1479 1496 1506 1513 1521 1533 1556  
1567 1607 1633 1640 1643 1673 1710 1712 1764

Name \_\_\_\_\_ Phone \_\_\_\_\_

Address \_\_\_\_\_

City \_\_\_\_\_

State \_\_\_\_\_ Zip \_\_\_\_\_ BY-584

Valid for new members only. Foreign applicants will receive special ordering instructions. Canada must remit in U.S. currency. This order subject to acceptance by The Computer Book Club®

to numbers and uppercase letters to conserve memory. Listing 3 gives the high-resolution graphics, text-generator program, and table 1 is the graphics character look-up table. The program takes the textual character that is to be displayed on the graphics screen and matches it to a corresponding graphics character contained in the look-up table. This graphics character is then displayed on the screen by loading it into the correct memory location in page 2 of the high-resolution-graphics memory block. By using this subroutine, you avoid having to "draw" text on the graphics screen using the PLOT commands. The routine is initialized by using POKES to insert the subroutine entry address into memory locations (decimal) 54 and 55. Any PRINT statements that follow will force the text that was to be printed to be displayed on the graphics screen.

### Data-Scroll Routine

The information that is routed to the video display when the Apple is in the high-resolution-graphics mode comes from an 8192-byte block of memory that is defined (for the secondary picture-page buffer) between memory locations 4000 and 5FFF (see figure 1). The rationale that determines the relationship between a dot's position on the screen and the dot's position in the picture-page buffer is not all that obvious to me. The best that I have been able to do is to map out the relationship between a dot's position on the screen and a memory-address location in the picture-page buffer.

Seven of the 8 bits in each byte contained in the picture-page buffer are displayed as dots; the eighth bit determines the color of the other 7 dots. A total of 40 bytes is displayed on each horizontal line of the video display. The LSB of the first byte in a line is displayed on the left-hand edge of the screen, followed by the second bit, the third bit, etc. A total of 280 dots (40 bytes × 7 dots) is displayed on each of the 192 lines (24 lines × 8 dots) that can be displayed on the screen.

In order to help myself understand the picture-page memory map, I con-

### Listing 2 continued:

9064	AD F3 C0	LDA	\$C0F3	Load data from input #3
9067	91 0A	STA	(\$0A),Y	Store data
9069	C8	INY		Increment LSD
906A	D0 02	BNE	\$906E	Branch on result not zero
906C	E6 0B	INC	\$0B	Increment MSD
906E	40	RTI		Return from interrupt

### Listing 3: High-resolution text-generator routine.

8F00	0B	PHP		Save processor status
8F01	4B	PHA		Save contents of accumulator
8F02	84 4E	STY	\$4E	Save contents of Y register
8F04	C9 8D	CMP	#\$8D	Test for carriage return
8F06	F0 07	BEQ	8F0F	
8F08	C9 8C	CMP	#\$8C	Test for line feed
8F0A	D0 05	BNE	8F11	
8F0C	18	CLC		
8F0D	90 5C	BCC	8F6B	
8F0F	F0 5C	BEQ	8F6D	
8F11	A5 25	LDA	\$25	Relate cursor position to HGR2 screen position
8F13	4A	LSR		
8F14	29 03	AND	#\$03	
8F16	09 40	ORA	#\$40	Define HGR page #2
8F18	85 2B	STA	\$2B	
8F1A	A5 25	LDA	\$25	
8F1C	6A	ROR		
8F1D	0B	PHP		
8F1E	0A	ASL		
8F1F	29 18	AND	#\$18	
8F21	85 2A	STA	\$2A	
8F23	0A	ASL		
8F24	0A	ASL		
8F25	05 2A	ORA	\$2A	
8F27	0A	ASL		
8F28	28	PLP		
8F29	6A	ROR		
8F2A	18	CLC		
8F2B	65 24	ADC	\$24	
8F2D	85 2A	STA	\$2A	
8F2F	68	PLA		
8F30	29 7F	AND	#\$7F	
8F32	48	PHA		
8F33	A9 88	LDA	888	MSB of graphics character look-up table
8F35	4A	LSR		
8F36	4A	LSR		
8F37	4A	LSR		
8F38	85 27	STA	\$27	
8F3A	68	PLA		Match text character to graphics character position in look-up table
8F3B	48	PHA		
8F3C	2A	ROL		
8F3D	26 27	ROL	\$27	
8F3F	2A	ROL		
8F40	26 27	ROL	\$27	
8F42	2A	ROL		
8F43	26 27	ROL	\$27	
8F45	29 F8	AND	8F8	
8F47	85 26	STA	\$26	
8F49	A0 00	LDY	\$00	
8F4B	B1 26	LDA	(\$26),Y	Get first row of graphics design from look-up table
8F4D	84 4F	STY	\$4F	
8F4F	A0 00	LDY	\$00	
8F51	48	PHA		
8F52	68	PLA		
8F53	51 2A	EOR	(\$2A),Y	
8F55	91 2A	STA	(\$2A),Y	Store graphics design in screen memory block
8F57	A4 4F	LDY	\$4F	
8F59	A5 2B	LDA	\$2B	
8F5B	18	CLC		
8F5C	69 04	ADC	804	
8F5E	85 2B	STA	\$2B	
8F60	C8	INY		
8F61	C0 08	CPY	808	
8F63	D0 26	BNE	8F4B	Jump if all rows not finished
8F65	E6 24	INC	\$24	Increment LSD of cursor position
8F67	A5 24	LDA	\$24	
8F69	C5 21	CMP	\$21	
8F6B	90 10	BCC	8F7D	

Listing 3 continued on page 388

Text continued on page 395



# BUY A BANK FOR \$15.95



## The DiskBank® Media Mate.



Media Mate 3 for new micro diskettes.  
Media Mate 5 for 5 1/4" diskettes.



Convenient easy-carry handle.

Introducing Media Mate... another affordable solution in diskette filing technology from DiskBank.

Media Mate combines an attractive desktop appearance with superior protection, organization and storing capability for 50 diskettes. All at a cost your budget will appreciate.

Available in sizes to accommodate both 5 1/4" and 3 1/2" diskettes, Media Mate includes a fortress of features:

- Sturdy, high impact styrene construction
- Attractive smoke see-thru cover

- Convenient adjustable tab dividers
- Self-locking cover with easy-carry handle
- Case on case stackability

For protecting, organizing and storing your valuable diskettes, make the little investment that pays off big. Buy a Bank. Buy DiskBank.

**DISKBANK®**  
AMARAY CORPORATION  
2251 Grant Road, Los Altos, CA 94022  
(415) 968-2840, Telex 171627 Amaray-Ltos

# DeSmet C The fastest 8088 C Compiler available

## FULL DEVELOPMENT PACKAGE

- C Compiler
- Assembler
- Linker and Librarian
- Full-Screen Editor
- Newsletter for bugs/updates

## SYMBOLIC DEBUGGER

- Monitor and change variables by name using C expressions
- Multi-Screen support for debugging PC graphics and interactive systems
- Optionally display C source during execution
- Breakpoint by Function and Line #

## COMPLETE IMPLEMENTATION

- Both 1.0 and 2.0 DOS support
- Everything in K&R (incl. STDIO)
- Intel assembler mnemonics
- Both 8087 and Software Floating Point

## OUTSTANDING PERFORMANCE

Sieve Benchmark  
 COMPILE 4 Sec. RAM —  
 22 Sec. FDISK  
 LINK 6 Sec. RAM —  
 34 Sec. FDISK  
 RUN 12 Sec.  
 SIZE 8192 bytes

**DeSmet C  
Development Package \$159**

To Order Specify:

Machine \_\_\_\_\_

OS  MS-DOS  CP/M-86

Disk  8"  5 1/4 SS  5 1/4 DS

**CW A R E**  
CORPORATION

P.O. BOX 710097

San Jose, CA 95171-0097

(408) 736-6905

California residents add sales tax. Shipping U.S. no charge. Canada add \$5, elsewhere add \$15. Checks must be on a US Bank and in US Dollars.

Listing 3 continued:

8F6D	A5 20	LDA	\$20
8F6F	85 24	STA	\$24
8F71	86 25	INC	\$25
8F73	A5 25	LDA	\$25
8F75	C5 23	CMP	\$23
8F77	90 04	BCC	\$8F7D
8F79	A5 22	LDA	\$22
8F7B	85 25	STA	\$25
8F7D	A4 4E	LDY	\$4E
8F7F	68	PLA	
8F80	28	PLP	
8F81	60	RTS	

Increment MSD of cursor position

Restore Y register  
 Restore accumulator  
 Restore processor status  
 Return to calling routine

8900-	00	00	00	00	00	00	00	00	Space
8908-	10	10	10	10	00	00	10	00	!
8910-	24	24	24	00	00	00	00	00	"
8918-	24	24	7E	24	7E	24	24	00	#
8920-	10	78	14	38	50	3C	10	00	\$
8928-	00	46	26	10	08	64	62	00	&
8930-	0C	12	12	0C	52	22	5C	00	'
8938-	20	10	08	00	00	00	00	00	(
8940-	20	10	08	08	08	10	20	00	)
8948-	04	08	10	10	10	08	04	00	*
8950-	10	54	38	7C	38	54	10	00	+
8958-	00	10	10	7C	10	10	00	00	,
8960-	00	00	00	00	00	18	18	0C	-
8968-	00	00	00	7E	00	00	00	00	.
8970-	00	00	00	00	00	18	18	00	/
8978-	00	40	20	10	08	04	02	00	0
8980-	3C	42	62	5A	46	42	3C	00	1
8988-	10	18	14	10	10	10	7C	00	2
8990-	3C	42	40	30	0C	02	7E	00	3
8998-	3C	42	40	38	40	42	3C	00	4
89A0-	20	30	28	24	7E	20	20	00	5
89A8-	7E	02	1E	20	40	22	1C	00	6
89B0-	38	04	02	3E	42	42	3C	00	7
89B8-	7E	42	20	10	08	08	08	00	8
89C0-	3C	42	42	3C	42	42	3C	00	9
89C8-	3C	42	42	7C	40	20	1C	00	:
89D0-	00	00	18	18	00	18	18	00	;
89D8-	00	00	18	18	00	18	18	0C	<
89E0-	20	10	08	04	08	10	20	00	=
89E8-	00	00	3E	00	3E	00	00	00	>
89F0-	04	08	10	20	10	08	04	00	?
89F8-	3C	42	40	30	08	00	08	00	A
8A00-	38	44	52	6A	32	04	78	00	B
8A08-	18	24	42	7E	42	42	42	00	C
8A10-	3E	44	44	3C	44	44	3E	00	D
8A18-	3C	42	02	02	02	42	3C	00	E
8A20-	3E	44	44	44	44	44	3E	00	F
8A28-	7E	02	02	1E	02	02	7E	00	G
8A30-	7E	02	02	1E	02	02	02	00	H
8A38-	3C	42	02	72	42	42	3C	00	I
8A40-	42	42	42	7E	42	42	42	00	J
8A48-	38	10	10	10	10	10	38	00	K
8A50-	70	20	20	20	20	22	1C	00	L
8A58-	42	22	12	0E	12	22	42	00	M
8A60-	02	02	02	02	02	02	7E	00	N
8A68-	42	66	5A	5A	42	42	42	00	O
8A70-	42	46	4A	52	62	42	42	00	P
8A78-	3C	42	42	42	42	42	3C	00	Q
8A80-	3E	42	42	3E	02	02	02	00	R
8A88-	3C	42	42	42	52	22	5C	00	
8A90-	3E	42	42	3E	12	22	42	00	

Table 1: Graphics character look-up table.

Table 1 continued on page 390



announcing

# THE INSIDER!

A 10 Mega-byte Internal Hard Disk Drive System...

Only **\$895!**



## Expand your PC to perform like the XT at a fraction of the cost.

Micro Design International, Inc. announces 10-Megabytes of formatted capacity with complete internal installation, all for \$895.00. Now you can expand your IBM® PC to a XT. By equipping it with the MDI Hard Disk save up to \$2,000 over the cost of a XT. This system also works with most PC look alike, and is DOS 2.0 and 2.1 compatible.

Unlike other internal drives which require an external power supply, The Insider uses available power. In fact, it uses only 0.9A of current thereby eliminating overheating, a problem which has plagued other drives. Our drive and electronics are so good that we carry a full one year warranty.

The MDI System includes complete software, cables, simple installation instructions and is available in the following configurations:

- MODEL
- IS00 Complete Winchester Disk System . . . . . \$895.00**
  - IS01 Insider Winchester System w/Multifunction Card . \$1095.00**
  - IS02 Insider Winchester System and Floppy Disk Controller \$1,295.00**

- IS03 Insider Winchester System w/RAM Memory. Card that will hold up to 256K RAM & RAM . . . \$1,295.00**
- IS04 Expansion Memory Module for Model IS03 to allow 320K additional RAM for a total of 576K & RAM . . . . . \$129.00**
- IS05 64K of RAM for IS03 and IS04 . . . . . \$ 75.00**
- IS06 Multifunction Card . . . . \$ 88.00**
- MODULES FOR USE WITH IS01 AND IS06 ABOVE**
- IS07 Parallel Port Module (Centronics) . . . . . \$ 59.00**
- IS08 Serial Port Module (RS232) . . . . . \$ 95.00**
- IS09 Clock Calendar Module w/battery . . . . . \$ 65.00**
- IS10 Game Adaptor Module . . \$ 55.00**
- IS11 Hard Disk Controller . . . \$395.00**
- IS12 Hard Disk Boot ROM . . . \$ 48.00**

To expand your PC to the performance of a XT at a fraction of the cost. CALL TODAY. MasterCard and Visa are accepted; or send check or money order to Micro Design International, Inc.

TO ORDER  
CALL COLLECT 305-677-8333

**Micro Design International, Inc.**

Suite 7 6586 University Blvd.  
Winter Park, Florida 32792

IBM is a trademark of the International Business Machines Corporation.

Circle 264 on inquiry card.

# Everyone from Commodore to IBM User Will Want This Remarkable Guide to Creating User-Oriented Software



Paul Heckel feels that to be "friendly" software should be visual, interactive, and above all, *communicative*. He first summons up the techniques of the great masters of communication in film, and of painters like Pablo Picasso and writers like Mark Twain. He then adds techniques of his own developed through years of successful software design, including programs for the Craig Language Translator and the all-new Viewdex™ system for the Epson HX-20. The result is a free-wheeling guide that is as delightful and surprising to read as it is easy and practical to use.

*The Elements of Friendly Software Design* explains:

- The thirty principles of friendly software design
- How filmmakers' communication techniques can be used to make software design "friendly"
- Visual thinking as a key to design
- Planning for prototyping and revision
- Factors that determine user acceptance
- Examples of excellence—why VisiCalc is so successful
- Seven traps that snag even the most experienced designers

**"Unique and indispensable; by far the most important and practical book on the subject"**

—Larry Tesler, Manager, User Interface Design, Apple's Lisa

**Now In Quality Paperback**

**WARNER SOFTWARE  
WARNER BOOKS**

A Warner Communications Company

To order, send check or money order for \$10.20 in U.S.A. or \$12.00 in Canada (includes postage and handling) to Dept. PWA-X38-040, BY Warner Books, 686 Fifth Avenue, New York, NY 10103. Please allow four to six weeks for delivery.

390 BYTE May 1984

Table 1 continued:

8A98-	3C	42	02	3C	40	42	3C	00	S
8AA0-	7C	10	10	10	10	10	10	00	T
8AA8-	42	42	42	42	42	42	3C	00	U
8AB0-	42	42	42	24	24	18	18	00	V
8AB8-	42	42	42	5A	5A	66	42	00	W
8AC0-	42	42	24	18	24	42	42	00	X
8AC8-	44	44	44	38	10	10	10	00	Y
8AD0-	7E	40	20	18	04	02	7E	00	Z

Listing 4: Right-to-left scroll routine.

8700	A9 00	LDA	#\$00	Initialize base address
8702	8D FE 87	STA	\$87FE	
8705	A9 40	LDA	#\$40	
8707	8D FF 87	STA	\$87FF	
870A	A9 02	LDA	#\$02	Initialize block counter
870C	8D FD 87	STA	\$87FD	
870F	A0 08	LDA	#\$08	Initialize box counter
8711	8D F7 87	STA	\$87F7	
8714	20 50 87	JSR	\$8750	Jump to main routine
8717	18	CLC		
8718	A9 28	LDA	#\$28	Set up for second block
871A	6D FE 87	ADC	\$87FE	
871D	8D FE 87	STA	\$87FE	
8720	CE PD 87	DEC	\$87FD	
8723	D0 EA	BNE	\$870F	Jump if second block not complete
8725	A9 06	LDA	#\$06	Number of boxes remaining (two boxes reserved for text)
8727	8D F7 87	STA	\$87F7	
872A	20 50 87	JSR	\$8750	Jump to main routine
872D	60	RTS		Return to calling routine
8750	AD FE 87	LDA	\$87FE	Save base address
8753	8D FB 87	STA	\$87FB	
8756	AD FF 87	LDA	\$87FF	
8759	8D FC 87	STA	\$87FC	
875C	A9 08	LDA	#\$08	Initialize row counter
875E	8D FA 87	STA	\$87FA	
8761	AD FB 87	LDA	\$87FB	Set up LSB of left hand side of screen
8764	8D E6 87	STA	\$87E6	
8767	18	CLC		
8768	69 02	ADC	#\$02	Set up shift distance
876A	8D E3 87	STA	\$87E3	
876D	18	CLC		
876E	69 1A	ADC	#\$1A	
8770	8D F0 87	STA	\$87F0	Set up LSB of right hand side of screen
8773	8D F3 87	STA	\$87F3	
8776	EE F3 87	INC	\$87F3	Next byte
8779	AD FC 87	LDA	\$87FC	Set up MSB of
877C	8D E4 87	STA	\$87E4	left hand side of screen
877F	8D E7 87	STA	\$87E7	right hand side of screen
8782	8D F1 87	STA	\$87F1	
8785	8D F4 87	STA	\$87F4	
8788	20 E0 87	JSR	\$87E0	Jump to shift routine
878B	18	CLC		
878C	A9 04	LDA	#\$04	Add 4 to MSB of
878E	6D E4 87	ADC	\$87E4	left hand side of screen
8791	8D E4 87	STA	\$87E4	
8794	8D E7 87	STA	\$87E7	right hand side of screen
8797	8D F1 87	STA	\$87F1	
879A	8D F4 87	STA	\$87F4	
879D	CE FA 87	DEC	\$87FA	Decrement row counter
87A0	D0 E6	BNE	\$8788	Jump if box not complete
87A2	18	CLC		
87A3	A9 80	LDA	#\$80	Set up next box address
87A5	6D FB 87	ADC	\$87FB	
87A8	8D FB 87	STA	\$87FB	
87AB	A9 00	LDA	#\$00	
87AD	6D FC 87	ADC	\$87FC	
87B0	8D FC 87	STA	\$87FC	
87B3	CE F7 87	DEC	\$87F7	Decrement box counter
87B6	D0 A4	BNE	\$875C	Jump if block not complete
87B8	60	RTS		Return to calling routine

Listing 4 continued on page 391





	Row 1	\$4000		Row 1	\$4028		Row 1	\$4050
	Row 2	\$4400		Row 2	\$4428		Row 2	\$4450
	Row 3	\$4800		Row 3	\$4828		Row 3	\$4850
Box 1	Row 4	\$4C00	Box 1	Row 4	\$4C28	Box 1	Row 4	\$4C50
	Row 5	\$5000		Row 5	\$5028		Row 5	\$5050
	Row 6	\$5400		Row 6	\$5428		Row 6	\$5450
	Row 7	\$5800		Row 7	\$5828		Row 7	\$5850
	Row 8	\$5C00		Row 8	\$5C28		Row 8	\$5C50
	Row 1	\$4080		Row 1	\$40A8		Row 1	\$40D0
	Row 2	\$4480		Row 2	\$44A8		Row 2	\$44D0
	Row 3	\$4880		Row 3	\$48A8		Row 3	\$48D0
Box 2	Row 4	\$4C80	Box 2	Row 4	\$4CA8	Box 2	Row 4	\$4CD0
	Row 5	\$5080		Row 5	\$50A8		Row 5	\$50D0
	Row 6	\$5480		Row 6	\$54A8		Row 6	\$54D0
	Row 7	\$5880		Row 7	\$58A8		Row 7	\$58D0
	Row 8	\$5C80		Row 8	\$5CA8		Row 8	\$5CD0
	Row 1	\$4100		Row 1	\$4128		Row 1	\$4150
	Row 2	\$4500		Row 2	\$4528		Row 2	\$4550
	Row 3	\$4900		Row 3	\$4928		Row 3	\$4950
Box 3	Row 4	\$4D00	Box 3	Row 4	\$4D28	Box 3	Row 4	\$4D50
	Row 5	\$5100		Row 5	\$5128		Row 5	\$5150
	Row 6	\$5500		Row 6	\$5528		Row 6	\$5550
	Row 7	\$5900		Row 7	\$5928		Row 7	\$5950
	Row 8	\$5D00		Row 8	\$5D28		Row 8	\$5D50
	Row 1	\$4180		Row 1	\$41A8		Row 1	\$41D0
	Row 2	\$4580		Row 2	\$45A8		Row 2	\$45D0
	Row 3	\$4980		Row 3	\$49A8		Row 3	\$49D0
Block 1 Box 4	Row 4	\$4D80	Block 2 Box 4	Row 4	\$4DA8	Block 3 Box 4	Row 4	\$4DD0
	Row 5	\$5180		Row 5	\$51A8		Row 5	\$51D0
	Row 6	\$5580		Row 6	\$55A8		Row 6	\$55D0
	Row 7	\$5980		Row 7	\$59A8		Row 7	\$59D0
	Row 8	\$5D80		Row 8	\$5DA8		Row 8	\$5DD0
	Row 1	\$4200		Row 1	\$4228		Row 1	\$4250
	Row 2	\$4600		Row 2	\$4628		Row 2	\$4650
	Row 3	\$4A00		Row 3	\$4A28		Row 3	\$4A50
Box 5	Row 4	\$4E00	Box 5	Row 4	\$4E28	Box 5	Row 4	\$4E50
	Row 5	\$5200		Row 5	\$5228		Row 5	\$5250
	Row 6	\$5600		Row 6	\$5628		Row 6	\$5650
	Row 7	\$5A00		Row 7	\$5A28		Row 7	\$5A50
	Row 8	\$5E00		Row 8	\$5E28		Row 8	\$5E50
	Row 1	\$4280		Row 1	\$42A8		Row 1	\$42D0
	Row 2	\$4680		Row 2	\$46A8		Row 2	\$46D0
	Row 3	\$4A80		Row 3	\$4AA8		Row 3	\$4AD0
Box 6	Row 4	\$4E80	Box 6	Row 4	\$4EA8	Box 6	Row 4	\$4ED0
	Row 5	\$5280		Row 5	\$52A8		Row 5	\$52D0
	Row 6	\$5680		Row 6	\$56A8		Row 6	\$56D0
	Row 7	\$5A80		Row 7	\$5AA8		Row 7	\$5AD0
	Row 8	\$5E80		Row 8	\$5EA8		Row 8	\$5ED0
	Row 1	\$4300		Row 1	\$4328		Row 1	\$4350
	Row 2	\$4700		Row 2	\$4728		Row 2	\$4750
	Row 3	\$4B00		Row 3	\$4B28		Row 3	\$4B50
Box 7	Row 4	\$4F00	Box 7	Row 4	\$4F28	Box 7	Row 4	\$4F50
	Row 5	\$5300		Row 5	\$5328		Row 5	\$5350
	Row 6	\$5700		Row 6	\$5728		Row 6	\$5750
	Row 7	\$5B00		Row 7	\$5B28		Row 7	\$5B50
	Row 8	\$5F00		Row 8	\$5F28		Row 8	\$5F50
	Row 1	\$4380		Row 1	\$43A8		Row 1	\$43D0
	Row 2	\$4780		Row 2	\$47A8		Row 2	\$47D0
	Row 3	\$4B80		Row 3	\$4BA8		Row 3	\$4BD0
Box 8	Row 4	\$4F80	Box 8	Row 4	\$4FA8	Box 8	Row 4	\$4FD0
	Row 5	\$5380		Row 5	\$53A8		Row 5	\$53D0
	Row 6	\$5780		Row 6	\$57A8		Row 6	\$57D0
	Row 7	\$5B80		Row 7	\$5BA8		Row 7	\$5BD0
	Row 8	\$5F80		Row 8	\$5FA8		Row 8	\$5FD0

Table 2: Picture-page buffer/memory-address organization as discussed in the text.



# WE ALL AGREE



## We can't think of anyone who isn't better off with A DX-15 DAISY WHEEL PRINTER.

Auto Cut Sheet Feed (option)



Tractor Feed (option)



Keyboard (option)



Dynax's DX-15. And if you want the kind of printer that lives in the fast lane, the DX-15 is your printer. It does it all, certainly all that far more expensive models can do. The DX-15 offers you some important options like Keyboard, Tractor Feed and Auto Cut Sheet Feed. Not only that, the DX-15 is a very durable unit, be it for business, home or word processing applications. And who says a great printer has to be expensive? Not us! What we say is you'll be dumbfounded when your dealer tells you just how inexpensive the DX-15 happens to be. Give him a call or drop by. Dynax's DX-15 says it ALL.

**Dynax, Inc.**<sup>TM</sup>

5698 Bandini Blvd., Bell, CA 90201  
(213) 260-7121

Circle 148 on Inquiry card.



# “Thoughtware, How Good A Manager Am I?”



*Thoughtware is new, easy-to-use software that will help you see and understand how to become a better manager. It's a unique series of personal, computer-based management diagnostic and training programs.*

© Thoughtware is a registered trademark of the Institute for Management Improvement.

How good a manager are you? Thoughtware Module 1.1 “Assessing Personal Management Skills” will tell you. This program is a three-part, comprehensive self-assessment of your personal attitudes, behavior and understanding as they relate to your effectiveness as a manager.

**Unit 1** assesses your leadership style by examining the degree to which you are task- or people-oriented and how you use communication, teamwork, participation, initiative and support to get results. It also assesses your understanding of what motivates employees, promotes teamwork, and the extent to which you provide feedback.

**Unit 2** assesses your attitudes about setting goals and objectives, clarifying roles and responsibilities, and delegating. It also assesses the methods you use to improve employee performance and the ways you conduct performance evaluations.

**Unit 3** assesses your personal effectiveness by looking at how you manage time and stress, how you conduct meetings and solve problems. The programs conclude with specific recommendations designed to address the weaknesses identified.

To introduce you to Thoughtware, we'll send you “Assessing Personal Management Skills” (which normally sells for \$350), for only \$150. (See adjacent column for details.) Offer expires May 31, 1984.

*Thoughtware programs run on the following: IBM® PC, PC XT, PCjr and compatible PC's. Apple® II Plus and Iie.*



## Thoughtware™

*Expanding The Universe Of Learning.*



## Thoughtware Is The Future.

It's a new way to learn, a logical and innovative approach to management training. It will revolutionize management training now, and in the future.

Thoughtware utilizes the latest research in management development from leaders in the field, and has been tested nationally.

For individuals, and their organizations, the educational, economic and operational benefits of Thoughtware's computer-based learning programs are enormous. But Thoughtware isn't just the future.

## Thoughtware Is The Present.

Some of the largest and most prestigious corporations and organizations in the world have purchased Thoughtware's assessing Personal Management Skills Program.

American Express	Ingersoll-Rand
American Mgt. Assoc.	IRS
Apple Computer	Johns Hopkins Univ.
AT&T	Levi Strauss
Avon	Marriott
Bankers Life	Marsh & McLennan
Blue Cross & Blue Shield	Mass. Mutual
Bank of Boston	McGraw-Hill
Bureau of the Census	MCI
Chevron USA	U.S. Navy
Ciba-Geigy	NCR
Citibank	NYU
City of Dallas	Owens-Illinois
Crown Zellerbach	Owens-Corning Fiberglas
Dow Jones	Royal Cup Coffee
Dun & Bradstreet	Sentry Insurance
DuPont	Singapore Embassy
Ernst & Whinney	Stone & Webster
Exxon	St. Regis Paper
Federal Reserve Bank	Tampax
Fireman's Fund	The Nestle Co.
General Electric	The Rouse Co.
General Foods	3M Corporation
Georgia-Pacific	TRW
Gov'l of Canada	Univ. of Illinois
Gulf Oil Corporation	United Parcel Service
Hewlett Packard	United Way
Horn & Hardart	Univ. of Mass.
Hughes Aircraft Co.	Westmoreland Coal
Husky Oil	Westinghouse Corp.
IBM	Xerox

And hundreds more. What they've learned, you can now discover.

You can reap the benefits of Thoughtware by visiting your local computer dealer, or call us at our toll-free number 1-800-THT-WARE, or write:

Thoughtware Inc.  
Suite S, 2699 So. Bayshore Dr.  
Coconut Grove, Florida 33133.

Thoughtware Programs include:

- 1.3 Understanding Personal Interaction Styles (\$350)
- 2.1 Leading Effectively (\$450)
- 2.3 Defining Goals And Objectives (\$450)

## Listing 5: Left-to-right scroll routine.

8700	A9 00	LDA	#\$00	Initialize base address
8702	8D FE 87	STA	\$87FE	
8705	A9 40	LDA	#\$40	
8707	8D FF 87	STA	\$87FF	
870A	A9 02	LDA	#\$02	Initialize block counter
870C	8D FD 87	STA	\$87FD	
870F	A0 08	LDA	#\$08	Initialize box counter
8711	8D F7 87	STA	\$87F7	
8714	20 50 87	JSR	\$8750	Jump to main routine
8717	18	CLC		
8718	A9 28	LDA	#\$28	Set up for second block
871A	6D FE 87	ADC	\$87FE	
871D	8D FE 87	STA	\$87FE	
8720	CE FD 87	DEC	\$87FD	
8723	D0 BA	BNE	\$87DF	Jump if second block not complete
8725	A9 06	LDA	#\$06	Number of boxes remaining (two boxes reserved for text)
8727	8D F7 87	STA	\$87F7	
872A	20 50 87	JSR	\$8750	Jump to main routine
872D	60	RTS		Return to calling routine
8750	AD FE 87	LDA	\$87FE	Save base address
8753	8D FB 87	STA	\$87FB	
8756	AD FF 87	LDA	\$87FF	
8759	8D FC 87	STA	\$87FC	
875C	A9 08	LDA	#\$08	Initialize row counter
875E	8D FA 87	STA	\$87FA	
8761	AD FB 87	LDA	\$87FB	Set up LSB of right hand side of screen
8764	8D E3 87	STA	\$87E3	
8767	18	CLC		
8768	69 02	ADC	#\$02	Set up shift distance
876A	8D E6 87	STA	\$87E6	
876D	18	CLC		
876E	69 FE	ADC	#\$FE	
8770	8D F0 87	STA	\$87F0	Set up LSB of left hand side of screen
8773	8D F3 87	STA	\$87F3	
8776	EE F3 87	INC	\$87F3	Next byte
8779	AD PC 87	LDA	\$87FC	Set up MSB of right hand side of screen
877C	8D E4 87	STA	\$87E4	
877F	8D E7 87	STA	\$87E7	
8782	8D F1 87	STA	\$87F1	left hand side of screen
8785	8D F4 87	STA	\$87F4	
8788	20 E0 87	JSR	\$87E0	Jump to shift routine
878B	18	CLC		
878C	A9 04	LDA	#\$04	Add 4 to MSB of right hand side of screen
878E	6D E4 87	ADC	\$87E4	
8791	8D E4 87	STA	\$87E4	
8794	8D E7 87	STA	\$87E7	
8797	8D F1 87	STA	\$87F1	left hand side of screen
879A	8D F4 87	STA	\$87F4	
879D	CE FA 87	DEC	\$87FA	Decrement row counter
87A0	D0 E6	BNE	\$87E6	Jump if box not complete
87A2	18	CLC		
87A3	A9 80	LDA	#\$80	Set up next box address
87A5	6D FB 87	ADC	\$87FB	
87A8	8D FB 87	STA	\$87FB	
87AB	A9 00	LDA	#\$00	
87AD	6D FC 87	ADC	\$87FC	
87B0	8D FC 87	STA	\$87FC	
87B3	CE F7 87	DEC	\$87F7	Decrement box counter
87B6	D0 A4	BNE	\$875C	Jump if block not complete
87B8	60	RTS		Return to calling routine
8780	A2 18	LDX	#\$18	Set up byte counter
8782	8D 00 40	LDA	\$4000,X	Shift 2 bytes (14 points) right
8785	9D 02 40	STA	\$4002,X	
8788	CA	DEX		Decrement counter
87E9	E0 FF	CPX	#\$FF	
87EB	D0 F5	BNE	\$87E2	Jump if shift not complete
87ED	A9 00	LDA	#\$00	Clear left most 14 points
87EF	8D 00 40	STA	\$4000	
87F2	8D 01 40	STA	\$4001	
87F5	60	RTS		Return to calling routine

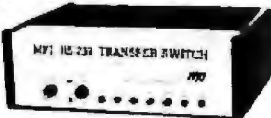
Text continued from page 386:

sider the total display to be made up of three blocks; each block is made up of eight boxes; each box is made up of eight rows. Table 2 shows a break-

down of the picture buffer organized so that each row has a memory address associated with it that defines the leftmost 7 dots (plus the associ-

## Multi-function RS-232 Transfer Switches

MFJ-1240  
\$79.95  
Choice of 8 models



Multi-function RS-232 transfer switches let you switch your computer among printers, modems, terminals, any RS-232 peripherals; monitor data/line failure, protect data lines from surges, and use as null modem for less cost than a switch alone.

Switches 10 lines (2, 3, 4, 5, 6, 8, 11, 15, 17, 20). LED data/line indicators monitor lines 2, 3, 4, 5, 6, 8, 20. Metal oxide varistors protect data lines 2, 3 from voltage spikes and surges. Push button reverses transmit-receive lines (2, 3). PC board eliminates wiring, crosstalk, line interference. Connects any one input to any one output.

Model	Price	In	Out	Model	Price	In	Out
MFJ-1240	\$79.95	1	2	MFJ-1244	\$139.95	3	3
MFJ-1241	\$99.95	2	2	MFJ-1245	\$169.95	3	5
MFJ-1242	\$119.95	2	3	MFJ-1246	\$199.95	5	5
MFJ-1243	\$119.95	1	4	MFJ-1247	\$99.95	1	2

switches 20 lines

## AC Power Centers

MFJ-1108  
\$99.95

MFJ-1108, \$99.95. Add convenience, prevent data loss, head bounce, equipment damage. Relay latches power off during power transients. Multi-filters isolate equipment, eliminate interaction, noise, hash. MOVs suppress spikes, surges. 3 isolated, switched socketpairs. One unswitched for clock, etc. Lighted power, reset switch. Pop-out fuse. 3 wire, 5 ft. cord. 15A, 125V, 1875 watts. Aluminum case. Black. 18x24x2 in. MFJ-1107, \$79.95. Like 1108 less relay. 8 sockets, 2 unswitched. MFJ-1109, \$129.95. Like 1107 but intelligent. Switch on device plugged into control socket and everything else turns on. Others available.



## Acoustic/Direct Coupled Modem



Use with any phone anywhere MFJ-1233 \$129.95

MFJ-1233 Acoustic/Direct Coupled 300 baud modem. Versatile. Use with virtually any phone, anywhere. Use battery or 110 VAC. Direct connect mode: Plug between handset and base. Use with single or multi-line phones. Acoustic coupled mode: Use with phones without modular plugs. Quality muffs give good acoustic coupling, isolates external noise for reliable data transfer. Originate/answer. Self test. Carrier detect, ON LEDs. RS-232, TTL compatible. Reliable single chip modem. Crystal controlled. Aluminum cabinet. 9x17x4 in. Other models available.

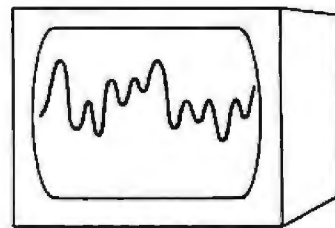
Order from MFJ and try it. If not delighted, return within 30 days for refund (less shipping). One year unconditional guarantee.

Order yours today. Call toll free 800-647-1800. Charge VISA, MC. Or mail check, money order. Add \$4.00 each for shipping and handling.

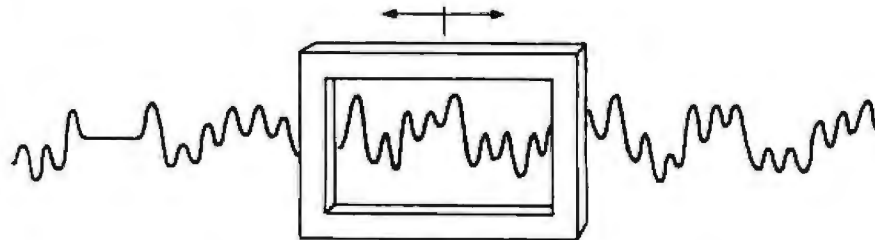
CALL TOLL FREE ... 800-647-1800  
Call 601-323-5869 in MS, outside continental USA.

**MFJ ENTERPRISES INCORPORATED**

921 Louisville Road, Starkville, MS 39759



VIDEO MONITOR



SCROLLING WINDOW

Figure 2: A representation of how the scrolling-window software described in the text relates to the data displayed on the video monitor.

ated color bit) for each horizontal line displayed on the screen. Notice that the memory address for each horizontal line on the display is not in sequential order with respect to magnitude, but that there is a repeating pattern.

The data-scroll routines let you control a window that permits examination of blocks of 209 adjacent samples of data. The position of this window is controlled by the left and right arrow keys (see figure 2). The data-scroll routines are broken up into two machine-language programs. Listing 4 gives the machine-language program that shifts data from right to left across the screen; listing 5 gives the routine that shifts data from left to right.

Without going into exhaustive detail, these routines move the contents of the picture-buffer memory so that the displayed data shifts either 14 data points to the left or the right on the screen. The rightmost (or leftmost) 14 data points are cleared so that new data can then be shifted in. The subroutines have to take into consideration the picture-buffer structure shown in table 2 (it would have been a lot easier if the picture buffer had been organized in a sim-

ple sequential manner). The shifting effect results in a window that can move back and forth across the memory block containing the digitized data.

### Conclusion

I encourage those of you with modest data-acquisition and data-analysis requirements to consider the use of a system similar to the one described here. In our laboratory, we have found it to be a relatively inexpensive way to pursue research interests and have no doubt that it will continue to be a valued part of our laboratory in the years to come. The only items required are an Apple II and the circuitry and listings presented here. ■

*Richard C. Hallgren is an associate professor in the Department of Biomechanics, Michigan State University, East Lansing, MI 48824. He works on applications of microprocessor-based systems to scientific research.*

**Author's Note:** If you do not have either the time or capability to construct such a project, please write to me and I will direct you to a source for the hardware and the system software.





## Encounter REVELATION

For \$950, Revelation Software by Cosmos will give your PC capabilities that no microcomputer has ever had before. Through a versatile, high performance Relational Data Base Management System developed by Cosmos, Revelation will give your microcomputer all the power and sophistication of a minicomputer.

Revelation features a data base with variable-length fields and records, (up to 64K), and unlimited files and accounts. File size is

limited only by disk size.

Also featured: A powerful, hybrid programming language.

A fourth generation applications and program generator  
Our programs write programs!

Communications functions that give your PC the power to utilize applications, programs, and data from thousands of existing mainframe and minicomputers.

8087 math chip support

Revelation co-exists with MS/DOS™ or PC/DOS™ 1.0, 1.1,

2.0 versions, and is compatible with the IBM PC™ XT™ COMPAQ™ Corona™ Columbia Multi-Personal® and the Eagle 1600™. It's also compatible with mini-computers utilizing the PICK Operating System™. Minimum configuration requires 320K memory and 8087 math chip.

MS/DOS™ of Microsoft Corp. IBM PC Registered TM of International Business Machines Corp. COMPAQ™ of COMPAQ Computer Corp. PICK Operating System™ of

PICK SYSTEMS Eagle 1600™ of Eagle Computers. Corona PC™ of Corona Data Systems Columbia Multi-Personal™ of Columbia Data Products Inc.

P. O. Box AH, Morton, WA 98356

# COSMOS

Circle 113 on inquiry card.

Telephone 1-800-422-2511  
Inside Washington 206-496-5974.



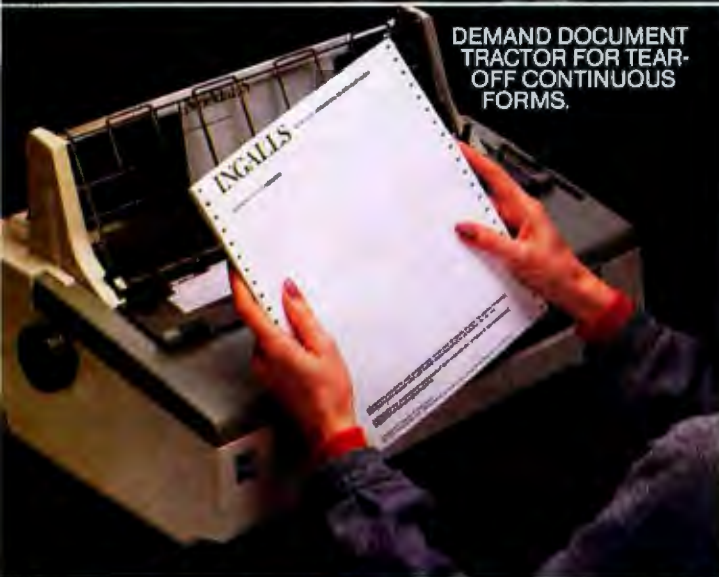
# SPINWRITER INTRODUCES PAPERWORK



BIDIRECTIONAL TRACTOR FOR CONTINUOUS, FAN FOLD PAPER OR LABELS WITH SUB/SUPER-SCRIPTING.



CUT SHEET GUIDE FOR SINGLE SHEETS.



DEMAND DOCUMENT TRACTOR FOR TEAR-OFF CONTINUOUS FORMS.



UNIDIRECTIONAL TRACTOR FOR CONTINUOUS, FOLD PAPER OR LABELS.



DUAL BIN ADAPTER FOR FIRST AND SECOND SHEETS.



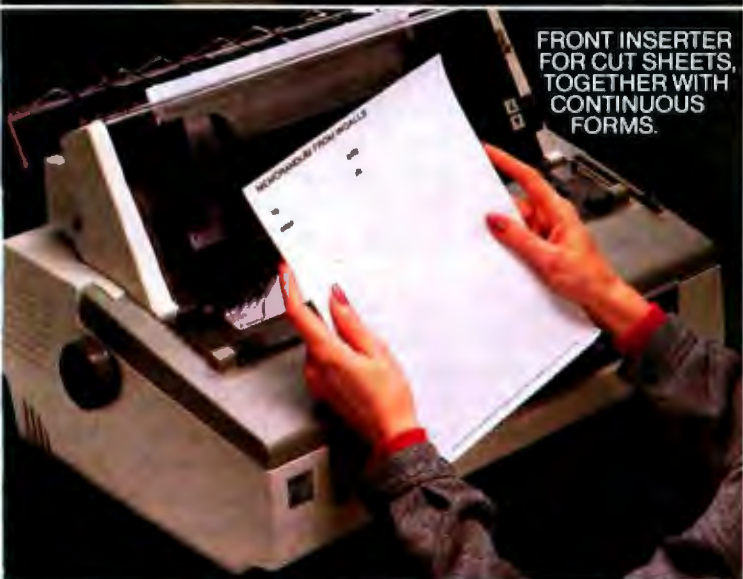
ENVELOPE FEEDER FOR INTERFEDING WITH CUT SHEETS.



# ES 9 WAYS TO GET YOUR MOVING FASTER.



FEEDER FOR CONTINUOUS FEED OF SINGLE SHEETS.



FRONT INSERTER FOR CUT SHEETS, TOGETHER WITH CONTINUOUS FORMS.



FRICITION FEEDER

These nine NEC forms handlers can automate most of the printing operations in your office.

With most other printers, you'd be lucky to find even one of these productivity tools.

Most competitive forms handlers are made by third parties. Which means they're compromises.

NEC forms handlers have all been conceived by the Spinwriter team. So they are perfectly integrated with the Spinwriter® 3500 and 2000 Series letter quality printers.

You'll find Spinwriters along with forms handlers at:

Participating Computerland stores (California) 1-800-321-1101, (Outside California) 1-800-423-3008

Entré Computer Centers 1-800-HI ENTRE

Sears 1-800-228-2200

Also available at IBM Product Centers.

Or call 1-800-343-4418 for your nearest authorized NEC distributor nationwide. In Massachusetts call (617) 264-8635. For product literature, use the coupon below. And find out why more and more PC users are saying, "NEC and me."

Circle 292 on inquiry card.

Spinwriter is a registered trademark of NEC Corporation.

B5/84

Send me literature on **spinwriter** forms handlers.

Name \_\_\_\_\_

Title \_\_\_\_\_

Company \_\_\_\_\_

Address \_\_\_\_\_

City \_\_\_\_\_

State \_\_\_\_\_

Zip \_\_\_\_\_

FH/U \_\_\_\_\_

NEC Information System, Inc. 1414 Mass. Ave.  
Boxborough, MA 01719

**NEC  
AND  
ME**



# ISIM

## A Continuous-System Simulation Language

*The structure and features of a simulation language designed to run under CP/M*

Roy E. Crosbie

California State University

The key to effective simulation is the availability of a mathematical model of the relationships between the system variables including accurate data. When this model is accurately programmed and validated, useful simulations can be performed. This programming usually involves the use of advanced techniques such as the solution of differential equations, random-number generation, graphics, and statistical analysis. Many simulation models involve thousands of relationships between variables.

It is hardly surprising that simulation, which is widely used by many who are not expert programmers, should have stimulated the development of special software aids including special simulation languages.

### Discrete and Continuous Languages

There are two groups of simulation languages that have a sufficiently wide area of application to warrant the title "general purpose." These are the discrete and the continuous simulation languages. Discrete simulation languages are applied mainly to problems arising in management sciences and operational research studies, particularly queuing systems. These systems remain in a particular state until an event occurs that

causes a change in the state of the system.

This article, however, is mainly concerned with the second group, continuous-system simulation languages (CSSLs). A continuous system, as its name suggests, is one whose state changes continuously. The mathematical description of a continuous system is based on differential equations. A differential equation can be regarded as a relationship between a quantity and its rate of change.

For example, consider a piece of metal at a temperature of  $x$  degrees F (Fahrenheit) cooling in an ambient temperature of 70°F. The rate of cooling is approximately proportional to the temperature difference

$$\text{Rate of cooling} = k(x-70)$$

Mathematical notation uses the  $dx/dt$  to represent the rate of change of the quantity  $x$  with time  $t$ . The notation  $x'$  is also used—in the example,  $x'$  is the rate of cooling of the metal object in °F/second.

The differential equation  $x' = k(x-70)$  describes a continuous system in which the temperature  $x$  is changing continuously as time passes. Simple models of this kind can be solved easily, but computer simulation comes into its own when more complex systems are involved

with more complex differential equations.

In many practical applications it may be necessary to solve dozens or even hundreds of equations simultaneously. One of the main advantages of using a CSSL is that the numerical techniques necessary for solving these equations are built into the language. It is only necessary to specify the differential equation in a natural notation and the language does all the work.

Of the several CSSLs presently available for microcomputers, we should mention micro-DYNAMO from Addison-Wesley and TUTSIM from Twente University (Netherlands). Within this article, I shall focus on ISIM, a language developed for the CP/M environment. We will explore the syntax and capabilities of ISIM by creating a simulation of a rocket launch.

### ISIM—A CSSL for Microcomputers

ISIM is a development of the ISIS language (see text box), modified to run under the CP/M operating system. Even so, ISIM retains most of the notable features of its parent, several of which are unique to CSSLs on any kind of computer.

We start our description of the language with the way of defining differential equations. We have already



## CSSLs Before the Micro

To appreciate current developments, we should know something about the history of CSSLs. The very first simulation languages for continuous systems date back to the mid-1960s when even general-purpose programming languages were still in their infancy. These early languages often required that the system be represented by a block diagram with function blocks representing operations such as integration, addition, multiplication, etc. The simulation program was prepared in the form of a table of connections of the inputs and outputs of the function blocks, one line per block. These languages are called block-structured and were popular because of the similarity of the block diagrams to analog computer flow diagrams. At that time, analog computers were widely used for continuous system simulation because of the limited power and speed of the avail-

able digital computers and block-structured languages were often used to check analog computer solutions.

As digital computers increased in power, they came to be used more for simulation in their own right, and the limitations of block-structured languages led to the development of statement-structured languages that bore a closer resemblance to general-purpose languages such as FORTRAN and Algol. These new languages featured a structure that simplifies simulation programming as well as special built-in functions to make system description easier. However, such languages were heavy users of computing resources, especially memory, so their use was confined to large mainframe systems. Perhaps the best known and most widely used CSSL of this vintage was the IBM product for the System 360: CSMP (Continuous-System Modeling Program). This type of CSSL is widely used for large-scale simula-

tion of mainframes and the more powerful minicomputers.

In the 1970s, a number of simulation languages with rather different characteristics were developed. This was a period that saw a rapid expansion in the use of inexpensive minicomputers that were incapable of supporting full-scale CSSLs. Instead, CSSLs were developed specifically to exploit the advantages of minicomputers, particularly their ability to provide hands-on, interactive computing. These languages included ISIS, developed at the University of Salford (England) by Dr. John Hay and the author, and the DARE series of languages developed by Korn and Wait at the University of Arizona.

ISIS was an interpreter language written in FORTRAN (initially for the DEC PDP-8). It provided the basis for the ISIM language.

seen one example; another is listed below:

$$VEL' = G * (THRUST - DRAG) / W - G$$

Readers familiar with FORTRAN or BASIC should be reasonably comfortable with this example. The only unusual feature is the use of a prime (') to represent differentiation. We would use a second derivative (e.g., VOUT'') to define a second-order differential equation.

A complete model of a system will often contain a mixture of differential and algebraic equations. For example:

### DYNAMIC

$$W = 3000 - 40 * T$$

$$DRAG = K * Y' ** 2$$

$$Y'' = G * (THRUST - DRAG) / W - G$$

These equations are a very simplified model of the launch phase of a rocket. The first statement uses the key word DYNAMIC to introduce the equations.  $W$  is the weight of the rocket plus fuel that is initially 3000 pounds, but is falling at the rate of 40 pounds per second. DRAG is the

drag force that is proportional to velocity squared. The final statement relates the acceleration of the rocket  $Y''$  to the THRUST of the rocket motors, the DRAG, the weight  $W$ , and the gravitational acceleration  $G$ . THRUST is treated as a constant in this case and is set elsewhere in the program.

The part of the program depicted above is called the DYNAMIC region. It specifies the differential and related equations to be solved between an initial time (usually zero) and a user-specified final time. The solution proceeds in a step-by-step manner using a time increment that is also set by the user.

Before the DYNAMIC region can be processed, a certain amount of initialization of the model is needed. Time  $T$  must be set to zero and the initial values of  $Y$ ,  $Y'$ , and THRUST (all zero) must also be set. These operations need only be performed once and this occurs in the INITIAL region that precedes the DYNAMIC region as follows:

### INITIAL

$$Y = 0; Y' = 0; T = 0$$

$$THRUST = 7000$$

ISIM, along with most other CSSLs, also has a TERMINAL region for any calculations or output to be made after the completion of a run.

To be of any utility, a simulation needs output statements. Because CSSLs are concerned with time histories, the most useful types of output are tabulated numerical output or graph plots. These can be easily provided by ISIM statements of the form:

OUTPUT T, Y, Y'

for a table of values of T, Y, and Y' and

PLOT T, Y, 0, TFIN, 0, 50,000  
for a graph of Y against T.

The OUTPUT statement automatically prints headings, selects number formats, and prints one line of output at regular intervals controlled by the user by setting the value of system variable CINT (communication interval). A sample of the output produced is shown below:

T	Y	Y'
1.0000	0.0000	0.0000
2.0000	21.659	43.319
3.0000	86.984	87.330

**COMPUTER SUPPLIES**

**DISKETTES**

5 1/4  
S/S S/D  
MIN. ORDER 50

**\$160**

**RIBBONS**

EPSON  
MX100  
MIN. ORDER 6

**\$784**

**HARDWARE**

CORVUS 20MEG  
HARD DISK REG. 3995<sup>00</sup> 2940<sup>00</sup>  
EPSON FX100 REG. 795<sup>00</sup> 680<sup>00</sup>

PeachText 5000 REG. 395<sup>00</sup> 235<sup>00</sup>  
complete line of

**ACCOUNTING SOFTWARE**  
plus other major brands  
• Terms: Visa, M.C. or C.O.D.  
• Dealer Inquiries Invited

**COMPU-MEDIA  
SOFTWARE, INC.**  
159 Main St. S.L.N.Y. 10307  
CALL TOLL FREE 1-800-248-2418  
in N.Y. State 212-967-1700



AUTHORIZED DISTRIBUTOR

Circle 407 on inquiry card.

**USED PERSONAL  
COMPUTER  
BROKERAGE**

- A nationwide database service matching buyers and sellers of used P.C.'s and peripherals.
- UPCB acts as middleman, providing security for both the buyer and the seller.
- All equipment tested and warranted by UPCB
- All makes and models accepted for listing
- Bonded and insured
- Reasonable listing rates and commissions

For more information mail today!  
I am interested in Buying  Selling

Name \_\_\_\_\_  
Address \_\_\_\_\_  
City, State, Zip \_\_\_\_\_  
Telephone ( ) \_\_\_\_\_

Mail to: UPCB Fulfillment Dept.  
Suite 21 • 1116 A 8th Street  
Manhattan Beach, CA 90266

Circle 439 on inquiry card.

**IBM-PC  
COMPATIBLE!**

Build your own with A PERSONAL COMPUTER (APC) kit. It runs most of the programs written for the IBM-PC.

APC Mother Board: 11 1/2" x 14", 64K RAM expandable to 128K on the board, parallel port, serial port, speaker/audio port, cassette port, game port, 5-62 pin edge connectors, 48K EPROMS, Socket for 8087 co-processor.

- Bare Board ..... \$88.95
- BIOS ROM ..... \$48.95
- Components ..... Call
- Assembled & Tested ..... Add \$129.95

APC Color High Resolution Graphics Board ..... \$229.95  
APC Disk Controller Board ..... \$129.95  
with a parallel port option ..... \$169.95  
APC Memory Board expandable to 384K RAM... \$99.95  
APC Power supply ..... \$129.95  
APC Cabinet ..... \$139.95  
APC Cooling Fan ..... \$18.95  
APC Keyboard ..... \$189.95  
APC Disk Drive ..... \$219.95  
APC Monitor 12" Diagonal ..... \$129.95

(Prices subject to change without prior notice)

**AMERICAN COMPUTER SYSTEMS**  
3819 Thousand Oaks Blvd. • Westlake Village, CA 91382  
(805) 497-1445

DEM/Dealer Inquiry Welcome Domestic/International

Circle 440 on inquiry card.

The PLOT statement produces a graph plot of Y against T on a graphics terminal. The additional parameters specify that T will be plotted between zero and its maximum value TFIN (time final), another system variable set by the user. Y will be plotted from zero to 50,000 (the estimated maximum altitude of the rocket for this run).

### Encore Presentations

So far, our program is concerned with describing the system that is to be simulated and the form of output. All CSSLs also provide facilities for controlling a sequence of simulation runs, since it is rarely sufficient to simply make one run of the simulation with fixed parameters. Multiple runs may be made for several reasons: to observe the behavior of the system with different values of key parameters or initial conditions; or to run the same case with a different step-length for the numerical integration routine, to check on accuracy; or to run it with different OUTPUT or PLOT statements, and so on. (In simulation terminology, we are performing an experiment on the model.)

ISIM provides a slightly unusual but very flexible approach to defining the experiment compared to most other CSSLs. The conventional approach is to use RUN-control commands that change values and output requirements, and call for a single run. Setting up a sequence of runs using this approach can involve long lists of commands specifying each change with a RUN command for each run. The ISIM method is to incorporate the definition of the experiment into the program in a control section of code that appears before the model definition. This section of code can be written using looping and branching statements based on FORTRAN DO and IF statements. A run of the model is called using a SIM statement. This structure sees the experiment as a main program and the model as a subroutine. As an example, an experiment that calls for three runs with THRUST set to 6500, 7000, and 7500 pounds, and uses a time step (CINT) of 1 second to a final time (TFIN) of 50 seconds, can be

programmed as follows:

```
: ROCKET PROBLEM
CINT=1.0; TFIN=50
DO 10 THRUST=6500,7000,7500
RESET; SIM
10 CONTINUE
```

The colon (:) signifies a comment line. The DO statement is like a FORTRAN DO. The 10 is a label that defines the range of the DO loop. CONTINUE is a do-nothing statement that simply provides a convenient place to terminate the DO. RESET initializes the model to the state it had before its last run and SIM calls for the simulation to be run. In the example, three simulation runs will be made with THRUST set to 6500, 7000, and 7500 pounds.

Our complete program is shown in listing 1.

ISIM has a number of other features, including functions and subroutines and special simulation functions. A feature common to most CSSLs is the PREPARE statement. The keyword PREPARE is followed by a list of variables. Rather than being tabulated or plotted, the value of the variables are stored in a disk file at each time step. They are then available at the end of a series of runs to be plotted in a variety of ways, the user having the choice of which variables and which runs are to be plotted. These graphs can be produced on a graphics terminal or as character plots on a video display terminal or printing terminal.

### Interactive Features

The full power of ISIM cannot be appreciated without some reference to its command structure, for it is through ISIM's commands that the interactive power of the language is made available. The ISIM system is always in one of two modes, command mode or program mode. In command mode the system prompt is "\$" and in program mode it is "?".

When in program mode, ISIM statements are entered from the keyboard. The ISIM processor checks each line for syntax errors as it is input and generates an immediate er-



ror message when a fault is detected. Correct lines are translated to an intermediate code that is interpreted at run time (similar to the Pascal p-system).

To switch to command mode, type "\$" followed by an ISIM command. Commands are available to list all or part of the current program (\$LIST), to change, delete, or insert lines in the program (\$CHANGE, \$DELETE, or \$INSERT), and to execute the program (\$START). Alternatively, the program can be saved to a CP/M file (\$SAVE), the program buffer can be cleared (\$KILL), or a new program can be read from a file (\$READ).

After a program has been executed, further commands can be used. The final value of any variable can be requested by using the command \$VAL followed by the variable name. If the program contains a PREPARE statement, the \$GRAPH or \$TGRAPH command will produce graphs on a graphics terminal or alphanumeric terminal respectively.

Nor is this type of interaction confined to the end of a program run. Execution of the program can be interrupted and temporarily suspended in one of two ways: either at a predetermined point by inserting an INTERACT statement in the program at the point of interruption, or by simply pressing any key on the keyboard during program execution.

Once the program is suspended it is possible to request values of variables or change them, using the \$VAL command. It is even possible to change the time step or the method of solving the differential equations for the remainder of the run. One can also change the output specification: the \$OUTPUT or \$PLOT commands override the effect of existing program statements, if any, and \$XOUT or \$XPLOT reverts to the programmed situation.

When these features are taken as a whole, they provide the ISIM user with the ability to interact with the computer in the development, execution, and evaluation of simulation models. The single-user environment of most microcomputers lends itself particularly well to this type of operation. Larger mainframes and multi-

**Listing 1:** This rocket simulation model is run with three different values of thrust.

```

: ROCKET PROBLEM
  CINT = 1.0;TFIN = 50
  DO 10 THRUST = 6300,7000,7500
  RESET;SIM
10 CONTINUE
INITIAL
  Y = 0;Y' = 0;T = 0
: THRUST IS NOW SET IN EXPERIMENT
DYNAMIC
  W = 3000 - 40*T
  DRAG = K*Y**2
  Y' = G*(THRUST - DRAG)/W - G
  OUTPUT T,Y,Y'
  PLOT T,Y,0,TFIN,0,50000
  
```

user minicomputers, though capable of handling larger programs, are often unable to support this degree of interaction. In many ways the microcomputer provides an ideal basis for interactive simulation, especially the more powerful 16-bit systems that can address more memory than the 8-bit systems.

### Where Do We Go from Here?

Shortage of memory restricts the power of the simulation system in two ways. One is that provision of a full range of facilities such as are present in ISIM takes a lot of code, more than can be handled at one time in 64K bytes of memory. Disk overlays are necessary, although no disk swapping occurs during actual execution of a simulation run. ISIM uses nine overlays. Second, the amount of memory that can be allocated for the user program is also restricted. The much larger available memory space of the 16-bit systems will largely eliminate these problems and an IBM PC (Personal Computer) version of ISIM is due to be released early in 1984. ■

*Roy E. Crosbie is a professor of computer science at California State University (Chico, CA 95926). He has a B. Eng. and a Ph.D. in electrical engineering from Liverpool University in England.*

### Software Information

To obtain software mentioned in article contact Crosbie, Hay, and Associates, POB 943, Chico, CA 95927.



**EDGE-PC: An Affordable IBM PC-Compatible System.**

- PC-99 CPU card \$399
- Color/Graphic card \$189
- 5-1/4" double adapter card \$145
- Multifunction card (64k) \$270
- Keyboard \$153
- System Enclosure \$129
- 65W Power Supply with fan box \$135

**EDGE MICRO SYSTEMS, INC.**  
2350 WALSH AVE., SANTA CLARA, CA 95051  
(408) 966-9685 TLX 3718075 EDGE UB

Circle 443 on Inquiry card.

## Printer Cables

— Parallel —

**\$35.00\*** ALTOS  
ATTACHE  
ATARI **\$35.00\***  
CENTRONICS  
COLUMBIA  
EAGLE  
IBM-PC **FREE SHIPPING**  
KAYPRO **FREE SHIPPING**  
OSBORNE  
SANYO  
TI-99 **\$35.00\***

— SERIAL —

ATTACHE COM  
RS232 (DB25P)  
(9 conductor 1-8, 20)

**CABLES BY WORSWICK**  
4030 Wabaska Dr.  
San Diego, CA 92107  
619-571-5400  
\*CA Residents Add 6% Sales Tax (52-04)

Circle 445 on Inquiry card.

**XEBEC (Datamac)—Sunol Systems**  
**Winchester Disk Drives**  
**I WILL BEAT ANY PRICE IN U.S.A.**  
Outstanding Quality Products, Latest Technology  
Satisfaction Guaranteed  
7 Days Trial  
The Best Hard Drive Subsystem in the World  
Complete and Ready to Run  
Full Year Warranty

10 MB 5 1/4"	\$ 1,195.00
16 MB 5 1/4"	\$ 1,895.00
25 MB 5 1/4"	\$ 2,150.00
30 MB 5 1/4"	\$ 2,185.00
40 MB 5 1/4"	\$ 3,495.00
65 MB 5 1/4"	\$ 3,995.00
92 MB 5 1/4"	\$ 4,895.00
184 MB 5 1/4"	\$ 8,995.00
368 MB 5 1/4"	\$17,895.00
MX-4 Multiple User Kits	\$ 400.00
PTR Server Automatic Despools	\$ 1,295.00

Compatible with the following systems:  
Access Matrix (Actrix)/IBM & IBM  
Compatibles/Apple II, II+, IIe, III, III+ /Atos/  
Atari 800/DEC EPSON QX-10/NEC P.C.-8000/  
North Star/Osborne/S-100/Texas Instrument  
TRS 80 Model I, II, III/Zenith 289, 90, 100/  
Kaypro/Xarox 820.

(Next day delivery available)  
**MANDINGO COMPUTERS & CAMERAS**  
900 CASCADE DRIVE  
FORT WASHINGTON, MARYLAND 20744  
(301) 292-5632

Circle 444 on Inquiry card.

# BASIC COMPILER

## SuperSoft® Language Library

For PC DOS®, MS DOS,  
CP/M-86®, and others



A programmer's most important software tool is the language compiler or interpreter he uses. He has to depend on it to work and work well.

At SuperSoft, we believe it. That's why we offer three fine compilers: SuperSoft FORTRAN, SuperSoft BASIC, and SuperSoft C, that answer the programmer's need for rock solid, dependable performance on 16 bit systems.



## Compatible with Microsoft BASIC

The SuperSoft BASIC compiler, available under CP/M-86 and MS DOS, is compatible with Microsoft\* BASIC and follows the ANSI standard.

## Greater accuracy with BCD math routines

If you have used other languages without BCD math, you know how disconcerting decimal round off errors can be. For example:

With IBM PC* BASIC	With SuperSoft BASIC with BCD math
10 A=.99	10 A=.99
20 PRINT A	20 PRINT A
30 END	30 END
Output: .9899999	Output: .99

As you can see, SuperSoft BASIC with BCD provides greater assurance in applications where accuracy is critical.

SuperSoft's BASIC is a true native code compiler, not an intermediate code interpreter. It is a superset of standard BASIC, supporting numerous extensions to the language. Important features include:

- Four variable types: Integer, String, and Single and Double Precision Floating Point (13 digit)
- Full PRINT USING for formatted output
- Long variable names
- Error trapping
- Matrices with up to 32 dimensions
- Boolean operators OR, AND, NOT, XOR, EQV, IMP
- Supports random and sequential disk files with a complete set of file manipulation statements
- IEEE floating point available soon as an option
- No run time license fee

Requires: 128K memory  
BASIC compiler: \$300.00

## For CP/M-86®, MS DOS, and PC DOS

\*SuperSoft BASIC is compatible with Microsoft BASIC interpreter and IBM PC BASIC. Due to version differences and inherent differences in compilers and interpreters some minor variations may be found. Machine dependent commands may not be supported. The vast majority of programs will run with no changes.



# FORTRAN

SuperSoft FORTRAN is the answer to the growing need for a high quality FORTRAN compiler running under CP/M-86 and IBM PC DOS. It has major advantages over other FORTRAN compilers for the 8086. For example, consider the benchmark program used to test the IBM FORTRAN in *InfoWorld*, p. 44, Oct. 25, 1982. (While the differential listed will not be the same for all benchmark programs, we feel it is a good indication of the quality of our compiler.) Results are as follows:

IBM FORTRAN:	38.0 Seconds
SuperSoft FORTRAN	2.8 Seconds

In its first release SuperSoft FORTRAN offers the following outstanding features:

1. Full ANSI 66 standard FORTRAN with important extensions
2. Standard data types, double precision, varying string length, complex numbers
3. Free format input and free format string output
4. Compact object code and run time support
5. Special functions include string functions, dynamic allocation, time/date, and video access
6. Debug support: subscript checking, good runtime messages
7. Full IEEE floating point
8. Full 8087 support available as option (\$50.00).
9. Ratfor preprocessor available as option (\$100.00).

#### Program developers:

SuperSoft's family of FORTRAN compilers means you can write your programs once and they will run under CP/M-80, CP/M-86, and MS DOS. This lets you get your applications running fast no matter what the environment.

## SuperSoft FORTRAN: available NOW and working great!

Requires: 128K with CP/M-86 or MS DOS,  
32K with CP/M-80  
FORTRAN: \$425.00 (in each environment)  
8087 Support: \$ 50.00  
Ratfor: \$100.00

## For CP/M-86\*, MS DOS, IBM PC DOS\*, and CP/M-80\*

In conjunction with SuperSoft, SuperSoft FORTRAN was developed by Small Systems Services, Urbana, IL, a leader in FORTRAN development.

#### Japanese Distributor

ASR Corporation International, TBL Building 7th Floor  
1-19-9 Toranomon Minato-Ku Tokyo 105 Japan  
Tel 103-5025550 Telex 222-5650 ASRTYO J

#### European Distributor

SuperSoft International Ltd 51 The Pantiles  
Tunbridge Wells, Kent England TN2 5TE  
Tel 0892-45433 Telex 95441 Micro-G

# C Compiler

In 1982 SuperSoft helped C programmers around the world move their applications from 8 to 16 bit operating systems with the first C compiler under CP/M-86\*, PC DOS, and MS DOS.

Today there are several C compilers on the market, and you can look at them all. But if you want a C that's fully portable, syntactically compatible with UNIX version 7 C, rigorously tested, fast in both compilation and execution, packed with more library functions than any other, and produces a very highly optimized assembly code... then you'll find only one. The SuperSoft C compiler.

## Professional Quality

SuperSoft started working on C over three years ago, and the work has never stopped. While others were struggling to put in features, SuperSoft was refining and polishing... adding the quality professionals depend on.

## Thoroughly Tested

SuperSoft C has been tested with hundred of commercial application programs. And all this testing has paid off... with a compiler that's highly reliable in every phase of operation.

## Portable

SuperSoft C is now available in most operating systems environments. Since we don't sell operating systems, we can support them all. And as new operating systems become popular, SuperSoft C will be there.

## Packed with Library Functions

SuperSoft now has the most complete set of library functions available. All provided with source code.

## Thorough User Manual

The new user manual is extensive—jammed with thorough explanations to help you every step of the way. And our technical hotline can help answer any additional questions.

SuperSoft C: \$350.00

# SuperSoft®

FIRST IN SOFTWARE TECHNOLOGY

P.O. Box 1628 Champaign, IL 61820  
(217) 359-2112 Telex 270365

Microsoft is a trademark of Microsoft Corporation  
IBM PC is a trademark of International Business Machines Corporation  
CP/M and CP/M-86 are registered trademarks of Digital Research  
UNIX is a trademark of Bell Laboratories

Circle 367 on inquiry card.

# Indexing Open-Ended Tree Structures

*How to "walk" through a "grove" of A-trees in search of hierarchical nodes*

John Snyder  
Disc Inc.

One challenge to software designers is the problem of how to keep track of the elements within a hierarchy. For example, in a multilevel, menu-driven system, users always start with a main menu that lists the major functions. They select a major function, which may result in another menu of subfunctions. If it does, they then select a subfunction, which may result in still another menu of sub-subfunctions. When a function is completed, there should

be a flexible, automatic selection of another function (e.g., return to the main menu or go directly to another subfunction menu).

Another example of a hierarchical structure is an assembly process, where, instead of a main menu, there is an assembled part and, instead of subfunctions, subparts.

Both examples represent open-ended tree structures. That is, each node may be a terminus, or it may be the origin of any number of subnodes.

## Problems with Open-Ended Trees

For the purpose of menu (or similar selection-driven) processing, subscripts are the easiest index to use. For example, if we start each subscript with zero, then the main menu is 0, 0, 0, . . . , and the *l*th selection from the main menu is *l*, 0, 0, . . . , and so on.

Assuming that the depth of the tree is the longest chain of nodes, the tree can be structured as an array with its dimension equal to the depth, and it can be indexed by conventional subscripts (*l*, *j*, *k*, . . . ). Actual entries in this multidimensional array may be record numbers, function codes, or whatever the application dictates. However, such an array will be lightly filled and subject to the restriction that entry *l*, *j*, *k* can exist only if entry *l*, *j* exists.

What is needed is a structure for looking up entry values that are indexed by subscripts without the prohibitive overhead of this potentially huge array.

## The A-Tree Solution

Instead of using a single multidimensional array, two one-dimensional arrays are used to effect a solution. The first array describes the tree structure and is called an A-tree ("A" for awkward). This array has one element for each node of the tree. By "walking" through the tree from top to bottom and from left to right, you

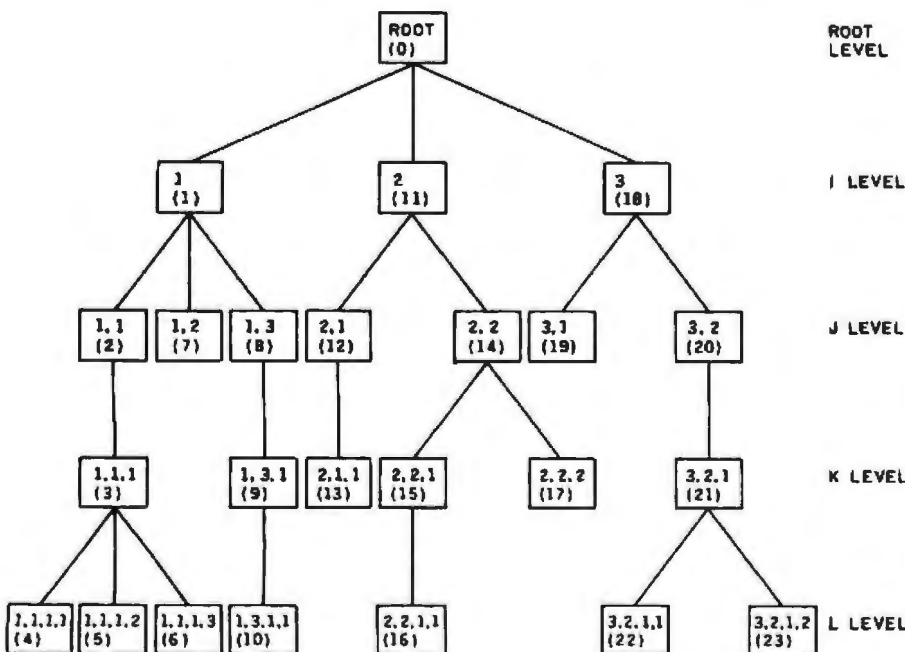


Figure 1: In this sample A-tree, each box denotes a node. Each node is identified by two numbers: its subscript node number and, in parentheses, its element number. The subscript levels are depicted to the right of the tree.



can discover the relationship between the nodes of the tree and the array elements.

Figure 1 illustrates a sample A-tree. Each node is marked with its subscript reference number and with its A-tree element number in parentheses. The absence of unused lower-level subscripts emphasizes the open-ended depth of the tree. The values of the A-tree array describe the tree structure. Each element contains the number of subnodes originating from the node to which the element corresponds. The first three columns of table 1 list the A-tree array that corresponds to the sample tree in figure 1.

Clearly, the array uniquely defines the tree structure. Now, once you locate an entry in the A-tree array, the corresponding entry in the second array will contain the data needed for processing. Thus, the second array is a parallel reference array for the A-tree array.

### The A-Tree Searching Method

The definition is simple enough, and the structure is certainly space efficient, but now that you have it, what do you do with it? Obviously, the A-tree cannot be interrogated by any conventional search method. You certainly do not want to do a "tree walk" to look up an entry every time.

It turns out there is a fairly effective—if not simple—method of scanning the A-tree array through the use of a *difference table*. This difference table is developed as follows: if  $N$  is an A-tree element number, and  $A(N)$  is its corresponding A-tree element value, first define the *sum* ( $S$ ) for this element as  $S(0) = 0$  and  $S(N) = S(N - 1) + A(N - 1)$  for  $N$  greater than 0. Then define the *difference* ( $D$ ) for this element as  $D(N) = S(N) - N$ .

The last two columns of table 1 list the sums and differences for our sample tree in figure 1. You can now use the A-tree array and its associated difference values to find any subscripted reference. (The sums are only intermediate calculation figures; they are not actually used in the search.)

The basic algorithm is as follows: if  $N$  is an A-tree element number that

Subscript Node Number(a) (I, J, K, ...)	A-Tree Element Number (N)	A-Tree Element Value (A)	Element Value Sum (S)	A-Tree Difference Value (D)
Root	0	3	0	0
1	1	3	3	2
1, 1	2	1	6	4
1, 1, 1	3	3	7	4
1, 1, 1, 1	4	0	10	6
1, 1, 1, 2	5	0	10	5
1, 1, 1, 3	6	0	10	4
1, 2	7	0	10	3
1, 3	8	1	10	2
1, 3, 1	9	1	11	2
1, 3, 1, 1	10	0	12	2
2	11	2	12	1
2, 1	12	1	14	2
2, 1, 1	13	0	15	2
2, 2	14	2	15	1
2, 2, 1	15	1	17	2
2, 2, 1, 1	16	0	18	2
2, 2, 2	17	0	18	1
3	18	2	18	0
3, 1	19	0	20	1
3, 2	20	1	20	0
3, 2, 1	21	2	21	0
3, 2, 1, 1	22	0	23	1
3, 2, 1, 2	23	0	23	0

Table 1: A tabular representation of the sample A-tree. The first two columns contain the data from figure 1. Column 3 holds  $A(N)$ , the element value that corresponds to  $N$ . Column 4 shows each node's sum, a number used to calculate its difference, which is shown in column 5.

corresponds to a given node, and you wish to find the element number corresponding to the  $I$ th subnode originating from the given node, then, first, check  $A(N)$  to make sure it exists, i.e.,  $A(N)$  cannot be less than  $I$ ; then calculate  $V = D(N) + A(N) - I$ ; finally, scan for the first occurrence of  $V = D(M)$  with  $M$  greater than  $N$ . Such an occurrence is guaranteed, and  $M$  will correspond to the desired node.

Since the root is always element zero (0), and since the algorithm can be repeated for as many subscript levels as are necessary, you can find the element number of any combination of subscripts through successive scans.

For example, suppose you wish to find the A-tree element corresponding to subscripts 3, 2, 1 in the sample tree. Using table 1, start at the root and look for 3. Since  $A(0) = 3$ , you know 3 exists. Then, calculate

$$V = D(0) + A(0) - 3$$

$$= 0 + 3 - 3$$

$$= 0$$

So, starting with element number 1, scan the differences for the first 0, located at element number 18. Looking now for 3, 2 (3, 2 exists because  $A(18) = 2$ ), calculate

$$V = D(18) + A(18) - 2$$

$$= 0 + 2 - 2$$

$$= 0$$

Scanning from element number 19, you will find the first difference of 0 at element 20. Finally (3, 2, 1 exists because  $A(20) = 1$ ), calculate

$$V = D(20) + A(20) - 1$$

$$= 0 + 1 - 1$$

$$= 0$$

Scanning from element number 21, you will find the first difference of 0

at element 21 and that completes your search. (This method can be mathematically proven by induction through the subscript levels.)

Programming this is much easier than it sounds at first, and it can be quite fast when you use string scan instructions. You can speed it up even more by saving the subscripts of the last node found and the pointers to each of its upward chain nodes. This enables you to start the next search with the lowest common node to the last node.

### Updating the A-Tree

Adding entries to or deleting entries from an existing A-tree is slightly tedious and involves shifting portions of the array. To add a new node, first check that a *back chain*, or entry for the next highest subscript value, exists. Then add 1 to the element value of the next highest subscript. Finally, insert a 0 in the appropriate location (a difference table search can be used to find this location), and shift all remaining entries up by one position.

To delete a node, reverse this procedure. First, check that no *forward chain* exists, that is, that the A-tree entry for the element to be deleted has a value of 0. Then, subtract 1 from the element value of the next higher subscript. Finally, delete the entry by shifting all remaining entries down by one position.

These procedures assume that you can insert or delete a *middle* node for a given subscript level. For example, you can add an entry between 2, 3 and 2, 4 as a new 2, 4, making the existing 2, 4 now 2, 5, and so on down the line. If doing this causes problems, you can modify these procedures to only allow adding or deleting the last entry at a subscript level.

### Comments on Applications

In actual use of an A-tree, you must determine the maximum number of nodes allowed in the tree and the maximum number of subscripts to be allowed for reference. If the A-tree reference array is being used for a limited resource, such as record numbers, it may be useful to keep

deleted reference entries at the end of the reference array for reuse when new entries are added.

Note that each entry of the A-tree is the start of another complete A-tree. That is, every A-tree consists of a "nest" of A-trees. In the part assembly example, it may be useful to have a separate index on the A-tree array by part number. Such an index provides direct reference to each nested A-tree subpart. To demonstrate the handiness of the A-tree, imagine that you wish to find all of the unassembled subparts that constitute a given part. To do so, you need only search for all of the A-tree entry values of 0 between the given subpart and the next subpart at the same subscript level.

The reference array entries need not be unique. In fact, the same item may appear any number of times in a given tree. If such duplication is extensive and includes not only individual nodes but all subordinate subnodes, you can use reference "pointer" nodes. That is, after the first occurrence of a subtree, any other occurrences of the same sub-

tree are represented by terminus nodes that point to the subtree's starting node.

You can even make "reentrant" references, pointing from one node to a node linked above it. Pointer nodes allow cross-branching and make the connectedness (and hierarchy) of the tree unlimited.

### Sample Programs

To illustrate the structure of A-trees, I have included listings 1, 2, and 3, functions written in C that perform the A-tree search algorithm. Routines Searcher and Findindx are open-ended (they do not know the overall length of the A-tree or the number of subscript levels it contains). As long as the lowest subscript value passed is 0, they will terminate properly. To accomplish this, it is necessary to define several work arrays (used exclusively by these functions) as arguments.■

---

*John Snyder is a vice-president responsible for technical support for Disc Inc. (3837 Naylors Lane, Baltimore, MD 21208). He has been a software consultant for 17 years.*

---

Listing 1: Routine Calcdiff, written in C, determines the A-tree's difference values.

```

/*****
**
**      name          calcdiff — Calculate the difference table for an
**                                A-Tree
**
**      synopsis      calcdiff(atree, adiff, size);
**                    int *atree;   Pointer to input A-Tree
**                    int *adiff;   Pointer to output difference table
**                    int size;    Number of entries in atree[]
**                                and adiff[]
**
**      description   If N is an A-Tree element number and A(N) is its
**                    corresponding A-Tree element value, first define
**                    the "sum" for this element as
**                    S(0) = 0 and
**                    S(N) = S(N-1) + A(N-1) for N>0.
**                    Then define the "difference" for this element as
**                    D(N) = S(N) - N.
**
*****/
calcdiff(atree, adiff, size)
int *atree, *adiff, size;
{
    int sum = 0, count = 0;
    do {

```

Listing 1 continued on page 410



LIFEBOAT Associates:  
The full support software  
source.

# Reach for the programming horizon of the 80's with Lattice C, the fastest C compiler.

Set the course of your next software project towards greater power and portability by selecting Lattice C, recognized as the finest and fastest 16-bit C compiler. Lattice C, the full implementation of Kernighan and Ritchie, continues to lead the way by announcing full memory management up to 1 Megabyte. Major software houses including Microsoft, MicroPro and Sorcim are using Lattice C to develop their programs.

Lifeboat offers Lattice C with a tested set of software tools to provide a complete development system including:

HALO™  
PANEL™  
PMATE™  
PLINK™-86  
C-FOOD SMORGASBORD™  
LATTICE WINDOW™  
FLOAT87™

Color graphic primitives  
Screen design aid  
Customizable program editor  
Overlay linkage editor  
Screen and I/O utilities  
Multi-window functions  
8087 floating point math

Lattice C is available for a wide variety of 16-bit personal computers including IBM NCF, Esprit Instruments, Victor Wang and other microcomputers running PC-DOS, MS-DOS and CP/M86.

Call LIFEBOAT at 212-860-0300 for free information on the Lattice C family of software development tools.

## LIFEBOAT

Associates

### LIFEBOAT

Associates

1651 Third Avenue  
New York, NY 10028  
212-860-0300

Please send me free information on: **Name** \_\_\_\_\_

- Lattice and development tools  
 How to get your software published  
 Corporate purchase program  
 Dealer program  
 OEM agreements

**Company** \_\_\_\_\_

**Address** \_\_\_\_\_

**City** \_\_\_\_\_

**State** \_\_\_\_\_

**Zip** \_\_\_\_\_

**Telephone** \_\_\_\_\_

LATTICE C, C-FOOD SMORGASBORD and  
LATTICE WINDOW, TM © Lattice, Inc.

Circle 234 on inquiry card.

LIFEBOAT, TM Lifeboat Associates  
HALO, TM Media Cybernetics  
PANEL, TM Roundhill Computers, Ltd  
PMATE and PLINK, TM Phoenix Software

FLOAT87, TM Microfloat  
IBM and PC, © TAA International Business Machines  
MS, TM Microsoft  
CP/M86, TM Digital Research







# IBM PC Software: the value of choosing



Shoes.

If they don't fit, they're not worth wearing.

Software programs.

If they don't fit, they're not worth using.

That's why it's altogether fitting that IBM Personal Computer Software offers you a choice.

## Size up the selection.

You'll find many types of programs in the IBM software library. They'll help keep you on your toes in the office, at home or in school.

There are, in fact, seven different categories of IBM programs called "families." A family of software for business, productivity, education, entertainment, lifestyle, communications or programming.

Of course, every program in every family is tested and approved by IBM. And IBM Personal Computer Software is made to be compatible with IBM Personal Computer hardware.





# *programs that fit.*

## ***Putting your best foot forward.***

Although every person isn't on equal footing when it comes to using personal computer software, there's something for almost everyone in the IBM software library.

For example, you may be on a shoestring budget and want a big selection of programs with small price tags.

You may be introducing students to computing and want programs that are simple to use and simple to learn.

You may run a business requiring sophisticated inventory and payroll programs. Or you may run a business requiring a single accounting program.



You may write interoffice memos and want a streamlined word processing program. Or you may be a novelist looking for a program with features worth writing home about.

Now you can find IBM Personal Computer Software that fits—to help you accomplish specific tasks and reach individual goals.

## ***Stroll into a store today.***

What's the next step?

Visit an authorized IBM Personal Computer dealer or IBM Product Center near you. To find out exactly where, call 800-447-4700. In Alaska or Hawaii, 800-447-0890.

Ask your dealer to demonstrate your choice of programs. Then get comfortable. Sit down at the keyboard and try IBM software on for size.

The classic IBM logo, consisting of the letters 'IBM' in a bold, sans-serif font with horizontal stripes through them.

*Personal Computer Software*

Circle 205 on inquiry card.



Little Tramp character licensed by Bubbles Inc., s.a.

# ADDS STACKS UP BEST



**Designed for  
Operator Enjoyment.**

The leader in quality and reliability now offers the Viewpoint family with all the most user-requested features:

- Earth-tone colors and small size to complement any office environment.
- Tilt and swivel display for operator comfort.
- Low profile keyboard with adjustable height for easier data entry.

**ADDS**  
Applied Digital Data Systems Inc.  
A Subsidiary of NCR Corporation

100 Marcus Boulevard, Hauppauge, NY 11788 (516) 231-5400  
Atlanta, GA (404) 456-7120 • Boston, MA (617) 875-2337  
Dallas, TX (214) 367-2337 • Palo Alto, CA (415) 856-0580  
Philadelphia, PA (215) 564-0135 • Phoenix, AZ (602) 968-0950  
Shawburg, IL (312) 843-7555 • Tustin, CA (714) 730-6700  
ADDS, UK 44 01 949 1272



**VIEWPOINT®/Color.**  
The first truly low-cost color terminal



**VIEWPOINT®/90.**  
OEM's delight... double-high / double-wide, split screen, programmable function keys, down-line loadable, and more.



**VIEWPOINT®/78 and  
VIEWPOINT®/78 Color.**  
IBM functionality in mono-chrome and color



**VIEWPOINT®/60.**  
A fully featured editing terminal.



**VIEWPOINT®.**  
Best price/performance in a conversational terminal.

VIEWPOINT is a registered trademark of Applied Digital Data Systems Inc.

# IT ALL ADDS UP.



# Using Comments to Aid Program Maintenance

*Complex software can be maintained more easily by the judicious use of remarks embedded within program code*

Richard A. Thomas  
Engineering and Mining Journal

**DOCUMENTATION**—noun (Latin *documentum*, "warning") 1. The promised literature that fails to arrive with the supporting hardware; 2. A single, illegible, photocopied page of proprietary caveats and suggested instructions; 3. The detailed, unindexed description of a superseded package.

—From *The Devil's DP Dictionary* by Stan Kelly-Bootle

Real-life documentation comes disturbingly close to Kelly-Bootle's comic assessment, a fact bemoaned by programmers who have to set up, modify, or maintain software. Documentation is a critical part of program maintenance, and maintaining programs has been estimated to consume up to 50 percent or more of the average electronic-data-processing budget in a company.

Programming "comments" are a more important aspect of documentation than is generally recognized. Often these comments, written into the program code, are the only form of documentation a maintenance programmer uses when trying to navigate an unfamiliar program. In

theory they are the programmer's guide to how a program works.

Comments are part of the "internal" documentation written for the programmer, as differentiated from the end-user's manual. But the industry is, as yet, without a standard for such comments or a widely accepted format for their placement. As many companies have found, rarely does this internal documentation—which includes flowcharts, pseudocode, and the listing itself, as well as the comments—contain all the information necessary for maintaining a program.

What internal documentation is present, according to Robert Glass and Ronald Noiseux in their *Software Maintenance Guidebook*, "is frequently out of date and thus, unreliable." Of the different types of often unreliable internal documentation, comments are perhaps the worst offenders. These remarks turn out to be inadequate, misleading, or dead wrong as much as half the time. And for better or worse, they tend to be the most long-lived documentation because they are embedded in the code itself.

## Problems with Comments

Comments are intended for people, not compilers. As such, they are most often set off by delimiters, the first of which signals the compiler to ignore the material that follows until it sees some terminating delimiter. Assembly language and all higher-level languages have some notation for setting off program comments. In assembly language, an asterisk or semicolon in column 1 identifies the line as a comment; in COBOL, an asterisk appears in column 7; in FORTRAN, a "C" is used in column 1; in RPG, an asterisk appears in column 7; and in APL, a special "jot" symbol is used.


According to one computer-industry study done in England, 10 generations of maintenance programmers maintain an average program before it is discarded and rewritten. If the intra-program documentation in this average program is up to date and explicit, many man-hours of code deciphering will be saved over the life of the program. If the comments are redundant, out of date, or otherwise misleading, maintaining the program will consume many

## IBM PC & COMPATIBLES INTERNAL 10 MB HARD DISK

W/ WESTERN DIGITAL Controller  
No change in BIOS, Boot from hard  
disk. Simple to install like a floppy,  
DOS 2.0. 1 Year factory warranty,  
tested & formatted, several  
installed. Complete kit \$1050  
Additional 10 MB hard disk \$750;  
Fixed + Removable HD (10MB) - \$CALL  
Hard disk + Tape backup - \$CALL

## FLOPPY DISK DRIVES PC EXPANSIONS: AST, Maynard, 64K chips & JUKI Printer - \$CALL

**SRI DATA SYSTEMS**  
9 E Pleasant Ave Maywood, NJ 07807  
(201) 684-4518 Visa, MC, Check, COD



**DOUBLE** COLOR PRINT  
**THE OPTION CAPACITY**  
OF YOUR IBM PERSONAL COMPUTER  
**PC-XTRA**

- DIRECT EXTENSION OF IBM PC BUS
- NO SOFTWARE CHANGES
- NO HARDWARE MODIFICATION
- STYLING CONSISTENT WITH IBM

Add all these special options that you've been wanting without worrying about fitting your plug-in and back panel space.

DEALER INQUIRIES INVITED.  
\$549.00\* P.O.B. SANTA ANA  
CALIFORNIA RESIDENTS ADD 9% SALES TAX  
**P.C. HORIZONS, INC.**  
300 N. TUSTIN AVE. SANTA ANA, CA 92700  
(714) 963-5300

Circle 441 on inquiry card.

## SINGLE-CHIP MICROCOMPUTERS

**BOARDS & KIT**  
From \$29.95 to \$99.95  
—8040/8048/8049/8749  
—8031/8051/8751/8052  
—T1 7000/7001/7041  
—6511/6502/6541/6803

## EPROM & MICROCOMPUTER CHIP PROGRAMMER

## SINGLE-CHIP CONTROL & DEVELOPMENT SYSTEMS

Write for more information:

**TECH STAR LABORATORY**  
Suite 504, R&B Corp. Park  
1701 N Greenville Avenue  
Richardson, TX 75081

budget dollars, frequently more than if the code had been completely un-commented.

Hence, comments sometimes are not only useless but also result in substantial hidden costs that pad the data-processing maintenance department's time sheets.

Why do comments so often fail to lower maintenance costs, and in some cases actually increase them? Problems with comments in listings appear to fall into one of five general categories:

1. Comments are present but not useful in understanding the code, usually because they are redundant, self-indulgent, or vague.
2. Comments are incorrect translations of the associated code.
3. Too many comments exist, causing distraction.

---

## Often these comments are the only form of documentation a programmer uses to navigate an unfamiliar program.

---

4. Comments are absent altogether, leaving the maintenance programmer to guess at code meanings.
5. Comments are outdated, not having been maintained along with the code.

The first problem is the most common. Comments frequently echo the code, with no added value accruing to the reader. Redundancy is often the result of adhering to an arbitrary standard that specifies  $x$  number of comments for  $y$  number of coded lines. The programmer may find nothing much to say about the last three lines of code that the code does not say itself. The result is a trivial comment like "Multiply M by N and add result to total."

Redundancy also occurs because a programmer does not understand the meaning behind the program's application. For example, the programmer may insert comments like "Multiple price by quantity" or "Sub-

tract Velocity1 from Velocity2 and divide result by Time" that echo the code, unaware that, in fact, "Revenue" and "Acceleration," respectively, are being calculated.

A programmer's egoism may also contribute to the lack of usefulness of the comments. Ed Yourdon, in his book *Techniques of Program Structure and Design*, writes, "Many programmers seem to write comments as personal messages to themselves, that is, to remind themselves of the purpose of the particular instruction or program statement they used. The personal note, though, may be completely indecipherable to anyone else."

Often a programmer's comments are vague and imprecise, seemingly written with the unconscious assumption that the maintenance programmer is a part-time telepath who can divine meanings from the ether. Some authors feel this supports the widespread belief that programmers hate to document and are notoriously bad writers. Yourdon further suggests that some software creators strike the superior attitude: "Any decent programmer ought to be able to understand this."

The second category, comments that don't even remotely agree with the associated code, is particularly costly. The maintenance programmer looking at such comments is, in a sense, starting from below zero on the understanding scale, not even knowing that the comment has actually said nothing related to the code. The maintenance programmer then falls victim to what Gerald Weinberg calls the "psychological set."

Loosely defined, the psychological set is a blind spot caused by what you believe to be true. If, as a programmer, you read an erroneous comment and then delve into the code, you will be hindered by what you "know." Yourdon and Weinberg both cite experiments indicating that maintenance programmers might at times be better off stripping all comments from the code before trying to debug or modify a listing. With some experienced programmers, this is already standard operating procedure.



# Three good reasons to try Encore™ diskettes.



## 1. It saves you money.

Encore diskettes meet the same high standards as the more expensive brands. In fact, Encore actually exceeds system requirements.

Yet you can buy Encore disks for 1/3 the price of the high-priced diskettes. (only \$1.59 for single-sided, single-density 5 1/4" diskettes, when you purchase 4 or more boxes, ten diskettes to a box.)

### A diskette intended for a wide range of uses.

Whether you use a lot of diskettes or only a few, you need something more than guaranteed accuracy and reliability. You need economy.

Encore was designed to meet the demand for a reliable, low-cost diskette.

At Encore's low price, it's ideal for memos, rough drafts, spreadsheets, reports, even scratchpad-type uses.

### Designed for all major personal computers.

**IBM** **Apple** **Radio**  
**commodore** **Shack**

Encore was specifically designed to provide optimum performance and reliability on the four leading computer systems. Inmac's Quality Assurance Department constantly monitors all Encore diskettes to ensure they meet or exceed the media specifications for these systems.

Our on-going testing program guarantees that the Encore diskette you buy tomorrow will be as good as the one you buy today.



## 2. It's absolutely reliable.

Encore is guaranteed for one full year, or Inmac will replace it, free.

Inmac's Quality Assurance Department requires that Encore meet the media specifications for the most popular systems - Apple, Commodore, IBM, and Radio Shack - exactly. So you can rely on Encore diskettes in your system. They won't lose information or cause read/write errors.

### 45-day money-back trial.

We're backing our Encore diskettes with a 45-day money back trial because we're positive you'll be delighted with Encore's quality and performance.

And we're sure that once you try Encore, you'll agree that it's the most reliable economy floppy available.

If you don't agree for any reason, just return the three diskettes for a full refund.



## 3. And you can get one, free.

For a limited time only, we're offering a special trial pack of three 5 1/4" Encore diskettes. You pay the regular price for two of the diskettes, but the third one is free.

We'll send you 3 single-sided, single-density 5 1/4" diskettes for only \$5.19. (Single-sided, double-density for \$5.99. Double-sided, double-density for \$8.79.) Use all three Encore diskettes for 45 days.

Then, if you're not completely satisfied, return the three diskettes for a full refund.

### Here's how it works.

Simply mail the attached postage-paid card, or phone our toll-free number,

# 1-800-538-8157

extension 987. In California, 1-800-672-3470, extension 987.

For this special offer, please include payment with your order. You may send a check, money order, or bill it to your Mastercard or Visa account. Company PO's accepted with verification.

Offer is limited to one trial pack per customer. Good only in U.S. Customer must be 18 years or older to order.

**Offer expires September 30, 1984.**

Remember to ask for your free Inmac catalog. It contains over 2,500 computer supplies and accessories, many not available anywhere except through the Inmac catalog or special offers like this one.

## **inmac**™

2465 Augustine Dr., Santa Clara, CA 95051



**"Let us be ready to take the field whenever danger calls." JOHN HANCOCK**

Training and readiness are vital for today's minute men too. So is support from you, their employers. Write: Employer Support of the Guard and Reserve, Arlington, VA 22209. Protect their future while they protect yours.



**EMPLOYER SUPPORT OF THE GUARD & RESERVE**



**A Public Service Council of This Publication**

**SAVE AT ELEK-TEK ON PRINTERS**

**EPSON RX-80**

100 CPS DOT MATRIX  
Tractor Feed Only

**\$275.00**



**RX 80 FT**

Includes fric. & trac. capability

**CALL**

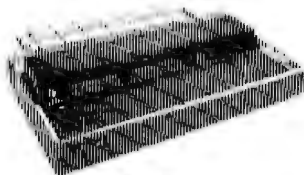
**RX 100**

132 Col. version of RX 80 FT . . . **CALL**

**EPSON FX-80**

160 CPS DOT MATRIX

**\$455.00**



**FX 100**

132 Col. version of FX 80 . . . **CALL**

**CABLES/ACCESSORIES**

**Cables for Epson**

PA10A 10 ft. 36/36 pin standard parallel	32.00
IB-P10 10 ft. 36/25 pin parallel for IBM	32.00
PAGT 6 ft. 36/16 pin parallel for TI-99/4A	25.00
RS10A 10 ft. 25 pin standard RS-232 (full loaded)	25.00
RS1Y RS-232 Y cable for TI-99/4A	25.00

**Interfaces**

CARDCO G	65.00
APPLE DUMPLING GX	65.00
GRAPPLER PLUS	105.00
Buffered (16K) GRAPPLER PLUS	185.00
814B Ser. (For FX or FX Models)	90.00
8161 IEEE-488 Interface	60.00

**Ribbon Cartridges**

EP 192 For EPSON 80 col. printers	4.00
EP 193 For EPSON 132 col. printers	7.00
Elek-Tek Dust Covers available for all models	5.00

Corp. Accts. invited. Min. Ord. \$15.00. Minimum for Fed. or State Govt. Min. Order 1000. Money Ord. 2000. Add \$4.00/line. (AK, HI, P.R., Canada add \$10.00 first item) \$1.00/line add 1000. & final shipment \$1. add \$10.00 7% tax. Free ready to charge. Write for free catalog. Return policy: Return only for defective or damaged. Transfer: MFR. Warranty expires. **AN ELEK-TEK MERCHANDISE IS BRAND NEW, FIRST QUALITY AND COMPLETE.**

**ELEK-TEK, inc.**

6557 N. Lincoln Ave. Chicago IL 60645  
(800) 621-1269 (312) 677-7660

The third category, too many comments, may come as a surprise to new programmers operating under the general academic edict that "more is better." The problem most often springs from arbitrary decrees concerning code/comment ratios (discussed earlier), from programmers not having enough to do, or from abortive attempts to document a particularly tricky or obscure piece of logic.

Since a maintenance programmer working in a high-level language is required to remember a wide range of variables, many of which are irrelevant to the present assignment, the addition of a barrage of unnecessary comments compounds the problem by distracting or misleading the programmer and thus reducing the readability of the code.

The fourth category, uncommented programs, resides at the opposite end of the spectrum. Yourdon does not mince words about the importance of comments in listings:

In my opinion, there is nothing in the programming field more despicable than an uncommented program. A programmer can be forgiven many sins and flights of fancy . . . however, no programmer, no matter how wise, no matter how experienced, no matter how hard-pressed for time, no matter how well-intentioned, should be forgiven an uncommented program.

Reasons for not commenting a program vary considerably, but the result is usually the same—maintenance programmers wandering around for hours, chewing up pencils and scratching their heads, trying to puzzle out what 10 lines of code do in a 20-page listing.

Here are some reasons why code goes uncommented: (1) documentation gets skipped on "rush" projects; (2) the programmer believes the program is only going to be used once; (3) the programmer mistakenly thinks comments will take up too much space (a consideration only in very small microsystems); (4) the programmer believes the program will



run substantially faster without comments; (5) the program is simple, and the programmer feels no one could misunderstand it; (6) the programmer is lazy.

The final category of problems, outdated comments, is only a subset of a larger problem, namely, outdated documentation. As I mentioned earlier, programs are around a long time before being put to pasture. The accompanying documentation, both internal and external, frequently becomes marginal or useless after a few changes are made in the software.

Many programmers simply do not bother to change comments to reflect their modifications. Usually, no review is made to discover whether comments have also been updated during maintenance. Getting the program back up and running is a company's only concern. Often when updates or refinements are made in the code, the maintenance programmer will document these changes at the top of the module or program, leaving a host of now-irrelevant comments in the body of the listing, to be tripped over by the next generation.

### Historical Treatment in Literature

After examining a sizable portion of the available information on program comments in both books and magazines, I can offer a few short generalizations.

First, most books on electronic data processing treat the subject superficially or not at all. This is especially true of journals, which, paradoxically, run a fair share of articles on documentation but seem unaware that this includes comments. On the other hand, those books that do treat the subject in some depth are very new (late 1970s through the early 1980s); hence, the ideas embodied in them are not yet widely disseminated. And, finally, much of the available literature is divergent, strongly opinionated, and somewhat dogmatic.

Regarding this last point, the most evident debate centers on how many comments are appropriate. Several authors advise liberal use of com-

# DATA EXCHANGE/64K SPOOLER



The ADS-8212 DATA EXCHANGE/64K is a computer independent interface converter and print spooler. It can be installed between virtually any computer and any peripheral.

Data can be input in either serial or parallel, stored in its 64K bytes of RAM, and output serial or parallel. Serial ports support baud rates from 50 to 19 200 and both hardware and software handshaking. The input and output ports are completely independent: input data with one protocol and baud rate and output it with a different protocol and baud rate. Selections are dip switch selectable.

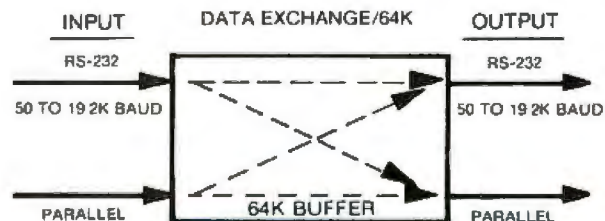
A unique feature is its ability to make unlimited numbers of copies. Hitting the copy button will send another copy to the printer. When done making copies, hit the reset button to clear the memory.

Included with the DATA EXCHANGE/64K are two 4 foot output cables, one parallel cable with standard Centronics type connector and one serial cable with standard DB 25 connector. Standard plugs are supplied for input ports.

RS-232 HANDSHAKING:  
RDY/BSY (DTR)  
Xon/Xoff  
ETX/ACK

Suggested list price: \$339.00

Dealer inquiries welcome.



Available at your local dealer or contact

**ADS**

**ANTEX DATA SYSTEMS**

A Division of International Antex Inc.  
2630 California Street

Mountain View, California 94040 ■ Phone: (415) 941-7914  
Telex: 704 969 INTERAX UD

ments; some even presume to offer a numerical guideline (surprisingly, Yourdon recommends an average of one comment for every two to three lines of code). Other sources caution that the programmer be stingy with comments, using them only where absolutely necessary. Still others suggest that the question of how many comments misses the point—it is quality that counts.

Another debate concerns standards. Should they be applied to program comments, or will suggested guidelines suffice? Standards are accused of stifling creativity in some literature, while elsewhere they are lauded as the only means for controlling output.

A third controversy revolves around where important internal documentation should be physically located. While most internal documentation currently resides in manuals and other media separate from the actual code, several theorists believe the main documentation should be embedded within the code itself. Glass and Noiseux's text on

maintenance "... recommends the 'heresy' that the listing be the place where most software documentation is placed. Nearly every requirement for documentation describing a program can be met and, in fact, probably exceeded by requiring the same information in the listing."

### Combating the Problem

Given the existence of high program-maintenance costs in the electronic-data-processing industry and the importance of comments to the maintenance programmer, what seems to be needed is a more structured approach to the use of comments. This means more extensive treatment in universities and colleges, specifically in programming and design classes, and the development within industry of more effective standards and other means for controlling how comments are used.

The suggestion that educators play a larger role in developing standards may raise the ire of instructors who feel they have treated the area sufficiently. What I suggest is a more for-

mal approach to the use of programming comments with emphasis on (1) debunking the "many-comments" myth; (2) determining when to add comments in a program's development cycle; (3) deciding what to comment; (4) establishing where the comments are best placed, assuming options exist; and (5) working toward the "egoless programming" model, all detailed below.

Perhaps the dogma about the positive value of many comments should be de-emphasized and replaced by a better understanding of how and why comments should be used. Comments are a form of "defensive code" that should protect a maintenance programmer, much like "idiot-proofing" a program protects the data-entry clerk or the user.

The brief survey that accompanies this article (see the text box on page 421) is my own invention. Not meant to be a scientific sampling, the responses are from 100 people who work in the data-processing field, teach, or edit computer journals. The survey points out that many data-processing professionals append comments after they are finished coding, a practice that goes relatively undisputed (and largely unaddressed) in the classroom. However, several writers suggest that this temporal separation is far from optimal.

According to Eric Weiss in *Computer Usage—Fundamentals*, "Too often, programmers wait until they have finished their programs before turning to documentation. THIS IS A SERIOUS MISTAKE. The programmer can save effort and time, and make his documentation much better, simply by documenting his program as he prepares it." Yourdon reinforces this: "Documentation can be just as useful during the design and implementation of a program as it is afterward. The very act of writing documentation usually forces the programmer to reexamine the basic workings of his programs."

Authors' opinions vary on which specific elements of a program require comments. However, a few generalizations are available to guide the new programmer. Among the most important of these is Weinberg's

# Business as Usual?

Business as usual these days means a computer that's up and "humming." But if your computer were stolen or damaged, you wouldn't have business as usual.

YOU'D HAVE TROUBLE!

You can get fast replacement for your entire system and be back in business in a hurry by protecting your computer with SAFEWARE Personal Computer Insurance. It's the only coverage designed specifically for personal computers used for business — in your office, shop or home.

SAFEWARE protects ALL hardware, ALL purchased software and ALL media against theft, damage or any other kind of loss, regardless of use, after a low \$50 deductible.

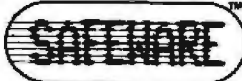
(Not without your computer it wouldn't be.)

Past, onerous claims handling prevents your losing valuable business computing time.

Find the premium price for the coverage you need listed in the table below, available for as low as \$35 per year. Fill in the coupon today. Your coverage will begin as soon as your coupon application is received. Or for even faster coverage, call our toll free number.

**1-800-848-3469**

(In Ohio call 1-614-262-0559)  
Phonics open 8 a.m. to 8 p.m.  
Monday through Saturday



Mail to: SAFEWARE, P.O. Box 9221, Columbus, OH 43202

## Before I'm out of business,

please insure my SAFEWARE computer coverage.

Name \_\_\_\_\_  
Street \_\_\_\_\_  
City \_\_\_\_\_ State \_\_\_\_\_ Zip \_\_\_\_\_  
System value \$ \_\_\_\_\_  
I'd like to pay by  Check  Enclosed  VISA  MasterCard

Total Hardware, Media & Software System Value	Annual Premium
Up to \$ 2,000	\$ 35
\$ 2,001 - \$ 5,000	\$ 60
\$ 5,001 - \$ 8,000	\$ 75
\$ 8,001 - \$11,000	\$ 90
\$11,001 - \$14,000	\$105

Call toll-free for rates on higher coverage. Coverage differs in areas. It is an underwriting requirement that you insure your system for its full value.

1977



## Comments on Comments

The survey results below represent a sampling of 100 data-processing executives, teachers, and computer-magazine editors, all of whom have had experience with program analysis. Participants were not selected by means of any statistical pattern, and their responses are meant only as a straw poll on the subject of programming comments.

1. Does your organization use any project-documentation standard? (sample size (N) = 100 respondents; average number of years experience = 8)

Yes: 67  
No: 33

2. If your answer to question 1 is Yes, does the standard contain any rules or guidelines concerning the use of comments in program listings? (sample subset = 67)

Yes: 23  
No: 15  
I don't know: 29

3. When do you insert or attach comments to programs that you are creating? (N = 100)

Before: 8  
During: 73  
After: 35

(11 people checked more than one answer: 5 checked all three, 6 checked During and After coding)

4. How useful are other people's comments in helping you to understand, modify, and/or maintain their programs? (where 1 = very useful, 5 = no value, and 10 = harmful)

Average = 341 points divided by 100 respondents = 3.41

5. When maintaining/modifying someone else's code, do you change old comments to reflect your updates?

Rarely: 24  
Usually: 28  
Frequently: 11  
Always: 37

6. How successful were the creators of COBOL in their attempt to make a language "self-documenting"?

Unsuccessful: 21  
Somewhat successful: 65  
Very successful: 14

reminder that the whole idea of a comment is to prepare the mind of the reader for a proper interpretation of the instruction to which it is appended. A brief sampling of authors' suggestions on what should be commented includes the following recommendations:

- Comment all data, since understanding data is often the key to understanding the program.
- Distinguish between true constants and initialized variables via comments.
- Introduce all modules with comments—a practice that often helps the programmer recognize that a module is not functionally cohesive. (Some authors even suggest putting the pseudocode at the top of each module.)
- Comment all "tricky" or obscure logic; however, it is better to make such logic "untricky." As a rule it is better to rewrite such code.

Most authors agree that comments should be physically offset from the associated code. Weiss suggests that comments can be handled more easi-

ly as insertions between instructions than as attachments to the instructions themselves; the comments can then be changed readily without having to retype or repunch any instruction, which may allow new errors to creep in.

In other scenarios, comments can be consistently indented or even highlighted with underlines or bold-face. Glenford Myers suggests in his book *Software Reliability: Principles and Practices* that comments be offset to the extreme right of a listing, permitting a programmer to examine the code without interruption. In his words, comments "should be analogous to footnotes in a book."

A programmer should view the code as a part of the entire project rather than his or her personal, fragile baby. With regard to comments, this means recognizing that a given piece of code does not rise and set by its creator's word. Other people will rework it, probably many times over. Ego pursuit can even blind the programmer to the fact that a module may have unintended interactions with other modules, a problem for which the art of com-

ment writing has few remedies.

Classroom discussions on the five concepts above cannot single-handedly combat the future drain on financial resources caused by poor commenting. The electronic-data-processing industry must also establish and support more explicit standards or guidelines for using comments.

"Programs written to standards, whatever else may be said about them, are usually more predictable and therefore often easier to get aboard more quickly. That, in turn, contributes to preventing maintenance," say Glass and Noiseux, who express a preference for general guidelines over less flexible standards. They further call for an audit to see that comments are inserted properly.

Unfortunately, the industry appears remiss in driving these points home. An unexpectedly high percentage of the data-processing professionals surveyed have no project-documentation standard in their companies (see survey question 1).

Two other points about standards for comments are worth mentioning.

First, their quality must be high—clear, concise, well-written—or they will simply be ignored. Second, as William McGee emphasizes in *Effective Program Development—The Choices*, supervisors' reinforcement must be positive and regular, with support from all levels of management. Standards alone will not produce high-quality documentation.

### The Future

Comments are necessary because programs are cryptic. In this writer's

opinion, it is a safe bet that compilers of the future will support more self-documenting, more English-like programming languages, thereby reducing the need for comments.

However, current efforts at making languages self-documenting have met with only limited success. The industry's greatest attempt to create a self-documenting language—COBOL—was only partly successful (see the final survey question).

Until self-documenting languages achieve better results, industry will

operate on a "show-me" basis. Companies are slow to incorporate new approaches without concrete cost/benefit data. And no panaceas will permanently roll back maintenance costs into insignificance. Glass and Noiseux conclude: "No matter how well the preventive maintenance task is performed, we must face the onerous fact that the majority of the effort will be simply hard work. Only by thorough, painstaking attention to the detail of the program can some problems be resolved." ■

**HAUPPAUGE COMPUTER WORKS**

**THE HIGH SPEED MATH CAPABILITY YOU NEED TO STAY AHEAD OF THE COMPETITION**

source code for all our 8087 math libraries. Experts in the use of the 8087 numeric processor chip, we deliver an extensively tested, accurate and latest 8087 Math Pak installation disks just a few minutes with the simple, well-programmed instructions. The 8087 chip comes in an easy to install carrier, so no more dual in-line!

The 8087 Math Pak includes:

- Math Interface Library for the IBM BASIC Computer
- Math Interface Library for the IBM PASCAL Library
- Math Interface Library for the IBM FORTRAN Library
- Math Macro Library for the IBM MACRO Assembler

The software also includes a one year software update. All new software added to the 8087 Math Pak will be sent to update subscribers!

**NOW INCLUDES:** high speed MATRIX Manipulating routines for use with the IBM BASIC, FORTRAN and PASCAL Computers. Source code written in the IBM MACRO Assembler. Language included for Speed FFT routines.

**COMING SOON:** High Speed FFT routines.

**We also offer the BEST 8087 PRICE!**

**87 MATH PAK: \$295.**

- Tested 8087 in easy to install chip carrier with installation instructions.
- Disks with all software and source code.
- Complete operating instructions.
- One Year Software Update Service.

**87 CHIP \$175.**

- Tested 8087 in easy to install chip carrier with installation instructions.
- 102 with installation instructions.

**87 SOFTWARE PAK \$180.**

- Disks with all software and source code.
- Complete operating instructions.
- One Year Software Update Service.

**87 MACRO PAK \$245.**

- Tested 8087 in easy to install chip carrier with installation instructions.
- Disks with Math Macro Library for the IBM MACRO Assembler.
- Complete Operating Instructions.

Available from your local computer dealer.

**HCW**

**THE NEW 87 MATH PAK NOW INCLUDES:** from the PC Library of BRADY Publications, the book entitled, "8087 Applications and Programs for the IBM-PC" by Richard Startz.

Hauppauge Computer Works 516-360-3827  
358 Veterans Memorial Highway, Suite MS1  
Commack, New York 11725

For a demo Contact: Kanatax Micro Box 19029 Newark, Ontario M9A 1S3 813-829-9165

### References

1. Computer Usage Co. Inc. Eric A. Weiss, ed. *Computer Usage—Fundamentals*, 2nd ed. New York: McGraw-Hill, 1975.
2. Glass, Robert L., and Ronald A. Noiseux. *Software Maintenance Guidebook*. Englewood Cliffs, NJ: Prentice-Hall, 1981.
3. Jordain, Philip B., and Michael Breslau, eds. *Condensed Computer Encyclopedia*. New York: McGraw-Hill, 1969.
4. Kelly-Bootle, Stan. *The Devil's DP Dictionary*. New York: McGraw-Hill, 1981.
5. Kernighan, Brian W., and P. J. Plauger. *The Elements of Programming Style*, 2nd ed. New York: McGraw-Hill, 1978.
6. Kreitzberg, Charles B., and Ben Shneiderman. *The Elements of FORTRAN Style: Techniques for Effective Programming*. New York: Harcourt Brace Jovanovich, 1972.
7. McGee, William C. *Effective Program Development—The Choices*. Los Angeles: Data Processing Digest, 1969.
8. Myers, Glenford J. *Software Reliability: Principles and Practices*. New York: John Wiley & Sons, 1975.
9. Needham, R. M., and J. D. Aron. "Software Engineering and Computer Science." In *Software Engineering: Concepts and Techniques*. P. Naur, B. Randell, and J. N. Buxton, eds. London: Mason-Charter Publishers, 1976.
10. Sammet, Jean E. *Programming Languages: History and Fundamentals*. Englewood Cliffs, NJ: Prentice-Hall, 1969.
11. Weinberg, Gerald M. *The Psychology of Computer Programming*. New York: Van Nostrand Reinhold, 1971.
12. Yourdon, Edward. *Techniques of Program Structure and Design*. Englewood Cliffs, NJ: Prentice-Hall, 1975.

Richard A. Thomas is a senior editor of Engineering and Mining Journal, a McGraw-Hill technical publication (1221 Avenue of the Americas, New York, NY 10020). He is a regular consultant on computerized typesetting systems used by the company. Mr. Thomas holds an M.B.A. in computer systems and finance from Pace University, and he is a micro-computer hobbyist.





# THIS IS ALL IT TAKES TO RUN OUR HARD DISK.



**Compatibility.** A lot of manufacturers talk about it. Mostly, compatibility is defined as something that almost works like the original. Our hard disk subsystem for the IBM PC runs on 2.0 without modifications, patches or use of device drivers. Just boot 2.0 and run.

And we haven't cut back on reliability either. The Apparat hard disk uses the Xebec controller and connects via a host interface module to one of the slots in your PC. The HIM also contains an RS-232 serial async port for use with a

mouse, modem, etc. Even with compatibility and reliability built in, we've managed to provide some very competitive pricing. The 10, 15 and 26 megabyte drives are priced at **\$2,295**, **\$2,695** and **\$3,395** respectively.

When you use a multifunction RAM Card, such as the Apparat Combo II (with up to 512K of RAM, RS232, parallel printer, clock calendar, and game adapter) along with the HIM, floppy disk controller and CRT monitor adapter cards in your PC, you still have one slot available for future expansion.

If you're considering a fixed disk for your IBM PC, look at all the systems available. Look for compatibility. Look for reliability. Look for value. We think you'll pick ours.

For more information or to order yours call **800/525-7674** or write Apparat, Inc., 4401 S. Tamarac Parkway, Denver, CO 80237, 303/741-1778. Dealer inquiries invited.

IBM PC is a registered trademark of International Business Machine Corp.  
Price and specifications subject to change without notice.

 **Apparat, Inc.**

Circle 426 on inquiry card.

**THE** *first* **BYTE**





# COMPUTER SHOW

Chicago  
McCormick Place  
May 10-12, 1984

**W**elcome to the new computer shows designed specifically for BYTE subscribers. . .the *BYTE Computer Shows*. The first will be in Chicago's McCormick Place on May 10-12, but you don't have to travel cross-country to get there—others will be held this year in San Francisco, Boston and Los Angeles.

The *BYTE Shows* will be "selling" shows—where you can buy, not just look. *BYTE* subscribers will enjoy special reduced admission prices to all *BYTE* shows, and conference seminars. Those seminars will be targeted to the interests of *BYTE* subscribers, and led by such *BYTE* favorites as

Jerry Pournelle.

The *BYTE Shows* will be professionally produced by The Interface Group—the same pros who bring you the Comdex Shows. Their show know-how, combined with *BYTE*'s editorial expertise, will make the *BYTE Shows* ideal information centers and shopping marts for *BYTE* subscribers.

**M**ore details on *BYTE* subscriber benefits will be coming to you by mail. But plan now to be in Chicago May 10-12, or at the *BYTE Show* nearest you!

**BYTE**



## Heathkit Happiness

Dear Jerry,

I was very disappointed with the "Heathkit Horror" letter written to you by Mr. Richard J. Townsend (January, page 452). I feel very strongly that Mr. Townsend didn't convey the whole story of his experience with his H-100 kit.

Building a Heathkit is not an electronic experience; it is an experience in following a long, detailed checklist. My wife knows very little about electronics but has successfully completed several Heathkits. She uses her skills as a seamstress (which includes following instructions) to complete the kits.

My rampant curiosity over Mr. Townsend's letter led me to call a Heath store with the same, but hypothetical, problem. We worked with the assumption that the board was ruined when it was half completed. I was offered several options. I could buy a blank board for \$25 and start over again. I could then finish the new board with the unused components. I might have to buy replacement parts for the ones I couldn't salvage from the ruined board. If the parts were not on hand, they could be ordered to arrive in 5 to 10 days. This option would cost between \$40 and \$75, a cheap lesson in carefulness.

If I were really in a hurry, and free with my money, I could buy the entire disk-controller kit (H-207) for about \$395 and start fresh. Again, if not on hand, the delay would be no more than 5 to 10 days.

This consultation was conducted over the telephone, free of charge and mine for the asking. Mr. Townsend probably could have had this information had he asked for it.

Digging a little deeper, I figured that the "local Heath store" for Orinda, California, was probably the El Cerrito store. I gave the "We Won't Let You Fail" folks there a call to find out how Mr. Townsend's problem could fall through the cracks. When I called, the problem had been long solved. The end of the story for Mr. Townsend was a brand-new, fully assembled, functionally checked, disk-controller board.

According to the Heath folks, this is the current policy for customers that fry that particular board during construction.

That is part of the attitude that makes me a loyal Heath/Zenith customer. It would be a cold day in a fiery place before I would expect Radio Shack or IBM to serve their customers out of pocket like that.

Daniel J. Epright  
Murfreesboro, TN

*Thanks for tracking down the end of the story. I know the Zenith folks were pretty upset when they saw Townsend's letter, but it arrived there during a blizzard in Illinois, and I missed the rest.*

*I agree that assembly of Heathkits is in large part an exercise in carefully following instructions. I know five or six people who've built their own Z-100s, and they're all happy with them. They also understand their computers better. If you have the time, it's not a bad way to get into the computer revolution. . . . Jerry*

## In Defense of CB-80

Dear Jerry,

I've noticed Modula-2 growing on you over the last several months. I don't want to start a contest between it and CB-80 but merely address an issue you raised in your January User's Column on page 80.

To me, it was good news, not bad news, to discover that CB-80 does no range checking on array indices. It seems to me that wherever an index could get out of range, the program has to check it anyway so as not to crash, even if there is an error message. Much array work is controlled by loops. In those situations, the speed gained by skipping the range check may be valuable. In other words, automatic, low-level range checking would be, in any actual case, either unnecessary or inadequate at run time. True, its absence can put a burden on the programmer—one more possible mystery to debug—but I think it's worth the burden. Of course, the new structure certainly ought to have been documented.

CB-80's not checking ranges and not insisting on a DIM statement (being satisfied with a declaration) are the very things that provide a way to write functions that operate on arrays. The installment of my series in the February *Lifelines* offers the idea in the course of a discus-

sion of array structure. In particular, you can write function `KILARY%`, which recovers the space of an array as you suggest. It is a bit cumbersome, I admit, and you need one for each dimensionality. And it sure would be nice if we could pass arrays to functions more easily. Still, it does the job; to me, the overall speed and simplicity are worth the effort in the relatively few cases where they're needed.

One other point. As I understand it, the unassigned value of a string is not exactly a default, but no value at all. The compiler allocates a word of space to each string mentioned in the source; the value of that word is zero until the string is assigned, at which time the value becomes a pointer (SADD) to the string. The assignment `NULL$=""` compiles a constant consisting of a length word of zero and, at run time, copies that constant to a new place whose address is placed in the allocation for `NULL$`. The address of the allocation, of course, is `VARPTR(NULL$)`.

John S. Coggeshall  
Philadelphia, PA

*Of course, one person's bug is another's feature; my problem with CB-80 is that it's all too easy (for me, anyway) to write code that can sometimes let a subscript exceed its intended range; the resulting crash gives no indication whatever that this is the problem.*

*The original CB-80 really was Compiled CBASIC; that meant you could compile your program under CBASIC, which, being only pseudocompiled and then interpreted, was very slow but had range and dimension checking. This made it simple to test programs, and when they ran properly under CBASIC, you could compile them for speed.*

*Alas, the last versions of CB-80 have nifty features that were not added to CBASIC.*

*Programming "philosophy" varies with the programmer. Those who spend a lot of time writing programs will generally prefer speed of execution to programmer convenience. In my case, though, programming is something I do along with many other things, and I need all the help the computer can give me. One of the values of Pascal is that once you get a program past the compiler, the program generally does what you wanted it to do. CBASIC used to work that way; CB-80 doesn't. I hate to think like a computer. I want the compiler to catch my mistakes.*



# DIRECT SOFTWARE™

## DISCOUNT DIGEST

TO ORDER CALL (415) 459-1282 • TOLL FREE (800) 533-3012 CA (800) 533-3011 USA

### Direct Software™ Discount Prices Save \$\$ and Make Sense to Smart Buyers Who Know What They Want!!

DIRECT SOFTWARE™ is committed to being Number One in service and reliability, at low, low prices. Our satisfied customers include America's largest corporations, educational institutions, the U.S. government and thousands of individuals all around the world. Call on our courteous sales staff to find what we can do for you! We can beat any legitimate price advertised in this magazine, and still give you full technical support and personalized service, with same-day shipment on most orders.

List Sale

#### ALPHA SOFTWARE

Apple-IBM Connection	250	169
Data Base Manager II	295	245
Typeface	125	79

#### ANDERSON-BELL

ABSTAT	395	265
--------	-----	-----

#### ASHTON-TATE

dBASE II	700	379
Friday	295	185

#### ASPEN SOFTWARE

Grammatik	75	56
Proof Reader	50	38

#### A.T.I.

Training WordStar	75	60
Training dBASE II	75	60
Training Multiplan	75	60

#### BRUCE and JAMES

Wordvision	80	68
------------	----	----

#### CDEX

MYB-Lotus 1-2-3	70	60
MYB-Visicalc	70	60

#### DIGITAL MARKETING

Milestone	295	249
Datebook II	295	179
Footnote	129	84
Bibliography	125	84
Notebook	150	98
MICROLINK II	89	60

#### ACCOUNTING REAL WORLD

Accounts Payable	650	379
Accounts Receivable	650	379
Payroll	650	379
General Ledger	650	379
RM Cobol		129

#### I.U.S.

General Ledger	595	338
Accounts Receivable	595	338
Accounts Payable	595	338

#### PEACHTREE

General Ledger	750	425
Accounts Receivable	750	425
Accounts Payable	750	425

<b>DIGITAL RESEARCH</b>	List	Sale
Concurrent CP/M 86	350	249
CB 80 Compiler	500	369
CBASIC (CP/M 80)	150	94
SID (CP/M 80)	100	75

#### FOX & GELLER

Quickcode	295	169
dGraph	295	169
dUtil	99	58

#### CONDOR

Condor 3	650	319
----------	-----	-----

#### GAMMA PRODUCTION, INC.

Taxwizard 83 (IBM)	50	50
Taxwizard 83 (CP/M)	50	40

#### HUMANSOFT

DBPlus	125	84
--------	-----	----

#### IUS

Easy Filler	400	220
Easy Planner	250	164
Easy System II	395	239
(writer, mailer, speller)		

#### LEXISOFT

Spellbinder	495	239
-------------	-----	-----

#### LIFETREE

Volkwriter	195	125
Volkwriter Deluxe	245	199

#### LOTUS

1-2-3	495	315
-------	-----	-----

#### MDBM

Knowledgeman	500	329
--------------	-----	-----

### SPECIALS

	List	Sale
DBASE II + Quickcode	995	525
DBASE II + dUtil	799	429
DBASE II + DGraph	999	539
DBASE II + ABSTAT	1095	717
DBASE II + DBASE Window	949	558
DBASE II + WordStar	1195	629
<b>WORDSTAR \$245 dBase II \$379</b>		
<b>SuperCalc 3 \$239 LOTUS \$315</b>		
<b>RBASE: 4000 \$345</b>		

#### METASOFT

Benchmark Word Processor	350	279
Benchmark Mail List	250	139

#### MICROPRO

WordStar	495	245
Professional Pak	845	365
InfoStar	495	248
InfoStar - CP/M Card	695	329
WordStar - CPM Card	695	329
MailMerge	250	126
SpellStar	250	125
CalcStar	145	88
WordStar/Option	295	219

#### MICROFIM

R Base 4000	495	345
-------------	-----	-----

<b>MICROSOFT</b>	List	Sale
Multiplan	250	159
BASIC Interpreter	350	249
Flight Simulator	50	38
Word/Mouse	475	319

#### MICROSTUFF

Crosstalk	195	109
-----------	-----	-----

#### OASIS

The Word Plus	150	105
Punctuation & Style	150	95

#### PEACHTREE SOFTWARE

Peachpak 4	395	275
Peachtext 5000	395	219

#### PERFECT SOFTWARE

Perfect Writer	349	218
Perfect Speller	129	98
Perfect Filer	249	175
Perfect Writer/Speller	399	298

#### PETER NORTON

Norton Utilities	80	58
------------------	----	----

#### SELECT Information Systems

Select Word Processor	295	199
SelectWrite	99	79

#### SOFTWORD SYSTEMS

Multimate	495	295
-----------	-----	-----

#### SORCIM

SuperCalc1	195	129
SuperCalc2	295	154
SuperCalc3	395	239

#### SSI

Word Perfect	495	315
--------------	-----	-----

#### TYLOG

dBase Window	249	155
dBase Door	149	94

#### VISICORP

VisiOn Graph	250	199
Visicalc IV	250	159
Visicalc Advanced (Apple)	400	249

#### WOOLF SYSTEMS

Move It	150	85
---------	-----	----

#### CALL FOR PRODUCTS NOT LISTED!

- Purchase orders accepted
- Prompt UPS service
- Dealer and Institutional discounts
- Quantity discounts available
- Call for charges and return policy:
- No credit card surcharge!

Prices may change: No Refunds

ALL SALES FINAL

Call today for our free catalog

TO ORDER CALL

(415) 459-1282

TOLL FREE

(800) 533-3012 CA (800) 533-3011 USA

850 College Ave., Suite #3  
Kentfield, CA 94904

*Incidentally, Digital Research tells me it's looking at a number of possible upgrades to CB-80, including having a special compiler that would do range checking and other debugging assistance. That should be good news to CB-80 enthusiasts. . . Jerry*

**Jerry Quixote**

Dear Jerry,

Yesterday I opened my latest purchase of software for my IBM PC. It's a 6805

cross-assembler by Avocet Systems of Dover, Delaware. I am aware of your software disclaimer crusade and I thought that you should see what I found in my licensing agreement.

Sit down.

The manufacturer actually guarantees the software will work or it will fix it; if the company can't fix it, it will give my money back.

I have included a copy of that section of the disclaimer where Avocet doesn't disclaim anything.

Don't get cocky, but I think you may have knocked over a small windmill.

**Thomas Quinn  
Blue Bell, PA**

*I saw the Avocet people at CP/M East, just after my tirade about the company's previous disclaimer appeared in print. They were very polite and said they intended to make real changes in the licensing agreement. However, I never received the update. Thanks. It's quite reasonable. That's an agreeable surprise.*

*Now for the larger windmills. . . Jerry*

**Almost Persuaded**

Dear Jerry,

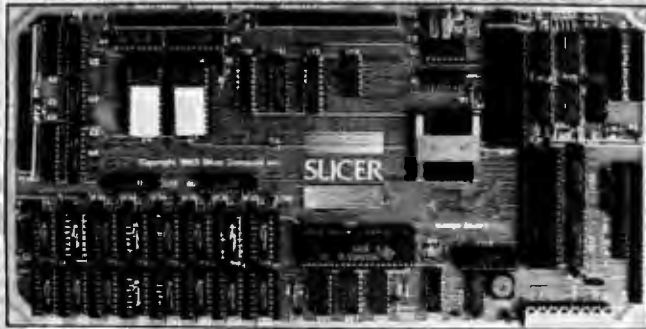
A couple of comments concerning FORTH: first, Leo Brodie, who wrote *Starting FORTH*, has completed a sequel, *Thinking FORTH*, to be published this spring by Prentice-Hall. I have read the manuscript and it is excellent. The first part of the book, in which he discusses general precepts of programming, will be of interest even to non-FORTH programmers. I hope that you will have an opportunity to read the book.

FORTH, unlike most computer languages, was developed and refined "in the field" by practicing programmers who faced real-world tasks and demands. Its structure and methods stem directly from the need to get the job done with minimum use of critical resources: computer memory, computer power, and programmer time. FORTH was thus designed so that programs written in it would be easy to write, modify, and maintain.

FORTH, like Modula-2 and Pascal, is compiled, but in FORTH compilation is immediate upon the definition of a word, and the new word is called merely by invoking its name. This frees the programmer from various intermediary complexities (separate compilation, linking, etc.). More important, it allows for immediate, on-the-spot testing and use of each small unit, which permits the programmer a natural and iterative process of development.

The immediacy of the compilation, and the brevity of definition that allows, enables the programmer to interact with the program as it is written. In situations in which the feedback from one's actions is immediate, one can achieve a state of mind in which one's efforts and effects each shape the other and consciousness merges with the process so that one

**GET REAL 16 BIT POWER**



**A SINGLE BOARD COMPUTER FEATURING THE INTEL 80186 THE SLICER**

(see Byte magazine April '83)

- Full 8MHz 16-bit microprocessor having complete software compatibility with the 8086 and 8088
- 256K Bytes of RAM plus 32K Bytes of EPROM memory capacity on-board
- Floppy disk controller can run the combination of 8", 5-1/4", 3-1/2" drives simultaneously
- SASI port for hard disk controller
- Two full function RS232C serial ports with individually controlled baud rates from 80 to 38.4K baud
- 8K of EPROM contains drivers for peripherals, commands for hardware checkout and software testing
- Source for monitor and bios included on disk
- Bios for CP/M 86\* supports 8", 5-1/4", 3-1/2" drives and the Xebec 1470 controller for hard disks
- Board size 6" x 12" power requirements +5 @ 3A, +12V @ 60mA, -12V @ 50mA
- Complete documentation included.

Sold in various forms:  
 Assembled and tested . . . . . \$1,075.00  
 Full Kit . . . . . 895.00  
 Easy Kit (hard to get parts) . . . . . 450.00  
 Bare Kit (board, Rom, doc, and disk) . . . . . 150.00  
 CP/M 86\* available . . . . . 85.00  
 Regular U.P.S. shipping within continental U.S. is included.

**THE NEW SLICER EXPANSION BOARD**

- 256K bytes dynamic RAM using the TMS4500 DRAM controller
- 2 RS232C serial asynchronous ports using the Signetics 5C2681 serial communications circuit with baud rates selectable from 38.4K baud to 50 baud
- 2 RS232C serial asynchronous ports using the Zilog 8630 SCC with header connectors for synchronous communications personality cards
- Real Time Clock with battery back-up using the CDP8818 RTC circuit, on-board or off-board battery
- Parallel printer port for Centronics-type printers
- Same size as the SLICER, Power: 5V @ 1.5A, +12 @ 200 mA - 12V @ 100 mA

Sold in various forms:  
 Assembled and tested . . . . . \$800.00  
 Full Kit . . . . . 650.00  
 Memory Board . . . . . 450.00  
 3 Port Board and Clock . . . . . 225.00  
 Bare Board and Doc . . . . . 95.00  
 Regular U.P.S. shipping within continental U.S. is included.

**SLICER™**  
 Choose 8 MHz CPU for speed  
 6 MHz CPU for speedy delivery  
**SLICER COMPUTERS INC. 2543 Marshall St. N.E.  
 Minneapolis, MN 55418 (612) 788-9481**

Mastercard, Visa,  
 check, money order or  
 C.O.D. orders accepted.  
 Please allow 4 weeks for delivery.

\*CP/M is a trademark of Digital Research, Inc.



# IF YOUR DATA GETS WIPED OUT, YOU WON'T BE.

**Alloy's PC BACKUP gives IBM, Eagle, Columbia, Compaq, Kaypro, Corona, Texas Instruments, and Zenith users total data protection.**



PC BACKUP from Alloy, the leader in data backup technology, eliminates the headache of costly, time-consuming data loss for users of the IBM PC and all 100% compatibles. It backs up your files with the finest file-oriented cartridge tape backup and retrieval system for Winchester hard disks available today. So your data is safe when not in use, and at your fingertips when you need it. And only Alloy can deliver high performance storage/retrieval and data protection with such reliability.

Designed to meet PC owners' increasing storage needs and to put an end to data loss, PC BACKUP is the standard among major PC users today.

Here are some of its remarkable features:

**COMDEX™/Spring '84**  
BOOTH # 2832

Alloy's TIP-SIX, the latest version of the industry standard Tape Interchange Package. A comprehensive, menu-driven software package, with over 30,000 installations. File-by-file data transfer at nearly

1 Megabyte/minute. Automatic sub-directory backup with date and time stamp and archive bit support.

Insure against data loss, find out more about PC BACKUP. It's available right now. Call Alloy today at (617) 875-6100, or ask your local dealer about PC BACKUP.



**ALLOY**  
Computer Products, Inc.

Alloy Computer Products, Inc., 100 Pennsylvania Ave., Framingham, Massachusetts 01701. Tel: (617) 875-6100, TWX: 710-346-0394  
In Europe: contact: Alloy Computer Products (Europe) Ltd., Cirencester, Gloucestershire, England. Tel: 0285-68709, Tlx: 43340

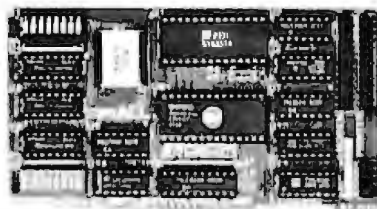
# REPORT ON NEW PERIPHERAL HARDWARE:

## CHOOSING A SERIAL INTERFACE FOR YOUR APPLE\* COMPUTER.

### The "Second Serial Hardware Decision"...

Once you've selected the right serial printer or modem for your Apple\* system, your hardware decisions are over for a while. Right?

Wrong, of course! You still have to decide on an interface card. This "second serial hardware decision" is an important one—one made much simpler



SERIALL Printer/Modem Interface by SERIALL™, the new serial interface for Apple computers.

At a significantly lower cost than Apple's own serial card—\$159.00 vs \$195.00—SERIALL gives you a bunch more features. Practical, everyday features, not useless extras.

For one, SERIALL is the only interface that provides graphics capabilities for serial printers including Apple's new dot matrix Imagewriter™.



Graphics capabilities for serial printers

SERIALL also offers 27 easy commands for text formatting and screen dumps, making it the most intelligent serial interface you can use with an Apple.

Equally important, SERIALL gives you complete communications interfacing capability. You can use it for modems or in the special terminal mode for timesharing and talking to other computers.

In fact, SERIALL completely emulates the Apple serial card as a communications interface.

No additional software or hardware modification is required.

Finally, consider the quality. SERIALL's five-year warranty is proof that this interface is built to work long and hard. No other serial card is backed by a guarantee like this.

After comparing SERIALL feature-for-feature with other serial interface products, we think you'll agree—SERIALL truly is the Do-It-All serial card for Apple computers.



Available from Practical Peripherals—makers of MICROBUFFER™, PROGLOCK™, PRINTERFACE™, and GRAPHICARD™.

\*Apple and Imagewriter are registered trademarks of Apple Computers, Inc.

**PRACTICAL PERIPHERALS**

31245 La Baya Dr., Westlake Village, CA 91362 • (818) 991-8200 • TWX 910-336-5431



becomes "lost" in the work—a maximally productive state of mind. This state of mind is familiar to most artists. In their work with brush, pencil, or clay, they are in immediate contact with their medium—they can try something, see what it does, and let that result shape their next step. It is familiar to actors, to athletes, and to all who get immediate feedback as they work.

It is unfamiliar to most programmers simply because most programming languages are structured and implemented in a way that presents a barrier to immediate feedback, that erects a wall of time and procedures between idea and result, and that discourages impromptu casual experimentation that leads to serious experimentation that leads to this creative state of mind.

Although a computer program is purely a work of the mind, few programming languages pay attention to how the mind works: the way people deal with "chunks" of information, the relatively small number of "chunks" that can be active at any one time, the importance of names for these chunks, the processes of analysis—dividing large tasks into small tasks—and synthesis—combining these pieces synergistically into a whole—and the importance of immediate, interactive feedback, as described above. The programmers who created FORTH perhaps did better than they realized, because FORTH's structure matches in all important ways the processes by which people create expressions of their ideas.

Moreover, FORTH's internal structure and mechanisms are so few and so simple that the programmer can look inside it and understand exactly how it works; such an understanding is also a key component of a good tool, because the programmer gains from it a strong sense of control and confidence that enables him or her not only to get the most from the FORTH as he or she received it, but also to extend the language to address novel situations and unique problems.

That is why FORTH programmers become so devoted to this language: like any good tool, it fits. It is shaped to match the user, and thus feels like a natural extension of the user's own capabilities. It doesn't get in the way but allows the user to focus on the problem at hand. And because FORTH so well matches the way we work, it even helps in solving the problem. Who could ask for more?

**Michael Ham**  
Iowa City, IA

*You make such a good case for FORTH that I'm tempted to try it. Alas, I don't seem to have any good current implementation for any of the machines I have, and I suspect that by the time I get one, I'll have lost the impulse; but perhaps not.*

*I know something of the creative mood you speak of; indeed, I'm reminded of some of my best programming efforts, which were done in BASIC, when I first started playing with these machines. Those programs have long since been converted to more efficient languages, but their concepts remain pretty good.*

*Certainly FORTH produces devoted and enthusiastic followers! . . . Jerry*

**More on Modula-2**

Dear Jerry,

I am following with great interest your comments on the fascinating language Modula-2. I have two questions: Are there any publications, in addition to Dr. Wirth's book? What is the address of the



**32 BIT SINGLE BOARD SUPER MICRO**

**Features:**

- **Ideally Suited For:**
  - Industrial Control
  - Robotics
  - Personal Computers
  - 68000 Software/Hardware Development
  - Hobbyists
  - Education
- Mounts directly on 3 1/4" Disk Drive
- 8 Mhz 32 bit 68008 microprocessor (Fully software compatible with 68000 microprocessor) 8 bit data bus
- 128K Bytes on board (no wait state) RAM Plus 4, 8, 16, 32 or 64 K Bytes EPROM memory
- 2 8 bit Parallel Ports
- 2 RS-232 Serial Ports (30 - 38.4K baud, software selectable)
- Floppy disk controller can run up to four 5 1/4, 3 1/2, 3 1/4 or 3" drives. Single or double sided, single, double or quad density.
- Full debug monitor with single line assembler and disk loader
- Extended expansion bus includes all data, address and control signals plus all decoded and multiplexed address and control lines for an additional 128K of RAM
- Power Requirements - +5V @ 1.5A, +12V @ 100mA, -12V @ 100mA

**\$595** COMPLETE. Assembled and tested. Includes documentation and surface shipping within continental U.S.

**OEM and DEALER DISCOUNTS AVAILABLE**



**EMERALD  
COMPUTERS**

4000 S.E. International Way, Suite F203  
Milwaukie, Oregon 97222 (503) 654-9666







# Why are there so many ads in BYTE?

BYTE carries more pages of advertising than any other computer magazine in the world, because:

1. BYTE is the **only** high-tech magazine serving the entire microcomputer field. Our editorial covers all hardware, all software, all peripherals. Therefore, every computer-related product **belongs** in BYTE.

2. Do you know any sophisticated computer user who **doesn't** know BYTE? Over 400,000 pay to read BYTE every month because it is **the** authority, the international standard by which all other computer magazines are measured. Including pass-along, BYTE's high-tech readership totals nearly 850,000. It's an audience **every** advertiser wants.

3. Do BYTE readers **like** all those ads? They'll send over **6 million** "more-information" inquiries to our advertisers this year. No other magazine comes close. Whether in the front, middle or back of the magazine, ad pages in BYTE average over 1,000 inquiries. Some back-of-book advertisers have pulled over 2,000 with a single ad!

**That's** why there are so many ads in BYTE.

If you're an advertiser, or are thinking about becoming one, talk to us—we're the people who wrote the book on microcomputer marketing. Just call Pete Huestis, Advertising Sales Manager, at (603) 924-9281.

## BYTE

THE INTERNATIONAL STANDARD



n	Time (seconds)	Result*
30	2.2	2.48199 x 10 <sup>6</sup>
40	4.9	8.1533 x 10 <sup>6</sup>
50	9.2	2.053552 x 10 <sup>7</sup>
60	15.6	4.369284 x 10 <sup>7</sup>
70	24.5	8.272824 x 10 <sup>7</sup>
80	36.3	1.4384182 x 10 <sup>8</sup>
90	51.5	2.3429192 x 10 <sup>8</sup>
100	70.4	3.6250627 x 10 <sup>8</sup>

\*Computed to single precision (24-bit mantissa), so trailing digits may be nonsense

**Table 1: NS16032 timing results.**

n	Time (seconds)	Result*
30	246.45	2.48199 x 10 <sup>6</sup>
40	584.04	8.1533 x 10 <sup>6</sup>
50	1107.93	2.05355 x 10 <sup>7</sup>
60	1899.90	4.36928 x 10 <sup>7</sup>

\*Computed to single precision (24-bit mantissa), so trailing digits may be nonsense

**Table 2: Timing results of largest cases that fit into the Olivetti M20 (in BASIC).**

Modula Research Institute? I thank you in advance for the information.

A. Vargas  
New York, NY

The documents that come with Volition Systems Modula-2 are about the best introduction to the language I know of. I know of no other Modula-2 introduction in print except for Wirth's book, which some claim to be a sure cure for insomnia. Dr. Michael Hyson and I are writing a tutorial and introduction that ought to be in print next fall.

A lot of Modula-2 software is in the public domain and can be obtained from Modula Research Institute, 950 North University Ave., Provo, UT 84604. . . . Jerry

**Timing the NS16032**

Dear Jerry,

Seeing your reminder in the December 1983 User's Column (Kazango!, page 92) galvanized me into—well, reduced sloth. Table 1 shows the n x n time results for an NS16032 CPU with NS16081 FPU running at 10 MHz and no wait states. The program is the Pascal version. Table 2 illustrates the results from my Olivetti M20.

Richard Mateosian  
Berkeley, CA

That 16032 is fast! The chip looks awfully good; a lot of minicomputers can't do what the 16032 can do. Now all we have to do is get systems using it . . .

Bill Godbout tells me he'll have an S-100 version running fairly well late this spring, but it will be for development work only; users will have to wait a year or so. . . . Jerry

**QX-10 CP/M Utilities**

Dear Jerry,

You've mentioned that Barry Workman is putting a number of CP/M utilities into Epson QX-10 format, available for a reasonable charge. What are they, and how can they be gotten hold of? I love the machine, but as you know, obtaining formatted software is a royal pain in the neck. Naively I contacted my dealer, expecting her to access some programs. She referred me to an "Epson Hot Line," which turned out to be a wholesale distributor of Epson programs in California. The only way that software could be obtained, however, would be by having my dealer contract to buy programs from them. Help!

Irene Matiatos  
Jackson Heights, NY

Barry has a number of CP/M general-purpose utilities, such as disk catalogs, directory handlers, erased-file recovery programs, etc., which he sells at reasonable prices. Recently he put a number of them over onto the Epson QX-10.

I have an experimental copy of Wordstar for the Epson; it seems to work fine.

For the utilities, you need to talk to Barry Workman at (818) 796-4401. For Epson Wordstar, you'll need to write Micropro; it should have it commercially available by now. . . . Jerry

**Another Valdocs User**

Dear Jerry,

I couldn't disagree more strongly with your distaste for the Epson QX-10. I've had mine for a year, am a beta site for Valdocs, and have been through nearly every version of that marvelous piece of software.

Is the QX-10 slow? Absolutely not. I touch-type at a fairly high speed and have no problems whatsoever. Disk operations can be somewhat less speedy than I'd like—block moves, for instance, are definitely tedious—but on balance, I see little difference between my QX-10 with Valdocs and an IBM PC running Wordstar. (Timing differences, that is. For ease of use, keyboard excellence, and on-screen display, the QX-10 cannot be beaten.) I did add the Comrex hard disk, which significantly improves speed and flexibility.

I use the QX-10 daily, have written many hundreds of thousands of words on it, and am totally satisfied. As West Coast Editor for *Popular Science*, I use the QX-10 to transmit my copy to New York and to receive proof copies back. I get electronic-mail news releases from JPL and a Los Angeles PR agency, both of which have installed QX-10s and are happy. I expect to receive considerably more electronic mail as the Valdocs program improves.

I am frequently asked for computer recommendations, as you are. The only machines I recommend to writers are the QX-10, for those who can afford it, and the Kaypro, for those who can't. In any office setting, where word processing is important, the QX-10 is a superb machine and Valdocs is the only way to go. I'll stand by that until I see something better.

By the way, the new Titan board, which converts the QX-10 into an IBM PC look-alike and which serves as a 256K-byte RAM disk for Valdocs, should make the



# CompuPro...

for Performance, Quality and Reliability

Anyone can sell you a box full of hardware. But is it too much computer? Too little? Will it run the appropriate software? What about service? If you need the right answers both before and after the sale, call your nearest Full Service CompuPro System Center. For product information, see pgs. 120-1.

## ALABAMA

**Birmingham**  
Costi Plus Computers  
(205) 879-5976

## ARIZONA

**Scottsdale**  
S-100  
(602) 991-7870

## CALIFORNIA

**Bakersfield**  
Creative Computing Serv  
(805) 835-1118

**Berkeley**  
American Computers  
& Engineers  
(415) 849-0177

**Track Computer Center**  
(415) 845-6366

**Burlingame**  
Mentzer Computer  
Systems  
(415) 340-9363

**Canyon Country**  
Creative Computing Serv  
(805) 251-9877

**Chatsworth**  
Priority One Electronics  
(818) 705-6789

**Hayward**  
Best Computers Hayward  
(415) 886-4732

**Irvine**  
Priority One Electronics  
(714) 660-1411

**Los Angeles**  
American Computers  
& Engineers  
(213) 477-6751

**Gifford Computer  
Systems**  
(213) 477-3921

**Mountain View**  
ACC  
(415) 969-4969

**Oakland**  
Track Computer Center  
(415) 444-8725

**Pacific Palisades**  
System Interface  
Consultants  
(213) 454-2100

**Pasadena**  
Omni Unlimited  
(818) 795-6664

**Petaluma**  
Advanced Information  
Management  
(707) 763-7283

**Pleasanton**  
Best Computers  
Stoneridge  
(415) 463-2233

**Sacramento**  
Logic Systems  
(916) 922-3377

**San Leandro**  
Gifford Computer  
Systems  
(415) 895-0798

**San Rafael**  
Computer House  
(415) 453-0865

**Santa Barbara**  
Data Bank  
(805) 962-8489

**Santa Maria**  
Data Bank  
(805) 922-1333

**Santa Rosa**  
Matrix Computers  
(707) 542-0571

**Sunnyvale**  
Pragmatic Designs Inc  
(408) 736-8670

## COLORADO

**Lakewood**  
Rocky Mountain  
Microsystems  
(303) 232-4545

## FLORIDA

**Orlando**  
Data/Office  
(305) 629-6776

**Satellite Beach**  
Binary Magic, Inc.  
(305) 777-7080

**Tampa**  
Micro Computer  
Technology  
(813) 985-0919

## HAWAII

**Kahului Maui**  
Capacity Plus  
Computers  
(808) 771-7984

## ILLINOIS

**Athens**  
Computers Plus  
(217) 636-8491

**La Grange Park**  
Small Business  
Systems, Inc.  
(312) 579-3311

**Skokie**  
Lillipute Computer  
Mart, Inc.  
(312) 674-1383

## INDIANA

**Terra Haute**  
General Software, Inc.  
(812) 234-9421

## KANSAS

**Ellinwood**  
Genesys Systems, Inc.  
(316) 564-3636

## MARYLAND

**Baltesda**  
JR Systems  
(301) 657-3598

## MASSACHUSETTS

**Boston**  
New England  
Electronic Exch  
(617) 491-3000

**Chestnut Hill**  
Key Micro Systems  
(617) 738-7306

## MISSISSIPPI

**Pascagoula**  
Automated Accountants  
(601) 769-2937

## MISSOURI

**Kansas City**  
BBRL  
(816) 753-5900

## NEW YORK

**Amherst**  
Gifford Computer  
Systems  
(716) 833-4758

**Deer Park**  
Datapro Systems, Inc.  
(516) 595-1311

**New York**  
Park Plaza Computer  
Center, Inc.  
(212) 759-5820

**Park Plaza Comouter  
Center, Inc.**  
(212) 505-8200

**Park Plaza Computer  
Center, Inc.**  
(212) 344-5151

**Park Plaza Computer  
Center, Inc.**  
(212) 595-5353

**Staten Island**  
John D. Owens Assoc.  
(212) 448-6283

## NORTH CAROLINA

**Greensboro**  
General Semantics  
Computers  
(919) 378-1500

## OREGON

**Portland**  
Microwest Computer  
Products  
(503) 238-6274

## PENNSYLVANIA

**Reading**  
Fraser Business  
Equipment  
(215) 378-0101

## RHODE ISLAND

**Coventry**  
Key Micro Systems  
(401) 828-7270

## TEXAS

**Austin**  
CPA Systems, Inc.  
(512) 458-9281

**Informa, Inc.**  
(512) 459-4216

**Omegax Systems**  
(512) 476-6069

**Dallas**  
Dator Systems  
(214) 521-0915

**R. Worth**  
Dataworth Computer  
Systems  
(817) 877-4041

**Houston**  
Gifford Computer  
Systems  
(713) 680-1944

**Informa, Inc.**  
(713) 861-7612

**Segula**  
CPA Systems, Inc.  
(512) 379-0660

## VIRGINIA

**Woodbridge**  
Office Networks Corp.  
(703) 690-3312

## WASHINGTON

**Bellevue**  
North Ridge  
Computer Systems  
(206) 453-0596

**Seattle**  
American Computers &  
Engineers  
(206) 583-0130

## WISCONSIN

**Greenfield**  
Byte Shop  
of Milwaukee  
(414) 281-7004

**Madison**  
Beam International  
(608) 255-2325

## AUSTRALIA

**Banksstown**  
Automation Statham  
Ply., Ltd.  
(02) 709-4144

## CANADA

**Coquitlam, B.C.**  
CSC System Center Ltd.  
(604) 941-0622

**Vancouver, B.C.**  
Dynacomp Business  
Computers Ltd.  
(604) 872-7737

## THE PHILIPPINES

**Quezon City**  
Corona International Inc.  
78-34-71

## UNITED KINGDOM

**Swansea**  
Comcen Technology Ltd.  
(0792) 796000

# CompuPro®

A GODBOUT COMPANY

3506 Breakwater Court, Hayward, CA 94545

## EMPLOYMENT OPPORTUNITIES

# Software Engineers

Discover a whole new dimension in professional growth at Computer Horizons Corp. Learn why we are among the top 15 software services firms in the country with a client list that includes numerous Fortune 500 leaders. Currently state-of-the-art projects include development of software modifications to meet specific client applications, as well as developing solutions to client problems relating to software computer design, evaluation and analysis.

If your background includes experience in any of the following areas, we definitely have the opportunity for you.

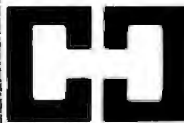
**HARDWARE:** DEC, Hewlett Packard, Wang, Z-80, IBM PC, Tandem, Prime, Datapoint  
**SOFTWARE:** Unix\*, Vax, RSX, DPL, Graphics, CAD/CAM  
**LANGUAGES:** "C", Pascal, Fortran  
Any Real Time Assemblers

Opportunities exist in our offices in New Jersey, New York, Chicago, Indiana, San Francisco, Denver, Cincinnati, and Detroit. Our excellent salaries are above industry average with a superior benefits including health and dental insurance, unlimited tuition refund, relocation assistance and much, much more.

Please call or send your resume to:

**Mr. Bob Pamieri, Vice President Personnel**

In New York Call (212) 371-9600  
Outside Of New York Call (800) 847-4097



**COMPUTER HORIZONS CORP.**

747 Third Avenue, Department B 5/84  
New York, NY 10017

An Equal Opportunity Employer M/F  
\*UNIX is a trademark product of Bell Labs

## New EMPLOYMENT OPPORTUNITIES Section

BYTE will feature a special section for recruitment advertising in all future issues.

BYTE is the perfect place to look for those High Technology professionals you need—over 400,000 paid subscribers.

Or, if you're looking for a new position, this is the place to feature a **Position Wanted** ad.

The cost for any display ad in this new **EMPLOYMENT OPPORTUNITIES** section is only \$356 per inch. For quotes on all **EMPLOYMENT OPPORTUNITIES** ads, or any additional information on recruitment advertising, call our special recruitment telephone sales at 212/512-2556.

Or send in your order to:

**BYTE  
Recruitment Advertising Center  
P.O. Box 900  
New York, NY 10020**

## BYTE's User to User

machine even more attractive. I hope to have one installed in my QX-10 within a few weeks.

This letter was written on my QX-10 and printed out on my antique MX-80. Valdoks lets the MX-80 produce fairly sharp type, which I frequently use for correspondence. From starting to write to completing the printing, this letter took 16:02 (timed with the Valdoks timer, by the way).

**James L. Scheffer  
Playa del Rey, CA**

*I'm glad you like your QX-10.*

*Epson continues to improve the machine, and I'm told there will be a really wonderful new Valdoks Real Soon Now. I've always thought Valdoks was great in conception but too complex for a Z80; when 16-bit conversions for the QX-10 are available, maybe the execution will be up to the concept.*

*Meanwhile, it takes nearly a full minute simply to erase a single file under Valdoks, and if it took us 16 minutes to produce each letter, we'd be further behind than we are. . . . Jerry*

## Detecting Errors

Dear Jerry,

In the January User's Column on page 68 you said, "Eagle tells me it did a lot of work on parity checking and found that it decreases the overall reliability by 15 percent." Did you really think about this before you committed it to print?

Some companies realize that memory chips have higher error rates than most other computer circuits and have designed appropriate error-detection schemes, such as parity, into their computers. For Eagle to produce a computer that will let these errors go undetected and tell us this is better upsets me.

Perhaps the problem is the definition of reliability. Apparently some people feel that a computer is reliable if it will always do something without regard for the validity of the result. I view reliability as being able to trust what the computer tells me. Detecting errors with parity and similar techniques increases reliability.

If you need your computer "right now," you might be upset when your machine stops running because of a small error. Alternately, undetected errors can result in misleading responses when you ask "What if. . ." What if you make an important business decision based on erroneous answers? Wouldn't you rather





Advancing the technology of data security

## Introducing Data Sentry.<sup>®</sup> Computer security so advanced, even Mata Hari couldn't hack it.

Your most confidential files may be easy prey for the advances of an artful hacker.

That's why Lockheed used its years of experience with high-technology systems to create Data Sentry.

### Protection for sensitive data

Its own internal computer gives you the telecommunications features of an intelligent modem. But unlike other modems, Data Sentry is smart enough to keep your secrets from the most persistent computer intruders.

Data Sentry puts an electronic wall around both large and small computers. And because its protection is external to your CPU, it can eliminate the expense of internal security software. It blocks the inquiries of would-be Mata Haris with a sophisticated security sequence.

### Security for every situation

First, Data Sentry requests the phone number of a caller desiring access to your computer. Then it hangs up the phone and searches its list of authorized phone numbers. If the caller's number is authorized, Data Sentry dials the caller back and requests entry of a password. If the correct password isn't supplied within three tries, Data

Sentry disconnects and will not return further calls from that phone number.

Data Sentry also lets users select other lower levels of security if desired, including callback to any number with entry of password. And an option, Remote-ON,<sup>®</sup> lets you turn your computer's power on and off from a remote terminal after security has been cleared.

### Versatile and confidential

Data Sentry logs all attempted contacts for audit trails and analysis of users. Its security set-up is locally controlled by a master password that is accessible only to authorized personnel. And its design includes high-reliability components, the latest LSI circuitry, plus Autodial 300/1200 baud full-duplex communications, with auto ranging for incoming data.

Data Sentry will deal with your toughest security problems.

And it'll never fall for just a pretty face.

For a list of your nearest Data Sentry distributors, call toll-free 1-800-443-0100, Ext. 471. Or write: Lockheed GETEX, Suite 945, 1100 Circle 75 Parkway, Atlanta, Georgia 30339.



 **Lockheed-GETEX**  
Leadership in Technology

Circle 236 on inquiry card.





# Send 2000 Letters Per Hour via Your Personal Computer

Delivered in 48 hours or sooner at 26 cents a piece using MAIL-COM.™



## Presenting E-Com

Two years ago the U.S. Postal Service quietly announced the E-Com® Service, enabling specially equipped personal computer users to bypass costly manual

mail preparation, by electronically submitting their messages and mailing lists directly to the Postal Service via modem.

This high speed computer originated mail arrives at its destination within 48 hours—often less—in an attention-grabbing blue E-Com envelope.

## Announcing MAIL-COM. Only from Digisoft Computers.

MAIL-COM is powerful software you can use with your personal computer to access E-Com. With your personal computer, a modem and MAIL-COM you can send from 200 to 2000 letters per hour for just 26¢ each. Typed, addressed, folded, inserted, sealed and delivered. Complete.

MAIL-COM is the complete integrated software available for E-Com operation. It's easy to use. No special training is necessary. And since Digisoft Computers developed MAIL-COM in accordance with U.S. Postal Service specifications, users are guaranteed certification for use upon purchase of MAIL-COM software.

MAIL-COM is the easiest and most economical way to do your mailings.

MAIL-COM includes a complete letter editor and address maintenance program, as well as communications software.

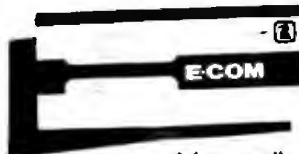
Directly interfaces with dBASE II, Wordstar, MailMerge and other databases.



Each letter in your mailing can be identical or all can contain variable insertions. MAIL-COM operates all the features offered by E-Com.

## Thousands of Uses.

If you have need for fast, economical mass mailing capabilities, MAIL-COM puts you and E-Com together.



Use it for new product announcements, invitations to press events, invoicing, fund raising, collection, bulletins to your sales force, new business prospecting, reactivation of customers and much, much more. Every department in your company will have use for MAIL-COM.

## Don't Delay

With MAIL-COM you could be saving time and money on fast, efficient E-Com letters. MAIL-COM software is available for the IBM PC, PCjr., Kaypro, CP/M, Apple II and other formats. Order today. Call 212-734-3875.

## Digisoft

Digisoft Computers, Inc.

(212) 734-3875

Circle 130 on Inquiry card.

Retail Dealer Inquiries Invited

Digisoft Computers Inc.  
Attn: MAIL-COM Marketing  
1501 Third Avenue  
New York, NY 10028

Yes! I want to eliminate the 6 costliest steps in preparing my organization's business mail. Please RUSH my MAIL-COM software to me immediately.

I'll need software for:  
 IBM PC (\$195)       CP/M (\$195)  
 Victor (\$195)      (specify disk format)  
 Alpha Micro (\$495)       Other (specify)  
 Apple II (\$195.00)

My check or money order is enclosed (residents of New York State add sales tax).  
 Charge my     Visa or     MasterCard:

Account No. \_\_\_\_\_ Exp. Date \_\_\_\_\_

Name \_\_\_\_\_

Address \_\_\_\_\_

City \_\_\_\_\_

State \_\_\_\_\_ Zip \_\_\_\_\_

Telephone(\_\_\_\_\_) \_\_\_\_\_

© 1983, Digisoft Computers, Inc.

printed in your December 1983 column from Alan Beagley in Australia ("For Your Information," page 508). Obviously, Mr. Beagley's friend is a novice user of the Superfile utility program since neither he nor Mr. Beagley realized that the power of the rename facility lies in its being able to rename any filename to any other filename, even ones that are illegal in CP/M. Therefore, the file he accidentally renamed to MAIL LIS could have easily been renamed again using the Superfile utility program. You don't need DU, Spat,

or some other program to do this.

FYI Inc. (the maker of Superfile) gives the utility program away with Superfile. When I asked the company why it went to the trouble to write the utilities, FYI said that it wrote it for its own use and decided to include it with Superfile for customers who needed its capabilities.

It is also obvious from your comments last June and your comments after Mr. Beagley's letter that you have not taken the time to learn what Superfile really does. But I'll bet even you will be as-

tounded by FYI's newest product called FYI 3000 (available on the IBM PC). I recently used one and could hardly believe my eyes. This program takes standard text files from my word processor and cross-indexes all the paragraphs in the files, using every word as a keyword. FYI says that it will handle 65,000 keywords and 65,000 paragraphs (with 500 words each) in a single filing system. One more amazing feature of FYI 3000: it gives me a count of each word in my text so I can analyze my word usage.

If you call FYI, I'll bet it will send you a review copy of FYI 3000 if you promise to give it a closer look than you did Superfile. Please try to reorient your thinking from the fixed-field approach to the more natural free-format approach used by Superfile and FYI 3000.

I read your column and appreciate your frank approach. However, I do wish you would be a little more careful in your research so that you don't give your readers erroneous advice.

John Shine

*You may recall that FYI's silly licensing agreement was so terrible that I couldn't legally run its software, since I have to use more than one machine. I understand it has changed that and made other changes as well. Apparently I had an early copy of the program; in any event, I haven't seen the updated version you describe.*

*Although I do sometimes solicit review software, for a while there was such a long queue of good stuff that I hesitated to add to it. Now that we've added to the permanent staff, things are a little better here at Chaos Manor. A little better. . . Jerry*

*Jerry Pournelle welcomes readers' comments and opinions. Send a self-addressed, stamped envelope to Jerry Pournelle, c/o BYTE Publications, POB 372, Hancock, NH 03449. Please put your address on the letter as well as on the envelope. Due to the high volume of letters, Jerry cannot guarantee a personal reply.*

*Jerry Pournelle is a former aerospace engineer and current science-fiction writer who loves to play with computers.*

## Comprehensive Graphics at Practical Prices

Imaginator 2 adds smart graphics to your H/Z-29 terminal. You gain high speed, high resolution graphics with Tektronix® 4010/4014 compatibility standard.

### Check these outstanding features:

- 1 Fast — 500,000 pixel per second vector drawing rate
- 1 High Resolution — 672 x 500 pixel graphics
- 1 Standard 1024 x 1024 memory plane
- 1 Hardware "Pan" and "Zoom"
- 1 Up to 24 pages of graphics memory, 6 standard
- 1 Instantaneous paging facilitates animation
- 1 Tektronix® 4010/4014 compatibility with GIN mode, standard
- 1 High speed graphics character generator
- 1 Commands may be directly output from any language
- 1 Hard copy directly from terminal via optional port
- 1 Dual processor architecture for greater efficiency
- 1 Expandable to full color and/or gray scale

Also ask us about our Imaginator 1 upgrade for H/Z-19 terminals and H/Z-89 computers.

Call or write us today for additional information.



18001 Englewood • Cleveland, OH 44130 • 216/243-1198

# Your Z-29 Can Do This...

# IMAGINATOR



Imaginator is a registered trademark of Tektronix, Inc. Superfile and Imaginator are trademarks of Cleveland Codonics, Inc.



**WE SELL WHAT YOU NEED... NOT JUST WHAT WE STOCK. PLUS... LOW PRICES. TECH SUPPORT AND RELIABILITY.**

DISKETTES	3M	MEMBER
5250 - 8 IN	\$2 20/50	\$2 35/100
5250 - 5 1/4 IN	\$2 10/50	\$2 05/100
5250 - 5 1/4 IN	\$2 10/50	\$2 10/100
5250 - 5 1/4 IN	\$2 05/50	\$2 05/100
5250 - 5 1/4 IN	\$4 30/50	\$4 45/100

PLASTIC STORAGE BOX WITH KEY FOR 100 DISKETTES #24 00

TAPES AND CARTRIDGES (300)		
DC1000	\$15.20/1-10	\$14.10/10+
DC3000	\$24.70/1-10	\$21.50/10+
1/4 IN FT TAPE REEL	\$15.00/10-50	\$14.25/50+
1/4 IN FT TAPE REEL	\$18.25/10-50	\$15.00/50+

MINICASTER DRIVES		
10MB (FORMATTED)		\$535
15MB (FORMATTED)		\$750
20MB (FORMATTED)		\$950
32MB (FORMATTED)		\$1155

FLOPPY DRIVES	INTERNAL	EXTERNAL
IBM/RADIO SHACK S SIDE	\$195	\$255
IBM/RADIO SHACK S SIDE	\$245	\$335
APPLE		\$210

HARD DISK SUBSYSTEMS	5MB	10MB	15MB
APPLE	\$1250	\$1450	\$1650
IBM	\$1300	\$1500	\$1700

**Met-Chem**  
Met-Chem International Corporation  
2911 Dixwell Avenue, Hamden Conn 06518  
Phone (203) 248-3212 or 1-800-839-7436

Circle 256 on inquiry card.

**TeleVideo USERS RETAIL**

- Fast Dump/Restore CPM, TurboDOS over 600k per disk ..... \$90.00
- BasicZ with GraphZ ..... \$345.00
- TurboDOS for TeleVideo ..... from \$300.00
- LYNC Communications Package ..... \$195.00
- 8" Disk Drive for 802 and 800A Drive, board and software ..... \$1200.00
- RM/COBOL Systems ..... from \$250.00
- DataFlex 2.0 ..... from \$750.00

**New!** 803, 803H, TPC-1 and MOUSE programs:  
Draw! ..... \$90.00  
Games Pak I ..... \$34.95

- 816 and 806C Tape Backup ..... from \$175.00
- Salt Standby Power Systems: 200MA/400MA/800MA ..... from \$550.00

**New!** Anti-Static Products ..... from \$39.95  
RM/COBOL trademark of Ryan-McFarland Co.  
CPM trademark of Digital Research  
TurboDOS trademark of Software 2000  
LYNC trademark of Norton-Lambert  
DataFlex trademark of Data Access

**PLUS OTHER GOOD TELEVIDEO STUFF!**  
**COGITATE, INC.**  
SPECIALISTS IN UNIQUE TELEVIDEO SOFTWARE  
24000 Telegraph Road, Southfield, MI 48034  
(313) 352-2345  
VISA/MASTERCARD Accepted

Circle 82 on inquiry card.

**IBM® PC/XT COMPATIBLE OEM COMPONENT SALE**

- Computer Case ..... \$140.00
- Key Board ..... \$199.00
- Power Supply ..... Call
- Mother Board-Bare ..... \$ 95.00
- Mother Board without ICs ..... \$225.00
- Mother Board with ICs ..... \$525.00

Dealers/OEM Buyers  
Quantity Discounts Available.

All items are fully PC/XT Compatible. Case comes with interchangeable rear panel for PC Users. Bare board comes with complete instruction with part list. 90 days manufacturers warranty on all items.

VISA and MasterCard welcome  
Price change without notice  
IBM is a trademark of International Business Machine

**HiTech International, Inc.**  
4946 El Camino Real, Suite 101  
Los Altos, CA 94022 (415) 949-0141  
TLX 171854 IBC

Circle 199 on inquiry card.

Let your fingers do the shopping in the "Electronic Mall"

For all of your Radio Shack and TRS-80™ Needs  
Save Time - Save Money!

**GO PE-1**  
Now on CompuServe

Pan American Electronics  
(800) 531-7466/(512) 581-2756  
Telex 767339  
1117 Conway Ave.  
Mission, Texas 78572

Circle 306 on inquiry card.

(6502 & Z-80 dual processor) 84K COMPUTERS (Apple compatible) in super modern styles US\$420

US\$400  
US\$360  
US\$425

IBM pc compatible, parts, (Above prices exclude drives, monitor) case, CPU, etc.  
-Add 5% as shipping charge \$CALL  
(Detail brochure forwarded on request)  
•We also sell cases, keyboards, power supplies, motherboards, components separately and interfaces.  
•Full repair & guarantee available  
•Assembled in Canada with USA. (Shipment from WA, USA.)  
ABC COMPUTERS LTD. (6 stores in B.C. Canada)  
683 E. HASTING ST., VANCOUVER, B.C. CANADA V6Z 2Z8  
PH: (604) 254-2634 & 254-1082 Dealer requires visa/mc  
Apple is a registered trademark of Apple Computer Inc.

Circle 12 on inquiry card.

**AFFORDABLE M-68000 COMPUTER SYSTEM**

**M68KCPU** 6-10 MHz CPU, 20K static RAM, 16K EPROM, on board monitor, two RS-232 serial ports, 16-bit parallel port, 5 timer/counters expansion bus.  
Bare board.....\$ 99.95  
Complete Kit ..... \$515.00

**M6812K** 128-512K static RAM, floppy disk controller & hard disk interface  
Bare board.....\$ 99.95  
Complete Kit (128K) ... \$725.00

**M68KE** Enclosure with power supply, fan, filter, 4 slot card cage ..... \$249.00

**M68KABM** M68000 Macro Cross Assembler for CP/M80, IBM PC, TRS-80 and Apple II computers ..... \$149.00

UPS shipping & handling \$ 4.00  
COD orders add \$ 3.00  
Foreign orders add \$20.00  
California residents add 6.5% tax

**EMS Educational Microcomputer** (714) 553-0133  
Systems  
P.O. Box 16115 • Irvine, CA 92713

Circle 154 on inquiry card.

**DATA ACQUISITION and control for ANY computer**

The Model 8232 communicates via RS-232, and has 8 analog inputs (0-5 VDC; 8 bits), 8 digital inputs and outputs, and a 2000 point buffer. Suitable for field data logging or lab use, the 8232 costs only \$540. Direct bus-connect unit for TRS-80/III & 4 is \$295. Detailed manual, \$6. Phone our applications engineer or write:

★★ **STARBUCK DATA COMPANY** ★★  
PO Box 24, Newton, MA 02162 (617) 237-7695

Circle 364 on inquiry card.

**INDUSTRIAL CONTROL MICROCOMPUTERS**

We have six single board computers, two video boards and 20 other control products. You can use our products for security systems, heat control, light control, automated slide show, traffic lights, irrigation systems, home computer systems, automated process control, and robot control just to name a few. OEM prices available. For catalog call or write to:

**JOHN BELL ENGINEERING, INC.**  
1014 CENTER STREET  
SAN CARLOS, CA. 94070  
(415) 592-8411

Circle 56 on inquiry card.

**HARD DISK DRIVE SURPLUS SALE!**

**\$350 ea.\***

\*Say you're a BYTE reader to get this special price — normally \$380!

High reliability 8" Shugart SA 1002 5.33 Mbyte drives for \$350. ea., unused in their original factory packed cartons. 1000's of pleased customers. Also available: new Western Digital controller card (\$350.); interfaces for IBM, Apple, S-100, STD, Heath/Zenith, SS-50, SS-30. Shipping for drive, \$12. Call before they're gone — LIQUIDATORS, 803-877-9828, or send check or money order to 105 S. Main St., Greer, S.C. 29651

Circle 235 on inquiry card.

# EPSON



**Minor miracle.**

Alcalá



You've never seen anything quite like the new Epson LQ-1500 Business Printer. It switches effortlessly back and forth between draft and letter-quality printing, on fanfold or single sheet paper. And it does it at a price every office can afford.

**Two for one.**

With the LQ-1500 in draft mode, you can race through a report at 200 characters per second. Then switch over to letter quality and polish off a pile of correspondence four times faster than the average daisy wheel.

Need graphics? The LQ-1500 gives you business charts with a crispness and definition you wouldn't think possible in a dot

matrix. And with the LQ-1500's 15.5-inch carriage, your spreadsheets and ledgers can take on a distinction they've never had before.

**The secret.**

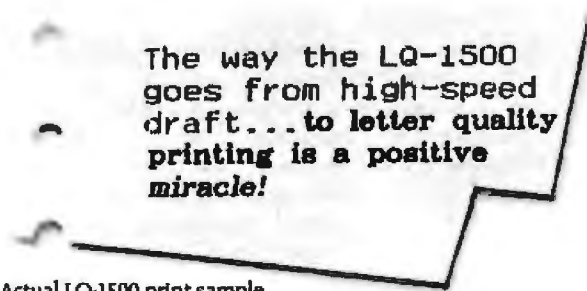
The Epson LQ-1500 is the logical extension of Epson's outstanding dot matrix printers. Instead of nine "wires" forming each letter, however, the LQ-1500 has 24. So you get letter-quality characters to rival fine office typewriters. In proportional. Italic. And condensed, expanded, subscript, superscript and over 200 other different typefaces. All without changing a print wheel. With the LQ-1500, you can even create 128 characters or symbols of your own and add them to the printer's internal memory.

**String of miracles.**

For Epson, the LQ-1500 is just one more in a long line of miracles, many of which are also on display at your neighborhood computer dealer.

And like all products in the Epson line, the LQ-1500 is now backed by a one-year warranty on parts and labor, ready to go to work with just about any personal computer made, and available in more places than any other brand.

But that's not really miraculous. That's just Epson.



The way the LQ-1500 goes from high-speed draft... to letter quality printing is a positive miracle!

Actual LQ-1500 print sample.

**Number one. And built like it.**

**EPSON**  
EPSON AMERICA, INC.

3415 Kashiwa Street, Torrance, California 90505

Call (800) 421-5426 for the Epson dealer in your area. In California call (213) 539-9140.

Epson is a registered trademark and LQ-1500 is a trademark of Epson America, Inc.

\*With optional tractor unit

Circle 168 on inquiry card.

# Event Queue

## May 1984

### May-June

**Computer Showcase Expos**, various sites throughout the U.S. National and local vendors exhibit a broad range of small systems, peripherals, software, services, and supplies. For a show schedule, contact the Interface Group Inc., 300 First Ave., Needham, MA 02194, (800) 325-3330; in Massachusetts, (617) 449-6600.

### May-June

**Courses from QED Information Sciences**, various sites throughout the U.S. and Canada. A few of the courses to be held are "Project Management," "Systems Design," and "Structured Programming." For a complete list of titles, contact Priscilla Goudreault, QED Information Sciences Inc., QED Plaza, 170 Linden St., POB 181, Wellesley, MA 02181, (800) 343-4848; in Massachusetts, (617) 237-5656.

### May-June

**National Educational Computer Library Conferences**, various sites throughout the U.S. The National Educational Computer & Technology Conference and the Eastern and Southern Educational Computer Conferences are on the agenda this spring. For details, contact National Educational Computer Library, POB 792, Torrington, CT 06790, (203) 489-2728.

### May-June

**Productivity '84**, various sites throughout the U.S. This series of two-day programs serves as a showcase of Hewlett-Packard products. Seminars are available, and more than 25 products are to be demonstrated, including the HP 150 personal computer and laser printers. Ad-

mission is free. For more information, contact Hewlett-Packard, Public Relations Department, 3000 Hanover St., Palo Alto, CA 94304, (800) 554-4466.

### May-June

**Seminars from the Continuing Education Institute**, various sites throughout the U.S. Among the seminars offered are "Database Machines: An Overview," "Modern Techniques in Digital Signal Processing and Spectral Estimation," and "Peripheral Array Processors." For complete information, contact Continuing Education Institute, Oliver's Carriage House, 5410 Leaf Treader Way, Columbia, MD 21044, (301) 596-0111; in California, (213) 824-9545.

### May-June

**Seminars from Datapro Research Corporation**, various sites throughout the U.S. Subject areas include data communications, microcomputers, and information systems. In-house presentations of technical programs can be arranged. For a 40-page catalog of seminars, contact Datapro Research Corp., 1805 Underwood Blvd., Delran, NJ 08075, (800) 257-9406; in New Jersey, (609) 764-0100.

### May-June

**Seminars from Technology Transfer Institute**, various sites throughout the U.S. The Technology Transfer Institute sponsors the James Martin Seminar and a one-day executive-only seminar called "The End-User Revolution." The programs explore such topics as evolving to electronic banking, relational database, and executive strategies for the information age. Full details on the seminars, registration, and meeting locations are available from the Technology Transfer Institute, 741 10th St., Santa

Monica, CA 90402, (213) 394-8305.

### May-June

**Understanding Microprocessor-based Equipment and Troubleshooting**, Chicago, IL, Detroit, MI, and Minneapolis, MN. This comprehensive four-day seminar provides a background in microprocessor fundamentals and troubleshooting techniques for technicians and engineers. Equipment familiarization and hands-on experimentation are emphasized. On-site presentations can be arranged. For information, contact the Registrar, Micro Systems Institute, Garnett, KS 66032, (913) 898-6152.

### May-July

**Courses from Integrated Computer Systems**, various sites throughout the U.S. Among the courses to be presented are "Designing with 16-bit Micros," "Programming in C: A Hands-on Workshop," and "Hands-on Unix Workshop." The fee for each course is \$895. Enrollment details are available from Ruth Dordick, Integrated Computer Systems, 6305 Arizona Place, POB 45405, Los Angeles, CA 90045, (213) 417-8888.

### May-July

**Reliability and Maintainability Engineering Institutes and Short Courses**, various sites throughout the U.S. A couple of the programs to be offered are "Reliability Engineering, Testing, and Maintainability Engineering" and "Mechanical Reliability and Probabilistic Design for Reliability—The Stress/Strength Interference Approach to Designing a Desired Reliability into Components and Equipment." For a complete schedule, contact Dr. Dimitri Kececioglu, Col-

lege of Engineering, Aerospace and Mechanical Engineering Department, University of Arizona, Tucson, AZ 85721, (602) 621-2495.

### May-August

**Compuworkshops Computer Seminars for Educators**, various locations throughout California. Among the seminars offered are "Authoring Tools and Word Processing for Educators," "BASIC Programming for Educators," "Designing Educational Courseware," "Computer Literacy for Educators," and "How to Set up a Computer-based Education Program in Your School or District." The fee is \$50 per course. For details, contact Compukids of Seal Beach, Rossmoor Shopping Center, 12385 Seal Beach Blvd., Seal Beach, CA 90740, (213) 430-7226; West Los Angeles, (213) 473-8002; Tarzana, (213) 343-4008; Rancho Bernardo/San Diego, (619) 451-1742.

### May-August

**Conferences and Expositions from the Society of Manufacturing Engineers**, various sites throughout the U.S. and around the world. More than 25 conferences and expositions are scheduled. For a calendar, contact the Public Relations Department, Society of Manufacturing Engineers, One SME Dr., POB 930, Dearborn, MI 48121, (313) 271-0777.

### May-August

**Courses in C Language and Unix**, Concord, MA, Somers Point, NJ, and College Park, MD. Three five-day courses are offered: "C Programming Workshop," "Advanced C Topics Seminar," and "Unix Workshop." For complete details, contact Joan Hall, Plum Hall Inc., 1 Spruce Ave., Cardiff, NJ 08232, (609) 927-3770.



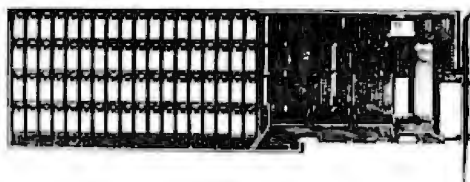
# IBM PC/XT COMPATIBLE

## 10MB and 20MB WINCHESTER



Chrislin's 10MB & 20MB Hard Disks come with host interface adapter, controller, winchester drive, power supply and cable

Enhance your system with a  
**CHRISLIN HARD  
DISK SUBSYSTEM  
and  
MEMORY**



Each Chrislin memory comes with an RS232C (serial) port, RAM disk emulator and 256KB-512KB of parity memory.

*"DEALER INQUIRIES INVITED"*

# DEC LSI-11 COMPATIBLE

## 10MB to 140MB Q-BUS WINCHESTER

Each winchester comes with 2MB dual drive, double density (8") floppy backup. All systems include controller and cabling.

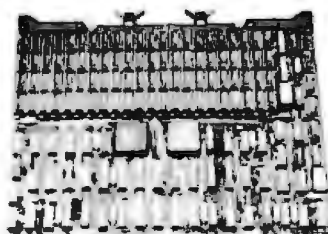
### EMULATION RL02

10MB Winchester/Floppy (8") \$4495  
20MB Winchester/Floppy (8") \$4995  
40MB Winchester/Floppy (8") \$5995

### EMULATION RK06/RK07

42MB Winchester/Floppy (8") \$6995  
70MB Winchester/Floppy (8") \$7195  
140MB Winchester/Floppy (8") \$8195

Call for pricing on RM02 emulation and / or tape backup.



## 256KB to 4MB Q-BUS MEMORIES

### UP TO 4MB QUAD

- Control status register
  - On board parity
  - Block mode DMA
- SINGLE QTY. PRICE: 1MB \$1975

### UP TO 2MB QUAD EDC

- Error detecting & correcting
  - Block mode DMA
  - Battery back-up mode
- SINGLE QTY. PRICE: 512K \$1495

### UP TO 1MB DUAL

- Control Status Register (CSR)
  - On board parity generator checker
  - Battery back-up mode
- SINGLE QTY. PRICE: 256KB \$525

## MICRO COMPUTER CI-MICRO-11 SYSTEM FEATURES

- 11/23 PLUS CPU board which includes two serial lines diagnostics and boot or 11/73 CPU
- 22 bit addressing backplane and power supply
- 256KB - 4MB of parity memory (Block Move, CSR)
- RD51, 10MB, 20MB or 40MB 5¼" (13.3cm) mini winchester disk or a subsystem from 10-140MB
- RX50 1.6 MB 5¼" (13.3cm) dual mini-floppy disk or 2 MB RX02 floppy
- An eight slot quad LSI-11 BUS backplane

## STANDARD CONFIGURATION

LSI 11/23 CPU, 256KB memory, 20MB winchester, 800KB dual floppy, 2 serial I/O, bootstrap, power supply, 4 x8 backplane all in a rack mountable chassis. \$6850

*"OFFERING QUALITY WITH AFFORDABLE PRICING"*

See us at NCC '84.  
Booths D3530 and D3532



# Chrislin Industries, Inc.

31352 Via Colinas • Westlake Village, CA 91362  
Telephone: 818-991-2254 • TWX 910-494-1253 CHRISLIN WKVG

RL02, RK06, RK07, QBUS, LSI, DEC are Trademarks of Digital Equipment Corporation. IBM is a Trademark of International Business Machines.

## Event Queue

*May-August*

**Digital Consulting Associates' Classes and Seminars**, various sites throughout the U.S. For descriptions of seminars and classes on dBASE II, Lotus 1-2-3, database administration, and other micro-computer-related topics, contact Digital Consulting Associates Inc., 339 Salem St., Wakefield, MA 01880, (617) 246-4850.

*May-August*

**Software Banc Seminars**, various sites in the U.S. and Canada. Such seminars as "Problem Solving with 1-2-3," "dBASE II," and "Exploring Unix" are planned. For information and registration, contact Software Banc Inc., 661 Massachusetts Ave., Arlington, MA 02174, (800) 451-2502; in Massachusetts, (617) 641-1241.

*May-September*

**Computer Competence Seminars**, Boston University Metropolitan College, Boston, MA. This series of hands-on presentations is tailored for managers who know little or nothing about computers and for those who wish to sharpen their computing skills. Some of the seminars on the docket are "PCs for Improving Financial Analysis and Decision Support" and "Personal Computers for Sales and Marketing Professionals." Fees range from

\$225 to \$595. In-house programs can be organized. For details, contact Joan Merrick, University Seminar Center, Suite 415, 850 Boylston St., Chestnut Hill, MA 02167, (617) 738-5020.

*May-September*

**Technical and Management Seminars for Professionals**, various sites throughout the U.S. Subject areas encompass system-performance management, networking, personal computing, applications design and programming, real-time applications design, management development, and other issues relating to computers. On-site seminars can be arranged. For a brochure, contact Digital Equipment Corp., Educational Services, Seminar Programs BUO/E58, 12 Crosby Dr., Bedford, MA 01730, (617) 276-4949.

*May-October*

**Tutorial Short Courses from Hellman Associates**, various sites throughout the U.S. Among the courses offered are "VLSI Design," "Digital Control," and "Error Correction." Fees are generally \$895. For a descriptive brochure, contact Hellman Associates Inc., Suite 300, 299 California Ave., Palo Alto, CA 94306, (415) 328-4091.

*May-December*

**Seminars from the Institute**

for Professional Education, various sites throughout the U.S. Programs in statistics, management, simulation and modeling, personal computers, and computer science are offered. For an explanatory pamphlet, contact the Institute for Professional Education, POB 756, Arlington, VA 22216, (703) 527-8700.

*May 10-12*

**BYTE Computer Show**, McCormick Place, Chicago, IL. Seminars, product displays, and conference sessions are some of the highlights of this show sponsored by BYTE and *Popular Computing* magazines. For complete details, contact the Interface Group, 300 First Ave., Needham, MA 02194, (800) 325-3330; in Massachusetts, (617) 449-6600.

*May 11*

**Writing Efficient Programs**, Mathematics and Science Building, Room W-117, Montclair State College, Upper Montclair, NJ. Dr. Jon Bentley from Bell Laboratories will speak on writing machine-independent code. He will present a general set of rules for using this tool and show how those rules can speed up a program. A subtheme will address the problem of converting programming tricks into engineering techniques. For information, contact Gideon Nettler, Department

of Mathematics and Computer Science, Montclair State College, Upper Montclair, NJ 07043, (201) 893-4294.

*May 13-17*

**Computer Graphics '84**, Convention Center, Anaheim, CA. Panel discussions on specific standards, technical sessions exploring the application of standards in a working environment, and tutorials explaining standards will be complemented by an exposition. For details, contact the National Computer Graphics Association, Department ZF, Suite 601, 8401 Arlington Blvd., Fairfax, VA 22031, (703) 698-9600.

*May 14-17*

**The Twenty-fifth International Conference of the Association for the Development of Computer-based Instructional Systems**, Hyatt Regency Hotel, Columbus, OH. Guest speakers will focus on the problem of exchanging courseware between computer systems. The use of computers, education for the disabled, and computer-based instruction in home economics and music are other topics of interest. Hardware, software, and courseware will be demonstrated. Program particulars can be obtained from the Association for the Development of Computer-based Instructional Systems, 409

## PC-MATE SWITCH. \$99<sup>50</sup>!

Time-saving. Space-saving. Money-saving.

Our versatile push button PC Mate Switch series lets you connect two printers to one computer . . . or eliminate forms loading/unloading by keeping two dot matrix printers stocked . . . or pair one dot matrix printer with a slower Daisy wheel printer for finished letters.

Each PC Mate comes with one input panel connector, 2 output connectors on 8' ribbon cables. And for \$99.50, they're the best bargains around. Specify model.

Serial: RS-232/D-25, 20 leads switched

Parallel: Centronics 36 pin/20 leads switched.

For more information, write or call: **Hadax Electronics**, 79 Hazel Street, Glen Cove, NY 11542 (516) 876-7950

**HADAX ELECTRONICS**

The widest switch line in the industry. And growing.





# See What You'll Be Getting Into!

**1984  
Best Western International  
Road Atlas & Travel Guide**



**ASSURED RESERVATIONS**  
Stop by any Best Western.



To find the right place to stay at the right price, pick up your free copy of our full-color 300-page Travel Guide at any Best Western.\* It's loaded with maps, photos and details about 3,000 delightful Best Westerns in 2,100 cities worldwide.

\*or send \$2 (mailing cost) to Travel Guide, P.O. Box 10203, Dept. PM, Phoenix, AZ 85064. Allow 8 weeks.



*Stay with us!*

### **Instant Reservations**

Make reservations at any Best Western, contact your travel agent or call toll-free  
**1-800-528-1234.**



Andorra, Aruba, Australia, Austria, Barbados, Belgium, Canada, Denmark, Finland, France, Great Britain, Guadeloupe, Holland, Ireland, Italy, Liechtenstein, Luxembourg, Mexico, New Zealand, Puerto Rico, Sweden, Switzerland, United States, Virgin Islands, West Germany

# Some of the World's Largest computer companies

WANG IBM  
Apple TRS-80

## Call Us for medical systems on their machines. Why don't you...

The reason is simple. We do a better job  
and have more features than our competitors.

Below are just a handful of our special features.

- AMA Claim Form • Multiple Providers • Daily Journal
- Productivity Report • Superbill • Referral Letters
- RVS/ICDA Codes • Patient Recall • Financial Histories
- Hotline Service • Word Processing • Appl. Reminder
- Collection Report • Private A/R Aged
- Manual & Training System Available • 100,000 Patients
- 22,000 Patient Appointment System

Call your dealer for a FREE demonstration  
or call CMA about our low cost  
"See It In Your office"  
training units.



**MICRO COMPUTER DIVISION**  
55722 Santa Fe Trail  
Yucca Valley, California 92284  
(619) 365-9718

## Event Queue

Miller Hall, Western Wash-  
ington University, Belling-  
ham, WA 98225.

May 14-18

**Auditing in the Contempo-  
rary Computer Environment**,  
Honolulu, HI. Participants  
will learn a comprehensive  
audit approach for com-  
puter-based systems. Topics  
include how to evaluate con-  
trols, how to prepare an audit  
report, and how to design a  
program of tests using ques-  
tionnaires, checklists, soft-  
ware tools, and flowcharts.  
Contact Beth Ann Musto,  
EDP Auditors Foundation,  
373 South Schmale Rd.,  
Carol Stream, IL 60187, (312)  
682-1200.

May 15

**Breakthroughs in Artificial  
Intelligence**, Worcester Poly-  
technic Institute Campus,  
Worcester, MA. This ex-  
ecutive briefing explores the  
impact of artificial intelli-  
gence on corporate strategy.  
Sessions are limited. To re-  
serve a space, contact Kathy  
Shaw, Office of Continuing  
Education, Worcester Poly-  
technic Institute, Worcester,  
MA 01609, (617) 793-5517.

May 15-16

**Factory Systems Summit  
Conference**, Chicago, IL.  
Factory-automation experts  
will discuss total systems in-  
tegration and how to imple-  
ment them, new develop-  
ments in technology, and  
how to plan for the future.  
For details, contact Lisa  
Caruso, the Yankee Group,  
89 Broad St., Boston, MA  
02110, (617) 542-0100.

May 15-17

**Criminal Justice Systems  
Conference**, Virginia Com-  
monwealth University, Rich-  
mond, VA. Presentations and  
panel discussions on recent  
developments in criminal  
justice applications of com-  
puter technology are  
planned. Additional sessions

will address the uses of  
microcomputers in law en-  
forcement. The fee is \$20. In-  
formation is available from  
Ben Wood, Department of  
Criminal Justice Services, 805  
East Broad St., Richmond,  
VA 23219, (804) 786-4000.

May 15-17

**Electro/84 and Mini/Micro  
Northeast/84**, Boston, MA.  
Conference sessions will ad-  
dress a broad range of topics,  
including artificial intelli-  
gence, communications and  
networks, distributed sys-  
tems, microprocessor tech-  
nology, and robotics. For de-  
tails, contact Electronic Con-  
ventions Inc., 8110 Airport  
Blvd., Los Angeles, CA  
90045, (213) 772-2965.

May 15-17

**Micro City '84**, Exhibition  
Complex, Bristol, England.  
More than 100 companies  
will exhibit computers, busi-  
ness systems, and communi-  
cations equipment. For com-  
plete details, contact Tomor-  
row's World Exhibitions Ltd.,  
9 Park Place, Clifton, Bristol  
BS8 1JP, UK; tel: (0272)  
292156/7.

May 15-18

**Computacion '84**, U.S. Trade  
Center, Mexico City, Mexico.  
Computer equipment, pe-  
ripherals, services, and soft-  
ware for business will be ex-  
hibited. For complete details,  
contact the United States  
Trade Center, Centro de  
Comercio Estadounidense,  
Liverpool 31, 06600 Mexico  
City, Mexico; tel: (905)  
591-0155; Telex: 1773471  
USTCME.

May 16-18

**Data Communications**, Cin-  
cinnati, OH. Eighteen major  
topics, including concepts  
and definitions, types of  
data-communications equip-  
ment, modems, satellite com-  
munications, and protocols,  
will be addressed. Registra-  
tion is \$695; multiple dis-

# New Service



In CA (818) 701 6951

**800-645-3006** You may order  
the products advertised in this and  
following issues at our Toll Free Order  
desk.

No shipping charges — Freight Free  
Catalogs on request.

Toll Free Line compliments of



# Byte Book Club™

## POWERFUL TOOLS! POWERFUL SAVINGS!



Take any 3 books  
for \$1.00  
only each  
(Values up to \$79.50)

If you join now for a trial period and agree to purchase three more books—at handsome discounts—during your first year of membership. (Publishers' prices shown)

- |  |  |   |   |
|--|--|---|---|
| <p><b>SOFTWARE ENGINEERING: A Practitioner's Approach</b> By R. S. Pressman<br/>507/813B \$34.95<br/>(Counts as 2 of your 3 books)</p> <p><b>INTERACTIVE PROGRAMMING ENVIRONMENTS</b> By D. R. Barstow<br/>038/856B \$34.95<br/>(Counts as 2 of your 3 books)</p> <p><b>GUIDE TO THE IBM PERSONAL COMPUTER</b> By W. Sikonowicz<br/>574/847 \$19.95</p> <p><b>PROGRAMMING LANGUAGES: Design and Implementation, 2/e</b> By T. W. Pratt<br/>582879-0B \$29.95<br/>(Counts as 2 of your 3 books)</p> <p><b>THE CP/M BIBLE: The Authoritative Reference Guide to CP/M</b> By M. Waite<br/>582917-7B \$29.95<br/>(Counts as 2 of your 3 books)</p> | <p><b>AN INTRODUCTION TO VISICALC® MATRIXING FOR APPLE® AND IBM®</b> By H. Anbarlian<br/>016/054 \$22.95</p> <p><b>APPLE PASCAL</b> By P. Luehrmann<br/>491/712 \$20.00</p> <p><b>BUILD YOUR OWN Z-80 COMPUTER—and 280 USERS MANUAL</b> By S. Ciarcia &amp; J. Carr<br/>582337-3B \$29.90<br/>(Counts as 2 of your 3 books)</p> <p><b>MICROCOMPUTER OPERATING SYSTEMS</b> By M. Dahmke<br/>150/710 \$16.95</p> <p><b>THE MCGRAW-HILL COMPUTER HANDBOOK</b> By H. Helms<br/>279/721A \$79.50<br/>(Counts as 3 of your 3 books)</p> <p><b>SYSTEMS PROGRAMMING FOR SMALL COMPUTERS</b> By D. H. Marcellus<br/>582937-1B \$26.95<br/>(Counts as 2 of your 3 books)</p> | <p><b>MICROCOMPUTER GRAPHICS AND PROGRAMMING TECHNIQUES</b> By H. Katzan, Jr.<br/>582576-7 \$22.50</p> <p><b>BASIC: GETTING STARTED</b> By W. S. Davis<br/>582355-1 \$6.95</p> <p><b>PRINCIPLES OF INTERACTIVE COMPUTER GRAPHICS, 2/e</b> By W. M. Newman &amp; R. F. Sproull<br/>463/387B \$36.95<br/>(Counts as 2 of your 3 books)</p> <p><b>THE SMALL COMPUTER CONNECTION</b> By N. L. Shapiro<br/>564/124 \$15.95</p> <p><b>COMPUTER PROGRAMMING FOR GRAPHICAL DISPLAYS</b> By D. Ryan<br/>582931-2B \$26.95<br/>(Counts as 2 of your 3 books)</p> <p><b>CIARCIA'S CIRCUIT CELLAR, Volume 3</b> By S. Ciarcia<br/>109/656 \$15.95</p> | <p><b>A PROGRAMMER'S VIEW OF INTEL 432</b> By E. Organick<br/>477/191B \$29.95<br/>(Counts as 2 of your 3 books)</p> <p><b>DATABASE DESIGN 2/E</b> By G. Wiederhold<br/>701/326B \$33.00<br/>(Counts as 2 of your 3 books)</p> <p><b>CONVERSION OF COMPUTER SOFTWARE</b> By J. R. Walberg<br/>582588-0 \$19.95</p> <p><b>THE C PRIMER</b> By L. Hancock &amp; M. Krieger<br/>259/81X \$16.95</p> <p><b>INTRODUCING THE UNIX SYSTEM</b> By H. McGilton &amp; R. Morgan<br/>450/013 \$18.95</p> <p><b>BOWKER/BANTAM 1984 COMPLETE SOURCEBOOK OF PERSONAL COMPUTING</b> By R. R. Bowker<br/>582915-0 \$24.95</p> |
|--|--|---|---|

### Why YOU should join the Byte Book Club now!

- **Best and newest books from ALL publishers!** Books are selected from a wide range of publishers by expert editors and consultants to give you continuing access to the best and latest books in your field.
- **Big savings!** Build your library and save money too! Savings range up to 30% or more off publishers' list prices—usually 20% to 25%.
- **Bonus books!** You will immediately begin to participate in our Bonus Book Plan that allows you savings up to 70% off the publishers' prices of many professional and general interest books!
- **Convenience!** 14-16 times a year (about once every 3-4 weeks) you receive the Club Bulletin FREE. It fully describes the Main Selection

and alternate selections. A dated Reply Card is included. If you want the Main Selection, you simply do nothing—it will be shipped automatically. If you want an alternate selection—or no book at all—you simply indicate it on the Reply Card and return it by the date specified. You will have at least 10 days to decide. If, because of late delivery of the Bulletin you receive a Main Selection you do not want, you may return it for credit at the Club's expense.

As a Club member you agree only to the purchase of three additional books during your first year of membership. Membership may be discontinued by either you or the Club at any time after you have purchased the three additional books.

Fill out the card and mail today! If the card is missing, write to:  
**BYTE BOOK CLUB™**, P.O. Box 582, Hightstown, New Jersey 08520

## Event Queue

counts are available. For complete details and registration forms, contact Data-Tech Institute, 386 Franklin Ave., POB 569, Nutley, NJ 07110, (201) 661-2300.

May 16-18

**Teaching Math with Microcomputers**, Marriott Hotel, Miami, FL. This program, sponsored by the National Council of Teachers of Mathematics (NCTM), is designed to inform elementary, intermediate, and secondary school mathematics teachers how to effectively use the microcomputer as a classroom tool. For further information, contact NCTM, 1906 Association Dr., Reston, VA 22091, (703) 620-9840.

May 19

**The Seventh Annual Show & Tell Microcomputer Conference**, University of Oklahoma Mathematics and Physical Science Complex, Norman. Computer hobbyists are invited to speak briefly, demonstrate an example of their presentation, and answer questions. For details, send a self-addressed, stamped envelope to Show & Tell, Dr. Richard Andree, University of Oklahoma, Mathematics Department, 601 Elm St., Norman, OK 73019.

May 20-23

**The Fourth Annual Conference of the Association of Human Resource Systems Professionals**, Hyatt Regency, Fort Worth, TX. Roundtable discussions will address topics related to the theme "People, Data, and Systems... Putting It All Together." Embracing cross-disciplinary concerns and emphasizing the practical requirements of successful human-resource information-system development, discussions will explore networking, vendor evaluation, and time management. For

complete details, contact HRSP Inc., 3051 Adeline St., Berkeley, CA 94703, (415) 548-1364.

May 20-23

**Personnel Data Systems' 1984 Annual Users Conference**, Fairmont Hotel, Dallas, TX. On-line software demonstrations and sessions on Personnel Data Systems' products highlight this convocation. Contact Personnel Data Systems Inc., 15 East Ridge Pike, Conshohocken, PA 19428, (215) 828-4294.

May 20-23

**The Thirteenth Mid-Year Meeting of the American Society for Information Science**, Indiana University, Bloomington. The theme for this meeting is "The Micro Revolution: Implications for the Information Age." Joseph Weizenbaum, author of *Computer Power and Human Reason* and a professor of computer science at Massachusetts Institute of Technology, will speak. For more information, contact Stephen Harter, School of Library and Information Science, Indiana University, Bloomington, IN 47405, (812) 335-5113.

May 20-25

**The Fourth Jerusalem Conference on Information Technology—JCIT**, Jerusalem, Israel. Papers, panel discussions, workshops, and exhibits will emphasize software engineering and manufacturing related to the theme of this international event, the "Next Decade in Information Technology." The fee is \$225. Isratech '84, the national exhibition of high technology, runs concurrently with JCIT. For information on Isratech '84, contact the Government of Israel Trade Center, 350 Fifth Ave., New York, NY 10118, (212) 560-0660. For details on JCIT, contact the Fourth Jerusalem Conference on Information

Technology, POB 29313, 61292 Tel Aviv, Israel; tel: (03) 258-535.

May 21-22

**Evaluating Decision Support Software: Personal Computer, Mainframe, and Distributed Applications—A Managerial Perspective**, New York Hilton, Rockefeller Center, New York City. This conference will explore the influence of new developments in end-user computing, software design, distributed decision support, local-area networks, microcomputer technology, fourth-generation languages, and artificial intelligence. Further information is available from the DSS Conference, 215 First St., Cambridge, MA 02142, (617) 547-5061.

May 21-23

**AAMSI Congress 1984—The Third Spring Joint National Congress**, Hilton Hotel, San Francisco, CA. Invited and contributed papers, special sessions, tutorials, reviews, panel discussions, and demonstrations will focus on the applications of computers and information technology and systems to all fields of medicine. Program sponsors include a dozen professional organizations that have joined the American Association for Medical Systems and Informatics (AAMSI) in producing this three-day program. For particulars, contact AAMSI, Suite 402, 4405 East-West Highway, Bethesda, MD 20814, (301) 657-4142.

May 21-23

**Data Processing for the Non-Data Processing Executive, Part 2**, Miyako Hotel, San Francisco, CA. This is the second part of a program that addresses microprocessor and database technology, packaged software, and data communications. It's designed for people with a basic understanding of elec-

tronic data processing. In-house presentations are available. Register with the American Management Associations, POB 319, Saranac Lake, NY 12983, (518) 891-0065.

May 22-24

**Softwest '84**, Denver Merchandise Mart, Denver, CO. This conference and exhibition features educational seminars, lectures, and panel discussions on software, equipment, and peripherals for Apple and IBM computers. For information, contact the Colorado Conference Group, Suite C, 3312 Cripple Creek, Boulder, CO 80303, (303) 499-1034.

May 22-25

**COMDEX Spring**, Georgia World Congress Center, Atlanta. For details, contact the Interface Group, 300 First Ave., Needham, MA 02194, (800) 325-3330; in Massachusetts, (617) 449-6600.

May 22-26

**Micro Expo '84**, Palais des Congrès, Paris, France. Manufacturers and vendors of hardware, software, peripherals, and accessories for the microcomputer market will attend this conference and exposition. For details, contact Sybex France, Centre Paris Daumesnil, 4 Place Felix Eboué, 75583 Paris Cedex 12, France. In the U.S., contact the International Show Coordinator, Sybex Inc., 2344 Sixth St., Berkeley, CA 94710, (415) 848-8233.

May 22-26

**Oficom Korea 84—The International Korean Office and Information Management Exhibition and Conference**, Korea Exhibition Center, Seoul, South Korea. Exhibits will include demonstrations of computers, communications equipment, and business machines. Contact Clapp & Poliak International,



# COMPU SHACK

PRICES AND AVAILABILITY SUBJECT TO CHANGE WITHOUT NOTICE  
 ALL RETURNED MERCHANDISE SUBJECT TO A 20% RESTOCKING FEE.  
 ADD 10% FOR NET TERMS  
 PRICES GOOD IN U.S. ONLY.  
 PRICES REFLECTED IN THIS SECTION ARE LOWER THAN FRANCHISE STORES.

WE TEST EVERY COMPUTER SYSTEM BEFORE WE SHIP IT!



**IBM**  
 PERSONAL  
 COMPUTER  
 Special  
 of the  
 Month!

## IBM PC<sup>®</sup> COMPLETE LINE

### IBM PC

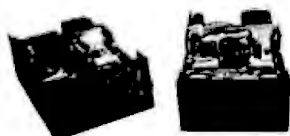
64K, Two 320KB Disk Drives, Floppy Disk Controller, Video Card and High Res Monitor. **\$2599.00**

### HARD DISK SYSTEM FOR IBM PC

256K IBM PC<sup>®</sup> 360KB Disk Drive, FDC, IOMB Hard Disk W/Controller, Cabinet Controller & Software, Video Card and Monitor. **\$3999.00**

Hard Disk Sub-System for IBM PC By TAVA CORP. .... **\$1275.00**

LOTUS 1-2-3 SOFTWARE . . . **\$399**



## FLOPPY DISK DRIVES For IBM PC

### ADD-ON DRIVE FOR PC Jr.<sup>®</sup> . . CALL

#### TANDON

TM-100-2 DS/DD . . . . . **CALL**

#### SLIMLINE 320KB

BY TAVA CORP. . . . . **\$199**

## PRINTERS

#### OKIDATA

82A . . . . . **\$429.00**  
 83A . . . . . **\$669.00**  
 84AP parallel . . . . . **\$999.00**  
 84AS serial . . . . . **\$1099.00**  
 92A . . . . . **\$525.00**  
 93A . . . . . **\$899.00**

#### BROTHER

HR-25 . . . . . **\$799**  
 Dalsywriter Dalsywheel  
 Printer . . . . . **\$1099.00**

#### NEC SPINWRITER



7710-1 . . . **\$2095** 3510 . . . **\$1495**  
 7715-1 . . . **\$2295** 3515 . . . **\$1495**  
 7730-1 . . . **\$2095** 3530 . . . **\$1695**  
 7720-1 . . . **\$2695** 3550 . . . **\$1995**  
 7725-1 . . . **\$2695** PC8023A . . . **\$ 595**

**COMPANY SHOWROOM**  
 WALNUT CREEK, CA  
 (415) 945-8011

## SPECIAL OF THE MONTH!



Desk Top IBM PC<sup>®</sup> Compatible Computer, 128K RAM, Two 320KB Disk Drives, Floppy Disk Controller, Video Adapter and Monitor, One Parallel Port, Two Serial Ports. System runs DOS 1.1, 2.0, and CP/M86<sup>®</sup>. **CALL FOR PRICE**

**Suggested List \$2395.00**

Low Price High Quality TAVA Personal Computer Uses The Industry Standard Operating Systems: CP/M86<sup>®</sup> MS DOS<sup>®</sup> UCSD p-system<sup>®</sup> One year warranty on all parts. Runs most of the Software for IBM PC, eg. Lotus 1-2-3<sup>®</sup> dBaseII<sup>®</sup> Words Star<sup>®</sup> Multiplan<sup>®</sup> PFS<sup>®</sup> and Thousands more



## TAVA PRODUCTS

Composite Hi Res Green Monitor **\$189.00**  
 TTL Hi Res Green Monitor **\$199.00**  
 Add \$15 for Amber  
 TAVA RGB Color Monitor **\$599.00**  
 No Glare  
 Color Graphics Card **CALL**  
 Monochrome Card . **CALL**  
 Floppy Controller . **\$199.00**  
 Floppy & Video Controller **CALL**

## AST RESEARCH

IO Plus-Parallel & Serial Port, Clock Calendar W/Bat back-up, Superdrive Superspool . . . . . **\$199.00**  
 Combo Plus—256K, Parallel & Serial Port, Clock Calendar W/Bat back-up, Superdrive, Superspool . . . . . **\$450.00**  
 Mega Plus—512K, Parallel & Serial Port, Clock Calendar W/Bat. back-up . . . . . **\$999.00**

## QUADRAM

Quad Board - 256K, Parallel Port, Serial I/O Clock Calendar with battery backup . . . . . **\$450.00**  
 512K Ram with Serial I/O . . . . . **\$799.00**

## CONOGRAPHIC

Color Card . . . . . **\$995.00**

## HERCULES GRAPHICS CARD

This card gives you 720x350 graphics . . . . . **\$499.00**

## BIG BLUE

. . . . . **\$479.00**

## HAYES MICROCOMPUTER PRODUCTS

Micromodem 300 baud . . . . . **\$299.95**  
 Smartmodem 1200 baud . . . . . **\$529.95**

Circle 83 on inquiry card.

## MONITORS

### AMDEK

300A . . . . . <b>\$199.00</b>	I . . . . . <b>\$349.00</b>
300G . . . . . <b>\$169.00</b>	II . . . . . <b>\$699.00</b>
310A . . . . . <b>\$199.00</b>	III . . . . . <b>\$399.00</b>
IV . . . . .	. . . . . <b>\$1199.00</b>



### APPLE IIe

Computer System Controller, Two Disk Drives, Monitor . . . . . **\$1699**

**BROTHER, TAVA, NEC, TANDON, SHUGART, TOSHIBA, AND OTHER MFRG. PRODUCTS AVAILABLE!**

# COMPU SHACK

HIGH TECHNOLOGY • LOW PRICES

CALL FOR STORE LOCATION



**COMPANY SHOWROOM**  
 TUSTIN, CA  
 (714) 730-7227

IBM PC is a registered trademark of IBM Corp.  
 \*OS/2 is a registered trademark of ASHTON-TATE, Inc.  
 LOTUS 1-2-3 is a registered trademark of Lotus Development  
 Wordstar, Speller, Mailmerge are registered trademarks of Micropro International  
 Visicalc is a registered trademark of Visicalc

Multiplan is a registered trademark of Microsoft Corp.  
 PFS is a registered trademark of Software Publishing Co.  
 CP/M86 is a registered trademark of Digital Research, Inc.  
 MS-DOS is a registered trademark of Microsoft Corp.  
 UCSDP is a registered trademark of Softech Microsystems.

PRODUCTS AND PRICES NOT AVAILABLE AT ALL STORES

ALL FLOPPIES REPAIRED QUICKLY AT LOW COST

**(714) 261-1000**

16861 ARMSTRONG, IRVINE, CA 92714  
 HEADQUARTERS/TELEX: 181467—ANSWER BACK: COMPU SHACK (IRIN)

## Event Queue

POB 70007, Washington, DC 20088, (301) 657-3090.

May 23

**Breakthroughs in Artificial Intelligence**, Loew's Summit, New York City. For details, see May 15.

May 23-24

**Automach-Australia '84**, Royal Hall of Industries, Showground, Sydney. This trade show serves to update Australian manufacturing industries on automated, integrated factory systems incorporating numerically controlled machinery, CAD/CAM, and robotics. For details, contact Mr. Greco, Howard Rotavator Pty., POB 82, Parramatta 2150, New South Wales, Australia; tel: 630-1231; Telex: AA21328. In the U.S., contact SME World Headquarters, One SME Dr., POB 930, Dearborn, MI 48121, (313) 271-1500.

May 23-24

**Distribution/Computer Expo '84**, Hyatt Regency, Chicago, IL. This is said to be the largest exhibit of computer systems and services for the transportation, distribution, logistics, and warehousing industries. Entrance fee per person is \$35. Registration brochures are available from CS Report Inc., POB 453, Exton, PA 19341, (215) 363-7156.

May 23-24

**The 1984 Trends and Applications Conference**, National Bureau of Standards, Gaithersburg, MD. Presentations will address current systems and applications as well as research into advanced concepts relating to the theme, "Making Database Work." Information can be obtained from Trends and Applications 84, POB 639, Silver Spring, MD 20901, (301) 921-3491.

May 23-25

**Data Communications**, Fort Lauderdale, FL. For details, see May 16-18.

May 23-25

**The Eighth Conference on Computer Applications in Radiology**, Stouffer's Riverfront Towers, St. Louis, MO. Patient information systems, personal computers and computers for the private office, teleradiology, computer-assisted instruction, and artificial intelligence are a few of the topics to be covered. Exhibits are included. The fee is \$350. For details, contact American College of Radiology, 20 North Wacker Dr., Chicago, IL 60606, (800) 227-5463; in Illinois, (312) 236-4963.

May 23-25

**The Third Annual European Semiconductor Industry Conference**, Hotel Kempin-

ski, Berlin, West Germany. International industry leaders will discuss issues facing the semiconductor industry. Contact Barbara Chupp, Dataquest Inc., 1290 Ridder Park Dr., San Jose, CA 95131, (408) 971-9000.

May 24

**The Selection, Care, and Feeding of Consultants**, College of Management, Georgia Institute of Technology, Atlanta. This course teaches business people with limited time and resources how to define problems and how to locate the trained consultant for the job. Office automation and productivity are a few of the problem areas to be considered. The course fee is \$175. Contact Elaine Hadden Nicholas, Department of Continuing Education, Georgia Institute of Technology, Atlanta, GA 30332-0385, (404) 894-2547.

Easy to install P.C. Kit  
All you do is assemble  
**Kit Includes:**

- Attractive Sturdy Case
- H.D. Power Supply with Built In Fan
- Detachable Low Profile Keyboard
- Mother Board fully wave soldered, stuffed & tested
- With Disc Drive Controller Card
- 5 Expansion Slots
- 128 K
- Teac 55B (DSDD-48 TPI)
- Complete instructions & documentation

# IBM Products

1-714-953-7411

Color Graphics Card with Printer Port

Disc Drive Controller Card

NOTE: Static & Dynamic Ram in Stock

NEW

## Dealer Inquiries Invited



3 1/4"  
Tabor  
Drive

Just Plug In!



5 1/4"  
NEW!  
Teac  
FD55B  
48TPI

Just Plug In!

Laser 1/2 High  
SSDD 48TPI  
163 KB  
40 Track  
with Patch



3 1/4" Apple  
NEW  
SSDD



## Apple Products

2 in  
1 Apple  
Acts As  
2 Drives

48TPI Drive  
Double Sided Drive By LASER  
Costs much less than 2 Drives DSDD-48TPI  
Disc Drive Control Card  
in stock also!



LASER  
FULL  
HIGH  
143 KB SSDD-48TPI  
35 Track



THE  
DOUBLE  
2-1/2 Hi. Drives  
in one case.

Disc Drives  
for  
Commodore 64

CANADA  
Pacific Rim Electronics  
13439 111th  
Edmonton Canada T5E4Z9  
403-475-0555

## LASER MICRO SYSTEMS

USA 1-714-953-7411  
1701 E. Edinger (Suite J-4)  
Santa Ana, CA 92705  
TLX: 181281 LASER SNA

TAIWAN  
P.O. Box 26-264  
Taipei, Taiwan ROC  
TLX: 12318 EOINTCOL

\*Eagle, IBM, Apple, Apple IIe, and Commodore are all registered trademarks of Eagle, IBM, Apple and Commodore corporations



---

**"95% of  
all PC information  
management needs  
can be handled  
by DATAEASE."**

***Ira Krakow, Independent Consultant;  
Business Computer Systems Reviewer***

DATAEASE — The totally integrated information management system that delivers ease-of-use without compromising power. Join the corporate clients that are turning to DATAEASE to get their information filed, sorted, analyzed and reported.

- AT&T
- Chemical Bank
- Exxon
- General Electric
- IBM
- Proctor & Gamble
- Prudential Life
- Stanford University
- Touche Ross
- United Technologies

**If you can read,  
you can build a powerful application with**

**DATAEASE™**

For a free demonstration diskette, call:  
**800-243-5123**



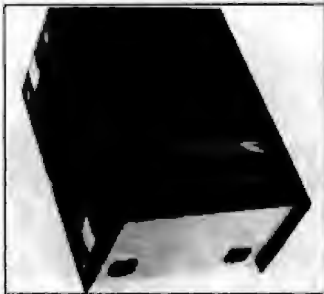
Software Solutions, Inc., Milford, CT 06460 • Telex 703972

**See us at COMDEX Booth 4710**

## MICRO CONTROLLED DIGITAL DATA RECORDER

### FEATURES:

Microprocessor controlled data buffering • Buffers data in RAM • Data comes in at any standard baud rate, plays back at any baud rate (switchable) • Tape runs only during block record/playback • RS232 input/output 110/220 v ac or 12 v dc • 1.2 MB per tape side • Uses chrome oxide audio cassettes • Has hold-off during playback via CTS line • No data hold-off during record.



### APPLICATIONS:

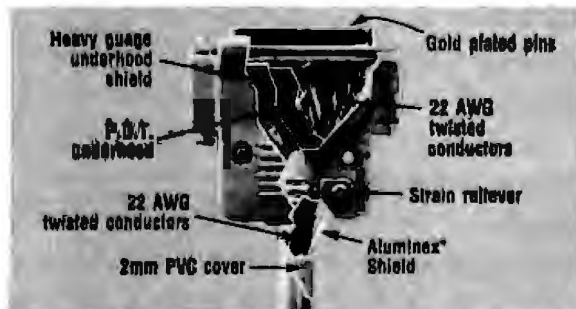
PROCESS CONTROL • POINT OF SALE • TELEPHONE SWITCH LOGGING (SMDR) • INSTRUMENTATION • DIAGNOSTIC SUPPORT • PROGRAM LOADING • DATA LOGGING.

BUFFERED VERSION MODEL PD1-BF..... \$595.00  
NON BUFFERED VERSION - MODEL PD-1.....\$335.00

TO ORDER, DIAL:  
(201) 356-9200



## BEFORE YOU BUY CABLE ASSEMBLIES,



## CHECK UNDER THE HOOD!

DATA SPEC™ cable assemblies are the very best. Each cable is fully shielded to exceed FCC EMI/RFI emission requirements. Furthermore, the unique P.D.T. technique is employed beneath the hood shield for maximum integrity under the most adverse conditions. DATA SPEC™ was the first to use the P.D.T. process, and cable assemblies constructed with P.D.T. carry a lifetime warranty. DATA SPEC™ has interface cables for all your requirements: Modems, Monitors, Disk Drives, and much more. Insist on DATA SPEC™ cables in the bright orange package. Available at better computer dealers everywhere. For more information, call or write:

# DATA SPEC™

A Division of Alliance Research Corporation

18215 Parthenia Street, Northridge, CA 91325 (818) 701-5853

## Event Queue

May 26-27

**The Third Annual Toronto PET User's Group (TPUG) Conference**, Constellation Hotel, Toronto, Ontario, Canada. This program consists of formal speeches, product exhibits, and a trader's corner for used computer equipment. For information, contact Chris Bennett, TPUG Business Office, 1912A Avenue Rd., Toronto, Ontario M5M 4A1, Canada, (416) 782-9252.

May 29-31

**Gulf Coast Computer and Office Show**, New Orleans, LA. Speakers, technical sessions, and product displays will highlight this exhibition. For full details, contact Gulf Coast Computer and Office Show, 119 Avant Garde Circle, Kenner, LA 70062, (504) 467-9949.

May 29-June 1

**The Technical Manager in a Dynamic Environment**, San Francisco, CA. The fee for this short course is \$875. Advanced registration is required. For information, contact Continuing Education in Engineering, University of California Extension, 2223 Fulton St., Berkeley, CA 94720, (415) 642-4151.

May 31-June 2

**Personal Computer and STD Computer Interfacing for Scientific Instrument Automation**, Blacksburg, VA. This workshop provides hands-on experience in wiring and testing interfaces. The fee is \$395. For more information, contact Dr. Linda Leffel, C.E.C., Virginia Polytechnic Institute and State University, Blacksburg, VA 24061, (703) 961-4848.

## June 1984

June

**Continuing Engineering Education Courses from**

**George Washington University**, Washington, DC. Courses include "Improved CAD/CAM Utilization," "Systems Analysis Techniques for Information Managers," and "Algorithm Design for Managers and Entry-level Programmers." Tuition ranges from \$625 to \$795. For complete course outlines, contact George Harrison, Continuing Engineering Education, George Washington University, Washington, DC 20052, (800) 424-9773; in the District of Columbia, (202) 676-6106.

June-August

**Engineering Summer Conferences**, Chrysler Center, North Campus, University of Michigan, Ann Arbor. Topics include aerospace, chemical, computer, information, control, electrical, nuclear, marine, metallurgical, mechanical/automotive, and industrial engineering. Courses will also be offered in written communications and optical technology. A continuing education unit is awarded for every ten hours of attendance and students are awarded certificates indicating the number of units earned. Lecture notes are provided. Fees range from \$450 to \$1000, depending upon course length. Room and board are additional. For more information, contact Engineering Summer Conferences, 200 Chrysler Center—North Campus, University of Michigan, Ann Arbor, MI 48109, (313) 764-8490.

June 1-3

**The First Annual Computer Country Fair & Exposition**, New Hampshire Voc-Tech College, Stratham. Demonstrations and displays of computer hardware and software for home, personal, and business uses will be featured. Adult admission is \$2.50. For more information, contact Julianne Cooper,



# Professional Software for the Software Professional

DMA products operate on  
the full range of  
Z80, 8086, 8088 processors,  
including the IBM-PC

## Here's what you can do!

### Application Creation

#### FORMULA II™

##### The Application Creator

The first and only Application Creator—a do-it-yourself concept for office automation. FORMULA II lets you define your files, forms, menus, and reports—FORMULA II then creates your program. FORMULA II includes a Database manager with an English Query language and a Form/Report Creator with word processing features.

### Communications

#### ASCOM™

ASCOM™ is the most versatile asynchronous communication package for microcomputers on the market. It features interactive, menu-driven, and batch operations; supports auto-answer and auto-dial modems; includes most popular protocols; provides network simulation; and many other options. Xerox Corporation, NCR, Monroe Systems for Business, and the big 8 accounting firms use ASCOM™.

**SYNC/COM™**—A bisynchronous communication package that will be configurable for a variety of systems and includes a flexible interface to the operating system. 2780/3780/3270 protocols available on microcomputers with appropriate hardware.

**TERMCOM™**—A configurable terminal emulator allowing any personal computer to emulate most conversational and selected block mode terminals with asynchronous communications. Available December 1983.

### Utilities

#### EM80/86™

This software emulator lets you use eight bit software on sixteen bit microcomputers without hardware modifications.

#### The 8086 O.S. Converter™

CP to MS—Permits execution of Digital Research's CP/M-86 programs under Microsoft's MSDOS (or PCDOS).

MS to CP—Permits execution of MSDOS programs under CP/M-86.

#### UT-86™

This package of user-friendly utilities for the IBM Personal Computer and similar systems includes copying, directory sorting, patching, and a general purpose file print utility.

### Coming Soon

**DMA."C"™**—A "C" language compiler which will generate either Z80 or 8086 assembly language code. Due to a unique optimization routine which is based upon a functional "P-code" model, the efficiency of DMA."C" will far exceed that of existing compilers.

# DMA DMA DMA

**WE SPEAK YOUR LANGUAGE WE SPEAK YOUR LANGUAGE WE SPEAK YOUR LANGUAGE**

DYNAMIC MICROPROCESSOR ASSOCIATES, INC.

545 FIFTH AVENUE, NY, NY 10017

Dealer Inquiries only • (212) 687-7115

## Event Queue

Cooper/GK, 41 Front St., Exeter, NH 03833, (603) 778-0344.

June 2-3

**The Ninth NJ-NY-CT Micro-computer Show & Flea Market**, Meadowlands Hilton Hotel, Secaucus, NJ. More than 250 vendors will display computer equipment, parts, supplies, software, and accessories. Admission is \$6. Contact Ken Gordon Productions, POB 13, Franklin Park, NJ 08823, (201) 297-2526.

June 4-5

**Electronic Motion Control Association Seminar**, Chicago, IL. This educational program combines tutorial sessions with technical paper presentations. Devices and systems will be displayed. For details, contact the Electronic Motion Control Association, Suite 1200, 230 North Michigan Ave., Chicago, IL 60601, (312) 372-9800.

June 4-6

**Advanced Project Management**, Berkeley, CA. The fee for this short course is \$645. Advanced registration is required. Contact Continuing Education in Engineering, University of California Extension, 2223 Fulton St., Berkeley, CA 94720, (415) 642-4151.

June 4-7

**Electronics in Oil and Gas/U.S.**, Convention Center, Dallas, TX. This exhibition will focus on electronics technology as it applies to processing, production, supervision, data control, communications, navigation, maintenance, testing, instrumentation, exploration, and safety. The conference program, held concurrently with the World Oil and Gas Show and Conference, will cover telemetry, sensing, computers, simulation, and automation. Complete par-

ticulars are available from Martin C. Dwyer International, 1350 East Touhy Ave., Des Plaines, IL 60018, (312) 299-9311.

June 4-7

**Robots 8**, Cobo Hall, Detroit, MI. More than 80 industry experts will expound upon the latest aspects of robot implementation, applications, and research. Nearly 250 builders and suppliers of industrial robots, related services, and components will exhibit their wares. For more information, contact RI/SME, POB 930, Dearborn, MI 48121, (313) 271-0023.

June 4-8

**The Thirteenth Annual Meeting of the MUMPS Users Group**, Adam's Mark Hotel, Philadelphia, PA. Introductory and advanced tutorials on MUMPS programming and applications, workshops, round-table discussions, site visits, and formal presentations will be offered. In addition, hardware, software, and systems will be demonstrated. Contact the MUMPS Users Group, Suite 308, 4321 Hartwick Rd., College Park, MD 20740, (301) 779-6555.

June 6-8

**Introduction to the Design of Fault-Tolerant Microcomputer Systems**, San Francisco, CA. This course serves as an introduction to such major topics in fault-tolerant computing as microprocessor testing, redundancy techniques, error correction and detection, and fault classification, detection, diagnosis, and recovery. The fee is \$650. For information, contact William C. Dries, Engineering and Applied Science, University of Wisconsin—Extension, 432 North Lake St., Madison, WI 53706, (800) 362-3020; in Wisconsin, (608) 262-2061.

June 6-8

**ACM SIGCOMM '84 Symposium on Communications Architectures and Protocols**, Montreal, Quebec, Canada. Address inquiries to Rebecca Hutchings, Honeywell/FSD, 7900 Westpark Dr., McLean, VA 22102, (703) 827-3982.

June 6-9

**The 1984 Rochester FORTH Applications Conference**, University of Rochester, NY. An international conference now in its fourth year, this convocation is appropriate for both experienced users and newcomers to the FORTH language. Invited speakers will discuss real-time systems and FORTH applications and techniques. Contact Diane Ranocchia, Institute for Applied FORTH Research Inc., 70 Elmwood Ave., Rochester, NY 14611, (716) 235-0168.

June 11-13

**Data Processing for the Non-Data Processing Executive, Part 2**, New York City. For details, see May 21-23.

June 11-15

**Auditing in the Contemporary Computer Environment**, New York City. For details, see May 14-18.

June 11-15

**Fiber and Integrated Optics**, Teaneck, NJ. This short course explores such fiber-optic components as single- and multimode fiber cabling, photo detectors, receiver and repeater technology, and optical-fiber sensors. The fee is \$875. For details, contact Continuing Engineering Education, George Washington University, Washington, DC 20052, (800) 424-9773; in the District of Columbia, (202) 676-6106.

June 11-15

**Managing the Audit Computer-based Bank Systems**, Chicago, IL. A course provid-

ing a comprehensive audit approach for evaluating and testing controls in computer-based bank systems. Information is available from Darlene Flooding, Bank Administration Institute, 60 Gould Center, Rolling Meadows, IL 60008, (312) 228-6200.

June 11-30

**Faculty Development Institute: Retraining in Computer Science**, Wheaton College, Norton, MA. The Faculty Development Institute, made up of introductory and intermediate courses, is designed to increase educators' capacity to teach computer science at the college level. The tuition is approximately \$1000, with additional expenses for room and board. For further information, contact Nercomp Inc., 439 Washington St., Braintree, MA 02184, (617) 848-6494.

June 12-14

**Advanced Manufacturing Systems Exposition & Conference—AMS 84**, McCormick Place, Chicago, IL. The theme for this event is "The Computer: Mind of the Factory of the Future." Demonstrations of information and automated production systems directed at the needs of manufacturing companies, more than 50 conference sessions, workshops, and short courses will be featured. Some topics of interest include planning for closed-loop systems, software selection and systems integration, systems implementation, artificial intelligence, and robotics. AMS runs concurrently with Info/Software (see below). For details on AMS 84, contact Clapp & Poliak, 708 Third Ave., New York, NY 10017, (212) 370-1100 or 661-8410.

June 12-31

**Info/Software**, McCormick Place, Chicago, IL. An exposition and conference de-



# WE MADE IT POWERFUL. BUT WE KEPT IT SIMPLE.

When you're cooking up a unique software product, it's not enough to think of all the right ingredients. You also have to mix them very carefully. Especially when you're serving the wide variety of people who use the IBM personal computer today.

Until now, if you wanted to use your IBM PC to turn data into meaningful information, you had to make an unappetizing choice between two kinds of data base management systems: Multifile systems so powerful they're difficult to use. Or single file systems so simple they can't be used to do much.

Until Power-base.™

Power-base is the only multifile data base manager powerful enough to get the job done, yet simple enough to be mastered in one sitting. Even if you've never used a computer.

There are no languages to learn, no commands to memorize. To tell Power-base what you want, simply keep choosing from the menu which never goes away, yet never gets in the way. Even making a selection is simple. You use the same three keys every time. To make a change, you simply make another choice.

And the unique DataZOOM™ gives you the power to move rapidly from file to file, right to the piece of information you need.

It's hard to make a simpler choice than Power-base.

Especially with a price so easy to digest: \$395.

Get a taste of Power-base for yourself. For a demonstration copy, send us \$10. It's refundable when you purchase Power-base at your local participating Computerland or other authorized dealer.

Power-base Systems, Inc. 12 West 37th Street, New York, NY 10018. (212) 947-3590.



**QUALITY PARTS AT DISCOUNT PRICES!**

<p><b>SUB-MINIATURE D TYPE CONNECTOR</b></p> <p>SOLDER TYPE SUB-MINIATURE CONNECTORS USED FOR COMPUTER HOUR UPS</p> <p>DB 15 PLUG \$2.75 DB 15 SOCKET \$4.00 DB 15 HOOD \$1.50 DB 25 PLUG \$2.75 DB 25 SOCKET \$3.50 DB 25 HOOD \$1.25</p>	<p><b>KEY ASSEMBLY 5 KEY</b></p> <p>CONTAINS 5 SINGLE POLE NORMALLY OPEN SWITCHES MEASURES 3 1/4" LONG</p> <p><b>6 KEY</b></p> <p>CONTAINS 6 SINGLE-POLE NORMALLY OPEN SWITCHES MEASURES 4 1/4" LONG</p>	<p><b>SOLID STATE RELAYS 2 AMP</b></p> <p>MOTOROLA 4 AMP 12002 RATED CONTROL - 3.0 5VDC LOAD - 120VAC 2 AMPS 1:1 COMPATIBLE SIZE 1 1/2" x 4 1/2" HIGH</p> <p>\$3.50 EACH 10 FOR \$12.00</p>
<p><b>"PARALLEL" PRINTER CONNECTOR</b></p> <p>SOLDER STYLE 36 PIN MALE USED ON "PARALLEL" DATA CABLES</p> <p>\$5.50 EACH</p>	<p><b>BCD DIP SWITCH</b></p> <p>10 POSITION ROTARY SCREWDRIVER ADJUST. FITS 5 PIN DIP</p> <p>\$1.85 EACH</p>	<p><b>120V INDICATOR</b></p> <p>NEON INDICATOR RATED 120 V 1/3 W MOUNTS IN 5/16" HOLE RED LENS</p> <p>75¢ EACH 10 FOR \$7.00 100 FOR \$65.00</p>

**FREE! FREE! FREE!** SEND FOR **NEW 1984 48 PAGE CATALOG**

<p><b>MINIATURE TOGGLE SWITCHES</b></p> <p>ALL ARE RATED 5 AMPS @ 125 VAC</p> <p><b>S.P.D.T. (on-on)</b></p> <p>P.C. STYLE NON-THREADED BUSHING 75¢ EACH 10 FOR \$7.00</p> <p><b>S.P.D.T. (on-on)</b></p> <p>SOLDER LUG TERMINALS \$1.00 EACH 10 FOR \$9.00 100 FOR \$90.00</p> <p><b>S.P.D.T. (on-off-on)</b></p> <p>SOLDER LUG TERMINALS \$1.00 EACH 10 FOR \$9.00 100 FOR \$90.00</p> <p><b>S.P.D.T. (on-off-on)</b></p> <p>NON-THREADED BUSHING P.C. STYLE 75¢ EACH 10 FOR \$7.00</p> <p><b>S.P.D.T. (on-on)</b></p> <p>P.C. LUGS THREADED BUSHING \$1.00 EACH 10 FOR \$9.00 100 FOR \$90.00</p> <p><b>D.P.D.T. (on-on)</b></p> <p>SOLDER LUG TERMINALS \$2.00 EACH 10 FOR \$19.00 100 FOR \$180.00</p>	<p><b>EDGE CONNECTORS</b></p> <p>22/44 22-44 GOLD PLATED CONTACTS 356 CONTACT SPRING</p> <p>\$2.00 EACH 10 FOR \$18.00</p> <p><b>5 STATION INTERLOCKING</b></p> <p>MADE BY ALPS 3-2PDT AND 2-8PDT SWITCHES ON FULLY INTERLOCKING ASSEMBLY 3 1/4" BETWEEN MOUNTING CENTERS.</p> <p>\$2.50 EACH</p> <p><b>5 STATION NON-INTERLOCKING</b></p> <p>SAME AS ABOVE EXCEPT EACH SWITCH OPERATES INDEPENDENTLY</p> <p>\$2.50 EACH</p>
---	--

**ALL ELECTRONICS CORP.**  
905 S. VERMONT • P.O. BOX 10400 • LOS ANGELES, CA 90000  
**TOLL FREE ORDERS • 1-800-826-5432**  
(IN CALIFORNIA: 1-800-258-6666)  
AK, HI, OR INFORMATION • (213) 380-8000

• QUANTITIES LIMITED • FOREIGN ORDERS INCLUDE SUFFICIENT SHIPPING • CALIF RES ADD 8.25%

**Event Queue**

voted exclusively to demonstrations of applications and systems software. Mainframe, minicomputer, and microcomputer software will be featured. Info/Software runs concurrently with AMS 84 (see above). Further information is available from Clapp & Poliak, 708 Third Ave., New York, NY 10017, (212) 370-1100 and (212) 661-8410.

Cormick Place West, Chicago, IL. Further information can be obtained from Mitch Hall Associates, POB 860, Westwood, MA 02090, (617) 329-8090.

**June 14-17**  
**BYTE Computer Show**, Convention Center, Los Angeles, CA. For details, see May 10-12.

**June 12-14**  
**Update '84**, Hyatt O'Hare Hotel, Chicago, IL. This forum is targeted at the information-management and micrographics industry. Trends in office automation technologies and their relevance to imaging and image-transmission capabilities will be considered along with the opportunities and competitive pressures that these technologies represent. For details, write to IMC Update '84, POB 34404, Bethesda, MD 20817.

**June 14-17**  
**International Computer Show**, Cologne, West Germany. Seminars, workshops, and hardware and software exhibits will highlight this international event. The focus is on informing users on buying-decision criteria, how to scrutinize software, and how to solve user's needs such as customer service, advice, and spare parts. Contact Messe- und Ausstellungs-Ges.m.b.H Köln, Messeplatz, Postfach 210760, D-5000 Cologne 21, West Germany; tel: (0221) 821-1; Telex: 8873 426 a mua d.

**June 13-15**  
**Clinical Laboratory Computers Symposium 1984**, Towsley Center, University of Michigan Medical School, Ann Arbor. Contact the Office of Continuing Medical Education, Towsley Center Box 057, University of Michigan Medical School, Ann Arbor, MI 48109, (313) 763-1400.

**June 16**  
**Writing for the Computer Industry**, Plymouth State College, Plymouth, NH. Topics to be addressed include how to write computer-related text for an international audience, electronic documentation, training and linguistic style, and how to integrate text and graphics. Contact Dr. Sally Boland, 5 Reed House, Plymouth State College, Plymouth, NH 03264, (603) 536-1550.

**June 13-15**  
**The Sixth Annual National Educational Computing Conference—NECC '84**, University of Dayton, OH. Papers, workshops, and exhibits are designed to promote a higher quality of classroom instruction in educational computing. Complete details on NECC '84 are available from Lawrence A. Jehn, Computer Science Department, University of Dayton, Dayton, OH 45469, (513) 229-3831.

**June 17-20**  
**The Seventeenth Annual Association for Small Computers Users in Education Conference**, Western Kentucky University, Bowling Green. This conference will focus on academic computing, robotics, computer applications in libraries, and the effective use and control of institutional word processing. Demonstrations and a

**June 13-15**  
**PC-World Exposition**, Me-

**INSTEAD OF CONTINUOUS FORM CHECKS!**

**ORDER PAPERCAPER II AND SAVE!**



► Save an average 7¢ per check with PaperCaper II.  
► Retain your personal check numbering sequence.  
► Carries 7 personal size checks or 2 letterheads.

**\$20**

► Minimum width printer 9 1/2".  
► Durable synthetic paper will last and last.  
► Check or VISA/Master Card (please give card number and expiration date.)

**Services Squared**  
Box 2665 • Las Cruces, NM 88004



# The Rixon PC212A... The Perfect Modem For Your IBM® PC ...Only \$499

The Rixon® PC212A offers you the only 300/1200 BPS full duplex card modem with auto dial and auto answer that plugs directly into any of the IBM PC®\* card slots. Because the Rixon PC212A was designed specifically for the IBM PC, it is loaded with user benefits.

The PC212A eliminates the need for an asynchronous communications adapter card and external modem cable, this alone saves you approximately \$190. The PC212A provides an extra 25 pin EIA RS232 interface connector, a telephone jack for alternate voice operation, and a telephone line jack for connection to the dial network.

Without question, the PC212A is the most user friendly, most reliable, and best performing modem for your IBM PC. An internal microprocessor allows total control, operation, and optioning of the PC212A from the keyboard.

A user friendly HELP list of all interactive commands is stored in modem memory for instant screen display. Just a few of the internal features are auto/manual dialing from the keyboard, auto dial the next number if the first number is busy and instant redial once or until answered.

In the event of power disruption a battery back-up protects all memory in the PC212A. In addition, the PC212A is compatible with all of the communication programs written for the Hayes Smartmodem™\*\* such as CROSSTALK.™† Also available for use with the PC212A is the

Rixon PC COM I,™‡ a communications software program (Diskette) and instruction manual to enhance the capabilities of the PC212A and the IBM PC. PC COM I operates with or replaces the need for the IBM

Asynchronous Communications Support Program. The program is very user friendly and provides single key stroke control of auto log on to multiple database services (such as The Source<sup>SM&</sup>), as well as log to printer, log to file transfer and flow control (automatic inband or manual control). PC COM I is only \$49.00 if purchased at the same time as the PC212A. The PC212A comes with a 2 year warranty. For more information contact your nearest computer store or Rixon direct at 800-368-2773 and ask for Jon Wilson at Ext. 472.

PC212A .....\$499.  
PC212A WITH  
ASYNCH PORT .....\$539.

BANGOR WESTON  
Schlumberger

**RIXON** INC.

2120 Industrial Pky., Silver Spring, Md. 20904  
301-622-2121 TWX 710-825-0071 TLX 89-8347



- \* IBM is a registered trademark of the International Business Machine Corp.
- \*\* Hayes Smartmodem is a product of the Hayes Stack™ series, a registered trademark of Hayes Microcomputer Products Inc.
- † CROSSTALK is a trademark of Microsoft Inc.
- ‡ PC COM I is a trademark of Rixon Inc.
- § The Source is a servicemark of Source Telecomputing Corp.

3043A © RIXON INC. 1983

See us Spring Comdex  
Booth 2740

## The Rixon PC212A Card Modem

Another Modem Good Enough To Be Called RIXON

Circle 338 on Inquiry card.

## Event Queue

site tour are on the docket. Contact Dr. Dudley Bryant, Western Kentucky University, Bowling Green, KY 42101, (502) 745-0111.

June 17-21

**International Banking Conference on Computer Networks**, Hilton, Tel Aviv, Israel. This educational program for bankers, corporate executives, government representatives, and electronics manufacturers will center around the theme, "Bank Transfers Via Computer Networks." Security and fraud concerns will also be discussed. The program will be complemented by speakers and an exhibition of computer products that support networking. For details, contact Nancy Italia, UMB/PSI Conference Coordinator, Suite 350, 2700 Cumberland Parkway, Atlanta, GA 30339, (404) 432-2892; Telex: 80-4294.

June 18-21

**People, Computers, and FORTH Programming**, Humboldt State University, Arcata, CA. This is a hands-on, introductory course for individuals wanting to gain an understanding of the internal workings of FORTH and enough knowledge to write applications programs. Prior experience using a computer language is advised. The fee is \$125 or \$175 with three quarter hours academic

credit. Register with Claire Duffey, Office of Continuing Education, Humboldt State University, Arcata, CA 95521, or call (707) 826-3731.

June 18-22

**The Fourth Annual Notre Dame Short Course Series: Computers in Biology**, University of Nevada-Reno. Three concurrent short courses on Computers in Biology will be offered: "Computers in Bioeducation," "Microcomputers in Classroom and Laboratory," and "Computerized Data Analysis in Biological Research." A computer background is not required. Most days will include lectures and hands-on sessions. Tuition is \$450. Contact Professor Theodore J. Crovello, Bio-computing Short Course Coordinator, Department of Biology, University of Notre Dame, Notre Dame, IN 46556, (219) 239-7496.

June 18-22

**Office Information System Software**, Massachusetts Institute of Technology, Cambridge, MA. This course provides a systematic treatment of the concepts behind the design of multifunction office workstations, including technologies, human factors, software, and applications generators. Further information is available from the Director of the Summer Session,

Room E19-356, MIT, Cambridge, MA 02139.

June 18-July 27

**Experimental Music Studio**, Massachusetts Institute of Technology, Cambridge. Two complementary sessions, "Techniques of Digital Audio Processing" and "Workshop in Computer Music Composition," make up this program. The former, which runs from June 18-29, provides a technical background as well as practical experience in digital sound-synthesis methods. The latter, which begins July 2, gives composers the opportunity to experiment with the computer as a musical instrument. Both workshops involve lectures, tutoring, and hands-on experience. No special technical knowledge is required. Application information is available from the Director of the Summer Session, Room E19-356, Massachusetts Institute of Technology, Cambridge, MA 02139.

June 19-21

**Computerized Office Equipment Expo/Office Information Systems Conference—COEE/OIS**, O'Hare Exposition Center, Rosemont, IL. For information, contact COEE/OIS Program Coordinator, Cahners Exposition Group, Cahners Plaza, 1350 East Touhy Ave., POB 5060,

Des Plaines, IL 60018, (312) 299-9311.

June 19-22

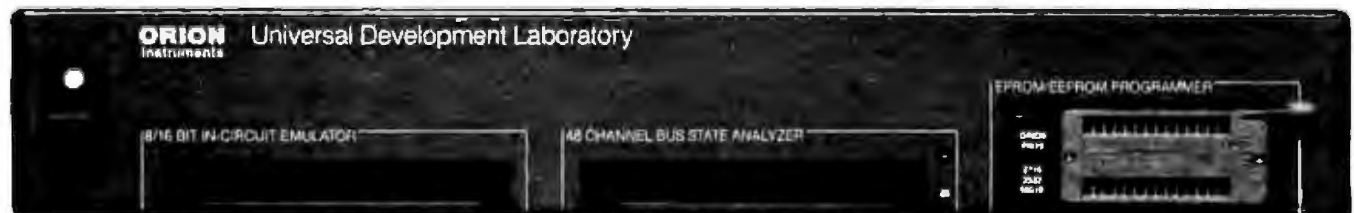
**Percom '84—The Second International Exhibition and Conference on Business and Personal Computers**, Jade Ballroom, Hotel Furama Intercontinental, Hong Kong. Exhibits at this show cover a wide spectrum of mini- and microcomputers, hardware, software, peripherals, accessories, components, and publications. The emphasis is on products for the commercial, manufacturing, and education industries. Contact Adsale Exhibition Services, 20/E, Tung Sun Commercial Centre, 194-200 Lockhart Rd., Wanchai, Hong Kong; Telex: 63109 ADSAP HX.

June 20

**How to Document a Computer System**, Sheraton Commander Hotel, Cambridge, MA. This seminar presents a series of procedures that covers the system-development process, including project initiation, study, design, programming, implementation, and maintenance. The fee is \$155. Contact Technical Communications Associates, Suite 210, 1250 Oakmead Parkway, Sunnyvale, CA 94086, (800) 227-3800, ext. 977; in California, (408) 737-2665.

## THE \$2395 DEVELOPMENT SYSTEM

Turns any personal computer into a complete micro-computer DEVELOPMENT SYSTEM. Our integrated control/display program runs under PCMS-DOS, CP/M, or TRS-DOS, and controls the UDL via an RS-232 port.



Up to 128K bytes of ROM EMULATION (8K standard) allows you to make program patches instantly. Since the target ROM socket connects data and address lines to both the analyzer and the emulator, no expensive adaptors or personality modules are needed.

The powerful BUS STATE ANALYZER features four-step sequential triggering, selective trace, and pass and delay counters. \$99 symbolic trace disassemblers are available for Z-80, 8048, 8500, 6800, 8031, 8085, 3870, Z-8, 1802, 8088, & 8088.

The PROM PROGRAMMER also doubles as a STIMULUS GENERATOR. For a brochure and list of cross assemblers call or write:  
172 Old Ave., Woodside, CA 94092  
(415) 861-1172

**ORION**  
Instruments



# John Fairchild likes our style

**DHL,<sup>#1</sup> Worldwide Courier Express, now makes time-critical deliveries overnight throughout the U.S.**

To cover the volatile, ever-changing world of fashion, "It's not enough to be fast," says John Fairchild, Chairman, Fairchild Publications. "You must be accurate and reliable."

That is what has made his *Women's Wear Daily* and *W* the leading barometers of the American fashion industry.

That same speed and reliability have made John Fairchild a steady client of DHL.

"For overnight delivery," says

Fairchild, "DHL is the next best thing to taking it there yourself."

From samples to sketches, from photos to contracts, DHL delivers all kinds of time-critical documents and packages overnight across the country.

**30,000 locations.**

**More on-time deliveries to**

**more places around the world than any other express courier.**

**Servicing 97% of the "Fortune 500."**

DHL's state-of-the-art delivery system encompasses 727s, Learjets, helicopters and fleets of trucks to speed things on their way.

As John Fairchild says, "I like their style."

**For information, call your local office of DHL Worldwide Courier Express.**



*John Fairchild  
- Chairman  
Fairchild Publications*

**NEXT BEST THING TO TAKING IT THERE YOURSELF**

## Event Queue

June 20-22

**The First International Conference on Computers and Applications**, Fragrant Hill Hotel, Peking, People's Republic of China. More than 100 technical papers on parallel processing, database systems, local-area networks, and distributed processing will be delivered at this joint technical program sponsored by the Chinese Institute of Electronics (CIE) and the IEEE Computer Society. Conference details can be obtained from the IEEE Computer Society, POB 639, Silver Spring, MD 20901, (301) 589-8142.

June 21-23

**The Great Southern Computer Show**, Veterans Memorial Coliseum, Jacksonville, FL. Hardware, software, peripherals, accessories, and word- and data-processing exhibits will be featured.

Workshops and seminars complement the displays. For registration information, contact Great Southern Computer Shows, POB 655, Jacksonville, FL 32201, (904) 356-1044.

June 22

**How to Document a Computer System**, Empire Hotel, New York City. For details, see June 20.

June 25

**How to Document a Computer System**, University Inn, Pittsburgh, PA. For details, see June 20.

June 26-28

**PCExpo**, Coliseum, New York City. This show is dedicated to the IBM Personal Computer market. Exhibits by manufacturers, software producers, and vendors will be complemented by a daily seminar program. Contact

PCExpo, 333 Sylvan Ave., Englewood Cliffs, NJ 07632, (201) 569-8542.

June 26-29

**Logo '84 Conference**, Massachusetts Institute of Technology, Cambridge. Four main themes, Logo Learning, Learning Environments, Technical Forecasts, and Images of Future Work, constitute the main program. Product exhibits will correspond with the discussions. Contact the Special Events Office, Room 7-111, Massachusetts Institute of Technology, Cambridge, MA 02139.

June 26-29

**Using FORTH Effectively**, Humboldt State University, Arcata, CA. This is a hands-on advanced course on the generation and internal operations of a FORTH system. A mastery of an introductory FORTH course or

minimum of six months using FORTH, knowledge of assembly language, and operating-system principles are prerequisites. The fee is \$150 or \$200 with three quarter hours academic credit. Registration information is available from Claire Duffey, Office of Continuing Education, Humboldt State University, Arcata, CA 95521, (707) 826-3731.

June 27-29

**Introduction to the Design of Fault-Tolerant Microcomputer Systems**, Boston, MA. For details, see June 6-8.

## July 1984

July 2-6

**Contemporary Computer Auditing: Integrity Controls**, New York City. This program is designed to provide an

## COMPETITIVE EDGE

P.O. Box 556  
Plymouth, MI 48170

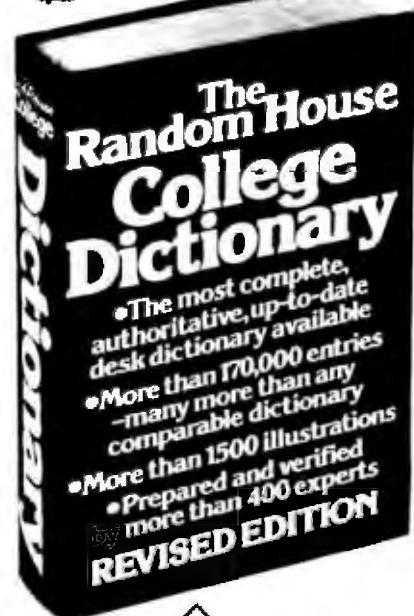
Orders 800-336-1410  
Info. 313-451-0665

### COMPETITIVE EDGE INTEGRATED SYSTEMS

LDP INC THUNDER 186™ SINGLE BOARD 80186, 256K, COMPUTER .....	\$1195
THUNDER 186™ IN 4 SLOT CABINET WITH 2-5" DRIVES .....	1995
THUNDER 186™ IN 4 SLOT CABINET WITH 2-8" DRIVES .....	2495
THUNDER 186™ IN 4 SLOT CABINET WITH 1-8" FLOPPY 1 10MB HD .....	3095
THUNDER 186™ IN 4 SLOT CABINET WITH 1-8" FLOPPY 1 10MB HD .....	3295
15 SLOT CABINET AVAILABLE FOR \$300 ADDITIONAL TO ABOVE	
LDP INC LIGHTNING 286™ CPU, 128K STATIC, 2-8" DR 15 SLT .....	4095
LDP INC. LIGHTNING 1™ (8086) 128K DRAM, 2-8" DR 15 SLT .....	2895
40 MEGABYTE HARD DISK ADD \$2795. 16.5 MB TAPE BACKUP .....	1895
MANY OPTIONS INCLUDING MULTI USERS, 8 PORT SERIAL BRD. ....	316
COMPUPRO® CPU 2™, RAM 17™, DISK 1™, 1/0 4™, 2-8", CP/M® 15 SLOT	2895
COMPUPRO® 85/88, RAM 17, DISK 1, 1/0 4, 2-8", CP/M® 15 SLOT	2995
COMPUPRO® 85/88, RAM 21, DISK 1, SS1, 1/0 4, 2-8" CP/M® 8-16™	3695
COMPUPRO® 85/88, RAM 22, DISK 1, SS1, 1/0 3, 2-8" MP/M® 8-16™	4395
COMPUPRO® 85/88, 2-RAM 22, DISK 1, SS1, 1/0 3, 2-8" MP/M® 8-16™	5350
COMPUPRO® CPU 68K™, RAM 21™, DISK 1™, 1/0 4™, 2-8" CP/M® 68K™	3595
COMPUPRO® 10MHZ 68K, RAM 32™, DISK 1™, 1/0 4™, SS1, 2-8", CP/M®	4495
40 MEGABYTE HARD DISK SUB SYSTEM ADD \$2995. 16.5 MB TAPE	1895
LDP THUNDER 186 S1 195	
LDP 128K DRAM ... 396	
LDP 72 DISK CONT ... 220	
LDP GRAPHICS ... 396	
MSDOS™ for LOMAS225	
COMPUPRO CPU 2™ 215	
CPU 8085/8088™ ... 327	
INTERFACER 4™ ... 297	
DISK 1A™ A&T ... 459	
RAM 22™ A&T ... 1155	
RAM 16™ A&T ... 358	
CP/M® 2.2 ... 119	
CCP/M® 8-16™ .CALL	
TELETEK® HD/CTC™ HARD DISK AND CARTRIDGE TAPE BOARD .....	499
TELETEK SYSTEMMASTER® Z80A 64K, DISK CONTROLLER SINGLE BRD .....	585
TELETEK SBC-II™ DUAL SLAVE 64K AND 2 SERIAL PORTS /USER .....	1046
LIGHTNING 1 9MHZ 3420	
LDP 256K DRAM ... 636	
8 PORT SERIAL ... 316	
LIGHTNING 286 ... 1116	
CCP/M® 86™ LATEST 280	
CPU 8086™ A&T ... 495	
CPU 286™ A&T ... 1196	
INTERFACER 3™ ... 459	
DISK 1™ A&T ... 327	
RAM 21™ A&T ... 657	
MDRIVE H A&T ... 995	
CP/M® 8-16™ ... 198	
SPUZ SLAVE ... 459	
10MHZ L1 ... 5320	
RAM 67 128K ... 723	
HAZITALL ... 475	
80287 OPT ... 395	
MP/M® 86™ ... 523	
CPU 68K™ ... 459	
10MHZ 8086 ... 561	
SYS SUPPORT™ ... 297	
DISK 3™ A&T ... 525	
RAM 17™ ... 329	
20 SLT MB ... 311	
MP/M™ 8-16™ ... 429	
12 SLOT MB ... 139	

Many terminals, printers, and software packages available. All prices and specifications subject to change without notice. Availability subject to stock on hand. Compupro is a Godbout Company. Compupro is a registered trademark of Godbout Electronics. CFM, MP/M, CCP/M are either trademarks or registered trademarks of Digital Research. Thunder 186, Lightning 1, and Lightning 286 are trademarks of LDP Inc. MP/M 8-16, CP/M 8-16, CPU 2, Interfacer 3, Interfacer 4, CPU 68K, CPU 8086, CPU 8088, System Support 1, Disk 1, Disk 1A, RAM 21, RAM 22, RAM 17, RAM 16 are trademarks of Compupro and Godbout Electronics. MSDOS is a trademark of Microsoft.

THE *Smart* CHOICE



Now at your bookstore  RANDOM HOUSE

Publishers of The Random House Dictionary of the English Language, Unabridged Edition



# THE AT&T INTERNATIONAL BUSINESS NETWORK: IT COSTS LESS TO SEND YOUR FACTS BY FAX.

SAN FRANCISCO



TOKYO

An exact copy of the original.  
That's fax. And fax is the  
only system that can transmit  
blueprints, legal documents, and

signed contracts almost any-  
where in the world.

This unique ability makes fax  
one of the most exciting electron-  
ic mail technologies available today.

All you need is a telephone  
and a facsimile machine.

And in as little as 25 seconds,  
an exact duplicate arrives at its  
destination.

With fax, faster is cheaper.

And different machines have  
different capabilities, different  
speeds.

With the AT&T Network, you  
can transmit up to 400 words on  
a 1-minute call.

Most telex machines transmit  
at a standard 66 words per minute.

Any fax machine can match  
that rate. And most beat it easily.

In fact, you can save as much  
as \$8.00 per page with AT&T's

lowest rates compared  
with sending the same  
page via telex. With  
some fax machines, you

don't even have to be there.

They can be programmed  
to transmit during Discount and  
Economy periods. Telex has no  
daily reduced rate periods.

Since fax is a copy of the  
original, you don't need a typist.  
No special operators.

And since there's no retyping,  
no redoing of any kind, fax is free  
of transcription errors.

So if your international  
customer or business associate  
needs a document, a blue-  
print, or a signed contract in a  
hurry, you can fax it on the spot.

Transmitting facts with fax.

Another cost-effective service  
for your business from the AT&T  
International Business Network.

International service to and from continental US  
FOR A FREE BROCHURE, CALL TOLL FREE:

1 800 874-8000



## Event Queue

overview of the complete computer-auditing environment, its controls, and the interrelationships. Full details are available from Beth Ann Musto, EDP Auditors Foundation, 373 Schmale Rd., Carol Stream, IL 60187, (312) 682-1200.

**July 8**  
**The Third Annual National Conference of the Association for Women in Computing, Holiday Inn Center Strip, Las Vegas, NV.** The conference theme, "Choice or Chance in Computing Careers," will be the starting point for sessions about women entrepreneurs, technologies in the forefront of the eighties, and career development. Registration and additional information can be obtained from Patricia Timpanaro, AWCC '84 Registration, 40 Main St. #206, Stoneham, MA 02180.

**July 9-12**  
**The 1984 National Computer Conference—NCC, Convention Center, Las Vegas, NV.** One of the most prestigious computer shows, the NCC will provide professional-development seminars, more than 650 exhibits, and nearly 100 technical sessions in ten program tracks. Contact the American Federation of Information Processing Societies Inc., 1899 Preston White Dr., Reston, VA 22091, (703) 620-8926.

**July 9-13**  
**Fiber and Integrated Optics, San Diego, CA.** For details, see June 11-15.

**July 10-12**  
**Computer-Security Technology, University of California, Berkeley.** This short course looks into protective technologies in three general categories: procedural, hardware, and software. A module evaluating a computer-security program will be included.

Registration costs \$595, which includes all materials. For details, call or write Continuing Education in Engineering, University of California Extension, 2223 Fulton St., Berkeley, CA 94720, (415) 642-4151.

**July 23-25**  
**Summer Computer Simulation Conference—SCSC '84, Copley Plaza Hotel, Boston, MA.** Technical sessions made up of plenaries, papers, panel discussions, and a variety of tutorials will be featured. Highlights include displays of simulation computers, simulators, auxiliary devices, and software. Special sessions will also be held on artificial intelligence. Contact Charles Pratt, Simulation Councils Inc., POB 2228, La Jolla, CA 92038, (619) 459-3888.

**July 23-27**  
**ACM SIGGRAPH '84, Minneapolis, MN.** This is the eleventh annual ACM conference on computer graphics and interactive techniques. Refereed technical paper presentations, panel discussions, a design show, film and video presentations, and nearly 30 courses are some of the features of this event. Course offerings will be divided into four categories: CAD/CAM/CAE, animation/image synthesis, graphics, and general topics. What is said to be the first totally computer-generated Omnimax film will be shown. For details, contact SIGGRAPH '84 Conference Office, 111 East Wacker Dr., Chicago, IL 60601, (312) 644-6610.

**July 23-27**  
**Advanced Technology: Its Impact on International Business, Economics, Finance, and Trade, Miramar Sheraton Hotel, Santa Monica, CA.** Speakers at this symposium will explore the need for cooperation and

competition with Pacific Rim countries in the building of supercomputers. Program details and registration information are available from Charles Partington, West Coast University, 440 Shatto Place, Los Angeles, CA 90020, (213) 487-4433.

**July 27-29**  
**International Heath/Zenith Users' Group Conference, Pheasant Run Resort, St. Charles, IL.** For details, call or write the Heath Users' Group, Hilltop Rd., St. Joseph, MI 49085, (616) 982-3463.

**July 30-August 3**  
**Robot Manipulators, Computer Vision, and Automated Assembly, Massachusetts Institute of Technology, Cambridge.** This short course will emphasize ways of developing strategies for solving problems in robotic sensing, spatial reasoning, and manipulation. Also covered is the use of existing industrial robots and binary vision systems. Contact the Director of the Summer Session, Room E19-356, MIT, Cambridge, MA 02139. ■

In order to gain optimal coverage of your organization's computer conferences, seminars, workshops, courses, etc., notice should reach our office at least three months in advance of the date of the event. Entries should be sent to: Event Queue, BYTE Publications, POB 372, Hancock, NH 03449. Each month we publish the current contents of the queue for the month of the cover date and the two following calendar months. Thus a given event may appear as many as three times in this section if it is sent to us far enough in advance.

## BYTE's Bits

### Database Aids Cancer Treatment

The National Cancer Institute's PDQ database provides physicians with up-to-date information on the prognosis and accepted treatment options for specific cancers. PDQ, designed for use with office or personal computers, offers several files of information, such as treatment statements for each type and stage of cancer and data on active cancer-treatment research protocols that are open to patient accrual. A list of physicians who are members of organizations that have a special interest in cancer-patient care is another feature of PDQ.

Currently, physicians have access to PDQ through more than 2000 National Library of

Medicine MEDLARS centers. During the course of this year, the Institute plans to make an expanded version of PDQ more widely available through the cooperation of commercial vendors. Those vendors willing to participate will receive monthly updates from the Institute in machine-readable form. The Institute will promote PDQ among physicians and encourage vendors to conduct their own promotional efforts. If you're willing to help bring this vital service to community-based physicians, write to NCI PDQ, Room 11A49, Building 31, National Institutes of Health, Bethesda, MD 20205, for more information. ■



# The V6 diesel

## 4 million miles of testing made it right.

## Oldsmobile Cutlass Ciera makes it great!

In the lab and on the road—the most thoroughly tested engine ever offered by Oldsmobile. V6 engines were run non-stop... 24 hours a day... six days a week... for nearly two months. In all, over 1,000 hours of dynamometer testing of the V6 diesel. Additionally, six fleets of over 150 diesel V6 vehicles were tested over a 3-year period... on the road... coast to coast. In all, over 4.1 million miles of testing.



*Venturi-shaped pre-combustion chamber for efficient, precise combustion.*

Impressive performance and diesel efficiency through precision engineering. The inherent advantages of a diesel were teamed with the balance and smoothness of the V-type engine configuration. The results: remarkable —0 to 30 in 5.2

*Roller hydraulic lifters help quiet operation.*

seconds and 0 to 50 in 11.7 seconds — in a V6 diesel Cutlass Ciera, according to test track data.

The fuel economy? Equally impressive at —43 estimated highway and 28 EPA estimated mpg.\*

Conclusion: with a high technology diesel Oldsmobile, you get both spirited performance and money-saving economy.

**Additional savings with Olds Diesel Traveling Package.** Now you can save \$300 compared to the Manufacturer's Suggested Retail Price of the same options purchased separately, on V6 Diesel Traveling Package equipped Olds Cutlass Ciera models with: AM/FM Stereo Radio, Wire Wheel Discs, Power Door Locks and Cruise Control or Rear Window De-logger. See your dealer for details.

**3-year/50,000-Mile Protection.** Another plus in the diesel Oldsmobile. As part of the Olds new



*Rotary fuel injection pump precisely measures fuel for each cylinder.*

car limited warranty the diesel engine is covered for 3 years or 50,000 miles, whichever comes first. Subject to a deductible after the first

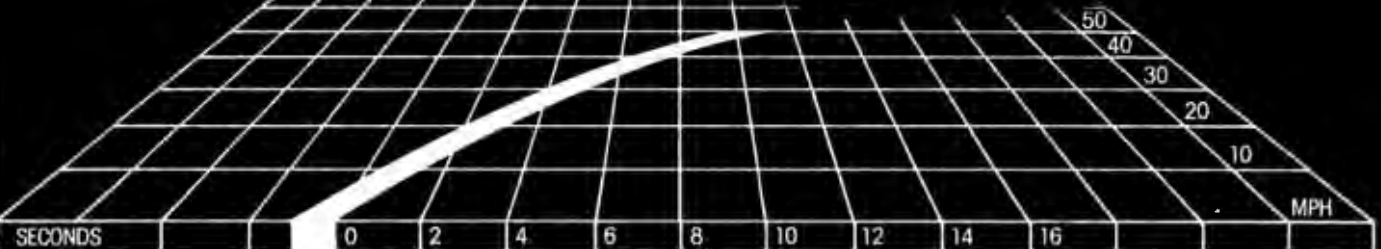
12 months-12,000 miles.

Test-drive a V6 diesel Cutlass Ciera for 1984 at your Oldsmobile dealer. The way you'll feel behind the wheel will be the final and most convincing test of all.

There is a special feel in a diesel



\*Use the estimated mpg for comparison. Your mileage may differ depending on speed, distance, weather. Actual highway mileage lower. Estimates lower in California. Some Oldsmobiles are equipped with engines produced by other GM divisions, subsidiaries or affiliated companies worldwide. See your dealer for details.



# COMPUTER MAIL ORDER

**NEC PRINTERS**  
 NEC 2080 ..... \$999.00  
 NEC 3500 ..... \$1879.00

**PERCOM/TANDOM DISK DRIVES**  
 5 1/4" 320K floppy ..... \$289.00  
 5 Meg Hard w/Controller ..... CALL  
 10 Meg Hard w/Controller ..... CALL  
 15 Meg Hard w/Controller ..... CALL  
 20 Meg Hard w/Controller ..... CALL

**AMDEK**  
 310A Amber Monitor ..... \$189.00  
 DXY 100 Plotter ..... \$599.00  
 Color II ..... \$399.00

**AST RESEARCH**  
 So Pak Plus from ..... \$279.00  
 Combo Plus II from ..... \$279.00  
 Mega Plus from ..... \$309.00  
 VO Plus from ..... \$139.00

**QUADRAM**  
 Quadrix ..... \$479.00  
 Quadboard as low as ..... \$299.00  
 Quad 512 Plus as low as ..... \$249.00  
 Quadcolor as low as ..... \$219.00  
 Chronograph ..... \$89.00  
 Parallel Interface Board ..... \$89.00  
 64K RAM Chip Kit ..... \$59.00

**MICROPRO**  
 WordStar/MailMerge ..... \$349.00  
 InfoStar ..... \$299.00  
 SpellStar ..... \$199.00  
 CalcStar ..... \$99.00

**MICROSTUF**  
 Crosstalk ..... \$105.00

**MICROSOFT**  
 Multiplan ..... \$159.00

**ASHTON-TATE**  
 dBASE II ..... \$389.00  
 Friday ..... \$185.00

**IUS**  
 EasyWriter II ..... \$249.00  
 EasySpeller ..... \$119.00  
 EasyFilter ..... \$229.00

**CONTINENTAL SOFTWARE**  
 1st Class MailForm Letter ..... \$79.00  
 Home Accountant Plus ..... \$89.00

## IBM

### VISICORP

IBM APPLE  
 VisCalc ..... \$199.00 \$199.00  
 VisCalc 4 ..... \$159.00  
 VisCalc Advanced ..... \$249.00  
 VisWord/Spell ..... \$199.00  
 VisSend/Plot ..... \$199.00  
 VisLink ..... \$169.00  
 VisFile ..... \$189.00  
 VisSchedule ..... \$189.00  
 VisDraw ..... \$159.00  
 VisPlot ..... \$135.00  
 VisTerm ..... \$75.00  
 Desktop Plan ..... \$199.00  
 Bus Forecast Model ..... \$75.00  
 StructCalc ..... \$75.00  
 VisLaser Calc ..... \$99.00  
 VisLaser Advanced ..... \$75.00  
 VisLaser Word ..... \$299.00  
 Vis-Dn Calc ..... \$299.00  
 Vis-Dn Graph ..... \$179.00  
 Vis-Dn Ward ..... \$275.00  
 Vis-Dn Mouse ..... \$159.00  
 Vis-Dn Host ..... \$119.00

### pf8

IBM APPLE  
 Write ..... \$99.00 \$79.00  
 Graph ..... \$99.00 \$79.00  
 Report ..... \$79.00 \$79.00  
 File ..... \$99.00 \$79.00  
 Solutions\* as low as ..... \$19.00 \$19.00  
 \*Call On Traces

### MONOGRAM

Daters and Senses ..... \$109.00

### LOTUS

1-2-3 ..... \$399.00

### PROFESSIONAL SOFTWARE

PC Plus/The Boss ..... \$349.00

### SYNAPSE

File Manager ..... \$99.00

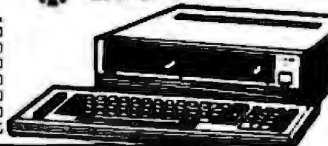
### SOFTWARE ARTS

TK Solver ..... \$199.00

**MBC-550.....CALL**  
**MBC-555.....CALL**

MBC 1100 ..... \$1499.00  
 FDD 3200 320K Drive ..... \$399.00  
 MBC 1150 ..... \$1899.00  
 MBC 1200 ..... \$1849.00  
 FDD 6400 640K Drive ..... \$469.00  
 MBC 1250 ..... \$2099.00  
 PR 5500 Printer ..... \$599.00

## SANYO



### APPLE/FRANKLIN DISK DRIVES

**MICRO-SCI**  
 A2 ..... \$219.00  
 A40 ..... \$299.00  
 A70 ..... \$319.00  
 C2 Controller ..... \$79.00  
 C47 Controller ..... \$89.00

### RANA

Box 1 ..... \$279.00  
 Box 2 ..... \$399.00  
 Box 3 ..... \$599.00

**APPLE II STARTER PACK**  
 64K Apple II, Disk Drive & Controller, 80 Column Card, Monitor II & DOS 3.3  
**COMPLETE.....CALL**

## FRANKLIN



ACE 1000 Color Computer ..... CALL  
 ACE Family Pack System ..... CALL  
 ACE PRO PLUS System ..... CALL  
 ACE 1200 Dfmc Mgmt. System ..... CALL  
 "Not In Expense"

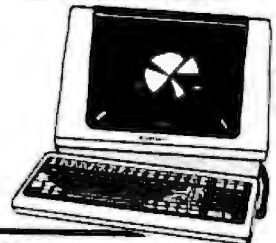
### TERMINALS

814 ..... \$599.00  
 824 ..... \$599.00  
 925 ..... \$739.00  
 950 ..... \$929.00  
 970 ..... \$1099.00

### COMPUTERS

Teleport Portable ..... CALL  
 800A ..... \$1099.00  
 802 ..... \$2899.00  
 803 ..... \$1949.00  
 802M ..... \$4995.00  
 806/820 ..... \$4999.00  
 818/40 ..... \$9199.00  
 802 ..... \$3999.00  
 803 ..... CALL

## TeleVideo



## PRINTERS

**AXIOM**  
 AT-100 Atari Interface ..... \$239.00  
 GP-100 Parallel Interface ..... \$199.00  
 AT-845 Interface ..... \$99.00

**BMC**  
 401 Letter Quality ..... \$599.00  
 84-80 Dot Matrix ..... \$299.00

**CENTRONICS**  
 122 Parallel ..... \$299.00  
 739-1 Parallel ..... \$199.00  
 739-3 Serial ..... \$249.00

**C.I.TOH**  
 Gorrila Banner ..... \$209.00  
 Promoter 8510P ..... \$379.00  
 Promoter 1530P ..... \$599.00  
 A10 (18 cps) ..... \$599.00  
 8900 P ..... \$629.00  
 F10-40 ..... \$999.00  
 F10-55 ..... \$1499.00

**COMREX**  
 ComWriter II Letter Quality ..... \$499.00

**DIABLO**  
 820 Letter Quality ..... \$949.00  
 630 Letter Quality ..... \$1749.00

**DABYWRITER**  
 2000 ..... \$999.00  
 Tractor Feed ..... \$109.00

**EPSON**  
 MX-80FT, MX-100, RX-80, RC-80FT, FX-80, FX-100 ..... CALL

**IDB**  
 Print 80 For Configurations ..... CALL  
 Print 32 For Configurations ..... CALL

**MANNESMAN TALLY**  
 160L ..... \$599.00  
 180L ..... \$799.00  
 Sprint 80 ..... \$109.00

## NEC

2010/2030 ..... \$699.00  
 8023 Dot Matrix ..... \$379.00  
 8025 Dot Matrix ..... \$699.00  
 3510 Serial/Letter Quality ..... \$1449.00  
 3530 Parallel/Letter Quality ..... \$1499.00  
 7710/7730 Serial/Parallel ..... \$1949.00

## OKIDATA

82, 83, 84, 92, 93, 2350, 2410 ..... CALL

## SMITH CORONA

TP-2 ..... \$399.00  
 Tractor Feed ..... \$119.00

## SILVER REED

500 Letter Quality ..... \$469.00  
 950 Letter Quality ..... \$699.00

## STAR

Gemini 10X ..... \$299.00  
 Gemini P15X ..... \$399.00  
 Delta 10 ..... \$599.00  
 Serial Board ..... \$75.00

## TOSHIBA

1350 ..... \$1699.00

## TRANSTAR

120P ..... \$499.00  
 130P ..... \$699.00  
 315 Color ..... \$499.00

**APPLE INTERFACE CARDS & BUFFERS**  
 Choose from PKASO, Orange Micro MPC, MicroMax, Tymac, Quadram & Practical Peripherals. **PRINTER CABLES** are available for most all computers on the market. We supply all your computer needs.

## PAPER SUPPLIES

1000 sheet 8 1/2x11 Tractor Paper ..... \$19  
 1000 sheet 14 1/2x11 Tractor Paper ..... \$24  
 1 or 2" Address Labels ..... \$9

## ANCHOR

Volkmodem ..... \$59.00  
 Mark II ..... \$79.00  
 Mark VII (Auto Ans./Auto Dial) ..... \$119.00  
 Mark X (1200 Baud) ..... \$299.00  
 TRS-80 Color Computer ..... \$99.00  
 9 Volt Power Supply ..... \$9.00

## HAYES

Smartmodem 300 ..... \$209.00  
 Smartmodem 1200 ..... \$499.00  
 Smartmodem 1200B ..... \$449.00  
 Micromodem II ..... \$269.00  
 Micromodem 100 ..... \$299.00  
 Smart Com II ..... \$99.00  
 Chronograph ..... \$199.00

## MODEMS

## NOVATION

J-Cat ..... \$99.99  
 SmartCat 103 ..... \$179.00  
 SmartCat 103/212 ..... \$399.00  
 AutoCat ..... \$219.00  
 212 AutoCat ..... \$449.00  
 Apple Cat II ..... \$249.00  
 212 Apple Cat ..... \$599.00  
 Apple Cat 212 Upgrade Kit ..... \$309.00  
 ..... \$139.99

## ZENITH

ZF1 ..... \$399.00  
 ZF10 ..... \$309.00  
 ZF11 ..... \$369.00

## AMDEK

300 Green ..... \$149.00  
 300 Amber ..... \$159.00  
 310 Amber ..... \$199.00  
 Color 1 ..... \$279.00  
 Color 1 Plus ..... \$299.00  
 Color 2 ..... \$399.00  
 Color 2 Plus ..... \$419.00  
 Color 3 ..... \$349.00  
 Color 4 ..... \$699.00

## BMC

12" Green ..... \$99.99  
 12" Green Hi-Res ..... \$119.99  
 9181-13" Color ..... \$249.00

## GORILLA

12" Green ..... \$99.99  
 12" Amber ..... \$95.99

## NEC

JB 1280 Green ..... \$109.00  
 JB 1301 Green ..... \$149.99  
 JB 1305 Amber ..... \$159.99  
 JC 1215 Color ..... \$259.00  
 JC 1216 RGB ..... \$429.00  
 JC 1480 Color ..... \$359.00

## MONITORS

## PRINCETON GRAPHICS

HX-12 RGB ..... \$119.00

## SAKATA

100 ..... \$299.00

## TAXAN

210 Color RGB ..... \$299.00  
 400 Med-Res RGB ..... \$319.00  
 415 Hi-Res RGB ..... \$439.00  
 420 Hi-Res RGB (IBM) ..... \$499.00  
 100 12" Green ..... \$125.00  
 105 12" Amber ..... \$135.00

## USI

P 1, 8" Green ..... \$99.99  
 P 2, 12" Green ..... \$119.99  
 P 3, 12" Amber ..... \$149.99  
 P 4, 8" Amber ..... \$139.99  
 1400 Color ..... \$299.99

## QUADRAM

Quadchrome 8400 ..... \$549.00

## ZENITH

ZVM 122 Amber ..... \$109.00  
 ZVM 123 Green ..... \$99.99  
 ZVM 133 Color/RGB ..... \$459.99

east

**800-233-8950**

In PA call (717)327-9575, Dept. 40501  
 Order Status Number: 327-9576  
 Customer Service Number: 327-1450  
 477 E. 3rd St., Williamsport, PA 17701

canada

Ontario/Quebec

**800-268-3974**

Other Provinces 800-288-4559  
 In Toronto call (416)928-0866, Dept. 40501  
 Order Status Number: 928-0866  
 2505 Dunwin Drive, Unit 3B  
 Mississauga, Ontario, Canada L5L1T1

west

**800-648-3311**

In NV call (702)588-5654, Dept. 40501  
 Order Status Number: 588-5654  
 P.O. Box 6689  
 Stateline, NV 89449

No risk, no deposit on C.O.D. orders and no waiting period for certified checks or money orders. Add 3% (minimum \$5) shipping and handling on all orders. Larger shipments may require additional charges. NV and PA residents add sales tax. All items subject to availability and price change. Call today for our catalog.



# COMPUTER MAIL ORDER



**KOALA PADS**

Acorn (Disk)	\$75.00
Acorn (ROM)	\$62.00
C-64 (Disk)	\$75.00
C-64 (ROM)	\$62.00
IBM	\$85.00
Apple/Franklin	\$85.00

**commodore**

CBM 8032.....\$599  
CBM 4032.....\$599



**8X-64 PORTABLE \$839**

**VIC 20.....CALL**

**CBM 84.....\$189**

C1541 Disk Drive	\$249.00
C1530 Datasize	\$68.00
C1520 Color Printer/Platier	\$129.00
M-801 Dot Matrix Printer	\$219.00
C1525 Dot Matrix/Serial	\$289.00
C1702 Color Monitor	\$249.00
C1311 Joystick	44.89
C1312 Paddle	\$11.89
C1800 VIC Modem	\$59.00
C1650 Auto Modem	\$89.00
Logg 84	\$49.00
Word Pro 84 Plus	\$59.00
Parallel Printer Interface	\$49.00
Calc Result 84	\$65.00
Calc Result Easy	\$39.00
Codemaster 84	\$75.00
Duck Brown FK	\$49.00
NCS 801 Color Printer	\$499.00
OPS 1101 Daisy Printer	\$459.00
Magic Voice Speech Module	\$54.00
Desk Organizer Lock	\$49.00
Vidas Telecommunications	\$34.85

**MSD 501 Disk Drive**.....\$349.00  
**MSD 502 Disk Drive**.....\$599.00  
**CBM 8086**.....\$888.00  
**CBM 9000**.....\$888.00  
**8128-80**.....\$769.00  
**8032 to 9000 Upgrade**.....\$269.00  
**2031 LP Disk Drive**.....\$299.00  
**8050 Disk Drive**.....\$948.00  
**8290 Disk Drive**.....\$1199.00  
**4023 Printer**.....\$379.00  
**8023 Printer**.....\$589.00  
**6400 Printer**.....\$1399.00  
**Z-RAM**.....\$499.00  
**Secur Office**.....\$699.00  
**The Manager**.....\$189.00  
**SoftROM**.....\$125.00  
**VisCalc**.....\$159.00

**PROFESSIONAL SOFTWARE**

Word Pro 2 Plus.....\$159.00  
 Word Pro 3 Plus.....\$189.00  
 Word Pro 4 Plus/5 Plus each.....\$279.00  
 InfoPro.....\$179.00  
 Administrator.....\$399.00  
 Power.....\$79.00

We stock a full inventory of software for Commodore, such as: Artworx, Broderbund, Commercial Data, Creative Software, EPYX, HES, MicroSpec, Nufekop, Romox, Sirius, Synapse, Thorn EMI, Tronix, UMI, Victory, Spinnaker, Rainbow & Timeworks!

**INFOCOM**

Zork 1,2,3 (AT/AY/CBM/IBM)	\$29.00
Deadline (AT/AY/CBM/IBM)	\$32.95
Enchanter (AT/AY/CBM/IBM)	\$32.85
Planetfall (AT/AY/CBM/IBM)	\$32.95
Whyrans (AT/AY/CBM/IBM)	\$32.95
Sarcross (AT/AY/CBM/IBM)	\$29.00

**ATARIBOFT**

IBM/AY	C64/VC
RecMan	\$29.99
Compage	\$29.99
Dig Dig	\$29.99
Donkey Kong	\$29.99
Defender	\$29.99
Robotron	\$29.99
Star Gate	\$29.99

## CMO'S PORTABLE CORNER



**HP 71B \$499**

**41CV.....\$189**  
**41CX.....\$249**

HP 10C.....\$51.99  
 HP 11C.....\$69.99  
 HP 12C.....\$89.99  
 HP 15C.....\$88.99  
 HP 16C.....\$88.99  
 HP 75C.....\$748.99  
 HPL Module.....\$98.99  
 HPL Cassette or Printer.....\$359.99  
 Card Reader.....\$143.99  
 Extended Function Module.....\$63.99  
 Time Module.....\$63.99

**PC-8201 \$599**

**NEC**

PC-8221A Thermal Printer	\$149.99
PC-8281A Data Recorder	\$99.00
PC-8201-05 8K RAM Chip	\$105.00
PC-8206A 32K RAM Cartridge	\$328.00

**TIMEX/SINCLAIR**

Times/Slider 1000	CALL
Times/Slider 2088	CALL
16K Memory	\$25.00
2040 Printer	\$88.99
VisCalc	\$17.99
Minisort Printer	\$99.99

**SHARP**

**PC-1500A.....\$185**  
**PC-1250A.....\$88**

CE-125 Printer/Cassette	\$128.99
CE-150 Color Printer/Cassette	\$171.99
CE-155 8K RAM	\$93.99
CE-161 16K RAM	\$134.99
CE-500 ROM Library	\$29.99

# HOME COMPUTERS

## ATARI WHILE SUPPLIES LAST! ATARI 600XL \$149

1010 Recorder	\$74.00
1020 Color Printer	\$249.00
1025 Dot Matrix Printer	\$349.00
1027 Laser Quality	\$329.00
1030 Direct Connect Modem	\$119.00
1050 Disk Drive	\$339.00
CX30 Paddle	\$9.00
CX40 Joystick, each	\$4.00
CX77 Touch Tablet	\$48.00
CX80 Track Ball	\$105.00
CX85 Keypad	\$28.00
488 Communicator II	\$47.00
4003 Assorted Education	\$33.00
4011 Star Readers	\$29.00
4012 Message Command	\$29.00
4013 Asteroid	\$189.00
9049 VisCalc	\$79.00
7079 Logo	\$99.00
7101 Entertainment	\$75.00
7102 Arcade Champ	\$33.00
8025 Dig Dig	\$33.00
8030 E T Phone Home	\$39.00
8031 Donkey Kong	\$35.00
8033 Robotron	\$39.00
8034 Pole Position	\$79.00
8036 Atari Winner	\$39.00
8040 Donkey Kong, Jr.	\$39.00
8043 Ms Pacman	\$39.00
8044 Joust	\$39.00

**800XL.....\$299**  
**1200XL.....CALL**  
**1400XL.....CALL**



AT 88-81	\$359.00
AT 88-A1	\$259.00
AT 88-51 PD	\$449.00
AT 88-00A	\$119.00
RFD 40-51	\$449.00
RFD 40-A1	\$299.00
RFD 40-82	\$699.00
RFD 44-51	\$399.00
RFD 44-52	\$899.00

**TEXAS INSTRUMENTS**

TX 99-51.....\$279.00

**RANA**

1000.....\$329.00

**TRAK**

AT-D2.....\$389.00

**INDUS**

GT-Drive.....\$379.00

**MEMORY BOARDS**

Acorn 32K	\$99.00
Acorn 48K	\$99.00
Acorn 128K	\$299.00
Intec 32K	\$59.00
Intec 48K	\$64.00
Intec 64K	\$99.00
Intec Real Time Clock	\$29.00

**ALIEN VOICE BOX**

Acorn	\$119.00
Apple	\$149.00

**CONTROLLERS & JOYSTICKS**

**WICO**

Joystick	\$21.99
3-way Joystick	\$22.99
Famous Red Ball	\$21.99
Power Gnp	\$17.99
9055 Joystick	\$24.99
ATARI/VC Track Ball	\$54.99
Apple Track Ball	\$15.99
Apple Adaptor	\$37.99
Apple Analog	\$37.99

**KRAFT**

Acorn Single Fire	\$12.99
Acorn Switch Mixer	\$15.99
Apple Paddles	\$34.99
IBM Paddles	\$34.99
IBM Joystick	\$48.99

**AMIGA**

3100 Single	\$13.99
3101 Pair Joystick	\$19.99
3102 Pair Joystick	\$37.99

**TO**

Acorn Track Ball	\$47.99
Apple Joystick	\$47.99
Apple Track Ball	\$47.99

**east**

**800-233-8950**

In PA call (717)327-9575, Dept. 40501  
 Order Status Number: 327-9576  
 Customer Service Number: 327-1450  
 477 E. 3rd St., Williamsport, PA 17701

**canada**  
 Ontario/Quebec

**800-268-3974**

Other Provinces 800-268-4559  
 In Toronto call (416)828-0866, Dept. 40501  
 Order Status Number: 828-0866  
 2505 Dunwin Drive, Unit 3B  
 Mississauga, Ontario, Canada L5L1T1

**west**

**800-648-3311**

In NV call (702)588-5654, Dept. 40501  
 Order Status Number: 588-5654  
 P.O. Box 6689  
 Stateline, NV 89449

**CANADIAN ORDERS:** All prices are subject to shipping, tax and currency fluctuations. Call for exact pricing in Canada.  
**INTERNATIONAL ORDERS:** All shipments outside the Continental United States must be pre-paid by certified check only. Include 3% (minimum \$5) shipping and handling.  
**EDUCATIONAL DISCOUNTS:** Additional discounts are available to qualified Educational Institutions.  
**APD & FPO:** Add 3% (minimum \$5) shipping and handling.

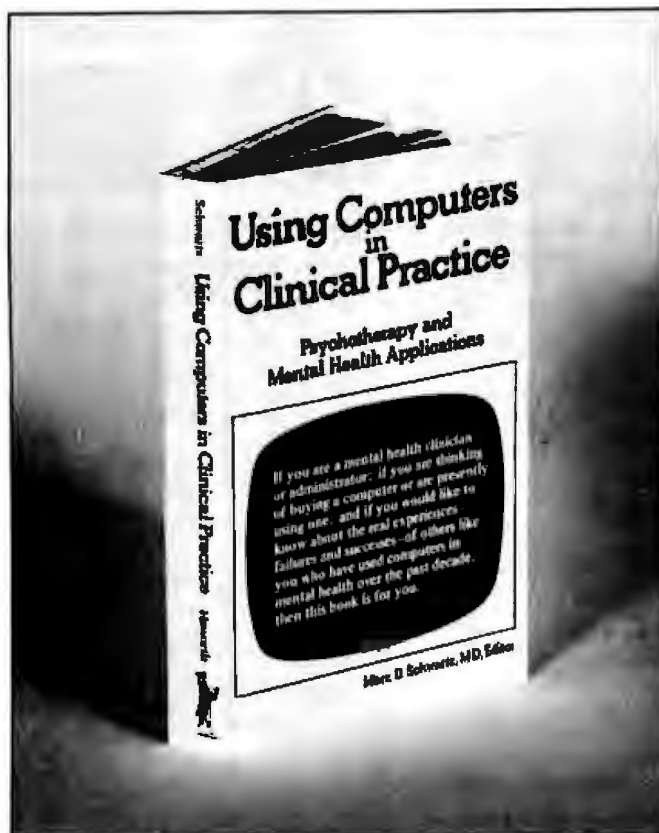
## Using Computers In Clinical Practice

Marc D. Schwartz, M.D., ed.  
The Haworth Press,  
New York, 1984,  
510 pages, hardcover,  
\$34.95

Reviewed by  
Evie Wilson

Are you a mental health professional unwilling to accept the thought of using computers to do the sensitive, sometimes intuitive, work of psychotherapy? At the same time, if your sense of futuristic mental health practices intrigues you, then you would be interested in reading *Using Computers in Clinical Practice*. Without resorting to a hard-sell approach, the 66 contributors will lead you objectively through various steps of getting acquainted with the possibilities computers offer. In what is a surprisingly readable format, even humorous at times, this book presents selected, relatively brief articles by experienced mental health professionals who use computers in varying degrees in their practices.

The articles in this book are grouped under 14 topics and, fortunately, they do not always agree with each other. The reader is thus exposed to various pro and con points of view. Nevertheless, the main goal of the editor, Dr. Marc D. Schwartz, is not to cause readers to choose an all-or-nothing stance, but to present in an unbiased manner the experiences, successes, and difficulties encountered by the pioneers currently introducing computers to the field of psychology. Because these people are mental health professionals first and com-



puter specialists second, they tend to discuss the issues pertinent to clinical psychology using the language of the profession even though their prime focus, in this book, is on technology and computerization. This helps the more therapeutically oriented reader like myself become more involved, even absorbed, in the discussions.

Some of the articles listed in the table of contents that immediately piqued my interest were reviews on "A Probabilistic System for Identifying Suicide Attemptors," a "Computerized Analysis of Verbal Behavior in Schizophrenia," and on a "Direct Assessment of Depression by Microcomputer," the latter being one of several articles contributed by the editor of this volume.

This is actually a handbook that provides an overview of the multiple uses of computer hardware and software

as they currently apply to mental health. For example, it includes discussions of the time-saving advantages of word processing and how to preprogram the routine phrases or diagnostic definitions necessary for repetitive report writing. It covers extensive considerations of the value, drawbacks, and unknowns related to computerized assessment, diagnosis, and testing procedures that have heretofore been tedious pencil-and-paper methods.

### Seeing the World

Not all is portrayed as rosy, however. The authors raise substantive legal, ethical, and humanistic questions. For instance, how will a depressed, depersonalized client react to being assessed by a machine rather than a caring human being? Will computer-using professionals begin to treat their microcomputers and

software as authorities or become reluctant to introduce innovation into stable programs that have taken years to perfect? What happens to worker satisfaction when human interaction is exchanged for a full day of computer interaction?

On a more optimistic note, how about computerized fantasy games in child therapy? Or educational systems for cognitive rehabilitation in neuropsychology? Self-help via bulk mail? Or just plain old improvements in billing procedures and cash flow for the psychotherapist as a small-business owner?

### Keeping in Mind

Considerations are many in this relatively unexplored area; that is why this book is essential. It invites you to be aware of various options and warnings that you may not even have begun to imagine. In addition to words of caution, the contributors also include helpful suggestions. It seems that the editor wants to make certain that once you invest in a computer, you will be able to take full advantage of it and not relegate it, unused, to a dusty corner due to unanticipated frustrations. This is reason enough to read this book, since your investment can range from \$2000 to \$20,000.

What are some of those suggestions? Consider, for example, Parts I and II entitled "An Overview" and "Dealing With People," respectively. Once you have decided to go ahead and merge technology with the humanities, apparently the first roadblock is likely to come from other office personnel and colleagues who may feel professionally threatened. The authors offer insight into this fairly com-



# The Micromint Collection

Micromint. Supporting the varied projects that appear in Steve Ciarcia's monthly article in *BYTE Magazine*, "Ciarcia's Circuit Cellar." Offering a wide range of computers and peripherals designed to meet the exacting demands of the hobbyist as well as worldwide corporate clients.

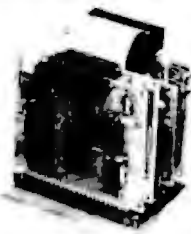
## TERM-MITE ST SMART TERMINAL BOARD

As featured in *Ciarcia's Circuit Cellar* *BYTE Magazine*, January & February 1984

All you need to build a Smart Video Terminal equivalent to the types advertised for \$1,000.00 or more is a Term-Mite ST circuit board, scanned or parallel keyboard, video monitor and power supply

- Uses brand new Nat'l Sem MS455A Terminal Processor
  - 24 lines by 80 characters, 25th reverse-video status
  - Upper & lowercase Line (block) graphics
  - Selectable data rate, parity & display options
  - Reverse video, half intensity, double height & width, underlined, blinking and/or blank character
  - Separate sync or composite video output. Self Test
- Term-Mite ST Video Display Terminal Board  
BCC22 Assembled & Tested ..... \$284.  
BCC23 Complete Kit ..... 244.

## Z8 BASIC SYSTEM CONTROLLER NEW!!!



As featured in *Ciarcia's Circuit Cellar* *BYTE Magazine*, July & August 1981

The Z8 Basic System Controller is an updated version of our popular BCC01. The price has been reduced and features added. The entire computer is 4" by 4 1/2" and includes a tiny BASIC interpreter, up to 6K bytes of RAM and EPROM, one RS-232C serial port with switchable baud rates and two parallel ports. BASIC or machine language programming is accomplished simply by connecting a CRT terminal. Programs can be transferred to 2732 EPROMs with an optional EPROM programmer for auto start applications. Additional Z8 peripheral boards include memory expansion, serial and parallel I/O, real time clock, an A/D Converter and an EPROM programmer.

- Uses Zilog Z8 single chip microprocessor
- Data and address buses available for 124K memory
- Can be battery operated
- Cross assemblers for various computers

BCC11 Assembled & Tested ..... \$149  
New Low Price

## COMING SOON! FORTH LANGUAGE VERSION OF THE Z8

With the new Z8 with on board 4K FORTH you can program high speed control functions in a few simple high level language commands. Perfect for data reduction, process control and high speed control applications.

- BCC20 Z8 FORTH Microprocessor chip ..... \$160
- BCC21 Z8 FORTH System Controller  
(This board is a BCC11 with a BCC20 installed)  
Assembled & Tested ..... 280.

## Z8 CROSS ASSEMBLERS

- From Micro Resources
- IBM PC, APPLE, 6502 Systems 514: CP/M 2.2 B ..... \$ 75.
- From Allen Ashby
- TRS-80 Model I, II, Norbitar 5V1 ..... 75.
  - CP/M 2.2 B ..... 150.

## Z8 FIVE SLOT MOTHER BOARD

- Expand your Z8 BASIC System with minimum effort
  - Contains five slots complete w/44 pin connectors
- M802 Assembled & Tested ..... \$69.

## TRIPLE VOLTAGE POWER SUPPLIES

- +5V @ 300 ma. + -12V @ 25 ma.  
UP501 Assembled & Tested ..... \$35.
- UP502 Complete Kit ..... 27.
- +5V @ 1 Amp. +12V @ 5 Amp. -12V @ 50 ma.  
UP503 Assembled & Tested ..... 60.
- UP504 Complete Kit ..... 50.

## SPEECH SYNTHESIZERS

### MICROVOX TEXT-TO-SPEECH SYNTHESIZER



As featured in *Ciarcia's Circuit Cellar* *BYTE Magazine* September, October 1982.

Microvox is a second generation professional voice quality text-to-speech synthesizer that is easily interfaced to any computer, modem, RS-232C serial or parallel output device and provides speech of unbelievable clarity.

- Unlimited vocabulary
  - 64 programmable inflection levels
  - 6K text-to-speech algorithm
  - Full ASCII character set recognition and echo
  - RS232C and parallel output
  - 1000 character buffer, 3000 optional
  - Adjustable baud rates (75-9600)
  - Spelling output mode
  - 7 octave music and sound effects
  - On board audio amplifier & power supply
  - X-On X-Off handshaking
- MV01 Assembled with 1K buffer ..... \$299  
MV02 Complete Kit with 1K buffer ..... 219.  
Add \$15.00 for 3K buffer option.

### VOTRAX SC-01A PHONETIC SPEECH SYNTHESIZER IC

The SC-01A Speech Synthesizer is a completely self-contained solid state device that phonetically synthesizes continuous speech of unlimited vocabulary. Used in our Microvox and Sweet-Talker.

SC01A Quantity 1-99 ..... \$44. 00.  
100 + ..... 32. 00.  
1000 + ..... 24. 00.

## MICRO D-CAM DIGITAL TV CAMERA



As featured in *Ciarcia's Circuit Cellar* *BYTE Magazine*, September & October 1983

### GIVE YOUR COMPUTER THE DIMENSION OF SIGHT

- Interprets, enhances and stores images
  - 256 x 128 digital image sensor
  - Plug-in boards for the IBM-PC, APPLE II & etc.
  - Software includes utilities for auto exposure, multi-level greyscale, screen dump and image enhancement.
  - Includes interface card, 4 foot extension cable, camera assembly, manual, and software on diskette
- DC01 IBM PC Assembled & Tested ..... \$289.  
DC02 IBM PC Complete Kit ..... 254.  
DC03 APPLE II Assembled & Tested ..... 299.  
DC04 APPLE II Complete Kit ..... 264

## 300 BAUD ANSWER/ ORIGINATE MODEM KIT



As featured in *Ciarcia's Circuit Cellar* *BYTE Magazine*, March 1983

Micromint's latest 300 Baud Modem Kit is crystal controlled, uses the TI TMS9953 IC, contains just 25 parts and requires no calibration or adjustments. Use with acoustic coupler or in direct connect mode.

MD04 Complete Kit as shown ..... \$60.  
MD05 Transformer for Direct Connect Mode ..... 9.  
AC01 Acoustic Coupler Kit ..... 20.

## E-Z COLOR GRAPHIC INTERFACE WITH SPRITES

APPLE II E-Z Color plug-in board with Graphics Editor on 3.5 disk

EZ01 Assembled & Tested ..... \$150.  
EZ02 Complete Kit ..... 125.

APPLE II E-Z Color Plus

- Allows the use of a single monitor or TV set

EZ11 Assembled & Tested w/Graphics Editor ..... \$200

KRELL LOGO for E-Z Color and E-Z Color Plus Supports Sprite Graphics.

EZ21 Krell LOGO w/full documentation ..... \$89.

Animation Software for E-Z Color Plus

- Draw with Sprites using joystick or Keala Pad
- Animate Sprites from your own BASIC program

EZ21 Animation Software ..... \$49.

\$100 E-Z Color Graphics Board

- With sound generator & joystick interface
- MBASIC Graphics Editor on 8" diskette

EZ04 Assembled & Tested ..... \$289

MICROMINT INC. 561 Willow Avenue, Cedarhurst, NY 11516

To Order: Call Toll Free 1-800-645-3479  
For Information Call: 1-516-374-6793  
Call: Monday-Friday, 9-5 PM



## MPX-16 MICROCOMPUTER IBM PC COMPATIBLE



As featured on the cover of *BYTE Magazine*. Also featured in *Ciarcia's Circuit Cellar* November, December 1982 & January 1983

The Computer With A Split Personality

- Use it as an IBM PC look alike that directly boots PC DOS 1.1 and accepts all expansion boards designed for the IBM PC
- Use it as a powerful 8088 single board computer for all your OEM applications. Just add serial terminal, disk drive and power supply. Directly boots CP/M-86

Buy the MPX-16 in the form that best meets your needs or budget. As a bare board, as a wave soldered board that contains all components less ICs, as an assembled and tested circuit board or as a complete system.

- Directly boots PC DOS 1.1 and CP/M-86
- Most IBM PC software executes with no modifications
- IBM PC bus compatible + 9 expansion slots
- Intel 8088 16-bit microprocessor
- Optional Intel 8087 math coprocessor
- 256K bytes on board memory
- Up to one megabyte of system memory.
- Up to 64K bytes of system ROM/EPROM
- 2 RS-232C Serial & 3 Parallel I/O ports
- Disk controller for 5 1/4" or 8" drives.
- Solder level of vectored interrupts

- MPX-16 Circuit Board Assembled w/8K RAM ..... \$1,200.  
OEM 100 quantity price ..... 989.  
MPX-16 Circuit Board Assembled w/256K RAM ..... 1,400
- MPX-16 Sams-Kit (wave soldered circuit board w/all components) Less ICs ..... 595.  
MPX-16 Unpopulated (bare) PC Board ..... 380.  
Complete Kit of ICs w/256K RAM ..... 595.  
MPX-16 Unpopulated (bare) PC Board ..... 380.  
CP/M-86 Operating System - Manuals ..... 80.  
MPX-16 Switching Power Supply ..... 300.  
MPX-16 Technical Reference Manual ..... 50.  
MPX-16 Metal Enclosure with Fan Drive ..... 300.  
IBM PC Keyboard Interface Adapter ..... 100.  
Shipping & handling additional on all MPX-16 orders.

IBM PC is a trademark of International Business Machines Corp. CP/M-86 is a trademark of Digital Research Inc. Z8 is a trademark of Zilog Inc.

Circle 269 on inquiry card

## Z8 MEMORY, I/O EXPANSION. CASSETTE INTERFACE

- 4K bytes of additional RAM or EPROM
  - Three additional 8 bit parallel ports
  - Cassette interface—300 baud K/C Standard
  - Software real time clock.
- BCC03 w/4K RAM Assembled & Tested ..... \$150  
BCC04 w/6K RAM Assembled & Tested ..... 180

## Z8 EPROM PROGRAMMER

- Transfer BASIC or Assembly Language application programs from RAM to 2716 or 2732 EPROM
  - Comes with programming & utility routines on EPROM
  - Requires BCC03 Z8 Expansion Board for operation
- BCC07 Assembled & Tested ..... \$145

## Z8 ANALOG TO DIGITAL CONVERTER

- Uses Analog Devices 7561 IC. 8-channel 8-bit
  - Adds process control capability to the Z8 system
  - Over 1,000 conversions per channel per second
  - Monitors 8 analog signals in one of two 10v ranges
- BCC13 Assembled & Tested ..... \$140.

## Z8 SERIAL EXPANSION BOARD

- Adds additional RS-232C and opto-isolated 20 ma current loop serial port to the Z8 System
  - Runs at 75 to 19,200 baud in all protocols
  - Comes with listings of sample serial I/O routines
- BCC08 Assembled & Tested ..... \$160

## Z8 16K MEMORY EXPANSION BOARD

- Add up to 16K of additional memory, RAM or EPROM, to your Z8 System Controller in any multiple
  - Accepts 2016, 6116, 2716, or 2732 memory types.
  - Four 16k cards may be installed on the Z8 System bringing the total memory to 64K
- BCC14 Assembled & Tested w/8K RAM ..... \$120.  
BCC16 Assembled & Tested w/16K RAM ..... 155.

mon reaction and suggest ways of introducing your new ideas in stages that are easier to accept.

In addition, precautions are raised in Parts I and II regarding facets of professional computerization that have apparently thwarted more than a few enthusiastic, though uninformed, potential computer users. First, although computers have the capacity to capitalize tremendously on the power of information, they can be subject to inconvenient programming limitations. Second, you may need to learn how to program your own software, because ready-made software is not always available or appropriate to specific needs. Finally, you are made aware that contracting a programmer to develop an operational program is very different financially from receiving a functional program. The former means simply that the program runs. The latter means the programmer stays on the job long enough to work out unforeseen bugs in the system. A misunderstanding of this contractual wording can result in a \$40-per-hour charge for program modification costs until all the data is printing the way you want it.

For those readers who are employed by larger operations than private practice, such as hospitals, community-planning agencies, or mental health centers, this book contains valuable advice from those with previous experience. The authors emphasize that clinicians must be quite familiar with the computer systems in their agencies in order to adequately input their programming needs. Otherwise, programmers and administrators could set up programs that are not relevant to clinicians' information needs or are not sensitive to the human elements in thera-

peutic work. Then the result is potentially more, meaningless paperwork for the clinician, or you are stuck with a system that is woefully underused by the agency. The writers of the "Administrative and Clinical Information Management" chapters are both helping other professionals in the field to avoid the pitfalls they have experienced and expressing satisfaction with their accomplishments.

Selected articles in "Choosing a Computer" continue in the effort to offer guidance. Although the language in this article includes more technical terms than in any

empathic, reflective-listening statements from the computer. Did you know a Lithium Information Center exists? Or that computers are beginning to read minds by decoding brain-wave patterns that are produced by merely thinking of a word? You say, shades of 1984? Perhaps—but what about disabled people whose perfectly good minds are trapped in bodies that cannot move well enough to speak or write? A final chapter under "Other Issues" discusses tax tips for computer owners—another reason to invest in this book before computerizing your profession.

---

### **Contracting a programmer to develop an operational program can result in a misunderstanding that is largely financial.**

---

other portion of the book, it should not deter you. Yet this is the next to last of the 14 sections, so if you have read thus far and are ready to choose your computer, you need to know, in spite of technical terms, such considerations as how an Apple II compares with a Vector 2600.

#### **Broadening Horizons**

I recommend reading this book candy-box style. Pick out intriguing articles for the pure enjoyment of learning more about some fascinating applications of computers in mental health. Did you know, for instance, that computers can be programmed to respond as Rogerians, or Gestalt or Rational Emotive therapists? To date, these artificial-intelligence therapists are not the real thing, though. A set of repetitive Yes statements by a human tester elicits a series of hilarious, though

#### **Few Criticisms**

As I read, I carefully watched for drawbacks in *Using Computers in Clinical Practice*, though, I must admit, I really couldn't find many. It seems to contain something for everyone ranging from the uninitiated to those with serious purchasing intentions. If anything could have been expanded, however, I would have liked to have read more about client reactions, e.g., case studies, articles by clients, and quotes. I found one of the most engaging articles to be "A Computer Assisted Therapy Game for Adolescents: Initial Development and Comments" because it did briefly cover clients' behaviors and attitudes. Other articles that brought in clients' reactions to some extent were those on self-help sex therapy and a review of "Talking to a Computer About Emotional Problems." I had hoped the chap-

ter "Eliza and Her Offspring" might satisfy my desire to hear from clients, but as I read on I discovered Eliza is herself (itself?) an artificial-intelligence psychology program.

In sum, this book is outstanding and timely. It is a thorough overview that is both easy and enjoyable to read. It is well bound and clearly printed on nonglossy pages. It contains references at the end of many chapters as well as an extensive, categorized bibliography. Because of the overall writing style, the novice as well as an experienced user can learn a wealth of information almost effortlessly.

According to one article, it seems that during the 1970s panels designed to discuss computer use by the American Psychological Association were not very well attended. In 1980, however, these panels drew huge crowds of new computer owners who, having purchased the hardware, needed someone to show them what to do with it. Conclusion: computers are a growing facet of the mental health practice. If you are a clinician, it is time to find out what you may not already know, and *Using Computers in Clinical Practice* is an excellent first step. ■

---

*Ernie Wilson (POB 258, Gilsum, NH 03448) is a psychotherapist, a clinician at a mental health service, and a professor of psychology at Hawthorne College in Antrim, New Hampshire.*

---

*BYTE is always looking for qualified book reviewers. Submit queries and proposals accompanied by a resumé, writing samples, or a list of computer-related interests and expertise to BYTE's Book Review Editor, POB 372, Hancock, NH 03449.*







CRAFTSMEN OF THE NEW TECHNOLOGY.  
BEST PRICES WITH QUALITY SUPPORT\* ON SOFTWARE AND HARDWARE.

# ORYX SYSTEMS

## QUALITY DISCOUNTS

Circle 428 for Hardware/Peripherals. Circle 429 for Software. Circle 430 for May Specials on Networking.

Check Oryx's  
New Ad Listings!

### APPLE/ FRANKLIN

<b>ASHTON-TATE</b>	
d-Base II	\$ Call
<b>ASPEN/WANG SOFTWARE</b>	
Grammatik	\$ 60
Proofreader	42
<b>BEAGLE BROS.</b>	
Apple Mechanic	\$ 22
DOS Boss	17
Utility City	22
<b>BRODERBUND</b>	
Bank Street Writer	\$ 45
General Ledger w/AP	305
Payroll	275
<b>COEX</b>	
Visicalc Training	\$ 45
<b>CENTRAL POINT</b>	
Copy II +	\$ 34
<b>CONTINENTAL SOFTWARE</b>	
Home Accountant	\$ 49
<b>DIGITAL RESEARCH</b>	
Excellent selection on current and the exciting new products	\$ Call
<b>DOW JONES</b>	
Market Analyzer	\$ 245
Market Manager	219
Microscope	252
<b>LIVING VIDEOTEK</b>	
Think Tank	\$ 99

### d-BASE II CORNER

<b>Anderson-Bell</b>	
Abstat	\$ Call
<b>Ashton-Tate</b>	
d-Base II	\$ 389
FPL	410
Friday	179
<b>Fox &amp; Geller</b>	
Quick Code	\$ 175
D Util	58
<b>Human Soft</b>	
d-Base Plus	\$ 90
<b>Sensible</b>	
D-Programmer	\$ Call
<b>Software Banc</b>	
d-Base II	
User's Guide	
w/ d-Base II	
Purchase	\$ 15
w/o d-Base II	
Purchase	20
<b>Tylog Systems</b>	
d-Base Window	\$ 159
d-Base Door	\$ Call
*All above available on PC-DOS	

### LOGO CORNER

Krell Logo	\$ 75
Terrapin	\$ Call
<b>MICROPRO</b>	
Wordstar (Special w/ CP/M Card	
70 col. & 64K)	\$ Call
Infostar (Includes CP/M, 70 col., 64K)	\$ Call
Pro Pak (WS/MW/SS/Index)	399
<b>MICROSOFT</b>	
Cobol-80	\$ 499
Fortran-80	145
TASC Compiler	119
A.L.D.S.	79
Multiplan (DOS)	165
<b>OMEGA</b>	
Locksmith	\$ 79
<b>PEACHTREE</b>	\$ Call
<b>PENGUIN SOFTWARE</b>	
Complete Graphics	\$ 50
Graphics Magician	39
Complete Graphics/Apple Tablet	86
<b>SIERRA ON-LINE</b>	
Homeward	\$ Call
<b>SOFTech</b>	
Basic Compilers	
Runtime	\$ 169
Softech	94
UCSD P-system Set	469
<b>SOFTWARE PUBLISHING</b>	
PFS: File, Gr, Rep. ed.	\$ 79
<b>SUPERSOFT</b>	
Basic Tutor	\$ 79
Fortran 80	299
All Others	\$ Call
<b>SYSTEMS PLUS</b>	
Landlord	\$ 375
<b>VISICORP</b>	
Visicalc (II or IIE)	\$ 165
Visischedule	195

### CP/M SOFTWARE

#### FORMATS AVAILABLE

All prices below are for 8" standard. Other formats are available. Some formats subject to "Download" fee and require minimum 2 weeks for delivery. Please inquire.

<b>COMPUVIEW</b>	
*V-Edit 8080 Z80, IBM/PC	\$ 130
*V-Edit CP/M 86, MS DOS	160
*Systan	99
<b>DIGITAL RESEARCH</b>	
*Pascal MT + W/SPP	\$ 389
DR Assembler & Tools	149
CP/M 2.2	125
C Basic 2	95
PL/1-80	375

<b>DIGITAL RESEARCH (Cont'd)</b>	
*Personal Basic	120
*CP/M Plus 3.0	262
*CP/M Gold Card	\$ Call
Access or Display Mgr.	299
C Language/Compiler	260
Concurrent CP/M 2.0	Call
All 8" - 86 Version of Above	\$ Call
<b>INFOCOM</b>	
*Deadline	\$ 49
*Starcross	39
*Suspended	39
*Zork, I, II, III (each)	39
<b>MARK OF THE UNICORN</b>	
*Final Word	\$ 199



### PEACHTREE CORNER

PeachPak 4 (GL, AP, AR)	\$ 215
Series B (GL, AP, AR, Sales Inv., Inv., Control, Job Cost, Client Post. & Acct. each mod.)	\$ 389

<b>MICROPRO</b>	
*WordStar	\$ Call
*InfoStar	\$ Call
*Pro-Pak (WS/MW/SS Index)	\$ Call
All others	\$ Call
<b>MICROSOFT</b>	
Basic 80	\$ 239
Basic Compiler	249
Fortran 80	330
Cobol 80	449
Macro 80	130
MuMath/MuSimp	179
*Multiplan	165

<b>REVASCO</b>	
Z80 Disassembler	\$ 85
<b>SMI</b>	
*Open Access	\$ Call
<b>SORCIM</b>	
*Supercalc II	\$ Call
Superwriter (w/Speller & Mailer)	\$ 169
<b>SELECT</b>	
Select Word Processor	\$ 249
<b>STAR SOFTWARE SYSTEMS</b>	
*Legal Time, Billing	787
Property Mgmt	787
<b>SUPERSOFT</b>	
*Diagnostic II	\$ 89
Disk Doctor	74
*Fortran 4	299
Basic-8086	225
C Cross Assembler	400
*ScratchPad	187
<b>T MAKER III</b>	\$ 215

### IBM/PC

Please see CP/M listing. All products with an \* in front are also made for PC/DOS and are priced the same unless otherwise specified.

<b>ALPHA SOFTWARE</b>	
Data Base Mgr. II	\$ 179
Executive Pkg.	105
Apple-IBM Connection	Call
<b>AMERICAN INT'L COMMUNICATIONS</b>	
*Tlx-A-Syst	\$ 199
*Gram-A-Syst	199

### STAR SOFTWARE SYSTEMS ACCOUNTING PARTNER

Easy to use menu-driven programs for the beginner that can be linked with a sophisticated system as needed.

Your "Partner" includes: general ledger, accounts receivable, accounts payable and payroll. Also included for a nominal fee is an "800" number for access to the Star Question Center Back-Up Support Unit.

ORYX PRICE	\$ 279
------------	--------

<b>MICROSTUF</b>	
*Crosstalk	\$ 109
<b>NORTHWEST ANALYTICAL</b>	
*Statpak	\$ 365
<b>OASIS</b>	
The Word Plus	\$ Call
Punctuation and Style	\$ Call
<b>ORGANIC SOFTWARE</b>	
*Datebook	\$ 229
*Milestone	229
<b>PICKLES &amp; TROUT</b>	
CP/M for TRS	\$ 180
<b>PRO/TEM SOFTWARE</b>	
*Footnote	\$ 105

<b>AUTODESK</b>	
Autocad	\$ Call
<b>B&amp;L</b>	
*Multi-Job (runs nine programs at once)	\$ 145
<b>BULLISH INVESTMENT</b>	
Net Worth	\$ Call

Please call us regarding products for Macintosh and IBM PC Jr.

<b>CENTRAL POINT</b>	
Copy II PC	\$ 34
<b>CONTINENTAL</b>	
Home Accountant	\$ 89

Computer Systems for Medical, Dental, Insurance, Law and other professional groups. Call Oryx.

<b>CTek</b>	
PC Calculator	\$ 29
Prog. PC Calculator	49
Prog. PC Calculator w/ Fin. Mod.	55
<b>DIGITAL RESEARCH</b>	
Concurrent CP/M 86	\$ Call
Pascal MT + 86	375
Pascal MT+ (PC/DOS)	385
DR Logo	\$ Call

<b>DOW JONES</b>	
Market Analyzer	\$ 245
Market Manager	219
*Connector	39

<b>ECO-SOFT</b>	
Microstat	\$ Call

<b>ENERTRONICS</b>	
Energraphics	\$ Call

<b>FINANCIER</b>	
Tax Series	105
Financier II	\$ 119
<b>FOX &amp; GELLER</b>	
*Grafax	\$ 199

<b>FYI</b>	
Superfile	\$ 139
FYI 3000	287

<b>GRAPHIC SOFTWARE</b>	
Super Chartman II	\$ 299
Super Chartman IV	199
<b>HERITAGE</b>	
*Smart Key	\$ 75
*Smart Print	39
*Smart Key/Print	105

<b>LIFETREE</b>	
Waltwriter Deluxe	\$ 179
<b>LIVING VIDEOTEK</b>	
*Think Tank (256K)	\$ 139

<b>MICROPRO</b>	
*Starburst	\$ Call
<b>MICRORIM</b>	
R-base	\$ Call
<b>NORELL DATA SYSTEMS</b>	
*Systems Backup	\$ 42

<b>PEACHTREE</b>	
See CP/M listing	
PeachText 5000	\$ Call
<b>PEARLSOFT</b>	
Pearl Acct'g 2 (16 bit) (GL, AP, AR, P, INV.)	\$ 650
Personal Pearl	209

<b>SCIENTIFIC MARKETING</b>	
*Market Fax	\$ 349
<b>SORCIM</b>	
*Supercalc III	\$ 249



<b>SUPERSOFT</b>	
C Compiler - 8086	\$ 350
Sior Edit	180
Disk Edit	75
Basic Compiler	225
8087 Support	40

<b>SYSTEMS PLUS</b>	
Landlord (prog mgmt)	\$ 375
Runtime Basic	
(req'd for above)	45

<b>VISICORP</b>	
VisiOn Line	\$ Call
... and many more!	

## APPLE/ FRANKLIN BOARDS

ALS CP/M Card	\$ 299
ALS Smarten II	145
ALS Z-Card II	115
ABT Keyboard	99
Axlan Romdisk 128K	269
Bit 3 Dual Comm-plus	209
CCS 7710 Async Serial	119
Central Point Alaska	Call
East Side	
Wild Card II	\$ Call
Wild Card Plus	\$ Call
Microsoft 16K Ramcard	69
Microsoft Softcard	219
Microsoft Softcard +	419
Microsoft Premium	
Softcard (IIE)	335
Microtek Printer I/F	75
Microtek Dumping-16	195
Microtek Dumping-GX	119
Mountain A-D/D-A	\$ Call
Mountain Music	
System w/Software	\$ Call
PCP 4 MHz	
Appl-Card + 88 Card	509
PCP 88 Card	
16 Bit + 64K	425
55M ASIO Serial I/F	
w/cable	129
55M AIO 2 Serial/	
Parallel	179
Tymec Parallel I/F	
w/cable	79
Videx Display	
Enhancer II	99
Videx Display	
Enhancer II	109
Videx Func. Strip	59
Videx Videoterm	
VT-600	189
Videx Ultraterm	249
Wesper 16K Ram Card	69

## IBM/PC BOARDS

<b>AST RESEARCH</b>	
ComboPlus 64K (CI/Cal,	
Ser & Par, I/F,	
256K capacity)	\$ 279
MegaPlus 64K, (CI/Cal,	
Ser Port, 512K capacity	
w/Megapak)	\$ 269
Extra parts available	
for Megaplus and I/O	
Plus II (Game, P/S)	\$ 40
Megapak 256K upgrade	
for Megaplus	\$ Call
I/O Plus II CI/Cal	
and Ser Port	115

<b>MAYNARD ELECTRONICS</b>	
Flappy Drive Cntrl	\$ 160
w/ Par Port	209
w/ Ser Port	219
Sandstar Floppy	
Drive Cntrl	\$ 194
Sandstar Mem Card	
- 3 modules cap.	145
Sandstar Multifunction	
Card-6 modules cap.	71
Sandstar Modules	\$ Call

## DISPLAY CARDS CORNER

Hercules Gr Bd	\$ 359
Orchid	
Monochrome	
Gr Adapter	\$ Call
Plantronix	
Colorplus	\$ Call
Paradise/USI	
Display Card (color/ monochrome)	\$ Call
Amdak MAI Card	\$ Call
Teconer	
Graphic Master	\$ Call

<b>QUADRAM</b>	
Quadboard 64K,	
(CI/Cal, Ser & Par	
Ports, Software)	\$ 279
Macrofazer Stack Printer	
Buffer (esp. to 512K)	
Parallel/Parallel 8K	132
Parallel/Parallel 64K	188
Serial/Parallel 8K	170
Serial/Serial 8K	170
Quadlink 64K Mem	
(allows Apple SW to	
run on IBM/PC)	\$ Call
Other Quadram Prods	\$ Call

<b>TECMAR Products</b>	\$ Call
XEDEX/MICROLOG	
Baby Blue	\$ Call
Baby Blue II	\$ Call

## MONITORS

Amdak 300A Am	\$ 149
Amdak Color II	435
NEC JB1201 - 12" Gr	\$ Call
NEC JB1260 - 12" Gr	\$ 119
NEC JC1216 RGB	435
PGS HX12 KGB Clr	\$ Call
Panasonic CT160	
10" comp.	\$ Call
Quadchrome	\$ Call
Sanyo B112 12" HR Gr	\$ Call

### SONY

Profel 12"	\$ Call
Profel 19"	\$ Call
Profel 25"	\$ Call

<b>TAXON</b>	
KG12N-UY 12" HR Am	\$ 139
KG12N 12" HR Gr	132
RGB Vision-1	
12" LR Clr	\$ Call
RGB Vision-3	
12" HR Clr	\$ 459
US1 1200A 12" HR Am	\$ 159

## MODEMS

Hayes 300	\$ 205
Hayes 1200	495
Hayes 1200B (Int'l)	449
Hayes Chronograph	189
Novation	
Apple-Cat II	\$ 259
PC Cat w/ Crosstalk	
(also known as	
Access 1-2-3 1200B)	\$ Call
217 Smart Cat	\$ 409
<b>US Robotics</b>	
Auto-Dial 300/1200	\$ 459
Auto-Link 300/1200	410
S-100 Modem	345
Password	\$ Call
<b>Zoom Telephonics</b>	
Networker	\$ 109

## NETWORKING by ORCHID or SANTA CLARA

Starter Kit -	
Special Price	\$1,245
Add'l Adapter Cards	
& Cabling Available:	
For Pricing	\$ Call

## DISK DRIVES

CDC 1800	\$ Call
Corona	
5 MB Hard w/cntrl	1,395
10 MB Hard w/cntrl	1,795
Corvus	\$ Call
Davong 10/15/20 MB	\$ Call
Santa Clara	\$ Call
Tandon TM-100-2	239
<b>HALF HIGHS</b>	
Matsushita	\$ 249
Panasonic	205
Shugart	229
Super 5 (Apple)	229
Taac w/brackets	259

## PRINTERS

Anodex	\$ Call
C. Itoh Stenwriter	\$1,049
C. Itoh Prowriter 8510P	\$ Call
C. Itoh Prowriter 1550P	\$ 599
Dialo 630 ECS	\$ Call
Dialo 630 API	\$ Call
Epson	\$ Call
<b>IDS/Data Products</b>	
Prism 80 w/4 options	1,399
Prism 132 w/4 options	1,547
Microprism	\$ Call
<b>Mannesman Tally</b>	
MT180L	Call
MT160L	585
Spirit	\$ Call
NEC 3550	\$ Call
NEC 8023A	389
NEC 2031	\$ Call
Okidata 82-93	\$ Call
Quadram Quadjet	\$ Call
Siemens	
Ink Jet Printers	\$ Call
Silver-Reed	\$ Call
Daisy Wheel	\$ Call
<b>Star Micronics</b>	
Gemini 10X	299
Gemini 15X	\$ Call
RadiX 10/15	\$ Call
Delta	\$ Call
Teletax T1014	\$ Call
<b>Transfer</b>	
T-130 P&S	665
T-315 P - Dot Matrix	510
T-120 P&S	475

... and much more.

## DISKETTES

3M 5" DS, DD, Box	\$ 40
CDC	\$ Call
Acutrack	\$ Call

We offer the following complete systems w/ full support on our technical line.\*

Franklin 1000 & 2000	NEC APC & 8800
Corona	Columbia
Televideo	Hyperion

Maxell 5" DS, DD,	
MD2, Box	\$ 40
Verbatim 5"	
DS, DD, Box	\$ 35
Ultra Magnetics 5"	
DS, DD, Bonus Box	\$ 35
(12 Diskettes)	
(3 Boxes Diskettes Minimum)	

## PLOTTERS

Enter P100 Sweet P	
Apple/Franklin,	
IBM/PC	\$ Call
Strobe M100 Plotter	\$ 499
w/ I/F Apple/Franklin	\$ 499
Strobe M100 Plotter	\$ 499
(RS 232)	\$ 499
Panasonic	
Digital Plotter	\$ Call

## MISC.

<b>Alpha-Delta "MACC"</b>	
Surge Protector	\$ 69
Chalkboard	\$ Call
Curtis PC Products	\$ Call
EDP Surge Protectors	\$ Call
<b>Keytronic</b>	
Keyboard 5150	\$ Call
WP KB5151	\$ Call
WP KB5151 Dvarak	\$ Call
<b>Koska Technologies</b>	
Graphic Tablet	\$ Call
<b>Orange Micro</b>	
Grappler Plus	\$ 117
Grappler Plus w/Buffer	\$ 115

### PROTHEUS

Apprentance	\$ 99
Pro Modem	449
Venacard	159

<b>Seattle Computer</b>	
8087 Package	\$ 299
<b>Street Electronics</b>	
Echo Speech Synth IBM	\$ 179
Echo II Speech Synth	129
Echo Word	\$ Call
<b>Syntec</b>	
Light Pen IBM/PC	\$ 140
Light Pen Apple/FRK	200
<b>TG</b>	
Joystick IBM/PC	\$ 49
Joystick Apple/FRK	46
<b>Wico</b>	
Analog Joystick	\$ 59
Apple Adapter	18
IBM/PC I/F Card	\$ Call
<b>Vena Computing</b>	
VenaWriter	\$ 235

Below are several of the terminals available at ORYX.  
Adds - Qume - Televideo - Liberty - Teletax - Wyse  
For technical assistance call (715) 848-1374  
To order, use our toll free line.

### Please:

- Wisconsin residents add 5% for sales tax.
- Add \$3.50 for shipping per software and light items. For multiple and other items, call.
- Foreign - add 15% handling & shipping for prepayment. (Int'l money order)
- Prices are subject to change without notice.
- All items subject to availability.

## ORYX SYSTEMS, INC.

CRAFTSMEN OF THE NEW TECHNOLOGY  
425 First Street • PO. Box 1961  
Wausau, Wisconsin 54401

\*For technical assistance, order status and in Wisconsin:  
715-848-1374

Int'l Telex: 260181  
ORYX SYS WAU

### We Welcome:

- COD (Add \$2.00 per shipment. Cash or certified check required.)
- Visa, MasterCard (Add 3%) & American Express (Add 4%)
- Checks. (Allow 1-2 weeks for clearing.)

**Working Hours:** Central Time  
Mon. - Fri. 8:30 - 5:00 / Sat. 10:00 - 2:00

If at first you don't succeed  
in finding products that you need,  
Use our phone line...it's toll free  
For great prices / availability!

**ORDER TOLL FREE OUTSIDE WISCONSIN 1-800-826-1589**



# Book Reviews

## The Power Of: SuperCalc, 2nd ed.

Robert E. Williams and  
Bruce J. Taylor  
Management  
Information Source Inc.  
Portland, OR,  
1983, 232 pages,  
softcover, \$14.95

Reviewed by  
Jack Bishop

The idea of a book designed to teach you how to make user-friendly software work really boggles the mind. Philosophical questions aside, a book is an old, familiar, and reliable companion, whereas the computer sometimes requires two microcomputers, side by side, to present a computerized tutorial.

### Expectations

A user's manual is expected to focus on the commands of the program. In any handbook on computer software, I look to the author to either provide an introduction that explains the workings of the software in a unique way or to develop special and powerful insights (tricks of the trade) that go beyond the scope of the user's manual. *The Power Of: SuperCalc* seems to sit astride these two poles but leans toward the former, a beginner's manual. The introduction clearly states that the goal of this updated edition is to demonstrate Supercalc functions, rather than to illustrate specific problem-solving methods. And it uses a dozen exercises to do so.

### A Misnomer

*The Power Of: SuperCalc* is thus misnamed by my standards. Based on its contents, *A Simple Tour of Supercalc* would be a more accurate description. Such a simple tour

Area	Supercalc	Power
Math Functions	7	6
Boolean Expressions	4	3
Trigonometric Functions	9	3
Miscellaneous Functions	4	2
Commands	12	5
Calculation	4	—
Display	16	11

Table 1: The coverage of *The Power Of: SuperCalc* is fairly complete but ignores a few key commands (such as NPV, LN, LOG).

is not intended to be derogatory, for simple tours are worth a great deal. But to earn its name, I expected this handbook to take me more deeply into applications of Supercalc (see table 1). When I see the word "power," I also expect to be led through an appreciation of the limitations of a program. I can imagine any user trying to expand any one of the exercises to a business use, only to find that limitations of the calc structure lead him or her into a dead end, and often when it is least convenient.

### Exercises

The Accounts Receivable Ageing Report is an exercise that develops a simple report with columns for several categories: Current Billing, Over 30 Days, Over 60 Days, Over 90 Days, and Total Due. The report is clean and fits on the 80-column screen or printer without a fuss. The use of the Execute file to update the report each month will pay for the cost of the book in one update session. The addition of titling and multipages could give you a no-frills report for about 150 customers.

Invoicing from Inventory uses a multiple-table look-up to find pricing for 16 products as well as volume discounts.

Cost Recovery for an

equipment-rental company provides an example of recording "...a declining balance as entries accumulate against the fixed value." Rents received are used to offset the purchase price of each piece of equipment, the profit margin reflecting the difference between rents and initial cost. The use of the Execute command to update the worksheet is a good example of the power of Supercalc.

Production Scheduling extends the concept of comparing a value to a fixed base (as in the previous example) and to a variable base, in the scheduling of operations for a manufacturer of stained glass lamps. The Supercalc worksheet is set up to allow customer orders to be shifted from week to week to evaluate the effect on the schedule.

The Estimating exercise on machining and cost estimating for a small shop provides an example of using the calculation sequence in Supercalc. The example calculates values for a table, uses the table for reference, and finally selects values from the table for further calculations. The cleverness of the example is hidden in the excellence of the worksheet's layout.

Checkbook Ledger is a simple ledger, illustrating

posting and maintaining a balance.

Engineering Formula uses a simple vector calculation to illustrate the ability to calculate mathematical formulas easily. While using only the cosine, square root, and exponentiation functions, engineers should have no trouble generalizing (if they needed the example in the first place!).

Payroll Reporting illustrates the updating, storage, retrieval, and use of multiple worksheets.

Monthly Sales Reporting is the vehicle to illustrate the development of multiple reports on one worksheet.

Daily Inventory extends the ability of Supercalc to develop a daily report, then update totals and clear the report for the next day. The use of a logic command (IF) provides the key for reordering the product.

Financial Forecasting and Accounts Payable exercises provide further examples of functions already illustrated.

### Insights

The most powerful feature of the examples is the experience with the Execute file to update, reorganize, and clear a worksheet. Beginning calc users will not appreciate the power of this ability for a while, but the multiple examples should give everyone a feeling of confidence in this capability of Supercalc.

*The Power Of: SuperCalc* provides three insights I believe will prove valuable to many readers. First, the look-up table is a very powerful and, I suspect, underused aspect of the various calc spreadsheets. The several illustrations of its applications should provide the background to increase its use. Putting a zero at the beginning and end of the table is



the sort of trick of the trade I look for in a book of this sort.

Second, the calendar feature, while not a specific function of SuperCalc, is a simple way to ensure that the end-of-the-month change is handled smoothly and effortlessly. It is well described and laid out in this book.

Finally, the power of the example, discount taken versus the cost of borrowed money, is the simple idea of comparing the discount to the cost of borrowing the money, and using the SuperCalc to lay out the results simply, easily, and clearly. **Format**

*The Power Of: SuperCalc* is laid out with commands on the left, explanations on the right. The commands are spelled out, as is the word Return. More than one reader will issue oaths when

discovering that typing the letters *r-e-t-u-r-n* is not what the author intended. (Ever wonder why we have carriage returns on the keyboard? That's another story!)

I would've gladly paid more for this book to cover

manual contains a Repeat Text command that appeared unworkable. Then I realized the squiggle at the other side of the page was an apostrophe, not a comma, and the mystery was solved.

All in all, the book is well

---

**With some modification, these worksheets will provide greater individual productivity as well as the opportunity to learn several aspects of the language of SuperCalc.**

---

the costs of highlighting the commands in color and for necessary typesetting improvements. The commas and colons tend to get lost unless your eyes are very young and the light is good and your arms are short and.... For example, the

worth the price. While *The Power Of: SuperCalc* provides a good short tour, the real power of SuperCalc lies beyond the horizon for self-discovery. For a few, the payoff of *The Power Of: SuperCalc* will come in just having spent a few dollars to have a

security blanket on the shelf. For others, the author's slightly different approach to the material in the SuperCalc user's manual will be sufficient. Teachers will benefit from accompanying overhead-projection transparencies (\$49.95) and a floppy disk (\$64.95). A final group will find one or more of the 12 exercises applicable to their special needs. With some modification, these worksheets will provide greater individual productivity as well as the opportunity to learn several aspects of the language of SuperCalc. For the price, you are getting honest examples carefully done. ■

---

*Dr. Jack Bishop (Bishop Associates, 2000 Sherman Ave., POB 311, Evanston, IL 60201) is a management consultant specializing in corporate planning and economics.*

---



## UniPrint Built for Apple® owners that demand quality and features on a budget!

When you're trying to find the right parallel interface for your printer, look to Videx to bring you the best in quality and features. At only \$89.00 suggested retail, the UniPrint is packed with features:

- Full Basic, Pascal, ProDOS, and CP/M compatibility.
- Text and High Resolution Graphics transfers.
- Logo graphics transfers!
- Color graphics transfers to the Dataproducts (IDS) Prism.
- Centronics— Compatible Cable Included.
- Comprehensive 48 page manual Includes easy installation and operating instructions, and configurations for over 25 different printers.

### Parallel Printer Interface



Suggested Retail Price  
**\$89.00**

### UniPrint . . . A simple solution to your printer interfacing needs!

UniPrint is easy to install and use. And Videx' customer support lets you buy UniPrint with confidence! We've taken the guessing out of shopping for a full featured card.

UniPrint is a trademark of Videx, Inc.  
Apple and ProDOS are trademarks of Apple Computer, Inc.  
CP/M is a trademark of Digital Research, Inc.  
Prism is a trademark of Dataproducts, Inc.

**Videx**  
1105 N.E. Circle Blvd. • Corvallis • OR • 97330  
503-758-0521



*Esprit I*



*Esprit II*



*Esprit III*



*Esprit III Color*



*ESP-6310*



*Executive*

**ESPRIT.**  
**WE GIVE YOU MORE**  
**THAN TECHNOLOGY,**  
**WE GIVE YOU**  
**PEACE OF MIND.**







Executive 10/25

Executive 10/51

Executive 10/78

Executive 10/102

Executive 10/102G

**N**owadays, technology is advancing so rapidly that today's latest breakthrough may be replaced as soon as tomorrow by something even more revolutionary.

### PEACE OF MIND A NEW DIMENSION.

To the rapidly-changing world of high technology, Esprit—the company with more experience in terminal technology than any other—would like to introduce a new and un-changing dimension: peace of mind.

Designed right into every terminal in Esprit's complete line are the features, the functions and the flexibility that make it not only user-friendly but systems-friendly. In other words, the kind of comfort, quality and trouble-free technology that can provide real peace of mind.

Backed up with an extensive nationwide service force and our own special toll free service number (800-645-4508)—so you can reach us about anything that concerns you—to insure your own peace of mind.

### PEACE OF MIND FOR THE NEXT GENERATION IN TERMINALS.

One look at the Esprit ESP 6310 and you'll recognize the next generation of terminals. With performance and features far superior to other terminals in its price category. And the kind of quality you can feel comfortable with.

### DESIGNED FOR PEACE OF MIND.

From the sleek and stylish lines of its ergonomic design to the sculptured lines of its low-profile

keyboard with its 11 user-programmable function keys—shiftable to 22—in non-volatile memory back-up, that can be programmed directly or down-line loaded from the host computer.

From its high resolution, green phosphor display with a well defined character font, in a large 7 x 11 dot matrix, in an 80 column x 25 line format to its screen saver feature which deactivates the screen after 20 minutes of inactivity.

From its tilt and swivel monitor to its smooth scrolling and line graphics capabilities.

Our ESP 6310 provides enhanced performance and incorporates emulations of the TeleVideo 925/910 PLUS\*, ADDS Regent 25/Viewpoint\* and Lear Siegler ADM3A\*, as well as the popular Esprit series.

### PEACE OF MIND PRICE. \$695.

That means even our low price is designed to give you peace of mind. And so for your own peace of mind, please fill out the coupon below or call.

**800-645-4508**

Esprit Systems, Inc.  
100 Marcus Drive  
Melville, N.Y. 11747

Yes for my own peace of mind I would like to receive a brochure on your complete line of Esprit terminals.

NAME \_\_\_\_\_

TITLE \_\_\_\_\_

ADDRESS \_\_\_\_\_

CITY \_\_\_\_\_ STATE \_\_\_\_\_ ZIP \_\_\_\_\_

*Esprit*  
Systems, Inc.

B51

# PEACE OF MIND TECHNOLOGY.

\*TeleVideo 925/910 Plus is the registered trademark of TeleVideo Systems, Inc. Regent 25/Viewpoint is the registered trademark of Applied Digital Data Systems, Inc. ADM3A is the registered trademark of Lear Siegler, Inc.)

# Clubs and Newsletters

## Opportunity for Kids

The San Pablo Computer Club, formed by the San Pablo Institute, a nonprofit public-service organization, is devoted to making computer education available to economically disadvantaged young people. The club offers programming instruction and an environment in which youngsters can meet and share ideas. Because it does not charge membership dues, the club relies on donated computer equipment, peripherals, and software. For information, write to the San Pablo Institute, 234 Mullen St., San Francisco, CA 94110.

## Tipping the T.I.P.C. User

T.I.P.C., a group of Texas Instruments Professional Computer users, meets every month in Houston, Texas. Group members wish to contact TI PC users nationwide to share software and hardware information, develop a software library, and assist in the publication of a newsletter. For further details, contact Stephen Gay, T.I.P.C., 1608 Elmen, Houston, TX 77019, (713) 520-6990.

## Participate Locally

*Computer Users* is a quarterly newsletter produced in cooperation with the Computer Users Federation (CUF) of Southeast Wisconsin. Participation in local events is facilitated due to the newsletter's listings of a regional club and group directory and computer-related activities. An area calendar of classes, seminars, shows, and meetings is posted on a telecommunications system made up of two local bulletin boards.

Subscriptions to the newsletter are available for \$3 a year; the newsletter is free to any club upon submittal of its mailing list. To send or receive information, contact CUF, POB 23483, Milwaukee, WI 53223.

## Sooners Form Commodore Clubs

The Greater Oklahoma Commodore Club comprises three chapters: Oklahoma City, Midwest City, and Edmond. More chapters may be added later. A newsletter, *OKCommodore Connection*, is produced. For further information, contact Randy Hill, Greater Oklahoma Commodore Club, 1401 North Rockwell, Oklahoma City, OK 73127, (405) 789-3229.

## Serving the Victor

*SIVic-9000*, a newsletter for Victor-9000 users, has reports on new software and hardware releases, user critiques, a technical question-and-answer column, gameware, and personal-use software reviews. Interviews and feature articles of interest to Victor-9000 users are included. A charter subscription is \$24 a year. For details, contact Michael McNeilly, *SIVic-9000*, Suite 456, 3277 Roswell Rd. NE, Atlanta, GA 30326.

## Hoosier Computerlists Meet In High Land

The Terre Haute PC Users Group (THPCUG) is for users of the IBM PC and compatible computers and everyone else interested in small computers. Meetings are held at 7 p.m. on the first Monday of the month in the Terre Haute area of Indiana.

A \$10 annual membership fee includes group-purchase discounts and a subscription to the THPCUG monthly newsletter. A monthly disk produced by the club is available for a minimal copying charge. For further information, contact the Terre Haute PC Users Group, POB 3174, Terre Haute, IN 47803.

## Unir Project Is for Unix Users

Membership in the Unir Project, a user group for people interested in the Unix operating system and in the C programming language, is open to anyone fascinated by interactive computer systems. A \$25 membership fee entitles you to receive a copy of the current quarterly newsletter and a certified UNID (a Unirversal Numeric Identifier) used to order reports and software from the Unir Project and to access the members' database. Subscriptions to the newsletter alone are \$24. To become a member, send your name, address, and phone number plus a brief description of your interests to Unir Corp., Suite 106, 5987 East 71 St., Indianapolis, IN 46220, or call (317) 842-7014.

## Pick Ideas and Tools

*Logto Zircon*, a monthly newsletter for Pick users, provides a source for ideas and tools to improve the performances of operating systems. Each issue explores such themes as security, offers creative programs, or reports on design improvements. In addition, each issue contains programming tools. An annual subscription is \$59.95. For further information, contact Catherine Hill, Zircon Co. Inc., 215 Salem

St., Woburn, MA 01801, (617) 935-6901.

## Computerlists Meet In the Granite State

The New Hampshire Atari Computer Club (NACC) meets on the first Tuesday of the month in Nashua, New Hampshire. For details, contact Scott Mitchell, NACC, 346 South Taylor St., Manchester, NH 03103, or call (603) 624-0089.

## Micro Library Up and Running

The Library Micro Clearinghouse is a national nonprofit endeavor to promote library management through the exchange of library-application templates for use with public-domain software. Librarians are encouraged to duplicate the templates they receive, adapt the programs to meet their needs, and share them with other libraries. Templates come in single- and double-disk versions for \$5 and \$7.50, respectively. To donate applications templates for public-domain distribution or for further information, contact Eric Anderson, Micro Computer Libraries, 145 Marcia Dr., Freeport, IL 61032.

## Stamp Out Sour Computer Experiences

The Lemon Byte Society assists personal computer users by combating some of the shortcomings of the computer industry. Aimed at users who are stymied by severe deficiencies encountered in using software or hardware, the professionals who comprise the Society act as go-betweens



for the user and supplier. They document the problem, contact the parties responsible for the defect, and print their findings and results in a monthly bulletin available to all members. Annual membership is \$32, which entitles you to all the Society's services. For further details, contact The Lemon Byte Society, POB 558250, Miami, FL 33155, (305) 386-3479.

### WUE Has Recipe for Success

The World Users Exchange (WUE) assists user groups in their efforts to promote computer knowledge. As a result of a recently conducted survey, WUE found that several user groups needed help in improving their programs and in planning services to members. One way WUE

helps user groups is by offering possible solutions to organizational snafus in each issue of its newsletter, *The Exchange*. User groups are encouraged to share their solutions to problems so that they may be avoided by newer organizations. For details, write the World Users Exchange, POB 12132, Roanoke, VA 24022.

### Health-care Applications Supported

The *Micro MD Journal* is a monthly newsletter for novice and experienced computer users in the health-care field. It focuses on applications for clinical and diagnostic areas, office management, and personal-investment fields. A catalog listing medical and dental software, hardware, and accessories is

provided and purchase discounts are offered. A charter subscription is \$36 annually; \$60 for two years. Send inquiries to Micro MD Publishers, POB 2500, Chesapeake, VA 23320.

### Users Converge in Toms River

The Computer Club of Ocean County (CCOC) New Jersey welcomes users of any personal computer to attend its meetings. Held at 7:30 p.m. on the first Friday of each month in the Ocean County Municipal Building in Toms River, CCOC meetings include speakers, presentations, and magazine swaps. The club produces a quarterly newsletter and an annual membership directory. An electronic bulletin board, (201) 244-2259, is open to the public from 4 p.m. to

7 a.m. weekdays and 24 hours a day on weekends. It supports 300- and 1200-bps (212A) operation and offers special privileges to club members. Downloading and uploading of text or programs and general-message storage/retrieval are supported and running on a Heath Z-89. For further details, contact Stuart MacDonald, CCOC, 6 Whitaker Dr., Toms River, NJ 08753, (201) 240-9323.

### Meet with Fellow HP 80 Users

All users of the Hewlett-Packard Series 80 personal computer in Orange County, California, are welcome to attend meetings offered by the HP Club 80. Members meet on the first Wednesday of the month in the Irvine area. There are no dues. For details

# GTEK INC. (601) 467-8048

## DEVELOPMENT HARDWARE/SOFTWARE

### HIGH PERFORMANCE/ COST RATIO

# EPROM PROGRAMMER

Compatible w/all Rs 232 serial interface port \* Auto select baud rate \* With or without handshaking \* Bidirectional Xon/Xoff and CTS/DTR supported \* Read pin compatible ROMS \* No personality modules \* Intel, Motorola, MCS86, Hex formats \* Split facility for 16 bit data paths \* Read, program, formatted list commands \* Interrupt driven, program and verify real time while sending data \* Program single byte, block or whole EPROM \* Intelligent diagnostics discern bad and erasable EPROM \* Verify erasure and compare commands \* Busy light \* Complete w/Textool zero insertion force socket and integral 120 VAC power (240 VAC/50Hz available)

DR Utility Package allows communication with 7128, 7228, and 7956 programmers from the CP/M command line. Source Code is provided. PGX utility package allows the same thing, but will also allow you to specify a range of addresses to send to the programmer. Verify, set the Eprom type.

**MODEL 7316 PAL PROGRAMMER**  
Programs all series 20 PALS. Software included for compiling PAL source codes.

Software Available for CPM,<sup>1</sup> ISIS,<sup>2</sup> TRSDOS,<sup>3</sup> MSDOS.<sup>4</sup>

1. TM of Digital Research Corp.
2. TM of Intel Corp.
3. TM of Tandy Corp.
4. TM of Microsoft.

Post Office Box 289  
Waveland, Mississippi 39576  
[601]467-8048

Avocet Cross Assemblers are available to handle 8748, 8751, 28, 6502, 680X, etc. Available for CP/M and MSDOS computers. Order by processor type and specify kind of computer.

Model DE-4 U/V Products hold 8, 28 pin parts. High quality professional construction.

**MODEL 7334 PAL PROGRAMMER**  
Programs all series 20 & 24 PALS. Operates stand alone or via RS232.

**5879 stand alone MODEL 7956**

**MODEL 7956 GANG PROGRAMMER**  
Intelligent algorithm. Stand alone. Copies eight EPROMS at a time. With RS-232 option \$1099.

**5549 MODEL 7316**

**5549 MODEL 7228**

**MODEL 7228 EPROM PROGRAMMER**  
All features of Model 7128 plus Auto Select Baud, super fast adaptive programming algorithms, low profile aluminum enclosure. Programs 2764 in one minute!

**5429 MODEL 7128**

**MODEL 7128 EPROM PROGRAMMER**  
Programs and Reads:

	NMOS	NMOS	CMOS	EEPROM	MPU'S
2508	2758	27C16	5213	8748	
2516	2716	27C32	5213H	8748H	
2532	2732	C6716	X2816	8749H	
2564	2732A	27C54	48016	8741	
68766	2764		12816A	8742H	
68764	27128			8741H	
8755	27256			8751	
5133					

**81195 MODEL 7324**

Model 7128-L1,L2,L2A	\$239.00
Model 7128-24	\$329.00
DR8 or DR5	\$ 30.00
DR8PGX or DR5PGX	\$ 75.00
Cross Assemblers	\$200.00
XASM (for MSDOS)	\$250.00
U/V Eraser DE-4	\$ 78.00
RS232 Cables	\$ 30.00
8751 adapter	\$174.00
8755 adapter	\$135.00
48 Family adapter	\$ 98.00

## Clubs and Newsletters

or to get on the mailing list, contact Milt Beychok, 63 Oak Tree Lane, Irvine, CA 92715, (714) 786-0837.

### Volunteers Host 64 Users

The E T 64 Users Group is a club in Tennessee dedicated to learning about using the Commodore 64 computer. For further details, contact Walt Turner, E T 64 Users Group, POB 495, Knoxville, TN 37901, or call (615) 966-8478.

### Garden of Software Created for Adam

Sage Enterprises has created a public-domain software library and exchange for owners of Coleco's Adam personal computer. In addition, Sage Enterprises will offer a bimonthly newsletter of information about the public-domain software, user groups, and new products. For further information, contact Sage Enterprises, Route 2, Box 211, Russellville, MO 65074.

### Microcomputerists Gather in Memphis

The Memphis Area IBM PC Users Group meets on the fourth Wednesday of the

month in room 233 of the Dunn Building on the campus of Memphis State University in Tennessee. Address further inquiries to Peter Vermilye, Memphis Area IBM PC Users Group, POB 241756, Memphis, TN 38124-1756, or call (901) 345-8760.

### Commodores at Golden Gate

The San Francisco Commodore Users Group provides beginners with an introduction to programming skills, hardware modifications, and software for the Commodore 64 and VIC-20. For details, contact Roger Tierce, San Francisco Commodore Users Group, 278 27th Ave. #103, San Francisco, CA 94121, or call (415) 387-0225.

### Sanyo Strong In Boston

The Sanyo Users Group/USA (SUG/USA), located in Boston, Massachusetts, gives support to Sanyo computer owners via a bimonthly newsletter and distribution of public-domain software. Sanyo products are reviewed, and software patches, articles from users about various applications, lists of public-domain software, and book

reviews are included in the newsletter. Future plans call for access via CompuServe and a computerized bulletin-board service. SUG/USA will act as a referral service to help Sanyo users form local chapters. Contributions of articles and public-domain software are welcome. The membership fee is \$15 annually. Write to the Sanyo Users Group/USA, POB 8069, Boston, MA 02114-8069.

### Sanyo Group Seeks Your Input

The Sanyo PC users group collects and welcomes information from business and personal users of the Sanyo 550 or 555 PC. A newsletter is planned. Send inquiries to Roger Wilcox, 425 Woodlawn Ave., Zanesville, OH 43701.


### MS-DOS Users Rally in Zürich

The PC-Club Zürich was started for users of IBM, Columbia, Corona, and other MS-DOS-based systems. For more information, contact Kurt Fürer, PC-Club Zürich, Kuenzlistrasse 38, CH-8057 Zürich, Switzerland.

### Texans Form TRS-80 Club

The TRS-80 Club meets at 7 p.m. once a month at the McLennan County Library in Waco, Texas. The *H.O.T. TRS-80 Club Monthly Newsletter* contains meeting dates, articles, editorials, and advertisements for purchase discounts available only to members. For further details, write to The TRS-80 Club, POB 1923, Waco, TX 76703.

If you would like BYTE readers to know about your club or newsletter send the details accompanied by no more than one newsletter to Clubs and Newsletters, BYTE Publications, POB 372, Hancock, NH 03449. Overseas groups are encouraged to participate. Please allow at least three months for your announcement to appear.

 A Public Service of This Magazine  
& The Advertising Council

# Give Blood. Give Life.

Giving blood is everyone's business. After all, company blood drives provide a vital part of our nation's blood supply.

They benefit everyone. Your community gets much needed blood. Your employees get a lift when they give blood. And your company gets the good will.

So please have your firm start planning for a blood drive, today. And you can help save many lives tomorrow.

American  
Red Cross



We'll Help Will You?



# Books Received

*The ABZ's of Word Processing for Executives and Professionals*, Robert M. Segal and Susan B. Kelley. New York: Stravon Educational Press, 1983; 64 pages, 21.5 by 28 cm, softcover, ISBN 0-87396-097-1, \$10.95.

*Abstraction Mechanisms and Language Design*, Paul N. Hülfinger. Cambridge, MA: The MIT Press, 1983; 192 pages, 18 by 23.5 cm, hardcover, ISBN 0-262-08134-2, \$27.50.

*Advanced Programming Techniques for Your Atari Including Graphics & Voice Programs*, Linda M. Schreiber. Blue Ridge Summit, PA: Tab Books, 1983; 224 pages, 19.5 by 23.5 cm, softcover, ISBN 0-8306-1545-8, \$14.50.

*Adventures with the Atari*, Jack B. Hardy. Reston, VA: Reston Publishing Co., 1984; 368 pages, 17.5 by 23.5 cm, softcover, ISBN 0-8359-0172-6, \$14.95.

*Affordable Word Processing*, Richard A. McGrath. Englewood Cliffs, NJ: Prentice-Hall, 1983; 160 pages, 15.3 by 22.8 cm, softcover, ISBN 0-13-018259-1, \$10.95.

*Algorithmic Program Debugging*, Ehud Y. Shapiro. Cambridge, MA: The MIT Press, 1983; 248 pages, 18 by 23.7 cm, hardcover, ISBN 0-262-19218-7, \$30.

*Apple Assembly Language*, W. Douglas Maurer. Rockville, MD: Computer Science Press, 1984; 432 pages, 15.3 by 23.8 cm, softcover, ISBN 0-914894-82-X, \$17.95.

*Apple II Applications*, Marvin L. De Jong. Indianapolis, IN: Howard W. Sams & Co., 1983; 240 pages, 13.5 by 22.8 cm, softcover, ISBN 0-672-22035-0, \$13.95.

*Apple II User's Guide*, 2nd ed., Lon Pool. Berkeley, CA: Osborne/McGraw-Hill, 1983; 496 pages, 16.3 by 23.5 cm, softcover, ISBN 0-88134-104-5, \$17.95.

*Area-Efficient VLSI Computa-*

*tion*, Charles E. Leiserson. Cambridge, MA: The MIT Press, 1983; 152 pages, 18.3 by 23.8 cm, hardcover, ISBN 0-262-12102-6, \$22.50.

*Assembly Language Programming for the IBM Personal Computer*, David J. Bradley. Englewood Cliffs, NJ: Prentice-Hall, 1984; 352 pages, 18.5 by 24 cm, hardcover, ISBN 0-13-049189-6, \$19.95.

*Automating Your Financial Portfolios*, Donald Woodwell. Homewood, IL: Dow Jones-Irwin, 1983; 270 pages, 15.5 by 23.5 cm, hardcover, ISBN 0-87094-399-5, \$19.95.

*Basic Disk I/O Faster and Better & Other Mysteries*, Lewis Rosenfelder. Upland, CA: IJG Inc., 1983; 432 pages, 21.3 by 27.8 cm, softcover, ISBN 0-936200-25-1, \$29.95.

*Basic Fun with Graphics the Apple Computer Way*, Margaret Ann Zuanich and Susan Drake Lipscomb. New York: Avon Camelot Books, 1983; 128 pages, 13 by 19 cm, softcover, ISBN 0-380-85043-5, \$3.95.

*Basic Fun with Graphics the Atari Computer Way*, Margaret Ann Zuanich and Susan Drake Lipscomb. New York: Avon Camelot Books, 1983; 128 pages, 13 by 19 cm, softcover, ISBN 0-85050-8, \$3.95.

*Basic Fun with Graphics the IBM/PC Computer Way*, Margaret Ann Zuanich and Susan Drake Lipscomb. New York: Avon Camelot Books, 1983; 160 pages, 13 by 19 cm, softcover, ISBN 0-380-85068-0, \$3.95.

*BASIC II Advanced*, William C. Conley. New York: Petrocelli Books, 1983; 208 pages, 13.8 by 21 cm, softcover, ISBN 0-89433-202-3, \$10.95.

*The Birds of Babel, Satellites for the Human World*, Hal Glatzer. Indianapolis, IN: Howard W. Sams & Co., 1983; 240 pages, 23 by 23.5 cm, softcover, ISBN 0-672-22033-4, \$12.95.

*Bowker/Bantam 1984 Com-*

*plete Sourcebook of Personal Computing*. New York: R. R. Bowker Co. and Bantam Books, 1983; 650 pages, 16 by 23.5 cm, hardcover, ISBN 0-8352-1767-1, \$24.95.

*Business-Office Computers*, Gary Gagliardi. New York: Bantam Books, 1983; 64 pages, 13 by 19.5 cm, softcover, ISBN 0-553-34079-4, \$2.95.

*Choose Your Own Computer*, Peter Rodwell, ed. Woodbury, NY: Barron's Educational Series Inc., 1983; 176 pages, 9.5 by 19 cm, softcover, ISBN 0-8120-2706-X, \$4.95.

*Commodore 64 Computing*, Ian Sinclair. Englewood Cliffs, NJ: Prentice-Hall, 1983; 144 pages, 15.3 by 22.8 cm, softcover, ISBN 0-13-152306-6, \$12.95.

*The Commodore 64 Music Book*, James Vogel and Nevin B. Scrimshaw. Cambridge, MA: Birkhäuser Boston Inc., 1983; 144 pages, 15.3 by 23.5 cm, softcover, ISBN 0-8176-3158-5, \$14.95.

*The Complete Buyer's Guide to Personal Computers*, Tim Hartnell and Stan Velt. New York: Bantam Books, 1983; 400 pages, 10.5 by 17.5 cm, softcover, ISBN 0-553-23873-6, \$4.95.

*Complexity Issues in VLSI*, Frank Thomson Leighton. Cambridge, MA: The MIT Press, 1983; 146 pages, 18 by 23.5 cm, hardcover, ISBN 0-262-12104-2, \$19.95.

*Computational Aspects of VLSI*, Jeffrey D. Ullman. Rockville, MD: Computer Science Press, 1984; 514 pages, 23.5 by 15.5 cm, hardcover, ISBN 0-914894-95-1, \$32.95.

*Computational Methods in Bifurcation Theory and Dissipative Structures*, M. Kubiček and M. Marek. New York: Springer-Verlag, 1983; 256 pages, 24.3 by 15.5 cm, hardcover, ISBN 0-387-12070-X, \$42.

*Computer-Assisted Instruc-*

*tion*, Jack A. Chambers and Jerry W. Sprecher. Englewood Cliffs, NJ: Prentice-Hall, 1983; 240 pages, 17 by 23.5 cm, softcover, ISBN 0-13-164376-2, \$12.95.

*Computer Confidence, A Woman's Guide*, Dorothy Heller and June Bower. Washington, DC: Acropolis Books Ltd., 1983; 264 pages, 21 by 24 cm, hardcover, ISBN 0-87491-555-4, \$16.95.

*Computer Dictionary for Beginners*, Arthur Naiman. New York: Ballantine Books, 1983; 160 pages, 13.5 by 21 cm, softcover, ISBN 0-345-31223-6, \$6.95.

*The Computer Phone Book*, Mike Cane. New York: New American Library, 1983; 480 pages, 13.5 by 20 cm, softcover, ISBN 0-452-25446-9, \$9.95.

*Computer Wimp*, John Bear. Berkeley, CA: Ten Speed Press, 1983; 296 pages, 18.5 by 23.5 cm, softcover, ISBN 0-89815-101-5, \$9.95.

*Contemporary Business Letters with WordStar*, Jane E. Robbins and Dennis P. Curtin. Somerville, MA: Curtin & London, 1983; 240 pages, 21.5 by 27.8 cm, softcover, ISBN 0-930764-63-3, \$15.50.

*Cosmic Games for the Commodore VIC 20*, Hal Renko and Sam Edwards. Reading, MA: Addison-Wesley, 1983; 142 pages, 15.3 by 15.3 cm, softcover, ISBN 0-201-16476-0, \$5.95.

*Creating Computer Programs for Learning*, Gary W. Orwig. Reston, VA: Reston Publishing Co., 1983; 192 pages, 17.3 by 23.3 cm, softcover, ISBN 0-8359-1168-3, \$14.95.

*dBASE II Programmer's Notebook*, Steven G. Meyerson. Poquoson, VA: Computech, 1983; 50 pages, 21.5 by 28 cm, spiral-bound, ISBN-none, \$12.95.

*Database Machines*, H. O. Leilich and M. Missikoff, eds. New York: Springer-Verlag, 1983; 356 pages, 16.5 by

## Books Received

24.5 cm, softcover, ISBN 0-387-12959-6, \$23.

*The Design of Interpreters, Compilers, and Editors for Augmented Transition Networks*, Leonard Bolc, ed. New York: Springer-Verlag, 1983; 228 pages, 17 by 25 cm, hardcover, ISBN 0-387-12789-5, \$29.

*The Directory of Software Publishers*, Eric Balkan, ed. New York: Van Nostrand Reinhold, 1983; 320 pages, 22 by 29 cm, hardcover, ISBN 0-442-21429-4, \$25.50.

*Discover Your VIC-20*, Donald Kahn Jr. and Nevin B. Scrimshaw. Cambridge, MA: Birkhäuser Boston Inc., 1983; 112 pages, 16 by 23.5 cm, softcover, ISBN 0-8176-3160-7, \$10.95.

*Discovering Apple Logo*, David D. Thornburg. Reading, MA: Addison-Wesley, 1983; 158 pages, 18.7 by 23.5 cm, softcover, ISBN 0-201-07769-8, \$14.95.

*Discrete Optimization Algorithms with Pascal Programs*, Maciej M. Syslo, Narsingh Deo, and Janusz S. Kowalik. Englewood Cliffs, NJ: Prentice-Hall, 1983; 560 pages, 18.5 by 24.3 cm, hardcover, ISBN 0-13-215509-5, \$37.50.

*Electronic Life*, Michael Crichton. New York: Alfred A. Knopf, 1983; 224 pages, 14.6 by 22 cm, hardcover, ISBN 394-53406-9, \$12.95.

*Executive VisiCalc for the Apple Computer*, Roger E. Clark. Reading, MA: Addison-Wesley, 1983; 144 pages, 18.8 by 23.3 cm, softcover, ISBN 0-201-10242-0, \$14.95.

*Executive VisiCalc for the IBM Personal Computer*, Roger E. Clark. Reading, MA: Addison-Wesley, 1983; 260 pages, 18.5 by 23.5 cm, softcover, ISBN 0-201-10243-9, \$12.95.

*Experiments in Four Dimensions*, David L. Heiserman. Blue Ridge Summit, PA: Tab

Books, 1983; 512 pages, 19.5 by 23.5 cm, softcover, ISBN 0-8306-1541-5, \$17.50.

*54 SuperCalc Models*, Robert H. Flast. Berkeley, CA: Osborne/McGraw-Hill, 1983; 256 pages, 21 by 27.5 cm, softcover, ISBN 0-88134-118-5, \$15.95.

*Formal Specification of Interactive Graphics Programming Languages*, William R. Mallgren. Cambridge, MA: The MIT Press, 1983; 290 pages, 18 by 23.8 cm, hardcover, ISBN 0-262-13191-9, \$35.

*Fundamentals of Data Structures in Pascal*, Ellis Horowitz and Sartaj Sahni. Rockville, MD: Computer Science Press, 1984; 560 pages, 15.5 by 23.8 cm, hardcover, ISBN 0-914894-94-3, \$26.95.

*Funny Things, Computers*, Trevor Hutchings. Toronto, Canada: James Lorimer & Company Publishers, 1983; 66 pages, 13.5 by 19.5 cm, softcover, ISBN 0-88862-678-

9, \$6.95.

*Games for Your Atari Computer*, Paul Bunn. New York: Dell Publishing Co., 1983; 128 pages, 14.5 by 25 cm, spiral-bound, ISBN 0-440-52800-3, \$5.95.

*Games for Your Timex/Sinclair 1000*, Mark Charlton. New York: Dell Publishing Co., 1983; 128 pages, 14.5 by 25 cm, spiral-bound, ISBN 0-440-52785-6, \$5.95.

*Games for Your Timex/Sinclair 2000*, Peter Shaw. New York: Dell Publishing Co., 1983; 128 pages, 14.5 by 25 cm, spiral-bound, ISBN 0-440-52794-5, \$5.95.

*Games for Your VIC-20*, Alastair Gourlay. New York: Dell Publishing Co., 1983; 128 pages, 14.5 by 25 cm, spiral-bound, ISBN 0-440-52789-9, \$5.95.

*Graphics Primer for the IBM PC*, Mitchell Waite and Christopher Morgan. Berkeley, CA: Osborne/McGraw-

# BYTE Back Issues for sale

	1976	1977	1978	1979	1980	1981	1982	1983	1984
Jan.				\$2.75	\$3.25	\$3.25		\$3.70	\$4.25
Feb.			\$2.75	\$2.75	\$3.25	\$3.25		\$3.70	\$4.25
March			\$2.75		\$3.25		\$3.70	\$3.70	\$4.25
April			\$2.75	\$2.75	\$3.25	\$3.25	\$3.70	\$3.70	\$4.25
May		\$2.00	\$2.75	\$2.75	\$3.25		\$3.70	\$3.70	
June		\$2.00	\$2.75	\$2.75	\$3.25		\$3.70	\$3.70	
July	\$2.00	\$2.00	\$2.75	\$2.75	\$3.25		\$3.70	\$4.25	
Aug.		\$2.00	\$2.75	\$2.75		\$3.25	\$3.70	\$4.25	
Sept.		\$2.75	\$2.75	\$2.75	\$3.25		\$3.70	\$4.25	
Oct.			\$2.75	\$2.75	\$3.25	\$3.25	\$3.70	\$4.25	
Nov.				\$3.25		\$3.25	\$3.70	\$4.25	
Dec.		\$2.75	\$2.75	\$3.25	\$3.25	\$3.25	\$3.70	\$4.25	

Circle and send requests with payments to:  
**BYTE Back Issues**  
**P.O. Box 328**  
**Hancock, NH 03449**

Prices include postage in the US. Please add \$.50 per copy for Canada and Mexico; and \$2.00 per copy to foreign countries (surface delivery).

Check enclosed

Payments from foreign countries must be made in US funds payable at a US bank.

VISA

Master Card

Card # \_\_\_\_\_

Exp. \_\_\_\_\_

Signature \_\_\_\_\_

Please allow 4 weeks for domestic delivery and 12 weeks for foreign delivery.

NAME \_\_\_\_\_

ADDRESS \_\_\_\_\_

CITY \_\_\_\_\_

STATE \_\_\_\_\_ ZIP \_\_\_\_\_



Hill, 1983; 448 pages, 18 by 23.3 cm, softcover, ISBN 0-931988-99-3, \$21.95.

*Graphics Programs for the IBM PC*, Robert J. Traister. Blue Ridge Summit, PA: Tab Books, 1983; 256 pages, 19.8 by 23.5 cm, softcover, ISBN 0-8306-1556-3, \$15.50.

*Graphiques de Gestion*, Denis Charpentier. Paris, France: Masson, 1983; 176 pages, 16 by 24 cm, softcover, ISBN 2-225-80110-X, 150 francs.

*Home-Family Computers*, Gary Gagliardi. New York: Bantam Books, 1983; 64 pages, 13 by 19.5 cm, softcover, ISBN 0-533-34077-8, \$2.95.

*How To Do It on the TRS-80*, William Barden Jr. Upland, CA: IJC Inc., 1983; 200 pages, 21 by 27.5 cm, softcover, ISBN 0-936200-08-1, \$29.95.

*How to Find and Buy Good Software*, Jess W. Curry Jr. and David M. Bonner. Engle-

wood Cliffs, NJ: Prentice-Hall, 1983; 176 pages, 17.5 by 23.3 cm, softcover, ISBN 0-13-406652-9, \$8.95.

*How to Microcomputerize Your Business*, Jules A. Cohen with Catherine Scott McKinney and the staff of Orbis. Englewood Cliffs, NJ: Prentice-Hall, 1983; 192 pages, 17.3 by 23.3 cm, softcover, ISBN 0-13-423889-3, \$9.95.

*IBM Personal Computer & XT*, Gerald VanDiver. Prior Lake, MN: Micro Information Publishing, 1983; 1024 pages, 21 by 27.8 cm, softcover, ISBN 0-912603-00-3, \$24.95.

*Introducing LOGO for the Apple II Computer, Texas Instruments 99/4A, and Tandy Color Computer*, Peter Ross. Reading, MA: Addison-Wesley, 1983; 260 pages, 15.5 by 23.5 cm, softcover, ISBN 0-201-14652-5, \$12.95.

*Introduction to Ada*, David Price. Englewood Cliffs, NJ:

Prentice-Hall, 1984; 160 pages, 15.5 by 23.5 cm, hardcover, ISBN 0-13-477653-4, \$22.95.

*An Introduction to the Commodore 64*, Nevin B. Scrimshaw and James Vogel. Cambridge, MA: Birkhäuser Boston Inc., 1983; 144 pages, 16 by 23.5 cm, softcover, ISBN 0-8176-3161-5, \$11.95.

*Introduction to DECSYS-TEM-20 Assembly Programming*, Stephen A. Longo. Monterey, CA: Brooks/Cole Publishing Co., 1984; 208 pages, 18.5 by 23.5 cm, softcover, ISBN 0-534-02942-6, \$17.95.

*An Introduction to Vu-Calc Spreadsheets for the Timex/Sinclair 2000 and the Sinclair ZX Spectrum*, Harry Anbarlian. New York: McGraw-Hill, 1984; 448 pages, 23.5 by 17 cm, spiral-bound, ISBN 0-07-001698-4, \$22.95.

*Instructional Computing with the TRS-80*, Herbert L.

Nickles and George H. Culp. Monterey, CA: Brooks/Cole Publishing Co., 1984; 240 pages, 18.5 by 23.5 cm, softcover, ISBN 0-534-02966-3, \$15.95.

*Invitation to COBOL for the TRS-80*, Lawrence L. McNitt. New York: Petrocelli Books, 1983; 304 pages, 15.5 by 23.5 cm, softcover, ISBN 0-89433-209-0, \$15.

*Low-Cost Word Processing*, Laurence Press. Reading, MA: Addison-Wesley, 1983; 240 pages, 18 by 23.5 cm, softcover, ISBN 0-201-05735-2, \$10.95.

*Management Information Systems*, 3rd ed., Jerome Kanter. Englewood Cliffs, NJ: Prentice-Hall, 1984; 464 pages, 18.3 by 24.3 cm, hardcover, ISBN 0-13-549543-1, \$27.95.

*The McWilliams II Word Processor Instruction Manual*, Peter A. McWilliams. West Hollywood, CA: Prelude

A REFURBISHED DAISY WHEEL TERMINAL  
FOR PERSONAL COMPUTER USERS AND SMALL BUSINESSES.

## Three-In-One Offer! Just \$895 From Your Computer Store.

- A 30 cps letter-quality printer
- A timesharing keyboard terminal (when modem equipped)
- A Selectric\*-style keyboard typewriter

AJ daisy wheel printer terminals are renowned for exceptional performance, high reliability, and applications versatility. Now you can have all this for only \$895\*\* in our special limited offer.

- 30 cps letter-quality printing
- Changeable type faces
- Full ASCII keyboard with numeric pad
- High resolution X-Y plotting
- Complete electronic forms control
- 128-character buffer
- Asynchronous RS-232 interface
- Printwheel, ribbon cartridge, and cable included
- 30-day parts/labor warranty

And you can choose from a list of options including forms tractor, pin-feed platen, paper trays, side shelves, extra printwheels, APL keyboard and 2K buffer.

Call your nearest AJ region office to find the nearest computer store: San Jose, CA (408) 263-8520 (Sales); Rosemont, IL (312) 671-7155; Fair Lawn, NJ (201) 794-9316

\*\*Suggested selling price, excludes options and is subject to change without notice. Model shown includes certain options. Offer available only in the contiguous U.S.

\*Selectric is a trademark of IBM



**A** ANDERSON  
JACOBSON

## Books Received

Press, 1983; 144 pages, 13.3 by 21 cm, softcover, ISBN 0-671-50433-9, \$3.95.

*Microcomputer Software Design*, Sally Campbell. Englewood Cliffs, NJ: Prentice-Hall, 1984; 240 pages, 17.5 by 23.3 cm, softcover, ISBN 0-13-580621-6, \$12.95.

*The Minute Manual for Apple Writer IIe*, Jim Pirisino. Columbia, MD: Minuteware, 1983; 140 pages, 13.5 by 22.8 cm, softcover, ISBN 0-913131-01-6, \$7.95.

*Multidimensional Digital Signal Processing*, Dan E. Dudgeon and Russell M. Mersereau. Englewood Cliffs, NJ: Prentice-Hall, 1984; 416 pages, 18 by 24.3 cm, hardcover, ISBN 0-13-604959-1, \$36.95.

*The New American Computer Dictionary*, Kent Porter. New York: New American Library, 1983; 320 pages, 10.5 by 17.8 cm, softcover, ISBN 0-451-12578-9, \$3.50.

*Office Automation & Word Processing Buyer's Guide*, Tony Webster. New York: McGraw-Hill, 1984; 352 pages, 28 by 21.5 cm, softcover, ISBN 0-07-068962-8, \$19.95.

*PATCA Directory of Consultants, 1983-1984*, Professional & Technical Consultants Association. San Jose, CA: PATCA, 1983; 140 pages, 21 by 13.5 cm, softcover, ISBN 0-939840-02-2, \$7.95.

*Pascal for BASIC Programmers*, Charles Seiter and Robert Weiss. Reading, MA: Addison-Wesley, 1983; 256 pages, 18.7 by 23.7 cm, softcover, ISBN 0-201-06577-0, \$10.95.

*Pascal for FORTRAN Programmers*, Ronald H. Perrott and Donald C. S. Allison. Rockville, MD: Computer Science Press, 1984; 352 pages, 15 by 23 cm, softcover, ISBN 0-914894-09-9, \$18.95.

*Pascal Programs for Games & Graphics*, Tom Swan.

Rochelle Park, NJ: Hayden Book Co., 1983; 224 pages, 18 by 23.5 cm, softcover, ISBN 0-8104-6271-0, \$15.95.

*Personal Computer Buyers Guide*, Dennis J. Grimes and Brian W. Kelly. Cambridge, MA: Ballinger Publishing Co., 1983; 300 pages, 22.8 by 27.8 cm, softcover, ISBN 0-88410-917-8, \$16.95.

*The Personal Computer Handbook*, Peter Rodwell. Woodbury, NY: Barron's Educational Series Inc., 1983; 208 pages, 21.5 by 28 cm, softcover, ISBN 0-8120-2704-3, \$14.95.

*Personal Computing: BASIC Programming on the TRS-80*, Robert R. Hare Jr. Monterey, CA: Brooks/Cole Publishing Co., 1984; 352 pages, 21.3 by 27.8 cm, softcover, ISBN 0-534-02768-7, \$19.95.

*Practical WordStar Uses*, Julie Anne Arca. Berkeley, CA: Sybex, 1983; 336 pages, 17.8 by 23 cm, softcover, ISBN 0-

89588-107-1, \$16.95.

*Professional-Personal Computers*, Gary Gagliardi. New York: Bantam Books, 1983; 64 pages, 13 by 19.5 cm, softcover, ISBN 0-533-34078-6, \$2.95.

*A Programmer's View of the Intel 432 System*, Elliot I. Organick. New York: McGraw-Hill, 1983; 432 pages, 16 by 23.5 cm, hardcover, ISBN 0-07-047719-1, \$29.95.

*Programming the 8086/8088*, James W. Coffron. Berkeley, CA: Sybex, 1983; 336 pages, 14.8 by 23 cm, softcover, ISBN 0-89588-120-9, \$15.95.

*Programming Projects for Your Timex/Sinclair 1000*, Frank Wattenberg. Englewood Cliffs, NJ: Prentice-Hall, 1983; 112 pages, 17.5 by 23.5 cm, softcover, ISBN 0-13-729673-8, \$8.95.

*Programming the M68000*, Tim King and Brian Knight. Reading, MA: Addison-Wesley, 1983; 160 pages, 15.5 by

# DANA'S COMPUTER DISCOUNT

★ Highest Quality - Lowest Prices ★

<p><b>IBM PC KIT</b> INCLUDES:</p> <ul style="list-style-type: none"> <li>• DELUXE CASE</li> <li>• POWER SUPPLY W/FAN</li> <li>• DETACHABLE LOW PROFILE KEYBOARD</li> <li>• MOTHER BOARD FULLY SOCKETED</li> <li>• ALL COMPONENTS INCLUDED</li> <li>• FULL DOCUMENTATIONS</li> <li>• 128 K RAM</li> <li>• 5 EXPANSION SLOTS</li> </ul> <p><b>ONLY \$995<sup>00</sup></b> ASSEMBLE IN 1 HOUR</p>	 <p><b>HALF HEIGHT</b> Apple II &amp; E Compatible 512m line 40 trac w/patch Single sided 143 K capacity</p> <p><b>\$194<sup>00</sup></b></p>	<p><b>FULL HEIGHT</b> Apple II &amp; E Compatible 35 Trac Single sided 143 K capacity</p> <p><b>\$169<sup>00</sup></b></p> 	 <p><b>TEAC FD55B</b> The Highest Quality! Slim line 40 trac capability Double sided, double density Compatible</p> <p><b>\$189<sup>00</sup></b></p>	<p><b>LMS JOYSTICK</b> Apple II &amp; E Compatible Heavy duty case</p> <p><b>\$29<sup>00</sup></b></p> 
---	--	--	--	--

**Commodore® Compatible Drive \$299<sup>00</sup>**

**RAM CHIPS** 4164 150NS \$5.95 ea. Limit 64 Pc  
4164 200NS \$5.50 ea. per customer

### Dana's Discount Computer Buyers Club ★ ★ ★ ★

- \$12.00 ANNUAL MEMBERSHIP (REFUNDABLE)
- \$10.00 CREDIT TOWARD FIRST PURCHASE.
- SPECIAL ADDED DISCOUNTS.
- MONTHLY SPECIALS FOR MEMBERS ONLY
- SPECIAL MEMBERSHIP ACCOUNT AND I. D. CARD
- PERSONAL CHECKS ACCEPTABLE FROM CLUB MEMBERS.

TRAC FD55F (DSDD-8STPI)	\$239.95
12" Amber Monitor/ Low Res	89.95
12" Green Monitor/ Low Res	89.95
13" BMC Color Monitor	249.95
12" Altrona Amber Monitor/ Hi Res	109.95
12" Altrona Green Monitor/ Hi Res	109.95
80 Col. BMC Printer	249.95
3 1/4" Apple Compatible	CALL
3 1/4" IBM PC Compatible	CALL
5 1/4" (SSDD) Floppy Discs (Box of 10)	16.95
Cooling Fans for Apple	44.95

### APPLE II & E

Disc Drive Controller Card  
Printer Interface Card  
Epson Compatible



**\$44<sup>00</sup>**

### APPLE COMPATIBLE COMPUTER ONLY:

64 K Upper Lower  
247 Functions on Keyboard  
Numeric Keypad  
H.D. Case

**\$499<sup>00</sup>**

### IC's Available & More

74LS323	\$3.25
6118	4.99
2114	1.49
8502	4.85

ORDER DESK 8:00 A.M. TO 5:00 P.M.  
PST MON. THRU FRI.  
Orders normally shipped within 48 hours.

Join Our Club  
And Save!

Orders: 1-800-262-DANA

International orders accepted with a \$5.00 surcharge for handling, plus shipping charges • We accept Visa, MasterCard, Money Orders, and Certified checks • Checks require bank clearance • California residents add 8% sales tax • All subject to availability, acceptance, and verification • All sales are final • Satisfaction guaranteed or full refund.

## Dana's Computer Discount

P.O. Box 15485, Santa Ana, California

In California: (714) 953-9105

\*Eagle, IBM, Apple, Apple II/E, and Commodore are all registered trademarks of Eagle, IBM, Apple and Commodore corporations



## Books Received

23.5 cm, softcover, ISBN 0-201-11730-4, \$12.95.

*Programs for the T1 Home Computer*, Steve Davis. Englewood Cliffs, NJ: Prentice-Hall, 1983; 126 pages, 21.5 by 28 cm, softcover, ISBN 0-13-729534-0, \$14.95.

*Real-Time Software*, Robert L. Glass. Englewood Cliffs, NJ: Prentice-Hall, 1983; 464 pages, 15.8 by 23.5 cm, hardcover, ISBN 0-13-767103-2, \$24.95.

*Science and Engineering Programs for the IBM PC*, Cass Lewart. Englewood Cliffs, NJ: Prentice-Hall, 1983; 144 pages, 15 by 23 cm, softcover, ISBN 0-13-794934-0, \$12.95.

*Semiconductor Memories*, Betty Prince and Gunnar Due-Gundersen. New York: John Wiley & Sons, 1983; 216 pages, 15.5 by 23.5 cm, hardcover, ISBN 0-471-90146-6, \$21.95.

*Simple Interfacing Projects*, Owen Bishop. Englewood Cliffs, NJ: Prentice-Hall, 1983; 176 pages, 23 by 15.3 cm, softcover, ISBN 0-13-811083-2, \$10.95.

*Spreadsheets on the TRS-80 Color Computer*, Harry Anbarlian. New York: McGraw-Hill, 1983; 320 pages, 17 by 23.5 cm, spiral-bound, ISBN 0-07-001595-3, \$39.95. Includes a cassette.

*The Software Sifter*, Philip Frankel and Ann Gras. New York: Macmillan Publishing Co., 1983; 271 pages, 21.3 by 28 cm, spiral-bound, ISBN 0-02-949330-7, \$24.95.

*Survival on Planet X with the Atari Home Computer*, Michael Orkin and Ed Bogas. Reston, VA: Reston Publishing Co., 1984; 161 pages, 17.5 by 23.5 cm, softcover, ISBN 0-8359-7412-X, \$12.95.

*Thrilling Games for the Tandy Color Computer*, Hal Renko and Sam Edwards. Reading, MA: Addison-Wesley, 1983; 156 pages, 15.3 by 15.3 cm, softcover, ISBN 0-201-16481-7, \$5.95.

*Through the MicroMaze: A Visual Guide*, Wayne Creek-

more. Culver City, CA: Ash-ton-Late, 1983; 64 pages, 21.5 by 25.3 cm, softcover, ISBN 912677-02-3, \$9.95.

*The Timex/Sinclair 1000 Basic Handbook*, Douglas Hergert. Berkeley, CA: Sybex, 1983; 192 pages, 14 by 21 cm, softcover, ISBN 0-89588-113-6, \$7.95.

*20 Programs for the ZX Spectrum & 16K ZX81*, S. Daly. London, England: Bernard Babani Ltd., 1983; 128 pages, 11.3 by 18 cm, softcover, ISBN 0-85934-103-8, £1.95.

*Using the Commodore 64 in the Home*, Hank Librach and Bill L. Behrendt. Englewood Cliffs, NJ: Prentice-Hall, 1983; 110 pages, 14.8 by 23 cm, softcover, ISBN 0-13-940072-9, \$10.95.

*VIC-20: The Affordable Learning Tool for the Mature Adult*, John A. Heil and Jack Martin. Wayne, PA: Banbury Books, 1983; 206 pages, 18 by 23.5 cm, spiral-bound, ISBN 0-88693-001-4, \$14.95.

*Word Processing on the IBM*, Peter A. McWilliams. Los Angeles, CA: Prelude Press, 1983; 288 pages, 15 by 23 cm, softcover, ISBN 345-31530-8, \$9.95.

*The WordStar Handbook*, Dennis P. Curtin. Somerville, MA: Curtin & London, 1983; 176 pages, 28 by 21.5 cm, softcover, ISBN 0-930764-64-1, \$16.50.

*Xanadu*, Roy Mason with Lane Jennings and Robert Evans. Washington, DC: Acropolis Books Ltd., 1983; 262 pages, 21 by 23.5 cm, hardcover, ISBN 87491-701-8, \$18.95.

*Your Commodore 64*, John Heilborn and Ran Talbott. Berkeley, CA: Osborne/McGraw-Hill, 1983; 464 pages, 16.8 by 23.5 cm, softcover, ISBN 0-88134-114-2, \$14.95.

*Your First Microprocessor*, James W. Coffron. Englewood Cliffs, NJ: Prentice-Hall, 1984; 352 pages, 17.5 by 23.5 cm, softcover, ISBN 0-13-978446-2, \$14.95. ■

## 64K S100 STATIC RAM

\$199<sup>00</sup>  
KIT

NEW!

LOW POWER!  
RAM OR EPROM!



BLANK PC BOARD  
WITH DOCUMENTATION  
\$55

SUPPORT ICs + CAPS  
\$17.50

FULL SOCKET SET  
\$14.50

FULLY SUPPORTS THE  
NEW IEEE 696 S100  
STANDARD  
(AS PROPOSED)  
FOR 56K KIT \$185

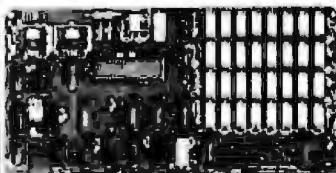
ASSEMBLED AND  
TESTED ADD \$50

### FEATURES:

- Uses new 2K x 8 (TMM 2016 or HM 5118) RAMs.
- Fully supports IEEE 696 24 BIT Extended Addressing.
- 64K draws only approximately 500 MA.
- 200 NS RAMs are standard. (TOSHIBA makes TMM 2016 as fast as 100 NS. FOR YOUR HIGH SPEED APPLICATIONS.)
- SUPPORTS PHANTOM (BOTH LOWER 32K AND ENTIRE BOARD)
- 2716 EPROMs may be installed in any of top 48K.
- Any of the top 8K (5000 H AND ABOVE) may be disabled to provide windows to eliminate any possible conflicts with your system monitor, disk controller, etc.
- Perfect for small systems since BOTH RAM and EPROM may co-exist on the same board.
- BOARD may be partially populated as 56K.

## 256K S-100 SOLID STATE DISK SIMULATOR!

WE CALL THIS BOARD THE "LIGHT-SPEED-100" BECAUSE IT OFFERS AN ASTOUNDING INCREASE IN YOUR COMPUTER'S PERFORMANCE WHEN COMPARED TO A MECHANICAL FLOPPY DISK DRIVE.



BLANK PCB  
(WITH CP/M™ 2.2  
PATCHES AND INSTALL  
PROGRAM ON DISKETTE)

\$69<sup>85</sup>

### FEATURES:

- 256K on board, using +5V 84K DRAMS.
- Uses new Int'l 8203-1 LBI Memory Controller.
- Requires only 4 Dip Switch Selectable I/O Ports.
- Runs on 6080 or Z80 S100 machines.
- Up to 8 LS-100 boards can be run together for 2 Meg. of On Line Solid State Disk Storage.
- Provisions for Battery back-up.
- Software to make the LS-100 to your CP/M™ 2.2 DOS is supplied.
- The LS-100 provides an increase in speed of up to 7 to 10 times on Disk Intensive Software.
- Compare our price! You could pay up to 3 times as much for similar boards.

\$399<sup>00</sup>

MLS-100 (FULL 256K KIT)

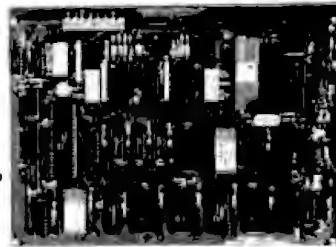
## THE NEW ZRT-80

### CRT TERMINAL BOARD!

A LOW COST Z-80 BASED SINGLE BOARD THAT ONLY NEEDS AN ASCII KEYBOARD, POWER SUPPLY, AND VIDEO MONITOR TO MAKE A COMPLETE CRT TERMINAL. USE AS A COMPUTER CONSOLE, OR WITH A MODEM FOR USE WITH ANY OF THE PHONE-LINE COMPUTER SERVICES.

### FEATURES:

- Uses a Z80A and 6845 CRT Controller for powerful video capabilities.
- RS232 at 16 BAUD Rates from 75 to 19,200.
- 24 x 80 standard format (60 Hz).
- Optional formats from 24 x 80 (50 Hz) to 64 lines x 96 characters (60 Hz).
- Higher density formats require up to 3 additional 2K x 8 5116 RAMS.
- Uses N.S. INS 8250 BAUD Rate Gen. and USART combo IC.
- 3 Terminal Emulation Modes which are Dip Switch selectable. These include the LSI-ADM3A, the Heath H-1B, and the Beethiv.
- Composite or Split Video.
- Any polarity of video or sync.
- Inverse Video Capability.
- Small Size: 6.5 x 9 inches.
- Upper & lower case with descenders.
- 7 x 8 Character Matrix.
- Requires Par. ASCII keyboard.



BLANK PCB WITH 2716  
CHAR. ROM, 2732 MON. ROM  
\$59<sup>85</sup>

SOURCE DISKETTE - ADD \$10  
SET OF 2 CRYSTALS - ADD \$7.50

WITH 8 IN.  
SOURCE DISK!  
(CP/M COMPATIBLE)

\$129<sup>95</sup>

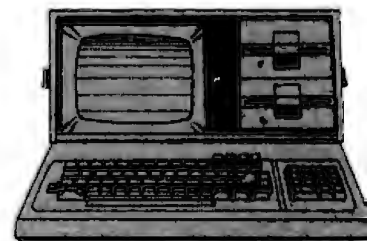
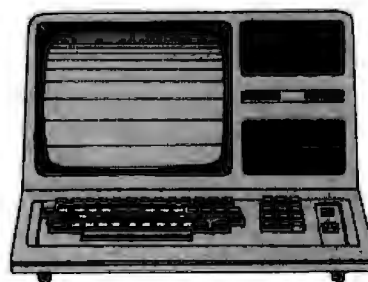
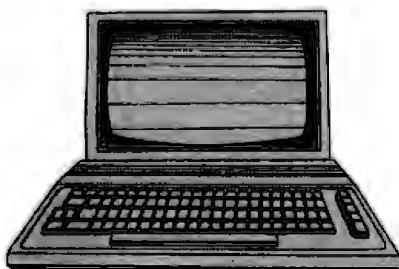
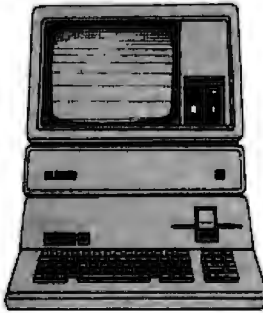
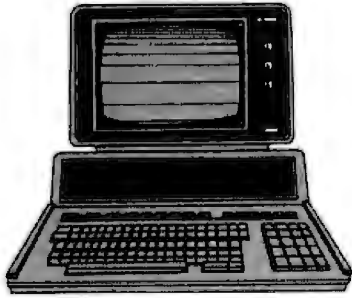
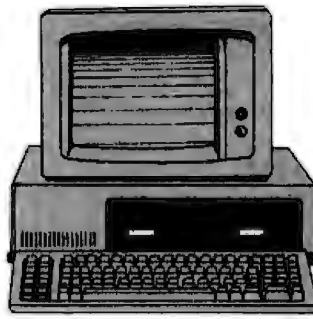
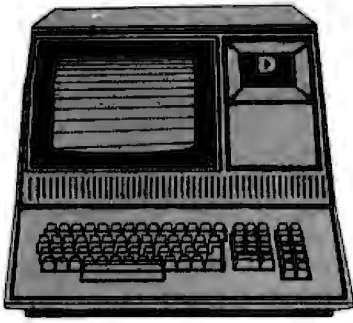
(COMPLETE KIT,  
# ZRT-80  
2K VIDEO RAM)

## Digital Research Computers

P. O. BOX 461565 • GARLAND, TEXAS 75046 • (214) 271-3538

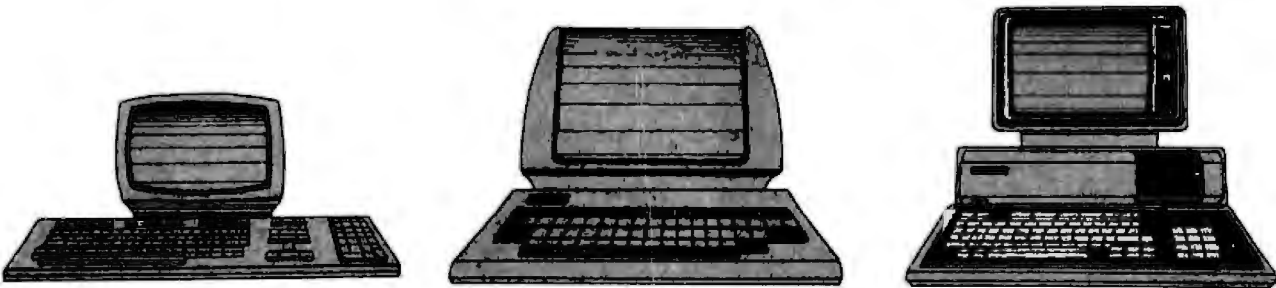
TERMS: Add \$3.00 postage. We pay balance. Orders under \$15 add 75¢ handling. No C.O.D. We accept Visa and MasterCard. Texas Res. add 5% Tax. Foreign orders (except Canada) add 20% P & H. Orders over \$50 add 85¢ for insurance.

ALL SALES SUBJECT TO THE TERMS OF OUR 90 DAY LIMITED WARRANTY. FREE COPY UPON REQUEST.



**Now  
you can  
reach  
anyone  
with  
your small  
computer.**





At last, there's a practical way to enjoy the benefits of "electronic mail." It's Western Union EasyLink™ service.

With it you can literally reach any business or any person in writing, almost anywhere on earth. With EasyLink service, you can link your personal computer or word processor to almost any other, to the global Telex network and to anyone, nearly anywhere, with an array of rapid delivery Western Union message services.

EasyLink can increase your equipment's usefulness, improve office productivity and dramatically cut message delivery time.

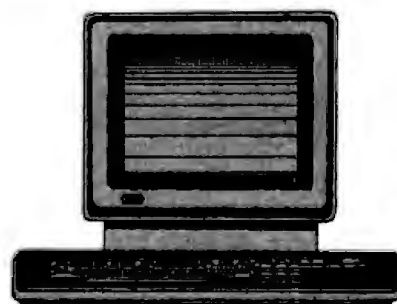
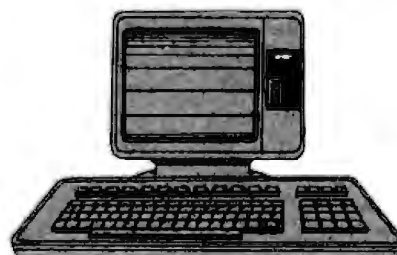
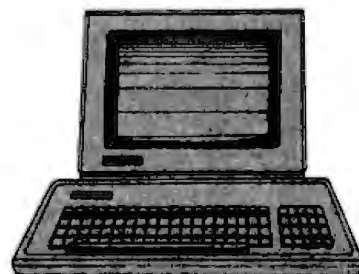
**Links to the WorldWide Telex network.**

EasyLink subscribers have a direct link to Western Union's WorldWide Telex. Through this service, you can reach any of the 1.5 million businesses who are Telex subscribers in 154 countries.

Your message arrives in just minutes, in writing, for a fraction of the cost of a long-distance phone call. And you will get your own number to receive messages from anyone on the worldwide network.

**Available now.**

EasyLink service is now available. Let us demonstrate how easy it is to send and receive messages from your communicating desktop terminals. Call us toll-free at 800-336-3797. Ext. 348. \* Or contact Clyde Meador, Western Union, One Lake Street, Upper Saddle River, New Jersey 07458.



# Western Union EasyLink service.

The easy way to link your computer to the world.

\*In Virginia, call 703-448-8877. Ext. 348.

Circle 403 on Inquiry card.

# Software Received

## Apple

**Apple Logo**, an interactive computer language. This program is an introduction to programming using turtle graphics. When you see the shapes you create, you learn what steps are involved in programming technique. Suitable for children or adults. For II, II Plus, and IIe; floppy disk, \$175. Logo Computer Systems Inc., 9960 Cote de Liesse, Lachine, Quebec H8T 1A1, Canada.

**Appleworks**, an integrated software package for use in business and at home. This program combines word processing, database managing, and financial modeling into a single program. You can write and edit letters and documents, make financial calculations on spreadsheets, and keep important information on disk. For the IIe; floppy disk, \$250. Apple Computer Inc., 20525 Mariani Ave., Cupertino, CA 95014.

**Basic Accounting**, a financial-management system for use in business and at home. You can keep track of checkbooks, charge cards, savings books, cash accounts, and business accounts. Update, search, edit, print, and even secure your system using a secret password. For II, II Plus, and IIe; floppy disk, \$89. Practical Software Inc., 31245 La Baya Dr., Westlake Village, CA 91362.

**Beat the Street**, a stock-market technical-analysis training simulator. Beginning or experienced investors can practice playing the market without real capital losses on poor investments. Learn point and figure charting and interpret the price pattern as it unfolds based on actual price his-

stories of over 175 stocks on the big board. Simulation can take the place of years of experience in trading stocks. For II and IIe; floppy disk, \$49.95. MEA Software Associates, POB 2385, Littleton, CO 80161.

**The Bilestoad**, a strategic adventure game. In a futuristic setting of 39 levels and 44 combat fields, your job is to help mankind survive in a violent world. Barbaric battles are fought man to man or man against robot. For the II; floppy disk, \$39.95. Data-most, 8943 Fullbright Ave., Chatsworth, CA 91311-2750.

**Calculus**, an educational program for use in both schools and business to solve calculus problems. This second edition program contains 22 user-friendly and self-contained working programs in BASIC. For II Plus and IIe; floppy disk, \$39.95. Sasoco, 5004 Glen Forest Dr., Raleigh, NC 27612.

**Caverns of Callisto**, an arcade-type game. Save your space station from aliens who are attacking you and running off with your ship's panels and the ion drive. Try to retrieve your ship parts and fight off the aliens so you can repair your ship. For II, II Plus, and IIe; floppy disk, \$34.95. Origin Systems Inc., 1545 Osgood St. #7, POB 99, North Andover, MA 01845.

**Compu Fed**, a database program for dog breeders. You can keep track of three to five generations of pedigree dogs even if you are a computer novice. Log in the dog's name, birthdate, AKC number, sex, and the dog's parents' names. For II Plus and IIe; floppy disk, \$37.50. B & L Mac, 132 Patton, Richland, WA 99352.

**Da Poma GB**, a gradebook-emulation program. A teacher's tool that keeps track of up to 50 students' grades and averages for the academic year. Each student's record has 42 individual scores that are divided into three categories that include test and exams, homework, and any other items you need to consider. For II Plus and IIe; floppy disk, \$49. Da Poma Inc., POB 23192, Honolulu, HI 96822-0910.

**Exodus: Ultima III**, the third in a series of role-playing adventure games. You are sent out to conquer treacherous foes in the realm of Sosaria. With new powers, you must create characters from a variety of attributes, form and disband an adventure party, and restore peace. For II, II Plus, and IIe; floppy disk, \$59.95. Origin Systems Inc. (see address above).

**Flight Simulator II**, a flying-simulation package. Once you've learned to maneuver a Piper during day or dusk, land in various cities, and perform aerobatics, you can test your skills in a World War I aerial-battle simulation. For II, II Plus, and IIe; floppy disk, \$49.95. Sublogic Corp., 713 Edgebrook Dr., Champaign, IL 61820.

**Flow Charting**, a business package for use in diagramming an operation's work flow. Produce flowcharts in rapid succession for presentations or distribution by a trial-and-error method. For the II, II Plus, IIe, and III; floppy disk, \$138. Patton & Patton, 340 Lassenpark Circle, San Jose, CA 95136.

**Forecaster-Buy II**, an inventory-control package for business use. This program lets you monitor inventory order-

ing to reduce overstocking for faster turnover and cash flow. Features include printout of data-entry worksheets, updating, and monthly forecast reports of parts or material that consider reorder lead time. For II, II Plus, and IIe; floppy disk, \$800. Alessi Data Technology, POB 4, Needham Heights, MA 02194.

**Mastering the SAT**, a self-paced preparation course for the Scholastic Aptitude Tests in verbal, math, and standard written English skills. Endorsed by the National Association of Secondary School Principals (NASSP), this program analyzes students' answers and provides study and practice in skills covered on the SAT. For II Plus and IIe; floppy disks, \$150. CBS Software, One Fawcett Place, Greenwich, CT 06836.

**Micro-Dynamo**, a system-dynamics modeling language. This program lets you build a mathematical model of a hypothetical situation and simulate its behavior on a computer. When the simulation is complete, the program outputs the results in tabular or graphic form on the screen or printer. For the II; floppy disk, \$245. Addison-Wesley, 6 Jacob Way, Reading, MA 01867.

**One-on-One**, a basketball-simulation game. Choose from four levels of play: park and recreation, varsity, college, and professional basketball. Test your scoring skills against another player or against the computer. Action is sparked by comments from Julius Erving and Larry Bird from the game-development sessions. For II and IIe; floppy disk, \$40. Electronic Arts, 2755 Campus Dr., San Mateo, CA 94403.



**Pasdos**, a utility program written in Pascal and assembly language to allow transfers of files between DOS 3.3 and UCSD Pascal. Features include automatic display of either directory, automatic text-file formatting, code-file generation, and high-resolution picture transfer between printer and computer. Built-in demonstrations and documentation enable smooth conversions. For the II; floppy disk, \$39.95. Linnton Systems, POB 17612, Portland, OR 97217.

**Scientific Plotter, Version II**, a graphing program for plotting scientific, engineering, and business data. Superimpose more than one data set on the same graph easily with 20 plotting symbols. You control axis position, grid size, and scaling intervals. A stand-alone utility program prints labels on any high-resolution picture. For II, II Plus and IIe; floppy disk, \$50. Interactive Microware Inc., POB 771, State College, PA 16801.

**Talking Blissapple**, a tri-modal program written in a combination of machine language and FORTH that is designed for communicatively disabled children. It functions by interfacing with custom keyboards to act as a communication/writing aid. These children can write with Blissymbols and have their messages and stories displayed on a terminal, spoken, or printed on the printer. For II and II Plus; floppy disk, \$35. Trace Research and Development Center, 314 Waisman Center, 1500 Highland Ave., Madison, WI 53706.

**Time is Money**, a personal accounting package that can double for a small-business financial-management system. You can balance your checkbook, calculate and

monitor budgets, discern net worth, and record tax-deductible expenses without bookkeeping or accounting skills. You can track up to 240 income types, 240 income sources, 240 expenses, and 240 assets and liabilities. Full report generation and graphics capabilities are a few of the instructions that require a single keystroke. For II, II Plus, and IIe; floppy disk, \$100. Turning Point Software, 11A Main St., Watertown, MA 02172.

**Tom Thumb**, a reading program for preschoolers and first graders. This adaptation of the fairy tale by the Brothers Grimm improves reading, vocabulary, and comprehension skills. Features include self-paced reading levels, multiple vocabulary levels, easy-to-use software, color graphics, and special character sets. For II Plus and IIe; floppy disk, \$29.95. International Software Systems, POB 5427, Richmond, VA 23220.

**Trompers**, an arcade-type game. Due to a skip in Arnold Strump's shortwave radio, too many little creatures from the planet Tromp are falling from the sky into his domain. You have five levels in which to help old Arn catch them all and score the most points you can. For II, II Plus, and IIe; floppy disk, \$29.95. Avant-Garde Creations Inc., POB 30160, Eugene, OR 97403.

**Unprintable Physics**, an educational program for science and engineering students. You can use up to 32 simulations, demonstrations, examples, and quizzes of mathematical methods, mechanics, thermodynamics, electromagnetism, and wave phenomena. Learn modern physics in ways it cannot be taught by books. For II, II Plus, and IIe; floppy disk,

\$29.95. Prentice-Hall, Rt. 9W, Englewood Cliffs, NJ 07632.

---

## Atari

**Gridrunner**, an arcade-type game. As a pilot of an air-battleship, you try to stop the droids from attacking the orbiting solar-power station. Destroy pods, droid segments or leaders, and avoid the releases of plasma and ever-increasing attack waves. Requires a joystick. For the 400/800; cartridge, \$29.95. Human Engineered Software, 150 North Hill Dr., Brisbane, CA 94005.

**Omnitrend's Universe**, a three-dimensional tactical strategy game. You are a starship captain in search of the lost hyperspace booster. Save the civilization, become a hero, and win a fortune if you succeed. For 400/800 and 1200; floppy disks, \$89.95. Omnitrend Software, 8 Huckleberry Lane, West Simsbury, CT 06092.

---

## CP/M

**Compas Pascal**, a Pascal compiler. This superset of standard Pascal is a one-pass compiler that generates machine code quickly. The interactive editor is command compatible with Wordstar. It includes such features as overlays, dynamic strings, random-access files, and more. Floppy disk, \$440. K. J. Computer Services, POB 66, Mentone, Victoria 3194, Australia.

**FORTRAN Relabel**, a label-renumbering program. All the numeric labels in FORTRAN programs containing statements and line references can be renumbered

using this program. Subroutines, function programs, and Microsoft EDIT80 line numbers, if present, are processed automatically. You specify the ASCII filename, the desired new label beginning, and increment. Floppy disk, \$29.95. Cleydale Engineering, POB 784, Dahlgren, VA 22448. (This program's description was listed incorrectly in the March "Software Received," page 463. We regret any inconveniences this may have caused.)

**ICAMS**, an integrated condominium- and apartment-management system. You can perform property-management calculations with features that include semi-automatic billing and payment receipts, account updates, and 18 current reports. It can search for specific word clues and customization is an option. Floppy disk, \$1195. Advanced Management Approach Inc., POB 8576, Calabasas, CA 91302.

**LeBug**, a Z80-based assembly-level debugging tool. With this program, breakpoints do not need to be removed to resume execution because they are already transparent. You can manipulate arithmetic and symbolic expressions, address expressions using register contents, and benefit from nondestructive memory tests, error codes, and built-in disk protection from overwriting. Floppy disk, \$80. Lehey Microcomputer Systems, Postfach 145, 6365 Rosbach 1, Germany.

**Mailer, Version 1.2**, a mailing-list management package running on the CP/M 2.2 operating system. This program can read in address files created by word-processing and mailing programs to create new files. A screen form simplifies data entry and updating, delimit-

## Software Received

ing the entry fields and catching common entry errors. Floppy disk, \$150. Maurizi Associates, 1344 Fitch Way, Sacramento, CA 95825.

**Propstat**, a typeset-quality printing program. Print Wordstar document files via your proportional space printer to achieve true proportional spacing. This program supports boldface, doublestrike, strikeout, underscore, formatting, and subscripts and superscripts. Floppy disk, \$49.95. Civil Computing Corp., Suite 1, 2111 Research Dr., Livermore, CA 94550.

**Tarbell Database System**, an interactive database system whose programs use a common file format. It includes ASCII files with fixed- and variable-length records. You can make changes in the way the files are accessed without changing the files. It is also possible to change the structure of a file without changing the way that your file is accessed. Floppy disk, \$249. Tarbell Electronics, Suite B, 950 Dovlen Place, Carson, CA 90746.

## Commodore

**Attack of the Mutant Camels**, an arcade-type game. As the pilot of a combat ship, you must destroy enemy droids, deadly pods, and 20 attack waves of Cosmic Cameloids. You win an extra ship for every wave of challenges you encounter. Be prepared for the enemies' bizarre psychological disorientation tactics. Requires a joystick. For the VIC-20; cartridge, \$29.95. Human Engineered Software, 150 North Hill Dr., Brisbane, CA 94005.

**Commodore 64 BASIC Programs**, an introductory programming package. Complemented by a seven-chapter book, this package includes 30 programs that demonstrate the intricacies of the computer. You are encouraged to make modifications to improve program development and learn its techniques. For the 64; cassette, \$16.95. Howard W. Sams & Co., 4300 West 62nd St., Indianapolis, IN 46268.

**The Disk Librarian**, a utility program designed to keep

track of disk directories. You can search easily for a given directory attribute, catalog up to 150 disks, and easily back up the disks with a trilogy program. You can choose from nine facilities on the menu, including read and catalog, edit, display, print, comment line, and print disk labels. For the 4000/8000 Series; floppy disk, \$49.95. Computer Field Service, 660 Longview Lane, Palatine, IL 60067.

**Kindercomp**, a collection of six learning games to encourage computer skills in children between the ages of 3 and 8. As they create colorful pictures or find letters or numbers on the keyboard that match those on the screen, children are improving their reading readiness and counting skills. Pictures and sounds promptly reward each successfully matched shape or completed number sequence. For the VIC-20; cartridge, \$34.95. Human Engineered Software (see address above).

**Lazer Zone**, an arcade-type game. You try to control two lasers against encroaching aliens. After you learn firing

technique and movement, try to score as high as you can in 31 levels of increasing challenge. Requires a joystick. For the VIC-20; cartridge, \$29.95. Human Engineered Software (see address above).

**MusiCalc 1 Synthesizer and Sequencer**, a music-creation program. With or without a musical background, you can learn, play, compose, and understand music, rhythms, and sound produced by a synthesizer. You can use this program as an instrument, a songwriting or compositional aid, a music-theory tool, a sound-effects generator, and more. For the 64; floppy disk, \$74.95. Waveform Corp., 1912 Benita Ave., Berkeley, CA 94704.

**Synthesound 64**, a music-synthesizer program. Create music or special sound effects that include bagpipes, outer-space panic, footsteps, or chirping birds. You play keys on one of two keyboards: solo or accompaniment. Features include high-resolution piano-keyboard display, real-time clock, voices and filter modes, and storage of 256 patches. For

# Your HP Computer Deserves the Best!

Give your HP computer a high-performance disk drive like our new Series 3000 Winchester subsystem. Transferring data at 174 kbytes/s... It's the fastest micro-Winchester disk around! You can choose from storage capacities of 5, 10, 15, 20, 30 MB. Three sizes of optional floppy

drives: 3 1/2", 5 1/4", 8". And local back-up too.

Our Multi-port Option allows two or three HP computers to share one disk drive. Everything is 100% HP compatible. No software or hardware changes needed.

For complete specifications, please call 415/651-3300, or write today.

## **BERING**

The Specialist in HP Compatible Disk Products.

1400 Fulton Place, Fremont California 94539 TELEX 171596





the 64; floppy disk, \$34.95. Human Engineered Software (see address above).

**Time Money Manager**, a dual financial- and time-management program. In Finance 64, you can make informed decisions on buy versus lease options, payback analysis, profit margin, and future of present values. In Schedule 64, plan days or years in advance, get daily or weekly scans, or zoom in for detailed views. For the 64; floppy disk, \$69.95. Human Engineered Software (see address above).

**VIC-20: 50 Easy-to-Run Computer Games**, a collection of educational games. Each one of these 50 easily entered programs contains less than 30 statements and offers games that help you explore many facets of programming and debugging your computer. Choose from Hurray, Beethoven!, Bird Watching, and the Backward Test, to name a few. For the VIC-20; cassette, \$12.95. Howard W. Sams & Co. (see address above).

## IBM Personal Computer

**Autosort 86M**, a sort/merge/select utility program that places no limit on file size. Designed for large files with fixed-length fields within fixed-length records, this program can be used as a stand-alone sort routine with options that include nine modes of sort/select. Multi-users can sort simultaneously as long as they use different identification numbers. Floppy disk, \$150. Computer Control Systems Inc., 298 21st Terrace SE, Largo, FL 33541.

**Catalog-Master**, a disk-management system. You can

create and maintain a master-file directory of your disks to locate a desired file when you need it. The directory can include file descriptions, sort alphabetically by filename, and you can select only certain groups of files to output by using a file-selection template. Floppy disk, \$29.95. Generic Software, POB 790, Marquette, MI 49855.

**Certified Accounting Systems**, a group of five accounting packages for use in businesses. The packages consist of the Systems Guide to format the software for your requirements: Accounts Payable, Accounts Receivable, General Ledger, Inventory, and Payroll. Floppy disk, Systems Guide, \$45; with automatic update, \$295 each; without update, \$195 each. Certified Software Inc., 9900 SW Wilshire St., POB 25585, Portland, OR 97225.

**Data Evaluation System**, a data-evaluation utility package. A series of three routines that plot and fit data into a variety of mathematical models by nonlinear least squares. The results can be printed in full color. The menu and special-function keys are combined to easily select designed routines and also various options within each routine. You can also manipulate data. Floppy disk, \$250. R & L Software, 1299 Beacon St., Newton, MA 02168.

**Decision Maker**, a logical-analysis program. Make informed decisions by seeing graphs to help you determine the most logical choice. Input alternatives and factors, and the computer shows you the best decision in detail, summary, or graphic form. Floppy disk, \$12.95. HCS, 3616 Dannels Lane, Alexandria, VA 22311.

**Encore**, a financial-modeling,

spreadsheet-analysis, and decision-support system. Features include color graphics, plotting, printing, slide shows, and a graphics editor. Generate a formal report with one function key. The eight sections include an editor, spreadsheet, English modeling language, function library, an exec programming language, a report writer, a graphics system, and computation and analysis. Floppy disk, \$695. Ferox Microsystems Inc., Suite 611, 1701 North Fort Myer Dr., Arlington, VA 22209.

**Exec-I**, a database-management system for professionals, executives, and people in business. Includes mailing list, check management, appointment keeper, stock security, personal inventory, personal finances, and memo writing. Compatible with a word-processing program and other office-integration software. Floppy disk, \$198. Micro Architect Inc., 6 Great Pine Ave., Burlington, MA 01803.

**Executive Assistant**, an office-management record-keeping system. By accessing the flexibility of Lotus 1-2-3, this information-management system is ready for you to run without previous programming experience. It can store information on five files, including people, to do, calendar, events, and projects. Floppy disk, \$100. Reston Publishing Co., 11480 Sunset Hills Rd., Reston, VA 22090.

**Exette**, a data-retrieval system. You can restore up to 18 sectors on single- or double-sided disks that have been lost due to media wear, scratching, or other errors. The three functions include encode, verify, and restore. Data recovery transfers all information to a new disk containing corrections. Floppy disk, \$80. Errex Inc., 5 Re-

search Dr., Ann Arbor, MI 48013.

**FABS/PC**, an assembly-language subroutine program. With Fast Access Btree Structure (FABS) you can access large data files containing up to 65K records in one second or less. The speed of execution is due to balanced key structure where keys do not need resequencing. A few of the commands include create, open, close, search, insert, delete, replace, build file, and more. Floppy disk, \$150. Computer Control Systems (see address above).

**Frieze Graphics**, a printing and storing graphics-utility program. Without generating graphics, Frieze will produce a variety of screen dumps from an existing graphics display or save and retrieve pictures while a program is in progress. This program will work with nine assorted printers, producing up to 16 shading patterns on black-and-white printers and 256 colors on color printers. Floppy disk, \$55. ZSoft Corporation, 370 Hermitage Court SW, Marietta, GA 30064.

**Frustration**, a learning game of memory and skill. Try to guess the secret alphabetical sequence as you practice typing letters in ascending order. Improves memory and typing skills simultaneously as you try to light up 25 little boxes. Floppy disk, \$29.95. Asmara Productions, POB 1199, Noble, OK 73068.

**Incunabula**, a strategy game set in an ancient civilization. As your civilization advances and establishes arts and technologies, it develops from a tribe to a clan, a nation, and finally an empire. Disasters along the way reduce the population as you fend off enemies. In the struggle toward civilization, only the selection of wise laws will

## Software Received

determine the success of your civilization. Floppy disk, \$39. Expert Systems Inc., POB 9, Redmond, WA 98052.

**InteCalc**, an electronic-spreadsheet program. With three-dimensional, split-screen capability, you can custom-program or sort sample worksheets. Additional features include formula analysis by rows, columns, and pages; four numeric types; commas and floating dollar signs; and adjustable column widths for clarity. Floppy disk, \$295. Schuchardt Software Systems, 515 Northgate Dr., San Rafael, CA 94903.

**MicroPlan**, a financial-forecasting package for business professionals. Plan cash flow, prepare budgets, report variances, and analyze product pricing in simple steps with on-screen prompts. Build a financial model cell by cell. Specialized what-if capabilities available by the touch of a few keys provide quick solutions to puzzling forecasting problems. Floppy disk, \$495. Digital Research, 160 Central Ave., POB 579, Pacific Grove, CA 93950.

**Move-It**, a communications program for use in transferring data between computers. Move important documents between locations via modem regardless of hardware. The low error rate is due to error checking, auto-dial support, unattended operation, and on-line helps. The directory display ensures disk integrity. Combines with Speedstart, a load-and-go system. Floppy disk, \$150. Digital Research (see address above).

**The Organizer**, a file-link utility system for use with Lotus 1-2-3. Create a branching-tree file-selection menu system to organize and in-

stantly access files. An easy-to-edit menu board with handy commands. With push-button menu selections on a file-link master menu, you can access up to six files that provide access to an additional six files. Floppy disk, \$89. The Whiterock Alternative, 8255 15th Ave. NE, Seattle, WA 98115.

**Oubliette**, a fantasy-adventure game. This role-playing game uses text and graphics in ten dungeon levels of increasing challenges. You control six adventurers in their quest for gold and glory. But when you enter the dungeon there is one escape and occasional encounters with monsters. Floppy disk, \$39.95. Human Engineered Software (see address above).

**PlanStar**, a financial-planning and reporting package. Functioning like a visible calculator, this program stores data or arithmetic relationships at each spreadsheet position for financial modeling. It separates data from calculation rules allowing for sequential logic. You can specify calculations in English rather than matrix notation. Reports and graph formatting do not take up unnecessary spreadsheet space. Floppy disk, \$595. Micropro International Corp., 33 San Pablo Ave., San Rafael, CA 94903.

**Reportmaker**, a business tool for use in writing and presenting reports. The main menu offers several commands: a pie-chart generation program that can be cancelled without destroying data, the graph generator that is for bar charts with various shading methods, and a heading generator that lets you format. You can also design logos on the grid. Floppy disk, \$130. Krepec Software Inc., Suite 208, 5460

Royalmount, Montreal, Quebec H4P 1H8, Canada.

**RL-1 Relational Database Management System**, an integrated operational data-storage package. An interactive English-type language is used for the manipulation of data. A relational editor inputs and updates records into database. The report generator creates customized reports. And the program interface enables applications to be written in any high-level language. Floppy disk, \$495. ABW Corp., POB M1047, Ann Arbor, MI 48106.

**RXSet**, a printer-interface program. You set format and printer-control codes through interactive screens. In turn, receive a status report and access help screens to print numerous text files requiring different printing parameters. This program does not include graphics capabilities. Floppy disk, \$15.25. On-Disk Software, POB 382, Lincoln, MA 01773.

**The Sales Edge**, a business-strategy success program. You can evaluate the human factors affecting your sales performance by learning customer buying styles, being aware of your own behavioral techniques, and preparing customer-specific strategies for opening, presenting, and closing of sales negotiations. Floppy disk, \$250. Human Edge Software Corp., 2445 Faber Place, Palo Alto, CA 94303.

**Silver Software Series**, four business-applications programs. Silverwriter is the word processor for editing, creating and merging a mailing list, and printing. Silverbudget is the accounting and budgeting program. Silvercalendar is a multidimensional scheduling section. And Silverfolio is the personal inventory section. The

portfolio also offers financial functions such as net-worth statement, lists of property, and amortization schedules. Floppy disk, \$399. Douthett Enterprises Inc., 200 West Douglas, Wichita, KS 67202.

**Softplot/BGL**, a graphics library for Microsoft BASIC. Enhance systems with graphics displays and add hard-copy graphics capability to any system with a dot-matrix printer or plotter. Improve technical, business, educational, or other applications with a set of high-level commands to build graphics programs. Floppy disk, \$99. Graphic Software Inc., POB 367, Kenmore Station, Boston, MA 02215.

**SuperCalc 2**, an electronic-spreadsheet package. Without typing in commands, you can format and make backup copies of your disks, rename and erase data files you create and display them on the screen, and find out how much workspace is left. You can also set up what-if modeling spreadsheets. Floppy disk, \$295. Digital Research (see address above).

**Target Financial Modeling with Speedstart**, an electronic spreadsheet for financial modeling in accounting, marketing, finance, and banking. Features include forward referencing, conditional logic, column referencing, communication, data and statement consolidation, a report generator, and pre-written financial models. Floppy disk, \$325. Digital Research (see address above).

**Ten Key**, a concurrent calculator program. Integrated inside your computer, this calculating program lets you interrupt any application by pressing a command key. Press the key again, and the



former application is restored. It also has the ability to transport final totals back to the original application. Floppy disk, \$48.50. Photon Software, POB 1408, Bellevue, WA 98009.

**TMP/Free Form**, an information storage and retrieval system for management planning. Regardless of the drive you entered on the command line, you can specify what drive you want to access for storing, listing, and deleting files without losing your program. Because the program will use the drive you specify, you can use any number of drives. Floppy disk, \$225. United Software Co., 2431 East Douglas, Wichita, KS 67211.

**TMP/Manager I**, a structured database-management system. Two master disks contain the following program tools or functions: dictionary, edit, select and sort, transfer, report maintenance, report writer, catalog and label writer, and a database directory. Using tags instead of index files, you can speed up the process by selecting and sorting only a portion of your database. Floppy disk, \$595. United Software Co. (see address above).

**Under-Control**, a file-management system. Automatically generate data-entry screens, sort, write reports, select records, and total them up. Allows for customizing and defining new fields such as legal-time accounting and billing applications. Floppy disks, \$125. A+ Software Inc., 16 Academy St., Skaneateles, NY 13152.

**Wordstar Professional**, a collection of three word-processing packages that integrate with Wordstar. Mailmerge lets you combine information from various sources to produce letters,

documents, and files. With Spellstar, your spelling errors are located and checked against the 20,000-word *American Heritage Dictionaries*. With Starindex, you can create reference aids to help readers locate information in a report, contract, manual, or any document you prepare. Floppy disk, \$345. Micropro International Corp. (see address above).

**Word-X**, a word-processing package. Features include full-screen editor, word wrap, print text formatter, merge facility, function keys, help command, global changes, and the ability to obtain multiple copies. This program is compatible with other office-integration systems such as the database manager and executive information systems. Floppy disk, \$98. Micro Architect Inc. (see address above).

**WSSORT**, an interactive program. Select, merge, and sort sequential files, manage a database, or select up to 20 specifications and 20 levels of sorting simultaneously. The amount of information processed is disk based, and is thus not limited by memory. Floppy disk, \$69.95. Nugget Software Inc., POB 440979, Aurora, CO 80044.

**$\mu$ -Series Assemblers, Linker, and Librarian**, cross-assembler programs for program development. Several relocating macroassemblers and a few compilers are supported by a single universal linker named XLINK. A special symbolic format exists that contains module names, globals, and locals to use with external emulators and debuggers. XLIB, a universal librarian, is included to create and maintain object-code libraries. Floppy disks, price not available. IAR Systems AB, POB 23051, S-750 23 Uppsala, Sweden.

## TRS-80

**Accounts Payable**, a business-accounting program. This can handle four standard general-ledger accounts plus an additional 14 expense accounts that you define. It can contain up to 1100 transactions on file, 75 vendors, and an unlimited number of invoices per check. It automatically calculates due dates, discount dates, and can print in several formats. For the Model 4; floppy disks, \$199.95. Radio Shack, 1400 One Tandy Center, Fort Worth, TX 76102.

**AgDisk (Crop Management)**, a financial agricultural program. Designed to be used with Visicalc spreadsheets, this program helps in informed decision making of business crops. A few of the 11 templates include grain marketing, corn yield, gross margin, growing days, field calculations, pivot application, and fertilizer needs and costs. Combined with a calculator program with a grid 63 columns by 254 rows, you can construct formulas that ensure success. For the Model III; floppy disk, \$69.95. Radio Shack (see address above).

**AgDisk (Feedlot Cattle Management)**, an agricultural management program. Templates on the feedlot cattle management disk include cattle feeder, steer marketing, carcass evaluation, protein supplement, and ration formulation. Combined with Visicalc spreadsheets, you can keep up with changes and evaluate data for future reference. For the Model III; floppy disk, \$69.95. Radio Shack (see address above).

**Assembly Language Development System**, a tool for developing Z80 programs. The five systems this program

contains are a text editor, an assembler that converts source programs to Z80 object code, a linker, a debugger, and a file-transfer system. Previous knowledge of assembly language suggested. For Models III and 4; floppy disks, \$149. Radio Shack (see address above).

**Business Graphics Analysis Pak**, a colorful graphics package for business presentations. Enter data, select a chart type, format to your specifications, and print the screen. Choose from four types: line charts, bar charts, pie charts, and scatter charts. Select variations such as automatic scaling, formatting, labeling, chart width, straight or curved lines, solid or dotted lines, shading, frames, and numeric scale labels. You can also manipulate data. For Models II and 12; floppy disk, \$249. Radio Shack (see address above).

**Executive Calendar**, a time-management program. Plan your daily and weekly schedules or display and print any month of the year. The dates of 17 holidays are programmed in the calendar section, and the calculation ability lets you figure the number of days needed to complete a specific project. For the Model 100; cassette, \$19.95. Radio Shack (see address above).

**Graphicom**, a graphics-design program. You can create, edit, and transmit pictures and text. Written in FORTH and designed for the novice user, you let the graphics guide you through the program. This program can even facilitate communication between people of different languages. For the Color Computer; floppy disk, \$24.95. Spectrum Projects, 93-15 86th Dr., Woodhaven, NY 11421.

## Software Received

**Payroll**, a payroll system for small businesses that tracks earnings, deductions, and taxes for each employee. You can customize your system to meet local, state, and federal tax laws. It keeps historical records by current period, quarter, and year for all employee earning and deductions, plus all employer liabilities. It lets you design reports or print reports for audit trails. For the Model 4; floppy disk, \$199.95. Radio Shack (see address above).

**Spectulator**, a calculator program. Your screen becomes a worksheet with rows and columns. You can budget and forecast, do statistics, and even do math homework. Prepare a table format with formulas for easy recalculation to avoid retyping. It can print any or all of a document. For Models I and III;

cassette, \$34.95. Radio Shack (see address above).

**Starblaze 100**, a space-arcade game. With one of your three ships, you must move from planet to planet. You can fire up to three missiles at a time with the space bar. Be certain not to move when you are in the transporter or your ship will be destroyed. For the Model 100; cassette, \$19.95. Radio Shack (see address above).

**Videotex Plus**, a communications package. You can communicate with a variety of information services and host computer systems. The three modules include an interactive terminal and data communications program, a specialized program for use with store and forward information services, and a program to prepare auto-log-

on/auto-dial procedures. You can print hard copies with a printer-control feature. For the Model 4; floppy disk, \$49.95. Radio Shack (see address above).

## Other Computers

**Graphics Subroutine**, a graphics programming aid. Move small and large drawings smoothly around the screen one pixel at a time. Keep a drawing stationary to draw or color in your own animations or cartoons. For the Spectrum; cassette, £10. Fowler Software, Hendon Mill, Nelson, Lancashire BB9 8AD, England.

**MorseKey**, a Morse code to ASCII converter. Written for disabled children, this program is valuable for anyone wishing to use a computer as a communications device. For the Epson Notebook

Computer; microcassette, \$45. Blue Heron Software, POB 91927, West Vancouver, British Columbia V7V 4S4, Canada.

**Nest Egg II**, a strategic financial-planning program. Calculate retirement finances, your children's education, vacation plans, and trust funds. Test several assumptions and calculate alternative futures. For the Timex/Sinclair 1000/ZX81; cassette, \$19.95. Computer Ware Publishing, 3rd Floor, 234 Fifth Ave., New York, NY 10001.

**PID.COM**, a program that provides graphic, programmable, programmed instruction with phased experiments in closed-loop control. No previous mathematics required. For the Heath/Zenith H-Z-89; floppy disk, \$26. Friendliware, POB 21206, Lansing, MI 48909. ■

# FREE?

You know nothing's free and we're not giving anything away. What we're doing is offering you a unique opportunity to save hundreds or even thousands of \$ dollars \$ on computer hardware, software, video and videotape products.

We're angry about the high price of these products. We have spent over a year researching ways to save and have come up with a solution that delighted us and we believe will delight you. This research cost us a lot of time and money. The results can be yours for just \$10. No rip off. No catch. Just cold hard facts on how to save. A fee so small—probably retrievable on the purchase of 1 box of disks.

We are enthusiasts, just as you are, trying to provide a way to make financially feasible what we consider the most wholesome, educational, entertaining pastime America has ever known. If you can believe in us. If you can envision buying at or below wholesale and save more than you thought possible. Please send ten dollars to:

High Tech Friends Dept. BM  
RD#3 Evans City, PA 16033

*This is the final "Software Received" section in BYTE. It will be replaced by expanded coverage of software in our "What's New?" section beginning in June. This expansion will include color pictures in "What's New?" and the relocation of the beginning of this section to the front of the magazine. Color transparencies (slides), 35mm or larger, stand a better chance of being used than color prints. Publishers who*

*want their software to be considered for inclusion in "What's New?" should send information or products to New Products Editor, BYTE, 70 Main St., Peterborough, NH 03458. Of course, we will continue to do full reviews of software also. Publishers who want their programs to be considered for a full review should send a copy of their product to the Product Review Editor at the same address.*

## BYTE's Bits

### Used Equipment Repository

The Harvester is a nonprofit organization that places used computers in service with other nonprofit associations requiring computers but unable to afford them. Donations are tax deductible, and reimbursements for shipping fees are available.

The Harvester accepts pocket, mini-, and microcomputers as well as peripherals, software, and supplies. For information, call or write Ed Simpson, The Harvester, POB 931, Columbia, MD 21044, (301) 997-4992. ■



Conducted by Steve Clarcla

## Kaypro Composite Video

Dear Steve,

I would like to know how to connect a Kaypro II to a monitor that accepts 1-volt composite video. I have not been able to obtain schematics. Is there any way around this? Thanks.

Henri J. Poché  
New Orleans, LA

*The Kaypro II video output cannot be sent directly to a composite-video monitor. You will have to combine the Kaypro's horizontal sync, vertical sync, and video signals into a composite-video signal first.*

*The separate video signals are available at the following pins of connector J1:*

- Pin 1 horizontal sync
- Pin 2 (key)
- Pin 3 video
- Pin 4 vertical sync

*An example of a good video-combiner circuit can be found in an Intel application note titled "A Low Cost CRT Terminal Using the 8275." The number of the application note is AP-62, and it can be obtained from Intel Corporation, 3065 Bowers Ave., Santa Clara, CA 95051.*

*Kaypro schematics and a manual on the theory of the Kaypro's operation can be obtained from Micro Cornucopia, POB 223, Bend, OR 97709. . . . Steve*

## 80 by 24 on an H-19A

Dear Steve,

After reading "Build the Micro D-Cam Solid-State Video Camera" in the September 1983 BYTE, I realized that my system was deficient because I had no high-resolution graphics. My

system consists of a Heath H-19A terminal, Heath H-8 computer with 60K bytes of RAM, and a disk system. My terminal is connected to the computer via RS-232C.

What determines the 80-column by 24-line format in the display? And if I want high-resolution graphics, what modifications can I make to accomplish this? Will I be able to retain an 80 by 24 display with these modifications? Any help will be appreciated.

John Loong  
Oak Park, IL

*Most computer terminals have a similar set of components that allows characters to be displayed on a video-display screen. The components generally consist of*

1. A keyboard controller that converts key closures into ASCII (American National Standard Code for Information Interchange) code.
2. A memory system to store the input data.
3. A video-display controller to access the data and properly position it on the video display using timing circuitry.
4. A character generator that converts the data into readable characters on the video display.
5. A UART (universal asynchronous receiver/transmitter) to send the input data to the computer.

*When a character is entered at the keyboard and converted to ASCII code, it is simultaneously sent through the UART to the computer and to the internal memory in the terminal. If the terminal displays 24 lines of 80 characters, the size of the memory system is usually 2K bytes (24×80=1920 bytes—it's rounded up to an integer power*

*of 2). The video-display controller then continuously accesses data from the memory system and sends it to the character generator for display on the video display.*

*Each line of characters on the screen is composed of a number of "scan lines." Typically, several hundred scan lines are presented on the screen in a fraction of a second, which makes the display look like it is being presented all at once. These scan lines are composed of a number of dots that represent one slice of each character on the display line being presented. For example, depending on the character generator, the letter "T" might have five dots in the first scan line and a single dot in the next six scan lines, using a 5- by 7-dot character generator.*

*Terminals constructed in this manner cannot be used for high-resolution graphics unless significant modifications are made to the circuitry. One reason is that the amount of memory needed in a stand-alone terminal would have to be much larger than the 2K bytes built into the terminal. This doesn't mean it cannot be done. A good reference on the subject is a book written by Donald E. Lancaster, Son of Cheap Video, which can be obtained from Priority One Electronics or other advertisers in BYTE. An article in Microcomputing magazine shows how to use the TVT 6 5/8 terminal discussed in Don Lancaster's book with the Heath H-8 computer system (see "Cheap Video for Your Heathkit H-8," Microcomputing, March 1979, page 24).*

*Also, Heathkit is now offering a color graphics board for the H-8 computer that has three color display modes and 256- by 192-pixel resolution. This board is for use with a video device that accepts NTSC (National Television System Committee) composite video. . . . Steve*

## A Faster Z-89

Dear Steve,

How much would it entail to upgrade a Z-89 to operate at 4 or 6 MHz using a new crystal and a Z80A or Z80B in place of the original Z80? What else would have to be done?

Fred Ernst  
Skokie, IL

*Some care must be exercised whenever a piece of commercial equipment is modified to increase its speed. In some cases, it may be as easy as replacing the crystal and upgrading the processor. However, in most cases, the memory chips also must be replaced to be compatible with the new memory access times derived by the processor. Depending on the new processor clock rate, chips with access times of 150 to 200 nanoseconds will be needed. The existing chips should be checked to verify if their access time is compatible with the new clock rate. This also includes any ROM (read-only memory) chips in the circuit.*

*The schematics of the device also should be checked to verify that the new crystal is used only by the processor and not by other circuitry such as the video controller and disk drives. In many cases, all clock frequencies in a device are derived from the same master oscillator. . . . Steve*

## A 2716/2732 Programmer

Dear Steve,

I have finally realized that, for me, the era of the 2716 EPROM (erasable programmable read-only memory) is about over. Having stocked up on some 2732s and still having only a 2716 programmer, I'm looking for an easy method or an adapter that

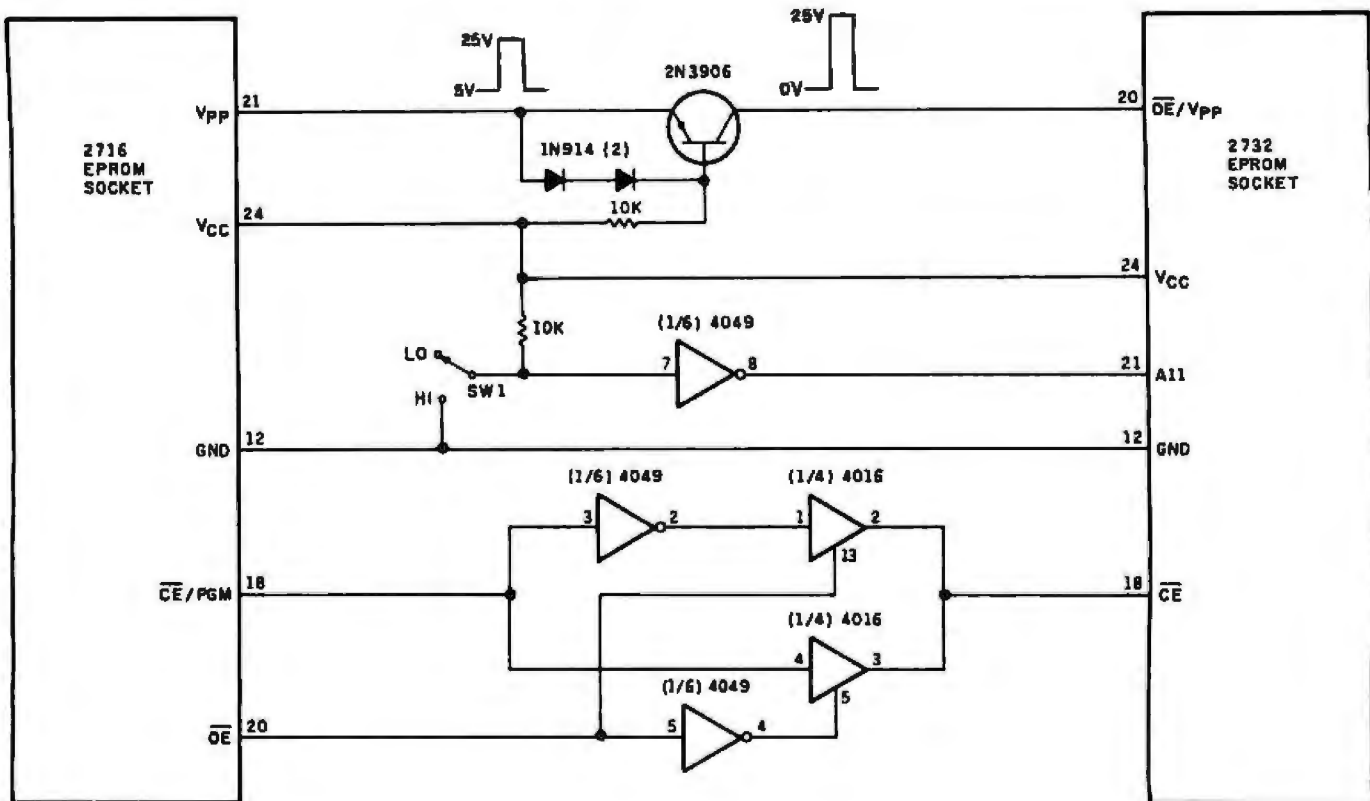


Figure 1: Programming the 2732 as two separate 2K-byte segments.

can be used to program 2732s on a 2716 programmer. What I have in mind is something that can plug into the existing socket on the 2716 programmer. Thank you.  
**Michael Graham**  
 Cameron Park, CA

There is no direct method of converting a 2716 EPROM programmer into a 2732 programmer by using the existing 2716 socket. Another address line, which does not appear on the 2716 socket, is needed for the 2732 (A11).

Figure 1 is a circuit diagram that shows how to get around this problem if you are willing to program the 2732 as two separate 2K-byte segments. The circuit assumes that you have a standard 2716 programmer and are going to convert it to program Intel-type 2732 EPROMs. To make the conversion, the functions of pins 18, 20, and 21 of the 2716 must be modified before they are sent to the 2732

programming socket. The following table shows the functions of these pins for the two EPROMs:

Pin	2716	2732
18	CE/PGM	CE
20	OE	OE/V <sub>pp</sub>
21	V <sub>pp</sub>	A11

As shown in figure 1, A11 is produced at the 2732 socket by a switch that selects either the upper 2K bytes or the lower 2K bytes of the 2732. This is not a terrible inconvenience because the 2716 programmer works with a maximum 2K-byte block of data.

V<sub>pp</sub> now must be routed from pin 21 on the 2716 socket to pin 20 on the 2732 socket. The problem is that the V<sub>pp</sub> pulse for the 2716 varies from +5 volts (V) to +25 V, and the voltage levels for OE/V<sub>pp</sub> on the 2732 vary from 0 V to 25 V. The transistor shown in the circuit performs this voltage translation. If you intend to use 2732As in the circuit instead of the standard 2732, the

	2716	2732
Mode	CE/PGM	OE
Read	low	low
Standby	high	high
Program	pulse	low
Verify	low	low
Inhibit	low	high

Table 1: A truth table.

maximum voltage must be reduced from +25 V to +21 V at pin 20 of the 2732 socket.

To produce a proper signal at the CE pin of the 2732, the truth table (see table 1) must be used.

The 4016 CMOS (complementary metal-oxide semiconductor) transmission gates and the 4049 CMOS inverters shown in figure 1 perform this translation. CMOS chips were selected to keep the power consumption from the 2716 programmer low, but equivalent TTL (transistor-transistor logic)

or LS (low-power Schottky) chips can be substituted.

All other lines from the 2716 socket should be routed directly to the 2732 socket. . . . Steve

### Starting Points

Dear Steve,

I want to buy test equipment so that I can start building computer kits and learning about digital electronics, but I don't know which instruments I really need and



how much performance they should have.

My main fears are that I will buy an instrument that I won't use a great deal and that I will buy an instrument that is not capable of the performance necessary for computer circuitry. I want to be able to work with processor clock speeds to 6 MHz.

I know I'll need a quality VOM (volt-ohm meter). Please help me choose other instruments that will get me started. Thanks,  
Tony L. Essman  
Bartlesville, OK

*As you start building and learning about digital and analog circuitry, you will find that your VOM will be the first piece of equipment you reach for when something doesn't work. It will be used to determine if your power-supply wiring is correct and if your voltage levels are proper. Your decision to obtain a quality VOM is thus an excellent one.*

A logic probe will also be important when analyzing digital circuits. You can obtain a good logic probe and pulse catcher combination from Priority One Electronics (see its ad in *BYTE*). The model number of the probe is 07GSCLP1, and the price is around \$45. This probe will respond to a pulse train of 10 MHz and to a single pulse as short as 50 nanoseconds. The probe has pulse- or transition-level storage capability.

A good oscilloscope is expensive, but if you are serious about learning more electronics it will be a valuable item. Priority One Electronics also has a scope that will fill your needs. The model number is 07BKP1522, and the price is about \$595 for a 20-MHz dual-trace scope. If you are interested in building a scope kit, you should look at Heathkit's IO-4550 dual-trace 10-MHz scope, which is advertised for about \$470 in its 1983 catalog. . . . Steve

Dear Steve,

I am a fairly new subscriber to *BYTE* who has been intrigued by your Circuit Cellar projects. But while I have a good understanding of computers, I have virtually no knowledge of electronics. Can you suggest any books or materials that would help me get started? Also, which of your projects would you recommend for a beginner? I am interested in computer peripheral devices. Any information or advice would be truly appreciated.  
Jeffery S. Bond  
Thousand Oaks, CA

*Many good books are available to assist you in getting a better understanding of electronics. If you scan the advertising pages in *BYTE*, you will find just about everything you need, or you can obtain many of these books at a Radio Shack store.*

*If you have never worked with electronics, you could start with material that covers DC and AC circuit theory, then advance to books on digital electronics and linear circuits. However, a mix of reading and hands-on experience is probably the most enjoyable way to get started. A good book called Getting Started in Electronics by Forrest Mims uses this approach.*

*As you begin building circuits, you also may need technical data manuals that describe the functions of the devices you are using. Most chip manufacturers publish data manuals that cover TTL (transistor-transistor logic), CMOS (complementary metal-oxide semiconductor), and linear devices.*

*You also will need some tools of the trade when you actually start building and checking out your circuit. To get started, you should have at a minimum a good VOM, a soldering iron, some wire-wrap equipment, and a lot of patience.*

*As a first project, don't pick the MPX-16. Choose a simple circuit like the ECM-103 modem*

*in the March 1983 *BYTE* or one of my other circuits with a low component count. You also can pick up a compilation of other Circuit Cellar projects in the volumes of Ciarcia's Circuit Cellar sold through the *BYTE* Book Club. . . . Steve*

Dear Steve,

I have three questions that I hope you will answer. First, what is virtual memory? Second, what is a memory cache? Finally, what are the pros and cons of the new 32-bit microprocessors? Thank you.

Sanjoy Mahajan  
Pittsburgh, PA

*Virtual memory is a concept, as opposed to a physical entity. The concept allows running very large programs in a relatively small physical-memory space. It works by bringing small segments of a program into main memory from disk or drum storage and running those segments of the program. When these program segments have been run, new segments are brought into the same memory space and overlay those previously run. In this manner, virtually any size program can be run in a limited memory space.*

*Cache memory is a relatively small but fast RAM buffer physically located in the processor of a system. Portions of the relatively slow main RAM are brought into the cache memory where they are executed at high speeds. For example, a large main memory could consist of MOS (metal-oxide semiconductor) RAM chips with access times of 150-200 nanoseconds (ns), while the cache RAM could be ECL (emitter-coupled logic) chips operating with 45-ns access times. By running program segments in cache, a large increase in performance can be obtained.*

*The pros and cons of 32-bit microprocessors are numerous. I will touch on a few. The obvious advantage is that wider data*

*buses offer an increase in speed because more bits can be manipulated with the same number of machine cycles. More powerful 32-bit instructions also make number crunching and string handling much more efficient. A disadvantage is that wider data buses and address buses mean carrying a lot more wires around the system. Another disadvantage, in the short term, is that software for the 32-bit microprocessors is not as available as it is for the smaller ones. . . . Steve*

---

### The ECM-103 Modem Revisited

---

Dear Steve,

I have your ECM-103 modem kit ("Build the ECM-103, an Originate/Answer Modem," March 1983 *BYTE*, page 26) and was wondering about the possibility of adding an auto-dial/auto-answer feature. Do you have any suggestions on how to accomplish this? I've seen inexpensive Touch-Tone chips advertised. How does the auto-answer mechanism work, and how could I go about integrating them? Thanks.

Ian Cassell  
Philadelphia, PA

*Implementing auto-answer/auto-dial features in a modem can be quite complicated if the full power of these features is to be used. For example, a full-featured auto-dial modem resolves all the call-failure conditions that normally exist when making a call, such as busy signals and no-answer conditions.*

*Simplified versions of these features can, however, be implemented with some available chips. Radio Shack is offering a set of telephony chips that can be used in these applications. They are the TCM1512A Ring Detector and the TCM5089 Tone-Dialing Encoder.*

*The TMS99532 modem chip*

used in the ECM-103 has a pin that can be used for Touch-Tone dialing purposes. An analog signal present on the EXI (external input, pin 17) pin of the modem is passed through to the telephone line. You can make a simplified version of an auto-dial function by using this pin and the tone encoder. The EXI input is enabled when ATE is high, ALB is low, and SQT is high. For the ECM-103, these conditions are met when the originate/answer switch is in the originate mode prior to a valid carrier-detect signal.

The ring detector can be used to connect the output of the ECM-103 to the phone lines when a ring signal is detected. The ECM-103 also should be switched to the answer mode by this signal if it is not already in this mode. Circuitry also can be introduced that causes the modem to automatically hang up if a valid carrier-detect signal is not received in a preset time period. . . . Steve

Dear Steve,

Two of us bought your ECM-103 modem. My friend connected one to his Drake Theta 9000E terminal for amateur radio use, and I connected mine to my Kaypro II. We have had some success, but not in the normal manner. When I use the Term program from Kaypro that converts my computer into a dumb terminal, I can receive the signals originating from my friend but not my own ASCII characters.

I can send files through CP/M using PIP, transferring from the file in disk, to TTY: or PUN:, and using the echo feature I am able to see what I send. But I am able to do this only if I put the modem in the originate mode and connect the "mysterious jumper" between pins 5 and 6. Although we can communicate, we had not anticipated that the conversations would be only "one way."

Here are my questions: What does the jumper do? Must one of us stay in the answer mode? We are using only the acoustic enclosures. Should we change to transformer coupling? Thank you.  
**Mario Handler**  
Caracas, Venezuela

First of all, let me clear up the question about the "mysterious jumper." When a modem and computer are linked together, they must have some method of telling each other what they are doing and what they want to do next. These signals that are passed back and forth are generally termed handshaking signals. Pins 4, 5, and 6 of the RS-232C cable are handshaking lines and are generally called RTS (request to send), CTS (clear to send), and DSR (data set ready).

DSR in the ECM-103 is always set to a high level, telling the computer that the data set is ready (the modem is connected in this case). Normally, the computer sends a signal back through the DTR (data terminal ready) line to tell the modem that it is there. Both devices now know that the other exists. Note that the ECM-103 does not look for the DTR signal on pin 20 because it is assumed that a terminal exists. When you want to send data from the computer to the modem, the computer sends out an RTS signal to the modem. If the modem is ready to accept the data, it sends back a CTS signal, and the computer or terminal then sends the data to the modem.

If the RTS and CTS lines in the ECM-103 are jumpered together, as soon as the computer asks permission to send data by setting RTS, it gets an immediate "yes you can" signal from the CTS line. This should satisfy most applications. The other way this can be handled is to set the CTS line to a state where it is always telling the computer that it is ready. This is done by placing the jumper between pins 5 and 6. One of these two con-

figurations will handle most cases where the terminal software needs a handshaking signal.

The ECM-103 was designed to be used in either the answer or originate mode depending on how the modem on the other end of the line was set. Both modems cannot be set to the same mode or you will not be able to communicate properly. In general, the caller is set in the originate mode and the modem that is called is set to the answer mode.

You should not have to go to transformer coupling to get proper response from the ECM-103. However, if the room noise is high on either end, direct connections would be helpful. . . . Steve

### Cable Computing

Dear Steve,

I have been wondering if anyone has invented a modem for cable TV. Because the idea of tying up the phone for local communications or paying for my own phone line doesn't excite me, I would welcome the development of such a device. I also would be interested to know if a device like this could have channels, not only so that you could switch to an empty channel, but so that different makes of computers could have designated channels.

Currently, our local cable company is letting a corporation and a community college use its cable as a high-speed link. I think it would make sense to make use of these frequencies.

**Joel Stevey**  
Nyack, NY

Taking advantage of the cable TV frequencies for computer communication is going to be one of the next big areas in home-computer technology. In fact, it has already begun, as you mentioned, with cable stations

being used for high-speed links. Teletext services also are being offered by networks and independent stations that send information in the vertical interval of regular TV broadcasts. However, decoders for this information are still very expensive, with prices ranging around \$2000.

The home computerist may soon see systems from Matsushita Electric that will include a combination teletext decoder and personal computer for communication over cable TV stations. This equipment would be rented by the cable company for use on its channels carrying this type of information service. Standards for this type of service are still being worked out, and the system may use the full TV channel rather than the vertical interval.

Full communication between computer users over cable networks will probably be next with all this activity in the area. A good source for keeping up with this type of technology is the Video Electronics column of Radio-Electronics magazine, where new developments in this area are periodically discussed. . . . Steve ■

In "Ask BYTE," Steve Clarcia answers questions on any area of microcomputing. The most representative questions received each month will be answered and published. Do you have a nagging problem? Send your inquiry to:  
Ask BYTE  
c/o Steve Clarcia  
POB 582  
Glastonbury, CT  
06033

Due to the high volume of inquiries, personal replies cannot be given. All letters and photographs become the property of Steve Clarcia and cannot be returned. Be sure to include "Ask BYTE" in the address.



# What's New?

## SOFTWARE



### Music-Writer Scores with Apples

Passport Designs is marketing Polywriter, a music-writing program for Apple II series computers. Polywriter generates and outputs to a printer musical scores of whatever is played on a Soundchaser keyboard. Diverse score formats can be printed: single treble line, single bass line, piano score, choral score, treble clef with piano, bass clef with piano, and full orchestral score.

Polywriter prints standard music notation. It handles note divisions, seconds, accidentals, ties, up or down octave adjustments, flags and beams, split stemming, triplet brackets, rests, any key signature, transposition up or down nine half-steps, and up to 15 time signatures, including complex and asymmetrical. Its full-scale editor can manage lyric and chord symbols.

Minimum system elements

are a Soundchaser Basic System, a floppy-disk drive, monitor, Grappler printer interface card, a dot-matrix printer with graphics capabilities, and an Apple II, II+, or IIe or equivalent compatible. The suggested list price is \$595. Passport Designs Inc. is located at Suite 103, 625 Miramontes St., Half Moon Bay, CA 94019, (415) 726-0280.

Circle 554 on inquiry card.

### File Sort for Visicalc

A machine-language Visicalc file-sorting utility is available from Keene Computing Services Company. XVCSort lets you sort any block of data made up of either strings or numeric constants. Sorts can be performed in ascending or descending rows or columns and with any number of col-

umns or rows setting the sort-comparison order. This utility's only requirement is that the model's data be saved in a /DIF file.

XVCSort is compatible with systems running LDOS 5.1.x or TRSDOS/LDOS version 6. The suggested price is \$25.00. When ordering, specify DOS and computer. Contact Keene Computing Services Co., Suite 43, 407 Nagle St., College Station, TX 77840, (409) 846-4426.

Circle 562 on inquiry card.

### Church Management Programs Available

ACTS church financial and information management packages are available from Burr Computer Consultants. The financial programs are designed to handle all general and special income and expenses. They include provisions for checkbook accounts, payroll, and donation accounting. They also include five monthly financial statements.

ACTS information management programs provide utilities to maintain member profiles, directory listings, visitor follow-up, attendance tracking, and shepherding programs. They offer profile-search functions as well as the ability to generate mailing lists and interface with word-processing programs.

Distributed in dBASE II source code, ACTS' minimum requirements are two double-sided, double-density 48-tpi disk drives. Programs are available in most CP/M, MS-DOS, and PC-DOS formats. Churches with memberships in excess of 500 require larger disk capacities. The programs are \$300 each, or both can be purchased for \$500. Manuals alone are \$30. Contact Burr Computer Consultants, 6402 Thoreau's Way, San Antonio, TX 78239, (512) 650-4342.

Circle 569 on inquiry card.

### Program Orders Disk Files

Catalog-Master organizes and maintains a master file directory of your floppy disks. It composes directory reports sorted in alphabetic order by filename. Individual file descriptions can be merged with master directory reports.

Catalog-Master will index any disk volume supported by CP/M-80 version 11. An 80-column by 24-line display and 48K bytes of memory are needed. Disk formats are available for Epson QX-10, Heath/Zenith 290, Kaypro II/4, and other CP/M-80-based computers. Catalog-Master is \$29.95. For full particulars, contact Generic Software, Department 14P, 190 Timber, Marquette, MI 49855, (906) 249-9801.

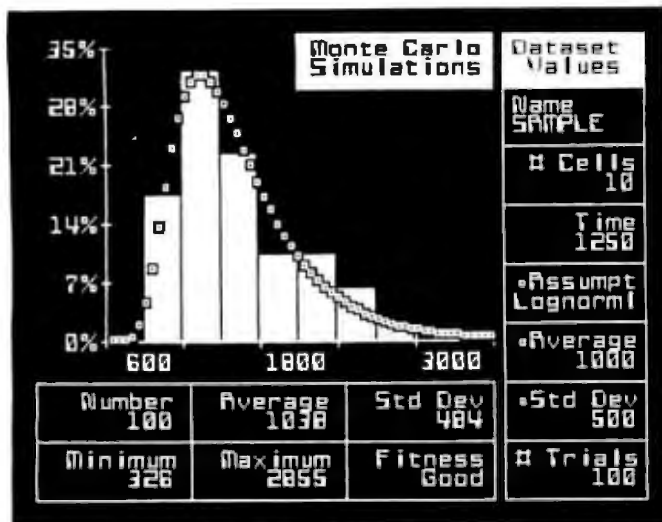
Circle 557 on inquiry card.

### Peachpak 4 for 16-Bit Computers

Peachtree Software is distributing an updated version of its Peachpak 4 accounting package that's fashioned to run on 16-bit microcomputers. Comprising general ledger, accounts receivable, and accounts payable modules, Peachpak has been enhanced with expand and compress abilities that let you adjust your work for 80-column printing without exiting to DOS. In addition, the operators manual has been rewritten.

Peachpak 4 will run on the following 16-bit microcomputers: Compaq, Eagle PC, IBM PC, Texas Instruments Professional Computer, and Zenith Z-100. It lists for \$395. For more information, contact Peachtree Software Inc., 8th Floor, 3445 Peachtree Rd. NE, Atlanta, GA 30326, (800) 247-3224; in Georgia, (404) 239-3000. Circle 550 on inquiry card.

# What's New?



## Statistical Simulators Released

Actuarial Micro Software has released two general-purpose statistical simulators for Apple II and IBM PC computers: Gass and Monte Carlo Simulations. Gass simulates as many as 10 variables simultaneously and combines them into a single user-defined algorithm. Variables can be either random, Boolean, functional, or compound. Random variables can be any of 13 different probability distributions, including empirical tables. Gass also features on-line documentation and the ability to produce reports that summarize final results, display intermediate values, and present histograms.

Monte Carlo Simulations can perform statistical analyses and construct models. It employs the chi-square goodness-of-fit test to match a set of raw data to a standard probability distribution. It features high-resolution graphics, color, and audio enhancements. Results of individual simulations can be incorporated into a spreadsheet to produce complex models.

Gass lists for \$450. Monte Carlo Simulations is \$60. For more information, contact Actuarial Micro Software, 3915 A Valley Court, Winston-Salem, NC 27106, (919) 765-5588.

Circle 573 on inquiry card.

## Rainbow Graphs Suitable for Presentation

Infograph 100 is a presentation-quality graphics system for novice and knowledgeable DEC Rainbow 100/100+ users. This menu-driven package has integral decision rules that help you make consistent and accurate graphs. Data may be entered directly from a spreadsheet program or manually by responding to a series of prompts.

Infograph 100 uses Digital

Research's GSX graphics extension of CP/M, which provides access to most standard graphics printers and plotters. It requires CP/M. This system costs \$395, including GSX. For the name of the Infograph dealer nearest you, contact GMS Software, 113 East Savarona Way, Carson, CA 90746, (213) 217-0161.

Circle 553 on inquiry card.

## HP/IBM PC Link

PCCOM from DWJ Associates provides the IBM PC with Hewlett-Packard terminal emulation and communications capabilities. Operating modes and terminal- and printer-control functions are selected through a 13-menu function-key hierarchy. PCCOM generates a 48-line display memory with a 23-line by 80-character screen window. Terminal configuration is performed through keyboard entries that can be saved to disk for automatic power-on terminal configuration. Its full-screen editing capabilities include line and page insert, delete, and clear. Video attributes such as inverse video, blinking, high intensity, and underline are supplied.

Among its print features are adjustable margins and character, line, or block operation in forms and nonforms modes. Fifteen transmission rates,

ranging from 50 to 9600 bps, and even, odd, zero, mark, or no parity transmissions are provided. Eight user-programmable function keys with up to 16 character labels and 80 character-string definitions are available. Also offered are serial-port capture into or transmission from user-specified data files, and carriage return/line feed, ENQ-ACK, and XON/XOFF pacing.

PCCOM is compatible with PC-DOS versions 1.0, 1.1, 2.0, and 2.1. It will emulate HP2622 and HP2624B terminals with the exception of their graphics modes and alternate character sets. It costs \$450. The manual alone is \$20. For more information, contact DWJ Associates Inc., One Robinson Lane, Ridgewood, NJ 07450, (800) 922-0090; in New Jersey, (201) 445-1711.

Circle 567 on inquiry card.



## Cross-Assembler for NS16000 Announced

Program Concepts has announced a cross-assembler development system for National Semiconductor's 32-bit NS16000 microprocessor. Designed for use with the IBM Personal Computer, this package comprises four utility programs: cross-assembler, cross-link, debugger, and librarian. Program features include macro instructions, floating-point mathematics, a memory-management unit, and

MMU support

Basic requirements are PC-DOS 2.0, 192K bytes of RAM, and dual 320K-byte floppy-disk drives. It costs \$595. A manual is supplied. A C language source and a multitasking operating system for the NS16000 will be available soon. Contact Program Concepts Inc., POB 8164, Charlottesville, VA 22901, (804) 978-1850.

Circle 559 on inquiry card.



# What's New?

## Tektronix Compatibility for Lisa

A Tektronix-compatible applications program, Mesa Graphics' Tekalike operates on the Apple Lisa. Tekalike is a graphics terminal communications package that supports communications to remote computers as an ASCII terminal. It maintains the Tektronix 4010 family's graphics protocols for graphics terminal I/O and is said to be compatible with most mainframe graphics software that works with the 4010 terminals, including Issco, Megatek, and SPSS/Graph. Tekalike also provides local facilities for zooming and plotting pictures. No modifications to the Lisa are required.

Tekalike is tailored for the Lisa, Lisa 2/5, and 2/10 with a hard-disk drive and 1 megabyte of RAM. It costs \$350 and is available from Mesa Graphics, POB 506, Los Alamos, NM 87544, (505) 672-1998. Circle 555 on inquiry card.

## Background Processing for IBM PC

The DoubleDOS operating system enhancer from Softlogic Solutions lets the IBM PC or PC XT run two tasks simultaneously. Acting as an extension to PC-DOS 1.1 or 2.0, DoubleDOS divides the PC's memory into two areas, one for each program running. Programs can be loaded into either memory area, where they are allowed to operate without requiring keyboard interaction. Program displays are trapped by DoubleDOS. When the background program screen is called up, any processing that occurred during operation is reflected.

DoubleDOS supports either monochrome or color display monitors. On PCs with both displays, it provides the option

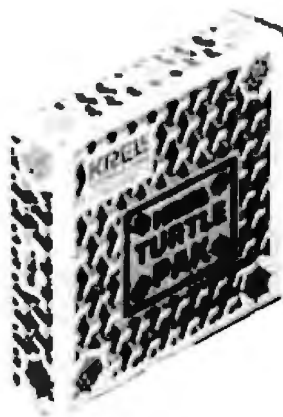
of using either one for background or normal applications. DoubleDOS also provides two 80-character type-ahead buffers.

DoubleDOS does not require software modifications or additional hardware. It can work with 128K-byte systems, but 192K bytes of RAM are recommended. The suggested price is \$299. For more information, contact Softlogic Solutions, 530 Chestnut St., Manchester, NH 03101, (800) 272-9900; in New Hampshire, (603) 627-9900. Circle 568 on inquiry card.

## Scribe Works with Notebook Computers

The Scribe word processor works with the NEC PC-8201 notebook computer's built-in Text program. Scribe features menu control, message prompting with defaults, automatic paging and numbering, text indentation, headers, insert, double-width characters, margin resets, right justification on/off, and the ability to stamp each page with filename, date, and time. Print attributes such as user-selectable tractor-feed or single-sheet paper and the ability to print documents of any length from a combination of RAM or tape files are standard. A typical unjustified text can be printed at about 25 to 50 cps.

Scribe uses only 2.3K bytes of memory. It requires approximately 3.5K bytes to load and run. Scribe cannot underline or create superscripts or subscripts. It costs \$29.50, plus \$2 for shipping and handling. A version for the Radio Shack Model 100 can be ordered. Contact Chattanooga Systems Associates, POB 22261, Chattanooga, TN 37422, (615) 892-2339. Circle 566 on inquiry card.



## Turtle Logo Paks In Two Sizes

The Krell Turtle Logo Pak for the Apple II is available in two sizes: 20 and 40 disks. Each Turtle Pak contains "Alice in Logoland" disks and primer and utility disks with a host of MIT's Logo programs: Dynatrack, Shape Editor, Music Editor, and Sprite Drivers. In addition, the Pak has Logo command wallcharts, Dan Watt's Learning with Logo, and the MIT technical manual, Logo for the Apple II.

The 20-disk version of Turtle Pak lists for \$499.95. The 40-disk version is \$899.95. For details, contact Krell Software Corp., 1320 Story Brook Rd., Story Brook, NY 11790, (516) 751-5139.

Circle 564 on inquiry card.

## Doodle with Graphics on Your Z-100

The Doodler Graphics Package for Heath/Zenith Z-100 computers works with color or monochrome displays. Doodler draws lines, boxes, circles, ovals, and mirror images and lets you move, copy, or erase portions of the screen. Text can be of variable width and proportionally spaced or scaled. Characters can be displayed in italics or with a back-slant, and Doodler's font editor lets you

build custom characters. The two-dimensional drawings created with Doodler can be saved to disk for later playback, editing, or merging with other programs.

Doodler is menu-driven, using single-keystroke commands. It comes with drivers for Gemini, Epson, C. Itoh, and similar dot-matrix printers. It costs \$79.95. Contact Paul F. Herman, Data Systems Consultant, POB 535, St. James City, FL 33956, (813) 283-2227.

## Passive and Active Circuit Analyzer

ACNAP is a general-purpose electronic circuit analysis program from BV Engineering. It analyzes passive and active circuits consisting of resistors, capacitors, inductors, controlled current sources, operational amplifiers, transistors, FETs, and so forth. It will analyze the response of any linear network consisting of up to 21 nodes and 60 components.

ACNAP works with component tolerances to provide worst-case and Monte Carlo analysis. It can calculate minimum, maximum, mean, and three sigma points of a circuit's gain/phase response to any frequency input. Linear and logarithmic frequency sweeps can be specified. Additional calculations include the sensitivity of the gain/response to components at a frequency or range of frequencies. Calculation of any circuit's noise equivalent bandwidth is automatic.

Every ACNAP command is either menu-driven or program-prompted. Circuit data is stored to disk; both ASCII and binary file structures are supported. Calculating the re-

# What's New?

sponse of a typical five-node circuit takes approximately 0.4 second.

This program is available in 5¼- and 8-inch CP/M formats for such systems as the Apple II Plus, IBM PC, Victor 9000, and Radio Shack TRS-80 Models I, III, and 4. It costs \$49.95, plus \$3 handling. For \$59.95 and shipping, 8087 co-processor versions for the IBM PC and Victor 9000 can be obtained. Contact BV Engineering, POB 3351, Riverside, CA 92519, (714) 781-0252. Circle 572 on inquiry card.

## Rainbow and TI Professional Business Software

State of the Art's FM Series of small-business accounting and word-processing programs are available for the Texas Instruments Professional Computer and the DEC Rainbow and Rainbow Plus. The FM Series is made up of general ledger (with bar-chart graphics), budget and financial reporting, accounts payable, accounts receivable, sales invoicing, inventory control, payroll, word processing, and professional time and billing modules.

These programs can serve as stand-alone modules or, for a complete accounting system, they can be integrated with each other. They can be customized to meet your organization's specific needs. Program highlights include information windows and on-screen prompts. For future expansion, all modules are designed to be easily expandable from a floppy-disk to a hard-disk-based MS-DOS system.

Individual FM Series packages range in price from \$495 to \$795. A hard-disk installation kit is \$95. Versions of FM Series are also available for the IBM PC, PC XT, Corona, Com-

paq, and Columbia. For further information, contact State of the Art Inc., 3183-A Airway Ave., Costa Mesa, CA 92626-4618, (714) 850-0111. Circle 565 on inquiry card.

## Function Key Program for Kaypro

Xtrakey from Xpert Software lets you redefine any key on your Kaypro's keyboard with character strings. It has a built-in screen dump that lets you produce hard-copy outputs of the current screen display while running another program. Xtrakey also provides variable-length strings (i.e., pausing), as well as clear-screen and two additional screen-dump functions. It comes with predefined key-string sets for a variety of programs and an editor for devising custom key strings. Xtrakey can also redefine cursor and numeric keypad keys.

With documentation, Xtrakey costs \$39.95. Add \$2 postage and handling when ordering factory-direct from Xpert Software, 8865 Pollard Ave., San Diego, CA 92123, (619) 268-0112. Circle 560 on inquiry card.

## Generate Fonts with Plotters

Centerpoint's Sign-Plot program lets you produce six different typeset-quality letter fonts for use with pen plotters from such manufacturers as Hewlett-Packard, Houston Instrument, and Enter. Uppercase, lowercase, punctuation, and numbers are part of this menu-driven program. Any character can be slanted for an italic effect, and letter sizes are variable. Characters may be positioned vertically and horizontally in fractional inch in-

crements. Additional fonts and symbols can be created.

Sign-Plot works with 128K-byte IBM Personal Computers with two disk drives and CP/M-80-compatible systems. It also works with Amdek, Apple, Calcomp, Mannesmann Tally, and Strobe plotters. Sign-Plot costs \$149. For more information, contact Centerpoint Computer Applications, 500 North Michigan Ave., Chicago, IL 60611, (312) 467-0333. Circle 570 on inquiry card.

## Protact Processing and Control for DEC

Protact, a transaction processing and control system for DEC Professional computers, gives you terminal, file, and network management capabilities and lets one or two users access applications on a remote or local Professional, PDP-11, or VAX. Its terminal management presents a form to be completed by the user and verifies user-specified primary edit checks as each field is entered. Form definition is kept separate from the program. A dispatching system provides a hierarchical menu structure. Protact can route items to another computer for processing. This is said to be transparent to the user and applications programmer. Security is definable at both the local and remote level.

Protact's file manager uses DEC's Record Management Services as its file-access method. Transparent remote file access is supported, and file definition is maintained outside the referencing program. A restart/recovery system with start- and commit-transaction logic is supplied.

Protact comes in three versions. The Developer's Kit, priced at \$2500, has the necessary components to write and carry out applications on

the Professional. (Applications are written in any language that supports CALL statements.) The Protact run-time system is made up of components used while an application is executing. A license is \$395. The Terminal Server, intended for Professional computers linked into an Ethernet network, has terminal- and network-management facilities. It costs \$595.

P/OS V1.5 and V1.7 are required. Multiple processor and educational institution discounts are available. Contact Advanced Systems Concepts Inc., 22 Hudson St., Hoboken, NJ 07030, (201) 798-6400. Circle 558 on inquiry card.

## Spreadsheet Link for IBM PCs

Spreadsheet Link lets you download data from the Dow Jones News/Retrieval database into Lotus 1-2-3, Visicalc, Multiplan, and other spreadsheet programs running on an IBM PC. This program works with the IBM PC, PC XT, and 3270 PC. Minimum memory requirements are 128K bytes; your spreadsheet may require more memory. With Visicalc, Spreadsheet Link only needs a single double-sided drive; Multiplan and Lotus require two. A monitor, acoustic coupler or 300/1200-bps modem, and a parallel or serial printer with an asynchronous communications adapter are requisite. The following modems are supported: Radio Shack TRS-80 Modem II, Hayes Smartmodem, and the Novation 103/212 Smart-Cat. The suggested retail price is \$249. For further information, contact Dow Jones & Co. Inc., POB 300, Princeton, NJ 08540, (800) 257-5114; in New Jersey, (609) 452-1511.

Circle 563 on inquiry card.



# What's New?

## MASS STORAGE

### 60K RAM for Portable Computers

Portapac 100 from Cryptronics expands a portable computer's memory by serving as a RAM disk. It comes with its own operating system and communicates with CP/M- and MS-DOS-based computers through its RS-232C serial port. It can access up to 32 separate files in a 60K-byte RAM, which is expandable to 252K. It can operate continuously for three hours and store data for two days before recharging the battery.

Portapac 100 is \$395. It's available from Cryptronics Inc., Suite 7, 11711 Coley River Circle, Fountain Valley, CA 92708, (714) 540-1174.

Circle 574 on inquiry card.

### Apple Disk Drive and Controller Card Marketed

Concorde Peripheral Systems markets a single-sided 163K-byte floppy-disk drive and a disk controller card for Apple computers. The Concorde Model C-111 disk drive has the following technical specifications: 35- or 40-track capabilities; track density: 48 tpi; data transfer rate: 250K bits per second; rotation speed: 300 rpm; recording frequency: 250 kHz. This single-head drive measures 6 by 3½ by 9 inches and weighs 4 pounds. It plugs directly into the Apple II Controller Card.

The C-130 Disk Controller Card can accommodate four single- or double-sided Concorde or Apple-compatible drives. Its supplied software allows Apple DOS 3.3 to function with Concorde's line of double-sided disk drives. The C-130 operates with DOS 3.3,

DOS 3.2, CP/M 2.2, and Pascal 1.1. One Apple slot is used.

The C-111 lists for \$249. The C-130 is \$89. Concorde Peripheral Systems Inc. is located at 23152 Verdugo Dr., Laguna Hills, CA 92653, (714) 859-2850.

Circle 575 on inquiry card.

### 33-Megabyte Winchester for PC

Interface Inc's Disksystem provides the IBM PC with 33.3 megabytes of formatted disk storage. This 5¼-inch Winchester hard-disk drive records at 640 tpi and offers an average access time of 40 milliseconds. System features include a 512-byte buffer, an architecture built around a micro-processor, a double shock isolation system, and error checking and corrections of 32 bits. Its physical dimensions are 5¼ by 8¼ by 15¼ inches.

Disksystem requires PC-DOS 2.0. It comes with its own power supply, cable, connector, and I/O adapter. The suggested list price is \$2795. For more information, contact Interface Inc, 7630 Alabama Ave., Canoga Park, CA 91304, (818) 341-7914.

Circle 577 on inquiry card.

### Line of Hard Disks Can Be Daisy-Chained

Disktjr from Systems Peripherals Consultants is a low-profile line of hard-disk drives for IBM PC's, Sanyo 550s, and PC-compatible portables. Disktjr's interconnect cables can be removed or daisy-chained up to four drives. The basic system chassis measures 2¼ by 6 by 12 inches.

Disktjr's formatted storage capacities are 10.8, 22.2, and 34 megabytes of fixed storage

and 5 or 10 megabytes of removable-cartridge storage. With the addition of an 8-bit controller, Disktjrs will work with such Z80-based systems as the Kaypro, North Star, and Televideo.

The 10-megabyte drive costs \$1495. The 22.2- and 34-megabyte units are \$2695 and \$3495, respectively. The 5-megabyte removable-cartridge Disktjr is \$1695; pricing for the

10-megabyte version, which will be available later this month, was not established at the time this was written. When drives are daisy-chained, additional controllers are not required, reducing the per-unit price. For details, contact Systems Peripherals Consultants, 9747 Business Park Ave., San Diego, CA 92131, (619) 693-8611.

Circle 576 on inquiry card.

## SYSTEMS



### Transportable PC-Compatible

The Colby PC-3 stand-alone portable computer is compatible with the IBM Personal Computer. A 26-pound unit, the PC-3 measures 8½ by 16 by 16½ inches. Its 9-inch amber monitor has an 80-column by 25-line display format and IBM PC graphics capabilities. Standard are 128K bytes of RAM, a real-time clock, serial and parallel ports, and a SASI hard-disk interface. Dual 360K-byte double-sided, double-density floppy-disk drives pro-

vide mass storage. A carrying handle eases transportation and serves as a tilt stand. Up to 1 megabyte of RAM and 3½ internal slots constitute this computer's expansion possibilities.

The Colby PC-3 lists for \$2795. For complete information, contact Colby Computer, 849 Independence Ave., Mountain View, CA 94043, (415) 968-1410.

Circle 584 on inquiry card.

# What's New?



## Z-100 PC Series

Zenith Data Systems' Z-100 PC series microcomputers are compatible with IBM Personal Computer expansion boards and software. The Z-100 PC line consists of three desktop computers and two portables. All are based on the 8088 microprocessor and contain 128K bytes of RAM, dual RS-232C serial ports, a single Centronics-type parallel interface port, RGB color output, an IBM expansion bus, and a de-

tached keyboard. The Z-100 PCs come with power-up diagnostics, three scrolling modes, and high-speed text and graphics displays. System software includes MS-DOS and a ROM-based BIOS. Mass-storage capacities range from 320K to 360K bytes per drive, depending on recording format. RAM is expandable to 640K bytes. When fully configured, the Z-100s have four expansion slots remaining for

future accessories.

The desktop Z-100 PCs are available with a single 5 $\frac{1}{4}$ -inch floppy-disk drive, dual floppy-disk drives, or with a floppy-disk and 10.6-megabyte Winchester hard-disk drive. Prices are \$2699, \$3099, and \$4799, respectively. Each desktop unit provides gray-scale monochrome output. Monitors are extra.

The portable systems are equipped with 9-inch amber monitors. They measure 19.5 by 8.38 by 19.13 inches and weigh approximately 33 pounds. They're offered in single and dual floppy-disk drive configurations. The prices are \$2799 for the former and \$3199 for the latter. For full details on these products, contact Zenith Data Systems, 1000 Milwaukee Ave., Glenview, IL 60025, (312) 391-8744. Circle 585 on Inquiry card.

## AKA PC Offers IBM Compatibility

The AKA Personal Computer is a 16-bit, 8088-based microcomputer that's compatible with IBM PC hardware and software. Equipped with 128K bytes of RAM, the AKA carries a pair of half-height, double-sided, double-density floppy-disk drives; five expansion slots; one parallel and two serial ports; and a low-profile detachable keyboard. A choice of monochrome or color-graphics display boards is offered. Its cabinet has room for four additional expansion slots and two disk drives. User memory can be increased to 256K bytes.

The AKA Personal Computer runs under MS-DOS. The AKA Plus, a version outfitted with a 10-megabyte hard-disk drive, is available. The AKA PC lists for \$3295. The AKA Plus

has a suggested retail price of \$4795. For further information, contact AKA Computers Inc., POB 36247, Charlotte, NC 28236, (704) 334-2504. Circle 579 on Inquiry card.

## Portable PC and PC Cluster Unveiled

IBM recently unveiled a portable computer and a PC Cluster program for connecting up to 64 IBM PCs, PC XTs, Portable PCs, and PCjr's. The Portable PC uses the 16-bit 8088 microprocessor and comes with 256K bytes of RAM, color graphics monitor adapter, a single 360K-byte slimline floppy-disk drive, and a universal power supply. It sports a built-in, 9-inch amber monitor; the display format is 80 characters by 25 lines. An optional slimline floppy-disk drive can use one of the Portable PC's five slots. IBM DOS 2.1 provides compatibility with most of the software available for the full-sized IBM PC. This 30-pound unit measures 20 by 17 by 8 inches. It lists for \$2797, including a carrying bag.

The IBM Personal Computer Cluster program lets you send, exchange, and share messages and information among IBM PC workstations. Workstations can share information and storage space on a fixed-disk drive at one machine in the Cluster. An interconnecting cable is required. A number of support options for connecting different IBM PCs are available: an adapter board, a PCjr Cluster attachment, and a Computer Cluster Cable Kit, which contains the cables and connectors for hooking together a pair of PCs.

A program license, priced at \$92, is required for each system in the Cluster. The Cluster adapter is \$340, and the Cluster Cable Kit lists for \$110. The



# What's New?

PCjr Cluster attachment costs \$400. Contact your local IBM Products dealer, or write to IBM Entry Systems Division, POB 2989, Delray Beach, FL 33444. Circle 578 on inquiry card.

## Havac Is an Apple Work-alike

Microsci Corporation recently introduced an Apple II work-alike computer called Havac. This transportable computer, constructed around the 6502 microprocessor and a 164K-byte 5¼-inch floppy-disk drive, offers 64K bytes of RAM, 8K bytes of ROM, a 62-key detached keyboard supporting uppercase and lowercase characters, four cursor keys, high-resolution color graphics, video connections, and printer, serial, and game ports. Among the supplied software are DOS, a card filer, calculator, BASIC, and a variety of utilities. The manufacturer asserts that more than 1000 Apple II programs have been successfully run on the Havac.

A stand-alone floppy-disk drive is offered as an option. The suggested list price is \$850 and includes all the features outlined above. For further details, contact Microsci Corp., 2158 South Hathaway St., Santa Ana, CA 92705, (714) 241-5600. Circle 583 on inquiry card.

## CP/M Computer Is Apple-Compatible

The Intertek System IV is a dual-processor, CP/M-based computer offering compatibility with Apple hardware and software. The System IV runs Microsoft CP/M 2.20B on its Z80A microprocessor while in the Apple mode; operations

are handled by a 6502 chip. The system features 64K bytes of RAM, high- and low-resolution graphics capabilities, a built-in RF modulator, six free peripheral connectors, speaker, game paddle/joystick ports, uppercase and lowercase characters, cassette interface, and diagnostics. It offers 16 colors and Integer BASIC. A QWERTY keyboard is augmented with a numeric pad, function keys, and automatic repeat.

A variety of peripherals are available: 12-inch green or amber monochrome monitors, 13-inch RGB or composite-video monitors, 5¼-inch half- and full-sized floppy-disk drives and controllers, serial or parallel 13-cps letter-quality printers, and joysticks. The suggested retail price of the base System IV is \$849. For details, contact Intertek Systems Inc., 1210 West Collins Ave., Orange, CA 92667, (714) 633-3591. Circle 582 on inquiry card.

## S-100 Bus Systems for Industry

Industrial-grade mainframe computers engineered around 8- or 16-slot IEEE-696 S-100 motherboards are marketed by Futech International Corporation. The Futech 2000 Series provides up to 25 rear-panel DB25 connectors, front bezels to accommodate up to six floppy- or Winchester-disk drives, and switchable heavy-duty 100, 120, 220, and 240 V AC 50/60 Hz power supplies.

The 2000 Series' multiuser, multiprocessor CP/M-compatible operating system supports concurrent hard disk and 8- and 5¼-inch floppy disks. Batch processing, record and file locking, multilevel security, and automatic log are provided. It supports high-performance spooling of up to 16

concurrent printers and 16 print queues.

The 2000 Series can handle both 8- and 16-bit slave processors in the same enclosure. Each slave has a dedicated microprocessor, RAM memory, and I/O ports. Other standard features include on-board LED warning indicators, gold-plated 100-pin edge connectors, built-in EMI/RFI filter, line surge/spike suppression, and two filtered fans.

The 2000 Series can incorporate a front-panel LED that displays time, date, and inter-

nal and ambient temperatures. Additional options include auxiliary connectors for floppy- and hard-disk drives, a synthesized warning voice, and backup power supply. A variety of applications packages and operating systems are available. The base price is \$730, quantity one. For complete specifications, contact Futech International Corp., Suite 1807, 2100 North Highway 360, Grand Prairie, TX 75050, (214) 660-1955.

Circle 581 on inquiry card.



## ET Desktop with Software

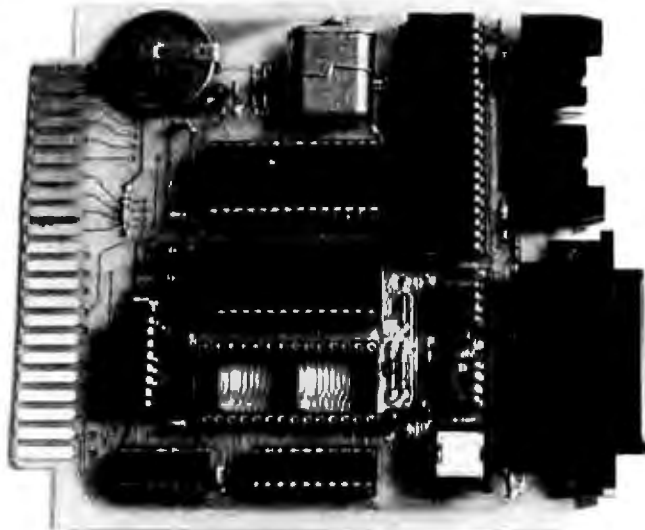
The ET-2010 desktop computer comes with a software bundle comprising an enhanced DOS that's compatible with CP/M 2.2, Business BASIC, and word processing, spreadsheet, general ledger, accounts receivable, accounts payable, and payroll with job costing packages. The ET-2010, a 64K-byte machine assembled around a 4-MHz Z80A microprocessor, has parallel Centronics and serial interface ports and a 76-key QWERTY keyboard plus a numeric pad. Its built-in 9-inch high-resolution green screen has an 80-character by 24-line display and strike-

through, blink, blank, reverse, and underline attributes.

Optional system hardware includes 9511 and 9512 arithmetic coprocessors, DMA controller, the 6-MHz Z80B, and a 10-megabyte hard-disk unit. A multiuser, multitasking operating system and networking capabilities are also offered. A two-disk system costs \$1349, including software, monitor, and keyboard. With a single disk drive, it's \$1225. Options range from \$25 to \$1100. Contact ET Computer Systems, 8161 Broadway, Lemon Grove, CA 92045, (619) 466-1671. Circle 580 on inquiry card.

# What's New?

## PERIPHERALS



### Dedicated Control Boards

Adaptive Micro Systems' AMS-1000 series of single-board computers is intended for dedicated control applications in which the board serves as the development and target application system. Standard are an RS-232C port, dual 8-bit parallel TTL I/O ports, a pair of 16-bit counter/timers with interrupt, 2K or 8K bytes of battery-backed CMOS RAM, and a 44-pin expansion bus. An extra socket is available for 2K- or 8K-byte EPROMs or EEPROMs. Programs can be automatically booted on power-up, and a wake-up feature for multidis-

tributed process-control applications is provided. The fully socketed board measures 4½ by 4½ inches.

The basic board comes with a 6502 microprocessor and an extended version of fig-FORTH and a 6502 assembler in firmware. The 2K-byte AMS-1000 is \$299. The 8K-byte version is \$399. Documentation and FORTH tutorials are supplied. Further details can be obtained by contacting Adaptive Micro Systems, POB 965, Sandy, UT 84091. Circle 595 on inquiry card.

### Apple Given Gold Card

Digital Research has announced the CP/M Gold Card for Apple II series microcomputers. The Gold Card combines a 6-MHz Z80B microprocessor, up to 192K bytes of memory, disk cache, and CP/M Plus on a single plug-in card. Standard are CBASIC, menu-driven utilities, 80-column display capacity, hash directory, time and date stamp facility, automatic loading, and console I/O redirection.

It comes with 64K bytes of memory, software application-development tools, and assembly-language utilities. The price is \$495. An add-on disk cache advances the Gold Card's memory to 128K bytes. It's \$325. A complete Gold Card package with cache is available for \$775. For a full account, contact Digital Research Inc., POB 579, Pacific Grove, CA 93950. Circle 588 on inquiry card.

### 8-MHz 80186 Heart of SBC

The Super 186, a high-speed, 16-bit single-board S-100 computer, is built around Intel's 8-MHz 80186 microprocessor. Manufactured by Advanced Digital Corporation, Super 186 is capable of addressing up to 1 megabyte of RAM without requiring banking techniques. It is supplied with 256K bytes of on-board RAM with parity, four serial RS-232C ports, two parallel ports, a two-channel DMA controller, three uncommitted counter/timers, and a floppy-disk controller that lets you operate 5¼- and 8-inch drives simultaneously. It can be equipped with 64K bytes of monitor EPROM. Bus master or slave/temporary master capability and compatibility with CP/M-86, TurboDOS, and MS-DOS are standard.

Optional hardware available includes a clock/calendar, battery backup, dual-ported memory, and mathematics coprocessors. Super 186 is \$1995. For more information, contact Advanced Digital Corp., 5432 Production Dr., Huntington Beach, CA 92649, (714) 891-4004. Circle 589 on inquiry card.

### Versatile Graphics Board for PC

Profit Systems' Multigraph single-board graphics adapter for the IBM Personal Computer lets you select either color or monochrome monitors. The basic board offers high-resolution 720- by 350-pixel monochrome graphics and the ability to run standard software for the IBM color board. In either color or monochrome, Multigraph gives you 32K bytes of on-board memory, flicker-free scrolling, and 32-bit internal architecture for in-

creased operating speed. The basic color resolution is 160 by 100, 320 by 200, or 640 by 200, using sixteen, four, or two colors, respectively. Alphanumeric displays of 80 by 40 can be achieved in the monochrome mode.

Expansion options include a parallel printer port, soft scrolling, and a 128K-byte display buffer. In color, resolution can be upgraded to 640 by 200 or 400 pixels with 16 colors. In monochrome, graphics can be upgraded to 720 by 700 resolution with 132 columns. The base price is \$499, complete with documentation. Dealer and OEM inquiries are invited. Full details can be requested from Profit Systems Inc., POB 1039, Berkley, MI 48072, (313) 559-0444.

Circle 608 on inquiry card.

### Abort Printing Without Reloads

The Passport Printer Emulator lets you quickly abort an ongoing print operation, preventing potential time and data losses. Passport has two operating modes: Print Pass-Through and Print Bypass. If you wish to cease printing or if you inadvertently invoke a printer operation, such as print screen, Passport's Print Bypass mode lets you terminate the printing without locking your keyboard or requiring a reload. Print Pass-Through permits normal operations.

Passport functions as a standard printer device. It emulates most parallel printers that connect with an IBM PC or PC-compatible cable. Passport costs \$29.95, plus \$2 handling. It's available from Micro Computer Components, 8660-D Miramar Rd., POB 195, San Diego, CA 92126, (619) 453-3367. Circle 597 on inquiry card.



# What's New?



## 24 by 80 Terminal

The LCT-100 terminal from Data Terminal Service produces 24-line by 80-character screen displays in a 9- by 12-dot grid. It generates 129 uppercase and lowercase ASCII characters and offers 12 video attributes, including blink, half-intensity, reverse, and underline. Miscellaneous features consist of a 58-key typewriter-format keyboard, 80 graphics characters, the ability to display control characters on screen, status displays of configuration switches and RS-232C interface settings, switchable automatic

line feed upon receipt of a carriage return, and an RS-170-like composite-video interface. The RS-232C interface has 16 switch-selectable transmission rates and 7 data bits/words with 1 or 2 stop formats. Full-duplex or local-echo protocols are provided.

The LCT-100 costs less than \$400. With an optional monitor, it's less than \$500. For complete details, contact Data Terminal Service Inc., 715 Rankin Rd., Albuquerque, NM 87192, (505) 345-1611.

Circle 602 on inquiry card.

## 16-Bit CPU Board for S-100 Systems

Seattle Computer's 8086 CPU board is purported to deliver true 16-bit high-speed performance to S-100 bus-based computers. It comes in 8- and 10-MHz versions. As a result of its 16-bit architecture and increased clock speeds, the CPU board can be used for enhancing the throughput capabilities of 8088-based systems, such as the IBM PC. It can operate with older 8- or 16-bit peripherals, including disk controllers and video units. The memory address range of the CPU board can be expanded up to 16 megabytes.

The board can be used as a stand-alone unit or as part of a three-card support/MMU set.

Software support includes MS-DOS and Xenix. The 8-MHz board is designed for use with the 8087 numeric processor. The 10-MHz board is \$795, and the 8-MHz board costs \$695. Both prices include a support board. Dealer and OEM inquiries are invited. For complete specifications, contact Seattle Computer Products Inc., 1114 Industry Dr., Seattle, WA 98188, (800) 426-8936; in Washington, (206) 575-1830. Circle 607 on inquiry card.

## New Life for Older PCs

A memory upgrade for older IBM PCs carrying the 16K- by 64K-byte CPU is obtainable from Add-Mem. With this upgrade, the PC's memory can be jacked up to 256K bytes without using an expansion slot. Upgrades of 128K, 192K, or 256K bytes are offered.

Add-Mem can install 256K bytes of RAM in your PC for \$335, or you can order a do-it-yourself kit. The kit, made up of DIP sockets, capacitors, wires, documentation, and instructions, involves assembling

and installing a small printed-circuit board and the soldering of nine jump wires. The basic kit is \$69.95. With an assembled board, it's \$99.95. For \$5.85 each, you can order RAM chips. A protective, anti-static carton with board removal and shipping instructions costs \$5. Call or write Add-Mem, 22151 Redwood Rd., Castro Valley, CA 94546, (415) 886-5443, for more information.

Circle 593 on inquiry card.



## Legacy Created for PCjr

Legacy Technologies is shipping an expansion box for the IBM PCjr called the Legacy. This modular unit is engineered around a power supply capable of accommodating either a floppy- or hard-disk drive, up to 512K bytes of RAM, and a four-slot, 80-pin bus for a variety of add-ons. Sixty of the bus pins are identical to the PCjr's; the rest are prepared to provide hookups for interrupt capabilities, control and synchronization signals for co-processors, or specialized I/O functions.

The basic Legacy, priced at \$395, comprises the power supply, an LED status panel, the expansion bus, and a cabinet. Options offered are a half-height disk drive, a 64K-byte RAM card that's expandable to 256K bytes in 64K-byte increments, a 10-megabyte hard-disk subsystem, and

printer spooler board with a clock/calendar and parallel port. For hobbyists, a \$199 L-Bus Developer's Kit with power supply, two wire-wrap cards, and manual are available.

With a half-height 320K-byte floppy-disk drive and controller (required), Legacy is \$795. The 10-megabyte hard-disk version is \$1595. The disk controller, floppy-disk drive, and the half-height hard-disk drive may be purchased separately for \$189, \$279, and \$995, respectively. The RAM card is \$299, with the 64K increments going for approximately \$100. The clock/calendar card costs \$159. Order directly from Legacy Technologies Ltd., Suite 100, 1414 O St., Lincoln, NE 68508, (800) 288-7257; in Nebraska, (402) 475-7257.

Circle 591 on inquiry card.

# What's New?



## Image Converter Serves as Camera/Computer Interface

The Model 450C image-processing scan converter serves as an interface between a video camera and a computer. The Model 450C has three video memories, any one of which can accept black-and-white images; all three are employed for a single color image. A total of 4096 separate hues can be simultaneously displayed in the color mode.

Computer access is accomplished through a bidirectional interface using a pair of independent 8-bit parallel ports. Individual pixels can be ran-

domly accessed for image enhancement, graphics generation, storage, and recall. Control over system operations is via a command set. An internal slow-scan video modem will transmit video images over voice-grade communications links.

The Model 450C has a suggested retail price of \$895. For technical specifications and ordering procedures, contact Robot Research Inc., 7591 Convooy Court, San Diego, CA 92111, (619) 279-9430.

Circle 596 on inquiry card.

## 68000 SBC Compatible with S-100

PSCE's X-tended 68000 single-board computer is compatible with the S-100 bus. The X-tended 68000 comes with an 8-MHz 68000 microprocessor, 16 megabytes of memory address space, 64K bytes of I/O address space, and 4K bytes of EPROM. Suitable for multiuser systems, X-tended's I/O controls include two RS-232C synchronous/asynchronous ports, both of which offer programmable data rates up to 9600 bps. One RS-232C port provides full modem controls. A Centronics-type parallel interface is standard.

For mass storage, X-tended's floppy-disk controller can handle a mix of four 8-, 5¼-, or 3½-inch single- or double-sided, single- or double-density drives. Its software-programmable floppy-disk write pre-

compensation can select one of six values for drive compatibility, and it can be optimized for the track being accessed. Also furnished are a DMA controller and two general-purpose undedicated 16-bit timers. Nonmaskable interrupts and three types of vectored interrupts are supported.

X-tended 68000 can work with a mix of 8- and 16-bit memory boards. A jumper option for generating the S-100 Mwrite signal and CP/M-68K with optimized BIOS, an editor, assembler, debugger, linker, librarian, and a C compiler with a full library are available. RAM is additional. The base price is \$850. For more information, contact PSCE Inc., POB 8, Port Jefferson, NY 11777.

Circle 603 on inquiry card.



## Inforite Recognizes Handwritten Characters

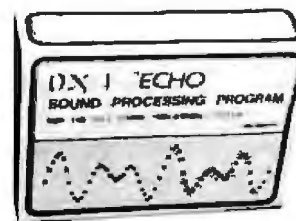
Inforite is a handwritten-character-recognition terminal. Incorporating dynamic character recognition, mark/sense recognition, and graphics capabilities, Inforite is suitable for applications that require direct computer entry of data from handwritten forms. It's based on the 4-MHz Z80A microprocessor and contains 64K bytes of RAM, 56K of ROM, and 48K bytes of battery-backed CMOS RAM.

Inforite can store almost 50 pages of data for more than three days. It transmits data to a local or remote computer through an RS-232C serial interface. Switch-selectable data rates range from 110 to 19,200 bps. DSR/DTR and XON/XOFF controls are supported. Standard features include a 2-line by 32-character LCD display that identifies the field and the data, error messages, and a programmable calculator function that computes extensions, subtotals, totals, tax calculations, and percentages as a form is being completed. It operates with a ballpoint pen and accommodates three-part forms.

A forms-definition package that lets you create forms tailored to your business is available as a \$450 option. In-

forite is \$2000. OEM prices quoted on request. Contact Inforite Corp., Suite 201, 1670 South Amphlett Blvd., San Mateo, CA 94402, (415) 571-8766.

Circle 605 on inquiry card.



## Sound Processing System Polishes Apples

Decillionix's DX-1 lets you record, process, and play back ordinary sounds with Apple II series computers. Sounds can be entered through a microphone or other source and saved, manipulated, sequenced, and modified in any way you choose. Pitch, volume, direction, and sequence are software-programmable, and real-time sound can be played through the Apple's keyboard.

Major system components are a printed-circuit board, a high-fidelity pre-amp circuit, a connecting cable, and software. Key features include 8-bit



# What's New?

sample record/playback techniques, variable sound rates ranging from 0.78 kHz to 30 kHz, variable play times from 0.8 to 10 seconds, the ability to play continuous sound sequences, and independently variable record and playback rates. The system software disk comes with 22 prerecorded sounds

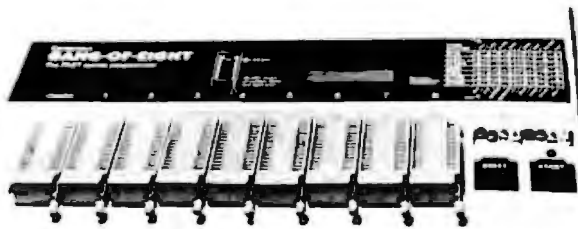
Echo, an optional software package with more than 40 key-selectable routines, adds echoing, reverb, and real-time

sound processing. Direct control of all parameters by joystick is provided. Echo costs \$149. A four-volume set of prerecorded sounds can be purchased for \$79.

DX-1 requires a 48K-byte Apple II or IIe with DOS 3.3 and Applesoft BASIC. List price is \$239. For further information, contact Decillionix, POB 70985, Sunnyvale, CA 94086. (408) 732-7758.

Circle 592 on inquiry card.

## FOREIGN



### Gang-of-Eight Programs EPROMs

The Gang-of-Eight EPROM Programmer from Dataman Designs can simultaneously program eight devices using manufacturers' recommended fast-programming algorithms. The programming time for a batch of 2764s reportedly averages 1.5 minutes. No special modules are required. The Gang-of-Eight has a simple switch setting that handles single-rail 24- or 28-pin devices, including the 27256. Programming voltage has fixed levels of 21 and 25 volts, a user-settable level, and a factory preset level of 12.5 volts, which is required by the newer, larger EPROMs.

For normal operations, the Gang-of-Eight has a single operating key. This device has a built-in intelligence feature that traps operator errors and an emergency Reset key for escaping those situations. Other features include an audible alarm and blank-check, pretest, and verify functions.

The Gang-of-Eight EPROM Programmer costs £395, including VAT (value-added tax). It's available from Dataman Designs, Lombard House, Cornwall Rd., Dorchester, DT1 1RX, England; tel: Dorchester (0305) 68066.

Circle 613 on inquiry card.

### RAM Disk Emulator for CDOS Systems

Tesco's TDrive RAM disk I/O emulator works with Cromemco computers. It serves as a single logical CDOS disk drive, providing access to up to 224K bytes of memory. Memory is partitioned into seven banks of 32K bytes (2K bytes are reserved for directory entries). It's compatible with 5¼-inch floppy-disk drives, and all CDOS software reportedly can be used on TDrive, including KSAM files under SBASIC.

TDrive works with systems that use bank-switched memory boards. It comes as a COM object file on either 5¼- or 8-inch CDOS floppy disks. TDrive installs directly under CDOS and makes all required patches within CDOS. All boards with a bank-switch feature, such as the Cromemco 64 KZ, are supported.

Tesco's TDrive RAM disk I/O emulator is available in the United States for \$98 from Albion Industries, POB 7, Millersville, MD 21108. It's produced and manufactured by Tesco, POB 10, 8714 Wiesenheid, West Germany; tel: 09383/1237.

Circle 609 on inquiry card.

### Structure-Analysis Program Aids Civil Engineers

AMP80-REV8340 is a structure-analysis program for civil engineers. When given the general configuration of a structure, the geometrical properties of its proposed sections, and its loads, this FORTRAN program produces such design stresses and forces as shearing, compression, and bending moments, each in two or more elements. It lets you enter shearing walls and several kinds of materials in the same frame, and it will accept load groups, sinking supports, earthquake forces, tilted loads, and so forth. Combinations of loads can be requested in the same run, and AMP80-RVCB340 can give you analyses of trusses. For producing direct design values, it lets you introduce load factors into a run. Results provide displacements and turns in every joint of the structure or at any intermediate point.

AMP80-REV8340 works with any 64K-byte machine with a FORTRAN compiler,

such as the Apple II Plus and the Franklin. It comes on two floppy disks and with instructions and examples. The price is \$1000. Order from Antoniano, Gonzalez Davila, Medina Mora, S.A. de CV., Nuevo León 209-601, México 11, D.F., Mexico; tel: 516-0293.

### Educational Robot Package for School and Industry

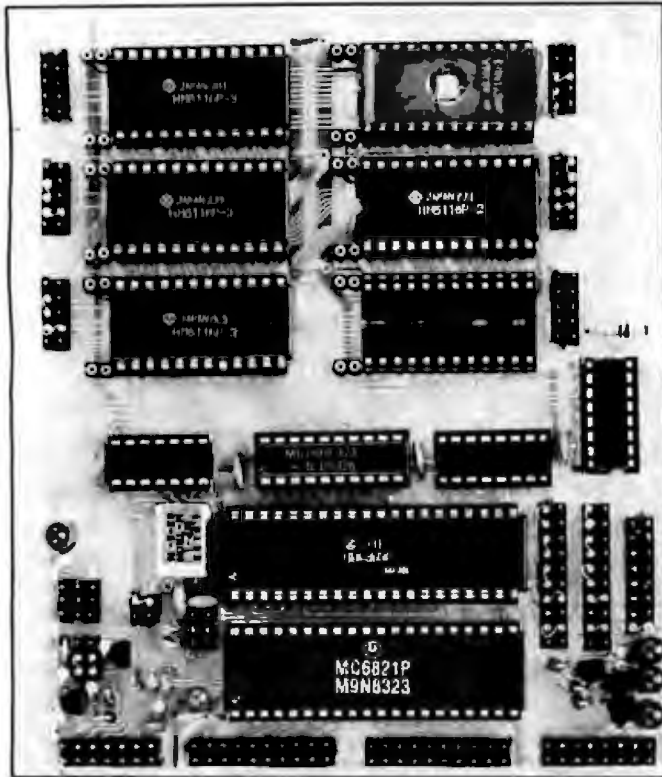
The Scorbot-ER III robot from Eshed Robotec Ltd. comes with a package of educational materials intended for technical schools, research laboratories, and industry. The complete system comprises the robot, textbooks, laboratory experiments, software, videotapes, slides, and overhead transparencies. The educational modules, which provide practical experiments, guide students from the principles of robotics through to state-of-the-art concepts.

Scorbot features an open-arm construction that lets students observe the operation mechanism. Its DC servomotors with closed-loop control are under the direction of an eight-axis controller that's capable of exercising simultaneous control on all eight axes. The controller has provisions for eight inputs and eight outputs. Scorbot connects to a host computer through an RS-232C serial interface. The rotation specifications for the working envelope are as follows: 360° body joint; ±150° elbow joint; ±90° pitch joint; 360° roll joint.

Software to run Scorbot is available for a variety of microcomputers. For full details, contact Eshed Robotec Ltd., POB 28346, Tel Aviv 61 282, Israel; tel: (03) 340860; Telex: 361131 ESHED IL.

Circle 610 on inquiry card.

# What's New?



## SBC Handles Mix of Chips

Brick from Dysys Inc. is a single-board computer suitable for sophisticated applications. Its 48K-byte memory space handles a mix of 2K-, 4K-, and 8K-byte RAMs, EPROMs, and EEPROMs. The Hitachi 6303 microprocessor, 33 I/O lines, a 16-bit timer/counter, an on-board UART for normal and multidrop communications, an asynchronous serial I/O line with selectable data rates, three LED indicators, and a power indicator are all standard.

Brick is marketed in four versions. Brick-1 is a development system offering a bus interface, voltage regulator, and a wire-wrap area for twenty 16-pin integrated circuits. Brick-2 is a plug-in board for OEM production, STD bus-compatible. Brick-3 is suitable for development and production of large systems. Brick-4 can be integrated into an OEM's circuit board at the drafting stage. Board dimensions vary.

A choice of Pascal or FORTH is available. Pascal provides an editor, interpreter, compiler, and run-time support. FORTH offers a screen editor, interpreter, and compiler directories. BASIC is optional.

Contact the manufacturer for pricing information on Brick-4. In lots of 10, prices for the other versions begin at \$560. Further information is available from Dysys Inc., Suite 206, 961 South Bland St., Halifax, Nova Scotia B3H 2S6, Canada. (902) 423-5308. Circle 612 on inquiry card.

## 8088 Processor Card Incorporates 80130 RMX

DY-4 Systems Inc. has announced the availability of the DSTD-187 processor card to its line of products for the STD bus. The DSTD-187, an 8088-

based card, incorporates the 80130 RMX processor and two RS-232C serial channels. A single 28-pin byte-wide socket for a RAM, EPROM, or ROM is provided. Its on-board memory can be disabled under software control. The contents of dynamic RAM will be preserved during reset. Full 1-megabyte memory addressing is supported, and the DSTD-187 provides transparent dynamic RAM refresh, which permits the use of high-density quarter-megabyte memory cards. Other features include Z80 and 8088 bus architecture support and compatibility with other DY-4 DSTD series cards.

An 8087 mathematics coprocessor is optional, and 8-MHz versions of the card can be obtained. The single-unit price is \$584. Contact DY-4 Systems Inc., Marketing Department, 888 Lady Ellen Place, Ottawa, Ontario K1Z 5M1, Canada. (613) 728-3711. Circle 615 on inquiry card.

## Easy-to-Use Mailing System

Orion Systems of Concord, Ontario, markets a computerized mailing system for users of the IBM Personal Computer. With Oscims, your client file can be added to, deleted from, and modified easily. This program has flexible facilities that let you print addresses on any type or size of label or flyer. Menu-driven, Oscims has the ability to print customer information and lets you select different customer types. A name-search option is included.

With user manual and distribution disk, Oscims costs \$59.95. Write to Orion Systems, 110 Riviera Dr., Concord, Ontario L4K 1A9, Canada. Circle 611 on inquiry card.

## PUBLICATIONS

### Products for Disabled Outlined in Catalog

A catalog of technical aids and systems for disabled individuals is available from Tash Inc. This 37-page brochure outlines ability switches, computer aids, environmental controls, communications and educational aids, and mobility and living aids. A price list is provided. For a copy, contact Tash Inc., Unit 1, 70 Gibson Dr., Markham, Ontario L3R 2Z3, Canada. (416) 475-2212. Circle 628 on inquiry card.

### Guide Probes Micropro Software

Jane Davis's Prostar Training Guide explains how to use a wide spectrum of Micropro office software. Programs covered are Wordstar, Spellstar, Datastar, Calcstar, Supersort, and Mailmerge. This 248-page book begins with an introduction to the computer, covering such topics as operating systems, floppy disks, and keyboards. Using step-by-step examples, Ms. Davis shows you how to type a letter in Wordstar, design a form and enter names and addresses in Datastar, alphabetically sort names and addresses with Supersort, and merge the letter and data file to produce form letters and envelopes using Mailmerge. Individual programs are then explored in greater detail, and advanced programming techniques are elucidated. Readers are also shown how to link the packages together.

The Prostar Training Guide is available for \$45, postage paid, from Jane Davis Publications, POB 717, Richboro, PA 18954. Circle 618 on inquiry card.



# What's New?



## Computer and Electronics Data Handbook

Joseph Electronics has released the second edition of its *Computer and Electronics Data Handbook*. This 32-page booklet contains glossaries of computer, electronic, fiber optic, and cable terminology. In addition, the most

commonly referred to electronic tables, formulas, and symbols are provided. Individual copies are \$1.95. Contact Joseph Electronics, 8830 North Milwaukee, Niles, IL 60648, (312) 297-4200. Circle 623 on inquiry card.

## Guide to Micro Periodicals

A 16-page guide with information on more than 100 microcomputer periodicals has been published. Fifty of the periodicals are profiled, while the remainder are organized according to the hardware, software, or topic they serve. Subscription prices and pertinent information are given for all the periodicals.

The guide is \$2.50. Order it from Microguide, POB 4363, Chicago, IL 60680, (312) 986-1536.

Circle 624 on inquiry card.

## Catalog Outlines Mail-Order Software

A catalog outlining brand-name software available through mail order can be obtained from 800-Software. This company markets packages from nearly 30 major software houses, including Ashton-Tate, Continental Software, Digital Research, Fox & Geller, Micropro, Microstuf, Pickles & Trout, and Visicorp. Computers from such manufacturers as Apple, Cromemco, Dynabyte, Heath/Zenith, Intertec, Micropolis, North Star, Televideo, Xerox, and others are supported. Both

5¼- and 8-inch formats are offered, and most programs are sold at less than list price. The catalog also contains comparison charts of database, spreadsheet, and word-processing programs.

Customer backing includes a support department that answers technical questions and a customer service department to handle program updates, exchanges, and returns. Both telephone and mail orders are accepted. For your catalog, contact 800-Software Inc., Suite 14, 940 Dwight Way, Berkeley, CA 94710, (800) 227-4587; in California, (800) 622-0678 or (415) 644-3611. Circle 617 on inquiry card.



## IC Master Lists 38,000 ICs

The 1984 edition of *IC Master* has been released by Hearst Business Communications. This two-volume, 3300-page reference book lists key specifications for more than 38,000 integrated circuits, microcomputer boards, microprocessor development systems, PROM programmers, and custom and semicustom integrated circuits from over 200 manufacturers. Only products currently offered are described in the data tables; however, an alternate-source directory covers both new and discontinued devices, provides

information on replacement parts, and lists approximately 60,000 IC substitutes.

*IC Master* is divided into 20 sections, such as microprocessors, memories, and linear integrated circuits, and each product group is organized by key specifications. Eleven technical-data sections, including military, digital, and interface, are arranged by function and parameters. An advertisers' product index, part-number index, and a manufacturer and distributor directory are among this set's eight supporting sections.

*IC Master* costs \$95. It can be ordered directly from *IC Master*, Hearst Business Communications Inc., 645 Stewart Ave., Garden City, NY 11530. Circle 619 on inquiry card.

## Information Resource

*The Whole Computer Catalog*, an illustrated guide to professional consultants, manufacturers, and associations, assists people seeking information on computers. Among the topics covered in this book are hardware in an evolving marketplace, available software, on-line information sources, computer careers, computer stores, the sociological impact of computers, magazines and newsletters, government publications, books, schools that specialize in computer science, and user groups. Each section begins with a discussion clarifying the scope of the topic presented.

*The Whole Computer Catalog*, edited by Narda Lacey Schwartz, is more than 400 pages long. It's available in softcover for \$35 from Designs III Publishers, 515 West Commonwealth Ave., Fullerton, CA 92632, (714) 871-9100. Circle 620 on inquiry card.

# What's New?

## MISCELLANEOUS



### Antistatic Wipes

Staticide Wipes are individually wrapped towelettes saturated with an antistatic solution that can reduce static buildup on terminal screens, computer housings, and peripheral cabinets. These low-lint, disposable towelettes can be used on any surface not adversely affected by water or alcohol. Static protection is provided at humidities as low as 15 percent. The saturating fluid

contains a topical antistat concentrate, deionized water, and isopropyl alcohol.

Each 5½-by-8-inch Staticide towelette is packed in a small foil package. The suggested price for a box of 24 is \$4.98. For a sample and more information, contact ACL Inc., 1960 East Devon Ave., Elk Grove Village, IL 60007. (312) 981-9212.

Circle 632 on inquiry card.

### Solderless Prototyping Board for Micros

The EZ Board from Sabadia Export Corporation is a solderless breadboard system for building experimental add-ons for microcomputers. EZ Board's breadboarding area consists of 1460 tie points capable of holding sixteen 14-pin DIPs. Components with lead diameters of up to 0.032 inch can be plugged in and connected with ordinary hookup wire.

This glass/epoxy printed-circuit board has four distribution buses, each with 50 tie points. The distribution buses can be used for power, ground, clock lines, and reset commands. A four-position DIP switch is mounted on-board, and each DIP position

corresponds to a set of tie-point-block sockets. For rapid identification, EZ Board has an easily accessible array of tie-point blocks from which each pin of the computer's I/O channels is labeled.

EZ Board is available for Apple, Commodore, and IBM PC systems, and their respective compatibles. Models for other computers are in the works. Including cable and connectors, EZ Board is \$174.95. Add \$5 shipping when ordering from Sabadia Export Corp., POB 1132, Yorba Linda, CA 92686. (714) 630-9335.

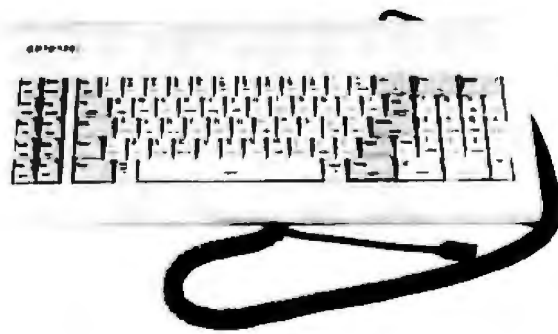
Circle 633 on inquiry card.

### Disks Meet ANSI Standards

Beck Manufacturing offers a line of single- and double-sided 5¼-inch floppy disks. Beck disks meet ANSI standards and are backed with a seven-year warranty. A 25-pack of single-sided disks costs \$54.75 (\$2.19 each); double-sided disks are \$69.75 (\$2.79 each). The Beck 25-packs come with hub-rein-

forcing rings, envelopes, color-coded labels, and nonmetallic protect tabs. To order, call (800) 232-5634 or write to Beck Manufacturing, Box 111, Main St., West Peterborough, NH 03468; in New Hampshire, call (603) 924-3821.

Circle 629 on inquiry card.



### Keyboard Replacement Has 90 Preset Functions

A detached extension 87-key keyboard, the Data Spec comes with 90 preprogrammed Apple II/III Plus functions and commands. By depressing the function key and a preprogrammed key, operating commands, programming key words, and operating-system commands are automatically entered into the Apple. Among the operating commands are BOOT, CATALOG, and INIT; programming key words include FOR, NEXT, PRINT. Some of the operating-

system commands are DIR, PIP, TYPE, and STAT. Dat Spec has a 10-key numeric pad, and a full ASCII character set with uppercase and lowercase. Overall dimensions are 7½ by 17¾ by 1½ inches.

The Data Spec Keyboard is supplied with a 10-foot coiled cable and a three-position tilt. The suggested price is \$299.95. It's available from Alliance Research Corp., 18215 Parthenia St., Northridge, CA 91325. (818) 701-5848. Circle 634 on inquiry card.

### QX-10 Support Packages Unveiled

Micronova recently unveiled two software packages for the Epson QX-10 microcomputer: MicroRAM and QXKeys. MicroRAM gives CP/M users access to 167K bytes of unused QX-10 memory by providing RAM disk emulation. QXKeys lets you reconfigure the QX-10 keyboard to your liking.

MicroRAM is \$80. QXKeys is \$25, including source code. Add \$2 postage to each order. You can purchase both packages factory-direct from Micronova, RR 5, Canning, Nova Scotia BOP 1H0, Canada, (902) 582-7016.

Circle 614 on inquiry card.



# What's New?

## Financial Analysis for Professionals

CRT Associates' MIFPADS (Microcomputer Interactive Financial Planning and Development System) is a financial-analysis package for professional users of Radio Shack's TRS-80 Models II, 12, 16, and 16B. It's suitable for such functions as amortization, trade credit decisions, economic order quantity, capital budgeting, time value of money, current portion of long-term debt, and interest rate calculations. MIFPADS can perform the following analyses: risk, statistics, ratios, and bonds. Hard copy can be generated. Previous programming experience is not required.

MIFPADS is available in both single- and multiuser versions. Apple IIe and IBM PC configurations are in the works. The price is \$595. Contact CRT Associates, POB 372, Dollar Bay, MI 49922, (906) 482-1339. Circle 556 on inquiry card.

## PCjr Word Processor Has Full-Screen Editing

Full-screen editing on the IBM PCjr is possible with CMA Micro Computer's Docuwriter jr word processor. Some of its editing commands are block move, deletion, insertion, copy, and search and replace. Docuwriter jr lets you create reports as large as 130 columns. Word-wrap and justification are also available.

Standard PC-DOS spelling checkers can work with Docuwriter jr files. In addition, Docuwriter jr disk-file outputs are compatible with such word processors as Wordstar. All the PCjr's keyboard editing-key operations, including cursor control, are retained. IBM graphics and thermal printers are also supported, although they are not mandatory.

Docuwriter jr requires 128K bytes of RAM and a single disk drive. The retail price is \$79.95. More information can be obtained from CMA Micro Computer, 55722 Santa Fe Trail, Yucca Valley, CA 92284, (619) 365-9718.

Circle 551 on inquiry card.

## Display and Print Scientific Graphs

GraphiC from Scientific Endeavors displays and prints scientific graphs calculated on the Corona or IBM PC. Written in C and assembly language, GraphiC provides 40 graphics routines that can be called upon to plot data or make text slides. Plots are created and stored in a 4096-by-3120-pixel Tektronix format. It has a zoom mode that can replay, shrink, enlarge, or shift a picture. Magnifications from 0.25 to 4.0 are available. Other features include five line types, eight curve markers, two fonts, and linear, logarithmic, and contour plots.

Tektronix-formatted plots from other computers can be replayed by GraphiC under certain conditions, and GraphiC files are compatible with mainframes that support Tektronix terminals. It operates with such dot-matrix printers as Epson FX/RX, C. Itoh Pro-writer, and Okidata 91 and 93.

Presently, GraphiC works with the C-Ware DeSmet C compiler. It requires a minimum of 192K bytes of memory. Although it can function on a single disk drive system, two double-sided, double-density disk drives are preferred. GraphiC costs \$150 and is available directly from Scientific Endeavors, Route 4, Box 79, Kingston, TN 37763.

Circle 571 on inquiry card.

## Apple ROMdisk Card

ROMdisk lets Apple II users store a full floppy disk of program files in EPROM. It can be used in on-line systems and permits Apple II computers to be used as workstations. ROMdisk comes with a menu-builder program that lets you select program files to be loaded and has the ability to automatically boot the menu or a desired program. Up to four ROMdisks can be used in a single Apple. Power is derived from the computer.

ROMdisk works with Apple-DOS 3.3 or the ProDOS operating system. It costs \$499. Further details are available from Curtis Inc., 22 Red Fox Rd., St. Paul, MN 55110, (612) 484-9183.

Circle 604 on inquiry card.

## Statistical Package for Mainframes Ported to PC

SPSS/PC is a menu-format IBM PC version of SPSS-X, a mainframe statistical-analysis and data-management package. SPSS/PC gives you univariate statistics, cross tabulations, correlations, multiple regressions, nonparametric tests, log linear, and contour and scatter plot procedures. You can analyze factors and variance and generate tables and graphs, which can then be reformatted for display or presentation-quality hard copy. SPSS/PC can handle missing values, sort cases, and compute new variables. Up to 150 variables can be drawn upon. Cases are limited only by disk space. Help commands, an integrated report-writing facility, and an on-line tutorial are supplied.

An IBM PC or PC XT with 320K bytes of RAM, a hard-disk drive, 8087 coprocessor, and PC-DOS are necessary.

(Note that SPSS/PC will use approximately 1 megabyte of hard-disk storage.) With documentation and demonstration disk, SPSS/PC costs \$795. A version for DEC Professional Series computers is available. For more information, contact SPSS Inc., Marketing Department, Suite 3000, 444 North Michigan Ave., Chicago, IL 60611, (312) 329-2400.

Circle 552 on inquiry card.

## CP/M Computer Mounts on Floppy Drive

The Little Board, a single-board CP/M computer from Ampro, can be screwed directly onto the mounting holes of a 5¼-inch floppy-disk drive. Outfitted with a 4-MHz Z80A central processor, 64K bytes of RAM, a boot EPROM, floppy-disk controller, terminal and modem ports, and a Centronics-type parallel port, Little Board can support four single- or double-density, single- or double-sided, 48- or 96-tpi disk drives. Through software, one of its serial RS-232C ports can put forth data at 75 to 38,400 bps, while the other administers rates ranging from 75 to 9600 bps.

The Little Board runs under CP/M 2.2. A set of utility programs for formatting and copying data is furnished. A disk-translation utility lets Little Board read, write, and execute programs and data from Kaypro, Morrow Designs, IBM PC, and other computers.

Power requirements are +5 V DC at 750 mA and +12 V DC at 50 mA. Little Board lists for \$349. CP/M BIOS source code is \$49. Contact Ampro, 67 East Evelyn Ave., POB 390427, Mountain View, CA 94039, (415) 962-0230. Circle 594 on inquiry card.

# What's New?

## 68000 Coprocessor Speeds Apple Programs

Saybrook II, a 16-/32-bit 68000 coprocessor board, is said to execute Apple Pascal, FORTRAN, and BASIC programs 10 to 30 times faster than normal. The base system comprises 128K bytes of RAM, UCSD p-System Run-time Unit version IV.13, Applesoft-compatible 68000 BASIC, turtle graphics, a 24-hour time-of-day clock, and five programmable timers. It's available in 8-, 12.5-, and 14-MHz versions for \$895, \$1195, and \$1395, respectively.

An advanced model of Saybrook II is also available. This system has all the features of the base unit plus a screen editor, graphics package, cross-assembler, and either a FORTRAN-77, Pascal, or BASIC compiler. Depending on the clock rate, the Saybrook II advanced model costs \$995, \$1295, or \$1495.

Options include compilers, CP/M-68K, Unix with C, and a 128K-byte RAM card that's expandable to 2 megabytes. The additional compilers cost \$95 each. Inquire about RAM card pricing. Produced and manufactured by Analytical Engines Inc., Suite 305, 3415 Greystone, Austin, TX 78731, (512) 346-8430.

Circle 599 on inquiry card.

## 68008 STD Board

Peopleware Systems has brought out a 68008-based STD bus microprocessor board. The 68008, a 16-/32-bit processor running at 8 MHz, has approximately 60 percent of the throughput of an equivalent 68000 microprocessor. This board has buffered data and control signals for expansion and three 28-pin JEDEC sock-

ets for 32K bytes of memory; one of the sockets is configured for 2764- or 27128-type EPROMs. Off-board memory access is facilitated by a one-of-eight decoder/driver that selects memory cards via a front connector; up to 1 megabyte of memory can be addressed. Two RS-232C ports with RTS and CTS signals are supported; the transmit and receive data rates can be individually set. All address, data, and control signals are TTL-compatible.

Prices begin at \$595. For a complete description, contact Peopleware Systems Inc., 5190 West 76th St., Minneapolis, MN 55435, (612) 831-0827. Circle 590 on inquiry card.

## Terminal Plug-Compatible with VT100

Tandberg Data's Series TDV 2200S editing/display terminal is plug-compatible with DEC VT100, Data General 6053, and other terminals. The basic TDV features an 8.75-MHz 8085/2 processor, a 70-Hz refresh rate, 8K bytes of dedicated RAM, 512 bytes of non-volatile memory, 16 soft switches under user or software control, tilt-and-swivel pedestal, height adjustment, 121-key (maximum) detachable keyboard, and a 15-inch screen. Characters are green-on-green; black-on-white is optional. The set-up menu is written in plain English.

The TDV can be equipped with up to 56K bytes of memory; some versions can store up to eight pages of data. An add-on controller enables the TDV to communicate through packet-switched networks using X.25 protocols. The TDV can transmit by character, page, block, or linefield. An

optional plug-in card produces bit-mapped raster-screen displays with a resolution of 684 by 384 pixels. In addition, this arrangement emulates Tektronix 4010/4014 vector drawing, point plotting, and graphics-input modes. The TDV character generator can handle 1024 characters. Latin, Cyrillic, and Greek alphabets are available, and mathematics and semigraphics symbols can be obtained. Characters can be double height and width.

Other options include a 2K-byte print buffer and communications protocols. The Series TDV 2200S begins at \$1875. For full specifications, contact Tandberg Data Inc., POB 99, Labriola Court, Armonk, NY 10504, (914) 273-6400.

Circle 587 on inquiry card.

## Development System for Adams

Frobco is marketing a software-development system for formatting 32K-byte Adam/Colecovision cartridges. This package contains a 32K-byte interface unit that plugs into the Coleco's expansion slot, an interface board for Apple slot number two, and a EPROM cartridge adapter board that

connects with the Coleco's cartridge slot. Any program in the interface unit can be read, modified, and run through the Adam. Programs in the interface RAM can be stored on an Apple disk.

Frobco's system development software lets you transfer programs from the Apple disk or Coleco cartridge to the interface unit, access the Adam/Colecovision's memory space and I/O channels, set breakpoints in code for initiating or halting graphics motion in real time, and observe and modify a cartridge's contents. A built-in Z80 disassembler lets you review a cartridge's object code.

With the EPROM cartridge adapter, you can create and run a prototype program. It has four 8K-byte 2764-type EPROM sockets. Detailed information on the Adam's operating system, memory map, display processor, and sound generator are supplied.

Minimum hardware requirements consist of an Apple II Plus or IIe, a floppy-disk drive, Microsoft-compatible Z80 card, monitor, and an Adam/Colecovision console. The list price is \$1995. For more information, contact Frobco, Tri-Comp Polytechnical Inc., 603 Mission St., Santa Cruz, CA 95060, (408) 429-1551.

Circle 600 on inquiry card.

## Where Do New Products Items Come From?

The information printed in the new products pages of BYTE is obtained from "new product" or "press release" copy sent by the promoters of new products. If in our judgment the information might be of interest to the personal computing experimenters and homebrewers who read BYTE, we print it in some form. We openly solicit releases and photos from manufacturers and suppliers to this marketplace. The information is printed more or less as a first-in first-out queue, subject to occasional priority modifications. While we would not knowingly print untrue or inaccurate data, or data from unreliable companies, our capacity to evaluate the products and companies appearing in the "What's New?" feature is necessarily limited. We therefore cannot be responsible for product quality or company performance.



**"More Computer for Your Calculating Dollar"**

**Try the New**

# XPC-XT by XOR

**Introductory Offer**

(Offer expires May 31, 1984)

# \$1995<sup>00</sup>

SYS-8100-00

**"Need a 16-bit IBM-PC™ to process your data?"**

The first IBM™ compatible that IS compatible! A complete system including the PC-DOS™ operating system from IBM™. Two thinline double-sided 5 1/4" Disk Drives hold 360K of formatted storage each, the other drive opening is fitted with a close-out plate. Removal of the plate will allow room for a Winchester Hard Disk. The Power Supply is like that of an IBM-PC XT™. Hard Disk ready! How compatible is the XPC-XT? It will run 1-2-3™, Flight Simulator™, dBASE II™, WordStar™, SuperCalc™, VisiCalc™ and hundreds of others. The system will also support MS-DOS™ 1.1 and 2.1, PC-DOS™ 2.2, CP/M-86™ and Unix Operating Systems. Add-on an additional 192K of RAM for a full 256K of on-board Memory for only \$195.00. This computer comes standard with 2 Serial and 1 parallel ports (IBM™ COM1 and COM2). No need to purchase Add-On cards.



## Standard Features:

- PC-DOS™ Operating System Vers. 2.1
- 64K of parity checked RAM, expandable on-board to 256K
- 8088 16-bit CPU
- 5 IBM compatible expansion slots
- 4 DMA and 3 Timer channels
- Up to 32K of EPROM (supplied with full 8K)
- DOS BIOS on EPROM
- Full size capacitance touch keyboard with 10 function keys and calculator type numeric keypad
- 8087 Math Co-Processor ready
- 110-220 VAC, 50-60 Hz
- High resolution, 12" Monitor with Green Screen and 18MHz bandwidth.
- Two Thinline 5 1/4" DS/DD 48 TPI Floppys @ 360K storage each.
- Floppy Disk Controller expansion card, runs up to four SS or DD Floppys
- ALSO supports MS-DOS™ and CP/M-86™ Operating Systems
- Power Supply is Hard Disk ready, no need to add-on additional power
- Full One Year Parts and Labor Warranty on all XDS Manufacturing products!

## BASIC XPC SYSTEM

If that Incredibly LOW Total System price doesn't suit you, try this "Do it Yourself System" and take your pick of the wide range of options listed below.

The Features: • 64K RAM • Expandable to 256K

• 4 DMA channels • 5 Expansion Slots

• Runs MS/DOS™ and CP/M-86™ (not included)

• Multi-function Keyboard and Cable

• Hard Disk Ready Power Supply

• 2 Serial and one Parallel Port

• and MORE! • SYS-8000-00

**Only \$895**



The following are registered Trademarks and their Companies: 1-2-3-Latus Development Company, MS-DOS, PC-DOS, Flight Simulator-MicroSoft, dBase II-Ashion-Tate, WordStar-MicroPro International Corp., SuperCalc-Sorcim, Inc., VisiCalc-VisiCorp, Inc., CP/M-86-Digital Research Inc., IBM, IBM-PC, IBM-PC XT-International Business Machines.

**Call or Write for Nearest Dealer and Full Catalog**

### FLOPPY INTERFACE

This is the standard Floppy Interface Card supplied in all systems not using Tape Back-up. It can access up to four drives in 48 or 96 TPI formats. The same high quality data separator as used in IBM™ counterparts, insures data integrity. BOA-6001-00 ..... \$255.00

### EXPANSION MEMORY

This super reliable, four layer design Memory Card can be expanded from 64K to 576K in 64K increments (at \$75.00 ea.). We've tested them all and can recommend this one with confidence. The price below is with 64K and includes Spooler and RAMDISK software. BOA-8850-00 ..... \$295.00

### CALENDAR CLOCK

This simple but effective Card should be ordered with every system. Battery Back-up (naturally) keeps your Disk Log right up to date. Saves typing in the date everytime you "boot up" the system. BOA-8700-00 ..... \$149.00

### 300/1200 BAUD MODEM

If this is your first computer, you will soon want it to Communicate. Compuserve and The Source are on your screen minutes after you plug-in this Custom Made Unit. Supplied with cable to plug into any wall outlet. Auto-Dial Software "remembers" phone numbers and log-in sequences to ease operation. Software included for each operating system. BOA-8800-00 ..... \$295.00

### SUPER 12 PAK MULTI-FUNCTION

Now we need a full page to describe this fantastic Card! Since we only have a little room, here are the features: IBM™ compatible Joystick Port (2), Real-Time Chronograph (Battery Back-up), Parallel Port, Serial Port, 64K to 384K of Parity Memory, Print Spooler and RAM-DISK software, and supplied with 0K of Memory. BOA-8860-00 ..... \$345.00



**MANUFACTURING**

## HARD DISK ADD-ON

**Complete Packages**

Includes BIOS Software, 5 1/4" Winchester Hard Disk, mounting hardware, Interface P.C.B. for expansion slot, and all the necessary power and data cables (the Power Supply in the XPC-XT is Hard Disk ready).

- |                              |                               |
|------------------------------|-------------------------------|
| 10 Megabyte<br><b>\$995</b>  | 65 Megabyte<br><b>\$2495</b>  |
| 20 Megabyte<br><b>\$1295</b> | 105 Megabyte<br><b>\$3295</b> |
| 40 Megabyte<br><b>\$1795</b> | 140 Megabyte<br><b>\$4195</b> |

Archive Tape Back-up unit shown above is of 20 and 40 megabyte capacity. Memtek unit will soon be available at 10 megabyte capacity at approximately One-Half the cost! Circle 410 on Inquiry card.

### MONOCHROME ADAPTOR

If you are impressed with all the rave reviews that the Hercules Graphics Card gets, you will love ours! Made expressly for the XPC-XT by Hercules themselves, it runs everything the Hercules Card does (1-2-3™, dBase II, etc.). BOA-8500-00 ..... \$395.00

### COLOR ADAPTOR

Color and monochrome combinations, can be run simultaneously. Flight Simulator™ 1-2-3™ all perform without modifications. NO FLICKER! Besides performing perfectly, included are: Light Pen Interface, Print Spooler, and RAM Disk options! BOA-8400-00 ..... \$495.00

### COLOR

MON-1500-00 \$345.00

Three models of Color to choose from, each with higher and higher resolution. Price from \$345.00 to \$788.00. Monochrome Unit is outstandingly clear and easy on the eyes. In Green or Amber screens.

### HARD DISK ONLY INTERFACE

A simple, quick solution to adding a Hard Disk to your XPC. All you need is this card, a Cable, and the Drive. Handles from 5 to 140 megabytes with minimum software configuration. Order with your System now or order later. Compatible with all the operating systems. BOA-8050-00 ..... \$375.00

### H.D./TAPE CONTROLLER

This package consists of a combination Interface Adaptor having SCSI H.O./TAPE Connector as well as the Floppy Controller. Two additional 5" form factor Boards are included and mount over the Tape Drive and Hard Disk. 10, 20, & 40 megabytes of Back-up is added to your Hard Disk. BOA-8875-00 ..... \$750.00

# CHECK SUNTRONICS NEW LOW PRICES

1-800-421-5775  
Call orders and all info Call 213-644-1149

IBM Compatible Products Apple Compatible Products General Products- cont.

S-100 Products



**QUADRAM-2 (2) Ser. Ports w/64K... \$355.00**  
**QUADBOARD (1 est)Par/Ser. w/64K... 365.00**  
**QUAD 512 + w/64K... 305.00**  
**QUAD 512 + w/512K... 665.00**  
**CLOCKCALENDAR BOARD... 165.00**  
**MODEM Signalman Mark 5... 215.00**  
**ADD-ON Hard Disk Drive System**  
 5Mb w/Power Supply & Cabinet... 1795.00  
 Controller for above Hard Drive... 279.00  
**PC 1600-1... Call**  
**COLUMBIA VP (Portable)... Call**  
**EAGLE COMPUTER PC-2... Call**  
**AST SIXPACK CARD 8in-function card**  
 with 64K-384K RAM Memory, Parallel Port,  
 Serial Port, Clock Calendar, Super Drive  
 and Super Spool... only 291.00  
**MSI DUAL VD (2 ea) Ser/Par. & CLK... 175.00**  
**MSI 256K RAM Board**  
 256K RAM Board with 64K... 199.00  
 256K RAM Board with 256K... Call  
**MSI 256K w/Parallel or Serial Port**  
 256K w/Parallel Port and 64K... 269.00  
 256K w/Parallel Port and 256K... Call  
 256K w/Serial Port and 64K... 259.00  
 256K w/Serial Port and 256K... Call  
**VISTA DISKMASTER DMA**  
 Diskmaster interfaces Sub 4", 5W", 8" &  
 V1200 6Mb Hard Disk... 225.00  
**IBM TEAC Disk Drive OSD.**  
 40 Track Slimline... 215.00  
**APPRATE IBM PROM Blister... 129.00**  
**CABLE Parallel for IBM,**  
 Eagle & Columbia... 29.95  
**IBM Prototype Board-SUN-208 double sided**  
 glass with gold plated terminals... 29.50



**AFDC-1 Floppy Disk Drive Controller... \$55.95**  
 Runs DOS 3.3 with any standard Shugart compatible 5 1/4" disk drive. (2 drives each card). Does not need 1/2 track.  
**Apprate PROM Blister... 119.00**  
 "ALB" 80 Column Card... 159.00  
 "ALB" 2-CARD (280 CPU)... 149.00  
**API Apple Parallel Printer Interface card.**  
 Centronics Compatible... \$39.00  
**Apple Compatible Drives (40**  
 Track, 163K)... 195.00  
**SUN-2-80 CARD (Softcard**  
 Compatible)... 65.00  
**SUN-80 COLUMN CARD... 97.00**  
**POWER SUPPLY (5 amp)... 59.95**  
**COOLING FAN... 42.00**

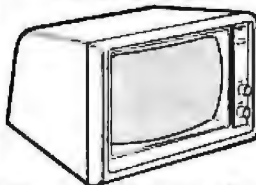
### Software

Formats for Following Software Include:  
 IBM, MS DOS, Apple CPM, 8" CPM 2.2  
**WORD PROCESSOR (Benchmark)... \$289.00**  
**MAILING LIST (Benchmark)... 140.00**  
**SPELLING CHECKER (Benchmark)... 105.00**  
**TELECOM (Benchmark)... 85.00**  
**CDEX IBM Training... 52.00**  
**PEARL Data Manager. See reviews... Easy-To-Use... Powerful... 189.00**

### General Products

**5W" Disksettes 30 up 100 up**  
**SS/DD (100% certified) 1.75 1.55**  
**DS/DD (100% certified) 2.50 2.30**  
**MODEM Novation 103 Smart-Cal... \$219.00**  
**MODEM Signalman Mark 7 (R5232)... 115.00**

### NEW MODEL SAMWOOD DISPLAY HI-RESOLUTION VIDEO MONITORS



**Features:** • Anti glare screen • Attractive case • Std composite video input, also output for second monitor • 22 MHz video bandwidth • High resolution; 1,000 lines or 132 characters across • Adjustable contrast, brightness, V.H.-hold, V.-axis, H.-center • Input impedance; high or 75 ohm • Passes FCC test for computer equipment • UL approved  
**Compatible With:** IBM, IBM PCjr, Apple II, Apple IIe, Commodore, Columbia MPC, Eagle, Radio Shack, Sinclair/Timeex, and more.

Each 3-up  
**DM-216 12" Green... \$135.00 Call**  
**DM-216 12" Orange... \$139.00 Call**

DEALER INQUIRY INVITED

**MX COMPATIBLE BMC PRINTER**  
**BX-80 dot matrix printer... 259.00**

**RAM & ROM IN STOCK... Call**

### Mother Boards & Card Cages

SLOTS	Base Bd	MT	A&T	w/CAGE
8	\$19.00	\$44.00	\$59.00	\$84.00
8	24.00	54.00	61.00	116.00
12	29.00	75.00	110.00	150.00

16MHz. No terminations. Includes power indicator and wiring for main len. Uses OK connector for solderless installation and removal of power & reset lines.



**64KSM A&T without RAM... \$155.00**  
**64KSM A&T w/64K RAM (32-6116's)... 339.00**  
**S-100 Board Uses 6MHz 6116's. 1/2 Amp max. power, Bank Select plus Extended Addressing allows for multi-memory board set-up. 4 independent 16K Blocks make easy use with multi-user systems. Any 2K RAM may be replaced by a 2716 EPROM.**

**SBC-880 Z80A CPU, A&T... \$149.00**  
**SBC-880 Z80A CPU, Kit... 129.00**  
 4MHz Z80A CPU boards with RAM, ROM & Serial/Parallel Ports.

**UFDC-1 Floppy Controller, A&T... 245.00**  
**UFDC-1 Floppy Controller, Kit... 225.00**

The UFDC-1 Floppy Controller uses the WD1795 chip which runs either and/or 8"/5 1/4" Disk Drives.

**CLOCK CALENDAR A&T... 115.00**  
**CLOCK CALENDAR Kit... 95.00**

This S-100 Clock Calendar Board has 4 Interrupts, Time, Day of Week and Battery Backup.

Call for S-100 Quantity Discounts

### Special Sale Items

**SUN-721 S-100 Prototype Board... 9.95**  
**SUN-722 Apple Prototype Board... 5.95**  
 See our January 1984 BYTE Ad for above item descriptions. Quantities are limited.

**SUNTRONICS CO., INC.**  
 12621 Crenshaw Blvd., Hawthorne, CA 90250

STORE HOURS: MON-FRI 9:00am to 6:00pm SATURDAY 10:00am to 5:00pm

Mail Order—Min. Order \$10 Visa or MasterCard (please include expiration date). Add \$2.00 (shipping and handling) for first 3 pounds plus .50 for each additional pound to your order. CA residents add Calif. sales tax.

**COMPUTER CONNECTION**  
 We Carry Much More... Call!

**MINI-W STOP AND LOOK AND SAVE \$ \$ \$**

### DISPLAY MONITORS

**USI**  
 PI 2 (12" Green) \$ 129  
 PI 3 (12" Amber) 135

**GORILLA**  
 HI-Res. 12" Green \$ 85  
 HI-Res. 12" Amber 95

**AMDEK**  
 V300G \$ 135  
 V300A 145  
 V310A for IBMPC 165  
 Color I, 13" Color Composite 269  
 Color II, RGB 409

**BMC**  
 12 UW (12" Green) \$ 69  
 8191 Color Composite 229  
 12 EU 20MHz (Hi-Res.) 125

**NEC**  
 JB 1260, 12" Green \$ 109  
 JB 1201M, 80 col. 155  
 JB 1205M(A) w/audio 165  
 JC 1203 HI-Res Color IBM comp 465

**TAXAN**  
 12N (12" Green) \$ 129  
 12NUY (12" Amber) 139

# YOUR LOW PRICED ANSWER...

### PERSONAL SYSTEMS

**FRANKLIN**  
 Ace 1000 w/color \$ 799  
 Ace 1200 w/drive 1399  
 1200 OMS straight from the factory 1889  
 Ace 1000 Pro Pak. drive w/col. s/w 1169

**KAYPRO**  
 Kaypro II w/software \$ 1445

**APPLE**  
 Apple IIe Starter System \$ 1395

**IBM**  
 IBMPC 64K, 1 Drive \$ 1895  
 IBMPC 64K, 2 Drives 2245

**SANYO**  
 MBC 550 \$ 795  
 MBC 555 1179

### DISK DRIVES

**SIEMENS**  
 FD 100B \$ 154

**TANDON**  
 TM100 2 for IBMPC \$ 219

**TEAC**  
 Double Sided 320K for Sanyo \$ 189

**Drives For Apple & Franklin**  
**MICRO-SCI**  
 A2 \$ 209

**QUENTIN RESEARCH**  
 Apple Mate \$ 109

**RANA SYSTEMS**  
 Elite I \$ 229  
 Elite II 249  
 Elite III 329

### PRINTERS

**C. ITOH**  
 Prowriter 8510 AP, 120 cps \$ 339  
 Prowriter II 1550 AP, 15" 120 cps 545  
 Starwriter F10-40PU, 40 cps 989  
 Printmaster F10-55PU, 55 cps 1345

**EPSON**  
 RX80PT, 120 cps \$ 409  
 FX80, 10" 160 cps 520  
 FX100, 15" 180 cps 725

**OKIDATA**  
 ML82A, 10" carriage \$ 299  
 ML83A, 15" carriage 559  
 ML92P, 180 cps 429  
 ML93P, 180 cps 709

**STAR MICRONICS**  
 Gemini 10X, 10" 120 cps \$ 278  
 Gemini 15X, 15" 120 cps 409  
 Delta 10, 10" 160 cps 469

**JUKI**  
 S100 LQ 15", 18 cps w/propor spec. \$ 469

**TOSHIBA**  
 P1350 (1) Dot Matrix, L.Q., graphics \$ 1695

### IBM/APPLE ACCESS.

**AST RESEARCH**  
 Six Pak Plus \$ 279  
 Mega Plus II 279  
 Combo Plus 269  
 Io Plus II 129

**64K MEMORY UPGRADE**  
 64K, 9 chips \$ 55

**MICROMAX**  
 Viewmax 80E, 128K 80 col. card for Apple IIe \$ 129  
 for Apple II & II+ 139

### PRINTER ACCESSORIES

**ORANGE MICRO**  
 Grappler + \$ 119  
 Buffered Grappler +, 16K exp. 64K 179

**WEBER**  
 Wizard Personal Card & Cable \$ 89

**FOURTH DIMENSION**  
 Par Card & Cable for Apple \$ 49

**TRACTORS**  
 Duidats for 82A & 92 \$ 49  
 Juki Bi-Directional 129  
 Toshiba Bi-Directional 199

**MICROTEK**  
 Dumping GX Graphic Interface \$ 99  
 Dumping GX w/16K 149  
 Dumping GX w/32K 165  
 Additional Buffering, 16K. 16

**CABLES**  
 Any Computer to Parallel Printer \$ 29

**IF YOU SEE IT ADVERTISED FOR LESS, CALL US FIRST FOR LOWEST QUOTE!**

**MAIL ORDER:**  
 12841 S. Hawthorne Blvd., No. 585  
 Hawthorne, California 90250

**ORDER DESK:**  
 [213] 514-8018  
 Mon.-Fri. 9 a.m. to 6 p.m.  
 Saturday 11 a.m. to 3 p.m.

We accept VISA, MasterCard, DDD (longdistance). Certified Checks or Wire Transfers. Store name subject to bank order. CA Res. add 5% Tax. Prices subject to change.



# Corporate & Institutional Buyers Welcome

We accept purchase orders from well qualified corporations & institutions. Place us on your bid list. Call for our Buyer's Guide.

## SERVICE • SELECTION • SATISFACTION • SAVINGS

Those are four very important words. To you as a customer and to us as a business. If you're just shopping price you'll find dozens of outlets to buy from. But if you're shopping value you'll search for a supplier with those four words to offer, not just one! We've been in business longer than 90% of our competition. Wonder why? We practice those four words; we offer a wider more popular collection of hardware and software, we have one of the best satisfaction guarantees, and of course our prices are very competitive. Go ahead . . . shop around. When you want more than just a price, shop with us.

### TOLL-FREE FOR CREDIT CARD ORDERS Only

If you have a major credit card, call our Credit Card Order Department, Toll-Free, 24 hours a day, 7 days a week. During the hours of 7:30 A.M. to 6:00 P.M. PST (Mon-Fri) an operator will take your order; other hours, just give your order to our automatic ordering service. In most cases, we'll process and ship that same day. This Toll-Free number connects to the order desk only. For other business, inquiries, or technical information please call our Customer Service Department, weekdays, 9:00 A.M. to 5:00 P.M. PST: (619) 460-6502.

# 800-854-6654

IN CALIFORNIA, ALASKA & HAWAII

CALL 619-460-6502

Circle 1 on Inquiry card.

### IBM ADD-ONS

- AST Research
  - All AST Boards come with SuperDrive, SuperSpool and one year warranty.
  - SixPak Plus 164K upgradeable to 384K with clock/calendar/serial and parallel ports 265
  - (game port optional)
  - MegaPak II 64K upgradeable to 256K (or more with MegaPak) with clock/calendar and serial port (parallel game or second serial port optional) 285
  - MegaPak 128K (not upgradeable) 225
  - MegaPak 256K 275
  - 1/0 Plus II with clock/calendar and serial port (parallel, game or second serial port optional) 115
  - Parallel Game or second Serial Port for any AST board (specify board) 40ea
  - 64K Memory upgrade increments for any AST board (that is upgradeable) 60ea
  - Connectall connector bracket 15
- Amdahl
  - MAI Board 458
- Mercurius Computer
  - Mercurius Graphics Card (with parallel port) 338
  - Graph X Software 45
- Keytronics
  - Typewriter style keyboard (KB5150) call
  - Deluxe keyboard call
  - Media Touch Tablet w/software (Connects to game port) 95
- Maynard Electronics
  - Floppy Disk Controller 175
  - Floppy Disk Controller (with parallel port) 279
- Paradise Systems
  - MultiDisplay Card (color & mono) 388
  - Persept 229
  - Color Graphics Board 339
  - SB64 64K Multifunction Card 389
  - Plantronics/Frederick COLORPLUS (with Color Magic) Quadram 389

- We are a Full Line Quadram Dealer
- New Expanded Quadboard 64K
  - expandable to 384K with clock/calendar, parallel serial & game port 1/0 bracket and Quadmaster software 250
  - 64K Memory upgrade increments for Quadram boards and buffers 80ea
  - Microtizer Printer Buffer (par 1) w/copy MP 64 (64K) 229
  - upgradeable to 512K 219
  - Quadcolor 1 (add-on to Quadcolor 1) 205
  - QuadLink - Newest Version (allows you IBM-PC to run most Apple II programs) 488
  - QuadLink (various size to 72 meg) call
- STB
  - RTDPlus 64K (upgradeable to 384K) with PC accelerator, clock/calendar, serial and parallel port and Connectall type bracket (game cable optional) 258
  - Graphics Plus (color & monochrome) 349
  - Call for prices on other STB products
- Technic
  - Graphics Master 538

### CALL FOR OUR DISK DRIVE PRICES

- #### SURGE PROTECTORS
- Light wall unit with 6 receptacles 45
  - Line power cord with 6 receptacles 59
  - Push wall unit, line filter & 6 receptacles 68
  - Orange power cord, line filter & 6 receptacles 99

### PRINTERS

Unless otherwise noted all of the printers listed have parallel interfaces

- #### Dot Matrix
- C. Tech
    - 8510P 120 cps 10 erg 368
    - 1550P 120 cps 15 erg 638
  - Epson
    - All Epson printers include GRAFTRAX PLUS
    - 80 80 100 cps 10 erg call
    - 80 FX 100 cps 10 erg call
    - 80 FX 100 160 cps 15 erg call
    - 80 FX 100 160 cps 15 erg call
    - Tractor for FX 80 30
    - Epson to IBM Parallel Cable 30
  - Okidata
    - Microline 82A 120 ps 10 erg call
    - Microline 92 160 cps 10 erg call
    - Microline 83A 120 cps 15 erg call
    - Microline 93 160 cps 15 erg call
    - Microline 64AP 200 cps 18 erg call
  - Quadram
    - Quadrjet 40 cps 8 1/2 erg color 880
  - Siar Micronics
    - Gemini 10X 120 cps 10 erg 398
    - Gemini 15X 120 cps 15 erg 398
    - Delta 10 160 cps 10 erg 448
    - Delta 15 160 cps 15 erg 624
  - Teshiba
    - 1340P 160 cps 10 erg 768
    - 1350P 160 cps 15 erg 1529
  - Transtar
    - 315 50 cps 10 erg color SPECIAL 374
- We also carry Remmane Tally and NEC
- #### Letter Quality
- C. Tech
    - Starwriter 40 cps 15 erg 998
    - Printmaster 55 cps 15 erg 1245
    - Daywriter 2000 40 cps 16 erg 995
  - Dyejet
    - HR-15 13 cps 13 1/2 erg 458
    - HR-25 23 cps 18 erg 725
    - Juki 6100 18 cps 13 1/2 erg 455
  - Silver Reed
    - EXP 500 16 cps 10 erg 438
    - EXP 550 20 cps 17 erg 568
  - Transtar
    - 120P 14 cps 12 erg call
    - 130P 18 cps 17 erg call
- We also carry NEC & Diablo

### MONITORS

24" minimum diagonal monitors for IBM are compatible with IBM PC compatible systems

- Amdahl
    - 300G 12 Green monochrome 148
    - 300A 12 Amber monochrome 159
    - 310A 12 Amber w/green mnm (IBM) 188
    - Color II Plus 12 composite color 299
    - Color II Plus 19" RGB 418
  - Gemini
    - 5600 12 Amber or green mnm (IBM) 148
  - Princeton Graphics
    - HX-12 12 RGB (690 x 240) 468
    - SR-12 12 RGB (690 x 460) call
    - MAX-12 12 Amber mono frame (for IBM) 188
    - Quadram Quadchrome RGB (690 x 240) call
  - USI
    - Pi 3 12" Amber or green mnm (IBM) 155
  - Toscan
    - 12" Amber or green monochrome 145
    - Vision III 12" 11 1/2 lines RGB 448
    - RGB 420 Super hi-resolution RGB 478
- We also carry NEC, BMC and ZENITH

### COMPUTERS

- IBM
  - PC with 256K or XT call
- Columbia
  - 1140 1101 1600 4 10mb w/software call
  - Columbia VP complete portable call
- Compaq or Compaq plus portable call
- Eagle
  - 11" PC & PC + w/10mb call
- Franklin Apple compatible systems call
- NEC
  - AP center & monochrome systems call
  - 486 870 portable minitower 599
- Tava PC compatible system call

### IBM SOFTWARE

- American Training Intl
    - Business software training packages specify the application each only 55
  - Alpha Software
    - Database Manager II 199
    - Apple IBM Conversion 169
  - Ashton Tate
    - Finale II 385
    - Finale III 199
  - BPI General Accounting
    - Conventional 158
    - High Accounting Plus 108
    - FLM (First Last Month) 88
    - High Plus (high register graph) 128
    - The Tax Advantage 48
    - Lotus 1-2-3 338
  - MicroPro International
    - WordStar Professional 448
    - WordStar 328
    - WordStar 329
    - WordStar 329
  - Micromm 8 Base 4000
    - Microsoft 319
    - Multi Tool Word with Mouse 248
    - Multi Tool Word 138
    - Microtool Crosstalk 58
    - Norton Utilities 58
  - Prokey by Rossoft
    - Software Products Intl 388
    - Open Access 388
  - Software Publishing
    - pls Write 98
    - pls File 96
    - pls Report 98
    - pls Graph 98
    - Pls Draft 98
    - Peachtree Peachtree 5000 248
- We have many more software packages available for the IBM PC. Send for our 1984 Buyer's Guide

### APPLE ADD-ONS

- ALS
    - Dispatcher serial RS-232 card 85
    - CP/M Card Plus (2 Card w/ CP/M 3.0) 318
    - 2-Card II 118
  - Garstar Snapshot II copy card 85
  - Microsol
    - Software w/ CP/M 248
    - Software Plus w/ 80 col card w/ 16K 448
    - Premium System w/ 80 col card & 16K 488
  - Orange Micro
    - Graphics Plus 135
    - Bullered Grapple 188
    - Rifter Board for use with Grappier 128
  - Videomem 80 column w/soft switch
    - U-termin 132 column card 228
    - 229
- We also carry many popular software packages for the Apple.

### MODEMS

- Anchor Automation
  - Mark VII 300 baud 116
  - Mark XII 1200 baud 275
- Hayes
  - Smartmodem 300 218
  - Smartmodem 1200 478
  - Smartmodem 1200E (IBM internal model) with 418
  - Smartcom II software 75
  - Smartmodem to IBM came 75
  - Micromodem II 235
- Navation
  - Access 1 2-3 (IBM internal model with Crystal) 385
  - Smartcal 103 300 baud 175
  - Smartcal 103/212 1200 baud 415
  - Appelcal II 248
- Premtech
  - Prismodem 1200 368
- SSM
  - Transmodem 1200 498

### DISKETTES

- Scotch 3M
  - 5 1/4 Sided - 100 Density 5 1/4 Box of 10 20
  - 5 1/4 Sided - 100 Density 5 1/4 Box of 10 31
  - Verbatim DS/DD 5 1/4 Box of 10 35
  - Elekham DS/DD 5 1/4 Box of 10 37
  - SK Certified & tested with Lifetime Warranty
  - Box of 10 DS/DD Super Special only 26

### INFORMATION

#### FREE! BUYER'S GUIDE

Our Buyer's Guide has all of our current products and all of our 100 low to advertise prices and some handy comparison charts. To receive your free copy, please write us with your name, address and type of computer you own or plan to buy, or call (619) 460-6502. NOTE: Operators cannot accept requests for the Buyer's Guide on our toll-free order line. Thank You.

### SATISFACTION GUARANTEE

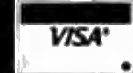
We guarantee every item in this advertisement for 30 days. If, for any reason whatsoever, you are not satisfied with any merchandise purchased from us, we want you to return it to us. We will exchange it for exactly what you want, or will refund your money. Defective software may only be exchanged for replacement due to copyright laws. For a full disclosure of our policies and terms of sales please write or call (619) 460-6502.

TERMS: All prices listed reflect a 5% cash discount for pre-paid (non-credit related) cash orders. For fastest service, send a money order, cashiers or certified check. Personal checks allow 3 weeks to clear. We accept VISA, MasterCard, American Express, Diner's Club and Carte Blanche (add 3%). Purchase orders from well qualified corporations and institutions are accepted; if not pre-paid with PO add 5% to ad prices. Terms are 2% 10 Net 30. Shipping handling & insurance charges add 3% of merchandise total (min. \$5.00). California destinations add 6% sales tax. Foreign customers please call or write. Returns must include all original materials and be in new and resalable condition for full refund. All equipment is new, complete, and warranted by the manufacturer. Prices and availability subject to change without notice. We are not responsible for typographical errors or omissions.

# NATIONAL COMPUTER PRODUCTS

A division of Synectics Corporation

8338 Center Drive • La Mesa, CA 92041-3791 (619) 460-6502



Circle 1 on Inquiry card.

**IBM PC 256K  
2X 320 KB DS/DD DISK DRIVES  
FLOPPY DISK CONTROLLER, COLOR CARD  
ALL FOR \$2599**

**IBM MULTIFUNCTION BOARD**

Quadboard 84K \$289.00  
Expandable to 384K  
Parallel, Serial Port  
Game Port, I/O Bracket

Quadboard II 84K \$289.00  
Memory expansion  
2 Serial ports

Profit Systems \$ CALL  
Run 9 programs  
simultaneously.  
Serial, Port  
Expandable to 512K  
ALSO AVAILABLE  
Excellent prices on  
STB, AST, MAYNARD

**MONITORS**

Amdek 300G \$144.50  
Amdek 300A \$155.00  
Amdek 310A \$ CALL  
Amdek Color II + \$385.00  
PGS HX-12 \$495.00  
PGS MAX 12 Amber \$179.00  
Quadchrome \$549.00

**ALSO AVAILABLE  
w/10 MB INTERNAL HARD DISK**

**\$3,599.00**

**IBM PORTABLE (Available)**

**\$ CALL**

(Call for other configurations)

**SPECIAL**

LOTUS 1-2-3  
\$295.00  
with the purchase  
of any IBM or  
TAVA PC

RBASE  
\$ CALL

**SOFTWARE**

IUS  
MICROPRO  
MICROSOFT  
CONTINENTAL  
PEACHTREE  
PERFECT  
SORCIM  
VISICORP

We carry over 100  
different lines of  
APPLE & IBM Software  
10%-45% below retail.

**\*"99 44/100% SYSTEM COMPATIBLE"**

P.C. World April 84

**TAVA PC**

**SYSTEM I**

128K  
2 DS/DD Disk Drives  
Color Graphic Board  
Printer Port  
2 Serial Ports  
Keyboard  
Amdek Monitor  
DOS 2.1  
\$1,995.00

**SYSTEM II**

256K  
1 DS/DD Disk Drive  
Color Graphic Board  
Printer Port  
2 Serial Ports  
Keyboard  
Amdek Monitor  
DOS 2.1  
10 MB HARD DISK  
\$2,995.00

**CALIFORNIA**

22110 Clarendon Street  
Woodland Hills, CA 91387  
(818) 999-1183

ALL PRICES SUBJECT TO CHANGE WITHOUT NOTICE

**SUPPORT SELECTION SAVINGS  
TO THE MAX...**

**compumax**

**MISSISSIPPI**

175 East Capitol  
Landmark Center  
Jackson, MS 39201  
(601) 355-8204



**Our specialty: 68000, DEC, graphic, database, communication, export**

Come visit us in our New York City Showroom \*IBM COMPATIBLE

**PRINTER**

MICRO- 110 cps, 84x84, graphic...379  
PRISM RS-232/parallel, pin & friction  
EPSON FX-80, FX-100, ... CALL  
BANANA 50 cps, ... 195  
OKIDATA Full Line... CALL  
PRISM 132 200 cps, 132 col... 1,100  
TOSHIBA 160 cps 24-wire... 1,425  
DEC LA50... 699  
GEMINI Delta 10... 625  
DIABLO P11 100 cps, 80 col... 488  
P38 400 cps, 132 col... 1,795  
M.T. Spirit 80 cps... 360  
\*Letter Quality\*  
NEC 2060 20 cps for IBM... 965  
3650 36 cps for IBM... 1,776  
7710 56 cps for serial... 2,160  
DYNAX HR25 23 cps parallel... 799  
DX15 13 cps... 475  
COMREX Comwriter II... 475  
C.I.TOH F-10 40 cps Excellent... 930  
A-10 18 cps... 530  
DIABLO 630 API w/interface... 1,735  
QUME 11+ 40 cps... 1,360  
50 cps... 1,650  
STAR 78 cps... 399  
TRANSTAR 315 graphic... 478

**COMPUTER**

ZENITH Z-150-PC  
IBM Best computer  
Compatible 128K RAM, two floppy  
LEADING 128K RAM, two drives  
EDGE software  
COLUMBIA \* 128K RAM, two floppies,  
monitor keyboard, softwares  
EAGLE \* 128K RAM, two floppies,  
software monitor  
SANYO MBC 550, 555  
TELEVIDEO 1605 256K RAM  
CORONA \* 128K RAM, two drives,  
EPSON 256K RAM, monitor,  
QX-10 keyboard, two floppies  
(Local)  
NEW IBM compatible option  
AST, PERSYST, PLANTRONIC  
TECMAR, QUADRAM, HERCULES  
Cromemco \* C-10 64K RAM, monitor, Z-80  
CPU keyboard, software  
DEC 64K RAM, Z-80 & 8088 CPU,  
RAINBOW monitor, CP/M keyboard  
NEC APC Color APC 128K RAM  
Dual 8" drives  
ALTOS, NORTHSTAR, OSM

**PLOTTER/DIGITIZER**

HOUSTON INSTRUMENT DMP 29... CALL  
DMP 40, ... 795  
DMP 41, DMP 42... CALL  
HIPAD digitizer... 725  
AMDEK XY plotter 1 pen... 665  
6 pens... 1,095  
MT PLOTTER PIXY-3 3 pens... 650  
TERMINAL/MONITOR  
ZENITH Z-29 smart terminal. BEST PRICE  
ZVM 135 \*RGB color/green monitor... 475  
ZVM 123 \*green monitor... 37  
124 22 MHZ, for IBM... CALL  
Amber Monitor: Panasonic, Comrex  
HAZELTINE Esprit II... 540  
Esprit III... 625  
WYSE 50... 645  
VISUAL 55... 726  
VT-100/VT-102 compatible... 895  
QUME 102... 648  
103 132 col... 835

**PORTABLE ON-THE-GO**

Columbia, Corona, Eagle Televideo (8-bk,  
16 bk) NEC PC 8021, ZENITH

Prices subject to change. American Express, Visa/  
Mastercard add 3%. F.O.B. point of shipment. 20%  
restocking fee for returned merchandise. Personal checks  
take 3 weeks to clear. COD on certified check only. N.Y.  
residents add sales tax. Manufacturers' warranty only.  
International customers, please confirm prices before  
order. Accept P.O. from Fortune 500, schools and gov't.

Computer Channel TELEX:  
21-55 44th Road 429418  
Long Island City, NY 11101 CSTNY  
For information CALL (212) 937-6363  
To order CALL 1-800-331-3343

**MODEMS**

HAYES Smartmodem 300/1200 bps 499  
Micromodem II w/software... 270  
NOVATION Smartmodem 300/1200 bps 415  
PC cat 300/1200 bps... 450  
LEXICON 300 bps acoustic coupler... 125  
USR Password 1200/300... 339

**KEYBOARD WITH MODEM**

Zenith ZT-1, ZT-11... CALL

**Computer Channel**



# MAY SPECIALS

"MOST OF OUR BUSINESS IS BY REFERRAL FROM SATISFIED CUSTOMERS. FIND OUT WHY."

CALL THE EXPERT  
(213) 344-6063 (800) 528-9537

## OTHER COMPUTERS

COLUMBIA 1600-1 DESKTOP w/SOFTWARE	\$ 2760
COLUMBIA PORTABLE VP	\$ 2598
COLUMBIA HARD DISK DESKTOP	\$ 3900
CORONA DESKTOP-2 DRIVES	\$ 2475
CORONA PORTABLE-2 DRIVES	\$ 2375

## IBM-PC SYSTEMS

#1 SYSTEM: 2-360K Drives, 64K, GRAPHICS VIDEO CARD	\$ 2400
#2 SYSTEM: 2-360K Drives, 64K, IBM MONOCHROME CRT & CRT	\$ 3875
#3 SYSTEM: 2-360K Drives, 64K, GRAPHICS w/ PRINTER PORT	\$ 2745
If you specify these options at time of order, we will install and test at NO EXTRA CHARGE-	
OPTION A: RAM SETS, 64K BY SET, MAXIMUM OF 8 SETS	\$59 PER SET
OPTION B: 10MB DATA DISK - INTERNAL	\$ 1150
OPTION C: 68000 PROCESSOR w/SOFTWARE PATCHES	\$ 265
OPTION D: 3 THINLINE 360K DRIVES**SWAP**	\$ 120
IBM-XT	LIST \$495 \$ 4300

CALL THE EXPERT  
(213) 344-6063 (800) 528-9537

## PC ACCESSORIES

KEYTRONICS KEYBOARD	\$ 105
QUADLINK IBM TO APPLE CONVERTER	\$ 485
10 MEGABYTE HARD DISK	\$ 1570
64K RAM EXPANSION SET	\$ 61
RANA 2.5MB FLOPPY	CALL
TANDON TM100-2 DSDD DRIVE	\$ 237
AST RESEARCH EXPANSION CARDS:	
I/O PLUS	\$ 120
COMBO PLUS	\$ 257
SIXPAK	\$ 270
MEGA PLUS	\$ 305
MEGA PAK	\$ 375
MA PEACOCK VIDEO w/PARALLEL	\$ 374
PLANATRONICS COLOR PLUS	\$ 440

CALL THE EXPERT  
(213) 344-6063 (800) 528-9537

## SOFTWARE FOR IBM

LETRS 1-2-3	\$ 335
DBASE II	\$ 425
PLANSIMULATOR	\$ 40
MEGAWRITE (WORD PROCESSOR FOR PC/AT)	\$ 90
MEGACALC	\$ 90
MAIL MERGE	\$ 95
FRIDAYS	\$ 260
CATALIST (UNIVERSAL "MAIL MERGE")	\$ 270

CALL THE EXPERT  
(213) 344-6063 (800) 528-9537

## VIDEO MONITORS

****MONTHLY SPECIAL**** JCS-RGB 13"	
FOR PC	\$ 390
PRINCETON GRAPHICS HX-12	\$ 475
BMC RGB	\$ 445
AMDEK AMBER 300A	\$ 160
AMDEK GREEN 300	\$ 140
DYNAX AMBER 20MHz	\$ 140
DYNAX GREEN	\$ 120
MRI220 GREEN 12" (PC MONOCHROME)	\$ 200
MRI220 AMBER 12" - BY ROLAND	\$ 210
NEC JR1200-M GREEN	\$ 192
SAKATA SC-200 RGB w/CABLE	\$ 455

CALL THE EXPERT  
(213) 344-6063 (800) 528-9537

## DISKETTES

VERMAYON VERMEX BSSD	\$
DATALIFE BSSD	\$
DATALIFE DSSD	\$
DATALIFE DSSD	\$
HEAD CLEANER KIT	\$
FLIPIT (USE BOTH SIDES OF DISKS)	\$
DISKETTE HAMPER	\$ 24
LIBRARY CASE - HOLDS 10 DISKS	\$ 2.25

## DAISYWHEEL PRINTERS

DIABLO 620	\$ 950
DIABLO 630-R155	\$ 1850
DIABLO 630-E104 (IBM)	\$ 2150
DYNAX DX-15 (15 CPS)	\$ 465
BROTHER HR-1 (19 CPS)	\$ 630
BROTHER HR-25 (25 CPS)	\$ 795
F-10 STARWRITER (40 CPS)	\$ 1050
F-10 PRINTMASTER (55 CPS)	\$ 1400
NEC 3630	\$ 1689
NEC 3550	\$ 1844
NEC 7710	\$ 1995
QUME 1140	\$ 1390
QUME 1155	\$ 1600

CALL THE EXPERT  
(213) 344-6063 (800) 528-9537

## DOT MATRIX PRINTERS

EPSON FX-80	\$ 550
OKIDATA 92	\$ 440
92-TRACTOR	\$ 46
99-PLUG-N-PLAY	\$ 45
OKIDATA 93	\$ 720
99-PLUG-N-PLAY	\$ 45
OKIDATA 84	\$ 1050
PROWRITER 8510	\$ 360
PROWRITER-II 1550	\$ 650
GEMINI 10X	\$ 279
GEMINI 15X	\$ 415
MANNESMANN-TALLY 160L	\$ 699
IDS PRISM-80 COLOR	\$ 1150
RITEMAN PORTABLE PRINTER	\$ 385
SUPER 5 CP-80 w/CARBON INK	\$ 265

CALL THE EXPERT  
(213) 344-6063 (800) 528-9537

## MODEMS

ANCHOR AUTOMATION "SIGNALMAN"	
MARK II (ATARI)	\$ 89
MARK III (TI)	\$ 40
MARK IV (COMMODORE PET-550)	\$ 120
MARK V (ORIGAMI)	\$ 100
MARK XII (1200 BAUD SMARTMODEM)	\$ 345
THE NETWORKER FOR APPLE w/SOFTWARE	\$ 159
THE NETWORKER - NO SOFTWARE	\$ 110
HAYES SMARTMODEM 300	\$ 215
HAYES SMARTMODEM 1200	\$ 505
HAYES MICROMODEM II-R	\$ 295
NOVATION ACCESS 1-8-3	\$ 445

CALL THE EXPERT  
(213) 344-6063 (800) 528-9537

## APPLE ACCESSORIES

ALS CPM CARD	\$ 285
ALS SMARTER II (80 COLUMN CARD)	\$ 145
INDUS GT DRIVE w/ 3 SOFTWARES	\$ 250
RANA ELITE I	\$ 255
RANA ELITE II	\$ 435
RANA ELITE III	\$ 555
MICROTEK DUMPLING-16K	\$ 160
SHAPPLER +	\$ 125
PROMETHEUS 16K RAM CARD	\$ 60
SUPER 5 THIN DRIVE	\$ 190

## NBI WORD PROCESSOR FOR PC

THIS COMBINATION OF HARDWARE AND SOFTWARE MAKES THE IBM-PC INTO A DEDICATED WORD PROCESSOR. PC MAGAZINE REVIEWED THIS EXTENSIVELY IN THE FEB. 7, 1984 ISSUE.	
NBI PACKAGE	LIST \$695 \$ 546
ADDITIONAL RAM SETS (64K PER SET)	\$ 55

CALL THE EXPERT  
(213) 344-6063 (800) 528-9537



EAGLE PC-2	\$ 2750
PC-2 COLOR	\$ 2500
SPIRIT XL	\$ 3900
COLOR GRAPHICS BOARD	\$ 240
SASI INTERFACE	\$ 110
MONOCHROME ADAPTOR	\$ 240
MONOCHROME MONITOR	\$ 280



FRANKLIN FAMILY PAK	\$ 1045
PRO PLUS	\$ 1287
ACE 1000	\$ 795
ACE PRO	\$ 1137
ACE 1200-1 DRIVE	\$ 1399
ACE 1200 OMS	\$ 1585



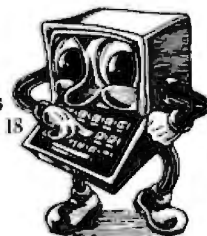
NEC'S ADVANCED PERSONAL COMPUTER NOW HAS BUNDLED SOFTWARE - NO EXTRA CHARGE	
NEC APC-1 DRIVE, GREEN #H01	\$ 2095
NEC APC-2 DRIVES, GREEN #H03	\$ 2550
NEC APC-2 DRIVES, COLOR #H03	\$ 3150
NEC APC-1 DRIVE, COLOR #H04	\$ 2575
EPSON QX-10	\$ 2195
APPLE II-R STARTER SYSTEM	\$ 1375



SANYO MBC550	\$ 795
MBC550 w/ADDED 360K 2ND DRIVE	\$ 1055
MBC555	\$ 1195
SANYO EXPLANATION: THE STANDARD MBC550 HAS ONE SINGLE SIDED DRIVE AND 3 PIECES OF SOFTWARE. THE STANDARD MBC555 HAS TWO SINGLE SIDED DRIVES AND 6 PIECES OF SOFTWARE. THE ENHANCED MBC550 HAS ONE SINGLE SIDED DRIVE, ONE DOUBLE SIDED DRIVE, AND 3 PIECES OF SOFTWARE.	
SANYO: WE BID ON LARGE QUANTITIES AND ACCEPT CORPORATE AND SCHOOL P.O.'S. WE OFFER EXTENSIVE OPTIONS, INCLUDING HARD DISK AND NETWORKS.	



TAVA PC-2 DRIVES, 128K, 2 SERIAL, 1 PARALLEL, GRAPHICS VIDEO, GREEN CRT	\$ 1865
TAVA PC - SAME AS ABOVE EXCEPT IBM-TYPE MONOCHROME VIDEO AND CRT	\$ 1865



EXPERT COMPUTERS  
21804 ROSCOE BLVD., SUITE 18  
CANOGA PARK, CA 91304  
(213) 344-6063  
(800) 528-9537

ADD 2% FOR VISA/MASTERCARD. 20% PREPAID DEPOSIT REQUIRED ON CTD ORDERS. CALIFORNIA RESIDENTS ADD SALES TAX. PRICES MAY CHANGE - CALL TO VERIFY PRICES AND DELIVERY.

"When you know enough to buy mail order, you're wise enough to buy from an expert."

# Super

# Computer



### SUPER XT/SUPER PC

- FEATURES:**
- \*8088 16 Bit Micro Processor W/8087 Co-processor
  - \*256K on board dynamic RAM with parity
  - \*4 CHANNEL DMA
  - \*8 CHANNEL INTERRUPT
  - \*8 I/O SLOT FOR SUPER XT 5(7) I/O SLOT FOR SUPER PC
  - \*Same power connector as IBM PC/XTM

SUPER PC/SUPER XT BARE BOARD W/ MANUAL	\$100.00
LOADED BOARD W/128K RAM W/O ROM	\$526.00
EASY BOARD	\$225.00
MANUAL ONLY	\$ 25.00
8K BIOS	\$ 25.00
LIMITED TIME OFFER COMPLETE SYSTEM: 2-360K DRIVE W/ COLOR BOARD AND DYNAX MONITOR	\$1995.00



### SUPER 2000

- FEATURES:**
- \*128K RAM ON BOARD
  - \*Z-80/6502 DUAL CPU
  - \*RGB OUTPUT
  - \*DETACKABLE KEYBOARD
  - \*CPM/APPLE COMPATIBLE



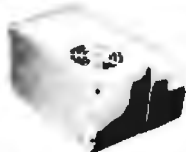
Diskette Box  
\$23.95

1. 64K RAM COMPUTER \$675.00
2. DRIVE SYSTEM I 64K COMPUTER \$945.00
3. DRIVES SYSTEM II 64K COMPUTER \$1150.00
4. DRIVES SYSTEM III 64K COMPUTER W/80 COLUMN & MONITOR 64K COMPUTER \$1375.00

<b>CAN-80</b>	<b>CAN-80 TRAINING KIT</b>	
Z-80 CPU WITH EP	8 BIT Z-80 CPU MICROPROCESSOR BASE WITH EPROM PROGRAMER \$375.00 ADD ON: X-PRINTER CARD \$86.00 8K RAM CARD \$85.00 SOUND CARD \$85.00 MANUAL ONLY \$26.00	\$249.00
EPROM P		\$ 79.00
MANUAL		\$ 25.00
<b>CAN-88</b>	<b>CAN-88 TRAINING KIT</b>	
8088 CPL	16 BIT 8088 CPU MICROPROCESSOR BASE \$480 *25% OFF FOR STUDENT (WITH PROVE!) *40% OFF FOR 10 OR MORE EDUCATIONAL GROUP PURCHASE DISCOUNTS FOR TRAINING KITS ONLY	\$350.00



SUPER XT/ SUPER PC COMPATIBLE TO IBM PC/XT POWER SUPPLY  
COMPUTER CASE  
(METAL) \$150.00



65 W POWER SUPPLY \$170.00  
100W POWER SUPPLY \$200.00  
130W POWER SUPPLY \$220.00



IBM™ COMPATIBLE  
83key Keyboard \$200.00



\*PCjr™  
JOYSTICK \$35.00  
GAME CARTRIDGE  
BARE PCB \$8.00  
GAME CARTRIDGE  
BOX \$8.00

ATTENTION: SOFTWARE HOUSE, CARTRIDGE  
PRODUCTION AND MASK ROM  
SERVICE AVAILABLE



COMPUTER CASE  
(METAL) \$99.00



SUPER 5 35/40T \$195.00  
Teac Drive 35/40T \$225.00



KEYBOARD \$150.00



Monitor Stand \$32.00

### IBM PC/XT, SUPER XT/PC COMPATIBLE ADD ON

#### ADD-ON BOARDS

	BARE BOARD	LOADED BOARD
*DISK PLUS I/O- DISK CONTROLLER W/SERIAL & PARALLEL	\$60.00	\$295.00
*MONOCHROME GRAPHIC BOARD: HI-RES. MONOCHROME W/720x348 GRAPHICS & PRINTER PORT	\$60.00	\$399.00
*SUPER COLOR I COLOR GRAPHICS BOARD	\$75.00	\$240.00
*ASYNC & BLASTER PROGRAM UP TO 128K EPROMS	\$70.00	\$245.00
*PARALLEL PRINTER BOARD	\$40.00	\$100.00
*EXTENSION BOARD	\$25.00	\$ 35.00
*PROTO-TYPE BOARD	\$25.00	

#### OTHERS

*INTERNAL HARD DISK 10MB W/PS	\$1395.00
*EXTERNAL WINCHESTER 10MB W/PS	\$1495.00
*MOUSE SYSTEM W/SOFTWARE	\$ 249.00
*HAYES 1200B MODEM	\$ 429.00
*QUADLINK-RUN APPLE PROGRAM	\$ 449.00
*AST 6 PACK PLUS W/64K	\$ 298.00
*TEAC SLIM DRIVE 360K	\$ 225.00
*PANASONIC 320K SLIM DRIVE	\$ 199.00
*MPI 320K FULL SIZE	\$ 199.00
*AMDEK 310A	\$ 179.00
*PRINCETON PGS RGB	\$ 499.00
*NEC RGB 1216	\$ 499.00
*62 PIN CONNECTOR	\$ 4.00
*QUAD RAM COLOR BOARD	\$ 240.00
*QUAD BOARD W/O	\$ 249.00
*QUAD DENSITY 1/2 HEIGH DRIVE FOR IBM PC	\$ 299.00

### APPLE COMPATIBLE ADD ON

#### ADD-ON BOARDS

128K RAM CARD	\$199.00
16K RAM CARD	\$ 39.00
80 Column Card	\$ 69.00
Auto Term	\$ 99.00
Disk Controller	\$ 45.00
Parallel Graphic Card	\$ 69.00
Message (RS-232)	\$ 85.00
Z-80 Card	\$ 69.00
EPROM Programmer	\$ 79.00
I.C. TESTER	\$150.00

#### OTHERS

Joy Stick	\$ 29.00
RF Modulator	\$ 15.00
Cooling Fan	\$ 39.00
Koala Pad	\$ 89.00
Power Supply (5A)	\$ 69.00
Micromodem lite	\$269.00
<b>DISK DRIVE</b>	
Shugart Drive	\$185.00
Suppr 5 35/40T	\$199.00
Teac Drive 35/40T	\$225.00
<b>MONITOR</b>	
Dynax Amber	\$139.00
Dynax Green	\$129.00

SEND \$2.00

FOR FULL PRODUCTS CATALOG

### SUPER COMPUTER, INC.

1101 S. GRAND AVE. STE J SANTA ANA CA92705

Dealer & OEM Inquiries Invited: (714) 543-2927

Mail Order: (714) 543-2901

Circle 368 on inquiry card.

TERMS: CALIFORNIA RESIDENTS ADD 6% TAX

ADD \$5 FOR PACKING & SHIPPING IN  
NORTH AMERICA COMPUTER, PRINTER,  
AND MONITOR ADD \$5 EXTRA EACH.

### BUILD YOUR OWN COMPUTER SUPER 2000

*Case	\$ 99.00
*Keyboard	\$150.00
*Case/KB	\$240.00
*Case/KB/PS	\$309.00

#### BARE BOARD

*128K RAM Card	\$ 25.00
*Mother Board (DUAL CPU)	\$ 75.00
*Other Interface Cards	\$ 18.00

#### PRINTERS

Gemini 10X	\$279.00
Riteman (120CPS)	\$275.00
EPSON Fx-80	\$525.00
EPSON Fx-100	\$750.00
Juki-6100	\$499.00
Brother DX-15	\$489.00
Brother HR-25	\$749.00

#### MODEM

Hayes 300 (Baud)	\$199.00
Hayes 1200 (Baud)	\$499.00
U.S. Robotics Password (1200)	

#### ACCESSORIES

Monitor Stand	\$ 38.00
Diskette Box	\$ 23.95
50-Pin Connector	\$ 2.50
40/80 Column Switch	\$ 10.00



# MEGA-BOARD™

**NEW!**

**Ideal for**

- **COMPUTERISTS**
- **OEM MANUFACTURERS**
- **DEVELOPMENT LABS**
- **UNIVERSITIES**
- **INDUSTRIAL APPLICATIONS**

**THE ULTIMATE OEM/PC  
COMPATIBLE SINGLE  
BOARD COMPUTER**

**FULL IBM - PC\*  
COMPATIBILITY!**

**DEALERS AND OEM MANUFACTURERS  
QUANTITY DISCOUNTS AVAILABLE**

**Standard Key-  
board Interface**  
(Full PC compatible)

**Hardware Reset**  
(Overcomes reset flaw  
in PC)

**Eight Compatible  
I/O Interface  
Connectors**  
(Full PC compatible)  
(compatible with all  
IBM-PC\* plug-in cards)

**Power Connector**  
(Full IBM\* pinout  
compatible)

**Special J1  
Interface**

(Allows horizontal mounting of compatible expansion cards for easy bus expansion and custom configuring) (Board has 62 pin gold plated compatible connector)

**8088 Processor**  
(Same as PC)

**8087 Numeric  
Processor**  
(Same as PC)

**Peripheral  
Support Circuits**  
(Same as PC)

**Extended ROM  
Capability**

(Runs all compatible PC ROMs) (Jumper programmable to accommodate all popular 8K, 16K, 32K and 64K ROM chips and NEW EE ROMS! VPP power pin available for EP ROM burning!) (External VPP voltage required)

**Configuration  
Switches**  
(Same as PC)

**Speaker/Audio  
Port**  
(Same as PC)

**Board Size**

10.5 inch X 13.5 inch

**Wire Wrap Area**  
To facilitate special custom applications!

**ORDER NOW!!!**

**Full Mega-Byte Ram Capacity!  
On board!**

(With parity)

- 256K Bytes using 64K chips
- 1 Mega Bytes using 256K chips

**ONLY!**  
**\$9995**  
**Evaluation  
Board Kit**

**MEGA-BOARD™ Evaluation Board Kit!**  
(Blank board with full assembly instructions and parts list.)

Includes highest quality PC board with gold plating, silk screen, solder mask

- MEGA-BOARD™** with full assembly instructions . . . . \$99.95
- USERS MANUAL** with theory of operation, schematics, block diagram, application notes . . . . \$19.95
- MEGA-BIOS™** fully compatible MS-DOS/PC-DOS BIOS \$29.95

**ORDER NOW!!!**

**SATISFACTION GUARANTEED!**

10-day money back guarantee if not completely satisfied

**DTC™** DISPLAY TELECOMMUNICATIONS CORPORATION

4100 SPRING VALLEY ROAD  
SUITE 400  
DALLAS, TX 75234  
(214) 991-1644

**TERMS:** Shipment made 2 to 5 weeks from receipt of order. VISA, MC, money order, company check accepted. COD'S require \$25 deposit. Balance UPS COD. Please add \$2.00 shipping and handling per order.

# MEGA-BYTES FOR MICRO-BUDGETS

## expand your system...shrink your cost.

Why pay more for top quality peripherals and accessories when our prices are consistently among the lowest anywhere? We invite you to compare prices, then call us.

MICROSOFT.	SALE PRICE
MULTIPLAN .....	\$176.00
MULTIWORD WITH MOUSE .....	339.63
MULTITOOOL FINANCIAL STATEMENT.....	70.49
MULTITOOOL BUDGET .....	104.96
SOFTCARD SYSTEM CARDS.....	CALL

VIDEX	SALE PRICE
UL-00 ULTRATERM .....	\$270.00
VT-600 VIDEOTERM 60 Hz.....	197.50
VT-601 VIDEOTERM 60 Hz SOFTSWITCH.....	218.71
VT-602 VIDEOTERM 60 Hz SOFTSWITCH INVER .....	225.80
PS-000 PSIO .....	162.10
ENH-FS-001 ENHANCER II, FUNCTION STRIP.....	126.70

DYSAN DISKETTES (Boxes of 10 each)	SALE PRICE
104/1 5 1/4" SINGLE SIDE, SINGLE DENSITY .....	\$37.20
104/1D 5 1/4" SINGLE SIDE, DOUBLE DENSITY .....	32.98
104/2D 5 1/4" DOUBLE SIDE, DOUBLE DENSITY .....	38.99
3740/1 8" SINGLE SIDE, SINGLE DENSITY .....	32.39
3740/1D 8" SINGLE SIDE, DOUBLE DENSITY.....	40.19
3740/2 8" DOUBLE SIDE, SINGLE DENSITY .....	40.19
3740/2D 8" DOUBLE SIDE, DOUBLE DENSITY.....	46.69

MISC. ITEMS	PRICE	MISC. ITEMS	PRICE
92P OKIDATA PRINTER .....	\$485.10	93P OKIDATA PRINTER .....	812.70
NEC JB1260 MONITOR .....	112.50	NEC JB1205 MONITOR .....	177.50
FX 80 EPSON PRINTER .....	535.00	FX 100 EPSON PRINTER .....	609.00
KOALA PAD .....	92.00	PENCEPT INC PENPAD 320 .....	850.00
AMDEK COLOR II MONITOR.....			488.50
HAYES SMARTMODEM 1200B (IBM PC) .....			425.00
HAYES SMARTMODEM 1200 (RS-232) .....			499.00
IBM PC 256K, 2 FLOPPY DRIVES.....			CALL
BAUSCH & LOMB DMP-29 PLOTTER.....			1,885.00

**LEADING EDGE Personal Computer \$2895.00 Complete**  
 • 50% Faster than IBM PC! • 256K • Clock  
 • 2 Floppy Disk Drives • 12" Hi-resolution Monitor  
 • DOS, BASIC and Word Processing Software Included!

GREAT LAKES (PEGASUS) HARD DISK SYSTEMS	SALE PRICE
10 MEGABYTE INTERNAL.....	\$1149.00
10 MEGABYTE EXTERNAL .....	1295.00
23 MEGABYTE EXTERNAL .....	1895.00
40 MEGABYTE EXTERNAL .....	2449.00
65 MEGABYTE EXTERNAL .....	3249.00
140 MEGABYTE EXTERNAL .....	4995.00
TAPE DRIVE 23 MEGABYTE INTERNAL .....	950.00
TAPE DRIVE 23 MEGABYTE STAND ALONE.....	1249.00

ORDERS ONLY 800-858-4810  
 IN CALIF. 900-821-6662



**COMMERCIAL BUSINESS SYSTEMS**  
 2858 S. ROBERTSON BLVD., LOS ANGELES, CA 90034



INFORMATION  
 (213) 559-0596

Phone orders accepted on Visa and Mastercard only. California residents add 6.5% sales tax. No C.O.D. Actual shipping and handling charge added to all orders. Prepaid orders as follows: Money orders or cashier's check—merchandise shipped upon receipt. Personal checks must clear before shipping. 20% restocking fee. Prices and availability subject to change. \$100 minimum order.

## THE LITTLE BOARD®

OEM — INDUSTRIAL — SCIENTIFIC

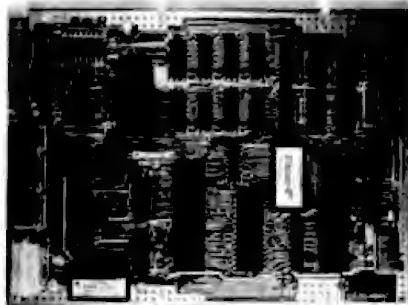
SECOND GENERATION SINGLE BOARD COMPUTER KIT!

4 MHZ Z80\* CPU! 64K RAM! DOUBLE DENSITY!

*New!*

**\$295.00**  
 (COMPLETE KIT)

MINI-SIZE:  
 ONLY  
 5-3/4 x 7-3/4 INCHES



FREE CP/M\* 2.2!!!  
 A \$139 VALUE! A FREE  
 5-1/4 IN. CP/M 2.2  
 DISKETTE IS INCLUDED  
 WITH EACH KIT.

A. & T. UNITS  
 \$349

FULLY SOCKETED! PERFECT MATE TO OUR ZRT-80 TERMINAL BOARD. THROUGH SPECIAL ARRANGEMENT WITH AMPRO COMPUTERS, WE ARE PLEASED TO OFFER THEIR LITTLE BOARD® IN KIT FORM.

FEATURES:

- 4 MHZ Z80 CPU!
- DOUBLE DENSITY (5-1/4 IN.) FLOPPY CONTROLLER
- 64K DYNAMIC RAM!
- CENTRONICS STYLE PARALLEL PRINTER PORT
- USES +5VDC @ .75 A. AND +12VDC @ 50MA
- TWO RS232 SERIAL PORTS
- SAME SIZE AS A MINI FLOPPY
- 2732 BOOT EPROM

**Digital Research Computers**  
 (OF TEXAS)

P.O. BOX 461565 • GARLAND, TEXAS 75046 • (214) 271-3538

TERMS: Shipments will be made approximately 3 to 5 weeks after we receive your order. VISA, MC, cash accepted. We will accept COD's with a \$75 deposit. Balance UPS COD. Add \$4.00 shipping.

USA AND CANADA ONLY



# EXPOTEK

"WE TURN AROUND FOR YOU"

**1-800-528-8960**

CUSTOMER SERVICE (602) 861-1141 • 10439 N. CAVE CREEK RD., #111 • PHOENIX, AZ 85020

All prices are for cash, cashiers check or money order. Allow 3 weeks bank clearance for personal checks. C.O.D.'s, Visa/MC, and P.O.'s accepted at additional charge. Prices subject to change. Returns must have authorization number (call 602-861-1141) and are subject to a restocking charge.

TERMINALS	FOR IBM PC		PRINTERS
<b>Adds</b> A-1 Green ..... \$485 A-2 Green ..... 490 Viewpoint 60 ..... 619 <b>Hazeltine</b> Espirit I ..... 485 Espirit II ..... 540 Espirit III ..... 735 <b>Qume</b> QVT 102 Green ..... 535 QVT 102 Amber ..... 550 QVT 103 Green ..... 840 QVT 103 Amber ..... 850 <b>Televideo</b> 910 + ..... 549 925 ..... 699 950 ..... 899 970 ..... 975 <b>Wyse</b> Wyse 100 ..... 680 Wyse 300 ..... 1020 Expirt III ..... 735 <b>Visual</b> Visual 50 Green ..... 599 Visual 55 Green ..... 720 <b>Zenith</b> Z-29 ..... 635	<b>IBM PC</b> ..... Call Save \$ <b>AST Research</b> Six Pak Plus—from ..... \$279 Combo Plus II—from ..... 279 Mega Plus—from ..... 309 I/O Plus—from ..... 139 <b>Quadram</b> Quadlink ..... 489 Quadboard ..... 289 Quad 512 Plus ..... 249 Quadcolor ..... 229 <b>SOFTWARE</b> <b>Lotus</b> 1-2-3 ..... \$319	<b>Micropro</b> WordStar/MailMerge ..... 349 InfoStar ..... 299 SpellStar ..... 159 CalcStar ..... 99 <b>Microstuf</b> Crosstalk ..... 105 <b>Microsoft</b> Multiplan ..... 159 <b> Ashton Tate</b> dBASE II ..... 389 Friday! ..... 185 <b>Ram Memory</b> 4164-150 ..... 59/9 per set	<b>Comrex</b> ComWriter II Letter Quality ..... \$469 <b>C. Itoh</b> Pro-writer I (8510A) Par ..... 339 Pro-writer (8510A) Serial ..... 439 1550 Parallel ..... 529 1550 BCD SERIAL ..... 589 F-10 40CPS ..... 949 F-10 55CPS ..... 1269 <b>Daisywriter</b> Daisywriter 2000 ..... 999 Daisywriter Cable ..... 40 <b>Datasouth</b> DS120 ..... 595 DS180 ..... 1155 DS220 ..... 1590 <b>Diablo</b> 620 (25CPS/Serial) ..... 875 630 (40CPS/Multi-F) ... 1710 <b>Juki</b> 6100-18 ..... 469 <b>Mannesman-Tally</b> 160L ..... 589 180L ..... 829 <b>NEC</b> 3550 (For IBM PC) ..... 1589 3510 ..... 1365 7710 ..... 1890 <b>Qume</b> 1140 W/IBM Interface , 1359 1155 W/IBM Interface , 1489 <b>Star Micronics</b> Gemini 10X ..... Call Gemini 15X ..... Call Gemini 15 ..... 370 <b>Silver Reed</b> EXP 550P ..... 575 <b>Transtar</b> 120 P ..... 499 315 Color Printer ..... 499 <b>Sheet Feeders &amp; Tractors</b> ..... Call
<b>Computers</b> <b>Altos</b> 580-10 ..... 3550 586-10 ..... 6598 586-14 ..... 7680 8600-12 ..... 8399 <b>Columbia</b> ..... Call <b>Eagle</b> ..... Call <b>Franklin</b> ..... Call <b>Pled Piper</b> ..... Call <b>NEC Portable</b> ..... Call <b>Northstar</b> Advantage ..... 2160 Advantage w/5MB ..... 3345 Advantage w/15MB ..... 4315 <b>Televideo Systems</b> 802H ..... 4210 803 ..... 1815 1603 ..... 2150 806/20 ..... 4775 800 A (user station) ..... 999 Teleport ..... Call <b>Zenith</b> ..... Call	<b>MODEMS</b> <b>Anchor</b> Mark I (RS-232) ..... \$ 79 Mark II (Atari) ..... 79 Mark III (TI-89) ..... 109 Mark IV (CBM/PET) ..... 125 Mark V ( Osborne) ..... 95 Mark VI (IBM-PC) ..... 188 Mark VII (Auto Ans./Auto Dial) ..... 119 Mark XII (1200 Baud) ..... 299 TRS-80 Color Computer ..... 99 9 Volt Power Supply ..... 9 <b>Hayes</b> Smartmodem 300 ..... 219 Smartmodem 1200 ..... 509 Smartmodem 1200B ..... 459 Micromodem II ..... 285 Micromodem II Plus ..... 299 Micromodem IIE ..... 269 Micromodem 100 ..... 299 Smart Com II ..... 89 Chronograph ..... 199 <b>Novation</b> J-Cal ..... 89 SmartCat 103 ..... 179 SmartCat 103/212 ..... 399 AutoCat ..... 219 212 AutoCat ..... 549 Apple Cat II ..... 249 212 Apple Cat ..... 549 Apple Cat 212 Upgrade ..... 309 Cat ..... 138 D-Cat ..... 149 PC-Cat ..... 339 <b>U.S. Robotics</b> 212A Auto Dial ..... 469 Password ..... 375	<b>ACCESSORIES</b> <b>Verbatim</b> 5 1/4" SS DD ..... \$26 5 1/4" DS DD ..... 36 <b>Elephant</b> 5 1/4" SS/SD ..... 18 5 1/4" SS/DD ..... 22 5 1/4" DS/DD ..... 26 <b>Head</b> 5 1/4" Disk Head Cleaner ..... 34 <b>Koala Pad</b> Atari ..... 75 Apple ..... 65 IBM ..... 85 CBM 84 ..... 75 <b>Kraft</b> Joystick ..... 41 Atari Single Fire ..... 12 Atari Switch Hitter ..... 15 Apple Paddles ..... 34 IBM Paddles ..... 34 IBM Joystick ..... 46 <b>TG</b> Atari Trak Ball ..... 47 Apple Joystick ..... 47 Apple Trak Ball ..... 47 <b>DISK DRIVES</b> <b>CDC</b> 5 1/4" 9409-DS/DD ..... 379 <b>Tandon</b> 5 1/4" TM 100-1-SS/DD 160K ..... 150 5 1/4" TM 100-2A DS/DD 320K ..... 225 TM101-4(96 TPI Quad Den) ..... 339 8" TMB48-2(DS/DD) 1.2 MG ..... 400 <b>Partec</b> 5 1/4" FD200-5 (160K SS/DD 40TR) ..... 139 A-40 (40TR) ..... 195 <b>Micro-Sci</b> A-2 (35TR) ..... 225 A-40 (40TR) ..... 269 A-70 (Quad) ..... 320 <b>Rams</b> Elite I ..... 249 Elite II ..... 399 Elite III ..... 509 1000 ..... 319	<b>NEW LINES</b> <b>IDS</b> ..... Save \$ <b>Comerex</b> ..... 359 <b>Riteman</b> Portable ..... 299 <b>SPECIAL PRICES</b> <b>Okidata</b> ..... Save \$ <b>Epson</b> ..... Save \$ <b>Toshiba (1351)</b> ..... Save \$
<b>MONITORS</b> <b>Amdek</b> Video 300 GREEN ..... 129 Video 300 AMBER ..... 145 Color 1 Plus ..... 275 Color II Plus ..... 425 <b>BMC</b> 12" Green ..... 89 12" Color ..... 219 <b>NEC</b> JB 1201 ..... 155 JB 1260 ..... 115 <b>Taxan</b> 12" Amber ..... 125 <b>Zenith</b> 12" Green Screen ..... 95 12" Amber Screen ..... 120	<p align="center"><b>"STRONG ENOUGH TO STAND ON"</b></p>  <p align="center"><b>LOCKING FILE CASE</b>                      Can Stack,                      Hang on Wall, and                      Has Carrying Handle.  <b>SPECIAL \$18<sup>90</sup></b></p>		





## CONNECTORS AND ACCESSORIES

### DOUBLE-ROW MALE HEADERS



• Solder to PC boards for instant plug-in access • .025" square posts on a 10" x .10" matrix

Part No.	Description
923862R	20 post double row male
923863R	26 post double row male
923864R	34 post double row male
923865R	40 post double row male
923866R	50 post double row male

## GENDER CHANGERS



Used to connect 2 cables which have the same gender.

Part No.	Description
JRSM-M	Connects 2 male (DB25P) cables
JRSF-F	Connects 2 female (DB25S) cables

## D-SUB CONNECTORS



### SOLDER-TYPE CONTACTS

Part No.	Description
DE9P	9 Pin Plug
DE9S	9 Pin Socket
DE9H	Hood for DE9 Series Connectors
DA15P	15 Pin Plug
DA15S	15 Pin Socket
DA15H	Hood for DA15 Series Connectors
DB25P	25 Pin Plug (Meets RS232)
DB25S	25 Pin Socket (Meets RS232)
DB25H	Hood for DB25 Series Connectors
DC37P	37 Pin Plug
DC37S	37 Pin Socket
DC37H	Hood for DC37 Series Connectors
DD50P	50 Pin Plug
DD50S	50 Pin Socket
DD50H	Hood for DD50 Series Connectors

## MICRO CHARTS



Instant Data on the Most Popular Computer and Microprocessor Parts

- Fully decoded data
- Compact 8½" x 11" size
- Durable credit card plastic
- Clear and concise two-sided tables for: Full instruction set, disassembly, ASCII, base conversion, pinout & much more...

Part No.	Description
MLZ80	Z80 CPU
ML6502	6502 (65XX)
ML7400	5400/7400 TTL Pinouts
ML8080A	8080A/8085A

## JE750 4-Digit Fluorescent Alarm Clock Kit



The JE750 Alarm Clock Kit is a versatile 12-hour digital clock with 24-hour alarm. The clock has a bright 0.5" high blue-green fluorescent display. The display will automatically dim with changing light conditions. The 24-hour alarm allows the user to disable the alarm and immediately reenable the alarm to activate 24 hours later. The kit includes all documentation, case and wall transformer. Other features: flashing colon, alarm tone 500Hz once per sec., 10 minute snooze alarm, am/pm indicator. Size: 8¼"L x 3¼"H x 1¼"D.

### Part No. JE750 Kit

## Insulation Displacement Connectors

### Dip Plug Connectors



Part No.	Description
609-14	14 Contact Dip Plug Connector
609-16	16 Contact Dip Plug Connector
609-24	24 Contact Dip Plug Connector
609-40	40 Contact Dip Plug Connector

### Socket Connectors



Mates 2 rows of .025" sq. dia. posts on patterns of .100" centers.

Part No.	Description
S20	20 Contact Socket Connector
S26	26 Contact Socket Connector
S34	34 Contact Socket Connector
S40	40 Contact Socket Connector
S50	50 Contact Socket Connector

### Card-Edge Connectors



Mates with double-sided 1/16" PC board with contact fingers on .100" centers.

Part No.	Description
C20	20 Contact Card-Edge Connector
C26	26 Contact Card-Edge Connector
C34	34 Contact Card-Edge Connector
C40	40 Contact Card-Edge Connector
C50	50 Contact Card-Edge Connector

## D-Sub Connectors



Part No.	Description	FLAT CABLE CONTACTS
CDE9P	9 Contact Plug	
CDE9S	9 Contact Socket	
CDA15P	15 Contact Plug	
CDA15S	15 Contact Socket	
CDB25P	25 Contact Plug	
CDB25S	25 Contact Socket	
CDC37P	37 Contact Plug	
CDC37S	37 Contact Socket	

## DATA BOOKS

Part No.	Description
210830	Intel Memory
210844	Intel Microprocessor
30001	National CMOS
30003	National Linear
30005	National TTL Logic
30009	Intersil Data
30013	Zilog Microprocessor



## SPEAKER

1-3/16" Square • 5/32" Thick  
8 Ohm • .40 Watt

- Stainless steel diaphragm • Ultra Slim
- For alarms, music sounds, telephone equipment, computers, speech aids, etc.

### Part No. TS30S



## JOYSTICKS

Part No.	Description
JS100K	100K Linear Taper Pots (with knob)
JS150K	150K Linear Taper Pots (with knob)
JVC-40	40K Video Controller in case (w/knob)



## Jim-pak

- DIODES
- CRYSTALS
- TRANSISTORS
- SOCKETS
- KITS
- SWITCHES
- RESISTORS
- LEDS
- HEAT SINKS
- KEYBOARDS
- WIRE
- SPEAKERS
- TOOLS
- CORDS
- SOLDER
- IC'S
- BOOKS
- CAPACITORS
- and more...

## CENTRONICS

⇐ Solder Type  
Insulation Displacement Type ⇐

Part No.	Description
CEN36M	36 Contact Male-Insulation Displace.
CEN36F	36 Contact Female-Insulation Displace.
57-30360	36 Contact Male - Solder
57-60360	36 Contact Female - Solder

## INSULATION DISPLACEMENT CABLE ASSEMBLIES

Part No.	Description
S20-36	20-pin 36" Single-End Socket
S26-36	26-pin 36" Single-End Socket
S34-36	34-pin 36" Single-End Socket
S40-36	40-pin 36" Single-End Socket
S50-36	50-pin 36" Single-End Socket
S20-6-S	20-pin 6" Double-Ended Socket
S20-18-S	20-pin 18" Double-Ended Socket
S26-18-S	26-pin 18" Double-Ended Socket
S50-18-S	50-pin 18" Double-Ended Socket
DB25P-10-P	25-pin male 10' Double-Ended Plug
DB25P-10-S	25-pin male 10' 25-pin female
CEN36M-5	36-pin Centronics 5' male
CEN36M-5-F	36-pin Centronics 5' male to female
CEN36M-5-M	36-pin Centronics 5' male to male

**—MODEMS—**

- \*Signalman MARK XII \$249.95  
1200/300 Baud Auto Dial/Ans  
Hayes™ Compatible
- \*VOSKMODEM 300 Baud \$59.95  
Limited Offer/FREE Source Memb.
- \*The Computer Phone Book \$9.95
- \*The Complete Handbook of  
Personal Computer Comm. \$12.95

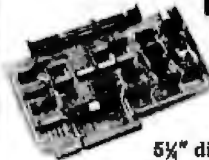
**—COMPUTER—**

**Sanyo MBC-550 \$845**  
Order: (800) 235-6646 OP 555  
Calif. (800) 235-6617 OP 555

VISA/MC ACOM Electronics  
Add 3% Dept. 120  
Shipping 4151 Middlefield Rd.  
Add 2% Palo Alto, CA 94303

Circle 14 on inquiry card.

**ZENITH/ Heath Users**



Double Your  
5 1/4" disk storage  
capacity without adding a drive.

Get twice as much from your H88 or H89 microcomputer. Our FDC-880H floppy disk controller. In conjunction with your 5 1/4" drives, for example, expands memory capacity from 256 bytes to 512 bytes per sector.

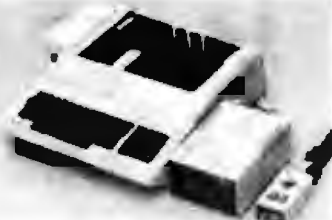
And it handles single and double-sided, single and double-density, 8" and 6 1/4" drives — simultaneously.



C.D.R. Systems Inc.

Controlled Data Recording Systems Inc.  
7210 Clairmont Mesa Blvd., San Diego, CA 92111  
(619) 560-1272

Circle 71 on inquiry card.



**APPLE COMPATIBLE**

- Disk Drive ..... \$150.00 ea.
- Controller Card ..... \$35.00 ea.
- Computer Case ..... \$55.00 ea.
- Keyboard ..... \$70.00 ea.
- (Numeric and Function Keys)
- Switching Power Supply . . \$49.50 ea.
- Joystick (Heavy Duty) . . . \$17.50 ea.
- Slim Fan ..... \$25.00 ea.

Prices for dealers in quantities of 25 or more.  
End Users Inquiries welcomed.

**ELECTRADE CO. (408) 946-2541**  
780 Trimble Rd. Suite 605  
San Jose, CA 95131

Circle 156 on inquiry card.

**12 Bit A/D Converter FOR YOUR APPLE™**



**AD1GB 16 CHANNEL \$299.95**

- I/O OR NMI INTERRUPT
- EXTERNAL START CONVERT
- HIGH SPEED - 25,000 CONV./SEC
- 7 VOLTAGE RANGES
- PRECISION SAMPLE & HOLD

**Bolt On Signal Conditioning FITS INSIDE APPLE™**

**A16G \$79.95**

- 16 OP AMPS- EACH WITH SEPARATE GAIN & FILTERING

**ASD from \$149.95**

- TRUE DIFFERENTIAL INPUTS
- 2 to 8 CHANNELS
- SEPARATE GAIN EACH CHANNEL

**Hollywood Hardware (818) 989-1204**  
6892 Wiljeun Ave  
Van Nuys, CA 91406

\*APPLE is a registered trademark of APPLE Computers, Inc.

Circle 201 on inquiry card.

**COMPUTER PRODUCTS-GUARANTEED SAVE UP TO 50%**

<b>*COMPUTERS</b>	
Zenith Z100 (2 Drives 640K)	\$2799.00
Columbia, Eagle, North Star, Sanyo and more	Call
<b>*PRINTERS</b>	
Brother HR-15 (Letter Quality)	\$485.00
Brother HR-25 (Letter Quality)	\$785.00
<b>*MONITOR</b>	
Toscan Green	\$125.00
Toscan Amber	\$125.00
Zenith ZVM122A-Non-Glare Screen, Amber	\$115.00
Zenith ZVM123A-Non-Glare Screen, Green	\$115.00
Zenith ZVM135 RGB Hi Res. Color	\$499.00
<b>*ACCESSORIES</b>	
Printer Stand 5 1/2 x 21 1/4 x 13 \$30.00, 5 1/4 x 15 x 13	\$25.00
Roll-Top Diskette File (holds 100)	\$34.85
Multi-Color Quality Diskettes, SSDD \$22.00, DSDD	\$28.00
3M, Verbatim and more (5 1/4" & 8")	Call
<b>*SOFTWARE</b>	
Peachtree5000 (M/P, Spool, Proofread, List Mng., Spread)	\$240.00
Peachpak (GL, AR, AP)	\$235.00
Peachtree Accounting-GL, AR, AP, Inventory Control, Payroll, Job Costing	\$399.00/ea.
<b>*TRAINING COURSE AND HANDBOOK</b>	
Louis 1-2-3, dBASE II, Wordstar, Accounting and others	\$65.00/ea.
Everyman's Database Primer (Book)	\$14.99
and many more	
MANY OTHERS, AT LOWEST PRICE, PHONE OR WRITE	
Mail or Phone Your Order	
<b>LF COMPUTER PRODUCTS</b>	
6880-D Miramar Rd. Suite 265, San Diego, CA 92126	
(619) 666-8823 — Phone order full rebate	
MasterCard/VISA add 3% Shipping & Handling \$1.95 Call Rev add	
8% Sales Tax. All Products Manufacturer Guaranteed.	

Circle 227 on inquiry card.

**PROGRAMMABLE COMMUNICATIONS TRANSLATOR**

THE PCT-100 IS A CONFIGURABLE IN-LINE RS-232 PROTOCOL AND DATA TRANSLATOR. THE PCT-100 CAN PROVIDE:

- TERMINAL OR PRINTER EMULATION
- DEC OR IBM SYSTEM COMPATIBILITY
- MACRO-FUNCTION KEYS
- "TYPE-AHEAD" AND DATA BUFFERING
- BAUD RATE CONVERSION
- HANDSHAKE PROTOCOL TRANSLATION (E.G. CTS/RTS, XON/XOFF)

THE PCT-100 IS CONFIGURED USING A BUILT-IN COMMUNICATIONS TRANSLATION LANGUAGE. PROGRAMS CAN BE EASILY ENTERED & EDITED FROM ANY ASCII DEVICE.

- PCT-100-PCB (PCB ONLY) . . . \$ 289
- PCT-100-ASM (PCB W/ CASE) . . . \$ 339
- PCT-512-MOD (POWER SUPPLY) . . \$ 59



MSI



**METHOD SYSTEMS INCORPORATED**  
19751 SOUTH LAKESHORE BOULEVARD  
EUKLID, OHIO 44119  
(216) 551-8484

Circle 258 on inquiry card.



**Scotch DISKETTES**

Call Toll-Free  
1-800-328-3472 for prices and information. Dealer inquiries invited. C.O.D. and charge cards accepted. All orders shipped from stock, within 24 hours. Call toll FREE

**NEW LOWER PRICES**



**North Hills Corporation**  
3564 Rolling View Dr.  
White Bear Lake, MN 55110  
1-800-328-3472  
MN Call Collect 1-812-770-0488

**BASIC™—Extended BASIC for Apple Users**

A powerful extension of Apple's BASIC for engineers, scientists and students. Some of the BASIC™ features are:

- **BUILT-IN COMPLEX ARITHMETIC**  
Replicates Apple's integer variables with complex variables for built-in complex arithmetic capabilities.
- **BUILT-IN COMPLEX FUNCTIONS**  
Useful functions for complex arithmetic like CSQR, CEPR, CABS and CLOG are available. Several complex/real and real/complex functions are standard.
- **POWERFUL EXTENDED NAMES COMMANDS**  
Are oriented by graphic capabilities for page manipulation, image magnification, inter-screen and intra-screen image translation, and screen/memory data movement. Commands for screen patching and displays, and clearing screens to different background colors.
- **PROGRAMMABLE CHARACTER SETS**  
Instead of the standard text screen, lines graphics can be used for upper/lower cases and for mixed graphic modes. Programmable character sets for foreign language alphabets, variable fonts and animation applications.
- **VARIABLE PITCH SCREEN PRINTING**  
Variable pitch printing capabilities permit printing 40 to 70 characters per line.

Several application programs (like FFT, EQUATION SOLVER) are contained in the BASIC™ diskette to illustrate the powerful features of the language.

Requires APPLE II/II Plus with a 16K memory card or APPLE II/E and one disk drive.

Price \$50 + \$7 shipping and handling + 6% tax for California residents. We accept checks, Visa or MasterCard.

Contact **S.S. Reddi, Softesmythe Software,**  
PO Box 17043  
Irvine, CA 92713  
Phone: 714-540-1644 or 714-660-0167

Circle 350 on inquiry card.

**CLASSIC MEMORY CORP**  
Flexible Diskettes

Life Time Warranty - 100% Certified  
33% Stronger Jacket . . . . . Longer Life  
High Density Oxide . . . . . Better Performance  
FREE CASE . . . . . Protective Storage  
Low Cost . . . . . More Diskettes For Your Money

<b>5 1/4" \$160 each</b> SINGLE SIDE 100 CASE 100% WRITABLE 100% READABLE Packed 10 per Soft Pack	<b>BULK SSSD \$140 each</b> 100 CASE Write Erase W/ FILE MARK
<b>5 1/4" \$189 each</b> SINGLE SIDE 100 CASE 100% WRITABLE 100% READABLE Packed 10 per Soft Pack	<b>BULK SSSD \$170 each</b> 100 CASE Write Erase W/ FILE MARK
<b>5 1/4" \$247 each</b> DOUBLE SIDE 100 CASE 100% WRITABLE 100% READABLE Packed 10 per Soft Pack	<b>BULK DSSD \$225 each</b> 100 CASE Write Erase W/ FILE MARK

**DELIVERED PRICES**  
Free shipping in continental USA. Call for quantity discounts. We accept money orders, certified checks, VISA and MasterCard. Personal checks accepted, but take two weeks to clear bank. N.D. add 4%.



**Software Servulces™**  
1328 - 25th St. S., Suite H  
Fargo, ND 58103  
1-800-634-2248

Circle 356 on inquiry card.



**74LS00**

74LS00	60	74LS166	2.50
74LS01	60	74LS168	1.35
74LS02	60	74LS169	1.35
74LS03	50	74LS170	2.50
74LS04	75	74LS173	1.50
74LS05	75	74LS174	1.50
74LS08	75	74LS175	1.50
74LS09	75	74LS181	2.50
74LS10	65	74LS190	1.45
74LS11	75	74LS191	1.45
74LS12	75	74LS192	1.35
74LS13	95	74LS193	1.35
74LS14	1.25	74LS194	1.45
74LS15	75	74LS195	1.35
74LS20	60	74LS196	1.35
74LS21	75	74LS197	1.35
74LS22	75	74LS221	1.35
74LS26	75	74LS240	1.85
74LS27	75	74LS242	1.85
74LS28	75	74LS243	1.85
74LS40	75	74LS244	2.85
74LS42	95	74LS245	3.85
74LS48	95	74LS247	1.85
74LS51	60	74LS248	1.85
74LS54	60	74LS249	1.85
74LS55	60	74LS251	1.75
74LS73	95	74LS253	1.75
74LS74	1.42	74LS256	1.50
74LS75	95	74LS259	2.95
74LS76	95	74LS260	1.15
74LS78	95	74LS261	3.75
74LS83A	1.15	74LS268	1.35
74LS85	1.25	74LS273	1.75
74LS86	75	74LS275	4.95
74LS90	95	74LS279	95
74LS92	95	74LS283	1.25
74LS90	95	74LS290	1.25
74LS95	95	74LS293	1.25
74LS96	1.25	74LS295	1.65
74LS107	75	74LS298	1.85
74LS109	75	74LS323	4.95
74LS113	95	74LS324	2.15
74LS114	.65	74LS347	2.55
74LS122	1.02	74LS348	2.55
74LS123	1.35	74LS352	1.65
74LS124	1.35	74LS353	1.95
74LS125	95	74LS363	1.95
74LS126	95	74LS385	1.25
74LS122	1.35	74LS386	1.25
74LS133	95	74LS367	95
74LS136	95	74LS368	95
74LS138	1.10	74LS373	2.50
74LS139	1.10	74LS374	4.95
74LS145	1.75	74LS375	1.25
74LS148	1.75	74LS377	1.95
74LS151	1.25	74LS378	2.55
74LS153	1.25	74LS385	1.95
74LS154	1.70	74LS378	2.55
74LS155	1.25	74LS386	1.25
74LS156	1.35	74LS381	3.95
74LS157	1.25	74LS390	2.55
74LS158	1.25	74LS393	2.55
74LS160	1.25	74LS395	2.55
74LS161	1.25	74LS424	3.95
74LS162	1.25	74LS640	3.95
74LS163	1.25	74LS668	2.75
74LS164	1.55	74LS645	4.95
74LS165	1.25	74LS670	2.50

**74S00**

74S00	75
74S02	75
74S03	75
74S04	75
74S05	75
74S08	95
74S09	95
74S11	95
74S12	95
74S13	95
74S14	95
74S15	95
74S20	1.95
74S21	95
74S22	95
74S26	95
74S27	95
74S28	1.50
74S40	1.25
74S42	1.25
74S48	1.25
74S51	1.25
74S54	1.25
74S55	1.25
74S73	1.25
74S74	1.25
74S75	1.25
74S76	1.25
74S78	1.25
74S83A	1.25
74S85	1.25
74S86	1.25
74S90	1.25
74S92	1.25
74S90	1.25
74S95	1.25
74S96	1.25
74S107	1.25
74S109	1.25
74S113	1.25
74S114	1.25
74S122	1.25
74S123	1.25
74S124	1.25
74S125	1.25
74S126	1.25
74S122	1.25
74S133	1.25
74S136	1.25
74S138	1.25
74S139	1.25
74S145	1.25
74S148	1.25
74S151	1.25
74S153	1.25
74S154	1.25
74S155	1.25
74S156	1.25
74S157	1.25
74S158	1.25
74S160	1.25
74S161	1.25
74S162	1.25
74S163	1.25
74S164	1.25
74S165	1.25

**GENERAL PURPOSE BOARDS**  
**BLANK BOARD — HOLES ON 100" GRID, No ETCHED CIRCUIT**  
**EXCEPT CONTACT FINGER**

	No Contacts	Size	Contact Centers	Price
P 441-1	22/44	4.5" x 8"	156"	9.95
P 442-1	22/44	4.5" x 5"	156"	10.95
P 721-1	36/72	4.5" x 8"	100"	9.95
P 722-1	36/72	4.5" x 5"	100"	10.95

**D— SUBMINIATURE CONNECTORS**

Description	Solder Cup		Right Angle PC Mounting		Hood	
	Pin	Socket	Pin	Socket	Grey	Black
Part No	DXKP	DXXS	RDXXP	RDXXS	DXXCGY	DXXC
Contacts	9	2 06	2 65	3 90	3 20	1 55
	15	2 05	3 60	3 70	5 40	1 55
	25	2 50	3 25	4 50	4 80	1 55
	37	4 75	7 10	3 40	10 95	2 95
	50	6 00	9 25	—	3 50	—

**MODEMS**

SIGNALMAN	MARK I	RS 232C, 300 BAUD, DIR CONN	89 00
	MARK VI	IBM COMPATIBLE 300 BAUD, DIR CONN., AUTO ANS/DIAL	199 00
	MARK VII	RS 232C 300 BAUD DIR CONN., AUTO ANS/DIAL	139 00
	MARK XII	RS 232C, 300/1200 BAUD, DIR CONN., AUTO ANS/DIAL	359 00
	ADAPTER	115VAC to 9V DC	9 00
HAYES	IBM PC SMARTMODEM 1200B Plug-in		449 00
	SMARTCOM II COMMUNICATIONS SOFTWARE		99 00
	SMARTMODEM 300 AUTO ANS/DIAL 300 BAUD RS232		109 00
	SMARTMODEM 1200 AUTO ANS/DIAL 1200 BAUD RS232		475 00
	SMARTMODEM II 300 BAUD AUTO ANS/DIAL Plug-in		279 00
	SMARTCOM I COMMUNICATIONS SOFTWARE		79 00

**BARE BOARDS**

P 25 x 45	2.5" x 4.5"	2 50
P 45 x 65	4.5 x 6.5	4 95
P 45 x 85	4.5 x 8.5	6 50
P 45 x 170	4.5" x 17.0"	11 95
P 85 x 170	8.5 x 17.0"	19 95

**EDGE CARD CONNECTORS**

44 PIN WW	4 95
44 PIN ST	2 95
72 PIN WW	5 95
72 PIN ST	6 95

**D- SUBMINIATURE CONNECTOR JUMPERS**

25DP36	36"	Single Male	12 00
25DS36	36"	Single Female	12 00
25DP36DP	36"	Male to Male	18 95
25DP60DP	60"	Male to Male	19 95
25DS36DS	36"	Female to Female	18 95
25DS60DS	60"	Female to Female	19 95
25DP36DS	36"	Male to Female	18 95
25DP60DS	60"	Male to Female	19 95

**FLOPPY DISK DRIVES**

FOR IBM PC					
Shugart	SA455L	5 1/4"	320 KB	High	209 00
Passanics			320KB		209 00
Toshiba			320KB		209 00
Tandon	TM100-2A		320KB		209 00
FOR APPLE II AND IIe					
Handwell	HD-40	5 1/4"		Full High	175 00
Handwell	HSD-80	5 1/4"		High	185 00
MONITORS					
Toscan	12 in	green			130 00
Toscan	12 in	amber			135 00
Toscan		color monitor	Vision 420		550 00
Toscan		color monitor	Vision III		500 00

**FOR APPLE II & IIe**

**16K RAM CARD**  
 Compatible with DOS 3.3 CP/M  
 Visicalc, PASCAL  
 1 YR WARRANTY  
**\$39.<sup>95</sup>**

**FOR IBM P/C**

**MULTIFUNCTION BOARD WITH**  
 128K 2 Serial Port  
 1 Parallel Port  
 Real Time Clock  
**\$399.<sup>00</sup>**

**Apple II/IIe Compatible Disk Drive**  
**\$175.<sup>00</sup>**

**CONTROLLER CARD**

**\$49.<sup>95</sup>**

**Speedy EPROM Programmer for Apple II**

**\$149.<sup>00</sup>**

Programming 2716, 2732, 2732A, 2764, 27128, 2516, 2532, 2564

in 30 seconds, software control programming, no additional hardware required

U/V EPROM ERASER  
 General Industries  
**\$37.50**

**SUPER COOLING FANS FOR APPLE WITH SURG**  
**\$39.<sup>50</sup>**

**Color Graphic Display Card**  
**\$270.<sup>00</sup>**

**64K MEMORY EXPANSION KIT for IBM/PC**  
**\$52.<sup>95</sup>**

**Joy Stick for IBM P/C**  
**\$35.<sup>00</sup>**

**8087 MATHEMATICS CO-PROCESSOR**  
**\$199.<sup>00</sup>**

VISA MasterCard

**7400 SERIES CALL FOR PRICE**

**MOS EPROM**

2708	5 95
2716-450	3 95
2732-450	5 95
2732-250	6 95
2764-450	7 95
2764-250	8 95
2764-300	9 95
27128-250	25 95
TMS2516	4 95
TMS2716	7 95
TMS2532	3 95

**STATIC RAM**

2101	2 95
5101	4 95
2114-450	1 95
2114-200	2 15
2147	4 95
6116-4	5 75
6116-3	6 75
6116-2	7 95
6116LP-4	6 75
6116LP-3	6 95
6116LP-2	6 95

**SOUND CHIPS**

76477	2 95
78489	8 95
AY3-8910	9 95
AY3-8912	12 95

**CRYSTALS**

32 758khz	1 75
1 0mhz	3 95
1 8432	3 95
2 0	2 95
2 097152	2 95
2 4578	2 95
3 2768	2 95
3 579535	2 95
4 0	2 95
5 0	2 95
5 0688	2 95
5 185	2 95
5 7143	2 95
6 0	2 95
8 144	2 95
8.5536	2 95
8 0	2 95
10 0	2 95
10 738835	2 95
12 00	2 95
14 31618	2 95
15 0	2 95
16 0	2 95
17 430	2 95
18 0	2 95
18 432	2 95
20 0	2 95
22 1184	2 95
32 0	2 95

**DYN. RAM**

4116-200	1 95
4116-160	2 25
4116-120	2 95
4164-200	6 75
4164-150	6 95

**MISC**

6502	4 95
88000	49 95
8748	24 95
8255-5	5 95
825123	2 65
825128	2 89
825131	3 99
93422	8 95
93L422	9 95
93425	3 95
93427	8 95
D2125AL-2	3 95
D2104	1 95
AY5-3600	12 95
6810	3 95
8304	3 95

**Handwell Corp**

**CENTRONICS RIBBON CONNECTORS**

CEN 36 M 8 75  
 CEN 36 F 9 75

**CAPACITORS**

- Ceramic Disc
- Electrolytic
- Tantalum
- Mylar
- Monolithic

TERMS For shipping include \$2.00 for UPS Ground or \$3.00 for UPS Blue Label Air. Items over 4 lbs. require additional shipping charges \$10.00 minimum order.

IBM is a trade mark of International Business Machines Corporation. Apple is a trade mark of Apple Computer.

Price is subject to change without notice

1-(800) 821-3628

**Handwell Corp**

4562 EL CAMINO REAL • LOS ALTOS, CA 94022 • (415) 962-9265

## Electronic Circuit Analysis

- AC and DC analysis
- Very fast, optimized machine language
- Worst case, sensitivity analysis
- Sweep component values
- 64 Nodes
- Compare circuits
- Log or linear sweep
- Full file handling
- Full editing, error trapping
- Frequency response, magnitude and phase
- Complete manual with examples
- Transmission lines
- Complex y parameters
- Available for CP/M, MSDOS, TRSDOS
- Price - \$150.00

Tatum Labs

P.O. Box 698  
Sandy Hook, CT 06482  
(203) 426-2184

Circle 374 on inquiry card.

## 6800 Family Cross-Software



6800/01/05/09 microprocessor software development tools for PDP-11, VAX, IBM or other mainframes: Cross-Assemblers, High-level Language PL/W Compilers, Linker, and Simulators.

**WINTEK**

Wintek Corp.  
1801 South Street  
Lafayette, IN 47904  
317-742-8428

Circle 408 on inquiry card.

## The Statistician

CPM IBM-PC  
TRS-DOS XENIX

- Multiple Regression
- Stepwise Ridge
- All Subsets
- Backward Elimination
- Time Series Analysis
- Descriptive Statistics
- Transformations
- Survey Research
- Nonparametrics
- XY Plots
- ANOVA
- Random Samples
- Data Base
- Search & sort
- Hypothesis tests

Please call TOLL FREE  
1-800-334-0854 (Ext. 814)



for more information  
or write:  
Quant Systems  
Box 628  
Charleston, SC 29402  
VISA-MC Accepted

Circle 325 on inquiry card.

## FREE SOFTWARE

RENT THE PUBLIC DOMAIN!

User Group Software isn't copyrighted, so no fees to pay! 1000's of CPM and IBM software programs in .COM and source code to copy yourself! Games, business, utilities! All FREE!

### CP/M USERS GROUP LIBRARY

Volumes 1-92, 46 disks rental - \$45

### SIG/M USERS GROUP LIBRARY

Volumes 1-90, 46 disks rental - \$40

Volumes 91-154, 30 disks rental - \$40

SPECIAL! Rent all SIG/M volumes for \$75

### IBM PC-SIG (PC-DOS) LIBRARY

Volumes 1-100, 5 1/4" disks \$99.50

MOST FORMATS AVAILABLE! SPECIFY.

Public Domain User Group Catalog Disk \$5 pp. (payment in advance, please)  
Rental is for 7 days after receipt, 3 days grace to return. Use credit card, no disk deposit.

Shipping, handling & insurance - \$7.50 per library  
(819) 841-0925 information,  
(819) 727-1016 anytime order machine

Have your credit card ready!  
Public Domain Software Center



**P.J.S. Co.**  
993 S. Sante Fe "C"  
Vista, CA 92083

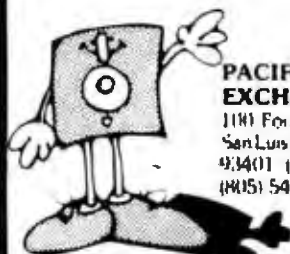
AM-EX



Circle 313 on inquiry card.

## BASF DISKETTES

BASF Diskettes at competitive price. Call TOLL FREE (800) 235-4137 for prices and information. Visa and Master Card accepted.



PACIFIC EXCHANGES  
1181 Foothill Blvd  
San Luis Obispo CA  
93401 (In Cal call  
(815) 543-1117)

Circle 305 on inquiry card.

## Dysan CORPORATION

### SPECIAL DISKETTE OFFER

The Dysan quality difference is yours to try with advanced production techniques that assure every diskette to be 100% error-free.

PLUS! If you call, write, or utilize reader service in response to this ad—we'll send you our full-range catalog of computer supplies with Special Offers good for further savings on Dysan diskettes and many other quality products.

**LYBEN COMPUTER SYSTEMS**  
1250-E Rankin Dr., Troy, MI 48063  
Phone: (313) 589-3440

Simply #1 in Service & Reliability

DISCOVER THE DYSAN DIFFERENCE

Circle 243 on inquiry card.

Serial ◀ ▶ Parallel



Convert What You Have  
To What You Want!

- RS232 Serial
- 8 Baud Rates
- Latched Outputs
- Centronics Parallel
- Handshake Signals
- Compact 3 1/2" or 5 1/4"

No longer will your peripheral choices be limited by the type of port you have available! Our new High Performance 700 Series Converters provide the missing link. Based on the latest in CMOS technology, these units feature full baud rate selection to 19.2K, with handshake signals to maximize transfer efficiency. Detailed documentation allows simplified installation. Order the Model 770 (Ser/Par) or Model 775 (Par/Ser) Today!

Shuttle Products  
Coming Soon!

**Shuttle Products**

only \$89.95  
Connector Option \$15.00  
CA Residents 6% tax  
10% Shipping \$3.00

CALL (805) 487-1666 or 487-1886

For FAST Delivery

Circle 182 on inquiry card.

## C LANGUAGE PROGRAMMERS

c-systems  
C COMPILER  
c-window™

The complete c language source level program testing and debugging tool.

- Single step by c source line.
- Set breakpoints at line numbers.
- Display and alter variables by symbol name, using c expression syntax.
- No more printf or assembler level debugging!

c-window™ is a support package for the c-systems C COMPILER for 8086/8088 based systems.

Contact:

c-systems  
P.O. Box 3253

Fullerton, CA 92634  
714-637-5362

TM c-systems

## CONVERSE WITH YOUR COMPUTER

AT LAST! A FULL IMPLEMENTATION of the original ELIZA program is now available to run on your microcomputer!

Created at MIT in 1966 ELIZA has become the world's most celebrated artificial intelligence demonstration program. ELIZA is a non-derivative psychoprogam that analyzes each statement as you type it and then responds with her own comments or questions - and her replies are often amazingly appropriate!

Designed to run on a large mainframe, ELIZA has never before been available to personal computer users except in greatly stripped down versions lacking the sophistication which made the original program so fascinating!

Now, run your microcomputer system possessing the FULL power and range of capabilities of the original in being offered at the introductory price of only \$25. And if you want to find out how she does it for each line she does move, we will include the complete SOURCE PROGRAM for only 10¢ additional!

Order your copy of ELIZA today and you'll never again wonder how to respond when you hear someone say "Daddy, let's see what this computer of yours can actually do!"

ELIZA IS AVAILABLE IN THE FOLLOWING FORMATS

- 1 5 1/4 inch disk for the IBM Apple II, II Plus, IIc or IIx 475 for Protected Version - \$45 for AppleII Source Version
- 2 5 1/4 inch disk for the IBM Personal Computer 485 for Protected Version - \$45 for IBM Disk BASIC Source Version
- 3 5 1/4 inch disk or tape cassette for the Commodore 64 (specify which) \$25 for Protected Version - \$45 for C-64 BASIC Source Version
- 4 Standard 8 inch single density disk for all CP/M based computers \$25 for ELIZA.COM - \$45 with Microsoft BASIC-80 Source
- 5 5 1/4 inch disk for most CP/M based computers (specify computer) \$25 for ELIZA.COM - \$45 with Microsoft BASIC-80 Source

Please add \$2.00 shipping and handling to all orders (California residents please add 6% sales tax)

ARTIFICIAL INTELLIGENCE RESEARCH GROUP

827 North La Jolla Avenue, Dept. B  
Los Angeles, CA 90024  
(713) 656-7368 (213) 654-2074  
MC, VISA and checks accepted



Circle 45 on inquiry card.



Apple Country Ltd. has your Number for

# ROCK BOTTOM PRICES



## 1-800-222-2602

### MONITORS

AMDEK COLOR I PLUS	309.95
AMDEK COLOR II PLUS	454.95
AMDEK COLOR IV	619.95
AMDEK VIDEO 100 (GREEN)	139.95
AMDEK VIDEO 100 (AMBER)	154.95
AMDEK VIDEO 110 (AMBER)	174.95
BMC 12" GREEN	89.95
BMC 13" COLOR	249.95
BMC 13" RGB AP2 COLOR	379.95
BMC 13" RGB IBM	449.95
COMREX 9" HI-RES AMBER	119.95
COMREX 13" COLOR W/SOUND	289.95
COMREX 12" HI-RES AMBER	139.95
COMREX 12" HI-RES GREEN	134.95
COMREX 12" HI-RES LT GRN	134.95
COMREX 13" RGB COLOR	274.95
GORILLA 12" AMBER	99.95
GORILLA 12" GREEN	89.95
NEC 12" HI-RES GREEN	154.95
NEC 12" ECOM GREEN	169.95
NEC 12" LO-RES COLOR	294.95
NEC 12" AMBER SCREEN	164.95
NEC 12" COLOR - IBM	439.95
PRINCETON GRAPHICS HK-12	519.95
SAKATA 13" COLOR	294.95
SAKATA 13" RGB COLOR	549.95
SAKATA SUPER RGB	749.95
SAKATA 12" GREEN	119.95
SANYO CTR-70 HRES COLOR	629.95
SANYO DM-255 25" RGB	799.95
SANYO DM-6500 13" RGB	419.95
TAKAM 12" GREEN	129.95
TAKAM 12" AMBER	139.95
TAKAM RGB VISION 1	329.95
TAKAM RGB VISION III	464.95
TAKAM RGB 420 IBM	549.95
ZENITH 12" AMBER	119.95
ZENITH 12" GREEN	99.95
ZENITH RGB ZVM-135 COLOR	524.95
USI 9" AMBER PI-4	129.95
USI 9" GREEN PI-1	119.95
USI 12" AMBER PI-3	144.95
USI 12" GREEN PI-2	129.95
USI 14" LO-RES COLOR	309.95

### MODEMS

ANCHOR MARK I (RS-232)	84.95
ANCHOR MARK II (ATARI)	84.95
ANCHOR MARK VII (RS-232)	119.95
ANCHOR MARK XII (RS-232)	289.95
ANCHOR VOLKSMODEM	64.95
HES MODEM VIC-C64	54.95
NOVATION J-CAT	119.95
NOVATION 212 AUTO CAT	624.95
RIKON R212A 1200 BAUD	429.95
SMARTCAT 103/212	429.95
SMARTCAT 103	199.95
SMARTMODEM 300 BAUD	219.95
SMARTMODEM 1200 BAUD	484.95
SMARTMODEM 1200B - IBM	449.95
US ROBOTICS AUTODIAL 212	499.95
US ROBOTICS PASSWORD	179.95

### PRINTERS

AMDEK DP-9501B	1099.95
AMDEK DP-9625B	1299.95
AMDEK DP-9620B	1179.95
AMDEK WP-6000	2299.95
AMDEK DP-6500BT 500CPS	2529.95
APPLE IMAGEWRITER	LOW!!
CENTRONICS 352 DP	2229.95
C.ITOH A10 DAISY WHEEL	569.95
C.ITOH 8510SP	499.95
C.ITOH 8600BP	949.95
C.ITOH 8510 SCP COLOR	579.95
COMREX CR-II DAISY WHEEL	499.95
DAISYWRITER 2000 4BK	1129.95
DELTA-10	529.95
DELTA-15	669.95
EPSON FX-80 W/TRACTOR	529.95
EPSON FX-100 F/T	719.95
EPSON MX-100 P/T	489.95
EPSON RX-80	324.95
EPSON RX-80 F/T	389.95
GEMINI 10X	299.95
GEMINI 15X	439.95
GORILLA BANANNA	169.95
IDC MICROPRESS 480	429.95
IDS PRISM 132	1459.95
JUKI 6100 PRINTER (P)	464.95
MANNESMANN TALLY M160L	639.95
MANNESMANN TALLY M180L	879.95
MANNESMANN TALLY SPIRIT	349.95
NEC 3550 SPINWRITER-IBM	1999.95
OKIDATA MICROLINE 80	279.95
OKIDATA PACEMARK 2350S	2329.95
OKIDATA PACEMARK 2410P	2569.95
OKIDATA PRISM 132	2639.95
OKIDATA 82A W/OKIGRAPH	379.95
OKIDATA 83A W/OKIGRAPH	664.95
OKIDATA 84P	1099.95
OKIDATA 84S	1199.95
OKIDATA 92P	484.95
OKIDATA 93P	799.95
OKIDATA 93S	894.95
PANASONIC P1090	334.95
PANASONIC P1091	394.95
PRINTMASTER [DAISY]	1439.95
PROMWRITER I (8510P)	364.95
PROMWRITER II (1550P)	599.95
QUME SPRINT 11/40+	1419.95
SANYO PR5500 DAISY WHEEL	719.95
SILVER-REED 550 DAISY	749.95
STAR POWER-TYPE DAISY	409.95
STARWRITER DAISY WHEEL	1139.95
TOSHIBA P-1350 LP	1749.95
TRANSTAR 315 COLOR	499.95
TRANSTAR 120P 14CPS	464.95
TRANSTAR 130P 18CPS	679.95
TRANSTAR 140P 40CPS	1329.95
MICROBUFFER EPSON RS232	129.95
GRAPHITY CARD (APPLE)	89.95
GRAPPLER + (APPLE)	119.95
MICROBUFFER II 16K (APPLE)	154.95
PKASO PRINTER I/P (APPLE)	139.95
WIZARD BPO 16K (APPLE)	139.95
WIZARD SOB 16K (APPLE)	199.95

OTHER PRINTERS AVAILABLE

### COMPUTERS

APPLE IIe STARTER SYSTEM	LOW!!
APPLE MACINTOSH COMPUTER	LOW!!
COMMODORE 64 COMPUTER	LOW!!
COMMODORE 1541 DISK DRIVE	LOW!!
COLUMBIA VP PORTABLE	2599.95
COLUMBIA 1600-1 COMPUTER	2949.95
IBM-PC COMPATIBLE SYSTEM	
128K, 2-DS/DD DRIVES, KEYBOARD	
WITH COMPLETE SOFTWARE PACKAGE	
EAGLE PC PLUS-2 SYSTEM	3399.95
128K, 2-DS/DD DRIVES,	
MONITOR, EAGLEWRITER, MS-DOS,	
EAGLECALC, & CP/M-86	
EAGLE SPIRIT-II	2799.95
EAGLE SPIRIT-XL	3999.95
PORTABLE 128K EXPANDABLE TO	
640K ON BOARD, 1 320K FLOPPY,	
10 MEGABYTE HARD DISK, IBM	
COMPATIBLE KEYBOARD, 2 SERIAL	
1 PARALLEL PORT, MS-DOS 2.0,	
MONOCHROME MONITOR, CP/M 86	
NEC APC-H01	2239.95
NEC APC-H02	2799.95
NEC 8201 COMPUTER	649.95
SANYO 550 COMPUTER	819.95
SANYO 555 COMPUTER	1124.95
ZENITH IBM COMPATIBLE	2649.95
ZENITH W/10 MEG DSK	3999.95
WILDCAT STARTER SYSTEM	1349.95
APPLE II COMPATIBLE SYSTEM	
64K, DETACHABLE KEYBOARD,	
2 APPLE COMPATIBLE DISK DRIVES,	
HI-RES 12" AMBER MONITOR,	
RGB & COMPOSITE COLOR OUTPUT,	
2 CPU'S (Z-80 A & 6502),	
80-COLUMN CARD & JOYSTICK	
ZORBA PORTABLE COMPUTER	999.95
BUILT IN 7" GREEN SCREEN,	
2 DS/DD DISK DRIVES, RS-232,	
PARALLEL, IEEE488 BUS, KEYBOARD	
EMULATION MODE FOR OSBORNE I,	
KAYPRO II, XEROX 820, DEC VT-180,	
CROMEMCO 520, TELEVIDEO 802	
AND MANY MORE!	
WORDSTAR, MAILMERGE, CALSTAR,	
C-BASIC, CP/M 2.2, M-80	
ATARI HARDWARE	
ALIEN VOICE BOX	99.95
KOALA PAD TOUCH TABLET	77.95
SANA 1800 SS/DD W/SPTM	369.95
TRAK AT-D2 SS/DD + DROU	419.95
DISKETTES	
SS/SD ELEPHANT	16.95
OPUS	17.95
SS/DD ELEPHANT	19.95
OPUS	20.95
DS/DD ELEPHANT	25.95
OPUS	26.95

### APPLE HARDWARE & SOFTWARE

4TH DIMENSION DRIVE-ONLY	214.95
4TH DIMENSION DRIVE+CTRL	299.95
ALS CP/M CARD	334.95
APPLE-CAT II MODEM	284.95
BANK STREET WRITER+	49.95
BUFFERED GRAPPLER+	199.95
d-BASE II (R20 2-80)	499.95
HAYES MICROMODEM II+	234.95
NACH II JOYSTICK II+	34.95
NACH III JOYSTICK II+	41.95
MASTERTYPE	29.95
MICROBUFFER II+ 16K (P)	199.95
PFS:FILE	89.95
PKASO/U PRINTER I/F	139.95
PREMIUM SOFTCARD II+	384.95
QUADRAM 64KB/COL CRD II+	124.95
VIDEX VIDEOTERM W/SPTSW	239.95
VIDEX ULTRATERM	294.95
IBM	
HERCULES GRAPHICS CARD	389.95
KOALA PAD TOUCH TABLET	119.95
KRAFT JOYSTICK	49.95
MICROBRO FPO PACK	419.95
MICROSOFT SYSTEMCARD 256K	479.95
MICROSOFT MOUSE	139.95
MOUSE SYSTEMS CP MOUSE	219.95
QUADROCHROME MONITOR	589.95
QUADLINK APPLE EMULATOR	519.95
QUADRAM QUADCOLOR I 64K	299.95
QUADRAM QUADCOLOR II	229.95
RAWA DS/DD DISK DRIVE	274.95
STB SUPER I/O MULTIFUNCT	184.95
TG JOYSTICK W/TOGGLE	44.95
TRANSEND P.C. MDDM 1200	439.95
VERSAWRITER GRAPH TABLET	249.95
WIZARD SPOOLER P/S 16K	249.95
COMMODORE 64	
CARDBOARD/5 5 SLOT EXPAN.	64.95
CARD7 GRAPHICS INTERFACE	69.95
DAT20 2-80 VIDEOPAK	229.95
DELPHI'S ORACLE DATA BASE	89.95
DISKEY	34.95
DONKEY KONG	34.95
EASY SCRIPTS4	34.95
EASY SPELL 64	34.95
FLIGHT SIMULATOR II	39.95
HOME ACCOUNTANT	54.95
HOMEROWD WORD PROCESSOR	49.95
JOUST	35.95
KOALA PAD TOUCH TABLET	79.95
MERLIN 64 ASSEMBLER	35.95
MSD-S01 DISK DRIVE	399.95
MULTIPLAN	74.95
OMNI-CALC	34.95
PAPER CLIP W/P	64.95
PAC-MAN	37.95
POPEYE	39.95
ROBOTRON	37.95
S.A.M.	44.95
SARGON II	27.95
VOICE BOX	84.95

We will try to meet or beat any advertised price!  
**CALL US... WE CAN HELP! 1-800-222-2602**

For technical assistance, order status and California calls (619) 765-0239  
 Apple Country, Ltd., P.O. Box 1099, 2602 Washington St., Julian, Calif. 92036

Terms: We accept American Express. No extra charge for Visa/MasterCard, Cashier's Check, personal check (allow 2 weeks to clear) Shipping & Handling: 5% (\$5 min.); APO FPO Alaska Hawaii & Monitors 5% (\$10 min.) Foreign orders 15% (\$15 min.) All items are new with manufacturer's warranty. Prices are subject to availability & change without notice. Purchase order must include check. California residents add 6% sales tax. Send \$1 (good toward first purchase) for new fall catalog.

Apple Country, Ltd. is a DISCOUNT MAIL ORDER HOUSE for the micro computer industry and is a California corporation not affiliated with Apple Computer Inc. Apple is a trademark of Apple Computer Inc.



**POWER PROTECTION FOR YOUR SYSTEM**

The Datasaver™ AC Power Backup fits most desktop and portable microcomputer systems. Call **Cuesta Systems, Inc.** at (805) 541-4160 for product information and application literature.

VISA/Mastercard orders

**INSTANT POWER**

Circle 118 on inquiry card.

**IBM PC/XT COMPATIBLE**

Computer Case	.....	\$140.00
Keytronic Style Keyboard	.....	\$160.00
PC 65 Watt Power Supply	.....	\$150.00
XT 100 Watt Power Supply	.....	\$195.00
PC/XT Bare Board	.....	\$ 90.00
Shugart SA455 320KB Floppy Disk	.....	\$185.00
Shugart SA712 10MB Hard Disk	.....	\$675.00
Shugart SA606 10MB Hard Disk	.....	\$475.00
Hard Disk Controller	.....	\$350.00
Floppy Disk Controller w/Serial, Parallel, Game Ports	.....	\$250.00
Color Graphic Card	.....	\$310.00
Monochrome Card	.....	\$225.00

OEM/DEALER INQUIRIES WELCOME

**ELECTRADE CO. (408) 946-2541**  
780 Trimble Rd., Suite 605  
San Jose, CA 96131

Circle 157 on inquiry card.

**Dysan CORPORATION**

Solve your disc problems, buy 100% surface tested Dysan diskettes. All orders shipped from stock, within 24 hours. Call toll FREE (800) 235-4137 for prices and information. Visa and Master Card accepted.

**PACIFIC EXCHANGES**  
100 Foothill Blvd.  
San Luis Obispo, CA  
93401 (In Cal call  
(805) 543-1037)

Circle 306 on inquiry card.

**1984 3M SPECIAL**

We're bringing in the New Year with specials on quality 3M information processing products. Including:

- DISKETTES • MAG TAPE
- DATA CARTRIDGES

**PLUS!** Specials on many other products in our full-range discount catalog of computer supplies. Call, write, or utilize reader service to obtain your FREE catalog of 1984 3M Specials.

**LYBEN COMPUTER SYSTEMS**  
1250-E Rankin Dr., Troy, MI 48063  
Phone: (313) 589-3440

Simply #1 In Service & Reliability

**3M** Authorized Distributor  
Information Processing Products

Circle 244 on inquiry card.

**Stepping-Motor Driver Box with on board BASIC in ROM**  
Controls Motion from any CRT or Computer

Process Control  
Robotics / 3-D X,Y,Z Motion

**HOOKUP AND GO!**  
Provides all required power  
Drives 4 motors at up to 5 amps per winding while sensing 8 limit switches

**STEPPING-MOTOR TIPS COOKBOOK \$8**  
with 3-D software & schematic

**BIG STEPPER**  
Parallel Version \$495/card only \$195  
Smart Version (RS232) \$850/wth BASIC \$985

Centre Computer Consultants, (814) 237-4535  
P.O. Box 739, State College, PA 16804

Circle 72 on inquiry card.

**THE OFFICIAL NUMBER TO CALL TO FIND OUT MORE ABOUT THE UNOFFICIAL APPLE LOGO:**

**617-492-8816**

**Terrapin™**  
The Logo People

Terrapin, Inc., 380 Green Street,  
Cambridge, MA 02139, (617) 492-8816

Circle 378 on inquiry card.

**A word for this Punch/Reader Combo is**

**Speed!** Model 510 punches paper tape at 110cps reads at 150cps. This rugged machine is computer compatible offering RS232C, current loop, parallel inputs. The ASCII-to-Baudot code conversion permits direct keyboard entry for Telex/TWX transmission. Plus: 256 character storage, 75-9600 baud rate, 5-8 level tape, stock ADDMASTER CORP 416 Junipero Serra Dr., San Gabriel, CA 91776 • 213/285-1121

Circle 18 on inquiry card.

**LSI C COMPILER for 8080/8085/Z80**

New version of the compiler is available now!

The object code is **COMPACT** and is **FASTEST** in current C compilers.

Our "Steve" program runs in 8.0 seconds (standard) and 6.2 seconds (optimized)

(See January 1984 BYD, pp 203-210)

price \$700 (FOB Japan)

for pamphlet write:  
P.O. Box 588 STA. CRUZ  
CA, USA 95962

for further information contact:  
**LSI JAPAN CO., LTD.**  
3-249 TOYOBU SHIBUYAKU TOKYO (100) JAPAN  
PHONE (03) 379-3437

Circle 242 on inquiry card.

**HOFACKER**

Books & Software in Hardware Add-Ons for your ATARI 800XL, 800 XL, Commodore 64, VIC-20, Spectrum, Trinitron, Apple II, Database-DSI

**BIJECTRY** - Move them just a word! No one can provide better performance for less price!  
The best programmer included for editing and networking the best workstations for the C-64  
Order No. 8995 \$48.00

**MACHOPRINT** - Master/Assembler for the C-64  
The best programmer you can buy!  
Order No. 8993 \$48.00

**SOFTWARES for your C-64**  
The Great Book of Games, Vol. 1  
48 programs for the Commodore 64  
Order No. 123 \$9.95

Programs from this book on disk \$19.95

**MOUSE ON THE BATTERY**  
The truth, lies, very important software!  
Order No. 122 \$9.95

Programs from this book on disk \$19.95

How to program in BASIC  
Language on your C-64  
Order No. 124 \$12.95

Commodore 64 Typing, Vol. 1  
How to expand your C-64  
Order No. 125 \$12.95

Small Business Program for the C-64  
Order No. 126 \$12.95

**HARDWARE ADD-ONS for your C-64**  
Parallel Printer Adapter, KIT  
Order No. 8999 \$19.95

Universal Expansion Board  
Order No. 8979 \$9.95

Expansion Board KIT - Hook up to 4 5.25" floppy drives!  
Order No. 8982 \$29.95

Order and Distributor contact on our website  
E-COMP PURCHASING, INC.  
23 Industrial Lane  
Pomona, CA 91768  
Phone: (714) 822-8214, TX 28 91 81

Development for all ATARI computers  
No one can provide better performance for less price!  
**ATEX1!**  
The workprogram is an excellent tool for your money! It handles screen or text editing, searching, saving, search, event control, left and right margin positioning, clear, 30 commands. Test it out on your disk or cassette  
Order No. 7219 cassette \$29.95  
Order No. 7216 disk \$34.95  
Order No. 7217 cartridge \$48.00

Order for the ATARI Computer  
The book describes software programs in BASIC, machine language, binary, hex, graphics and use of the hardware registers. Contains many ready to run programs in BASIC, and one called GRAFT-ART in machine language  
Order No. 121 \$7.00

How to program your ATARI in BASIC  
Machine Language  
Introduction to machine language for the BASIC programmer  
Order No. 120 \$9.95

**FORN on the ATARI** - Learning by Using  
Introduction, programs, assignments.  
Order No. 128 \$7.95

All programs from book No. 120 on disk  
Order No. 7218 \$29.95

**HACKERBOOK** for your Atari computer  
Techniques - Very important information on 6502 machine language. How to make inalterable character disks and 6502/65C02 Computer communication (BASIC and software) on how to build an 6502/65C02  
Order No. 172 \$9.95

Copyright © 1983 by E-Comp Purchasing, Inc.

Payment: Check, VISA, MC, CA, money order & US funds only. Outside USA add 50% for shipping. No shipping outside order \$5.00 and up. No shipping outside order \$5.00 and up.

Circle 165 on inquiry card.





**S-100**  
ESTABLISHED 1977

**SALES 800 - 528-3138**  
TECHNICAL 602-991-7870  
MODEM ORDERS 602-948-1387  
TELEX: 18 5025 FTCC SEC PHX.

# CompuPro

A GORDON COMPANY

SYSTEM 816/A A&T	\$3,999
SYSTEM 816/B A&T	\$4,999
SYSTEM 816/C A&T	\$6,399
SYSTEM 816/D A&T (8086)	\$9,999
SYSTEM 816/E A&T (86000)	\$6,399
TO ADD 40 Mb H.D. TO SYSTEM 816	\$2,475

S-100's 40Mb HARD DISK SUBSYSTEM  
W/DISK 3 & CP/M 80 & 86 \$2,895

100 HOUR SYSTEM "BURN-IN"  
\*XEROX ON-SITE SERVICE WHERE AVAILABLE

CPU 2 6MHz A&T	\$229
CPU 8086/88 A&T	\$349
CPU 8088 10MHz A&T	\$569
CPU 98/87 5MHz A&T	\$739
CPU 88K W/MMU OPTION A&T	\$629
CPU 68K 10MHz C&C	\$600
RAM 17 64K STATIC A&T	\$349
RAM 16 64K STATIC 6515 A&T	\$389
RAM 21 128K STATIC 8515 A&T	\$689
RAM 22 256K STATIC 8515 A&T	\$1,229
M-DRIVE/H 512K RAM-DISK	\$895
INTERFACER 3-8 SERIAL A&T	\$489
INTERFACER 4-3 SERIAL/2 PARALLEL	\$319
SYSTEM SUPPORT 1 A&T	\$319
DISK 1 A&T	\$349
DISK 2 A&T 8" H.D. CNTRL	\$559
DISK 3 W/CP/M 80&86	\$559
6 SLOT MOTHERBOARD W/TERMINATION	\$99

## MORROW

MD2 SYSTEM W/MDT80 TERMINAL AND TALLY SPIRIT PRINTER	\$1,899
MD3 AS EQUIP. ABOVE	\$1,899
MD3—MDCP88-256 SYS. AS EQUIP. ABOVE W/ 8088 CO-PROC. & 256K RAM UPGD	\$2,399
MD11 SYSTEM AS EQUIP. ABOVE W/CP/M 3.0, 128K RAM, DSDD FLYP AND 11Mb H.D.	\$2,745
MDP-3 PORT, SAME AS MD-3 W/5X7 SCREEN & DETACH K.B. & TALLY SPIRIT PRINT.	\$1,999



A whole computer system in one little box™

2 MODEMS, MX80 PRINTER, 2-DSDD 5" DRVS. CP/M, FANCY FONT, MONEY MAESTRO, CBASIC, MBASIC, PERFECT FILER, SPELLER, WRITER, CALC	CALL
ALSO W/DUAL 5" DSDD DRIVES	CALL
ALSO W/8088 CPU, 320K RAM, MS-DOS	CALL

## COLUMBIA

PORTABLE 1800-VP W/ALL SOFTWARE	\$2,495
DESK TOP 1600-1 W/KEYTRONICS 5160 K.B. & CRT CONTR (MON. NOT INCL.)	\$2,595
KEYTRONICS 5160 KEYBOARD/IBM-PC	\$189



**JEFFERSON  
ELECTRIC**

Litton

TRUE SINE WAVE, 100% BATTERY OPER. W/NO SWITCH-OVER, BYPASS STATIC SWITCH 760 WATTS @ 15 MIN. #370-811-100	\$1,575
1 HR. W/AUXILIARY BATTERY	\$149



400 WATT W/LVC  
STAND-BY POWER  
MORE THAN 1 HR. \$400

Circle 340 on inquiry card.

## TECMAR FOR IBM-PC

TIMEMASTER WITH BATTERY BACK-UP	\$101
DYNAMIC MEMORY 255K	\$342
1st MATE 256K, SERIAL, PARA. CLOCK	\$412
CAPTAIN SAME AS 1st MATE W/384K	\$557
GRAPHICS MASTER HI-RES RGB	\$521
IEEE 488 BOARD W/SOFTWARE	\$367
5Mb H.D. CARTRIDGE INSTALLS IN P.C.	\$1,498
33Mb FIXED H.D. W/5Mb REMOVABLE CART. IN AN EXPANSION CHASSIS	\$4,121
LAB MASTER W/MANY OPTIONS AVAIL.	\$746

## Cromemco

DPU W/68000 AND Z80 CPU'S	\$692
256KZ DYNAMIC MEMORY BOARD	\$1,127
D-7A DIGITAL/ANALOG INTERFACE	\$257
SCC 2-80 SINGLE CARD COMPUTER	\$431
8P10 8 PORT PARALLEL INTERFACE	\$257
84 FDC FLYP CNTRL. /TANDON DRVS.	\$518
C-10MP PERS. COMP. W/MICROPRO	\$2,084



EP128 128K EPROM BOARD	\$237
VB3A 80x24 DISPLAY VIDEO BOARD	\$424
VB3A 80x50 DISPLAY VIDEO BOARD	\$467
VB3A-S CP/M COMPATIBLE 8" DISK	\$48
KB1 PROTOTYPING BOARD	\$36
I/O4 2-SERIAL/2-PARALLEL I/O BOARD	\$247
I/O8 8-SERIAL I/O BOARD	\$489



QUASI-DISK RAM-DISK W/512K. ON-BD. LED'S FOR DRIVE STATUS, 8" 5580 INSTALL S.W. SAMPLE BIOS FOR ANY CP/M SYSTEM, LOGIC WRITE PROTECT, DMA COMPATIBLE	\$895
512K EXPANSION MODULE	\$895
BATTERY BACK-UP W/PWR. SUPPLY	\$169

64K CMOS STATIC RAM BOARD	
2K WINDOW SELECT., 160 n.s. RAM, MWRITE, BANK SELECT, EXTENDED ADDRESSING, SOCKETED, JUMPERABLE PHANTOM, CAN USE 2718 EPROMS	\$409

MFIO ALL-IN-ONE I/O BOARD	
IEEE 698/8-100 STD., 8 ASYNCH. SERIAL, INTERNAL BAUD RATE GENERATOR, 2 PARALL., REAL TIME CLOCK W/BATT., PROGRAMMABLE: 8 LEVEL PRIORITY INTERRUPT, WAIT STATES, ALARM	\$469
SERIAL OPTION BOARD	\$26
CENTRONICS OPTION BOARD	\$39
STD. PARALLEL OPTION BOARD	\$26



FD-1 8" SSDD \$36	FD-2 8" DSDD \$39
MD-1 8" SSDD \$23	MD-2 6" DSDD \$36
MD-200 (98 TPI) 6" DSDD	\$42

General Semiconductor Industries, Inc.  
SQUARE D COMPANY

TRANSIENT VOLTAGE/NOISE PROTECTOR 8 FT. CORD, 6 OUTLETS, CIRCUIT BREAKER, ILLUMIN. ON/OFF SWITCH #120 5K6	\$75
---	------

## PRINTERS

DAISYWRITER 2000 W/48K	\$998
OKIDATA 92	\$439
OKIDATA 93	\$729
EPSON MX, RX, & FX IN STOCK	CALL
TALLY MT160L	\$595
BROTHER HR-15 SERIAL	\$509
BROTHER HR-25 SERIAL	\$819
TALLY MT150L	\$819
TALLY 'SPIRIT' N.L.Q. @ 80 C.P.S.	\$299

## TERMINALS & MONITORS

FREEDOM 100 TERMINAL	CALL
FREEDOM 200 TERMINAL (EMUL TELEVIDEO 950 & ADM 31)	CALL
TAXAN RGB 420 (IBM LOOK-ALIKE)	\$495
USI AMBER 12" HI-RES MONITOR (20MHz)	\$119
QUME QVT102G	\$529
QUME QVT102A	\$545
WYSE-60 14", 132 COL., EMULATES TVI 910, 920, 925, ADDS-VP & HAZELTINE 1500	\$525
PRINCETON GRAPHICS HX12 HI-RES RGB	\$495
ZENITH ZVM-135, 13 INCH, HI-RES RGB	\$505
ZENITH 229	\$695
COMREX CR6800-Y, HI-RES, P-39	\$125

## DISK DRIVES

S-100'S DMA 5Mb REMOV. CART, W/5 Mb FIXED WINCH. H.D. W/CABINET, P/S, ALL CABLES, CNTRL. & OPER. SYS. DRIVERS	\$2,395
DMA SUBSYSTEM SAME AS ABOVE FOR IBM-PC	\$2,395

S-100'S DUAL QUME 242—QUANTUM 40Mb H.D. SUBSYS. W/DISK 1&3 & CP/M80&86	\$3,999
QUANTUM 40Mb WINCHESTER	\$1,895



270 DAY WARRANTY

142 DSDD 5 1/4" HI	\$179
242 DSDD 8 1/4" HI	\$395
842 DSDD 8 1/4" STD HI	\$455

## Tandon

100-2A 5 1/4" DSDD	\$206
--------------------	-------

## INDUSTRIAL QUALITY CABINETS

DUAL 1/2 HI HORIZONTAL 5 1/4"	\$75
SINGLE STD HI HORIZONTAL 5 1/4"	\$59
DUAL 1/2 HI VERTICAL 8"	\$195
SINGLE STD HI VERTICAL 8"	\$195
WINCH. 5 1/4" H.D. (1 STD OR 2 1/2 HI. DRVS)	\$219

## SOFTWARE

8DS "C" COMPILER	\$99
COMPUTER INNOVATIONS "C" COMPILER	\$299
COMPUVIEW VEDIT-80	\$135
COMPUVIEW VEDIT-86/MS-DOS	\$185
PERSONAL PEARL DATA BASE MGR.	\$215
ACCOUNTING PEARL FOR IBM-PC	\$635
FOX & GELLER dUTIL	\$69
FOX & GELLER QUICKCOOE	\$205
MICROPRO'S PRO PAK	\$435
KNOWLEDGEMAN 8086 DATA BASE MGR.	\$345
MIDROSOFT'S BASIC COMPILER	\$292
SORCIM SUPERCALC CP/M 2.2 8 INCH	\$121
SORCIM SUPERCALC-3/IBM-PC	\$245
ASHTON-TATE dBASE-2 CP/M-86 8 INCH	\$449

## DIGITAL RESEARCH

CONCURRENT CP/M-86	\$210
MP/M-86	\$390
"C" COMPILER/IBM-PC	\$210
DR. LOGO/IBM-PC	\$60
CBASIC COMPILER-80	\$300
PL/1-86	\$450
DR ASSEMBLER PLUS TOOLS	\$120
PASCAL MT+	\$210
DISPLAY MANAGER-80	\$240
ACCESS MANAGER-80	\$180
PC ACCOUNTING PACK	\$597
SELECT (WORD PROC.) MSDOS	\$299

S-100 DIV./696 CORP.  
14425 North 79th Street  
Scottsdale, Arizona 85260

FULL DEALER SUPPORT  
VISIT OUR SHOWROOM  
Hrs. 9:00AM - 5:30PM M-F

Subject to Available Quantities  
Prices Quoted Include  
Cash Discounts  
Shipping & Insurance Extra

# maxell®

**Floppy Discs**  
**CALL NOW - TOLL FREE**  
**1-800-328-3472**

Dealer inquiries invited. C.O.D.'s and charge cards accepted.

All orders shipped from stock, within 24 hours. Call toll FREE.

**NEW LOWER PRICES**



**North Hills Corporation**

3584 Rolling View Dr.

White Bear Lake, MN 55110

1-800-328-3472

MN Call Collect 1-812-770-0485

**APPLEWARE, INC.**

The Apple Users Group®  
**Software Library**

For the first time show your Apple to its fullest capacity using specially priced disks with over 60 outstanding programs, each (not available from any other source)

Each packed disk includes an extensive variety of programming, useful and entertaining programs, representative to all computerists! Mixed category packed disks include:

**BUSINESS • EDUCATIONAL • DATA BASE • GAMES • UTILITIES • SCIENCE • MUSIC • GRAPHICS • FINANCE**

Library Disks I, II and III are mixed categories. Single category disks are: **GAMES • UTILITIES • GRAPHICS • INTEGER • SCIENCE • TECH • MUSIC & AUDIO**

Individual disks available at \$29.95 each.  
 Order direct from the ad and save up to \$150. Buy Library Disks I, II and III and get a special bonus disk FREE (over 260 programs for \$179.95) + \$4 shipping BUT for the Best Value receive any 3 disks featuring over 600 of our best programs for only \$34 each for a package price of \$339. Certified Postage plus handling paid!

\*Send one-time membership fee of \$16. (no fee charged to institutions) for 1000 + program catalog and gain access to a library of over 10,000 programs at a special 15% discount (Foreign memberships \$28. U.S.)

For Orders Only Call new  
**TOLL FREE: 1-800-327-8844**  
 Florida: 1-305-997-9668

Or Write:  
 Appleware, Inc.  
 6400 Hayes Street  
 Hollywood, Fla. 33024

Program Disks compatible with Apple II, II+, IIx, III, IIIx, Franklin Ace and IBM Quad

**PROGRAMS 65¢ EACH**

MasterCard  
 VISA

Circle 40 on inquiry card.

# SMAL/80

SMAL/80	Assembler
HL=M (PTR);	LHLD PTR
DE=9;	LXI D,9
HL=HL+DE;	DAD D
IF A=L EQUAL	CMP L
THEN	JNE L1
A=A-14	SUI 14
ELSE	JMP L2
A=L;	L1:MOV A,L
M(BC)=A;	L2:STAX B

New! Z-80 version (runs on 8080's): \$175. 8080 version only: \$150. Macro-processor only: \$75. Available on CP/M disks. Add \$4 for shipping. Complete tutorial text: "Structured Microprocessor Programming" (Publ; Yourdon Press) \$20 plus \$2 shipping. Send for your free button and literature or try the Ultimate Demo: SMAL/80 is Guaranteed!

**Chromod Associates,**  
 1030 Park Ave., Hoboken, N. J. 07030  
 Telephone: (201) 653-7615

Circle 79 on inquiry card.

# CHIPS & DALE

THE INFLATION FIGHTERS!

4116	200ns	8/812.00
4116	150ns	8/813.74
2114L	300ns	8/812.00
2114L	200ns	8/813.00
4164	200ns	\$5.50 each
4164	150ns	\$5.95 each
616	150ns	\$7.50 each
6116	200ns	\$5.40 each
6116LP	150ns	\$8.97 each
1791	Disk Controller	\$20.00 each
1771	Disk Controller	\$19.50 each
Z80A, Z80ACTC		\$3.50 each
Z80A P10		\$4.00 each
8251A		\$10.20 each
8255		\$9.39 each
2716-1	5V 350 ns	\$5.35 each
2716	5V 450 ns	\$3.80 each
2732	5V 450 ns	\$5.09 each
2532		\$5.10 each
2764	5V 300ns 28 pin	\$8.25 each
2564	5V	CALL CALL
8087		CALL CALL

Allow up to 3 wks. for personal checks to clear. Please include phone number. Prices subject to change without notice. Shipping & Handling for Chips \$3.50. FOB Bellevue, WA for all else, Washington state residents add 7.9% Sales Tax.

CHIPS & DALE 1-206-451-9770  
 10655 N.E. 4th St., Suite 400  
 Bellevue, WA 98004

Circle 77 on inquiry card.

# FLOPPY DISK-DRIVE REPAIR

Command Services exclusively repairs Tandon and Shugart disk drives. We are affordable, fast and experienced.

For service, call toll free:  
 M-F, 9 a.m.-5 p.m., 7-9 p.m.  
 1-800-782-5500  
 In New York State call:  
 1-800-328-1800

**Command Services Corporation**  
 7143 Henry Clay Blvd.  
 Liverpool, New York 13088  
 315-457-1432



Circle 83 on inquiry card.

# S-100 COLOR GRAPHICS!

## MICROSPRITE

THE ORIGINAL TMS9918A GRAPHICS BOARD

- Field-proven board meets IEEE 680 standard fully socketed with solder mask, silkscreen and gold contact fingers
- Prioritized display with background and control planes plus 32 sprite planes each used in a plane can be colored or transparent
- Three graphics and one text display mode maximum graphics resolution is 256H x 192V in 16 colors
- Composite video output
- On-board 16K RAM is separate from system memory
- Vertical retrace interrupt for real time clock capability
- 0-4 wait states for use with fast CPUs
- All board options are DIP switch selectable
- Professional quality documentation with BASIC demonstration programs and 115 TMS9918A manual
- Exclusive Graphics Editor available on 8 SSSD CP/M-compatible cassette

**\$189.95\***

(A & T)

**MicroDynamics**

**Corporation**

6363 Poplar Ave • Suite 106

Memphis TN 38119

ORDER DESK  
 1-800-237-8400 ext 440  
 Technical inquiries  
 901-682-4054

\*Price includes MICROSPRITE with documentation Graphics Editor cassette - \$9.95 Manual - \$19.95 Base board - \$59.95 UPS ground - \$2.00 UPS air - \$4.00 COD - \$1.50 Foreign add \$15.00 VISA & MC welcome TN add 6%  
 DEALER AND OEM INQUIRIES INVITED

Circle 271 on inquiry card.

# SYMBOLIC DEBUGGING for IBM PC-DOS

The Mylstar Symbolic Debugging Program enhances your IBM PC-DOS Debug Program to make your work easier and simpler. Employing the same command structure, the Mylstar Program lets you use:

- \*Symbol Names
- \*Mathematic Expressions
- \*Batch Files
- \*On-Line Help
- \*Multi-Command Macros
- \*Loop Structures

Shorten your debugging process and work time. Designed for PC-DOS 1.1, 128K RAM minimum. Send \$125 check or money order to: Dept. 1158 Mylstar Electronics.

**MYLSTAR ELECTRONICS INC.**  
 183 West Lake Street  
 Northlake, Illinois 60164  
 Tel: (312) 562-7400  
 Telex: 72-8482

Dealer Inquiries Invited

### LOWEST PRICES

APPLE® Compatible Computers from \$439  
 LASAR 48K \$439  
 ELITE 3.84K Dual CPU 8502 • Z80A Detached Keyboard, Run APPLE® & CP/M \$639

We Have All APPLE® Cards CALL! SAVE! MORE MODELS TO CHOOSE FROM! CALL!

THIS ONE BEATS BIG BLUE FUJITSU 8086 • 28M Opt. 68000 128K 2 Drive CALL

TERMINALS	COMPUTERS
Televideo 910 \$418	Radio Shack SAVE! CALL
Televideo 914 \$506	Advanced Digital Z80B 6Mhz
Adas 3A+ \$442	Super 81a 128 w/PS Net/1
Zenith Z-29 \$655	\$555
Viewal 50 \$653	CompuPro 818A \$4106
	Altos 580-7 3 user \$2111
	CompuStars & Headstars

PRINTERS Smith-Corona TP-1 \$246 North Star Advantage CALL  
 Okidata - NEC Epson CALL  
 APPLE is a registered trademark of APPLE Computers, Inc.  
 Anadex CALL

WE SELL ENTIRE LINE OF MOST COMPANIES Call For Latest Prices & Availability Factory Guarantees We Best Prices!

**AMERICAN COMPUTERS**

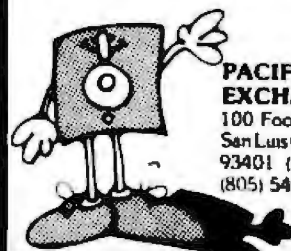
4167 Kest Dr., Johnston, North Carolina 27802  
 Tel: (919) 882-1106 (919) 882-4977

Circle 33 on inquiry card.

# wabash®

When it comes to Flexible Disks, nobody does it better than Wabash.

MasterCard, Visa Accepted.  
 Call Free. (800) 235-4137



**PACIFIC EXCHANGES**  
 100 Foothill Blvd  
 San Luis Obispo, CA  
 93401 (In Cal call  
 (805) 543-1037)

Circle 305 on inquiry card.

Circle 288 on inquiry card.



# MICROMAIL™

**THE PC SYSTEM SPECIALIST**

PRICES AND AVAILABILITY SUBJECT TO CHANGE WITHOUT NOTICE



## SPECIAL OF THE MONTH!



A Superior quality IBM PC Compatible Personal Computer. Runs DOS 1.1, 2.0, 2.1, CP/M86<sup>®</sup> UCSD p-System<sup>®</sup> Runs Lotus 1-2-3<sup>®</sup> Multiplan<sup>®</sup> Word Star<sup>®</sup> PFS<sup>®</sup> dBASEII<sup>®</sup> and many more! Hardware includes 128K CPU, Floppy Controller, Two DS/DD Disk Drives, Video Monitor, Video Adaptor, Parallel & Serial Ports.



**IBM**  
PERSONAL  
COMPUTER

Special  
of the  
Month!

IBM PC<sup>®</sup> COMPLETE LINE

### COMPLETE SYSTEM VERY SPECIAL PRICE

64K, Two Disk Drives, Floppy Disk Controller, Video Card and High Res Monitor ..... **\$2590**

256K RAM, 360KB Disk Drive, FDC, Video Monitor & Adaptor 10MB Hard Disk Sub-System. **\$3990**

## CALL FOR LOW PRICE

Suggested List \$2395.00

### HARD DISKS FOR IBM PC<sup>®</sup>

10 MB Hard Disk Sub-System by TAVA CORP. includes Software, Cables, etc. Internal. **\$1295**

### MEMORY BOARDS

#### CONOGRAPHIC

High Res. Color Graphics Card ..... **\$995**

#### QUADRAM

Quad Card. Fully pop. 256K ..... **\$450**

QUADLINK ..... **CALL**

AST SIXPAK 384K ..... **CALL**

HERCULES Graphics Card ..... **\$490**

#### APPLE IIe

Computer System, Controller, Two Disk Drives, Monitor ..... **\$1590**

#### DISK DRIVE FOR APPLE

Slimline, or Standard ..... **\$190**

NEC TANDON TAVA IBM APPLE QCS MAYNARD

### SLIMLINE DISK DRIVE FOR IBM PC

DS/DD 320KB by TAVA CORP. .... **\$190**

ADD-ON Disk Drive for IBM PCjr<sup>®</sup> .... **CALL**

### PRINTERS

DAISYWRITER 2000 ..... **CALL**

#### OKIDATA

82A	.....	<b>\$425</b>	84A	.....	<b>\$975</b>
83A	.....	<b>\$650</b>	92A	.....	<b>\$525</b>
93A	.....			.....	<b>\$850</b>

#### BROTHER

HR-25 ..... **\$795**

DX-15 ..... **\$450**

### MONITORS

#### AMDEK

300A	.....	<b>\$190.00</b>	I	.....	<b>\$340.00</b>
300G	.....	<b>\$160.00</b>	II	.....	<b>\$690.00</b>
310A	.....	<b>\$190.00</b>	III	.....	<b>\$390.00</b>

#### PRINCETON GRAPHICS SYSTEMS

Hi-Res Color ..... **\$490**

LNW ROMAR TOSHIBA PRODUCTS AVAILABLE

# MICROMAIL

631 E. First St., Tustin, CA 92680

**(714) 838-9100**

\*IBM PC is a registered trademark of IBM Corp.  
\*dBASE II is a registered trademark of AST/COMDATE, Inc.  
\*LOTUS 1-2-3 is a registered trademark of Lotus Development  
\*Wordstar, Spellstar, Mailmerge are registered trademarks of Micropro International  
\*Visicalc is a registered trademark of VisiCorp

Multiplan is a registered trademark of Microsoft Corp.  
\*PFS is a registered trademark of Software Publishing Co.  
\*CP/M86 is a registered trademark of Digital Research, Inc.  
\*MS-DOS is a registered trademark of Microsoft Corp.  
\*UCSDp is a registered trademark of Softech Microsystems

## DISK DRIVES

(For PC, Mod I, III & IV)

Qume 142A	\$209
Teac FD55B	\$209
Tandon TM100-2	\$225
Tandon TM101-4	\$315
CDC 9409	\$235
Case and PS	\$ 45

## PC EXPANSIONS

Maynard Disk Controller	\$159
Sandstar Series	\$call
Internal 10MB HD systems from	\$959
Quadboard (64K)	\$265
Quadcolor I	\$199
AST SixpackPlus (64K)	\$285
MegaPlus (64K)	\$265
I/O Plus	\$114
2nd SP PP or Game	\$ 35
HERCULES graphics board	\$349
HAYES Modems	\$call
Set of 9 chips (64K)	\$ 55

**VLM Computer Electronics**  
10 Park Place • Morristown NJ 07960  
(201) 267-3268 Visa, MC, Check or COD

## NOW YOU CAN Save Up To 50% On

### RIBBONS

Ribbon Type	3	5	10
C-IBM Prowriters	5 <sup>th</sup> ea	5 <sup>th</sup> ea	4 <sup>th</sup> ea
Epson/IBM FX/RL/MX-80	5 <sup>th</sup> ea	5 <sup>th</sup> ea	4 <sup>th</sup> ea
Epson/IBM FX/RL/MX-100	7 <sup>th</sup> ea	5 <sup>th</sup> ea	5 <sup>th</sup> ea
Genium 10/100/15/15X	2 <sup>th</sup> ea	2 <sup>th</sup> ea	2 <sup>th</sup> ea
Quadrax 80/82/83/82/83	2 <sup>th</sup> ea	2 <sup>th</sup> ea	2 <sup>th</sup> ea
Shop & Hand in Cont. U.S.	3 <sup>rd</sup>	Free	Free
Others: Quabe, Qume, Nec, Dec, T.I., etc.			CALL

### DISKETTES

5 1/4" Soft Sector	10	80	100
OPUS (3M Media) DS/DD	10 <sup>th</sup>	17 <sup>th</sup> /10	16 <sup>th</sup> /10
OPUS (3M Media) DS/DD	23 <sup>rd</sup>	21 <sup>st</sup> /10	19 <sup>th</sup> /10
Ship & Hand. in Cont. U.S.	3 <sup>rd</sup> /10	3 <sup>rd</sup> /50	4 <sup>th</sup> /100
Max. alt. post. Verbatim			CALL
Deboss Tray Write-Lock Holds 70 Disettes			18 <sup>th</sup>

Order Toll Free 1-(800) 821-5338  
or Call 1-(801) 298-0872  
or Rush Check or Money Order To:  
**C. R. E. Wholesale Products**  
P. O. Box 361 North Salt Lake, Ut. 84054

Circle 114 on inquiry card.

## WE'LL HELP YOU

Communicate with the World!

### MODEMS

U.S. Robotics 300/1200 Baud	
PASSWORD	only \$339.00
IBM P.C. Card ..	only \$339.00
Anchor 300/1200 Baud	
(Hays™ Compatible)	
MARK XII	only \$289.00
Anchor 300 Baud	
VOLKSMODEM	only \$69.00
VOLKSMODEM Cable.	19.95

Free Shipping & Handling in Cont. U.S.  
Shipped Direct from Stock  
Call for Excellent Quantity Discounts!

Order Toll Free 1-(800) 821-5338  
or Call 1-(801) 298-0872  
or Rush Check or Money Order To:  
**C. R. E. Wholesale Products**  
P. O. Box 361 North Salt Lake, Ut. 84054

Circle 115 on inquiry card.



Diskettes.  
Professional Excellence  
At Last.

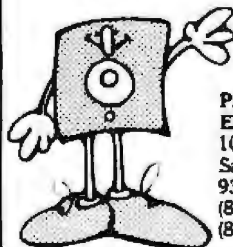
Dealer inquiries invited.  
(818) 303-1571

1720 Flower Ave Duarte CA 91010

Circle 200 on inquiry card.

## Verbatim flexible disks

Call Free (800) 235-4137 for  
prices and information. Dealer  
inquiries invited. C.O.D. and  
charge cards accepted.



**PACIFIC EXCHANGES**  
100 Foothill Blvd.  
San Luis Obispo, CA  
93401 In Cal. call  
(800) 592-5935 or  
(805) 543-1037.

Circle 305 on inquiry card.

## 6 times faster

Super Fast Z80 Assembly  
Language Development Package

### Z80ASM

- Over 6000 lines/minute
- Generates COM, HEX, or REL files
- Cross-Reference
- Zlog mnemonics
- Time and Date in listing
- Long labels

### SLANK

- One or two pass operation
- Cross-reference
- COM or HEX output
- Flexible address control

Most formats available for 286 CP M CDOS, and TURBODOS

**\$199.95**

**S L R Systems**

For more information or to order call  
1-800-833-2081 in Pa. (412) 282-0854  
1523 North Main Street, Butler, PA 16001  
VISA or Mastercard

Circle 349 on inquiry card.

## Your own representation in Düsseldorf City West Germany

Ideal set up for those starting a new  
business or needing part-time use of  
office and representation facilities.

Exclusively furnished executive offi-  
ces and conference rooms for 10 to  
30 persons - individual rent periods.  
Multilingual secretariate. Telephone  
service. Telex - mail service - word  
processing. Rooms for video/film/  
overhead facilities. Reception lounge  
(100 m<sup>2</sup>) with bar. For brochure:

**OFFICE + SERVICE CENTER  
INTERIM-BUROS GMBH**  
Raßstraße 166 • D-4000 Düsseldorf 30  
Tel. 0211/45 09 59 • Telex 8 588 321 osc d

Circle 298 on inquiry card.

## SOFTWARE REPRESENTATIVES

LIBRA Programming, Inc., a major  
supplier of business software and IBM  
authorized Value-Added dealer is  
looking for sales representatives for  
selected U.S. Markets. LIBRA, an INC.  
Magazine "500" company for 1983,  
represents an outstanding opportunity  
for an independent, motivated,  
high-earning person. Should have ex-  
perience selling software for small  
business.

Send resume or call

Lynn C. Alder,

National Sales Manager

1954 East 700 South

Salt Lake City, Utah 84121-3094

1-800-453-3827



**LIBRA**  
PROGRAMMING, INC.

Circle 233 on inquiry card.

## PRINTER RIBBONS

	PRICE	PER RIBBON	PER DOZEN
ANADIX 9500	13.50	13.50	147.00
APPLE DMP	5.95	5.95	68.40
CENTRONICS 150/152	7.00	7.00	81.00
C. ITOH PROWRITER	5.95	5.95	68.40
COMMODORE PET 8023P	7.00	7.00	81.00
EPSON MX-FX 70/80	5.25	5.25	60.00
EPSON MX-FX 100	9.95	9.95	108.00
GEMINI - 10	2.50	2.50	27.00
IBM HARMONICA 14"	6.75	6.75	78.00
IBM HARMONICA 35"	7.95	7.95	92.40
IDS MICROPRISM - 480	6.00	6.00	69.00
IDS PAPER TIGER 460/560	6.75	6.75	78.00
IDS PRISM	7.95	7.95	92.40
NEC - 3500 M/S S/S/C	6.95	6.95	80.40
NEC - 3500 NYLON	9.75	9.75	114.00
NEC - PC 8023A	5.95	5.95	68.40
OKIDATA 80/82/83/92	2.50	2.50	27.00
OKIDATA - 84	5.00	5.00	57.00
RADIO SHACK D.W. II NYLON	6.75	6.75	78.00
RADIO SHACK DMP - 2100	7.50	7.50	87.00
RADIO SHACK LP VI & VIII	6.00	6.00	69.00
SILVER REED EX55 S/S	5.00	5.00	57.00
SILVER REED EX55 - NYLON	9.00	9.00	105.00
TOSHIBA - 1350	7.50	7.50	87.00
XEROX 610/620 M/S	7.75	7.75	84.00

Add \$2.99 Shipping - To Order Call  
(313) 569-3218 or Write for our Catalog  
**DWIGHT COMPANY, INC.**  
15565 Northland Drive - West Tower  
Southfield, Michigan 48075-6496

Circle 147 on inquiry card.





# COMPUTER DISCOUNT PRODUCTS

## — SINCE 1977 —



HUGE Inventories of APPLE & IBM Products IN STOCK  
★ ASK ABOUT OUR FAIR PRICE POLICY - IT'S GUARANTEED! ★

**koala TOUCH PAD**  
\$85.99  
Apple, Atari, Commodore, IBM  
For Other Koala Ware \$5.00

### CDP SPECIALS

16K RAM CARD	39.99
POWER STRIP w/Surge	17.99
APPLE FAN w/Surge, 2 Outlets	39.99
PAR. PRINTER CARD & CABLE	39.99
16K UPGRADE 4118 200 NS (Selv)	9.99
64K UPGRADE 4164 200 NS (Selv)	79.99

**VCR TRAINING TAPES \$CALL**

### DISKETTES

DYSAN 5" SSDD (10)	31.99
DYSAN 5" SSDD (100)	299.99
DYSAN 5" DSDD (10)	34.99
DYSAN 5" DSDD (100)	369.99
MAXELL 5" SSDD (10)	27.99
MAXELL 5" SSDD (100)	259.99
MAXELL 5" DSDD (10)	37.99
MAXELL 5" DSDD (100)	369.99
VERBATIM 5" SSDD (10)	24.99
VERBATIM 5" SSDD (100)	229.99
VERBATIM 5" DSDD (10)	36.99
VERBATIM 5" DSDD (100)	349.99

### EDUCATIONAL SOFTWARE SPECIAL

Additional 10% OFF with order of any 5 educational programs from DLM, EDUWARE LEARNING COMPANY and SPINNAKER

### SPINNAKER

ALPHABET ZOO	18.99
DELTA DRAWING	32.80
ACEMAKER	21.99
TRACTION FEVER	21.99
KEY DIDDLE	19.99
UNDERDAMP	19.99
HIGST AMAZING THING	26.99
HYMNE & RIDDLE	19.99
WOOOPER TROOPS I & II	27.99
STORY MACHINE	21.99

**ALL OF ABOVE 226.99**

### APPLE SOFTWARE

BPI (GL, AP, AR, PAY, INV)	ea 274.99
BRODERBUND Arcade Machine	38.99
Banc Street Writer	44.99
Drol	34.99
Ladiesrunner	24.99
CENTRAL POINT Copy II	25.99
DATAMOST Aztec	26.99
DATASOFT Zarnox	34.99
OLM Alien Addition	Sch - 37.99, H - 27.99
Algebra Mix	Sch - 37.99, H - 27.99
Demolition Division	Sch - 37.99, H - 27.99
Dragon Mix	Sch - 37.99, H - 27.99
Metrol Multiplicator	Sch - 37.99, H - 27.99
Metrol Mission	Sch - 37.99, H - 27.99
Verb Viper/Word Invasion	ea 37.99
Word Man/Word Master	ea 37.99
Word Reader/Spelling Wiz	ea 37.99
EDUWARE Algebra I & II	31.99
Counting Bee	23.99
Decimals 3.0	28.99
Fractions 3.0	28.99
Hands on Basic	61.99
PSA Word Attack	28.99
SAT Word Attack	28.99
HAYDEN Fivestars	24.99
Sargon II	24.99
INCREDIBLE JACK	129.99
Jack Report	74.99
KENSINGTON Format II	128.99
LES Cressword Magic	38.99
LEARNING CO Bumble Bees	26.99
Bumble Plot/Magic Spell	ea 26.99
Gertvitas Puzzle/Secret	ea 26.99
Juggles Rainbow	18.99
Moplen Parade/Holes	ea 26.99
Rocky's Boots	34.99
MASTERTYPE	29.99
MICROLAB Miner 20-48er	27.99
MICROSOFT A.L.G.S.	75.99
Multipin	106.99
Multirol Budget	159.00
Multirol Financial Stmt.	89.99
ODESTA Chess	46.99
Odin	37.99
PENGUIN Graphics Magecan	38.99

### ACCESSORIES

FLUPN FILE (original)	17.99
FLUPN FILE w/Lockstay (25)	17.99
FLUPN FILE w/Lockstay (50)	27.99
HAYES 300 Baud Smartmodem	169.99
1200 Baud Smartmodem	474.99
LIBRARY CASE	1.99
KENSINGTON PC Saver	25.99
NOVATION 103 Smart Cat	189.99
103-219 Auto Cat	399.99
J Cat	99.99
Access 123	469.99
Cal Modem	134.99
Expansion Modem	28.99
PRINTERS C-ITION	378.99
Epson FX80	548.99
Epson FX80	248.99
On-base 82-85	84.99
PRINTER STAND 6m (plgbl)	24.99
PRINTER STAND Lg (plgbl)	29.99
RIBBONS-Brather	90.99
MX & FX 80	13.99
MX & FX 100	13.99
OKI 82, 83, 92, 93 & Gemini	94.99

**FINGERPRINT Epson Upgrade**  
RX, FX, MX 44.99

### IBM

1/2 Height DSDD Drive	239.99
ALPHA Typefaces	79.99
ASHTON ATE dBase II	429.99
Friday	104.99
Encyclopedia	59.99
AST Combo Plus	389.99
Six Pack Plus	299.99
BRODERBUND Serpentine	26.99
Logic Runner	24.99
CA Masters	ea 11.99
Subjects	ea 11.99
CENTRAL POINT Copy II PC	25.99
EDUWARE Algebra I	29.99
HAYDEN Pewriter	129.99
HAYES 1200B Modem	438.99
KRAFT Joystick	44.99
LIFETREE Wokswriter	119.99
MASTERTYPE	26.99
LOTUS 1-2-3	349.99
MICROLAB Miner 20-48er	27.99
MICROSOFT Mouse	129.99
Multipin	155.99
Multirol Budget	109.99
Multirol Financial Stmt	89.99
Word w/Mouse	289.99
319.99	
NORION Utilities	59.99
PC CRAYON	49.99
PC TUTOR	47.99
RFS Write	109.99
File	109.99
Report	109.99
Graph	109.99
POOL 1.5	27.99
SIERRA ON LINE Frogger	26.99
SW TECH Wizardy	44.99
SUB LOGIC Printball	29.99
TG Joystick	44.99
TITAN 64K BOARD	499.99
VISICORP Visicalc or Visidoc	164.99
Visicalc Schedule, Trend/Plot	ea 169.99
Vislink	84.99
Visispeh	179.99
Visword	269.99

**PLANTRONICS ColorPlus 375.99**

### Beasle Bros Micro Software Inc.

ALPHA PLOT	34.99
APPLE MECHANIC	18.99
BEASLE BASIC	24.99
DCS BOSS	15.99
DOUBLE TAKE	34.99
FLEX TEXT	18.99
FRAME-UP	16.99
PRONTO DOS	18.99
TIP DISK #1	14.99
TYPEFACES	14.99
UTILITY CITY	19.99

**ALL OF ABOVE 211.99**

### Continental

APPLE GRAPHICS BOOK	14.99
PSA (GL, AP, AR, PAY)	ea 148.99
CMFL 1st CLASS MAIL (AP)	61.99
CMFL 1st CLASS MAIL (IBM)	71.99
HOME ACCOUNTANT (IBM)	84.99
HOME ACCNT (RAYPRO OSB)	99.99
HOME ACCNT (TI PRO)	119.99
PROPERTY MANAGEMENT	285.99
AN ADVANTAGE (AP)	38.99

**ULTRAFILE (IBM) 156.99**  
**HOME ACCNT (AP) 44.99**

### APPLE HARDWARE

AUTO REPEAT KEY	18.99
BASIS 108	84.99
DAN PAYMAR Lower Case I (rev 1-4)	25.99
Lower Case 2 (rev 7)	15.99
DARK STAR Snapshot II	65.99
EASTSIDE Wacard II	119.99
FOURTH DIMENSION Drive	219.99
HAYES Micromodem IIe	84.99
KOALA PAD	85.99
KRAFT Joystick	38.99
Paddles	31.99
LEGEND 128K Ram	389.99
MICRO-SCI A-2 Drive	219.99
MOUNTAIN CPS Caro	199.99
Rambles - 32K	199.99
NOVATION Applicalt II	249.99
Applicalt Upgrade 1280 Baud	269.99
ORANGE MICRO Grappler +	119.99
Bullboard	119.99
Bullered Grappler +	179.99
PADDLE ADAPPL	24.99
SATURN 128K Ram	379.99
Accelerator II	444.99
heptone 64K	199.99

**ALS CP/M 3.0 259.99**

### APPLE HARDWARE

AUTO REPEAT KEY	18.99
BASIS 108	84.99
DAN PAYMAR Lower Case I (rev 1-4)	25.99
Lower Case 2 (rev 7)	15.99
DARK STAR Snapshot II	65.99
EASTSIDE Wacard II	119.99
FOURTH DIMENSION Drive	219.99
HAYES Micromodem IIe	84.99
KOALA PAD	85.99
KRAFT Joystick	38.99
Paddles	31.99
LEGEND 128K Ram	389.99
MICRO-SCI A-2 Drive	219.99
MOUNTAIN CPS Caro	199.99
Rambles - 32K	199.99
NOVATION Applicalt II	249.99
Applicalt Upgrade 1280 Baud	269.99
ORANGE MICRO Grappler +	119.99
Bullboard	119.99
Bullered Grappler +	179.99
PADDLE ADAPPL	24.99
SATURN 128K Ram	379.99
Accelerator II	444.99
heptone 64K	199.99

**ALS CP/M 3.0 259.99**

### IBM

1/2 Height DSDD Drive	239.99
ALPHA Typefaces	79.99
ASHTON ATE dBase II	429.99
Friday	104.99
Encyclopedia	59.99
AST Combo Plus	389.99
Six Pack Plus	299.99
BRODERBUND Serpentine	26.99
Logic Runner	24.99
CA Masters	ea 11.99
Subjects	ea 11.99
CENTRAL POINT Copy II PC	25.99
EDUWARE Algebra I	29.99
HAYDEN Pewriter	129.99
HAYES 1200B Modem	438.99
KRAFT Joystick	44.99
LIFETREE Wokswriter	119.99
MASTERTYPE	26.99
LOTUS 1-2-3	349.99
MICROLAB Miner 20-48er	27.99
MICROSOFT Mouse	129.99
Multipin	155.99
Multirol Budget	109.99
Multirol Financial Stmt	89.99
Word w/Mouse	289.99
319.99	
NORION Utilities	59.99
PC CRAYON	49.99
PC TUTOR	47.99
RFS Write	109.99
File	109.99
Report	109.99
Graph	109.99
POOL 1.5	27.99
SIERRA ON LINE Frogger	26.99
SW TECH Wizardy	44.99
SUB LOGIC Printball	29.99
TG Joystick	44.99
TITAN 64K BOARD	499.99
VISICORP Visicalc or Visidoc	164.99
Visicalc Schedule, Trend/Plot	ea 169.99
Vislink	84.99
Visispeh	179.99
Visword	269.99

**PLANTRONICS ColorPlus 375.99**

### QUADRAM

APIC (APPLE II PARALLEL)	129.99
RAM 80 column 64K IIE	84.99
MICROFAZER 8K Parallel	139.99
MICROFAZER 32K Serial	159.99
QUADBOARD I or II (64K)	399.99
QUADCOLOR I	219.99
QUADCOLOR II	399.99
QUAD S12 - (64K)	219.99

**aFAZER \$CALL**

### KENSINGTON MICROWARE

**SYSTEM SAVER**

- Surge Suppression
- Fits Apple Stand
- Dual Outlet
- U.L. Listed
- Great Gift

**\$ 65**

### INFOCOM

DEADLINE	32.99
ENCHARTER	32.99
PLANETFALL	32.99
SUSPENDED	32.99
WITNESS	32.99

**STARCROSS ZORK I, II, III ea 24.99**

### APPLE HARDWARE

AUTO REPEAT KEY	18.99
BASIS 108	84.99
DAN PAYMAR Lower Case I (rev 1-4)	25.99
Lower Case 2 (rev 7)	15.99
DARK STAR Snapshot II	65.99
EASTSIDE Wacard II	119.99
FOURTH DIMENSION Drive	219.99
HAYES Micromodem IIe	84.99
KOALA PAD	85.99
KRAFT Joystick	38.99
Paddles	31.99
LEGEND 128K Ram	389.99
MICRO-SCI A-2 Drive	219.99
MOUNTAIN CPS Caro	199.99
Rambles - 32K	199.99
NOVATION Applicalt II	249.99
Applicalt Upgrade 1280 Baud	269.99
ORANGE MICRO Grappler +	119.99
Bullboard	119.99
Bullered Grappler +	179.99
PADDLE ADAPPL	24.99
SATURN 128K Ram	379.99
Accelerator II	444.99
heptone 64K	199.99

**ALS CP/M 3.0 259.99**

### SIERRA ON-LINE INC.

FROGGER (Ap)	21.99
GENERAL MANAGER	49.99
HOME WORD	49.99
SCREENWRITER II	81.99
ULTIMA II	38.99

**80 QUEST FOR TRES OILS WELL NEW \$CALL**

### Videx

CHARACTER ROMS	24.99
ENHANCER II	99.99
FUNCTION STRIP	34.99
HARDSWITCH	19.99
MICROMODEM CRP	34.99
PCB	14.99
PRE-BOOTS Apple Writer	23.99
Apple Writer for Ultracom	38.99
Visicalc for Ultracom	71.99
Vocalc for Ultracom	64.99
SOFTWARE	25.99
ULTRACALC	84.99
VIDEOTERM w/SS + HW	379.99

**ULTRATERM 249.99**

### MicroPro

MAILMERGE	139.99
SPELLSTAR	139.99
WORDSTAR PRO	389.99

**INFOSTAR & WORDSTAR ea. 259.99**

### MONITORS

APPLE II 12" Green	199.99
PRINCE/TON RGB HY 12	499.99
TAXAN 12" Amber 18 mh	129.99
TAXAN 12" Green 18 mh	119.99
USI P1 1 9" Green 20 mh	99.99
USI P1 2 12" Green 20 mh	129.99
USI P1 3 12" Amber 20 mh	139.99
USI P1 4 9" Amber 20 mh	109.99
USI 1400C Color Compant	269.99

**TAXAN 420 RGB 499.99**

### DTC

Sheet Feeder	599.99
Tractors	129.99

**360 Z LETTER QUALITY DAISY WHEEL PRINTER**

- 48K Buffer
- 32 CPS
- Graphics
- 10, 12, 15 Pitch
- Proportional Spacing

**999.99**

Cable (Please Specify) 48.99  
**NEW! Stylewriter 699.99**

**MAIL & PHONE ORDERS:**

160 S. Winchester Blvd.  
San Jose, CA 95128  
(408) 985-0400

**SAN FRANCISCO**  
1230 Market St.  
San Francisco, CA 94102  
(415) 626-2244

**SAN JOSE**  
860 S. Winchester Blvd.  
San Jose, CA 95128  
(408) 985-0401

**SAN MATEO**  
4228 Olympic Ave.  
San Mateo, CA 94403  
(415) 571-1658

MON-FRI 10AM-7PM • SAT-SUN-HOL 10AM-5PM • San Jose Store Open Daily At 8AM

**COMPUTER DISCOUNT PRODUCTS**

- No Charge For Credit Cards
- Prices Subject To Change
- Software Sales Are Final
- International Orders Welcome
- Min UPS Chg \$4 + Ins.
- Min US Postal Chg \$10
- P.O.'s Welcome - Call First

## CP/M CROSS SOFTWARE for the NS16000

### INCLUDES:

- \* Cross Assembler \*
- \* Cross Linker \*
- \* Debugger \*
- \* N.S. ISE Support \*
- \* Librarian \*
- \* Pascal Cross Compiler \*

U.S. Prices start at \$500 for Assembler only

## SOLUTIONWARE

1283 Mt. View-Alviso Rd.  
Suite B  
Sunnyvale, CA 94089  
408/745-7818 • TLX 4994264

Circle 358 on inquiry card.

# uniforth

Come to us for your state-of-the-art FORTH needs! Announcing the latest additions to the UNIFORTH family:

16-bit 28000, 68000, 16032  
32-bit 80186, 68000, 16032

Obtain these stock items captured under traditional operating systems, or try our D816000, Slicer and CompuPro stand-alone versions. Complete compatibility is retained throughout the UNIFORTH product line (from the Commodore 64 to the VAX).

Features include software floating point, video editor, full macro assembler, debugger, decompiler, top-notch documentation, etc. Prices start at \$175. Call or write for our free brochure.

### Unified Software Systems

P O Box 2544 New Carrollton MD 20784 301/552-9590

DEC VAX POP RT-11 (REL-1) IBM Digital Equipment Corp  
QMS 77th Digital Research MSDOS 11th Microsoft VC 30  
17th Comshare

Circle 390 on inquiry card.

The IDEAL PERIPHERAL SWITCH should be Simple, Unobtrusive, Reliable and Inexpensive.



AP Series ABC peripheral switches are that and more! Simple. To select your peripheral, simply slide the selector lever to the desired position.

**Unobtrusive:** Measures only 9" wide by 3 1/2" deep by 1 1/8" high. It can be mounted on the side, behind, or underneath your desk, computer, or a peripheral. It can be placed to use no desk space, yet be instantly available. It is supplied with easy mounting tabs for any location. **Reliable:** You will use this switch for many years. Your computer may wear out first. **Inexpensive:** Where else can you buy a 3 to 1 full 24 line, RS-232 peripheral switch of this quality for less than \$100.00?

AP-Switch 3S Only \$87.95 plus \$3.00 shipping (RS-232 with female DB-25 connectors)  
AP-Switch 3P Only \$117.95 plus \$3.00 shipping (Centronics Parallel Female with Pass 1/8 31 36 switched)

We also have cables:

6 ft. DB-25 male-male \$24.95 plus \$2.00 shipping  
6 ft. Centronics male-male \$24.95 plus \$2.00 shipping

10 Day Money Back Guarantee - 1 Year Warranty

Send Check or M.O. to:

ARNDOS TECHNOLOGY

1027-A Avenida Azules • Camarillo, CA 93010

or Call 1 800 862-5800 USA or 1 800 962-3800 California  
9:00 a.m. - 5:00 p.m. weekdays Pacific Time - Orders Only  
C.A. Res. Add 6% Sales Tax - Listed are cash prices  
Video or MC add 3% - Technical info. Call 805 482-3804

Circle 43 on inquiry card.

## EASI Software, Inc.

Software tools for Architects and Consulting Engineers

**Structural Analysis**  
finite element w/plates, frames, & out of core solver

**Concrete Steel Design**  
columns, beams, & slabs

**Project Scheduling (PERT Method)**  
w/ cost analysis

**2-D Drafting System (high performance)**

**Coded Pressure Vessel Design**  
**Commercial Air Conditioning**

**Piping Design**

## EASI Software, Inc.

2891 LIVONIA CENTER ROAD  
LIMA, NEW YORK 14485  
(716) 346-2022

Circle 151 on inquiry card.



## Best Prices On TRS-80 Computers

Our 7th year of discounts  
Ed or Joe McManus  
Fgr. Prepaid. Save Tax.  
Toll Free 800-231-3680

Marymac Industries, Inc.

22511 Katy Fwy., Katy  
(Houston) Tx 77450

1-713-392-0747

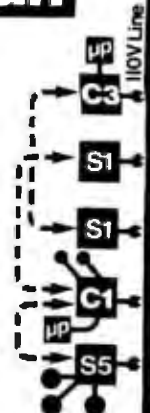
Telex 774132

See us in the Wall Street  
Journal every Tues. and Thurs.

Circle 250 on inquiry card.

## Powerlan™

Powerlan is a local area network that uses existing AC wiring for plug-in data collection and control of devices in the lab. Consisting of up to 32 powercoms and 64 powersats, it connects to any micro thru an RS232 interface. Powercom and Powersat both have digital I/O and analog inputs. Powercom is \$200 and powersat \$100.



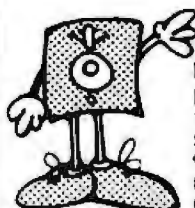
Powerlan  
128 Willow St.  
Acton, MA 01720

Circle 310 on inquiry card.



## FLEXIBLE DISCS

WE WILL NOT BE UNDER-SOLD!! Call Free (800)235-4137 for prices and information. Dealer inquiries invited and C.O.D.'s accepted.



**PACIFIC EXCHANGES**  
100 Foothill Blvd.  
San Luis Obispo, CA  
93401. In Cal, call  
(800)592-5935 or  
(805)543-1037

Circle 305 on inquiry card.

\*IBM PC Compatible



PRICES CALL LOWEST PRICES ANYWHERE

\*4164-150P ..... \$520  
\*4164-200/250 ..... 505/469  
4116-200 ..... 149  
\*4164-120 ..... 549  
6116-P3 ..... 499

Disk Drives (FDB Temp)

\*TM-100-2 ..... \$ 21924  
-4 ..... 29983  
\*TM- 55-2 ..... 22386  
\*10 mb Win ..... 1,38547  
(MS-DOS 2.0 IBM plug in 5.0)

Add \$2.95 shipping. All prices include 2.5% cash discount  
DEM • Quantity discounts available • P.O.s on approval • C.O.D. OK • FL residents add 5% tax • All new, no surplus, no seconds.  
(Prices subject to change)

4920 Cypress St., Tampa, FL 33607  
In FL, and for info., call 813-875-0299  
**FOR ORDERS ONLY, 800-237-8910**  
8 AM-8 PM EST

Circle 309 on inquiry card.

## SAVE MORE THAN EVER ON 3M Scotch® DISKETTES

LIFETIME WARRANTY!

**\$185** ea 5 1/4" SSDD (745) Qty. 20  
or (744)  
**\$235** ea 5 1/4" DSDD (745) Qty. 20

5 1/4" SSDD—96TP (745) \$2.60 ea  
5 1/4" DSDD—96TP (747) \$3.25 ea  
8" SSDD (740) \$2.06 ea  
8" SSDD (741) \$2.50 ea  
8" DSDD (743) \$3.10 ea

Shipping: 5 1/4" DISKETTES—Add \$3.00 per 100 or fraction thereof. 8" DISKETTES—Add \$4.00 per 100 or fraction thereof. OTHER ITEMS: Shipping charges as shown in addition to dealer shipping charges. Payment: VISA or MasterCard. C.O.D. orders only, add \$3.00. Taxes: Illinois customers, please add 8%.

Hours: 9 AM-5 PM Central Time

For last service call

Nationwide: 1-800-821-6827

In Illinois: 312-844-2788

**DISK WORLD!**

Suite 4806 • 30 East Huron Street • Chicago, Illinois 60611

Authorized Distributor  
Information Processing Products

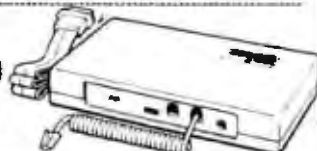


Circle 138 on inquiry card.



**SPECIALS on INTEGRATED CIRCUITS**  
 6502 @ 4.90 6520 @ 4.00 6522 @ 5.00 4115 @ 1.65  
 2532 @ 5.90 2716 @ 4.45 6116 @ 6.45 4164 @

**Anchor  
Automation  
Signalman  
MODEMS**



**FREE SOURCE MEMBERSHIP WITH SIGNALMAN**  
 All Signalman Modems are Direct Connect, and provide the best price-performance values Dealer and OEM inquiries invited

Volkmodem with computer cable	68
Mark VII Auto Dial/Auto Answer	99
Mark XII Smart Model 1200/300	279
<b>DC HAYES Smartmodem</b>	<b>210</b>
DC Hayes Smartmodem 1200/300	519



<b>PROM QUEEN for C64 or VIC</b>	<b>130</b>
Apple Emulator for Commodore B4	Call
STAT Statistics Package for C64	95
Solid Oak 2 Level Stand for C64 or VIC	29
C64/VIC Switch (networking)	129
BACKUP V1.0 tape copier for C64 or VIC	20
CARDBOARD/6 Motherboard - VIC	64
CARDBOARD/5 Motherboard - C64	56
CARD PRINT G Printer Int. with Graphics	79
CARD PRINT B Printer Interface - C64/VIC	48
CARDBOARD/3s Motherboard - VIC	32
CARDCO C64/VIC Calculator Keypad	22
CARDRAM/16 RAM Expansion - VIC	49
Complete CARDCO Line in stock	
CIE and VIE IEEE Interfaces in stock	
MSD Dual SuperDisk for C64 or IEEE	570
MAE Assembler for C64	50
Koolia Pad Touch Tablet - C64 or VIC	75
CBC 4/12 Analog to Digital 4 chn/12 bit	179
MULTIPLAN for C64	7
Dust Cover for C64 or VIC	6
Grand Master Chess for C64	24
COMAL Language for C64	14
with sprites, color graphics, sound, turtle graphics	
BusCard II from Batteries Included	159
ULTRA BASIC - 64 with Turtle Graphics	37
Super Disk Utility - C64 - includes backup	19
MicroChess - C64 - 8 levels of play	17
HES MODEM with software for C64	46
Commodore 64 Programmers Reference Guide	16
WordPro 3+/64 with Spellright	85
ViController (also C64) - BSR Controller	50
COM VOICE Synthesizer for C64 or VIC	139
VIC products in stock - call for extra discounts.	
Victory Software for VIC and C64 in stock.	

**APPLE—FRANKLIN ITEMS**

<b>FRANKLIN—complete line in stock</b>	
QUENTIN Drives for Apple/Franklin	189
Swapper Stepper	26
automatic switch between paddles and joystick	
KRAFT Apple Joystick	40
Kraft Apple Paddle Pair	30
Koolia Pad Touch Tablet-Apple/Franklin	80
SPINNAKER Software in stock	
Broderbund Software in stock	
16K RAM Card for Apple	59
Multiplex—Microsoft	185
Solid Oak 2 Level Stand for Apple	29
Serial Card for Apple	89
MPC RAM/80 column card for (to AP/TXT)	138
Z80 Softcard and CP/M (Microsoft)	235
RANA Elite I with Controller	389
Parallel Printer Interface/Cable	69
Microtrak and MPC Interfaces in stock	
Grappler + Interface	135
DC Hayes Micromodem II, tie with Smartcom	245
PF5: File or PFS: Report or PFS: Graph	95
Videx 80 Column Card	209
Apple Blue Book	19

**Commodore**

See us for Personal, Business, and Educational requirements. Educational Discounts available.

**PETSCAN I \$245 base price**

Allows you to connect up to 30 CBM/PET Computers to shared disk drives and printers. Completely transparent to the user. Perfect for schools or multiple word processing configurations. Base configuration supports 2 computers. Additional computer hookups \$100 each.

**COMPACT/STCP \$115**

Intelligent Terminal Package for PET, CBM, C64  
 Includes AGIA Hardware / STCP Software

MSD Dual Super Disk for IEEE or C64 570  
 replaces 4040 drive

SCREENMAKER 80 Column Adapter for C64 139

Provide big screen capability for business applications.

Copy-Writer Word Processor for C64 49

Full-featured package with 900 lines of text in memory. Includes double column printing, graphic capability, full printer support.

Special Screenmaker/Copy-Writer Combo 179

**VICTORY Software for VIC and C64**

Metamorphosis	18	Creator's Revenge	16
Labyrinth of Creator	16	Galactic Conquest	16
Kongo Kong	16	Annihilator	16
Chomper Man	16	Grave Robbers	13
Bounty Hunter	16	Adventure Pack I or II	16

PAPER CLIP Word Processor - CBM/C64 60

ORACLE Data Base from Batteries Included 89

SPINNAKER Software C64, Apple, IBM, Atari

Computer's First Book of PET/CBM

POWER ROM Utilities for PET/CBM

WordPro 4+ - 8032, disk, printer

VISICALC for PET, ATARI, or Apple

Computer's First Book of 64 Sound & Graphics

SM-KIT enhanced PET/CBM ROM UTILITIES

PET Spacemaker II ROM Switch

Computer's First Book of Games

Dust Cover for PET, CBM, 4040, or 8050

Cmc Interfaces (ADA1800, ADA1450, SADI in stock)

Computer's Reference Guide to 64 Graphics

Computer's Machine Language for Beginners

NES Software and Hardware in stock

**FlexFile for PET/CBM/C64 \$59**

DataBase, Report Writer with calculations, Mailing Lists. Easy to use, and can be modified

FORTH for PET/C64 full FIG model - Cargile/Riley 50

includes all FORTH 79 Standard extensions, structured 6502 assembler with nested decision macros, standard 16x64 screens, ability to read/write BASIC sequential files, sample programs, introductory + reference manual.

Metacompiler for FORTH for independent object code 30

Flexitag Point for FORTH 20

KMMM PASCAL IV for PET/CBM/C64 99

Virtually full Jensen-Wirth implementation is now suitable for advanced placement courses.

EARL for PET/CBM Disk-based ASSEMBLER 65

SuperGraphics - BASIC Language Extensions 45

Fast graphics, sound, turtle graphics routines for PET/CBM

RAM/ROM for PET/CBM 4K \$75 8K \$90

COMAL Language for C64, CBM, PET 14

CBM Public Domain Software - C64 27 disks 75

STAT for PET/CBM/C64 and Apple 95

Comprehensive Statistical Analysis Routines

Includes complete file handling capabilities, summary statistics, confidence intervals, hypothesis tests, exponential mean tests, multiple and power series regression, analysis of variance, histograms, and non-parametric tests

PageMate 50 Commanded Word Processor 20

Full-featured package for all Commodore computers.

Full screen editing, and supports disk, tape, and all printers.

**DISK SPECIALS**



Scotch (3M) 5" ss/dd	10/ 2.10	50/ 1.90	100/ 1.86
Scotch (3M) 5" ds/dd	10/ 2.65	50/ 2.45	100/ 2.40
Scotch (3M) 8" ss/sd	10/ 2.20	50/ 2.00	100/ 1.98
Scotch (3M) 8" ss/dd	10/ 2.80	50/ 2.50	100/ 2.47

**We stock VERBATIM DISKS**

Write for Dealer and OEM prices.

Sentinel 5" ss/dd	10/ 1.80	50/ 1.75	100/ 1.65
Sentinel 5" ds/dd	10/ 2.40	50/ 2.35	100/ 2.25

**We stock Dysan disks**

Wabash 5" ss/sd	10/ 1.50	50/ 1.45	100/ 1.40
Wabash 5" ss/dd	10/ 1.80	50/ 1.75	100/ 1.65
Wabash 5" ds/dd	10/ 2.50	50/ 2.45	100/ 2.35

**We stock MAXELL DISKS**

Write for dealer and OEM prices.

Disk Storage Pages	10 for \$4	Hub Rings 50 for \$6
Disk Library Cases	8"—3.00	5"—2.25
Head Disk Cleaning Kits	12	
AMARAY Disk Storage Systems	in stock	
Innovative Concepts FLIP 'N' FILES	in stock	

**CASSETTE TAPES—AGFA PE-611 PREMIUM**

C-10	10/ .61	50/ .58	100/ .50
C-90	10/ .85	50/ .82	100/ .70

**ZENITH data systems**

ZVM-122A	99	ZVM-123G	89
ZVM-131	300	ZVM-135	490
Z100 16-bit/8-bit System			CALL
Z29 Terminal (DEC and ADM compatible)			680
Z-150 IBM PC COMPATIBLE			CALL
Z-180 PORTABLE PC			CALL

We stock entire Zenith line

USI Video Monitors - Green or AMBER 20 MHz hi-res  
 Dealer and OEM inquiries invited

**WRITE FOR IBM PC COMPATIBLE PRICES**

Multiplex—IBM or Apple	179
Quadboard for IBM available	
KOALA PAD Touch Tablets—Apple, Atari, IBM, CBM	
Peachtext 5000 Software Package	199
PFS Software for IBM and Apple in stock	
SPINNAKER Software C64/VIC, Apple, IBM, Atari	
VOTRAX Personal Speech System	269
BMC 9191 Color Monitor	229
BMC 12A 12" Green Monitor	79
Dynax (Brother) DX-15 Daisy Wheel Printer	469
Brother HR-25 Daisy Wheel Printer (25 cps)	749
Itoh Prowriter Parallel Printer	379
Panasonic 1090 Printer with Correspondence Mode	279
Gemini 10X	289
EPSON, Okidata, Star Microsics printers in stock	
USI CompuMOD 4 R F Modulator	29
We Stock AMDEX Monitors	

A P Products 15% OFF

**COMPUTER COVERUPS IN STOCK**

BROOKS 6 Outlet Surge Suppressor/Noise Filter	54
Surge Suppressor-6 outlet	29
Electrohome 1302-2 13" Hi-res RGB Monitor	335
Panasonic 12" Monitor (20 MHz) with audio	135
Synertek SYM-1 Microcomputer	189

**Hewlett Packard**



Write or call for prices

**BATASHIELD BACKUP POWER SOURCE \$265**

Battery back up Uninterruptible Power Supply with surge and noise filtering. The answer to your power problems.

**ATARI - WE STOCK ENTIRE LINE**  
 SPINNAKER and Broderbund Software in stock.

215-822-7727  
 252 Bethlehem Pike  
 Colmar, PA 18915

**A B Computers**

**WRITE FOR CATALOG.** Add \$1.50 per order for United Parcel  
 We pay balance of UPS surface shipping charges on all prepaid orders  
 (add extra for mail, APO/FPO, air). Prices include cash discount.  
 Regular prices slightly higher. Prices subject to change.

## HALF HEIGHT DRIVES

Special!



**SHUGART: SA 455**  
Double Sided, 40 TRK/Side . . . . . **\$209**

**CDC: 9428**  
Double Sided, 40 TRK/Side . . . . . **\$199**

**PANASONIC: 551-2**  
Double Sided, 40 TRK/Side . . . . . **\$189**

- 120 Day Warranty
- Free Shipping
- No Charge For Credit Cards
- Order Toll Free



**1-800-531-5475** (Outside Of Texas)  
**(512) 250-1489** (In Texas)  
Texas Residents Add 5% Sales Tax.

**CompuAdd Corp**

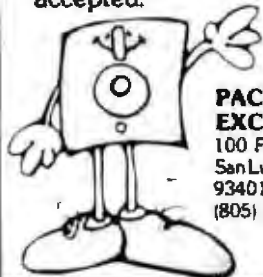
13010 Research Blvd., Suite 101  
Austin, Texas 78750

Circle 88 on inquiry card.

# TDK

## flexible disks

Call Free **(800)235-4137**  
for prices and information.  
Dealer Inquiries invited.  
C.O.D. and charge cards  
accepted.



**PACIFIC EXCHANGES**  
100 Foothill Blvd  
San Luis Obispo, CA  
93401 (In Cal call  
(805) 543-1037)



Circle 305 on inquiry card.

\*\*\*NEW LOW PRICES\*\*\*

## MEDIA CONVERSION

We Put Your Data Where  
YOU Want It!

Your data can be copied from and/or  
to any of the following: 1/2" mag tape,  
8" Diskette, 5 1/4" Diskette.

- 1/2 Inch Magnetic Reel Tape:  
800 / 1600 B.P.I.  
ASCII / EBCDIC
- 8 Inch Diskette:  
CP/M, IBM 3740, DEC RT-11
- 5 1/4 Inch Diskette:  
Apple II—DOX, CP/M, Pascal  
IBM PC/XT—MS-DOS, CP/M

\*\*\*PLUS\*\*\*

Virtually ALL Soft-sectored Formats  
**PROFESSIONAL DATA SERVICES**

385 Woodley Road

Santa Barbara, CA 93108

805/969-6993 9:00-5:30 PST

\*\*\*NEW FORMATS AVAILABLE\*\*\*

Circle 319 on inquiry card.

### QUASI-DISK, an 8-100 RAM-Disk \$915. with .5 Mbyte of 64K DRAM

QUASI-DISK is an 8-100 bus memory card  
with 84 sockets for Dynamic RAM. The ca-  
pacity is 5 Mbyte using 64K D-RAMs or 2.0  
Mbyte using 256K D-RAMs. Combinations of  
64K and 256K D-RAMs may be used.  
QUASI-DISK is supplied with CP/M 80 soft-  
ware including source code on an 8" dis-  
kette to allow the board to emulate a disk  
drive. This is a high quality six layer printed  
circuit board. Documentation includes pro-  
fessional schematics, however two PAL ICs  
are undocumented.

Because RAM can be accessed approxi-  
mately 1,000-fold faster than either a floppy  
diskette or a hard disk you will enjoy overall  
response times perhaps 35x faster than your  
current disk drive. Programming becomes  
more of a pleasure because your time is  
more productive.

OPTION 64 socket piggy back expansion  
board. Supplied with 5 Mbyte of 64K D-  
RAMs @ \$684. Capacity is expandable to  
2.0 Mbyte using 256K RAMs.

OPTION A battery back-up board.

**MICROPROCESSORS UNLIMITED**

George Chalmers  
(918) 287-4961

Price is subject to change.

Circle 274 on inquiry card.

## EPROM PROGRAMMER

ONLY  
**\$295.95**

COMPLETE WITH  
PERSONALITY  
MODULE

110V AC POWER-RS232 3 WIRE  
-6 BAUD RATES

**ALLOWS READ, WRITE & VERIFY**

Comes complete with BASIC Driver Program  
Listing for most small micros (or easily adapted).

**Full 1 Year Warranty**

Programs the following: 5 Volt 24 or 28 pin  
devices: 2716, 2732, 2732A, 2764, 27128,  
27256, 25xx series, 68766 plus others.  
Specify Personality Module desired with order.  
Additional Personality Modules only \$19.95 ea.

CALL OR WRITE FOR DETAILS

**APROPOS TECHNOLOGY**

1071-A AVENIDA ACASO

CAMARILLO, CA 93401

(805) 482-3604

AdJ  
\$4.00 Shipping  
VISA or MC Add 3%

Circle 44 on inquiry card.

## Disks 'n Things

★ Dealer Inquiries  
Welcomed

**maxell**

**Dysan**

**wabash**



**SUPER  
LOW  
PRICES**

- ★ Factory Warranty
- ★ Finest Quality
- ★ Fast Delivery

**CALL 818-706-8602**

- Credit For Direct Dial Call With \$30 Ord.rr
  - We Pay Shipping—MC/VISA—COD Costs
  - 2% Discount For Cash
- Applicable to USA Customers Only

**Disks 'n Things**

5605 Soltwind Way  
Agoura Hills, CA 91301

Price List Available



Circle 198 on inquiry card.

## DREDDBOARD ON THE BUS For IBM, Apple & Commodore



Build your developmental circuit quickly and  
easily. **eZ Board** is a developmental breadboard  
which plugs into your computer's expansion slot  
through an integral 16 inch cable. **eZ Board**  
makes your system bus easily accessible at the  
solderless breadboard at points clearly marked  
to match the bus designations of your computer.  
Plug-in up to 16 fourteen-pin DIPs plus discrete  
components, interconnect with ordinary hookup  
wire. No solder, no wire-wrap.

Complete system with idea booklet only  
\$174.95 plus \$5.00 S&H. Optional buffer/  
decoder and expansion breadboards available.

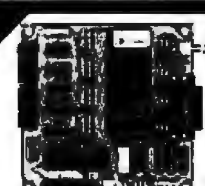
**S.E. Corporation**

P.O. Box 1132, Yorba Linda, CA 92666

Phone: (714) 630-9335 Telex: 756-582

Circle 341 on inquiry card.

**NOW INCLUDES  
TINY BASIC  
IBM PC DEVICE DRIVER  
KIT AVAILABLE**



## SIBEC 51

8051-Based Single-Board Computer with  
Monitor/Debugger

- 4 28-pin byte-wide sockets, monitor will program EEPROMS
- Perfect for System Development and Educational Applications



**\$335**



**Binary Technology**

P.O. Box 158 • HANOVER, Pa. 17375 • 610-643-7881

Circle 60 on inquiry card.

## MAKE YOUR COMPUTER TALK

**Best buy in speech synthesis!!**

Plug in **PROTALKER** by Speech, Ltd. & your computer could  
be talking today. **PROTALKER** uses superior technology  
to provide high fidelity reproduction of any speaker's voice  
& intonation. Record & play messages in any language.  
**PROTALKER** comes with ready-to-use software for easy  
preparation of speech files; playing messages from  
BASIC; and source assembly language drivers. You choose  
the best storage/quality trade-off with switch selectable  
digitizing rates of 2, 3, or 4 KB/sec. Use **PROTALKER** to in-  
sert voice instructions in all your programs. **PROTALKER** pro-  
vides the best quality speech synthesis available for your  
micro. **PROTALKER** is simple enough for the first-time user  
but powerful enough for the most advanced programmer.

**Free software** for ordering now!! **PROTALKER** &  
manual \$325. Manual only \$20. Specify S-100 or IBM PC  
board; CPM, CPM-86 or MS-DOS; 8" IBM SS-SD or 5 1/4"  
IBM PC disk format. MC & VISA, include your card number  
& expiration date. CA residents add 6.5% sales tax.

**SPEECH, LTD.**

3790 El Camino Real, Suite 213  
Palo Alto, CA 94306 415-841-2490

Circle 248 on inquiry card.





# FORMULA INTERNATIONAL INC.

12603 Crenshaw Blvd., Dept. B, Hawthorne, CA 90250

For information (213) 973-1921 • Orders Only (outside Calif.) (800) 672-8758



## pinecom™

No Copyright Problems!

## Pioneer of Low Cost Apple\* Compatible Computer

Compare These Features with Our Competitors:

- Powerful Utility Program (100% Apple Compatible)
- 68-Key Upper & Lower Case Keyboard with Numeric Keypad
- 25 Pre-programmed Function Keys
- 2 Speed Auto Repeat Function
- 64K User Memory—expandable to 192K
- 5A Switching Power Supply (110/220VAC)
- All ICs Are Socketed for Easy Service
- Nation-wide Dealer Network for Convenient Technical Support

And best of all, the price Assembled and Tested is just.....



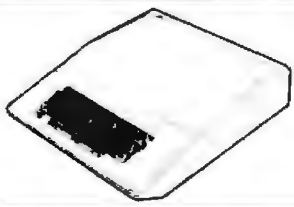
Now with New Improved Keyboard and 64K RAM **\$499<sup>00</sup>**

## pinecom™ DP-64

- Dual Processor (6502 and Z80A)
- Detached Keyboard
- 64K RAM Expandable to 192K
- 25 Function Key Keyboard
- Auto Repeat Keys w/Upper/lower Case
- 2 Slim Disk Drives (optional)
- 100% Apple II Compatible
- 40/80 Column Display (optional)
- Runs Both Apple Soft and CP/M Software



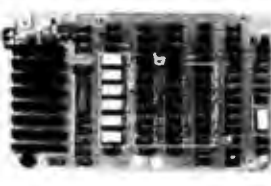
Model DP-64 Fully Assembled... **\$650<sup>00</sup>**



### AP-II COMPUTER A&T

Apple Look Alike  
48K User Memory  
Supports Upper & Lower Case  
100% Apple II\* Compatible

**\$455<sup>00</sup>**



### AP-II MOTHERBOARD

Apple II + \* Compatible  
48K Memory Space  
8 Expansion Slots

Bare Board..... **\$69.95 ea.**  
Assembled & Tested .... **\$295.00 ea.**



### PRINTER by Super-5

Parallel Interface (Centronics Compatible) Standard  
Microprocessor Electronics  
80cps Bidirectional with Logic Seeking  
96 Character ASCII  
Adjustable Sprocket and Friction Feed

Model CP-80 .... **\$265<sup>00</sup>**

### MICRO-II COMPUTER

100% Apple Compatible • No Copyright Problems!



Model I 48K RAM..... **\$475<sup>00</sup>**

Model II 64K RAM..... **\$515<sup>00</sup>**

Model III 64K RAM w/Dual CPU... **\$555<sup>00</sup>**  
(6502 for Applesoft & Z80A for CP/M)

Case and Keyboard Only..... **\$159.95**

All above models are standard with Numeric Keypad, Function Keys, Auto Repeat Keys, Upper/lower Case Function, Fully Assembled and Tested.

## PERIPHERALS

- Autoterm 80-Col. w/Softswitch ..... **\$99.95**
- 80-Column Card ..... **99.95**
- 80-Column for Apple II\* ..... **49.95**
- Z80 CP/M Card (no software) ..... **99.95**
- 16K RAM Card w/Cable ..... **47.50**
- Parallel Printer Interface ..... **85.00**
- Buffer for Printer Interface (16-64K) .... **85.00**
- Serial Printer Interface Card w/Adj. Baud . **85.00**
- Disk Controller ..... **65.00**
- Disk Controller DOS 3.2/3 Auto Select. **75.00**
- EPROM Writer Card (2716/2732/2764) ... **75.00**

## 3M DISKETTES SALE

Single Sided / Double Density Soft Sector

10 for **\$24<sup>50</sup>**

SEND ONE DOLLAR FOR OUR DETAIL CATALOG

Shipping & Handling Charges	
Under \$50.00	Over \$50.00
Purchase 10%	Purchase 5%
Overseas 15%	Overseas 10%
Overseas 25%	Overseas 20%

Minimum Order \$10.00/Calif. Residents add 6.5% Sales Tax. Phone Orders Accepted on VISA or MC ONLY. NO C.O.D.'s. Prices subject to change without notice.



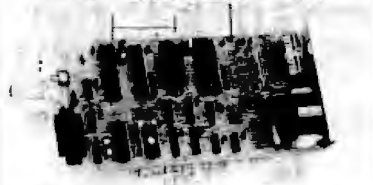
STORE HOURS  
MON-FRI—10-7  
SAT—10-6

\*Apple and Apple II are the trademark of APPLE COMPUTERS, INC.

Inside California  
Outside Calif. (incl. Mexico & Canada)  
Overseas

Circle 175 for Dealer inquiries. Circle 176 for End-User inquiries

## EPROM PROGRAMMER KIT - MODEL 1409



- Programs, lists, reads and verifies 2508, 2516, 2532, 2544, 2754, 2716, 2732A, 2764, 27128, 68732, 68764, 68768, 8941, 8746, H, H, H
- RS 232 interface, supports NON-KOFT and/or hardware handshaking (RTS, CTS, DTR)
- Auto baud rate select (300-9600 baud)
- Accepts keyboard entry with line editing capability, ASCII, INTEL, MOTOROLA, or HEX files
- User friendly monitor for easy I/O debugging
- On board power supply
- 1409-1: P.C. board, Klimatec software (4K EPROM) & documentation: \$299.50
- 1409-2: 1409-1 + full set of parts: \$194.50
- 1409-3: Assembled and tested unit: \$299.50
- Communication software for IBMPC, APPLE, CP/M, TRS80: \$35.00

### B&C MICROSYSTEMS

6322 Mojave Dr., San Jose, CA 95120  
Tel. (408) 927-7885, Tx. 4885383

Circle 52 on inquiry card.



## GREAT DISKETTES

Super low prices  
**SYNCOM**

The low priced, high quality diskette with a LIFETIME WARRANTY. Packed in polybags of 10 with Tyvek envelopes, labels and reinforced hubs.

One of the best buys we've seen **LIFETIME WARRANTY**  
**\$139** ea. 5 1/4" SSDD **\$185**  
QTY 20 QTY 20  
5 1/4" DSDD ea. †

### OTHER GREAT VALUES:

**DISKETTE 70**—Holds 70 5 1/4" diskettes in dust free safety \$14.95 ea. + \$3.00 Shipping  
**DISK CADDIES**—Flip up style holds 10 5 1/4" diskettes \$1.65 ea. + .20 Shpg.

Shipping: 5 1/4" DISKETTES—Add \$3.00 per 100 or fraction thereof. OTHER ITEMS: Shipping charges as shown in addition to diskette shipping charges. Payment: VISA or MC. C.O.D. orders only, add \$3.00. Taxes: Illinois customers, please add 8%.

Nationwide: 1-800-621-6827  
In Illinois: 1-312-944-2788

Minimum Order: \$35.00  
WE WILL BEAT ANY NATIONALLY ADVERTISED PRICE!

**DISK WORLD!**  
Suite 4806 • 30 East Huron Street • Chicago, Illinois 60611

## SYNCOM

Circle 139 on inquiry card.

**Dyan** DISKETTES

**5 1/4"** Specialty Soft 10 or 16 Sectors \$10 \$50 \$100

104-10	SSDD	29.00	142.50	280.00
104-20	DSDD	40.00	197.50	390.00
204-10	SSDD	40.00	197.50	390.00
204-20	DSDD	48.50	240.00	475.00

**8"** Unformatted \$10 \$50 \$100

3740-1	SSDD	34.00	167.50	330.00
3740-10	SSDD	42.50	210.00	415.00
3740-20	DSDD	50.00	247.50	490.00

### CALL TOLL FREE

800-824-7888  
OPERATOR 906  
(VISA, M.C., C.O.D.  
ORDERS ONLY)

7 Days a Week, 24 Hours a Day

### (408) 252-4210

M-F, 8:00 AM - 5:00 PM  
FOR NEXT DAY  
SHIPMENT  
Inquires Also

**Creativity Unlimited**

• Add \$2.00 Shipping  
Per Order  
• CA Residents Add Sales Tax  
1741 Saratoga Avenue, Suite #100  
San Jose, California 95128

Send for Our Free Catalogue • Dealer Inquiries Invited

Circle 116 on inquiry card.

## 8K Memory Module

50% OFF

Radio Shack Model 100  
NEC PC-8201

\* Suggested List \$120.00.

Purple price **\$59.95**

- Low power CMOS design.
  - Simple installation instructions included.
  - 30 day satisfaction guarantee or your money back.
  - 1 Year warranty.
  - Next day shipment via UPS included in price.
  - Optional Memory Test program \$15. (Cash/pte)
- No VMs direct connect Modern Cable - \$9.95

Shipping: From stock Free UPS surface Cont USA—Add \$4.00 for UPS 2 day Air—Add \$7.00 for Canada—Payment: VISA or M/C. Checks hold 14 days. —Tax: 6% (Calif. only).

**PURPLE COMPUTING**  
2068 Ventura Blvd.  
Camarillo, Ca. 93010

**CALL NOW**  
 (805) 987-4788

Circle 322 on inquiry card.

## IBM-PC

64K 2 DS/DD DRIVES

# \$ 2350

TAVA PC.....\$1950  
SANYO MBC-555..\$1119  
EAGLE PC 2 Plus..\$1995  
COLUMBIA 1600-1..\$2695  
DYNAX DX 15 lqp..\$ 435  
JUKI 6100 lqp...\$ 435  
Okidata 92 P dmp \$ call  
Taxan 210 col.mon. \$ 330

FOR Computers, Printers & more  
Call: THE COMPUTER CLUB Inc!!

VISA 7 Days 619/578-5654

Circle 95 on inquiry card.

## ICs PROMPT DELIVERY!!!

SAME DAY SHIPPING (USUALLY)

### DYNAMIC RAM

256K	200 ns	\$59.90
64K	200 ns	5.87
64K	150 ns	5.99
64K	120 ns	7.50
16K	200 ns	1.15

### EPROM

27128	300 ns	\$22.50
2764	250 ns	9.25
2732	450 ns	8.50
2716	450 ns	3.60
2532	450 ns	4.75

### STATIC RAM

6284P-15	150 ns	\$42.00
6264LP-15	150 ns	44.00
6118P-3	150 ns	6.56

MasterCard VISA or UPS CASH+COD  
Factory New, Prime Parts **UPON**  
MICROPROCESSORS UNLIMITED  
24 000 Sully Parkway Ave  
REDFORD, IL 60462 (818) 267-4961

Circle 275 on inquiry card.

## 5 1/4" DISK DRIVES

New Low Prices!



**TANDON: TM 100-2** \$229  
Double Sided, 40 TRK/Side

**TANDON: TM 100-1** \$179  
Single Sided, 40 TRK

**CDC: 9409** \$229  
Double Sided, 40 TRK/Side

- 120 Day Warranty
- Free Shipping
- No Charge For Credit Cards
- Order Toll Free

1-800-531-5475 (Outside Of Texas)  
(512) 250-1489 (in Texas)  
Texas Residents Add 5% Sales Tax.

**CompuAdd Corp**

13010 Research Blvd., Suite 101  
Austin, Texas 78750

Circle 89 on inquiry card.

## MEMOREX FLEXIBLE DISCS

WE WILL NOT BE UNDER-SOLD!! Call Free (800)235-4137 for prices and information. Dealer inquiries invited and C.O.D.'s accepted.



VISA

**PACIFIC EXCHANGES**  
100 Foothill Blvd.  
San Luis Obispo, CA  
93401 In Cal call  
(800)592-5935 or  
(805)543-1037

Circle 305 on Inquiry card.

## 10 M-BYTE DRIVES

WINCHESTER TANDON  
TM502

LIMITED SUPPLY  
**\$600**

NEW • TESTED  
ASK FOR  
SALES DEPARTMENT

**SBE**

4700 SAN PABLO AVENUE  
EMERYVILLE, CA 94608  
(415) 652-1805

Circle 275 on inquiry card.



# Lyc0 Computer Marketing & Consultants

TO ORDER  
CALL US

TOLL FREE 800-233-8760  
In PA 1-717-327-1824

PRINTER  
INTERFACING

PRINTER PAPER  
AVAILABLE

**SAVE** on these in-stock **PRINTERS**

Available for IBM PC, Apple, Atari, Vic 20 & Vic 64

## EPSON

**LETTER QUALITY**  
SMITH CORONA TP2...\$449.00  
**DIABLO 630 ..\$1719.00**

RX-80 .....\$849.00  
RX-80FT .....ON  
FX-80 .....In-Stock  
FX-100 .....EPSON  
MX-80FT .....PRINTERS  
MX-100 .....\$8CALL\$

## MANNESMANN TALLY

SPIRIT 80 .....\$CALL  
MT 160L .....\$CALL

## OKIDATA

80 .....\$849.00  
82A .....CALL for  
83A .....LOWEST  
84 .....PRICES  
92 .....on these  
93 .....In-Stock  
PACEMARK 3350...PRINTERS

**ATARI 850  
REPLACEMENTS  
IN-STOCK**

## CITOH

GORILLA GX100 .....\$178.00  
PROWRITER 8510 ...\$339.00  
PROWRITER II .....\$659.00  
8800 .....\$1025.00  
STARWRITER .....\$1099.00  
PRINTMASTER .....\$1499.00

## STAR MICRONICS

GEMINI 10X .....\$269.00  
GEMINI 15X .....\$CALL  
DELTA 10 .....\$479.00

## MODEMS

ANCHOR MARK I \$79.00  
ANCHOR MARK II \$79.00  
HAYES SMART \$239.00  
HAYES MICRO II \$309.00  
Micro Bit  
MPP-1000 .....\$129.75  
NOVATION  
CAT .....\$144.00  
D-CAT .....\$155.00  
J-CAT .....\$115.00  
APPLE CAT II .....\$279.00  
212 APPLE CAT .....\$589.00

## MONITORS

Sekata Color .....\$229.00  
Amdak Color I .....\$275.00  
Amdak 300 Green .....\$149.00  
Amdak 300 Amber .....\$149.00  
Gorilla Green .....\$99.00

## HES 64

Sound Box .....\$6.95  
64Forth .....\$55.75  
Hesmon .....\$25.75  
Turtle Graphics .....\$37.75  
Heswriter .....\$28.75  
Gridrunner .....\$19.75

## DUST COVERS

800 .....\$3.99  
400 .....\$3.99  
1200 .....\$3.99  
410 .....\$3.99  
810 .....\$3.99  
1050 .....\$5.99  
PROWRITER .....\$5.99  
GEMINI 10X .....\$5.99  
PERCOM DISK .....\$5.99

## SSI

Battle of Shilo .....\$26.75  
Tigers in the Snow .....\$26.75  
Cosmic Balance .....\$26.75



APPLE DUMPING GX \$99.75  
APPLE DUMPUNG 64 (16 Buffer) \$179.75

## INFOCOM

Zork I, II, or III .....\$26.75  
Desipline .....\$33.75

## CARDCO

Cardprinter / LO1 .....\$499.00  
Cardprint DM1 .....\$109.00  
5 Slot Expansion 64 .....\$54.00  
64 Write NOW .....\$39.00  
64 Mail NOW .....\$29.00  
2J Write NOW .....\$29.00  
64 Keypad .....\$29.00  
Universal Cass. Int. ....\$29.75  
Printer Utility .....\$19.75  
6 Slot Expansion .....\$79.95  
3 Slot Expansion .....\$24.95  
PRINTER INTERFACE .....\$39.75  
PRINTER INTERFACE with  
full graphics .....\$65.75  
LIGHT PEN .....\$29.75

## SPINNAKER 64

Kindercomp. ....\$21.75  
Story Machine .....\$23.75  
Face Maker .....\$23.75  
Snooper Trooper .....\$29.75  
Delta Drawing .....\$34.75  
Shamus II c/d .....\$24.95  
Pinhead c/d .....\$22.95

## SYNAPSE 64

ZEPPELIN C/O .....\$24.75  
BLUE MAX C/O .....\$24.75  
DIMENSION X C/O .....\$24.75  
EPYX 64  
ASPHI R .....\$26.75  
JUMPMAN JR R .....\$26.75  
PIT STOP R .....\$26.75

## commodore

### BRODERBUND 64

BANK STREET  
WRITER .....\$49.75  
CHOPLIFTER .....\$24.75  
LODE RUNNER .....\$24.75  
DROL .....\$24.75  
KOALA TOUCH TABLET .....\$69.75

**ATARI**  
Computers for people:

Voice Box 2...\$99.75

600XL...\$CALL  
800XL...for  
1400XL...Lowest  
1450...Prices  
1050 DISK DRIVE...\$849.00  
1010 RECORDER...\$74.75

**PARKER BROTHERS**  
Tutenkham R...\$33.75  
Super Cobra R...\$33.75  
Astro Chase R...\$33.75  
Frogger R...\$33.75  
QBert R...\$33.75  
Popeye R...\$33.75

Monkey Wrench 2 \$52.75  
**SPINNAKER**  
Story Machine R...\$26.75  
Face Maker R...\$24.75  
Kinderomp R...\$20.75  
Fraction Fever R...\$24.75  
Delta Drawing R...\$26.75

## BLANK DISKETTES ELEPHANT

Single Side 5D (10) .....\$17.75  
Single Side DD (10) .....\$21.75  
Double Side DD (10) .....\$26.75

## MAXELL

MD I (10) .....\$28.75  
MD II (10) .....\$38.75

## CERTRON CASSETTES

CC-10 12 for .....\$15.99  
CC-20 12 for .....\$17.99

## INNOVATIVE CONCEPTS

Disk Storage (holds 10) .....\$4.95  
Disk Storage (holds 15) .....\$9.95  
Disk Storage (holds 30) .....\$26.95

## TRAK DISK DRIVES

AT-01 .....\$379.00  
AT-02 .....\$399.00  
PRINTER CABLE .....\$22.95  
Software for ATD-2 .....\$22.95

## RANA DISK DRIVE

## COMPUTER CARE

818  
5 1/4" DISK DRIVE  
CLEANER .....\$12.75  
COMPUTER CARE  
KIT .....\$19.75

## HARD DISK DRIVES for

## APPLE IBM-PC

5MEG .....\$1349.00  
10MEG ...\$1599.00  
15MEG ...\$1999.00  
20MEG ...\$2359.00

\*Add \$10.00 for TRS HD Drives

## TEXAS INSTRUMENT

Disk Drive...\$245.00

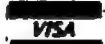
## PERCOM

## FOR ATARI COMPUTERS

AT88S1 ...\$299.00  
AT88S2 ...\$535.00  
AT\*\*S1PD...\$439.00  
RFD40S1...\$399.00  
RFD40S2...\$675.00  
RFD44S1...\$449.00  
AT88 doubler



TO ORDER



Circle 245 on inquiry card.

POLICY

CALL TOLL FREE

800-233-8760

Customer Service 1-717-327-1825 Jersey Shore, PA 1774C

or send order to  
Lyc0 Computer  
P O Box 5088

In-stock items shipped within 24 hours of order. Personal checks require four weeks clearance before shipping. No deposit on C.O.D. orders. Free shipping on prepaid cash orders within the continental U.S. PA residents add sales tax. All products subject to availability and price change. Advertised prices show 4% discount offered for cash, add 4% for Master Card or Visa. DEALER INQUIRIES INVITED.

# Maxell Floppy Disks

The Mini-Disks  
with maximum quality.



Dealer inquiries invited. C.O.D.'s accepted. Call FREE (800) 235-4137.



**PACIFIC EXCHANGES**  
100 Foothill Blvd., San Luis  
San Luis Obispo, CA 93401  
In Cal. call (800) 592-5935 or  
(805)543-1037

Circle 305 on Inquiry card.

# \$91.00 Single Board Computer



6800 MPU, serial I/O, parallel I/O, RAM, EPROM, 44-pin 4.5" x 6.5" PCB  
EXPANSION MODULES: RAM, EPROM, CMOS RAM/battery, analog I/O, serial I/O, parallel I/O, counter/timer, IEEE-488, EPROM programmer, floppy disks, cassette, breadboard, keyboard/display



**WINTEK**

Wintek Corp.  
1801 South Street  
Lubbock, TX 79404  
357-742-8428

Circle 434 on Inquiry card.

# GET ORGANIZED

WITH OUR NEW LINE OF QUALITY PRODUCTS

The "Get Organized" ergonomic chair. Features pneumatic lift and adjustable backrest. Comes in a choice of six colors — blue, red, camel, brown, light grey and charcoal grey.



\$99.95

To place your order today call anytime!

**1-800-328-2977**



We accept Visa and Mastercard. Add \$2.00 for shipping.

Mid America Wholesalers, Inc. Computer Accessories  
6135 215th St., Lakeville, MN 55044

Minnesota Residents Call Collect.

(612) 469-4666

Dealer inquiries invited.

300 BAUD	<b>MODEMS</b>	1200 BAUD
<p><b>SIGNALMAN...</b>                  MARK 12... 300/1200 AUTO..... \$279                  MARK 10... 300 AUTO..... \$169                  VOLKSMODEM &amp; cable..... \$ 79                  US ROBOTICS..... 'Hayes Compatible'                  'PASSWORD' 300/1200 baud..... \$339                  '1100' card 300/1200..... \$339                  'AUTO 212' dixe. 300/1200..... \$419</p>		
<p><b>DOT MATRIX PRINTERS</b>      <b>LETTER QUALITY</b>                  CABLES 6 feet IBM CP/M..... \$ 22                  GEMINI 10X 120 cps graphics..... \$279                  PROWRITER 120 cps hi density.... \$344                  DAISYWRITER fast! 40 cps 48K. \$CALL!</p>		
<p><b>IBM HARD DISKS</b>      <b>CP/M</b>                  Complete Systems... controller &amp; drive &amp; software                  10 Mbyte half height..... \$1295                  23 Mbyte ... \$2195    40 Mbyte ..... \$2795</p>		
<p><b>IMAGE COMPUTERS</b>                  P.O. Box 1164, Cardiff, CA 92007</p>		
<p>(619) 942-7373                          (619) 270-3600    <b>DEALER INQUIRIES INVITED</b></p>		

Circle 208 on Inquiry card.

## NEW! FORTH COMPUTER

The AMS-1000 series development/target single board computers for dedicated control applications include: Extended FORTH and 6502 assembler in 11K of firmware, RS-232 port, Two 8-bit TTL I/O ports, Two 16-bit counter/timers with interrupt, 2K or 8K of battery backed CMOS RAM, Extra socket will program 2K or 8K E or EPROMS. Extensive documentation and large tutorial type manual on the FORTH language. Autostart your program on power-up and there is a wake-up feature for multi-distributed process control. You supply CRT & 5v only @ 200ma. The board has a 44 pin bus and is 4.5" x 4.5". OEM qty. and pricing available. 2K-\$299 8K-\$399 single qty. For order or info write to:

**ADAPTIVE MICRO SYSTEMS**  
 P.O. BOX 965  
 SANDY, UTAH 84091  
 MC/VISA orders only call:  
 1-800-227-1617 ext. 125  
 1-800-772-3545 in Calif.

Circle 17 on Inquiry card.

**NEW!**

## SafeSkin

### KEYBOARD PROTECTOR

Remains in place during keyboard use. Prevents damage from liquid spills, dust, ashes, etc. Fits like a second skin, excellent feel. Homerow and numeric locators. Available for: IBM-PC, Apple IIe. Send \$29.95, check or M.O., Visa & MC Include exp. date and signature. Specify computer type. Dealer Inquiries invited. Free brochure available.

**MERRITT Computer Products, Inc.**  
 2925 LBJ, #180 / Dallas, Texas 75234  
 (214) 942-1142

Circle 255 on Inquiry card.

# GILTRONIX SWITCHES ARE THE BEST CHOICE.

... and here are 10 good reasons why:

## IBM PC



1. Serial (RS232) or Parallel (Centronics)
2. Printer/Teletype
3. Nationally Awarded Used Products
4. Broad Product Line
5. Over 20,000 Units Sold to Date
6. Sales and Technical Support

## APPLE



7. F.C.C. Approved Units
8. Manual and Automatic Units
9. Highest Quality PC Board Switch Technology
10. Buy Direct From Giltronix, or From Any Authorized Distributor

Manual Units—2 to 6 Ports  
Automatic Units—3 to 16 Ports

Circle 184 on Inquiry card.



1780 Fatman Way  
 Palo Alto, CA 94303  
 (415) 923-1100

ORDER HOT-LINE 1-800-531-1300 (Outside of California)

# NEW! BREAK-OUT-BOX

Tests, Monitors, Re-wires  
RS-232 Interfaces

Opens signal lines, rewires or monitors in one unit. Nine two-color LED's monitor 7 lines plus two spares. Wires included. 24 switches open any RS-232 line except pin 1. Requires no battery. Order Direct! Only \$149.95. Add \$1.75 postage & handling. IL res. add 6% sales tax. MC, VISA accepted. Free! New illustrated catalog of RS-232 interface and testing equipment.  
 Phone: 815-539-5827



**B & B electronics**  
 MANUFACTURING COMPANY  
 Box 68B, MENDOTA, IL 61342

Circle 53 on Inquiry card.

# COMPUTER BRIEFCASES



- • • Lightweight, tough, molded ABS case
- • • Aluminum closure, cast chrome locks
- • • Customized foam padding on all sides

<b>EXECUTIVE LINE</b> (w. shoulder strap)		
E-1	IBM PC, keyboard, cables	\$149
<b>PRESTIGE LINE</b> (add \$15 for shoulder strap)		
P-1	Transtar 120 (Silver Reed 500)	\$89
P-2	TRS-80 Model 100, Transtar 120	\$110
P-3	Epson MX-80 (IBM Printer)	\$89
P-4	TRS-80 Model 100, Epson MX-80	\$110
P-5	Epson MX-80 FT	\$105
P-6	TRS-80 Model 100, CCR-B1	\$99

Add \$5 for shipping/handling TX residents 6% sales tax. Cashier's check. MO Allow 4 weeks for personal checks.

**CarryCase** (713) 833-8248  
 P.O. Box 72762, Houston, TX 77272

Circle 70 on Inquiry card.



**TOLL-FREE  
ORDERING:  
800-222-8686**

# CCT<sup>®</sup> CUSTOM COMPUTER TECHNOLOGY

**1 CRAFTSMAN COURT — BOX 4160 — SEDONA, ARIZONA 86340**

**FOR TECHNICAL SUPPORT/  
SERVICE / IN ARIZONA:  
602-282-6299**

Purchase your Hardware and Software directly from an OEM / Systems Integrator. Take advantage of our buying power! We stock a full line of Board Level Components, Software and Peripherals. Call for your needs. We'll give you the Lowest Prices, and the Technical Support and Know-How we are quickly becoming well-known for. Satisfied Customers Nationwide. The Nation's Custom Systems House for Business, Education and Science. Call for a system quote.

**• FOREMOST QUALITY • ADVANCED SUPPORT • REASONABLE COST •**



LIBERAL DEALER PRICING  
ON ALL CCT PRODUCTS.

**CCT<sup>®</sup>**



### THE CCT EXCLUSIVE WARRANTY

With any system we build, we provide, in writing, an unconditional 12 month direct warranty on the entire system, including mainframe, boards, drives, power supplies, cabling and peripherals! We offer guaranteed 24-hour in-house repair and/or replacement with just a tech-line phone call. We can offer this, since we are so sure of our level of quality and reliability. It's great to know that in the event of a problem, you're not out of business waiting on service turnaround. We deliver!

Our various OEM contracts with all the manufacturers of the components we integrate, allow us this unprecedented flexibility. No factory O.K.'s necessary — just get it running - NOW!

### • 8" CP/M SOFTWARE SPECIALS •

dBASE II - Latest Version 2.4	.....	\$349
Supercalc 86 - for CP/M 86 & MP/M	..	\$ 99
Wordstar	.....	\$299 Pro-Pak .. \$429
Microsoft BASIC	..	\$299 Compiler .. \$339
Supersoft FORTRAN IV	.....	\$399 C Comp \$399
Peachtree Series 8 Modules	.....	each \$599
<b>• TOP SELLING PERIPHERALS •</b>		
CCT-90K Parallel S-100	.....	
Amber Screen - 90K Baud	.....	\$749
Wyse 100-14" Green	.....	\$699
Wordstar Prom Option	.....	\$ 75
Wyse 50	.....	\$529 75 .. \$609
200/300	.....	\$1069
Visual 50	.....	\$599 Televideo 925 .. \$749
950	.....	\$950 970 .. \$1099
Liberty Freedom 100	—	\$479 200 — \$679
Okidata 82	—	\$349 83 — \$619 84 — \$1029
92	.....	\$459 93 .. \$779
NEC 7710	.....	\$2150 7730 .. \$2150
Diablo 620	.....	\$969 630 .. \$1899

## INDUSTRIAL GRADE **CCT DISK DRIVE SYSTEMS** ROLLS ROYCES OF THE INDUSTRY SUPERIOR QUALITY **S-100 HARD DISK SUBSYSTEMS**

Professionally engineered ST-506 type systems for the business market S-100 Computer user. Includes industry top quality drives, CompuPro Disk 3 DMA controller, all cabling, A&T, formatted, burned-in. Provisions for up to two hard disks in each system. We include operating system update. CP/M 80, CP/M 86, CP/M 8-16, MP/M 8-16, CP/M 68K. Soon to be supported - MS-DOS. (/1 Systems are CCT innovated hard/floppy combinations, with Mitsubishi DSDD 8" drive.)

CCT-10 (11+ MEG)	.....	\$2349	CCT-10/1	.....	\$2849
CCT-20 (22+ MEG)	.....	\$2749	CCT-20/1	.....	\$3249
CCT-40 (36+ MEG)	.....	\$3349	CCT-40/1	.....	\$3849

Drive capacities shown are after formatting! We are working on tape cartridge back-up units.

### CCT-2.4 • Dual 8" DSDD

Mitsubishi 2.4 Megabyte in Extra Heavy horizontal enclosure, removeable filter air system, all cabling, A&T, Burned in. The fastest system available: .. \$1199  
with (2) half-height - CCT-2.4S .. \$1229  
Special configurations available — Call!

### FLOPPY SYSTEMS

### CCT-5 • 5 1/4" DSDD

IBM Compatible Tandon 320K. Extra Heavy Cabinet accommodates two drives, hard or floppy. All cabling, A&T, Burned-in. Perfect for our MS-DOS Package ... \$369  
with Hard Disk Power Supply .. \$389  
Two Drive Unit (720K) CCT-5/2 .. \$649

## ★ SUPER PRICES ★ COMPUPRO COMPONENTS ★ IN STOCK ★

SYSTEM SPECIAL—ALL CCT A&T, BURNED IN: 816A - \$4299			816B - \$4999	816C - \$6499
CCT-2 - \$6799	• CCT-3 - \$6699	• Disk 1 w/CP/M - \$469	• CPU 8086/87 - \$819	• M-Drive/H - \$1099
• CPU 8085/88 - \$329	• CPU 8086 - \$559/10Mhz - \$599	• CPU 68K - \$519/10Mhz - \$639		
CP/M-Z - \$249	• Disk 1 - \$369	• Disk 2 - \$579	• Disk 3 - \$539	• RAM 16 (12Mhz) - \$369
• RAM 21 (128K) - \$779	• RAM 22 (256K) - \$1359	• Interfacer 3 - \$459	• Interfacer 4 - \$349	• System Support 1 - \$329
Enclosure 2 Desk - \$599/Rack - \$649	• CP/M 80 (CCTHMX) - \$125	• CP/M 86 (CCTTMX) - \$175		
CP/M 8-16 (CCTTMX) - \$199	• MP/M 8-16 (CCTSX) - \$499	• CP/M 68K (CCTCX) - \$279		
CP/M 86 Upgrade Kit: CP/M 86, RAM 16, Sys. Supt. 1, Cable - \$829				
Call for CSC Boards — New Releases — CCT Mods Updates - \$30/U.S.				

### CCT-1 — ENTRY LEVEL S-100 BUSINESS SYSTEM

- Enclosure 2-Desk-20 Slot Mainframe
- CPU 8085/88 - 6Mhz 8085/8Mhz 8088
- Disk 1 - DMA Floppy Disk Controller
- RAM 16 - 64K Static RAM - 12Mhz
- Interfacer 4 - 3 Serial/2 Parallel I/O
- CCT-2.4-Dual 8" Mitsubishi DSDD Drive System - 2.4 Megabytes
- CP/M 80 - 2.2 HMX - CCT Modified
- All Cabling, Complete CCT Assembly, Testing, and Minimum 20 Hour Burn-in

**SPECIAL PRICE  
\$3,449**

**RUNS ALL STANDARD 8" CP/M SOFTWARE - INCLUDES OUR EXCLUSIVE 12 MONTH DIRECT WARRANTY**

**OPERATING SYSTEM NOTE:** Latest CP/M, CP/M 86, MP/M 8-16, CP/M 68K, have each been restructured and optimized by CCT, for utmost flexibility, power and speed.

### MS-DOS FOR COMPUPRO - IBM COMPATIBLE CCT MODIFIED SYSTEM

For any CP/M 86 CompuPro System — Includes MS-DOS Version 2.0 and 5 1/4" DMA Disk Controller, All Manuals - \$699

Prices & availability subject to change. All products new, and carry full manufacturer's warranties. Call for catalog. Free technical help to anyone. All products we sell are CCT individually tested and set up for your system - Plug-In & Go! Arizona residents add sales tax CCT<sup>®</sup> Trademark — Custom Computer Technology; MS-DOS<sup>®</sup> Trademark — Microsoft; IBM<sup>®</sup> Trademark — International Business Machines; CompuPro<sup>®</sup> Trademark — W.J. Godbout; CP/M<sup>®</sup> MP/M<sup>®</sup> Trademarks — Digital Research

The "Get Organized" copy holder is made of heavy acrylic and features copy clip, swing arm and sturdy base. Works with any system.



**GET ORGANIZED**  
WITH OUR NEW LINE OF QUALITY PRODUCTS



Sturdy W® bronze acrylic printer stand. Featuring bottom feed slot and padded rubber feet to protect surfaces and reduce noise. Available in two sizes.

PK #1 36x13x18 in. 80 column printers **\$29.95**  
PK #2 24x13x18 in. 60 column printers **\$39.95**

To place your order today call anytime!  
**1-800-328-2977**

We accept Visa and Mastercard. Add \$2.50 for shipping.

Mid America Wholesalers, Inc. Computer Accessories  
6135 215th St., Lakeville, MN 55044  
Minnesota Residents Call Collect.  
**(612) 469-4666**  
Dealer inquiries invited.

**PAL, EPROM PROGRAMMERS & UV ERASERS FROM \$49.95**

**LOGICAL DEVICES INC.**

*Where Reliability and Customer Support is of Outmost Importance*

SEE OUR AD ON PAGE 62



**ORDER TOLL FREE 1-800-EEL-PROM**  
(1-800-331-7766)

**5 VOLT EPROM PROGRAMMER**



IDEALLY SUITED TO PROTOTYPES, FIELD SERVICE OR EDUCATION - FOR ENGINEER, TECHNICIAN, STUDENT OR HOBBYIST.

- MICROPROCESSOR CONTROLLED, MENU DRIVEN SOFTWARE
- COMPLETE - NO PERIPHERAL HARDWARE
- ONE YEAR WARRANTY
- 2500, 2700 SERIES, 1K THRU 16K (BYTE) EPROMS
- CONNECT TO RS-232C INTERFACE, COMPUTER OR TERMINAL - SELECTABLE Baud RATES, 100 THRU 19.2K
- SECURITY CODE PROTECTION
- ERASE, READ, VERIFY & PROGRAM MODES SUPPORTED
- PROGRAM AN ENTIRE EPROM, A SELECTED PORTION OR BYTE-AT-A-TIME
- OBTAIN PROGRAM DATA FROM ANOTHER EPROM, COMPUTER MEMORY OR DIRECT FROM TERMINAL.
- CPU COMPATIBLE SOFTWARE SUPPLIED ON 5 1/4" DISKETTE ALONG WITH FULL DOCUMENTATION

**\$ 290 MODEL 305 - THE NORMAL CHOICE WITH COMPUTER AVAILABILITY**

**\$ 485 MODEL 3052 - ENHANCED VERSION, 16K (BYTE) DATA BUFFER WITH EDITOR - NO COMPUTER IS REQUIRED BUT ALLOWS GREATER FLEXIBILITY IF AVAILABLE**

COD'S WELCOME. DEALER INQUIRIES INVITED.  
(305) 334-3511

**EPIC ELECTRONICS**  
1074 NE COMMERCIAL ST.  
JENSEN BEACH, FL 33451

CPM is a trademark of DIGITAL RESEARCH

**Scotch® Diskettes**

Rely on Scotch® diskettes to keep your valuable data safe. Dependable Scotch diskettes are tested and guaranteed error-free. The low abrasivity saves your read/write heads. They're compatible with most diskette drives.



**(800)235-4137**



PACIFIC EXCHANGES  
1001 East 10th St. #10  
NORWALK, CA 94051  
1-800-235-4137

Dealer Inquiries Invited

**APPLE COMPATIBLE HARDWARE**

**INTERFACE FOR TYPEWRITER, CENTRONICS AND WORDSTAR COMPATIBLE**

Model #	Price
T1 Olivetti Praxis 30, 35, 40	\$99
T2 Olivetti Praxis 41	
T3 Silver Reed Ex 42, 43, 44 + Penman	
T4 Adler Satellite 11 and Alpha Royal 2001	
T5 Olympia Compact and Swinter 1146 CM	

**INFRARED INTERFACE FOR REMOTE OPERATION WITHOUT CABLES**

IRR Board, Receiver station	\$99
for use with one or all:	
IRN Numerical Pad ViaCal compatible	\$49
IRK Full keyboard with lower case	\$129
IRC Four direction cursor control	\$29

TO ORDER CALL (408) 734-8631 or write



**INTERFACE**  
Advanced Transducer Devices, Inc.  
1287 Lawrence St. Red. Sunnyvale, CA 94089  
Additional \$2.50 per order for shipping. Calif. residents add 8% tax.

**NORTHWEST MICROCHIPS DISTRIBUTORS**  
(206) 876-6298

DYNAMIC RAM	4186	200ns	\$150
	4184	150ns	\$50
STATIC RAM	618P-3	150ns	\$80
	618LP-3	150ns	\$70
	2128P-4	200ns	\$420
	5825	150ns	\$485
	6264LP-15	150ns	CALL
	EPROM		
286 FAMILY	2708	450ns	\$4.10
	2718	450ns	\$3.90
	2716-1	350ns	\$4.25
	2732	350ns	\$4.75
	2764	300ns	\$7.75
SPECIALI	2808 CPU, CTC, PIO		\$29
	DART		\$10
	DNA		\$7.50
	2808 CPU		\$7.95
	4184	200ns	\$5.00

(limited quantity)

6730 VIEW DRIVE S.E.  
PORT ORCHARD WA 98366

All prices subject to change. Quantity discounts available. We ship UPS-COD or prepaid. Shipping and insurance are extra. Washington residents add 7.8% sales tax.  
**CALL US ANYTIME!**

**8051 CROSS ASSEMBLER FOR THE APPLE II**

- Supports all 8051 family members: 8031, 8051, 8751, 80C31, 80C51, 8032, 8052, 8044, 8344, 8744.
- Written in machine language with no overlays for extremely fast execution.
- Mnemonics, syntax, directives and controls same as Intel's.
- Generates standard Intel Hex format file for easy PROM programming.
- Can be run on an Apple IIe or Apple II Plus.

**Price \$145.00**

**Metalink Corp.**  
P.O. BOX 126  
CHANDLER, AZ. 85224  
(602) 899-4592

**PRICE WAR**  
Technical Support, Low, Low Price and Prompt Delivery

**IBM PC**

- 64K, 2-320K drive and FDC ..... \$2299
- 64K, 1-320K drive, color & FDC card with green monitor ..... \$2399



- IBM XT, IBM PC jr ..... SCALL
- Compaq & Compaq Plus ..... SCALL
- Columbia PC & Columbia VP ..... SCALL
- Eagle PC & Corona PC (all others) ..... SCALL
- 64 KB RAM chips (tested) ..... \$53
- Tandon 100-L, CDC 9409 drives ..... \$229
- TEAC FD-55B slim line drive ..... \$190
- Pegasus, Davong, Maynard and Tall Grass hard disks ..... SCALL
- AST Products: 64K SPC & SW Str. Pack Plus, MEGA Plus, Combo Plus ..... \$279
- ALL OTHERS CALL
- STERIO Plus, Plantronics C+, Hercules and Quadboards ..... SCALL
- Paradise Multi Display Card ..... \$395
- ANDER-Mentors 300A ..... \$199
- 310A ..... \$169
- Color II Plus ..... \$439
- Princeton Graphic MX-12 ..... \$469
- PDS MAX-12 and SR-12 ..... SCALL
- EPSON FX-80 ..... \$539
- FX-100 ..... SCALL
- NEC 3350 ..... \$1695
- Okidata 9293 ..... SCALL
- Printer Cable ..... \$33
- IBM Software ..... SCALL
- Hayes Modems (all models) ..... SCALL

ASK FOR OUR TERMS ON SALES

F.O.I./M.C/VISA ACCEPTED, COD 20% DEPOSIT

**PC COMPONENTS**  
17842 Irvine Blvd., Suite 110  
Tustin, CA 92680  
(714) 669-0774 (714) 786-1897

WE PAY LONG DISTANCE PHONE ORDER  
Dealers Inquiries Welcome

**IBM PC**  
**2499** CALL FOR IBM-XT  
2 Drs. Graphic Adapter 64K, Keyboard

**COLUMBIA**  
1600-1 ..... 2499  
1600-4 ..... 3995  
VP ..... 2299

CORONA 128K, 2 Drs, software, monitor ..... 2395  
SANYO 550, 128K, 1 Dr, software ..... 799  
SANYO 555, 128K, 2 Drs, software ..... 1099  
FRANKLIN 1000 PRO+ ..... 1129  
FRANKLIN 1200 OMS+ ..... 1399

Call for plotter and items not listed

OKI 92 ..... 449	TP I ..... 259
OKI 84 ..... 948	TP II ..... 299
RX 80 FT ..... 369	Brother 15 ..... 429
FX 80 ..... 499	Brother HRI 499
FX 100 ..... 739	Silver R 550/599
Delta 10 ..... 399	Prowriter I ..... 359
Gemini 10X 289	Prowriter II ..... 599

**MICROLAND** 5223 Beechnut  
Price for prepaid Houston, TX 77096  
2% C.O.D. (713) 668-4695

Circle 257 on inquiry card.

Circle 308 on inquiry card.

Circle 272 on inquiry card.

Circle 238 on inquiry card.

Circle 164 on inquiry card.

Circle 23 on inquiry card.

Circle 296 on inquiry card.



U.S. MANUFACTURER  
ONE YEAR WARRANTY!

# 10 MEGABYTE HARD DISK FOR IBM PC!

**\$995<sup>00</sup>**

# JADE

Computer Products

## 10 MEGABYTE HARD DISK FOR IBM PC

Plug-n-Run, ready to go • complete with controller card, data cable, and mounting hardware • totally PC/XT compatible • 3 times faster than XT • handles 4 different operating systems • streamer tape back-up available

	YOUR PRICE	
10 mbyte internal	\$1795	\$995.00
10 mbyte external	\$2095	\$1195.00
15 mbyte internal	\$1995	\$1395.00
15 mbyte external	\$2295	\$1595.00
26 mbyte internal	\$2495	\$1995.00
26 mbyte external	\$2795	\$2249.00
Tape Back-up option	\$995	\$795.00

## HI-RES MONITORS

	YOUR PRICE	
AMDEK 310A	\$230	\$169.95
AMDEK 300G	\$179	\$129.95
AMDEK 300A	\$199	\$149.95
AMDEK COLOR I	\$379	\$259.95
AMDEK COLOR II	\$559	\$419.95
AMDEK COLOR IV	\$995	\$774.95
PGS • MAX-12	\$269	\$199.95
PGS • HX-12	\$699	\$469.95
PGS SR-12	\$799	\$649.95
QUADCHROME	\$795	\$499.95
COMREX CR6800	\$649	\$499.95

## KEYTRONICS KEYBOARDS

	YOUR PRICE	
5150	\$269	\$189.95
5151	\$299	\$239.95

## STB BOARDS FOR IBM PC

	YOUR PRICE	
GRAPHICS PLUS	\$495	\$379.95
RIO PLUS 128K	\$495	\$349.95
RIO PLUS 256K	\$595	\$449.95
RIO PLUS 384K	\$795	\$549.95
SUPER RIO 64K	\$419	\$329.95
SUPER RIO 128K	\$519	\$379.95
SUPER RIO 256K	\$619	\$479.95
SUPER 10	\$229	\$179.95

## SOFTWARE FOR IBM PC

	YOUR PRICE	
LOTUS 1 2 3	\$495	\$329.95
SYMPHONY	\$695	\$549.95
dBASE II	\$700	\$429.95
R:BASE 4000	\$495	\$319.95
SMART KEY	\$89	\$69.95
MOVE-IT	\$125	\$89.95
MULTIPLAN	\$250	\$169.95
ACCOUNTING PARTNER	\$395	\$249.95
CROSSTALK	\$195	\$129.95
PROKEY	\$75	\$54.95
MULTIMATE	\$495	\$299.95
SUPERCALC III	\$395	\$249.95
TRANSEND PC	\$189	\$139.95

## MICROSOFT FOR IBM PC

	YOUR PRICE	
MOUSE	\$199	\$129.95
SYSTEM CARD 64K	\$395	\$279.95
SYSTEM CARD 256K	\$625	\$429.95

## 320K DISK DRIVES

DOUBLE-SIDED, DOUBLE-DENSITY  
FOR IBM PC

**\$199<sup>95</sup>**

CHOICE OF

Tandon	Tec
Teac	Epson
Panasonic	Shugart

## DISKETTES For IBM PC

High quality double-sided, double-density diskettes, certified to be absolutely error free. Box of ten, warranted for one year.

Box of 10 w/FREE plastic case - \$39 \$19.95

## HIGH SPEED 8087 APU

Math co-processor chip  
List Price \$295 SALE PRICE \$89.95

## QUADRAM FOR IBM PC

	YOUR PRICE	
QUADBOARD No RAM	\$295	\$214.95
QUADBOARD 64K	\$395	\$275.95
QUADBOARD 128K	\$495	\$339.95
QUADBOARD 256K	\$595	\$399.95
QUADBOARD 384K	\$795	\$595.95
QUADLINK	\$680	\$449.95
QUAD 512 PLUS 64K	\$325	\$219.95
QUAD 512 PLUS 256K	\$550	\$389.95
QUAD 512 PLUS 512K	\$895	\$549.95
QUAD COLOR I	\$295	\$209.95
QUAD COLOR II	\$275	\$199.95

## IBM VIDEO BOARDS

	YOUR PRICE	
HERCULES GRAPHIC	\$499	\$339.95
PLANTRONICS COLOR I	\$549	\$379.95
STB GRAPHICS +	\$495	\$379.95
QUADCOLOR I	\$295	\$209.95
AMDEK MAI	\$649	\$495.95

## 64K RAM UPGRADE FOR IBM PC

High speed RAM upgrade kit with FREE! parity (error detection) and one year warranty

	YOUR PRICE	
64K KIT For IBM PC	\$90	\$49.95
128K KIT For IBM PC	\$180	\$95.95
192K KIT For IBM PC	\$270	\$143.95
256K KIT For IBM PC	\$360	\$199.95
384K KIT For IBM PC	\$540	\$289.95

## AST FOR IBM PC

	YOUR PRICE	
SIX PAK PLUS 64K	\$395	\$269.95
SIX PAK PLUS 256K	\$695	\$489.95
SIX PAK PLUS 384K	\$945	\$569.95
MEGA PLUS 64K	\$395	\$269.95
MEGA PLUS 256K	\$665	\$429.95
MEGA PLUS 512K	\$1095	\$799.95
I/O PLUS	\$165	\$119.95
MP 64K	\$295	\$199.95
MP 128K	\$395	\$249.95
MP 192K	\$495	\$299.95
MP 256K	\$595	\$349.95

## PLACE ORDERS TOLL FREE

Continental USA  
(800) 421-5500

Inside California  
(800) 262-1710

Los Angeles Area  
(213) 973-7707

We accept cash, checks, credit cards, or purchase orders from qualified firms and institutions. Minimum prepaid order \$15.00 California residents add 6½% tax. Export customers outside the US or Canada please add 10% to all prices. Prices and availability subject to change without notice. Shipping and handling charges via UPS Ground 50¢/lb. UPS Air \$1.00/lb. minimum charge \$3.00. Prices quoted are for pre-paid orders only.

# JADE

Computer Products

## APPLE ACCESSORIES ON SALE!

### SMARTMODEM Hayes

Sophisticated direct-connect auto-answer/auto dial modem, touch tone or pulse dialing RS232C interface programmable

	YOUR PRICE	
Smartmodem 1200	\$699	\$475.00
1200B for IBM PC	\$599	\$399.95
Smartmodem 300	\$289	\$199.00
Hayes Cronograph	\$249	\$199.95
Micromodem 100	\$399	\$299.95
Micromodem IIe	\$299	\$239.95

### 1200 Baud SMART CAT—Novation

103/212 Smart Cat and 103 Smart Cat, 1200 and 300 baud, built-in dialer, auto re-dial if busy, auto answer/disconnect, direct connect, LED readout displays mode analog/digital loopback self tests, usable with multi-line phones

	YOUR PRICE	
300 Baud 103 Smart Cat	\$249	\$199.95
1200 Baud 212/103 Smart Cat	\$595	\$449.95

### J-CAT MODEM

1/5 the size of ordinary modems, Bell 103, manual or, auto-answer Automatic answer/originate, direct connect, built-in self-test, two LEDs and audio beeps provide status information

	YOUR PRICE	
Novation J-Cat	\$149	\$114.95

### THE BUS PROBE

Best selling inexpensive S-100 diagnostic analyzer

	YOUR PRICE	
Bare board	\$89	\$59.95
Kit	\$249	\$179.95
A & T	\$299	\$199.95

### VERSAFLOPPY II SD Systems

Double density disk controller for 5 1/4" and 8"

	YOUR PRICE	
Versafloppy II with PROM	\$400	\$344.95
Versafloppy II/696 A & T	\$400	\$349.95
CP/M 3.0 with VF-II	\$200	\$80.00

### 64 STATIC RAM—Jade

Uses new 2K x 8 static RAMs, fully supports IEEE 696

	YOUR PRICE	
Bare board	\$69	\$49.95
Kit less RAM	\$149	\$89.95
32K kit	\$229	\$169.95
56K kit	\$299	\$225.95
64K kit	\$399	\$285.95
Assembled & Tested	\$50 add	\$30.00

### EXPANDORAM III

High density memory board, 64K, 128K, or 256K

	YOUR PRICE	
64K	\$475	\$398.95
128K	\$595	\$464.95
192K	\$709	\$524.95
256K	\$825	\$589.95

### ULTRA-VIOLET EPROM ERASERS

Inexpensive erasers for industry or home

	YOUR PRICE	
Spectronics w/o timer	\$99	\$89.95
Spectronics with timer	\$139	\$94.95
Logical Devices	\$89	\$49.95

### ISOBAR

The ISOBAR looks like a standard multi outlet power strip but contains surge suppression circuitry and built-in noise filters, plus 15amp circuit breaker

	YOUR PRICE	
4 receptacle	\$89	\$59.95
8 receptacle	\$99	\$69.95

### APPLE ACCESSORIES

Full Height Disk Drive	\$299	\$189.95
Half-Height Disk Drive	\$249	\$184.95
Controller	\$100	\$59.95
8 inch 2 Meg. system	\$2495	\$1395.00
20 Megabyte Hard disk	\$2495	\$1999.95
CP/M 3.0 Card	\$399	\$259.95
Z-Card with CP/M	\$169	\$139.95
16K RAM Card	\$99	\$39.95
Best 80 Column Card	\$219	\$139.95
64K IIe 80 Column	\$199	\$129.95
Fan w/surge protect	\$99	\$59.95
Koala Pad	\$125	\$89.95
Grappier Plus	\$175	\$119.95
64K Grappier w/16K	\$245	\$175.95
64K Grappier w/64K	\$345	\$239.95

### SUPER DISKETTE SPECIAL!

We bought out a major manufacturer's overstock and we are passing the savings on to you! Single-sided, double-density package of ten with FREE! plastic case

Box of 10 w/FREE! case \$34 \$18.95

### 5 1/4 inch DISK DRIVES

TANDON TM 100-1 SS/DD 48 TPI	List \$349	\$225.00 ea 2 for \$195.00 ea
SHUGART SA 400L SS/DD 48 TPI	List \$299	\$209.00 ea 2 for \$199.95 ea
TANDON TM 100-2 DS/DD 48 TPI	List \$399	\$229.00 ea 2 for \$225.00 ea
<b>5 1/4" Cabinets/Power Supply</b>		
Single cab w/power supply	\$99	\$69.95
Dual cab w/power supply	\$129	\$85.00

### 8 inch DISK DRIVES

SIEMENS FDD 100-8 SS/DD	List \$399	\$179.00 ea 2 for \$175.00 ea
SHUGART SA 801R SS/DD	List \$502	\$355.00 ea 2 for \$349.00 ea
SHUGART SA-851R DS/DD	List \$605	\$459.00 ea 2 for \$455.00 ea
QUME DT-8 DS/DD	List \$599	\$479.00 ea 2 for \$459.00 ea
TANDON TM 848-1 SS/DD thin-line	List \$499	\$369.00 ea 2 for \$359.00 ea
TANDON TM 848-2 DS/DD thin-line	List \$599	\$439.00 ea 2 for \$435.00 ea
NEC FD1165 DS DD thin-line	List \$599	\$450.00 ea 2 for \$440.00 ea
NEC FD1164 SS/DD thin-line	List \$499	\$360.00 ea 2 for \$350.00 ea

### DISK SUB-SYSTEMS

Handsome metal cabinet with proportionally balanced air flow system, rugged dual drive power supply, cable kit, power switch, line cord, fuse holder, cooling fan, nevertan rubber feet. All necessary hardware to mount two 8" disk drives, power supply, and fan. Does not include signal cable

#### Dual 8" Sub-Assembly Cabinet

Bare cabinet	\$75	\$49.95
Cabinet kit	\$299	\$199.95
A & T	\$349	\$249.95

#### 8" Sub-System—Single sided, Double density

Kit w/2 Siemens FD100-8Ds	\$950	\$579.00
A & T w/2 Siemens FD100-8Ds	\$995	\$595.00
Kit w/2 Shugart SA-801Rs	\$1195	\$939.00
A & T w/2 Shugart SA-801Rs	\$1295	\$969.00

#### 8" Sub-Systems—Double sided, Double density

Kit w/2 Qume DT-8s	\$1495	\$1229.00
A & T w/2 Qume DT-8s	\$1595	\$1249.00
Kit w/2 Shugart SA-851Rs	\$1495	\$1199.00
A & T w/2 Shugart SA-851Rs	\$1595	\$1219.00

### DUAL SLIMLINE SUB-SYSTEMS

#### Dual 8" Slimline Cabinet

Bare cabinet	\$75	\$59.95
A & T w/o drives	\$249	\$164.95

#### Dual 8" Slimline Sub-Systems

Kit w/2 SS/DD drives	\$1295	\$879.00
Kit w/2 DS/DD drives	\$1395	\$1060.00
A & T w/2 DS/DD drives	\$1495	\$1099.00

PLACE ORDERS TOLL FREE!

Continental USA (800) 421-5500 Inside California (800) 262-1710 Los Angeles Area (213) 973-7707



# SUPER PRICES ON PRINTERS!

## High Performance, New Lower Price! DTC-380Z

True letter quality Daisywheel printer up to 32 CPS, with a built-in 48K buffer. The 380Z comes with RS232 serial, parallel centronics, and IEEE-488 interfaces built-in

	YOUR PRICE
Full one-year factory warranty!	
DTC-380Z	\$1495 \$999.95
Sheet feeder	\$895 \$579.95
Forms Tractor	\$195 \$129.95
Cable (specify)	\$85 \$49.95

## OKIDATA PRINTER

(One hundred ninety-nine dollars and ninety-five cents)

THIS IS NOT A MISPRINT!

►80 CPS  
►Friction & pin feed **\$199<sup>95</sup>**

►Standard centronics parallel  
►80 or 132 columns

►Full ASCII character set

►Block mode graphics

We bought several truck loads of these printers at a one time special price. Hurry and place your order. We've got lots now but the demand will far exceed the limited supply. Includes full manufacturer warranty

## SPECIAL SALE PRICE!

### EPSON MX-100FT FREE Graftrax-Plus

With FREE! GRAFTRAX-PLUS 100 CPS, friction and tractor feed, 15 inch platen, one year warranty

List Price \$749.00

SALE PRICED AT **\$489<sup>95</sup>**

## CALL US FOR OUR BEST PRICE!

EPSON RX-80 100 CPS w/tractor, graphics  
CALL FOR OUR BEST PRICE

EPSON RX-80FT 100 CPS w/FREE! graphics  
Friction & tractor feed **SAVE \$150.00**

EPSON MX-80FT 80 CPS w/FREE graphics  
Friction & tractor feed **SAVE \$150.00**

EPSON FX-80 160 CPS w/FREE graphics  
Friction & tractor feed **SAVE \$50.00**

EPSON FX-100 160 CPS 15" platen  
Friction & tractor feed **SAVE \$150.00**

## PRICES TOO LOW TO PUBLISH! OKIDATA 92 & 93

160 CPS, true correspondence quality printing, full graphics, IBM PC compatible (optional), handles single sheet as well as fan-fold paper, professional design construction and quality

Oki 92 parallel	\$599	\$429.95
Oki 93 parallel	\$995	\$689.95
2K serial board	\$150	\$120.00
IBM PC ROMs for 92	\$59	\$49.95
IBM PC ROMs for 93	\$59	\$59.95
Extra Ribbon (2)	\$19	\$9.95
Tractor for Oki 92	\$89	\$54.95

## MICROLINE 82, 83, 84

120 CPS (82, 83) 200 CPS (84), industry standard printers, serial and parallel interfaces, true lower case descenders, handles single-sheet as well as fan fold

Oki 82	\$499	Now on SALE for \$349.95
Oki 83 w/FREE tractor	\$775	\$569.95
Oki 84 parallel	\$1395	\$1095.00
Oki 84 serial	\$1495	\$1195.00
2K serial board	\$120	\$99.95
Extra Ribbons 82/82, 83/83	\$19	\$9.95
Tractor for Oki 82	\$89	\$54.95
Ribbons for 84	\$19	\$9.95
IBM PC ROMs for 82 or 83	\$39.95	
IBM PC for 84	\$89.95	
Commodore Interface & Cable	\$59.95	

## MANNESMAN-TALLY

Spirit 80 CPS 10 inch parallel	\$399	\$329.00
180L, 160 CPS 10 inch	\$798	\$588.00
180L, 160 CPS 15 inch	\$1098	\$828.00

OPEN SATURDAYS  
10:00am—4:00pm PST

## GEMINI 10X & 15X

120 CPS, full graphics, friction & tractor Epson FX-80 compatible

Gemini 10X - CALL FOR OUR BEST PRICE!

Gemini 15X - CALL FOR OUR BEST PRICE!

Serial I/O Card \$69 \$54.95

Serial I/O Card w/4K buffer \$99.95

Commodore Interface & Cable \$59.95

## DELTA 10 & 15

160 CPS full graphics, 8K buffer, serial & parallel, Epson FX-80 compatible

Delta 10 **SAVE AT LEAST \$150.00**

Delta 15 **SAVE AT LEAST \$150.00**

## RADIX 10 & 15

200 CPS full graphics, 16K buffer, serial & parallel, semi-auto sheet feeder

RADIX 10 **SAVE AT LEAST \$200.00**

RADIX 15 **SAVE AT LEAST \$200.00**

## COMREX CR-II

Best buy in letter quality printers NEW! from Comrex! full featured letter quality printer, FREE 5K buffer, logic seeking bi-directional printing boldface proportional spacing, double-strike backspace, underline, super-script and sub-script, drop-in daisy wheel cartridge

CR-II parallel \$599 \$495.00

CR-II serial \$644 \$589.95

Tractor option \$120 \$99.95

Cut sheet feeder \$259 \$199.95

Keyboard option \$199 \$179.95

## POWER TYPE

18 CPS daisywheel printer, parallel and serial, four print sizes, Gume wheels and ribbons

Power Type \$499 **CALL for discount price!**

## MICROFAZER— Quadram

The microfazer stand-alone printer buffers are available in any configuration of serial or parallel input, with serial output. All are expandable up to 64K of memory (about 30 pages of 8 1/2 x 11 text). The parallel-to-parallel version is expandable to 512K copy and pause feature included

YOUR PRICE

Parallel/Parallel		
8K	\$169	\$139.95
32K	\$225	\$164.95
128K	\$445	\$269.95

Serial/Parallel		
8K	\$199	\$169.95
32K	\$260	\$199.95

Parallel/Serial		
8K	\$199	\$169.95
32K	\$260	\$199.95

Serial/Serial		
8K	\$199	\$169.95
32K	\$260	\$199.95

## MICROBUFFER Practical Peripherals

Stand-alone Microbuffers		
Parallel, 32K	\$299	\$229.95
Parallel, 64K	\$349	\$269.95
Serial, 32K	\$299	\$229.95
Serial, 64K	\$349	\$269.95
64K add-on board	\$179	\$149.00

Microbuffers for Apple II		
Parallel, 16K	\$259	\$189.95
Parallel, 32K	\$299	\$229.95
Serial, 16K	\$259	\$189.95
Serial, 32K	\$299	\$229.95

Microbuffers for Epson Printers		
Parallel, 16K	\$159	\$129.95
Serial, 8K	\$159	\$129.95

## STARWRITER F10

40 CPS, F10 parallel	\$1895	\$999.95
55 CPS, F10 parallel	\$1995	\$1299.95

# JADE

## Computer Products

# ADVANCED COMPUTER PRODUCTS

## APPLE COMPATIBLE SOFTWARE

**64K RAMS** Set of 9 \$50.00

Apple Compatible Software

SOFTWARE	ACF PRICE
APPLIED SOFTWARE Veratorm	\$299.00
Veratorm Hard Disk	299.00
ARISCI Magic Windows II	95.00
Ariscii	149.00
ASHTON-TATE DBASE III (CP/M)	295.00
Friday (CP/M)	199.00
BPI (GL, AR, AP, Pay Inv)	99.00
BRODERBUND Bank Direct Writer	49.00
BUSINESS SOLUTIONS The Incred Jack	149.00
CONTINENTAL (GL, AR, AP, Pay)	199.00
Home Accountant	49.00
DATACOST Real Estate Inv	99.00
DOW JONES Market Manager	249.00
Market Analyzer	299.00
Market Microscope	99.00
EMILE Money Decisions	149.00
FOX & GELLER Quizzes	199.00
d Utility	99.00
d Graph	199.00
HAYDEN Pie Writer	99.00
Compleat Plus	79.00
Basic Converter	49.00
HOWARDSOFT Tax Preparer	149.00
Rear Estate Analyzer	149.00
KENNESON Form III	99.00
LIGHTNING Macintosh	39.00
LIVING VIDEOKEY Time Trac	129.00
MICROPRO Wordstar	299.00
Maintenance or Specialist	129.00
Microstat Prof d Pak	449.00
Info Pak or InfoStar	Call
MICROSOFT Multiplan	179.00
Multiplan Financial	79.00
Multiplan Budget	119.00
MEGAWARE Megaletter	49.00
PEACHTREE Series 40 (GL, AR, AP)	379.00
Series 9 (Test Spot Mail)	399.00
PERFECT SOFTWARE	Call
QUARK Word Juggler (R)	199.00
Language Unit	99.00
Cap for Apple II	Call
SIERRA ON-LINE	Call
Screenwriter II	99.00
Screenwriter Professional	149.00
General Manager II	199.00
Concory	79.00
SOFTWARE PUBLISHING PFS:FLP	99.00
PFS:Exec or PFS:Flagset	99.00
STATE OF THE ART	Call
STONEWALL DR Master 4.0	249.00
BB Utility 1 or 2	79.00
SYSTEMS PLUS Acc Plus (GL, AR, AP)	999.00
VISICORP Visicorp 3.0	179.00
Visicorp Enhancer	199.00
Visicorp Wordstar	179.00

## HOME & EDUCATION

BRODERBUND Chapter	329.00
Dict & Underlining	79.00
Arabic Machine	49.00
Apple II	49.00
BUDGEBO Reader Blaster	29.00
Pinball Construction Set	29.00
COUNTERPOINT SOFTWARE	Call
Easy Games for Young Children	39.00
DATAMOST Aides	39.00
Fun for Shy Adults	39.00
DATASOFT Zaxxon	37.00
EDU-WARE Company	37.00
Algebra I, II or III	30.00
Compendium or CompuSed	32.00
EINSTEIN Memory Trainer	79.00
Fun for Shy Adults	39.00
HARCOURT Computer SAT	Call
HAYDEN Singing II	29.00
INFOCOM Zaxxon I, II or III	39.00
Dungeons	39.00
KOALA Modules (B available)	Call
LEARNING COMPANY	39.00
Juggles	39.00
Bunnie Games	41.00
Gemstone's Sports	99.00
L & S Crossword Magic	41.00
MICROFUN Menu 2048	Call
MICROSOFT Diction	Call
Typing Tutor II	19.00
MONOGRAM Dollars & Sense	74.99
ORIGIN Exodus Ultima III	41.99
PENQUIN The Quest	19.00
SENSIBLE Sensible Speller	99.00
SERIAL-ON-LINE Programs	29.00
SIRTECH Legacy of Lyrandia	39.00
Knight of Damocles	39.00
SOUTHEASTERN Data Capsule 4.0	44.99
SPINNAKER Alphabet 2.0	39.00
Data Drawing	39.00
Fraction Fever	29.00
Kindercomp	29.00
Fascinating	29.00
BIBLIOCAL Flight Simulator or Project	39.00
SUNDEX-Hit 1 (Hard Home Finance)	74.99
CPA Personal Accountant	74.99
CPA Personal Investor	49.99
Personal Payables	49.99
TERRAPHY Logic	99.00
TRANSEND Transend I	75.00
VIRTUAL Micro Cookbook	29.00

## UTILITIES SYSTEM

BEAGLE Apple MicroStar	529.00
Apple Plus or Priority (DOS)	29.00
Burge Basic	39.00
DOR Basic	17.00
Double Take or Utility Day	29.00
CENTRAL POINT Pay	14.00
Easy II Pack	31.00
LOCKSMITH	74.00
MICROSOFT A.L.D.S.	89.00
Condit 5.0	679.00
Format 80	189.00
PENQUIN DOS System	79.00
PHOENIX Zoom Graphics	31.00
SOUTHWEST Mutil	49.99

Send for Complete Catalog of Software

## APPLE COMPATIBLE DISK CONTROLLER

Only \$49.95

## Apple Compatible Printer Interface

w/Apple to Epson Cable \$49.95

## Apple IIe Compatible 80 Column Card w/64K

\$99.95

## APPLE COOLING FAN

With Surge Suppression \$49.95

## VISTA "SOLO"

Apple II/IIe Compatible Disk Drive

Only \$199.95

## Apple II 16K RAM CARD

Compatible with 280 Softcard™ . PASCAL CP/M™

Full 1 year Warranty. Top Quality by COEX

## NEW LOW ACY PRICE \$49.95

Also from COEX, NEW EPSON Parallel Interface for Apple. With cable \$49.95

## VISTA A800 8" Disk Controller

for Apple \$299.95

## VISTA "DISKMASTER" IBM Compatible

3", 5", 8" and VIBRO Compatible. \$169.95

## IBM PC MULTICARD™

"MULTICARD" multifunction card for the IBM PC & XT expandable to 256K. Thousands of this popular card have already been shipped by ACP.

- 64-256K
- Parallel Port
- Serial Port
- 1 Year Warranty
- Disk Emulator Software
- Printer Spooler Software
- Clock/Calendar
- Clock Software

\$229.00 w/64K \$229.00

## S-100 64K "CMOS" RAMCARD

Unbelievable Price! \$299.00

Assembled and Tested

- ACP has sold over 1000 of these IEEE compatible, low-priced, high-reliability 64K Static RAM Cards.
- Single 5-Volt operation.

## SIEMEN'S SALE

You can now purchase Shugart compatible 8" Disk Drives below your existing factory street pricing!

Those Prices are the lowest ever published. \*Siemser's \$399 FDD100-B... \$169.00

Also, with purchase of Disk Drives you can buy the Vista V-1000 Dual Case with Power Supply and Cable for only \$375.00. Regular Price \$495.00

Offer Limited! Factory Warranty 90 Days! Shipped immediately from Stock! \*OEM Unit/Unit

## DOT MATRIX PRINTER

COEX 80-FT

- 8x7 Dot Matrix, 80 CPS, 81 Directional Printing
- 2K Buffered Memory
- 80, 96, 132 Columns, Graphics and Block Printing
- Selectable Char Pitch, Line Spacing and Feed

COEX Interface Card to Apple \$49.95

\$199.00

## APPLE II™ COMPATIBLE APPLE COMPATIBLE DISK DRIVES

VISTA Solo 5 1/4" 5M	\$199.00
CUMANA 5 1/4" 5M	219.00
RANA Elite I	249.00
Elite 2	299.00
Elite 3	499.00
Elite Converter	82.00
SUPER 5 1/4" 5M Thickens	199.00
TEAC T40 Thickens	239.00
TEAC T80 Doubledrived Controller	329.00
	59.00

## TANDON 100-2

PC Compatible • Double Sided \$229.00

Mounting Kit for IBM PC \$4.95

TM100-1.....\$179.00

## TOSHIBA Half-High PC Compatible • Double Sided

\$179.00

TOLL FREE 800-854-8230

TWT 910-595-1565

Mail Order: P.O. Box 17329 Irvine, CA 92713

542 W. Trimble, San Jose, CA 95131

## Apple Computer

Complete Apple Support Facility

Complete Apple Service Center

We service most floppy disk drives

Apple IIe w/128K, 80 columns \$1195.00

Apple IIc Starter System \$1295.00

Includes: Apple IIe or 64K, 80 Columns Card, Monitor II, Disk II w/Controller \$399.00

Printer II \$179.00

Super Serial Card \$199.00

80 Column Text Card w/64K \$169.00

Imagewriter Disk Master Printer \$199.00

\*Apple Products Available In-store Only

## Apple Compatible Hardware

LIST	ACP
ALS CP/M 3.0 Plus Card	\$299.00
COMPUTER ACCESSORIES	Call
Power Control Center P12	99.00
COEX 16K Ram Card	99.00
Parallel Processor w/Cable	99.00
Apple II Photocopy Card	29.00
Apple I Expansion Card	29.00
64K Extended 80 Columns	199.00
CORVUS Hard Disk Ormwell	Call
EASTBROE Wastebay (11" x 9 1/2")	199.00
Wastebay 2 (11" x 9 1/2")	149.00
Wastebay Plus (9 1/2" x 10 1/2")	149.00
FINGERPRINT Epson Enhancer	49.00
QIBSON Light Pen	249.00
IS PKASO Interface (Rite)	199.00
PKASO Interface (R)	199.00
KENNESON System Saver	99.00
PC Saver	49.95
KEYTRONICS KR200 II Keyboard	299.00
KOALA Graphics Pad	125.00
KRAFT Joystick	89.00
Game Paddles	50.00
MCIT Speed Demon	299.00
MP128K Bubble Memory	879.00
MAR Supr Mod II RF Modem	69.00
Supr Fan	99.00
MICROPRO 6MHz Appcard + Word	Call
MICROPRO 2.00 Software	399.00
2.80 Softcard Plus	645.00
Software Premium Pak (I + II)	995.00
Software Premium Pak (I+II)	499.00
MOUNTAIN COMPUTER	Call
CPS Multifunction	239.00
Music System	399.00
A/D Plus II	350.00
MICROTECH Dumping Unit w/64K	349.00
ORANGE MICRO	Call
Graphic Plus	179.00
16K Bufferboard	179.00
Chopper Buffered w/16K	245.00
PCSI Appcard w/128K, 6MHz	325.00
8088 Coprocessor	999.00
8088/8028 w/128K, 4MHz	429.00
PERISORT (I & II) 1 Year Warranty	Call
Printer/Ink Unit, Parallel I/O	99.00
Message/Ink Serial I/O	125.00
Turbo/Ink Parallel Clock	110.00
Crash Graphics II	179.00
Double w/16K Buffer	199.00
PHYSICAL PERIPHERALS	Call
Microbuffer 16K (Epson Parallel)	159.00
Microbuffer 32K (Epson Parallel)	199.00
Microbuffer 16K (Epson Serial)	179.00
Microbuffer 32K (Epson Serial)	219.00
Microbuffer In-line 64K (Parallel)	349.00
Microbuffer In-line 64K (Serial)	379.00
PROMETHEUS Wastebay 4 in 1	199.00
QUADRAM Quadram	699.00
Microstar 16K (Parallel)	189.00
Microstar 16K (Serial)	220.00
Microstar 32K (Parallel)	229.00
BATHING TURTLE	Call
32K Ramcard	219.00
64K Ramcard	349.00
128K Ramcard	499.00
Accelerator II Card	599.00
Neptune 64K + 80	169.00
Neptune 128K + 80	299.00
Neptune 16K + 80	269.00
STREET Echo II (Apple)	149.00
Echo II Serial (In-line)	249.00
SYNETH Sprint I	149.00
Sprint II	349.00
Flashcard 128K	259.00
Flashcard 144K	249.00
Flashcard 288K	629.00

## TO PRODUCTS

Joystick	99.00	49.95
Softcard 6-pin	99.00	49.95
VideoCard	64.95	39.95
Apple II Toggle Sw	64.95	39.95
VOICE Videoliner (80)	349.00	199.00
Ultravision (132)	379.00	179.00
Enhance II	149.00	99.00

## VISTA COMPUTER

8000 8" Disk Controller	379.00	399.00
ASIO 5 1/4" Disk Controller	99.00	49.95
VIBRO Amlyn 6.25MB	1599.00	1099.00
VOTRAX Typst M74X	259.00	199.00
Personal System	295.00	329.00

## ROBOTS

ANDROBOT	LIST	ACP
Trip to Earth	\$1595.00	Call
Appollo III	95.00	Call
Topolator II (R)	100.00	Call
Topolator III (R)	159.00	Call
TOPORON (Educational Program)	349.00	Call
F.I.E.D. Scn III (R)	79.00	Call

## IBEX

IBEX Robot w/Kit	1799.00	Call
16K Memory Add-in	129.00	Call
Robot Arm Drive	599.00	Call
Vision Option	199.00	Call
Robot Hand	94.00	Call
Robot Control Language (R) Kit	399.00	Call
ZENITH HERO I	2495.00	Call

## Apple's Apple Trademark of Apple Computer

IBM™ IBM Trademark of International Business Machines

1280K 16 386X 16.5M. MC. Diskless. All prices include shipping and handling. All prices are in U.S. dollars. All prices are in U.S. dollars. All prices are in U.S. dollars. All prices are in U.S. dollars.

Apple's Apple Trademark of Apple Computer

Circle 20 on Inquiry card.



# ADVANCED COMPUTER PRODUCTS

Serving Computer Professionals Since 1976

TOLL FREE 800-854-8230

# IBM PC



★ COLOR SPECIAL ★  
THE COLOR GRAPHICS CARD  
(same designer as Colorplus Card)

\$269.00 PRICE BREAKTHRU! \$269.00  
1 year Warranty

## MULTI CARD II™ (exp.) \$199.00

(INTRODUCTORY OFFER)

Advanced Computer Product's best selling multifunction card for the IBM PC & XT (plus compatibles) now has been improved with expansion capability to a full 384K and at no charge an additional game port. You also get Print Spooler and Disk Emulation Software plus a full year SWAP-OUT Warranty at no extra charge. Why pay more when you can get the same function and performance as Quadboard II™ and AST Sixpak Plus™ for substantially less money. You compare! Try it at no obligation. 10 day no questions asked return privilege.

FUNCTION	Multicard II	Quadboard II	Sixpak Plus
Memory	0 to 384K	0 to 384K	0 to 384K
Parallel/Serial	Yes	Yes	Yes
Clock/Calendar	Yes	Yes	Yes
Game Port	Yes	Yes	No (\$50 list Opt.)
Software	Yes	Yes	Yes
Warranty	1 Year	1 Year	1 Year
ACP Price with OK	199.00	229.00	229.00

## EXPANSION MEMORY

- 64K Upgrade (Set of 9 64K RAMS) . . . . \$50.00
- 256K RAM's (256K x 1) . . . . . \$79.00
- 16K RAM's (16K x 1) . . . . . 10/\$9.99
- 8087 CPU (Arithmetic Processor) . . . . \$199.00

## IO/XT (Serial, Parallel, Clock/Calendar) . . . \$129.00

The most popular expansion card for the short slot of your IBM XT. All these functions on one card optimized to fit in one slot. 1 year warranty.

### COLOR/GRAPHICS/COLOR/GRAPHICS

- Plantronics COLORPLUS™ . . . \$429.00
- Hercules GRAPHICS CARD . . . \$375.00
- Quadram QUADCOLOR I&H. . . Call
- Scanpak COLORGRAPHICS . . \$269.00
- Amdel MAI . . . \$479.00
- Paradise MULTIDISPLAY . . \$489.00
- COMOGRAPHIC CARD . . . \$95.00
- MA Sys PEACOCK . . . \$349.00

### IBM PC COMPATIBLE DISK DRIVES

Tandon TM-100-1 Single Sided (160K) **\$179.00**

Tandon TM-100-2 Double Sided (320K) **229.00**

Control Data 9409 Double Sided (320K) **259.00**

TEAC® 55B 1/2 high Double Sided (320K) **199.00**

Toshiba® 1/2 high Double Sided (320K) . . . **179.00**

\*IBM PC Mounting Hardware for 1/2 highs. . . . **4.95**

Vista® Diskmaster® 5 1/4" & 8" Diskcontroller . . **169.00**

### HARDWARE

- AST Sixpak Plus w/OK(SPC) **\$229.00**
- Hexapack II w/OK(SC) **229.00**
- 10 Plus II (CS) **115.00**
- Game Serial/Parallel Options **35.00**
- 64K Memory Upgrade **50.00**
- CHALKBOARD **Call**
- COEX IBM PC Extender Card **29.00**
- IBM PC Prototype Card **35.00**
- DAVONG Hard Disk Drives **Call**
- KENSINGTON PC Saver **39.00**
- KEYBOARD IBM PC Compatible **149.00**
- KEYTRONCS WP Keyboard K85150 **199.00**
- KOALA **99.00**
- KRAFT or TG **Call**
- IBM PC Joystick **49.00**
- Game Paddles **39.00**
- MICROSOFT Mouse **189.00**
- IBM PC XT Exp Chassis (5 slots) **439.00**
- MOUSE 518 Mouse for PC **239.00**
- PERYST The Spectrum w/64K **299.00**
- PTI Back-up Power 200/400W **Call**
- QUADRAM Quadboard II w/OK **225.00**
- Quadlink (Apple Prop) **489.00**
- Quaddisk (up to 72Mb) **Call**
- Microfazer MP64 w/64K **199.00**
- VISTA Turbocard w/OK **Call**
- Mancard w/64K (up to 576K) **229.00**
- PC Master (10 I/O) **329.00**
- Diskmaster (Floppy Cont) **189.00**
- Dynamic Hard Disk **Call**
- PD Clock I/O **129.00**

### PRINTERS MONITORS

- BROTHER HP-25 (23cps daisy) **Call**
- HP-1A (18cps daisy) **Call**
- COEX 80P/T (80cps) **Sale \$199.00**
- DYNAM DK-15 (daisy, 2-color) **\$29.00**
- DAISYWRITER 2000 (17cps) **1049.00**
- EPSON FX-80 (100cps) **299.00**
- FX-80/FX100 **Call**
- NEC Spinwriter 3650 **1875.00**
- OKIDATA Model 8293 **399.00/619.00**
- Model 84P 84S **619.00/889.00**
- Model 92P/92S **495.00/695.00**
- Model 93P/93S **799.00/899.00**
- SILVER REED EXP550 (17cps) **849.00**
- STAR Gemini 10X (120cps) **309.00**
- Gemini 15X (120cps) **429.00**
- Delta 10 15 (180cps) **Call**
- TTX Model 1014 (12cps) **529.00**
- TRANSTAR 130P (16cps daisy) **899.00**
- 315 Color Printing **519.00**
- AMDEK Video 300G A **145.00/155.00**
- Video 310A amber (IBM) **159.00**
- Color I (composite) **299.00**
- Color II Plus (seprtn mon) **329.00**
- Color III RGB (IBM) analog **449.00**
- Color II Plus **479.00**
- Color III RGB (IBM) **399.00**
- Color IV RGB (IBM) analog **779.00**
- BMC 12" Green-Low cost **89.00**
- PGS MX-12 RGB (IBM) **499.00**
- ZENITH ZVM-121 12" green **99.00**
- ZVM-134 12" RGB color **399.00**

### DISKETTES

- DYSAN 5 1/4" SS DD 10/555 **\$36**
- DYSAN 5 1/4" DS DD 10/65 **46**
- IBM 5 1/4" SS DD 10/60 **43**
- IBM 5 1/4" DS DD 10/65 **47**
- VERBATIM 525-01 SS DD 10/45 **23**
- VERBATIM 550-01 DS DD 10/55 **34**
- MAXELL MD1 SS DD 10/50 **29**
- MAXELL MD2 DS DD 10/90 **38**
- File Storage Bee 5 1/4" (60 disks) **19**
- BULK SPECIAL SS 100/125 **19**
- With Sleeve and Box 100/125 **148**

### IBM ACCESSORIES

- COMPUABLE Keyboard drive dust covers **\$16.00**
- Computer keyboard vinyl cover **9.90**
- DURTS PC Protector **89.00**
- PGS Adapter **11.90**
- Vertical PC Stand **20.00**
- Mono Extension Cable **45.90**
- Keyboard Ext Cable (3-9') **35.00**
- EDP PROTECTION DEVICES The Lemon Peach **43.00/68.00**
- The Orange Lime **122.00/76.00**
- GILTRONIX SWITCH BOXES 2 Way 5 Lines **60.00**
- 4 Way 5 Lines **179.00**
- 2 Way 6 Lines **199.00**
- RIBBONS Each Dozen Epson MX 60 **5.75 59.00**
- Epson MX-100 **10.95 120.00**
- Star Gemini 10 15 **2.50 26.00**
- Onidale 80 82 83 **3.95 44.00**
- Onidale 84 82 83 **4.95 25.00**
- NEC 3550 **11.95 185.00**

### MODEMS

- GEZCOMP Model 2120 (Internal) **Call**
- HAYES Smartmodem 1200 **\$475.00**
- Smartmodem 1200B (w/ Smartcom III) **445.00**
- Smartmodem 300 **199.00**
- Smartmodem II **99.00**
- Smartmodem IBM Cable **25.00**
- NOVATION Access 1-2-3 **Call**

### SOFTWARE

- dBASE II/Friday **\$389.00/\$179.00**
- Condor **\$389.00**
- SuperCalc I/II/III **\$79.00/\$159.00/\$249.00**
- Multipan Vers. 1.1 **\$179.00**
- Microsoft Mouse/Word **\$369.00**

### Wordstar 3.3 \$269.00

### Micropro Pro Pak \$379.00

### Rbase II \$329.00

### T. K. Solver! \$319.00

### PFS File/Graph \$95.00/\$95.00

### Context MBA Call!

### Lotus 1-2-3 Vers. 1A Call!

### Copy II/PC Sideways Volkswriter Home Account Peachtree Crosstalk Digital Research

Send for Free Catalog 96 Pages of Selected Values

Circle 20 on inquiry card.

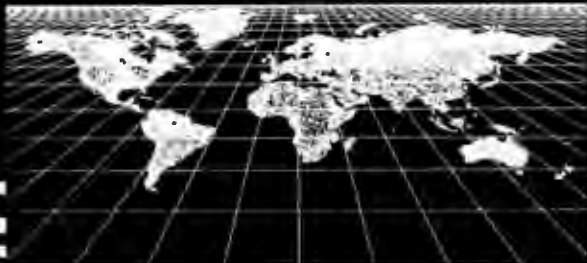
TERMS: We accept VISA, MC, MD, Discover and Personal Checks, Money Order and Company PO's. We do not charge your Card and will ship Personal Checks against your Invoice and credit. Call for No Surcharge Address in USA or MC, MD or Discover users. 30% deposit, web order. Add 3% shipping and handling fee UPS. We offer Layaway financing. Please subject to change without notice. We reserve the right to substitute merchandise. We are not responsible for typographical errors. Retail Sale Prices May Vary. IBM™, Intel™, Microsoft Corporation, Business Machines, Quattro™, Lotus™, and Quattro™ are registered trademarks of their respective owners. © 1987 Advanced Computer Products.

MAIL ORDER: P.O. Box 17329 Irvine, CA 92713  
Retail: 1310 E. Edinger, Santa Ana, CA 92705 (714) 558-8813  
542 W. Trimble, San Jose, CA 95131 (408) 946-7010

TOLL FREE  
**800-854-8230**  
TWX  
910-595-1565

64K UPGRADE - ONLY \$50.00 • CUSTOM CABLES AVAILABLE

WE STOCK CABLES • RIBBONS • DISKETTES • SPARE PARTS



# LOOK!

### Lotus Software

- ★ Lotus 123
- ★ THE Spread Sheet

**\$329**

### Sanyo Computer

- ★ MBC 550
- ★ 1, 160K Drive
- ★ Bundled Software & MS Dos Operating System

**\$789**

### Orange Micro

- ★ Grappler +
- ★ Full Graphics for your Apple
- ★ Parallel Interface w/Cable

**\$114**

### 64K Upgrade

- ★ 64 Expansion w/Parity
- ★ 1 Year Guarantee

**\$49 a set**

### Hi-Res. Monitor

- ★ Hi-Res. Green Screen
- ★ 80 x 24
- ★ BMC 12 auw

**\$79**

### USI Monitor

- ★ P13, 12" Amber
- ★ Non-Glare Screen
- ★ Hi-Res. 20MHZ

**\$100**

### Apple Starter

- ★ 1 Apple Disk II
- ★ Apple II Monitor
- ★ Apple CPU

**\$1326**

### IBM PC System Complete

- ★ PC w/256K
- ★ 2, 360K Drives
- ★ Green Monitor & Interface Card
- ★ Gemini 10X Printer, Cable & Interface

**\$3395**

### Televideo Terminal

- ★ TVC-950C
- ★ w/Detachable Keyboard

**\$899**



### Coding Fan

- ★ Apple II & IIE Compatible
- ★ w/Surge Protector

**\$29**

### Franklin Ace 1000

- ★ Ace 1000
- ★ 64K, Numeric Keypad
- ★ Fully Apple Compatible

**\$789**

### Franklin Ace 1200 OMS

- ★ 2 Disk Drives
- ★ Monitor
- ★ 128K
- ★ Software

**\$1589**

### Dynax Printer

- ★ DX 15
- ★ 15 cps, Letter Quality

**\$449**

### Diskettes

- ★ 5 1/4" Sgl. Side/Dbf. Density
- ★ Reinforced Hub
- ★ 5 Year Warranty

10 for **\$17**

100 for **\$160**

**Computer** Circle 85 on Inquiry card.  
**Components**  
**Unlimited**  
 A California Corporation

**800-847-1718**  
 OUTSIDE CALIFORNIA

**RETAIL STORE:**  
 11976 Aviation Blvd.  
 Inglewood, CA 90304

**MAIL ORDER:**  
 P.O. Box 1936  
 Hawthorne, CA 90250

**This Ad Supersedes All Others**  
**(213) 643-5188**

All merchandise new. We accept MC, Visa, Wire Transfer, COD Call, Certified Check, P.O.'s from qualified firms, APO accepted. Shipping Minimum \$4.50 first 5 pounds. Tax: California Res. Only add 6 1/2% sales tax.



Prices Subject to Change

**Mon. - Fri. 7 a.m. to 6 p.m.**  
**Sat. & Sun. 10 a.m. to 5 p.m.**



# THIS MONTHS DISCOUNTS FOR ALL BYTE READERS

FROM CCU...The World's Largest Single Computer Outlet!

**Siemens 8" Drive**  
 ★ FDD100-8  
 ★ Sgl. Side/Dbl. Density  
 As low as **\$130**

## BONANZA SPECIALS

**Dealer & OEM Inquiries Invited**

**Chinon 5 1/4" Slimline**  
 ★ 1 Disk Drive  
 ★ 160K  
 ★ Sanyo & IBM Compatible  
 As low as **\$130**

**Apple Compatible Slimline**  
 ★ FD 525-A  
 ★ 90 Day Guarantee  
 ★ Fully Compatible  
 As low as **\$130**

**Quentin Research**  
 ★ 300% Track to Track Faster  
 ★ Fully Compatible  
 ★ 1 Year Warranty  
 As low as **\$175**

**PC Products Cabinet**  
 ★ Single 5 1/4" Floppy  
 ★ Power Supply & AC Connectors  
 As low as **\$50**

### Apple Compatible Drives

	QUANTITY		
	1	2	10
<b>Micro Sci</b>			
A-2, 35 Track Controller	\$200 80	\$190 70	\$180 65
<b>Quentin Research</b>			
Apple Mate Controller	\$195 65	\$185 55	\$175 45
<b>Rana Systems</b>			
Elite I	\$240	\$235	\$225
Elite II, Dbl. Head	35	345	335
Elite III, Quad Density	455	445	435
Controller Controls 4 Drives	90	80	75
<b>Half Height</b>			
FD525A Fully Apple com.	\$150	\$140	\$130

### 5 1/4" Disk Drives All Applications

	QUANTITY		
	1	2	10
<b>Teac</b>			
FD55A, 160K	\$160	\$150	\$140
FD55B, 360K	180	170	160
FD55F, Quad Density	200	190	180
All Teac's are Half Heights			
<b>Tandon</b>			
TM100-1, 160K	\$200	\$190	\$180
TM100-2, 360K	220	210	200
TM101-4, Quad Density	280	270	260
TM55-2, 360K 1/2 Height	220	210	200
<b>MPI</b>			
B-52, 360K PC Compatible	\$200	\$190	\$180
<b>Shugart</b>			
SA400, 160K	\$200	\$190	\$180
SA455, 360K 1/2 Height	220	210	200
SA465, Quad Den. 1/2 Height	230	220	210
<b>Mitsubishi</b>			
4851, 1/2 Height	\$250	\$240	\$230
4853, Quad Den. 1/2 Height	320	310	300

### Control Data Corp.

CDC 9409, 360K	\$230	\$220	\$210
CDC 9409T, Quad Density	300	250	200
<b>Panasonic</b>			
JA-155	\$200	\$190	\$180
<b>Chinon</b>			
FD55A (same as Teac) 160K	\$150	\$140	\$130

### 8" Disk Drives All Applications

	QUANTITY		
	1	2	10
<b>Siemens</b>			
FDD-100-8	\$150	\$140	\$130
FDD-200-8	300	290	280
<b>Shugart</b>			
801R, Sgl./Dbl.	\$360	\$350	\$340
851R, Dbl./Dbl.	470	460	450
<b>Tandon</b>			
TM848-1, Sgl./Dbl. 1/2 Ht.	\$350	\$340	\$330
TM848-2, Dbl./Dbl. 1/2 Ht.	400	390	380
<b>Mitsubishi</b>			
M2894-63, Dbl./Dbl.	\$420	\$410	\$400
M2896-63, Dbl./Dbl. 1/2 Ht.	420	410	400
<b>Qume</b>			
DT8, Datatrak 8	\$450	\$440	\$430

### 5 1/4" & 8" Power Supply & Cabinets

	QUANTITY		
	1	2	10
<b>PC Products 5 1/4"</b>			
Single Cabinet w/pwr	\$ 70	\$ 60	\$ 50
Dual Thinline Cab w/pwr	80	70	60
Dual Cabinet & Power	80	70	60
All have 6 month Warranty			
<b>PC Products 8"</b>			
Sgl. Cabinet w/pwr & fan	\$220	\$210	\$200
Dual w/pwr for 2 thinline	220	210	200
Dual w/pwr & fan	270	260	250



# COMPUTER COMPONENTS UNLIMITED THE COMPANY THAT OFFERS

## MONITORS

### Amdek

Color I + Composite Video	\$ 289
Color II + RGB Video	419
300G, 12" Green	139
300A, 12" Amber	149
310A, Monochrome Amber	179

### BMC

12 AUW, 80 column	\$ 79
12 EUN Hi-Res Green	109
9191 Color New Version	239

### IBM

Monochrome Hi Res Green	\$ 319
RGB Color	699

### Princeton Graphics

PGS HX12, IBM Copy	\$ 469
PGS SR-12, Hi-Res Color	649
PGS MAX-12, 12" Monochrome	199

### USI

PI 1, 9" Green, Hi Res, 20MHz	\$ 100
PI 2, 12" Green, Hi Res, 20MHz	100
PI 3, 12" Amber, Hi Res, 20MHz	100
PI 4, 9" Amber, Hi Res, 20MHz	100

### Zenith

ZVM122, Hi-Res Green	\$ 109
ZVM123, Hi-Res Amber	109

## PRINTERS

### Dynax

DX15, Letter Quality	\$ 449
DX25	729

### Epson

RX-80 (120 cps)	\$ 319
RX-80FT (120 cps) Friction & Tractor	419
FX-80 (160 cps)	519
FX-100 (160 cps) 15" Carriage	729

### NEC

8023A-C New Version (120 cps)	\$ 399
8025 (15" Carriage)	699

### Okidata

82A (120 cps) Par & Ser Inter.	\$ 299
83A (15" Carriage)	569
84P (200 cps) Friction & Tractor	999

### New Series Okidata

92P (160 cps)	\$ 429
93P (15" Carriage)	739

### Star Micronics

Gemini 10X (120 cps)	\$ 279
Gemini 15X (120 cps) 15" Carriage	399
Power type (18 cps) Ltr. qual.	479

## COMPUTER SYSTEMS

### Apple

IIe Starter System	\$1326
CPU Only	999
McIntosh	2295

### Compaq

Portable (PC Compatible)	\$1895
--------------------------	--------

### Franklin

Ace 1000, 64K	\$ 789
Ace 1200 QMS	1589

### Kaypro

Kaypro II	\$1149
Kaypro 4+	1695
Kaypro 10	2495

### IBM

PC 64K, 2-Drives	\$2250
XT Hard Disk Drive, 128K	4695

### SANYO

MBC-550 PC Compatible	\$ 789
MBC-555 2-Drives, more software	1199

## 5 1/4" DISKETTES

### CCU

Sgl/Dbl reinforced hub	\$17
100 for 150	22
Dbl/Dbl reinforced hub	100 for 200

Not Bulk Packed

### Dysan

Sgl/Dbl	\$33
100 for 300	39
Dbl/Dbl	100 for 370

### Maxell

MD1 Sgl/Dbl	\$25
100 for 235	38
MD2 Dbl/Dbl	100 for 360

### Memorex

Sgl/Dbl	\$26
100 for 230	35
Dbl/Dbl	100 for 320

### Verbatim

Sgl/Dbl	\$26
100 for 240	36
Dbl/Dbl	100 for 340

### Wabash

Sgl/Dbl	\$22
100 for 200	29
Dbl/Dbl	100 for 270

## 8" DISKETTES

### Dysan

Sgl/Sgl	\$34
100 for 320	53
Dbl/Dbl	100 for 480

### Maxell

Sgl/Dbl	\$44
100 for 380	50
Dbl/Dbl	100 for 469

### Memorex

Sgl/Sgl	\$27
100 for 250	38
Dbl/Dbl	100 for 350

### Verbatim

Sgl/Sgl	\$30
100 for 280	40
Dbl/Dbl	100 for 360

### Wabash

Sgl/Sgl	\$24
100 for 220	34
Dbl/Dbl	100 for 320

## DISK ACCESSORIES

### Verbatim

8" or 5 1/4" Head Cleaning Kit	\$ 9
--------------------------------	------

### Flip Tub

5 1/4" Holds 50 disks, plexiglass	17
5 1/4" Holds 70 disks, plexiglass	21

## APPLE DRIVES

### Apple

Disk 2	\$ 299
Disk 2 controller w/ DOS 3.3	89

### Micro Sci

A-2 Fully compatible	\$ 200
Controller w/ diagnostics	80

### Quantin Research

Applemate	\$ 195
Controller	65

### Rana Systems

Elite I	\$ 240
Elite II Dbl Sided	355
Elite III Quad Density	455
Controller, controls 4	90

### Super 5

Slimline	\$ 189
Controller	75

For the WIDEST VARIETY OF PERIPHERALS  
and the LOWEST PRICES in this Magazine  
CALL 800-847-1718





**• No Surcharge on Credit Cards • Accepts  
COD'S and P.O.'s • Sells Nothing at List Price  
• And is the World's Largest Single  
Computer Outlet**

**DISK DRIVE CABINETS**

**5 1/4" Cabinets**

Single Cab. w/ power supply	\$ 70
Dual Cab. w/ power supply	80
Dual Thinline Cab. w/ pwr. sup.	80

**8" Cabinets**

Single Cab. w/ fan & power supply	\$ 220
Dual Cab. w/ fan & power supply	270

**LOOK!**

**5 1/4" DISK DRIVES**

**CDC**

9409 dbi/ dbi	\$ 230
9409T Quad Density	300

**Panasonic**

Slimline 320K PC comp.	\$ 200
------------------------	--------

**Tandon**

TM100-1, 160K	\$ 200
TM100-2, 320K	220
TM101-4 Quad Density	220

**8" DISK DRIVES**

**Mitsubishi**

2894 Dbi/ Dbi	\$ 420
---------------	--------

**Qume**

DT8 Dbi/ Dbi	\$ 450
--------------	--------

**Shugart**

801R Sgl/ Dbi	\$ 360
851R Dbi/ Dbi	470

**Siemens**

FDD 100-8 Sgl/ Dbi	\$ 150
--------------------	--------

**Tandon**

TMB48-1 Sgl/ Dbi Thinline	\$ 350
TMB48-2 Dbi/ Dbi Thinline	400



**PRINTER INTERFACES**

**Cables**

IBM to Printer	\$ 29
Kaypro to Printer	29
RS232 Cables	29

**Fourth Dimension**

Card & Cable	\$ 49
--------------	-------

**Microtek**

Dumpling GX (Grappler Compatible)	\$ 89
Dumpling GX exp to 64K	149
Dumpling GX 16K w/ 16K exp to 64K	169
for each additional 16K	15

**Okidata Options**

Tractor for 82 & 92	\$ 59
Serial Interface	99

**Orange Micro**

Grappler +	\$ 114
Grappler + w/ 16K	169

**Star or Epson**

Epson Serial Interface	\$ 119
Star Serial Interface	59

**Wesper Micro**

Wizard Full Graphics Interface	\$ 89
--------------------------------	-------



**MODEMS**

**Anchor**

Mark VII 300 Baud	\$ 119
Mark XII, 1200 Baud	279

**Hayes Micro Computer**

Smart Modem 300 Baud	\$ 199
Smart Modem 1200 Baud	489
Smart Modem 1200B for PC	389
Micro Modem IIE	239

**Novation**

J-Cat	\$ 119
Apple Cat II	259

**APPLE ADD ON'S**

**ALS**

Z Card	\$ 119
CPM 3.0 Card	269

**Apple**

Disk II	\$ 299
Monitor II	99

**Astar**

RF Modulator	\$ 15
Fan w/ Surge	29

**Kensington**

System Saver	\$ 69
--------------	-------

**Koala**

Graphics Tablet	\$ 89
-----------------	-------

**Kraft**

Joystick	\$ 49
----------	-------

**Micro Max**

Viewmax 80, 80 col. card	\$ 139
Viewmax 80E (F for IIE) 64K	129

**Micro Soft**

16K Card	\$ 69
Premium Soft Card IIE	369
Multiplan	189
Soft Card (280)	239

**Micro Tek**

Barn 16, 16K Memory	\$ 59
Serial Interface	89

**TG**

Joystick	\$ 44
Select-A-Port	31
Paddles	34

**IBM ADD ON'S**

**Ast Research**

Six Pack +	\$ 269
Mega +	269

**IBM**

Monochrome Adapter	\$ 319
Color Card	275

**Plantronics**

PC + w/ Software	\$ 389
------------------	--------

**Quadram**

Quad Color Card	\$ 219
Quad Link	479

**64K Upgrade**

64K of Memory	\$ 49
---------------	-------

**USI Research**

Paradise Systems multi-display card	\$ 399
-------------------------------------	--------

**RETAIL STORE:**

11976 Aviation Blvd.  
Inglewood, CA 90304

**MAIL ORDER:**

P.O. Box 1936  
Hawthorne, CA 90250

Mon. - Fri. 7 a.m. to 6 p.m.  
Sat. & Sun. 10 a.m. to 5 p.m.

This Ad Supersedes All Others  
No Surcharge for Credit Cards

**Sales Desk**

(800) 847-1718 (213) 643-5188  
Outside California Inside California

**Customer Service & Technical**

(213) 643-5191

All merchandise new. We accept MC, Visa, Wire Transfer, COD, Certified Check, P.O.'s from qualified firms, APO accepted. Shipping Minimum \$4.50 First 5 pounds. Tax, California Res. Only add 6% sales tax.

Prices Subject to Change

**Computer** Circle 86 on Inquiry card.  
**Components**  
**Unlimited**  
A California Corporation







# DoKay

COMPUTER  
PRODUCTS,  
Inc.

ORDER TOLL FREE

(800)  
538-8800

(CALIFORNIA RESIDENTS)

(800)  
848-8008



**TERMS:** Minimum order \$10.00. For shipping and handling, include \$2.50 for UPS ground or \$3.50 for UPS Blue (air). For each additional air pound, add \$1 for UPS Blue shipping and handling. California residents must include 6% sales tax; Bay area and LA residents include 6½% sales tax. Prices are subject to change without notice. We are not responsible for typographical errors. We reserve the right to limit quantities and to substitute manufacturers. All merchandise subject to prior sale.

**HOURS:** Mon. - Fri. 7:30 to 5:00  
Saturdays 10:00 to 3:00

VISIT OUR RETAIL STORE

2100 De La Cruz Blvd.  
Santa Clara, CA 95050  
(408) 988-0697

ALL MERCHANDISE IS  
100% GUARANTEED

# DoKay

## STATIC RAMS

2101	256 x 4 (450ns)	1.70
4101	256 x 4 (450ns) (cmos)	3.80
2102-1	1024 x 1 (450ns)	.80
2102L-4	1024 x 1 (450ns) (LP)	.90
2102L-2	1024 x 1 (250ns) (LP)	1.45
2111	256 x 4 (450ns)	2.45
2112	256 x 4 (450ns)	2.95
2114	1024 x 4 (450ns)	1.7/3.5
2114-25	1024 x 4 (250ns)	6.4/8.5
2114L-4	1024 x 4 (450ns) (LP)	6.4/8.5
2114L-3	1024 x 4 (200ns) (LP)	8/10.95
2114L-2	1024 x 4 (200ns) (LP)	8/11.85
2147	4096 x 1 (55ns)	4.90
TM34044-4	4096 x 1 (450ns)	3.45
TM34044-3	4096 x 1 (300ns)	3.85
TM34044-2	4096 x 1 (200ns)	4.45
MM4110	1024 x 8 (250ns)	1.90
TM22018-Z9M	2048 x 8 (200ns)	4.10
TM22018-150	2048 x 8 (150ns)	4.90
TM22018-100	2048 x 8 (100ns)	6.10
MM0110-4	2048 x 8 (200ns) (cmos)	4.70
MM0110-3	2048 x 8 (150ns) (cmos)	4.90
MM0110-2	2048 x 8 (120ns) (cmos)	5.90
MM0110LP-4	2048 x 8 (200ns) (cmos) (LP)	5.90
MM0110LP-3	2048 x 8 (150ns) (cmos) (LP)	6.90
MM0110LP-2	2048 x 8 (120ns) (cmos) (LP)	8.95
Z-6132	4096 x 8 (300ns) (Static)	33.95

LP = Low Power (ohm) = Quasi-Static

## DYNAMIC RAMS

TM34027	4096 x 1 (250ns)	1.95
UPD411	4096 x 1 (300ns)	2.95
MM0200	4096 x 1 (300ns)	2.95
MM4100	8192 x 1 (200ns)	1.90
MM5200	8192 x 1 (250ns)	1.90
4110-250	16384 x 1 (250ns)	.40
4110-200	16384 x 1 (200ns)	.80
4110-150	16384 x 1 (150ns)	1.20
2110	16384 x 1 (150ns) (5v)	4.90
4164-250	65536 x 1 (250ns) (5v)	4.45
4164-200	65536 x 1 (200ns) (5v)	4.45
4164-150	65536 x 1 (150ns) (5v)	6.45

5V = Single 5 Volt Supply

## EPROMS

1702	256 x 8 (1µs)	4.45
2700	1024 x 8 (400ns)	2.40
2750	1024 x 8 (450ns)	2.40
2758	1024 x 8 (450ns) (5v)	5.90
2716	2048 x 8 (450ns) (5v)	2.90
2716-1	2048 x 8 (350ns) (5v)	5.90
TM32510	2048 x 8 (450ns) (5v)	1.45
TM32716	2048 x 8 (450ns)	7.90
TM32532	4096 x 8 (450ns) (5v)	1.60
2732	4096 x 8 (450ns) (5v)	3.95
2732-250	4096 x 8 (250ns) (5v)	0.90
2732-200	4096 x 8 (200ns) (5v)	10.95
2784	8102 x 8 (450ns) (5v)	9.95
2784-250	8102 x 8 (250ns) (5v)	13.95
2784-200	8102 x 8 (200ns) (5v)	23.95
TM32564	8192 x 8 (450ns) (5v)	16.95
MC30764	8192 x 8 (450ns) (5v) (24 pin)	28.95
27128	16384 x 8 (5µs)	14.95

5v = Single 5 Volt Supply

## 74LS00

74LS00	.23	74LS92	.54
74LS01	.24	74LS93	.54
74LS02	.24	74LS95	.74
74LS03	.24	74LS96	.80
74LS04	.23	74LS107	.80
74LS05	.24	74LS109	.80
74LS09	.27	74LS112	.30
74LS09	.28	74LS113	.30
74LS10	.24	74LS114	.30
74LS11	.34	74LS122	.44
74LS12	.34	74LS123	.70
74LS13	.44	74LS124	2.95
74LS14	.50	74LS125	.40
74LS15	.34	74LS126	.40
74LS20	.24	74LS132	.50
74LS21	.26	74LS133	.50
74LS22	.24	74LS136	.30
74LS25	.28	74LS137	.54
74LS27	.28	74LS138	.54
74LS28	.34	74LS139	.54
74LS30	.24	74LS145	1.15
74LS32	.28	74LS147	2.45
74LS33	.54	74LS148	1.30
74LS37	.34	74LS151	.54
74LS38	.34	74LS153	.54
74LS40	.24	74LS154	1.85
74LS42	.48	74LS155	.60
74LS47	.74	74LS156	.60
74LS48	.74	74LS157	.64
74LS49	.74	74LS158	.68
74LS51	.24	74LS160	.64
74LS54	.28	74LS161	.64
74LS55	.28	74LS162	.68
74LS63	1.20	74LS163	.64
74LS73	.38	74LS164	.68
74LS74	.34	74LS165	.64
74LS75	.38	74LS166	1.90
74LS76	.38	74LS168	1.70
74LS78	.48	74LS169	1.70
74LS83	.95	74LS170	1.45
74LS85	.68	74LS173	.68
74LS86	.28	74LS174	.64
74LS88	.54	74LS175	.64
74LS91	.68	74LS181	2.10

74LS189	8.80	74LS363	1.30
74LS190	.88	74LS364	1.90
74LS191	.88	74LS365	.48
74LS192	.78	74LS366	.48
74LS193	.78	74LS367	.44
74LS194	.88	74LS368	.44
74LS195	.88	74LS373	1.36
74LS196	.78	74LS374	1.25
74LS197	.78	74LS377	1.25
74LS221	.88	74LS378	1.13
74LS240	.94	74LS379	1.30
74LS241	.94	74LS385	1.85
74LS242	.98	74LS386	.44
74LS243	.98	74LS390	1.15
74LS244	1.25	74LS393	1.15
74LS245	1.45	74LS395	1.15
74LS247	.74	74LS399	1.45
74LS248	.98	74LS424	2.90
74LS249	.98	74LS447	.36
74LS251	.58	74LS490	1.90
74LS253	.58	74LS624	3.85
74LS257	.58	74LS640	2.15
74LS288	.58	74LS645	2.15
74LS269	2.70	74LS668	1.85
74LS260	.58	74LS669	1.86
74LS266	.54	74LS670	1.45
74LS273	1.45	74LS674	9.60
74LS275	3.30	74LS682	3.45
74LS279	.48	74LS683	3.18
74LS280	1.95	74LS684	3.15
74LS283	.64	74LS685	3.15
74LS290	.68	74LS688	2.35
74LS293	.68	74LS689	3.15
74LS295	.98	74LS783	23.95
74LS298	.68	81LS95	1.45
74LS299	1.70	81LS96	1.45
74LS323	3.45	81LS97	1.45
74LS324	1.70	81LS98	1.45
74LS352	1.25	25LS2521	2.75
74LS353	1.25	25LS2569	4.20

## 6500 1 MHZ

6502	4.80
6504	6.90
6505	8.90
6507	9.90
6520	4.30
6522	8.80
6532	9.90
6545	21.50
6551	10.85

## 2 MHZ

6502A	6.90
6522A	9.90
6532A	10.95
6545A	26.95
6551A	10.95

## 3 MHZ

6502B	9.90
-------	------

## 6800

68000	58.95
6800	3.90
6802	7.90
6808	12.90
6809E	18.95
6809	10.95
6810	2.90
6820	4.30
6821	3.20
6828	13.95
6840	11.85
6843	33.95
6844	24.95
6845	13.95
6847	10.95
6850	3.20
6852	15.70
6860	9.90
6862	10.95
6875	6.90
6880	2.20
6883	21.85
68047	23.95
68488	18.95

## 6800

68800	9.95
68802	21.25
68809E	28.95
68809	28.95
68810	6.90
68821	6.90
68845	18.95
68850	5.90

## APPLE ACCESSORIES

80 Column Apple II+	149.95
80 Column Apple IIE	129.95
Z80 Apple II+	89.00
Z80 Apple II+ Kit	59.00
Z80 Apple IIE	89.00
Z80 Apple IIE Kit	59.00
18K Card	39.95
18K Bare Board	13.95
Cooling Fan	38.95
Power Supply	74.95
Joystick	29.95
RF Modulator	13.95
Disk Drive	199.00
Controller Card	59.95



## The Flip Sort PLUS™

The Flip Sort Plus™ adds new dimensions to storage. Designed with similar elegant lines as the original Flip Sort™, in a transparent smoked acrylic. Holds over 100 diskettes and has all the outstanding features you have come to expect from the Flip Sort Family.

**\$24.95**



## The FLIP SORT™

The new Flip Sort™ has all the fine qualities of the original Flip Sort™, with some added benefits. Along with a new design, capacity has been increased 50% to hold 75 diskettes and the price is more reasonable than ever - **\$19.95**

**Z-80**

**2.5 MHZ**

Z80-CPU	3.90
Z80-CTC	3.95
Z80-DART	10.95
Z80-DMA	13.95
Z80-PIO	3.95
Z80-SIO/0	11.95
Z80-SIO/1	11.95
Z80-SIO/2	11.95
Z80-SIO/8	11.95

**4.0 MHZ**

Z80A-CPU	4.29
Z80A-CTC	4.80
Z80A-DART	9.95
Z80A-DMA	12.95
Z80A-PIO	4.29
Z80A-SIO/0	12.95
Z80A-SIO/1	12.95
Z80A-SIO/2	12.95
Z80A-SIO/8	12.95

**6.0 MHZ**

Z80B-CPU	9.95
Z80B-CTC	12.95
Z80B-PIO	12.95
Z80B-DART	12.95

**ZILOG**

Z8132	33.95
Z8871	38.95

## DISC CONTROLLERS

1771	15.95
1791	23.95
1793	25.95
1795	48.95
1797	48.95
2791	53.95
2793	53.95
2795	58.95
2797	58.95
8843	33.95
8272	38.95
UPD765	38.95
MB8876	28.95
MB8877	33.95
1691	16.95
2143	17.95

## UARTS

AY3-1014	6.90
AY3-1013	3.90
AY3-1015	6.90
PT-1472	9.90
TR1602	3.90
2330	9.90
2651	6.90
TMS6011	5.90
IM8402	7.90
IM8403	8.90
INS8250	8.95

## INTERFACE

8T28	1.54
8T28	1.84
8T95	.86
8T98	.88
8T97	.88
8T98	.88
DMB131	2.90
DP8304	2.24
DS8835	1.94
DS8836	.98

## VOLTAGE REGULATORS

7805T	.74	7905T	.84
7805C	.34	7908T	.84
7808T	.74	7912T	.84
7812T	.74	7915T	.84
7815T	.74	7924T	.84
7824T	.74	7905K	1.44
7805K	1.34	7912K	1.44
7812K	1.34	7915K	1.44
7815K	1.34	7924K	1.44
7824K	1.34	79L05	.78
78L05	.68	79L12	.78
78L12	.68	79L15	.78
78L15	.68	LM323K	4.80
78H05K	9.80	UA76S40	1.90
78H12K	9.90		

C.T - TO-220      K - TO-3      L - TO-92

## DIP SWITCHES

4 POSITION	.84
5 POSITION	.89
6 POSITION	.89
7 POSITION	.94
8 POSITION	.94

## IC SOCKETS

	1.89	100
8 pin ST	.12	.10
14 pin ST	.14	.11
16 pin ST	.16	.12
18 pin ST	.19	.17
20 pin ST	.26	.26
22 pin ST	.29	.26
24 pin ST	.29	.26
28 pin ST	.39	.31
40 pin ST	.46	.38
64 pin ST	4.20	call

ST = SOLDERTAIL

8 pin WW	.58	.48
14 pin WW	.56	.51
16 pin WW	.58	.57
18 pin WW	.88	.89
20 pin WW	1.04	.97
22 pin WW	1.34	1.23
24 pin WW	1.44	1.30
28 pin WW	1.84	1.44
40 pin WW	1.84	1.75

WW = WIREWRAP

16 pin ZIF	5.90
24 pin ZIF	7.90
28 pin ZIF	8.90

ZIF = TEXT TOOL (Zero Insertion Force)

## CRYSTALS

32.768kHz	1.69
1.0 mhz	3.69
1.8432	3.69
2.0	2.69
2.097152	2.69
2.4578	2.69
3.2768	2.69
3.579535	2.69
4.0	2.69
5.0	2.69
5.0688	2.69
5.185	2.69
5.7143	2.69
6.0	2.69
6.144	2.69
6.5536	2.69
8.0	2.69
10.0	2.69
10.738635	2.69
14.31618	2.69
15.0	2.69
16.0	2.69
17.430	2.69
18.0	2.69
18.432	2.69
20.0	2.69
22.1184	2.69
32.0	2.69

## RESISTORS

1/4 WATT 5% CARBON FILM, ALL STANDARD VALUES FROM 1 OHM TO 10 MEG OHM

50 pcs	1.25
100 pcs	2.00
1000 pcs	15.00

## 5 1/4" DISKETTES ATHANA

SSSD	18.95
SSDD	22.95
DSDD	27.95

## BULK DISKETTES 5 1/4" DISKETTES NO LABEL

SINGLE SIDED DOUBLE DENSITY (WITH JACKETS AND HUB RING)

Pack of Ten	\$ 18.95
Pack of 100	\$149.00

# SPRING SPECIALS

4116	250ns	49¢/ea
4116	200ns	89¢/ea

2708	8K EPROMS	2.49
2716	16K EPROMS	2.95
2732	32K EPROMS	3.95
2764	64K EPROMS	5.95
27128	128K EPROMS	19.95

4164	64K DYNAMIC 250ns	4.45
4164	64K DYNAMIC 200ns	5.45
4164	64K DYNAMIC 150ns	6.45

2114	450ns	8/7.95
------	-------	--------

## QUV-T8/1 EPROM Eraser



**\$57.95**

QUV-T8/1 Economy Model: This is a low cost EPROM Eraser housed in a plastic enclosure. The UV element and components are installed in the top lid and you place the EPROMS in the bottom half. No timer or switch option is included.

- Erases up to 8 EPROMS in 15 to 20 minutes.
- 12,000 u Watts at 1" distance.
- 90-Day Warranty

# Do Kay

2100 De La Cruz Blvd.  
Santa Clara, CA 95050

**TOLL FREE**

**1-800-545-2633**

**Mail Order Hours:**

**Monday - Friday 8 a.m. to 6 p.m.**

**Sat. 10 a.m. to 5 p.m.**

**(Sometimes much later)**

**The Great Salt Lake  
Computer Company, Inc.**

**DISK DRIVES**

SHUGART	
5 1/4" SA400 (35 TR) 180K	169.00
5 1/4" SA400L (40 TR) 190K	189.00
5 1/4" SA455L (40 TR) 320K 1/2 HGT	200.00
8" SA801R/SS/DD) 600K	355.00
QUME	
5 1/4" 142 (40 TR) 320K 1/2 HGT	200.00
8" DT8 (842)	490.00
MITSUBISHI	
8" M-2896-63 Thinline 8" DS/DD 1.2 MG	419.00
8" M-2894-63 (110V) Standard 8"	419.00
DS/DD 1.2 MG	
CDC	
5 1/4" 9409-DS/DD	225.00
TANDON	
5 1/4" TM100-1 SS/DD 160K	150.00
5 1/4" TM100-2A DS/DD (320K)	
FOR IBM-PC	
TM101-4 (96 TPI Quad Den)	209.00
8" TM848-2 (DS/DD) 1.2 MG	400.00
TM 100-4 (96 TPI Quad Den)	299.00
SIEMAN'S	
8" FD100-8 (SS/DD) 110V (801 R)	169.00
8" FD100-8 (SS/DD) 220V (Compatible)	199.00
MPI	
5 1/4" B-51 40TR SS/DD 180K	169.00
5 1/4" B-52 40TR DS/DD 320K	
(FOR IBM PC)	180.00

**DRIVE CABINETS**

8" CABINETS	
8" DDC88V28 w/PS vertical for 2-8" drives	269.00
8" DDC88T-1 w/PS vertical-for 2 or 4-8" thinline drives	269.00
8" DDC88T-2 w/PS vertical for 2-8" thinline drives	155.00
8" DDC8V w/PS vertical for 1-8" drive	249.00
8" DDC88H w/PS horizontal for 2-8" drives	269.00
5 1/4" CABINETS	
5 1/4" DDC5H w/PS horizontal-for 1-5 1/4" drive	55.00
5 1/4" DDC5V w/PS vertical-for 1-5 1/4" drive	50.00
5 1/4" DDC55V w/PS vertical-for 2-5 1/4" drives (NEW)	85.00
NEW "SLIMLINE" DRIVE CABINET	
5 1/4" DDC55H w/PS horizontal for 2 ea - 5 1/4" drive - Specify DRIVE	75.00
All Cabinets Available with Extender Connector Add 110.00 ea.	

**DISKETTE STORAGE**

SRW LIBRARY CASES	
CAS-5 1/2 (Holds 10 ea. 5 1/4" Disks)	2.35 ea.
CAS-8 (Holds 10 ea. 8" Disks)	2.80 ea.
Color Burst Packs (5 colors of CAS-5)	10.95 ea.
Color Burst Pack B (5 colors of CAS-8)	12.50

**OUR BEST BUY**

**OUR BEST QUALITY DISKETTE STORAGE**  
Holds 75 Disks —  
Heavy Duty w/ Lock & Key  
Available in Red, Clear & Smoke

RING KING MD-70 .. 19.00

**DATA CABLES**

8" DSC 88-2SKT-for 2-8" drvs w/skt conn	20.00
5 1/4" DSC55-2SKT-for 1-5 1/4" drvs w/skt conn.	20.00
RS232MM-5" (male to male)	19.00
IBM to PAR or COLUMBIA to PAR	26.00
Osborne to PAR	28.00
Kaypro to PAR	26.00

Many Others Available

**PRINTERS**

BROTHER	
HR-25 25 CPS Daisywheel	775.00
HR-1A 17 CPS Daisywheel 3K Bull	495.00
DATA-SOUTH	
DS 180 180CPS/Serial or Par/Tractor	1,400.00
DAISYWRITER	
Daisywriter 2000-48K Buffer/20T040CPS Letter Quality Par or Serial	1,095.00
DIABLO	
620 (25CPS/Serial)	920.00
630 (40CPS/Multi-F)	1,719.00
630 ECS/IBM	2,100.00
DYNAX	
Dynax-15 Par-13CPS Daisywheel	469.00
2 color PTG-3K buff	525.00
Dynax 15 Serial-13CPS Daisywheel	525.00
EPSON	
FX80 (160 CPS-Par 10")	CALL
FX100 (160 CPS-Par 15")	CALL
C. ITOH	
Pro-writer I (8510A) Par 120 CPS	359.00
Pro-writer I (8510A) Serial 120 CPS	529.00
F-10 40CPS/Diablo/Par or Serial	1,125.00
F-10 55CPS/Diablo/Par or Serial	1,425.00
F10 Tractor	459.00
JUKI	
6100-18CPS/Diablo Compatible Par/Daisywheel	569.00
MANNESMAN-TALLY	
Spirit 80CPS Par 10"	330.00
160L (160CPS-40CPS Letter Quality 10")	589.00
160L (160CPS-40CPS Letter Quality 15")	839.00
NEC	
NEC2010 20CPS Serial Daisywheel	950.00
NEC2050 20CPS for IBM Daisywheel	1,050.00
NEC3550 35CPS for IBM	1,850.00
NEC7710 55CPS Serial Daisywheel	1,995.00
NEC7715 55CPS Diablo Compatible Daisywheel	1,995.00

**OUR BEST BUY**

**RITEMAN — Briefcase Size - 120 CPS - Par Port - Epson Compatible — 289.00**  
1 Year Warranty

OKI-DATA	
Microline 82A (SER & PAR-120CPS 10")	CALL
Microline 83A (SER & PAR-120CPS 15")	CALL
Microline 92 (PAR-160CPS-LTR-10")	CALL
Microline 93 (PAR-160CPS-LTR-15")	CALL
Microline 84P (PAR-200CPS-LTR-15")	CALL
Microline 84S (SER-200CPS-LTR-15")	CALL
STAR MICRONICS	
GEMINI 10X NEW VERSION	
(PAR-120CPS-10")	CALL
Gemini 15X (PAR-120CPS-15")	CALL
Gemini Delta 10 (Par-160CPS-10")	CALL
8K buffer serial)	CALL
Star Radix 10 (Coming Soon)	CALL
SILVER REED	
EXP 550P-17CPS Daisywheel-PAR	650.00
EXP 560S-17CPS Daisywheel-Serial	680.00
TOSHIBA	
P1340 - Smaller version of 1350 / 10" Carriage / 112 CPS Draft Mode / 54 CPS Ltr Quality	CALL (List Price \$1395)
P-1350 — 192 CPS Draft Mode / 120 CPS Ltr Quality / Specify Par or Serial	CALL
P-1351/1360 — Same as 1350 and has "Downloadable Font"	CALL

**Minimum Shipping \$3.00**  
**TOLL FREE 1-800-545-2633**  
**in the Continental U.S.A.**

Prices subject to change without notice

**PRINTER ACCESSORIES**

BROTHER	
HRIA Tractor	110.00
HR25	110.00
HR25 Cut SHT FDR	195.00
DAISYWRITER	
Bi-Di Tractor	CALL
Uni-Di Tractor	159.00
Portrait SHT FDR	600.00
Landscape SHT FDR	895.00
DIABLO	
Diablo 620-Uni-Direct Tractor	110.00
Diablo 630-Bi-Direct Tractor	275.00
Diablo 630-DBL Sheet Feeder	1,395.00
DYNAX	
Tractor	95.00
Cut SHT FDR	195.00
Keyboard	175.00
JUKI-6100	
RS232 Interface	60.00
Uni-Di Tractor	100.00
Bi-Di Tractor	145.00
NEC	
Vertical Tractor	219.00
Bi-Dir. Tractor	330.00
Cut Sheet Feeder	1,100.00
OKI-DATA	
82/92 Tractor	55.00
Serial Intf. w/2K Buffer (For 92 & 93)	110.00
Okigraph I 82A or 83A Graphics ROM	50.00
Okigraph II 82A or 83A Disk for Apple	60.00
STAR-MICRONICS	
Serial Intf. Bd	70.00
Serial Intf. Bd w/4K Buffer	120.00
TOSHIBA	
P-1350 Cut Sheet Feeder	800.00
P-1350 Bi-Dir Tractor	210.00

**ALL RIBBONS AVAILABLE**

**DISKETTES**

15% Discount for Qty 100

FOR APPLE, ETC.	
5 1/4" Soft Sector SS/DD	17.00/10
FOR IBM PC & PARTNERS	
5 1/4" Soft Sector DS/DD	22.00/10
• Lifetime Warranty	
• All have Hub Rings and PLASTIC CASE	

**CENTECH**

Color code your files: 5 colors in each pkg.  
(Red, Yellow, Blue, Green, Brown)

5 1/4" Sgl side/dbl den—Rainbow Pak	23.00/10
5 1/4" Dbl side/dbl den—Rainbow Pak	30.00/10
5 1/4" 10 sector—Rainbow Pak	24.00/10
5 1/4" 16 sector—Rainbow Pak	24.00/10
8" Sgl side/dbl den—Rainbow Pak	30.00/10
8" Dbl side/dbl den—Rainbow Pak	40.00/10
• Lifetime Warranty • Hub Rings • Also Available in Solid Color Specify Color	

**OUR BEST BUY**

**MAXELL**

Sgl. side/dbl. den 5 1/4", 48 TPI	24.00
Dbl. side/dbl. den 5 1/4", 48 TPI	36.00
Dbl. side/quad. den 5 1/4", 96 TPI	45.00

Apple™ Apple trademark is Apple Computer  
IBM™ IBM trademark is International Business Machines  
Compaq™ Compaq trademark is Compaq Computer Corp.



Circle 186 on inquiry card.



# SYSTEMS

CUSTOMER SERVICE

AND RETURNS

CALL DAVID 1-801-972-2739

Prices subject to change without notice

## The Great Salt Lake Computer Company, Inc.

Larger PS for  
IBS can be purchased  
to run 4 drives 10A or 12A PS.

### COLUMBIA



COLUMBIA (1600-1) 16 bit, 128K RAM 2 ea 320K Disk Drive-2 SER, 1 PAR, Key Bd. 8 slots Display Cd. bundled software ..... CALL  
COLUMBIA 1600-4 Same as 1600-1 except has 12MB Hard Disk & only 1 F.D. .... CALL  
COLUMBIA MPC-VP Portable 16/BIT 128K RAM 2 each 320K drives SER & PAR Port. 9" monitor, bundled software ..... CALL

Service —

Bell & Howell Co. Nationwide

### IBM



IBM PC-1—Includes 64K RAM, 1 ea 320K Disk Drive ..... 1,995.00  
IBM PC-2—Includes 64 RAM, 2 ea. 320K Disk Drive ..... 2,250.00  
IBM PC-3—Includes 256K RAM, 2 ea 320K Disk Drive IBM Mono Adapter, IBM Mono Display ..... 2,888.00  
IBM PC-4—Includes 256K RAM, 2 ea, 320K Disk Drive, Peacock Color Card, Princeton HX 12 Display ..... 3,395.00

#### IBM XT

• 128K RAM • 1 ea 320K F.D. • 1 ea 10MG Hard Disk ..... 4,685.00  
8087 CPU ..... 198.00

### IBS



#### IBM "LOOK-A-LIKE"

PC-2000 — Basic Mainframe ..... 995.00  
FEATURES

- 3 Slot Mother Bd w/64K (Expands to 256K)
- Power Supply w/Fan
- Lo-Profile Keybd - 96 Key
- 2 ea Serial • 1 ea PAR
- Space for 4 ea. 1/4 HGT Drives or 2 Full Size.
- Will run PC/DOS or MS/DOS
- Will run all MS/DOS Compatible Software

PC-2001 — Includes 64K RAM, 1 ea 320K F.D ..... 1,395.00  
PC-2002 — Includes 64K RAM, 2 ea. 320K F.D ..... 1,650.00  
PC-2003 — Includes 256K RAM, 2 ea. 320K F.D., Video CD, 12" 310A Mono Display ..... 1,995.00  
PC-2004 — Includes 256K RAM, 2 ea. 320K F.D., Color Cd, Princeton Color Monitor ..... 2,499.00

### NEC PORTABLE



PC8201A-Portable 2.4 MHZ CPU 16K Ram/ Expands to 64K-32K RAM LCD Display—Keybd (67 key-5 function) Modem, Serial and Par Port-FD and Cassette Interface—Uses 4AA Bati—bundled software ..... 660.00  
8201-06 Ram Chip - (8k) modl ..... 105.00  
8206-A 32k Ram Cartridge - modl ..... 329.00  
8221-A Thermal Printer - pmt ..... 149.00  
8271-02 AC Adapt/Print & Rec - accs ..... 15.00  
8271-A AC Adaptor - accs ..... 17.00  
8281-A Cassette Recorder - accs ..... 105.00  
8201A-90 Nicad Battery Pak - accs ..... 16.00  
Modem Communication Cable - accs ..... 25.00  
Thermal paper for 8221-A - accs (5 rolls per pack) ..... 13.00

### EAGLE



PC-2 — "The ORIGINAL Version"  
Features 128K RAM • 2 ea. 320K F.D. • Serial • Parallel • MS/DOS • 12" Grn Monitor • Bundled Software ..... 2,595.00

PC+2 — "The NEW Version"  
• Same as PC-2 except has no Monitor or Mono Adapter • Software consists of GW Basic, MS/DOS & CPM 86 ..... 2,295.00

### APPLE FRANKLIN



APPLE IIe Starter—Includes CPU 1 F.D. Monitor and Stand ..... 1,325.00  
FRANKLIN ACE 1000 w/color ..... 799.00  
FRANKLIN ACE 1200 QMS includes CPU-2 F.D. and bundled software ..... 1,699.00

### APPLE SOFTWARE

APPLE — Apple Writer 2 ..... 79.00  
ASHTON-TATE — D-Base II ..... 409.00  
MICRO PRO — Word Star ..... 249.00  
MICROSOFT — Macintosh Basic ..... 125.00  
MICROSOFT — Multi-Plan (Specify) ..... 175.00  
MICROSOFT — Multi-Tool Financial ..... 75.00  
MICROSOFT — Typing Tutor II ..... 17.95  
SILICON VALLEY — "The Handlers" (3 pkg) 39.00  
SILICON VALLEY — List Handler ..... 35.00  
SILICON VALLEY — Spell Handler ..... 50.00  
SILICON VALLEY — Word Handler ..... 39.00  
SILICON VALLEY — Easy Learner ..... 11.95  
SILICON VALLEY — Rapid Reader ..... 11.95  
SILICON VALLEY — Toddler's Tutor ..... 11.95  
SILICON VALLEY — Turbo Charger ..... 11.95  
SILICON VALLEY — The Collector ..... 11.95  
SILICON VALLEY — Lancaster (Shoot Game) 9.95  
T-MAKER (Needs CPM Card) ..... 149.95  
VISICORP  
Visicalc (Specify 2 or E) ..... 179.95  
Visidex (Specify 2 or E) ..... 179.95  
Visitrend/Plot (Specify 2 or E) ..... 229.00

### SANYO PORTABLE



MBC-550 128K, 1 FD w/Word Star, Easywriter, Calcstar ..... 849.00  
MBC-555 — 128K, 2 FD, w/Word Star, Easywriter, Calcstar, Mailmerge, Spellstar, Infostar ..... 1,149.00

Circle 186 on inquiry card.

### IBM SOFTWARE

ASTON-TATE — D-Base II ..... 389.00  
CONTINENTAL — Home Accountant ..... 89.00  
MICRO-PRO — Mail Merge ..... 129.00  
MICRO-PRO — Spell Star ..... 129.00  
MICRO-PRO — Word Star ..... 279.00  
MICRO-PRO — Calc Star ..... 119.00  
MICROSOFT — Word with Mouse ..... 329.00  
Multi-Plan ..... 175.00  
Multi-Plan Financial ..... 69.00  
T-MAKER — T-Maker 3 ..... 169.00  
S.S.I. — Word Perfect ..... 349.00

### TELECOMMUNICATIONS FOR MODEM SOFTWARE

UNITED SOFTWARE — ASC II Express ..... 99.00  
MICRO-STUFF — Cross-Talk ..... 139.00  
LOTUS 1-2-3 ..... 339.00

**TOLL FREE**

**1-800-545-2633**

**CUSTOMER SERVICE**

**AND RETURNS**

CALL DAVID 1-801-972-2739

Prices subject to change without notice

**The Great Salt Lake Computer Company, Inc.**

**QT PRODUCTS**

**S-100**

**QT 8" THINLINE MAINFRAME**

•Provisions for 2 ea 8" thinline drives 6 ea DB25 cutouts 2 ea 50 pin 2 ea 34 pin 1 ea Centronic •EMI filter (fused) 2 AC outlets •Power supply (+8V16A/-5V/+24V6A+5V6A)  
**QTC-IMF +DD8F (6 slot MB) ..... 350.00**



**QT 5 1/4" MAINFRAME**

•Provisions for any 2-5 1/4" drives  
**QTC-MF + MD12 (12 slot MB) ..... 560.00**



**QT 8" MAINFRAME**

•Provision for any 2-8" drives (hard or floppy) Desk Top Version  
**QTC-MF + DD6 (8 Slot MB) ..... 575.00**  
**QTC-MF + DD8 (8 Slot MB) ..... 625.00**  
**QTC-MF + DD12 (12 Slot MB) ..... 675.00**  
 All mainframes have EMI filter, 2 AC outlets, 15 ea. DB25, 2 ea. 50 pin, 2 ea. 34 pin, 1 ea. Centronic cutouts, power supply for 8" MF (-5V1A/+5V5A/+8V14A/+16V3A/+24V5A)



**QT STANDARD MAINFRAME**

•Provisions for any 2-5 1/4" drives 15 ea DB25 cutouts 2 ea 50 pin 2 ea 34 pin 1 ea Centronic EMI filter (fused) 2 AC outlets •Avbit with 5-8-12-18 or 22 slot MB •Power supply (+8V16A-16V3A)  
 Desk Top Version  
**7014/QTC-MF + 12 ..... 499.00**  
**7016/QTC-MF + 18 ..... 525.00**  
**7015/QTC-MF + 22 ..... 650.00**

**CARD CAGES/MOTHERBOARDS**

\*IEEE-696 No termination required

Slots	Bare Bd	A + T	w/card cage	bare card	card
4	20.00	45.00	65.00	20.00	
6	25.00	53.00	75.00	22.00	
8	30.00	74.00	105.00	31.00	
12	35.00	104.00	145.00	41.00	
18	50.00	135.00	205.00	50.00	
22	65.00	190.00	-	75.00	

All card cages will accommodate a 4" fan  
 Add \$20.00 for 1 fan-Add \$30.00 for 2 fans

**CLOCK/CALENDAR**

S-100 •Time in hrs. min. sec •AM/PM or Military Format •Date in Mo., Day, Yr., Day of Week & Leap Year recognition 4 hard interrupts (1024 Hz 1 Hz 1 min, 1 hr) •On board battery (will last 14 mos. w/no power on)  
**QTC-CCS-BB (S-100) ..... 45.00**  
**QTC-CCS-A (A+T) for S-100 ..... 105.00**

**QT/COMPUTIME BOARD SET**

Best Bare Board Set Available

**QTC-SBC 2/4 CPU (SBC 880)**  
**QTC-EXP + III 256K (CT256) Memory bd./**  
 Expandable to 1 MG  
**QTC-FDC 5/8 Floppy disk controller**  
**Bare Board Set ..... 165.00**  
 1) Includes manuals & assembly instructions  
 2) Parts available 3) Monitor & BIOS available

**CPU MEMORY BOARDS**

**QTC-SBC 2/4 BB (SBC880) ..... 50.00**  
**QTC-SBC 2/4 A A+T (SBC880) ..... 265.00**  
**DYNAMIC (64K/256K or 1 MEG)**  
**QTC-EXP + III Bare Bd (CT256) ..... 75.00**  
**QTC-EXP + III 64K A + T (CT256) ..... 375.00**

**Minimum Shipping \$3.00 in the Continental U.S.A.**

**COMPUPRO PRODUCTS**

**S-100**

**SYSTEMS**

System 816A	4,395.00
System 816A with RAM 21	4,589.00
System 816A - H40	7,169.00
System 816B	5,595.00
System 816B - H40	8,349.00
System 816C	7,150.00
System 816C - H40	9,999.00
System 816D	11,089.00
System 816D - H40	13,995.00
System 816E (68K)	7,150.00
System 816E - H40	9,999.00
System 816Z	3,999.00
System 816Z - H40	6,725.00

**CPU BOARDS**

CPU Z 6 MHz	245.00
CPU 8085/88 - 6/8 MHz	369.00
CPU 8086 - 8 MHz	650.00
CPU 8086 - 10 MHz	750.00
CPU 88K - 8 MHz	575.00
SPUZ (March '84)	575.00

**MEMORY BOARDS**

RAM 16	475.00
RAM 17-64	369.00
RAM 21	839.00
RAM 22	1,475.00
M-DRIVE H	1,199.00

**INTERFACE BOARDS**

Interfacer 1	220.00
Interfacer 2	245.00
Interfacer 3	575.00
Interfacer 4	349.00

**DISK CONTROLLERS**

Disk 1	399.00
Disk 1A	575.00
Disk 2 (In 1, CP/M 80)	750.00
Disk 3	750.00

**DISK DRIVE SUBSYSTEMS**

8" Floppy/H-40	4,595.00
8" Dual H-40 w/encl	6,000.00
Dual Floppy Subsystem	2,695.00

**MOTHERBOARDS AND COMPUTER ENCLOSURES**

6 Slot Motherboard	129.00
12 Slot Motherboard	149.00
20 Slot Motherboard	220.00
Enclosure 2-D	739.00
Enclosure 2-R	795.00

**MISCELLANEOUS BOARDS/CONTROLLERS**

Memory Manager	75.00
System Support 1	349.00
MPX 1	495.00
Active Terminator	60.00
8087 Support Board for 8085/88	379.00

WARRANTY: 1 year from date of purchase by end user

**OPERATING SYSTEMS**

CP/M 2.2 (Disk 1)	150.00
CP/M 86 (Disk 1 8085/88)	199.00
MP/M 8-16 (For 8085/88)	495.00
MAP FORTH OS	169.00
CP/M 68K	269.00

**SIERRA DATA**

**SIERRA DATA S-100 BOARDS**

SDS-SBC-100-280 (4mhz) master 2 serial	
2 par/floppy controller/64k ram	655.00
SDS-SBC-100S4mhz slave/2 serial	
2 par/64k ram	565.00
SDS-ZSIO/4-4 serial port I/O bd	250.00
SDS-MUX-RS232 multiplexer bd	235.00
SDS-HDI-M-Hard disk bd for micropolis	129.00
SDS-CPM/B105-cp/m for SBC 100 w/BIOS	150.00
SDS-Turbodos-Multi-user for master & slaves	645.00

**E-PROM ERASERS**

**E-PROM ERASERS**

QUV-T8/1H (hobby)	49.95
QUV-T8/2 (Industrial version)	66.95
QUV-T8/2P (w/timer & safety switch)	97.50

**MODEMS**

Anchor Volkmodem - 300 Baud Orig/Answer	
Direct Connect	69.00
Cable for Above	9.95
Hayes 300	219.00
Hayes 1200	499.00
Novation D-CAT	159.00
Novation J-CAT	109.00
U.S. Robotics "Password" - 300/1200	375.00

**OUR BEST BUY**

**ANCHOR MARK XII**

300/1200 Band Auto Answer/Auto Dial Direct Connect Intelligent Modem w/RS 232 Cable Included 2 Telephone Jacks, Low Power (80 MA) Dial Tone Detect ..... 279.00

**DISPLAY MONITORS**

GREEN	
BMC 12AU (15MHZ) 80 Col/12"	80.00
USI PI-1 (20 MHZ) Hi-Res/9"	119.00
USI PI-2 (20 MHZ) Hi-Res/12"	129.00
AMBER	
USI PI-4 (20 MHZ) Hi-Res/80-Col/9"	125.00
USI PI-3 (20 MHZ) Hi-Res/80 Col/12"	119.00
COLOR	
Amdex I-12" Composite (For Apple)	259.00
Amdex I+ Composite w/audio	275.00
Amdex II-12"-RGB (For IBM-PC) w/audio	419.00

**OUR BEST BUY**

**OUR BEST BUY FOR APPLE**

SAKATA SC-100 Best Composite Video for Apple According to Creative Computing Analysis 275.00

**OUR BEST BUY FOR IBM**

Princeton HX-12-RGB (For IBM-PC) ..... 469.00

**TERMINALS**

**ADDS**

Viewpoint-A1 (White)	509.00
Viewpoint-A2 (Green)	539.00
Viewpoint-3A + (Green)	509.00
Viewpoint 50-Same as TeleVideo 925	715.00

**QUME**

QVT-102 80 Col Green (810 comp)	549.00
QVT-102 80 Col Amber	580.00
QVT-103 80/132 Col Green	865.00
QVT-103 80/132 Col Amber	895.00
QVT-108 80/132 Col Amber (925 comp)	715.00

**TELEVIDEO**

TV910	529.00
TV910+	565.00
TV925	715.00
TV950	925.00
TV970	1,019.00
2nd Page Memory	ADD 25.00
RG 1000/TV80 Graphics Upgrade for 925/950	1,100.00

**AC SURGE ELIMINATORS**

Lemon (6AC outlets-3 prong)	44.00
Lime (5-3 prong pwr cord w/on-off switch)	69.00
Orange-AC surge + EMI filter (6 outlets)	55.00
Peach (3 outlets AC surge/EMI filter)	69.00
Grizzly (200W) uninterruptible power system + surge protection	799.00
Grizzly (500W) uninterruptible power system + surge protection	1850.00

**RELAX TECHNOLOGY**

Both in Metal Enclosures

<b>POWER CONTROL 1</b>	59.95
• Master Control, Switch, 3 PWR Switch, AC Surge Protect, 6 ft. cord 4 PWR Outlets Metal Enc.	
<b>POWER CONTROL 2</b>	79.95
Same except has RFI Noise Suppressor	

Circle 187 on inquiry card.



8 YEARS (1976)

EXPERIENCE IN

COMPUTER MAIL

ORDER BUSINESS

CALIFORNIA RESIDENTS

SAVE 6% SALES TAX

The Great Salt Lake  
Computer Company, Inc.

IBM ACCESSORIES

AST PRODUCTS  
Combo Plus (Serial/Par/CLK 84 to 256K) 259.00

OUR BEST BUY

Six Pak Plus (Serial/Par/CLK/64K  
Expands to 384K) 279.00  
Six Pak Plus (Serial/Par/CLK/384K) 569.00

Meg-A-Plus (Serial/CLK/64K  
Expands to 256K) 270.00  
Meg-A-Pak (Expands Meg-A-Plus  
to 512K) 270.00  
AST-5251 (Allows connection of IBM PC  
to System 340038) 749.00  
Game Port Kit (Specify Board) 45.00  
Par Port Kit (Specify Board) 45.00  
Serial Port Kit (Specify Board) 45.00

COMPUERVE D.C. HAYES

Smartmodem 1200B-Smarcom 2  
w/software 429.00  
Smarcom II 79.00

KEYTRONICS

Enhance your PC-with a superior  
keyboard 210.00

MAYNARD

Floppy Controller 160.00  
Floppy Controller (Serial) 230.00  
Floppy Controller (PAR) 210.00

MODULAR  
ADD-ONS FOR  
SANDSTAR  
MOD-FDC

Sandstar MDD-FDC  
(for 5 1/4" or 8" drives) 205.00  
Parallel MOD 60.00  
Serial-MOD 79.00  
Clock Calendar MOD 69.00  
Game Adapter MOD 49.00

Sandstar Multi-Function Bd (Holds up to  
6 modular add-ons) 82.00  
NEW - 10 MG Hard Disk (Internal)  
w/Controller 1,195.00

APPLE FRANKLIN

ACCESSORIES

APPLE  
Disk II 269.00  
Monitor II 99.00

ALB

CPM 3.0 Card 269.00  
Z-Card II 119.00  
Smarterm 2 139.00

ASTAR

RF Modulator 18.00

COMPUERVE

Beginner's Kit (5 hrs. time) 32.00  
Videotax Software for IIE 59.00

COOL TIME

Fan, Surge Protection, Real Time Clock 2 Outlets  
for Printer & Monitor 85.00

GENERIC

80 Col. Video (Videx Compatible) 99.00  
Joy Stick 20.00  
Keyboard 175.00  
Parallel Interface 49.00  
RF Modulator 15.00  
16K RAM Add-on 40.00

HAYES JOYSTICKS

Mach II (For II & IIE) 33.95  
Mach III (with firing button) 42.95

HAYES MODEM

Micro-Modem IIE 259.00  
Micro-Model IIE w/terminal package 279.00

KENSINGTON

System Saver/Fan & Surge Protection 75.00

KOALA

Graphics Tablet 89.00

KRAFT

Joystick for IIE 44.00

1-801-972-2717

Circle 167 on inquiry card.

IBM ACCESSORIES

P.C. PRODUCTS CORP

Rainbow Color Card 375.00  
• 4 Times Better Than IBM Color  
• Expands to 128K RAM • PAR Port  
• Serial Port • Game Adapter • Light Pen Int'l  
• Mono Output • Composite Output

PLANTRONICS COLOR PLUS

Color - Color Display Card (16 colors) 379.00

PRINCETON GRAPHICS

NEW PGS HX12-Hi-Res Color The Best 469.00  
PGS-SR-12 NEW CALL  
PGS-MAX 12 NEW CALL

QUADRAM

Quadlink—Allows Apple Software to be used in  
IBM PC HAS 64K Ram-Game Port Display  
Gen-Disk Int'l. w/software 450.00  
Quadcolor 219.00  
Quadboard I w/64K CALL  
Quadboard II w/64K CALL

VISTA

Diskmaster (controls 5" & 8") drives  
Software Included 169.00

IBM COLOR CARDS

Amdek MA 495.00  
PC Peacock 289.00

OUR BEST BUY

IBM UP-GRADE KIT

INCLUDES 9 EA 4164-200NS FOR EXPANSION  
ON ALL IBM PRODUCTS WITH PARITY

\$52.00/per set

5 KITS 548.00/per set

10 KITS 46.00/per set

APPLE FRANKLIN

MICRO-MAX

View Max 80 (80 Col for II+) 149.00  
View Max 80E (80 Col w/64K Memory  
Expands to 128K) 139.00

MICRO-SOFT

Premium Soft Card IIE 379.00  
Multi-Plan 175.00  
Softcard (Z80) 239.00

MICROTEK

Dumping O (Expands to 64K) 139.00  
Dumping 64K/Interface and Graphics  
64K Buffer 235.00  
Dumping GX-P/Par Interface Card  
and Cable 99.00  
Parallel Interface Board (RV611G) 61.00  
BAM 16 (16K Add-on Memory) 55.00  
Serial Interface 99.00

NOVATION

Apple Cat II w/software 269.00

ORANGE MICRO

Parallel Interface (No Graphics) 61.00  
Grappier + (Graphics Interface) 119.00  
Grappier + 16K (Buffer and 5 to 64K) 175.00  
Buffer Board 135.00

TG PRODUCTS

Joy Stick—For Apple II + 38.00  
Paddles 29.00  
Selecta Port 38.00

VIDEX

Ultraterm 279.00  
Videterm 179.00

VISTA

AB00 Floppy Controller for 8" Drives 300.00  
A-800-1 Cable 27.00

OUR BEST BUY

WESPER

WIZARD BPO (Same as Grappier + 16K  
Specify Printer) 149.00  
WIZARD IPI (Same as Grappier  
Specify Printer) 78.00  
WIZARD EBO (Internal Buffer for Epson) 109.00

IBM DISK DRIVES

CDC

CDC 5 1/4" 9409 DS/DD 320K Quest Drive 225.00

QUME

5 1/4" #142 - (40 TR) 320K 1/2 HGT Belt Drive  
w/Brackets 200.00

PANASONIC — BEST BUY IN 1/2 HGT

5 1/4" JA-155 (40 TR) 320K 1/2 HGT Direct Drive  
w/Brackets 199.00 ea.  
2 for 385.00

TEAC

5 1/4" F-55B (40TR) 320K 1/2 HGT Direct Drive  
(For Sanyo & IBM) w/Brackets 199.00 ea.  
2 for 385.00

SHUGART DISK DRIVES

SA455L-1/2 HGT 320K DS/DD  
w/BRACKETS 200.00 ea.  
2 for 385.00

TANDON DISK DRIVES

TM 100-2A 320K DS/DD 209.00  
TM55-2 1/2 HGT 320K DS/DD 249.00 ea.  
w/BRACKETS 440.00 for 2

OUR BEST BUY

M.P.I.

B-52 (DS/DD) 320K (Saves Disk's & Disk Head)  
Standard Size 180.00

TRADE YOUR 5 1/4" DRIVE

STANDARD SIZE

SGL SIDE/DBL DEN FOR DBL SIDE/DBL DEN  
DRIVE \$75.00 ALLOWANCE

STANDARD SIZE

DBL SIDE/DBL DEN FOR 1/2 HGT DRIVES  
(Your choice)  
\$140.00 ALLOWANCE

APPLE DISK DRIVES

STANDARD SIZE

Micro Sci A-2 (35TR) 199.00

OUR BEST BUY

Micro-Sci XL (35TR) NEW 179.00  
Same as A-2 Except Plastic Case

1/2 SIZE

Super 5" "Green" Thinline 163K 40TR  
Belt Drive 169.00  
Super 5" "Blue" Thinline 163K 40TR  
Direct Drive 199.00  
Super 5" "Red" Thinline 163K 40TR  
Teac Drive 225.00

RANA

RANA 1 245.00  
RANA 2 Dbl Sided 359.00  
RANA 3 Quad Density 469.00

ALL DRIVES 1 YR. WARRANTY

APPLE DISK CONTROLLERS

Micro-Sci (35TR) 60.00  
Generic (35TR) 50.00  
Micro-Sci (40TR) 89.00  
RANA 85.00

MAIL ORDER TOLL FREE

1-800-545-2633

TERMS

Open account to state supported universities &  
companies with high Dun & Bradstreet rating.  
3% surcharge on American Express only.

Visa, MC, Check or Money Order

U.S. funds only.

Minimum order \$15.00.

LOWER PRICES-BETTER SERVICE



20 Slot IEEE  
896/S-100  
Mainframe  
with Constant  
Voltage Transformer



OUR  
BEST!

During their recent move, CompuPro discovered a few pallets of their 1983 model mainframes. They do not include most of the current cosmetic features such as shrouded/protected reset switch, or multiple rectangular cutouts on the rear panel for hard disks. As last year's model, we can offer these mainframes at tremendous savings!

- Power supply 0V @ 25A ±16V @ 3A
- Forced Air Cooled with Filter
- AC Line Filter and Convenience Outlets
- Rear Panel Punched for Multiple "D" Connectors
- Lighted Reset Switch
- 90 Day Warranty

Desk Top  
List Price: \$925.00

Rack Mount  
List Price: \$975.00

**\$595**

BESPP04  
(Sh. Wt. 55 lbs.)

**\$649**

BESPP04RM  
(Sh. Wt. 55 lbs.)

Dual QUME 8" Floppy  
Drive Subsystem With  
\$100 DMA Controller  
and CP/M 816™!!!



2.4 Mbytes of On Line Storage!

Sale Price **\$1495.**

SAVE OVER \$1500.

BESPP02 (shipping weight: 55lbs.)



U.S.  
ROBOTICS INC.

Auto Dial/  
Answer  
1200  
Baud  
Modem

**PASSWORD**

BEUSPPASSWORD List Price: \$449.00

SALE PRICE **\$295**

(Sh. Wt. 3 lbs.)

BUY From The WORLDS LARGEST SUPPLIER of S-100 Boards!!



ADVANCED  
DIGITAL  
CORPORATION

CPU BOARDS

Part No.	Description	List Price	SALE Price
BES07S1000	CPU 68K A&T 8MHz	\$ 695.00	\$ 488.00
BES07S1008	CPU 68K CSC 10MHz	\$ 850.00	\$ 785.00
BES07S1004	Co-Processor w/8086 only A&T	\$ 750.00	\$ 494.88
BES07S1008	Co-Processor w/8086 only CSC	\$ 850.00	\$ 696.96
BES07S1007	CPU 8086/8087 A&T	\$1050.00	\$ 838.00
BES07S1007	CPU 8086/8087 CSC	\$1150.00	\$1098.00
BES07S1008	CPU 8085/88 A&T	\$ 495.00	\$ 348.95
BES07S1008	CPU 8085/88 CSC	\$ 594.00	\$ 487.87
BES07S1000	3/6MHz CPU-Z A&T	\$ 325.00	\$ 228.95
BES07S1000	3/6MHz CPU-Z CSC	\$ 425.00	\$ 347.87

DISK CONTROLLER BOARDS

Part No.	Description	List Price	SALE Price
BAP07112CPM	DISK 1 (A&T) w/CP/M 2.2	\$670.00	\$488.00
When purchased with two 8" disk drives: \$450.00			
BES07S4018	DISK 1 Floppy controller (A&T)	\$495.00	\$428.00
BES07S41000	CP/M 2.2 for Z80/8085	\$148.00	
BES07S41000	w/manuals & BIOS, 8" S/D Disk		\$248.00
BES07S4025	CP/M-86* for CPU 8085/88 & CPU 8086/87 CPUs w/manuals, BIOS 8" S/D Disk		\$248.00
BES07S4025	DISK 2 8" hard disk controller	\$795.00	\$698.00
BES07S4025	w/CP/M 2.2 (A&T)		
BES07S4025	DISK 3 ST-506 type 5 1/4" hard disk controller w/CP/M-86* & CP/M-86* (A&T)	\$795.00	\$698.00

I/O BOARDS

Part No.	Description	List Price	SALE Price
BES07S0010	System Support 1 Multifunction	\$450.00	\$318.00
BES07S0010	V/O (A&T)		
BES07S0010/80831	SS1 w/8231 Math Chip A&T	\$645.00	\$570.00
BES07S0010/80832	SS1 w/8232 Math Chip A&T	\$645.00	\$570.00
BES07S3030	Interface 3 - 8 port serial (A&T)	\$699.00	\$488.00
BES07S3040	Interface 4 - 3 Serial 1 Centron- \$450.00	\$450.00	\$318.00
	1cs Parallel, 1 Parallel (A&T)		

8/16 BIT MEMORY BOARDS

Part No.	Description	List Price	SALE Price
BES07S2010	RAM 16 12MHz 32K Static A&T	\$50.00	\$ 48.00
BES07S2021	RAM 21 12 MHz 128K Static A&T	\$95.00	\$ 88.00
BES07S2022	RAM 22 12MHz 256K Static A&T	\$175.00	\$128.00
BES07S2012	M-Drive/HPS 512K RAM Disk A&T	\$175.00	\$ 84.25

MAINFRAMES

Part No.	Description	List Price	SALE Price
BES07S1200	20 Slot Desk Top (A&T)	\$925.00	\$674.00
BES07S1200	20 Slot Rack Mount (A&T)	\$975.00	\$784.00

For more CompuPro Specifications see pages 2 - 33 of our New Catalog

*Vector*

Manufactured by Vector Electronics Co. under license from CompuPro

BES07S0008FD	Interface 1, 2-Serial (A&T)	\$295.00	\$218.00
BES07S0008FZ	Interface 2, 3-Par, 1-Ser (A&T)	\$325.00	\$238.00
BES07S000817B	RAM 16 64W 10MHz Static RAM (A&T)	\$450.00	\$388.00

CompuPro is a registered trademark of CompuPro

Part No.	Description	List Price	SALE Price
BES07S3005	SBD-300 4MHz Z80A CPU A&T	\$ 741.00	\$ 618.00
BES07S3002	SBD-300 6MHz Z80B CPU A&T	\$ 825.00	\$ 688.00
BES07S3007	Z80 Starter System A&T	\$ 450.00	\$ 388.00
BES07S3008	ExpandoRAM IV 256K A&T	\$1145.00	\$ 978.00
BES07S3009	ExpandoRAM IV 256K w/EDC A&T	\$1990.00	\$1678.00
BES07S3007	ExpandoRAM (I/O) 256K	\$ 825.00	\$ 748.00
BES07S3011	PRAM-100 w/software A&T	\$ 285.00	\$ 218.00
BES07S3002	RAM Disk 256K A&T	\$ 875.00	\$ 775.00
BES07S3001	ROM Disc 128K A&T	\$ 350.00	\$ 318.00
BES07S3006	V/O-B 4-Port Async Ser. A&T	\$ 680.00	\$ 548.00
BES07S3003	V/O-B 8-Port Async Ser. A&T	\$ 695.00	\$ 588.00
BES07S3004	V/O-B 4 Sync, 4 Async, 8-Port Serial V/O A&T	\$ 795.00	\$ 688.00
BES07S3009	Versatility III Floppy & ST-506	\$ 895.00	\$ 798.00
	Hard Disk Controller		
BEP00W330145*	w/5 1/4" unbanked CP/M* 3.0	\$1083.00	\$ 888.00
BEP00W330148*	w/8" unbanked CP/M* 3.0	\$1083.00	\$ 888.00
BEP00W330147*	w/5 1/4" banked CP/M* 3.0	\$1083.00	\$ 888.00
BEP00W330148*	w/8" banked CP/M* 3.0	\$1083.00	\$ 888.00
BES07S3009	Versatility (I/O) 96 (A&T)	\$ 400.00	\$ 344.00
BEP00W330141*	w/5 1/4" unbanked CP/M* 3.0	\$ 588.00	\$ 424.00
BEP00W330142*	w/8" unbanked CP/M* 3.0	\$ 588.00	\$ 424.00
BEP00W330143*	w/5 1/4" banked CP/M* 3.0	\$ 588.00	\$ 424.00
BEP00W330144*	w/8" banked CP/M* 3.0	\$ 588.00	\$ 424.00
	*CP/M-Plus™ (3.0) configured for the 586-300		

See Complete Specifications on Pages 12-25 Of Our '83/'84 Engineering Selection Guide



BOARD LEVEL PRODUCT

Part No.	Description	List Price	SALE Price
BES07S007NP	8087 for CPU 6/16	\$ 308.00	
BES07S008P	CP/M-86*	\$ 158.00	
BES07S009P	Concurrent CP/M-86*	\$ 185.00	
BES07S010P	MP/M-86*	\$ 485.00	
BES07S011	ST-506 Hard Disk Controller	\$ 595.00	\$ 474.85
BES07S012	19.2Mb Hard Disc Subsystem	\$2295.00	\$1885.00
BES07S013	256K Static RAM (A&T)	\$1850.00	\$1718.00
BES07S014	512K Dynamic RAM (A&T)	\$1450.00	\$1348.00

See Specifications on Pages 12-27 Of Our '83/'84 Engineering Selection Guide

COMPLETE OCTAGON 8/16" SYSTEMS

BES07S1000P	w/256K Static RAM & MP/M-86*	\$7350.00	
BES07S1000P	w/256K Static RAM & Concurrent CP/M-86	\$7350.00	
BES07S1000P	w/512K Dynamic RAM & MP/M-86	\$7350.00	
BES07S1000P	w/512K Dynamic RAM & Concurrent CP/M-86	\$7350.00	

See Complete Specifications on Page 8 Of Our New '83/'84 Engineering Selection Guide

Z80 SINGLE BOARD COMPUTERS

Part Number	Description	List Price	SALE Price
BEAC00P0120	Super Six 6MHz 128K Master	\$995.00	\$848.00
	w/1 ADC PS1 RS232 Serial Adapter		
BEAC00P016120	Super Quad for 5 1/4" drives	\$595.00	\$505.00
BEAC00C015	Super Quad for 8" drives	\$750.00	\$695.00

SOFTWARE & I/O PORT ADAPTERS

BEAD00P01	PS/Net1 RS232 Serial Adapter	\$ 35.00	
BEAD00P02	Centronics Parallel Port Adapter	\$ 35.00	
BEAD00P02**†	Advanced Digital CP/M* 2.2	\$150.00	
BEAD00P03**†	Advanced Digital CP/M Plus™ (3.0)	\$350.00	
BEAD00P04**†	TurboDoc™ 1, 2, or 4 Multi-user	\$850.00	

\* Replace \* with 0 to specify Super Quad, 8 for Super Six  
† Replace † with 0 for 8" IBM\* 3740 format, 48 for 5 1/4" 48 TPI format or 96 for 5 1/4" 96 TPI format

ST506/SA1000

HARD DISK CONTROLLER

BEAD00C00015	ST506 5 1/4" Winchester Cont.	\$500.00	\$395.00
BEAD00C00018	8" Winchester Cont.	\$500.00	\$395.00
BEAD00C00019	Instal program for use with non-ADC	\$ 10.00	

CP/M board (Supplied on 8" CP/M\* compatible disk)

See Complete Specifications on Pages 14 - 27 of our '83/'84 Engineering Selection Guide

MACROTECH International Corp.

MAX: 1 S-100 SLOT

1 MEGADYTE

The MACROTECH MAX is a 256K to 1 Megabyte S-100 IEEE/896 dynamic memory board. That's right, up to 1 Megabyte on a single standard size S-100 board. The first 384K is on the Host card that plugs into your motherboard. The remaining 640K is located on a unique "piggy-back" card that attaches to the host. The MAX family is ideally suited to applications where density, speed, and software flexibility are essential. See Page 16 Of Our New '83/'84 Engineering Selection Guide for Complete Specifications

Ordering Information: The 256K and 384K versions include the fully socketed Host card. The 512K and larger versions also include the fully socketed "piggy-back" card.

Part No.	Description	List Price	SALE Price
BEAC00P01200	256K Dynamic RAM (A&T)	\$1125.00	\$1185.00
BEAC00P01200	384 Dynamic RAM (A&T)	\$1467.00	\$1895.00
BEAC00P01200	512K Dynamic RAM (A&T)	\$1890.00	\$1768.00
BEAC00P01200	1 MEG Dynamic RAM (A&T)	\$2449.00	\$2325.00
BEAC00P01200	Memory Mapping Option	\$ 81.00	

Attention CompuPro CPU 8085/88 Users: You must order the CPU modification hardware to insure complete compatibility

BEAC00P01200 Hardware modification for CompuPro CPU 8085/88 \$ 88.00



**PRINTERS**



\$289

Part Number	Description	List Price	Our Price
NESTR0810X	120 cps, 80 col (20 lbs)	\$399.00	\$368.00
NESTR0815X	120 cps, 132 col (26 lbs)	\$849.00	\$368.00
NESTR0817X	Serial Interface for 10X and 15X		\$ 39.00
NESTR0817XAN	Same as above with 4K Buffer		\$110.00
NESTR0817A10	160 cps, 80 col (20 lbs)	\$649.00	\$468.00
NESTR0817A15	160 cps, 132 col (26 lbs)	\$799.00	\$688.00
NESTR0817TYPE	18 cps Letter Quality (25 lbs)		\$448.00

**MANNESMAN-TALLY**

Letter Quality Dot Matrix Printers

BEYALM1100L	160 cps, 80 col (21 lbs)	<del>\$579</del>
BEYALM1100L	160 cps, 132 col (26 lbs)	<del>\$799</del>
BEYALM110100	Replacement Ribbon for M1100L	\$15.75
BEYALM110100	Replacement Ribbon for M1100L	\$17.00

**PRINTER CABLES**

BEPC030P120P	Centronics Male to Male 5'	<del>\$24.95</del>
BEPC030P220P	IBM PC™ to Centronics Parallel 6'	<del>\$34.95</del>
BEPC030P0P	6' 9 conductor shielded RS-232	<del>\$18.95</del>

**PRACTICAL PERIPHERALS** **PRINTER DUFFERS**

MICRODUFFER - Stand Alone Duffer

BEPP001004	64K Serial	\$349.00	\$288.00
BEPP001004	64K Parallel	\$349.00	\$288.00
BEPP001004	64K Expansion Module	\$179.00	\$148.00

**MICRODUFFER II+ For Apple II/IIe**  
16K, Expandable to 64K. Extensive Graphics, Serial & Parallel Ports.

BEPP001004	w/Serial Cable	\$259.00	\$188.00
BEPP001004	w/Parallel Cable	\$259.00	\$188.00
BEPP001004	Graphics Only Card	\$ 99.00	\$ 88.00
BEPP001004	Centronics Parallel V/D Card	\$ 75.00	\$ 68.00

**DUFFERS FOR EPSON PRINTERS**  
Compatible with EPSON MX, FX, RX Series and IBM Printers

BEPP001004	Serial 8K buffer	\$159.00	\$128.00
BEPP001004	Parallel 16K buffer	\$159.00	\$128.00

**VIDEO MONITORS**

SANYO

12" 80 x 24 18MHz

Part Number	Description	List Price	Our Price
BEYTD00012CX	Black & White Display	\$240.00	\$148.00
BEYTD00012CX	B&W w/Audio	\$260.00	\$168.00
BEYTD000112CX	Green P31 Display	\$240.00	\$148.00
BEYTD000112CX	Green P31 w/Audio	\$260.00	\$168.00
BEYTD00012CX	Amber Display	\$240.00	\$148.00
BEYTD00012CX	Amber w/Audio	\$260.00	\$168.00

13" RGD COLOR w/AUDIO

BEYTD000300	Medium Res 350 x 350 lines	\$495.00	\$348.00
BEYTD000700	High Res 1480 x 1240 dots	\$725.00	\$488.00
BEYTD000900	Ultra High 1600 x 1240 dots	\$1095.00	\$778.00

Shipping Weights on above monitors 12" 24 lbs. ea. / 13" color 30 lbs. ea.

TAXAN

12" 80 x 24 18MHz

BEYTD001200V	Amber Display	\$189.00	\$128.00
BEYTD00120	Green Display	\$179.00	\$118.00

12" RGD COLOR

BEYTD0001	Medium Res 310 lines	\$399.00	\$348.00
BEYTD0001	Super High Res 630 lines	\$699.00	\$448.00
BEYTD00020	IBM 1 inch Abbe 630 lines	\$699.00	\$448.00

**15M Byte Hard Disk For IBM PC™**  
50% More Capacity Than The XT™!



Interchangeable  
Instructions  
Interoperable

- Plug and Run — ready to go right out of the box!
- Complete with controller card, data cable & internal mounting hardware
- Total PC/XT compatibility — will boot directly from the hard disk under DOS 2.0\*
- No special software needed
- BK BIOS emulates XT command set
- Controller will support any 2 hard drives (ST506 Compatible)
- Hard disk can be partitioned into 4 operating systems
- 2.1 interleaving (data transfer rate 3 times faster than XT\*)

**INTERNAL 10M Byte Hard Disk With Controller**

**\$995**

BEIHNDPC110 (Sh. Wt. 22 lbs.)

**INTERNAL 15M Byte Hard Disk With Controller**

**\$1395**

BEIHNDPC110 (Sh. Wt. 11 lbs.)

**EXTERNAL 15M Byte Hard Disk With Controller**

The 15Mbyte drive is mounted in a 11H05001 cabinet with power supply. All hardware specifications are the same.

**\$1595**

BEPP001004 (Sh. Wt. 16 lbs.)  
External 15 Mbyte Hard Disk w/Controller & Data Cable



**Backed By a 6-Month Warranty!**

BEIHNDPC001 **\$50.00**

Required disk boot program for older original PCs with 128K memory. Using 4116 - 16K memory chips



**MODEMS**

1200 Baud, Auto Dial/Auto Answer

Part Number	Description	List Price	Our Price
BEHBAB1200A	1200 baud with LEDs	\$599.00	\$468.00
BEHBAB100	1200 Baud S-100 Card	\$449.00	\$388.00

**TELPAC COMMUNICATIONS SOFTWARE**

BEBS001000A	Software on Apple 5 1/4" Format	\$ 79.00
BEBS001000B	Software on 8" 5SSD CPM* Disk	\$ 78.00

**D.C. HAYES**

BEBCND400P	1200 Baud Smartmodem	\$695.00	\$478.00
BEBCND200P	300 Baud Smartmodem	\$279.00	\$228.00
BEBCND300P	Cronograph	\$249.00	\$198.00
BEBCND100P	MicroModem 100	\$399.00	\$298.00
BEBCND000P	MicroModem II	\$379.00	\$298.00
BEBCN1200B	IBM-PC™ Modem Card with Software included	\$695.00	\$478.00

**RIXON**

1200 Baud Direct Connect w/10 Number Memory

BEBCND121A	1200 Baud Stand-Alone Unit	\$495.00	\$388.00
BEBCND121A	1200 IBM PC™ Modem (2 lbs.)	\$495.00	\$388.00
BEBCND0001	IBM PC™ Modem Software (1 lb.)	\$ 68.00	
BEBCND1200	IBM Modem & Software Together (3 lbs.)	\$448.00	

**MURA**

BEBCND1100	300 Baud Modem (2 lbs.)	\$99.95	\$78.00
------------	-------------------------	---------	---------



**PRIORITY**



**ELECTRONICS**



9161 Deering Ave., Chatsworth, CA 91311-5887

**ORDER TOLL FREE (800) 423-5922 - CA, AK, HI CALL (818) 709-5111**

Temp. US VISA MC BAC Check Money Order U.S. Funds Only. CA residents add 6 1/2% Sales Tax. MINIMUM PREPAID ORDER \$15.00. Include MINIMUM SHIPPING & HANDLING \$2.00 for the first 2 lbs. plus 40¢ for each additional pound. Orders over 70 lbs. sent freight collect. Just in case, include your phone number. Prices subject to change without notice. We will do our best to maintain prices through May, 1984. Credit card orders will be charged appropriate freight. We are not responsible for transportation errors. Sale prices for prepaid orders only. Circle 318 on inquiry card.

**FLIP 'N' FILE**  
50 Capacity  
Stores 50 5 1/4" Diskettes  
(Sh. Wt. 9 lbs.)  
BEINC03613138  
**\$29.95**

**5 1/4" Double Density Soft Sector, 40 Track**  
Use with IBM, Sanyo, Apple and Most Personal Computers.

Part Number	Manufacturer	Boxes	1 Box	2 or More Boxes
BEULT51401	ULTRA	1	<del>\$18.95</del>	<del>\$18.95</del>
BEULT52401	ULTRA	2	<del>\$32.00</del>	<del>\$30.00</del>
BEMLND110	MAXELL	1	<del>\$26.00</del>	<del>\$24.00</del>
BEMLND200	MAXELL	2	<del>\$39.00</del>	<del>\$37.00</del>
BEBSN10410	DYSAN	1	<del>\$34.00</del>	<del>\$32.00</del>
BEBSN10420	DYSAN	2	<del>\$41.00</del>	<del>\$39.00</del>

CALL FOR HARD SECTOR & 77 TRACK DISKS NOT LISTED HERE.

**8" Double Density, Soft Sector**

BEMLF01120N1200	MAXELL	1	<del>\$44.00</del>	<del>\$38.00</del>
BEMLF01120N1200	MAXELL	2	<del>\$51.00</del>	<del>\$47.00</del>

# PRIORITY ONE ELECTRONICS

## MS-DOS™ Computer with Monitor, Printer, and Software



### Hardware

#### SANYO MDC555

- 16 Bit 8088 CPU
- Socketed for Optional 8087 MPU
- 128K of RAM expandable to 256K
- Centronics Printer Port
- 2 Single Sided Disk Drives (160K Bytes Each)
- 10 Programmable Function Keys
- Speaker and Joystick Port
- Video and printer cables included

### Software

- MS-DOS™ Operating system
- SANYO BASIC

#### MicroPro Software:

- WordStar®
- SpellStar®
- CalcStar®
- DataStar®
- ReportStar®
- InfoStar®
- MailMerge®

Runs Many Off-The-Shelf Programs for IBM-PC™

- BEP08555SP1 w/Green Screen
- BEP08555SP3 w/Amber Screen



- AMBER or GREEN Screen Monitor
- GEMINI 10X Dot Matrix Printer

List Price: \$2034.00

# \$1495

(Shipping weights on above items: 3 boxes: 30 lbs., 30 lbs. and 20 lbs.)

RGB Color Monitors and Letter Quality Printers may be substituted at additional cost.



## UNINTERRUPTABLE POWER SYSTEM!

- All The Features as a Minicomputer Regulator!
- AC Power Delivered When Power Fails!

Part Number	VA Rating	Weight	List Price	SALE PRICE
BESLA280660750300	750VA / 10 min.	95 lbs.	\$1862.00	<b>\$1497.00</b>
BESLA280650400301	400VA / 20 min.	126 lbs.	\$1865.00	<b>\$1406.00</b>

## THE CLEAN POWER SOLUTION!

## Short-Circuit SOLA's Price-Increase!

A UNIT OF GENERAL SIGNAL GS

**SOLA**

WE MAINTAIN OUR LOW PRICES THROUGH SOLA'S PRICE INCREASE!

## MINICOMPUTER REGULATORS

- Constant Voltage • EMI/RFI Filtering
- Total AC Isolation • Better Than Dedicated AC Power!

Part Number	VA Rating	List Price	SALE PRICE
BESLA8313070	10 lbs. 70 VA	\$ 169.40	<b>\$149.00</b>
BESLA8313114	18 lbs. 140 VA	\$ 259.44	<b>\$219.00</b>
BESLA8313125	31 lbs. 250 VA	\$ 309.18	<b>\$261.00</b>
BESLA8313150	47 lbs. 500 VA	\$ 428.84	<b>\$362.00</b>
BESLA8313175	60 lbs. 750 VA	\$ 546.08	<b>\$461.00</b>
BESLA8313210	75 lbs. 1000 VA	\$ 632.56	<b>\$534.00</b>
BESLA8313220	108 lbs. 2000 VA	\$ 1075.54	<b>\$895.00</b>

# SOFTWARE The Best Sellers At The Best Prices!

## IDM PC/MS™ DOS™ 5 1/4" FORMAT

Part Number	Description	SALE PRICE
BEASTDRIM	ASHTON-TATE - dBASE II	<b>\$399.00</b>
BE MPRPROPARI	MICRO-PRO - WordStar professional, includes WordStar, Mail-Merge, SpellStar & Star Index	<b>\$425.00</b>
BE MSHMPLPLM	MICROSOFT - Multiplan	<b>\$169.00</b>
BE SWMNMATEI	SOFTWARE SYS - Multimate	<b>\$299.00</b>
BE ASTFRIDAYI	ASHTON-TATE - Friday!	<b>\$189.00</b>
BE OASVNDI	LIFETREE - Volkswriter Deluxe	<b>\$189.00</b>
BE SORSC3I	SORCIM - SuperCalc III	<b>\$249.00</b>

Part Number	Description	SALE PRICE
BE MICRBASEI	MICRORIM - R-Base	<b>\$319.00</b>
BE STSTARPARI	STAR SOFTWARE - Star Partner	<b>\$249.00</b>
BE WLFMOVI	WOOLF SOFTWARE - Move-II	<b>\$ 89.00</b>
BE HARPMJGRI	HARVARD SOFTWARE - Harvard Project Manager	<b>\$249.00</b>
BE BWPCPENAI	SOFTWARE PRODUCTS, INT. - Open Access	<b>\$399.00</b>
BE MSHFAS2I	MICROSOFT - MBASIC	<b>\$219.00</b>

## CP/M-80™ 8 BIT 8" SSSD FORMAT

Part Number	Description	SALE PRICE
BE DIRC800	DIGITAL RESEARCH - CBASIC 80	<b>\$ 99.00</b>
BE LEXPLND	LEXISOFT - Spellbinder	<b>\$259.00</b>
BE SOBSC280	SORCIM - SuperCalc II	<b>\$179.00</b>
BE MPRPROPARI	MICRO-PRO - WordStar Professional (Includes WordStar, SpellStar, Mail-Merge, and Star Index)	<b>\$399.00</b>
FCMCSNSTLK	MICROSTUFF - Crosstalk	<b>\$119.00</b>

Part Number	Description	SALE PRICE
BE MSHFAS2I	MICROSOFT - MBASIC	<b>\$219.00</b>
BE FAXQCB0	FOX & GELLER - Quickcode	<b>\$179.00</b>
BE STSTARPARI	STAR SOFTWARE SYST. - Star Partner	<b>\$249.00</b>
BE ASTON80	ASHTON-TATE - dBASE II	<b>\$399.00</b>
BE ASTFRIDAYI	ASHTON-TATE - Friday!	<b>\$189.00</b>
BE MSHMPLPLM	MICROSOFT - Multiplan	<b>\$169.00</b>

## APPLE CP/M® & DOS™ FORMAT

Part Number	Description	SALE PRICE
BEAST0800A	ASHTON-TATE - dBASE II	<b>\$399.00</b>
BE MPRWST8ZA	MICRO-PRO - WordStar 3.3 w/8MHz 280 Card, 64K RAM, & CP/M 2.2	<b>\$299.00</b>
BE MSHMPLPLM	MICROSOFT - Multiplan	<b>\$169.00</b>
BE MSH357780	MICROSOFT - Softcard Premium IIe (280A, 64K, & CP/M™, MBASIC)	<b>\$299.00</b>
BE LEXPLND8A	LEXISOFT - Spellbinder	<b>\$229.00</b>

Part Number	Description	SALE PRICE
BE OASWPL8ZA	OASIS - Word PLUS	<b>\$ 99.00</b>
BE MPRPROPAP8A	MICRO-PRO - Prof. Optional Pack (Includes MailMerge, SpellStar, and Star Index)	<b>\$189.00</b>
BE WLFMOVA	WOOLF SOFTWARE - Move-II	<b>\$89.00</b>
BE BRD8NKWRA	BRODERBUND - Bank Street Writer	<b>\$ 49.00</b>

ORDER TOLL FREE (800) 423-5922 - CA, AK, HI CALL (818) 709-5111



# PRIORITY ONE ELECTRONICS

## DRIVES & ENCLOSURES

### 5 1/4" FLOPPY DISK DRIVES

DEMP151*	MPI Full Height SS 48TPI (5 lbs.)	\$200.00
DEMP152*	MPI Full Height DS 48TPI (5 lbs.)	\$270.00
DEMP151*	MPI Full Height SS 96TPI (5 lbs.)	\$275.00
DEMP152*	MPI Full Height DS 96TPI (5 lbs.)	\$400.00
DEMP1601	MPI 1/2-Height SS 48TPI (4 lbs.)	\$200.00
DEMP1602	MPI 1/2-Height DS 48TPI (4 lbs.)	\$300.00
DEMP1601	Tandon Full Height SS 48TPI	\$179.00
DEMP1602	Tandon Full Height DS 48TPI	\$219.00
DEMP1614	Tandon Full Height DS 96TPI	\$329.00

\*Replace with 0 for MPI Door, or 8 for Shugart SA400 Type Door

### 5 1/4" Disk Drive Cabinets

BEJMR103	Single Drive Cabinet (5 lbs.)	\$ 79.00
BEJMR203	Dual Drive Cabinet (9 lbs.)	\$ 89.00
BEJMR206	Dual w/Internal Data Cable (9 lbs.)	\$118.00

### 8" Floppy Disk Drives

DESH0010	Shugart Full Height SS (18 lbs.)	\$349.00
DESH0011	Shugart Full Height DS (18 lbs.)	\$479.00
DESEFDD1008	Siemens Full Height SS (18 lbs.)	\$129.00
DEMETRAK42	Qume Full Height DS (18 lbs.)	\$458.00
DEMT209433	Mitsubishi Full Height DS (18 lbs.)	\$375.00
DEMP413	MPI Full Height SS (11 lbs.)	\$388.00
DEMP423	MPI Full Height DS (11 lbs.)	\$489.00
DEMP410	MPI Dual 1/2-Height SS (22 lbs.)	\$789.00
DEMP420	MPI Dual 1/2-Height DS (22 lbs.)	\$830.00
DEMP41M	MPI 1/2-Height SS (9 lbs.)	\$380.00
DEMP42M	MPI 1/2-Height DS (9 lbs.)	\$460.00
DETNDTM441	Tandon 1/2-Height SS (9 lbs.)	\$325.00
DETNDTM442	Tandon 1/2-Height DS (9 lbs.)	\$399.00



Dual 8" Disk Enclosures

All of these rugged enclosures feature forced, filtered air cooling, heavy power supply, with the heat producing elements mounted to outside for cool reliable operation. The rear panels are punched for the appropriate data cables.

FDE02: Economical design for two standard size 8" floppies. Hinged lid for easy drive access. Power supply: 5V@4A, -5V@.5A, +24@.3A.

DTL02: Cabinets for two 1/2-height 8" drives or 1 full height 8" floppy or Winchester. Includes Shugart type AC power cable.

Part Number	Description	List Price	SALE Price
DEHFDE02	FDE02 Dual Enc (35 lbs.)	\$359.95	\$329.00
DEHDTL02SH	DTL02 Dual This Line (12 lbs.)	\$225.00	\$178.00
DEHDTL02MKT	MPI 1/2-Height DTL adapter kit		\$ 24.00
DEHICLS023849M	Shugart to Qume AC Cable		\$ 4.95

## BUY CABINETS WITH DRIVES AND SAVE!

### Combinations with FDE002

DEPDBHFDE22	w/2 SHU801R Drives	\$ 689.00
DEPDBHFDE2M2	w/2 MFM209463S Drives	\$1049.00
DEPDBHFDE202	w/2 QMETRAK842 Drives	\$1199.00
DEPDBHFDE2051	w/2 SHUB51R Drives	\$1239.00
DEPDBHIE	w/2 FDD1008 Drives	\$ 499.00

### Combinations with DTL002

DEPDBHDT01	w/2 TNDTM441 Drives	\$ 679.00
DEPDBHDT02	w/2 TNDTM442 Drives	\$1039.00
DEPDBHMP1	w/2 MP41M Drives	\$ 679.00
DEPDBHMP2	w/2 MP42M Drives	\$1039.00

### 5 1/4" Hard Disk

DETM0001	Tandon 6 Mb (9 lbs.)	\$ 699.00
DETM0002	Tandon 12 Mb (9 lbs.)	\$ 799.00
DETM0003	Tandon 19 Mb (9 lbs.)	\$ 899.00



## DUAL 5 1/4" HARD DISK DRIVE CABINET

All of the necessary power for two TANDON TMS00 series or equivalent hard disk drives. Just imagine, you can have 100Mbytes of storage using two of the Micropolis 5 1/4" Winchester disk drives and this cabinet! Power supply +5V@6A and +12V@6A. The rear panel is punched for two 20, two 34, and one 50 pin header connectors. Fan cooled.

DEH00002	Dual Hard Disk Enclosure (Sh. Wt. 20 lbs.)	\$389.00
DEH00001	Single hard disk enclosure (Sh. Wt. 15 lbs.)	\$249.99

## BUY CABINET WITH DRIVES AND SAVE!

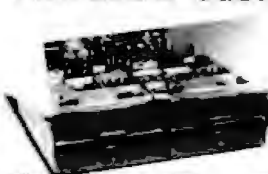
DEPDB02100	w/2 TMS01 Drives	\$1599.00
DEPDB02100	w/2 TMS02 Drives	\$1899.00
DEPDB02100	w/2 TMS03 Drives	\$2149.00

Disk drives will be shipped separately from cabinets.

Don't forget to include shipping for each disk drive cabinet.

## BUY DRIVE AND CABINET TOGETHER AND SAVE!!

### DUAL SIEMENS FDD1008's with IIFDE002 Cabinet



**\$499.00**  
**SAVE \$84.00**

DEPDBHIE

(Drives are shipped separate from cabinet. Package shipped in 3 containers)

## SIEMENS



FDD1008  
8" Drive  
Single Sided  
Double Density

**\$129.00** each

DESEFDD1008 (be sure to include \$7.00 per drive for shipping)

## ADD ON DRIVE FOR IBM PC™

### Tandon JMR



TM1002-1 Full  
Height 5 1/4" 40 Track  
48 TPI Drive

DOUBLE  
SIDED  
**\$219**

FETNDTM1002  
(Sh. Wt. 4 lbs.)

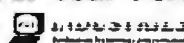


5 1/4" Floppy Cabinet  
Holds 2 Half or 1 Full  
Height drive with  
Power Supply

**\$69**

BEJMR2SV5  
(Sh. Wt. 7 lbs.)

## NOW! The Affordable UPS For Your Personal Computer!

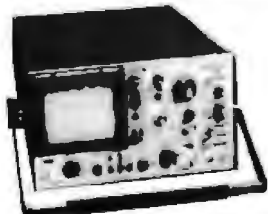


**\$359.00**



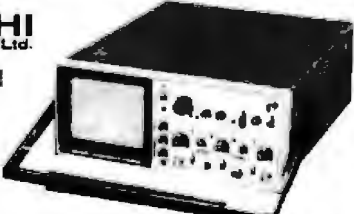
200 Watts For 5 Minutes of Uninterruptible Power With  
AC Surge and EMI/RFI Filtering Built-in!  
Perfect for Morrow Micro Decision, IBM PC™, Apple IIe,  
and many, many more!

BEPTIPC200 (Sh. Wt. 21 lbs.) **\$359.00**



HITACHI  
Hitachi Denshi Ltd.

5 YEAR  
WARRANTY!!  
PROBES  
INCLUDED!



## DELAYED SWEEP w/TRIGGER VIEW

100MHz  
3rd & 4th TRACE  
BEHIT1050F

**\$1295**  
List: \$1595.00 (31 lbs.)

60MHz  
3rd TRACE  
BEHIT650F

**\$995**  
List: \$1195.00 (31 lbs.)

## NEW! LOW PROFILE DUAL CHANNEL

40MHz  
DUAL TRACE  
BEHIT422

**\$695**  
List: \$895.00 (17 lbs.)

20MHz  
DUAL TRACE  
BEHIT222

**\$549**  
List: \$595.00 (17 lbs.)

Circle 318 on Inquiry card.



PRIORITY



ELECTRONICS



9161 Deering Ave., Chatsworth, CA 91311-5887

ORDER TOLL FREE (800) 423-5922 - CA, AK, HI CALL (818) 709-5111

Terms: U.S. VISA, MC, BAC Check, Money Order, U.S. Funds Only. CA residents add 6 1/2% Sales Tax. MINIMUM PREPAID ORDER \$15.00. INCLUDE MINIMUM SHIPPING & HANDLING OF \$3.00 for the first 3 lbs. plus 40¢ for each additional pound. Orders over 70 lbs. sent freight collect. Just in case, include your phone number. Prices subject to change without notice. We will do our best to maintain prices through May, 1984. Credit card orders will be charged appropriate freight. We are not responsible for typographical errors. Sale prices for prepaid orders only.

ORDER TOLL FREE (800) 423-5922 - CA, AK, HI CALL (818) 709-5111

# PIPELINE

## COMPUTERS

Computer Components Unlimited may be the King  
of Computer Peripherals — but . . .

**PIPELINE will be the KING of all IBM Products . . .  
The Source!**

### QUADRAM QUADLINK

- ★ Runs Apple Software
- ★ Turn your PC to Apple
- ★ Special Liquidation Price  
This Month Only

List \$595 **\$399**

### CPS COLOR CARD

- ★ RGB & Composite Video
- ★ Same as IBM's Card
- ★ w/ Par. & Ser. Port

List \$495 **\$349**

### SANYO MBC 555 COMPUTER

- ★ 16 Bit 8088 CPU ★ Exp. to 256K
- ★ MS Dos Operating System
- ★ 2, 160K Disk Drives
- ★ Centronics Printer Port

List \$1399 **\$1099**

### PIPELINE COLOR CARD

- ★ Identical to PC's  
performance
- ★ Runs All Software Graphics

List \$299 **\$199**

### ANCHOR MODEM

- ★ PC Compatible
- ★ 300 Baud Direct Connect
- ★ No Port Needed

List \$199 **\$94**

### 8087 CO PROCESSOR

- ★ The Math Chip

List \$399 **\$179**

### KEYTRONICS KEYBOARD

- ★ Quality Keyboard for PC

List \$299 **\$179**

### HERCULES GRAPHIC CARD

- ★ Compatible w/Lotus &  
All Majors
- ★ Includes Par. Printer Port

List \$499 **\$339**

### MAXIMIZER MULTI- FUNCTION CARD

- ★ 64K exp. to 384k
- ★ Part Ser. Port
- ★ Optional Ser. & Game Port
- ★ Software Included

List \$395 **\$239**

### IBMPC SYSTEM

- ★ 64k exp. to 256k
- ★ 2, 360k Disk Drives
- ★ Clr. Graphics Interface Card
- ★ 80 x 24 Hi-Res Gr. Monitor

List \$3098 **\$2469**

### TEAC DISK DRIVE

- ★ FD55B
- ★ 360K Slimline
- ★ PC Compatible
- ★ 90 Day Warranty

List \$299 **\$169**

### 64K MEMORY EXPANSION

- ★ 1 yr. Warranty
- ★ 9 to A Set

List \$89 **\$49**

# PIPELINE

## COMPUTERS

**The Source!**



- We Accept MC, Visa, Wire Transfers, Certified Checks
- COD's Available
- All Prices Reflect a Prepaid Discount

- Shipping Minimum 4.50
- Purchase Orders Accepted
- This Ad Supersedes all Others

Prices Subject to Change

**The Source**





# CALL TOLL-FREE (800) 841-0905

## For Lowest Prices & Fast Delivery

### IBM COMPATIBLE DISK DRIVES

#### TANDON

TM-55-2, 1/2 Height (360K) ..... \$ 209  
 TM-100-2 (360K) ..... \$ 209

#### TEAC

FD55A Sgl. Head (160K) ..... \$ 149  
 FD55B Dbl. Head (360K) ..... \$ 169

#### PANASONIC — SHUGART

SA455-Panasonic ..... \$ 169

#### CDC

9409 Dbl. Head (360K) ..... \$ 229

### PRINTERS

#### OKIDATA

ML 82A (120 cps) ..... \$ 319  
 ML 92A (160 cps) ..... 429  
 ML 93A (160 cps) 15" carriage ..... 729  
 82 & 92 Tractor Option ..... 59  
 92 & 93 Plug & Play ..... 49

#### C. ITOH

8510AP Prowriter ..... \$ 339  
 F10-40 Starwriter ..... 979  
 F-10-55 Printmaster ..... 1319

#### JUKI

6100, 18 cps ltr. qual. .... \$ 449  
 Tractor Feed ..... 129

### MODEMS

#### HAYES MICRO INC.

Smart Modem 300 ..... \$ 205  
 Smart Modem 1200 ..... 489  
 Internal 1200B ..... 399

#### ANCHOR

Mark VII 300 Baud ..... \$ 94  
 Mark XII 1200 Baud ..... 269

#### PROMETHEUS

ProCom 1200 ..... \$ 369

#### RIXON

PC212A, 1200 Baud Stand Alone .. \$ 409  
 P212A, 1200 IBMPC ..... 409

#### U.S. ROBTICS

Password, 1200 Baud ..... \$ 339

#### NOVATION

Access 123 ..... \$ 449

### MONITORS

#### AMDEK

300G, 12" Green ..... \$ 129  
 300A, 12" Amber ..... 139  
 310A, 12" Amber Monochrome .. 169  
 Color I + Color Composite ..... 299  
 Color II + RGB w/Cable ..... 409

#### PRINCETON GRAPHICS

HX12, RGB PC Copy ..... \$ 479

### DISKETTES

#### PIPELINE

Dbl./Dbl. Reinforced Hub 1 year warranty ..... \$ 19  
 Flip File Holds 70 (smk. plexiglass) 16

### IBM & COMPATIBLE COMPUTERS

#### IBM

PC w/64K, 1 Drive (128K) ..... \$1975  
 PC w/64K, 2 Drives ..... 2195  
 PC XT, 128K 10 Meg Disk ..... 4495  
 PC Jr. .... 1199

#### COMPAQ

Compaq 128K, 1 Drive ..... \$1895  
 Optional Drive ..... 229

#### EAGLE

PC-2, 128K, 2 - 320K Drives ..... \$2550  
 PC-2 + ..... 2250

#### COLUMBIA

1600-1, 2-Drives (360K) ..... \$2595  
 1600-4, 12MB Hard Disk ..... 3875  
 MPC-XP Portable ..... 2395

#### SANYO

MBC 550, 1-Drive, software ..... \$ 789  
 MBC 555, 2-Drives, more software . 1099  
 Optional Serial Port ..... 99

#### TAVA

2-Drives, 128K, 2 Ser. 1 Par. Port, Color Graphics Card & Hi-Res. Green Monitor ..... \$1895

### INTERFACE CARDS FOR IBM & COMPATIBLES

#### AST RESEARCH

SixPac + 64K Par. & Ser. Software . \$ 269  
 Mega + 64K exp. to 512K Ser. Port 269  
 MegaPack 256K option for Mega .. 279  
 I/O + Ser. & Optional Par. Game .. 149  
 Additional Ports ..... 49

#### QUADRAM

Color I ..... \$ 219  
 Color II ..... 229  
 Quadlink List 5680, Regular 5449  
 ..... Special 479  
 Quad Board I ..... 269  
 Quad Board II ..... 269

#### HERCULES

Color Graphics Card ..... \$ 339

#### PLANTRONICS

Color + ..... \$ 379

#### IBM

Dos 1.1 ..... \$ 39  
 Dos 2.1 ..... 59  
 Monochrome Monitor or Adaptor 309

#### FLOPPY DISK CONTROLLERS

Maynard ..... \$ 169  
 Maynard w/Ser. Port ..... 229  
 Maynard w/Par. Port ..... 229  
 Sigma Controller ..... 159  
 Vista ..... 159

#### PC PRODUCTS

Rainbow Color Card ..... \$ 369

#### AMDEK

MAI Card ..... \$ 489

#### DUST COVER

Covers Monitor, Mainframe & Keyboard ..... \$ 19

#### MORE ACCESSORIES

Koala Graphics Tablet ..... \$ 89  
 8087 Co-Processor ..... 179  
 Kraft Joystick ..... 39  
 Par. Printer Cable ..... 39

## The Source!

Circle 312 on Inquiry card.



#### ORDER DESK:

(213) 970-0177  
 (800) 841-0905  
 (OUTSIDE CALIFORNIA)

#### MAIL ORDER:

1142 Manhattan Avenue, CP21  
 Manhattan Beach, CA 90266

CUSTOMER SERVICE:  
 (213) 970-0177

Mon.-Fri. 8:00 a.m. to 6:00 p.m.  
 Saturday 9:00 a.m. to 1:00 p.m.

# 4164 64K DYNAMIC \$595 TMM2016 2KX8 STATIC \$415

200 NS

200 NS

## STATIC RAMS

2101	256 x 4 (450ns)	1.95
5101	256 x 4 (450ns) (cmos)	3.95
2102-1	1024 x 1 (450ns)	.89
2102L-4	1024 x 1 (450ns) (LP)	.99
2102L-2	1024 x 1 (250ns) (LP)	1.49
2111	256 x 4 (450ns)	2.49
2112	256 x 4 (450ns)	2.89
2114	1024 x 4 (450ns)	8/9.95
2114-25	1024 x 4 (250ns)	8/10.95
2114L-4	1024 x 4 (450ns) (LP)	8/12.95
2114L-3	1024 x 4 (300ns) (LP)	8/13.45
2114L-2	1024 x 4 (200ns) (LP)	8/13.95
TC5514	1024 x 4 (650ns) (cmos)	2.49
TC5516	2048 x 4 (250ns) (cmos)	9.95
2147	4096 x 1 (55ns)	4.95
TMS4044-4	4096 x 1 (450ns)	3.49
TMS4044-3	4096 x 1 (300ns)	3.99
TMS4044-2	4096 x 1 (200ns)	4.49
MK4118	1024 x 8 (250ns)	9.95
TMM2016-200	2048 x 8 (200ns)	4.15
TMM2016-150	2048 x 8 (150ns)	4.95
TMM2016-100	2048 x 8 (100ns)	6.15
HMS116-4	2048 x 8 (200ns) (cmos)	4.75
HMS116-3	2048 x 8 (150ns) (cmos)	4.95
HMS116-2	2048 x 8 (120ns) (cmos)	8.95
HMS116L-P-4	2048 x 8 (200ns) (cmos) (LP)	5.95
HMS116L-P-3	2048 x 8 (150ns) (cmos) (LP)	6.95
HMS116L-P-2	2048 x 8 (120ns) (cmos) (LP)	10.95
Z-5132	4096 x 8 (300ns) (Qstal)	34.95
HMS264	8192 x 8 (150ns) (cmos)	49.95

LP - Low Power Qstal - Quasi-Static

## DYNAMIC RAMS

TMS4027	4096 x 1 (250ns)	1.99
UPD411	4096 x 1 (300ns)	3.00
MM5280	4096 x 1 (300ns)	3.00
MK4108	8192 x 1 (200ns)	1.95
MM5299	8192 x 1 (250ns)	1.85
4116-300	16384 x 1 (300ns)	8/11.75
4116-250	16384 x 1 (250ns)	8/7.95
4116-200	16384 x 1 (200ns)	8/12.85
4116-150	16384 x 1 (150ns)	8/14.95
4116-120	16384 x 1 (120ns)	8/29.95
2118	16384 x 1 (150ns) (5v)	4.85
MK4332	32768 x 1 (200ns)	9.95
4164-200	65536 x 1 (200ns) (5v)	5.95
4164-150	65536 x 1 (150ns) (5v)	6.95
MCM6666	65536 x 1 (200ns) (5v)	8.95
TMS4164-15	65536 x 1 (150ns) (5v)	8.95

5V single 5 volt supply

## EPROMS

1702	256 x 8 (1us)	4.50
2708	1024 x 8 (450ns)	3.95
2758	1024 x 8 (450ns) (5v)	5.95
2718	2048 x 8 (450ns) (5v)	3.95
2718-1	2048 x 8 (350ns) (5v)	5.95
TMS2516	2048 x 8 (450ns) (5v)	5.50
TMS2716	2048 x 8 (450ns)	7.95
TMS2632	4096 x 8 (450ns) (5v)	5.95
2732	4896 x 8 (450ns) (5v)	4.95
2732-250	4096 x 8 (250ns) (5v)	8.95
2732-200	4096 x 8 (200ns) (5v)	11.98
2732A-4	4096 x 8 (450ns) (5v) (21vPGM)	6.95
2733A	4096 x 8 (250ns) (5v) (21vPGM)	8.95
2732A-2	4096 x 8 (450ns) (5v) (21vPGM)	13.85
2784	8192 x 8 (450ns) (5v)	6.95
2784-250	8192 x 8 (250ns) (5v)	7.95
2784-200	8192 x 8 (200ns) (5v)	19.85
TMS2584	8192 x 8 (450ns) (5v)	14.95
MCM68764	8192 x 8 (450ns) (5v) (24 pin)	39.95
MCM68766	8192 x 8 (350ns) (5v) (24 pin)(over dr)	42.95
27128	16384 x 8 (300ns) (5v)	29.85

5v Single 5 Volt Supply 21vPGM Program at 21 Volts

## \*\*\*\*\* HIGH-TECH \*\*\*\*\*

### HM6264 HITACHI 8K x 8 STATIC RAM

- Fast—150 ns • +5V Supply
- 28 Pin—Compatible w/2764 EPROM
- Low Power CMOS (TTL Compatible)
- 200 mW Operation/.01 mW Standby (LP)

HM6264P-15 \$39.95 HM6264LP-15 \$49.95

## \*\*\*\*\* SPOTLIGHT \*\*\*\*\*

- \* Computer managed inventory — virtually no back orders!
- \* Very competitive prices!
- \* Friendly staff!
- \* Fast service — most orders shipped within 24 hours!

## CRYSTALS

32.768 khz	1.95
1.0 mhz	3.95
1.8432	3.95
2.0	2.0
2.097152	2.95
2.4576	2.95
3.2768	2.95
3.579545	2.95
4.0	2.95
5.0	2.95
5.0688	2.95
5.185	2.95
5.7143	2.95
6.0	2.95
6.5144	2.95
6.5538	2.95
8.0	2.95
10.0	2.95
10.768635	2.95
14.31818	2.95
15.0	2.95
16.0	2.95
17.430	2.95
18.0	2.95
18.432	2.95
20.0	2.95
22.1184	2.95
32.0	2.95

## CMOS

4000	.29	4528	1.19
4001	.25	4531	.95
4002	.25	4532	1.95
4006	.89	4538	1.95
4007	.89	4539	1.95
4008	.85	4541	2.64
4009	.39	4543	1.19
4010	.45	4553	5.79
4011	.25	4565	.95
4012	.25	4585	.85
4013	.38	4587	1.95
4014	.79	4582	1.95
4015	.39	4584	.75
4016	.89	4585	.75
4017	.89	4702	12.95
4018	.79	74C00	.35
4019	.39	74C02	.35
4020	.75	74C04	.35
4021	.79	74C08	.35
4022	.79	74C10	.35
4023	.39	74C14	.59
4024	.85	74C20	.35
4025	.29	74C30	.35
4026	1.66	74C32	.39
4027	.65	74C42	1.29
4028	.69	74C48	1.99
4029	.79	74C73	.65
4030	.39	74C74	.65
4034	1.95	74C78	.89
9035	.85	74C83	1.99
4040	.75	74C85	1.95
4041	.75	74C86	.39
4042	.69	74C88	4.50
4043	.85	74C90	1.19
4044	.79	74C93	1.75
4046	.85	74C95	.89
4047	.95	74C107	.89
4049	.35	74C150	5.75
4050	.35	74C151	2.25
4051	.79	74C184	3.25
4053	.79	74C187	1.75
4050	.89	74C190	1.19
4058	.39	74C161	1.99
4058	.39	74C162	1.19
4059	.39	74C163	1.19
4070	.35	74C164	1.39
4071	.29	74C165	2.00
4072	.29	74C173	.79
4073	.29	74C174	1.15
4075	.29	74C175	1.19
4078	.79	74C192	1.49
4078	.29	74C193	1.49
4081	.29	74C195	1.39
4082	.29	74C200	5.75
4085	.95	74C221	1.75
4086	.95	74C244	2.95
4093	.49	74C373	2.45
4098	2.49	74C374	2.45
4099	1.95	74C901	.39
14409	12.95	74C902	.85
14410	12.95	74C903	.85
14411	11.95	74C905	10.95
14412	12.95	74C906	.95
14419	7.95	74C907	1.00
14433	14.95	74C908	2.00
4502	.85	74C909	2.75
4503	.65	74C910	9.95
4504	1.95	74C911	8.95
4510	.85	74C912	9.95
4511	.85	74C914	1.95
4512	.85	74C915	1.19
4514	1.25	74C918	2.75
4515	1.79	74C920	17.95
4516	1.55	74C921	15.95
4518	.89	74C922	4.49
4519	.39	74C923	4.85
4520	.79	74C925	5.95
4522	1.25	74C926	7.95
4526	1.25	74C928	7.95
4527	1.95	74C929	19.95

## UARTS

AY3-1014	6.95
AY5-1013	3.95
AY5-1015	6.95
PT1472	9.95
TR1602	3.95
2350	9.95
2651	8.95
IM6402	7.95
IM6403	8.95
INS8250	10.95

## GENERATORS

MC14411	11.95
BR1941	11.95
4702	12.95
COM5016	16.95
COM2116	10.95
MM5307	10.95

## FUNCTION

MC4024	3.95
LMS86	1.49
XR2206	3.75
8038	3.95

## MISC.

UPD7201	29.95
TMS99532	29.95
LILN2003	2.49
3242	7.95
3341	4.95
MC8470	4.95
MC3480	9.00
11C90	13.95
95H90	7.85
2513-001 UP	9.95
2513-002 LOW	9.95

## CLOCK

MM5314	4.95
MM5366	3.95
MM5375	4.95
MM58167	12.85
MM58174	11.95
MSM5832	3.95

## KEYBOARD

AY5-2376	11.95
AY5-3600	11.95
AY5-3600 PRO	11.95

## 6800

68000	49.95
6800	2.95
6802	7.95
6803	19.95
6806	13.90
6808E	14.95
6809	11.95
6810	2.95
6820	4.35
6821	2.95
6828	14.95
6840	12.95
6843	34.95
6844	25.95
6845	14.95
6847	11.95
6850	3.25
6852	5.75
6880	7.95
6875	6.95
6880	2.25
6883	22.95
68047	24.95
6848A	19.95

## 6800 = 1MHZ

68800	10.95
68802	22.25
68808E	29.95
68809	29.95
68810	8.95
68821	6.95
68840	19.95
68845	19.95
68850	5.95
68800 = 2 MHZ	

## 6500

6502	4.95
6504	8.95
6505	8.95
6507	9.95
6520	4.25
6522	6.95
6532	9.95
6545	22.50
6551	11.85

## 2 MHZ

6502A	6.95
6522A	9.95
6532A	11.95
6545A	27.85
6551A	11.85

## J MHZ

6502B	9.95
-------	------

## 8000

8035	5.95
8039	5.95
IMS-8060	17.95
IMS-8073	49.95
8080	3.95
8085	4.95
8085A-2	11.95
8086	24.95
8087	CALL
8088	29.95
8089	89.95
8155	6.95
8155-2	7.95
8156	6.95
8185	29.95
8185-2	39.95
8741	29.95
8748	24.95
8755	24.95

## CRT

6845	14.95
68845	19.95
HD465055P	15.95
6847	11.85
MC1372	8.95
68047	24.95
8275	29.95
7220	99.85
CRT5027	19.95
CRT5037	24.95
TMS9918A	39.95
DP8350	49.95

## 8200

8202	24.95
8203	39.95
8205	3.50
8212	1.80
8214	3.85
8216	1.75
8224	2.25
8226	1.60
8228	3.49
8237	19.95
8237-5	21



2114

450 NS

8/\$995

2114

250 NS

8/\$1095

74LS00

Table of 74LS00 components with part numbers and prices.

74S00

Table of 74S00 components with part numbers and prices.

VOLTAGE REGULATORS

Table of Voltage Regulators with part numbers and prices.

7400

Table of 7400 components with part numbers and prices.

BYPASS CAPS

Table of Bypass Caps with values and prices.

EPROM ERASERS SPECTRONICS CORPORATION

Table of EPROM Erasers with timer, capacity, intensity, and price.

INTERFACE

Table of Interface components with part numbers and prices.



DATA ACQUISITION

Table of Data Acquisition components with part numbers and prices.

CONNECTORS

Table of Connectors with part numbers and prices.

EXAR

Table of EXAR components with part numbers and prices.

INTERSIL

Table of Intersil components with part numbers and prices.

9000

Table of 9000 components with part numbers and prices.

LINEAR

Table of Linear components with part numbers and prices.

RCA

Table of RCA components with part numbers and prices.

TI

Table of TI components with part numbers and prices.

BI FET

Table of BI FET components with part numbers and prices.

H TO-5 CAN T TO-220 K TO-3

... It is a pleasure to deal with a firm that operates as you do. You are a rare gem! I tell all my computer owning friends about the "good guys" at JDR. Your service is appreciated, and I am sure, pays off in the long run. Your customer, Evan H. Foreman

MICRODEVICES AT MICROPRICES

**2716** 16K EPROMS

**\$395** EA

**4116** 250 NS

**8/\$795**

**BARGAIN HUNTERS CORNER**

**D-SUBMINIATURE CONNECTORS**

DB25P 25 PIN MALE 10/19.95  
 DB25S 25 PIN FEMALE 10/24.95  
 HOOD25 GREY HOOD 10/9.95

**CENTRONICS CONNECTORS**

CEN36 36 PIN MALE 5.95

**IC SOCKETS**

14 PIN ST LOW PROFILE 100/7.95  
 16 PIN ST LOW PROFILE 100/7.95

**SPECIALS END 5/31/84**

**RF MODULATOR**

(ASTECH UM1082) QUANTITIES LIMITED

- \* PRESET TO CHANNEL 3
- \* USE TO BUILD TV-COMPUTER INTERFACE
- \* +5 VOLT OPERATION

**NOW ONLY \$695**

**OPTO-ISOLATORS**

4N26	1.00	MCA-7	4.25
4N27	1.10	MCA-255	1.75
4N28	.69	IL-1	1.25
4N33	1.75	ILA-30	1.25
4N35	1.25	ILQ-74	2.75
4N37	1.25	H11C5	1.25
MCT-2	1.00	TIL-111	1.00
MCT-6	1.50	TIL-113	1.75

**DIODES**

1N751	5.1 volt zener	.25
1N759	12.0 volt zener	.25
1N414B	(1N914) switching	25/1.00
1N4004	400PIV rectifier	10/1.00
KBP02	200PIV 1.5amp bridge	.45
KBP04	400PIV 1.5amp bridge	.55
VM48	Dip-Bridge	.35

**NEW UN-USED MUFFIN FANS**

4.68" Square	14.95
3.125" Square	14.95

**HEAT SINKS**

TO-3 style	.85
TO-220 style	.35

**SWITCHES**

SPDT mini-toggle	1.25
DPDT mini-toggle	1.60
SPST mini-pushbutton	.39



**WE HAVE THE COMPLETE LINE OF DISC. TANTALUM AND ELECTROLYTIC CAPACITORS IN STOCK!**

**TRANSISTORS**

2N918	.50	MPS3708	.15
MP9919	.35	2N3772	1.85
2N2102	.75	2N3903	.25
2N2218	.90	2N3904	.10
2N2218A	.50	2N3906	.10
2N2219	.50	2N4122	.25
2N2219A	.50	2N4123	.25
2N2222	.25	2N4249	.25
PN2222	.10	2N4304	.75
MPS2369	.25	2N4401	.25
2N2484	.25	2N4402	.25
2N2906	.50	2N4403	.25
2N2907	.25	2N4857	1.00
PN2907	.125	PN4916	.25
2N3055	.79	2N5086	.25
3055T	.69	PN5129	.25
2N3393	.30	PN5139	.25
2N3414	.25	2N5209	.25
2N3563	.40	2N6028	.35
2N3565	.40	2N6043	1.75
PN3565	.25	2N6045	1.75
MPS3638	.25	MPS-A05	.25
MP3640	.25	MPS-A06	.25
PN3643	.25	MPS-A65	.25
PN3644	.25	TIP29	.65
MPS3704	.15	TIP31	.75
		TIP32	.79

**CAPACITORS**

**TANTALUM**

RV	10V	15V	20V	25V	35V	
.22uf					.40	
.27					.40	
.33					.40	
.47			.25		.50	
.68					.48	
1.0		.40	.40	.45	.45	
1.5			.45		.50	
1.8					.75	
2.2	.35	.40	.45		.85	
2.7	.40	.45			.90	
3.3	.45	.50	.55	.60	.65	
3.9	.48					
4.7	.45	.55	.60	.65	.85	
6.8			.70	.75		
8.2					1.00	
10	.55	.65	.80	.85	.90	1.00
12	.65		.85	.90		
15	.75	.85	.90			
18			1.25			
22		1.00	1.35			
27			2.25			
39		1.50				
47	1.35					
56	1.75					
100			3.25			
270			3.75			

**DISC**

50V .05	470	50V .05
50V .05	560	50V .05
50V .05	680	50V .05
50V .05	820	50V .05
50V .05	.001uf	50V .05
50V .05	.0015	50V .05
50V .05	.0022	50V .05
50V .05	.005	50V .05
50V .05	.01	50V .07
50V .05	.02	50V .07
50V .05	.05	50V .07
50V .05	.1	12V .10
	.1	50V .12

**MONOLITHIC**

.1uf-mono 50V .18 .47uf-mono 50V .25  
 .047uf-mono 50V .15 .01uf-mono 50V .14

**ELECTROLYTIC**

RADIAL		AXIAL	
47uf	50V .14	1uf	50V .14
1	25V .14	4.7	16V .14
2.2	35V .15	10	16V .14
4.7	50V .15	10	50V .16
10	50V .15	22	16V .14
47	35V .18	47	50V .20
100	18V .18	100	15V .20
220	35V .20	100	35V .25
470	25V .30	150	25V .25
2200	16V .60	220	25V .30
		330	18V .40
		500	18V .42
		1000	18V .60
		1500	16V .70
		6000	16V .85

**COMPUTER GRADE**

25,000uf 30V 3.95

**IC SOCKETS**

8 pin ST	1.89	100
14 pin ST	.15	.12
16 pin ST	.17	.13
18 pin ST	.20	.18
20 pin ST	.29	.27
22 pin ST	.30	.27
24 pin ST	.30	.27
28 pin ST	.40	.32
40 pin ST	.48	.39
64 pin ST	4.25	call
ST = SOLDERTAIL		
8 pin WW	.59	.49
14 pin WW	.69	.52
16 pin WW	.69	.58
18 pin WW	.99	.90
20 pin WW	1.09	.98
22 pin WW	1.39	1.28
24 pin WW	1.49	1.35
28 pin WW	1.69	1.49
40 pin WW	1.89	1.80
WW = WIREWRAP		
18 pin ZIF	5.95	call
24 pin ZIF	7.95	call
28 pin ZIF	8.95	call
ZIF = TEXTOL (Zero Insertion Force)		

**LED DISPLAYS**

HP 5082-7780	.43"	CC	1.29
MAN 72	.3"	CA	.98
MAN 74	.3"	CC	.99
FND-357 (359)	.375"	CC	1.25
FND-500 (503)	.5"	CC	1.49
FND-507 (510)	.5"	CA	1.49
TIL-311 4x7	.270"	HEX W/LOGIC	9.95

**LED LAMPS**

	1-99	100-up
JUMBO RED	.10	.09
JUMBO GREEN	.18	.15
JUMBO YELLOW	.18	.15
LED MOUNTING HARDWARE	.10	.09

**RESISTORS**

1/4 WATT 5% CARBON FILM ALL STANDARD VALUES FROM 1 OHM TO 10 MEG OHM  
 50 PCS. SAME VALUE .025  
 100 PCS. SAME VALUE .02  
 1000 PCS. SAME VALUE .015

**DIP SWITCHES**

4 POSITION	.85
5 POSITION	.90
6 POSITION	.90
7 POSITION	.95
8 POSITION	.95

**VISIT OUR RETAIL STORE**

HOURS: M-W-F, 9-5 T-Th., 9-9 Sat. 10-3

PLEASE USE YOUR CUSTOMER NUMBER WHEN ORDERING

TERMS: Minimum order \$10. For shipping and handling include \$2.50 for UPS Ground and \$3.50 for UPS Air. Orders over 1 lb. and foreign orders may require additional shipping charges — please contact our sales department for the amount. CA residents must include 8% sales tax. Bay Area and LA residents include 6.75%. Prices subject to change without notice. We are not responsible for typographical errors. We reserve the right to limit quantities and to substitute manufacturer. All merchandise subject to prior sale.



**JDR Microdevices**

1224 S. Bascom Avenue, San Jose, CA 95128

800-538-5000 • 800-662-6279 (CA)

(408) 995-5430 • Telex 171-110



**2732** 32K EPROM

**\$495**

**2764** 64K EPROM

**\$695**

**MICROCOMPUTER  
HARDWARE HANDBOOK  
FROM ELCOMP — \$14.95**

Over 800 pages of manufacturers data sheets on most commonly used IC's.

Includes:

- \* TTL — 74/74LS and 74F
- \* CMOS
- \* Voltage Regulators
- \* Memory — RAM, ROM, EPROM
- \* CPU's — 8800, 8500, Z80, 8080, 8085, 8086/8
- \* MPU support & interface — 6800, 6500, Z80, 8200, etc.

**DISK DRIVES  
TANDON**

**TM100-1** 5 1/4" (FOR IBM) DS/DD **229.00**  
**TM100-2** 5 1/4" (FOR IBM) DS/DD **259.00**

**SHUGART**

**SA 400L** 5 1/4" (40 TRACK) DS/DD **199.95**  
**SA 400** 5 1/4" (35 TRACK) DS/DD **189.95**

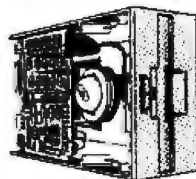
**PERTEC**

**FD-200** 5 1/4" DS/DD **179.95**  
**FD-250** 5 1/4" DS/DD **199.95**

**MPI**

**MP-52** 5 1/4" (FOR IBM) DS/DD **249.00**

NOTE: Please include sufficient amount for shipping on above items.



**8-INCH  
DISK DRIVE  
SALE**

**FD 100-8** SHUGART 801 EQUIV. DS/DD — 10/\$175 EA.  
**FD 200-8** SHUGART 851 EQUIV. DS/DD — 10/\$220 EA.

**\$18900**

**\$23900**

**BEST SELLING  
BOOKS**

**OSBORNE/MC GRAW-HILL**

- Apple II User's Guide ..... 16.95
- CRT Controller's Handbook ..... 9.95
- 68000 Assembly Language Programming ..... 16.99
- CBASIC User Guide ..... 15.00

**SYBEX**

- Your First Computer ..... 8.95
- The CP/M Handbook ..... 14.95
- The PASCAL Handbook ..... 18.95
- Microprocessor Interfacing Techniques ..... 17.95

**EDGE-CARD  
CONNECTORS**

- 8-100 ST 3.95
- 8-100 WW 4.95
- 72 pin ST 6.95
- 72 pin WW 7.95
- 50 pin ST 4.95
- 44 pin ST 2.95
- 44 pin WW 4.95



**CABINETS FOR 5 1/4" DISK DRIVES**

**CABINET #1 \$29.95**

- \* DIMENSIONS 8 1/2" x 5 1/2" x 3 1/2"
- \* COLOR MATCHES APPLE
- \* FITS STANDARD 5 1/4" DRIVES, INCL. SHUGART
- \* INCLUDES MOUNTING HARDWARE AND FEET

**CABINET #2 \$79.00**

- \* COMPLETE WITH POWER SUPPLY, SWITCH, LINE CORD, FUSE & STANDARD POWER CONNECTOR
- \* DIMENSIONS: 11 1/2" x 5 1/2" x 3 1/2"
- \* +5V @ 1 AMP, +12V @ 1.5 AMP
- \* FITS STANDARD 5 1/4" DRIVES
- \* PLEASE SPECIFY GRAY OR TAN

NOTE: Please include sufficient amount for shipping on above items.

**TRANSFORMERS  
FRAME STYLE**

- 12.6VAC 2amp 4.95
- 12.6VAC CT 2amp 5.95
- 12.6VAC CT 4amp 7.95
- 12.6VAC CT 8amp 10.95
- 25.2VAC CT 2amp 7.95

**PLUG CASE STYLE**

- 12VAC 250ma 3.95
- 12VAC 500ma 4.95
- 12VAC 1amp 5.95
- 12VAC 2amp 6.95

**DC ADAPTER**

6, 9, 12 VDC selectable with universal adapter 8.95

NOTE: Please include sufficient amount for shipping on above items.

**VISIT DURING  
OUR EXPANDED  
RETAIL STORE HOURS  
SATURDAY 10 to 3**

**CENTRONICS**

- IDCEN36 Ribbon Cable 36 Pin Male 8.95
- IDCEN36/F Ribbon Cable 36 Pin Female 8.95
- CEN36 Solder Cup 36 Pin Male 7.95

**DIP CONNECTORS**

DESCRIPTION	HIGH RELIABILITY TOOLED ST IC SOCKETS	COMPONENT CARRIERS (DIP HEADERS)	RIBBON CABLE DIP PLUGS (IDC)
ORDER BY	AUGATxx-ST	ICCx	IDPxx
CONTACTS 8	.99	85	
14	.99	75	1.45
16	.99	85	1.65
18	1.69	100	
20	1.89	1.25	
22	1.89	1.25	
24	1.99	1.35	2.50
28	2.49	1.50	
40	2.99	2.10	4.15

For order instructions see "IDC Connectors" below.

**RIBBON CABLE**

CONTACTS	SINGLE COLOR		COLOR CODED	
	1'	10'	1'	10'
10	.50	4.40	.83	7.30
16	.55	4.80	1.00	8.90
20	.65	5.70	1.25	11.00
25	.75	6.80	1.32	11.60
28	.75	6.80	1.32	11.60
34	.98	8.60	1.65	14.50
40	1.32	11.60	1.92	16.80
50	1.38	12.10	2.50	22.00

**D-SUBMINIATURE**

DESCRIPTION	SOLDER CUP		RIGHT ANGLE PC SOLDER		IDC RIBBON CABLE		HOODS	
	MALE	FEMALE	MALE	FEMALE	MALE	FEMALE	BLACK	GREY
ORDER BY	DBxxP	DBxxS	DBxxPR	DBxxSR	IDBxxP	IDBxxS	HOOD-B	HOOD
CONTACTS 9	2.08	2.66	1.65	2.18	3.37	3.69	—	1.60
15	2.69	3.63	2.20	3.03	4.70	5.13	—	1.60
25	2.50	3.25	3.00	4.42	6.23	6.84	1.25	1.25
37	4.80	7.11	4.83	6.19	8.22	10.08	—	2.95
50	6.06	9.24	—	—	—	—	—	3.50

For order instructions see "IDC Connectors" below.

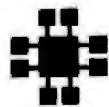
**MOUNTING HARDWARE 1.00**

**IDC CONNECTORS**

DESCRIPTION	SOLDER HEADER	RIGHT ANGLE SOLDER HEADER	WW HEADER	RIGHT ANGLE WW HEADER	RIBBON HEADER SOCKET	RIBBON HEADER	RIBBON EDGE CARD
ORDER BY	IDHxxS	IDHxxSR	IDHxxW	IDHxxWR	IDSxx	IDMxx	IDExx
CONTACTS 10	.82	.85	1.86	2.05	1.15	—	2.25
20	1.29	1.35	2.98	3.28	1.86	5.50	2.36
26	1.68	1.78	3.84	4.22	2.43	6.25	2.66
34	2.20	2.31	4.50	4.45	3.15	7.00	3.25
40	2.58	2.72	5.28	4.80	3.73	7.50	3.80
50	3.24	3.39	6.63	7.30	4.65	8.50	4.74

ORDERING INSTRUCTIONS: Insert the number of contacts in the position marked "xx" of the "order by" part number listed. Example: A 10 pin right angle solder style header would be IDH10SR.

# FOR APPLE COMPUTER USERS



## JDR Microdevices

**THOUSANDS SOLD!**

### JDR 16K RAM CARD FOR APPLE II+

- \* Expand your 48K Apple to 64K
  - \* Fully compatible with Apple Language System — Use in place of Apple Language card
  - \* Highest quality card features: gold edge connector, sockets for all IC's.
  - \* 2 YEAR WARRANTY
- Kit with Instructions ..... \$40.95 **\$44.95**  
 Bare PC Card ..... \$14.95

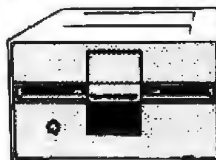
### GET SLIM IN 1984! JDR HALF-HEIGHT DISK DRIVE

- \* 35 Track if used with Apple Controller
- \* 40 Track Controller and DOS Available (Call for Price)

**\$209.95**



### MA SYSTEMS FD-35 DISK DRIVE



**\$199.95**

- \* Shugart Mechanism — Made in U.S.A.
- \* Direct Replacement for Apple Disk II
- \* Compatible with Apple Controller or other Apple compatible controllers
- \* Specially designed electronics with low power consumption
- \* DOS 3.3 and 3.2 compatible
- \* One Year Warranty

**CONTROLLER CARD  
 \$69.95**



### APPLE COMPATIBLE POWER SUPPLY

- \* Use To Power Apple-Type Systems
- \* +5V @ .5A +12V @ 3A
- \* -5V @ .5A -12V @ .5A
- \* Instructions Included

**\$79.95**

### BMC BMX-80 PRINTER

- \* 80 CPS Dot Matrix Printer
- \* Prints Bi-Directional in 40, 80, 71 or 142 Columns in Normal, Double Width or Compressed Text.
- \* Print Superscript As Well As Superb Graphics in Character or Bit Image

**\$279**



### micromax

#### VIEWMAX-80

**NOW ONLY \$159.95**

- \* 80 Column Card for Apple II+
- \* Video Soft Switch
- \* Inverse Video
- \* 2 Year Warranty

#### VIEWMAX-80e

**NEW \$129.95**

- \* 80 Column Card for Apple IIe
- \* 64K RAM Expandable to 128K
- \* 64K RAM Upgrade **\$47.50**

#### GRAPHMAX \$129.95

- \* Hi Resolution Graphics
- \* Printer Card
- \* Centronics Parallel Interface

Graphmax with Color & Zoom Options... **\$149.95**

### NASHUA DISKETTES

5 1/4" WITH HUB RING

MD1 SOFT SECTOR, SS/SD	19.95
MD1D SOFT SECTOR, SS/DD	26.25
MD2D SOFT SECTOR, DS/DD	30.75
MD2F SOFT SECTOR, DS/QUAD DENSITY	45.00
MD110 10 SECTOR HARD, SS/SD	19.85
MD210D 10 SECTOR HARD, DS/DD	30.75
8" WITHOUT HUB RING	
FD1 SOFT SECTOR, SS/SD	24.75
FD1D SOFT SECTOR, SS/DD	30.00
FD2D SOFT SECTOR, DS/DD	36.75

### VERBATIM DATALIFE DISKETTES

SS/DD SOFT SECTOR

**\$29.95**

SS/DD 10 HARD SECTOR

**\$29.95**

### 5 1/4" DISKETTE FILE

- \* ATTRACTIVE, FUNCTIONAL DISK STORAGE SYSTEM
  - \* 75 DISK STORAGE CAPACITY
  - \* MOLDED FROM DURABLE SMOKED PLASTIC WITH FRONT CARRYING HANDLE
- \$16.99**

### OTHER ACCESSORIES FOR APPLE II

#### THUNDERCLOCK \$129.95

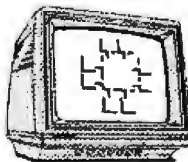
- \* Real-Time Clock Calendar
- \* Software Included
- \* Mountain Software Compatible
- \* BSR Control Options Available

#### KRAFT JOYSTICK \$39.95

### MONITORS

#### BMC MONITOR STAND MODEL PA-900

Your Display Will Tilt & Swivel **\$29.95**



#### MONOCHROME

BMC BM 12AUW GREEN 12"	\$89.95
BMC BM 12EUY 18 MHZ AMBER	\$139.95
BMC BM 12EUN 18 MHZ HIGH RES GREEN	\$115.00
NEC JB1201M - 20 MHZ GREEN	\$169.00
ZENITH ZVM-121 - 16 MHZ GREEN	\$99.00

#### COLOR

BMC BM-AU9191U COMPOSITE 13" ..... **\$279.00**

NO C.O.D. ORDERS PLEASE

### VISIT OUR RETAIL STORE

HOURS: M-W-F, 9-5 T-Th., 9-9 Sat. 10-3

PLEASE USE YOUR CUSTOMER NUMBER WHEN ORDERING

TERMS: Minimum order \$10. For shipping and handling include \$2.50 for UPS Ground and \$3.50 for UPS Air. Orders over 1 lb. and foreign orders may require additional shipping charges — please contact our sales department for the amount. CA residents must include 6% sales tax. Bay Area and LA residents include 6 1/2%. Prices subject to change without notice. We are not responsible for typographical errors. We reserve the right to limit quantities and to substitute manufacturer. All merchandise subject to prior sale.

© Copyright 1984 JDR Microdevices



## JDR Microdevices

1224 S. Bascom Avenue, San Jose, CA 95128

800-538-5000 • 800-662-6279 (CA)

(408) 995-5430 • Telex 171-110

Apple is a trademark of Apple Computer Corporation



# Unclassified Ads

**NEEDED:** The Center for Third World Organizing (CTWO), a progressive nonprofit minority organization, seeks tax-exempt donation of computer with word-processing and database management software. Computer will be used in legislative analysis and statistical projections, and editing newsletters and publications for Black, Latino, Native American, and Asian communities. Contact Margaret Shockley, CTWO, 4228 Telegraph Ave., Oakland, CA 94609. (415) 654-9601

**WANTED:** Tax-deductible donations of computers, peripherals, and software for use by a public charity organization to teach computer skills to economically disadvantaged young people. San Pablo Institute, 234 Muller St., San Francisco, CA 94110.

**NEEDED:** Information sought by United Nations computer novice (IBM-PC) from other microcomputer-equipped workers offering assistance to developing countries. This includes frequent field missions with portable computers for report generation, project evaluation, and on-site work that calls for communication via computer to other headquarters in industrialized countries. Correspondence with others interested in similar human applications of computerization welcome. Harumi Sakaguchi, 24 Chemin Brunet, Petit-Saconnex 1209, Geneva, Switzerland.

**WANTED:** Native American tax-exempt nonprofit organization seeks donation of Apple computer system, digitizer, plotter, dot-matrix printer, and 5-10 megabyte hard disk to improve management of resource information presently done by hand. Also seeking information on genealogical record keeping on microcomputers. Huanani Apolonia, Aka Like Inc., Oahu Island Center, 1316-A Kaimuki St., Honolulu, HI 96817. (808) 845-1486.

**NEEDED:** A nonprofit community mental health center seeks any standard personal computer with disk drive, printer and monitor for public relations, research, and evaluation. Will accept donation of any or all components and word-processing software. David S. Weed, Director of Consultation and Education, c/o Dr. John C. Conigan, Mental Health Center, 49 Hillside St., Fall River, MA 02720. (617) 678-2901

**WANTED:** Tax-deductible donation of microcomputer, disk drive, monitor, printer, and analog-to-digital converter for psychophysiology laboratory. Use includes digitization and storage of data from a Nico Bio-Systems 6-channel physiograph for subsequent analysis. David S. Holmes, Psychology Department, Kansas University Lawrence, KS 66045. (913) 864-4131

**NEEDED:** Mission seeks computer system as donation for educational programs and in conducting church business. Donations are tax deductible. Las Vegas, Trinity Episcopal Church, 423 East Spring St., Kingman, AZ 86401

**WANTED:** Tax-deductible donation of IBM PC, Vector 9000, or Sanyo 550/555 for financial reporting, catalog files, mailing and donor list files sought by nonprofit Christian organization that freely distributes recorded audio-cassette tapes and Bible literature. Also, host for local bulletin board for Bible research and Christian activities. Other systems considered if software is available. Ministry of Love, 404 Laurel Hill, San Marcos, TX 78666

**WANTED:** Tax-exempt nonprofit science museum seeks Apple II, IBM PC, VIC-20s or Texas Instruments for teaching computer basics and programming. Also, printers, monitors, disk drives, educational and accounting software, furniture and memory expansions are needed for a computer exhibit, membership drives, and financial reports. We'll give receipt and pay shipping. D. Costello, 5020 John R, Detroit, MI 48202. (313) 577-8415

**WANTED:** Aspen School District needs an experienced director/teacher to help us establish a summer computer workshop for students ages 5 to 18. Workshop will be held in Aspen on July 9 through July 20, 1984. Computer Educator, Aspen School District, POB 300, Aspen, CO 81612

**WANTED:** Information on how to get an RS-232C parallel port put in a Xerox 615 Memorywriter. John C. Toth, 411 Queen Margaret Lane, Jackson, MS 39209

**WANTED:** Step-by-step instructions about how to duplicate the "S1" SEQ file from one disk onto another on the Commodore 64. David Alexander, 1667 Midland Dr., East Meadow, NY 11554.

**WANTED:** A computer science student with experience in BASIC, FORTRAN, COBOL, Pascal, and assembly language for the 8085 seeks a computer-related job or interested people to offer accommodations in England or France from July through September 1984. Also has experience in software projects, teaching computer programming, and technical writing in computer magazines. Tareef Aljatar, POB 1429, Salat, Kuwait

**NEEDED:** Repairs for iCOM S100 controller card (200062-1007), runs FD2411 5 1/4-inch drives. Will pay reasonable repair costs. Larry Shengrom, MD, 139 Lamoni Lane, Gaithersburg, MD 20878, (301) 977-5450

**WANTED:** MSAI 8080 computer (unassembled kit). May consider completed unit if meet condition with full documentation. Also, want accessory boards and MSAI peripherals. W. R. Coe, 11-B East Pointe Dr., Oswego, NY 13126

**WANTED:** I would like to receive and/or trade any TRS-80 Color Computer software (games, business or utilities in BASIC or Machine Language cassettes, disks, or cartridges). Also memory maps, hardware schematics, ROM cassettes, BASIC or Machine Language programming techniques, or any TRS-80 Color Computer or Dragon-80 information. Jim Katsic, 193 Bond St. #5, Astoria, OR 97103

**FOR SALE:** Used Hazeltone MOD 1 terminal, 6375. Used DEC LA-36 DECwriter II terminal, \$500. New California Computer Systems Z80 5100 bus Z80 CPU card and used 2422 5100 bus floppy-disk controller card, \$425 for both. Used CONRAC CNB-8 black-and-white monitor, \$25. Buyer pays shipping. Charles B. West, 533 Stratford Way, Clarksville, TN 37043. (615) 552-2199

**FOR SALE:** Commodore II Color Computer 16K. Software includes decompressible utilities and games. Also back issues of *Byte* and other user groups letters. \$800. Ohio Scientific, CIP 28K with software and manuals, \$275. Intel 8748 Single Chip Micro (2 total), \$25 each or \$225 for the lot. David Ross, POB 12278, Hamtramck, MI 48212. (313) 892-5960

**WANTED:** Apple user who would like to exchange programs, especially games and utilities. Please send a list of your collection and you'll receive mine. Jason Creek, 1034 South Catalina, Los Angeles, CA 90006

**WANTED:** Correspondent with interest in the design and assembly of microcomputers and peripherals, preferably the Z80. Ronald Bastien, 2927 Baldwin, Montreal, Quebec, H1L 5B6, Canada

**FOR SALE:** Early issues of *BYTE*, first issue through Vol. 4 #9 (September 1979) plus one each extra copies of issues #1 and #2. 50 magazines in all. \$180 includes shipping. Ed Appleyard, (616) 837-1714

**NEEDED:** 4040 disk drive for the Commodore. Will pay 33 percent of retail plus shipping or will trade approximately \$2000 of good software on 100 disks (with documentation). Also, will exchange software. Charles Struss, 714 West Elm, Carbondale, IL 62901

**FOR SALE:** Electronic surplus assortment: transformers, video IC, analog modem, RF modulator, many small components, \$40. Also, VCR commercial killer that will automatically edit out commercials on any black and white program when recording on VHS recorder with remote-pause jack. \$45. Mark Mickles, 138 Lake Hills Dr., Oak Ridge, TN 37830

**WANTED:** Copy of *BYTE* vol. 1, no. 3, November 1975. Also, have one copy of *BYTE* vol. 1, no. 11, July 1976 for sale or trade. Dave Lambirth, Old Amherst Rd., Mori Vernon, NH 03057. (603) 894-6177 days. (603) 673-3566 evenings and weekends.

**WANTED:** Any information concerning availability of software that will allow a Kaypro 2 (CPM 2.2) to emulate a Lear-Siegler ADM-11 terminal (using a Hayes Smartmodem 300). Also, any information concerning software to fit out prepared forms using bolt-printer responses (also for use on a Kaypro 2). Ken Rossman, 7 Warner Circle, West Islip, NY 11795. (516) 587-2589 evenings.

**WANTED:** Texas Instruments information on where to obtain their equipment. Also I want to join a club. Will buy or trade floppy disks for TI-99/4A disk drive. Norman Guerin, (617) 798-3517

**FOR SALE:** Heathkit Hero One robot, completely assembled, includes arm, voice, and robotics course. New, \$2500. Will sell for \$1450. Jim Schneider, 53 East Washington St., Hornell, NY 14843. (607) 324-0344

**WANTED:** An August, 1980 issue of *BYTE*. Scott Sewall, 2004 Randolph St., Paul, MN 55105

**FOR SALE:** 12-slot 5100 mainframe (9 slots installed) with 25A power supply, \$200. Two Qume DTB disk drives (DSDD) with cabinet and power supply (new), \$1000. Godbout Disk I DMA disk controller with CPM 2.2 (new), \$350. Signalman I 300-bps direct-connect modem, \$75. 15-MHz green-phosphor 12-inch monitor, \$90. Jace Big Z CPU board (without UART), \$90. *BYTE* 2/78 through 6/83, \$100. Mark Dentrick, 871 Mirror St., Pittsburgh, PA 15217

**FOR TRADE:** Want to trade software with other TRS-80 Model III users. Send a disk or lot of your best software and I will do the same. Also interested in an external disk drive (DSDD). Buc Burgess, 433 Oak Haven Dr., Altamonte Springs, FL 32701

**FOR SALE:** Complete set of *BYTE* in mint condition from issue #1 to present, sold only as complete set, \$500 firm. Dan Goldish, POB 778, Sudbury, MA 01776. (617) 734-3744 nights

**WANTED:** High school student would appreciate donated 5100 computer equipment to program and experiment with. I will pay postage. Nick Shue, 13910 Hough Rd., Berville, MI 48002

**FOR TRADE:** Items for Spectrum Microdrive and interface. Most in like-new condition. Also software. John Brown, 1405 Van Ness #603, San Francisco, CA 94109

**FOR SALE:** Commodore 64 with 64K, 320 by 200 high-resolution color graphics, etc. Has 10 hours of use, complete with power supply, cables, etc. in original box. Also, have Cardo cassette-interface adapter new in box. Panda Electronics EMI surge protector and programmer's reference guide all for \$225 or best offer. Joseph Cross, POB 3633, Langley Park, MD 20787

**FOR SALE:** *BYTE* January 1977 through April 1981 and *Kilobaud Microcomputing* January 1977 through April 1982 at \$30 per complete year. Some issues of *Interface Age* from 1977, 1978, and 1979 for \$2 an issue. Also, some issues of *Dr. Dobbs* (national). Jerry Chandik, 3407 Cannon Pass Court, Sugar Land, TX 77478. (713) 980-9091

**WANTED:** To trade all kinds of programs for the Apple II. Sanjay V. Deshmukh, 521 South Gunderson, Oak Park, IL 60304

**FOR SALE:** 5100 boards: two Itasca Audio Bk memory, \$55 each. Morrow cassette interface with parallel port and RS-232C, \$50. Vector Graphic 16k memory kit, all parts less 4114 RAMs: \$45. SSM VB-18 64 by 16 memory-mapped video: \$45. Data Vector 16k EPROM including 12 2708s: \$60. All boards working (see text kit), in excellent condition with original documentation. Ben Eisinger, 11510 Alejandro, Boise, ID 83709. (208) 376-2378

**WANTED:** Apple II Plus programs to trade with my large selection of games, utilities, etc. Send a list of your programs and I'll do the same. Bill Vargas, Box 239 Suntea Village, Peru, NY 12972

**FOR TRADE:** Apple II Plus and the programs: games, utilities, business, etc. Send your list or disk of your best programs, with your name and address and I will return it with the best of mine. Lance Stewart, 101 4th Ave. NE, Clanton, IA 50525

**FOR SALE:** *BYTE* issue #2, October 1975 through (and including) issue #16, December 1976. Some doubles, in addition, February, March, June, July, August, November, and December of 1977. Bernard Greenblot, POB 1378, Boca Raton, FL 33432

**FOR SALE:** Hewlett-Packard HP-87A with 160K bytes of RAM, 1M ROM, Plotter, ROM, B2920M 5 1/4-inch single-disk drive, HP-IB cable, carrying case, and dust cover. Vascak Plus, Word/80, File/80, Statistics Pac, and FORTH operating system included. Everything in excellent condition; best offer over \$2150. Steve Roda, 1734 Plateau Dr., Jackson, MI 49203. (517) 784-3255

**FOR SALE:** Blue case Osborne computer, factory modified for double density, 54. 80 or 104 columns; Smart Modem, Amdek high-resolution green-screen monitor, with software in both single and double density. Manuals and many disks included. Original cost, \$3027, asking \$1850 or best offer. E. J. Gentsch, 5080 Falcon Ridge Rd., Roanoke, VA 24014

**FOR SALE:** WH11A Heath/Zenith Data Systems computer in excellent condition with: L311 CPU with 64K memory, WH12 floppy-disk-drive system with two drives of 250KB capacity each, two WH11-S serial-interface modules. Software includes HT11 operating system BASIC interpreter, editor, disk utilities, and all manuals: \$1895. Carl E. Smech, 8200 Snowflake Rd., Cleveland OH 44141. (216) 526-4386

**FOR SALE:** Vector Graphic System B, a word processing and small-business system. Memorex III word processor with Mailing List System, Execuplan spreadsheet, COMIX Comm-Pac communications software, CPM 2.2 Raid debugger, Scope editor, MBASIC 5.2, S100 (18-slot), Z80, 56k, dual 315K Micropops drives, 12-inch black and white terminal, three serial and two parallel ports. Everything in excellent condition. Cost over \$6000, asking \$1950. Jack W. Long, 2518 East 54th, Tulsa, OK 74105. (918) 749-6393

**FOR SALE:** Problem Solver Systems mainframe 12-slot 5100 bus. Solid State Music VBI8 Video Interface Board, Microdysys MD-690 6800-based microprocessor board, Memory Merchants MM16K14 16K static RAM board, All barely used with documentation: \$300 or \$75 each. J. Reina, 39 Thomas St., Staten Island, NY 10306. (212) 979-1547

**WANTED:** College engineering student needs any used or surplus computer and electronics equipment in any condition. Vance Morgan, 8422 Beverly, Shawnee Mission, KS 66207

**WANTED:** Documentation for the following S100 boards: Franklin Electric IO Interface—it has three RS-232C ports (board has PIN 48005A) and Vector Graphic Z80 (rev 3). Will pay postage and copying costs. Jim Wolfe, POB 6601, Torrance, CA 90504. (213) 376-2931

**WANTED:** Software for Vector 9000. All kinds needed, games and functional purpose. In MS-DOS or CPM. Using up to 896K of RAM, (prefer to use 128K) twin disk, single-sided at 612K bytes each. Also, need memory boards and battery-based clock. Mike Carpenter, Suite B, 1930 South Westwood Dr., Mesa, AZ 85207

**WANTED:** Apple II owners for software exchange. Send your list of programs. B. Olsen, Osterlien 1, N-1487 Toyenhaugen, Norway

**UNCLASSIFIED POLICY:** Readers who have computer equipment to buy, sell, or trade or who are requesting or giving advice may send a notice to *BYTE* for inclusion in the Unclassified Ads section. To be considered for publication, an advertisement must be noncommercial (individuals or bona fide computer clubs only), typed double-spaced on plain white paper, contain 75 words or less, and include complete name and address. This service is free of charge; notices are printed once only as space permits. Your confirmation of placement is appearance in an issue of *BYTE* as we engage in no correspondence. Please allow at least three months for your ad to appear. Send your notices to Unclassified Ads, *BYTE*/McGraw-Hill, POB 372, Hancock, NH 03449.

# Unclassified Ads

**FOR SALE:** Two Tandon TM 100-1 48-tpi 5 1/4-inch disk drives without enclosure. SSDD 160K, includes manual. Will sell for \$170 each or both for \$325. UPS COD. Marty Brewster, 5740 Greens Dr., Westcosville, PA 18106, (215) 395-0195.

**WANTED:** Am rebuilding a Basic/Four BB-2 unit. Still need memory boards and a terminal controller. If you have parts or are stripping a similar unit let me know. Rande Hansen, 8371 Morrison Dr., Burnaby, British Columbia V5A-2C1, Canada.

**FOR TRADE:** Please send a list of IBM PC software. S. Sudhi, POB 6074, Arlington, VA 22206.

**FOR TRADE:** Apple II programs, games, utilities, and their documentations. Send listing with your name and address. Patsy Phillips, #275 Country Lane, Mobile, AL 36608, (205) 460-0816.

**FOR SALE:** IBM PC power for the Apple II with the 8088 Meta-Card from Metamorphic Systems. Includes 5-MHz 8088 CPU, 128K RAM, real-time clock, MS-DOS, CP/M-86, UCSD p-System and four disks of public-domain software. Excellent condition with complete original documentation. \$850. Bill Giffen, 1205 Deirmore Circle, Plano, TX 75075, (214) 423-6287.

**FOR SALE:** Radio Shack TRS-80 Model 100 (24K) in excellent condition and in original carton. \$750 or best offer. Mark A. Conson, 9374 Roosevelt St., Crown Point, IN 46307.

**WANTED:** High school student seeks donation of a computer system, disks, books, software, and a printer for experimentation and programming. John White Water, Apt. 1, 1133 North 'A' St., Toledo, OH 43691.

**FOR SALE:** Amdel Color Plus composite monitor \$260. Atari 850 serial/parallel interface (missing data cable) \$100. B30 acoustic modem (requires 850 interface) \$100. 850 to Epson printer cable \$20. Cartridges Telex I 515 Assembled/Editor \$25. Disk Micro-soft BASIC and DOS# 365 Commodore 2064 interfaced/cable to Epson printer \$45. Joe Gunter, Lot 125, RR2, Box 823, Pompano Beach, FL 33067, (305) 421-6301.

**FOR TRADE:** I will trade more than 25 games for the Apple II Plus, VIC-20, and Atari. Paul Lo, 519 Maple, Yankton, SD 57078, (605) 665-4378.

**WANTED:** High school student would like donated Apple computer equipment and peripherals for programming and experimentation purposes. Will pay all postage. Bobby Roberts, 330 Green Meadows Dr., Wilmington, NC 28405, (919) 799-1514.

**WANTED:** Information exchange with PDF-II/150 owners and users. Hardware modification and expansion and software exchange. D. S. Tong, 1310 Maple Ave., Evanston, IL 60201, (312) 864-7549, preferably evenings and weekends.

**FOR SALE:** Hewlett-Packard computer peripherals, software, and interfaces Series 80, (for 85, 86, 87) B2909 RS-232C interface \$300. IDS 560G 200-cps printer \$850. 9130A 5 1/4-inch disk drive (for 86A) \$580. For 86, 87-85-13058 Statistics Pac. \$170. Write/idea word processor \$120. 85-13044 Data-Comm Pac. \$150. dBASE II \$360. Also, want used Hewlett-Packard HP-86A computer with built-in parallel interface. Randy Webb, 622 East 11th St., Bloomington, IN 47401, (812) 335-1858 or (812) 339-7661 after 5 p.m.

**FOR TRADE:** Expansion interface for TRS-80 Model I, Level II. Can be Radio Shack, LNW, Micromint, or Lobo. Any amount of memory OK. Prefer working, but will consider any condition. Please state make, asking price, and condition. James Nolt, POB 24985, Omaha, NE 68124.

**FOR SALE:** Terbell cassette-interface board with Terbell Basic \$125. SSM VB-1B board. \$100. SSM 100-2 board. \$75. SSM 100-4 board. \$150. Ithaca Audio Z-80A board with monitor. \$100. Cherry Pro keyboard. \$100. EconoRAM 4 16K. \$75. EconoRAM 14 16K. \$125. SSM T-1 Active Terminator board. \$50. Electronic Systems TVT board. \$150. Electronic Systems cassette DMA interface. \$75. Ingrand S-100 enclosure. \$275. Will accept any reasonable offer. M. Meccord, POB 371, Moorestown, NJ 08057, (609) 778-3460.

## BOMB

### BYTE's Ongoing Monitor Box

ARTICLE #	PAGE	ARTICLE	AUTHOR(S)
1	40	Trump Card, Part I: Hardware	Ciarclia
2	59	User's Column:	
		Chaos Manor's Hard-Disk System	Pournelle
3	88	BYTE West Coast: Bulletin Boards in Space	Markoff
4	101	A Professional's Perspective on User-Friendliness	Raduchel
5	108	A Computer in the Doctor's Waiting Room	Zucconi
6	122	The Microcomputer as a Decision-Making Aid	Callamaras
7	127	Benchmarking Business-Modeling Software	Jlession
8	137	Expert Systems for Personal Computers	Rubel Konopasek Jayaraman
9	160	How Lawyers Can Use Microcomputers	Wilkins
10	171	Computerizing a Medical Office	Javitt
11	189	Thinktank	Hershey
12	196	The ODP-300 Computer	Joyce
13	206	The Kaypro 10	McMahon
14	225	Converting the TRS-80 Model III for CP/M	Renne
15	236	Robographics CAD-1	Jedrnicek
16	246	Two More Versions of C for CP/M	Clark
17	258	LNW-80	Kelley
18	276	The Apple IIc Personal Computer	Markoff
19	288	Inside the Model 100's ROM	Cameron
20	307	Maximizing Hard-Disk Performance	Chaney, Johnson Williams
21	339	Update on Apple Macintosh and Lisa 2	Williams
22	340	Fitting Curves To Data	Caceci, Cacheris
23	366	Laboratory Data Collection with an IBM PC	Gates
24	382	Putting the Apple II Work, Part 2: The Software	Hallgren
25	400	ISJM: A Continuous-System Simulation Language	Crosbie
26	406	Indexing Open-Ended Tree Structures	Snyder
27	415	Using Comments to Aid Program Maintenance	Thomas

#### THE CHAMPIONS OF FEBRUARY

Readers selected February's two cover stories for top billing this month: Gregg Williams's exposé on "The Apple Macintosh Computer" won first place, and second-place winner was "An Interview: The Macintosh Design Team," written by Phil Lemmons. Because both authors are on BYTE's staff, they will forgo the prizes. Third place was scooped up by Jerry Pournelle's User's Column, "Chaos Manor Gets Its Long-awaited IBM PC." A feature written by Gregg Williams about the new Lisa's compatibility with the Macintosh, entitled "Apple Announces the Lisa 2," placed a close fourth. And in fifth place was Steve Ciarclia's "Build the Circuit Cellar Term-Mite ST Smart Terminal, Part 2: Programming and Use." Congratulations to these authors.

#### CORRESPONDENCE

Address all editorial correspondence to the editor at BYTE, POB 372, Hancock, NH 03449. Unacceptable manuscripts will be returned if accompanied by sufficient first-class postage. Not responsible for lost manuscripts or photos. Opinions expressed by the authors are not necessarily those of BYTE. Copyright © 1984 by McGraw-Hill Inc. All rights reserved. Trademark registered in the United States Patent and Trade Office. Where necessary, permission is granted by the copyright owner for libraries and others registered with the Copyright Clearance Center (CCC) to photocopy any article herein for the flat fee of \$1.50 per copy of the article or any part thereof. Correspondence and payment should be sent directly to the CCC, 21 Congress St., Salem, MA 01970. Specify ISSN 0360-5280/83. \$1.50. Copying done for other than personal or internal reference use without the permission of McGraw-Hill is prohibited. Requests for special permission or bulk orders should be addressed to the publisher. BYTE® is available in microform from University Microfilms International, 300 North Zeeb Rd., Dept. PR, Ann Arbor, MI 48106 USA or 18 Bedford Row, Dept. PR, London WC1R 4EJ, England.



# Reader Service

Inquiry No.	Page No.	Inquiry No.	Page No.	Inquiry No.	Page No.	Inquiry No.	Page No.
1	1ST NATIONAL COMPUTER 517	66	COMP COMPNTS UNLTD 552, 553	169	ESPRIT SYSTEMS INC. 476, 477	258	METHOD SYS INC. 526
2	1ST PLACE SYSTEMS 92	67	COMPAQ COMPUTER CORP 12, 13	170	EXECUTIVE MANAGEMENT SYS. 375	259	MFJ ENTERPRISES, INC 396
3	800 SOFTWARE 91	87	COMPETITIVE EDGE 462	171	EXPERT COMPUTERS 518	280	MICRO AGE COMP.STORES 315
4	A.S.T RESEARCH 15	88	COMPUADD 536	172	EXPOTEK 523	281	MICRO COM 272, 273
11	AB COMPUTERS 537	89	COMPUADD 540	432	EXTERNAL AFFAIRS 199	262	MICRO CRAFT CORP 223
12	ABC COMPUTERS LTD 441	90	COMPUMAX 518	173	EXXON OFFICE SYS 145	263	MICRO DATA BASE 168, 169
13	ABC DATA PRODUCTS 334	90	COMPUPRO 120, 121	175	FORMULA INT'L 539	264	MICRO DESIGN INT'L 399
14	ACOM ELECTRONICS 526	91	COMPUER 435	176	FORMULA INT'L 538	265	MICRO FOCUS 359
15	ACTION COMPUTER 95	83	COMPUSERVE 132, 133	310	FOX & GELLER INC 338	266	MICRO MANAGEMENT SYS 232
16	ACTION COMPUTER 95	83	COMPUSHACK 451	178	FUJITSU PROFESS.MICROSYS 257	267	MICRO MART INC. 74
17	ADAPTIVE MICRO SYS 542	372	COMP. BOOK CLUB, THE 385	179	FUTECH INT'L CORP. 106	268	MICRO MART INC 75
18	ADDMASTER CORP 530	85	COMPUTER CHANNEL 518	181	GENERAL TECHNOLOGY 181	268	MICRO MINT 469
19	ADV.BUSN.COMPUTERS 379	86	COMPUTER CLUB INC. 540	182	GENICOM 209	270	MICRO-TAX 289
20	ADV.COMP.PROD 548, 549	96	COMPUTER CONNECTION INC 516	183	GIFFORD COMP SYS 65	271	MICRODYNAMICS 532
421	ADV DIGITAL CORP 319	97	COMPUTER DISCOUNT PROD. 535	184	GILTRONIX, INC. 542	272	MICROMAIL 544
22	ADV SYS CONCEPTS 212	98	COMPUTER HUT OF N.E. 317	185	GREAT SALT LAKE COMP 558, 559	275	MICROMAIL 533
23	ADV TRANSDUCER DEVICES 544	89	COMPUTER INNOVATION 301	187	GREAT SALT LAKE COMP. 560, 561	274	MICROPROCESSORS UNLTD. 538
25	ALF PRODUCTS, INC 340	420	COMPUTER MAIL ORDER 466, 467	188	GTEK INC. 479	275	MICROPROCESSORS UNLTD 540
25	ALL ELECTRONICS CORP. 456	101	COMPUTER PRICE CLUB 224	189	HADAX ELECTRONICS 446	275	MICROSOFT CORP 134, 135
26	ALLOY COMP PROD 429	102	COMPUTER WAREHOUSE 325	190	HANDWELL CORP. 527	275	MICROSOFT CORP.—BUSN BASIC 153
27	ALPHA NUMERIC INT'L 410	102	COMPUTERLINE-A 380, 381	191	HAUPPAUGE COMP. WORKS 422	275	MICROSOFT CORP.—COBOL 155
28	ALPHA NUMERIC INT'L 411	103	COMPUTERS AND MORE 251	192	HAYES MICROCOMP PROD. 112, 113	275	MICROSOFT CORP.—PASCAL 157
28	ALPHA OMEGA COMPUTER 28	104	COMPUTERS WHOLESALE 173	194	HAYES MICROCOMP.PROD. 377	275	MICROSOFT CORP. 364, 365
30	AMARAY CORP 387	105	CONROY-LAPOINTE 244, 245	195	HEATH COMPANY 86, 97	278	MICROTECH EXPORTS 152
81	AMDEK CORP 73	106	CONROY-LAPOINTE 244, 245	195	H & E COMPUTRONICS 335	277	MICROWARE 172
448	AMERICAN COMP.SYS 402	107	CONROY-LAPOINTE 244, 245	196	HELIX SYS.DEV.CORP. 147	277	MID-AMERICA WHOLESALERS 542, 544
33	AMER SQUARE COMP 532	108	CONSOLINK 128	187	HEWLETT-PACKARD 253	278	MIDWEST-MICRO PERIPH 20
34	AMPRO COMPUTERS INC. 260	109	CONSOLINK 129	200	HIGH TECH FRIENDS 494	279	MILLER MICROCOMP. SRV 158
35	ANDERSON JACOBSON 483	110	CONTROL DATA 249	199	HITECH INT'L INC. 441	280	MINI MICRO MART 183
37	ANN ARBOR TERMINALS 227	111	CORONA DATA SYS. 58	200	HOFFMAN COMP PROD. 534	281	MOUNTAIN VIEW PRESS 164
38	ANTEX DATA SYS 419	112	CORVUS SYS INC 35	201	HOLLYWOOD HARDWARE 526	282	MPI 17
426	APPARAT 423	113	COSMOS 397	202	HOUSTON INSTR/BAUCHLOMB 233	283	MULTI-TECH SYSTEMS 82
39	APPLE COMPUTER INC. CII, 1	114	CRE WHOLESALE PROD 534	203	I.B.S. CORP 292	284	MUSY CORP 119
40	APPLE COMPUTER INC. 264, 265	115	CRE WHOLESALE PROD 534	204	IBM CORP 158, 159	285	MUSY CORP 119
41	APPLE COMPUTER INC. 311	116	CREATIVITY UNLTD 540	205	IBM CORP. 412, 413	285	MYLSTAR ELECTRONICS 532
42	APPLE COUNTRY LTD. 529	117	CROMEMO INC 5	206	IMAGE COMP PROD. 542	287	NATIONAL COMPUTER LTD. 202
40	APPLEWARE, INC. 532	118	CUESTA SYSTEMS 530	207	INMAC 417	288	NATIONAL INSTRUMENT 84
424	APPLICATION EXEC. CORP 299	118	CUSTOM COMP TECH 543	207	INTEGRAND 194	289	NEBS COMPUTER FORMS 301
42	APPLIED DIGITAL DATA SYS 414	120	DANA COMPUTER DISCOUNT 484	207	INTEL CORP 304, 305	290	NEC HOME ELECTR.USA 191
43	APROPOS TECHNOLOGY 536	121	DATA LINK 445	208	INTERACTIVE MICROWARE 202	290	NEC INFORMATION SYS. 295
44	APROPOS TECHNOLOGY 538	122	DATA SPEC 454	210	INTERACTIVE STRUCT. 211	292	NEC INFORMATION SYS. 398, 399
45	ARTIFICIAL INT'L RESEARCH 528	123	DATA SPEC 454	210	INTERTEC DATA SYS 11	292	NETWORK CONSULTING INC. 114
46	ASHTON-TATE 27	436	DATA TRANSLATION INC. 302	211	IQ TECHNOLOGIES 284	293	NICOLET PARATRONICS 162
47	ASHTON-TATE 175	124	DATASHIELD/PTI IND 255	212	JADE COMP PROD 545	294	NORTH HILLS CORP. 526, 532
48	ASHTON-TATE 271	125	DATASOUTH COMP. CORP 61	213	JADE COMP.PROD 546, 547	294	NORTHWEST DIGITAL SYS 94
425	ASHTON-TATE 383	128	DATEC INC 308	214	JAMECO ELECTR 68, 69	295	NORTHWEST MICROCHIPS DIST 544
49	AT & T LONG LINES 463	126	DAYFLO 234	215	JDR MICRODEVICES INC 598, 599	296	NOVATION, INC. 215
50	ATARI SOFT 373	127	DAYFLO 235	216	JDR MICRODEVICES INC. 570, 571	297	O'HANLON COMP. SYS. 165
51	AVATAR TECH INC. 24, 25	129	DHL WORLDWIDE COURIER 481	217	JDR MICRODEVICES INC 572	298	OFFICE & SERV CTR 534
50	AVOCET 333	130	DIGISOFT COMP. INC. 438	446	JIM-PAK 524, 525	299	OKIDATA 21
52	B & C MICRO SYSTEMS 540	131	DIGITAL EQUIPMENT CORP. 177	118	JUKI INDUSTRY OF AMERICA 213	300	OLDSMOBILE DIVISION 465
53	B&B ELECTRONICS 542	132	DIGITAL LABORATORIES 104	220	KADAK PRODUCTS 382	302	ORION INSTRUMENTS 460
54	BASF SYSTEMS 327	433	DIGITAL MICROSYSTEMS 269	221	KAYPRO 309	428	ORX SYSTEMS 472, 473
55	BAY TECHNICAL ASSOC 372	133	DIGITAL RESEARCH 38, 39	222	KERN PUBLICATIONS 326	429	ORX SYSTEMS 472, 473
96	BELL JOHN ENGR 441	134	DIGITAL RESEARCH 336, 337	223	KEYTRONICS CORP. 79	430	ORX SYSTEMS 472, 473
431	BERING 490	135	DIGITAL RESEARCH COMP 485	224	KNOWLEDGE SYS 293	441	P.C. NETWORKS 416
57	BEST WESTERN INT'L. INC. 447	135	DIGITAL RESEARCH COMP 522	225	KOALA TECHNOLOGIES 138	304	P.C. NETWORK 348
58	BETACOLD SYSTEMS 174	135	DIRECT SOFTWARE 427	225	KORSMEYER ELECTRONICS 16	306	PACIFIC EXCHANGES 528, 530, 532, 534, 536, 538, 540, 542, 544
58	BHR? 180	135	DISCOUT SOFTWARE 162	226	L.E.J. INC. 34	306	PAN AMERICAN ELEC. INC. 441
59	BIBLE RESEARCH SYS. 292	136	DISKETTE CONNECTION 210	226	L.F. COMPUTER PRODUCTS 526	308	PC COMPONENTS 544
60	BINARY TECHNOLOGY 538	137	DISKS 'N THINGS 538	228	LABORATORY MICROSYS. 362	309	PC PIPELINE 536
61	BIZCOMP 71	137	DISKWORD INC 314	229	LASER MICRO 452	311	PEGASUS DATA SYS 454
63	BORLAND INT'L 30, 31	138	DISKWORD INC 536	230	LEADING EDGE PROD. CIII	312	PIPELINE COMPUTER 586, 587
63	BUSINESS SOFTWARE 267	138	DISKWORD INC 540	231	LIBERTY ELECTRONICS 231	313	PJS 528
64	BUSINESS SOFTWARE 267	140	DISPLAY TELECOMMUNCTNS. 521	232	LIBERTY GROUP INC. 218	185	POWER BASE SYS. INC. 457
65	BYTE ADVERTISING SALE 432, 433	141	DMA 455	233	LIBRA PROGRAMMING 534	310	POWERLAN 536
65	BYTE BACK ISSUE 482	142	DOKAY COMP.PROD INC 586, 557	234	LIFEBOAT ASSOC. 409	314	PRACTICAL PERIPH. 115
65	BYTE COMPUTER SHOW 424, 425	143	DOW JONES 66	235	LIIQUIDATORS COMPANY 441	315	PRACTICAL PERIPH. 430
65	BYTE SUBSCRIBER MESSAGE 118	144	DOW JONES SOFTWARE 224 A-F	236	LOCKHEED-GETEX 437	316	PRENTICE HALL INC. 221
66	BYTEK COMP SYS CORP 26	144	DUAL SYSTEMS CORP 291	237	LOGICAL DEVICES 62	317	PRINCETON GRAPHIC SYS 105
66	BYTEWRITER 104	145	DUPONT COMPANY 163	238	LOGICAL DEVICES 644	318	PRIORITY ONE 582, 583, 584, 585
67	C WARE 388	145	DUPONT COMPANY 185	238	LOGITECH INC. 178	319	PROMOTIONAL DATA SERV 538
67	C-SYSTEMS 528	146	DUPONT COMPANY 167	240	LOMAS DATA PRODUCTS 100	320	PROMETHEUS PRODUCTS 193
67	C.S.D INC 270	147	DWIGHT CO., INC. 534	241	LOTUS DEVELOPMENT 80, 81	321	PURCHASING AGENT, THE 212
445	CABLES BY WORSWICK 403	148	DYNAX, INC. 393	242	LSI JAPAN 530	322	PURPLE COMPUTING 540
69	CALIF DIGITAL 554, 555	149	DYSAN CORP. 184, 185	243	LYBEN COMP.SYS. 528	323	QUANT DIV. 219
69	CALIF MICRO COMP 324	150	E. T. I. 67	244	LYBEN COMP.SYS 530	324	QUANT SYSTEMS 529
70	CAPITAL EQUIPMENT 70	151	EASI SOFTWARE 536	245	LYCO COMPUTER 541	326	QUARK INCORPORATED 369
71	CARRY CASE 542	152	EASTERN ENTERPRISES 182	246	M-H RECRUITMENT 436	327	QUBIE DISTRIBUTING 139
71	CDR SYSTEMS 526	153	ECOSOFT 180	246	MA SYSTEMS 186	328	QUCES 55
423	CENTENNIAL COMP.PROD. 83	443	EDGE MICROSYS 403	247	MACMILLAN BOOK CLUBS 352, 353	329	QUELO 222
72	CENTRE COMP CONSULT 530	154	EDUCATIONAL MICROCOMP 441	247	MACROTECH INT'L 131	330	RADIO SHACK CIV
497	CHAMPION SOFTWARE 241	155	ELCOMP 530	444	MANDINGO COMP 403	331	RANA SYSTEMS 29
498	CHAMPION SOFTWARE 241	156	ELECTRADE CD 528	249	MANX SOFTWARE SYS 22	332	RANDOM HOUSE 462
76	CHECK-MATE 284	157	ELECTRADE CD 530	250	MARYMAC INDUSTRIES 536	334	RCA 93
77	CHIPS & DALE 532	438	ELEK-TEK 418	251	MAXELL DATA PROD. 312, 313	335	RELSM 154
78	CHRISLIN IND INC. 445	159	ELLIS COMPUTING INC. 77	252	MAYNARD ELECTRONICS 203	336	RIGON 459
79	CHROMOD ASSOC. 532	160	EMERALD COMPUTER 431	253	MC-P APPLICATIONS 347	338	ROLAND CORP 23
80	CLEVELAND CODOMICS 440	161	EMPIRICAL RESEARCH GROUP 90	254	MCGRAW-HILL BOOK CO. 449	339	ROLANDSHAUER OF AMERICA 361
81	CMA MICRO COMP. DIV. 448	162	ENRCOMP 32	254	MEDIANICS BYTEWORLD 79	340	S-100 DIV 698 CORP. 531
82	COGITATE 441	164	EPIC ELECTRONICS 544	255	MEMOTECH 141, 142, 143	341	SABADIA EXPORT CORP. 539
83	COMMAND SERVICES CORP 532	427	EPOCH 268	256	MERRITT COMP. PROD 542	342	SAFEWARE 420
84	COMMERCIAL BUSINESS SYS 582	168	EPSON AMERICA 86, 87	256	MET-CHEM INT'L CORP. 441	342	SAGE COMP. TECH. 283
85	COMP COMPNTS. UNLTD 550, 551	168	EPSON AMERICA 442, 443	257	METALINK CORP. 544	342	SBE INC. 540

To get further information on the products advertised in BYTE, fill out the reader service card with your name and address. Then circle the appropriate numbers for the advertisers you select from the list. Add a 20-cent stamp to the card, then drop it in the mail. Not only do you gain information, but our advertisers are encouraged to use the marketplace provided by BYTE. This helps us bring you a bigger BYTE. The index is provided as an additional service by the publisher, who assumes no liability for errors or omissions. \*Correspond directly with company.





# SON OF STARWRITER™

HALF THE SPEED, FOR HALF THE MONEY.



First there was the Starwriter 40 CPS by C. Itoh, one of the world's most popular letter-quality printers.

And deservedly so, because it gives you more of just about everything than any other printer in its price range (mid-arena). And it churns out copy at a very brisk 40 characters per second or about half a minute for an average business letter.

Now, there's the Starwriter 18 CPS™. It takes after its father in that it's simply the finest printer you can buy for anywhere near the price—which in this case is just about half what Daddy charges.

The only major difference is speed.

Instead of 40 characters per second, this Starwriter trots along at just over 18 cps—which costs you about 30 seconds per average business letter.

But it retains the rest of the family resemblance: like low profile and low noise, plug-in compatibility with just about any serial or parallel microcomputer on the market, making it a perfect companion in a typical office environment.

And perfect for typical office chores, like letters, memos, announcements... In fact, the vast majority of stuff that can afford to wait a few seconds to get typed.

Enough said?

If not, then this, the Starwriter 18 CPS gives you crisp, letter-quality copy (including boldface, underlining, sub and superscripts) with your choice of friction feed or optional tractor feed for precise print positioning of tabular and graphic data, using easily available industry-standard ribbon cartridges and long-lasting plastic daisy wheels.

But it also gives you something that's far from industry-standard.

A full-year warranty. And for a mere half-a-minute per letter.

We think it's well worth the wait.

Marketed exclusively by Leading Edge Products, Inc., 225 Turnpike Street, Canton, MA 02021, 1-800-343-6833 or in Massachusetts 16171-828-8150.



LEADING EDGE

Circle 230 on inquiry card.

# Save \$200 on America's #1 Portable Computer



## Radio Shack's TRS-80 Model 100 Comes with Five Built-In Programs!

- Personal Word Processor
- Appointment Scheduler
- Address/Phone Directory
- Telephone Auto-Dialer
- BASIC Programming Language

Since its introduction, the TRS-80 Model 100 has become the most highly-acclaimed lap-size computer ever. Why? Because it's a true portable that includes a built-in modem and full-size typewriter keyboard. And Model 100 works on batteries or with an optional AC adapter.

## Ready to Use

Turn on Model 100 and select a program listed on the easy-to-read display. With the self-contained communication program and modem, you can send and receive data by phone. Add a cassette recorder and use ready-to-run software, too.



You can also expand with a printer, disk storage, standard video display and bar code reader.

## Hurry—Sale Ends May 31, 1984

Get your own Model 100 today at the Radio Shack Computer Center, participating store or dealer nearest you.

<b>8K Model 100</b>	<b>24K Model 100</b>
<b>59900</b> <small>26-3801</small>	<b>79900</b> <small>26-3802</small>
Reg. 799.00	Reg. 999.00
<small>As Low As \$35 Per Month On CitriLine Credit</small>	<small>As Low As \$45 Per Month On CitriLine Credit</small>

**Radio Shack**  
The Technology Store™

A DIVISION OF TANDY CORPORATION

Prices apply at participating Radio Shack stores and dealers.

Circle 330 on Inquiry card.