

BYTE

JUNE 1984 VOL. 9, NO. 6

\$3.50
\$4.95 IN CANADA/£2.10 IN U.K.
A MCGRAW-HILL PUBLICATION
0360-5280

THE SMALL SYSTEMS JOURNAL

COMPUTERS AND EDUCATION
On every desk, in lab and field



JUNE 1984

BYTE

COMPUTERS AND EDUCATION

Volume 9, Number 6

Introducing Macintosh. What makes it tick. And talk.

Well, to begin with, 110 volts of alternating current.

Secondly, some of the hottest hardware to come down the pike in the last 3 years.

The garden variety 16-bit 8088 microprocessor.



Macintosh's 32-bit MC68000 microprocessor.



Some hard facts may be in order at this point:

Macintosh's brain is the same blindingly-fast 32-bit microprocessor we gave our other brainchild, the Lisa™ Personal Computer. Far more powerful than the 16-bit 8088 found in current generation computers.

Its heart is the same Lisa Technology of windows, pull-down menus, mouse commands and icons. All of which make that 32-bit power far more useful by making the Macintosh™ Personal Computer far easier to use than current generation computers. In fact, if you can point without hurting yourself, you can use it.

Now for some small talk.

Thanks to its size, if you can't bring the problem to a Macintosh, you can always

bring a Macintosh to the problem. (It weighs 9 pounds less than the most popular "portable.")

Another miracle of miniaturization is Macintosh's built-in 3½" drive. Its disks store 400K—more than conventional 5¼" floppies. So while they're big enough to hold a desk full of work, they're small enough to fit in a shirt pocket. And, they're totally encased in a rigid plastic so they're totally protected.

And talk about programming.

There are already plenty of programs to keep a Macintosh busy. Like MacPaint™,



a program that, for the first time, lets a personal computer produce virtually any image the human hand can create. There's more software on the way from developers like Microsoft®, Lotus™, and Software Publishing Corp., to mention a few

And with Macintosh BASIC, Macintosh Pascal and our Macintosh Toolbox for writing your own mouse-driven programs, you, too, could make big bucks in your spare time.

You can even program Macintosh to talk in other languages, like Yiddish or Serbo-Croatian, because it has a built-in polyphonic sound generator capable of producing high quality speech or music.

The Mouse itself. Replaces typed-in computer commands with a form of communication you already understand — pointing.

Some mice have two buttons. Macintosh has one. So it's extremely difficult to push the wrong button.

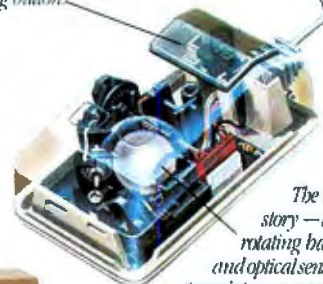

The inside story — a rotating ball and optical sensors translate movements of the mouse to Macintosh's screen pointer with pin-point accuracy.

All the right connections.

On the back of the machine, you'll find built-in RS232 and RS422 AppleBus serial communication ports. Which means you can connect printers, modems and other peripherals without adding \$150 cards. It also means that Macintosh is ready to hook in to a local area network. (With AppleBus, you will be able to interconnect up to 16 different Apple computers and peripherals.)

Should you wish to double Macintosh's storage with an external disk



Macintosh automatically makes room for your illustrations in the text.



MacPaint produces virtually any image the human hand can create.



Microsoft's Multiplan for Macintosh.

Macintosh is a trademark licensed to Apple Computer, Inc. Apple, the Apple logo, MacPaint and Lisa are trademarks of Apple Computer, Inc. Microsoft is a registered trademark of Microsoft Corporation. Lotus is a trademark of Lotus Development Corporation. For an authorized Apple dealer near you call (800) 538-9696. In Canada, call (800) 268-7796 or (800) 268-7637.

Ultra compact, switching-type power supply and high resolution video circuitry.

Battery for Macintosh's built-in clock/calendar.

Built-in handle for getting carried away.

Thanks to clever venting, Macintosh requires no internal fan.

RS232, RS422 AppleBus serial communications ports for printers, modems and other peripherals.

Mouse connector.

External disk drive connector.
Polyphonic sound port.

Macintosh's digital board — the processing power of an entire 32-bit digital graphics computer in 80 square inches.

9" high resolution 512 x 342 pixel bit-mapped display.

Brightness control.

128K bytes RAM.

Built-in 3 1/2" disk drive.

Keyboard connector — a telephone-type jack you already know how to use.

Clock/calendar chip.

64K bytes ROM.

32-bit Motorola MCG8000 microprocessor.

© 1984 Apple Computer, Inc.

drive, you can do so without paying for a disk controller card—that connector's built-in, too.

There's also a built-in connector for Macintosh's mouse, a feature that costs up to \$300 on computers that can't even run mouse-controlled software.

One last pointer.

Now that you've seen some of the logic, the technology, the engineering genius and the software wizardry that separates

Macintosh from conventional computers, we'd like to point you in the direction of your nearest authorized Apple dealer.

Over 1500 of them are eagerly waiting to put a mouse in your hand. As one point-and-click makes perfectly clear, the real genius of Macintosh isn't

its 32-bit Lisa Technology, or its 3 1/2" floppy disks, or its serial ports, or its software, or its polyphonic sound generator.

The real genius is that you don't have to be a genius to use a Macintosh.

You just have to be smart enough to buy one.

Soon there'll be just two kinds of people. Those who use computers. And those who use Apples. 

C·O·N·T·E·N·T·S



111

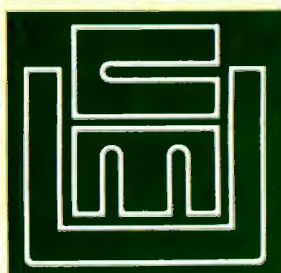

162

FEATURES

- INTRODUCTION** 109
- THE HP 110** by Ezra Shapiro 111
This new battery-powered machine has 752K bytes of RAM and ROM and has built-in software including Lotus 1-2-3.
- TRUMP CARD, PART 2: SOFTWARE** by Steve Ciarcia 115
The BASIC and C compilers for this Z8000 card boost the performance of the IBM PC.
- FASTER FORTH** by Ronald L. Greene 127
Substituting a macro for the executable part of a word reduces overhead in subroutine-threaded languages.
- AN ADA LANGUAGE PRIMER, PART 1** by Sabina H. Saib 131
An introduction to the language endorsed by the Department of Defense.
- MACINTOSH PASCAL** by G. Michael Vose 136
With the introduction of this version, Pascal becomes an interpreted language.
- BUILD A PRINTER BUFFER** by John Bono 142
While waiting for your printer to finish your latest enormous listing, you can build a buffer that eliminates the wait.
- APPLE FAX: WEATHER MAPS ON A VIDEO SCREEN**
by Keith H. Sueker 146
This project lets your Apple display real-time weather maps on a high-resolution screen.
- SPREADSHEET IN BASIC** by Rodolfo Cerati 154
This program permits more cells than some commercial spreadsheets and is written in Microsoft BASIC.

THEME: EDUCATION

- INTRODUCTION** 161
- A COMPUTER ON EVERY DESK** by Donna Osgood 162
More and more universities in America are using personal computers as tools for education and communication.
- PROGRAMMING BY REHEARSAL** by William Finzer and Laura Gould . . . 187
Using the theatrical stage as a metaphor, this development environment makes it easier to write educational software.
- GAME SETS AND BUILDERS** by Ann Piestrup 215
Two types of graphics-based educational software go beyond computer-aided instruction.
- CAUTIONS ON COMPUTERS IN EDUCATION** by Stephen L. Chorover . . . 223
A psychologist ponders the relationship between computer-based systems and human social systems.
- LANGUAGES FOR STUDENTS** by Fred A. Masterson 233
Above all, languages must show simplicity, power, compatibility, and cognitive richness.
- MICROCOMPUTERS IN THE FIELD** by Robert P. Case 243
An anthropologist describes the selection and "hardening" of a portable computer for use in field research.
- KERMIT: A FILE-TRANSFER PROTOCOL FOR UNIVERSITIES, PART 1: DESIGN CONSIDERATIONS AND SPECIFICATIONS**
by Frank da Cruz and Bill Catchings 255
Personal computers need to talk to minicomputers and mainframes in universities, and this protocol lets them do so.
- SAN FRANCISCO'S EXPLORATORIUM** by John Markoff 279
A hands-on, interactive museum uses personal computers to teach science through experience.

BYTE June



327

DESIGNING A SIMULATED LABORATORY by Nils Peterson . 287
A personal computer simulates a classic experiment and teaches the concepts of cardiac function.

REVIEWS

REVIEWER'S NOTEBOOK 301

ANOTHER LOOK AT CP/M-80 C COMPILERS
by Christopher Kern 303
Whitesmiths, O/C, and Supersoft Cs get a close examination.

ARCHON by Gregg Williams 321
This game requires a sense of strategy and dexterity.

THE CHAMELEON PLUS by Rich Krajewski 327
Compatible with the IBM PC, the Chameleon Plus merits serious consideration but does have some drawbacks.

THE TEXAS INSTRUMENTS SPEECH COMMAND SYSTEM
by Mark Haas 341
This voice input and output system for the TI Professional comes under the scrutiny of an experienced user.

VOLITION SYSTEMS' MODULA-2 by Eric Eldred 353
The author compares this version of Modula-2 for the Apple with familiar Apple Pascal.

INFOSCOPE by George Bond 367
A RAM-based data-management system that exploits the IBM PC's color monitor wins the praise of an old hand at databases.

REVIEW FEEDBACK 374
Readers react to previous reviews.

KERNEL

INTRODUCTION 385

COMPUTING AT CHAOS MANOR: A SUPERBUSY MONTH
by Jerry Pournelle 387
Jerry celebrates a new hard disk, examines the Apple-Franklin decision, and romps through an assortment of new hardware and software.

CHAOS MANOR MAIL 400
Jerry's readers write, and he replies.

BYTE WEST COAST: LESSONS LEARNED by Ezra Shapiro 405
SoftOffice's gestation was difficult, but this package provides icon-based integrated software at low overhead.

EDITORIAL: BYTE'S NEW LOOK 6

MICROBYTES 9

LETTERS 14

UPDATE 38

WHAT'S NEW 50, 468

ASK BYTE 60

BOOK REVIEWS 79

CLUBS AND NEWSLETTERS 91

EVENT QUEUE 94

BOOKS RECEIVED 463

UNCLASSIFIED ADS 525

BYTE'S ONGOING MONITOR BOX, BOMB RESULTS 526

READER SERVICE 527

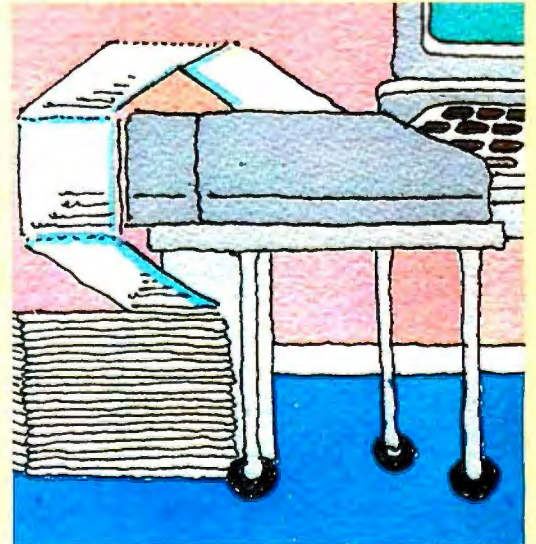

142



469



ULTRATERM? JUST ASK THE PROFESSIONALS!

With the wide variety of peripherals available, it's difficult to evaluate the quality of accessories for your Apple. Listen to what the professionals say about UltraTerm.

BYTE—FEB. '84

"Overall, the UltraTerm display card is one of the best peripheral devices I have seen to enhance the display capabilities of the Apple."—P. Callamaras

SOFTALK—SEPT. '83

"The UltraTerm shines brightest in use with spreadsheets and word processors."

COMPUTER RETAILING —FEB. '84

"The UltraTerm is a high quality investment for anyone who has an Apple product and wants to add to it."

PEELINGS II—VOL. 4. NO. 8 '83

"The UltraTerm will be the new industry standard for Apple video display cards. The availability of the extra modes will enhance almost any software product that uses the text screen."

PERSONAL COMPUTING —MAY '83

"Perhaps the most impressive achievement of the UltraTerm expansion board is that the character set it produces is so sharp that its difficult to see the dots that make up each character."

The experts agree—the UltraTerm is one of the best display devices for Apple computers.

Videx Inc.
1105 NE Circle Blvd.
Corvallis, OR 97330
(503) 758-0521

EDITOR-IN-CHIEF
PHILIP LEMMONS
MANAGING EDITOR
GENE SMARTE
CONSULTING EDITORS
STEVE CIARCIA
JERRY POURNELLE
SENIOR TECHNICAL EDITORS
RICHARD MALLOY, *Reviews*
G. MICHAEL VOSE, *Features*
GREGG WILLIAMS
TECHNICAL EDITORS
GLENN HARTWIG
RICHARD KRAJEWSKI
ARTHUR A. LITTLE
BRUCE ROBERTS
KEN SHELDON
RICHARD A. SHUFORD
JANE MORRILL TAZELAAR
STANLEY WISZOLA
ALAN EASTON, *Drafting*
WEST COAST EDITORS
EZRA SHAPIRO, *Bureau Chief, San Francisco*
JOHN MARKOFF, *Senior Technical Editor, Palo Alto*
DONNA OSGOOD, *Associate Editor, San Francisco*
MANAGING EDITOR, USER NEWS
GEORGE BOND
USER NEWS EDITORS
ANTHONY J. LOCKWOOD, *What's New*
MARK WELCH, *Microbytes*

CONTRIBUTING EDITORS
DENNIS ALLISON, *at large*
MARK DAHME, *video, operating systems*
MICHAEL ECKER, *mathematical recreations*
RIK IADRNICKEK, *CAD, graphics, spreadsheets*
MARK KLEIN, *communications*
ALAN MILLER, *languages and engineering*
WILLIAM RAIKE, *Japan*
PERRY SAIDMAN, *computers and law*
ROBERT STERNE, *computers and law*
BRUCE WEBSTER, *software*
RICHARD WILLIS, *at large*

COPY EDITORS
ELIZABETH R. COOPER, *Chief*
DENNIS BARKER
MARGARET COOK
ANNE L. FISCHER
NANCY HAYES
PAULA NOONAN
IOAN V. ROY
BUD SADLER
WARREN WILLIAMSON

ASSISTANTS
PEGGY DUNHAM
FAITH KLUNTZ
BEVERLY JACKSON
LISA JO STEINER

ART DIRECTOR
ROSSLYN A. FRICK

PRODUCTION
DAVID R. ANDERSON, *Associate Director*
VIRGINIA REARDON, *Production Manager*
MICHAEL J. LONSKY
JAN MULLER
SHERRY MCCARTHY, *Chief Typographer*
NAN FORNAL
LEN LORETTE
VALERIE PAGE
DONNA SWEENEY

Editorial and Business Office: 70 Main Street, Peterborough, New Hampshire 03458 (603) 924-9281
West Coast Offices: McGraw-Hill, 425 Battery St., San Francisco, CA 94111, (415) 362-4600
McGraw-Hill, 1000 Etwell Court, Palo Alto, CA 94303, (415) 964-0624

Officers of McGraw-Hill Publications Company: President: John G. Whede. Executive Vice Presidents: Paul F. McPherson, Operations; Walter D. Serwatka, Finance & Services. Senior Vice President-Editorial: Ralph R. Schulz. Senior Vice President Publishers: Harry L. Brown, David J. McGrath, James R. Pierce, Gene W. Simpson, John E. Slater. Vice President Publishers: Charleton H. Calhoun III, Richard H. Larsen, John W. Patten. Vice Presidents: Kemp Anderson, Business Systems Development; Shel F. Asen, Manufacturing; John A. Bunyan, Electronic Information Services; George R. Elsingler, Circulation; Michael K. Hehr, Controller; Eric B. Herr, Planning and Development; H. John Sweger, Jr., Marketing. Virginia L. Williamson, Business Development.

Officers of the Corporation: Harold W. McGraw Jr., Chairman; Joseph L. Dionne, President and Chief Executive Officer; Robert N. Landes, Senior Vice President and Secretary; Ralph I. Webb, Treasurer.

BYTE is published monthly by McGraw-Hill Inc. Founder: James H. McGraw (1860-1948). Executive, editorial, circulation, and advertising offices: 70 Main St., Peterborough, NH 03458, phone (603) 924-9281. Office hours: Mon—Thur 8:30 AM—4:30 PM, Friday 8:30 AM—1:00 PM, Eastern Time. Address subscriptions to BYTE, Subscriptions, POB 590, Martinsville, NJ 08836. Postmaster: send address changes, USPS Form 3579, undeliverable copies, and fulfillment questions to BYTE, Subscriptions, POB 590, Martinsville, NJ 08836. Second-class postage paid at Peterborough, NH 03458 and additional mailing offices. USPS Publication No 528890 (ISSN 0360-5280). Postage paid at Winnipeg, Manitoba. Registration number 9321. Subscriptions are \$21 for one year, \$38 for two years, and \$55 for three years in the USA and its possessions. In Canada and Mexico, \$23 for one year, \$42 for two years, \$61 for three years. \$69 for one year air delivery to Europe. 17,100 yen for one year surface delivery to Japan. \$37 surface delivery elsewhere. Air delivery to selected areas at additional rates upon request. Single copy price is \$3.50 in the USA and its possessions, \$4.25 in Canada and Mexico, \$4.50 in Europe, and \$5 elsewhere. Foreign subscriptions and sales should be remitted in United States funds drawn on a U.S. bank. Please allow six to eight weeks for delivery of first issue. Printed in the United States of America.

Address all editorial correspondence to the Editor, BYTE, POB 372, Hancock, NH 03449. Unacceptable manuscripts will be returned if accompanied by sufficient first-class postage. Not responsible for lost manuscripts or photos. Opinions expressed by the authors are not necessarily those of BYTE.

Copyright © 1984 by McGraw-Hill Inc. All rights reserved. Trademark registered in the United States Patent and Trademark Office. Where necessary, permission is granted by the copyright owner for libraries and others registered with the Copyright Clearance Center (CCC) to photocopy any article herein for the flat fee of \$1.50 per copy of the article or any part thereof. Correspondence and payment should be sent directly to the CCC, 29 Congress St., Salem, MA 01970. Specify ISSN 0360-5280/83. \$1.50. Copying done for other than personal or internal reference use without the permission of McGraw-Hill Inc. is prohibited. Requests for special permission or bulk orders should be addressed to the publisher. BYTE is available in microform from University Microfilms International, 300 North Zeeb Rd., Dept. PR, Ann Arbor, MI 48106 or 18 Bedford Row, Dept. PR, London WC1R 4EJ England.

Subscription questions or problems should be addressed to: BYTE Subscriber Service, POB 328, Hancock, NH 03449

PUBLISHER
GENE W. SIMPSON
ASSOCIATE PUBLISHER/PRODUCTION DIRECTOR
JOHN E. HAYES
PUBLISHER'S ASSISTANT
DORIS R. GAMBLE

ADVERTISING SALES
J. PETER HUESTIS, *Sales Manager*
SANDRA FOSTER, *Administrative Assistant*
ADVERTISING
DEBORAH PORTER, *Supervisor*
MARION CARLSON
JEANNE CILLEY
CATHY A. R. DREW
ROB HANNINGS
JEANNA REENSTIERN
LISA WOZMAK
WAI CHIU LI, *Quality Control Manager*
LINDA J. SWEENEY, *Advertising/Production Coordinator*
JULIE NELSON

CIRCULATION
GREGORY SPITZFADEN, *Director*
ANDREW JACKSON, *Subscriptions Manager*
BARBARA VARNUM, *Assistant Manager*
PHIL DECHERT
MARY EMERSON
LOUISE MENEGUS
AGNES E. PERRY
JENNIFER PRICE
JANE VARNUM
JAMES BINGHAM, *Single-Copy Sales Manager*
LINDA TURNER, *Assistant Manager*
CAROL AHO
CLAUDETTE CARSWELL
EDSON WARE

MARKETING COMMUNICATIONS
HORACE T. HOWLAND, *Director*
DOUG WEBSTER, *Director of Public Relations*
VICKI REYNOLDS, *Marketing Associate*
NANCY GIACALONE, *Assistant*
STEPHANIE WARNESEY, *Graphic Arts Supervisor*
SHARON PRICE, *Graphic Arts Designer*
MICHELE P. VERVILLE, *Research Manager*
PATRICIA AKERLEY, *Market Research Analyst*
CYNTHIA DAMATO, *Reader Service Coordinator*

ACCOUNTING
DANIEL RODRIGUES, *Business Manager/Controller*
KENNETH A. KING, *Assistant Controller*
MARY E. FLUHR, *Accounting & D/P Manager*
KAREN BURGESS
PATRICIA BURKE
LYDA CLARK
JULIE FERRY
VERN ROCKWELL
LINDA SHORT
JOANN WALTER
VICKI WESTON

TRAFFIC
N. SCOTT GAGNON, *Manager*
ANTHONY BENNETT
BRIAN HIGGINS

RECEPTIONIST
L. RYAN MCCOMBS

PERSONNEL/OFFICE MANAGER
CHERYL A. HURD



68000-based systems. Just tell us what you need.

68000-based systems to fit your application.

Right from the pages of our catalog, we can deliver 68000-based supermicro systems to match virtually any application.

Including yours.

Here's how.

Built on the IEEE-696 (S-100) bus, Cromemco systems offer up to 21 board slots. And a family of 35 boards—CPU, memory and specialized I/O—to fill the slots any way you choose.

At the heart of each system is our 68000/Z-80 dual processor. Backed by as much as 16 Mb of error-correcting RAM. Full multi-tasking capability. I/O to handle up to 16 terminals.

And that's just the beginning.

You can select single or dual floppies, 5¼" or 8" A 21 Mb 5¼" Winchester hard disk. And a nine-track tape drive.

We can accommodate your taste for the exotic, too. With boards like our SMD interface that supports up to 1200 Mb of disk storage. An NTSC standard color graphics interface. A TV camera digitizer. A/D and D/A converters. An IEEE-488 bus interface. Communications. And more.

Intelligent workstations.

Then, if you're designing a distributed processing system, you'll want to take a look at our C-10 personal computer. The Z-80-based C-10 can serve our 68000-based systems

as a powerful intelligent workstation in a distributed processing mode. Or as an independent personal computer with its own floppy storage.

High-level languages and applications software.

That brings us to software. It starts with CROMIX[®], our UNIX™-like operating system that you're free to tailor to your application.

CROMIX can execute both 68000- and Z-80-based programs. So right along with your 68000-based packages, your system will accommodate a wide selection of CP/M[®] software written for the Z-80.

And our high-level language support is second to none. From a 68000 Macro Assembler. To 68000 FORTRAN 77, PASCAL, GSA-certified high-level COBOL, C and BASIC.

Cromemco means business. Your business.

You see, when we say, "Just tell us what you need," we're not kidding.

You won't find another family of 68000-based microcomputers that can fit your needs as exactly as ours.

So if you're in the business of providing specialized computing solutions, you really should be doing business with Cromemco.

For a copy of our Systems Catalog, contact: Cromemco, Inc., 280 Bernardo Avenue, P.O. Box 7400, Mountain View, CA 94039. (415) 964-7400.

In Europe: Cromemco/GmbH, 6236 Eschborne 1, Frankfurter Str. 33-35, P.O. 5267, Frankfurt Main, Germany or Cromemco Ltd., The Cambridge House, 178-182 Upper Richmond Rd., Putney, London SW15 England.

Cromemco[®]

*Cromemco and CROMIX are registered trademarks of Cromemco, Inc.™ UNIX is a trademark of Bell Laboratories.®CP/M is a registered trademark of Digital Research. ©1983, Cromemco, Inc.

Circle 92 on inquiry card.

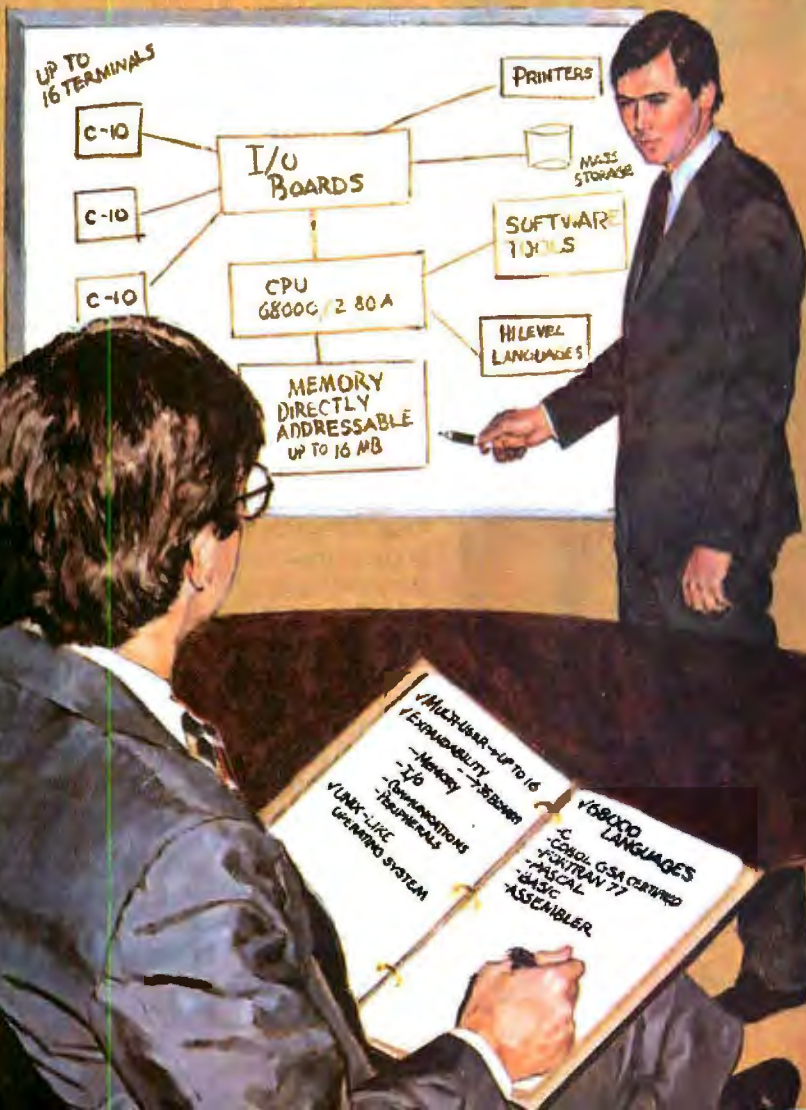

BYTE'S NEW LOOK

The redesign of a magazine always requires some adjustment by the reader, and so we pondered the matter before proceeding to change BYTE's appearance. In the end, we went ahead for several reasons. We want to make BYTE easier to read without making it less technical. We want to include more input and feedback from readers, to make reviews easy to distinguish from feature articles, to make review findings clearer by using graphics, and to give some of BYTE's most popular articles the best possible setting.

Note that we have made no changes for change's sake. There is much continuity. Robert Tinney, whom time only improves, remains our cover artist. Our new typeface, Novarese, has a classic feeling, like that of our old Palacio, but is more chiseled. Steve Ciarcia and Jerry Pournelle still appear prominently in major sections. The redesign, developed by McGraw-Hill's Joe Davis and refined and implemented by Rosslyn Frick, our new art director, keeps BYTE clean and simple. We think the judicious use of art and white space makes BYTE more pleasing to the eye and not garish or splashy.

The front of the magazine now includes an "Update" section where we can bring important matters to your attention. "Update" will contain, among other things, corrections of errors in previously published articles. Another addition to the front is a few pages of the most important items from "What's New." You will also find up front "Ask BYTE," "Book Reviews," "Clubs and Newsletters," and "Event Queue."

We have included more reader input and feedback by setting letters to the editor in smaller type, by introducing "Review Feedback" at the end of the Review section, by introducing "Update," by expanding the space for responses to Jerry Pournelle's popular column (more on this below), and by



enlarging Steve Ciarcia's "Ask BYTE."

The four main sections of BYTE are the Feature section, the Theme section, the Review section, and the Kernel. The distinguished artist Ivan Chermayeff has done graphics to introduce the first three of these sections. The Feature section now comes first. This section provides a variety of previews and descriptions of major new products and in-depth articles on topics of interest to sophisticated personal computer users. This month we provide a close look at the HP 110 portable, the second half of Steve Ciarcia's blockbuster article on building a Z8000 board for the IBM PC, part I of an Ada primer, and other articles including a preview of the innovative Macintosh Pascal and a clever way of making FORTH work faster. We have moved "Ciarcia's Circuit Cellar" to the Feature section because Steve really writes a major feature article each month rather than a traditional column.

Next comes the Theme section, which explores in depth a different subject each month. This month's theme articles discuss computers in education, with an emphasis on their use at the university level. Thanks to DEC, IBM, Apple, Zenith, and other companies, personal computers are now reaching campuses in volume. Associate Editor Donna Osgood's introduction to the Theme section shows the variety of uses for personal computers in universities, schools, and outside the formal educational system.

The Review section follows the Theme section. Reviews carry a slug on each page identifying them as reviews. The graphics in reviews of the Chameleon Plus, Infoscope, and C compilers give an indication of what to expect in BYTE's future reviews. Note how the graphs in the Chameleon review compare that machine's features and performance with two de facto standards—the IBM PC and the Apple IIe. From now on, you will see similar graphs for every system

(text continued on page 8)



**SEEQUA BELIEVES
PAYING IBM PRICES
FOR A PERSONAL COMPUTER
COULD MAKE A TRAMP
OUT OF ANYONE.**

PRESENTING THE CHAMELEON BY SEEQUA FOR JUST \$1995.

The Chameleon by Seequa lets you run popular IBM software like Lotus® 1-2-3™ and dBase II.® It gives you a keyboard just like the IBM. A disk drive like the IBM. And a bright 80x25 character screen just like you know who. And it all comes complete at a price that isn't at all like an IBM.

But the Chameleon's \$1995 price tag isn't its only advantage over its famous competitor. The Chameleon also has an 8 bit microprocessor that lets you run any of the thousands of CP/M-80® programs available. It comes complete with two of the best

programs around, Perfect Writer™ and Perfect Calc.™ It's portable. And you can plug it in and begin computing the moment you unwrap it.

So before you spend all your money on an IBM, consider the IBM compatible Chameleon by Seequa.

It's a tool for modern times that won't set you back a fortune.



The Chameleon by



**SEEQUA
COMPUTER
CORPORATION**

8305 Telegraph Road
Odenton, MD 21113

Chameleon shown with optional second disk drive.
To learn more about Seequa or for the location of the Seequa dealer nearest you, call (800) 638-6066 or (301) 672-3600.

IBM is a registered trademark of International Business Machines Corporation.

(text continued from page 6)

we review, making general month-to-month comparisons much easier than before.

After the Review section comes the Kernel, a major new section that starts with Jerry Pournelle's popular column, includes "BYTE West Coast," and will soon include "BYTE Japan" by William Raiké and a rotation of other columns on important topics such as artificial intelligence and telecommunications. You will find Bill Raiké's name on the masthead with those of other new contributing editors who will help make the Kernel a mainstay. Jerry Pournelle's fans will have no trouble recognizing his column under its new title, "Computing at Chaos Manor." What makes Jerry's writing so popular is his unique way of looking at things from Chaos Manor's techno-cluttered halls. His writing was originally entitled "The User's Column" not because Jerry is a typical user, but

because in earlier days, Jerry was virtually BYTE's only writer who was a mere user—he didn't create compilers and computers, he just used them. We have renamed Jerry's column in recognition of his individuality. Feedback to Jerry's column now comes immediately afterward in "Chaos Manor Mail."

"Programming Insights" (formerly "Quickies"), "Technical Forums," "Application Notes," "What's New," "Books Received," and "Unclassified Ads" round out the magazine (although we may not have material in every category every month).

To make it easier for readers to learn something about our authors, we've moved "about the author" information to the front of each article. Look for it near the bottom of the first or second page of each piece.

THE AIM INQUIRY SYSTEM

This month, BYTE inaugurates the first

electronic reader service processing system for readers and advertisers of computer magazines. Just as BYTE's new design is intended to refine the magazine and make it easier to read, the new electronic inquiry system is intended to modernize our reader inquiry service and make it easier for you to get information about products seen in BYTE. This automated inquiry management (AIM) system allows subscribers to request information from advertisers by using any Touch-Tone telephone. The AIM system will trim the typical six-week response time of the current reply-card system to as few as seven days. Here's how it works.

During the next three months, every BYTE subscriber will receive by mail a Subscriber Identification Card and ID number. Using your unique number, you can call the BYTE Reader Service Computer and then key in your subscriber number and the reader service numbers from the ads in BYTE you'd like more information about. When you're finished, close the session with a special ending code, and then watch your mailbox for replies from the manufacturers of products you've expressed an interest in.

Complete instructions appear in your copy of BYTE (if you've received your identification number) on the page facing the traditional reader service card. In this location you'll also find a form to help you organize your AIM system call before you make it.

If you did not receive your subscriber identification number this month, yours will be arriving in the next two months. The AIM system is being brought to a new one-third of our subscribers each month for the June-July-August period.

For those who live in an area without Touch-Tone service, who are not subscribers, or who prefer the traditional reply method, we'll continue to provide reader service reply cards.

—Phil Lemmons, Editor in Chief

WRITING FOR BYTE

BYTE continues to solicit and publish articles and reviews that keep you informed about what's new and important in microprocessor-based technology, and many of our articles are still written by you, the people directly involved with the field we report on. Details on querying us about article, product-review, and book-review ideas are listed below. We also welcome submissions (typed and double-spaced, please) to our Letters to the Editor column. Please contact us, via the appropriate department at:

BYTE
POB 372 Hancock, NH 03449
(603) 924-9281

You may also want to call or write us (send a stamped, self-addressed business envelope) for our current author guidelines.

ARTICLES

Because our editorial needs are very specific and subject to change, we prefer receiving query letters instead of completed articles. A query letter should contain one or two pages explaining the subject to be covered, its importance to the BYTE reader, and the focus of the proposed article; it should also contain a one- or two-page outline and a tentative first two pages of the proposed article. Query letters should be addressed to the features editor.

If you send us a completed article, we need double-spaced printed versions of the main text (up to 25 numbered pages) and all listings, figures, and tables; please label all items and place all captions on a separate page. Photos should be 35 mm (or larger) transparencies or 5- by 7-inch (or larger) prints. If possible, we would also like to receive magnetic copies of the text, listings, and tables on Apple DOS, IBM PC, Kaypro, or 8-inch CP/M disks; we will pay an additional \$20 for this. The files should be standard ASCII text files and should not contain any nonprintable characters; we prefer files that use carriage returns *only at the end of each paragraph*. You should also include a stamped, self-addressed return envelope of the appropriate size. Address these to the features editor.

PRODUCT REVIEWS

We frequently need good product reviewers and sometimes accept unsolicited reviews. BYTE product reviews must be fair, accurate, and comprehensive. Reviewers must have considerable experience in the microcomputer field. Writing experience is preferred but not required, and reviewers must have no financial connection to the company whose products are being reviewed. If you are interested in becoming a BYTE reviewer, send a letter to our product-review editor stating what computer products you own, what products you are interested in, and what writing experience you have.

BOOK REVIEWS

BYTE is always looking for qualified book reviewers. Submit queries and proposals accompanied by a resume, writing samples, or a list of computer-related interests and expertise to the book-review editor. Unsolicited book reviews also will be considered.

We pay competitive rates for articles and reviews and offer you the chance to share your expertise with hundreds of thousands of BYTE readers. Your comments and submissions are always welcome.

The second BYTE Computer Show takes place June 14-17 in the Los Angeles Convention Center. Subscribers are especially welcome and receive a full-day pass to exhibits and conferences for \$7.50. See you at the show. . . . P. L.

Franklin Unveils CX Series Computers

Franklin Computer Corp. has introduced a line of transportable computers. All are said to be Apple II compatible; MS-DOS or CP/M options are available. The CX-1, with a 6502 processor, 64K bytes of RAM, serial and parallel ports, a 7-inch display, and one disk drive, costs \$1425. The \$1730 CX-2 adds a second disk drive. The \$2049 CX-3 also adds a card with a Z80 processor and 64K bytes of additional RAM, while the \$2395 CX-4 adds an 8086 and 128K bytes of RAM.

The CX computers use a 12K-byte write-once memory (WOM) to store the operating system, which is loaded from floppy disk after power-up; after this, the memory cannot be written to until the machine is turned off and on again.

Hayes Enters New Field: Data-Management Software

Hayes Microcomputer Products Inc., best known as a maker of modems, has moved into the software arena with its data-management system called Please. Not surprisingly, a modem-communications link is part of the program. Please has extensive help screens to ease learning and is written in assembly language for speed of execution. The menu-driven program allows up to 999 characters per field and 99 fields (2000 characters total) per record; the number of records per file is hardware limited. Hayes also sells application templates for the program, including mailing list, membership, household records, and appointments. Please retails for \$349; application templates are \$29.95 each.

Videotex Capabilities Added to Micros

Several manufacturers have recently announced videotex capability for microcomputers. Wang introduced the PC Viewdata Decoder, a \$250 program for its Professional Computer. Digital Equipment Corp. unveiled Pro/NAPLPS, a \$195 program for its Professional 350 computer. Sony showed a NAPLPS/ASCII terminal, the VDX-1000, as well as a videotex frame-creation system. Avcor, in Toronto, announced a \$100 cartridge enabling the Commodore 64 to act as a NAPLPS/ASCII terminal.

IBM announced PC/Videotex, software enabling the IBM PC, PC XT, or PCjr to act as a videotex terminal. PC/Videotex will be available in October for \$220 to \$250. Network Videotex Systems Inc. of Toronto is selling Quick-Pel, a \$625 expansion card allowing the IBM PC to function as a NAPLPS videotex terminal. TVOntario, also of Toronto, offers a NAPLPS page/frame-creation system for the IBM PC for \$1450.

Texas Instruments has developed a single-chip video-display processor that supports the NAPLPS standard used for American videotex. TI's Advanced Video Display Processor is software compatible with TI's popular 9918 video processor.

Wilcom Announces Telecommunications Device for IBM PC

Wilcom Inc., Roswell, GA, has introduced Asher, a telecommunications device for the IBM Personal Computer. Asher includes an expansion card with a 300-bps modem, a telephone handset, and MS-DOS software for memory partitioning, appointment scheduling, and card file/speed dial functions. While several applications can be in memory simultaneously, they do not execute concurrently. The Asher software uses 128K bytes in addition to the memory needed for other programs, so a minimum of 256K bytes is needed. Asher will be available this month for \$795.

TeleVideo Personal Mini Uses IBM PCs as Workstations

TeleVideo Systems has introduced the Personal Mini, a 16-user computer that uses IBM-compatible computers as intelligent workstations. The Personal Mini includes a 40-megabyte hard disk and 80186 and Z80 processors. Microcomputers can be linked to the system using a \$99 interface card and cable; special "diskless workstations" are also available. TeleVideo says users can run any PC-DOS or MS-DOS software on the workstations or can use any of 50 available multiuser software packages. The Personal Mini should be available this month for less than \$10,000.

(text continued on page 10)

(text continued from page 9)

Fourteen Firms Back Network Standard

Fourteen computer makers, communications firms, and manufacturers announced their support of a network based on the IEEE 802.4 broadband token bus standard. General Motors and Boeing Computer Services signed an agreement pledging support of the standard and promising to demonstrate a working network at the National Computer Conference next month. Also participating in the demonstration will be IBM, Hewlett-Packard, Digital Equipment Corp., Honeywell, NCR, Charles River Data Systems, Intel, Motorola, and others. While the demonstration will be of a factory-floor network, 802.4 could also be used to network personal computers. General Motors showed the network earlier this year at its technical center in Warren, Michigan.

Epson and Commodore Show New Computers

Epson showed the PX-8, a new notebook computer, at the recent Hannover Fair in West Germany. The computer includes 64K bytes of RAM, an 8-line by 80-column LCD, a micro-cassette tape drive, a Z80-compatible processor, and the CP/M 2.2 operating system in ROM. MicroPro announced that ROM-based versions of its application software programs, including Portable WordStar, Portable Calc, and Portable Scheduler, are bundled with the PX-8, which is not yet available in the U.S.

Although Commodore showed prototypes of several computers, it didn't announce details, pricing, or availability dates for any of the products. The most talked-about machine was an 8088-based MS-DOS computer, reportedly based on Bytec's Hyperion. Commodore also displayed a Z8000-based computer with dual floppy-disk drives, 256K bytes of RAM, and the UNIX-like Coherent operating system. Commodore also showed the Commodore 16, a scaled-down version of its 64.

Microrim Offers Conversational Query Language

Microrim Inc. has introduced a conversational query language for its R:base series of database-management programs. The language, called CLOUT, allows a user to get database information by using commands that resemble English-language questions. CLOUT requires an IBM PC with at least 256K bytes of RAM and two double-density double-sided disk drives; a hard disk is recommended. The \$195 program works with PC-DOS, MS-DOS, BTOS, and UNIX, using R:base, which costs \$495.

Microrim also announced two new versions of R:base—the Model 6000 for multiuser systems and the Model 2000 for the IBM PCjr and other small systems.

NANOBYTES

IBM has developed an experimental 1-megabit dynamic random-access memory (DRAM) chip using existing manufacturing facilities. The chip uses a silicon and aluminum metal oxide semiconductor (SAMOS) technology. . . . **Phoenix Software**, Norwood, MA, is offering its custom-written IBM-compatible ROM BIOS for MS-DOS to computer makers. Phoenix says the code was written without any knowledge of IBM's BIOS and thus companies using it should be free from lawsuits. . . . **Holmes Engineering**, Murray, UT, is offering the Portable Micro Drive, a wafer tape drive for the Radio Shack TRS-80 Model 100 notebook computer. The \$370 unit can store up to 64K bytes on a tape cartridge and includes a rechargeable battery. . . . **Fujitsu America**, San Jose, CA, announced a 671-megabyte 14-inch Winchester disk drive with a price of \$7045 in quantities of 100. . . . **Digital Equipment Corp.** is now offering an eight-user Micro/PDP-11 for about \$20,000, including two terminals and a printer. . . . **Seequa Computer Corp.**, Odenton, MD, will use **Tabor's** 3¼-inch disk drive in its Seequa 325, an enhanced version of its Chameleon. Seequa is the first computer maker to use the drive.

From Nikkel BYTE, Tokyo: Epson appears ready to unveil two hand-held computers, the HC-80 and HC-88, with built-in Japanese-language processing functions. The high-resolution LCD will show either 90 kanji (Chinese) or 640 English characters at a time. . . . **Mitsubishi** and **B-Con Systems** are selling a kanji version of Microrim's R:base 4000 database software for Japanese MS-DOS computers.



Integrated.

Printegrated.

Now, translate your integrated software into integrated hard copy, with the TI OMNI 800™ Model 855 printer. So versatile, it combines letter-quality print, draft-quality print and graphics as no other printer can. **It prints letter-quality twice as fast** as comparably priced daisy wheel printers, yet gives you characters just as sharp, just as clear.

It prints rough drafts ten times faster than daisy wheel printers... faster than most any other dot matrix printer. **Only the TI 855 has snap-in font modules.** Just touch a button; change your typestyle. The 855 gives you more typestyles to choose from than ordinary dot matrix printers. It makes them quicker, cleaner, easier

to access than any other dot matrix or daisy wheel printer. **The 855's pie charts are rounder...** all its graphics are sharper than on other dot matrix printers, because the TI 855 prints more dots per inch. As for daisy wheel printers... *no graphics.*

The TI 855 Printer

The printer for all major PC's



For under \$1,000 you get twice the performance of typical dot matrix printers. Or all the performance of a daisy wheel printer, and then some, for half the price.

So get the best of all printers, and get optimum results from your integrated software. With the TI 855. See it at your nearest authorized TI dealer. Or call toll-free: 1-800-527-3500. Or write Texas Instruments Incorporated, P.O. Box 402430, Dept. DPF-182BY, Dallas, Texas 75240.

TEXAS INSTRUMENTS

Creating useful products and services for you.

"Dare to

TI makes the best software perform even better.

When choosing a computer, there are two important things to look for. Who runs the best software—and who runs the software *best*? That's why we're staging a dramatic country-wide side-by-side comparison against IBM™ called "Dare to Compare."

Come to a participating dealer and take the "Dare to Compare" challenge. You'll see first-hand how...

TI makes software faster to use.

Take a closer look. See how we give you more information on-screen than the IBM PC? That way you'll spend less time looking for data, and more time using it. We also give you 12 function keys, while they give you 10. Unlike IBM, we give you a separate numeric keypad and cursor controls. And that saves you both keystrokes and time. We also isolated the edit/delete keys to reduce the chance of making mistakes.

TI makes software easier to use.

TI gives you up to 8 colors on-screen simultaneously, which makes separating the data a lot easier. IBM displays only 4. Our graphics are also sharper. And easier on the eyes.



IBM Personal Computer

Compare"

And TI makes it easier to get your data on-screen. Our keyboard is simpler—it's more like the familiar IBM Selectric™ typewriter than the IBM PC keyboard is.

TI lets you see for yourself.

Right now, you can "Dare to Compare" for yourself at participating TI dealers all over the country. Stop in, present your business card, put both machines through their paces using the same software titles, and see the difference for yourself. We'll give you a TI solar powered calculator, free, just for taking our challenge*.

For the name of a participating dealer near you, please call TI toll-free at 1-800-527-3500, or write: Texas Instruments Incorporated, P.O. Box 402430, Dept. DCA232BY, Dallas, Texas 75240.



TEXAS INSTRUMENTS

Creating useful products and services for you.

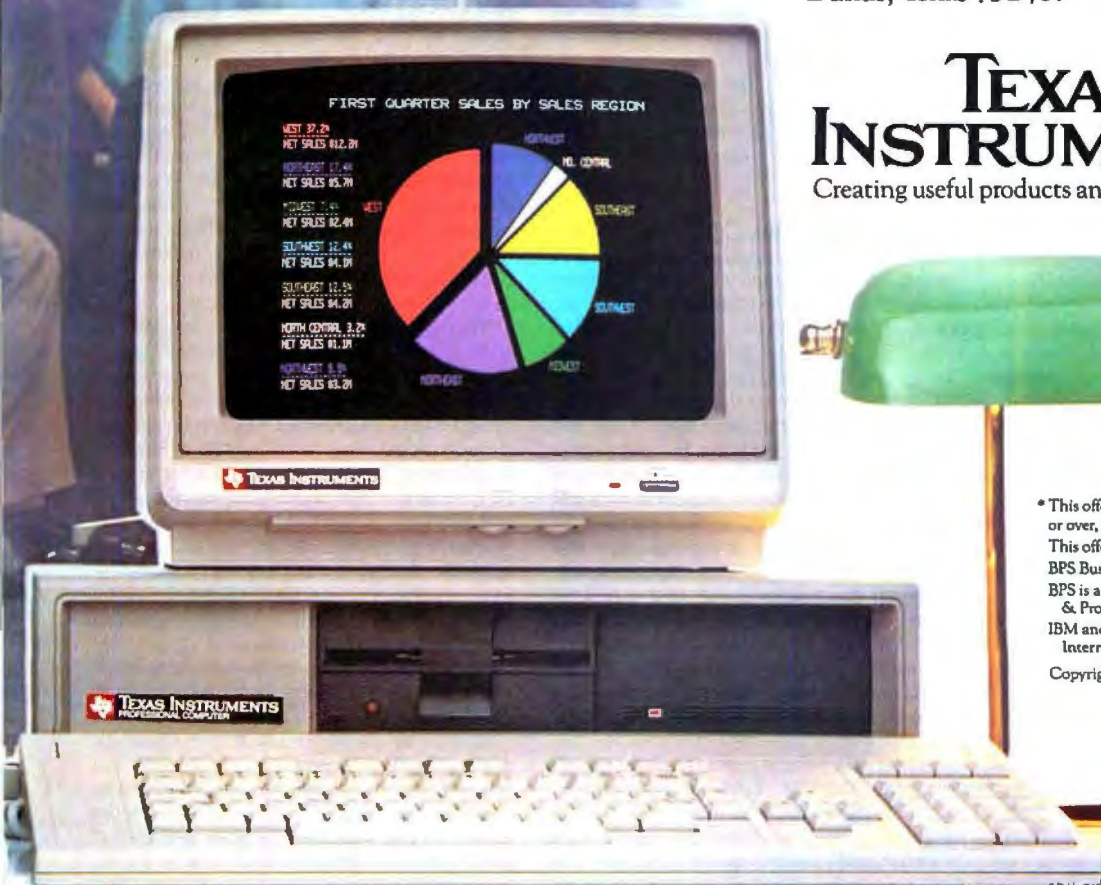

* This offer available only to persons age 21 or over, while supplies last.
This offer expires July 31, 1984.
BPS Business Graphics™ shown.
BPS is a trademark of Business & Professional Software Incorporated.
IBM and Selectric are trademarks of International Business Machines, Inc.
Copyright © 1984 Texas Instruments

Texas Instruments Professional Computer

CONTROLLER CORRECTION

I recently ran into a problem with my Apple II disk drive. I couldn't find a controller card that wouldn't stop every two seconds while reading in a text file longer than two sectors. This pause was annoying because the disk drive sounded like it was dying and it took me twice as long to read the file.

I don't know how many companies and how many of their controller cards have this problem, but I have experienced it twice. I asked some people at the Hughes Apple Byter's Club, with which I'm affiliated, about this problem, but nobody really knew what caused it. It has been suggested to me that there may be a POKE command that keeps the motor running, but I have yet to find out if this is true.

My roommate noticed that while using an Apple controller, the drive continued to run approximately 1½ seconds after control had returned to the user. I solved this problem by increasing the size of the tantalum capacitor on the threshold of the timer chip by about 10 microfarads. The capacitor controls the amount of time the output line stays enabled on the motor control. This allows the drive motor to stay on a few milliseconds longer than before, so DOS has a chance to finish transferring the contents of the file buffers and return for more data before the motor stops spinning. Otherwise it would have to restart the drive motor before it could resume reading. This is what added the extra time it took to read in the file(s).

I hope this information will save your readers some unnecessary frustration.

CHRIS A. NIELSEN
Nielsen Engineering
2910 Seventh St.
Santa Monica, CA 90405

AMERICAN AS APPLE PIE

The introduction of the Apple Macintosh computer has been eagerly awaited by many home and business computerists. The complete description in the February BYTE ("The Apple Macintosh Computer" by Gregg Williams, February, page 30) is certainly impressive and I can see many applications for the Macintosh. I would consider the Macintosh for those applications were it not for one negative factor. The Apple computer has been, since its introduction, one of the most popular computers, regarded as American as apple pie. Now comes the Macintosh computer and, lo and behold, it uses a Sony storage medium. It seems to me that if the United States is going to lead the world in computer technology, it has to be innovative and responsible enough to develop

those leading technological products that make it the world leader.

When I go look at television sets, video-cassette recorders, cameras, etc., I find an almost total predominance from the Japanese manufacturers. This is appalling. What has happened to U.S. technology in these fields? It has appeared that our technical excellence has returned in the areas of computers and certainly the world has looked to the U.S. for computers in the past several years. If the American-as-apple-pie computer suddenly incorporates Japanese-supplied hardware, what is the next step?

I, for one, have given up considering the Macintosh computer for any application I have. I will not contribute in any way to the furthering of Japanese technology into the American computer industry, and I think Apple Computer Inc. deserves a failing grade for contributing to an already substantial balance of payments deficit with its Macintosh design. I hope the rest of the computer-buying public will recognize this un-American approach and express their reaction at the computer store purchase counter.

DAVID A. NIBBELIN, P.E.
President, Variable Acoustics Corp.
2222 West Vickery Blvd.
Fort Worth, TX 76102

IN THE RAINBOW CORNER

I would like to comment on recent criticisms of the DEC Rainbow that appeared in two March articles ("The User Goes to COMDEX, 1983," by Jerry Pournelle, page 352, and "Reviewer's Notebook," by Rich Malloy, page 213) and in a letter to the editor by Carter Scholz (page 20) in the same issue. It was just last month (February 1984) that the (then) editor in chief of BYTE, Lawrence J. Curran, editorialized on the drive to be compatible with IBM equipment. Mr. Curran's point was that the compatibility craze might be stifling innovation that usually arises from smaller companies. Now in March, Messrs. Pournelle and Malloy criticize the DEC Rainbow for not running IBM software and for not having the IBM disk format, and because it is not being cloned. Possibly they should read the March editorial, because they too seem to be caught up in the compatibility craze.

Mr. Pournelle's article correctly grasps the obvious, that the DEC Rainbow was never intended to mimic the IBM, therefore it will not run IBM software. Many initial purchasers of the Rainbow (and I can assure Mr. Pournelle that there are many Rainbow owners) were individuals who were already familiar with DEC minicomputers. These people wanted a home

computer compatible with other DEC equipment that also ran the popular commercial software packages (the Rainbow emulates the VT100 terminal, an industry standard that is often cloned). In providing for the needs of the initial market, DEC created a product superior to the IBM. The screen resolution is better, there are built-in communications and printer ports, and space is provided for a second set of half-height floppy-disk drives or a hard-disk drive. I disagree with Mr. Pournelle about the keyboard, and I feel that it is superior to that of the IBM and may be the best in microcomputers today.

Mr. Malloy makes some remarks about the DEC that I feel are incorrect. He implies that the Rainbow 100 Plus is required to format MS-DOS disks. Rather, it is the version of MS-DOS that determines whether the Rainbow will format MS-DOS disks. My regular Rainbow using version 2.05 of MS-DOS formats disks perfectly. The version 2.05 MS-DOS was a no-cost option with my computer, and it is supplied by default with the 100 Plus computer. Mr. Malloy also slighted the Rainbow because the Rainbow 100 Plus looks like the 100 except for a plastic sticker. This is a cheap shot: DEC's Plus option to the Rainbow is merely an addition of the hard-disk drive, hardly requiring a change in the processor enclosure. I recall Mr. Pournelle discovering that he had the IBM PC XT motherboard only after he had removed the cover and inserted his own memory chips ("Chaos Manor Gets Its Long-Awaited IBM PC," February, page 113).

The Digital Classified Software (DCS) needs some clarification. The DCS program ensures that the software is adapted to the Rainbow hardware and special-function keys. The DCS program also requires DEC to provide software support. I can't imagine calling IBM in San Jose to ask about Lotus 1-2-3, yet this is the service DEC provides. DEC is providing hardware and software support from one source, a trend I find comforting. Also, third-party software is now available; in fact, I saw a DEC booklet (at the local computer store) listing hundreds of independent (nonauthorized) vendors providing programs on Rainbow-compatible disks. Eventually software will provide translation links between disk formats that all manufacturers (IBM, DEC, Tandy, etc.) fail to provide.

Finally, I would like to state that the Rainbow is a capable home and business computer that has sufficient and improving software. (Don't be fooled, all the biggies provide software for the Rainbow.) The Rainbow was never intended to be a hacker's machine and Mr. Scholz should never have purchased one. The Rainbow has sufficient slots for extra memory, a superb

(text continued on page 16)

Get A HeadStart™ On The Other Guys.



HeadStart Features:

Size: 15" wide, 11" deep, 10 1/4" high.

Weight: 25 lbs.

Processors: Z80A (8 bit) and 8086 (16 bit).

Memory: 128K to 1MB depending on model. All models are expandable.

Disk Storage: 500K to 1MB (unformatted) on a 3 1/2" Micro-Disk.

Display: 12" (diagonal) P31 phosphor, non-glare screen, 25 lines x 80 or 132 columns.

Keyboard: Detachable with 105 total keys. An optional portable version snaps onto the front screen area for easy transportability.

Disk Operating Software: *CP/M 80 for 8 bit. **MS DOS for 16 bit. LAN DOS for multi-user 8 or 16 bit operation.

Networking: Up to 255 HeadStart VPUs may be connected via coaxial interface into one of 2 optional data storage systems.

Interfaces: One RS449/RS232 compatible serial port. One Centronics compatible parallel printer port. External data bus. Coaxial communications interface. External disk I/O interface.

Optional Data Storage Systems: 2 models available. A 10MB, 5 1/4" system is expandable to 20MB. A 50MB, 8" system (25MB fixed, 25MB removable) is expandable to 200MB.

*CP/M is a registered trademark of Digital Research.

**MS DOS is a registered trademark of Microsoft.

Intertec's HeadStart is the smallest, smartest, fastest, most powerful business computer money can buy. And the most expandable (it's networkable up to 255 user stations).

Great Ideas Come In Small Packages.

Instead of three bulky components, HeadStart needs only two—the keyboard and CRT. There's no need for a cumbersome disk and processor cabinet. With HeadStart, it's all in the CRT enclosure.

HeadStart's small but powerful 3 1/2" disk drive offers as much storage as larger 5 1/4" disks. Its 8 and 16 bit processors make software availability no problem.

And HeadStart's small size permits easy transportability with no sacrifice in performance. Each Video Processing Unit (VPU) comes with its

own easy-carrying handle. A portable keyboard option is also available.

How Fast Is Fast?

HeadStart's RAM Disk, an electronic emulation of the typical second drive, responds up to fifty times faster than conventional microcomputers.

Depress a key and you get a response within a split second. Literally before your finger leaves the key.

And HeadStart is incredibly powerful, too. Up to one megabyte of internal memory can tackle even the most sophisticated applications.

Some Ideas Are Bigger Than Others.

Because HeadStart is designed to be both a single *and* multi-user computer, you buy only as much computer as you need today.

But as your business grows, it grows with you.

Each HeadStart Video Processing Unit comes with its own memory, processors, disk and multi-user interfaces.

Just add a 10 or 50 megabyte Data Storage System and up to 255 users can share a common data base in an incredibly powerful, multi-user network.

HeadStart is available in three different models. All offer full performance, transportability, and are easily expandable.

Unlike conventional, single-user-only computers, HeadStart is here today with the designed-in technology to be here tomorrow.

So get a HeadStart on the other guys. For more information, call (803) 798-9100 or write: Intertec, 2300 Broad River Road, Columbia, SC 29210.

intertec™

WAREHOUSE SOFTWARE

TECHNICAL INFORMATION (602) 286-2222

Call for programs not listed. We will try to meet or beat any legitimate price for CP/M or IBM PC Software. Most disk formats available.

DATA BASE MANAGEMENT SYSTEMS

UNSEATABLE PACKAGE PRICE!
DBASE II+ Everyman's data base primer + Extra Diskette with Dbase Accounting, Mail list and Inventory Programs. For IBM PC and and CP/M Call for our special price.

- Fox and Geller Quickcode **\$159**
- DB+ SORT **\$89**
- Condor III **\$330**
- NWA Statpack **\$350**
- TIM IV **\$249**
- Infostar **\$255**
- PFS File **\$95**
- RBASE 4000 **\$285**
- Personal Pearl **\$145**
- Fast Facts for IBM PC **\$135**

WORD-PROCESSING

- Wordstar, Mail Merge, Spellstar, Index **\$345**
- Wordstar **\$230**
- Mail Merge or Spell Star **\$130**
- Microsoft Word W/Mouse **\$305**
- Word Perfect **\$295**
- Volkswriter for IBM PC **\$110**
- Wang Spellchecker **\$36**
- Metasoft Benchmark **\$265**
- Multimate **\$275**
- Peachtext 5000 **\$195**

SPREADSHEETS

- Calstar - IBM PC Spec. **\$65** .. Others **\$95**
- Supercalc II **\$159**
- Supercalc III **\$215**
- Microsoft Multiplan **\$159**

ACCOUNTING

TCS, Equivalent of Peachtree - Specially Augmented By Warehouse Software Customized For Your IBM PC Terminal and Printer - GL, AR, PA, AP, CP/M, for PC XT, DOS 1.1, 2.0
 Each Module **\$75** For All Four **\$275**

- CYMA **Call**
- Dollars and Sense - Monogram **\$105**
- BPI GL, AR, AP, PA each **\$415**
- Real World, GL, AR, AP, PA .. each **\$350**

TRANSFER PROGRAMS

- Move-It **\$85**
- Microstuf Crosstalk **\$105**

Best Price in U.S. for IBM PC or Clones Multifunction Board—Includes Async Adapter, Parallel Adapter, Clock with battery back-up and Software, 64K Memory Expandable to 384K, 1 year warranty **\$225**

LANGUAGES

- Lifeboat C Compiler **\$295**
- Microsoft C Compiler **\$335**
- Microsoft Pascal Compiler **\$245**
- Microsoft Basic Compiler **\$285**
- Microsoft Basic Language **\$250**
- CBASIC 86 for IBM PC **\$135**
- CBASIC CP/M-80 **\$95**

For the IBM PC - Winchester Drives
 10 Megabyte Low Cur. Int. Drive **\$995**
 24 Megabyte Ext. Drive w/Fan **\$1795**

FOR PC DOS

- Norton Utilities **\$55**
- Copy II PC **\$34**
- Prokey V3.0 **\$86**
- Howardsoft Tax Preparer 84 **\$215**
- Microsoft Flight Simulator **\$38**

HARDWARE

- Hayes 1200 Modem **\$495**
- CDC D/S D/D Disk Drives **\$229**
- Anchor Signalman 1200baud Modem **\$285**
- STB Graphics Board **\$325**
- Quadram Color I Board **\$199**
- 256 K Ram Board **\$299**
- Princeton RGB Hi-res Monitor **\$495**
- Epson, Okidata Printers **Call**
- Gemini 15X, 10x Printers **Call**
- Corona Computer - Port. or Desk Top. .. **Call**

TERMS: Prices include 3% cash discount. Add 3% for charge orders. Shipping on most items \$5.00.
 AZ orders +6% sales tax. Prices subject to change.

TOLL FREE ORDER LINE 1-800-421-3135
WAREHOUSE SOFTWARE
 2701 West Glendale Ave., Suite 6
 Phoenix, AZ 85021

LETTERS

(text continued from page 14)

graphics board and a second storage medium (floppy or hard disk). Recall that the I/O ports are already installed and not sold as extras. The Rainbow has filled the needs of this nonhacker with good installation and software documentation.

CAMERON T. MURRAY
 Department of Polymer Science
 and Engineering
 University of Massachusetts
 Amherst, MA 01003

As far as reviews are concerned, BYTE has no bias either for or against DEC or any other company. We are concerned with how well a product works, how much software is available for that product, how readily available that software is, and how easy it is to turn that product into an even better product. IBM PC compatibility is desirable only because it provides a tremendous amount of readily available software and hardware peripherals. For a long time, Rainbow software was not available in local computer stores. And there are still few readily available third-party hardware peripherals for it. If, in a year's time, you can buy third-party hardware for the Rainbow at your local computer store, then the Rainbow will be a much stronger machine.

—RICHARD MALLOY
 Senior Technical Editor
 BYTE Magazine

Having just received the March issue of BYTE and, obviously, not having seen the April issue for which you have scheduled a review of the DEC Rainbow, I would like immediately to comment on the letter from Carter Scholz, lest other readers get a misleading impression of this machine.

Mr. Scholz admits to 50 hours of intensive use. Having obtained my machine in February 1983, I have over 1650 hours of experience with it in connection with my consultancy business—a figure I feel sure must exceed even that of most reviewers of any one machine. To that extent, I suggest that my comments may have more than ordinary validity.

The observation that the documentation is "wretched" is, at the least, an overstatement. It is true that screen formatting and the use of function keys are not covered, which certainly is regrettable. With one exception—the manual for the LA50 printer, which, I readily admit, is appalling—the documentation is perfectly sound and helpful.

Mr. Scholz may not have wished to make an outlay for the technical manuals; but I had nothing but the most courteous cooperation and help from DEC's Canadian Customer Support Center when, at an early stage, I too had to raise screen-formatting and function-key questions.

DEC has not claimed that "thousands" of CP/M and CP/M-86 disks can be run on the Rainbow. As their *Guide to Personal Computing* points out, the machine can run a "very wide selection" of the "thousands" of software programs available on CP/M, CP/M-86, and MS-DOS. At the beginning there was a shortage of available

programs because of the then-new disk format; today there are several hundreds of software packages available, the great majority of which are from third-party vendors and are not part of the "DEC-approved" program. Even the problem of nonavailability of DEC's distinctive disks—except from DEC—is no longer a problem, and most of the major disk manufacturers have added the Digital RX50 format to their lines at reasonable prices.

As one who can claim extensive experience with the Rainbow, I cannot speak too highly of a machine that is a real joy to use, and I would hate to have readers draw unfavorable conclusions on the basis of Mr. Scholz's inaccurate letter. I might add that the only hardware problem I have had was with the LA 50 printer which, due to a faulty chip, packed up after about three months. Under warranty, it was replaced in about four hours. (Incidentally, this printer, bearing the Digital logo, is considerably more versatile than the look-alike model produced by the same manufacturer.)

TOM WALKER
 Fortsask Infodata Ltd.
 Box 3026
 Fort Saskatchewan
 Alberta T8L 2T1
 Canada

As a DEC Rainbow user for over a year, I've learned to ignore most of what I read in the computer trade press about the product. Rarely are the facts in order. If other products were comparably reported, the computer trade press would have earned a reputation comparable to that of the computer salesperson.

Of course, after a year, I'm happy to see the product mentioned at all. Please accept my sincere gratitude for printing the words "DEC Rainbow"—and for promising (as you always have) to review it.

But your March issue was somewhat misguided, and I'd like to set the record straight.

Although Chaos Manor is one of my favorite haunts, Jerry Pournelle's reaction (from afar) to the DEC keyboard was hardly responsible journalism (and his disclaimer at the beginning of the article doesn't justify that). [See "The User Goes to COMDEX, 1983," March, page 352.]

The test of a keyboard is daily use. Seven people have used the Rainbow keyboard at our weekly magazine for a year. They universally acknowledge it as a work of art. Sure it's unconventional—so is a Ferrari. The point of doing ergonomic research, as DEC did for its personal computers, is to find out how things ought to be designed, not how they have been designed. Despite its unique design, it is easy to learn the keyboard. Within one session, almost all of us had accustomed ourselves to its enhancements.

Specifically, I found Mr. Pournelle's complaint about the Shift and Return keys ridiculous. The Shift key measures the same travel as a Selectric Shift key (I regularly use both without trouble adapting), and the Return key is large and easily located. The Compose Character key is a very handy user-defined key in many word-processing programs, and it is easily learned

(text continued on page 18)



“We bought an IBC Middi Cadet™ because no other system could do the job.”

Sue Kardas
 Director of Career Training
 Burlington Area Vocational-Technical Center



“When the Burlington Area Vocational-Technical Center needed a multi-user system for student training, we considered many multi-user systems, but in demo after demo there was too much of a user delay.

Then IBC contacted us, and offered to demonstrate the Middi Cadet’s multi-user capabilities—we were skeptical, but we gave it a try.

First, the Middi Cadet ran 9 users doing word processing without any delays. As a second test, we had the Middi operating 3 terminals each on word processing, accounting and BASIC programming. Again, no user delay. This was the multi-user, multi-tasking system we had been looking for.

With the Middi Cadet, we got a higher speed Z80B processor, a very fast hard disk drive and enough memory to do the job (512K Bytes).

On top of that, we felt that we got a very good price from an excellent vendor. Our system was delivered and installed two weeks later. Since then we’ve been so pleased with the Middi that we’re planning to buy another. With two systems providing 18 stations we will be equipped to offer training in all aspects of information processing.”

The Middi Cadet is a 10 user system that includes a 6MHz, Z80B CPU; 256 to 512K Bytes of RAM memory; a 20 MB, 5¼” hard disk drive and a one megabyte 5¼” floppy disk drive.



For more information on the Middi Cadet, see your local IBC dealer.

To locate the dealer nearest you, call or write:

OUTSIDE THE USA

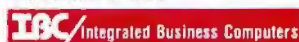

21621 Nordhoff Street
 Chatsworth, CA 91311
 (818) 882-9007 TELEX NO. 215349

WITHIN THE USA



1140 36th Street, Suite 212
 Ogden, Utah 84403
 (801) 621-2294

KNOCK ON WOOD!

LETTERS



(text continued from page 16)

by a touch-typist. Obviously, Mr. Pournelle didn't look closely enough to notice the dip in the F and J keys—a more subtle and successful "homing" device than some other keyboards that distinguish the home row.

Carter Scholz's letter in the same issue raised more serious points. First of all, "wretched" is an irresponsible description of the documentation, hardly earned by a missing bottle of screen cleaner (which *was* supplied with the first monitors). I frankly don't find the errors he seems to have run across.

Second, my prejudice may be that I can't take BASIC seriously, but we have formatted the screen very easily in dBASE II, Turbo Pascal, and assembly language.

Third, he fails to distinguish between disk formats and software. The machine can read several disk formats (Robin, VT180, Rainbow, IBM 8 and 9 sector) and hundreds of programs off the shelf (not counting RCP/M software), and with additional software can read many more disk formats.

Mr. Scholz intimates a use for the machine quite different from that for which it was designed. And his representation of DEC's software-classification program (which we think of as insurance against uninstalleable or immature products) and disk format (400K is an enhancement over 320K in my book, not "perverse") is libelous.

Let me explain what this "collage of impressive features with limited utility" did for my company in the last year:

- It typeset 45 magazine pages of insurance-company statistics using Multiplan and transmitted them to our typesetter using nothing more than the communications parameters in ROM and the operating-system commands.
- It stepped in to typeset our stories when our typesetter went down.
- It scheduled and billed our advertising, then it took over the scheduling, billing, and circulation maintenance of our directory.
- It estimated and billed all our commercial printing.
- This year it replaced our ledger, no mean achievement for an "immature product" with little utility.

DEC understands us. We want an appliance that gets specific jobs done and doesn't break down. If we have a question (even about programming function keys), we want a number to call with a prompt and courteous answer at the other end. DEC delivers that at a very low cost.

In fact, any intelligent cost analysis of their formatted quad-density disk offering proves it is competitively priced. Again and again we find (with rare exception) DEC on our side.

Finally, Mr. Scholz appears as naive about the stock market as he is about the business world. As all Rainbow users have come to know, the wheels of justice grind slowly, but they grind exceedingly small.

Well, I'm still looking forward to your review
(text continued on page 22)

The *Only* Pure Oak Wood

COMPUTER FURNITURE

ESPECIALLY designed and created for Personal Computers

Select the *best* computer furniture for your personal computer that will last because it's made of wood throughout, finished throughout, not wall board or other imitation board. SPECIFIC AREAS for:

- Your personal computer
- Your printer and paper storage with access from top or front
- Modem and Floppy disks with diskette space
- Monitor for easy viewing
- Books and slip-cases
- and, room for much, much more

Plus these great features:

Finished back, adjustable shelf with pullout glare-reducing hood, light for book area, sound reducing material in printer area, cooling fans included for cooling CRT and printer areas, space for expansion chassis/power, supply/telephone handset large work areas, security doorlocks, multiple electrical outlets, and much more. Enhance any decor. 52" w x 32" d x 52" h (approx.)

DAISY DESK price **\$99000**

subject to volume discounts

Your choice of Oak: Light/Medium/Dark

Order directly from

Circle 94 on inquiry card.



DAISY-NET INTERNATIONAL, INC.

P.O. Box 1152
Northbrook, IL 60062
(312) 724-3800



PRINTER/CRT TABLE



FILE CABINET



DAISY DESK JR.



BOOK CASE



DATA CADDY



PRINTER CADDY

"Knock on Daisy-Net Wood for Extra Wood Quality Throughout"



Quadmodem.TM The intelligent way to talk to other computers.



Ordinary modems can't do what
the QuadModem can. Because
they're not as smart.

If you expect your computer to communicate effectively with other intelligent systems, you can bet it'll need an intelligent modem. That's where the new QuadModem from Quadram comes in.

QuadModem connects directly to your phone line. From there it can dial a number from memory; detect incoming baud rates; answer the phone when another modem calls; and distinguish between dial tones, busy signals, data transmissions, and human voices (remember those?). It also automatically adjusts for rotary or Touch Tone phone systems and shows you what's happening right on your computer screen.

Even problems aren't problems.

An advanced microprocessor in QuadModem can automatically spot phone problems, and the QuadModem is fully compatible with Bell 103/212A dial up modems and the most popular modem brands.

QuadModem is the complete intelligent modem: with two different versions, an internal model for IBM PC's and most compatibles and a stand-alone for the PC and other popular brands. Both come with full supporting documentation and user manuals. Plus right now, we'll include an introductory offer from The Source.TM And to round it out, you can add QuadTalk, our very powerful, highly intelligent communications software that's menu-driven and very friendly.

If you expect your computer to communicate properly, it's got to act intelligently. It can with the new QuadModem from Quadram.

QUADRAMTM
An Intelligent Systems Company

4355 International Blvd./Norcross, Ga. 30093
(404) 923-6666/TWX 810-766-4915 (QUADRAM NCRS)

INTERNATIONAL OFFICES

Interquadram Ltd. 442 Bath Road, Slough, England SL16BB
Tel: 6266-63665 Tlx: 847155 Aurema G Interquadram GmbH
Fasanenweg 7, 6092 Kilsterbach, West Germany Tel: 8107-3089
Tel: 417770 Servo G Interquadram s.a.s.l. 41, Rue Ybny, 92522 Neuilly
Tel: 758-1240 Tlx: 630642 Iso Bur Chevo Computing 6581 Kitimat
Road, Mississauga, Ontario, Canada L5N-2X5 Tel: 416-821-7600

IBM[®] PC, XT, PCjr. are registered trademarks of International Business Machines Corporation.

[®]The Source is a registered trademark of Source Telecommunicating Corporation.

©Copyright 1984 Quadram Corporation. All rights reserved.

Circle 274 on inquiry card.

"Just beautiful."

That's what Bill Coleman of VisiCorp* calls our iAPX 86 architecture. He should know. He and his staff of over 50 people spent three years with it. Writing VisiOn*, the application software destined to become a multitasking

industry standard.

The key to creating VisiOn was memory management. Allowing Coleman and his team to create an efficient concurrent processing environment, where different processes are active all at once.

As Bill puts it, "The real beauty of this architecture is that you don't have to keep an entire program in memory at any one time. Just the active segments of code actually being run."

In the 8086 architecture, those memory segments are variably-sized and mapped as needed. So loading is very fast. And the resulting performance is very high, because you can load the exact memory you need. Which then gives you the highest performance from any given memory size.

That means some significant runtime advantages. Like faster switching from task to task and window to window. While keeping your mice from running wild.

Another advantage of the 8086 is its extended family, the members of which are perfectly compatible. So your product, and your investment, are protected longer.

The 8087 coprocessor, for example. It adds float-

ing point power, with calculations running up to 100 times faster than normal.

Or the new iAPX 286 microprocessor. In Coleman's words, "an optimal VisiOn machine."

The 286 handles some of VisiOn's multitasking chores in hardware, setting the software free for more powerful functions. Plus, it has on-chip memory management which protects one task from another and even helps prevent system crashes.

Best of all, you can experience all this for yourself. Because VisiOn is an open applications system. And VisiCorp is sharing information to encourage independent software development.

Which means you've got a wonderful opportunity to share in the forthcoming wealth.

But before you start building, study a little architecture. Call (800) 538-1876. In California, (800) 672-1833. Or write Intel, Lit. Dept. F-7, 3065 Bowers Ave., Santa Clara, CA 95051.

Who knows? You might find yourself looking at your own work in a whole new way.



*William T. Coleman, VisiCorp's
Director of Product Development*



intel[®]

*VisiOn and VisiCorp are registered trademarks of VisiCorp. © 1984 Intel Corporation

Now - Your Printer
Search Is Over With . . .

Gemini 10X

From MidWest Micro-Peripherals

by **star**
MICROPERIPHERALS

FREE GIFT!
Get a deluxe anti-dust,
anti-static cover for
your new Star printer
A \$16 value - yours
free with your purchase.

only
\$289



Word processing...graphics...charts...the advantages of owning a printer are endless. And so are the advantages of purchasing a Star Micronics Gemini-10X from MidWest Micro-Peripherals.

The Gemini-10X is compatible with all major brands of computers. It comes standard with a Centronics compatible printer port (serial optional), plus tractor, friction, and roll feed. With 120 cps bi-directional, logic seeking carriage control and 816 character buffer (expandable to 4K and 8K), you'll get crisp, clean hard copy without having to wait.

If you want variety, the Gemini-10X features Epson compatible printer codes. For a wide range of graphic looks, the unit offers six character sets and eight fonts as standard.

All this and more at the **guaranteed lowest price**. If you can find a verifiable better price anywhere on any Star printer, **WE WILL BEAT IT**. But besides price, MidWest also offers the best service. We ship 95% of our orders from stock within 24 hours.

We have cables and interfaces in stock for IBM, Apple, Commodore, TRS-80, and most other micro-computers.

And the experienced MidWest staff is ready to help you before, during and after your purchase. So call us today and let us help you find a happy ending to your Great Printer Search.

More Star Printers		Sale Price
Gemini-10X	120 cps	\$289
Gemini-15X		419
Della 10		439
Della 15	160 cps	589
Radix 10		639
Radix 15	200 cps	739
PowerType	DaisyWheel	399

Call NOW For Information, Ordering & Quantity Pricing.

1-800-423-8215
In Ohio 1-800-321-7731

We accept VISA and MASTERCARD (Add 3%), certified checks, money orders



MidWest Micro-Peripherals
(Division of Intel, Inc.)
135 South Springfield St.
St. Paris, Ohio 43072

101BY

LETTERS

(text continued from page 18)

of the Rainbow. I hope it will be as professional as the machine itself.

MIKE PASINI
Underwriters' Report
667 Mission Street
San Francisco, CA 94105

I read with interest Carter Scholz's letter on the DEC Rainbow 100 PC. We purchased five Rainbow PCs and I am sorry now that we did not return them as did Mr. Scholz. Although I agree in part with Mr. Scholz's criticisms (particularly in regard to the documentation) and I have additional complaints about the Rainbow and DEC in general, all of Mr. Scholz's criticisms are not correct, at least in my experience:

1. In an attempt to modify MODEM7 for the Rainbow I needed the communication-port status and data addresses. This is not in the documentation supplied by DEC (unless one purchases the extended documents referred to in Scholz's letter—we are still waiting for ours). However, a phone call to Customer Support not only produced the information over the phone but also a copy of the appropriate section of the extended document in the mail. As it turned out, the MODEM7 cannot be configured for the Rainbow. Once again however, Customer Support came to my aid and supplied me with an article (actually the whole magazine) giving the address for obtaining public-domain software equivalent to MODEM7.
2. DEC has an "authorization" program for Rainbow software but that does not mean that third-party software is not available. We purchased Spellbinder (which to my knowledge is not "authorized" by DEC), after finding that the so-called "authorized" word-processing software was either so slow that the secretaries were frustrated or so complex that it was not usable.

R. S. NEWMAN
Faculty of Medicine
Memorial University
St. John's
Newfoundland A1B 3V6
Canada

I have been a Rainbow owner since April 1983. Although I have had some problems, I feel Mr. Scholz's conclusions are incorrect. I offer the following replies to his objections.

1. Documentation for the Rainbow is professionally produced. I would be surprised if there weren't contradictions. This would be consistent with other machines and software, particularly a new machine. In use, however, the machine and the software perform as advertised. The escape sequences of all function keys are listed on pages 32 and 34 of the *Rainbow 100 User's Guide*. Utilizing them in user-written programs is the simple matter of interpreting the sequences they generate. Screen formatting is more difficult. DEC published a set of basic sub-routines in *Prospective* in the summer of 1983. You could also obtain a copy of a VT100

manual, which explains all the attributes of the Rainbow screen that it emulates.

2. Lack of high-level language support is found only in Microsoft BASIC or perhaps languages that are not screen intensive such as COBOL. I have the new Turbo Pascal from Borland International and both function keys and screen attributes are supported. Many other machines or software vendors have failed to initially support some of the features of their environments, some because they felt other features were more important and deserved more initial support.

3. The contention that the Rainbow cannot run "thousands" of CP/M-80 and CP/M-86 programs is totally false. I purchased Condor III directly from Condor in Rainbow format, Reportmaker from Krepec, and TURBO Pascal from Borland. I think that Mr. Scholz has failed to look beyond the magazine advertisements. Most advertise IBM and IBM compatibles because that's the largest segment of the market. MS-DOS is also available for the Rainbow. Any authorized software dealer can obtain numerous software-applications packages in Rainbow format. Many of us do not consider the fact that this format allows about 400K bytes per disk to be a drawback.

I think that there is a difference in philosophy in the design and marketing of DEC microcomputers. Their philosophy seems to be that their primary market is the plug-in-and-go non-programmer. This is supported by the fact that there are only a few expansion ports and a private bus structure. That does not inherently produce a bad machine, just one that may not fit a "hacker's" needs.

DEC supports its hardware and authorized software. This support includes a toll-free line for help (try that at IBM), factory service, and extended warranties. Few other manufacturers offer this commitment to their purchasers. I cite Mr. Scholz's own statement that he was able to return the machine for a refund. That is the true test of factory support if there ever was one.

Rainbows are relatively new on the market and market support has been slow. Part of this could be the big push to get IBM software out first due to its market share. There are, however, two DEC micro-oriented magazines now available—*Digital Review* and *Personal and Professional*. There also have been changes in DEC operations that should enhance users' options. However, based on hardware and ease of use, the Rainbow is still one of the better machines on the market.

GERALD ARTMAN
828 East Third St.
Royal Oak, MI 48067

VIVE LA DIFFERENCE

I greatly appreciated the December 1983 BYTE article on the TI personal computer ("The Texas Instruments Professional Computer," page 286). The unbiased evaluations and the well-chosen
(text continued on page 24)



AZTEC C86
 Optimized "C" compiler for PC DOS, MS DOS & CP/M-86
 PC DOS, UNIX I/O, math, screen, graphics libraries
 8086 assembler, linker & librarian, overlays
 /PRO—library source, debug, ROM, MASM & RMAC, 8087, large model



NEW C COMPILERS
 AZTEC C68K for MACINTOSH
 VAX cross compilers



AZTEC C II
 Optimized "C" compiler for CP/M, TRSDOS & LDOS
 assembler, linker & librarian, overlays, utilities
 UNIX I/O, math & compact libraries
 /PRO—library source, ROM, M80 & RMAC

C TOOLS & AIDS
 Z editor (like Vi), C TUTOR compiler, PHACT database,
 C GRAFX, UNI-TOOLS I, QUICK C, BABY BLUE for PC
 to CP/M cross, QUADLINK for PC to APPLE cross

AZTEC C65
 "C" compiler for APPLE DOS 3.3, ProDOS or COMMODORE 64
 VED editor, SHELL, UNIX & math libraries
 /PRO—library source, ROM, overlays



CROSS COMPILERS
 Compile & link on HOST—test on TARGET machine
 HOSTS: UNIX, PC DOS, CP/M-86, CP/M-80, VENIX, PCIX, APPLE
 TARGETS: PC DOS, CP/M-86, CP/M-80, APPLE, RADIO SHACK,
 COMMODORE 64, other hosts and targets available



PRICES

AZTEC C86 C COMPILER

PC DOS MSDOS	249
CP/M-86	249
BOTH	399
/PRO EXTENSIONS	249
Z (VI EDITOR)	125
C TUTOR COMPILER	99
PHACT DATABASE	299
C GRAFX	99
SUPERDRAW	299
UNI-TOOLS I	99
QUICK C	125

AZTEC C II C COMPILER

CP/M	199
/PRO EXTENSIONS	150
TRS 80 MODEL 3	149
TRS 80 MODEL 4	199
TRS 80 PRO (3 & 4)	299

AZTEC C65 C COMPILER

APPLE DOS 3.3	199
ProDOS	199
BOTH	299
/PRO EXTENSIONS	99
C TUTOR COMPILER	99
E EDITOR	99
QUICK C	125

AZTEC C CROSS COMPILERS

PDP-11 HOST	2000
PC DOS HOST	750
CP/M-86 HOST	750
CP/M-80 HOST	750
APPLE HOST	750



MANX SOFTWARE SYSTEMS
 Box 55
 Shrewsbury, NJ 07701
 TELEX: 4995812

TO ORDER OR FOR INFORMATION:
CALL: 800-221-0440 (outside NJ)
201-780-4004 (NJ)

Australia: Blue Sky Industries — 2A Blakesley St. — Chatswood NSW 2067 — Australia 61-2419-5579
 England: TAMSYS LTD — Pilgrim House — 2-6 William St. — Windsor, Berkshire SL4 1BA — England — Telephone Windsor 56747
 Shipping: per compiler next day USA \$20, 2 days USA \$6, 2 days worldwide \$75, Canada \$10, airmail outside USA & Canada \$20
 UNIX is a trademark of Bell Labs. CP/M, CP/M-80 and CP/M-86 are trademarks of DRI. PC DOS is a trademark of IBM. MS DOS is a trademark of MICROSOFT.
 N.J. residents add 6% sales tax.

Less for Your Money

If you do word processing on your personal computer, you probably know that there are many programs for sale to help you with your spelling. But the biggest spelling error you'll ever make is paying too much for your spelling correction software. The Random House ProofReader gives you less for your money — less trouble, that is, and fewer spelling errors. The Random House ProofReader is based on the world famous Random House Dictionary. It contains up to 80,000 words, depending on your disk capacity. You can add new words with the touch of a key. It shows you the error and the sentence it's in. It instantly suggests corrections. It even rechecks your corrections. And it costs half as much as other programs with far less power. The Random House ProofReader is compatible with all CP/M 2.2®, MS-DOS® and IBM Personal Computer® systems.

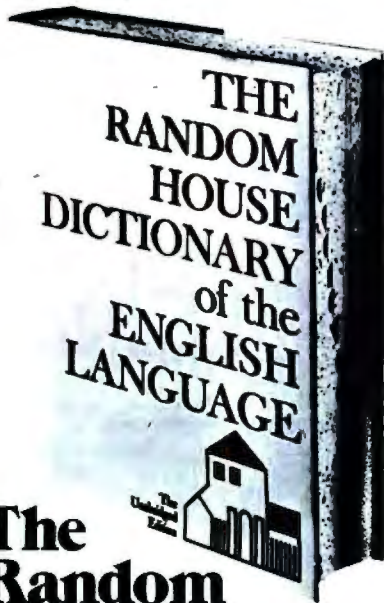

The Random House ProofReader \$50

For orders or information, see your local dealer or call 505-281-3371. Master card and VISA accepted. Or write Wang Electronic Publishing, One Industrial Ave., Lowell, MA 01851. Please enclose \$50 and specify your computer model, disk size and memory.

Random House and the House design are registered trademarks of Random House, Inc. CP/M is a registered trademark of Digital Research, Inc. IBM and IBM Personal Computer are registered trademarks of International Business Machines, Inc. MS-DOS is a registered trademark of Microsoft, Inc.

LETTERS

(text continued from page 22)

industry-wide comparisons were a welcome change from the maudlin treatment given the IBM machine in November 1983. Your intro to the IBM articles left me perplexed. How could such phrases as "transformed the computer industry" or "legitimized personal computers" or "single-handedly enabled microcomputers to assume a greater percentage of the world's computational tasks" be used with a straight face? All conscience aside, the IBM PC is widely accepted and is making a lot of money for a lot of people. I could wish, however, that as an industry we were more self-critical.

JAMES A. BARNETT
4719 Williston St.
Baltimore, MD 212299

SIMSCRIPT II.5

Although a good general overview, the article "Computer Simulation: What It Is and How It's Done" by Richard Bronson (March, page 95) was incomplete and somewhat inaccurate in its treatment of SIMSCRIPT II.5.

Despite being lumped with GASP, SIMSCRIPT does not require that "a complete coded model [consists] essentially of calls to subroutines and assignment statements. . ." For example, the essence of the barbershop problem given in the article could be represented by

```
Process GENERATOR
  For N = 1 to 100,
  Do
    Activate a CUSTOMER now
    Wait Exponential.f(25..2) minutes
  Loop
End
Process CUSTOMER
  Request 1 BARBER
  Wait Normal.f(20..5..1) minutes
  Relinquish $ BARBER
End
```

In the example, the number 1 is specified before BARBER to give the number of units of the resource needed. Units other than 1 are used, for example, when modeling computer resources, where a 42K-byte allocation of 256K-byte main memory is sought. The final parameter in the two SIMSCRIPT-defined random distribution functions is a stream number that allows isolation of the inherent side effects of taking successive samples from a pseudo-random generator.

Contrary to the article and as suggested in the example, SIMSCRIPT II.5 is a process-oriented simulation language. At the same time, it retains the event-based capabilities of the Rand Corporation's original SIMSCRIPT I.

Finally, a word about language preprocessors such as GASP and SLAM. Although they can be valuable tools for developing simulation models, they are not true programming languages. For medium- and large-scale applications (1000 to 100,000 lines) a user is usually forced to revert to the underlying programming language—FORTRAN—thus losing the preprocessor "language." A preprocessor is a good

short-term solution, but no substitute for a complete compiler and support library, which is why SIMSCRIPT abandoned its FORTRAN translator with the introduction of SIMSCRIPT 1.5 in 1965.

JOEL W. WEST III
CACI Inc.
3344 North Torrey Pines Court
La Jolla, CA 92037

WHAT IS A TYPICAL COMPUTER PROFESSIONAL?

Yesterday I took the kids to see *WarGames*. Apparently the movie has entrenched the latter-day meaning of the word "hacker" (synonymous with database intruder). I recall when the word was simply the computer equivalent of the radio "ham."

What really upset me was the way the movie portrayed the (typical?) computer professional. The two main characters, certainly escapees from the loony bin, apparently were able to think only in binary, and they obviously were unfit for human company. Is this the image computer people and computer magazines such as *BYTE* want to project to the general public?

Back in the dark ages, before the microprocessor, I used to read *Computers and Automation*, edited by Edmund C. Berkeley. The magazine strove to place computers and computer people in a meaningful relationship with the community. I don't know what became of *Computers and Automation*. Perhaps this is something to consider? "If you prick us, do we not bleed?"

Opinions please!

TORRE RAMBOL
Granliveien 37
N-3440 Royken
Norway

STANDARDIZATION ENCOURAGES INNOVATION

While I am one who always looks forward to advances and innovation in the computer field, I fail to find the flaws in the home-computer market you claim exist in your February editorial ("The Compatibility Craze," by Lawrence J. Curran, page 4). The fact that IBM has become the de facto standard in microcomputers has led, I believe, to more, not less innovation. While the rate of change of new and radically different hardware pieces may have slowed down, both the quality and quantity of software have increased tremendously. The fact that one standard is dominating the hardware market means it's possible and profitable for larger and/or more unique software packages to be produced. One need only look at the success of a piece of software like Lotus 1-2-3. Would such a product have come to market had there not been standardization through the large sales of IBM PCs and PC-compatibles? Probably not. The cost of writing sophisticated software is high, both in terms of time and money. It has become less risky for software firms to introduce a new product because their initial ver-

(text continued on page 26)

Pick up a SixPakPlus™ for your IBM® PC.

Introducing ... SixPakPlus™, the refreshing new 384KB multi-function card! In response to the changing needs of the IBM PC and PC-XT marketplace, AST Research, Inc. is proud to announce the latest addition to our line of multifunction enhancement products, the SixPakPlus! This new product is the result of extensive marketing research into the needs of IBM PC users whether they have the original 64K system board, the newer 256K system board, or the PC-XT. The SixPakPlus has been engineered to meet these needs at a competitive price while main-

taining AST's high standards for quality and reliability.

The SixPak, as we like to call it, could have been named for the six banks of RAM on it. However, we like to think that it was named for the six functions of the card. The features of the SixPak include:

1. RAM memory starting at 64K, user-expandable in 64K increments to 384K. This makes the SixPak ideal for the PC or PC-XT with a 256K system board; 384K on a SixPak added to 256K on the system board yields 640K, the maximum addressable user memory in these systems.
2. One Serial (async) communications port, configurable as either COM1 or COM2, for use with serial printers, modems, a "mouse," and other serial devices. The serial port has on-board jumpers for easy management of the RS-232C lines, simplifying the wiring of cables in many installations.
3. One Parallel (printer) port, configurable as LPT1 or LPT2 (LPT2 or LPT3 when the IBM monochrome card is installed), for use with the IBM/Epson and other compatible printers. The port is compatible with IBM diagnostics.
4. A Clock-Calendar with battery backup, featuring an easily replaceable Lithium battery and a quartz-controlled timebase for a high degree of accuracy.
5. An optional IBM-compatible Game Adapter port, for use with an IBM-type joystick. In conjunction with application programming, this game port may be used for cursor control, in generating graphics or for playing games at the end of your work day!
6. Every SixPak comes with an AST SuperPak utility diskette which includes SuperDrive and SuperSpool, the most powerful disk emulator and print spooler software you can get. These programs will greatly enhance the throughput of your PC or PC-XT by emulating disk drive and printer access at RAM speeds rather than the normal slower speed of mechanical devices. SuperPak is the first of such software to be compatible with both DOS 1.1 and DOS 2.0.

Most important of all, the SixPak comes with the AST "Plus," AST's unsurpassed reputation for quality, reliability, after-the-sale support, and overall design excellence that gives our products the best price/performance ratio in the industry! Hence the name, SixPakPlus!

AST products are available from Computerland, Entre', ComputerMart, and selected dealers worldwide. Call factory if your dealer does not have the AST products you want.

© IBM is the registered trademark of International Business Machines

AST
RESEARCH INC.

Circle 5 on inquiry card.

2121 Alton Avenue • Irvine, CA 92714
(714) 863-1333 • TLX 753699 ASTR UR

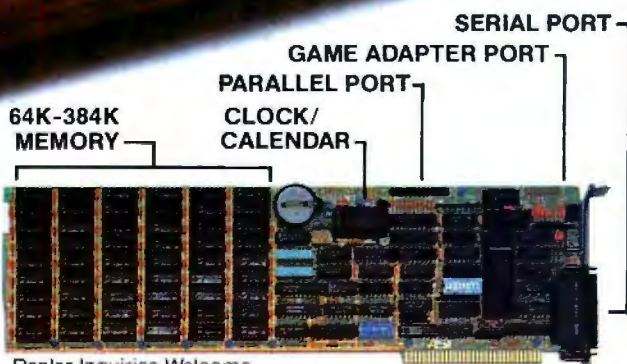

Dealer Inquiries Welcome

(text continued from page 24)

sion (assuming it's written for the IBM and its compatibles) has the potential to reach a larger audience. No longer do software houses and individuals have to create a myriad of different versions to capture just a small share of the market. The success of Lotus 1-2-3 is largely based on this one standard. Other firms and individuals who can't afford, in terms of time or money, to write software for all of the different machines in existence have the oppor-

tunity to write software with a better chance for returns. If this means that other, lesser "standards" such as CP/M-80 fall by the wayside, so be it. Consumers have already benefited significantly from the software that might not otherwise have been introduced.

Second, I do not see a decline even in the introduction of new, innovative hardware. Just because much of what's being introduced isn't as radically different as some might like does not mean that innovation has ceased. I like to

think of this time as a period of refinement, versus the last period of a hodgepodge of products, many with dubious quality. I think the area of printers is a fine example. Over the past five years the price of the letter-quality machines has declined markedly while quality and durability have increased. And what of disk drives, modems, and other peripherals? One finds the same situation as with printers.

Over the past three years we have seen the introduction of new and innovative machines. Look at Osborne, Kaypro, the Epson QX-10, the NEC and Tandy "lap" computers, Grid, etc. Surely, these machines qualify as new and innovative.

I believe that the de facto standard that IBM has established in the home-computer market is a good thing. Further, I do not believe that this has led to a decrease in innovation. If anything is responsible for any perceived slowdown in innovation, I would place the blame with the nature of the new technology itself. Gone are the days of computers made in garages. The technology of late is complex. Smaller firms cannot compete with many of the larger ones because of this complexity. One need only read the series of articles on the latest Apple, the Macintosh, in your February issue. If Jobs and Wozniak were starting now and had to compete with the likes of an Apple or an IBM in the home-computer market, their chances for success would be slim.

I remember a few short years ago when everyone was hollering for standardization. The market has done much in achieving this end. The fact that the composition of the businesses in the market is changing does not mean that innovation has died. If one is convinced that innovation is dead with respect to the manufacture of computers proper, look to the peripherals market, as here you will find an abundance of diverse firms producing a multitude of innovative products. The market is a mechanism that works. Entrepreneurial spirit is anything but dead in the computer industry. To "urge" funds to be spent differently, as you do in the aforementioned editorial, is a form of coercion no different from the urging done by Luddites (see your January editorial), albeit to different ends. The market has taken us this far already. As consumers, let us sit back and enjoy. We are the dictators of the market, not editors of magazines.

RAYMOND FRIGO
64 Hamilton Park West
London N5
England

I just received the February BYTE and I see that your magazine, along with several other computer magazines this month, is objecting to the IBM PC "compatibility craze" because it hinders innovation, stifles creativity, etc. I would like to point out that computer makers have compelling reasons for this behavior that seem to be ignored in all the editorials on this subject.

First, the phenomenal success of the IBM PC shows that it is exactly what a large number of computer buyers want. The market ultimately provides what the consumer demands. When

(text continued on page 30)

GET UP THE RAMP WITH OUR EE/EPROM PROGRAMMERS & UV ERASERS

Reliability
Affordability
Maintainability
Program



NOW AVAILABLE: PAL PROGRAMMERS (call)

GANGPRO-8™ MULTIPROGRAMMER \$995.00

GANGPRO-8™ allows user to program up to 8 EE/EPROMS simultaneously using the latest state of the art programming algorithms. It can test and duplicate a wide variety of devices from 16K to 256K. There are no personality modules to buy. 8 digit alphanumeric display prompts user with messages. This unit is extremely easy to operate and is ideally suited for a production environment.

QUV-T8™ series UV EPROM ERASERS

QUV-T8/2T (\$97.50) is an industrial quality eraser, designed in a steel enclosure with a 5" wide tray UV indicator lens, anistatic pad, 60 minute rugged timer and safety interlock switch. erases standard. Capacity is 24 EPROMS. 15-20 minutes erase time for 15 EPROMS.

QUV-T8 / Z (\$124.95) Similar to QUV-T8/2T (with 40% faster Erase Time).

QUV-T8/2N (\$66.95) Same as the QUV-T8/2T version without the timer and safety interlock switch.

QUV-T8/1 (\$49.95) Economy model in a molded two part plastic case. Erases 15 EPROMS in 15 minutes.

*MCS-48 is a registered trademark of Intel Co

PROMPRO-7™ SERIAL RS-232 STAND-ALONE \$489.00

MCS-48™ FAMILY PROGRAMMING WITH PROMPRO-7™ PROMPRO-7™ is an intelligent self-contained unit, ideally suited for engineering development, or for field service & production. It can program and verify a wide variety of 8K to 128K EPROMS. This unit has a 32K (4K BYTES) internal RAM buffer that could be accessed by the user through a computer or terminal. This unit can also program the micro chips such as the 8748, 8749, 8751, 8741, 8742, 8755. The price includes all modules up to 32K EPROMS & The 8748 & 8749H Micros Upload/download is done by either Motorola or Intel Hex format.

PROMPRO-8™ SERIAL RS-232 STAND-ALONE \$689.00

This extremely versatile programmer has as much as 128K (16Kx8) of internal RAM dedicated to the EE/EPROMS. This RAM buffer can be accessed either through a computer terminal, or by user target system (EPROM emulation). PROMPRO-8 8 digit alphanumeric display prompts user with the system messages. A keypad option is available for stand-alone editing. An impressive range of devices are programmed (as standard feature).

SEE US AT COMDEX
SPRING ATLANTA

ORDER TOLL FREE 1-800-EEL-PROM (331-7766)

AVAILABLE SOFTWARE DRIVERS

1. IBM PC 2. APPLE II 3. MDS-ISIS 4. CPM
5. TEKTRONICS 8002 6. COMMODORE 64 7. TRS-80 COLOR 8. FLEX

LOGICAL DEVICES, INC.

DEPT. 6, 1321-E N.W. 65th PLACE, FORT LAUDERDALE, FLORIDA 33309
INFO. TEL. (305) 974-0967
DISTRIBUTORS WELCOME FOR QUALIFICATIONS

LOGICAL

Last June,
we hatched.



**CBS
SOFTWARE**
Making you the best.

CBS Software A Unit of CBS Inc.

We've helped CBS fly,

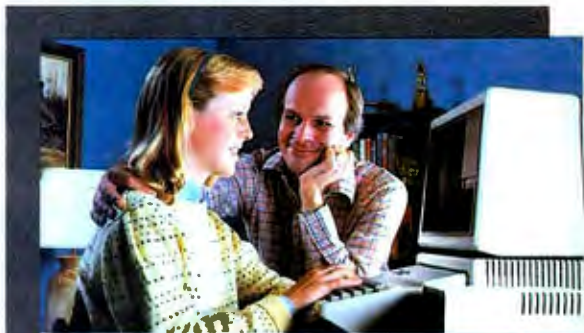

PLATO
The face of quality
educational courseware.



Plato is a registered trademark of Control Data Publishing

Plato® courseware educate,

Thoughtware.
Expanding The Universe Of Learning.



Thoughtware.

Thoughtware is a registered trademark of the Institute for Management Improvement

and Thoughtware® expand
the universe of learning.

If you don't know us, you probably should.

The world's leading producers of quality software trust their software duplication to us. We're Allenbach Industries. We created the diskette duplication industry. So it is no surprise that the most respected names in software turn to us for their duplicating needs. We understand that your reputation lives or dies with every package sold. So does ours. That's why every step of the duplication process — from copy protection to labeling to package design and assembly — is supported by a complete staff of professionals. When your product leaves our facility, whether it be a duplicated diskette or the entire market-ready package, it's ready for your name.

Give us a call at (800) 854-1515* and discover how we can help you fly.

*In California, call collect (619) 438-2258.

ALLENBACH
INDUSTRIES, INC.

2101 Las Palmas Drive • Carlsbad, California 92008 • 619-438-2258 • 800-854-1515
We Set the Standard in Software Duplication

Circle 19 on inquiry card.

© 1984 Allenbach Industries, Inc.

We wrote the book on portability. In nine different languages.

	8080/8085/280 CP/M MP/M II	8086/8088/8186 CP/M-86 Concurrent CP/M™	8086/8088 IBM PC DOS	8086/8088 MS DOS	MC-68000 CP/M-68K
FORTRAN-77		✓	✓	✓	TBA
C BASIC Compiler	✓	✓	✓	✓	✓
Pascal/MT+	✓	✓	✓	✓	✓
Level II COBOL		✓	✓	✓	TBA
PL/I	✓	✓	✓	✓	TBA
C		✓	✓	✓	✓
Assembler Plus Tools	✓	✓	✓	✓	TBA
Access Manager	✓	✓	✓	✓	TBA
Display Manager	✓	✓	✓	✓	TBA
micro/SPF		✓	✓	✓	✓
COBOL Animator	✓	✓	✓	✓	TBA
Personal BASIC		✓	✓	✓	TBA
Dr. Logo		✓	TBA		



To every software developer who'd written off portability as an impossible dream, Digital Research humbly announces a few monumental breakthroughs.

We not only offer languages that are portable from 8 to 16 to the 32-bit chips of the future, they're portable across all popular operating systems, too. What's more, we supply the broadest range of quality languages and development tools available today. And will tomorrow.

So rest assured. Whether you design applications at a major corporation, plan to become a major corporation or just qualify as a hobbyist, you only have to write it once.

Simply pick the Digital Research language that's right for you. From Personal BASIC™ to Digital Research FORTRAN-77™. The newest member of our remarkable family.

To complement languages, we offer a complete workshop of development tools. Our Display Manager™ and Access Manager™ simplify the design of screen displays and data bases. So you spend less time and effort.

If you write in COBOL, our Animator™ source level debugger will get your software running in record time.

And for programmers skilled with IBM mainframe SPF, we offer micro/SPF™. An editor that helps turn your invaluable experience into valuable new software applications.

At Digital Research, we work as hard for you after the sale as we do to get the sale. With backup like quality documentation, software updates and a phone line to our technical support team.

With so much productivity and service to draw on, it's small wonder IBM chose our languages for its IBM® PC, XT and the new IBM 3270/PC.

For more information, call your IBM representative.

Or, for the Digital Research retailer nearest you, call 800-227-1617, ext. 400. In California, 800-772-3545, ext. 400.

micro/SPF is a trademark of Phaser Systems, Inc. Animator and Level II COBOL are trademarks of Micro Focus. IBM is a registered trademark of International Business Machines Corporation. The Digital Research logo and products are either trademarks or registered trademarks of Digital Research Inc. © 1984 Digital Research Inc. All rights reserved.



There's a better way to pack more muscle in your micro.



The HarDrive™ by QuCeS. More bytes for your buck. In a flash.

If you're looking for a way to get more performance out of your microcomputer, look no further than QuCeS.

With a QuCeS HarDrive subsystem, you can make your micro behave almost like a mainframe. 10 to 114 megabytes of mass storage lets you handle data bases that would make the normal micro blow a fuse. And you can access, update and process data so incredibly fast, you won't believe your eyes. A QuCeS HarDrive with an optional 5 megabyte backup cartridge, also means you won't have to rely on a very unreliable storage medium for your crucial data—namely floppy disks—ever again.

Another QuCeS plus is compatibility. It interfaces with most popular microcomputers like IBM, Radio Shack, Apple, DEC, Epson—you name it. Installation couldn't be easier, our software is easy to use, and each HarDrive is backed by a 1-year warranty.

The QuCeS HarDrive. It will make your micro mightier and faster than ever before.



For complete details, contact

Quality Computer Services



3 Quces Drive, Metuchen, N.J. 08840 (201) 548-2135
TELEX 299410 QCS

LETTERS

(text continued from page 26)

innovation is required (by the user) it will be forthcoming.

Second, today's "innovation" is tomorrow's "for sale" item when the newness has worn off and something more advanced comes along. A de facto standard like the IBM PC provides stability in the marketplace and allows the computer purchased today to retain its value—both monetarily and functionally—for a longer time.

Third, a new computer, no matter how advanced, cannot succeed if there is no software to run on it. What software manufacturer (except the very largest) can afford to modify its products every time a new innovation comes along? Small companies could not possibly afford to provide versions for every kind of computer. A proliferation of incompatible hardware clearly would inhibit the innovative small software manufacturer.

HERBERT R. SOROCK
2241 Thornwood Ave.
Wilmette, IL 60091

THANKS AGAIN

Please express my appreciation to E. Hart Rasmussen on the quality of his article entitled "Queue Simulation" (March, page 157).

I teach a class called "Port and Harbor Facilities Planning" at Oregon State University in which queuing applications relative to ship movements are discussed. Accordingly, I have called Mr. Rasmussen's article to the attention of students and staff interested in queuing applications.

Thanks again for a most informative article and for including an adaptable program on queuing.

LARRY S. SLOTTA, PH.D., P.E.
Slotta Engineering Associates, Inc.
570 Northwest Van Buren St.
POB 1376
Corvallis, OR 97339

A REVIEWER REPLIES

I just read the letter from David Colver (March, page 15) regarding my review of what HP now calls the HP9000 Series 200 Model 16. I feel compelled to reply to some of his statements.

Mr. Colver complains that my review of HP BASIC was inadequate, feeling that a game program is trivial as an example. He also said that I ignored file I/O and the subroutine and function features.

I stated in the review that I was not a fan of BASIC, making my prejudice clear. This was stated more strongly in my original manuscript, but it was made less prominent in the editing process. (This is not a complaint—my rant against BASIC was a bit excessive for a review of this nature.) My main purpose in using the game program was to illustrate the use of the knob, the user-programmable softkeys, and the graphics. The program in fact has four subroutines. I plead guilty to ignoring file I/O. I tried it, it worked, and I didn't feel the need

(text continued on page 33)

The best ... for peanuts!

Get the most computing power from your IBM/PC Jr. with these exciting Amdek monitors.

The COLOR-I accepts composite video input for complete compatibility ... and it has a built-in speaker and quality resolution. It's the most popular color monitor in the entire world!

The VIDEO-300 with amber or green screen provides 80 column text or graphics display capability ... and its nylon mesh, non-glare screen eliminates distracting reflections.

Both monitors are backed with the best warranty in the business (2 years!) ... and you won't have to shell out a lot of money to own one.

2201 Lively Blvd • Elk Grove Village, IL 60007
(312) 364-1180 • Tlx 25-4786

REGIONAL OFFICES: Southern Calif. (714) 662-3949 • Texas (817) 478-2334
Northern Calif. (408) 370-9370 • Denver (303) 754-1471

AMDEK



Your computer's telephone.

Hayes



What are the adverse effects of this compound?



Gary: The pedigrees for next week's auction are as follows...



Sold 1000 shares at 33 for net profit of 6000, Richard.

Wouldn't it be great if you could use your IBM* PC to tap into vast resource libraries across the country? To transfer files to your partner, upstate? Or from your broker, down the street?

It's possible. All you need is a modem, to connect your computer to others. Down the hall. Or thousands of miles away.



Hayes Smartmodem. Think of it as your computer's telephone. Hayes Smartmodem 300™ and the faster Smartmodem 1200™ allow you to communicate over ordinary phone lines.

But any modem will send and receive data. Hayes Smartmodems

also dial, answer and disconnect calls. Automatically. And without going through the telephone receiver, making them far superior to acoustic coupler modems.

Choose your speed; choose your price. The lower-priced Smartmodem 300 is ideal for local data swaps and communicates at 300 bps. For longer distance and larger volumes, Smartmodem 1200 operates at baud rates of 300 or 1200, with a built-in selector that automatically detects transmission speeds.

Both work with rotary dials, Touch-Tone® and key-set systems; connect to most time-sharing systems; and feature an audio speaker.

Smartmodem 1200B™ is also available as a plug-in board. Developed specifically for the PC, it comes packaged with Hayes' own communications software, Smartcom II.™

Smartcom II. We spent a lot of time developing it, so you can spend less time using it. Smartcom II prompts you in the

simple steps required to create, send, receive, display, list, name and re-name files. It even receives data completely unattended—especially helpful when you're sending work from home to the office, or vice versa.

If you need it, there's always "help." This feature explains prompts, messages, etc. to make communicating extra easy.

With Smartcom II, it is. Case in point. Before you communicate with another system, you need to "set up" your computer to match the way the remote system transmits data. With Smartcom II, you do this only once. After that, parameters for 25 different remote systems are stored in a directory on Smartcom II.

Calling or answering a system listed in the directory requires just a few quick keystrokes.

You can store lengthy log-on sequences the same way. Press one key, and Smartcom II automatically connects you to a utility or information service.



Smartmodem 300, 1200, and 1200B are FCC approved in the U.S. and DOC approved in Canada.

Smartmodem 1200B. (Includes telephone cable. No serial card or separate power source is needed.)



Smartcom II communications software.

NOTE: Smartmodem 1200B may also be installed in the IBM Personal Computer XT or the Expansion Unit. In those units, another board installed in the slot to the immediate right of the Smartmodem 1200B may not clear the modem; also, the brackets may not fit properly. If this occurs, the slot to the right of the modem should be left empty.

And, in addition to the IBM PC, Smartcom II is also available for the IBM Personal Computer XT, COMPAQ Portable, Corona Portable PC, Columbia MPC, DEC Rainbow 100, Xerox 820-II, and Kaypro II personal computers*

Backed by the experience and reputation of Hayes. A solid leader in the microcomputer industry, Hayes provides excellent documentation for all products. A limited two-year warranty on all hardware. And full support from us to your dealer.

So see him today. Break out of isolation. Get a telephone for your Personal Computer. From Hayes.

Hayes Microcomputer Products, Inc., 5923 Peachtree Industrial Blvd., Norcross, GA 30092. 404/441-1617.

Smartmodem 300, Smartmodem 1200, Smartmodem 1200B and Smartcom II are trademarks of Hayes Microcomputer Products, Inc. *Trademarks of International Business Machines Corporation, Compaq Computer Corporation, Corona Data Systems, Columbia Data Products, Inc., Digital Equipment Corporation, Xerox Corporation, and Kaypro Corporation. Touch-Tone is a registered service mark of American Telephone and Telegraph. ©1984 Hayes Microcomputer Products, Inc.

Circle 153 on Inquiry card.

LETTERS

(text continued from page 30)

to test it further because there was so much other stuff to test.

Mr. Colver also complains about my treatment of HP Pascal, saying that I ignored the elegant features of modules borrowed from Modula-2 in favor of picking on the bleeper. The point of the bleeper raillery was to illustrate the rigmarole needed to access the simplest hardware functions and the lack of attention to detail I found in the Pascal package. Yes, the module feature is neat and elegant, but it renders programs that use it incompatible with either the ISO Pascal standard or Modula-2. Further, this feature was not borrowed from Modula-2 at all, but from MODCAL. HP's proprietary version of a hybrid (that's the nice word) between Pascal and Modula-2. (MODCAL was the implementation language of the Pascal system).

I still liked the machine. I think my impressions were summed up well in the March editorial ("Where BYTE Is Going," page 4), but a further problem I found was the alleged compatibility with the other members of the Series 200 family. *Almost compatible* is often more frustrating than *incompatible*.

BERRY KERCHEVAL
Zehntel Inc.
2625 Shadelands Dr.
Walnut Creek, CA 94598

because they are either slow or incorrect.

Unless magazines such as BYTE encourage software vendors such as Lotus and Microsoft to centralize their software screen and keyboard handlers to go through overlay or device driver files (if done correctly, only one subroutine call overhead in performance), only clones will succeed. BYTE also could encourage reviewers not to grade machines solely on IBM compatibility. Some machines have implemented the communications interrupts correctly, it's just that nobody uses them and the software authors have made no provisions for supporting MS-DOS. If it's true that operating system compatibility is dead, then hardware is where it's at. And if that's true, we have taken a giant step backward and some of the responsibility lies with magazines such as BYTE.

AVRAM TETESKY
555 Tech Sq. MS 92
Cambridge, MA 02139

SIMPLE INNOVATIONS

Your editorial call for innovation in the February issue ("The Compatibility Craze" by Lawrence J. Curran, page 4) was well placed. Three articles in the same issue deal with useful, fairly simple enhancements that vendors could add to new or even existing microcomputer designs:

- "A Low-Cost, Low-Write Voltage EEPROM" by Joe D. Blagg, page 343, explained how to add circuitry to allow the in-memory reprogramming of EEPROMS.
- "Foot Control" by Dennis M. Pfister (page 346) shows how to add sockets to the keyboard to allow the attachment of foot switches to activate the Control key, Escape key, etc. The user could even activate both keys, using two such switches, one for each foot. This would eliminate most double key-stroke operations, and give microcomputers most of the convenience of dedicated word processors. Hopefully, some computer stores will offer to retrofit keyboards with such sockets and sell foot switches to go with them.
- More ambitiously, vendors might offer a built-in, software-selectable 132-column by 48-line display option (as described in "The Videx Ultraterm" by Peter V. Callamaras, page 310). Such a display truly expands the user's horizons.

ROGER KNIGHTS
5446 45 Ave. SW
Seattle, WA 98136

MAC FLAK

Although I can understand your enthusiasm for the technical "bells and whistles" on the Macintosh ("The Apple Macintosh Computer" by Gregg Williams, February, page 30), I must say that as a practical productivity tool for business, it is abysmal. It is slow going from one function to another, text editing with the mouse is inefficient and cumbersome (try deleting or adding a single character—it's difficult to know exactly where the pointer is pointing), and its one strong point—the graphics free-form capability and creative fonts—is of limited value in a serious business environment. In short, it's a delightful, expensive, toy computer for those who have been afraid of trying computers. It is not a productivity aid.

SUSAN GOLD
POB 6095
Santa Fe, NM 87502

FIGHTING CITY HALL

Your editorial comment "that IBM's burgeoning influence in the PC community is stifling innovation because so many other companies are simply mimicking Big Blue" ("The Compatibility Craze," February, page 4) is too little too late. How can a company dare to introduce a better machine when Microsoft's Word runs only on IBM PC hardware (no graphics/keyboard device drivers or overlays). (Perhaps for a sizable fee, Microsoft will create a special version for MS-DOS.) And what about the glitches with INT 14 for servicing the RS-232C or the hardware problems in the 8150 UART? Very few software packages go through MS-DOS or PC-DOS RAMs

COMPARING COMPILERS

I found Kaare Christian's "Inside a Compiler: Notes on Optimization and Code Generation" (February, page 349) most intriguing, and I rushed to my IBM PC to see what kind of optimized code Microsoft's 3.13 Pascal compiler produces for the Sieve of Eratosthenes. [For more information see "Eratosthenes Revisited: Once More through the Sieve" by Jim Gilbreath (text continued on page 34)]

(text continued from page 33)

and Gary Gilbreath, January 1983, page 283.] Eagerly comparing my .COD listing to the DRI and Intel listings, I saw a close correlation between Microsoft's and Intel's optimization strategies.

My summary: Where Intel dedicates CX and AX to somewhat specific functions, Microsoft seems to use AX generally. This results in five instructions (that the Intel code did not require) to load AX with the desired values. In one case, Microsoft saves an instruction, adding directly to the count in memory whereas Intel adds to and then stores AX. The bottom line is that Intel produces a tighter, faster Sieve, but not by much.

Because I use MS-DOS and do not have access to iRMX/86, I was pleased to see how well Microsoft Pascal optimizes. Although some may be bothered by the fact that the Microsoft .COD file is just a memo listing and not an assembly-language source that can be modified, this suits me just fine. Code that is not tinkered with is one less picket in the fence to come loose—or one less to be hammered up in the first place. The fact that the compiler does such a good job of optimizing is key to my happiness.

As Christian points out, the use of COD lists is most helpful in analyzing alternative coding tactics. In one case, a piece of my Pascal source

code looked redundant because a variable expression was explicitly stated in two consecutive lines. When I compiled this alongside an alternative that precomputed the expression, I discovered that the compiler carried the results of the expression evaluation to the second line, doing automatically, and in less code, what I attempted to achieve in my alternative.

As a final note, Christian's discussion of ways to beat the FOR loop control was most instructive. Microsoft, by the way, exhibits the same weakness that Intel does.

CHET FLOYD
664 18th St.

Manhattan Beach, CA 90266

STILL MORE ON THE MODEL 16

I have read with interest the correspondence regarding the performance of the TRS-80 Model 16 under XENIX (Letters, October 1983, page 20; December 1983, page 20; and February 1984, page 24). In one sense Radio Shack is not to blame for the slow response under MBASIC or Multiplan because the use of floating-point arithmetic in both these products appears to substantially downgrade the potential.

We have been using the Model 16 for almost

a year with both MBASIC and Multiplan and have found it surprising that with these products the performance was not impressive but that the system commands (written in C) suggest that the machine had all the power we wanted.

More recently we benchmarked the system in C. For a simple processing loop we found that even with floating-point arithmetic, C will perform the operation around 15 times faster than interpretive MBASIC, but if integer arithmetic is used, the speedup becomes a factor of around 90 times.

The message is clear. Floating-point arithmetic on the Model 16 is the main cause of poor performance.

Given the speedup provided by software written in C, there seems little doubt that, in terms of processing, the Model 16 is more than adequate to deal with the number of users that Radio Shack says can be supported. I would be interested to learn from your readers whether there are any hardware solutions I could use to overcome the floating-point arithmetic problem.

D. O. ROWE
109 King Charles Rd.
Surbiton,
Surrey,
England ■

**UNIX
TIMESHARE+**

***UNIX System III POWER and sophistication are yours.
Let THE SOLUTION turn your micro into all you
dreamed it could be, bringing the Ultimate
programming environment as close as
your modem. Just a local call
from over 300 cities
nationwide via Telenet.**

THE SOLUTION™

- Expansive Software development facilities.
- Berkeley and local enhancements.
- Complete online Unix manuals.
- Extensive Text formatting capability.
- Communication with over 500 UNIX sites on over 150 subjects.
- Interuser mail.
- Online discount shopping for Hardware/Software.
- LOW COST and FAST response time.
- \$24.95 = 1 hr. free system time + SOLUTION Newsletter subscription + BYTE BOOK (Introducing The Unix System 556 pp.)

Korsmeyer
ELECTRONIC DESIGN, INC.

*UNIX is a trademark of Bell Labs.

5701 Prescott Avenue
Lincoln, NE 68506-5155
402/483-2238
10a-7p Central

VISA MasterCard
Payment via VISA or Master Card

EQUATIONS PROCESSED NO PENCIL. NO PAPER. NO MANUAL LABOR.

The TK!Solver® program will take on your toughest problems—linear, quadratic, simultaneous equations, whatever. Then stand back. Because TK!Solver turns your personal computer into a simple, yet powerful, desktop equation processor.

Whether your problem is a simple formula or a model consisting of many equations, TK!Solver can help improve your productivity. Once the equations are written, enter the known values, press the ! key, and TK!Solver gives you the answer.

Engineers, scientists, architects, financial analysts and planners, educators, researchers, and other professionals who use equations and mathematical models can work more creatively with TK!Solver.

TK!SOLVER GIVES YOU: BACKSOLVING

If the programs you use now require you to rewrite the same equation to solve for different unknowns, TK!Solver can dramatically improve your productivity. Enter your problem once and then solve for the unknowns no matter where they are in your equation.

ITERATIVE SOLVING

If TK!Solver can't solve an equation directly, take an educated guess at the answer. Type the ! key and the TK!Solver program starts with your guess and performs repeated approximations to converge on the answer.

LIST SOLVING

Given a list of input values, TK!Solver automatically calculates the equation for every value in



your list. For example, if you want to know how different interest rates will affect monthly loan payments, enter a list of interest rates and let TK!Solver calculate the payment amount for each value.

UNIT CONVERSIONS

Any type of unit conversion—Fahrenheit to Celsius, meters to feet, dollars to deutschemarks, newtons to dynes—can be made without altering your equations. Just define the numerical relationship between two units of measurement and the TK!Solver program automatically converts the variable value to the unit you specify.

TABLES AND PLOTS

Quickly generate tables and plots of your results on your screen or printer.

AVAILABLE NOW

You can run the TK!Solver program on the IBM® PC and XT and compatible machines, the Digital™ Professional™ 350, the Digital™ Rainbow™ 100, the Wang Professional Computer, Apple® IIe, and on the following personal computers using MS™-DOS: TI Professional Computer, GRiD Compass Computer,™ Canon AS-100, Eagle® 1600, Toshiba T300, and the Zenith Z-100.™

SEE IT TODAY

There's more. Lot's more. But you'll have to see it to believe it. And that's easy. Bring your own equations into your nearest computer retailer and ask to see the TK!Solver program in action. The world's first equation processor for personal computers.

TK!Solver®
By Software Arts,™ creators of VisiCalc®
27 Mica Lane, Wellesley, Massachusetts 02181 617-237-4000

Copyright © 1984 Software Arts, Inc. All rights reserved.

HOW
TO RUN
THE
WORLD.

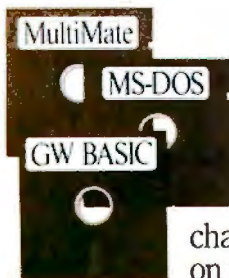
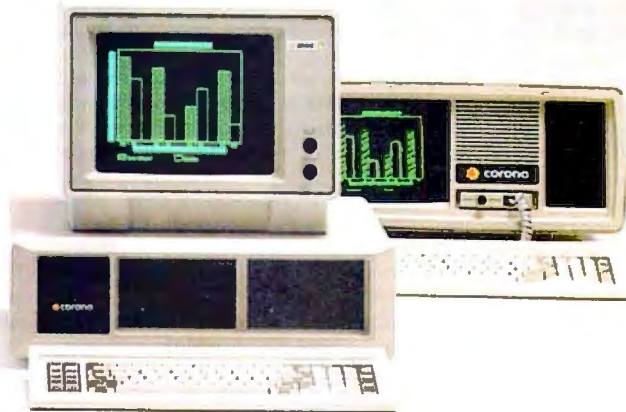

Without software you're nowhere.

That's why the Corona PC runs virtually everything. Word Star!¹ dBASE II!² Lotus 1-2-3^{3*}. Thousands of packages in all. But we didn't stop there.

We give you 60% better graphics than IBM® (640x325 pixels). So your pie charts look tastier. We doubled the memory: 128K memory expandable to 512K on the main board. For power that won't quit. And we bundle software. For instant productivity right out of the box. All at a price about 20% less than IBM's.

The Corona PC. Once you can run the world, running your business looks easy. In North America, call 1-800-621-6746 for the Authorized Corona Dealer near you. In Holland, call 020-03240-18111. There are over 1600 dealers worldwide. And their job is to help. Service by Xerox.



THE CORONA PC

©Corona Data Systems 1984. 1. TM Micropro Corp. 2. TM Ashton-Tate. 3. TM Lotus Development Corp. *HTS driver needed for graphics only.

Circle 89 on inquiry card.

DEVELOPMENTS

More on the Tandy TRS-80 Model 2000

In our Product Description of the Tandy Model 2000 (March, page 306) Rich Malloy mentioned that a numeric coprocessor chip may be offered as an option at some future date. The chip he suggested was the Intel 80187. We have since learned that the motherboard for the Tandy 2000 does not have a socket for a numeric coprocessor chip and that such an option will most likely be offered as part of an add-on board for one of the expansion slots.

We have also learned that Intel has decided not to market an 80187 coprocessor chip to work with the 80186 microprocessor. According to Rick Schue, a Regional Applications Specialist at Intel's Dayton, Ohio, sales office, Intel instead will make available an integrated bus-controller chip called the 82188. This chip will allow the 80186 processor to work with the 8087 numeric coprocessor, which is readily available. The new bus controller will also permit the 8086 family of processors to work with two other coprocessors: the 82586, a local-area-network coprocessor, and the 82730, a text coprocessor that will simplify such things as proportional spacing and superscripts.

Sweet Talker II

If you're interested in buying the SSI263 speech-synthesizer chip described in the March Circuit Cellar project, "Build a Third-Generation Phonetic Speech Synthesizer" (page 28), it's available from CCI, Box 428, Tolland, CT 06084, (203) 875-5795, for \$65 plus \$2 shipping (includes the Apple algorithm and data sheets).

You also can buy the assembled and tested Sweet Talker II speech-synthesizer board. This board comes with the SSI263, demonstration software, a user's manual, and a text-to-speech algorithm on a DOS 3.3-formatted floppy disk. It costs \$100 plus shipping, from The Micromint Inc., 561 Willow Ave., Cedarhurst, NY 11516; to order toll-free, call (800) 645-3479. For information only, call (516) 374-6793.

If you decide to build the board yourself, be aware of an error in figure 2 (page 32). IC1 pin 22 should connect with the Apple Bus pin 38.

Product News

Santa Clara Systems recently announced that increased outlays for components have forced the company to raise the price of its PCterminal to \$1595. The PCterminal is an IBM PC-compatible computer with a built-in local-area network. It can function as an intelligent terminal in a PCNet network. The original price was \$1295.

- The Word Processor—Professional Version has undergone a number of changes according to its Fresno-based publisher, Mirage Concepts. Primarily, its price has dropped to \$89.95 from \$99.95. Also, a spelling checker has been added, and its print and loading capabilities have been streamlined.

- 3Com Corporation has reduced the cost of its Etherlink interface and software to \$795, a 16 percent reduction. In addition, EtherShare software now supports a single IBM PC as both a network server and workstation; previously, a dedicated server was required. A new chip, called EtherStart, which allows the IBM PC to function on the network without local drives or controllers, was also announced by the Mountain View, California, communications company.

- From Solana Beach, California, we learn that Kaypro Corporation has dropped the price of the Kaypro 2 to \$1295. The company hopes this move will encourage more people to try its popular computer.

- Novation has announced across-the-board price reductions of its Apple-Cat II communications line. Cutbacks range from \$40 off the Apple-Cat II 1200-bps modem upgrade (now \$349) to a \$130 price cut for the 300/1200-bps 212 modem, which now lists for \$595. Novation, headquartered in Chatsworth, California, is also trying to induce consumers by offering a free CompuServe demonstration pack with their purchase.

- Staff Technology Corporation, Del Mar, California, has lowered the price of the serial version of The Key to \$210 (1 to 99 units). The Key is a hardware module that protects software from unauthorized use.

- Lotus will no longer market a version of 1-2-3 for the Victor 9000 computer. Jim Manzi, vice-president of sales and marketing for the Cambridge, Massachusetts, software developer, cited Victor Technologies' recent financial woes as reason for the decision. Lotus will continue to support all Victor users who have purchased 1-2-3.

Info Interchange Standards

The American National Standards Institute (ANSI) has been working on a set of standards and formats to facilitate the electronic interchange of business information. When fully implemented, the new procedures should eliminate such paper exchanges as purchase orders and invoices for companies desiring the greater speed and efficiency of electronic communications.

A free report discussing these standards is now available. Single copies can be obtained from X12 Secretariat, TDCC, 1101 17th St. NW, Washington, DC 20036, (202) 293-5514.

FEEDBACK

Benchmarks and Age

Mike Forman, employed with Hewlett-Packard's Systems Division in Fort Collins, Colorado, wrote us in defense of the HP 9845A computer, which he felt was slighted in Jeffrey Star's article "Favorite Benchmarks" (February, page 436). While running his CBASIC benchmarks, Mr. Star noticed that the \$30,000 HP computer was "not suited for plain number-crunching because of its BASIC-in-ROM interpreter" and that it was "faster than the \$5000 IMS5000's pseudo-interpretive CBASIC (version 2) but slower when compared with compiler Microsoft FORTRAN-80."

Mr. Star attributed the slow response to the fact that CBASIC and CB-80 use double-precision real mathematics. Mr. Forman points out that the HP 9845 employed quad-precision mathematics.

"The crux of the matter," says Forman, "is that comparing an older product against current competition will always give a false indication of the price/performance ratio. Newer products cost less for a given performance level."

He then ran Mr. Star's benchmark on an HP 9000 Model 216, which costs approximately \$5000 with BASIC. The benchmark was run in interpretive, interactive BASIC, using quad-precision (i.e., 64-bit numbers); integers were not used for loop counters. Table 1 on page 40 shows the results.

In summary, Mr. Forman reminds us that benchmarks can be misleading. "One must be aware of the intended application before selecting a benchmark. Just because a language is interpreted doesn't mean that the machine is slow. Conversely, a compiled language doesn't assure speed."

Technical Point Clarified

Katherine Hammer, Texas Instruments' section manager/natural-language branch, dropped us a line to express her satisfaction with Mark Haas's article on TI's NaturalLink to the Dow Jones News/Retrieval service (January, page 324) and to clarify a technical misunderstanding that cropped up in the article.

The point in question was Mr. Haas's suggestion that NaturalLink's "Build Questions" option is table-driven. "Such a deduction," explains Ms. Hammer, "is understandable since the syntactic simplicity of the command language for Dow Jones News/Retrieval would lend itself to such an approach. Nevertheless, the actual software underlying [NaturalLink's] component . . . is a general-purpose parser/translator capable of handling a large portion of the structures that
(text continued on page 40)

Our Family Tree Is Growing Again

SBC-II A two user multiprocessing S-100 slave complete with a Z-80 CPU (4 or 6 MHz), 2 serial ports, 64K RAM, and 2K FIFO buffer for each user! A cost effective way to add users to your multiprocessing system.

HD/CTC A hard disk and cartridge tape controller combined together on one board! A Z-80 CPU (4 or 6 MHz); 16K ROM, and up to 8K RAM provide intelligence required to relieve disk I/O burden from host system CPU. Round out your multi-processing system with an integrated mass storage/backup controller.

Systemmaster*
The ultimate one board computer; use it as a complete single-user system or as the "master" in a multi-processing network environment. Complete with Z-80A CPU, 2 serial and

SBC-1 A multiprocessing slave board computer with Z-80 CPU (4 or 6 MHz), 2 serial ports, 2 parallel ports, and up to 128K RAM. Provides unique 2K FIFO buffering for system block data transfers. When used with TurboDOS or MDZ/OS the results are phenomenal!

2 parallel ports, floppy controller, DMA, real time clock, RAM drive disk emulation package, and Teletek's advanced CP/M BIOS or TurboDOS.

4600 Pell Drive Sacramento, CA 95838 (916) 920-4600 Telex #4991834 Answer back -Teletek

TELETEK

(text continued from page 38)

Table 1: The results obtained by Mr. Forman after a 40-run loop of the benchmark program described in "Favorite Benchmarks." All the results, except for those listed for the HP 216, appeared in Jeffrey Star's February article.

Time (seconds)	IMS 5000				
	HP Model 216	HP9845	CBASIC	FORTRAN-80	CB-80
	16	74	443	44	285

occur in natural language. Consequently, this software can be used to provide a similar kind of interface to any number of underlying systems."

Our thanks to Ms. Hammer for clearing up this issue.

MISCELLANEA

Library Templates Sought

Microcomputer Libraries would like to hear from librarians willing to share general-purpose software templates that they might have developed. Any librarians desiring to use the templates or contribute to the group's collection are encouraged to write Microcomputer Libraries, 145 Marcia Dr., Freeport, IL 61032.

Computer Science Programs to Share

The ECN, an educational forum promoting the interchange of ideas and applications, has a number of computer-science programs to share with educators. In all, 15 programs can be obtained for the price of the disk and postage. The programs are designed for the Apple II+ and IIe and include BASIC, machine-language, and DOS tutorials. For information, send a self-addressed stamped envelope to Educational Computing Network, POB 8236-CS, Riverside, CA 92515.

Address Update

LDH Computing, publisher of the Tutor-PC/ Graphics program, which was recently men-

tioned in BYTE, has moved. The new address is 1496 North Morningside Dr. NE, Atlanta, GA 30306, (404) 885-9735; Source account: TCD257; CompuServe account: 70270.140.

Music for Your Ears

PC Musician, a free musical-composition program for the IBM PC, lets you create and edit music on screen as well as store, retrieve, and play back your creations. PC Musician requires 64K bytes of memory, a single disk drive, PC-DOS, and a monochrome or color-graphics adapter. A donation is requested if you find the program useful or enjoyable. Send a formatted disk and a postage-paid mailer to Christopher Wiley, POB 111, VAMC, Prescott, AZ 86313.

\$10,000 Scholarship to be Awarded for Best Program

Software City has announced that it will award a \$10,000 college scholarship to the student who produces the most marketable computer program. In addition, four runner-ups will receive \$1000 scholarships. Eligible programs must be formatted to run on Adam, Apple II/IIe, Atari, Commodore 64, or IBM Personal Computers. Other formats may be announced, and

(text continued on page 44)

ALF COPY SERVICE

1315F Nelson Street Denver, CO 80215 (303) 234-0871

FAST • RELIABLE • LOW COST

If you produce software, ALF's disk copying service is the quick, convenient answer to your duplication needs. Most orders are shipped in less than a week. Every disk we copy is verified bit by bit and guaranteed 100% flawless.

We can copy virtually any soft-sectored mini format. Standard formats: Apple II (including nibble-copy proof, double-boot, and fast load), Apple III, Atari, IBM PC, Kaypro, NEC PC8000, Osborne, TRS-80 I and III, Zenith Z-90 and Z-100, and more. Copy protection is available for most formats.

Our "no frills" pricing means you don't have to buy extras you don't need—set-up charges start at \$10, and copying charges are 30¢ to 40¢ per side. (See blank disk prices at right. Minimum: 50 copies.) Quantity discounts available for large orders.

Of course, we have the frills too: label application, 3-hole vinyl pages, printing of labels and sleeves, shrink packaging, heat sealing, and much more. We can put your product in a customized package—vinyl folder or IBM-style binder/slip case—for a low price in small or large quantities.

ALF is one of the oldest and most trusted names in the duplication business. ALF designs and manufactures copying machines that other copying services and software publishers around the world rely on every day. Our complete understanding of duplication technology assures you of the finest reproduction available.

We're eager to solve your duplication and packaging problems—whether you want one service or a total package. Give us a call today!

BLANK DISKS

ALF buys large quantities of disks for our disk copying service — and we can pass our savings on to you. If you're buying hundreds of disks, ALF is your ideal source for top quality disks at a reasonable price. We buy our disks in bulk packages, avoiding the expense of fancy printing and labeling.

The disks listed below are 5 1/4", soft sector, double density, unlabeled, with hub reinforcement ring. Other disks are available, call for details.

SINGLE SIDED

MEMOREX \$160 per 100
NASHUA \$160 per 100
VERBATIM \$160 per 100

DOUBLE SIDED

MEMOREX \$185 per 100
VERBATIM \$195 per 100

OTHER BRANDS AVAILABLE.

Without sleeves: add \$2.50 shipping per 100.

With tyvek sleeves: add \$7 plus \$2.50 shipping per 100.

Packed in boxes of 10 with tyvek sleeves: add \$15 plus \$3.00 shipping per 100.

**One word
from us
could solve
your PC
service
problems.**

AMERICARE

We've noticed that some words cause PC owners extreme anxiety. Words like "The disk drive blew..." "The data won't come up on the screen..." and "The printer won't print."



Service for a variety of systems.

Well, the next time words like that are echoing in your ears, just ask

for Americare service from Xerox.
Unlike a lot of manufacturers and deal-

ers, we don't restrict our repair service to one select brand. Instead, we service 22 of them, including 82 different models. From IBM PCs to Quadram boards. And from Amdek monitors to Okidata printers.



Repairs in 48 hours or less.

Our technicians undergo intensive training on the equipment we service. In fact, they probably know as much about servicing it as the people who made it.

And they work fast, so in most cases they can have your PC up and running

XEROX® and Americare™ are trademarks of XEROX CORPORATION.
IBM PC® and the IBM logo are registered trademarks of International Business Machines Corporation.
Quadram® is a registered trademark of Quadram Corporation.

ICARE™

again in 48 hours or less.

Of course, you can't get it back fast if the parts aren't available. Which is why we're downright obsessive about keeping our parts department well stocked.

Americare has Xerox Service Centers that provide you with a nationwide support system. And to

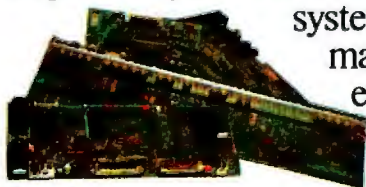

Well stocked parts departments.

make service even easier, you can reach us through our network of over 3,000 authorized computer dealers.



A nationwide support system.

In addition, we offer a choice of on-site, depot or pick-up and delivery service. Year-long service contracts or time and materials service agreements are available.

So call 800-238-2300 for the Americare dealer nearest you.

AMERICARE™

PC repair beyond compare from Xerox

It's the first thing to do when you're looking for the last word in service.

(text continued from page 40)

applications for other computers will be considered on a case-by-case basis. Applications will be judged in one of five categories: business, home, recreation, and system software. Applicants must have graduated high school after January 1, 1984.

All entries must be received by December 31, 1984. For complete information and scholarship application, contact Software City Corporate Headquarters, 1415 Queen Anne Rd., Teaneck, NJ 07666, Attn: Scholarship Director. Software City, which specializes in software and accessories, had more than 60 franchises in operation at the end of 1983.

Free Update for Macintosh Multiplan

Microsoft Corp. was to begin shipping free updates of Macintosh Multiplan version 1.00 in mid-April. Registered owners should receive the update, Multiplan version 1.01, automatically. The 70 percent of owners who have not registered their purchase should send the warranty card to receive the update. If the warranty card is lost, a sales receipt as proof of purchase can be sent to Microsoft Corp., Customer Service, 10700 Northup Way, Box 97200, Bellevue, WA 98009.

Art Curricula Available from Museum

The Capital Children's Museum has made available two courses for classroom teachers: "Teaching Art Through Computers" and "Teaching Computers Through Art." Both curricula come with complete lesson plans and suggestions for supplementary materials. Designed for students ages 11 to 15, they are based on the use of the Atari 800 and a graphics program called Paint. Computer use is a part of each lesson.

Either curriculum can be obtained for the price of copying and shipping by teachers who will test the programs and provide the museum with suggestions for improvements. The cost is \$5. Additional information is available from Computer Curricula, Capital Children's Museum, 800 Third St. NE, Washington, DC 20002.

Educational Conference Proceedings

Arizona State University has announced the availability of the 1983 *Microcomputers in Education Conference Proceedings*. The proceedings cost \$20. The 1982 conference proceedings are still available for \$15. Purchase-order transactions cost \$5 more. Contact Arizona State University, College of Education, Payne Hall B203, Tempe, AZ 85287, Attention: Tina Hite.

BYTE'S BUGS

Confusion's Cause: Omitted Symbols

The greater-than and less-than symbols were inadvertently omitted from Richard Willis's IBM PCjr benchmark programs, which accompanied G. Michael Vose and Richard S. Shuford's article "A Closer Look at the IBM PCjr" (March, page 320). Make the following corrections to listing 1:

```
820 IF A(I) <= A(I+1) THEN 870
1220 IF ASC(CS(I)) < 65 THEN 1250
1230 IF ASC(CS(I)) > 90 THEN 1250
```

Gremlins in Utility Program

Gremlins bit into listing 1 in James Folts's "A Cross-Reference Utility for IBM PC BASIC Programs" (August 1983, page 378). In line 610, the conditional statement checks for REM or data codes. If true, the remainder of the line is skipped. The 2-byte code for the FRE function is 255 143, and the code for SGN is 255 132. Byte 143 will be interpreted as a REM and byte 132 as a data code, which causes the rest of the line to be discarded.

To correct this, make the following changes:
(text continued on page 46)

FREE SHIPPING

Order line: 800-354-7330

SANYO SUPER SYSTEMS

SYSTEM #1

SANYO MBC-550 \$1195

- SANYO GREEN MONITOR
- GEMINI 10 X • SOFTWARE •

Sanyo MBC-550 Single Drive Computer • Sanyo CRT-36 Monitor • Star Micronics Gemini 10X • Cabling • WordStar • CalcStar • Easywriter • MS-DOS • Sanyo Basic •

SYSTEM #2

SANYO MBC-555 \$1525

- SANYO GREEN MONITOR
- GEMINI 10X • SOFTWARE •

Sanyo MBC-555 Dual Drive Computer • Sanyo CRT-36 Monitor • Star Micronics Gemini 10X • Cabling • WordStar • CalcStar • SpellStar • InfoStar • Mail Merge • Easywriter • MS-DOS • Sanyo Basic •

PRINTERS

C. ITOH

A10-20 \$505

Prowriter 8510 \$335

8510 SP \$460

8510 SCP \$530

8510 BPI \$420

F-10 Serial or Parallel \$940

COMREX

Cr-2 \$450

Keyboard \$150

DIABLO

620 RO \$860

630 RO \$1715

630 ECS/IBM \$2090

S-11 \$560

P-11 \$560

EPSON

All models \$AVE

INFORUNNER

Rileman \$250

JUKI

6100 \$480

NEC

2010 \$780

2050 \$905

3510 \$1370

3550 \$1715

8023A \$385

8025 \$675

OKIDATA

All models \$AVE

PANASONIC

1090 \$AVE

1091 \$AVE

1092 \$AVE

QUME

11/40 w/Interface \$1370

11/55 w/Interface \$1570

Letter Pro 20P \$609

Letter Pro 20S \$609

SILVER REED

EXP400 \$AVE

EXP500P \$390

EXP500S \$425

EXP50DP \$485

EXP550S \$500

STAR MICRONICS

Gemini 10X & 15X \$AVE

Delta 10 \$AVE

TALLY

MT 160L w/tractors \$AVE

MT 180L w/tractors \$AVE

Spirit \$299

Spirit 80 \$AVE

TOSHIBA

1340 \$AVE

1350 Serial or Parallel \$1450

1351 Serial or Parallel \$1550

TRANSTAR

130P \$675

120P \$450

T315 \$450

TERMINALS

TELEVIDEO

910 + \$535

914 \$540

924 \$670

925 \$705

950 \$905

970 \$980

Personal Terminal \$AVE

ZENITH

Z-29 \$649

COMPUTERS

NEC

PC-8201A \$590

PC-8201A CPU \$589

PC-8206A 32K Ram \$289

PC-8281A Recorder \$89

PC-8201A-90 Battery Pack \$15

SANYO

MBC-550 System \$1195

MBC-555 System \$1525

TELEVIDEO

803 \$1799

ZENITH

Z-100 Low Profile \$2635

Z-100 All-In-One \$2815

MODEMS

HAYES

1200 \$490

1200B \$435

300 \$205

Micromodem IIe \$240

DISK DRIVES

RANA

Elite 1 \$215

Elite 2 \$345

Elite 3 \$410

1000 w/DOS (for Atari) \$305

MONITORS

TAXAN

12" Amber \$125

ZENITH

12" Green \$95

12" Amber \$120

Prices reflect 3% to 5% cash discount. Product shipped in factory cartons with manufacturer's warranty. Free shipping is on UPS ground only. Prices & availability subject to change without notice. Send cashier's check or money order...all other checks will delay shipping two weeks.

SILICON SPECIALTIES
2034 WEST SOUTHERN
MESA, ARIZONA 85202
602-969-0909

**NEW INSIDER
SUB SYSTEMS**

\$895.⁰⁰

*IS18 SHOWN

- IS00**
- 10 Mega-Byte Winchester
 - Hard Disk Controller

UPGRADES FOR YOUR IBM PC /PC COMPATIBLES

- IS01**
- 10 Mega-byte Winchester
 - Modular hard disk controller
- \$1095.00**
- IS02**
- 10 Mega-byte Winchester
 - Floppy/Hard disk controller
- \$1295.00**
- IS16**
- Half-high tape drive
 - XT-Power Supply
- \$ 995.00**
- IS17**
- Half-high tape drive
 - Half-high floppy drive
 - XT-Power Supply
- \$1265.00**
- IS18**
- Half-high tape drive
 - Half-high 10 Mega-byte Winchester
 - Hard disk controller
 - XT-Power Supply
- \$2095.00**
- IS20**
- 20 Mega-byte Winchester
 - Hard disk controller
- \$1595.00**
- IS21**
- Half-high tape drive
 - Half-high 20 Mega-byte Winchester
 - Hard disk controller
 - XT-Power Supply
- \$2495.00**
- IS40**
- 40 Mega-byte Winchester
 - Hard disk controller
 - XT-Power supply
- \$2895.00**

- IS41**
- Half-high tape drive
 - Half-high floppy drive
 - 40 Mega-byte Winchester
 - Hard disk controller
 - XT-Power Supply
- \$3795.00**
- ISPS**
- XT-Power Supply
- \$ 290.00**

TAPE FOR YOUR IBM XT

- XT01**
- Half-high tape drive
 - Half-high floppy drive
- \$ 995.00**

Micro Design International Inc. has been serving the computer industry for over 7½ years, call us today for our complete catalog or to place your order.

**TO ORDER CALL COLLECT
(305) 677-8333**

Master Card/Visa/Check/or Money Order

**MICRO DESIGN
INTERNATIONAL INC.**

"Your internal solution"

6586 University Blvd. Suite 7
Winter Park, Florida 32792

IBM is a registered trademark
of International Business Machines Corporation

Circle 214 on inquiry card.

(text continued from page 44)

```
610 IF (C=143 OR C=132) AND COLD
    <> 255 THEN WHILE C
        <> 0 ....
7050 COLD=C : C=ASC(CS(PTR))
```

The variable COLD contains the value of the previous byte. Line 610 will now check the new byte as well as the previous one.

Many thanks to J. A. Griffioen for this correction.

Typo Mars Listing

Sharp-eyed Ken Dawson of Louisville, Kentucky, found a typo in Kaare Christian's article "Inside a Compiler: Notes on Optimization and Code Generation" (February, page 349). Under the Pascal-86 code in listing 3 on page 358, change the second line in P7 to read

```
INC AX
```

Our thanks to Ken Dawson.

Bugs Blemish Character Editor

P. E. Burcher of Alexandria, Virginia, has reported a number of minor errors in Raymond A. Diedrichs's "A Character Editor for the IBM PC" (November 1983, page 467). For listing 1, Burcher recommends that you change

FFREPEAT in line 1320 to FREPEAT and that you delete the word REM in line 3140. To avoid an unwanted scroll when the last line of the experiment page is displayed, change line 3160 to read

```
3160 IF I<EXPROW THEN PRINT
```

Also, correct the number 1024 to read 1023 in line 8065. This allows the BASIC interpreter and the Font Editor to read user-defined symbols correctly.

Like most programmers, Burcher couldn't resist the urge to tamper with a program. Listing 1 (presented here) is Burcher's prescribed patch for a more graceful exit to the BASIC command mode.

Raymond Diedrichs wrote us with an update of the Font Editor's initialization of the interrupt vector for newer PCs. (It's correct for older versions.) Change line 8070 to

```
8070 DEF SEG= 0: POKE 124,0:
    POKE 125, (TABLEADDR/256)
```

and add line 8071

```
8071 POKE 126,0: POKE 127,0
```

An improved copy of the Font Editor program is available to any interested readers who send Mr. Diedrichs a formatted disk and return postage.

Listing 1: P. E. Burcher prescribes this patch for a more graceful exit to the BASIC command mode from Raymond Diedrichs's character-editor program for the IBM PC.

```
1055 CLOSE: GOTO 9100      'STOP

9100 'RESTORE SOFTKEYS AND END
    GRACEFULLY

9105 KEY 1, "LIST": KEY 2,
    "RUN"+CHRS(13): KEY 3, "LOAD"
    KEY 4, "SAVE"+CHRS(34):KEY 5,
    "CONT"+CHRS(13)

9110 KEY 6, ""+CHRS(34)+"LPT1:"+
    CHRS(4(34)+ CHRS(13): KEY 7,
    "TRON"+ CHRS(13): KEY 8,
    "TROFF"+ CHRS(13): KEY 9,
    "KEY": KEY 10, "SCREEN 0, 0, 0,
    ""+CHRS(13)

9115 KEY ON: SCREEN 0, 0, 0: CLS

9120 END
```

GTEK INC. (601) 467-8048
EPROM PROGRAMMER

DEVELOPMENT HARDWARE/SOFTWARE
 HIGH PERFORMANCE/ COST RATIO

Compatible w/all Rs 232 serial interface port • Auto select baud rate • With or without handshaking • Bidirectional Xon/Xoff and CTS/DTR supported • Read pin compatible ROMS • No personality modules • Intel, Motorola, MCS86. Hex formats • Split facility for 16 bit data paths • Read, program, formatted list commands • Interrupt driven, program and verify real time while sending data • Program single byte, block, or whole EPROM • Intelligent diagnostics discern bad and erasable EPROM • Verify erasure and compare commands • Busy light • Complete w/Textool zero insertion force socket and integral 120 VAC power (240 VAC/50Hz available)

DR Utility Package allows communication with 7128, 7228, and 7956 programmers from the CP/M command line. Source Code is provided. PGX utility package allows the same thing, but will also allow you to specify a range of addresses to send to the programmer. Verify, set the Eprom type.

MODEL 7316 PAL PROGRAMMER
 Programs all series 20 PALS. Software included for compiling PAL source codes.

Software Available for CPM,¹ ISIS,² TRSDOS,³ MSDOS.⁴

1. TM of Digital Research Corp.
2. TM of Intel Corp.
3. TM of Tandy Corp.
4. TM of Microsoft.

Post Office Box 289
 Waveland, Mississippi 39576
 (601)-467-8048

Avocet Cross Assemblers are available to handle 8748, 8751, Z8, 6502, 680X, etc. Available for CP/M and MSDOS computers. Order by processor type and specify kind of computer.

Model DE-4 U/V Products hold 8, 28 pin parts. High quality professional construction.



5879 stand alone
MODEL 7956

MODEL 7956
GANG PROGRAMMER

Intelligent algorithm. Stand alone, copies eight EPROMS at a time. With RS-232 option \$1099.

\$549
MODEL 7316



\$1195
MODEL 7324



MODEL 7324 PAL PROGRAMMER
 Programs all series 20 & 24 PALS. Operates stand alone or via RS232.



\$549
MODEL 7228

MODEL 7228 EPROM PROGRAMMER
 All features of Model 7128 plus Auto Select Baud . . . super fast adaptive programming algorithms, low profile aluminum enclosure. Programs 2764 in one minute!



\$429
MODEL 7128

MODEL 7128 EPROM PROGRAMMER
 Programs and Read:

NMOS	NMOS	CMOS	EEPROM	MPU'S
2508	2758	27C16	5213	8748
2516	2716	27C32	5213H	8748H
2532	2732	C6716	X2816	8749H
2564	2732A	27C54	48016	8741
68766	2764		12816A	8742H
68764	27128			8741H
8755	27256			8751
5133				

- Model 7128-L1,L2,L2A . \$239.00
- Model 7128-24 \$329.00
- DR8 or DR5 \$ 30.00
- DR8PGX or DR5PGX . . \$ 75.00
- Cross Assemblers \$200.00
- XASM (for MSDOS) . . . \$250.00
- U/V Eraser DE-4 \$ 78.00
- RS232 Cables \$ 30.00
- 8751 adapter \$174.00
- 8755 adapter \$135.00
- 48 Family adapter . . . \$ 98.00

BASF QUALIMETRIC™ FLEXYDISKS® BUILT FOR ETERNITY - WARRANTED FOR A LIFETIME.

BASF Qualimetric FlexyDisks® offer you more...an extraordinary new lifetime warranty. The BASF Qualimetric standard is a dramatic new international standard of quality in magnetic media...insurance that your most vital information will be secure for tomorrow when you enter it on BASF FlexyDisks today.*

We can offer this warranty with complete confidence because the Qualimetric standard reflects a continuing BASF commitment to perfection...a process which begins with materials selection and inspection, and continues through coating, polishing, lubricating, testing, and 100% error-free certification. Built into our FlexyDisk jacket is a unique two-piece liner. This BASF feature traps damaging debris away from the media surface, and creates extra space in the head access area, insuring optimum media-to-head alignment. The result is a lifetime of outstanding performance.

When your information must be secure for the future, look for the distinctive BASF package with the Qualimetric seal. Call 800-343-4600 for the name of your nearest supplier.

Circle 41 on inquiry card.



ENTER TOMORROW ON BASF TODAY



BASF

Your System Deserves The Best!

Key Tronic Keyboards.

To enhance the performance of your personal computer or computer terminal, ask your dealer for a plug-compatible Key Tronic keyboard.

Key Tronic Corporation is the world's largest independent manufacturer of computer keyboards.

Key Tronic keyboards are engineered for performance and reliability, and are backed by a 14-year tradition of manufacturing excellence. All Key Tronic plug-compatible keyboards feature:

- Familiar typewriter key locations and legends
- Low-profile design
- Solid-state capacitive switches
- Positive tactile feedback

Each production element, from printed circuit boards to keytops is generated in-house to insure high quality.

So ask your computer dealer for a hands-on demonstration of a Key Tronic keyboard.

Call Toll Free 1-800-262-6006 for the retailer closest to you. (7 am-3 pm Pacific Time). Warranty information may be obtained by writing to the address below.



KB 5151 and 5151jr — *The Professional Series*

KB 5151 is plug-compatible with the IBM* PC and XT. KB 5151jr is plug-compatible with the IBM PCjr*. Both are available in DVORAK and foreign layouts, and special models are made for the handicapped. Suggested Retail Price: \$255.00

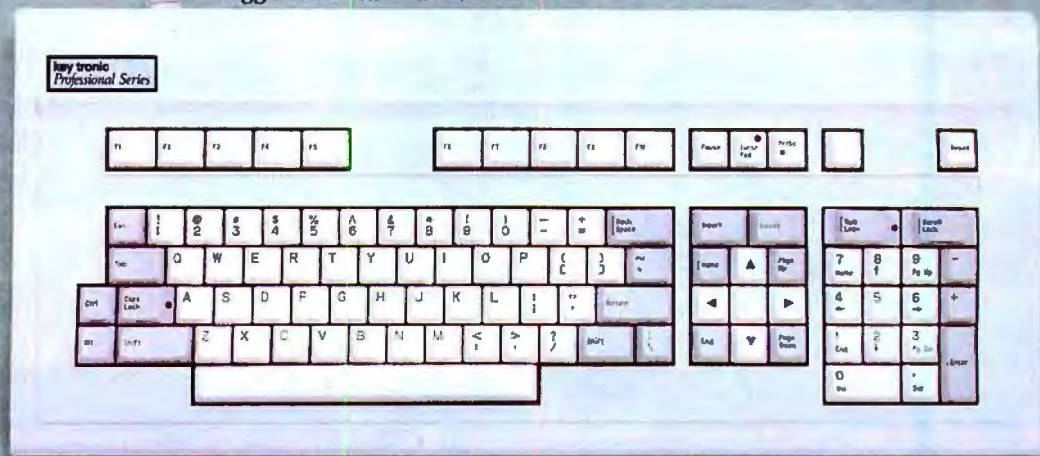

key tronic

"THE RESPONSIVE KEYBOARD COMPANY"

Department E • P.O. Box 14687 • Spokane, WA 99214 (U.S.A.) • (509) 928-8000
Circle 182 on Inquiry card.



KB 200
Plug-compatible with
the Apple II*, and models
are available for the handicapped.
Suggested/Retail Price: **\$298.00**



KB 100
Plug-compatible with
the Dec VT-100*
Suggested Retail
Price: **\$379.00**



KB 500
Replacement keyboard
for the Radio Shack
TRS-80 Color
Computer*
Suggested Retail Price:
\$89.95



KB 925
Plug-compatible with
the Televideo 925*
Suggested Retail Price:
\$324.00



KB 5150 and 5150 jr — *The Professional Series*
KB 5150 is plug-compatible with the IBM* PC
and XT. KB 5150 jr. is plug-compatible
with the IBM PC jr.* Both are available in
DVORAK and foreign layouts, and a special
model is made for the handicapped.
Suggested Retail Price: **\$209.00**



*IBM and PC jr. are registered trademarks of IBM Corporation.
*Apple II is a registered trademark of Apple Computer, Inc.
*DEC VT-100 is a registered trademark of Digital Equipment Corporation.

*Televideo-925 is a registered trademark of Televideo Systems, Inc.
*Radio Shack is a registered trademark of Tandy Corporation.

W·H·A·T'S N·E·W

Plug-in Bubble-Memory Boards Boost PC Storage

Hicomp Corporation's MBM-550 Bubble Drive family gives you either 256K or 512K bytes of nonvolatile high-speed mass storage on a single card that plugs into any IBM PC's I/O slot. The MBM-550 is compatible with PC-DOS 1.1 and 2.0 and appears to the user, DOS, and applications software as an additional floppy disk. The MBM-550 can be used as a stand-alone unit or in conjunction with floppy and hard disks. With a Bubble Drive, you can store applications programs, programs that are disk intensive, or critical data.

Inasmuch as the MBM-550 is nonmechanical, it is practically maintenance free and many times more reliable than a floppy-disk drive. Nonvolatile bubble memory retains data without battery backup and is immune to dust, dirt, extreme temperatures, humidity, shock, and vibrations. These charac-

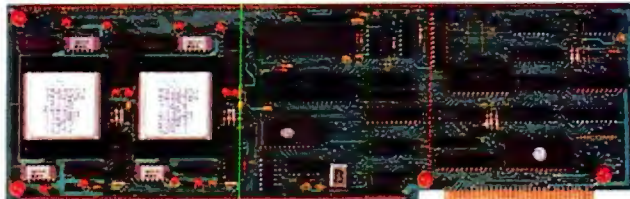

teristics also make the MBM-550 bubble drives suitable for storing the DOS or programs and data files when the operating environment precludes the use of mechanical disk drives.

Write-protect and boot-enable switches are standard features of the Bubble Drives. The write-protect feature prevents stored files from being erased or written over, while the boot-enable lets you boot your PC from the drive.

Other features include a self-installation feature that automatically installs the Bubble

Drive software after power-up.

The 256K-byte MBM Bubble Drive offers an average access time of 45 milliseconds and an average transfer rate of 17K bytes per second. The 512K-byte version has a 45-millisecond access time and a 34K-byte-per-second transfer rate. They list for \$995 and \$1495, respectively. An optional RS-232C port increases the price \$50. Contact Hicomp Computer Corp., 5016 148th Ave. NE, Redmond, WA 98052, (206) 881-6030.

Circle 700 on inquiry card.

Rainbow 100B

The Rainbow 100B is an enhanced version of DEC's dual-processor personal computer. The 100B includes 128K bytes of RAM (now expandable to 768K bytes), two 5¼-inch 400K-byte floppy-disk drives, dual Z80 and 8088 processors, and three expansion slots. An optional hard-disk drive can be added more easily than in the earlier Rainbow.

Bundled with the DEC Rainbow 100B are the CP/M-80, CP/M-86 version 2.0, and MS-DOS version 2.05 operating systems. Concurrent CP/M-86 is also available as an option for \$150.

The DEC Rainbow 100B is priced at \$2750 without keyboard or monitor. For more information, contact Digital Equipment Corp., 200 Baker St., Concord, MA 01742, (800) 344-4825.

Circle 702 on inquiry card.

Stand-Alone Videotex for the Pro 350

Pro/Videotex allows a Digital Equipment Corporation Professional 350 computer to be used as a stand-alone single-user videotex system. Screens

of videotex graphics and text are stored on the system's 10-megabyte hard disk and can be recalled through menus, by keyword, or by page number.



HP Laser Printer

Hewlett-Packard's Laserjet prints either text or graphics at a speed of eight pages per minute, or about 325 cps. This high-speed laser printer has an RS-232C interface so that it can be used with many personal computers, including the HP-150 and IBM PC. While graphics can be printed with a resolution of 300 by 300 dots per square inch, configuration software will be needed for most graphics programs. Although the printer is a version of Canon's LBP-CX, it adds a special intelligent interface card.

Priced at \$3500, the Laserjet will compete with high-speed daisy-wheel printers. Type-font cartridges cost \$200 each. The ink, toner, and drum come in a \$99 cartridge, which has an estimated life of about 3000 pages. Contact your local Hewlett-Packard sales office, or call (800) 547-3400; in Oregon, (503) 758-1010.

Circle 701 on inquiry card.

Graphics and text are displayed using the NAPLPS protocol with a resolution of 768 by 240 pixels on a monochrome or color monitor.

The videotex database can be modified either by loading new information via floppy disk or by calling a remote mainframe computer. Pro/Videotex costs \$895. It requires a Professional 350 computer with Pro/Communications software, the P/OS version 1.7 operating system, the extended bit-map graphics option, and a 10-megabyte hard disk. Contact Digital Equipment Corp., 200 Baker St., Concord, MA 01742 (800) 344-4825.

Circle 703 on inquiry card.

A NAPLPS-coded image is displayed on the DEC Professional 350 computer's color display using Pro/Videotex.

(text continued on page 52)

BUYING A PASSWORD™ MODEM CAN SAVE YOU UP TO \$250. AND THAT AIN'T HAYES!*

You can bank on it. Your outlay will be less than if you settle for our major competitor, but not your output! A Password™ modem sends and receives up to 120 words a minute. Provides both 1200 and 300 baud capacity. Offers total interchangeability that lets you transmit information from any make microcomputer to any other make. And your investment is protected by a 2-year warranty.

Unlike our major competitor, Password™ delivers operating simplicity, plus the convenience of uncommon portability. Thanks to lighter weight, it goes almost anywhere. And because of the ingenuity of Velcro™ strips, it attaches wherever you need it, from the side of a desk to the side of a computer!

This means that Password™ doesn't tie you down, and its price won't hold you up. It features auto-dial, auto-answer, and even knows when to disconnect. If you're cost conscious, but refuse to sacrifice high-speed capability and performance, hook up with the right modem—Password™. The smart decision.

PASSWORD™
by U.S. Robotics, Inc.



1123 W. Washington
Chicago, IL 60607
Phone: (312) 733-0497



*Based on suggested retail price comparisons of U.S. Robotics, Inc. and Hayes Microcomputer Products, Inc.

Eagle Turbo Reportedly Twice as Fast as IBM PC

The Eagle Turbo XL has network file-server capabilities and is said to be twice as fast as the standard IBM PC-compatible. Operating at 8 MHz, the Turbo XL is designed with the 16-bit Intel 8086 microprocessor and with a minimum of wait states. A 256K-byte computer, the Turbo XL comes with a 10-megabyte hard-disk drive and a 360K-byte IBM-format double-sided, double-density 5¼-inch floppy-disk drive. The processing speed is switch-selectable from 4.77 MHz to 8 MHz to accommodate a variety of programs.

A detached 84-key Selectric-format keyboard is augmented with 10 function keys, a numeric pad, and LED indicators on all lock keys. Five IBM PC-compatible slots and a parallel port

comprise the Turbo XL's expansion capabilities. Up to 512K bytes of RAM can be installed on the main circuit board.

A 12-inch, P39 green-phosphor monitor and a 13-inch RGB monitor are available. Both provide high-resolution displays (i.e., 720 by 352 pixels monochrome or 640 by 200 color) and 80 by 25 formats.

Additional options such as EagleNet 1 local-area networking software, monochrome adapter board, a color/graphics board, and interface ports are offered.

The Eagle Turbo XL costs \$4995. Contact Eagle Computer Inc., 983 University Ave., Los Gatos, CA 95030, (408) 399-4200.

Circle 704 on inquiry card.

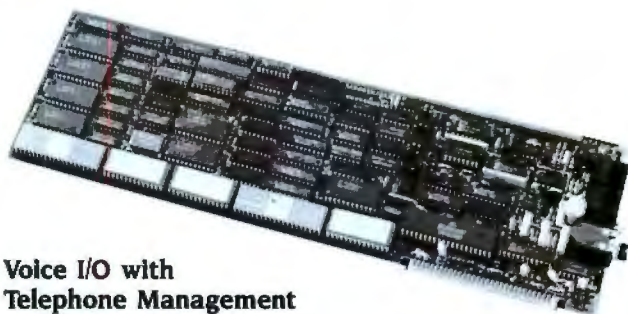

Voice I/O with Telephone Management on Single IBM PC Board

Votan's VPC 2000 Voice Card is a single plug-in card that provides the IBM PC with voice recognition, speech generation, and telephone-management functions. With its accompanying software, you can use the Voice Card for speech command and control of your existing IBM PC programs.

For each applications program, you can define and incorporate up to 64 voice utterances that are linked to a sequence of applications-specific keystrokes. Each keystroke can contain as many as 30 characters. Thus, you can replace cumbersome keystroke combinations used to activate a word processor or spreadsheet with the voice input of your choosing.

The Voice Card features Votan's continuous speaker-dependent recognition (CSDR), which lets you speak to your computer in a normal conversational flow, without pause between words. A word-spotting capability homes in on target words located anywhere within a stream of conversation. Rather than using fragmented grammar,

a series of commands or data input can be issued using normal sentence structure.

Votan asserts that its technology is the only commercially available speech recognition that operates over telephone lines. These abilities let you talk to your IBM PC from remote locations and have it respond to your commands verbally. The Voice Card's telephone-interfacing capabilities include auto-answer, auto-dial, and Touch-Tone encoding and decoding. A supplied program gives you immediate access to these features. In addition, these abilities give you a voice-controlled telephone dialer and an automatic answering/voice mail system.

The VPC 2000 Voice Card is contained on a single printed-circuit board that plugs into any of the IBM PC's long auxiliary system bus slots. A microphone, speaker, software, and documentation are included in its \$2450 list price. Contact Votan, 4487 Technology Dr., Fremont, CA 94538, (415) 490-7600.

Circle 705 on inquiry card.



Briefcase Computer's Integrated Software Has Windows

The IS-11 briefcase computer by Sord Computer of America comes with an integrated software package with multiwindow screens. Data handling, calculation, word processing, and communications capabilities are standard. The IS-11's six function keys provide access to these applications and to a Help key. Optional applications software, including financial, communications, and advanced word-processing programs, comes in 60K-byte ROM packs.

The IS-11's hardware features are 32K bytes of nonvolatile RAM, 64K bytes of ROM, and an 8-line by 40-character LCD display with an angle adjustment. A high-speed recorder provides mass storage; each tape can accommodate more than 128K bytes of data. The IS-11, built with CMOS technology, operates on rechargeable NiCad batteries. One charge is good for eight hours of operation. An AC adapter/battery charger is supplied. The

unit weighs 4 pounds 6 ounces and measures 11½ by 8½ by 1½ inches.

A thermal printer, a numeric keypad with 16 additional function keys, and a micro-floppy-disk drive are options. The base price is \$995. A version with a built-in modem will cost \$1095. Contact Sord Computer of America Inc., 645 Fifth Ave., New York, NY 10022, (212) 759-0140. Circle 706 on inquiry card.



(text continued on page 54)

PC Owners . . . Reach for Your Phone! This Winchester is Loaded . . . with **UNIX** Software.



That's right, partner. Now is the time to upgrade your PC with the *Sundown*™ disk. Includes controller. Installs right inside your PC in less than 10 minutes. Backed by our full one-year warranty.

But that's only half the story . . . The *Sundown* comes loaded with *VenturCom Venix/86*. This highly-acclaimed operating system is a licensed implementation of AT&T's UNIX and is the only MULTI-USER, MULTI-TASKING UNIX environment available on the IBM PC. Plus you can store and run your MS/DOS programs and files as well!

We offer immediate delivery. And our price . . . now that will blow your boots off! Need we say more? Reach for your phone and dial:

617-491-1264

Unisource Software Corp., Department 4109
71 Bent Street, Cambridge, MA 02141

*UNIX is a trademark of Bell Laboratories.

\$399 Modem Emulates Smartmodem Command Structure

The Signalman Mark XII modem emulates the Hayes Smartmodem's command structure. You can manually manipulate this answer/originate modem from your computer's keyboard or set it for automatic operation.

For Bell 103 compatibility, Mark XII can send or receive calls at 300 bps, while its 1200-bps data rate provides Bell 212A compatibility. The Mark XII detects dial tone and busy

signals, automatically displaying the status.

An on-board CMOS microprocessor, an RS-232C serial interface with built-in cable, and dual telephone jacks are provided.

The Signalman Mark XII is \$399. Further information is available from Anchor Automation Inc., 6913 Valjean Ave., Van Nuys, CA 91406, (213) 997-6493.

Circle 707 on inquiry card.

Color Display for PCjr



IBM recently introduced a color display monitor for its PCjr. In its 80-character mode, this di-

rect-drive display is said to provide better character definition than a color composite-video monitor. Features include a 13-inch (diagonal) screen, 40- by 25-character mode, 320 by 200 lines, 16 colors, nonglare face, internal speaker, earphone connector, and front-panel controls. The display, which can tilt 10 degrees, can be placed on top of the PCjr system unit.

The IBM PCjr Color Display is \$429. Contact IBM Corp., Entry Systems Division, POB 2989, Delray Beach, FL 33444. Circle 708 on inquiry card.

DisplayWrite Software For IBM's Personal Computers

In a move intended to tie the IBM PC, PC XT, and PCjr more closely to the world of the company's larger computer systems, IBM has announced software for its personal computers that emulates many of the features employed by its minicomputer and mainframe computer word-processing systems and that can share files with those machines.

Both DisplayWrite 1 and DisplayWrite 2 have user interfaces that resemble those used by the DisplayWriter.

DisplayWrite 1 is a general-purpose menu-driven word processor for the full range of IBM personal computers. It requires DOS 2.1 and 128K bytes of RAM.

DisplayWrite 2 extends the features of DisplayWrite 1 by adding a spelling checker, automatic hyphenation and pagination, and merge functions. However, because it requires 192K bytes of RAM, it will not run on the PCjr. An optional legal dictionary is available for DisplayWrite 2.

Both programs can generate ASCII files; DisplayWrite 2 can produce output that is directly

compatible with that of the DisplayWriter.

PCWriter for the PC, PC XT, and Portable PC is designed to look like and replicate most of the functions of word processing on the IBM 5520 Administrative System and the IBM System/23 Datamaster.

IBM will also market software called DisplayComm BSC for personal computers equipped with the IBM Personal Computer Binary Synchronous Communications Adapter, a minimum of 256K bytes of RAM, and an appropriate modem.

DisplayComm BSC provides emulation of IBM 2770/3780 and 2780 terminals and can be used to transmit DisplayWrite 2 files to the DisplayWriter as well as a selection of larger IBM systems.

DisplayWrite 1 will sell for \$95. DisplayWrite 2 for \$299. DisplayWrite Legal Support (optional legal dictionary) for \$165, PCWriter for \$199, and DisplayComm BSC for \$375. Contact IBM Corp., Information Systems Group, 900 King St., Rye Brook, NY 10573.

Circle 709 on inquiry card.

MicroPro Spelling Checker Features Phonetic Analysis

MicroPro International has unveiled a successor to SpellStar, the spelling checker sold as a complement to the company's WordStar word-processing package. The new program, named CorrectStar, is based on Houghton Mifflin's *American Heritage Dictionary*. Predictably, CorrectStar is fully interactive with WordStar—when it replaces a misspelled word in a WordStar file with a correction of a different length, the paragraph containing the error is reformed automatically and soft hyphens are inserted into text where appropriate. Corrections can be made one by one or replaced globally.

The program is a full-word checker; i.e., it uses no algorithms for attaching prefixes and suffixes to a list of roots, and hence is relatively fool-proof. CorrectStar uses three

dictionaries: a 9000-word basic vocabulary that it reads into memory, a main dictionary of 65,000 words kept on disk, and a user-generated 1500-word personal dictionary. Personal dic-

tionaries for specific subjects can be maintained and used for different documents, and all dictionaries can be edited as if they were WordStar text files.

The major advance in spelling

checker design, however, is CorrectStar's ability to suggest corrections based on phonetic similarities. For every word it can't locate in one of its dictionaries, CorrectStar recommends an alternative, and the program's algorithms enable it to "sound out" improbable spellings and achieve a high rate of success in determining replacements.

CorrectStar is available for the IBM PC, generic MS-DOS machines, the TI Professional, the DEC Rainbow, and the Tandy 2000. The memory requirement is 192K bytes of RAM. Suggested price is \$195, and SpellStar owners will be able to purchase upgrades for \$85. Contact MicroPro International Corp., 33 San Pablo Ave., San Rafael, CA 94903, (415) 499-1200.

Circle 710 on inquiry card.

(text continued on page 56)



Free and Easy

using a Business Plotter is difficult and expensive, right? Wrong! That's the way things used to be. Roland DG's new hardware/software package not only makes plotting easy, it also makes part of the deal free!

During the months of April, May and June with the purchase of a Roland DG DXY-800 8-Pen X-Y Plotter, you get the KeyChart Presentation Graphics Software to run the plotter—*Absolutely Free!* A savings of \$375.00.

At the heart of the package is the Roland DG DXY-800 X-Y Plotter, (the lowest priced 8-pen plotter on the market). The DXY-800 is an 8-pen intelligent plotter offering an 11" x 17" plot bed, Centronics parallel and RS-232 serial interfaces, and can also be used in either a horizontal or vertical (60 degree inclined) position, to conserve your desk-top space. Use regular paper or even acetate to produce overhead projection graphics.

Next add KeyChart, probably the quickest, and easiest software program for generating presentation-quality business graphics. You don't have to be a programmer to use KeyChart. It is completely menu-driven and can provide automatic default values for every characteristic. Load in your data from the keyboard, or from almost any electronic spreadsheet, including Lotus 1-2-3.

keyChart graphics software is high-quality, quick, and easy.

M O D E L
DXY800

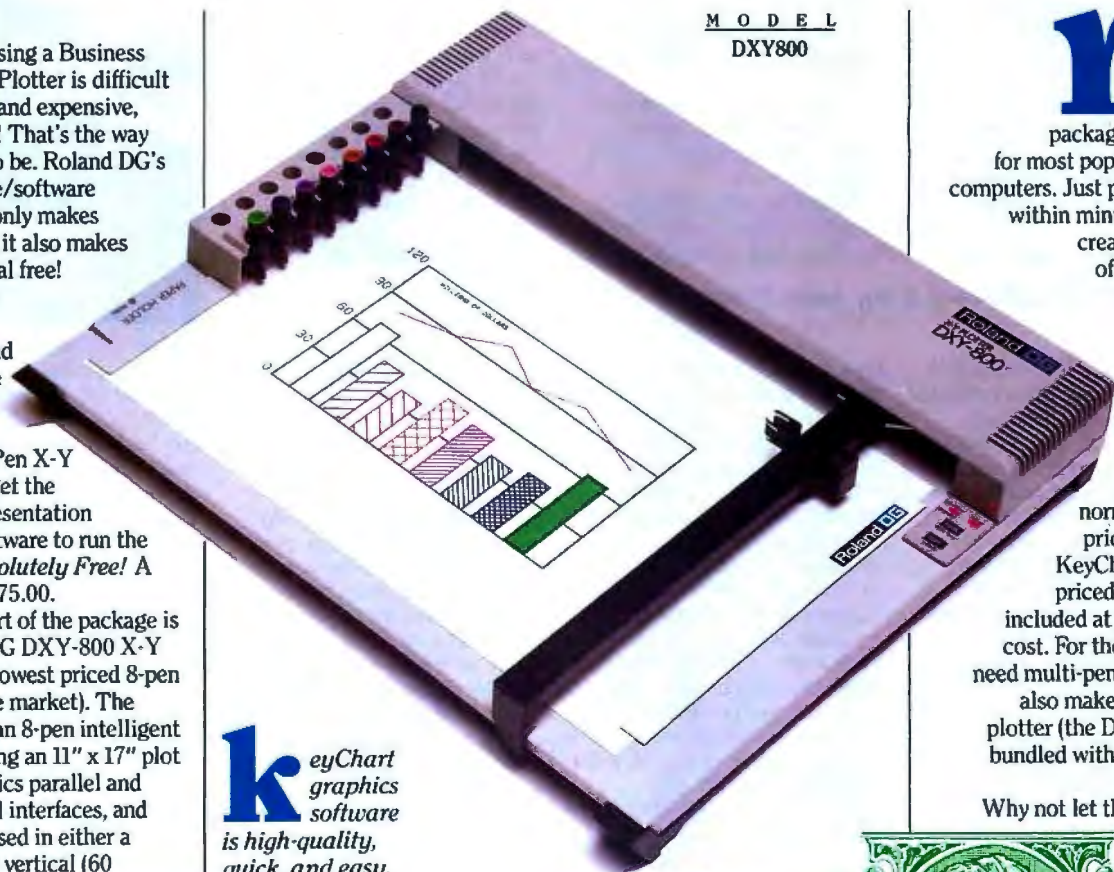

Why not take the work out of your next business presentation?



thanks to Roland DG, KeyChart can come to you for free.



But you'd better hurry, this kind of free and easy dealing isn't going to last forever, just until June 30th. For a dealer near you contact: Roland DG, 7200 Dominion Circle, Los Angeles, CA 90040, (213) 685-5141.

roland DG's DXY-800 KeyChart package is available for most popular personal computers. Just plug it in, and within minutes you'll be creating the kind of graphics you thought might take days of programming. All of this comes to you for the DXY-800's normal low retail price of \$995.00. KeyChart, normally priced at \$375.00 is included at no additional cost. For those who don't need multi-pens, Roland DG also makes a single pen plotter (the DXY-101), also bundled with KeyChart for only \$750.00

Why not let the Roland DG graphics system improve the quality of your business presentations?

KeyChart is a trademark of SoftKey Software Products Inc. Lotus and 1-2-3 are trademarks of Lotus Development Corp.

Roland DG

Create Graphics with Tablet, Software

Suncom's Animation Station touch-sensitive graphics tablet and DataSoft's UltraGraphics software let you create graphics for presentations, animate screen displays, reposition words and symbols, store images, and draw pictures for the fun of it. With a touch of a finger or stylus, you can stretch, reshape, copy, and erase images.

The Animation Station has

side-mounted dual left- or right-hand function buttons, and its surface area complements a home television's proportions. Printouts can be generated.

A line of software for education, entertainment, interior design, and word processing is in development.

Animation Station with UltraGraphics software is available for the Apple IIe, the Com-

modore 64, the IBM PCjr, and Atari computers. The Apple IIe version is \$104.95. For the PCjr, it's priced at \$124.95. The Atari and Commodore packages are \$79.95. A Coleco Adam package will be offered. For more information, contact Suncom Inc., Suite E, 650 Anthony Trail, Northbrook, IL 60062, (800) 323-8341; in Illinois, (312) 291-9780.

Circle 711 on inquiry card.

Multipurpose Software from Ashton-Tate

Framework is a fully integrated software package that combines word processing, database management, financial modeling, business graphics, and outline processing in a flexible windowing environment. Users can create multiple windows, or "frames," each of which contains up to 32,000 characters of data organized into one of four formats: text, spreadsheet, database report, or graphics. Data can be copied or moved from one frame to another, or linked between frames; as an example, it's possible to build a series of spreadsheets (in manageable units for output) that share common data and that recalculate themselves automatically when linked cells are modified. Though an individual frame can be treated as a complete file, the program is designed to allow frames of differing formats to be chained together into larger documents.

The heart of the program (and what gives Framework its great

flexibility) is the underlying structure provided by the way it organizes frames into hierarchies. Single frames may be created as independent units of equal status, or they may be opened "within" or "above" other frames. The program constructs an outline of frame titles as you work, and the resulting outline can be rearranged or modified as if it were a text file. By changing a frame's position within the outline, you change its location in the hierarchy. At any time, you can move from a screenful of frames to a view of the overall structure (the outline) with a couple of keystrokes. By moving the cursor to a new point within the outline and reversing the process, you can shift rapidly to working in a frame that's far removed from your starting point. It's also possible to organize your work flow by first writing an outline and then creating the related frames one at a time, in any order you

decide to arrange them.

The user interface of Framework is smooth and well-designed. At no time are you more than two keystrokes away from an assortment of drop-down menus, and on-line help can be had with the push of a single function key. The bottom few lines of the screen report status (position within a frame or hierarchy, etc.) and show the nature of the current operation, e.g., cell formulas in a spreadsheet. All elements of the program are as powerful as many competing single-function products: the word processor supports complex formatting and handles sophisticated search-and-replace operations; the spreadsheet accepts intricate formulas and macro functions, either built-in or user-defined; the database manager is a table-oriented relational system that can also be used to generate views of existing dBASE II files; graphics can be derived from either spreadsheet or database information.

Finally, Framework includes its own extensive programming language; complicated manipulations can be developed and reused by any user or programmer.

Framework runs on the IBM PC and compatibles and requires only a two-floppy (double-sided) system with a minimum of 256K bytes of RAM. The program will be available in early July, at an announced price of \$695. For further information, contact Ashton-Tate, 10150 West Jefferson Blvd., Culver City, CA 90230, (213) 204-5570.

Circle 712 on inquiry card.

Adult Power for PCjr



The "jr extender" from Falcon Technology gives the IBM PCjr the capability of running "real" IBM PC software—all in a compact add-on box styled to match the PCjr's exterior. The "jr extender" contains a second double-sided, double-density 360K-byte disk drive; sockets for memory expansion up to an additional 256K bytes of random access memory; a power supply; two switched outlets for the PCjr and a display monitor. A single switch turns on or off the PCjr, monitor, and "jr extender."

The unit plugs into the PCjr's expansion port and attaches to the right side of the PCjr with four thumbwheel screws. The extender comes with a version of DOS 2.1 enhanced to accommodate the modifications.

As an option, you can purchase a lithium-powered clock and mouse port combination; you can attach either the two-button Microsoft mouse or a licensed version of the same product from Falcon. The clock board has an automatic timer function that allows you to preset the system to perform a task at a specific time.

The "jr extender" will retail for \$995. No fixed prices were available for the options at press time, but a company spokesperson estimated that the clock/mouse port would sell for around \$100, and the mouse for approximately \$175. Contact Falcon Technology Inc., Suite T-101, 6644 South 196th St., Kent, WA 98032, (800) 722-2510; in Washington, (206) 251-8282.

Circle 713 on inquiry card.

(text continued on page 468)

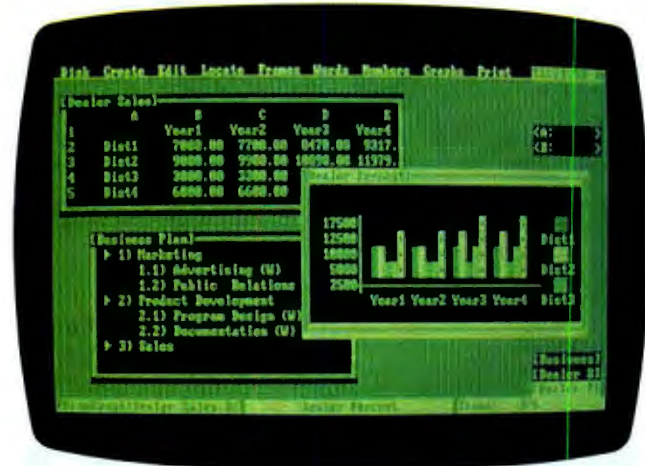

QUARK COMBINES
WORD JUGGLERTM
AND
LEXICHECKTM
FOR HALF THE PRICE.

Now you can have the power of Quark's Word Juggler word processor. And the convenience of the Lexicheck spelling checker, with its 50,000 word dictionary and special Word Guess PlusTM feature. All in one package. For virtually half the price.

The new suggested retail for Word Juggler IIe is only \$189. Word Juggler for the Apple III and III Plus is only \$229*.

Ask for a demonstration today. For the name of the Quark dealer nearest you, call 1 (800) 543-7711. And be sure you look into Quark's other popular office automation tools for the Apple IIe, Apple III and Apple III Plus. Especially the CatalystTM program selector.

*Previous list prices: Word Juggler IIe, \$239; Lexicheck IIe, \$129; Word Juggler for the Apple III, \$295; Lexicheck for the Apple III, \$149. All prices suggested U.S. retail.

Quark, Word Juggler, Lexicheck, Word Guess Plus and Catalyst are trademarks of Quark Incorporated. Apple is a registered trademark of Apple Computer, Inc.

Circle 278 on inquiry card.

QuarkTM
INCORPORATED
Office Automation Tools
2525 West Evans, Suite 220
Denver CO 80219

Apple's® new baby has



Microsoft BASIC
on Apple's new Macintosh

It's called Macintosh™. And it has our brains and a lot of our personality.

We're called Microsoft®. And our part of Macintosh is five new programs that are bright, intuitive, outgoing, understanding and born to perform.

Our pride, your joy.

Taking advantage of Macintosh's mouse and rich graphics, we've designed software that works like you, even thinks like you.

All our programs share the same plain English

commands. So what once took days to learn, now takes hours or minutes to learn with Macintosh.

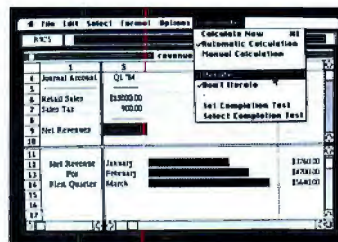

Microsoft Multiplan

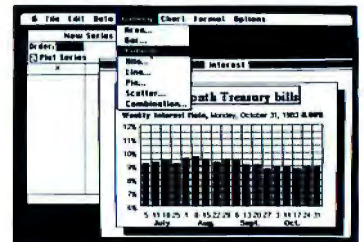

Microsoft Chart

Meet the family.

Our financial whiz is MULTIPLAN®, an electronic spreadsheet that actually remembers how you work. Even offers suggestions on spreadsheet set-up.

When it comes to writing, nothing travels faster

our best features.

than our WORD. Using the mouse, it lets you select commands faster than you can say "cheese."

Our most artistic child is CHART. It gives you 40 presentation-quality chart and graphic styles to choose from.

FILE is our most manageable child, an advanced personal record management program. **MICROSOFT**
The High Performance Software

And BASIC, the language spoken by nine out of ten microcomputers worldwide, is the granddaddy of them all. Now enhanced to take advantage of the

Macintosh mouse, windows and graphics.

We'll be adding more to the family soon. So call 800-426-9400 (in

Washington State call 206-828-8088) for the name of your nearest Microsoft dealer.

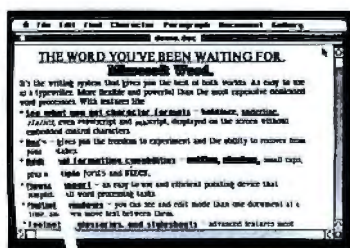

Microsoft Word

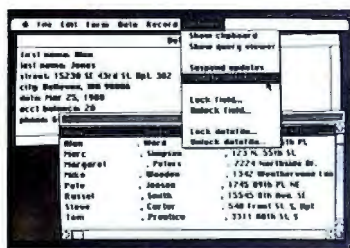

Microsoft File

MICROSOFT

RS-232C FOR THE APPLE II

Dear Steve,

I would like to build an RS-232C card for my Apple IIe to use with your modem described in the March 1983 BYTE ("Build the ECM-103, an Originate/Answer Modem," page 26). Just what would be involved? Could you recommend a good reference? Thanks.

TONY SIMON
St. Paul, MN

An article in a back issue of the Amateur Computer Group of New Jersey (POB 319, South Bound Brook, NJ 08880) newsletter should answer your need for an RS-232C serial interface for your Apple IIe computer. "An Apple II Serial Interface" by Jeff Galinat, while written for an Apple II, will work equally well on your IIe. The circuit need not be copied exactly, and sufficient information is provided if you wish to customize it. The MC14411 bit-rate generator chip, which is rather expensive, can be replaced with one of the less expensive versions on the market.—Steve

STALKING THE MCL1303

Dear Steve,

I recently decided to build your breakout box ("Build an RS-232C Breakout Box," April 1983 BYTE, page 28), but I'm having trouble locating a source for the MCL1303 diodes. Can you help? Thank you.

GARY GLASSCOCK
Renton, WA

The MCL1303 diode is a field-effect current-limiting diode manufactured by Motorola. It is designed for applications requiring a current reference or a constant current over a specified voltage range. It can be obtained from any Motorola distributor.—Steve

MORE ON LINE FILTERS

Dear Steve,

In your December 1983 Circuit Cellar project ("Keep Power-Line Pollution Out of Your Computer," page 36), you show how to modify a four-outlet power strip for better protection. How can I modify a six-outlet power strip?

MILES RINEHART
Hoffman Estates, IL

Because all four outlets are in parallel, it does not matter where the MOVs (metal-oxide varistors) are placed. While figure 1 on page 43 shows the MOVs ahead of the sockets, each is protecting an entire side of the line and can

be installed in any convenient manner. For a six-outlet power strip, any three positions will be adequate. The important thing is to connect an MOV to each side of the line and across the line.—Steve

LCD SOURCES

Dear Steve,

I'd like to build or buy an LCD (liquid-crystal display) that shows a 16-character message whose content depends on the presence/absence of voltage on 10 input lines. Can you provide some information? Thank you.

KEVIN DWAN
Nevada City, CA

My article on page 54 in the February 1983 BYTE, "Build a Handheld LCD Terminal," featured a 16-character LCD that should suit your applications. Two sources for such a display are AND Inc., 770 Airport Blvd., Burlingame, CA 94010, (415) 347-9916 (for its Model 1811) and Epson America Inc., LCD Division, 23155 Kashiwa Court, Torrance, CA 90505, (213) 534-0360 (for its Model MA-B955B).

Interfacing and scrolling can be simplified by using the CY300 LCD controller chip from Cybernetic Micro Systems, POB 3000, San Gregorio, CA 94074, (415) 726-3000.—Steve

HOME-SECURITY RESOURCES

Dear Steve,

My home recently fell prey to burglars, and my fairly expensive computer is gone. I'd like to use my old computer to guard my house while I'm away. Can you recommend any good publications to help me computerize a home-alarm system? Any help would be appreciated.

MARC WEIGEL
Delta, British Columbia, Canada

Home security is a high-technology field. The abundance of low-cost microprocessors has produced a plethora of devices to protect any given area. Reasonably priced sensors are available to detect motion, heat, smoke, noise, and vibration, as well as the simple opening or closing of a door or window. Before a computerized alarm system can be designed or installed, you must first decide on the level of protection that you need and the price that protection costs. I wrote a series of articles in the January-March 1979 issues of BYTE that describes a security system built and installed in my home. In it, I discuss the philosophy of protection, typical sensors and where to mount them, circuit diagrams, flowcharts, and a computer program to control the system. This series

of articles has been reprinted in Ciarcia's Circuit Cellar, Volume II.

An excellent source for security devices is Mountain West. Its catalog features a complete line of burglar-alarm controls, switches, sensors, wiring aids, and advice. Write for a copy to Mountain West, 4215 North 16th St., POB 10780, Phoenix, AZ 85064.—Steve

TWO QUESTIONS

Dear Steve,

I have a Zenith Z-90 with two disk drives and three serial ports. My printer is on the blink, and I have gone to a backup system (a Royal typewriter). Most of the printers here are the Centronics parallel type, and my Zenith has only serial ports. I was wondering if I could construct a serial-to-parallel converter like the one in your September 1981 article on the Votrax phoneme synthesizer. Will that logic drive a printer as well? Would it be easier to make a whole new port? I am worried about having to change the BIOS. Commercial converters run around \$100. Would I be saving any money?

I have noticed that some equipment will run on either 110-240-V, 50- or 60-Hz current. That was the reason I bought the Z-90—it has a switch for that. What happens to other power supplies if they are not rated at other frequencies? Voltage differences are usually amenable to transformers, but what happens to my disk drive when I run it at 110 V, 50 Hz? The drive itself takes only DC, so the only problem should be the power supply. I've been told that it can be damaged.

I once had an old Hammarlund Super Pro receiver with a monstrous power supply that would go to 25 Hz. Was its size related to those capabilities? Thank you.

JONATHAN YUEN
Taiwan, Republic of China

The circuit shown on page 48 of the September 1981 BYTE can be used to convert the serial output from your computer to a parallel input for a Centronics-type printer. The conversion is accomplished completely with hardware; no software is required.

In a transformer-type power supply, the frequency rating is a function of the amount of iron in the transformer core. Transformers rated at 60 Hz will run hot at 50 Hz—and could possibly burn up. If the unit is rated at 50 Hz, it will operate safely at 60 Hz. That 25-Hz power supply of yours was monstrous due to the size of the iron core of its power transformer. Units rated for 110-220 V have a dual primary wind-

(text continued on page 62)

WAIT REDUCTION MADE EASY.

You know how hard it is to wait for the printer to finish before using the computer again. It's wasteful! Counter productive!

The solution: simply install Microbuffer™ printer buffer into the system, in seconds. And you can print and process simultaneously.

With one swift command, all printing data is dumped to the Microbuffer—it handles the printer and frees the computer for other functions.

Presto! Instant wait reduction.

Microbuffer II and II+ for the Apple II, II+, and IIG computers.

Microbuffer II comes in either a serial or a parallel version with 16K or 32K of RAM. Microbuffer II+, available with 16K, 32K or 64K, has both serial and parallel capabilities, so you can control two different printers at once. The Microbuffer II+ has on board high resolution graphics routines for 37 popular printers, and all include expanded graphics capabilities and text formatting in addition to the inherent benefit of letting you use your computer while your printer is working.

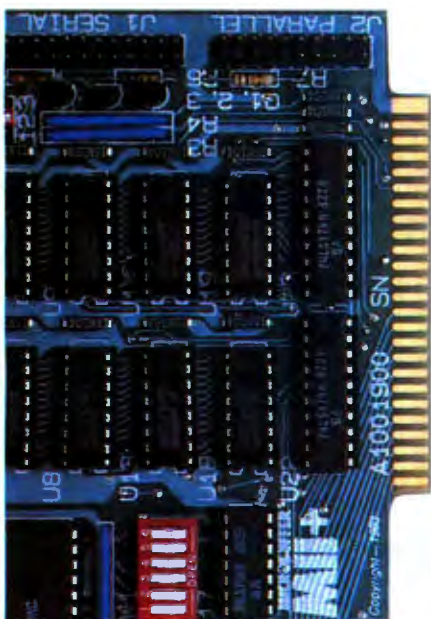

Microbuffer In-line for virtually any computer/printer combination.

These are stand-alone units that install In-line between virtually any computer and printer.

Besides printer buffering, the In-line serial interface (MBIS) can be used to efficiently transmit data from the computer to almost any device using a serial RS-232C interface. The parallel Microbuffer In-line (MBIP) is built exclusively for parallel interfacing, and works exceptionally well in virtually any parallel computer and any parallel printer.

Each of the stand-alone models have controls for making multiple copies (up to 255). With the pause control, printing may be halted at any point and continued later—it will pick up right where it left off. Even while you are printing copies of a document, additional files can be sent to the buffer and they will be processed in turn. Both

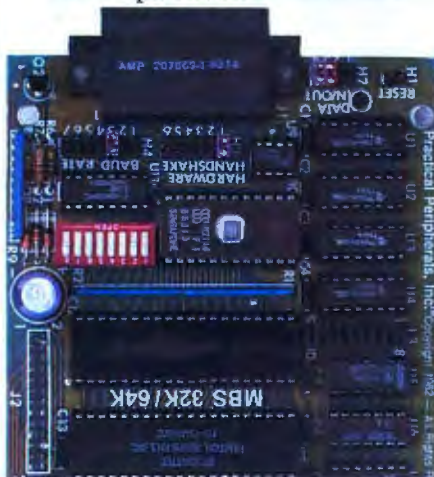

come with either 32K or 64K of RAM, and are easily upgradable up to 256K for processing greater amounts of data.

Microbuffer/E for Epson printers.

Fully compatible with Epson MX, FX, RX, and IBM-PC series printers, these easy-to-install boards simply plug inside the printer.

For parallel interfaces, the Microbuffer models MBP-16K and MBP-64K are available.

For serial interfacing, Microbuffer models MBS-8K and MBS-32/64K are available. The MBS-8K supports both hardware and software (X-ON/X-OFF) handshaking; the MBS-32/64K supports three handshaking configurations (hardware, software X-ON/X-OFF and ETX/ACK).

SO WHAT ARE YOU WAITING FOR?



PRACTICAL PERIPHERALS

31245 La Baya Drive
Westlake Village, CA 91362 USA
(213) 991-8200 • TWX 910-336-5431

©1983 PRACTICAL PERIPHERALS

FREE SHIPPING

WEST OF MISSISSIPPI
EAST — 1/2 UPS CHARGES

CALL FREE
1-800-841-2748

COMPUTERS

ALTOS 580-20	\$3645
ALTOS 586-20	\$5565
ATARI	\$CALL
APPLE LOOK-A-LIKE	\$CALL
SANYO 550-555	\$CALL

TELEVIDEO

803	\$1769	1603	\$2019
PORTABLE	\$CALL

NORTHSTAR

ADVANTAGE	\$2135
-----------	-------	--------

PRINTERS

ABATI	\$389
BROTHER HR15P	\$479
DAISYWRIER 48K	\$975
DATASOUTH DS220	\$1575
GEMINI	\$275
JUKI 6100	\$459
OKIDATA (LOW PRICES)	\$CALL
QUME 1140+	\$1275
QUME 1155+	\$1475

CITOH

8510	\$339	1550	\$559
F10-40C PS	\$970	F1055	\$1299

DIABLO

620	\$860	630	\$1689
-----	-------	-------	-----	-------	--------

NEC

3550	\$1535	3510	\$1235
7710	\$1655	2030	\$659

TERMINALS — MONITORS

ALTOS II	\$875
QUME 102G	\$529
TELEVIDEO 914	\$540
TELEVIDEO 924	\$689
TELEVIDEO 950	\$905
TELEVIDEO 970	\$965

AMDEK 300G	\$129
AMDEK 300A	\$145
AMDEK COLOR I+	\$275
AMDEK COLOR II+	\$429
B.M.C. GREEN	\$89
B.M.C. COLOR	\$245
PRINSTON HX12	\$489

DISK DRIVES — MODEMS

INDUS APPLE	\$259
MICRO SCI A2	\$229
ATARI 1050	\$365
INDUS ATARI	\$345
RANA 1000	\$310
PROMODEN	\$359
HAYS SMART MODEM	\$199
SMARTMODEM 1200	\$475
SMARTMODEM 1200B	\$415
MICROMODEM II E	\$235
RIXON 212A	\$449
U.S. ROBOTICS PASSWORD	\$325

1st PLACE

COMPUTER SYSTEMS
13422 N. CAVECREEK RD.

PHOENIX, AZ. 85022

OTHER INFORMATION: 602-867-9897



Free shipping is on UPS ground only.

Send cashier's check or money order all other checks will delay shipping two weeks.

Prices & availability subject to change without notice.



ASK BYTE

(text continued from page 60)

ing in the transformer with a selector switch for the proper voltage.

The voltage ratio is not substantially affected by small changes in frequency. Running a 50-Hz supply on 60 Hz will yield the same output voltages, so equipment operation is not affected. Your computer and disk drives run off of the rectified voltage from the transformer secondary and will not notice any change.—Steve

MORE ON THE CARRIER-CURRENT MODEM

Dear Steve,

In regard to your article "Build a Power-Line Carrier-Current Modem" in the August 1983 BYTE (page 36), I have some questions. What is the minimum separation required for mark and space frequencies? Do you have any kits or circuit boards available? Thanks for your help.

BRENT LOWENSOHN
Woodland Hills, CA

EXAR Application Note AN-01 gives several guidelines for designing with its XR-2206 modulator and XR-2211 demodulator. One of these relates to minimum bandwidth: "For any given pair of mark and space frequencies, there is a limit to the baud rate that can be achieved. When maximum spacing between the mark and space frequencies is used (where the ratio is close to 2:1) the relationship mark-space frequency difference (Hz) \geq 83 percent (maximum data rate in baud). For narrower spacing, the minimum ratio should be about 67 percent."

Thus, the minimum spacing for 300 baud would be $0.67 \times 300 = 200$ Hz, and this is the separation used in the 103-type modem format. Because, in the carrier-current modem, adequate bandwidth was available and a higher center frequency was used, the 5-kHz separation was a convenient choice.

The power-line carrier-current modem is not available as a kit, and no circuit boards have been configured.—Steve

More on Scoping Your Data

Dear Steve,

I just read the December 1983 "Ask BYTE," and on page 560 you seem to give some bad advice to Mr. Chuck Gollnick of Pullman, Washington, regarding the use of an oscilloscope to determine the data rate, parity, and stop-bit characteristics of data coming from an RS-232C port.

Specifically, you recommend the use of a character with lots of consecutive 1s to determine the data rate. This would work great if RZ signaling was used. But RS-232C uses NRZ-L signaling; what is thus needed is a character with alternating 1s and 0s to make it possible to see distinct opposite-polarity pulses. For example, the character 01010101 = U would be useful.

I have successfully determined the stop-bit characteristics of Baudot signals from a radio-teletype interface using an oscilloscope by

watching the display for extra-length bits. If you see a bit 1.5 times longer than the shortest one seen, you know it is 1.5 stop bits. By slowing the sweep so that one or two characters are seen on the display, you may also be able to come up with the stop-bit characteristics.

ROBERT FRENCH
District Heights, MD

You are correct. The transmission of alternating 1s and 0s will simplify the measurement of data rate using an oscilloscope. A series of Us is a good choice. Your method of determining stop-bit characteristics is sound and should work on an ASCII signal (7 data bits) as well as the Baudot (5 data bits). Thank you for your correction and clarification.—Steve

CLEANING DISK DRIVES

Dear Steve,

I recently noticed the large number of ads for disk-drive cleaners. This sparked two questions I'd like to have answered. How much attention do disk drives require, and what type of cleaner is best for them? Thank you for your help.

BRIAN CRAIG
Claremont, CA

The iron-oxide coatings used on most disks are somewhat abrasive. The in-out motion of the read/write head of the disk drive against this rotating medium produces a self-cleaning action and minimizes the buildup of oxide and dirt. Unless a poor-quality medium is used, head cleaning is not required often and can be accomplished with a cotton swab and some isopropyl alcohol, as well as the many head-cleaning disks available. Some head-cleaning disks are quite abrasive and should be used on an as-needed basis rather than at regular intervals.—Steve

E-Z COLOR IN KUWAIT

Dear Steve,

I plan to buy the E-Z Color Graphics Interface for my TRS-80 Model I. I am not certain, however, whether it can be used with a TV set here in Kuwait because the TV system here is based on the PAL color system and not the NTSC, as in the United States. Can the composite-video output from the TMS9918A chip be fed to a UHF modulator and the modulated RF to a 256-line PAL color TV set?

If the TMS9918A is not suitable to drive a PAL system, is there a similar chip that could be substituted in your E-Z Color Graphics Interface project in the August 1982 BYTE, "High-Resolution Sprite-Oriented Graphics," page 57?

Thank you for your time and assistance.

M. I. SALEEM
Safat, Kuwait

The Texas Instruments TMS9918A Video Display Processor used in the E-Z Color Graphics Interface is designed for a composite-video output to the NTSC format and is not compatible with a PAL TV system. A similar chip, the

(text continued on page 64)



THE PERSONAL PRINTER BUILT LIKE A SHERMAN TANK PERFORMS LIKE A CONCERT GRAND.

Why We Get Encores. Okidata takes center stage with a cast of printers that can't be outperformed. All eight dot matrix printers offer you more features for your money than you can find anywhere else. Pick your tempo: data processing at speeds from 80 to an exceptional 350 cps; to stress a point, enhanced and emphasized printing at up to 100 cps; outstanding letter quality printing at speeds three times faster than most daisywheels — up to 85 cps. Add a full range of graphics capabilities, down-line loadable character sets for creating personalized typefaces and symbols, and your print repertoire is virtually unlimited.

We Play On and On. Our virtuosos feature rugged steel frames, laser-

welded parts, and our long-life, non-ballistic print head warranted for up to one full year. With this tank-toughness you'd expect Okidata to have the lowest warranty claim rate in the industry. And we do: less than 1/2%.

In Tune with All Major Computers. We've designed each of these finely tuned instruments to be harmonious with all the major names in personal computers. And to give you more than you'd get from the major computer name printers. After all, we specialize in printers. The computer folks specialize in computers. (That's why MOST buy their printers from somebody else).

Larger Selection. Smaller Prices. Because we make more printers than anybody else, we can give you just the

right one to fit your specific needs. Not to mention your budget. Suggested retail prices range from \$299 to \$2995. Call 1-800-OKIDATA (in NJ, 609-235-2600) for the dealer nearest you. Both you and your computer will enjoy the performance. Or write OKIDATA, Mt. Laurel, NJ 08054.



OKIDATA
an OKI AMERICA company

(text continued from page 62)

TMS9929A, is pin compatible except for four pins and outputs luminance and color-difference signals that can be combined through a video encoder (such as the National Semiconductor LM1889) to produce a 625-line PAL composite-video signal. This signal can be fed through a modulator to your color TV or additional circuitry added to use the modulator feature of the LM1889.

The video-encoder circuit requires modifica-

tion of the E-Z Color Card and the addition of extra components.—Steve

HARDWARE TRAINING PROGRAM

Dear Steve,

I would appreciate your comments on the value of hardware training programs. Over the last few years I have done some work with software, but I would now like to investigate hard-

ware design. Any information you have would be appreciated.

MICHAEL R. FORRY
Newport Beach, CA

The Heathkit hardware training courses are an excellent means of learning electronic hardware operation and design. Heath's documentation is famous for being clear and thorough, and the hardware breadboard trainers give you the "lab" work so necessary to support the theory. You can proceed at your own pace and tailor your studies to your particular interests.

In addition to the Heathkit courses, other schools offer at-home training in electronics. Two of them are NRI Schools, McGraw-Hill Continuing Education Center, 3939 Wisconsin Ave., Washington, DC 20016 and National Technical Schools, 4000 South Figueroa St., Los Angeles, CA 90037. Write them for further information.—Steve

BASIC VIDEO

Dear Steve,

I'd like to ask a couple of questions on everybody's favorite topic—video monitors. What do references to column widths mean in ads for monitors? Some just list monitors, but others advertise 40-, 60-, or 80-column monitors, as if they're talking about printers. I'm thinking of adding a monitor driver to my Radio Shack Color Computer, connecting it to a monochrome monitor, and using it with the Telewriter's word-processing program. Because Telewriter's highest resolution provides an 85-character line, do I need an 85-column monitor (I've never seen one advertised), or do I need to worry about such things at all, considering that the program uses the high-resolution-graphics mode to draw the letters on the screen?

I've seen three green-screen monitors in the \$100 price range. Can you comment on and/or recommend any of these, or are all \$100 monitors pretty much equal?

With monitors available in the \$100 price range, is it worthwhile considering converting a TV into a monitor by bypassing the tuner and other circuits, or is that more trouble than it's worth?

DUFF KENNEDY
Santa Barbara, CA

With all the letters pertaining to video monitors that I've recently received, it must be everybody's favorite subject.

Column width is a simplified means of relating the video bandwidth of monitors. Many computers are designed to be used with a TV set and display only about 40 characters per line. This occurs because a TV set's bandwidth is restricted (TV channels are only 6 MHz apart, and the video bandwidth is about 3.5 MHz) and cannot clearly display more than this number. Monitors advertising 40-column width are comparable to a TV set.

Word processing requires an 80-column line to completely fill a standard sheet of 8½- by 11-inch paper, and monitors that can display this
(text continued on page 66)

The Data Defenders



The Ring King™ Data Defenders. A rugged defense against grit, sharp objects, bending and all other enemies of magnetic media.

New Tray. The Ring King 070 Tray has an attached, hinged lid that locks. Built-in handles for easy moving. Inside are seven rigid dividers and room for 70 mini diskettes.

Flip File. Closed, it's a vinyl binder that protects 20 mini diskettes. Open, the cover flips up and out of the way to pre-

sent diskettes for fingertip selection.

These Data Defenders can organize and protect your data. Visit your Ring King dealer or write for our Diskette and Data Filing Systems Catalog. Ring King Visibles, Inc., 2210 Second Ave., Muscatine, Iowa 52761 (800) 553-9647, in Iowa (319) 263-8144.

**LEADERS IN
COMPUTER SUPPORT**



In the Hard Disk Jungle Tallgrass Clears A Path



In today's hard disk jungle, Tallgrass clears a path by offering high performance, integrated mass storage solutions for the IBM® PC/XT, the T.I. Professional and related computers.

TALLGRASS INNOVATIVE FEATURES

MASS STORAGE SYSTEMS with formatted HardFile™ capacities of 6, 12, 20, 35 and 70 Mb, all with built-in tape backup.

CONVENIENT INTEGRAL TAPE BACKUP SYSTEM allows rapid tape "image" streaming, or incremental file-by-file backup and restore on ANSI standard inexpensive data cartridges, instead of the usual floppies, video cassettes, or low-capacity removable Winchester devices.

NETWORK READY and fully compatible with networks such as PCnet® and EtherShare™.

HIGH RELIABILITY with dual directory and read-after-write verify options. A dedicated landing zone, where the read/write heads reside when the disk is idle, provides data protection during powerdowns and transportation.

Follow the Tallgrass path to your local computer dealer and watch your personal computer transform into a powerful data processing system.

Available from COMPUTERLAND®, Entré® Computer Centers, MicroAge® Computer Stores and other participating computer dealers.

New! IBM-XT Cartridge Tape Backup

World Headquarters: Tallgrass Technologies Corp. / 11100 W. 82nd St.
Overland Park, KS 66214 / 913/492-6002 / Telex: 215406 TBYT UR

Canadian Headquarters: Tallgrass Technologies (Canada), 1775 Meyerside Drive
Mississauga, Ontario, Canada L4V 1H2 / 416/673-3244

European Distributor: CPS Computer Group, LTD
Birmingham, England B276BH / (021) 7073866

Australian Headquarters: Tallgrass Technologies (Australia) / Five Dock Plaza,
Suite 12/50 Great North Road / Five Dock / Sydney, N.S.W. 2046 / (02) 712-2010



**Tallgrass
Technologies**
Corporation

LOOK NO FURTHER! we'll get you low prices and fast service, or else!



ALPHA OMEGA COMPUTER PRODUCTS

COMPUTERS

TAVA PC IBM Compatible, 128K, 3-320K Drives, Parallel Port, Monitor	\$1989
SANYO MBC 555 w/software	1049
ROMAR 64K Apple compatible	SAVE
IBM PC 64K, 2-320K Drives, Color Graphics Board, DOS 2.1, Amdek 300G	2669

DISKETTES

SCOTCH 3M SSDD	\$23
MAXELL MD2 DSDD	.39

PRINTERS

C. ITOH 8510 P. 120 cps	SAVE
EPSON FX80 160 cps	\$495
EPSON FX100 160 cps	695
OKIDATA Microline 92 160 cps	445
OKIDATA Microline 93 160 cps	719
BMC BX-80 Printer	259
GEMINI 10X 120 cps	279
GEMINI 15X 120 cps	425
NEC 3550 35 cps L/Q	SAVE
JUKI 6100 L/Q 18 cps	445
PRINTER Pal	24

MODEMS

HAYES Smartmodem 1200	\$489
HAYES Smartmodem 1200B	425
HAYES Micromodem IIe	249
ANCHOR A. Mark I 300 Baud	81
ANCHOR A. Mark XII 300/1200	269

MONITORS

TAXAN 12" Amber	\$115
GORILLA 12" Green	85
AMDEK 310A for IBM PC	169
AMDEK 300G 12" Green	135
AMDEK 300A 12" Amber	145
AMDEK Color I 13"	305
PRINCETON HX-12 RGB	495
BMC 13" Color	219

APPLE PERIPHERALS & SOFTWARE

VIDEX Videoterm 80C w/softswitch	\$209
VIDEX Ultraterm	279
MICROSOFT 16K RAMcard	69
MICROSOFT 280 Softcard	245
MICROSOFT Premium Pack	479
MICROSOFT Premium Softcard IIE	345
KRAFT & TG Joystick	45

HAYES Mach II Joystick	33
PROMETHIUS 1/2 Height Drives	195
WIZARD IPI Parallel Interface	75
PROMETHIUS Versacard	149
EPS Keyboard	289
KENSINGTON Systemsaver	68
COOL & TIME (fan, surge, clock)	75
KOALA Pad	93
PFS Filing System	81
PFS Report	81
DBase II	389
Wordstar	249
Home Accountant	SAVE
Multiplan	165
DB Master Version 4	249
DB Utility 1 or 2	95
Magic Window II	109
Zaxxon	29
Chopliker	25
Zork I/II/III	28
Wizardry	39
Sublogic Pinball	27

IBM PERIPHERALS & SOFTWARE

TANDON TM100-2 360K	\$219
TEAC 1/2 Height 360K	195
MICROSOFT Mouse	139
QUADRAM Quadboard w/64K	269
QUADRAM Quadlink	SAVE
QUADRAM Quadcolor I	209
64K RAM Kit 200 ns	55
AST 6-pack plus	SAVE
STB w/64K clock, par, serial, game	295
HAYES Mach II Joystick	35
MAYNARD Int. 10MB Hard Disk	999
Property Management	335
Home Accountant +	SAVE
Multimate	329
PFS Filing System	89
PFS Report	81
Lotus 1,2,3	325
DBase II	389
Friday	189
Wordstar	259
Wordstar Propack w/Mallmgr, Spellstar	359
Multiplan	165
Flight Simulator	33
Deadline	38
Zork I/II/III	28

Hundreds of available items. Call for complete pricing information.

We do not charge for VISA or MASTERCARD

(213)
(818) **345-4422**

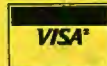

18612 Ventura Blvd., Tarzana, CA 91356

All products are in factory sealed packages. We guarantee all items for 30 days. Within this period, defective merchandise returns must be accompanied by RMA number. All other returns will be subject to a 10% restocking fee. For prepaid orders there will be a 3% shipping charge; 5% for UPS Blue Label; \$5.00 minimum; all orders outside U.S. at 15% shipping. There will be an additional \$4.00 surcharge on C.O.D. orders. Cash or Cashiers Check is required on C.O.D. orders. Calif. residents add 6.5% sales tax. Prices subject to change without notice.

ASK BYTE

(text continued from page 64)

many characters need increased bandwidth. Whether they are advertised as 80- or 85-character displays is not important; the ad is telling you that they have the bandwidth to display a full line.

Rather than comment on the \$100 monitors, I refer you to the October 1983 Consumer Reports. Pages 537-540 feature an article on choosing a monitor and include comparisons of several monitors in the \$100 price range.

Finally, it is more trouble than it is worth to convert a TV into a monitor, especially if proper grounding and isolation techniques are not used. The risk of electric shock or an unwanted ground loop fed back into your computer can more than offset the cost of a good monitor.—Steve

MULTIPROCESSING HELP

Dear Steve,

I want to build a multiuser, multiprocessor, CPM-oriented computer in which each user has a microprocessor and 64K bytes of RAM. I know enough about CPM to write the BIOS (basic input/output system), and that once a bootstrap loader is written to load CPM from disk to memory and to transfer execution to CPM, I am home free. But because I have never used a multiprocessor computer, the concept is unclear to me as to what is going to happen when two users try to access the same disk or file simultaneously.

Once I physically configure the system, however, how can I use it to write the CPM and bootstrap loader and save it on a floppy disk starting on sector 0, track 1? Also, can I be sure that the automatic power-up sequence in the floppy-disk controller will load the bootstrap loader in at location 80 hexadecimal and transfer execution there?

My main problem is that in this part of the world I can't get any book I need or pop into the local computer store for questions. I would really appreciate your help on this.

TARIQUL HASAN
Dhaka-2, Bangladesh

In a multiuser CPM system, each user is assigned a user code number from 0 to 15. The user numbers are assigned using the built-in CPM function called USER. Once a user number is assigned, the user can access only files on the disks with that user number. It is not necessary to set aside disk space for each user because the user number is assigned to the file when it is put on the disk. When a cold start is performed, each user is assigned to user 0 and can access only programs in that user area until a different user number is assigned with the USER command.

When a system operates with CPM, the instructions for initiating the system usually come with the microprocessor hardware or with the CPM software you receive with the microprocessor. If these instructions do not come with the system you purchase, it would be a good

(text continued on page 68)

MEGABYTES FOR MICROBUCKS

In a field where so-called "break-throughs" are proclaimed nearly every day, SORD's new M68 is the genuine article. Incredible memory, processing speed and software flexibility at simply unbelievable prices. Ideal for your business, scientific and engineering applications.

DUAL PROCESSOR ARCHITECTURE

Not just any two processors, either. The state-of-the-art MC68000™ 16-bit main CPU runs at a blinding 10 MHz. A Z80A™ CPU runs thousands of 8-bit applications, and the AMP9511 Arithmetic Processing Unit can make them faster than ever before.

A MAINFRAME'S WORTH OF MEMORY

The base M68 model starts with 256K of parity-checked RAM and is expandable up to 3.2 megabytes. The M68-IM starts with a megabyte and can be expanded to an incredible four megabytes with available plug-in boards. Even large mainframes don't enjoy such power. Think of the number-crunching you can do with four megabytes on your desk.

ADVANCED GRAPHICS

High resolution graphics are standard on all M68's. 640 x 400 pixels in either monochrome or up to 16 colors, with a detailed 8 x 16 character grid for easy readability hour after hour, even in color. Special LSI circuitry and the super fast CPU make high speed drawing a reality.



EXPANDABILITY PLUS

M68's are now available with high-capacity 5¼-inch disks; 8-inch floppy disk and hard disk drives available this fall. Two serial ports, a Centronics-compatible printer port, a light pen port and a GPIB/IEEE-488 port are standard.

SOFTWARE VERSATILITY

The M68 can run more software than any machine in its class. Operating system choices include CP/M-68K™, RDOS, UCSD P-system™, CP/M-80™, KDOS and the PIPS software system that has revolutionized Japanese management and is now used by Citibank, Bank of America and other major corporations in over 45 countries. Choose from C, FORTRAN, Pascal, COBOL, BASIC and more. Supports mainframe communications links, graphics, and a wealth of applications software.

MIND-BOGGLING PRICING

If this kind of power sounds expensive, guess again. M68 systems start at less than \$5,000, and even four megabyte systems start at approximately \$13,000! Each IMB plug-in board is \$2495, available separately as required.

FIND OUT MORE NOW

SORD may be the new guy in the U.S. market, but they're big news around the world. SORD, Japan's fastest growing company, and one of Japan's largest manufacturers of business microcomputers, is an international leader in both hardware and software.

GET STARTED NOW

Find out how you can benefit from the most powerful desktop systems available.

1-800-223-1796

IN NEW YORK: (212) 206-4045

SORD

THE NEXT GENERATION...NOW

SORD COMPUTER OF AMERICA, 723 West 7 Street, Los Angeles, CA 90017
645 Fifth Avenue, New York, NY 10022

CPM—Reg'd trademark of Digital Research UCSD Pascal: Reg'd trademark—Univ. of Calif. at San Diego MC68000—Reg'd trademark, Motorola Corp. Z80A—Reg'd trademark, Zilog, Inc.



M2CBASIC™ translates BASIC-80™ directly to CBASIC™.

If your code is in any of these languages: IBM PC BASICA, MBASIC, GW BASIC, Business BASIC or DR Personal BASIC; M2CBASIC can translate it to syntax for CB-80, CB-86 and CB-68K compilers. You get the best features of both languages:

- Random I/O supported
- Multi-line functions
- DR Access Manager
- DR Display Manager
- Multi-user record locking
- BCD arithmetic

Get the M2CBASIC program today from Westico. We carry hundreds of software programs in formats to fit over 120 microcomputers. We ship orders within 24 hours. And, our after sales service will keep you smiling. Find out about all our programs with our new software directory.

- Please send me an M2CBASIC program and documentation: \$175*
- M2CBASIC documentation only: \$25*
- Send me your new software directory.

C.O.D. _____ Visa _____ MasterCard _____
 Card No. _____ Exp. _____
 Model of Micro _____ 5 1/4" _____ 8" _____
 Name _____
 Firm _____ Tel. _____
 Address _____
 City _____ State _____ Zip _____

(* Plus \$3.00 shipping and handling in North America. CT residents add 7 1/2% sales tax.)

Mail to:

WESTICO

25 Van Zant Street • Norwalk, CT 06855
 (203) 853-6880 • Telex 64-3788

BASIC-80 is a trademark of Microsoft, Inc.
 CBASIC is a trademark of Digital Research, Inc.
 M2CBASIC is a trademark of BUZZWORDS, Inc.
 © Copyright 1984, Westico, Inc., Printed in U.S.A.

WES-41

ASK BYTE

(text continued from page 66)

idea to purchase a reference guide that shows you how to write a bootstrap loader. A good manual on the subject is *The Programmer's CPM Handbook* by Andy Johnson-Laird. For information on translations and book distributors outside the U.S., write to Osborne/McGraw-Hill, 2600 Tenth St., Berkeley, CA 94710.

In general, the bootstrap loader for a system resides in a PROM or an EPROM that is bank-switched into the memory address space starting at address 0000 hexadecimal. When a hardware reset is performed, the microprocessor looks at this address for its first instruction. If the bootstrap were not in firmware, a boot program would have to be written each time the system was reset. The program must load the CCP (command control processor), BDOS (basic disk operating system), and BIOS from disk and then transfer control to the cold-boot entry point in the BIOS. Hardware manufacturers usually offer this firmware with the CPM system they are selling.

For further information on this subject, you should purchase the manuals for the particular system that you intend to buy.—Steve

COMMUNICATION WITHOUT WIRES

Dear Steve,

You are no doubt extremely familiar with most input and output devices. My project involves the transmission of data from one computer to another (I am using two VIC-20s). The catch is that I will try to achieve this without using wires, i.e., transmitting data without having the two machines connected.

I realize that connecting computers and peripherals by infrared light has already been accomplished, therefore I am considering using the radio spectrum as a means of transmission.

My best bet would probably be to utilize the RS-232C interface for my actual transmission and reception. The concept would involve (from what I understand) converting the parallel signal to a serial, and then to an analog, which could be transmitted over a carrier wave to the receiving unit.

This is purely an idea. I have no working knowledge in the area and can only guess. I would value greatly your reflections on the subject. Thank you very much.

DALLAS KACHAN
 Blind River, Ontario, Canada

Your idea of transmitting computer data via the radio spectrum is a form of radioteletype, which has been in use for years with a 5-bit code known as Baudot. Early devices were mechanical in nature and connected by wires. Radio transmission was achieved by connecting these mechanical units to a modulator for transmitting and a demodulator for receiving. Recently, the U.S. Federal Communications Commission approved the transmission of ASCII over the airwaves, which stimulated the application of computers to this form of communications.

The concept of radioteletype is analogous to Morse code, except that marks and spaces replace the dots and dashes. Where Morse code uses timing to distinguish dots from dashes, radioteletype uses frequencies to distinguish marks from spaces. Data is converted into a serial stream, modulated into audio tones, and then transmitted. On the receiving end, these tones are demodulated and decoded into data.

This system operates much as a modem connects two computers via a telephone line. In the February 1981 *BYTE*, I wrote an article on controlling a Big Trak computerized toy tank (page 44). I used a pair of inexpensive citizens band walkie-talkies to send data via the airwaves using a modem. A small, inexpensive modem, described on page 26 in the March 1983 *Circuit Cellar* article "Build the ECM-103, an Originate/Answer Modem," simplifies the project by reducing the number of components involved.—Steve

ADVANCED VIDEO

Dear Steve,

In an "Ask *BYTE*" letter from D. K. Broberg ("Calculating Bandwidth Revisited," November 1983, page 602), the argument was made that the video bandwidth required of a video pixel stream can be obtained not as the inverse of the pixel rate but as the inverse of half the pixel rate. The reasoning was that driving alternating pixels fully on and fully off represents the worst-case demand for bandwidth, so the inverse of the two-pixel period yields the frequency of interest.

This argument is not correct. If the video-stream pixels could be accurately represented by sine waves or contiguous half-cycles of sine waves, Broberg would be quite right. However, a harmonic structure is associated with any kind of waveform other than sines, and a pixel stream requires a better representation than sines in order to preserve edge definition in the image. Ideally, the pixel stream would show instantaneous jumps from the amplitude level for one pixel to the amplitude for the next. At worst, this would result in a square-wave period equal to two pixel times. However, the bandwidth is not 1/(two pixel times). Fourier analysis shows that a square wave contains all odd harmonics. To get an acceptable picture, it is necessary for the video amplifiers to pass the third harmonic, which is at 3/(two pixel times). For a pixel time of 100 nanoseconds, this requires a video bandwidth not of 5 MHz, but of 15 MHz.

ROBERT P. COLWELL
 Pittsburgh, PA

Thank you very much for your response to D. K. Broberg's letter. The harmonic content of square waves is often overlooked in digital analysis when only levels are of concern. As you correctly point out, however, third-harmonic distortion should be kept low, and a video-amplifier bandwidth sufficient to pass these fre-

(text continued on page 70)

LOOK WHO BUYS SOFTWARE FROM US!

IBM • XEROX • NCR
 CHEVRON • GTE • SPERRY
 JFK SPACE CENTER • ARAMCO
 AT&T • BENDIX • PRICE WATERHOUSE
 HEWLETT PACKARD • GENERAL ELECTRIC
 GENERAL DYNAMICS • TRW • ARTHUR ANDERSEN & CO.

If you order software from us, you're in good company. You see, some of our best customers are America's biggest corporations.

Maybe they're attracted by our low, low prices (big companies are price-conscious too!).

Or maybe when you're an "IBM", you're looking for something extra. Like the personal service, giant inventory, and in-depth technical support you'll

find at 800-SOFTWARE.

You see, when you call us, we'll take care of you like our business depends on it. Because it does. Which means when you place an order, you can be sure we'll fill it promptly. And that our unique Order Tracking System™ is keeping tabs on your order every step of the way.

Most important, we'll be there if you need us after your software arrives. We'll make

sure that you'll receive the finest technical support and customer service in the industry. And that's a promise.

Next time you're looking for low price and great service, do what IBM, General Electric, and a lot of other big companies do. Pick up the phone and give us a call.

We'll show you why some hard-headed companies buy their software from us.

CHECK OUT ALL OUR INCREDIBLE BUSINESS SOFTWARE PRICES:

WordStar™ PROF PAK \$389	Lotus™ 1-2-3 \$329	SuperCalc 3™ \$259	dBASE II™ \$399	
WordStar™ \$269	InfoStar™ \$289	SuperCalc 2™ \$169	Crosstalk™ \$119	
ANDERSON BELL™ Abstat \$339 ASHTON-TATE™ dBase II \$399 dBase II User's Guide \$ 20 Friday! \$219 ATI™ TRAINING PRODUCTS CALL CDEX™ TRAINING PRODUCTS CALL CONDOR™ 3 \$269 CONTINENTAL™ Home Accountant \$105 DIGITAL RESEARCH™ CPM 86 CALL Concurrent CPM 86 CALL CBasic 86 CALL All Other Products CALL FOX & GELLER™ Quickcode \$199 dGraph \$199 dUtil \$ 65	All Other Products CALL HAYES™ Smartmodem 300 \$249 Smartmodem 1200 \$549 Smartmodem 1200B \$489 HERCULES™ Color Graphics Card \$409 HOWARDSOFT™ Tax Preparer \$229 HUMANSOFT™ DB Plus \$ 79 IMS™ 4-Point Graphics \$129 All Other Products CALL IUS™ EasyWriter II System \$229 EasyWriter I System \$140 IUS Accounting \$299/mod. All Other Products CALL LIFETREE™ Volkswriter Deluxe \$179 LOTUS™ 1-2-3 \$329	MAXELL™ DISKETTES CALL MEMOREX™ DISKETTES CALL MICROPRO™ WordStar (w/Training Mod.) \$269 WordStar Prof. Pak (WS/MS/SS/ST) \$389 WordStar/MailMerge \$369 InfoStar \$289 Options Pak (MM/SS/ST) \$169 MailMerge \$139 PlanStar \$339 ReportStar \$229 Star Index \$129 All Other Products CALL MICRORIM™ RBase 400B \$369 RBase Extended Report Writer \$109	Interface \$299 MICROSOFT™ Fortran \$269 Multiplan™ \$149 Word™ \$289 Word™ w/Mouse \$359 All Other Products CALL MICROSTUF™ Crosstalk \$119 NORTON™ UTILITIES \$ 59 PEACHTREE™ PEACHTEXT 5000 \$239 PERFECT SOFTWARE™ Perfect Writer \$209 Perfect Link \$119 All Other Products CALL QUADRAM™ Quadboards 64K/256K \$329/\$489 Quadlink \$559	ROSESOFT™ Pro Key \$ 99 SOFTWARE PUBLISHERS™ PFS File \$105 PFS Graph \$105 PFS Report \$ 95 PFS Write \$105 SOFTWARE SYSTEMS™ Multimate \$349 SORCIM™ Supercalc 2 \$169 Supercalc 3 \$259 All Other Products CALL VISICORP™ Visicalc Advanced (Apple IIe) \$269 Visicalc \$189 Visi-On Products CALL All Other Products CALL

WE ALSO CARRY HUNDREDS OF OTHER PRODUCTS!



WRITE:
 800-SOFTWARE, INC.
 940 Dwight Way, Suite 14
 Berkeley, CA 94710



Copyright 1984 Software Inc.
 Microsoft is a registered trademark.

800-SOFTWARE

TO ORDER CALL TOLL FREE:
 800-227-4587 or 415-644-3611

- We guarantee our products against manufacturing defects.
- Quantity discounts available through our National Accounts Program.
- Purchase orders accepted. Please call in advance.
- Prompt U.P.S. or Federal Express shipping. Overnight delivery available. Call for shipping charges.
- Call for free catalog and other low software prices.
- We do not add surcharge for credit card purchases.
- Prices may change.
- International orders welcome. Telex #751743 800-SOFTWARE UD.

(text continued from page 68)
 quencies should be used. A general rule would be to use as high a bandwidth as possible but settle for any monitor that you visually judge to have a satisfactory display.—Steve

SHUGART SA-400s FOR APPLES

Dear Steve,

I have an Apple II with one 5¼-inch Apple disk drive. I'd like to use my Apple with a

Shugart SA-400 drive. I know these components are incompatible, but can you show me how to create a proper interface? Thank you.

CLAUDIO PUGLIESE
 Buenos Aires, Argentina

A printed-circuit board and complete instructions for modifying a Shugart SA-400 disk drive for use with your Apple II can be obtained for \$29.95 from R & D Electronics, 100 East Orange-thorpe, Anaheim, CA 92801, (714) 773-0240.

Several traces on the SA-400 printed-circuit board must be cut and several jumper wires installed in addition to the interface-circuit board that connects between the Apple II cable and the 34-pin edge connector on the SA-400.

It is important to note that the SA-400 and this modification draw about 450 milliamperes from the Apple II's +5-V supply. If your system has many expansion cards, you may want to consider a separate power supply.—Steve

REPLACING 4116s WITH 4164s

Dear Steve,

I have an Atari 400 with the 16K-byte memory board. I would like to know if it is possible to change the 4116 memory chips to 4164 chips, add some jumpers, and have a 64K-byte board. Thank you for your help.

RANDY B. BUMGARNER
 Taylorsville, NC

In theory, upgrading from the 4116 to the 4164 is as simple as adding a few jumpers if the memory system was originally designed to do this. In most cases, it is more complicated.

The 4116 used a three-voltage power-supply system that was changed to a single +5-V supply for the 4164. This left two extra pins that could be used for addressing. On the 4164, only one of these pins was needed to upgrade the chip to a 64K-byte part. The following chart shows the reassignment of the pins:

Pin	4116	4164
1	-5 V	N.C.
8	+12 V	+5 V
9	+5 V	A7

Pin 1 can be handled easily by cutting the -5-V trace on your board that goes to your memory array. Pin 8 can be reassigned by cutting the +5-V and +12-V traces to your memory array and jumpering the trace from pin 8 to the +5-V supply. The trace from pin 9 now will be your new address line, and all decoupling capacitors on this line in your memory array must be removed.

That was the easy part. Now the memory address multiplexing portion of your board must be modified to bring in the new address line A7. Because I am not familiar with the addressing used on the Atari board, I can only suggest that you look over that portion of the circuit carefully before making any changes. An error here will be disastrous. You also must be careful that your new 64K-byte memory does not conflict with any other memory already assigned in the system, for example, any ROM or memory-mapped I/O devices.—Steve

REAL-TIME CLOCK THOUGHTS

Dear Steve,

I'd like to suggest a project for your Circuit Cellar.

I just after a real-time clock for my IBM PC, but all my expansion slots are full of other
 (text continued on page 74)



**DATASOUTH DS 120
 LOW COST HIGH PERFORMANCE
 FOR YOUR DECwriter II**

With the DS120 Terminal Controller, your DECwriter II's LA36 performs like a DECwriter III, at only a fraction of the cost. In minutes, you can replace your LA36 logic board with a DS120, and get all these high performance features:

- 165 CPS BIDIRECTIONAL PRINTING
- HORIZONTAL AND VERTICAL TABS
- PAGE LENGTH SELECTION
- 110-4800 BAUD OPERATION
- 1000 CHARACTER BUFFER
- X-ON, X-OFF PROTOCOL
- SELF TEST
- LSI MICROPROCESSOR ELECTRONICS
- RS232 INTERFACE
- 20 MA CURRENT LOOP INTERFACE
- TOP OF FORM
- ADJUSTABLE MARGINS
- DOUBLE WIDE CHARACTERS
- PARITY SELECTION
- OPTIONAL APL CHARACTER SET
- STRICT QUALITY CONTROL

More than 10,000 LA36s are already using DS120 Terminal Controllers to perform like DECwriter IIIs. So can yours. Call now, toll-free, for all the details.

datasouth
 HIGH PERFORMANCE MATRIX PRINTERS
 CALL TOLL FREE:
 1-800-222-4528

Datasouth Computer Corporation
 P.O. Box 240947, Charlotte, N.C. 28224
 704/523-8500 Telex 6843018 DASOU UWW

WE BUILD TO SUIT

How would you like your Sanyo System? We're selling Sanyo 550 systems with dual disk drives, MS-DOS, Sanyo Basic, Wordstar, Calcstar, EasyWriter I, a high-resolution Sanyo CRT-36 monitor, and cables for \$1099.

We have Sanyo Systems with the same software, dual 320/360K disk drives, and a CRT-36 monitor for \$1399. And, if you buy your Sanyo from us we'll install and test an additional 128K of RAM for a mere \$98.

But we don't just offer 1 or 2 specially-priced package deals. Tell us what you want and we'll put together a system for you. We think you'll find our prices competitive and our service second to none.

PC PLUS™ \$1099
PC DELUXE™ \$1399

Extra software w/purchase: Spellstar, InfoStar and Mailmerge add \$199.
 No dealers please.

SANYO 550



SANYO

FREE LG PRINTER



Special sale on "4-digit" Sanyo computers. All include dual drives, Basic, Wordstar, Calcstar, Mailmerge, Spellstar and Infostar. Plus prices include a Sanyo 5000 letter quality printer (may be deducted for \$200 credit). The 1150's have dual 320K drives, the 1250's and 4050's feature 1.2 megabytes of formatted storage.

All Sanyo systems have a full one year warranty on the main board, 90 days on everything else, and can be serviced at over 30 service centers nationwide (quantities limited).

1150 w/CP/M \$1695
 1250 w/CP/M \$2095
 4050 w/CP/M-86 \$2149

ALTOS



From the lowest-priced dual-floppy multi-user systems to true 16-bit 10Mhz, multi user systems. Local service available via TRW. We will configure, test and install your systems for an additional charge (call for prices).

580-20 \$3629
 580-40 \$5099
 586-30 \$6995
 586-40 \$7395
 8000 Series Call

Columbia

Now even lower prices!



Don't buy a clone alone when you can get one with MS-DOS, CP/M/85, Basic, Perfect Writer™, Perfect Speller™, Perfect Calc™, Perfect File™, Fast Graphs, Home Acc't Plus, Space Commanders, a tutorial and nationwide Bell and Howell service. (Prices for 1600 series include video card and keyboard).

V.P. \$2249
 Xtra 128K Installed \$279
 1600-1 \$2499
 1600-4 (10mb) \$3695

TERMINALS



ADDS VIEWPOINT \$449
 Also great prices on the Viewpoint 60, Wyse, TeleVideo, Altos, Zenith and Qume terminals.

DRIVES

1/2 Height Teoo Drives
 160K (55A) \$89
 320K (55B) \$189

PLOTTERS

Sweepco \$479
 HI DMP-29 \$1795
 HI DMP-40 \$745
 HI DMP-41 \$2340

TeleVideo Multi-User Systems Call

PRINTERS

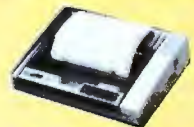

Tally Spirit \$298
 Tally 160/L \$599
 Tally 180/L \$777
 Okidata 92 \$174 Off
 Okidata 93 \$290 Off
 Plug N' play FREE
 Gemini 10X \$115 Off
 Gemini 15X \$140 Off
 Prism 132
 all aprs. \$1449
 Toshiba 1351 \$1515
 Riteman new low prices

Scottsdale Systems Ltd.

617 N. Scottsdale Road, Suite B, Scottsdale, Arizona 85257

 (602) 941-5856 

Call 8-5 Mon.-Fri. Closed July 1-8 for Summer Vacation



We participate in arbitration for business and customers through the Better Business Bureau of Maricopa County.

SERVICE/ORDERING

INTEGRATION: Prices listed are for new equipment in factory sealed boxes with manufacturer's warranty. We will pretest your equipment, integrate your system, configure your software, provide special cables, etc., for an additional charge. Call for prices.

ORDERING: MAIL ORDER ONLY. Prices listed are for cash. No C.O.D.'s. We sell on a Net 30 basis to Fortune 1000 companies and Universities with good credit. P.O.'s add 2% charge cards add 3%. Az. residents add 6%. Prices subject to change, product subject to availability. Personal checks take 3 weeks to clear. 0-20% restocking fee for returned merchandise. Shipping extra - products are F.O.B. point of shipment. CP/M and MP/M are registered trademarks of Digital Research, Wordstar is a registered trademark of MicroPro International, IBM and IBM PC are registered trademarks of International Business Machines Corporation. TeleVideo® is a registered trademark of TeleVideo Systems, Inc.™ SOFTWARE: Sold only w/systems, not warranted for suitability.

LETTER QUALITY

Silver Reed 500 \$409
 Silver Reed 550 \$559
 Diablo 630 \$1669
 NEC 2030 \$799
 NEC 3550 \$1771
 NEC 7710 \$1949
 DTC 360Z \$995
 Juki 6100 \$449

PASSWORD 300/1200

The best price on the best selling auto dial/auto answer, 300/1200 baud, auto speed, auto mode, full/half duplex, modem. Price includes power, phone, and RS-232 cables.

\$319



OKIDATA

Now you can have twice the resolution of an Okidata 92 for less. Buy an Okidata 82 at the retail price of \$349 and we'll install an Ok-Writer enhancement for \$60. You'll have the perfect double duty printer with 120 c.p.s. in draft mode and a 18x17 resolution in correspondence mode, plus a serial port. Call for print sample, you be the judge.

Ok 82 w/Ok-Writer \$409



WANTED



SOMETHING TO RELIEVE THIS MESS!

If you've ever found yourself searching for a calculator or a notepad when you've got a computer right in front of you, then you know the absurd situation we're illustrating.

Sure, there are clumsy little programs you can boot up to accomplish these tasks . . . but it always means first stepping out of the software you're working with.

What's always been needed is a tiny piece of software, occupying only a few K, that would be tucked away in an unused part of RAM no matter what program you're running. Whether you were running dBaseII, Lotus 1-2-3,

WordStar or whatever . . . it would always be ready for lightning-fast use. You could just hit a button and a window would open that would offer you a notepad, business or scientific calculator, an ASCII table, a Metric converter and even an appointment calendar. Hit the button again and your work would be saved to disk and you'd be right back in your original software!

WANT DELIVERED

Something totally new in applications software from Borland, the folks who make Turbo Pascal®

ALWAYS PRESENT IN RAM, NO MATTER WHAT SOFTWARE YOU'RE RUNNING!

- A CALCULATOR
- A NOTEPAD
- AN ASCII TABLE
- METRIC CONVERSION
- APPOINTMENT CALENDAR

HIT THE BUTTON, AND THE SIDEKICK® WINDOW OPENS ...

HIT IT AGAIN, AND YOU'RE RIGHT WHERE YOU LEFT OFF IN YOUR ORIGINAL PROGRAM!
(You never really left!)



SIDEKICK®
INTRODUCTORY OFFER
\$49.95

Available only for the IBM PC, XT, jr. and Compatibles.

NOW . . . Whether you're working in dBaseII, Lotus 1-2-3, WordStar or whatever . . . You'll have your SIDEKICK®, too!

Something brand new. Crafted in Assembly language as carefully as Borland's famous Turbo Pascal®, so that it's lightning-fast and as compact as only Borland knows how to make it! With a notepad that has a full-screen editor that saves your notes to disk. Then, your applications software can access and use those files.

Suppose, for example, that you're working with a spreadsheet, and you suddenly have an important idea. All you have to do is hit the button, a window opens, you write the note and hit the button again. You're right back where you left off in the spreadsheet. The calculator, the ASCII table and the Metric Converter all work the same way, too.

We designed it because we needed it. If you've ever been writing a report and needed to do a quick calculation or jot down a note, then you understand why.

Circle 49 on Inquiry card.

Order Your Copy of SIDEKICK® Today!

For Visa and MasterCard orders call Toll Free 1-800-227-2400 ext 953 in California 1-800-772-2666 ext 953
(lines open 24 hours, 7 days a week) Dealer and Distributor Inquiries Welcome 408-438-8400

SIDEKICK® \$49.95

(plus \$5.00 shipping and handling • Shipped UPS)

Check Money Order

VISA MasterCard

Card # _____

Expiration Date _____

Please be sure your computer is an IBM PC, XT, jr., or true compatible!

NAME _____

ADDRESS _____

CITY/STATE/ZIP _____

TELEPHONE _____

California residents add 6% sales tax. Outside U.S.A. add \$15.00. (If outside of U.S.A. payment must be by bank draft payable in the U.S. and in U.S. dollars.) Sorry, no C.O.D. or Purchase Orders.

8 B15

BORLAND
INTERNATIONAL

Borland International
4113 Scotts Valley Drive
Scotts Valley, California 95066
TELEX: 172373

For low-cost RS-232C port expansion, BayTech has...

THE RIGHT STUFF

SERIAL PORT EXPANDERS



- Increase I/O ports to 4, 8 or 16.
- Mix & match peripheral devices.
- Port selection through software control; all ports can run with different configurations.
- Models for most applications.

NETWORKING

MODEL 528F \$619

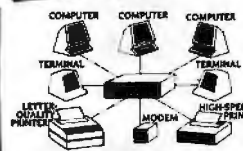

With its host port and eight peripheral ports capable of any-

port-to-any-port interconnection, networking applications with this unit are virtually unlimited.

MULTI- PLEXING

MODEL 524E \$319



This unit allows four lines of data to be multiplexed and sent sequentially over a single line, then demultiplexed by a 2nd 524E with automatic distribution to the corresponding peripheral ports.

PORT CONTENTION

MODEL 528B \$629

This unit maximizes utilization of available ports. Among other configurations, 6 terminals can contend for 3 ports or 7 terminals for 2 ports.



Need 16 ports... \$1595

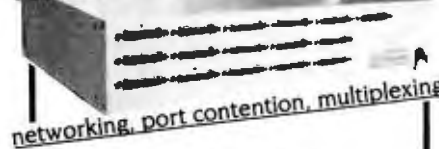

To place your order or discuss your expansion needs...

1-800-523-2702

BIA BAY TECHNICAL ASSOCIATES, Inc.
 HIGHWAY 803, P.O. BOX 387
 BAY ST. LOUIS, MS 39520
 (601) 467-8231

ASK BYTE

(text continued from page 70)

things. I suspect that some type of clock/calendar would be easy to put together, the only consideration being how to interface it without taking up an expansion slot. Two possibilities occur to me: use the ROM socket(s) "reserved" for future use by IBM or interface to the cassette-recorder input port. Of the two, the cassette idea strikes me as the most promising because it might apply to Apples and other computers. The only drawbacks might be that the cassette interface is not available on the PC XT and that the clock must "broadcast" the time and date serially.

The project would be especially neat if you could use a cheap digital clock or watch movement that would display and be set external to the system.

If you can put something like this together, I think a lot of PC owners would be overjoyed.

THOMAS G. CASSIDY
 Bloomington, MN

A battery-powered clock is indeed a useful addition to the IBM PC or any other computer that has date and time functions available. And a unit such as you suggest could be made to work through the cassette port. However, I believe this would have rather limited appeal for two reasons. First, because the first expansion board purchased by many IBM PC owners is one of the popular "six-function" boards that provides clock, printer port, serial port, and sockets for memory expansion all on one board; and second, because cassette data-transfer rates and protocols vary between different makes of computers so that the unit wouldn't be as universal as one would like.

Another approach, which I described in "Everyone Can Know The Real Time" in the May 1982 BYTE (page 34), is to interface the clock circuit through the RS-232C port. This has the advantage that the protocol is well established, and ICs are available to simplify design and construction of the necessary interface circuits.

Because the IBM PC has a software real-time clock written into its operating system, all that is needed to make use of an external hardware clock (once it has been set to the correct time) is to write a program to read the time from the serial port and output it to the PC's clock port whenever the computer is started up or reset. This can be written in BASIC and run automatically by calling it with an Autoexec program.—Steve

PC-OPERATED CASH DRAWER

Dear Steve,

I am attempting to use my computer as a cash register in my business. My problem is interfacing an electronic stand-alone cash drawer with my IBM PC. I need to make a digital-to-analog (D/A) converter. Ideally, I would like to output a byte to the serial port of my computer and have that digital signal converted to a voltage that would, in turn, trip a relay to unlock the cash drawer.

Can you supply me with any information about how I can build or purchase such a

device? I know where I can get an electrically operated cash drawer; the problem is the interfacing. I would greatly appreciate any advice or information.

JASON E. GAPCO
 White Plains, NY

Probably the easiest way to interface your IBM PC to your cash register is by using the cassette port, which provides a 6-V DC power source rated at 1 ampere for driving a tape-cassette motor. Connect your relay to pins 3 and 1 of the cassette interface connector (the 5-pin DIN connector next to the keyboard connector on the rear panel). Pin 3 is +6 V DC, and pin 1 is common.

If your cash-register program is written in BASIC, the relay can be activated by adding the lines shown in listing 1 to your program in the appropriate place. This will set up your program so that function key 10 will open the cash register any time it is pressed. You can, of course, choose any other function key if you want, and you can provide more restricted access by using the KEY(10) ON and KEY(10) OFF statements as needed throughout your program. You also may need to play around with the timing loop to get the correct delay.

If your program is in assembly language or a compiled language, you can still use this port by outputting a 1 to bit 3 of port 61 (hexadecimal) and holding it for the required time. This can be done by modifying your program or by redirecting the INT 16 (hexadecimal) keyboard interrupt to a custom program that performs the output if the key just pressed is F10 or transfers to the normal keyboard if it isn't. A method for doing this is suggested in the book 8088 Assembler Language Programming: The IBM PC by David C. Willen and Jeffrey I. Krantz (Howard W. Sams & Co.)—Steve

Listing 1: Additional lines to activate the relay.

```

1 ON KEY(10) GOSUB 10000: KEY(10) ON
.
.
.
10000 OON=1
10010 OFFF=0
10020 MOTOR OON           'Activate relay.
10030 FOR T=1 TO 10: NEXT 'Wait for drawer
                           'to open.
10040 MOTOR OFFF         'Turn relay off.
10050 RETURN
    
```

A SENIOR PROJECT

Dear Steve,

I am a senior in electrical engineering at Howard University. My idea for a senior project is to design and construct a system that will continuously monitor (in the home) a person's body temperature, blood pressure, respiration, etc., and transmit this data via radio throughout the household to a remote radio receiver that is interfaced with a personal computer. The

(text continued on page 76)

Answer: Smith-Corona

Question: What company offers a new daisy wheel printer, three dot matrix printers and a combination printer-typewriter, with suggested retail pricing of \$395 to \$795?

Question: What printer company offers print quality that challenges printers costing hundreds of dollars more?

Question: What printer company offers dual interfaces for all five of its printer models?

Question: What printer company offers removable and adjustable tractor feeds as standard equipment on all of its dot matrix models?

Question: What printer company has a toll-free telephone number to call if you ever have a problem? And an extensive service system, too?

D-300 (TM) dot matrix printer.



L-1000 (TM) daisy wheel printer.

Ultrasonic III Messenger (TM) portable typewriter with optional Messenger Module.

D-100 (TM) dot matrix printer.

D-200 (TM) dot matrix printer.

- Please send me more information about Smith-Corona printers: I am interested in in-home use.
- Please send me more information about Smith-Corona printers for office use.

Name _____

Company Name _____

Business Address _____

City _____ State _____ Zip _____

Type of Business _____

Send to: Jerry Diener, V.P. Sales, Smith-Corona
65 Locust Avenue
New Canaan, Connecticut 06840

SMITH-CORONA®

MicroTime



1-800-MICRO 84

IBM® COMPATIBLE

NEW  **NEW**

ZENITH

DESKTOP PC-150
PORTABLE PC-160

FREE ON-SITE SERVICE SET-UP ASSISTANCE

LOWEST PRICES

COLUMBIA • BENCHMARK
ANDEK • ZENITH • HAYES
HOUSTON INSTRUMENTS
OKI • GEMINI • NEC • TTX
DATASOUTH • BROTHER
SILVER REED • DTC

PHONE SUPPORT

SYSTEM INTEGRATION
SOFTWARE SUPPORT
SET-UP ASSISTANCE
MODEM TEST LINE

IBM®-APPLE®
ADD-ONS

KOALA • ORANGE • TITAN
QUADRAM • TECMAR

800-642-7684

OPEN SATURDAY

 **411 W. Grant** 
Tucson, AZ 85703

* Apple is a registered trademark of Apple Computers, Inc.
* IBM is a registered trademark of International Business Machines, Corp.

ASK BYTE

(text continued from page 74)

personal computer will then process and store this data for subsequent retransmission via telephone lines to a family physician. The telemetry link is an important part of this system because the person being monitored would be able to move about the house unencumbered by wires. I find a project like this very interesting but quite challenging. Therefore, I would appreciate your answers to the following questions:

1. What type of transducers are available to monitor body temperature, blood pressure, respiration, etc.? Who manufactures such devices?
2. What ICs are available for conditioning the transducer outputs? Other than amplification and buffering, what signal conditioning is necessary to modulate an RF (radio frequency) carrier?
3. Once the analog signals from the transducers are properly "conditioned," should they be converted to digital signals and then transmitted via RF or transmitted in their analog form and then converted to digital signals on the receiver/computer end?
4. What form of carrier modulation should I use? AM, FM, pulse-width modulation? And what carrier frequency do you suggest (in the home environment)?
5. With a view toward making the transducer/signal conditioner/transmitter unit as small as possible and battery operated, are there any low-power ICs that contain a complete transmitter and receiver on a chip? National Semiconductor's LM1871 Radio Control Encoder/Transmitter and LM1872 Radio Control Receiver/Decoder seem likely candidates, but they are generally used for control of hobby servos.

I hope you can share your insights and shed some light. Thank you.

ROBYN L. KING
Washington, DC

The project you selected is, as you say, very interesting and challenging. The questions you asked also are very challenging and could take many pages to answer. Instead of answering them directly, I will try to give you a selection of reference materials where you can find the answers yourself (after all, it is your project).

Several sources can be reviewed to find the type of transducers you need. EDN (Electronic Design News) and Electronics magazines often carry articles on medical electronics. A review of these magazines should yield all the information you need. For example, an article in a September 1980 EDN discusses the Hughes HLSS-0533 heart-rate monitor chip that employs the photoplethysmographic monitoring technique. The March 20, 1980 EDN, page 122, had a special report on sensors and transducers, and an April 1977 Electronics had an article on a silicon transducer to measure blood pressure. Electronic Products is another good source of reference material. An article in the November 1982 issue (page 49) discusses advances in signal conditioning.

Transmitting and receiving these signals can become a project in itself. I have taken the approach of "not reinventing the wheel" several times and used commercially built devices like walkie-talkies to do the job. You can find discussions of these techniques in two of my articles: "Handheld Remote Control for Your Computerized Home," July 1980 BYTE (page 22) and "A Computer-Controlled Tank," February 1981 BYTE (page 44).

I hope these references will be helpful in your senior project.—Steve

A KAYPRO 10/S-100 COMBO

Dear Steve,

As an author's portable word processor, the Kaypro 10 with an Epson FX-80 printer seems to be a good choice. For everything else, an 8086 with several IBM-compatible slots is advisable.

The Kaypro 10 has a parallel printer output, two RS-232C ports, and one light-pen input jack.

If I want to use the Kaypro screen, keyboard, and large disk, but also want to use a Semidisk or RAM Disk and an 8086 for the bulk of internal processing, what sort of hookup makes sense?

SAM TIMAC
Ft. Vermilion, Alberta, Canada

As I read your letter, I get the impression that even though you say "IBM-compatible slots" you are really thinking in terms of an S-100 bus system with an 8086 microprocessor rather than an IBM PC. The S-100 bus offers a wide selection of boards to run with the 8086, including several Semidisk, or RAM Disk, boards, but in no way compatible with IBM hardware.

The Kaypro 10 does look good as a portable word processor, and if you like the relatively small screen (compared to a full-sized terminal), it might be used as a terminal for an S-100 system. Because S-100 systems are designed to be run with remote terminals rather than built-in displays, you should have no trouble at that end, and the Kaypro can easily function as a terminal with the proper software. Your dealer should be able to recommend a communications program that will configure the computer as a suitable terminal. The physical connection between the two computers will be through the RS-232C ports.—Steve ■

IN "ASK BYTE," Steve Ciarcia answers questions on any area of microcomputing. The most representative questions received each month will be answered and published. Do you have a nagging problem? Send your inquiry to:

Ask BYTE
c/o Steve Ciarcia
POB 582
Glastonbury, CT 06033

Due to the high volume of inquiries, personal replies cannot be given. All letters and photographs become the property of Steve Ciarcia and cannot be returned. Be sure to include "Ask BYTE" in the address.

Introducing the world's first complete, self-contained, 16-bit portable computer system.

The Panasonic Sr. Partner with a built-in printer.

The Panasonic Sr. Partner is one of the most flexible and versatile portable computers on the market today. So there are many reasons to buy one.

Runs IBM PC Compatible Programs.

To begin with, the Sr. Partner runs IBM PC compatible programs. So you can pick from hundreds of popular programs from an existing software library. Including Lotus® 1-2-3®, Multiplan® and even Flight Simulator.

In addition, included with the Sr. Partner are five of the most respected business-related programs including VisiCalc®, WordStar®, PFS®, Graph, File and Report plus G.W. BASIC®. All at no extra charge.



This "bundle" allows you to go to work immediately doing word processing, electronic spread sheets, file management, graph development and your own programming.

And because it also accepts IBM PC compatible hardware the Sr. Partner's technical capabilities can be expanded even further.

Built-in Printer.

The Sr. Partner is the only portable in its class with a built-in printer. It has graphics capability and can provide you

or your customers with printouts of statistics, budget figures, conference notes, graphs and much, much more.

The printer is also extremely quiet and offers an 80-character line and the 132-character line that's perfect for spread sheets and other accounting programs. And its bi-directional logic design delivers fast printing.

A Complete System.

The Sr. Partner is an integrated system that doesn't require costly add-ons to be called complete.

It has 128K internal memory (RAM) expandable to 512K. A nine-inch, high-resolution CRT with monochrome screen. An 8088 microprocessor with a MS-DOS™ 2.11 operating system. An 8087 co-processor socket. A built-in, double-sided, double density, 360K, 5 1/4-inch disc drive and the capability of handling another one just like it. Built-in color and graphics at no extra cost. An option slot for IBM hardware. An RGB monitor output. A centronics parallel interface I/O port that accepts optional peripherals. And an RS-232 serial interface I/O port. All for a price that's surprisingly affordable.

The Sr. Partner is also backed up by a 12-month limited warranty. Most of the competition offers only 90 days.

And if the Sr. Partner should ever need servicing, we have a national network of authorized service dealers.

Over 60 Years of Dependability.

We're not one of those "here today, gone tomorrow" companies.

Our parent, Matsushita Electric Industrial Co., has been in business since 1918 and is one of the world's largest consumer electronics manufacturers.

Matsushita's recent contributions and innovations to computer and office technology include: a data entry system that directly connects facsimile data to a computer. An online optical character reader. A "pocket terminal" telephone data entry system. And a 64K static memory chip.

For more information about the Sr. Partner write to: Computer Department, Panasonic Industrial Company Division of Matsushita Electric Corporation of America, One Panasonic Way, Secaucus, NJ 07094. Or call: (201) 392-4261.

The Panasonic Sr. Partner. It's everything you've always needed in a portable computer but never had before.

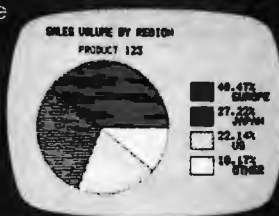

Panasonic
Industrial Company



*Trade Dress: Page Subject: ©1987Panasonic

Registered Trademarks: WordStar, MicroPro International Corporation, Lotus, Lotus Development Corporation, VisiCalc, Microsoft Flight Simulator, G.W. BASIC and Multiplan, Microsoft

Circle 250 on inquiry card.

StarPolish™

Polished WordStar® is a Sight to Behold!



What You See is What You Get...and MORE

On-Screen Enhancements:

With Color Adaptor and Monitor:

Bold, underline, sub and superscript, italic, and technical

With Monochrome Adaptor:

Bold and underline. Others indicated on status line

Custom Level 3 Help Screen

Replaces need for keyboard template for keystroke savings

WordStar Compatibility - No Retraining

Keystrokes

User has option of keystroke saving techniques

Files

Old WordStar files accessible

Polished WordStar files accessible by standard WordStar

Utilities

Use of MailMerge®, SpellStar®, StarIndex® is not affected

Printer Support Enhanced Too!

Get the most from your dot matrix or ink jet printer without worrying about an assembly language patch. A menu of popular printers gives you automatic installation of all features. A custom installation question/answer session is available for printers not on the menu.

Versions Now Available For:

IBM PC® and PC-XT®
PC Compatibles
Victor 9000®

\$125.00

Md. Customers add 5% Sales Tax



VISA

We've made WordStar a lot more likeable!

StarPolish is a trademark of TDI Systems, Inc.

WordStar, MailMerge, SpellStar, StarIndex are registered trademarks of MicroPro International Corp.

IBM PC and PC-XT are registered trademarks of International Business Machines, Corp.

Victor 9000 is a registered trademark of Victor Technologies, Inc.



TDI SYSTEMS, INC.

620 Hungerford Drive
Suite 33
Rockville, Maryland 20850
(301) 340-8700

B·O·O·K R·E·V·I·E·W·S

LEARNING WITH LOGO
Dan Watt
BYTE Books/McGraw-Hill
New York: 1983
208 pages, \$22.95

THE TOLL FREE
MICROCOMPUTER INDEX
Richard J. Volz and
Gene E. Thompson
Spokane Technical Press
Spokane, WA: 1983
360 pages, \$14.95

LEARNING WITH LOGO
Reviewed by Tim Barclay

When teachers ask what they should be doing with microcomputers at the elementary school level, we say Logo, and the second thing we say is, get Dan Watt's book, *Learning with Logo*. As a part of the MIT Logo Project, Watt was responsible for the pilot study in Brookline, Massachusetts, schools. Before working on Logo, he was an elementary school teacher

ILLUSTRATED BY WILLIAM GIESE



at the middle school level, and prior to that he was a curriculum developer with the Elementary Science Study, a federally supported curriculum-development project of the late 1960s. It is this depth of teaching experience combined with his thorough understanding of Logo that he brings to his book, and it shines through. The book is a successful combination of Logo programming, Logo philosophy, and teaching strategies. Although there are other books that deal with one or another of these aspects of Logo, none that I know of encompasses all three, not to mention with such success.

The book is written for an Apple using the Terrapin/Krell versions of Logo but includes appendixes that list necessary modifications for Apple Logo and TI

Logo users. A separate edition of the book, *Learning with Apple Logo*, is also available; editions for Logo on Atari, Commodore, and Texas Instruments are in preparation.

A LEARNING ADVENTURE

Learning with Logo is challenging and rewarding for children and adults alike. The initial chapters of the three-part book are written with 10- to 13-year-olds in mind, but in no way does this introduction insult the intelligence of the novice adult embarked on a new adventure. The ideas are also accessible to younger children with the help of a teacher; in fact, the author includes several teaching hints within each chapter for this purpose.

The basic graphics commands for

drawing on the screen are all introduced in this first section as well as the necessary commands for saving procedures and pictures on disk and for going to the editor to define your own new procedures. Anyone who completes the first portion of this spiral-bound, easy-to-use book befriends the Logo turtle and learns how to draw designs and pictures on the screen.

The second section of the book introduces more sophisticated programming concepts that use graphics, words, and lists. The uses of variables and conditionals are also included. These abstract concepts, which can be so mystifying when first encountered in algebra, come as simple solutions to real needs that every Logo learner encounters while writing graphics programs. It is an example

of what Seymour Papert, the head of the MIT Logo Project, is talking about when he refers to setting up natural learning environments. That means providing a context in which students can explore, try new ideas, and find their own solutions as problems arise.

Watt shows the reader examples of some of the complex designs that can be drawn using recursion, such as rotating polygons, growing squares, and spirals. He explains the procedures that he used to create these shapes and suggests further investigations.

In addition to these more advanced graphics programming ideas, the author introduces the use of words and lists, explaining how to write interactive programs in a chapter called "Conversa-

(text continued on page 80)

(text continued from page 79)

tions with the Computer: Activities with Numbers, Words and Lists." As is true throughout the book, in his presentation of new commands and concepts Watt braids several modes of presentation together. They include:

- examples for the reader to try on the microcomputer that use commands needed to work with lists
- explanations of what the examples are doing
- cartoon sequences that graphically present the ideas
- "explorations"—suggested problems to try on your own
- "helper's hints"—more detailed explanations and teaching suggestions

By the end of this chapter, the reader is able to write procedures for conversations with the computer and quiz programs that are carefully designed using multiple subprocedures. For the person willing to work through these steps,

understanding and fluency can develop.

The third section of the book builds upon the skills that have been developed in the first two sections. Each of the four chapters in this section takes a single programming project and develops the many procedures that make up the final program. The first project is an interactive computer game called Shoot, in which the player tries to hit a target with the turtle. Next is Quickdraw, which is described as a "Turtle Drawing Activity for Young Children." A chapter on animating the turtle follows, accompanied by a project called Racetrack, and last is a chapter on writing poetry called Poet. These later sections are appropriate for both older readers working independently or for younger users with assistance nearby.

TEACHERS ALSO BENEFIT

Learning with Logo is designed to be used with a preprogrammed disk of procedures (\$15.95) that includes the afore-

mentioned Shoot, Quickdraw, Racetrack, and Poet. Watt intends his audience to learn these procedures gradually, initially by just using and seeing them in action, later by studying and changing them. The disk also enables beginning learners to experience Logo in a more exciting way than they otherwise could. As an alternative to buying the disk, you can get a copy by typing the procedures listed in the appendix of the book.

A motto of Logo is "no threshold, no ceiling." This means that the language is easily accessible to young children yet is still a powerful and sophisticated language. For instance, many 4-year-olds are using Logo, as are students at MIT. The low-threshold part lies in the turtle graphics. If you have used Logo at all you have undoubtedly experienced the delight of drawing designs or solving geometric problems. But a question teachers often ask is, what next? Right-

(text continued on page 82)

A REFURBISHED DAISY WHEEL TERMINAL
FOR PERSONAL COMPUTER USERS AND SMALL BUSINESSES.

Three-In-One Offer! Just \$895 From Your Computer Store.

- A 30 cps letter-quality printer
- A timesharing keyboard terminal (when modem equipped)
- A Selectric*-style keyboard typewriter

AJ daisy wheel printer terminals are renowned for exceptional performance, high reliability, and applications versatility. Now you can have all this for only \$895** in our special limited offer.

- 30 cps letter-quality printing
- Changeable type faces
- Full ASCII keyboard with numeric pad
- High resolution X-Y plotting
- Complete electronic forms control
- 128-character buffer
- Asynchronous RS-232 interface
- Printwheel, ribbon cartridge, and cable included
- 30-day parts/labor warranty

And you can choose from a list of options including forms tractor, pin-feed platen, paper trays, side shelves, extra printwheels, APL keyboard and 2K buffer.

Call your nearest AJ region office to find the nearest computer store: San Jose, CA (408) 263-8520 (Sales); Rosemont, IL (312) 671-7155; Fair Lawn, NJ (201) 794-9316

**Suggested selling price, excludes options and is subject to change without notice. Model shown includes certain options. Offer available only in the contiguous U.S.

*Selectric is a trademark of IBM.



AJ ANDERSON
JACOBSON



©1984 Cosmos Inc.

How long is an idea?

With Revelation[®] by Cosmos, it won't matter. Our variable length structure lets you think long or short without worrying about needing disk space you don't have, or squandering space you can't afford. Think of it. Relational Data Base Management Software that saves up to 40% of your PC's disk space.

As a powerful, enhanced version of the PICK[™] Operating System, Revelation uses plain English to create files, menus, entry screens, process information and generate reports. Plus, you can build,

customize and update your data base application without being an experienced programmer.

When you introduce your IBM[®] PC or compatible to Revelation, you'll see it change into a friendly brute that can communicate with other computers. Also featured is a hybrid full-structured programming language with an interactive debugging tool for serious development work.

Besides bringing the power, speed and flexibility of a minicomputer to your PC, Revelation works with

MS/DOS[™] so you can use all the popular microcomputer software packages with the applications you develop.

Indeed, Revelation is easy to get along with. A veritable gentle giant. But, you need to know more before you decide to buy what may become your most valuable business tool. So call us at (206) 824-9942 and let us arrange for you to see what we've got here.

MS/DOS[™] of Microsoft Corp. IBM PC Registered TM of International Business Machines Corp. PICK Operating System[™] of PICK SYSTEMS.

Cosmos Inc. 19530 Pacific Highway S.

COSMOS[™]

Seattle, WA 98188, (206) 824-9942

Circle 90 on inquiry card.

(text continued from page 80)

fully so, for there is more beyond the turtle world, such as using words and lists, writing interactive programs, and getting into embedded recursion. Beginners tend to expect that this part of Logo will also be as easily accessible, and it is not. Watt tackles this teaching problem by leading the reader carefully through material with the use of examples, explanations, and teaching suggestions, all to be tried hands-on. After reading and working through this part of the book, teachers have told us that, for the first time, they understand words and lists.

MINOR CRITICISM

One potential pitfall when writing a book on Logo is how to sequence concepts and activities. Because there are any number of approaches, every Logo teacher will develop a favorite way. The author acknowledges this phenomenon by admitting "Here is what worked for

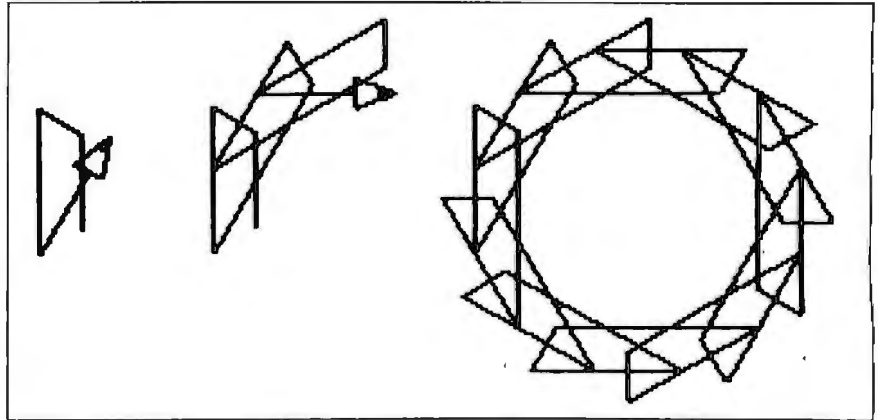

Figure 1: Repeating a random shape creates a design.

me, you should do what works best for you." And one section in his book where Watt's sequencing did not work for me was in Chapter 3 on Quickdraw.

Quickdraw is a program that lets you perform turtle graphics with single-key entries. For instance, instead of typing FD space 20 Return (a total of six keys),

you just type F. With F, B, R, and L as single keys for FORWARD 20, BACK 20, RIGHT 30, and LEFT 30, respectively, you can move and turn the turtle by pre-determined increments to make graphics designs. Quickdraw has some other useful procedures for saving and re-

(text continued on page 84)

Figure reprinted with permission from McGraw-Hill Book Company

DANA'S COMPUTER DISCOUNT

★ Highest Quality - Lowest Prices ★

<p>IBM OR APPLE HARD DRIVE</p>  <ul style="list-style-type: none"> • 10 MB External Type • Fully Documented • Fully Software Compatible • Includes Heavy Duty Power Supply • One Year Warranty <p>\$1595.00 MFG BY XEBEC</p>	<p>COLOR CARD FOR IBM</p> <ul style="list-style-type: none"> • RGB Hi Res Color • Color Graphics • Composit Hi Res Color • 4 Layer Board • Composit Hi Res Green <p>\$199.95</p> 	<p>DISK DRIVE CONTROL CARD</p> <ul style="list-style-type: none"> • Can Control 4 5 1/4 Drives <p>\$159.95</p> 	<p>MULTI FUNCTION CARD</p> <ul style="list-style-type: none"> • 128k Ram Built-in, Expandable to 256k • 2 Serial Asynchronous Communication Ports (RS-232 Interface) <p>\$299.95</p> 	
<p>IBM PC KIT</p> <p>INCLUDES:</p> <ul style="list-style-type: none"> • Deluxe Case • Power Supply w/Fan • Detachable Low Profile Keyboard • Mother Board Fully Socketed • All Components Included • Full Documentations • 128 K Ram • 5 Expansion Slots <p>ASSEMBLE IN 1 HOUR</p> <p>ONLY \$995.00</p>	<p>IBM COMPATIBLE POWER SUPPLY</p> <ul style="list-style-type: none"> • Heavy Duty 130 Watt • Recommended For Hard Drive • Overload & Short Circuit Protection <p>\$149.95</p> 	<p>CASE</p> <ul style="list-style-type: none"> • Includes Drive Brackets • Hinged Lid • IBM Style Front Panel <p>\$79.95</p> 	<p>IBM COMPATIBLE KEYBOARD</p> <ul style="list-style-type: none"> • Low Profile • 10 Function Keys • Numeric Key Pad • Cursor Control Keys <p>\$149.95</p> 	
<p>COMMODORE DRIVE</p> <ul style="list-style-type: none"> • Direct Drive Motor • Fully Commodore Compatible • Using Slim Line Mechanism <p>\$329.95</p> 	<p>3 1/4 DRIVE IBM OR APPLE</p> <p>NEW</p> <p>CALL FOR PRICE</p> 	<p>4164 RAM 9 PC. MIN. ORDER ONLY \$4.95</p>		
		<p>FULL HEIGHT Apple II & E Compatible</p> <p>35 Trac</p> <p>Single Sided 143 K Capacity</p> <p>\$169.95</p> 	<p>IBM COMPATIBLE DRIVES</p> <p>TEAC FD55B \$179.95</p> <p>TEAC FD55F \$249.95</p> 	<p>HALF HEIGHT Apple II & E Compatible</p> <p>Slim Line - 40 Trac w/Patch</p> <p>Single Sided 143 K Capacity</p> <p>\$179.95</p> 

Dana's Discount Computer Buyers Club ★ ★ ★ ★ ★

- \$12.00 Annual Membership (Refundable).
- \$10.00 Credit Toward First Purchase.
- Special Added Discounts.
- Monthly Specials For Members Only.
- Special Membership Account And I.D. Card.
- Personal Checks Acceptable From Club Members.

ORDER DESK 8:00 A.M. TO 5:00 P.M.
PST MON. THRU FRI.
Orders normally shipped within 48 hours.

Join Our Club
And Save!

Orders: 1-800-262-DANA

Dana's Computer Discount

P.O. Box 15485, Santa Ana, California

92705

In California: (714) 953-9105

International orders accepted with a \$5.00 surcharge for handling, plus shipping charges • We accept Visa, MasterCard, Money Orders, and Certified checks • Checks require bank clearance • California residents add 6% sales tax • All subject to availability, acceptance, and verification • All sales are final • Satisfaction guaranteed or full refund.

*Eagle, IBM, Apple, Apple IIE, and Commodore are all registered trade marks of Eagle, IBM, Apple and Commodore corporations.



HOW TO TURN IBM® INTO ABC.

Introducing the Plume/Waite Computer Series.

The Waite Group, the people who wrote the book on computer books, have done it again. They've produced a remarkable series on the world's most popular personal computers, the IBM® PC and IBM® XT.

The complete Plume/Waite library for the IBM PC and XT consists of five detailed volumes written for everyone from the computer beginner to the professional programmer.

- **DOS Primer for the IBM® PC and XT** — the first book anyone with an IBM PC and XT should buy. It gets you started managing resources and controlling & running programs — so you can get the most out of your computer.

- **BASIC Primer for the IBM® PC and XT** — the guide for BASIC, the world's most popular computer language. It offers a wide variety of at-the-keyboard examples, along with projects that draw on the versatile graphic and sound capabilities of the PC and XT.

- **PASCAL Primer for the IBM® PC** — for those ready to take the next step in computer science. This general purpose language can be used by both the novice and the programmer who wants to develop commercial software.

- **ASSEMBLY LANGUAGE Primer for the IBM® PC and XT** — the book that teaches the programmer the innermost secrets of the IBM PC and XT. Because ASSEMBLY is the most powerful language available, you'll be able to

access each and every one of your machine's features.

- **BLUEBOOK OF ASSEMBLY ROUTINES** for the IBM® PC and XT — the book where you'll find a variety of pre-tested, debugged routines you can use with your own BASIC, PASCAL, or ASSEMBLY LANGUAGE programs — routines that will improve your software's performance and save you time.

So if you'd like to get the most out of your computer, get the Plume/Waite Computer Series. Whatever your level, it'll make learning your IBM PC and IBM XT as easy as ABC.

New American Library, P.O. Box 999
Bergenfield, N.J. 07621

B684

Please send me:

___ Dos Primer Z5494 (\$14.95); ___ Basic Primer Z5495 (\$16.95); ___ Pascal Primer Z5496 (\$17.95); ___ Assembly Language Primer Z5497 (\$21.95); ___ Bluebook of Assembly Routines Z5498 (\$19.95). Add \$1.50 postage and handling per order. I enclose ___ check, ___ money order (no COD's or cash), or charge ___ Visa, ___ Master Card.

Card # _____ Exp. Date _____

Signature _____

Name _____

Address _____

City _____ State _____ Zip _____



Allow a minimum of 4-6 weeks for delivery. This offer, prices and numbers are subject to change without notice. Offer expires December 31, 1984.

(text continued from page 82)

drawing a set of commands, but it does not include any other graphics commands.

One very practical use for Quickdraw is for young children who cannot type the longer command words. Another use is to speed up graphics drawing. What I find inappropriate, however, is the series of suggested drawing activities using Quickdraw. These drawings (see figure 1) really beg for the REPEAT command. Without the REPEAT command, you have to enter the sequence of commands for the random shape (FLLFLLLLLFFLLLLLFF) and then type them in repeatedly twelve more times. There is something to be said for motivating the learning of a new command by creating a need for it, but that does not seem to be part of the author's scheme here. This example seems to highlight the challenge of trying to balance easy access against interesting output.

Just as Logo uses turtle graphics as an entry into understanding programming, so also the author has included graphics in this book to clarify language and computer concepts. For this he has used a series of cartoon characters who act out the processes being carried on inside the computer. But the cartoons of a Logo elf, robot primitives, mailbags, mailboxes, and trash cans do not seem to help. Rather than being worth a thousand words, the cartoons require all the intense study that a page of print can demand if you are to understand the concepts being presented. They are easily skipped over, however, so you can ignore them and concentrate on just the words. This is a minor criticism about an otherwise marvelous book.

Anybody planning to teach Logo should have his or her own copy available in the classroom for quick reference. The more you refer to Dan Watt's book, the more enamored with it and with Logo you will become.

THE TOLL FREE MICROCOMPUTER INDEX
Reviewed by Maria V. Peeler

One problem with promising too much is that it's hard to live up to it. In this case, the product is slightly less than the promise.

That's the core of the discrepancy with *The Toll Free Microcomputer Index*. The authors use so much space in the first 14 pages glorifying the book's virtues—how it will save money, time, and headaches; how it will save the cost of a professional research service or consultant, the cost of microcomputer-magazine subscriptions, the cost of training the neophyte computer enthusiast—that the simple usefulness of the book is buried, leaving the reader a little shortchanged in the end.

TAKE A LOOK

Neophytes don't become wise com-
(text continued on page 86)

SATISFY YOUR DRIVES!

70 MAIN/FRAMES & DISK ENCLOSURES FROM \$100



800D2F
5" Floppy Main/Frame
(10 cards) **\$392**



2215
5" Floppy Winchester
Main/Frame (7 cards) **\$380**



2905
5" Disk Enclosure **\$100**

32 Page
Free Fakt
Pakt Catalog

Write or call for our brochure which includes our application note: "Making micros, better than any ol' box computer"

INTEGRAND

8620 Roosevelt Ave./Visalia, CA 93291
209/651-1203

We accept BankAmericard Visa and MasterCard

HIGH TECHNOLOGY AT AFFORDABLE PRICES

Dot Matrix Printers

C. Itoh Prowriter (8510).....	\$ 369.88
C. Itoh Prowriter 2, (136 col).....	589.88
C. Itoh Prowriter BPI (Code compatible with IBM-PC dot matrix printer).....	439.88
C. Itoh HotDot.....	509.88
C. Itoh HotDot-2 (136 col).....	729.88
Epson RX/FX Series.....	CALL
DataProducts P-480.....	439.88
DataProducts P-132 w/4-color.....	1699.88
Infurunner Riteman.....	339.88
Mannesmann Tally 160-L.....	629.88
Mannesmann Tally 180-L.....	879.88
Mannesmann Tally Spirit-80.....	329.88
Okidata Microline 82A/83A.....	CALL
Okidata Microline 84 Step II.....	CALL
Okidata Microline 92.....	CALL
Okidata Microline 93.....	CALL
92/93/84 Plug-n-Play ROMs for graphic compatibility with IBM-PC.....	CALL
Star Micronics Gemini 10X.....	299.88
Star Micronics Gemini 15X.....	419.88
Star Micronics Delta 10.....	439.88
Star Micronics Delta 15.....	589.88
Star Micronics Radix 10/15.....	CALL
Toshiba P-1351.....	1689.88
Toshiba P-1351 Tractor.....	169.88

Letter-Quality Printers

C. Itoh A-10 Starwriter (18 cps).....	\$ 549.88
C. Itoh F-10 Starwriter (40 cps).....	1079.88
C. Itoh F-10 Printmaster (55 cps).....	1379.88
Diablo Series Printers.....	CALL
NEC 2010/2030 (18 cps).....	749.88
NEC 2050 for IBM-PC (18 cps).....	899.88
NEC 3530 (33 cps).....	1429.88
NEC 3550 for IBM-PC (33 cps).....	1779.88
NEC 7730 (50 cps).....	1939.88
Qume Series Printers.....	CALL
Silver Reed EXP-770 (25 cps).....	979.88
Silver Reed EXP-550 (17 cps).....	559.88

Silver Reed EXP-500 (12 cps).....	439.88
Smith Corona Memory Correct III Messenger (12 cps) w/interface module.....	589.88
Star Micronics PowerType (18 cps).....	CALL

Printer Accessories

Printer Cables.....	\$ 29.88
Pkasso-U Printer Card & cable.....	129.88
Grappler+ Printer Card & cable.....	109.88
80 Column Printer Stand.....	39.88
132 Column Printer Stand.....	49.88
Trace Sound Traps.....	CALL
2-Way Printer Switch Box.....	109.88
4-Way Printer Switch Box.....	159.88
Quadram Microfazer Print Buffers.....	CALL

Monitors

Amdek 300G (green).....	\$ 144.88
Amdek 300A (amber).....	159.88
Amdek Color-1+.....	319.88
Amdek Color-2 (RGB).....	459.88
NEC JB-1205M (amber).....	159.88
NEC JB-1201M (green).....	159.88
Princeton Graphics HX-12 (RGB).....	509.88
Princeton Graphics Max-12.....	199.88
Quadram QuadChrome (RGB).....	519.88
Roland DG-121 (green/amber).....	149.88
Roland DG-122 (green/amber).....	179.88
USI Pi-3 (12" amber).....	179.88

Modems

Hayes Micromodem IIe.....	\$ 259.88
Hayes Smartmodem 300.....	239.88
Hayes Smartmodem 1200.....	559.88
Hayes 1200B (IBM-PC).....	479.88
Novation AppleCat 300 baud.....	239.88
Novation AppleCat 1200 baud.....	489.88
Novation SmartCat 103, 300bd.....	179.88
Novation SmartCat 212, 1200bd.....	429.88
Novation Access 1-2-3 (IBM-PC).....	449.88

USR Password, 1200 baud.....	369.88
USR PC 1200 baud Modem/Multifunction board w/64-256K, clock, parallel port & Telpac software.....	CALL

IBM-PC Peripherals

64K Memory (4164/200ns) 9/pkg.....	\$ 79.88
AST MegaPlusII (64K).....	289.88
AST SixPak Plus (64K).....	299.88
Hercules Graphics Card.....	379.88
Microsoft Mouse (parallel).....	149.88
Microsoft Mouse (RS-232).....	159.88
Mouse Systems PC-Mouse.....	219.88
Paradise MultiDisplay.....	479.88
Quadram Quadboard.....	CALL
Quadram Quad 512 + (64K).....	239.88
Quadram QuadColor-1.....	219.88
Quadram QuadColor-2.....	229.88
Quadram Parallel Card, RS-232C Card or Clock/Calendar Card.....	79.88
Tandon TM 100-2 Double-sided floppy disk drive.....	229.88
Titan Cygnus I/O (parallel).....	149.88
Titan Cygnus I/O (RS-232).....	169.88
TG Joystick.....	59.88

Apple Peripherals

ALS CP/M Plus Card (CP/M 3.0).....	\$ 329.88
AMT MicroDrive (half height).....	219.88
Microsoft Z80 Softcard.....	CALL
Quadram eRAM (IIe 80 cols).....	119.88
Rana Elite-1 Disk Drive.....	259.88
TBL Cooling Fan.....	59.88
TBL Disk Drive Controller.....	69.88
Titan Accelerator II.....	469.88
Titan Memory Board Boards.....	CALL
Videx VideoTerm.....	239.88
Videx UltraTerm (80/160 column).....	289.88
Videx Enhancer II.....	109.88
Videx PSIO interface board.....	179.88

ALLOY • ADVANCED LOGIC SYSTEMS • AMDEK • ANADEX • AST • CCS • CARDCO • C ITOH • COMREX • COLUMBIA DATA PRODUCTS
 CURTIS MANUFACTURING • DATA PRODUCTS (IDS) • DIABLO • DTC • EAGLE COMPUTER • EASIFEED • EPD • EPSON • FRANKLIN COMPUTER
 HAYES MICROCOMPUTER PRODUCTS • HERCULES COMPUTER TECHNOLOGY • INFURUNNER • INTERACTIVE STRUCTURES • JMM
 JUKI • KENSINGTON MICROWARE • LEADING EDGE • LQ • MANNESMAN TALLY • MA SYSTEMS • MICROSOFT • MILFORD NULL MODEM
 MOUSE SYSTEMS • NOVATION • NEC • OKIDATA • ORANGE MICRO • PARADISE SYSTEMS • PERFECT DATA • PRINCETON GRAPHICS
 QUADRAM • QUME • QCS • RANA SYSTEMS • ROLAND DG • SILVER REED • SMITH-CORONA • STAR MICRONICS • TANDON • TECMAR
 TITAN • TOSHIBA • USI • US ROBOTICS • VIDEX

**We know computer mail-order...
 We wrote the book!**

The book is ready; our **Spring 1984 Catalog**, a comprehensive buyer's guide that makes shopping by mail easier than ever before. Now you can get straight answers and complete specifications from one source. And we explain the technical terms so that even beginners can understand what they're buying. No matter how you order—by phone or mail—you'll get the answers you need to select the right item every time.

Choose from over 300 products: dot-matrix & letter-quality printers, printer interfaces, cables, stands, printwheels, ribbons & supplies, plus modems, monitors & peripheral boards for the Apple/Franklin, IBM-PC and compatibles. We also carry the Columbia, Eagle, Franklin and Memotech computer systems.

Find out what it's like to shop with the company that wrote the book on computer mail order: send \$2 for our **Spring 1984 Catalog** (sent 1st Class US Mail).



(603) 881-9855

TECHNICAL SALES DESK

(800) 343-0726

TOLL-FREE ORDER DESK

Hours: 9:00 to 5:30 EST, Mon-Fri

- FREE UPS ground shipping on all orders
- Shipments fully insured at no extra charge
- MasterCard, VISA, American Express, Diners Club & Carte Blanche credit cards accepted
- No surcharges on credit card
- Credit cards are not charged until your order is shipped from our warehouse
- CODs accepted up to \$1000 (add \$10 for COD handling). Payable with certified check, money order or cash.
- Full mfg. warranty on all products sold
- 1-year extended warranty service is now available for many products (just ask us)
- Sorry, no APO/FPO or foreign orders

THE BOTTOM LINE

MILFORD, NH 03055-0423 □ TELEPHONE (603) 881-9855

Circle 50 on inquiry card.



(text continued from page 84)

puter buyers by calling 1-800-numbers; businesses can't completely bypass consultants or research services by calling 1-800-numbers; and most of us who buy computer magazines do so to enjoy articles, learn a little, and find out who has the lowest price on a Hayes modem this month—not to find out which companies have toll-free numbers.

That doesn't mean that this book isn't worth a look. It just means that *The Toll Free Microcomputer Index* is not the super-book its authors proclaim it to be. Taken in that light, it can be a helpful manual—especially to computer dealers, consultants, and myriad other individuals who tend to rely on information and merchandise from national rather than local sources.

COLORFUL CONTENTS

The *Toll Free Microcomputer Index* consists of two parts. The White Pages are an

alphabetized database holding over 500 records on companies that maintain toll-free lines. The Orchid Pages consist of an alphabetized listing of keywords pertinent both to specific brands and large general categories. The two sections more or less correspond to a telephone book's white and yellow pages and function similarly.

The foreword to the Orchid Pages promises an index to the Keyword Index (which gives the name of the company and a one-line description), a Catalog Index, Information Index, and Location Index. Don't bother looking for the last three. They aren't there. According to the authors, funding ran out and they hope to include those indexes in the next edition.

OVERSIGHTS

A few oversights exist. For example, it has a list for Morrow Inc., but it describes it only under Morrow Micro Decision Computer Systems and makes

no mention or cross-reference to Morrow's hard-disk manufacturing.

Despite the exclusion of three indexes, the oversights, and the overpraising in the stiff, textbook prose of the first 14 pages, the book looks professional. The cross-references, although not exhaustive, are at least accurate and adequate for its limited database. It is well printed on good quality paper, has a pleasant cover, and has few errors or typos. The book is available to user groups or clubs at a discount. ■

.....
 Tim Barclay, director of the Computer Resource Center at Technical Education Research Centers, 8 Eliot St., Cambridge, Massachusetts 02138, writes frequently for its newsletter, Hands On. He also conducts teacher workshops on using microcomputers in education.

Maria V. Peeler (7002 37th SE, Lacey, WA 98503) is a technical writer and a public-information officer at the Washington State Utilities and Transportation Commission.

Modula-2. Simply Better.

More and more software developers are finding a new language simply better than C or Pascal. They're finding

Modula-2, by Niklaus Wirth, the creator of Pascal. For professional programmers, it's simply a better language.

Modula-2. Simple like Pascal (if you know Pascal, you can be writing Modula programs in hours) but with much more power and flexibility. Power to handle any professional application, so there's no need for extensions.

Modula-2. Better than C because it gives you strong typing and superior separate compilation facilities. That means you write cleaner programs, faster.

Only LOGITECH's Modula-2/86 system translates directly into high-speed native code for PC-DOS™, MS-DOS™ and CP/M-86™.

No other system speeds your Modula programs along faster than our native code compiler. And our high-level, symbolic debugger ensures your programs arrive in flawless running condition.

Multi-level overlays, 8087 support, ROMable code, and a full library of standard modules make Modula-2/86 the perfect system for every professional application.

We also offer the only VAX/VMS™ resident and cross compiler for the 8086.

For VAX mainframes to PCs, look to LOGITECH's Modula-2 software development systems. For professional programmers, it's simply a better choice.



LOGITECH

805 Veterans Blvd., Redwood City, CA 94063
 415-365-9852
 LOGITECH SA (in Europe), CH-1143 Apples, Switzerland
 LOGITECH Srl., Corso Nigra 60, 10015 IVREA TO, Italy

PC-DOS is a TM of IBM. MS-DOS is a TM of Microsoft. CP/M-86 is a TM of Digital Research. VAX/VMS is a TM of Digital Equipment Corp.

A disk of a different color.



CenTech's Premium ColorDisk™ Diskettes for Rapid Coding and Filing Ease.

Every diskette individually tested and certified 100% error free — beyond 65% clipping level.

- Advanced microfinishing of media surface.
- Quality and reliability backed by CenTech's exclusive Timeless Warranty!™

CenTech* ... the diskette you'll wish you had started with.

Call 801/255-3999 or Telex 499-6093

*CenTech is a registered trade name for Cenna Technology.

Circle 392 on inquiry card.

CENTECH

Cenna Technology, Inc., 185 Cottage Avenue, Sandy, Utah 84070, U.S.A.

WHAT TO WARE WHILE

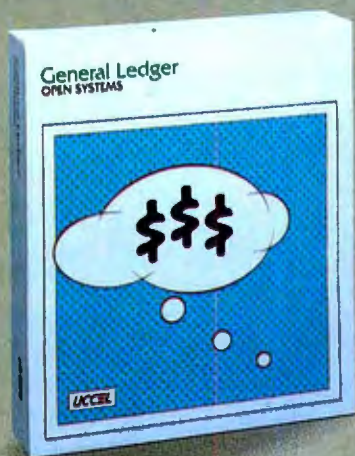

Go ahead. Slip into something comfortable. Ware the most comfortable, most sophisticated microcomputer accounting software in the world. Open Systems. Accounting software so rich in features, it can handle the complex problems of today's small business with unprecedented ease. Software so flexible, it runs on all popular microcomputers. And can grow right along with your business needs.

With Open Systems, you can start with one product then add others as

your business prospers. No other accounting line is so complete. With a choice of General Ledger, Accounts Receivable, Accounts Payable, Inventory, Payroll, Job Cost, Sales Order, Purchase Order and Fixed Assets as well as a Report Writer that links your accounting data to popular spreadsheets, word processors and graphics software. Assuring you the luxury of a perfect software fit. Today, tomorrow and for years to come.

The fact is, Open Systems meets the needs of today's small business

BALANCING THE BOOKS.

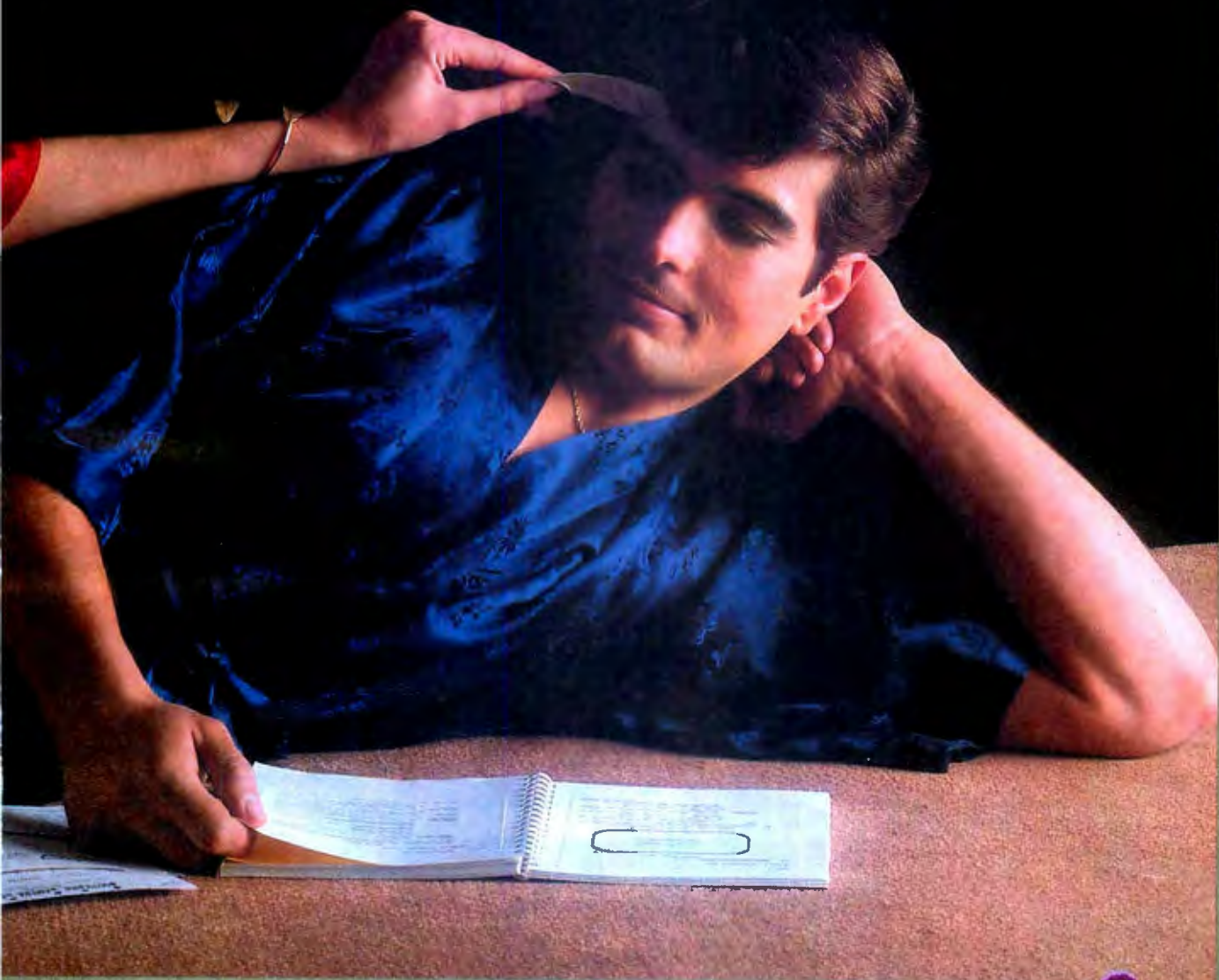

so completely, it's become one of the best selling lines of accounting software on the market. More than 300,000 accounting products are providing comprehensive accounting solutions for businesses throughout the world. Now that's comforting.

Call Open Systems right now. And get your mind off the books. For the dealer nearest you call
1-800-328-2276

OPEN SYSTEMS™
The accounting software that makes you look good.

Circle 246 on inquiry card.

Venix

BSD 4.1/4.2

Xenix

Idris.

UNIX III

UNIX-6

***The brightest star
in the
micro UNIXverse.***

UNIX-7

UNIX V

Whitesmiths, the company who brought you the C compiler in 1979 and Idris, the micro UNIX, in 1980, now announces Idris as an application under MS-DOS.

Available to run on the IBM PC, Data General, DEC Rainbow and other PC/MS-DOS-based systems, Idris as an application:

- runs better on the micros than UNIX
- has twice as many users as UNIX
- runs more tasks simultaneously
- will be complying with the UNIX /usr/group standards
- provides application portability
- contains all the most important UNIX utilities in a 1.5 megabyte disk
- all at a new, low price.



Whitesmiths, Ltd.

97 Lowell Road, Concord, MA 01742, (617) 369-8499, Telex 750246 SOFTWARE CNCM

UNIX, UNIX-6, UNIX-7, UNIX III, UNIX V, BSD 4.1/4.2 are trademarks of Bell Laboratories; Venix is a trademark of Venturecom; MS-DOS, Xenix are trademarks of Microsoft Corp.; PC-DOS is a trademark of International Business Machines Corp.; Rainbow is a trademark of Digital Equipment Corporation; Idris is a trademark of Whitesmiths, Ltd.

C·L·U·B·S & N·E·W·S·L·E·T·T·E·R·S

● **CHICAGO BBS ON ART AND TECHNOLOGY.** The Center for Advanced Studies in Art and Technology (CASAT) at the School of the Art Institute of Chicago has set up a bulletin-board system (BBS) for artists and scientists to exchange information and ideas concerning the uses of technology in the arts. Research projects under way include sound synthesis and image processing. You can up- or download Apple high-resolution images to the system. CASAT's bulletin board is (312) 443-3744.

● **50 FIGS ON TREE.** The FORTH Interest Group (FIG) announces the formation of the 50th chapter in Berkeley, California. FIG, a nonprofit organization, serves more than 4000 users of the FORTH computer language. It also sponsors the FIG-Tree, an on-line FORTH database (a 300-bit-per-second BBS) at (415) 538-3580. Membership is \$15 a year (\$27 foreign) and includes a subscription to *FORTH Dimensions*, a bi-monthly newsletter. Contact the FORTH Interest Group, POB 1105, San Carlos, CA 94070, (415) 962-8653.

● **ARTISTIC GRASS ROOTS.** *Art, Computers and Education (ACE)* is a grass-roots group of artists, teachers, technicians, software developers, and art educators that meets to discuss issues in the arts and in art education involving the use of computers. Its newsletter contains interviews, software reviews, and reviews of arts peripherals. A \$5 membership fee per school year entitles you to receive the ACE newsletter. For details, write to ACE, 3155 Avalon Court, Palo Alto, CA 94306.

● **HUG IN CONN.** The Connecticut Heath Users Group (CONNHUG) meets at 7 p.m. on the first Wednesday of each month at the Heathkit Electronic Center in Avon, Connecticut. The club maintains a bulletin board at (203)

674-8915. By providing a forum for information exchange, CONNHUG aims to educate in the area of computer science, particularly Heath/Zenith computers. For further details, contact CONNHUG, 395 West Main St., Avon, CT 06001, (203) 678-0323.

● **GET INSIDE IRIS.** The IRIS Users Group (independent of Point 4 Data Corporation, which owns the IRIS license) produces a quarterly newsletter, *Inside IRIS*, that contains educational and informative articles for more than 20,000 users. A BBS using the IRIS (interactive real-time information system) operating system is on line at (303) 44X-CLJJB. A membership fee is \$35 a year and includes the newsletter. For further information, call Doc Gordon at (303) 449-7637, Chauncey Taylor at (303) 663-1400, or write the IRIS Users Group, 1531 North Lincoln Ave., Loveland, CO 80537.

● **ASK THE ORACLE.** Oracle Network Headquarters' Silicon Valley Interchange RCP/M (remote CPM) bulletin-board system is a nonprofit public-domain system operating 24 hours a day. Running on a CompuPro 816 with a 40-mega-byte hard-disk drive, Oracle can accommodate more than 2500 on-line files of news releases, communications, utilities, data on 16-bit computers, and items of interest to users of Apple, Osborne, IBM PC, and CompuPro. The 300- or 1200-bps system's number is (408) 732-9190. Registration is required. Send a six-digit password and a \$25 annual membership fee to Oracle Network Headquarters, Silicon

Valley Interchange RCP/M, Attn: Registration, POB 532, Cupertino, CA 95015.

● **"WORKSTEADER'S" FACT SOURCE.** The National Association for the Cottage Industry is a nonprofit association that provides the home-based businessperson with access to information supporting "worksteading" as a financially viable alternative. It sponsors quarterly regional conferences and periodic seminars. A related newsletter, *Mind Your Own Business At Home*, is available. Contact the National Association for the Cottage Industry, POB 14460, Chicago, IL 60614, (312) 472-8116.

● **HAWKEYE AREA ATARI USERS GROUP.** Eastern Iowa Atari owners have banded together to form Hawkatari, a users group that meets monthly and produces a newsletter. A library of public-domain software is maintained and members are encouraged to submit their programs. New members are welcome to join for \$6 a year. Contact J.K. Wiese, Hawkatari, 2565 22nd Ave., Marion, IA 52302.

● **ACES MEET IN THE SUNSHINE STATE.** The Jacksonville Atari Computer Enthusiasts (JACE) is an independent users group that meets regularly and produces a newsletter that contains reviews, program listings, classified ads, and news. A \$10 membership fee entitles Atari owners to become members. Sample newsletters are \$1 each. Contact JACE, 1187 Dunbar Court, Orange Park, FL 32073.

● **HOW TO EXPORT SOFTWARE.** World Software Markets

(WSM) are covered in *The WSM Newsletter*, a monthly publication from World Education Markets Inc. It provides readers with information about overseas export and licensing opportunities of software. This includes trends and developments in home, business, and school microcomputer markets. For details, contact WSM, Garrett Park, MD 20896-0255.

● **A SOURCE FOR COMPARATIVE PRICING.** *Computer Price Alert* is billed as a national survey of computer and software prices. Each issue reports the three lowest prices on certain materials as the result of a scan of several hundred discount and mail-order firms. It includes a listing of vendors who don't advertise elsewhere, thus keeping overhead expenses down. A one-year subscription (20 issues) is \$48; a trial subscription (12 issues) is \$36. Club discounts are available. For details, contact *Computer Price Alert*, POB 574, Cambridge, MA 02238, (617) 354-8116.

● **BRIEFS FOR COMPUTER BUFFS.** Owners of any brand of computer who live in the District of Columbia will benefit from the resources outlined in a monthly newsletter entitled *Home Computer Briefs*. It features articles on training, repairs, and other services; a word-processing column; a calendar of events; reviews of microcomputer books; and a column for readers to share experiences. The information selected for the contents of the newsletter is designed to help disgruntled users tap the full potential of their equipment. A one-year subscription is \$18. Contact *Home Computer Briefs*, Suite 1739, 3421 M St. NW, Washington, DC 20007, (202) 965-4428.

● **NORTH COUNTRY EDUCATORS UNITE.** *North Country Micro* is produced five times a year and brings together almost 1500 educators in the
(continued on page 92)

.....
CLJJBs & NEWSLETTERS is a forum for letting BYTE readers know what is happening in the microcomputing community. Emphasis will be given to electronic bulletin-board services, club-sponsored classes, community-help projects, field trips, and other activities outside of routine meetings. Of course, we will continue to list new clubs, their addresses and contact persons, and other information of interest. To list events on schedule, we must receive your information at least four months in advance. Send information to *BYTE, Clubs & Newsletters*, POB 372, Hancock, NH 03449.

INTRODUCING THE:

Printer Partner

PAPER SUPPLIER Patent Pending

FEEDS UP TO FOUR TYPES OF PAPER WITHOUT MOVING BOXES AND STACKS PRINTED PAPER

PAPER SUPPLIED FROM:

- TOP SHELF
- UNDER PARTNER
- UNDER PRINTER

ALL PRINTED PAPER RECEIVED AND STACKED AT TABLE LEVEL

ATTACHES TO WALL OR CAN SET ON ANY DESK OR TABLE BEHIND PRINTER.

WALL BRACKETS INCLUDED FOR USE WITHOUT BASE UNIT

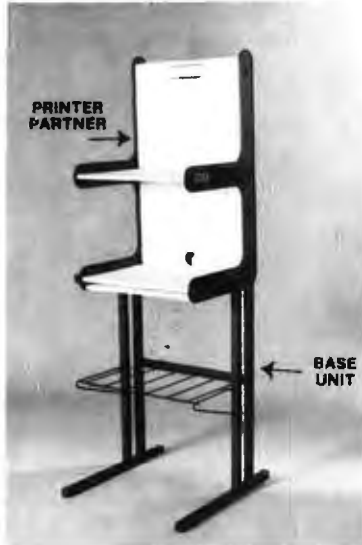

PRINTER PARTNER

\$99⁹⁵

WITH BASE AND ADDITIONAL SUPPLY SHELF

\$149⁹⁵

- HI IMPACT POLY STYRENE WITH STEEL SUPPORTS
- STEEL BASE
- BLACK SATIN SIDES AND BASE
- EMBOSSED WHITE SHELVES

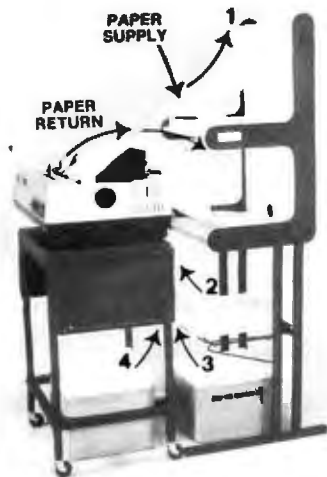

FREE STANDING FOR OPEN AREAS

Texas Residents Add 6% Sales Tax
For handling and shipping, add \$6.00
For pre-assembled unit, add \$7.50

ORDER NOW: 1-800-521-3158

In Texas Call Collect: (713) 681-3074

Major Credit Cards Accepted
or Mail Check to: Crestmont Sales,
3612 Mangum, #204, Houston, TX 77092

CLUBS & NEWSLETTERS

(continued from page 91)

Franklin/Essex/Hamilton area of northern New York state. They work on common problems and keep up on modern classroom technology via editorials, applications of existing software to education, reviews of hardware and software, and updates on what other school systems are doing regarding computer education. *North Country Micro* contains bibliographies for further study; subscriptions are free. To inquire, contact Kirk Peterson, Paul Smith's College of Arts and Sciences, Paul Smiths, NY 12970.

• **CALIFORNIAN COMMODORIANS.** The Orange County 20-64 Users Club meets at 1 p.m. on the fourth Saturday of each month to discuss news items and see presentations. Separate libraries for the VIC-20 and the C-64 are maintained for the members. A \$24 annual membership includes a subscription to the computerized newsletter. For details, contact Burt Bonem, 11212 Barclay Dr., Garden Grove, CA 92641, (714) 539-5909.

• **THE USERS GROUP FOR PCjr** The User's Group offers IBM PCjr owners up-to-date information, new products, and support via a newsletter and program exchange. The User's Group will publish a list of approved products based on its testing standards of reliability, ease of use, and pricing. The membership fee is \$15 annually. For details, contact Brian Gratz, The User's Group, 4620 50th St. A-9, Lubbock, TX 79414, (806) 799-0327.

• **MACINTOSH USERS UNITE** National Apple Pie is a clearinghouse for information and software exchange for users of the Apple Macintosh and Lisa computers. The bimonthly newsletter, *MacinTouch*, is free for members seeking information on seminars, meetings, workshops, new products, developments, and hands-on assistance. Annual membership is \$19. For details, contact National Apple Pie, Wayland Square, POB 3198, Providence, RI 02906.

• **RURAL RUCUS** Computer users who are farmers and ranchers living in remote areas can now ask high-tech vendors questions about

computers, thanks to a newsletter produced by the Rural Computer Users Society (RUCUS). Articles range from improving gross revenue and methods of scheduling to programs for the school-age reader. The focus of the newsletter is to help novices figure out how to best use their computers for business purposes. Send for information from RUCUS, POB 233, Hamilton, VA 22068.

• **INVEST WISELY** The American Association of Microcomputer Investors (AAMI) is an independent nonprofit organization that provides information to investors on how to use their microcomputers for profit in the stock, options, and commodities markets, bonds, real estate, and other investment opportunities. *The AAMI Journal* is produced bimonthly and contains reviews of investment software and on-line stock-market databases. A quarterly directory updates investment software. Computer programs, software discounts, and study guides are also available to members. For further information, contact AAMI, POB 1384, Princeton, NJ 06542, (609) 921-6494.

• **WHEN OPPORTUNITY KNOCKS.** New members of the Commodore Club receive a copy of a booklet entitled, *Cash from Your Computer!* Members exchange software, programming tips, and information. The bimonthly newsletter, *IO*, contains technical columns, computer applications, and other topics related to the Commodore. Annual dues are \$15 and include a newsletter subscription. Send a self-addressed, stamped envelope to Joe Kamenar, 225 Dunbar Lane, Horsham, PA 19044.

• **SOFTWARE IS AN ISSUE** *Software Issues* is an independent quarterly newsletter for people involved in the design, development, purchase, maintenance, or use of computer software. It addresses the development of quality computer programs, design and documentation methods, user interfacing, testing techniques, computer literacy, and more. An annual subscription is \$12. Contact GDW Associates, POB 14258, Clearwater, FL 34279. ■

Computer's Choice.

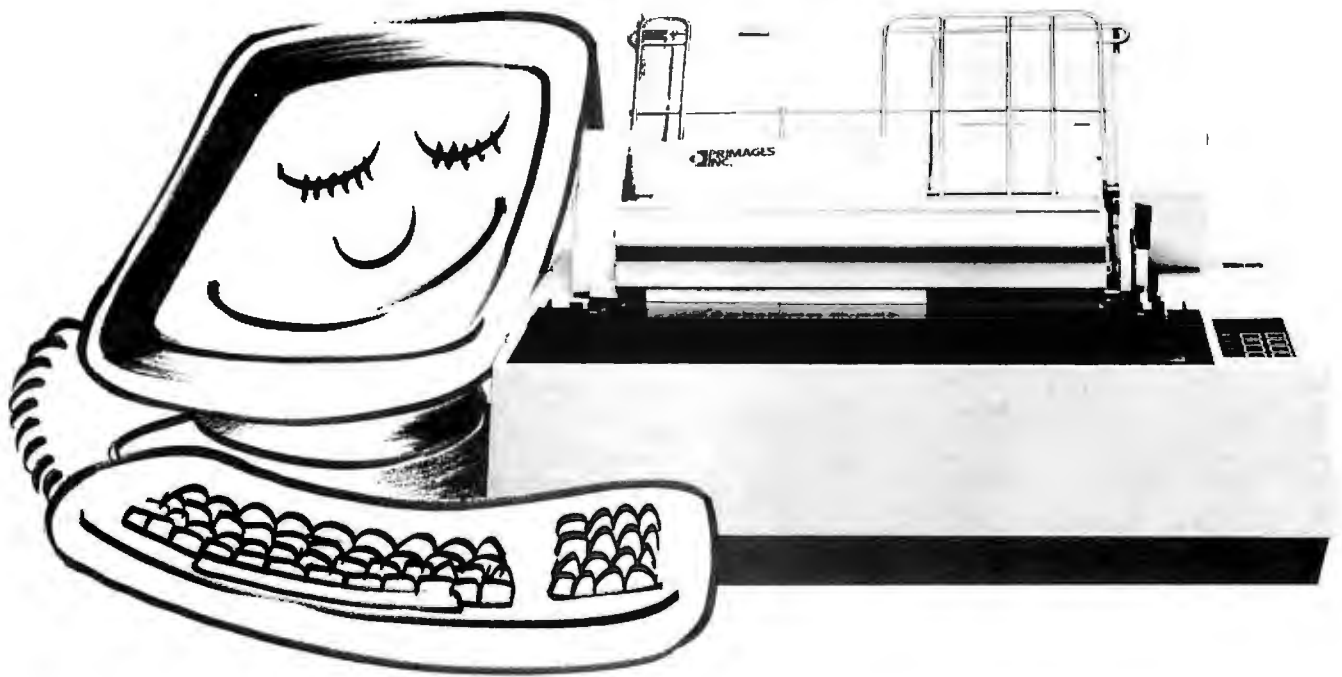

Primage I

Sooner or later, you'll probably want to use your business computer for word processing or data communications applications. And if you let your computer choose the best printer to provide letter quality printing at high production speeds, its first choice would be Primage I.

That's because when all the facts are entered, the Primage I with PageMate I sheet feeder, gives you more for your money than any other daisy system—45 cps, heavy duty, letter quality printing, with automatic sheet feeder, for hundreds of dollars less than its closest competitor.

The lower cost and higher performance are all made possible by a totally new control technology that allows simple, inherently more reliable stepping motors to run at much higher speeds. The design eliminates lots of parts that

you find in other serial printers. Parts you don't have to pay for and, just as important, parts you don't have to maintain. Primage I features simplified controls, easy paper feeding and a wide choice of fonts. It also comes with a unique 100-spoke daisy wheel that provides switch selectable multiple languages, and an easy access, easy set-up interface that connects to popular PC's without special cable fittings.

When you compare Primage I with top quality daisy printers and sheet feeders that cost up to 50% more, we're confident you'll make the same choice your computer would. So come into your computer dealer today for a first hand demonstration. Or contact us for detailed product literature. Primages Inc., 620 Johnson Ave., Bohemia, NY 11716 (516) 567-8200.

 **PRIMAGES
INC.**

E·V·E·N·T Q·U·E·U·E

June 1984

● SOFTWARE ONLY

Info/Software, McCormick Place, Chicago, IL. Mainframe and mini- and microcomputer software will be featured. Contact Clapp & Poliak, 708 Third Ave., New York, NY 10017, (212) 370-1100 and 661-8410. *June 12-14*

● MEDICINE AND COMPUTERS

Clinical Laboratory Computers Symposium 1984, Towsley Center, University of Michigan Medical School, Ann Arbor. Contact the Office of Continuing Medical Education, Towsley Center Box 057, University of Michigan Medical School, Ann Arbor, MI 48109, (313) 763-1400. *June 13-15*

● NECC NUMBER SIX

The Sixth Annual National Educational Computing Conference—NECC '84, University of Dayton, OH. Papers, workshops, and exhibits to improve computer-based classroom instruction. Contact Lawrence A. Jehn, Computer Science Department, University of Dayton, Dayton, OH 45469, (513) 229-3831. *June 13-15*

● PC IN SPOTLIGHT

PC-World Exposition, McCormick Place West, Chicago, IL. Contact Mitch Hall Associates, POB 860, Westwood, MA 02090, (617) 329-8090. *June 13-15*

● BYTE HOSTS COMPUTER SHOW

BYTE Computer Show, Convention Center, Los Angeles, CA. Seminars, product displays, and technical conference sessions are some of the highlights of this show sponsored by BYTE and *Popular Computing* magazines. Contact the Interface Group, 300 First Ave., Needham, MA 02194, (800) 325-3330; in Massachusetts, (617) 449-6600. *June 14-17*

● COMPUTING GERMAN

STYLE, International Computer Show, Cologne, West Germany. Seminars, workshops, and hardware and software exhibits. Con-

tact Messe- und Ausstellungs-Ges.m.b.H Köln, Messeplatz, Postfach 210760, D-5000 Cologne 21, West Germany; tel: (0221) 821-1; Telex: 8873 426 amua d. *June 14-17*

● VOICE/DATA ISSUES,

ANSWERS, Voice/Data Integration: Issues and Answers, Newport Beach Marriott, CA. Contact Bernie Ilson, 65 West 55th St., New York, NY 10019, (800) 638-6590; in New York, (212) 245-7950. *June 15*

● MIDWEST COMPUTER FAIR

The Ninth Annual Midwest Affiliation of Computer Clubs' Computerfest '84, Convention Center, Dayton, OH. Commercial exhibits, computer and electronics flea market, seminars, and mini-courses highlight this event. Tickets are \$6. Contact Computerfest '84, POB 24505, Dayton, OH 45424. *June 15-17*

● TECHNICAL WRITING

Writing for the Computer Industry, Plymouth State College, Plymouth, NH. Topics: how to write computer-related text for an international audience, electronic documentation, training and linguistic style, and how to integrate text and graphics. Contact Dr. Sally Boland, 5 Reed House, Plymouth State College, Plymouth, NH 03264, (603) 536-1550. *June 16*

● ACADEMIC COMPUTING

The Seventeenth Annual Association for Small Computer Users in Education Conference, Western Kentucky University, Bowling Green. Contact Dr. Dudley Bryant, Western Kentucky University, Bowling Green, KY 42101, (502) 745-0111. *June 17-20*

● INTRO TO FORTH PROGRAMMING, People, Computers, and FORTH Programming, Humboldt

State University, Arcata, CA. A hands-on, introductory course providing an understanding of the internal workings of FORTH and enough knowledge to write applications programs. Prior experience with a computer language is advised. The fee is \$125 or \$175 with three quarter hours academic credit. Contact Claire Duffey, Office of Continuing Education, Humboldt State University, Arcata, CA 95521, or call (707) 826-3731. *June 18-21*

● COMPUTERS AND BIOLOGY

The Fourth Annual Notre Dame Short Course Series: Computers in Biology, University of Nevada-Reno. Three concurrent short courses: "Computers in Bioeducation;" "Microcomputers in Classroom and Laboratory;" and "Computerized Data Analysis in Biological Research." Technical expertise is not required. Tuition is \$450. Contact Theodore J. Crovello, Biocomputing Short Course Coordinator, Department of Biology, University of Notre Dame, Notre Dame, IN 46556, (219) 239-7496. *June 18-22*

● ELECTRONIC OFFICE

CONCEPTS, Office Information System Software, Massachusetts Institute of Technology, Cambridge. The concepts behind the design of multifunction office workstations, including technologies, human factors, software, and applications generators, will be studied. Contact the Director of the Summer Session, Room E19-356, MIT, Cambridge, MA 02139. *June 18-22*

● DIGITAL MUSIC

TECHNIQUES, Experimental Music Studio, Massachusetts Institute of Technology, Cambridge. Two complementary sessions: "Techniques of Digital Audio Processing" and "Workshop in Computer Music Composition." The former, which

runs from June 18-29, provides a technical background and experience in digital sound-synthesis methods. The latter, which begins July 2, gives composers the opportunity to experiment with the computer as a musical instrument. No special technical knowledge is required. Contact the Director of the Summer Session, Room E19-356, MIT, Cambridge, MA 02139. *June 18-July 27*

● THE OFFICE OF THE

FUTURE, Computerized Office Equipment Expo/Office Information Systems Conference—COEE/OIS, O'Hare Exposition Center, Rosemont, IL. Contact COEE/OIS Program Coordinator, Cahners Exposition Group, Cahners Plaza, 1350 East Touhy Ave., POB 5060, Des Plaines, IL 60018, (312) 299-9311. *June 19-21*

● DOCUMENTATION METHODS

How to Document a Computer System, Sheraton Commander Hotel, Cambridge, MA. A series of documentation procedures will be presented. The fee is \$155 prepaid. Contact Technical Communications Associates, Suite 210, 1250 Oakmead Parkway, Sunnyvale, CA 94086, (800) 227-3800, ext. 977; in California, (408) 737-2665. *June 20*

● TECHNICAL PROGRAM IN

PRC, The First International Conference on Computers and Applications, Fragrant Hill Hotel, Peking, People's Republic of China. More than 100 technical papers will be delivered. Contact IEEE Computer Society, POB 639, Silver Spring, MD 20901, (301) 589-8142. *June 20-22*

● COMPUTING IN NE FLORIDA

The Great Southern Computer Show, Veterans Memorial Coliseum, Jacksonville, FL. Hardware, software, peripherals, accessories, and word- and data-processing exhibits complemented by workshops and seminars. Contact Great Southern

(continued on page 96)

.....
IF YOU WANT *your organization's public activities listed in BYTE's Event Queue*, we need to know about them at least four months in advance. Send information about computer conferences, seminars, workshops, and courses to *BYTE, Event Queue*, POB 372, Hancock, NH 03449.

ANNOUNCING . . . VERSION 2.0

EXTENDED PASCAL FOR YOUR
IBM PC, PC jr., APPLE CP/M,
MSDOS, CP/M 86, CCP/M,
OR CP/M 80



NOW . . .
WITH
WINDOWING
\$49.95

NEW FEATURES

"What I think the computer industry is headed for: well documented, standard, plenty of good features, and a reasonable price."

Jerry Pournelle,
Byte, February 1984

"The Perfect Pascal"

Alan R. Miller,
Interface Age, January 1984

If you already own Turbo Pascal version 1.0, you can upgrade to 2.0 for \$29.95. Just send in your old master with your check. (Manual update included of course).

WINDOWING!

... This is a real shocker. On the IBM PC or PC jr. you'll now have a procedure to program windows. . . . Any part of the screen can be selected as a window and all output will automatically go to this part of the screen only. As many windows as you please can be used from the same program.

AUTOMATIC OVERLAYS!

... No addresses or memory space to calculate, you simply specify OVERLAY and TURBO PASCAL will do the rest.

GRAPHICS, SOUND AND COLOR SUPPORT

... For your IBM PC or JR!

FULL HEAP MANAGEMENT!

... via dispose procedure.

OPTIONAL 8087 SUPPORT!

... Available for an additional charge.

If you have a 16 bit computer with the 8087 math chip—your number crunching programs will execute up to 10X faster!

ORDER YOUR COPY OF TURBO PASCAL VERSION 2.0 TODAY

For VISA and MasterCard orders call toll free:

1-800-227-2400 x968

In CA:

1-800-772-2666 x968

(lines open 24 hrs, 7 days a week)
Dealer & Distributor Inquiries welcome
408-438-8400

CHOOSE ONE (please add \$5.00 for shipping and handling for U.S. orders)

- Turbo Pascal 2.0 \$49.95
- Turbo Pascal 2.0 with 8087 support \$89.95
- Update (1.0 to 2.0) Must be accompanied by the original master \$29.95
- Update (1.0 to 8087) Must be accompanied by the original master \$69.95

Check Money Order
VISA MasterCard
Card #: _____
Exp. date: _____ Shipped UPS

BORLAND
INTERNATIONAL

Borland International
4113 Scotts Valley Drive
Scotts Valley, California 95066
TELEX: 172373

My system is: 8 bit _____ 16 bit _____
Operating System: CP/M 80 _____
CP/M 86 _____ MS DOS _____ PC DOS _____
Computer: _____ Disk Format: _____
Please be sure model number & format are correct.

NAME: _____

ADDRESS: _____

CITY/STATE/ZIP: _____

TELEPHONE: _____

California residents add 6% sales tax. Outside U.S.A. add \$15.00. (If outside of U.S.A. payment must be by bank draft payable in the U.S. and in U.S. dollars.) Sorry, no C.O.D. or Purchase Orders. B15

Circle 130 on Inquiry card.

THE WAREHOUSE

1421 Carlisle, Alb., NM 87110
(505) 255-3360

STOP

TO ORDER CALL 1-800-222-1494

ORDER DESK HOURS 8 A.M. to 5 P.M. MST Monday through Friday and 10 to 4 Saturday.

COMPUTERS



ZF 101-21	\$2,199
ZFA 121-22	\$2,799
ZF 121-22	\$2,899
F 111-32	\$4,100
ZF 121-32	\$4,379

FREE

MS-DOS & Lotus 1, 2, 3
included with each
computer!

MONITORS



ZVM 123-2	swivel base	... \$ 15.00
ZVM 123 (C)	...	\$115.00
ZVM 122 (A)	...	\$115.00
ZVM 124 (A)	...	\$189.00
ZVM 131	med. res. co.	... \$299.00
ZVM 435	high res. co.	... \$475.00

PRINTERS

INFOSCRIBE

500	\$940.00
700	\$1345.00
1000	\$1130.00
1100	\$1230.00
1200	\$1395.00

MPI

MPI-99	\$ 599.00
MPI-150	\$ 995.00

BLUE CHIP

BDC 40/15	...	\$1,899.00
BDC 20/15	...	\$ 899.00

Manufactured by CGK, a wholly owned subsidiary of Seimens

TERMINALS



ZT-10	\$379.00
ZT-11	\$449
Z-29	\$649

SOFTWARE ALSO AVAILABLE.
PLEASE CALL FOR QUOTES.

CALL FOR QUOTES

NEC TELEVIDEO AMDEK ANADEX SEIKO QUME

ORDERING INFORMATION AND TERMS: All items usually in stock. Cashiers Checks, Money Orders, Fortune 1000 Checks and Government Checks, we immediately honor. Personal or other Company Checks allow 20 days to clear. No C.O.D. Prices reflect 3% cash discount so ADD 3% to above prices for VISA or MC. For U.S. Mainland, add 3% for shipping, insurance and handling (S&H) by UPS with \$5 minimum for S&H. UPS ground is standard so add 3% more for UPS Blue with \$10 minimum for S&H. Add 12% total for S&H for US Postal, APO or FPO with \$15 minimum for S&H. For Hawaii, Alaska and Canada, UPS is in some areas only, all others are Postal so call, write or specify Postal. Foreign orders except Canada for S&H add 18% or \$25 minimum for S&H except for monitors add 30% or \$50 minimum for S&H. Prices subject to change and type errors, so call to verify.

EVENT QUEUE

(continued from page 94)

Computer Shows, POB 655, Jacksonville, FL 32201, (904) 356-1044, June 21-23

● **COMPUTERS IN MEDICAL PRACTICE—MEDCOM 84,** The First National Conference on Computers in Medical Practices, Masonic Memorial Temple, Nob Hill, San Francisco, CA. Twenty educational sessions plus exhibits and an investment-planning seminar. Contact MEDCOM 84, 1803 Golden Gate, San Francisco, CA 94115, (800) 468-2211; in California, (800) 445-2121 or (415) 931-0910. June 23-25

● **GRAPHICS STANDARD COURSE,** Introduction to GKS, Hyatt Regency Hotel, Austin, TX. A course on the Graphical Kernel System (GKS) standard. The fee is \$495. Contact Nova Graphics International Corp., 1015 Bee Cave Woods, Austin, TX 78746, (512) 327-9300. June 25-26

● **COMPUTATIONAL METHODOLOGY,** Conference on the Frontiers of Large-scale Computational Problems, National Bureau of Standards, Gaithersburg, MD. The interdisciplinary application of large-scale computing technology will be addressed. The focus is on complex problems that test the limits of traditional experimental and computational methodologies. Registration is \$275. Contact Wm. L. Schrader, FF '84, Newman Laboratory, Cornell University, Ithaca, NY 14853, (607) 256-3455. June 25-27

● **MICROS IN EDUCATION** Stanford Institute on Microcomputers in Education, Stanford University, Stanford, CA. An intensive session that provides the background necessary to serve as a school or district resource person. Hands-on programming, word processing, and administrative computing. Contact Stanford Institute on Microcomputers in Education, POB K, Stanford, CA 94305, (415) 322-4640. June 25-July 27

● **COMPUTERS IN DENTAL PRACTICE—DENTCOM 84,** The First National Conference on Computers in Dental Practices, Masonic Memorial Temple, Nob Hill, San Francisco, CA. Twenty educational sessions plus ex-

hibits and an investment-planning seminar. Contact DENTCOM 84, 1803 Golden Gate, San Francisco, CA 94115, (800) 468-2211; in California, (800) 445-2121 or (415) 931-0910. June 26-28

● **SOFTWARE, SYSTEMS, STRATEGIES,** The 1984 Coronado Invitational Conference on Software, Systems, and Strategies: The Next Five Years, Hotel del Coronado, San Diego, CA. Contact Gnostic Concepts Inc., Suite 300, 951 Mariner's Island Blvd., San Mateo, CA 94404, (415) 345-7400. June 26-28

● **PC IN BIG APPLE** PCExpo, Coliseum, New York City. IBM Personal Computer hardware, software, and vendor exhibits. Daily seminars. Contact PCExpo, 333 Sylvan Ave., Englewood Cliffs, NJ 07632, (201) 569-8542. June 26-28

● **FEDERAL COMPUTING EXPO** Government Computer Expo—GCE84, Sheraton Washington Hotel, Washington, DC. Workshops, exhibits, and technical programs focusing on end-user computing and applications. Contact U.S. Professional Development Institute, 1620 Elton Rd., Silver Spring, MD 20903, (301) 445-4405. June 26-29

● **LOGO CONVOCATION** Logo '84 Conference, Massachusetts Institute of Technology, Cambridge. Four main themes, Logo Learning, Learning Environments, Technical Forecasts, and Images of Future Work. Product exhibits. Contact the Special Events Office, Room 7-111, MIT, Cambridge, MA 02139. June 26-29

● **FORTH PROGRAMMING TIPS** Using FORTH Effectively, Humboldt State University, Arcata, CA. A hands-on, advanced course on the generation and internal operations of a FORTH system. A mastery of an introductory FORTH course or a minimum of six months using FORTH and a knowledge of assembly language and operating-system principles are pre-requisites. The fee is \$150 or \$200 with three quarter hours academic credit. Contact Claire Duffey, Office of Continuing

(continued on page 101)

From Apple to Zilog, Leave the Care and Feeding of your Computer to Inmac.

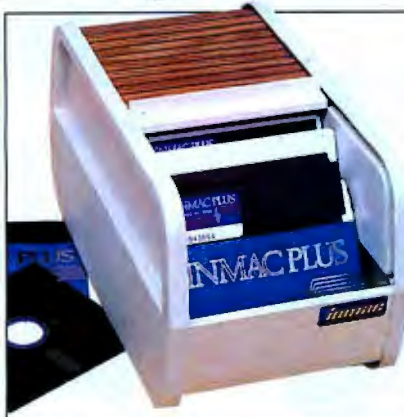

Unique roll-top file protects 120 floppies!

Our new file protects more floppies than other files that cost more.

The cover slides back and "disappears" for instant access. 11 dividers keep disks vertical. Order now for easy access to over a hundred floppies.

Roll-Top Floppy File.
No. 2537-PT4 \$39.95

Inmac PC turntable: lots of tilt & turn . . . little \$\$\$!

Inmac's compact PC monitor turntable rotates and tilts your monitor so you can work in glare-free comfort.

It costs less than most, yet has greater flexibility and looks terrific!

Rubber pads keep your monitor secure. It fits most popular equipment. Let our monitor tilt and swivel so you don't have to. Call by noon, we'll ship it today!

PC Adjustable Turntable. No. 4850-PT4 \$39.95



Clean your floppy drive heads in 30 seconds . . .

Before oxide build-up shuts your system down!

With a 60 cleaning capacity, at less than a dollar each, our kit saves you as much as 62% over other kits.

Order today and get over a year of weekly cleanings.

Economy Size Clean Cycle Kit for 5¼" drives.
No. 7159-PT4 \$45



Unique rack keeps Apple manuals handy.

Our manual rack keeps your spiral bound software and computer documentation at your fingertips where it's easy to find and use.

Clear acrylic rods slide through the spiral bindings of up to 8 books as tall as 9½". You can easily add or remove manuals at any time.

The rack is angled for comfortable reading and quick flipping from book to book. Holds all Apple and spiral bound manuals.

Order yours now. Once you try it, you'll wish we'd invented it sooner!

Spiral Bound Manual Rack. No. 3720-PT4 \$49.95

Covers protect IBM keyboard and drive.

These handsome covers preserve the sleek silhouette of your IBM PC while shielding vulnerable areas from harmful dust and dirt.

The keyboard cover is made of durable smoke-tinted acrylic. The drive cover blends with the IBM's styling and has a cushioned edge that forms a dust-proof seal.

Order today and protect your PC from contamination.

Keyboard and Disk Drive Cover Set.
No. 2976-PT4 \$19.95



Call toll-free 1-800-547-5444*

Ordering is easy as A-B-C. Fill out the postage-paid card opposite or call toll-free. Verbal P.O.'s welcome. Visa, MasterCard. No minimum order. Our friendly staff and technical experts will be glad to assist you.

Fast delivery. Call us by noon, we'll ship your order the same day. By UPS or USPS. Overnight delivery available.

Double Protection Guarantee. If you're not completely satisfied, return any product within 45 days for a full refund. All products shown here have one year replacement guarantees.

*in California, call 1-800-547-5444.

FREE INMAC CATALOG.

For 2500 more great ways to feed and care for your mini, micro or wp, call today and we'll rush you the latest edition. With paper, ribbons, cable, media, modems, **inmac** and more.



The TeleVideo IBM PC

The best hardware for



TeleVideo versus IBM. Make a few simple comparisons and you'll find there is no comparison.

RUNS IBM SOFTWARE.

With the TeleVideo® IBM Compatible line—PC, XT and portable computers—you'll get the most out of all the most popular software written for the IBM® PC—more than 3,000 programs.

Because every TeleVideo Personal Computer offers the highest level of IBM compatibility on the market

THE BEST HARDWARE FOR THE BEST PRICE.

Features	Tele-PC	IBM PC	Tele-XT	IBM XT
Monitor	YES	OPTIONAL	YES	OPTIONAL
Screen Size	14"	12"	14"	12"
Tilt Screen	YES	NO	YES	NO
Quiet Operation	YES (NO FAN)	NO	YES	NO
Memory	128K	128K OPTION	256K	256K OPTION
Graphics Display (640x200 resolution)	YES	OPTIONAL	YES	OPTIONAL
Printer Port	YES	OPTIONAL	YES	OPTIONAL
Communication Port	YES	OPTIONAL	YES	YES
MS™-DOS/BASIC*	YES	OPTIONAL	YES	OPTIONAL
System Expansion Slot	YES	YES	YES	YES
RGB and Video Port	YES	OPTIONAL	YES	OPTIONAL
Typical System Price	\$2995	\$3843	\$4995	\$5754

compatibles. the best software.

and has the standard—not optional—features you need to take full advantage of every job your software can do.

Study the chart at the left. It proves that TeleVideo—not IBM—offers the best hardware for the best price.

Note that TeleVideo's ergonomic superiority over IBM extends from fully sculpted keys and a comfortable palm rest to a 14-inch, no glare screen that tilts at a touch.

THE BEST MICROCHIPS.

What is perhaps most impressive about the TeleVideo IBM PC Compatible can be found deep within its circuitry. We use the same 8088 central processing unit that runs an IBM PC. But we also employ new VLSI (Very Large Scale Integration) microchips that are designed and built exclusively for TeleVideo.

These interface more efficiently with the powerful 8088 and yield numerous benefits.

For example, our tiny custom chips do the work of many of the larger, more expensive circuit boards in an IBM PC. So we can offer a computer system that comes in one attractive, integrated case, is ready to run and occupies less desk space. A computer that edges out IBM's added-cost component system for reliability, ease of service and purchase simplicity.

Fewer circuit boards to cool also allowed us to eliminate the noisy, irritating fan IBM and most other PCs force you to put up with. And TeleVideo compatibles accept



THE BEST PORTABLE FOR THE BEST PRICE.

Features	TPC II	COMPAQ
High Capacity Storage	YES	NO
2nd Disk Drive	YES	OPTIONAL
Quiet Operation (No Fan)	YES	NO
Ergonomic Display	YES	NO
Communication Port	YES	OPTIONAL
International Power Supply	YES	NO
MS™ DOS 2.11	YES	NO
Graphics Display	YES	YES
Typical System Price	\$2995	\$3710

any IBM hardware options without modification.

THE BEST LINE.

But the Tele-PC is only one element of the TeleVideo IBM PC Compatible line.

The TeleVideo XT is the best hardware for users of popular IBM XT software who would appreciate an extra 10 megabytes of storage capacity along with the advantages listed on the preceding chart.

As the chart above demonstrates, our portable IBM compatible computer, the TPC II, is far and away better hardware than COMPAQ™. Better hardware—standard—at a better price.

THE BEST MANUFACTURER.

The TeleVideo IBM PC Compatible line is made by the world leader in multi-user computer systems and the number one independent manufacturer of terminals.

Our compatibles are available at participating ComputerLand and Entré (call 800-HI-ENTRE) dealers or you may call 800-538-8725 for the dealer nearest you. In California, call 800-345-8008.

Before you invest, make a few simple comparisons. You'll find that TeleVideo—not IBM or COMPAQ—has the best hardware for the best software. At the best price.

IBM is a registered trademark of International Business Machines. MS is a trademark of MicroSoft Corporation. GW Basic is a registered trademark of MicroSoft Corporation. COMPAQ is a trademark of COMPAQ Computer Corporation.



TeleVideo®
Personal Computers
● TeleVideo Systems, Inc.

Circle 329 on inquiry card.

BUY A BANK FOR \$15.95



The DiskBank® Media Mate.



Media Mate 3 for new micro diskettes.
Media Mate 5 for 5 1/4" diskettes.



Convenient easy-carry handle.

Introducing Media Mate... another affordable solution in diskette filing technology from DiskBank.

Media Mate combines an attractive desktop appearance with superior protection, organization and storing capability for 50 diskettes. All at a cost your budget will appreciate.

Available in sizes to accommodate both 5 1/4" and 3 1/2" diskettes, Media Mate includes a fortress of features:

- Sturdy, high impact styrene construction
- Attractive smoke see-thru cover

- Convenient adjustable tab dividers
- Self-locking cover with easy-carry handle
- Case on case stackability

For protecting, organizing and storing your valuable diskettes, make the little investment that pays off big. Buy a Bank. Buy DiskBank.

DISKBANK®

AMARAY CORPORATION

2251 Grant Road, Los Altos, CA 94022
(415) 968-2840, Telex 171627 Amaray-Ltos

EVENT QUEUE

(continued from page 96)

Education, Humboldt State University, Arcata, CA 95521, (707) 826-3731. June 26-29

● **MEDICINE AND COMPUTERS**
Annual American Society of Computers in Medicine and Dentistry Conference, Lodge at Vail, CO. An introduction to computers for doctors and dentists and a forum for expanding the use of computers. Contact Arlene Rogers, ASCMD, POB 21483, Upper Arlington, OH 43221, (614) 421-8487. June 28-30

July 1984

● **WORKSHOPS FOR EDUCATORS.** Compuworkshops Computer Seminars for Educators, various locations in California. Among the seminars offered are "Authoring Tools and Word Processing for Educators," "BASIC Programming for Educators," and "Designing Educational Courseware." Each course is \$50. Contact Compu-kids of Seal Beach, Rossmoor Shopping Center, 12385 Seal Beach Blvd., Seal Beach, CA 90740, (213) 430-7226; in West Los Angeles, (213) 473-8002; in Tarzana, (213) 343-4008; and in Rancho Bernardo/San Diego, (619) 451-1742. July-August

● **SME CONFERENCES & EXPOS.** Conferences and Expositions from the Society of Manufacturing Engineers, various sites in the U.S. and around the world. A calendar is available. Contact the Public Relations Department, Society of Manufacturing Engineers, One SME Dr., POB 930, Dearborn, MI 48121, (313) 271-0777. July-August

● **C. UNIX COURSES**
Courses in C Language and UNIX, Concord, MA, Somers Point, NJ, and College Park, MD. Three five-day courses are offered: "C Programming Workshop," "Advanced C Topics Seminar," and "UNIX Workshop." Contact Joan Hall, Plum Hall Inc., 1 Spruce Ave., Cardiff, NJ 08232, (609) 927-3770. July-August

● **DBM SEMINARS**
Digital Consulting Associates' Classes and Seminars, various sites in the U.S. Seminars and classes on dBASE II, Lotus

1-2-3, database administration, and other microcomputer topics. Contact Digital Consulting Associates Inc., 339 Salem St., Wakefield, MA 01880, (617) 246-4850. July-August

● **DATABASE SEMINARS**
SoftwareBanc Seminars, various sites in the U.S. and Canada. Such seminars as "Problem Solving with 1-2-3," "dBASE II," and "Exploring UNIX" are planned. Contact SoftwareBanc Inc., 661 Massachusetts Ave., Arlington, MA 02174, (800) 451-2502; in Massachusetts, (617) 641-1241. July-August

● **EFFICIENT COMPUTING TECHNIQUES.** Microcomputers: Techniques for Improving Your Computer Efficiency, Valley Inn and Tavern, Waterville Valley, NH. Four intensive two-day seminars: "Microcomputers: Programming in BASIC," "Introduction to VisiCalc," "Micro Database Applications," and "Engineering and Management Applications." Tuition is \$495, or \$679 with meals and lodging. Contact New Hampshire College, Resource Center, 2500 North River Rd., Manchester, NH 03104, (603) 668-2211, ext. 175. July-September

● **MANAGERIAL SEMINARS**
Computer Competence Seminars, Boston University Metropolitan College, Boston, MA. A series of hands-on presentations tailored for managers who know little or nothing about computers and for those who wish to sharpen their computing skills. On the docket are "PCs for Improving Financial Analysis and Decision Support" and "Personal Computers for Sales and Marketing Professionals." Fees range from \$225 to \$595. In-house programs can be organized. Contact Joan Merrick, University Seminar Center, Suite 415, 850 Boylston St., Chestnut Hill, MA 02167, (617) 738-5020. July-September

● **RAINBOW SEMINARS**
All-Hands-On, Boston, MA, Chicago, IL, New York City, and San Francisco, CA. A series of applications seminars featuring the DEC Rainbow 100. Contact Carol Ericson, BUO/E50, Educational Services, Digital Equipment Corp., 12 Crosby Dr., Bed-

(continued on page 102)

MOVE-IT™
makes
communication
simple



FOR PC DOS, CPM-86 and CPM Systems.

- **SIMPLE TO INSTALL.** MOVE-IT can be installed in under 5 minutes by answering simple questions at the console. Included is the set-up information for over 100 micros and 10 I/O boards.
- **SIMPLE TO USE PROGRAM.** MOVE-IT'S 20 commands allow you to auto-dial and access remote information utilities, and bulletin boards, including upload and download. Transfer files error free between PC and other micros when both run MOVE-IT. Display both local and remote directories... and a whole list of other features.
- **SIMPLE TO UNDERSTAND MANUAL.** Complete 80 page manual is included. Over 8000 programs now in use. "One of the few packages that actually works as advertised," says Interface Age.

MOVE-IT program and manual suggested retail \$150. For CPM systems \$125. Specify disk format and operating system when ordering.

WOOLF SOFTWARE SYSTEMS INC.

6754 ETON AVE. CANOGA PK, CA 91303 (213) 703-8112

High Quality!

NDC SERIES
100/200



5 1/4" DISK CONTROLLER

KEY FEATURES

- Full sector buffering
- Logical sector addressing
- Multiple sector, cylinder operation
- 11 bit burst ECC
- Self-diagnostic capability
- Automatic sector alternation for the defective sectors
- Automatic Error Retry
- Industry Standard SASI I/F

National Computer Ltd.

LIASON OFFICE IN CALIFORNIA
PHONE: (408) 734-1006 FAX: (408) 744-0709

AKEBONO BLDG. 2-6-12 IWAMOTO-CHO
CHIYODA-KU, TOKYO, JAPAN
PHONE: (03) 863-6705 TLX: J27542
FAX: (03) 864-4581

COMPETITIVE EDGE

P.O. BOX 556 ORDERS 800-336-1410
 PLYMOUTH, MI 48170 INFO 313-451-0665
40 MEGABYTE HARD DISK SUB-SYSTEM AT 20MB PRICE \$2595
 DISK 3™ CONTROLLER, 40 MB HARD DISK, CP/M® 80 & 86, CAB & PS
 READY TO RUN WITH ALL CompuPro® OPERATING SYSTEMS

COMPETITIVE EDGE S-100 BCTM & S-100 SCTM BUSINESS COMPUTER & SCIENTIFIC COMPUTER

TYPE	SINGLE USER	4 USER	6 USER	8 USER +
RAM/HARD DISK	256K	512K 10MB	768K 20MB	1024K 40MB
S-100-BC 286 5"	\$3495	\$5495	\$6995	\$8195
S-100-BC 186 5"	\$1995	\$4295	\$5795	\$6995
S-100-BC Z 8"	\$2295 64K	\$4595 320K	\$5995 448K	\$7595 576K
S-100-BC 85/88	\$2895 64K	\$7595 40MB	\$8750 40MB	\$9895 40MB
S-100-BC 68K 8"	\$6699 40MB 256K STATIC			

TYPE	FLOPPY BASED	40 MB HARD DISK BASED
S-100-SC 286/287 5"	\$4795 256K STATIC	\$6995 256K STATIC
S-100-SC 86/87 5"	\$3895 256K STATIC	\$6095 256K STATIC

COMPONENTS FROM CompuPro®, Lomas, Teletek

Disk 1A™	\$459	Disk 1™	\$327	Disk 3™ w/ CP/M® 80 & 86	\$525
RAM 22™	1155	Ram 21™	657	Ram 17™	\$329
SS1	297	I/O 3	459	I/O 4	297
CP/M® 68K™	242	RAM22 CSC	1287	CPU86™CSC	561
CPU 85/88	327	CPU Z™	215	DISK 1CSC	393
SS1 CSC	363	I/O 4 CSC	363	ENCL0S 2	599
ACT TERM	55	20 SLOT MB	195	12 SLT MB	129
LIGHTNING 1	420	10MHz L1	520	HAZITALL	275
LIGHTN. 286	1116	286/287	1595	RAM 67	725
256K DRAM	636	CC/PM 86	280	M CCP/M86	360
OCTAPORT 8	316	GRAPHICS	396	THUNDER 186 256K, CCP/M	1195
SYSTEMMASTER®	557	SBC-1 4MHz	525	6MHz SBC1	695
HD/CTC	499	6-128 SBC1	733	13MB HD	795
40MB HD	1595	53MB HD	1795	HD/CTC, 53MB HD, CAB & PS 2495	

TERMINALS, PRINTERS, SOFTWARE, MODEMS

WYSE 50	\$550	WYSE 75	\$650	QUME 102 GR	\$539	QUME 102AM	\$549
ZENITH Z29	675	TV 925	749	TV 970	1095	VISUAL 55	795
EPSON FX80	499	IDS P 80	969	P 132 COLOR	1495	C. ITOH 8510	549
F10 40	1095	F10 55	1395	C. I 1550	675	1550 SERIAL	725
DRI C	225	C.I. C	295	SPELLBINDER™	295	S-100 MODEM	315

ALL PRICES SUBJECT TO CHANGE AND SUBJECT TO STOCK ON HAND — CP/M, CCM-86, MP/M are either registered trademarks or trademarks of Digital Research, CompuPro™ is a Godbout Company, Disk 1, Disk 1a, Disk 3, MP/M 8-16, CPM 8-16, CPU 8-16, CPU Z, CPU 85/88, CPU 86, CPU 86, RAM 22, RAM 21, RAM 17, RAM 18 are trademarks of CompuPro™. Systemmaster™ is a registered trademark of Teletek Enterprises Inc. MSDOS is a trademark of Microsoft. Spellbinder™ is a trademark of Lexsoft Inc.

EVENT QUEUE

(continued from page 101)

ford, MA 01730. (617) 276-4572.
 July–September

● DEC SEMINARS

Technical and Management Seminars for Professionals, various sites in the U.S. Subject areas: system-performance management, networking, personal computing, applications design and programming, real-time applications design, and management development. On-site seminars can be arranged. Contact Educational Services, Digital Equipment Corp., Seminar Programs BUO/E58, 12 Crosby Dr., Bedford, MA 01730. (617) 276-4949. July–September

● HIGHTECH TUTORIALS

Tutorial Short Courses from Hellman Associates, various sites in the U.S. Among the courses offered are "VLSI Design," "Digital Control," and "Error Correction." Fees are generally \$895. Contact Hellman Associates Inc., Suite 300, 299 California Ave., Palo Alto, CA 94306. (415) 328-4091.
 July–October

● PROFESSIONAL EDUCATION

Seminars from the Institute for Professional Education, various sites in the U.S. Programs in statistics, management, simulation and modeling, personal computers, and computer science. Contact the Institute for Professional Education, POB 756, Arlington, VA 22216. (703) 527-8700. July–December

● COMMODORE DISSECTED

Commodore College '84, Brandon University, Manitoba, Canada. Workshops on graphics, sound, file handling, disk techniques, and 6502 machine language. Contact Faculty of Education, Brandon University, Brandon, Manitoba R7A 6A9, Canada. (204) 728-9520. July 1–6

● PC SHOW IN LONDON

The 1984 PC User Show, Novotel, London, England. Devoted to the IBM Personal Computer. More than 100 exhibits. Contact Geoff Dickinson, EMAP International Exhibitions Ltd., 8 Herbal Hill, London EC1B 1PA, England; tel: 01 837 3699. July 3–5

● WOMEN AND COMPUTING

The Third Annual National Con-

ference of the Association for Women in Computing Conference, Holiday Inn Center Strip, Las Vegas, NV. The conference theme is "Choice or Chance in Computing Careers." Contact Patricia Timpanaro, AWCC '84 Registration, 40 Main St. Number 206, Stoneham, MA 02180. July 8

● NCC

The 1984 National Computer Conference—NCC, Convention Center, Las Vegas, NV. Professional-development seminars, more than 650 exhibits, and nearly 100 technical sessions. Contact the American Federation of Information Processing Societies Inc., 1899 Preston White Dr., Reston, VA 22091. (703) 620-8926. July 9–12

● FIBER-OPTIC METHODS

Fiber and Integrated Optics, San Diego, CA. Course topics: single- and multimode fiber cabling, photo detectors, receiver and repeater technology, and optical-fiber sensors. The fee is \$875. Contact Continuing Engineering Education, George Washington University, Washington, DC 20052. (800) 424-9773; in the District of Columbia, (202) 676-6106. July 9–13

● SPECIAL EDUCATION

INSTITUTE, Microcomputers in Special Education: Today's Challenge, Lesley College, Cambridge, MA. Subjects: Logo, software evaluation, administrative applications, and model programs. Technical expertise not required. Contact Joy Nikkel, Lesley College, 29 Everett St., Cambridge, MA 02238. (617) 868-9600. July 16–20

● SIMULATION CONFERENCE

Summer Computer Simulation Conference—SCSC '84, Copley Plaza Hotel, Boston, MA. Technical sessions, papers, panel discussions, exhibits, and tutorials. Contact Charles Pratt, Simulation Councils Inc., POB 2228, La Jolla, CA 92038. (619) 459-3888. July 23–25

● SIGGRAPH

ACM SIGGRAPH '84, Minneapolis, MN. Technical papers, panel discussions, a design show, film and video presentations, and nearly 30 courses. Contact SIGGRAPH '84 Conference Office, 111 East Wacker (continued on page 104)

EVEN LOWER PRICES for SERVICE, SAVINGS, and SATISFACTION

Call for June Specials!!

PRINTERS

Dynex 15X	439
Epson FX-100	679
FX-80	499
RX-80 FT.	389
Gemini 10X	259
15X	389
NEC 3550	1829
2030	Call
OkiData 92P	439
83P	747
Prowriter	349
HP Ink Jet	499

MONITORS

Amdek 310A	159
300	135
Princeton HX 12	479
Sekate SC100 Color	259
Taxan Amber	119
Vision 3	449
Zenith 123 12" Green	95
122 12" Amber	95
135 13" Color	459

MODEMS

Hayes 1200	479
1200B	399
MM //e	240
300 baud	199
Novation Apple Cat 2	259
Promodem 1200	CALL
Signalman Mark I	81
Mark X	210
XII	278
Volks Modem 300 baud	59



apple
 //e
 64K CPU, 2 Drives,
 Controller, 80-Cot
 S SAVE \$
 NEW ARRIVAL!!
 MACINTOSH...Call

MONTH'S SPECIALS

Juki 6100	\$449
Gemini 10X	CALL
Gemini 15X	\$389
Word w/Mouse	\$269
Slim Line Drive	
Apple/IBM	\$189



IBM
 PC 64K
 2-Drives, Controller
 Color & Monochrome,
 Parallel Port
 \$2455

IBM XT \$4295
 Call for Special Deals!

APPLE PRODUCTS

Micro Sci A2 Drives	199
Rena Elite I	219
Teac Drive	210
Chinon Drive	189
Videx 80 col w/softswitch	189
Ultraterm	289
Grappler+	119
Weeper Full Graphics	79
Buffered 16K	139
18K Ram	87
System Saver Fan	99
Microsoft Prem //e	289
Softcard CPM	229
Multiplan	179
MAC Multiplan	139
Basic	109
Apricorn Serial Card	69
Koala Graphic Tablet	79
Z-80 Card	59

IBM PRODUCTS

Tandon TM 1002	219
Panasonic 320K	179
Teac 558 320K	189
STB Graphix Plus	258
RIO+	258
Super RIO	279
Microsoft Multiplan	179
64K Ram	149
Flight Sim	39
Lotus 1-2-3	289
AST 6 Pak	269
Mega+	269
Quadboard EK	219

WE SUPPORT THESE FINE SYSTEMS:
 Altos, Apple, Columbia, Compaq,
 Corana, DEC, Epson, IBM, KayPro,
 Sanyo, TeleVideo, Zenith, Zorba, and
 many more.



Computer Price
 Club
714 841-6160

16783 Beach Blvd,
 Huntington Beach, CA 92647

NO CLUB FEE
 PRICES SUBJECT TO CHANGE WITHOUT NOTICE
 CASH PRICE!

5/84

NOW! Choose From 3 Hard Disc Drive Systems That Convert Your IBM* PC To Perform Like The PC XT!

Our Winchester Hard Disc Drive Systems offer 10 Mega-bytes of formatted capacity, are internally installed and use available power!

Maynard Electronics introduces three Winchester Hard Disc Drive Systems — the only drive systems to offer you 10 Mega-bytes of formatted capacity with complete internal installation! These systems offer the user countless benefits and features: capability of booting off the hard disc; additional functions while requiring only one card slot in your PC; and, use of available power, thereby preventing overheating problems which have affected other drives. Handling heavyweight data was never easier.

All three systems are quality engineered and work with DOS

2.0 without any special software drivers and also run with other operating systems designed to make use of the XT hard drive system. All you need is the IBM* DOS 2.0 Manual and you're ready to run!

Each system is equipped with a low-power hard disc drive, complete software, cable, a SandStar™ Card and Hard Disc Controller Module. SandStar™ is the first family of modular peripherals created for the IBM* PC. Simple instructions for easy installation are included and all components are backed by an Unconditional One Year Parts and Labor Guarantee.

WS 1

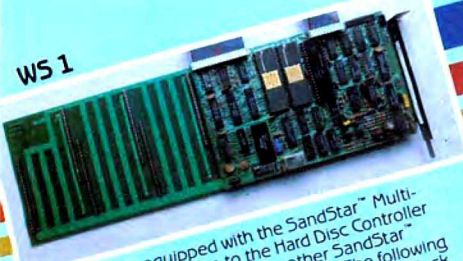

This System is equipped with the SandStar™ Multi-function card. In addition to the Hard Disc Controller Module, you can add up to three other SandStar™ Modules while using only one card slot. The following modules are available: Serial Port, Parallel Port, Clock Calendar, Game Adaptor, and Prototyping Module.

WS 2

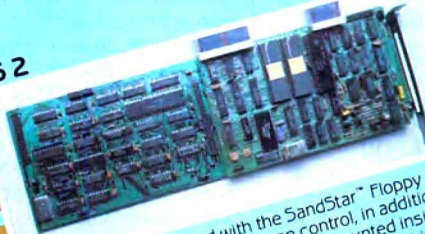

This System is equipped with the SandStar™ Floppy Drive Controller Card. The Card can control, in addition to the Hard Disc Drive, two floppy drives mounted inside your PC and optionally two additional 5¼" or 8" drives mounted externally. This leaves three system slots for other expansion boards.

WS 3

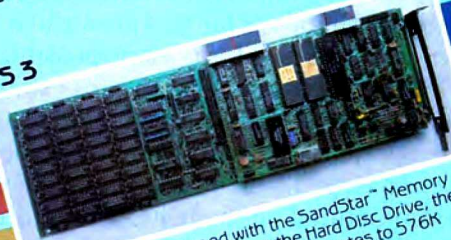

This System is equipped with the SandStar™ Memory Card. In addition to controlling the Hard Disc Drive, the Memory Card allows you to add 64K bytes to 576K bytes of memory using only one card slot.



To expand your PC to perform like the PC XT, one of our Winchester Hard Disc Drive Systems is right for you. And if you have already made the wise decision to install any of Maynard's SandStar™ Cards, the SandStar™ Hard Disc Controller Module may be purchased separately.

TO ORDER, CONTACT YOUR LOCAL DEALER OR DISTRIBUTOR.



We make modern times better.

MAYNARD
400 East Semoran Blvd.
Casselberry, Florida 32707
305/331-6402

ELECTRONICS

**NOW!
Compatible
with
COMPAQ! ****

Circle 207 on inquiry card.

*IBM is a trademark of the International Business Machines Corporation.
**COMPAQ is a trademark of the COMPAQ Computer Corporation.



LMC's 32-Bit Virtual Memory MegaMicro Is The-State-Of-The-Art UNIX Microcomputer

LMC's 32-bit MegaMicro provides mainframe or super-minicomputer performance at prices competitive with today's far less powerful 8- and 16-bit microcomputers. This is made possible by use of the next generation of logic chips—the National Semiconductor 16000-series. LMC MegaMicros incorporate: the NS16032 central processing unit which has true 32-bit internal logic and internal data path configured on the IEEE 796 multibus; demand-paged virtual memory implemented in hardware; and hardware 64-bit double-precision floating-point arithmetic.

The LMC MegaMicro is supplied with HCR's UNITY* which is a full implementation of UNIX** and includes the Berkeley 4.1 enhancements to take advantage of demand-paged virtual memory. Also included are C and FORTRAN. Typical multi-user systems with 33 megs. of fast (30 ms. average access time) winchester disk storage, a half meg. of RAM, virtual memory, hardware floating-point arithmetic, UNIX, C, and FORTRAN 77 are available for \$20,000 (and even less with quantity or OEM discounts).

* UNITY is a Trademark of Human Computing Resources.
**UNIX is a Trademark of Bell Laboratories.

LMC MegaMicros The Logical Alternative™

LMC

The Logical MicroComputer Company

4200 W. Diversey, Chicago, IL 60639 (312) 282.9667



A member of The Marmon Group of companies

EVENT QUEUE

(continued from page 102)
Dr., Chicago, IL 60601. (312) 644-6610. July 23-27

● **INTERFACING TIPS FOR TEACHERS.** Microcomputer-based Instrumentation for Schools, Middletown, OH. An introductory, hands-on workshop for college and secondary teachers. Contact Bill Rouse, 301 McGuffey Hall, Miami University, Oxford, OH 45056, (513) 529-2141. July 23-August 2

● **MICROS IN EDUCATION** Stanford Institute on Microcomputers in Education, Stanford University, Stanford, CA. See June 25-July 27. July 30-August 31

August 1984

● **SCHOOL COMPUTER COORDINATORS.** The Computer: Extension of the Human Mind, Center for Advanced Technology in Education, University of Oregon, Eugene. For individuals responsible for the use of computers and emerging technologies at the school and district levels. Pre- and post-conference workshops. Registration is \$95. Contact Summer Conference Office, College of Education, University of Oregon, Eugene, OR 97403. August 1-3.

● **SHOW FOR TARHEELS** Great Southern Computer Show, Civic Center, Charlotte, NC. Hardware, software, peripherals, and accessories for the home and office. Seminars and workshops. Contact Great Southern Computer Shows, POB 655, Jacksonville, FL 32201, (904) 356-1044. August 2-4

● **HOME AND OFFICE** The First Annual Tampa Bay Computer Show & Office Equipment Exposition, Curtis Hixon Convention Center, Tampa, FL. Hardware, software, accessories, and peripherals for industry and home. Contact CompuShows Inc., POB 3315, Annapolis, MD 21403, (800) 368-2066; in Annapolis, (301) 263-8044; in Baltimore, 269-7694; in the District of Columbia, 261-1047. August 2-5

● **AI INVESTIGATED** The National Conference on Artificial Intelligence, Performing

Arts Center, University of Texas, Austin. Seminars, exhibits, and panel discussions. Registration for American Association for Artificial Intelligence (AAAI) members is \$100; nonmembers pay \$140. Contact Claudia C. Mazzetti, AAAI, 445 Burgess Dr., Menlo Park, CA 94025, (415) 328-3123. August 6-10

● **COMPUTERS IN ENGINEERING.** The 1984 ASME International Computers in Engineering Conference and Exhibit, Hilton Hotel, Las Vegas, NV. More than 60 panel discussions and paper sessions. Product exhibits. Contact American Society of Mechanical Engineers, 345 East 47th St., New York, NY 10017, (212) 705-7100. August 12-16

● **MICROS & VOC ED** Microcomputers and High Technology in Vocational Education Conference, Vocational Studies Center, University of Wisconsin, Madison. Concurrent sessions, formal classes, presentations, speeches, and videotaped programs. Preregistration fee is \$55, or \$65 at the door. Contact Dr. Judith Rodenstein, 964 Educational Sciences Building, University of Wisconsin, 1025 West Johnson St., Madison, WI 53706, (608) 263-4367. August 13-16

● **COMPUTERS AND BIOLOGY.** The Fourth Annual Notre Dame Short Course Series: Computers in Biology, University of Notre Dame, Notre Dame, IN. See June 18-22. August 13-17

● **GRAPHICS & CONSTRUCTION.** The Third International Conference and Exposition on Computers/Graphics in the Building Process, BP '84, Embarcadero Center, Hyatt Regency, San Francisco, CA. Tutorials, plenaries, and technical sessions will focus on the theme "The Building Process in Transition." Contact Conference Director, BP '84, Suite 333, 2033 M St. NW, Washington, DC 20036, (202) 775-9556. August 19-23

● **PCB TECHNICAL SEMINAR** The 1984 Printed Circuit Fabrication Technical Seminar, Boston, MA. Contact Donna Esposito, PMS Industries, 625 Sims Industrial Blvd., Alpharetta, GA 30201, (404) 475-1818. August 27-29 ■

Introducing the Most Powerful Business Software Ever!

TRS-80™ (Model I, II, III, or 16) • APPLE™ • IBM™ • OSBORNE™ • CP/M™ • XEROX™



The VERSABUSINESS™ Series

Each VERSABUSINESS module can be purchased and used independently, or can be linked in any combination to form a complete, coordinated business system.

VERSA RECEIVABLES™ \$99.95
 VERSARECEIVABLES™ is a complete menu-driven accounts receivable, invoicing, and monthly statement-generating system. It keeps track of all information related to who owes you or your company money, and can provide automatic billing for past due accounts. VERSARECEIVABLES™ prints all necessary statements, invoices, and summary reports and can be linked with VERSALEDGER II™ and VERSAINVENTORY™.

VERSA PAYABLES™ \$99.95
 VERSAPAYABLES™ is designed to keep track of current and aged payables, keeping you in touch with all information regarding how much money your company owes, and to whom. VERSAPAYABLES™ maintains a complete record on each vendor, prints checks, check registers, vouchers, transaction reports, aged payables reports, vendor reports, and more. With VERSAPAYABLES™, you can even let your computer automatically select which vouchers are to be paid.

VERSA PAYROLL™ \$99.95
 VERSAPAYROLL™ is a powerful and sophisticated, but easy to use payroll system that keeps track of all government-required payroll information. Complete employee records are maintained, and all necessary payroll calculations are performed automatically, with totals displayed on screen for operator approval. A payroll can be run totally, automatically, or the operator can intervene to prevent a check from being printed, or to alter information on it. If desired, totals may be posted to the VERSALEDGER II™ system.

VERSA INVENTORY™ \$99.95
 VERSAINVENTORY™ is a complete inventory control system that gives you instant access to data on any item. VERSAINVENTORY™ keeps track of all information related to what items are in stock, out of stock, on backorder, etc., stores sales and pricing data, alerts you when an item falls below a preset reorder point, and allows you to enter and print invoices directly or to link with the VERSARECEIVABLES™ system. VERSAINVENTORY™ prints all needed inventory listings, reports of items below reorder point, inventory value reports, period and year-to-date sales reports, price lists, inventory checklists, etc.

VERSA LEDGER II™ \$149.95
 VERSALEDGER II™ is a complete accounting system that grows as your business grows. VERSALEDGER II™ can be used as a simple personal checkbook register, expanded to a small business bookkeeping system or developed into a large corporate general ledger system without any additional software.

- VERSALEDGER II™ gives you almost unlimited storage capacity (300 to 10,000 entries per month, depending on the system),
- stores all check and general ledger information forever,
- prints tractor-feed checks,
- handles multiple checkbooks and general ledgers,
- prints 17 customized accounting reports including check registers, balance sheets, income statements, transaction reports, account listings, etc.

VERSALEDGER II™ comes with a professionally-written 160 page manual designed for first-time users. The VERSALEDGER II™ manual will help you become quickly familiar with VERSALEDGER II™, using complete sample data files supplied on diskette and more than 50 pages of sample printouts.

COMPUTRONICS

50 N. PASCACK ROAD, SPRING VALLEY, N.Y. 10977

SATISFACTION GUARANTEED!

Every VERSABUSINESS™ module is guaranteed to outperform all other competitive systems, and at a fraction of their cost. If you are not satisfied with any VERSABUSINESS™ module, you may return it within 30 days for a refund. Manuals for any VERSABUSINESS™ module may be purchased for \$25 each, credited toward a later purchase of that module.

To Order: **Write or call Toll-free (800) 431-2818**
 (N.Y.S. residents call 914-425-1535)

- * add \$3 for shipping in UPS areas
- * add \$5 to CANADA or MEXICO
- * add \$4 for C.O.D. or non-UPS areas
- * add proper postage elsewhere

DEALER INQUIRIES WELCOME
 All prices and specifications subject to change / Delivery subject to availability.

* TRS-80 is a trademark of the Radio Shack Division of Tandy Corp. • APPLE is a trademark of Apple Corp. • IBM is a trademark of IBM Corp. • OSBORNE is a trademark of Osborne Corp. • CP/M is a trademark of Digital Research • XEROX is a trademark of Xerox Corp.

THE ESSENTIALS

CompuPro Disk Subsystems

When it comes to answering your data storage needs, CompuPro has the essential components. Like our Floppy and Hard Disk Subsystems with Disk 3™ and Disk 1A™ controllers. They're the IEEE 696/S-100 products that will keep you and your system on the cutting edge of computing for years to come. Each reflects the most advanced technology available. And that's what you've come to expect from CompuPro. Because we've built our reputation on quality components like these for more than a decade.

DISK 1A™: Our high-performance floppy disk controller handles any combination of up to four 8" or 5¼" drives. The Disk 1A is perfectly suited for the highest level single or multi-user microcomputer system. It features state-of-the-art LSI architecture, high-speed DMA interface, and complete compatibility with CP/M-80™, CP/M-86®, CP/M-68K™, CP/M®8-16™, MP/M™8-16™, and Concurrent CP/M™8-16™ operating systems.

DISK 3™: Our hard disk controller, which supports as many as four 5¼" Winchester drives, achieves new levels of performance for multi-tasking systems. The Disk 3's many features include transfer of each disk sector using high speed "burst mode" DMA, and a channel processor for independent seeking, reading and writing, as well as the capability to transfer large blocks of data between disk and memory with a single command. Compatible with the same operating systems as Disk 1A.



OF DATA STORAGE

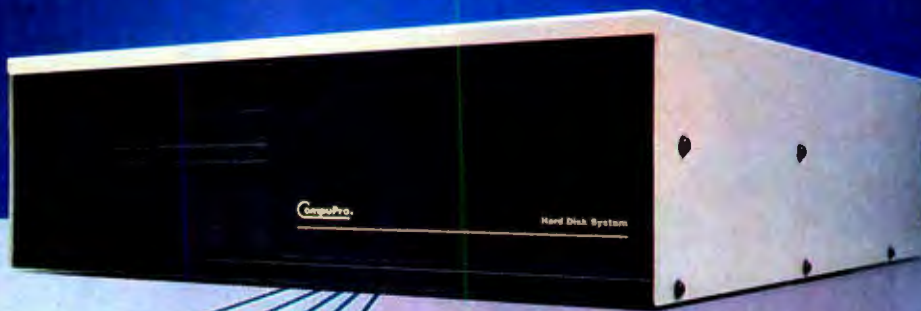

FLOPPY/ HARD DISK SUBSYSTEMS:

Here's the essential peripheral for your micro-computer. Choose from a wide range of models to obtain the perfect disk subsystem for your application. We offer combinations of 20, 40 or 80Mb hard disks, with either a single 8" floppy drive or two 5 1/4" floppy drives to give you maximum flexibility in a single unit. Or you can have a unit containing two hard disks or two floppy drives. It's all up to you. Hard disks are manufactured by Quantum, and double-sided, double-density floppy drives by Qume and Mitsubishi. . . all are assembled in our famous disk enclosure. These packages can also be purchased without controllers and software for those upgrading their current system.

You can learn even more about making the most of your microcomputer by sending for our free catalog. In it, you'll find components and systems that can improve the way you work. And why CompuPro is essential to you.

The Essential Computer™

See us at NCC booth #H854.

CompuPro®

A GODBOUT COMPANY

3506 Breakwater Court, Hayward, CA 94545

(415) 786-0909

Circle 70 on Inquiry card.

CP/M and CP/M-86 are registered trademarks and CP/M-80 and CP/M-68K are trademarks of Digital Research Inc. CP/M 8-16, MP/M 8-16 and Concurrent CP/M 8-16 are compound trademarks of Digital Research Inc. and CompuPro. Disk 1A, Disk 3 and The Essential Computer are trademarks of CompuPro. Specifications subject to change without notice. ©1984 CompuPro



Tom Churney DT

Features

THE HP 110 <i>by Ezra Shapiro</i>	111
TRUMP CARD, PART 2: SOFTWARE <i>by Steve Ciarcia</i>	115
FASTER FORTH <i>by Ronald L. Greene</i>	127
AN ADA LANGUAGE PRIMER <i>by Sabina H. Saib</i>	131
MACINTOSH PASCAL <i>by G. Michael Vose</i>	136
BUILD A PRINTER BUFFER <i>by John Bono</i>	142
APPLE FAX: WEATHER MAPS ON A VIDEO SCREEN <i>by Keith H. Sueker</i>	146
SPREADSHEET IN BASIC <i>by Rodolfo Cerati</i>	154

ALTHOUGH BYTE'S LOOK and organization change this month, the Feature section will continue to offer a range of topics; previews of innovative machines and software, techniques for using hardware and software, and in-depth explanations of how important technologies work. We welcome Steve Ciarcia to the Feature section effective this issue. The originality and diversity of Steve's popular construction projects rival those of some large manufacturing companies.

West Coast editor Ezra Shapiro opens the Feature section this month with a preview of the impressive Hewlett-Packard battery-powered portable computer, the HP 110. Small and light, the HP 110 packs powerful software into its ROM, including Lotus 1-2-3 and a text editor. The HP 110 accelerates the trend toward self-contained, truly personal (carry it with you everywhere) productivity tools.

Next, Steve Ciarcia completes his tale about turning the IBM PC into a personal minicomputer. "I know BASIC," Steve recently said, "and I don't want to learn any other high-level language." But Steve didn't resign himself to plodding through life at interpreter speeds. The Z8000 Trump Card lets Steve run BASIC and other software on the IBM PC at lightning speeds. This second and final part of the Trump Card article describes its software.

Ronald L. Greene follows with a lucid article that explains how macro substitution for the executable portions of words can make subroutine-threaded compilers produce faster code. Greene's article addresses reducing overhead in threaded interpreted languages and shows how to make FORTH run faster.

The monolith called the Department of Defense has given us Agent Orange and the F-111 bomber in recent years. As of January 1, 1984, it insists that Ada is the new computer language of the military-industrial complex. Whether this is bad or good, we offer this month the first installment of a two-part Ada primer written by Sabina H. Saib.

An interpreted version of Pascal will soon debut as Macintosh Pascal. Our product preview reveals that a company called Think Technologies produced this full implementation of the language combining BASIC's interactivensess and Pascal's structure to provide a powerful teaching language.

We've put John Bono to work on the hardware front, designing a low-cost printer buffer that you can build over a weekend. The result of John's effort is an article that'll help you build a device that frees your computer from periods of servitude to your printer.

In what may develop into a technique we'll all use some day, Keith H. Sueker explains how he receives radio-transmitted weather maps and displays the resulting data on a video monitor using his Apple computer. His article, called "Apple FAX: Weather Maps on a Video Screen," includes a screen photograph proving that the technique is a workable one. The hardware needed is inexpensive and the software relatively simple.

After last month's look at structured, incrementally-compiled BASIC, this month Rodolfo Cerati shows you how to write a spreadsheet in old-fashioned BASIC, in an article that reveals some interesting programming techniques.

—G. Michael Vose, Senior Technical Editor, Features

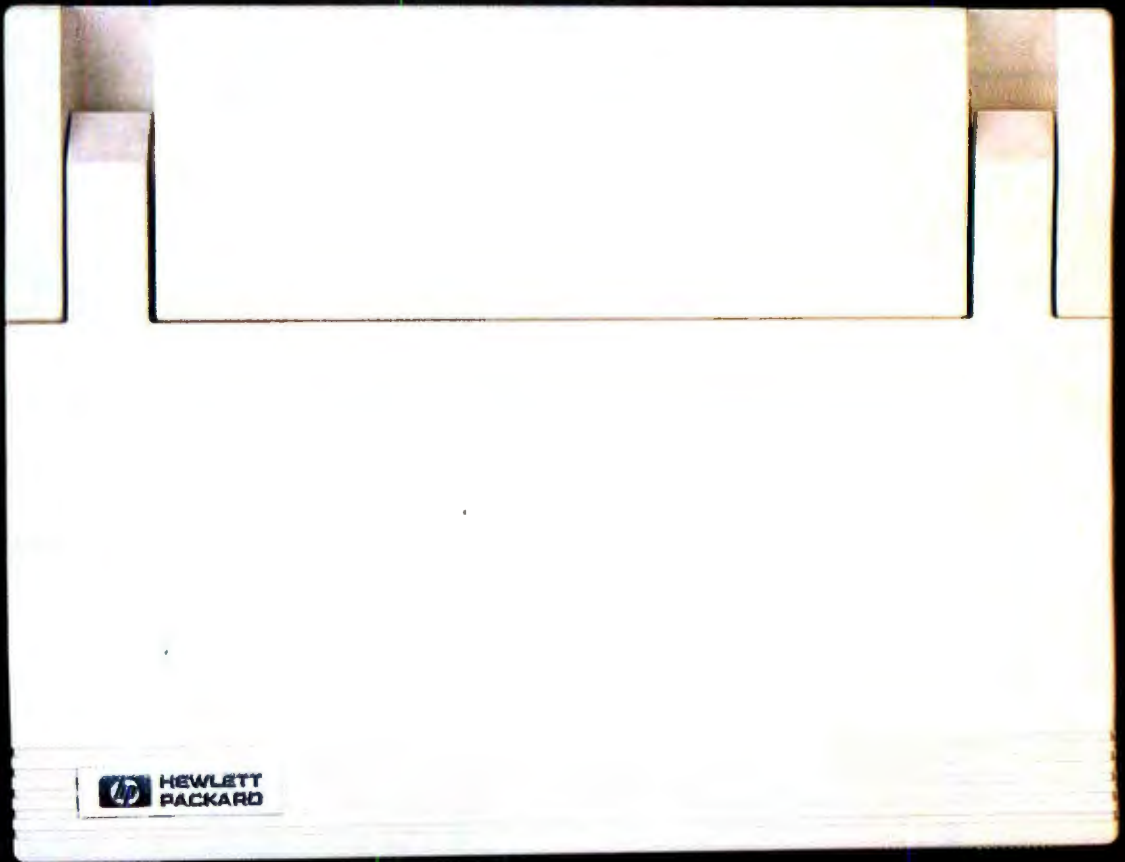
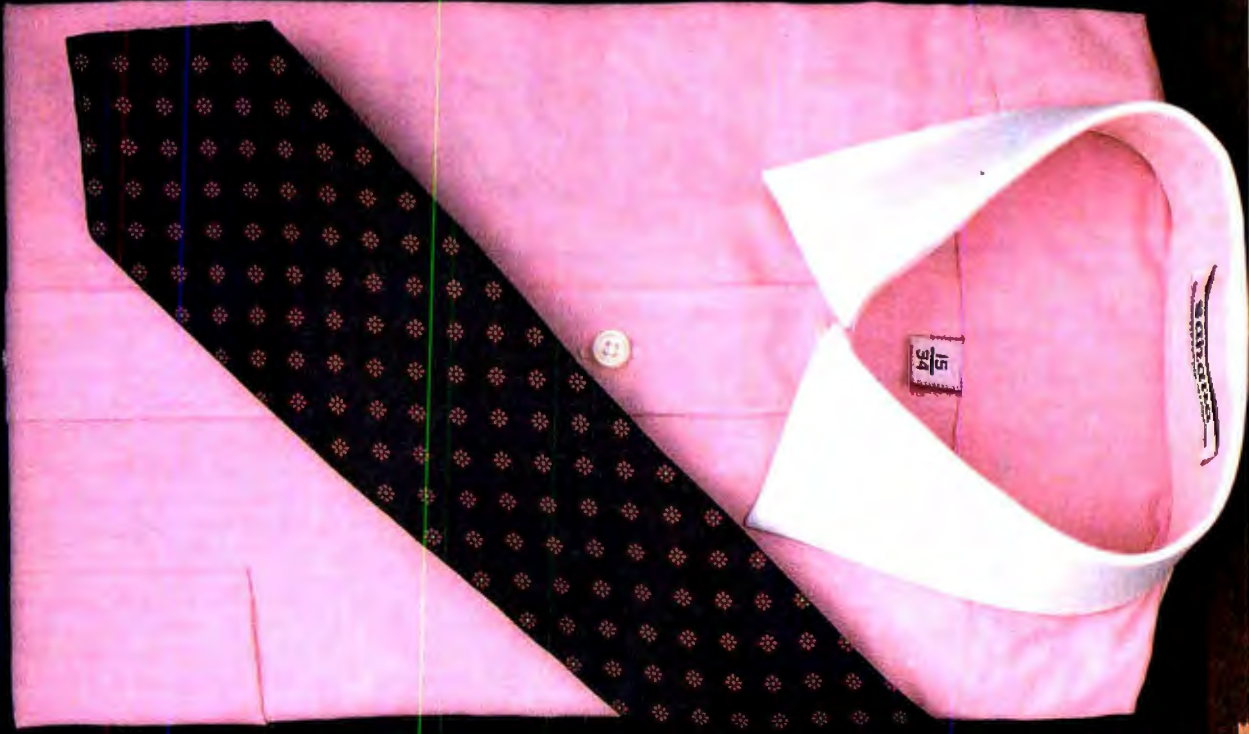

 HEWLETT
PACKARD

P·R·E·V·I·E·W

The HP 110

A light and powerful portable

IN THE BATTLE for dominance in the growing market for lightweight, battery-powered, briefcase-size portable computers, Hewlett-Packard has unveiled its new model, the HP 110. The unit is outwardly similar to many of its competitors—it's about the size of a metropolitan phone directory and has a flip-up LCD (liquid-crystal display) screen that lifts to uncover a typewriter-style keyboard. But two aspects of the design philosophy behind the 110 help set it apart from the crowd.

First, the 110's combination of abundant internal memory and silicon-based software makes it an extremely satisfactory traveling computer, freeing you from a large part of the dependence on disks and other cumbersome storage media. Second, the HP 110 was seen from the very first as the hub of an integrated system of components, an

ideal that has been realized with the concurrent announcement of related products from Hewlett-Packard (see photo 1).

The guts of the computer are built around the Harris 80C86, a CMOS (complementary metal-oxide semiconductor) version of the popular 8086 microprocessor chip, running at 5.33 MHz (megahertz). Available memory consists of 272K bytes of CMOS RAM (random-access read/write memory), which you can divide between system RAM and electronic disk emulation, and a whopping 384K bytes of CMOS ROM (read-only memory). System RAM can range from a minimum of 96K bytes to a

(text continued on page 112)

Ezra Shapiro is a technical editor at BYTE's West Coast bureau. He can be reached at McGraw-Hill, 425 Battery St., San Francisco, CA 94111.

BY EZRA SHAPIRO

AT A GLANCE

Name

HP 110

Type

Portable computer with built-in 300-bps modem

Manufacturer

Hewlett-Packard Corporation
11000 Wolfe Rd.
Cupertino, CA 95014
(800) 367-4772

Processor

Harris CMOS 80C86

Memory

272K bytes CMOS RAM, user-definable as RAM or solid-state disk; 384K bytes CMOS ROM

Data Storage

RAM-based disk emulator; no internal drives

Size

13 by 10 by 3 inches; 9 pounds

Display

LCD, 16 lines by 80 characters; graphics resolution, 480 by 128 pixels

Power Supply

Rechargeable lead-acid batteries, rated 20 hours

Software Provided

MS-DOS 2.01, Personal Applications Manager, Lotus 1-2-3, Memomaker (word processor), terminal and communications packages

Price

\$2995

Options

Thinkjet (HP 2225B) ink-jet printer, HP 9114 single 3½-inch disk drive, IBM PC/HPIL interface card with HPLINK software, various Hewlett-Packard interface converters

(text continued from page 111)

maximum of 256K bytes. Onboard ROM contains an assortment of software, including HP's Personal Applications Manager (a shell-style user interface), MS-DOS version 2.01 (the operating system itself plus a collection of utilities for file management, directory maintenance, disk formatting, etc.), Lotus 1-2-3, Memomaker (a simple word-processing program), and a timer/ alarm program. Also contained in ROM is the communications software to drive the computer's three output ports: an RS-232C serial interface, a proprietary HPIL (Hewlett-Packard Interface Loop) interface, and a built-in 300-bps (bits per second) modem that accepts a standard phone plug (see photo 2). There is no internal disk storage, but the battery-powered CMOS chips are essentially nonvolatile; that is, you can turn off the display and come back to the computer a week later and pick up exactly where you left off.

Hewlett-Packard manufactures its own CMOS ROM and RAM chips at Corvallis, Oregon, home of the division that has been producing hand-held computers and calculators for several years. Designers of the 110 took advantage of this facility to engineer two other CMOS chips for this project: an LCD controller with 8K bytes of display ROM, software fonts for the character generator, and bit-mapping for graphics; and another 8K-byte ROM chip, known as "the kitchen sink," that includes the timer, interrupts, serial port, and keyboard interface. These efforts resulted in a main printed-circuit board and an I/O (input/output) board with lower chip counts than you might expect. The final boards are not tightly packed; descendants of the 110 will have room for more interesting goodies.

The display is an 80-character by 16-line LCD, though the large expanse of plastic bezel around the screen suggests the possibility of a bigger display in the indeterminate future. In fact, HP engineers commented that they had looked at 24-line screens but had decided that product reliability and image quality were still too uncertain to make them acceptable at this time. You can select two character fonts: Hewlett-Packard's and an alternate set compatible with that of the IBM Personal Computer (PC). You can program the display in graphics mode as a grid of 480 by 128 pixels (picture elements). This is relatively high resolution, particularly for an LCD, and is suitable for most types of business graphics. Brightness (actually, darkness in this case) can be

controlled with a single key on the right side of the keyboard. Characters and graphics are sharp, and screen updates are quite rapid.

The 110's keyboard is laid out in the standard Selectric format (i.e., the Return and Shift keys are in the old familiar locations) and has a full complement of computer keys: Control, Break/Stop, Escape/Delete, Caps Lock, and Print/Enter. A key labeled "Extend char" generates a non-ASCII (American National Standard Code for Information Interchange) character and is equivalent to the Alt key of the IBM PC. An additional row of keys along the top of the keyboard includes eight soft (determined by individual programs) function keys, two menu keys that generate or remove a map of the function keys from the bottom three lines of the screen, a Select key that chooses a highlighted option within a program, and four cursor-movement keys. There is no separate numeric keypad.

The rechargeable lead-acid batteries that power the 110 are rated at 20 hours of continuous use. In actual practice, the 110 can go for a week or more of sporadic use before the batteries become dangerously weak. The system is designed to preserve memory at all costs. The display is the major power drain, and the computer shuts it off at a preset interval of inactivity: you can choose an interval of anywhere from 30 seconds to 30 minutes. When the batteries reach 5 percent of capacity, the 110 refuses to turn on the display until they've been recharged. If the 110 is not used at all, you can expect a couple of months on a single charge.

The unit is a compact device with a high-impact molded plastic shell, measuring 13 by 10 by 3 inches (closed); its color is the typical nondescript off-white. It weighs in at 9 pounds. The basic package includes a plug-in recharger (similar to those used for other portable products) and a black vinyl carrying case with a handle and a wide, adjustable shoulder strap.

The HP 110 is tested to rather severe standards. However, the Hewlett-Packard quality-control staff stresses that these are goals rather than absolute guarantees for each machine: 0 to 50 degrees Celsius for operation, -25 to 55 degrees for storage, and 95 percent humidity for five days at 40 degrees. The units are also put through condensation, moisture absorption, and rapid temperature cycling tests. HP 110s have withstood altitudes of 50,000 feet and forces of 100 G on all axes. The fact that there are no sensitive internal

drives—no moving parts at all, with the exception of the keys and the lid hinges and latches—makes the 110 an extremely rugged computer. All units must pass FCC Class B limits on electromagnetic interference; Hewlett-Packard is working with the FAA to end the controversy over computer use on commercial airliners and to establish hard, published standards for portable computer radiation.

THE SOFTWARE

When you first open the HP 110, the screen is blank; pressing any key activates the display. The first time you use the computer, you will see Hewlett-Packard's Personal Applications Manager (PAM), modified somewhat from the original version distributed with the HP 150 touchscreen personal computer (see photo 3). Subsequently, turning on the display returns you to where you were the last time you used the computer. PAM is an operating-system shell; most file manipulation and system configuration is accomplished through PAM's main or subsidiary menus.

The initial PAM screen shows a number of important status items: date, time, remaining battery life, and space available on the electronic disk drive (called the A: drive). Most of the display is used to show the applications you can run. At the outset, these applications are those programs resident in ROM (called the B: drive); if at some point you load programs into the RAM disk, those programs are also displayed on the screen. Moving the cursor to a program and pressing either the first function key (Start Applic) or the Select key loads and runs the program. Data files are not listed.

The second function key (File Manager) leads to a secondary shell. The File Manager displays all the files in the default directory and a list of alternate directories. On this screen, the function keys enable you to print or delete a file or a directory, create a new directory (following MS-DOS path rules), choose a new directory to display, copy a file, rename a file, or format a new disk (more on this later in the section on peripherals). The File Manager serves as the shell for most of the MS-DOS maintenance commands.

The third function key (Clock Config) provides access to the clock configuration commands, letting you reset the time and the date. The fourth key (Reread Discs) rescans the directories and updates the PAM screen. The fifth function key (Datacom Config) leads to a menu for setting the parameters (com-

munications rate, word length, stop bits, parity, protocol) for the HPIL interface and either the modem or the RS-232C serial port (you can't run these two outputs simultaneously).

The sixth function key brings up the system configuration menu (see photo 4). Here, you can allocate system memory and RAM-disk space, indicate the number of external disk drives plugged into the computer, select a read-after-write verification of disk action, set the display time-out interval, choose between a block or an underscore cursor, select the character set, determine the length of the warning beep, and configure the printer interface.

Pressing the seventh key, either from the main PAM menu or from any of the secondary menus, produces a menu for a series of detailed Help screens on all operations of the HP 110 (see photo 5). The eighth key returns you to the main menu from a secondary menu; if ac-

tivated from the main menu, the key shuts off the display.

The four applications programs listed by PAM include Memomaker, Lotus 1-2-3, Terminal, and DOS Commands. Memomaker is a rudimentary word processor developed by Hewlett-Packard for quick notes, brief business correspondence, and ASCII program script files (such as the scripts PAM uses to trigger the alarm or run a program at a specific date and time). If you're accustomed to working with a full-fledged word-processing program, you might find Memomaker severely lacking in sophistication, particularly when it comes to formatted output.

Lotus 1-2-3, on the other hand, is a delight to use (see photo 6). Maximum system memory enables use of a spreadsheet with 2048 by 512 cells, certainly more than adequate for most modeling problems. Because everything

(text continued on page 414)



Photo 1: The HP 110 links to two optional battery-powered peripherals, the HP 2225B ink-jet dot-matrix printer and the HP 9114 single 3 1/2-inch disk drive.



Photo 2: The back view of the HP 110. Shown from left to right are the two connections for the HPIL serial interface, the socket for the plug-in recharger, a nine-pin RS-232C port, and a modular phone jack for the internal modem. The removable panel in the center provides access to the lead-acid batteries.

With Microfazer, you could be doing this...

While your printer is doing this.



Your personal computer works fast. Except when you're printing. Then it doesn't work at all. And when your computer's not working you're stuck waiting. But with Microfazer there's no more waiting. Microfazer is the print buffer that frees your computer. So you can compute and print at the same time.

Compute while you print
Microfazer stores data from your computer, then sends it to the printer at an appropriate speed. Because Microfazer remembers exactly what your printer

needs, you and the computer can get back to business fast. This makes Microfazer perfect for any buffer task: word processing, complicated graphics, you name it.

But Microfazer remembers more...

Microfazer remembers to give you the hardware features you're looking for in a print buffer. Features that include memory expansion to 512K,

(Parallel-to-Parallel version), RESET, PAUSE, and COPY functions. Plus a choice of serial or parallel interfaces (or combinations of both) for your data transmission requirements.

The perfect system buffer
Microfazer goes with printers and plotters to make it the perfect buffer for all your system needs.

And Microfazer's price makes it perfect, too.

So stop waiting on your printer. Get Microfazer and compute while you print. Microfazer. The buffer that remembers it all.

MICROFAZERTM BY QUADRAMTM



© Copyright 1984 Quadram Corporation. All rights reserved.
Circle 275 on inquiry card.

4355 International Blvd./Norcross, Ga. 30093
(404) 923-6666/TWX 810-766-4915 (QUADRAM NCRS)
International Offices
Chevco Computing • 6581 Kitimat Road #14
Mississauga, Ontario, Canada L5N-2X5 • 416-821-7600

C·I·A·R·C·I·A'S C·I·R·C·U·I·T C·E·L·L·A·R

Trump Card Part 2: Software

TBASIC and C compilers and an assembler

BY STEVE CIARCIA

Last month, we looked at the hardware of the Trump Card, a coprocessor board for use with the IBM Personal Computer (PC) or compatible computers. The presentation centered mainly on the Zilog Z8000's processor architecture, the support circuitry, and the interface between the Z8000 and the Intel 8088. But the power of the Trump Card can be unleashed only by the right software. This month, I'll describe the collection of software I've assembled for the Trump Card from several sources—most of it designed to support further program development. Let's first quickly review the features of the Trump Card.

WHAT IS THE TRUMP CARD?

The Trump Card (see photo 1) is a printed-circuit board that plugs into any I/O (input/output) expansion slot of an IBM PC, an IBM PC XT, or any computer compatible with them. It contains a Zilog Z8001 16-/16-bit microprocessor (the memory-segmented version of the Z8000) running at 10 MHz and up to 512K bytes of RAM (random-access read/write memory). The Trump Card communicates with the PC's built-in 8088 processor through a 256-byte FIFO (first-in/first-out) buffer.

A variety of software is available for the Trump Card. The most important, from my point of view, is the language system for its special version of BASIC. As you would expect, the Trump Card's TBASIC compiler excels at making user programs run fast, but it's also so easy to use that it makes some interpreted versions of BASIC look clumsy. The source language accepted by the TBASIC compiler is nearly identical with that of the IBM PC's Advanced BASIC interpreter (BASICA) and includes a few enhancements, such as compilation of programs larger than 64K bytes.

Other software included with the Trump Card follows:

- CP/M-80 emulator. The Trump Card can run programs designed to run under Digital Research's CP/M-80 DOS (disk operating system) by emulating the 8-bit Z80 instruction set and DOS calls. No

special file headers or instruction-translation programs are required.

- C compiler. The source language accepted by this compiler follows that of Kernighan and Ritchie with a few minor differences (see reference 6).

- Screen editor. Incorporating many of the features normally found only in word-processing packages, the screen editor, called EE, enables you to write or examine ASCII (American National Standard Code for Information Interchange) text files for use either with the Trump Card or in the normal IBM PC environment.

- Y multilevel-language compiler. The unusual Y language system is essentially a structured assembler that enables Pascal-like control constructs and data types, arithmetic expressions with automatic or specified allocations of registers, and procedure calls with parameter passing.

- Debugger. With the debugger, you can examine and replace the contents of memory and registers, set breakpoints, or single-step through programs. Intended to aid in program development, the debugger is an integral part of Y.

- Semiconductor disk emulator. Under versions of PC-DOS equal to or higher than 2.0, Trump Card can allocate 128K to 387K bytes of its on-board RAM to function as a RAM disk or disk emulator. This memory is separate from the memory already existing on the PC's motherboard or other expansion boards and resides in the Z8000's separate address space. The Trump Card can run another function concurrently with the disk emulator.

(text continued on page 116)

Copyright (c) 1984 Steven A. Ciarcia. All rights reserved.

.....
Steve Ciarcia (pronounced "see-ARE-see-ah") is an electronics engineer and computer consultant with experience in process control, digital design, nuclear instrumentation, and product development. In addition to writing for BYTE, he has published several books. He can be contacted at POB 582, Glastonbury, CT 06033.

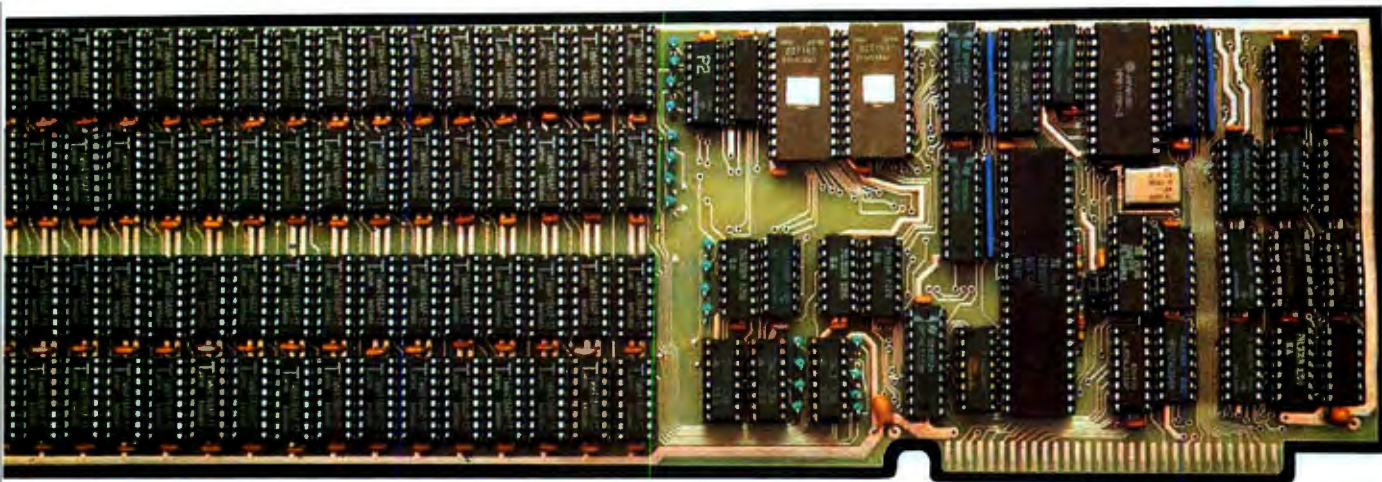

*TBASIC is a new
version of the
BASIC language
that looks like an
interpreter and
executes like
a compiler.*

Photo 1: The soldered prototype printed-circuit version of Trump Card. RAM sockets are at left, EPROMs are top center, and the Z8001 and support chips fill the remainder of the board.

(text continued from page 115)

BRINGING THE TRUMP CARD UP

To initialize the Trump Card, run a program called LDZSYS.COM from PC-DOS. When it has completed setting up the Trump Card and installing the device driver needed by PC-DOS to communicate with it, LDZSYS returns control to PC-DOS and the host 8088 processor, with the Z8000 awaiting further instructions. Example 1 in the text box on page 118 contains examples of this and other typical user commands (in italics) and the system's response (in roman type). The operation of the Trump Card is transparent to programs running on the host 8088. (If you think that you will always want the Trump Card's capabilities available, you can add a line containing LDZSYS to your PC-DOS AUTO-EXEC.BAT file.)

To begin using the Trump Card, execute the "go" program, G.COM (G). When the Z8000 has control of the system, it returns with a colon prompt, as the fourth line of example 1 shows, indicating that the Z8000 is ready to accept commands. The text box also shows the command format for editing and compiling files and programs, which may be stored on the same disk used to boot PC-DOS.

INTERPRETERS VERSUS COMPILERS

As I said last month, a chief cause for my building the Trump Card was a feeling of frustration with the slowness of BASIC interpreters. I had, of course, considered using an off-the-shelf BASIC compiler to speed up my programs, but I did not relish all the overhead operations required by the compilers I had seen, such as Microsoft's BASIC compiler.

The typical compiler requires three separate operations to run a BASIC program. First, the program source code must be written using an editor program. Next, the ASCII program text from the editor is compiled into object code and stored in a disk file, which often takes several minutes. Finally, the special BASIC run-time processor is loaded from the disk to supervise execution of the object program. At last, the program does its thing.

Interpreters, for all their inefficiency of execution, do have one important benefit: you quickly can add a line to your program and type RUN to see its effect. But if you want to change a line in a compiled program, it's back to the editor and all the way through the process again. So when you finally have your debugged, compiled program, it may indeed execute 100 times faster than under an interpreted one, but it may have taken you 10 times as long to get it running right. I think this is one reason BASIC compilers are not in wider use.

To counter this criticism, compiler manufacturers suggest developing code on an interpreted BASIC first and then compiling it. Such a suggestion, while valid, ignores the reason for a compiler in the first place. If a hundredfold increase in speed is necessary to achieve a program's objective, it hardly makes sense that to write and test the original program you must wait 100 times longer each time you must run it.

The answer seemed relatively trivial to me—simply write a version of BASIC that looks like an interpreter and executes like a compiler. The result is TBASIC.

The Trump Card's TBASIC language system is a BASIC compiler that offers

significantly faster execution of BASIC programs than does a BASIC interpreter, while furnishing an operating environment much like that of an interpreter. TBASIC bridges the gap between traditional BASIC interpreters, which have built-in editors and are known for ease of use, and typical BASIC compilers, which produce rather efficient object code but can be difficult to work with. TBASIC's extremely fast compilation times and its capability for immediate-mode execution make working with it as easy as working with a friendly but slow interpreted BASIC, but the resulting programs run with the speed of a compiler. Unlike other compilers, the object code is not written into a disk file before execution (unless you request it). Therefore, no long delays are needed. When you load the file into the Trump Card, TBASIC compiles the program in a few tenths of a second.

Most programs that will run under the IBM PC's BASICA interpreter can be fed into TBASIC for compilation. You can use either the Trump Card's EE screen editor or the BASICA editor to write the programs. But if you then run the same program under both BASICA and TBASIC, depending upon the instructions you use, you will notice an increase in program performance by a factor of anywhere from 7 to 100. A listing of TBASIC's keywords is shown in table 1. TBASIC also supports most of BASICA's color and graphics commands (see photo 2).

Line numbers aren't required in the source code of programs written for TBASIC except where a line is to be referenced elsewhere in the program; for example, the destination of a GOTO or GOSUB statement would need a line number. Although not requiring them, TBASIC certainly allows line numbers on every line, so existing BASICA source code will run under TBASIC, to the extent that the program is compatible with TBASIC's syntax. Such programs can immediately benefit from the increase in performance provided by TBASIC.

The development of a program using a BASIC interpreter occurs in two modes: editing the program and running it. Developing a program with TBASIC involves three modes: editing, compiling, and running. Obviously, the only difference is compilation, which is invoked on the Trump Card by the DO command; once the program has been compiled, the familiar RUN command executes it.

Example 2 on page 118 shows some examples of the kind of interaction that

occurs when you use TBASIC: how to enter a program using the EE editor, compile it, and run the compiled program. In the text box, input by the user is shown in italic type while the system's prompts and output are shown in roman characters.

During compilation of a program, error messages are issued each time an error is encountered. The line of the source file in which the error was detected is displayed; in some cases, an error message is also displayed. After an error is found and displayed, compilation continues and any other errors found also will be displayed. When the compilation has been completed, a list of any undefined symbols also may be output, in which case the program should not be run.

TBASIC PROGRAMS

Three methods can be used for entering program statements into the system for compilation under TBASIC. The first is to use the Trump Card's built-in EE screen editor, as mentioned previously (see photo 3). A second method is to enter the statements using TBASIC's direct-entry mode. The third choice is to enter and test the program using the computer's regular BASICA interpreter and then run it for effect using TBASIC.

The three methods may be used interchangeably.

Example 3 shows an example of these functions with a minimally modified version of the Sieve of Eratosthenes program often used as a system benchmark (see references 4 and 5). A program called SIEVE.S was previously written in BASICA and stored as an ASCII file on the disk in drive B.

Suppose you want to run the program under both BASICA and TBASIC while recording how long it takes to be executed. You could use a stopwatch, but it's easier to add a few more program lines that record the starting and ending times automatically by calling the TIMES function. It's possible to invoke the editor directly from TBASIC, as shown in example 3, to add two lines. And you can see that TBASIC took about 2 seconds to run the modified program as measured by the internal clock.

The program changes quickly were added and executed, and, when you left the editor with a QU command, the file SIEVE.S on drive B was updated to contain the TIMES-function statements. After running the slightly revised program under BASICA, you see that it takes 202 seconds, around 100 times as

(text continued on page 118)



Photo 2: Color (2a) and graphics (2b) tests demonstrate TBASIC's support of colorgraphics commands normally associated with BASICA.

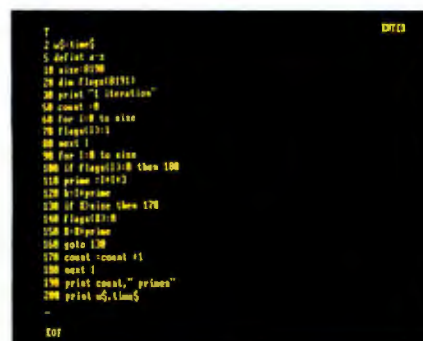
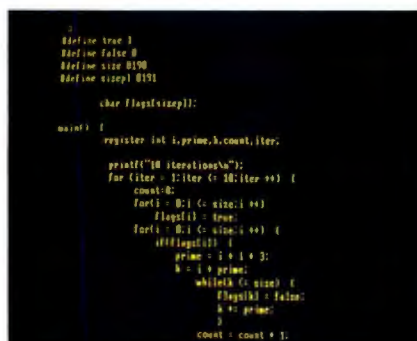

Photo 3: Programs in BASICA (3a) and in C (3b) can be written for Trump Card or the PC by using Trump Card's built-in EE editor.

(text continued from page 117)

long. Now consider the aggravation of making changes in programs that take this long to run and waiting for the results each time. Perhaps you now understand why I built the Trump Card. If you're interested in how fast some

TBASIC speeds up development and debugging as well as execution.

other computers and BASIC systems executed essentially the same program, see table 2. Another program that demonstrates how TBASIC speeds things up is the simple looping benchmark shown in listing 1. The results are shown in table 3.

Not all programs run a hundred times faster in TBASIC. The Sieve program purposely uses integer arithmetic and avoids difficult floating-point calculations. But we can get an idea of floating-point performance from the simple benchmark routine of listing 2. In this program, TBASIC takes 3.2 seconds while BASICA takes 24.2. This benchmark shows the wide variation in performance you can expect from a different mix of statements.

Of course, most other BASIC compilers for the IBM PC also can demonstrate dramatic speed increases over interpretive BASICA. But I believe that TBASIC is different because it speeds up development and debugging as well as execution.

(You might be wondering if the installation of an Intel 8087 Numeric Processor Extension in the IBM PC would help speed up execution of BASIC programs. Under BASICA, it would have no effect whatsoever because BASICA is not written to use it. I did a quick informal test using Morgan Professional BASIC, which uses the 8087. Morgan BASIC took 12.8 seconds to execute listing 2.)

TBASIC'S EASE OF USE

TBASIC has many of the same convenience features for running programs that an interpreter has. You can use the commands RUN, RUN<line number>, GOTO<line number>, and GOSUB<line number> just as in BASICA. To stop a program from the console, you just hit

EXAMPLE 1

Computer Interaction	Comments
A > LDZSYS	Initialize Trump Card from PC-DOS.
A >	Control is returned to PC-DOS.
A > G	Turn control over to Trump Card.
:	(Trump Card's command prompt.)
:	
: EE<filename>	Edit a file.
:	
: Z80EM<filename>	Emulate Z80 and run CP/M-80 programs.
:	
: C<filename>	Compile and run a C program.
:	
: Y<filename>	Compile and run Z8000 structured assembly language.
:	
: BASIC<filename>	Compile and run TBASIC programs.
:	
: #	Exit from Z8000 command interpreter.
A >	Control returns to PC-DOS.

EXAMPLE 2

Computer Interaction	Comments
A > B: (Return)	Set the PC-DOS default drive to B. TBASIC will also use this drive as its default drive.
B > G (Return)	Type G to "go to" the Z8000.
:	The colon (:) is the Z8000 system command prompt, equivalent to the A > or B > prompt of PC-DOS.
:BASIC (Return)	Invoke TBASIC.
-	The hyphen (-) is the command prompt used by TBASIC; you may now invoke any TBASIC command.
-EDIT TESTFILE (Return)	Edit a new file using the EE editor.
T	You are now in the EE editor
EOF	in command mode.
E	Type "E" to enter text.
FOR I=1 TO 5 (Return)	
PRINT "Demo program" (Return)	Type in your BASIC program.
NEXT I (Return)	
(Escape)	Hit the Escape key to leave the Enter mode.
OU (Return)	Quit and save program on default disk B.
-	The "-" prompt shows that you are now back in TBASIC.
-DO (Return)	Compile the program by using the DO command (takes about 0.1 second).
-	Your program is now compiled.
-RUN (Return)	Type RUN to execute the compiled program.
Demo program	Compiled program output.
Demo program	
Demo program	
Demo program	
Demo program	
:// (Return)	The # command exits TBASIC. (The SYSTEM command could be used instead.)
:DIR (Return)	Call for a disk directory from the command interpreter.
DIRECTORY OF DRIVE B:	
TESTFILE	There's the source file you created with the EE editor.
:// (Return)	The # command exits the Z8000's B > command mode and returns control to PC-DOS.

EXAMPLE 3

Computer Interaction	Comments
B > G (Return)	Go to the Z8000 operating system.
: BASIC SIEVES (Return)	Get SIEVES from disk and compile it in about 0.2 second.
- RUN (Return)	Execute program in TBASIC.
I ITERATION	
1899 PRIMES	The program produces output and ends.
-	Awaiting next command.
-EDIT (Return)	Call the editor from TBASIC prompt.
T	T indicates display from top of file: the complete Sieve file is displayed, ready to edit.
5 DEFINT ACZ	
10 SIZE = 8190	
20 DIM FLAGS(8191)	
30 PRINT "Only 1 iteration"	
50 COUNT = 0	

```

60 FOR I = 0 TO SIZE
70 FLAGS(I) = 1
80 NEXT I
90 FOR I = 0 TO SIZE
100 IF FLAGS(I) = 0 THEN 180
110 PRIME = I+1 +3
120 K = 1 + PRIME
130 IF K > SIZE THEN 170
140 FLAGSIK) = 0
150 K = K + PRIME
160 GOTO 130
170 COUNT = COUNT + 1
180 NEXT I
190 PRINT COUNT: " PRIMES"
E (Return)
2 JS = TIMES
200 PRINT JS: TIMES
(Escape, Return)
QU (Return)
- DO (Return)

```

Enter mode, allows text entry.
Two lines are added to print the time.

```

- RUN (Return)
1 ITERATION
1899 PRIMES
01:01:25 01:01:27
-
-# (Return)
: # (Return)
B> BASICA (Return)
LOAD "SIEVE.S"
RUN
1 ITERATION
1899 PRIMES
01:05:35 01:09:01

```

Type Escape key to exit Enter mode.
Finished changes. Leave editor and return to TBASIC.
The file is recompiled with the DO command, taking about 0.2 second.
The program is run again with changes.
The program produces output.

The prompt returns after execution ends.
Exit TBASIC.
Exit the Trump Card system.
Get BASICA and run SIEVE.S.
(SIEVE.S was stored in ASCII format.)

The program produces output.

EXAMPLE 4.....

```

Computer Interaction
B> G (Return)
: BASIC (Return)
- /DIAG (Return)
- PRINT 2+3 (Return)
CExit:Clmmxlnit:Ki00000000:
CPrtlnit:Ki00000002:Ki00000003:
b+:CPrT:CPrtCR:R: 5
- PRINT2.027+3.094 (Return)
CExit:Clmmxlnit:Ki00000000:
CPrtlnit:Kf01BA5E82:Kf46041982:
CFltAdd:CPrtF:CPrtCR:R: 5.121

```

```

Comments
Activate the Trump Card.
Enter TBASIC.
Invoke subroutine-diagnostic mode.
Directly add and print 2+3.
The listing shows the compiler
subroutines that are executed to
perform the function. CExit (call exit) jumps out of the
console-input mode: Clmmxlnit calls for immediate ex-
ecution with a flag integer-constant value of 0 set as
Ki00000000.
CPrtlnit (call printer) directs printing to the console: the
two integer values are expressed as Ki00000002 and
Ki00000003, respectively: b+ calls a binary add routine:
CPrtI prints the integer.
CPrtCR finishes by sending a carriage return to the
printer or console while R designates a return to the
system. The computed value, 5, appears at the end.
Floating-point values produce a slightly different result.
This time the constants are stored
as floating-point numbers, and
floating-point add and print routines are called instead.

```

EXAMPLE 5.....

```

:
:C (Return)
-
-/DO BASICIO.C (Return)
-/DO CDEMOC (Return)
-/IMAGE CDEMO E=MAIN (Return)
-# (Return)
:
:CDEMO (Return)
C language
C language
C language
C language
C language
:
: # (Return)
B>

```

```

Back in command interpreter.
Call C compiler, the "-" is
the C compiler prompt.
Compile I/O routines.
Compile CDEMOC program (listing 3).
Save memory image of compiled program in a disk file
called CDEMO.
Get out of C compiler.
Back in command interpreter.
Run compiled program.
The program produces output.
Back in command interpreter.
Get out of interpreter.
Back to IBM PC-DOS command prompt.

```

Control-C. If possible, TBASIC will display the statement label nearest the point in the program where the stop occurred. Programs may contain STOP statements and may be restarted by a CONT command.

TBASIC also can execute statements and commands in immediate mode. You simply type the program line without a line number. (If you precede a statement with a line number, it will be compiled into the existing program.) You can get results like

```

-PRINT SQR(2)
1.414214
-
-PRINT 2*3
6
-

```

You can print out variables or run specific program lines that contain line-identifier labels. Immediate-mode statements and commands also may be included in program files.

TBASIC also has some commands useful in debugging and problem diagnosis that you probably have not seen before. You can examine the actual compiled machine-language object code with commands like /DIAG. If you give the /DIAG command before a program is compiled, a complete list of compiler subroutine calls will be produced. This can be demonstrated in the direct-execution immediate mode, as shown in example 4 for both integer and floating-point values.

C COMPILER

For more ambitious program development, the Trump Card also supports a compiler for programs in the C language, as described by Kernighan and Ritchie (see reference 6). Programs need

*The Trump Card
also supports a
compiler for
programs written
in the C language.*

only slight modifications for compilation. Developing and running a C program is a three-step operation similar to the process used in TBASIC: editing, compiling, and running.

(text continued on page 120)

(text continued from page 119)

C compilers expect to find input and output routines in a subroutine library separate from the compiler. Kernighan and Ritchie describe a file called "stdio.h" that contains the I/O facilities. The Trump Card's C compiler uses a file of I/O routines called "basicio.c", which includes the following routines: "getchar", "putchar", "open", "close", "read", "write", "printf", "scanf", "lseek", and "creat".

The implementation of "scanf" and "printf" in the Trump Card's version of C differs slightly from that of Kernighan and Ritchie. In their implementation, the conversion characters "d" and "x" may each be preceded by an "l" to indicate a pointer to a "long" value rather than a pointer to an "int" value appears in the argument list. In this implementation, the uppercase conversion characters "D" and "X" are used for the same purpose. The conversion character "f" is used for floating point. The "scanf" routine assumes that the input values are separated by Space or Tab characters and that a Return character ends an input sequence.

The Trump Card's C compiler was designed with a user interface similar to that of TBASIC, and it's just as easy to use. Listing 3 shows a C program that is entered into the system using the EE editor in a manner such as that used for TBASIC. Example 5 shows how the program is compiled and run. Should you care to try the Sieve program in C, it is shown in listing 4 set up for 10 iterations. It runs in 3.2 seconds on the Trump Card, which compares quite favorably with versions of C running on 8-MHz MC68000 processors and with assembly-language versions on the IBM's 4.77-MHz 8088.

Y MULTILEVEL LANGUAGE

The Y language system compiles a multilevel language that can be best described as structured assembler code. It allows you to write programs using a mixture of Z8000 assembly language (in Zilog mnemonics), Pascal-like control structures, data types, arithmetic expressions with automatic or specified allocation of registers, procedure calls with parameter passing, and a descriptive compiler language. The different levels of constructs may, for the most part, be freely mixed.

The Y compiler generates code directly into memory with one pass and supports immediate execution of statements, conditional compilation, user-defined extensions to the language, and symbolic debugging. Most of the Z8000

Table 1: Keywords for statements and functions available in the TBASIC compiler for the Trump Card. An asterisk indicates a new feature.

Function	Statement	Command	Variable
ABS	BEEP	ALLOCATE*	CSRLIN
ASC	CALL	BLOAD	DATISS
ATN	CLOSE	BSAVE	ERR
CALLINTS*	CIRCLE	CONT	INKEYS
CDBL	CLS	DIAG*	TIMES
CHRS	COLOR	DISP*	
CINT	DATA	DO*	
COS	DATES	EDIT	
CSNG	DEF FN	KILL	
CVI	DEF SEG	LIST	
CVS	DEFTYPE	MAP*	
CVD	DIM	NAME	
EOF	END	NEW	
EXP	FIELD	REGIONS*	
FIX	FOR...NEXT	REGS*	
HEXS	GET	RESET	
INP	GOSUB	RUN	
INPUTS	GOTO	SAVE	
INSTR	IF	SYSTEM	
INT	INPUT		
LEFTS	INPUT#		
LEN	LSET		
LOC	LET		
LOF	LINE		
LOG	LINE INPUT		
LPOS	LINE INPUT#		
MIDS	LOCATE		
MKIS	LPRINT		
MKSS	LPRINT USING		
MKDS	ON ERROR		
OCTS	ON GOSUB		
PEEK	ON GOTO		
POINT	OPEN		
POS	OUT		
RIGHTS	PAINT		
RND	POKE		
SCREEN	PRINT		
SGN	PRINT USING		
SIN	PRINT#		
SPACE	PRINT# USING		
SPC	PSET		
SQR	PUT		
STR\$	PRESET		
STRINGS	RANDOMIZE		
TAB	READ		
TAN	REM		
VAL	RESTORE		
	RESUME		
	RETURN		
	RSET		
	SCREEN		
	SEEK*		
	SOUND		
	STOP		
	TIMES		
	WAIT		
	WHILE...WEND		
	WIDTH		
	WRITE		
	WRITE#		

Table 2: Comparison of Sieve benchmark results (one iteration) on other computers running Microsoft-derived BASIC interpreters (times measured in seconds).

Apple II	Apple III	TRS-80 Model II	IBM PC (BASICA)	IBM PC (TBASIC with Trump Card)
224	222	189	206	2.4

Table 3: Execution time in seconds for the looping program of listing 1 on several interpreters.

Apple II	IBM PC (CBASIC-86)	IBM PC (BASICA)	IBM PC (TBASIC with Trump Card)
101	275	80	0.9

Table 4: A listing of the standard CP/M-80 2.2 functions. Those marked with an asterisk are supported by the Trump Card Z80 emulator.

Function	Supported?
0 System Reset	•
1 Console Input	•
2 Console Output	•
3 Reader Input	
4 Punch Output	
5 List Output	•
6 Dir Console I/O	•
7 Get I/O Byte	
8 Set I/O Byte	
9 Print String	•
10 Read Con Buffer	•
11 Console Status	•
12 Version Number	•
13 Reset Disk Sys	•
14 Select Disk	•
15 Open File	•
16 Close File	•
17 Search For 1st	•
18 Search For Next	•
19 Delete File	•
20 Read Sequential	•
21 Write Sequential	•
22 Make File	•
23 Rename File	•
24 Login Vector	•
25 Current Disk	•
26 Set DMA Address	•
27 Get Alloc Addr	
28 Write Protect	
29 Get R/O Vector	•
30 File Attributes	
31 Disk Params Addr	
32 User Codes	
33 Read Random	•
34 Write Random	•
35 Comp File Size	•
36 Set Random Rec	•

mnemonics are implemented; those that are not can be used via the WORD pseudo-operation, as in the following: LDCTL REFRESH.R3 = WORD 07D3B.

The TBASIC and C compilers are written in Y. Each of the compiler subroutines is a Y file that has been compiled into assembly-language code. A full explanation of Y is beyond the scope of this article, but listing 5 shows some Y code for your inspection. Y is an advanced tool for the experienced programmer.

CP/M-80 EMULATOR

The Trump Card supports a software emulator for CP/M-80 version 2.2, which allows the Trump Card to execute assembly-language programs for the 8-bit Z80 microprocessor.

The Z80 program must be transferred to a PC-DOS (or MS-DOS) floppy disk. (This can be done by linking a Z80-based computer and an IBM PC through a serial RS-232C connection, either through a direct cable or through a modem.) Once the Z80 program is on the IBM-format disk, its filename extension must be changed from ".COM" to ".CMD", which is consistent with the CP/M-86 convention and avoids the problem of trying to run a Z80 program under IBM PC-DOS.

The emulator normally resides on a disk in drive B and is used in a manner very much like that of the other Trump Card software we've looked at. Nearly all the normal CP/M-80 system calls are supported by the emulator, with a few exceptions as shown in table 4. The standard CP/M-80 BIOS (basic input/output system) calls dealing with the disk, punch, and reader devices are not supported by the Z80 emulator; the remaining BIOS calls are supported.

IN CONCLUSION

The Trump Card is a board-level hardware approach to upgrading the performance of your IBM PC (or a compatible system). Aside from its function as a

(text continued on page 122)

Listing 1: A simple FOR...NEXT loop benchmark program in BASIC.

```
100 FOR A=1 TO 10
115 FOR J=1 TO 10
120 FOR T=0 TO 200
130 GOSUB 200
140 B=I
150 NEXT T
155 NEXT J
160 NEXT A
170 PRINT "DONE"
200 RETURN
```

Listing 2: A simple BASIC benchmark program for floating-point division.

```
60 A=2.71828
80 B=3.14159
100 FOR I=1 TO 5000
120 C=A/B
320 NEXT I
```

Listing 3: A demonstration program for the C compiler.

```
main()
{
    int count,step;
    count=1;
    step=1;
    while (count <= 5)
    {
        printf(" C language\n");
        count=count+step;
    }
}
```

(text continued from page 121)

Z8000 development system, it provides many popular system enhancements in a single package: add-on memory, execution of Z80 programs, a separate editor, and language compilers. It was designed to solve my specific personal problem—I wanted a better BASIC that wasn't slow or cumbersome—and to support the PC in other ways: as a language and RAM-disk peripheral. If you're like me, these characteristics will be the most important ones to you.

In the process of building the Trump Card, however, I've found that it has potential I never imagined. Besides the software I've described, I expect that object-code translators for Z80-to-Z8000 and 8088-to-Z8000 conversions will soon be available, along with other utilities such as a print spooler. You also eventually will see Bell Laboratories' UNIX operating system for the Trump Card.

NEXT MONTH

Whimsy is in vogue, as Steve designs a musical telephone bell. ■

Z8000 and Z80 are trademarks of Zilog Corporation, a subsidiary of Exxon. CPM-80 is a trademark of Digital Research.

To receive a complete list of Ciarcia's Circuit Cellar project kits available, circle 100 on the reader-service inquiry card at the back of the magazine.

Listing 4: The Sieve of Eratosthenes benchmark in C.

```

#define true 1
#define false 0
#define size 8190
#define sizepl 8191
char flags[sizepl];
main(){
register int i,prime,k,count,iter;
printf("10 iterations\n");
for (iter = 1; iter <= 10; iter ++){
count=0;
for(i = 0; i <= size; i ++){
flags[i] = true;
for(i = 0; i <= size; i ++){
if(flags[i]){
prime = i + i + 3;
k = i + prime;
while(k <= size){
flags[k] = false;
k += prime;
}
count = count + 1;
}
}
}
printf("\n%d primes",count);
}

```

REFERENCES

1. Brown, Peter J. *Writing Interactive Compilers and Interpreters*. New York: John Wiley & Sons, 1979.
2. Ciarcia, Steve. "Trump Card, Part I: Hardware." *BYTE*, May 1984, page 40.
3. George, Donald P. "Professional BASIC." *BYTE*, April 1984, page 334.
4. Gilbreath, Jim. "A High-Level Language Benchmark." *BYTE*, September 1981, page 180.
5. Gilbreath, Jim, and Gary Gilbreath. "Eratosthenes Revisited: Once More through the Sieve." *BYTE*, January 1983, page 283.
6. Kernighan, Brian W., and Dennis M. Ritchie. *The C Programming Language*. New York: Prentice-Hall, 1978.
7. Lee, J. A. N. *The Anatomy of a Compiler*, 2nd ed. New York: Van Nostrand Reinhold, 1974.
8. Mello-Grand, Sergio. "The Docutel/Olivetti M20: A Sleek Import." *BYTE*, June 1983, page 188.

The following items are available from

Sweet Micro Systems Inc.
50 Freeway Dr.
Cranston, RI 02910
(800) 341-8001 for orders
(401) 461-0530 for information

1. Trump Card, including IC sockets, assembled and tested with 256K bytes of the 512K-byte RAM space populated. Includes TBASIC compiler, C compiler, Z8000 Y assembler, CPM-80 emulator, RAM-disk driver, and documentation. Software supplied on a PC-DOS 2.0 disk unless otherwise specified. 256TCB.....\$995
2. Trump Card, printed-circuit board completely socketed, assembled, and tested with 512K bytes of RAM, support software described above, and documentation. Software supplied on a PC-DOS 2.0 floppy disk unless otherwise specified. 512TCC.....\$1325
3. Trump Card partial kit, completely socketed and wave-soldered with all passive components, less ICs but including bootstrap loader EPROMs, 10-MHz Z8001, and Z8581. Includes support software described above on PC-DOS 2.0 floppy disk (unless otherwise specified) and documentation. OKTCA.....\$525

Please add \$10 for shipping and insurance in continental United States, \$20 elsewhere. Rhode Island residents please include 6 percent sales tax.

Editor's Note: Steve often refers to previous Circuit Cellar articles. Most of these are available in reprint books from BYTE Books, McGraw-Hill Book Company, POB 400, Hightstown, NJ 08250.

Ciarcia's Circuit Cellar, Volume I covers articles that appeared in *BYTE* from September 1977 through November 1978. *Ciarcia's Circuit Cellar, Volume II* contains articles from December 1978 through June 1980. *Ciarcia's Circuit Cellar, Volume III* contains articles from July 1980 through December 1981. *Ciarcia's Circuit Cellar, Volume IV* contains articles from January 1982 through June 1983.

Listing 5: TBASIC subroutines written on the Y multilevel-language compiler.

```

[5a]
if SWITCH=0 or CNT>100 then begin
SWITCH:=1: GODOIT(2, VAL&OF)
end
else begin
R3:=~ABC: R5:=@R9[2]: R1:=CNT/2
LDIR @R3,@R5,R1
end

[5b]
COLOR: PROC ...passed flag, then other params
depending on flag
...if flag bit 2=1, then set border color (if text
mode)
...if bit 1=1, set background color (text) or
palette (graphics)
...if bit 0=1, set foreground color (text) or
background color (graphics)
save R6,R7
POPL RR6,@RR12
if BIT R7,2 not zero then begin
POPL RR2,@RR12
if SCRMODE<=1 then SETBORDER(R3)
end
if BIT R7,1 not zero then begin
POPL RR2,@RR12
if R0:=SCRMODE<=1 then SETBG(R3) else
if R0=2 then
SETPALET(R3)
end
if BIT R7,0 not zero then begin
POPL RR2,@RR12
if R0:=SCRMODE<=1 then SETFG(R3) else
if R0=2 then

```

```

SETGRAPHBG(R3)
end
restore R6,R7
RET

SOUND: PROC ...passed duration
(in 1/18.2 secs) and frequency
...make sound
POPL RR4,@RR12 ...duration
POPL RR2,@RR12 ...frequency
EXB RL3,RH3: EXB RL5,RH5
R3:->BX: R5:->CX
AH:=4 ...sound
EXTCALL(SPSCRINT)
RET

```

SourceTools™ Increases Programmer Productivity

Nalica zebra (actual area: 12 x 20 mm)
Photograph by Ron Cronin



Productivity in nature depends on structural integrity. Nature's forms are consistent and stable because they are built from efficient and compelling designs.

Software development is as dynamic as nature. Programmers must map a universe of details that constantly changes. Software systems can become a complicated collection of parts seemingly impossible to track ... until now.

SourceTools provides an efficient, compelling design

for controlling changes in software source text files, and for constructing systems from those files. This clean design minimizes organizational and maintenance duties

throughout the software life cycle. Software becomes consistent and stable.

SourceTools works with any language, and is designed for individual and team environments. It runs on VAX/VMS, PDP-11/RSX, RSTS.

SourceTools improves productivity, naturally.

© Copyright 1984 Oregon Software

Oregon Software

2340 S.W. Canyon Road, Portland, Oregon 97201

For Technical Information and Price, Call Toll-Free:

1-800-547-3000

Ask for Department No. 219-A

In Oregon Call: (503) 620-1602

SourceTools is a trademark of Oregon Software. VAX/VMS, PDP-11/RSX and RSTS are trademarks of Digital Equipment Corporation.

“WHO’S NAUGHTY WORLDWIDE?”

“NOW, ANYBODY CAN GET INTO THE COMPUTER AGE. EVEN A BIG-TIME EXECUTIVE LIKE ME.”

For the first time in history, there’s a software program that lets anyone talk to a personal computer in plain English. It’s called R:BASE CLOUT™ (Conversational Language Option).

Instead of making you learn computerese, it learns your language. Since it actually learns from experience, it even remembers your favorite abbreviations and slang. So if you want to know what salesmen in California were naughty last month, just ask. You get straight answers to your questions—not more questions from your computer.

“I CAN USE THE BEST RELATIONAL DATABASE MANAGEMENT SYSTEM SOUTH OF THE POLE.”

R:BASE CLOUT is designed specifically to work with R:BASE™, the fastest growing relational database management system in the world. R:BASE is the fastest, most powerful, easiest way to juggle billions of pieces of data simultaneously. It lets you



TY? WHO'S NICE? NO PROBLEM!"

open 40 files at the same time. And handle up to 400 fields, and hundreds of millions of records. It even sorts all that information six times faster than the leading first generation DBMS. With R:BASE CLOUT, anyone can organize the data any way they like—then instantly, reorganize it for a new look. And maybe a new idea.

**"DON'T WAIT FOR
CHRISTMAS TO TRY IT!"**

Microrim makes R:BASE and R:BASE CLOUT. And they can make a believer out of you. They'll send you a full demonstration packet*

of both programs for only \$14.95.

Just call 1-800-547-4000, Dept. 822. In Oregon, or outside the U.S., call 1-503-

684-3000, Dept. 822. Or ask for the demonstration packet at your nearest software store or ComputerLand® dealer.



R:BASE™ FROM MICRORIM®

*Requires 256K of memory. Runs on MS™-DOS and PC/DOS operating systems.





When I use a word,
it means just what
I choose it to mean
- neither more
nor less.



ILLUSTRATION BY ANDRZEJ DUDZINSKI

FASTER FORTH

Reducing overhead in threaded interpretive languages

T

BY RONALD L. GREENE

hreaded interpretive languages (TILs), of which FORTH is the most well known, possess a number of characteristics that make them nearly ideal microcomputer languages. One useful feature of a TIL is that, like BASIC, it can be used in an interpretive mode in which the computer immediately acts on commands. This is a major advantage when you're debugging programs. But a TIL can have many more immediately executable commands available to it than BASIC does, and you can create additional commands, thus adding to the power of the language.

A second desirable trait of a TIL is that it can be used in a compile mode. As with other compiled languages, such as Pascal or FORTRAN, programs written in the source code of the TIL can be compiled into machine code once and for all rather than retranslated each

(text continued on page 128)

Ronald L. Greene is an associate professor of physics at the University of New Orleans (New Orleans, LA 70148). His research specialty is semiconductor physics.

Previously debugged words need not be recompiled when errors are found in subsequent source code.

(text continued from page 127)

time they are run. But unlike the more common compiled languages, the compiler used in a TIL is incremental; that is, it compiles portions of code at a time under the interactive control of the programmer. In practice this means that you can name, compile, test, and debug small, logically related blocks of code (called "words" in TIL jargon) before you proceed to the next block. Previously debugged words need not be recompiled when errors are found in subsequent source code. Because of this, a TIL can produce programs that execute faster than most interpretive languages.

Other languages can be programmed using this modular technique to some extent through the use of functions, subroutines, and procedures. However, to debug one of these subprograms, you must write a main program to call it, and typically both must be compiled, linked, and executed repeatedly. A new TIL word, by contrast, can be compiled and then executed immediately using the interpretive mode; there is no need to write a main program to call it. In addition, the compilation step is almost trivial compared to other compiled languages because each new word is composed of previously defined (i.e., compiled and debugged) words.

Finally, a TIL can be extended. As mentioned above, new commands (words) can be constructed from previously defined words. These new words have the same power as the older ones; that is, they can be executed interpretively or used in the compile mode to define still other words. In fact, typical TIL programs consist of short, progressively defined new words. You enter the final word or words of the program to perform the required task.

These characteristics result in a language that is well suited to program development. In addition, if a TIL is implemented with care at the machine level, it can produce very efficient code.

The next section of this article will ex-

amine two approaches to implementing FORTH, the most common TIL. The usual method is very efficient in its use of memory and at the same time produces quite respectable execution times. The other technique is less memory efficient (though still superior to most common compiler languages) but can result in significantly shorter execution times.

IMPLEMENTING THREADED CODE

Several years ago in *BYTE*, Terry Ritter and Gregory Walker discussed four approaches to the implementation of threaded interpretive languages (see reference 5). I group three of the methods—direct-threaded, indirect-threaded, and token-threaded—under the generic name of "pointer-threaded" code. Pointer-threaded code is the most common method for implementing a TIL. The technique is also discussed in detail by R. G. Loeliger (see reference 3).

Most of this article is devoted to a form of subroutine-threaded code, which is the fourth approach Ritter and Walker cover. It allows the programmer to specify whether a given operation of the language is used as a subroutine or as a macro. I'll examine the advantages and disadvantages of the macro/subroutine approach in relation to the pointer-threaded technique. I use the syntax of FORTH for my high-level examples, but the techniques can be applied to any TIL. My low-level examples use 8086/8088 assembly code, but, again, they can be adapted to other processors.

All TILs have at their roots a set of executable, machine-language primitive operations called words. Examples from FORTH are such arithmetic operations as +, -, and * and such stack manipulation operations as DUP, DROP, and ROT. Additional (secondary) words are defined using these primitives or previously defined secondary words. All words, whether primitive or secondary, are kept in memory in a "dictionary." Each dictionary entry consists of a header (made up of the number of characters in the name), ASCII code for the characters of the name or part of the name (often the first three characters), and a link address for getting to the previous (or the next, depending on the implementation) dictionary entry. After the header comes the body of the word. The body of a primitive word consists of executable machine code that performs the operation. The body of a secondary word varies according to the type of threading used.

In pointer-threaded code the second-

ary word consists of a sequence of addresses, each of which is a pointer (direct or indirect) to either a primitive or another secondary word (see figure 1). Thus, it is necessary to provide a simple, "inner" interpreter that gets the pointer, jumps to the proper address, and then either executes the machine code if the routine is a primitive or continues the process of interpretation if the routine is another secondary word. Usually there can be as many levels of secondary routines as you like, but the interpreter must eventually get to the machine code of a primitive before it can start back down the ladder of interpretation. The execution speed of such an arrangement is critically dependent on the efficiency of this inner interpreter, which not only has to get the address of the next word to be executed but has to save the current address in order to continue with the flow of the program after execution of that routine.

If you are familiar with assembly language but not with the structure of a TIL, you may wonder, "Why write a special interpreter to save return addresses and jump to new routines when the processor contains the instructions to do just that in hardware, through subroutine calls and returns?" The answer is that a pointer-threaded compiler/interpreter has a smaller overall memory requirement than one that uses subroutine threading. I will return to this point shortly.

Figure 2 illustrates the organization of subroutine-threaded code. The form for the primitives is basically the same as in pointer threading, except that they end with a return from subroutine instruction (RET in 8086/8088 mnemonics). Pointer-threaded primitives, in contrast, end with more involved code that gets the interpreter to the pointer of the next word to be executed. The major difference lies in the secondary words. Subroutine-threaded secondary words are made up of executable subroutine calls to the starting addresses of primitives or other secondary words. Since these primitives or lower-level secondary words are terminated by a return instruction, the processor hardware or microcode itself controls the flow, without the need for the inner interpreter. The result is smaller overhead and faster execution.

A modification of the above scheme allows the execution overhead to be reduced even further. Very short words, consisting of a few bytes of code, need not be treated as subroutines at all. Instead, the subroutine call can be replaced by a macro substitution of the

entire executable portion of the word, thus eliminating the overhead of the subroutine call and return completely. We'll look at how to implement this plan next.

THREADING CODE WITH SUBROUTINES OR MACROS

In order to add the possibility of macro substitution to the subroutine-threaded compiler/interpreter, you must include additional information within the header of each word. First, there must be a way for the compiler to determine whether the word is to be used as a subroutine or a macro. One simple way to do this is to use the high-order bit of the character-count byte as a flag. The bit is checked during compilation of the word. If, for example, it is a 0, the compiler writes code for a subroutine call to the address of the first executable statement of the word. On the other hand, if it is a 1, the compiler copies the executable code byte by byte (except for the RET). In order to reliably copy the required code, the number of bytes in the executable portion of the word being referenced must be stored. This is done by devoting an additional byte to the header. If you like, you could use the high-order bit of this byte (rather than the character-count byte) as the subroutine/macro flag.

Even if a given word is to be used as a macro in the compile mode, its executable code should be terminated by a RET statement. This is because pure subroutine threading is the best way of handling the interpretive mode of the TIL. Also, note that any word to be used as a macro should be written to contain only one RET statement—at the end.

With this scheme, you control whether a given word is to be used as a subroutine or as a macro. All you need do is define two additional primitives for the language—perhaps SUBROUTINE and MACRO—which clear or set the flag bit.

COMPARISON OF THREADING TECHNIQUES

To get a concrete understanding of the tradeoff between memory and execution speed, let's look at some specific examples of primitives and secondary words as used in the two threading schemes discussed above. In Chapter 3 of *Threaded Interpretive Languages*, Loeliger calculates the overhead for a primitive and a secondary word in terms of processor cycles. Following his lead, I have translated his (indirect-threaded) inner interpreter for a "generic computer" into one applicable to an 8086/8088 microprocessor; the routines are shown

in listing 1. For ease of comparison, the labels in the listing are the same as those used by Loeliger. The correspondence between his generic registers and my choice of 8086/8088 registers is given within the listing. Because most of the new personal computers using Intel microprocessors use the 8088 rather than the 8086, I have calculated the total number of 8088 clock periods for execution of the routines in listing 1, where the results are also given. Each execution of a primitive in this pointer-threaded language performs a call to the routines NEXT, RUN, and RETURN; thus, the number of 8088 machine cycles required is:

$$\begin{aligned} \text{primitive cycles} &= \text{NEXT} + \text{RUN} + \text{body} \\ &\quad + \text{RETURN} \\ &= 82 + \text{body} \\ &\quad \text{(pointer-threaded)} \end{aligned}$$

For simple primitives such as DROP or

+ (addition), which require four cycles each, the amount of overhead is enormous—20 times what is required for the operation itself. The machine code of other primitives, of course, takes longer than four cycles; however, most will be significantly shorter than 82 cycles.

The overhead for a secondary word depends on the number and kind of words in the definition of the secondary. As Loeliger notes, each call to the secondary word requires a NEXTRUN-COLON combination on entrance and a NEXTRUN-SEMI combination on exit. Lower-level secondary words in the definition will need these calls as well. In addition, any primitives within the definition use 82 cycles in overhead. The secondary word with the least amount of overhead is one that is made up of primary words. For example, the word 2DUP defined as a secondary word requires:

(text continued on page 418)

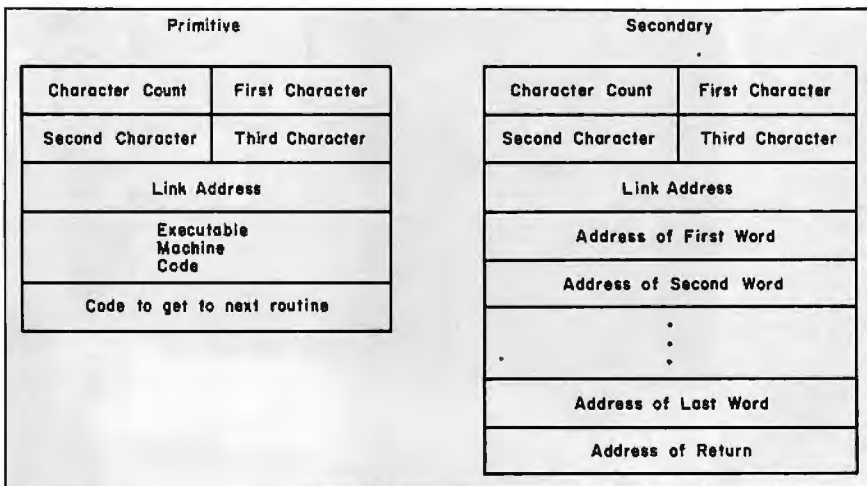

Figure 1: Organization of primitive and secondary words of a pointer-threaded interpretive language.

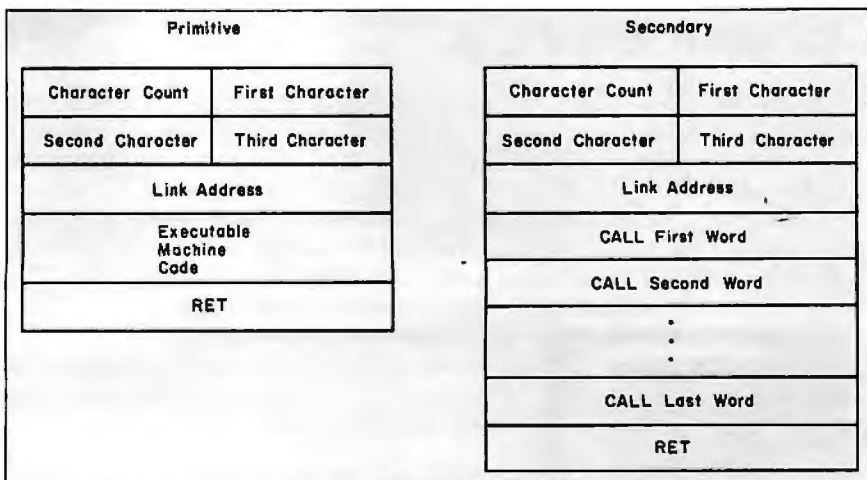

Figure 2: Organization of primitive and secondary words of a subroutine-threaded interpretive language.

THE SAKATA CONNECTION



Get value plus compatibility for your IBM PC jr.

The SAKATA SC-100 Composite Color Monitor is completely compatible with your IBM PC jr., for both the system unit and the slim-line floppy disk drive model. Combining low distortion, exceptional linearity and good sound, with true colors for vivid graphics, SAKATA's SC-100 gives better performance and extra value.

See the complete line of SAKATA CRT monitors wherever personal computers are sold...RGB High Resolution (SC-200) RGB Super High Resolution (SC-300) Monochrome Green (SG-1000), Monochrome Amber (SA-1000)...and SC-100 for IBM PC jr.

Or, write for illustrated and technical literature and prices.



"We Promise Performance."

If you desire RGB or 80-Column capabilities with the IBM PC jr. for the ultimate in graphic reproduction, we recommend the SAKATA SC-200 monitor.

SAKATA U.S.A. CORPORATION
651 Bonnie Lane, Elk Grove Village, Illinois 60007
(312) 593-3211 800-323-6647 (outside Illinois)

Sakata

"Serving industry worldwide since 1896"

Circle 292 on inquiry card.

PART 1 of this two-part article presents a brief overview of the Ada language and its history, as well as small examples of programs that demonstrate Ada's features. I have assumed that BYTE readers are familiar with programming languages, so I have not defined such concepts as variables, loops, functions, and arguments.

The following examples are intended to help you explore Ada's features. Each program focuses on a specific feature of the Ada language. The only drawback to this approach is that it sometimes sacrifices utility for exposition. The examples and the format of this article are a direct steal from James Joyce's two-part article, "A C Language Primer" (August and September 1983 BYTE). You can compare this article with his to compare the two languages.

To reinforce what you learn, I recommend that you enter each program into a computer, assuming, of course, that you have access to an Ada compiler. After a program runs successfully, experiment with omitting or changing parts of it. Introducing deliberate errors can provide a controlled exposure to Ada's sometimes cryptic error messages and can give you valuable experience in interpreting compiler diagnostics. Such messages are not the fault of the Ada language but of the compiler designs available today. As is the case with many language compilers, errors can have a cascading effect: many errors are actually the result of one original error.

This article does not pretend to explain everything you will want to know about Ada. My goal is to get you started with some key constructs and conventions in Ada.

Ada was designed by Jean Ichbiah at CII Honeywell Bull in France in 1978. Ichbiah improved the language in a second version, which was presented in 1980. It was based on Pascal with many features borrowed from more modern, but experimental, languages. Ada became an ANSI (American National Standards Institute) standard language in 1983 and is expected to remain unchanged until 1988. It is also a military standard and, as of this year, is used in many military applications.

Ada has many goals. Its primary reason for existence is to

replace the use of assembly language in small computers dedicated to specialized applications such as signal processing, process control, and communications. Furthermore, Ada is intended to make programs much more portable, readable,

maintainable, and reliable than programs written in other languages.

Someday Ada and its support tools will be available on many computers. Currently, there are only three true Ada compilers available: the New York University (NYU) Ada/Ed for the Digital Equipment Corporation (DEC) VAX; Rolm Ada and Ada Environment for the Data General Eclipse and the Rolm 3200; and Western Digital Ada for the Western Digital Microengine. There are also numerous partial compilers for Intel 8086/8088-based computers, for Zilog Z80-based computers, and for Motorola 68000-based computers. A true Ada compiler has passed more than 2000 tests provided by the Ada Joint Program Office. After passing the tests, the compiler is issued a certificate of validation good for one year.

No dates have been established for validation of the microcomputer-based compilers, nor for validation of compilers based on larger computers. I expect that several more validated compilers will be available in 1984, and that at least one will be a microcomputer-based Ada compiler.

As with any language, good programming style is important. Ada provides facilities to help "readability," but it is up to the programmer to use these features. Indentation and naming conventions can help to make a program more readable, and their use should be encouraged. On the other hand, nesting can be avoided, and unstructured constructs can be forbidden.

Ada has more protection against common programming errors than most other languages. Often, when you get a pro-

(text continued on page 132)

AN ADA LANGUAGE PRIMER



Augusta Ada Lovelace, Lord Byron's daughter. The language was named after the countess, who is considered to be the world's first programmer.

BY SABINA H. SAIB

Sabina H. Saib (1500 Holiday Hill, Goleta, CA 93117) is a member of the Aeronautical Operations Group at General Research Corp. Dr. Saib is the author of an Ada textbook to be published by Holt, Rinehart & Winston and co-author of a tutorial published by the IEEE Computer Society.

(text continued from page 131)

gram to compile, it runs the first time, which should help programmer productivity immensely. Like Pascal, Ada has many checks that it performs during execution. If a program is not time-critical, these checks should be left in. If the checks are burdensome, or if you are running benchmarks, they can (and should) be turned off.

ADA PROGRAM STRUCTURE

This is the smallest possible complete Ada program:

```
-- tiny1.ada --
-- The smallest Ada program
procedure smallest is
begin
  null; -- a comment
end smallest;
```

Comments in Ada begin with two hyphens (-) and end at the end of each line. No special character is needed for the end of a comment as in Pascal or C. This program has three comments: the ones in the first and second lines, which take up whole lines, and the one after the null statement, which takes up the rest of the line after the semicolon. This program is named *smallest* and does nothing. Any executable code would have been placed between the `begin` and `end` for the procedure.

To compile and execute this program on the NYU Ada/Ed system, the command is `$ada tiny1`.

Normally, Ada programs are in a file whose name ends in `.ada`. If the compilation is successful, the system presents a series of messages listing the time spent in compilation, binding, and execution. After finishing, the `$` prompt is displayed.

It is possible to compile a program without executing it and to create a library of programs for later binding.

Because Ada is a free-format language, we could have written this program in a more compact form, such as

```
-- tiny2.ada The smallest Ada
-- program rewritten
procedure smallest is begin null;
end smallest;
```

In fact, if we left out the comments, the *smallest* program could be written on a single line as

```
procedure smallest is begin null; end smallest;
```

However, this is poor style and is not recommended.

PACKAGES

Ada programs consist of *packages* of subprograms and a main program. You should structure a large program as a number of packages that contain related small subprograms.

In the following example, the program *small* calls a subprogram, `do_nothing`, that doesn't do anything.

```
-- Small1.ada
-- Smallest Ada program with
-- a subprogram in a package
package example is
-- subprogram specification
  procedure do_nothing;
end example;
package body example is
  procedure do_nothing is
-- subprogram implementation
  begin
```

```
    null;
  end do_nothing;
end example;
with example;
use example;
-- main program uses subprograms
-- in package example
-- main program
procedure small is
begin
  do_nothing;
end small;
```

The package named *example* has one subprogram named `do_nothing`. A package in Ada has two parts, each of which can be compiled separately. (The main program also can be compiled separately.) The first part of the package is called the *package specification*. It merely lists the names and parameters, if any, of the subprograms in the package. Data items and data types can also be placed in the package specification. The second part of the package is called the *package body*, which contains the complete Ada code for the subprograms listed in the specification of the package. Our example has just one subprogram that does not do anything.

A main program that uses a package normally names the package in `with` and `use` statements just before the first statement of the program. To call a subprogram in a package, the program just states the name of the program. Any arguments are placed within parentheses after the name. A semicolon follows every statement and serves as a statement terminator rather than as a statement separator (as in Pascal).

This main program calls the subprogram `do_nothing` in the package *example*. The subprogram does nothing and returns control to the main program, which does more nothing before finishing execution.

You could nest the subprogram `do_nothing`, instead of putting it in a package, as in the following example.

```
-- Small2.ada
-- Smallest Ada program
-- with a nested subprogram
procedure small is
-- nested subprogram
  procedure do_nothing is
  begin
    null;
  end do_nothing;
begin
  do_nothing;
end small;
```

The text of the subprogram is placed in the declaration part (before the `begin`) of the main program. This has an advantage in that the program text is smaller for our do-nothing example. However, this approach has serious disadvantages over using the package form. When nesting is used, the main program is no longer small. It usually takes longer to compile than when programs are placed in a separate package. Other users of subprograms placed in nested programs must include the text of the subprogram in their program, so there is much less sharing of software. Nesting also usually results in large data spaces accessible by all parts of the program. This is the usual Pascal approach to programming.

As demonstrated in the following example, Ada has a method of separate compilation that avoids long compilation time and long main-program text.

(text continued on page 134)

Ada for Microcomputers

BY MARK J. WELCH

A number of companies have developed, or are preparing, compilers for Ada or for subsets of Ada. As of January 1984, only three compilers had been approved by the Department of Defense, which holds the trademark to the name "Ada." A New York University implementation runs on the DEC VAX 11/780; a Rolm/Data General version runs on Rolm and Data General minicomputers; and GenSoft, formerly a Western Digital subsidiary, has developed a validated compiler and development system for Western Digital's WD-1600.

Of the three validated compilers, only GenSoft's version runs on a microcomputer. Although developed for the WD-1600, which is no longer produced, the compiler can be used on Digicomp Research's Delphi-100, which uses the same processor chip set. The Delphi-100 with a complete Ada development system would cost about \$15,000 to \$20,000. GenSoft is currently deciding whether to port the compiler to other processors or develop an entirely new version of the compiler.

Other vendors have announced either compilers that will be submitted for validation soon or subsets of Ada that will later be expanded to include the full language. Several of these run on microcomputers (see table 1). Many are cross-compilers that take advantage of the speed and memory of mainframes to produce code that can be run on microprocessors in dedicated systems—mostly for the military.

Alslys is developing compilers for the 8086 and 68000 processors, which the company hopes to submit for validation by the end of this year. The compilers need at least 1 megabyte of memory and a 10-megabyte hard disk.

Irvine Computer Sciences Corporation (ICSC) has developed Ada compilers for the 68000 and the Z8000. The 68000 compiler runs under Unisoft's implementation of UNIX and is available from Unisoft for \$3500. The Z8000 version is available from Zilog for its System 8000.

RR Software is selling Janus, a subset of Ada. The vendor says the product will be expanded to the full Ada language by the end of the year. Available for computers using MS-DOS, CP/M, CP/M-86, or Concurrent CP/M-86, Janus costs from \$300 to \$1100, depending on development tools included.

RR Software has also introduced PASTRAN, a Pascal-to-Ada translator to increase the speed of program translation. It costs \$100 for CP/M, CP/M-86, and MS-DOS. Nontranslatable features of

Pascal are flagged.

SofTech is retargeting its Ada Language System for the 8086 under a contract with the U.S. Air Force Systems Command. SofTech also sells an Ada-to-Pascal translator. The company hasn't discussed any commercial plans for the product.

SuperSoft announced an Ada subset in early 1982 and had planned to have a full version late that year. However, it has decided not to expand its compiler. SuperSoft is selling a \$300 CP/M-80 version, called SuperSoft-A, which it says includes about 65 percent of Ada's fea-

tures.

Telesoft has a \$3030 Ada Development Kit for the IBM Personal Computer (PC). The kit produces interpreted p-code. Telesoft submitted its \$4435 compiler for the Motorola 68000 for validation in February.

Intellimac Inc. released an Ada shell that enables eight people to use Telesoft-Ada on Intellimac's 68000-based IN/7000 compiler family.

.....
Mark J. Welch is a BYTE staff writer. He can be contacted at POB 372, Hancock, NH 03449.

Producer	68000	8086	Z8000	Z80	Other
Alslys 400 No.1 Totten Pond Rd. Waltham, MA 02154 (617) 890-0030	yes	yes			
Digicomp Research Terrace Hill Ithaca, NY 14850 (607) 273-5900					Delphi-100
GenSoft 319 South Craig St. Pittsburgh, PA 15213 (412) 621-0235					WD-1600 Delphi-100
Intellimac 6001 Montrose Rd. Rockville, MD 20852 (301) 984-8000		multiuser shell for Telesoft Ada (68000)			
Irvine Computer Sciences Corp. 18201 Sky Park Circle Suite L Irvine, CA 92714 (714) 250-1366	yes (Unisoft)			yes (Zilog)	
RR Software POB 1512 Madison, WI 52701 (608) 244-6436		\$500 (MS-DOS CP/M-86, CCP/M-86)		\$300 (CP/M)	
SofTech 460 Totten Pond Rd. Waltham, MA 02154 (617) 890-6900		yes (USAF)			
SuperSoft 1713 South Neil St. POB 1628 Champaign, IL 61820 (217) 359-2112				\$300 (48K, CP/M)	
Telesoft 10639 Roselle St. San Diego, CA 92121 (619) 457-2700	\$4435	\$3030 (IBM PC)			
Unisoft 2405 Fourth St. Berkeley, CA 94710 (415) 644-1230	\$3500				

EMACS
FOR THE
IBM PC

UniPress is pleased to announce the availability of MS-DOS EMACS to supplement our

existing UNIX and VMS versions. MS-DOS EMACS is full-function Gosling EMACS, including compiled MLISP, macros, command undo and much more.

UniPress Gosling EMACS: The famous multi-window full-screen editor. Edit several files at once. Interprocess communication on UNIX and VMS. Extensible via macros and the built-in compiled MLISP language.

UniPress Gosling EMACS: The ultimate programmer's tool: C, Pascal and MLISP language assist. EMACS manages execution of Unix makefiles, and automatically points to lines containing errors in the source code. Keys can be bound as desired, macros can be named, customized MLISP routines can supplement the many included packages, and much more!

UniPress Gosling EMACS: Use EMACS as your session manager — Divide your screen into a "shell window" to run commands, and one or more source file windows.

ALSO NEW! MINIMACS — Special efficiency-conscious EMACS. Faster and smaller; includes all standard editing features, keybinding, and multiple windows.

PRICES: UNIX: \$395/Binary; \$995/Source
VMS: \$2500/Binary; \$7000/Source
MS-DOS: \$375/Binary; \$995/Source
(Requires at least 384K)

UNIPRESS OFFERS A FULL LINE OF
SOFTWARE FOR UNIX, VMS AND MS-DOS.

Lattice® C compilers to the 8086-family; both native and cross. Write programs on your mainframe for execution on the IBM-PC, etc. (Cross compilers for UNIX and VMS.)

Q-CALC — extraordinary UNIX spreadsheet.

LEX — Powerful interactive UNIX word processor.

PHACT — Multi-keyed ISAM database record manager for UNIX and MS-DOS.

OTHER UNIPRESS PRODUCTS:

Full UNIX System V operating system for the Apple LISA, /RDB The Menu System, UniCalc, and more.

Call or write for more information.

UniPress Software, Inc.

2025 Lincoln Highway, Rt. 27, Suite 312, Edison, NJ 08817
201-985-8000 • Order Desk: 800-222-0550 (outside NJ)
Telex: 709418

Mastercard and Visa

Unix is a trademark of Bell Laboratories • VMS is a trademark of Digital Equipment Corp. • MS-DOS is a trademark of Microsoft • Lattice and UniCalc are registered trademarks of Lattice Inc. • IBM-PC is a trademark of IBM.

(text continued from page 133)

```
- Small3.ada
- Smallest Ada program with a
- separately compiled subprogram
procedure small is
  - nested subprogram
  - separately compiled
  procedure do_nothing is separate;
begin
  do_nothing;
end small;
separate (small)
- subprogram implementation
procedure do_nothing is
begin
  null;
end do_nothing;
```

Although this approach avoids the problem of a long main program, it still has the data space problem and the sharing problem common to nesting. Therefore, I believe that almost all Ada subprograms should be placed in packages instead of using nesting or separate compilation and nesting.

DISPLAYING A MESSAGE

Ada has several packages common to all compilers. Two of these are the `standard` package and the `text_io` package. The `text_io` package contains subprograms to display a message on the standard output device, which is usually your terminal.

```
- hello1.ada
- Greet the world
- Introduce output in Ada
with text_io;
- use of text_io package
use text_io;
procedure hello is
begin
  put ("Hello, world!");
  new_line;
end hello;
```

The message displayed by this example is the statement `Hello, world!` It is written as a character string within parentheses in the call to the `put` subprogram, which is in the `text_io` package. After the `put` subprogram, there is a call to the `new_line` subprogram, which positions the cursor at the beginning of the next line.

When using the `put` subprogram without a `new_line` call, the next output request puts the subsequent output on the same line on the display. Thus, we could write the message as follows:

```
- hello2.ada
- Greet the world
- in another version
with text_io;
- use of text_io package
use text_io;
procedure hello is
begin
  put ("Hello");
  put (" ");
  put (" ");
  put ("world");
  put ("!");
```

(text continued on page 428)

CONDOR

Data

Management Software



**Condor's
IBM™ PC -
compatible
Relational Data-
base Management**

*is the effective way to manage
your office automation needs,
such as personnel management,
inventory control, billing, manufacturing
systems, educational, and other office,
school or home needs.*

*With Condor you get the power and flexibility of a fully
relational database system complete with a "Step-by-
Step" MENU system to guide the new user. On-line
help is integrated into the Menu system. A complete
REPORT WRITER is also included, that even the new-
comers in our field recommend.*

*With Condor, setting up a new database of information,
is as simple as typing on a blank sheet of paper . . . typi-
cally, it takes a minute, maybe two. You are then ready to
enter your data into the database you just created, again just
like typing on a sheet of paper.*

*Then, you can SORT, SELECT, COMPUTE, POST, or PRINT your
information in almost any way that you desire. Plus, you can easily pass
information from Condor to your word processor's mail-merge, or pass spread-
sheet information into Condor. It's all very easy, and also very English.*

*Begin with Condor jr. (\$195), the advanced file manager. Upgrade later as your business and your data
grow, to Condor3 (\$650-or less the \$195 if you bought Condor jr.), the fully relational data management
system. It's the same system that hardware manufacturers like DEC, Sony, Zenith, and Hewlett-Packard
have selected to market with their personal computers. There are well over 100,000 satisfied users.*

*To find out how Condor Data management software can make your business easy to handle, see your
personal computer dealer, or call 1-800-221-8479 (In Michigan call 0-313-769-3992 collect)
for your nearest dealer.*

*He'll prove our point. That Condor is the data management software powerful enough to be useful to
business, yet simple enough for business to use.*



2051 South State Street Ann Arbor, MI 48104 313-769-3988

Circle 84 on inquiry card.

IBM is the registered trademark of
International Business Machines Corp.

MACINTOSH PASCAL

An interactive interpreter transforms Pascal into a language as easy to learn as it is expeditious to use.

Pascal's evolution has mirrored the growth of the microcomputer industry—both seek to bring usable, learnable computer power to a generation of inquisitive, educated people looking toward the next century. Niklaus Wirth created Pascal to make learning computer programming an easy but still rigorous task. Even before Carl Helmers called six years ago in this journal for the widespread adoption of Pascal, colleges and universities worldwide were beginning to embrace the language as a primary tool for teaching programming.

Apple Pascal was released in 1979 and was one of the first microcomputer implementations. Pascal became the primary programming language within Apple Computer Inc. for the development of new products. With this strong tie to Pascal, there was a good chance that Apple would be instrumental in the adoption of significant new Pascal products. The first of these new products is the recently announced version for the Macintosh.

The version of Pascal that Apple Computer offers for its new Macintosh is called Macintosh Pascal. Although it will be marketed by Apple, Macintosh

Pascal was created at Think Technologies Inc. (420 Bedford St., Lexington, MA 02173) by Melvin Conway, who conceived the project and wrote the prototype interpreter; Andrew Singer and John Hueras, who designed the product for the Macintosh; and Peter Maruhn and Terry Lucas, who wrote the Macintosh version. Running initially on the Macintosh only, Macintosh Pascal will be available for Apple's Lisa running under the MacWorks operating system. Think Technologies promises separate versions of the language for all major educational microcomputers in the next 18 months. Macintosh Pascal will retail for \$125.

A NEW BREED

An interactive interpreter is the most innovative feature of Macintosh Pascal. Programmers can write source code in Macintosh Pascal and run it immediately without going through a separate compilation step. Students can run individual commands to understand their functions. Using the Macintosh user interface—with its multiple windows, mouse, and data integration—makes Macintosh Pascal programming easy and efficient. New programmers can learn the language more quickly and effectively when they can interact with a program at the source-code level. Macintosh Pascal's program-development tools, including single-step execution, use of breakpoints, and an Observe window to track the alteration

of variables, further enhance this process (see "Macintosh Pascal's Development Tools" later in the text).

Macintosh Pascal is a full implementation, not a subset, of Pascal, and it emulates as closely as possible both the ANSI (American National Standards Institute) standard Pascal and LisaPascal. The following paragraphs describe the major differences between Macintosh Pascal and LisaPascal and Macintosh Pascal and ANSI Pascal.

Macintosh Pascal varies slightly from LisaPascal, particularly in the way the latter uses extensions to the language definition. Also, the scope anomalies of LisaPascal are errors in Macintosh Pascal. The Macintosh version differs in other significant ways, including:

- use of up to 255 significant identifier characters
- no support of compiler commands or nested comments
- simpler rules for *integer* and *longint* arithmetic
- additional *real* data types: *longreal*, *extended*, and *computational*
- requirement of the *otherwise* statement within a CASE construct
- no support of the *external* directive
- no support of user-defined units or segmentation
- no support of the functions

<i>exit</i>	<i>halt</i>	<i>heapresult</i>
<i>mark</i>	<i>release</i>	<i>memavail</i>
<i>pwroften</i>	<i>moveleft</i>	<i>moveright</i>
<i>scaneq</i>	<i>scanne</i>	<i>fillchar</i>

Editor's Note: This article is a BYTE Product Preview. It is not a review. We think this new product is significant and therefore offer this advance look at a prerelease version. An independent in-depth review, with appropriate benchmarks, will appear in a subsequent issue.

- support of the *pack* and *unpack* procedures

The Macintosh Pascal manual lists other minor differences between the two.

Macintosh Pascal conforms most closely to the ANSI standard for Pascal and is closer to that standard than is LisaPascal. Macintosh Pascal's major departures from the ANSI/IEEE 770X3.97-1983 standard include:

- the special symbol @ is an operator and never treated as a ^
- only the standard file variables INPUT and OUTPUT can be used as program parameters
- all quoted character strings are STRING data types, but Macintosh Pascal's compatibility rules are nonetheless compatible with the standard's

- support of the word symbols *otherwise*, *string*, and *uses*
- support of the underscore character within an identifier
- all *integer* and *real* data type operands are converted to *extended* before real arithmetic is performed; the result is always *extended*
- support of predefined *libraries*
- support of a set of string procedures and functions
- support of the *pointer* and *sizeof* functions for LisaPascal compatibility

The Macintosh Pascal manual lists other minor differences from the ANSI standard, including errors not automatically detected and reported, in an appendix.

Macintosh Pascal also supports the graphics functions of the Macintosh QuickDraw program. Macintosh Pascal

can take advantage of QuickDraw's functions by including the QuickDraw libraries. This is done with the *uses* clause; for example, *uses QUICKDRAW1, QUICKDRAW2*.

Macintosh Pascal also supports IEEE numerics conventions using the Pascal library SANE (Standard Apple Numeric Environment). The SANE package is the first implementation of IEEE numerics on a microcomputer.

PROGRAMMING IN MACINTOSH PASCAL

Because the language is interpreted, programming in Macintosh Pascal is very similar to using interpreted BASIC.

(text continued on page 138)

.....
G. Michael Vose is a BYTE senior technical editor. He can be contacted at POB 372, Hancock, NH 03449.

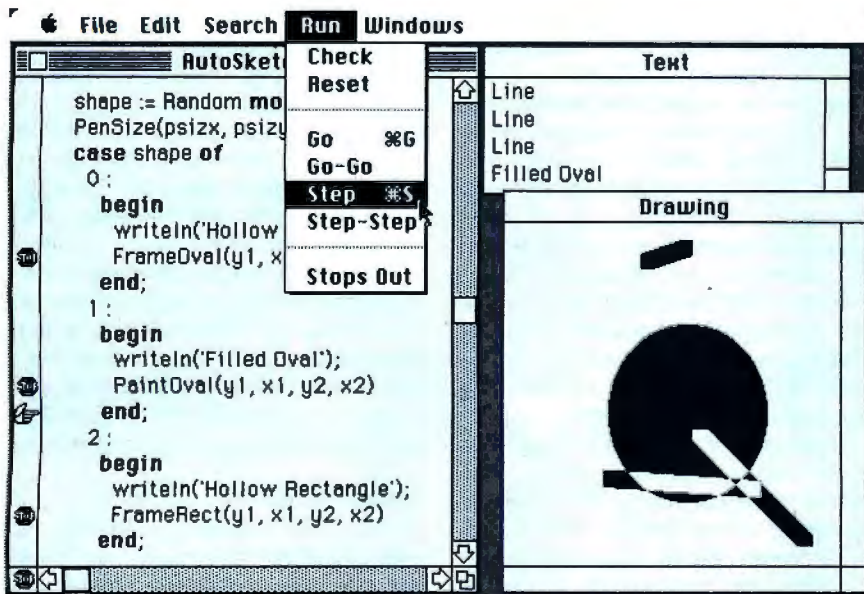

Figure 1: The Macintosh Pascal AutoSketch program. The Run menu appears in the upper center of the screen. At the right are the Text and Drawing windows. The listing window, on the left, shows breakpoints indicated by stop signs; the finger points to the next instruction to be executed in single-step mode.

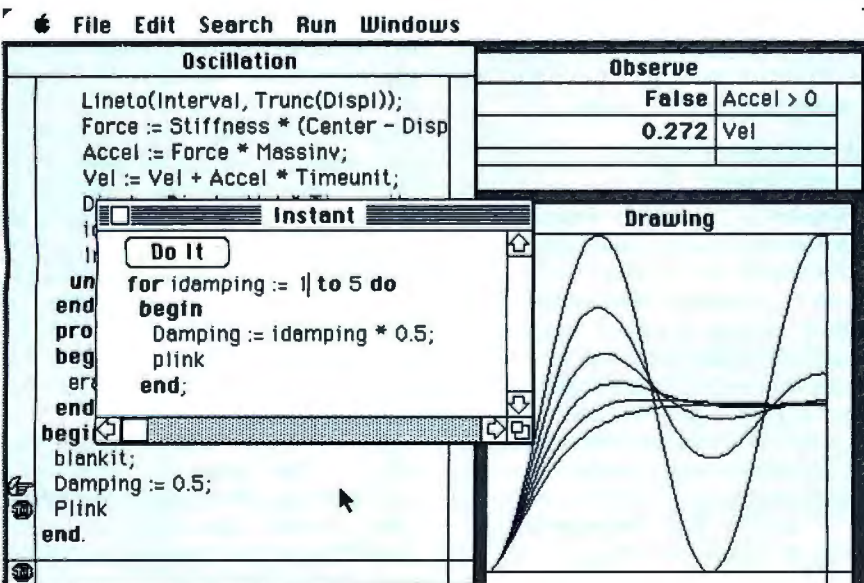

Figure 2: The Oscillation program. The Observe window in the upper right shows the value of variables or expressions. The Instant window enables execution of code fragments and the changing of variables during program execution.

Heart of TEXAS COMPUTER SYSTEMS

TRS-80

We carry the full line of TRS-80 computers, plus TCS upgrades. Call for our low discount prices.

Model 100 Briefcase size. **CALL**

Model IV Portable: **CALL**

Model 12 , 16 at discount: **CALL**

Model 12/16 Accessories/discount.

The TANDY-2000

Check out this terrific new computer from Tandy. It's beautifully designed and very versatile. Four times faster than the IBM-PC and has twice the floppy disk capacity. MSDOS compatible. It's a great machine and we have a great price. **CALL!**

DISK EXPANSION

	M-III	M-IV
1 Controller, Pwr.Sup. Hdw.,Instrct.	\$249	\$329
2 Kit 1, plus 1/40-trk.Tandon Dr.	\$429	\$479
3 Kit 1, plus 2/40-trk. Tandon Dr.	\$589	\$649
3a Kit 3 w/2 80 trk.drives (dual sided 40s)	\$698	\$729

Model IV needs 64K to operate. For 64K Kit, **CALL.**

Tandon

Quality disk drives--O.E. brand on IBM Available bare and in cabinets.

TM100-1: \$159

TM100-2: CALL

CALL US IF YOU FIND
LOWER PRICES!

CORVUS

25% OFF LIST PRICE!

OMNINET- A high speed multi-user network that connects several computers for instant communication up to 4,000 feet away.

Save over \$1,000 on a 20 mg. Corvus Hard Disk system for IBM PC and other computers.

5mg. \$1649 10mg. \$2279 20mg. \$3049

DAVONG Systems, Inc.

Single user or networking hard disk system for IBM & Apple. Lowest prices anywhere. Priced from \$1375. 10, 15, 21, 32 mg. & cartridge tape backup--**CALL.**

Star PRINTERS

Fast, dependable, versatile, low price.

Gemini 10X 9in., 120cps, Friction/Tractor

Gemini 15X 15in., 120cps, Friction/Tractor

DISKETTES \$1.70

CompuDisk, high quality mini floppy disks from \$1.70. Compare our prices. Disks come complete with hub rings, protective envelopes, write protect tabs, adhesive labels. **Fully tested. Certified 100% Error Free. Guaranteed. SDD or DSDD. Boxed or in Bulk. CALL.**

Heart of TEXAS COMPUTER SYSTEMS

P.O.Box 1327 Arlington, TX 76004

Toll Free 1-800-433-5184

Texas 1-817-274-5625

VISA, MC, cashier's check, Money Order. No tax out of state. Texans add 5%. Prices subject to change.

(text continued from page 137)

You type in or load from disk the code you plan to run and then run it. Because Macintosh Pascal program lines are precompiled with the entry of a carriage return, errors are detected and reported immediately. Macintosh Pascal is thus even friendlier than traditional interpreted BASIC in detecting errors.

Where BASIC uses the RUN command to start program execution, Macintosh Pascal uses GO or ⌘-G, Apple's Cloverleaf command key followed by G in the manner of the Control-X keystroke sequence. Macintosh Pascal also enables execution of a program with breakpoints (called Stops) placed within the code (GO-GO), or single-step execution of the code with (STEP-STEP) or without (STEP or Cloverleaf-S) breakpoints. The GO-GO and STEP-STEP commands run a program with breakpoints, pause briefly at each Stop, and then continue, updating variables or expressions in the Observe window (see "Macintosh Pascal's Development Tools").

Figure 1 is a Macintosh screen with the Macintosh Pascal program, Auto-Sketch, being executed in single-step mode. The Run menu appears at the upper center of the display. Breakpoints have been inserted into the code and are shown in the listing window as miniature stop signs within the left scroll bar. The miniature hand with pointing finger shows the command that will be executed next. The Text and Drawing windows show the program's output.

Macintosh Pascal program fragments cannot be run alone using the commands in the Run menu. There is an Instant window that provides this capability, however. Within this window, you can enter, edit, and execute any Macintosh Pascal statement. The Instant window has great potential as an educational aid but has additional capabilities as well that make it one of the language's development tools.

MACINTOSH PASCAL'S DEVELOPMENT TOOLS

Interestingly, Macintosh Pascal's program-development tools double as learning aids and can make the process of writing programs more efficient. The Instant window is a good example.

Students can use the Instant window to see how a specific command or program segment works. More experienced programmers can use this window to help create desired operations because it also can be used to change the value of a variable in a running program. Using the Instant window, you can play "what if" games with variables in a

program while it is running.

This intraprogram interactivity is the guiding philosophy behind the language's program-development tools. Besides the Instant window, you can use an Observe window to watch the value of variables and expressions change as a program executes; the Text and Drawing windows to see the text and graphics output, respectively, of the current running program; or the Clipboard window, which provides access to the Clipboard system utility, used to move text or graphics from one window or program to any other program or window.

Figure 2 shows a Macintosh Pascal program called Oscillation in a display that includes the Instant and Observe windows. The Observe window, in the upper right corner, shows that the value of the *Accel*>0 expression is false, while the value of the variable *Vel* is 0.272. The Instant window enables the execution of a single *for* loop, with its result shown in the Drawing window.

You can access Macintosh Pascal's other development tools through the File, Edit, and Search menus, and a special Pause menu that appears only while a program is executing. The functions available for file manipulation include opening, closing, saving, restoring after editing (Revert), and program printing. With the edit functions, you can cut, paste, copy, and clear (delete). Search functions are Find, Replace, and Everywhere (search and replace). The special Pause menu provides the single HALT command that stops program execution.

USING MACINTOSH PASCAL

Although the Macintosh makes full and extensive use of the mouse, Macintosh Pascal enables you to select many of its functions from the keyboard by using the Cloverleaf key as a control key. File and window functions cannot be invoked from the keyboard, but most edit, search, and run functions can be. Because these functions are the ones most often used during program development, this "mousetrap" ensures that programmers are not hindered much by the ubiquitous rodent.

Macintosh Pascal consumes approximately 50K bytes of the Macintosh's memory, leaving more than 35K bytes for programs. Program disks provide approximately 100K bytes of space for program storage.

Through Think Technologies, Apple plans to offer a system programmer's toolkit for the development of applications software. The toolkit will be released four to six months after Macintosh Pascal's debut. ■

COMPUTERS and more. . .

is your place to buy for SELECTION, SERVICE and SAVINGS.

We know that your needs are not the same as everyone's, so we don't treat you "just like every one else."
Your needs are special. That's why COMPUTERS and more. . . is your place to buy for. . .



... SCHOOL

COMPUTERS

IBM	EAGLE
64KPC w/2.320 drives 2295	PC-XL 3395
PC XT w/256KRAM 4795	Spiral II 2699
PCJR 128K CALL	

APPLE	DeskTop w/2 drives 2369
The Macintosh call	Portable w/2 drives 2195
Apple Starter System 1299	
Apple IIe 899	
New Apple Products call	

COLUMBIA	TS 1605 CALL
1600-3 w/1 year war. 2495	Teletote SALE
1600-1 Pack w/1 yr. war. 2795	Multi-User Systems CALL
1600-4 CPU only 3654	
VP Portable 2349	

DEC	SHARP
Rainbow 100 2295	PC-5000 1529
Rainbow 100 + 4495	

KAYPRO	NEC
Kavoro II 115	We sell and service all
Kaypro II + or 4+ CALL	Nec Models CALL

FRANKLIN	LEADING EDGE
Ace 1000 799	PC 2199
Ace OMS CALL	

COMPAQ	
Compaq 2-drive 128K 2599	
Compaq Plus 3995	

ACCESSORIES

IBM	R10-Plus 64K 269
Accel 128K 389	R10 64K + 1/0 cd 269
Keytronic 5150 189	SR10 by STB on sale
Keatronix 5151 219	Optical Mouse by Visi 199
Hercules Card 349	Quadboard Ex 64K 319
AST 6-Pack 265	Quadboard II 64K 249
AST PC Net CALL	Quadvue 289
Platronic Color Bd 369	Orrhid Tech CALL
Z-Plus by CCS 579	1200B w/St 429
Graphix Plus by STB 319	Technit Access CALL
256K cd by STB 379	

APPLE	80 Col 64K for IIe 116	80 Col Card 109
Par Interface 54	294 K by Synetex 499	
Serial Card 78	MicroModem IIe w/St 239	
Buffered Grappler + 159	Koala Pad 79	
Z-80 Card 97	Apph Cards call	

PROMPT DELIVERY!



1 Year Warranty Available

TO ORDER: Phone orders invited using Visa, MasterCard, or bank wire transfers. Visa, MC, service charge of 2%. Mail orders may send charge card number (include expiration date), cashiers check, money order, or personal check (allow 10 business days for personal or company checks to clear). Please add 3% (\$5.00 minimum) for UPS shipping, handling, and insurance. All equipment is in factory cartons with manufacturer warranty. Opened products not returnable. Restocking fee for returned merchandise. Equipment subject to price change and availability. Retail prices differ from mail order prices. Calif. residents add 6% State Tax; Company and school P.D.'s accepted on approval. IBM & Apple are registered trademarks.

INTERNATIONAL INQUIRIES WELCOMED
TELEX 697120, DATAMAX ATTN: DEPT. 322

... HOME

PRINTERS

JUKI	TOSHIBA
6100 18 cps 419	P1351 P 1599
Tractor 109	P 1351 S 1599
Cut-Sheet Feeder 529	P 1340 P 799
	P 1340 S 799

EPSON	RITEMAN
Fx-100 CALL	Riteman Plus 329
Fx-80 CALL	Riteman Blue 359
LQ-1500 NEW	

ABATI	MANN-TALLY
LQ-20 Parallel 389	We carry all
LQ-20 Serial 429	Mann-Tally Printers CALL

DAISYWRITER	SIEMENS
Daisy 2000 w/48 K Buf. 949	PT 88 Ink Jet 759
Tractor for 2000 119	Pt 89 Ink Jet 994
Cut-Sheet Feeder 659	

RICOH	ANADIX
RP-1300 35 cps 979	9500 B 995
RP-1600 45 cps Ser. 1395	9625 B 1195
	9000 B 989

STAR	OKIDATA
Power Type - New CALL	Call for our low sale prices
Delta IO & 15 CALL	on all OKI Printers
Gemini 10x & 15x CALL	
Radix 10 & 15 CALL	

TRANSTAR	
Transtar 120P 399	
Transtar 120S 399	
Transtar 130P 579	
Transtar 130S 579	
Tran 130 Sheet Feeder 329	

FREE * SHIPPING

PLOTTERS

AMDEK	HOUSTON-INST
Amplot 4-Color 719	DMP402 call
Amplot R Digital 899	DMP40 P 959
X-Y 6-Color 949	

ENTER	C-ITOH
Sweet-P for Apple 729	Call 549
Sweet-P for IBM 789	
Sweet-P Model 100 519	

DISK DRIVES

Tandon 100-2 219
CDC for IBM (320 K) 229
SPECIAL NOTE TO OUR CUSTOMERS:
Because Hard Disk Drive companies are rethinking their prices downward, please call for latest prices for QUADRAM, TECMAR, DA-VONG, CORVUS, PEGASUS AND OTHERS.

... OFFICE

SOFTWARE

FOR PC & XT	FOR JR.
Easywriter I 189	Home Acct. Jr. 54
Lotus 1-2-3 319	Tax Advantage Jr. 54
Lotus Symphony call	Personal Development 67
R-Base 4000 349	Filewriter 2 119
DesQ 339	Rescue at Rigel 24
MultiMate call	Easywriter I Sys. 189
Volkswriter DeLux 199	Kids on Keys Jr. 24
Wordstar on sale!	Creative Calc. 34
Home Accountant Plus 99	Creative Filer 34
Concurrent CP/M 86 239	Creative Writer 34
CP/M 86 CALL	Pipes 24
T.I.M. 329	Save New York 24
Q-Base 139	
Verse Form 379	
Ask Micro (ea package) 389	
Inview 219	
Micro Terminal 69	

APPLE
Friday 169
C Dex (each) 36
Quick Code 179
Micro Pro on sale!
PFS: File 83
PFS: Report 83
PFS: Graph 83
Visicalc 3.3 169
Visicalc Enhanced 179
Letter Perfect w/Mail 99
dBase II call
Tax Prepare '84 179
Magic Window II 97

MAC
Friday 199
dBase II 499
Micro Soft Basic 119
MultiPlan 139
Chart 99

Call for our free price list of software

MONITORS AND TERMINALS

Princeton Hx-12 464	Zenith 131 319
Princeton SR-12 on sale!	Zenith 135 487
Princeton Max-12 179	Zenith 122 109
Taxan 420 467	Amdek 310-A 169
Taxan Amber 119	Amdek Color II 429
Taxan Kx-122 159	Amdek Color IV 799
Quadram Quadchrome 499	NEC 1216 419
Quadram Color II 449	

TERMINALS	
WYSE 300 989	Teletideo 914 539
WYSE 100 689	Teletideo 924 687
QUME 102A 534	Teletideo 910A 549
QUME 103A CALL	Teletideo 950 895

SERVICE

EXTENDED WARRANTIES AND FAST REPAIR BY QUALIFIED TECHNICIANS FOR OUR ENTIRE LINE. CALL FOR MORE INFO.



COMPUTERS and more.

3620 30TH ST., SAN DIEGO, CA 92104



TO ORDER (619) 291-1442



"SE HABLA ESPAÑOL"

\$50 to \$200 rebate on system purchases
CALL FOR MORE INFORMATION.

* On All Pre-paid Cash Orders In. Cont. U.S.

P.O.'S ACCEPTED ON APPROVAL

7400

Table listing 7400 series components including Part No., Price, and Pin Count. Includes sub-sections for Micro-Processor Chips and Dynamic RAMs.

MICROPROCESSOR COMPONENTS

Table listing Micro-Processor Chips and Dynamic RAMs with Part No., Price, and Pin Count.

Digitalker™

DT1050 - Applications: Teaching aids, appliances, clocks, automotive, telecommunications, language translations, etc.

DT1057 - Expands the DT1050 vocabulary from 137 to over 260 words. Includes 2 ROMs and specs.

74LS

Table listing 74LS series components including Part No., Price, and Pin Count.

8080/8085 SERIES

Table listing 8080/8085 series components including Part No., Price, and Pin Count.

INTELSIL

Table listing IntelSil components including Part No., Price, and Pin Count.

74S

Table listing 74S series components including Part No., Price, and Pin Count.

8088/8088 SERIES

Table listing 8088/8088 series components including Part No., Price, and Pin Count.

30009 1983 IntelSil Data Book

30009 1983 IntelSil Data Book (1356pp) \$9.95

74HC High Speed CMOS

Table listing 74HC High Speed CMOS components including Part No., Price, and Pin Count.

74S/PROMS™

Table listing 74S/PROMS™ components including Part No., Price, and Pin Count.

8088/8088 SERIES

Table listing 8088/8088 series components including Part No., Price, and Pin Count.

74C CMOS

Table listing 74C CMOS components including Part No., Price, and Pin Count.

LINEAR

Table listing Linear components including Part No., Price, and Pin Count.

CA-LINEAR

Table listing CA-LINEAR components including Part No., Price, and Pin Count.

8088/8088 SERIES

Table listing 8088/8088 series components including Part No., Price, and Pin Count.

LINEAR

Table listing Linear components including Part No., Price, and Pin Count.

RS232 ADAPTER FOR VIC-20 AND COMMODORE 64



The JE232CM allows connection of standard RS232 printers, modems, etc. to your VIC-20 and C-64. A 4-pole switch allows the inversion of the 4 control lines. Complete installation and operation instructions included.

- Plugs into User Port
- Provides Standard RS232 signal levels
- Uses 6 signals (Transmit, Receive, Clear to Send, Request to Send, Data Terminal Ready, Data Set Ready).

JE232CM \$39.95

VOICE SYNTHESIZER FOR APPLE AND COMMODORE



Over 250 word vocabulary affixes allow the formation of more than 500 words • Built-in amplifier, speaker, volume control, and audio jack • Recreates a clear, natural male voice • Plug-in user ready with documentation and sample software • Case size: 7 1/4" L x 3 1/4" W x 1-3/8" H

JE520AP

JE520CM

• Over 250 word vocabulary affixes allow the formation of more than 500 words • Built-in amplifier, speaker, volume control, and audio jack • Recreates a clear, natural male voice • Plug-in user ready with documentation and sample software • Case size: 7 1/4" L x 3 1/4" W x 1-3/8" H

APPLICATIONS: • Security Warning • Telecommunication • Teaching • Handicap Aid • Instrumentation • Games

The JE520 VOICE SYNTHESIZER will plug right into your computer and allow you to enhance almost any application. Utilizing National Semiconductor's DIGITALKER™ Speech Processor IC (with four custom memory chips), the JE520 compresses natural speech into digital memory, including the original inflections and emphases. The result is an extremely clear, natural vocalization.

Part No.	Description	Price
JE520CM	For Commodore 64 & VIC-20	\$114.95
JE520AP	For Apple II, II+, and IIe	\$149.95



JE664 EPROM PROGRAMMER 8K to 64K EPROMS - 24 & 28 Pin Packages

Completely Self-Contained - Requires No Additional Supplies for Operation

- Programs and validates EPROMs
- Checks for properly erased EPROMs
- Emulates PROMs or EPROMs
- RS232C Computer interface for editing and program loading
- Loads data into RAM by keyboard
- Changes data in RAM by keyboard
- Loads RAM from an EPROM
- Completes EPROMs for content differences
- Copies EPROMs
- Power Input: 115VAC, 60Hz, less than 10W power consumption
- Enclosure: Color-coordinated, light tan panels with molded end pieces in mocha brown
- Size: 15 1/4" L x 8 1/4" W x 3 1/4" H
- Weight: 5 1/2 lbs.

The JE664 EPROM Programmer emulates and programs various 8-Bit Word EPROMs from 8K to 64K memory capacity. Data can be entered into the JE664's internal 2K x 8-Bit RAM in three ways: (1) from a ROM or EPROM, (2) from an external computer via the optional JE664 RS232C BUS, (3) from its panel keyboard. The JE664's RAM may be accessed for emulation purposes from the panel's test socket to an external microprocessor. In programming and emulation, the JE664 allows for examination, change and validation of program content. The JE664's RAMs can be programmed quickly to all "1"s for any reason; allowing master addresses in the EPROM to be programmed later without necessity of "UV" erasing. The JE664 displays DATA and ADDRESS in convenient hexadecimal (alphanumeric) format. A "DISPLAY EPROM DATA" button changes the DATA readout from RAM word to EPROM word and is displayed in both hexadecimal and binary code. The front panel features a convenient operating guide. The JE664 Programmer includes one JE664 Jumper Module (as listed below).

JE664-A EPROM Programmer \$995.00

Assembled & Tested (includes JMT16A Module)

JE665 - RS232C INTERFACE OPTION - The RS232C interface Option implements computer access to the JE664's RAM. This allows the computer to manipulate, store and transfer EPROM data to and from the JE664. A sample program listing is supplied in IBMASC by CP/M computers. Documentation is provided to attach the software to other computers with an RS232 port, 9600 baud, 8-bit word, odd parity and 2 stop bits.

FOR A LIMITED TIME A SAMPLE OF SOFTWARE WRITTEN IN BASIC FOR THE TRS-80™ MODEL I LEVEL II COMPUTER WILL ALSO BE PROVIDED

JE664-ARS EPROM Prog. w/JE665 Option \$1195.00

Assembled & Tested (includes JMT16A Module)

EPROM JUMPER MODULES - The JE664's JUMPER MODULE (Personality Module) is a plug-in Module that pre-sets the JE664 for the proper programming pulses to the EPROM and configures the EPROM select connections for that particular EPROM.

JUMPER	Manufacturer	Part No.	Programs	EPROM PARAMETERS	PRICE
JA00A	2708	2708	AMD, Motorola, Nat. Intel, TI		\$14.95
JA10A	2716, 27C25, 27C01	2708	Intel, Motorola, Nat. NEC, TI, AMD, Microware, Microware		\$14.95
JA20A	2702, 2704, 2708, 2716, 27C25, 27C01	2708	Intel, Motorola, Nat. NEC, TI, AMD, Microware, Microware		\$14.95
JA30A	2702, 2704, 2708, 2716, 27C25, 27C01	2708	Intel, Motorola, Nat. NEC, TI, AMD, Microware, Microware		\$14.95
JA40A	2702, 2704, 2708, 2716, 27C25, 27C01	2708	Intel, Motorola, Nat. NEC, TI, AMD, Microware, Microware		\$14.95
JA50A	2702, 2704, 2708, 2716, 27C25, 27C01	2708	Intel, Motorola, Nat. NEC, TI, AMD, Microware, Microware		\$14.95
JA60A	2702, 2704, 2708, 2716, 27C25, 27C01	2708	Intel, Motorola, Nat. NEC, TI, AMD, Microware, Microware		\$14.95
JA70A	2702, 2704, 2708, 2716, 27C25, 27C01	2708	Intel, Motorola, Nat. NEC, TI, AMD, Microware, Microware		\$14.95
JA80A	2702, 2704, 2708, 2716, 27C25, 27C01	2708	Intel, Motorola, Nat. NEC, TI, AMD, Microware, Microware		\$14.95
JA90A	2702, 2704, 2708, 2716, 27C25, 27C01	2708	Intel, Motorola, Nat. NEC, TI, AMD, Microware, Microware		\$14.95
JA00A	2708	2708	AMD, Motorola, Nat. Intel, TI		\$14.95
JA10A	2716, 27C25, 27C01	2708	Intel, Motorola, Nat. NEC, TI, AMD, Microware, Microware		\$14.95
JA20A	2702, 2704, 2708, 2716, 27C25, 27C01	2708	Intel, Motorola, Nat. NEC, TI, AMD, Microware, Microware		\$14.95
JA30A	2702, 2704, 2708, 2716, 27C25, 27C01	2708	Intel, Motorola, Nat. NEC, TI, AMD, Microware, Microware		\$14.95
JA40A	2702, 2704, 2708, 2716, 27C25, 27C01	2708	Intel, Motorola, Nat. NEC, TI, AMD, Microware, Microware		\$14.95
JA50A	2702, 2704, 2708, 2716, 27C25, 27C01	2708	Intel, Motorola, Nat. NEC, TI, AMD, Microware, Microware		\$14.95
JA60A	2702, 2704, 2708, 2716, 27C25, 27C01	2708	Intel, Motorola, Nat. NEC, TI, AMD, Microware, Microware		\$14.95
JA70A	2702, 2704, 2708, 2716, 27C25, 27C01	2708	Intel, Motorola, Nat. NEC, TI, AMD, Microware, Microware		\$14.95
JA80A	2702, 2704, 2708, 2716, 27C25, 27C01	2708	Intel, Motorola, Nat. NEC, TI, AMD, Microware, Microware		\$14.95
JA90A	2702, 2704, 2708, 2716, 27C25, 27C01	2708	Intel, Motorola, Nat. NEC, TI, AMD, Microware, Microware		\$14.95

HI-TEK 14-KEY NUMERIC KEYPAD

- Great keypad for many home and business computer applications
- SPST switching - Mounted on PC board - Size 5" L x 3" W x 1 1/4" H
- Color: Grey - Weight: 1 lb - Spec available

K-14 \$9.95

MICRO SWITCH ASCII Encoded Keyboards

- Large selection of keyboards - Hall effect switching - Some have parallel interfaces - Some have serial interfaces - All have status LEDs and a minimum of 88 keys - Some with numeric keypad capabilities, cursor controls, or both - Styles may vary - Weight: 2 lbs - No specs available

KB-MISC \$9.95

Mitsumi 54-Key Unencoded Matrix All-Purpose Keyboard

- SPST keyswitches - 20 pin ribbon cable connection - Low profile keys - Features: cursor controls, control, caps (lock), function, enter and shift keys - Color (keycaps) grey - Wt.: 1 lb. - Pinout included

KB54 \$14.95

71-Key ASCII Cherry Keyboard

- 7 bit parallel ASCII with strobe - 11 key numeric keypad - SPST mechanical keyswitches - 15/30 card-edge connector - Features: escape, control, cursor controls, plus 10 add'l. special function keys - Color white - Weight: 2 lbs. - Spec included

KB1801 \$29.95

87-KEY ASCII Cherry Keyboard

- 12-key numeric keypad - Cursor keypad - SPST mechanical keyswitches - 40-pin header connector - Colors: main and numeric keypad—orange; Cursor keypad—yellow - Weight: 2 lbs. - Spec included

KB8600 \$34.95

Nationally Known Manufacturer!

106-KEY 8-BIT SERIAL ASCII KEYBOARD

- The terminals were designed to be daisy chained around a central host computer and used as individual work stations - Hall effect switching - numeric and cursor keypad - 10 user definable keys - 50' interface cable with 9-pin sub-miniature connector - 7 LED function displays - Security lock - N-key rollover - Automatic key repeat function - Color: (case): white w/black panel—(key caps): grey and blue - Weight: 6 1/2 lbs. - Data included.

KB139 \$59.95



NEW!

- Bright 4-digit 0.5" high display
- 10 minute snooze alarm

The JE750 Clock Kit is a versatile 12-hour digital clock with 24-hour alarm. The clock has a bright 0.5" high blue-green fluorescent display. The display will automatically dim with changing light conditions. The 24-hour alarm allows the user to disable the alarm and immediately re-enable the alarm to activate 24 hours later. The kit includes all documentation, components, case and wall transformer. Size: 6 1/4" L x 3 1/4" W x 1 1/4" D.

JE750 Alarm Clock Kit \$29.95

DISK DRIVES AND SUPPLIES

5 1/4" APPLE™ Direct Plug-In Compatible Disk Drive

- Use Shugart SAS90 mechanics - 143K formatted storage - 35 tracks - compatible with Apple controller - Complete with connector and cable - Just plug into your disk controller card - Size: 6 1/4" L x 3 1/4" W x 8-3/16" D - Weight: 4 1/2 lbs.

ADD-514...\$195.95

Microcomputer Power Inc. Regulated Power Supply

- Perfect for computer or disk drive systems - Supply has AMP connectors for direct connection to two 5 1/4" disk drives - Cooling fan - Input: 100V/115/200/230VAC, 47-63Hz - Output (above) - Weight: 9 lbs.

CP167 \$59.95

13 1/4" L x 6 1/4" W x 5" H

INDUSTRIES Protect Yourself... DATASHIELD® Surge Protector

- Eliminates voltage spikes and EMI-RFI noise before it can damage your equipment or cause data loss - 6 month warranty - Power dissipation (100 microsecond): 1,000,000 watts - 6 sockets - 6 foot power cord - Normal line voltage indicator light - Brown out/black out reset switch - Weight: 2 lbs.

Model 100 \$69.95

Protect Yourself... DATASHIELD® Back-Up Power Source

- Provides up to 30 minutes of continuous 120 VAC 60Hz power to your computer system (load dependent) when you have a black out or voltage sag - Output: 200 watts - Six month warranty - Weight: 19 lbs.

Model 200 (PC200) \$349.95

IBM MEMORY EXPANSION KIT COMPAQ COMPATIBILITY

SAVE HUNDREDS OF \$\$\$ BY UPGRADING MEMORY BOARDS YOURSELF!

Most of the inputs, memory boards allow you to add an additional 64K, 128K, 192K, or 256K. The JE664 Kit will populate these boards in 64K byte increments. The kit is simple to install - just insert the nine 64K RAM chips in the provided sockets and set the two groups of switches. Directions are included.

IBM64K (Nine 200ns 64K RAMs) \$49.95

TRS-80 MEMORY EXPANSION KIT

TRS-80 to 16K, 32K, or 48K

- Model 1 = From 4K to 16K Requires (1) One Kit
- Model 3 = From 4K to 48K Requires (3) Three Kits
- Color = From 4K to 16K Requires (1) One Kit

*Model 1 equipped with Expansion Board up to 48K - Two Kits Required - One Kit Required for each 16K of Expansion

TRS-16K3 *200ns for Color & Model III \$12.95
TRS-16K4 *250ns for Model I \$10.95

TRS-80 Color 32K or 64K Conversion Kit

Easy to install kits comes complete with 8 ea. 4164-2 (200ns) 64K dynamic RAMs and conversion documentation. Converts TRS-80 color computers with D, E, ET, F and NC circuit boards to 32K. Also converts TRS-80 color computer to 64K Flex DOS or OS-9 required to utilize full 64K RAM on all computers.

TRS-64K2 \$44.95

UV-EPROM Eraser

8 Chips - 51 Minutes

1 Chip - 37 Minutes

Erases 2708, 2716, 2732, 2764, 2516, 2532, 2554. Erases up to 8 chips within 61 minutes (1 chip in 37 minutes). Maintains constant exposure distance of one inch. Special conductive foam liner eliminates static build-up. Built-in safety lock to prevent UV exposure. Compact - only 9.00" x 3.70" x 2.80". Complete with holding tray for 8 chips.

DE-4 UV-EPROM Eraser . . . \$79.95
UVS-11EL Replacement Bulb . . . \$16.95

POWER SUPPLIES

TRANSACTION TECHNOLOGY, INC. 5VDC @ 1 AMP Regulated Power Supply

- Output: +5VDC @ 1.0 amp (also -30VDC regulated) - Input: 115VAC, 60 Hz
- Two-tone (black/beige) self-enclosed case - 6 foot, 3-conductor black power cord - Size: 6 1/4" L x 7" W x 2 1/4" H - Weight: 3 lbs.

PS51194 \$14.95

Power/Mate Corp. REGULATED POWER SUPPLY

- Input: 105-125/210-250 VAC at 47-63 Hz - Line regulation: -0.05% - Three mounting surfaces - Overvoltage protection - UL recognized - CSA certified

Part No.	Output	Size	Weight	Price
EMAS/6B	5V @ 3A/5V @ 2.5A	4 1/4" L x 4 1/4" W x 2 1/4" H	2 lbs.	\$29.95
EMAS/6C	5V @ 6A/6V @ 5A	5 1/4" L x 4 1/4" W x 2 1/4" H	4 lbs.	\$39.95

ASTEC SWITCHING REGULATED POWER SUPPLY

- Apple III Power Supply - Multiple outputs for bench top uses and other applications - Input: 115VAC, 50-60 Hz @ 2.0 amp - Output: +5VDC @ 1.0 amp, +12VDC @ 1.0 amp, -12VDC @ 1.0 amp, +24VDC @ 1.0 amp, -24VDC @ 2.5 amp
- Size: 15" L x 3 1/4" W x 2 1/4" H - Weight: 2 1/2 lbs.

AS1155 \$39.95

POWER SUPPLY +5VDC @ 7.6 AMP 12VDC @ 1.5 AMP SWITCHING

- Input: 115VAC, 50-60Hz @ 3 amp/230VAC, 50Hz @ 1.6 amp - Fan with power supply select switches (115/230VAC) - Output: 5VDC @ 7.6 amp - 12VDC @ 1.5 amp - 8 foot black power cord - Size: 11 1/4" L x 13 1/4" W x 3 1/4" H - Weight: 6 lbs.

PS94VOS \$39.95

KEPCO/TDK 4-OUTPUT SWITCHING POWER SUPPLY

- Ideal for disk drive needs of CRT terminals, microcomputers and video games - Input: 115/230VAC, 50/60Hz - Output: +5V @ 5 amp, -12V @ 1.8 amp, -12V @ 0.5 amp - UL recognized - CSA certified
- Size: 7 1/4" L x 6-3/16" W x 1 1/4" H - Weight: 2 lbs.

MRM 174KF \$59.95

4-CHANNEL SWITCHING POWER SUPPLY

- Microprocessor, mini-computer, terminal, medical equipment and process control applications - Input: 90-130VAC, 47-440Hz - Output: +5VDC @ 5A, -5VDC @ 1A, +12VDC @ 1A, -12VDC @ 1A - Line regulations: +0.2% - Ripple: 30mV p-p - Load regulation: +1% - Overcurrent protection - Adj: 5V main output - 10% - Size: 6 1/4" L x 1 1/4" W x 4-1/16" H - Weight: 1 1/2 lbs.

FCS-604A \$69.95 each

Switching Power Supply for APPLE II, II+ & IIe™

- Can drive four floppy disk drives and up to eight expansion cards
- Short circuit and overload protection - Fits inside Apple computer
- Fully regulated +5V @ 5A, +12V @ 1.5A, -5V @ .5A, -12V @ .5A
- Direct plug-in power cord included - Size: 9 1/4" L x 3 3/4" W x 2 1/4" H
- Weight: 2 lbs.

KHP4007 \$79.95

\$10.00 Minimum Order - U.S. Funds Only
 California Residents Add 6% Sales Tax
 Shipping - Add 5% plus \$1.50 Insurance
 Send S.A.S.E. for Monthly Sales Flyer!

Spec Sheets - 30¢ each
 Send \$1.00 Postage for your
 FREE 1984 JAMECO CATALOG
 Prices Subject to Change

Mail Order Electronics - Worldwide

MasterCard **Jameco ELECTRONICS** **VISA®**

1355 SHOREWAY ROAD, BELMONT, CA 94002
 6784 PHONE ORDERS WELCOME - (415) 592-8097 Telex: 176043

BUILD A PRINTER BUFFER

An inexpensive project for the parallel port

BY JOHN BONO

Personal computers have eliminated many of life's minor frustrations. Unfortunately, they also have created a unique set of new frustrations. For instance, have you ever debugged a program with a listing so old that even your handwritten modifications are modified? If you're like me, you don't want to stop debugging to wait for a new printout. Have you ever been connected to a computer via a phone line and wished you could get hard copy but your printer was too slow to keep up with the data transmissions? Perhaps you have a program that produces so much printed output that you wait until lunch to run it? Tying up your computer to print data is a waste of time and resources. If these situations sound familiar, a printer buffer may be the solution.

A printer buffer holds characters to be printed out until the printer is ready to accept them. It allows the computer sending the characters to dump the characters and go back to other tasks. In the meantime, the printer prints the characters at its relatively slow pace.

Software printer buffers do exist, but they have these drawbacks: they are highly hardware dependent, limited in buffer space, incompatible with some programs, and

still slow down the computer somewhat.

The best solution is a hardware printer buffer external to your computer. These devices exist commercially, but they are relatively expensive. For that reason you should consider building one, as I did.

Photo 1 shows the completed printer buffer. It consists of only 24 chips, connectors, and a power supply. The entire unit cost less than \$150 to build. The parts list for this project is specified in table 1.

HOW IT WORKS

Figure 1 shows the flow of data from the host computer through the printer buffer and out to the printer. The computer sends a byte to the printer buffer interface. The microprocessor inside the printer buffer reads the byte and stores it in RAM (random-access read/write memory). This process continues until there are no more characters sent or until the buffer fills up. The buffer uses 64K bytes of RAM, which means that over

65,000 characters can be stored in the printer buffer. This translates to about 35 pages of printed material.

Output from the printer buffer takes place independent of input. The characters are taken from RAM in the same order as they are input. The microprocessor then sends the characters one by one to the printer interface. To the user, these two processes appear to take place simultaneously so that data can leave the computer and be printed as quickly as possible.

Figure 2 shows the block diagram for the printer buffer. The heart of the system is a Z80 microprocessor running with a 1-MHz clock. It executes instructions stored in an EPROM (erasable programmable read-only memory). The characters are input from the host computer into an 8-bit latch and are output to the printer through another 8-bit latch. The printer buffer includes 64K bytes of dynamic RAM. The RAM has a multiplexed address input and refresh-

ing requirements, so additional support logic is required for its operation.

GETTING DOWN TO THE NITTY GRITTY

Figures 3a and 3b (pages 450 and 452) show the schematic diagram for the printer buffer. The 1-MHz clock is generated by IC1, an MC4024. Exercise special caution when buying this part because it is not CMOS (complementary metal-oxide semiconductor) as its 4000 series number might lead you to believe. Order only a MC4024, not just a 4024, and you won't have a problem. The 0.001 μ F (microfarad) capacitor across pins 3 and 4 sets the frequency, and the connections to pin 2 adjust the frequency somewhat. In this application, the clock frequency is not at all critical—any clock rate between 0.5 and 2 MHz is acceptable.

IC2 is the Z80 microprocessor that runs the whole printer buffer. Pin 26 resets the processor when the 68- μ F

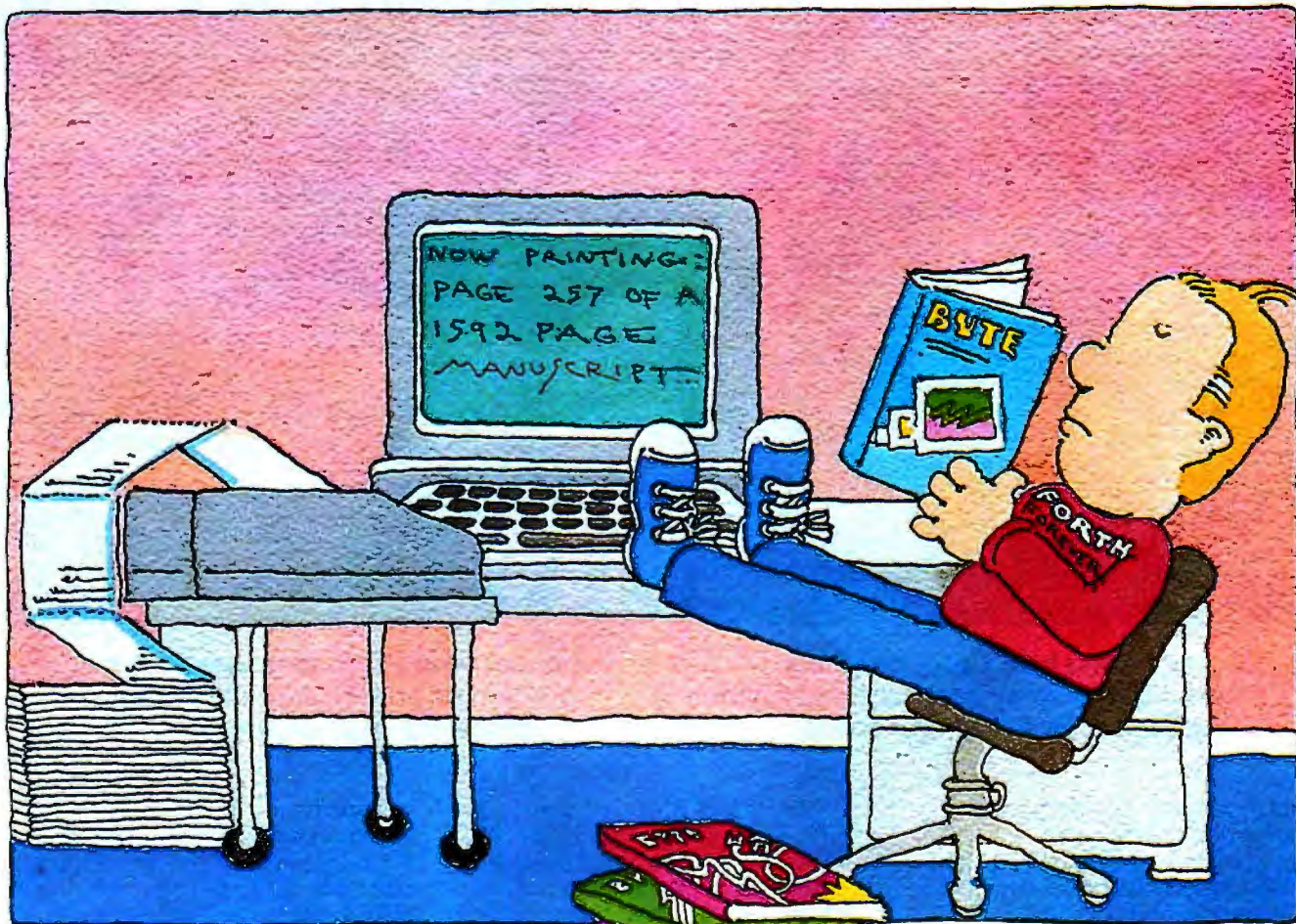

capacitor charges through the 10,000-ohm (Ω) resistor. This system is quite simple, therefore, all the interrupt and direct-memory handshaking inputs are strapped to their inactive state. One thing I have found is that the Z80 has an annoying feature of letting its high-address bus float at certain times, which causes random chip selects and could destroy the contents of the RAM. To avoid this problem, IC5, a 74LS373, latches the upper-address byte and keeps it valid during the entire instruction cycle.

The EPROM memory resides at address locations 0 through 2047 (although 256 bytes is more than enough memory). The EPROM chip select is generated by IC11. This 74LS138 decoder is used as a 5-input OR gate determining whether the EPROM or the RAM will be selected during a given memory cycle. If the output of IC11 is low, the EPROM will be selected; if it is high, then the RAM will be selected.

The RAM memory consists of eight 4164 chips. All of the chip's pins are connected in parallel except for the data input and output pins (2 and 14). The interface from the Z80 to the RAM chips was the most challenging part of the design. The dynamic RAM works like this: a row address is provided, the row-address strobe (RAS) goes low, a column address is provided, the column-address strobe (CAS) goes low, and then data goes either in or out. The level of the READ/WRITE pin at the time of CAS determines the data direction. IC7 and IC8 are the address multiplexers for the RAM. When their S input is high, the low byte of the Z80 address is provided to the RAM-address input. When their S input is low, the high byte of the Z80 address goes to the RAM-address inputs.

The memory-access sequence starts with the Z80 putting out an address.

The low-address byte goes to the RAM. The MEMORY REQUEST signal and either the READ or WRITE signal then occurs. These signals, with a RAM SELECT signal from IC11, are combined by IC4 to generate the RAS. Now, the RAM has the low-address byte. The RAS signal is delayed slightly by the buffers of IC14 and IC6 to allow for RAM-address hold time. Then the delayed RAS switches the address multiplexers IC7 and IC8 to provide the high-address byte to the RAM. The RAS is further delayed to allow for multiplexer settling time and then is fed to the RAM to provide CAS. When CAS goes low, the RAM either accepts or outputs the data byte depending on whether the Z80 is doing a READ or WRITE.

(text continued on page 446)

John Bono (23624 137th Ave. SE, Kent, WA, 98031) is an electrical engineer with Boeing Aerospace Company's Electrical Technology Organization in Kent, Washington.

Only one company can show you so many And it isn't IBM.

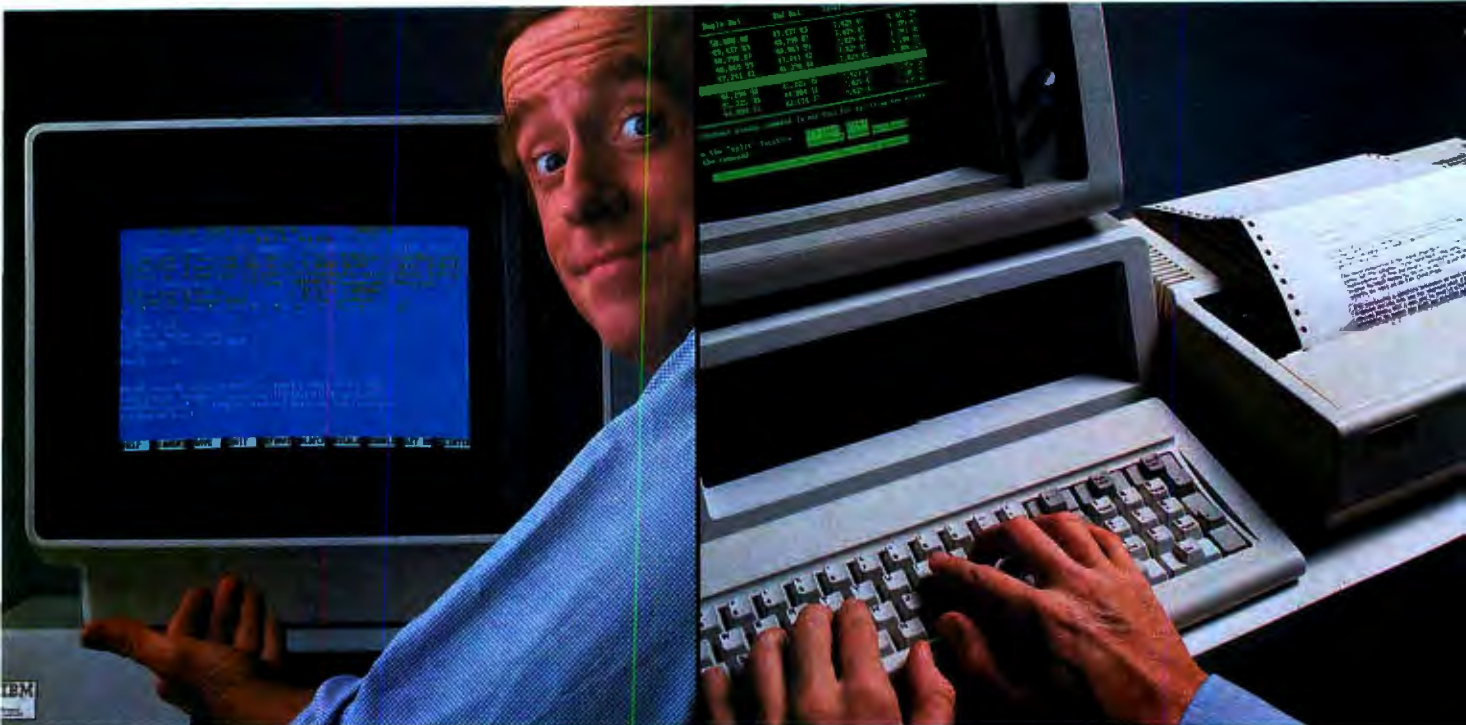

**Monochrome text. Color graphics.
Even a new super display adapter that provides
the Best of Both, on one board.**

**Connect your PC to peripherals like a
modem or printer, with the added
efficiency of print spooling.**

IBM today sets the standard in personal computers.

But what happens when you want to expand your PC's capability to something beyond standard?

That's when you have to look beyond IBM. To the one company that offers the widest range of products to make your PC work more powerfully, more efficiently.

Persyst.

Display adapters. Persyst introduces a significant technical advance.

Now Persyst redefines the basic utility of display adapters for IBM personal computers.

Our BoB™ super display adapter provides the sharpest text resolution ever as well as brilliant color graph-

ics—the Best of Both—on one board. Plus a unique option that lets you design and download custom programmable character sets.

Meanwhile, for great basic performance, we also offer PC/Monochrome™ and PC/Color Graphics™ display adapters engineered to deliver the same quality as IBM's own standard adapters.

Only Persyst offers you so much choice.

Memory and multifunction boards. Persyst has the most flexible ways to expand your PC.

Here again, Persyst offers a unique array of products to expand your PC beyond the IBM standard.

Want the most capable one-slot multifunction packages available?

Choose either Time Spectrum™ with up to 512K, or Time Spectrum™ SB384 with up to 384K RAM. Other functions include a bidirectional parallel port and async serial ports to link your PC with printers, modems and instrumentation. Calendar clock. Game port. Plus, Wait-Less Printing™ print spooling and Insta-Drive™ RAM disk software.

Want to expand function without adding memory?

Our Timeport™ gives you a calendar clock, bidirectional parallel port and two async serial ports, as well as capability for ROM and static

PC/MONOCROME
DISPLAY ADAPTER

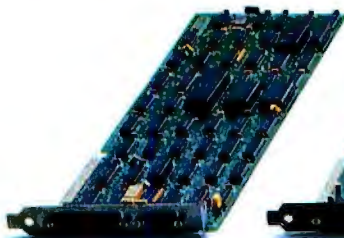

PC/ COLOR GRAPHICS
DISPLAY ADAPTER



BoB SUPER
DISPLAY ADAPTER

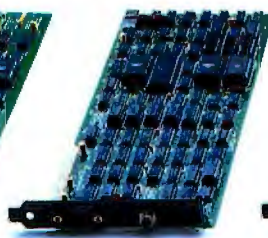

TIME SPECTRUM
WITH RAMPAK™



TIME SPECTRUM SB384

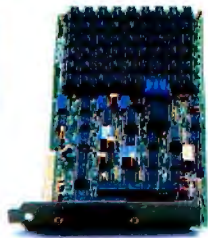

ways to expand the power of your IBM PC.



17664	3-08-83	12:00p
560	2-02-84	7:22p
133	1-01-80	12:00a
4	2-16-84	1:34p
273	2-16-84	3:49a
631	2-16-84	3:56a
280	2-22-84	11:24a
172	2-24-84	5:46p
615	2-24-84	5:50p
563	3-01-84	2:25p
1018	3-02-84	9:06a
311296 bytes free		

Memory expansion to let your PC utilize the most sophisticated software.

Productivity features like a calendar clock to date and time stamp your files automatically.

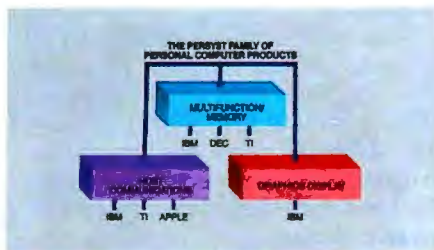

Quality and documentation. Persyst support is built into every product.

All Persyst expansion products include one important extra benefit—Persyst quality.

Each board is fully burned in. Completely system tested. And backed by a limited one-year warranty.*

What's more, award-winning Persyst documentation makes using any Persyst product simple.

Expand all the way from an IBM desktop PC to an IBM intelligent workstation. You can only do it with Persyst.

Persyst is the only resource that offers display adapters. Multi-

function and memory boards. And micro to mainframe communications.

The most complete selection of innovative, technically advanced expansion products to meet your needs today. And tomorrow.

Persyst dealers are ready to serve you. For the one nearest you, call (714) 660-1010.

Persyst Products, Personal Systems Technology, 17862 Fitch, Irvine, CA 92714. Telephone: (714) 660-1010. Telex: 467864.

PERSYST™
"You can only do it with Persyst."

IBM is a registered trademark of International Business Machines Corporation. Rainbow and DEC are registered trademarks of Digital Equipment Corporation. TI is a registered trademark of Texas Instruments Corporation. *Limited warranty details available with each product or on request.

Circle 373 on inquiry card.

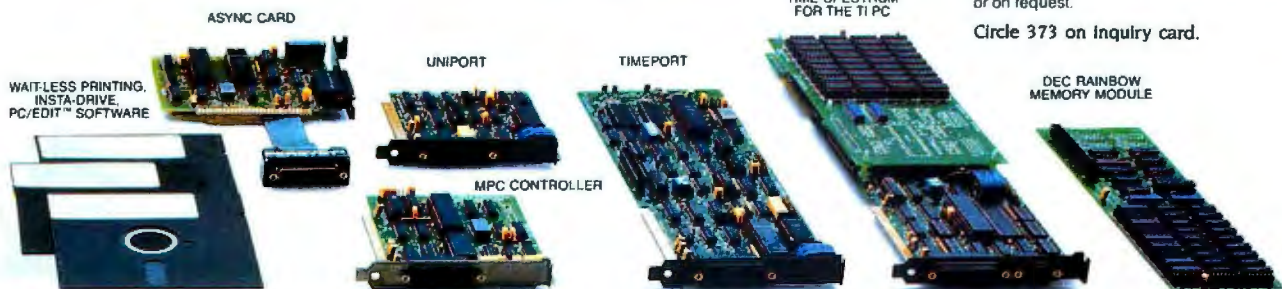

APPLE FAX: Weather Maps on a Video Screen

*With a simple converter circuit,
you can use your Apple to display
facsimile weather maps*

BY KEITH H. SUEKER

Behind the scenes, at television and radio stations and in hundreds of airports around the world, meteorologists ponder dozens of surface and upper-air weather maps several times each day. These maps display information about pressure, winds, temperature, and many other factors that forecasters use to predict the weather.

In this article I will describe a way to display real-time, radio-facsimile weather maps on the Apple II high-resolution video screen. With a short-wave receiver, a simple converter, and a short machine-language program, you can have a new window on the world.

Weather maps come in many forms and formats. Station NSS in Washington, DC, transmits a schedule of daily maps at 0000Z and 1200Z (7:00 a.m. and 7:00 p.m. EST). Some maps have a Mercator projection, some a polar projection. Some of the more interesting maps cover the northern hemisphere from Alaska to Gibraltar and include latitude and longitude lines as well as political and geographical boundaries. Many maps cover the North American continent from Mexico to the polar regions. State and provincial boundaries can be seen, along with major geographical features such as the Great Lakes and Hudson Bay. A sample display is shown in photo 1.

Other maps show a radar summary of precipitation over the U.S. mainland while still others show satellite-recorded cloud cover over large areas. Although the satellite maps are computer-enhanced to include geographical lines, this fine detail is lost when displayed on a video screen.

Photo 1: Polar weather from the Alaskan Peninsula at extreme left center to Scotland at extreme upper right. Baffin Island is at upper center. This composite photo is made from five sequential screen displays.

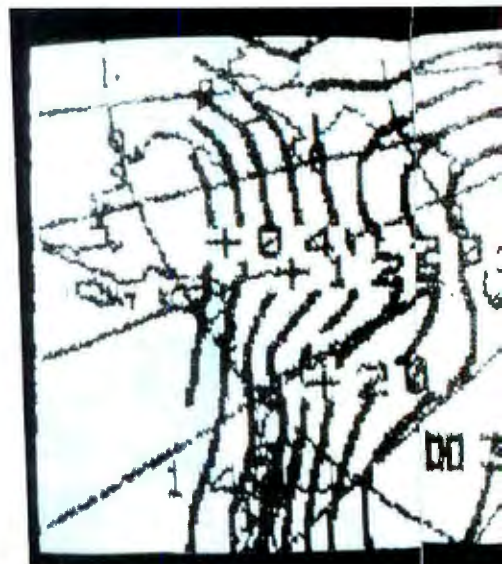

The content of these maps is not always obvious, and their complete interpretation is beyond my ability. Suffice to say that many maps show altitude contours for selected upper-atmosphere pressures, and that high- and low-pressure centers are often clearly shown.

FAX AND WX

Facsimile transmission (FAX) is widely used commercially for sending drawings over the common-carrier telephone lines. It is also used for transmitting weather maps (WX) to ships at sea on high-frequency radio circuits.

For mariners, weather is more than a matter of casual concern. It is vital for them to have as much forecast information as possible on wind velocity, wave heights, air and water temperatures, and other marine conditions. Sea-based aircraft pilots need forecasts of winds, cloud cover, temperatures, and other variables for marine operations. Weather information in the U.S. is collected by land and radio teletype circuits from a worldwide network of ground stations and ships at sea. Nearly every country in the world cooperates in this effort. Orbiting satellites provide additional inputs from specialized sensors. The resulting mass of data is assembled by the National Oceanic and Atmospheric Administration (NOAA) and fed into computers. NOAA's output is a daily stream of synoptic and forecast maps for almost anything you could want to know about the weather. The maps are transmitted nationally over FAX wire circuits and selected maps are also transmitted simultaneously on a number of high-frequency radio circuits through the facilities of the

U.S. Navy Fleet Weather Service. Many other nations also transmit FAX maps, and their transmissions can often be received in this country.

FAX can be visualized as transmission of a television picture at a snail's pace. The original copy is scanned in a series of lines, just as in television. Instead of the 15.750-kHz horizontal-scan rate of television, however, a typical FAX scan rate is 2 Hz or 120 scans per minute. The luminance information of FAX transmissions requires only a kilohertz or so of bandwidth to resolve fine detail because the scan rate is so slow. The video of television is audio in FAX, the result of adapting picture transmission to the frequency and bandwidth limitations of telephone lines and long-distance radio circuits. Because a full FAX picture may require five minutes or more to transmit, FAX is not a winner for live action—except possibly for chess. But it has real utility for handling still pictures.

RECEIVING FAX

My personal involvement with FAX reception began several years ago when I acquired a surplus Western Union Deskfax machine for the princely sum of \$15. This little machine uses a rotating drum covered with electro-sensitive paper and forms an image by sparking a fine wire that advances slowly along the axis of the drum. To make Deskfax functional on radio weather FAX frequencies I had to convert it from 180 scans per minute to the standard 120 scans by building a precision 40-Hz power supply to drive the synchronous motors. Synchronizing pulses are sent at the start of each weather map, but FAX machines run "open loop"; i.e., they

rely on a precise speed match between the transmitting and receiving scanners. Crystal-controlled motor drives provide the required accuracy.

The Deskfax machine also requires a receiving converter because the transmitted FAX signal is a continuous-wave carrier frequency shifted by the "video" information. Commercial FAX receivers employ automatic gain control (AGC) circuits with limiters and discriminators to recover the modulation and convert it to synchronizing pulses and a signal voltage that varies with pixel brightness in the original material. The signal voltage then drives whatever circuitry and mechanism is used to produce the received picture. For this project, I designed a much less elegant, but still functional, receiving adapter.

The Deskfax machine was a lot of fun to operate, but paper supply was a problem and the short drum could accommodate only enough paper for a small portion of each map. When I finally entered the computer age with the acquisition of an Apple II, it seemed logical to see if I could put FAX pictures up on the video screen.

APPLE HI-RES VIDEO

The high-resolution graphics (HGR) display of the Apple II is arranged as 192 lines of 280 horizontal pixels per line.

(text continued on page 148)

Keith Sueker (110 Garlow Dr., Pittsburgh, PA 15235) is a radio amateur (W3VF) who worked for 20 years at Westinghouse before becoming Power Systems engineering manager at Robicon Corp. in Pittsburgh. Sueker has a B.S.E.E. from the University of Minnesota and an M.S.E.E. from the Illinois Institute of Technology.



An attempt to display the entire picture width on the video screen produces a vertically elongated picture.

(text continued from page 147)

Each line is organized as 40 bytes of 7 pixel bits per byte. The page is stored in RAM from hexadecimal 2000 to 3FFF (8192 to 16,375 decimal). The lines are not in a simple sequential order but jump around, presumably to make things easier for the character generator and the low-resolution graphics displays. This design feature makes screen addressing somewhat complicated.

An individual pixel may be displayed by setting high the corresponding bit of the byte in which the pixel resides. Bits 0 through 6 are displayed from left to right with bit 0 (the least significant bit) on the left. The highest bit of each byte must be a common value to assure proper display positioning. The procedure in generating the FAX display is to sample the received radio signal from the signal converter (see figure 1) 280 times for each half-second scan line, and to set each pixel bit high or low according to the signal level at that moment. This arrangement only distinguishes between black and white.

The transmitted picture resolution is better than 500 pixels per line, but this resolution is degraded by transmission conditions, sampling errors introduced by digitizing (accomplished at the game port on the Apple II), and the limitations of the simple receiving converter. In the vertical direction (successive scan lines), line spacing on the screen is such that lines are much farther apart than their spacing on mechanical FAX machines like my Deskfax. An attempt to display the entire picture width on the video screen produces a vertically elongated

picture. For this reason, only about 20 percent of a scan line is displayed to preserve the proper aspect ratio.

HARDWARE

The receiver signal converter shown schematically in figure 1 is used for FAX reception with the Apple II. Audio output from the radio receiver is isolated and boosted in voltage by the input transformer, T1, an output transformer connected backwards. The impedance ratio is not critical. Diodes D1 and D2 rectify the signal and charge C1 to the peak voltage of the signal. Germanium diodes should be used for these rectifiers. Silicon diodes such as the 1N4148 can also be used, but they will require a considerably higher audio level from the receiver. Transistor Q1 acts as a level detector and its collector provides the computer with input using the game-controller socket. Nearly any type of NPN signal transistor will be satisfactory for Q1. The circuit is insensitive to layout and can be built on a breadboard, a printed-circuit board, or simply plugged into a prototype board. Audio leads to the receiver do not have to be shielded. The Apple's game port circuitry converts the analog signal from the radio receiver signal converter to the digital information used to display the map video image.

SOFTWARE

Listings 1 and 2 show the machine-language program for FAX picture reception and the few lines of the BASIC driving program that call it. The BASIC program simply sets the Apple II to full-page high-resolution graphics mode that clears the screen and calls the binary program. I chose to locate this program in the secondary high-resolution graphics page (HGR2) because it is not needed for the FAX display. The program can be relocated to run in any convenient location, however.

Let's examine screen addressing for a moment. The high-resolution screen has three symmetrical address divisions that I call "groups." These are each 64 lines long and have starting addresses of hexadecimal 2000, 2028, and 2050. Within each group there are eight "sets" of eight "rows" (or lines) each. Row addresses increment by hexadecimal 400 within each set, and set addresses increment by hexadecimal 80 within each group. This is the scheme the program follows in computing each new row address as the picture is drawn on the screen. There are probably more elegant ways of writing the program, so

(text continued on page 150)

Figure 1: A schematic diagram of the FAX Converter.

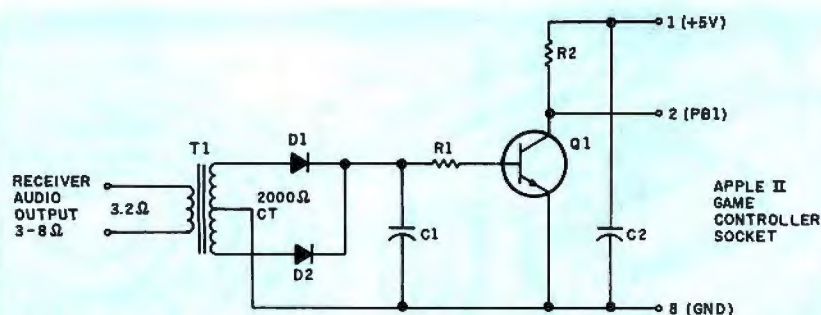

T1	Transistor-output transformer, 2000ΩCT/3.2Ω
D1, D2	Germanium diodes, 1N34 or equivalent
C1, C2	0.1 μF
R1	22,000 Ohms
R2	470 Ohms
Q1	2N4401, 2N3904, or similar type



GenTech

THIS MONTH'S SPECIALS

- NEC Spinwriter 3550 (IBM Codes) . . . \$1695
- BROTHER/DYNAX HR-25 . . . \$749
- EPSON FX-100. . . \$699
- STAR MICRONICS Delta-10 (160 CPS) . . \$419
- STAR MICRONICS Radix-10 (200 CPS) . \$599
- U.S. ROBOTICS Password Modem (1200 Baud) . . . \$349
- PGS Max-12 (12" Amber, For IBM) . . . \$189
- ROLAND MB-122A (12" Amber, IBM) . . \$175
- TANDON TM 100-2 (DSDD, For IBM) . . \$219
- TEAC 55B (ThinLine DSDD, IBM) . . . \$195
- FOURTH DIMENSION Super Drive (Apple) \$219
- GREAT LAKES 10 MB IBM Internal . . . \$1075
- OCS 10 MB External . . . \$1975
- TALLGRASS TECHNOLOGIES
 - 12 MB Hard Disk . . . \$Call
 - 20 MB Hard Disk . . . \$Call
- RANA ELITE I (Apple Compatible, 163K) . \$245
- RANA 1000 (For Atari) . . . \$309
- HERCULES Graphics Board For IBM-PC . \$349
- MA SYSTEMS PC Peacock . . . \$279
- ORCHID PC Network Kit . . . \$Call
- PLANTRONICS ColorPlus . . . \$419
- TECMAR
 - 1st Mate Board For IBM (No RAM) . . \$229
 - Graphics Master . . . \$519
- ORANGE MICRO
 - Buffered Grappler+ 16K/64K. . \$169/\$215
 - Grappler CD (Commodore) . . . \$105

CUSTOMER SERVICE & TECH. SUPPORT

401-273-2420

ORDERS ONLY

800-843-4302

150 Broadway, Suite 2212, N.Y. NY 10038

Money Order, Cashier's Ck, Personal Ck (3 Weeks to Clear)
 Add 3% MC/VISA, 5% AMEX Charge. Add 2% On COD Orders.
 APO Orders Add 6%. Add 3% For Net Terms.
 All Returned Non-Defective Merchandise Are Subject To 20%
 Restocking Charge.
 GenTech Reserves the Right to Change Advertised Prices.



COMPUTERS

- ALTOS**
586-20 Bus (8086, 512K, 5 Users,
XENIX/RT, 20 MB Hard Disk &
1 Floppy) . . . \$Call
- 986-40 Bus (9 Users, 42 MB) . . . \$Call
- COLUMBIA**
1600-1 (128K, 2 Drives) . . . \$Call
- 1600-4 (10 MB Hard Disk) . . . \$Call
- 1600-VP (Portable) . . . \$Call



- COMPUPRO All Models** . . . \$Call
- CORONA**
Desktop & Portable PC's . . . \$Call
- EABLE**
PC-Plus 2/PC-Plus XL . . . \$Call
- Spirit-2/Spirit-XL (Portables) . . \$Call
- FRANKLIN**
ACE 1000 w/ Color . . . \$799
- ACE PRO PLUS System . . . \$Call
- ACE 1000 PLUS FAMILY PAK . . . \$Call
- ACE 1200 (8602/Z608) . . . \$1399
- ACE OMS (2 Drives) . . . \$Call
- INTERTEC**
Head Start, CompuStar . . . \$Call
- MORROW DESIGNS**
MD2 (64K, 2 SSDD Drives, WordStar,
Correct-It, LogiCalc, etc.) . . \$1079
- MD3 (Same as Above except w/ 2 DSDD
Drives & QUEST Accounting) . . \$Call
- MD3P (Portable MD3, 10" Monitor) . \$Call
- MD11 (128K, 1 1/1 MB Hard Disk & 1 DSDD
Drive, Same Software as MD3) . . \$Call
- Multi-User DECISION Series . . . \$Call
- NEC PC-9201A (w/ 16K RAM)** . . . \$Call
- SANYO**
MBC 550 (IBM-Compatible, 8088, 128K,
1 SSDD Drive, WordStar, CalcStar,
EasyWriter) . . . \$799
- MBC 555 (550 Plus 1 Add. Drive,
MailMerge, SpellStar, InfoStar) . . \$Call
- SWP Micro Computer Products**
Co-Power-88 Board For Kaypro II & IV
(8088 w/ 256K) . . . \$Call
- TAVA IBM Look-Alike (128K, 2 Drives)** \$Call
- TELEVIDEO**
1605 (IBM Compatible, 8088, 128K, 2 Drives,
MS-DOS 2.0) . . . \$Call
- TPC-II (Portable Version of Above) . \$Call
- Multi-User Systems . . . \$Call

FOR IBM PC

- AST RESEARCH INC.**
MEGA PLUS II (64K, Ser & Ck) . . . \$289
- MEGAPAK 256K Module . . . \$309
- SIX PACK PLUS (64K, Ser/Par, Ck) . . \$279
- COMBO PLUS (64K, Ser/Par, Ck) . . \$279
- I/O PLUS II (Serial Port, Clock/Cal) . \$125
- **OPTIONS**
Each 64K Increment Is \$60.
Serial Port. . . \$45 Parallel Port. . \$45
Game Port. . . \$45
- QUADRAM**
EXPANDED QUADBOARD (S. P. Clock, Game)
64K . . . \$279 384K . . . \$529
- QUAD 512+ (Serial Port, Maximum 512K)
128K . . . \$289 256K . . . \$389
- QUADCOLOR I (Video Board) . . . \$209
- QUADLINK (6502 w/ 64K) . . . \$489
- MICROFAZER**
Parallel/Parallel
16K . . . \$139 64K . . . \$185 128K . \$239
- Serial/Serial, Serial/Parl, Parl/Serial
8K . . . \$145 16K . . . \$155 64K . \$209
- AMDEK MAI Board** . . . \$479
- CCS SuperVision (32 Column)** . . . \$599
- KEYTRONIC IBM Keyboard (5150)** . . \$199
- MA SYSTEMS PC Peacock (RGB &
Composite, Parallel Port)** . . . \$279

- MICROLOG Baby Blue (CP/M-80)** . . \$329
- STB SYSTEMS Graphix Plus** . . . \$349
- ** SPECIAL PRICES ON HERCULES, **
** TECMAR, MICROLOG (BABY BLUE) **
& PLANTRONICS PRODUCTS **

FOR APPLE II/IIe, Franklin Ace

- ALS CP/M Card** . . . \$289
- Smarterm II (80 Column Card) . . . \$135
- Printer Mate (Printer Card) . . . \$75
- EPD Surge Protectors . . . \$Call
- FOURTH DIMENSION 16K RAM Card** . \$49
- 80 Column Card w/ 64K (IIe Only) . \$159
- INTERACT, STRU, PKASO Universal** . \$125
- Shuffle Buffer (32K) . . . \$225
- KOALA TECH. Koala Pad** . . . \$89
- MICROSOFT Premium Softcard (IIe)** . \$289
- MICROTEK Dumping-16** . . . \$149
- ORANGE MICRO Grappler+** . . . \$119
- PROMETHEUS Graphitti** . . . \$85

HARD DISK



- CORVUS**

6 MB . . . \$1649	10 MB . . . \$1695
11 MB . . . \$Call	15 MB . . . \$2175
20 MB . . . \$Call	20 MB . . . \$2495
- CTI 11 MB Internal Hard Disk w/ 192K For
DEC Rainbow** . . . \$1995
- PEGASUS (GREAT LAKES)**
10 MB Internal For IBM . . . \$1059
- 23 MB External (w/ Controller) . . \$1799
- QCS 10 MB External w/ 5 MB Cartridge
Back-Up** . . . \$2895
- TECMAR Removable Cartridge Winchester
in PC (5 MB)** . . . \$1449

CALL FOR PRICES ON FOURTH
DIMENSION, FRANKLIN, CORONA, OCS,
QUADRAM, TALLGRASS & XCOMP

DOT MATRIX PRINTERS

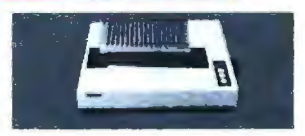

- ANADIX DP9625B (60 CPS NLO)** . . \$1199
- EPSON**
FX-80 . . . \$499 FX-100 . . . \$699
- RX-80 . . . \$299 RX-80 F/T . . \$379
- RX-100 . . \$529 LQ-1500 . . \$Call
- MANNESMANN TALLY**
MT 160L . . \$599 MT 180L . . \$829
- Spirit-80 . . \$319 1602 . . \$Call
- OKIDATA**
ML 92 . . . \$Call ML 93 . . . \$Call
- ML 84(P) . . \$Call Pacemark . . \$Call
- STAR MICRONICS**
Delta 10 . . \$419 Delta 15 . . \$569
- Radix 10 . . \$599 Radix 15 . . \$709
- DATASOUTH All Models** . . . \$Call
- PANASONIC KX-P1090** . . . \$299
- TOSHIBA P1340/1350** . . . \$809/\$1579
- TRANSTAR T315 Color Printer** . . . \$469

LETTER-QUALITY PRINTERS

- BROTHER/DYNAX**
DX-15 (13 CPS, Diablo Compat) . . . \$Call
- HR-25 (23 CPS, 3K Buffer) . . . \$749
- DAISYWRITER**
2000 EXP (25 CPS, 48K Buffer) . . . \$999
- DIABLO 630 ECS/IBM** . . . \$Call
- JUKI 6100 (17 CPS, Diablo Compat)** . \$Call
- NEC**
2030 . . . \$829 2050 . . . \$949
- 3515 . . . \$1475 3530 . . . \$1575

- QUME Sprint 1140/1155** . . . \$1345/\$Call
- LetterPro 20P . . . \$Call
- SILVER-REED**
EXP 550(P) . \$569 EXP 770(P) . \$899
- EXP 500(P) . \$419 EXP 500(S) . \$459
- TRANSTAR T120, T130 & T140** . . . \$Call

PLOTTERS

- AMDEK DXY-100, Amplot II** . . . \$Call
- ENTER COMPUTERS Sweet-P** . . . \$Call
- HOUSTON INSTRUMENTS**
DMP-40 . . . \$839 DMP-29 . . . \$1945
- DMP-41 . . . \$2495 DMP-42 . . \$2495
- MANNESMANN TALLY Pixy-3** . . . \$645
- ROLAND DXY-800 (11 x 17, 8 Pens)** . \$769
- STROBE M100/200/260** . . . \$Call

MONITORS



- AMDEK**
Video 300/300A/310A . . . \$139/149/169
- Color I+ . . . \$Call Color II+ . . \$449
- COMREX Color, Green, Amber** . . . \$Call
- GENTECH 9"/12" Green** . . . \$99/\$109
- PRINCETON GRAPHICS HX-12** . . . \$489
- SR-12 (690 x 480) . . . \$639
- ROLAND, SAKATA All Models** . . . \$Call
- TAXAN**
RGBvision 210 (380 x 262) . . . \$299
- RGBvision 420 (540 x 262) . . . \$499

TERMINALS



- LIBERTY Freedom 100/200** . . . \$Call
- QUME 102/102A** . . . \$559/\$579
- 103/108 . . . \$679/\$729
- TELEVIDEO All Models** . . . \$Call
- Personal Terminal (All Models) . . \$Call
- VISUAL All Models** . . . \$Call
- WYSE WY-75 (VT-100 Compat)** . . . \$839

MODEMS

- ANCHOR**
Mark VI (IBM) . . . \$189
- Mark XII . . . \$269
- HAYES**
Micromodem IIe (w/SmartCom I) . . \$239
- Smartmodem 300 . . . \$Call
- Smartmodem 1200 . . . \$Call
- Smartmodem 1200B (IBM) . . . \$439
- NOVATION**
Access 1-2-3 . . . \$Call
- J-Cat (Auto Orig/Answer, 300 Baud) . \$105
- Apple Cat II (300 Baud) . . . \$249
- 212 Apple Cat II (1200 Baud) . . . \$549
- 103 Smart Cat (300 Baud) . . . \$169
- 103/212 Smart Cat (1200 Baud) . . \$399
- TRANSEND (Formerly SSM)**
Modemcard w/ Source (For Apple) . \$239
- PC Modem Card 300 (For IBM) . . \$289
- U.S. ROBOTICS**
Password (1200 Baud) . . . \$349

SOFTWARE

- LOTUS 1-2-3** . . . \$349
- MBSI, STAR Accounting Software** . . \$Call
- MICROPRO WordStar (IBM, CP/M)** . \$319
- WordStar w/ Applicard (For Apple) . \$349
- PS WordPlus-PC w/ BOSS** . . . \$349
- SOFTWARE SYSTEMS Multimate** . . \$319
- SORCIM SuperCalc 3** . . . \$269

(text continued from page 148)

I offer this code simply as something that does the job.

In operation, the program sets starting addresses, waits one line, and then begins at "READ" by sampling the input flag on PBI. This appears as the highest bit of location hexadecimal

The high-res screen has three symmetrical address divisions called groups.

C061. The bit is rotated left into the carry flag and then right into buffer location hexadecimal 4F05. The bit delay, hexadecimal 08, between samples determines the percentage of each line that is displayed, choosing the proper aspect ratio as described earlier. This process continues until 7 bits have been rotated into the buffer. At this point, the carry bit is set and rotated into the buffer to complete the byte. Finally, the byte is written into the next computed screen location and displayed immediately. Note that the screen refresh circuitry is continually reading the entire block of memory that comprises the high-resolution graphics page, although this action is transparent to the user.

When all 40 (hexadecimal 28) bytes have been written, the row is complete. The program then waits before starting the next row. The wait time is critical to insure precise synchronism with the transmitted line rate. At the end of each group, the program examines the keyboard flag at hexadecimal C000 to see if a key has been pressed. If so, the display is halted. This feature allows the picture to be restarted from the beginning by pressing another key, or to be held until a second key is pressed. If the first key is pressed during the last group formation (at the bottom one-third of the screen), the full picture will be held. It can be stored on tape or disk by exiting the program and entering "BSAVE (filename if disk), AS2000, LS1FFF"

The video display shows about 20 percent of a map's width, and the 20 percent displayed comes up at random each time the program is initiated. The restart feature is useful in moving to the more interesting parts of the map. After the display is complete, the program immediately begins a new display by overwriting the old one from the top. The screen is not cleared because it is useful to visually "tack" the new section onto the old one for continuity.

Listing 1: The Facsimile driver program, written in 6502 assembly language.

```

SOURCE FILE: FAXT
4F00:          1 BITS      EQU  $4F00      ;BITS PER BYTE COUNTER.
4F05:          2 BUFF      EQU  $4F05      ;BUFFER TO FORM DISPLAY BYTE.
C061:          3 FLAG      EQU  $C061      ;INTERFACE INPUT ON PBI.
FCA8:          4 WAIT      EQU  $FCA8      ;MONITOR SR WAIT.
4F10:          5 ROW       EQU  $4F10      ;ROW COUNTER.
4F11:          6 SET       EQU  $4F11      ;SET COUNTER.
4F12:          7 GRP       EQU  $4F12      ;GROUP COUNTER.
4F13:          8 SADL      EQU  $4F13      ;STARTING ADDRESS
4F14:          9 SADH      EQU  $4F14      ;OF CURRENT SET.
4F15:         10 GADL      EQU  $4F15      ;STARTING ADDRESS
4F16:         11 GADH      EQU  $4F16      ;OF CURRENT GROUP.
C000:         12 KBD       EQU  $C000      ;MONITOR SR KBD.
C010:         13 KBDSTRB   EQU  $C010      ;MONITOR SR KBDSTRB.
----- NEXT OBJECT FILE NAME IS FAXT.OBJ0
4000:          14          ORG  $4000
4000:A9 08      15 START   LDA  #$08      ;START NEW PICTURE.
4002:8D 10 4F 16      STA  ROW      ;8 ROWS PER SET,
4005:8D 11 4F 17      STA  SET      ;8 SETS PER GROUP.
4008:A9 03      18      LDA  #$03      ;3 GROUPS PER PAGE
400A:8D 12 4F 19      STA  GRP      ;FOR THE DISPLAY.
400D:A9 00      20      LDA  #$00
400F:8D 13 4F 21      STA  SADL     ;SET LOW BYTE STARTING
4012:8D 15 4F 22      STA  GADL     ;ADDRESS FOR FIRST SET.
4015:8D 5D 40 23      STA  ADDL     ;GROUP AND ROW.
4018:A9 20      24      LDA  #$20
401A:8D 14 4F 25      STA  SADH     ;SET HIGH BYTE STARTING
401D:8D 16 4F 26      STA  GADH     ;ADDRESS FOR EACH SET.
4020:8D 5E 40 27      STA  ADDH     ;GROUP AND ROW.
4023:A9 00      28 INIT    LDA  #$00      ;START A NEW LINE AFTER DELAY.
4025:AA          29      TAX
4026:A9 29      30      LDA  #$29      ;:THIS COMBINATION OF WAIT
4028:20 A8 FC 31      JSR  WAIT     ;TIMES KEEPS DISPLAY ROWS
402B:A9 AA      32      LDA  #$AA      ;SYNCHRONIZED WITH SCAN
402D:20 A8 FC 33      JSR  WAIT     ;RATE OF FAX TRANSMISSIONS.
4030:A9 FF      34      LDA  #$FF      ;DELAYS CAN BE CHANGED TO
4032:20 A8 FC 35      JSR  WAIT     ;MATCH A PARTICULAR APPLE
4035:A9 FF      36      LDA  #$FF      ;CRYSTAL IF NECESSARY.)
4037:20 A8 FC 37      JSR  WAIT     ;DONE. READY FOR NEW ROW.
403A:A9 08      38 CHAR   LDA  #$08      ;SET BIT COUNTER FOR
403C:8D 00 4F 39      STA  BITS     ;SEVEN BITS PER BYTE.
403F:A9 00      40      LDA  #$00      ;CLEAR BUFFER FOR NEW
4041:8D 05 4F 41      STA  BUFF     ;BYTE STORAGE.
4044:AD 61 C0 42 READ  LDA  FLAG     ;READ INTERFACE INPUT AND
4047:2A          43      ROL  A        ;ROTATE INTO CARRY FLAG.
4048:6E 05 4F 44      ROR  BUFF     ;THEN INTO BUFFER.
404B:A9 08      45      LDA  #$08      ;WAIT BEFORE SAMPLING
404D:20 A8 FC 46      JSR  WAIT     ;INTERFACE AGAIN.
4050:CE 00 4F 47      DEC  BITS     ;BYTE COMPLETE? IF NOT,
4053:D0 EF      48      BNE  READ     ;TAKE ANOTHER SAMPLE.
4055:38          49      SEC          ;IF DONE, SET HIGH BIT
4056:6E 05 4F 50      ROR  BUFF     ;IN BUFFER, THEN
4059:AD 05 4F 51      LDA  BUFF     ;READ BYTE INTO A.
405C:9D          52      DFB  $9D      ;STORE BYTE FOR DISPLAY AT
405D:00          53 ADDL   DFB  $00      ;CURRENT SCREEN LOCATION WHICH
405E:20          54 ADDH   DFB  $20      ;WILL BE UPDATED LATER.
405F:E8          55      INX          ;COUNT OFF BYTE AND
4060:8A          56      TXA          ;CHECK TO SEE IF
4061:18          57      CLC          ;DISPLAY IS AT
4062:E9 27      58      SBC  #$27      ;END OF ROW? IF NOT,
4064:D0 D4      59      BNE  CHAR     ;CONTINUE.
4066:CE 10 4F 60      DEC  ROW      ;ONE MORE ROW DONE.
4069:F0 0C      61      BEQ  SETCHK    ;SEE IF AT END OF SET.
406B:AD 5E 40 62      LDA  ADDH     ;IF NOT, ADD $400 FOR NEXT
406E:18          63      CLC          ;ROW STARTING ADDRESS
406F:69 04      64      ADC  #$04      ;WITHIN SET AND PREPARE
4071:8D 5E 40 65      STA  ADDH     ;FOR NEXT ROW.
4074:4C 23 40 66      JMP  INIT     ;HERE WE GO - NEXT ROW.
4077:CE 11 4F 67 SETCHK DEC  SET      ;END OF SET? IF SO, CHECK
407A:F0 22      68      BEQ  GRPCHK    ;FOR END OF GROUP.
407C:AD 13 4F 69      LDA  SADL     ;IF NOT, FORM NEW ROW LOW
407F:18          70      CLC          ;STARTING ADDRESS BY
4080:69 80      71      ADC  #$80      ;ADDING $80.
4082:8D 5D 40 72      STA  ADDL     ;STORE FOR OUTPUT AND
4085:8D 13 4F 73      STA  SADL     ;UPDATE SET ADDRESS.

```



```

4088:AD 14 4F 74 LDA SADH :DO SAME FOR HIGH BYTE.
408B:90 03 75 BCC NEWSAD :DON'T FORGET TO BRING IN
408D:18 76 CLC :A POSSIBLE CARRY
408E:69 01 77 ADC #S01 :FROM LOW BYTE ADDITION.
4090:8D 14 4F 78 NEWSAD STA SADH :STORE BASE AND CURRENT
4093:8D 5E 40 79 STA ADDH :SET ADDRESS HIGH BYTE.
4096:A9 08 80 LDA #S08 :RESET ROW COUNTER
4098:8D 10 4F 81 STA ROW :AND
409B:4C 23 40 82 JMP INIT :HERE WE GO - NEXT SET.
409E:CE 12 4F 83 GRPCHK DEC GRP :END OF PICTURE? IF NOT.
40A1:D0 16 84 BNE ZERO :GO DO RESETS.
40A3:AD 00 C0 85 LDA KBD :DID THE BOSS PRESS A KEY?
40A6:30 03 86 BMI HOLD :YES. HOLD THE PHONE.
40A8:4C 00 40 87 JMP START :NO. START ANOTHER GROUP.
40AB:AD 10 C0 88 HOLD LDA KBDSTRB :NOW WAIT FOR HIM TO
40AE:AD 00 C0 89 LOOP LDA KBD :PUSH ANOTHER KEY.
40B1:10 FB 90 BPL LOOP :NOT YET.
40B3:AD 10 C0 91 LDA KBDSTRB :OK. WE'RE OFF AGAIN TO
40B6:4C 00 40 92 JMP START :START A NEW PICTURE.
40B9:AD 15 4F 93 ZERO LDA GADL :FORM NEW LOW BYTE GROUP
40BC:18 94 CLC :STARTING ADDRESS BY
40BD:69 28 95 ADC #S28 :ADDING S28.
40BF:8D 15 4F 96 STA GADL :STORE FOR BASE GROUP.
40C2:8D 13 4F 97 STA SADL :SET AND
40C5:8D 5D 40 98 STA ADDL :ROW ADDRESS.
40C8:AD 16 4F 99 LDA GADH :DO SAME FOR HIGH BYTE.
40CB:90 03 100 BCC NEWGAD :REMEMBERING TO BRING IN
40CD:18 101 CLC :A POSSIBLE CARRY FROM
40CE:69 01 102 ADC #S01 :LOW BYTE ADDITION.
40D0:8D 16 4F 103 NEWGAD STA GADH :STORE ALL THE HIGH BYTE
40D3:8D 14 4F 104 STA SADH :STARTING ADDRESSES
40D6:8D 5E 40 105 STA ADDH :AS ABOVE.
40D9:A9 08 106 LDA #S08
40DB:8D 10 4F 107 STA ROW :RESET ROW AND
40DE:8D 11 4F 108 STA SET :SET COUNTERS.
40E1:AD 00 C0 109 LDA KBD :ARE WE ON HOLD?
40E4:30 C5 110 BMI HOLD :YES. HOLD THE PHONE.
40E6:4C 23 40 111 JMP INIT :NO. START A NEW GROUP.
40E9:00 112 BRK

```

*** SUCCESSFUL ASSEMBLY: NO ERRORS

```

405E ADDH      405D ADDL      4F00 BITS      4F05 BUFF
403A CHAR     C061 FLAG     4F16 GADH     4F15 GADL
409E GRPCHK   4F12 GRP      40AB HOLD    4023 INIT
C000 KBD      C010 KBDSTRB  40AE LOOP    40D0 NEWGAD
4090 NEWSAD   4044 READ     4F10 ROW     4F14 SADH
4F13 SADL     4077 SETCHK   4F11 SET     4000 START
FCA8 WAIT     40B9 ZERO     4000 START   4023 INIT
403A CHAR     4044 READ
405D ADDL     405E ADDH     4077 SETCHK  4090 NEWSAD
409E GRPCHK   40AB HOLD     40AE LOOP    40B9 ZERO
40D0 NEWGAD   4F00 BITS     4F05 BUFF    4F10 ROW
4F11 SET      4F12 GRP      4F13 SADL    4F14 SADH
4F15 GADL     4F16 GADH     C000 KBD     C010 KBDSTRB
C061 FLAG     FCA8 WAIT

```

Listing 2: A BASIC program to load the Facsimile machine driver.

```

100 D$ = CHR$(4)
110 PRINT D$;"BLOAD FAXT.OBJO"
120 HGR
130 POKE 49234,0
140 CALL 16384

```

This program resulted in part from a desire to learn more about the Apple video display and to produce something useful in the process.

RECEPTION

FAX weather maps are transmitted on numerous frequencies from many different locations worldwide. Among

Signals can arrive from different paths and may augment or interfere with each other.

these are Washington, DC; Honolulu, HI; Bracknell, England; Guam; Tokyo, Japan; Canberra, Australia; Halifax, Canada; and Moscow, USSR. At my location transmissions from Washington are the most reliable (on frequencies of 3356 kHz, 4975 kHz, 8080 kHz, and 10,865 kHz). Many other frequencies and locations are available, however. A communications-type receiver with a beat-frequency oscillator (BFO) is required for reception. While a picture is being transmitted, the signal will sound like a short tone burst followed by a "skritch" sound. This is repeated twice each second. The tone burst should be tuned to zero beat so only the "skritch" is heard. A single sideband receiver is preferred but not essential.

THE FICKLE IONOSPHERE

Reception quality can be highly variable. Long-range radio reception depends on signal reflection from the ionosphere, and the density and height of the ionized layers can change rapidly. Signals can arrive from several different paths and may augment or interfere with each other. Multipath reception is often accompanied by differential time delays in transmission. The result is a smearing of horizontal details or the appearance of echo lines. Atmospheric or man-made electrical disturbances can also degrade picture quality. I mention these effects not to discourage the reader but, rather, to suggest that an element of uncertainty can add spice to the otherwise orderly world of digital computing. ■

References

1. Grove, Robert B. *Confidential Frequency List*. Park Ridge, NJ: Gilfer Associates Inc., pages 68-71.
2. Luebbert, William F. *What's Where in the Apple?* Chelmsford, MA: Micro Ink Inc., pages 12-14.

VCN EXECUVISIONTM

The Presentation Graphics Program from Prentice-Hall, Inc.TM



How you present your message is just as important as what you present in today's competitive environment. That's why so many executives, managers, salespeople, and professionals in every field, from doctors to attorneys... teachers to architects are relying more and more on visual presentations to convey their complex ideas and information.

Now there is an incredibly advanced software program that will allow you to create professional quality graphic presentations right on your IBM PC or IBM XT. VCN ExecuVision, from the Business and Professional Division of Prentice-Hall, brings the power of a complete graphic arts department to your computer. *In minutes*, you can create exciting presentations that previously would have taken days, or weeks, for an art department to complete. Presentations that you can run directly on your computer monitor or with an overhead projection screen...or convert to hard copy or slides.

VCN ExecuVision is the ideal tool for meetings, new business proposals, consulting symposia, educational/training programs, marketing plans, management reports, or virtually any other professional presentation.

Automatically plotted charts and graphs are just the beginning. You'll have access to hundreds of *pre-drawn* images and clip art from special add-on graphics libraries created specifically to add visual impact.

- Graphically frame your most important ideas and information with artwork from the *The Border Collection*.
- Use *The Initials & Decorative Design Collection* to emphasize key words or phrases in your text.
- From production lines to executive suites...there's an ideal visual to enhance your report or proposal data in *The Industry &*

Business Collection.

- Add the human touch to presentations by including representations of people from *Professions: The Faces and Figures Collection*.
- Images from all over the world are at your fingertips in the *International Symbols & Landmarks Collection*.
- Give your data geographic perspective and impact with images from *The Maps and Regions Collection*.

Each library contains both full screen images and partial screens (pixes). You can use the entire image, or, with the electronic CUT AND PASTE program function, use just a detail from the full screen. You can modify or enhance the images, mix and match them, choose from 64 possible color combinations... you can even set the images in motion across the screen using VCN ExecuVision's animation functions.

With the program's sketching capabilities, you can create your own visual images! For your text, choose from 10 different type styles, from bold to italic, plain to fancy.

Best of all, you don't have to be an artist to use VCN ExecuVision successfully. Every function is offered in a series of easy to follow menus. VCN ExecuVision also comes with a tutorial disk and an extremely easy-to-follow full-color manual that will take you step by step through the program.

VCN ExecuVision can immediately be put to use making all of your information and ideas—and you!—look sharper, more prepared, and more professional.

For a demonstration of VCN ExecuVision, visit your nearest computer software dealer. For more information, call toll-free 800-624-0023 (NJ residents call 800-624-0024), or return the coupon on the facing page.

MS DOS 2.0/2.1 VERSION
NOW AVAILABLE



"...Prentice-Hall's VCN ExecuVision will become the standard against which other programs will be gauged."
—PC Magazine



THE LINE & HOOK MOVE DOWN WHEN THIS SLIDE IS RUN →

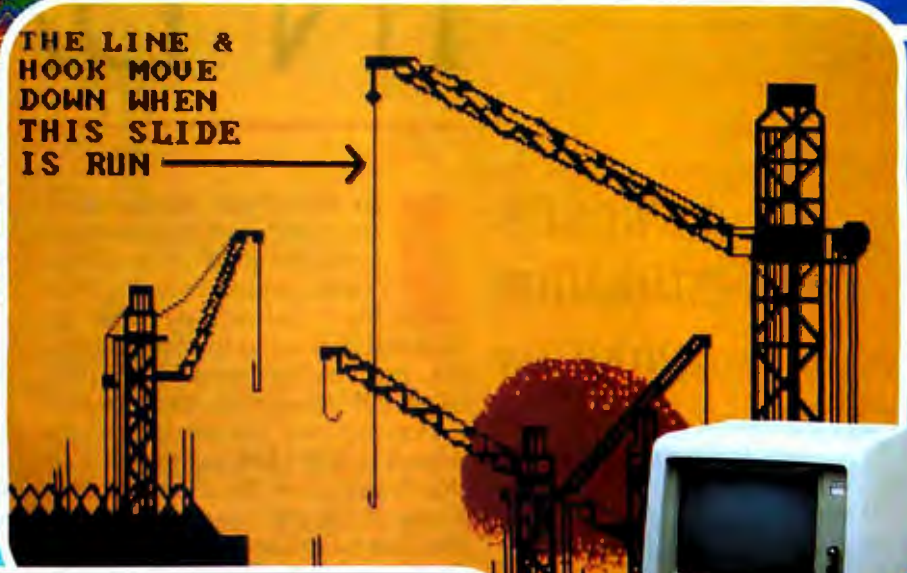

ABOVE: just two of the library slides from which you can pick images to enhance your presentation data.



THE LINES OF COMMUNICATION

PROJECTED INCREASE IN SERVICE OPTIONS



Designed for IBM PC and IBM XT

BYTE-6/84-C11

"You don't have to be an artist to create presentation slides like these in minutes!"

Suggested retail price \$395. Graphics Libraries individually priced \$80-\$90.

VCN ExecuVision is a trademark of Visual Communications Network, Inc., Cambridge, MA.
IBM is the registered trademark of International Business Machine Corporation, © 1984 Prentice-Hall, Inc.
Canadian inquiries: write to Prentice-Hall Canada, Inc., 1870 Birchmount Road, Scarborough, Ontario M1P2J7

Circle 264 on Inquiry card.

Mail to:
VCN
ExecuVision
Prentice-Hall, Inc.
200 Old Tappan Road,
Old Tappan, N.J. 07675
I would like to have more information on the exciting potential of VCN ExecuVision sent to the name and address below.
Name _____
Address _____
City _____
State _____
Zip _____

SPREADSHEET IN BASIC

An architect's cost-estimation program

BY RODOLFO CERATI

I am an architect, and as such I often need to estimate building costs. One good way to do this is with a spreadsheet. The trouble is, cost estimates often require several hundred spreadsheet cells, but my CalcStar spreadsheet only allows 295. To eliminate this limitation I wrote my own cost-estimation program, ESTIMATE.BAS, but I wrote it so that it would look like and be as easy to use as CalcStar. Specifically, it uses the same cursor-control codes, instantly recalculates values, saves and recalls spreadsheet values on disk, and interfaces with a database.

I wrote the program in Microsoft BASIC-80, so it should be easily ported to other CP/M-80 computers. I also grouped the screen-handling functions in a series of subroutines so you can easily change them to match your screen's requirements. Finally, I included the ability to interface with a database program that I've written.

To run the program, you'll need: a microcomputer with a Z80 microprocessor and at least 56K bytes of memory, the CP/M 2.2 operating system, Microsoft's BASIC-80 interpreter, and a terminal with a directly addressable cursor, a clear-screen command, a back-space-and-character-delete command, and an erase-to-end-of-line command. A reduced intensity character display comes in handy, too.

USING ESTIMATE.BAS

Once you've typed the program in, save it and type RUN. You'll see a menu that looks like this:

B=build up a new estimate
E=edit an existing estimate

S=save values on disk
R=read values from disk
L=load another program
ESC=exit

Let's suppose that you type E to edit an existing estimate. You would then see a spreadsheet something like the one in figure 1. To move from cell to cell in this spreadsheet, you use the same control codes that you would use for cursor movement in WordStar. The current cell is indicated by angle brackets (><). Unlike other spreadsheets, though, my spreadsheet will not let you place just any kind of information in the cells. Instead, you are limited to entering the type of information called for in the column headings. For instance, you may only enter names under "Job type" and numbers under "Unit cost"; you may not enter formulas in any of the cells. Whenever you enter new numbers under "Unit cost" and "Quantity" and type the proper command, the program recalculates the percentages in the last column and the total value in the "Total value" row. If you want to add or delete rows, jump to a different page of the spreadsheet, or print the spreadsheet, type a semicolon and capital H (;H) for a list of the proper commands.

The other items in the menu are self-explanatory.

PROGRAM NOTES

I've included many remark statements in my program (see listing 1), but a few more words will help, I'm sure. The program is built around a two-dimensional array—ARRS—that contains the contents of each cell. The array is dimensioned for 100 rows by 7 columns. Four one-dimensional arrays—TP%, L%, PO%, and

MSK%—hold the screen-display and formatting parameters. Array TP% tells whether the cell is alphabetic or numeric, array L% tells the length of each column, array PO% tells the screen position of each cell in the spreadsheet, and array MSK% contains the strings used by the PRINT USING statements for formatting purposes.

The variables VMIN%, P%, VMAX%, PS%, SCR%, HZ%, and VP% contain the absolute position of the current cell in the main array and its relative position on the screen.

The program is sectioned into many subroutines to simplify programming and debugging. The most often used subroutines are at the start of the program to minimize the time the BASIC interpreter has to spend looking for them. The initialization and main menu subroutines are at the end.

The program occupies 15K bytes of disk space in compressed form and 18K bytes in ASCII (American National Standard Code for Information Interchange) form. If you want to save space, you can delete all of the remark statements, which are indicated with an apostrophe.

To adapt the program to other computer terminals, you only need to change the CRT (cathode-ray tube) routines in lines 60000 and 60020. If your terminal doesn't support reduced intensity, you can use reverse video instead. Or just place a null string (" ") in variables WS(2) and WS(3).

To change the total number of cells in the main array, change MAX% in line 60060. To change the number of rows that are displayed, change the variables in line 60100. Finally, to change the screen-formatting parameters, change the DATA statements beginning in line 60220.

By now you have probably noticed that my program is not as flexible as CalcStar. It is, in fact, very specialized, but it has the same ease of data entry and display that commercial spreadsheets have. I've eliminated the flexibility of commercial programs in favor of a larger data capacity and a more compact program. I'm sure that you could adapt this program to your own purposes, especially if your applications are too large for conventional spreadsheets.

I can provide a copy of the program on disk in North Star double-density format for a nominal fee. Please write to me for details. ■

Rodolfo Cerati |Piazza Europa 26, 12100 Cuneo, Italy| is part owner of S & R Cerati Architects.

#	Code	Job type	u.m.	Unit cost	Quantity	Amount	%
1-	A/01	Excavations	m3	1.50	1,950.00	2,925.00	1.3
2-	B/01	Found. concrete	m3	14.50	130.00	1,885.00	0.8
3-	F/01	Steel bars	Kg	0.40	40,800.00	16,320.00	7.2
4-	S/03	R.concr. slabs	m2	25.50	2,780.00	70,890.00	31.5
5-	H/12	Exterior masonry	m2	28.50	1,350.00	38,475.00	17.1
6-	H/04	Int. walls (1)	m2	4.50	2,050.00	9,225.00	4.1
7-	H/02	Int. walls (2)	m2	6.75	385.00	2,498.75	1.2
8-	G/10	Plaster	m2	5.25	7,450.00	39,112.50	17.4
9-	L/01	Ext. finish	m2	6.50	1,850.00	12,025.00	5.3
10-	L/02	>Int. finish	<m2	2.50	6,200.00	15,500.00	4.5
11-	M/01	Marble floors	m2	52.50	195.00	10,237.50	4.5
12-	M/03	Synt. floors	m2	28.25	215.00	6,073.00	2.7
13-							
14-							
Total value						225,267.50	
type :		text	order :	L-R	Col.:	2	Row : 10
contents :		Int. finish					
edit :		_____					

Figure 1: An example of a fictitious estimate spreadsheet. The cursor is at column 2 and row 10. The unit abbreviations are cubic meters (m3), kilograms (Kg), and square meters (m2).

Listing 1: ESTIMATE.BAS, a construction-costs estimate program with a spreadsheet-like data entry and display.

```

1 *          #####
2 *          ESTIMATE.BAS
3 *          #####
4 *
5 *          Construction costs estimating program
6 *          © 1983 — Rodolfo Cerati, Architect
7 *          Piazza Europa 26, 12100 Cuneo, Italy
8 *          Version 2.0 — date : June 13th, 1983
9 *
10 GOTO 60000: <—Jump to initialization routine
85 *
86 *          #####
87 *          Often used subroutines (lines 100–950)
88 *          #####
96 *
97 * Print formatted value on screen
100 IF TP%(I%) THEN T=VAL(ARRS(I%,J%)):PRINT FNCS(PO%(I%),PS%)USING MSKS(J%):T:
    ELSE PRINT FNCS(PO%(I%),PS%)USING MSKS(J%):ARRS(I%,J%):
120 RETURN
248 *
249 * Clear partial screen
250 FOR T%=1 TO GAP%:PRINT FNCS(O.T%+OFS%–1)WS(1):NEXT T%:RETURN
298 *
299 * Calculate absolute row value in array (P%)
300 P%=VP%–(OFS%–1)+SCR%*GAP%:IF P%>MAX% THEN P%=MAX%:RETURN ELSE
    RETURN
318 *
319 * Calculate position on screen
320 PS%=P%+OFS%–1–SCR%*GAP%:RETURN
348 *
349 * Calculate bottom limit for screen display
350 VMAX%=VMIN%+GAP%–1:IF VMAX%>MAX% THEN VMAX%=MAX%
360 RETURN
396 *
397 * Backspace one character
400 IF LEN(D$)=0 THEN RETURN ELSE PRINT CHR$(8)""CHR$(8):
420 IF LEN(D$)=1 THEN D$=""":RETURN ELSE D$=LEFT$(D$,LEN(D$)–1):RETURN
697 *
698 * Get line

```

(listing continued on page 156)

We make C easy...



and work!

Eco-C compiler...we've got it all.

Whether you're a seasoned professional or just getting started in C, the Ecosoft C compiler has everything you'll ever need.

COMPLETENESS:

Our Eco-C compiler is a complete implementation of C and supports all operators and data types (including long, float and double).

EFFICIENCY:

The compiler generates extremely efficient Z80 code using Zilog's mnemonics. On the benchmarks tested, typically we finished either first or second using substantially less generated code.

PORTABILITY:

The Eco-C library contains over 100 functions that are UNIX V7 compatible, and includes a complete transcendental package. Programs developed with the Eco-C compiler can be moved to virtually any system with little or no change.

EASE OF USE:

The Eco-C compiler includes Microsoft's MACRO 80 assembler, linker, library manager and supporting documentation. The assembler (M80) generates industry-standard REL file output. The linker (L80) is fast and uses only the functions you request in the program. Program development is a snap.

The user's manual is clear, concise and full of useful information. For those of you just getting started with C, we also include a copy of the C Programming Guide (Que). This B. Dalton Best Seller has been adopted by a number of leading universities around the country and is included with each compiler. The book is designed to help you learn C from the ground up. We ought to know...we wrote the book.

We've made the compiler easy to work with for the professional and beginner alike. Most error messages, for example, tell you in English (not just a number) the line number and character position of the error, what was expected and a page reference to the Guide to consult for help if you need it.

PRICE:

We saved the best for last; we've cut the price by \$100.00. Now you can buy the Eco-C compiler for only \$250.00 (MACRO 80 and the book alone are worth \$218.00!). Shop around and we think you agree that the Eco-C compiler is the best value available.

The Eco-C compiler requires a Z80 CPU, CP/M, 54K of free memory and about 240K of disk space (one or two drives). An IBM-PC version will be available in the first quarter of 84. To order your Eco-C compiler, call or write.

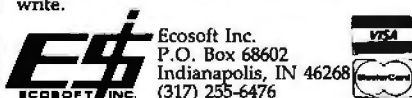

TRADEMARKS:
Eco-C (Ecosoft), MACRO 80 (Microsoft), CP/M (Digital Research)

SPREADSHEET

(listing continued from page 155)

```

700 LINE INPUT;" ":CS:PRINT CHR$(13)::RETURN
709 ' get single character and echo it on screen
710 GOSUB 730:IF T%=13 OR T%>31 THEN PRINT CS:CHR$(13)::RETURN ELSE PRINT""
      +CHR$(T%+64)CHR$(13)::RETURN
729 ' as above, but no echo
730 CS=INPUTS(1):T%=ASC(CS):RETURN
747 '
748 ' Waiting message
750 GOSUB 950:PRINT"Wait "WS(3)::RETURN
897 '
898 ' delete status line
900 PRINT FNCS(0.0)WS(1)::RETURN
947 '
948 ' Display program prompt
950 GOSUB 900:PRINT FNCS(0.0) "WS(2)::RETURN
995 '
996 ' #####
997 ' Print array
998 ' #####
999 '
1000 GOSUB 350:FOR I%=VMIN% TO VMAX%:PS%=I%+(OFS%-1)-SCR%*CAP%:
      PRINT FNCS(PO(1).PS%)USING MSKS(1):VAL(ARRS(I%.1)):
1020 IF ARRS(I%.2)<>" "THEN FOR J%=1 TO NN%:GOSUB 100:NEXT:PRINT
1040 NEXT:RETURN
1295 '
1296 ' #####
1297 ' Print single item & recalculate total
1298 ' #####
1299 '
1300 GOSUB 300:GOSUB 320:IF HZ%>4 THEN T#=VAL(ARRS(P%.NN%))
1320 ARRS(P%.HZ%)=DS:I%=P%:J%=HZ%:GOSUB 100:IF HZ%<5 THEN RETURN ELSE IF
      HZ%=7 THEN 1360
1340 TI#=VAL(ARRS(P%.NN%-2))*VAL(ARRS(P%.NN%-1)):ARRS(P%.NN%)=RIGHT$(STRS
      (TI#).LEN(STRS(TI#))-1):J%=NN%:GOSUB 100
1360 TOT#=TOT#+VAL(ARRS(P%.NN%))-T#:GOSUB 1600:RETURN
1395 '
1396 ' #####
1397 ' Print top title
1398 ' #####
1399 '
1400 PRINT FNCS(0.1)T1$ FNCS(0.2)T2$:RETURN
1495 '
1496 ' #####
1497 ' Print title for total
1498 ' #####
1499 '
1500 PRINT FNCS(0.17)STRING$(79.45)FNCS(0.18)"Total ----->>>"WS(1):GOSUB
      1600:RETURN
1595 '
1596 ' #####
1597 ' Print total value
1598 ' #####
1599 '
1600 PRINT FNCS(PO(7).18)USING MSKS(7):TOT#:RETURN
1795 '
1796 ' #####
1797 ' Print informations at bottom of CRT screen
1798 ' using Micropro's Calcstar conventions
1799 ' #####
1800 PRINT FNCS(0.19)STRING$(78.45)FNCS(0.20)WS(1)FNCS(15.20)"type : "FNCS(0.21)WS(1)
      FNCS(11.21)"contents : "FNCS(0.22)WS(1)FNCS(15.22)"edit : "
1820 PRINT FNCS(35.20)WS(2)"order : "":IF RD% THEN PRINT" T=B" ELSE PRINT"L=R"
1840 PRINT FNCS(50.20)"Col. "FNCS(65.20)"Row : "WS(3):RETURN
1845 '
1846 ' #####
1847 ' 2nd cursor routines
1848 ' #####
1849 ' display 2nd cursor, i.e. brackets
    
```

(listing continued on page 457)

THE FORTH SOURCE™

MVP-FORTH

Stable - Transportable - Public Domain - Tools

You need two primary features in a software development package . . . a stable operating system and the ability to move programs easily and quickly to a variety of computers. MVP-FORTH gives you both these features and many extras. This public domain product includes an editor, FORTH assembler, tools, utilities and the vocabulary for the best selling book "Starting FORTH". The Programmer's Kit provides a complete FORTH for a number of computers. Other MVP-FORTH products will simplify the development of your applications.

MVP Books - A Series

- Volume 1, All about FORTH** by Haydon. MVP-FORTH glossary with cross references to fig-FORTH, Starting FORTH and FORTH-79 Standard. 2nd Ed. \$25
- Volume 2, MVP-FORTH Assembly Source Code.** Includes CP/M®, IBM-PC®, and APPLE® listing for kernel \$20
- Volume 3, Floating Point Glossary** by Springer \$10
- Volume 4, Expert System** with source code by Park \$25
- Volume 5, File Management System** with interrupt security by Moreton \$25

MVP-FORTH Software - A Transportable FORTH

- MVP-FORTH Programmer's Kit** including disk, documentation, Volumes 1 & 2 of MVP-FORTH Series (All About FORTH, 2nd Ed. & Assembly Source Code), and Starting FORTH. Specify CP/M, CP/M 86, CP/M+, APPLE, IBM PC, MS-DOS, Osborne, Kaypro, H89/Z89, Z100, TI-PC, MicroDecisions, Northstar, Compuro, Cromenco, DEC Rainbow, NEC 8201, TRS-80/100 \$150
- MVP-FORTH Cross Compiler** for CP/M Programmer's Kit. Generates headerless code for ROM or target CPU \$300
- MVP-FORTH Meta Compiler** for CP/M Programmer's kit. Use for applications on CP/M based computer. Includes public domain source \$150
- MVP-FORTH Fast Floating Point** Includes 9511 math chip on board with disks, documentation and enhanced virtual MVP-FORTH for Apple II, II+, and Ile. \$450
- MVP-FORTH Programming Aids** for CP/M, IBM or APPLE Programmer's Kit. Extremely useful tool for decompiling, callfinding, and translating. \$200
- MVP-FORTH PADS (Professional Application Development System)** for IBM PC, XT or PCjr or Apple II, II+ or Ile. An integrated system for customizing your FORTH programs and applications. The editor includes a bi-directional string search and is a word processor specially designed for fast development. PADS has almost triple the compile speed of most FORTH's and provides fast debugging techniques. Minimum size target systems are easy with or without heads. Virtual overlays can be compiled in object code. PADS is a true professional development system. Specify Computer. \$500
- MVP-FORTH Floating Point & Matrix Math** for IBM or Apple \$85
- MVP-FORTH Graphics Extension** for IBM or Apple \$65
- MVP-FORTH MS-DOS file interface** for IBM PC PADS \$80
- MVP-FORTH Expert System** for development of knowledge-based programs for Apple, IBM, or CP/M. \$100

FORTH CROSS COMPILERS Allow extending, modifying and compiling for speed and memory savings, can also produce ROMable code. Specify CP/M, 8086, 68000, IBM, Z80, or Apple II, II+ \$300

FORTH COMPUTER

- Jupiter Ace** \$150

Ordering Information: Check, Money Order (payable to MOUNTAIN VIEW PRESS, INC.), VISA, MasterCard, American Express. COD's \$5 extra. Minimum order \$15. No billing or unpaid PO's. California residents add sales tax. Shipping costs in US included in price. Foreign orders, pay in US funds on US bank, include for handling and shipping by Air: \$5 for each item under \$25, \$10 for each item between \$25 and \$99 and \$20 for each item over \$100. All prices and products subject to change or withdrawal without notice. Single system and/or single user license agreement required on some products.

FORTH DISKS

FORTH with editor, assembler, and manual.

- APPLE** by MM, 83 \$100
- APPLE** by Kuntze \$90
- ATARI®** valFORTH \$60
- CP/M®** by MM, 83 \$100
- HP-85** by Lange \$90
- HP-75** by Cassidy \$150
- IBM-PC®** by LM, 83 \$100
- NOVA** by CCI 8" DS/DD \$175
- Z80** by LM, 83 \$100
- 8086/88** by LM, 83 \$100
- 68000** by LM, 83 \$250
- VIC FORTH** by HES, VIC20 cartridge \$50
- C64** by HES Commodore 64 cartridge \$60
- Timex** by HW \$25

Enhanced FORTH with: F-Floating Point, G-Graphics, T-Tutorial, S-Stand Alone, M-Math Chip Support, MT-Multi-Tasking, X-Other Extras, 79-FORTH-79, 83-FORTH-83.

- APPLE** by MM, F, G, & 83 \$160
- ATARI** by PNS, F,G, & X. \$90
- CP/M** by MM, F & 83 \$160
- Apple, GraFORTH** by I \$75
- Multi-Tasking FORTH** by SL, CP/M, X & 79 \$395
- TRS-80/II or III** by MMS F, X, & 79 \$130
- Timex** by FD, tape G,X, & 79 \$45
- Victor 9000** by DE,G,X \$150
- C64** by ParSec. MVP, F, G & X \$96
- FDOS** for Atari FORTH's \$40
- Extensions** for LM Specify IBM, Z80, or 8086
 - Software Floating Point \$100
 - 8087 Support (IBM-PC or 8086) \$100
 - 9511 Support (Z80 or 8086) \$100
 - Color Graphics (IBM-PC) \$100
 - Data Base Management \$200
- fig-FORTH Programming Aids** for decompiling, callfinding, and translating. CP/M, IBM-PC, Z80, or Apple \$200

FORTH MANUALS, GUIDES & DOCUMENTS

- ALL ABOUT FORTH** by Haydon. See above. \$25
- FORTH Encyclopedia** by Derick & Baker \$25
- The Complete FORTH** by Winfield \$16
- Understanding FORTH** by Reymann \$3
- FORTH Fundamentals, Vol. I** by McCabe \$16
- FORTH Fundamentals, Vol. II** by McCabe \$13
- FORTH Tools, Vol.1** by Anderson & Tracy \$20
- Beginning FORTH** by Chirlian \$17
- FORTH Encyclopedia Pocket Guide** \$7
- And So FORTH** by Huang. A college level text. \$25
- FORTH Programming** by Scanlon \$17
- FORTH on the ATARI** by E. Floegel \$8
- Starting FORTH** by Brodie. Best instructional manual available. (soft cover) \$18
- Starting FORTH** (hard cover) \$23
- 68000 fig-Forth** with assembler \$20
- Jupiter ACE Manual** by Vickers \$15
- 1980 FORML Proc.** \$25
- 1981 FORML Proc 2 Vol** \$40
- 1982 FORML Proc.** \$25
- 1981 Rochester FORTH Proc.** \$25
- 1982 Rochester FORTH Proc.** \$25
- 1983 Rochester FORTH Proc.** \$25
- A Bibliography of FORTH References, 1st. Ed.** \$15
- The Journal of FORTH Application & Research Vol. 1, No. 1** \$20
- A FORTH Primer** \$25
- Threaded Interpretive Languages** \$23
- META-FORTH** by Cassidy \$30
- Systems Guide to fig-FORTH** \$25
- Invitation to FORTH** \$20
- PDP-11 User Man.** \$20
- FORTH-83 Standard** \$15
- FORTH-79 Standard** \$15
- FORTH-79 Standard Conversion** \$10
- Tiny Pascal fig-FORTH** \$10
- NOVA fig-FORTH** by CCI Source Listing \$25
- NOVA** by CCI User's Manual \$25
- Installation Manual for fig-FORTH, Source Listings of fig-FORTH,** for specific CPU's and computers. The Installation Manual is required for implementation. Each \$15
 - 1802 6502 6800 AlphaMicro
 - 8080 8086/88 9900 APPLE II
 - PACE 6809 NOVA PDP-11/LSI-11
 - 68000 Eclipse VAX Z80 IBM

MOUNTAIN VIEW PRESS, INC.

PO BOX 4656

MOUNTAIN VIEW, CA 94040

(415) 961-4103

Now you can instantly make 35mm slides

Introducing the Polaroid Palette. It lets you make color 35mm slides or prints from your personal computer. In-house. Instantly.

Now you can incorporate the latest personal computer-generated data into your next presentation. Priced at under \$1500,* the Polaroid Palette Computer Image Recorder lets you make instant 35mm slides or prints. Right at your desk. You'll no longer need

to compromise time, money or security using outside suppliers to produce slides for in-house presentations.

Works with the IBM PC or XT, DEC Rainbow, Apple IIe and Apple II+.

Since the Palette links directly with your computer's software, the slides you make can be of much higher quality than what is displayed on your video monitor. The Palette can "backfill" digital data to give

your slides a smoother, more finished appearance.

Works with your graphics package.

The Polaroid Palette is designed to be compatible with many graphics software packages. In fact, when using such popular programs as Graphwriter, Chart-Master, Sign-Master, DR Draw and DR Graph, the Palette can virtually double the resolution of your monitor. The result is presentation quality slides.



for presentations at this convenient location.

Color slides even from a black & white CRT

Using a monochrome screen, you can choose from 72 colors to make your slide. Or, using a color monitor, you can modify colors to make combinations even more dynamic and better suited to your presentation.

Lets you add last minute information or make revisions.

The Palette is the fast, convenient, low-cost way to

prepare slides for your presentation. Perhaps even more important, the Palette lets you keep confidential information confidential. You don't have to send your work out to anyone.

See a demonstration of the Polaroid Palette today. Just call the toll-free number for the name of your nearest Palette dealer. Or mail the coupon to Polaroid Corp., E.I. Marketing, Dept. 600, 575 Technology Sq., Cambridge, MA 02139.



CALL 1-800-225-1618

Send information. Have representative call.

Name _____ Tel. _____

Company _____

Address _____

City _____ State _____ Zip _____

PC make and model _____

B- 6/84 *Suggested list price. Polaroid®



Polaroid



Education

A COMPUTER ON EVERY DESK <i>by Donna Osgood</i>	162
PROGRAMMING BY REHEARSAL <i>by William Finzer and Laura Gould</i>	187
GAME SETS AND BUILDERS <i>by Ann Piestrup</i>	215
CAUTIONS ON COMPUTERS IN EDUCATION <i>by Stephan L. Chorover</i>	223
LANGUAGES FOR STUDENTS <i>by Fred A. Masterson</i>	233
MICROCOMPUTERS IN THE FIELD <i>by Robert P. Case</i>	243
KERMIT: A FILE-TRANSFER PROTOCOL FOR UNIVERSITIES, PART I: DESIGN CONSIDERATIONS AND SPECIFICATIONS <i>by Frank da Cruz and Bill Catchings</i>	255
SAN FRANCISCO'S EXPLORATORIUM <i>by John Markoff</i>	279
DESIGNING A SIMULATED LABORATORY <i>by Nils Peterson</i>	287

"BY THE YEAR 1984, there will be millions of general-purpose microcomputers in schools..."—Tom Dwyer, August 1980 BYTE.

Well, it's 1984 and there are about a million general-purpose microcomputers in schools, but many of them are still used as computerized page-turners and drill-and-practice sergeants. In 1980, when BYTE published its first education theme issue, the emphasis was on computer literacy and CAI (computer-aided instruction). Today, as computers reach students in all disciplines, the focus is moving from the computer as an object of study to the computer as a versatile learning tool.

Until recently, computers in education have been mainframes and minicomputers, administered and controlled by institutions and dispensed to users. As microcomputers get cheaper, more powerful, and easier to use, though, they are showing up on students' and teachers' desks. Computing power is being redistributed to the educational grassroots.

Software designed for education is still largely based on traditional learning materials, using the computer as a convenient delivery system that can give immediate feedback. A few innovative researchers and educators, however, are beginning to explore the computer's real power, not only for computation, but for graphics, communications, and word processing.

Microcomputers are flooding American college campuses in record numbers. "A Computer on Every Desk" is a survey of schools that are trying to channel the tide to fit their educational goals.

Educational software suffers in the design loop: educators know what they want from software, but they can't write programs; programmers are not always versed in educational theory. The Rehearsal World, a programming environment developed at Xerox Palo Alto Research Center, is a first step toward a solution. In "Programming by Rehearsal," William Finzer and Laura Gould describe how a nonprogrammer can design and implement sophisticated software while the Rehearsal World writes Smalltalk code.

Learning software is only beginning to take advantage of the full power of computer graphics. Ann Piestrup of The Learning Company describes the design considerations behind TLC's powerful but playful interactive learning programs in "Game Sets and Builders."

Now more than ever, educators must be aware of the impact of computers on students and on the process of learning. How can computers best be introduced so that they will supplement, not supplant teachers? In this issue, Stephan L. Chorover ("Cautions on Computers in Education") and Joseph Weizenbaum (in the accompanying sidebar "Another View from MIT") offer warnings and suggestions to forestall the overzealous automation of learning.

An article by John Markoff on San Francisco's Exploratorium (with a text box on Telelearning's Electronic University), describes examples of alternate forms of off-campus education through the use of microcomputers.

Fred A. Masterson of the University of Delaware believes that programming languages can be useful pedagogic tools as well as programming tools. His "Languages for Students" describes the strengths and weaknesses of several popular, and some relatively unknown, languages for education.

There is now a great variety of microcomputers, minicomputers, and mainframes on many campuses. Naturally, all these machines need to communicate. One way is to use the Kermit protocol described by Frank da Cruz and Bill Catchings.

The possibilities for microcomputer applications in science and technology learning are endless. Examples in this issue include Nils Peterson's "Designing a Simulated Laboratory" and Robert P. Case's "Microcomputers in the Field."

Microcomputers are changing education—fast. Computing professionals and educators must work closely together to ensure that these changes are for the better.

—Donna Osgood, Associate Editor

A COMPUTER ON EVERY DESK

BY DONNA OSGOOD

A survey of personal computers in American universities

ACROSS THE COUNTRY colleges and universities are taking a serious look at the microcomputer as an essential part of the educational experience. A few dozen schools are already putting computers on students' desks, and hundreds more are exploring the possibilities. In several colleges, a personal computer is already as much a part of the cost of an education as tuition.

Why the move to micros? Plenty of reasons. Timesharing systems are overcrowded and expensive to upgrade. Students with an eye on the job market are beginning to demand "computer literacy" from their educations. And major computer manufacturers—most notably Apple, Digital Equipment Corporation (DEC), IBM, and Zenith—are wheeling and dealing to make their computers attractive.

The availability of personal computers is an obvious advantage. "Twenty-four hour access to a computer makes a tremendous difference in the way students view computing," says David Bray, dean of educational computing at Clarkson University. "Before, with our minicomputers and mainframes, students had to walk to the computer center and sometimes wait for hours to get to the computer. Some people are soured on computers that way."

Money is another powerful motivation for many schools. Faced with overbur-

dened timesharing systems and rapidly increasing demands for computing, administrators look to micros to absorb and distribute some of the cost. In most cases, the student buys the hardware, often at a sizable discount from the manufacturer, and pays for it over several semesters or as part of tuition. This shifts some of the financial responsibility for computing to the students, though the cost of implementing a campuswide computer program is still considerable for the institution.

Clearly, hardware manufacturers see long-term advantages to having their machines in students' hands. Schools such as MIT, Carnegie-Mellon, Stevens Institute, and Brown have entered joint-research agreements with manufacturers and are doing extensive development in hardware, software, and network design. In some cases, the manufacturer gets proprietary rights to the products developed this way. Other advantages to the computer companies are not so immediate or tangible, but may well be important: students who use a particular machine in college may be loyal to the manufacturer later, as consumers and professionals.

.....
Donna Osgood is an associate editor at BYTE's West Coast bureau. She can be reached at McGraw-Hill, 425 Battery St., San Francisco, CA 94111.

Students, faculty, and administrators are beginning to view the computer less as a computing machine and more as a broadly applicable tool for education and communication. "Our business is education, and we shouldn't lose sight of that," says Robert Golden of Rochester Institute. "Planning for computer use on campus has got to be curriculum driven, not just an afterthought to the selection of some hardware."

Most colleges either have plans to network microcomputers on campus or already have networks in place. Many schools will link the micros to larger computers for file storage or for terminal emulation. Networks can deliver electronic mail, student bulletin board and information services, and electronic library catalogs as well as communication among faculty, students, and staff.

Sociologists and psychologists are beginning to study the effects of widespread computer use on students. So far, the stereotype of the computer addict glued to a monitor screen and isolated from human contact just doesn't hold true. On the contrary, on many campuses the computer has brought together students who wouldn't otherwise have anything in common.

Private colleges and universities, with their greater financial and administrative flexibility, have been faster off the mark than their public counterparts. Even so,

only a handful of schools actually have large numbers of micros in student hands today, though several programs will start this September. No doubt some school administrators are holding back to watch and learn from the pioneers' mistakes. The 15 colleges and universities in the survey that follows are at the forefront of the movement.



**MASSACHUSETTS
INSTITUTE OF
TECHNOLOGY**
Cambridge, Massachusetts

"Coherence" is the watchword for MIT's Project Athena, a \$70 million joint research and development project with IBM and DEC. One of Athena's goals is to make hardware obstacles transparent to the user, so that a program produced on one part of the system is available to all other users. The entire university will rely on a single operating system and a comprehensive network.

IBM and DEC are supplying \$50 million in equipment, staff, and maintenance to the project. DEC equipment and support will be centered in the *School of Engineering*, while the rest of the institute will use IBM machines. By dealing with two vendors, and possibly more later, MIT can preserve flexibility and transportability for future developments without being locked in to one vendor's product line.

In the first phase of the project, equipment on the DEC side will be 63 networked VAX minicomputers with four to six terminals each. IBM equipment in Phase 1 will be a distributed system of 500 PC XT's with 32-bit coprocessors, high-resolution bit-mapped displays, and local-area network interface cards. The PC XT's will be organized into several local-area networks, each supported by a file server (an IBM 4341) and a laser printer.

In Phase 2, beginning in 1985, the advanced workstations from both vendors

(now under development) will be installed across campus. The workstations will have 32-bit processors, high-resolution bit-mapped displays, and networking capabilities. All Phase 1 software and curricular material should be transferable to the more advanced equipment.

Initially, Athena software will be based on Berkeley UNIX, version 4.2, with an editor, printing formatter, numerical analysis and graphics packages, a mail/file transfer program, and languages (C, FORTRAN, LISP, and Pascal). The system will evolve to accommodate new peripherals and software as well as improvements in the user interface.

The emphasis on coherence, which allows the transfer of information unimpeded by software and hardware considerations, brings its own restrictions. A set of rules is imposed on software design, limiting programming flexibility. Any group using the Athena network must agree to observe Athena's rules in its own programs.

MIT is investing \$20 million over five years to support Project Athena. More than half of that money will fund faculty software-development efforts. "The educational value of Athena rests more in the software than the hardware," says Steven Lerman, the project's director. "We envision an environment where faculty prepare curriculum materials linked to the Athena system. What we hope will come out of this is an entire new generation of educational software for the technical curriculum."

Lerman anticipates applications in laboratory data acquisition and simulations, computation, and visualization. "The traditional means which we have to illustrate things in three dimensions are very limited—you can't control them, you can't rotate them and look at them from different directions at will. What we hope to do is create graphic environments in which students can explore the three-dimensional space and really get an intuitive gut feel for what's going on. Some students don't need this, interestingly enough, and some students desperately need it. Those that don't acquire it are seriously handicapped. The notion of a good architect or engineer who doesn't have that three-dimensional instinct is very hard to imagine."

Right now, says Lerman, "Educational institutions tend to provide a narrow

band of ways to acquire information, principally the classroom and homework. Certain students seem to do well in one environment and not in another. I'm hoping that by creating a variety of software environments, we can extend the ways in which people can learn."

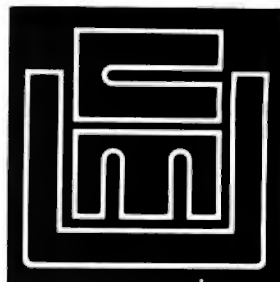

**CARNEGIE-MELLON
UNIVERSITY**
Pittsburgh, Pennsylvania

By 1986, if everything goes as planned, all freshmen at Carnegie-Mellon University will be required to buy a very powerful personal computer that will become an integral part of their education. That computer will probably be the product of Carnegie-Mellon's joint research and development project with IBM, though the school is not under contract to buy the machines from IBM. Over the next few years, CMU will make the transition from what is now primarily a timesharing system to distributed personal computers.

According to James Morris, Director of the Information Technology Center at CMU, "Computers that are currently available at a price students can afford (about \$3000) are not adequate to really make a difference to a student's education."

Specifications for CMU's machine are ambitious: it must have a bit-mapped display of a million pixels, a million instructions per second of processing power, a megabyte of real memory, and a virtual-address architecture with 32-bit address spaces. It must be connected to a local-area network as well.

Can they cram all that into a \$3000 computer? "That is a very close call," says Morris. "Looking at what is currently available on the market, if you assume that the price will be cut in half over the next three years, it's plausible. The price will depend on the market developing, the competition developing,

(text continued on page 164)

(text continued from page 163)

and a nontrivial discount from manufacturers, I would estimate." A prototype machine, an IBM PC with a National Semiconductor 16032 processor, will be available soon.

The computers will be networked in what Morris calls a "timesharing file system." It will encompass direct point-to-point communications and electronic mail but also will enable the user to browse through all the databases on campus. "It's the traditional kind of file sharing you find on timesharing systems," he says. Instead of hundreds of users, however, the system will handle thousands. "We're going to do that with large numbers of machines and local-area networks. The user doesn't have to worry about which machine is storing the file. Multiple copies of files will be kept on different machines, and there will be all sorts of computer system tricks to increase reliability and performance, but it will behave as one giant file system."

How will this tool change the way students work? "I can only speculate based on my experience at Xerox PARC [Palo Alto Research Center] over the last 10 years. If you provide people with a high-powered workstation and get them all connected into a common network and provide high-quality printing facilities, you drastically improve their ability to communicate with each other. People have seen fancy computers before. What they haven't seen before is a community of 5000 or 8000 people all wired together with this new communication medium."



CLARKSON UNIVERSITY
Potsdam, New York

In the fall of 1983, Clarkson University issued Zenith Z-100 microcomputers to all incoming freshmen. Each student pays \$200 additional tuition a semester

and a one-time maintenance deposit of \$200. On graduation, the student surrenders the deposit and owns the computer.

David Bray, Clarkson's dean of educational computing, believes that if students are not computer literate when they leave the school, "then we are shortchanging them." When these students graduate in 1987, he says, nearly every professional in their fields will be expected to use a computer. Bray wants to be certain that Clarkson graduates will be prepared.

The computers have 192K bytes of memory, both 8-bit and 16-bit processors, and one disk drive. Clarkson has promised the incoming class a complete network by the time they are seniors and is working on the network design.

It's the logistics of learning that are changing at Clarkson, not the curriculum content. Laboratory and class demonstrations can use computer graphics to illustrate principles that cannot be clearly explained in a lecture. Some faculty members have established office hours when students can bring in their disks and discuss their work.

To Bray, word-processing capabilities are one of the most significant advantages the computer will confer. Already, he says, students are becoming more critical of what they write, and for the first time professors feel free to demand rewrites.

Bray believes that accessible micros are the key to getting the faculty involved in computing. Nearly all the Clarkson faculty have computers. Professors who would not use the timesharing facilities at the computer center will use desktop computers. Faculty members got Z-100s six months before the students did, and many attended classes and seminars to help them integrate the machines into their teaching.

Professors must be involved in developing computer software to integrate the computer into their classes. A faculty member who has programming questions, needs someone to write small routines, or needs computer help in a research project will latch onto a student for help. These one-on-one relationships between students and faculty members are emerging as a fringe benefit of the micro program.

The administrators' fear that students

with micros would lock themselves into closets and become hackers was unfounded. In fact, according to Steve Newkofsky, acting dean of student life at Clarkson, the computer program has helped break down barriers between students in different fields by providing a common ground.

Five years from now, says Bray, "We will still be teaching chemistry, engineering, and so on. I don't think the educational process itself is going to change. Instead, we will be providing students with powerful tools and an effective educational assistant in the computer."

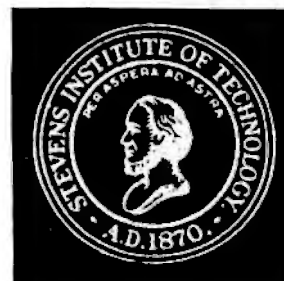

STEVENS INSTITUTE OF TECHNOLOGY
Hoboken, New Jersey

The Computers in Education program at Stevens has its roots in a decision made in 1978 to put new emphasis on computing and computers in the curriculum. By the fall of 1982, a pilot program was underway: all freshmen in the science and systems planning/management curricula were required to buy an Atari 800, at a 40 percent discount from the retail price. The computers were well received, and in the fall of 1983 the program was expanded to include all incoming freshmen.

The new group, however, is getting a lot more computer for its money. The school contracted with DEC to buy 16-bit DEC 325s with 512K bytes of RAM and dual disk drives, which would have cost students about \$1800. Through Stevens's special negotiations with DEC, however, students are getting an even sweeter deal: a Pro350 with dual floppy disks and a 10-megabyte Winchester disk, with software, for \$1950. This 80 percent discount from the list price is based on an educational discount from DEC and contributions from Stevens.

Joseph Moeller, dean of educational development, emphasizes that

Stevens's approach to integrating the computer into courses is "curriculum driven." Computer use in early courses is designed to develop general computer skills that will be useful later. Moeller says, "The development of such a 'computer thread' throughout the curricula allows for a comprehensive approach to the effective integration of computer methods into the course structure."

A local-area network will eventually incorporate students' 350s. The net is already in place to link all the academic departments, VAXes, and the mainframe, and the next major expansion will bring in the students' computers. Dormitories are being refurbished to accommodate the computers, and a conduit is being installed for the network in the process.

Stevens has not yet finalized a total networking strategy because of the lack of standardization in networking technology. A research project under way with DEC will lead to development of a comprehensive local-area network solution for the entire campus.

Microcomputers are used across the curriculum. For example, interactive calculus programs help students through mathematical analysis classes. Chemistry courses include graphic simulations and drill and practice in chemical principles. In an introductory engineering graphics course, the computer is being used as an electronic drawing board and to integrate computer graphics capabilities into engineering graphics concepts. In the lab, computers will be used to collect data, interface with equipment, control procedures, and simulate experiments that might be impractical, expensive, or dangerous.

Applications in the liberal arts include a program in political science that analyzes voting systems and word-processing programs that students use to prepare their papers. Stevens is investi-

Stevens is investigating the possibility of a joint project with AT&T to get Writer's Workbench running on the 350s.

gating the possibility of a joint project with AT&T to get Writer's Workbench, an editing program, running on the 350s.

"One of the most important benefits expected from this approach to computers," says Moeller, "is an increase in student involvement in project work—both independently and as part of teams. This was evident during the summer 1983 term, when approximately 30 faculty members and 20 undergraduate and graduate students formed software-development teams to prepare personal computer course materials for the fall semester. Many of the undergraduates were among those required to purchase Atari computers in 1982. Such activities have continued during the 1983–1984 academic year and are certain to increase, including both academic and research projects in the future."

Moeller believes the computers encourage better planning and less duplication from one course to another. Faculty involvement, central to the coordination effort, has led to an increase in interdisciplinary efforts by faculty members, he says.

Seventy-five percent of the full-time faculty is actively involved in the personal computer project. The institute supports an incentive program to encourage faculty members to buy and use computers. They can purchase the same DEC 350 system, with additional language capability, for \$1500—paid over a period of three years—and will use computers in research and writing in addition to curricular activities.

"Within five years," says Moeller, "we'll see every student, every faculty member, and most of the staff with a desktop computer. This computer will have the capability of what is now a minicomputer with substantial stand-alone computing capacity hooked into a network to facilitate communications and professional activities. We are not going to stop having classes in classrooms with direct interaction between students and faculty. There will be a shift in the way faculty and students interact, and perhaps an increase in the kinds of learning that can take place. I expect that students will approach problems in ways which take full advantage of the computer resource at their fingertips and will be able to address more complex problems in more depth than ever before."

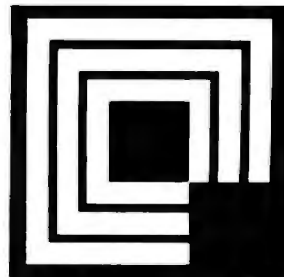

**ROCHESTER
INSTITUTE OF
TECHNOLOGY**
Rochester, New York

Rochester Institute is a larger and more diverse school than either Stevens or Clarkson. Computers from several manufacturers will be available to students through the bookstore at a discount, and the school will provide maintenance and training, but students are not required to buy personal computers.

Robert Golden, director of RIT's microcomputer task force, believes that fewer than a quarter of the 16,000 students will buy micros. He points out that no one machine would meet the needs of all the students, who major in such diverse fields as the fine and performing arts, hotel management and tourism studies, and engineering and sciences.

The computers getting the most emphasis at Rochester right now are DEC's. The whole range of DEC micros is available through the bookstore at discounts of from 30 percent to roughly 60 percent on some special packages, with training and maintenance facilities already available. RIT is using some of its resources to offer even larger discounts (as much as 82 percent) on some DEC packages for up to 200 faculty and staff members.

The school is developing an array of microcomputer uses in the classroom, from increased use of computer graphics in fine arts courses to a Survey of Computer Science course that uses computers as the primary mode of instruction. "We are just beginning the integration of computers into the classroom," says Golden, "but we see an incredible number of possible applications in the programs we offer here."

RIT has extensive timesharing facilities that are not yet overcrowded but could

(text continued on page 166)

Every building on campus, including student housing, is wired to a digital PBX network.

(text continued from page 165)

be in the foreseeable future. Golden sees the school moving toward expanding the availability of micros on campus to meet the increasing demand for computing. He adds, "The path into the future is students having micros that can access larger computers or other micros through a network."

Although RIT is working with DEC on a limited Ethernet microcomputer network, the question of what networking scheme it will use for the entire campus is still open. Golden says, "There are technological issues that haven't been resolved. . . . There still doesn't seem to be the degree of compatibility between brands of micros that we need. The more you want to do, the more difficult it is. I've heard it said that the smart thing to do in computer networks is to wait. . . there's no great advantage in being the first."

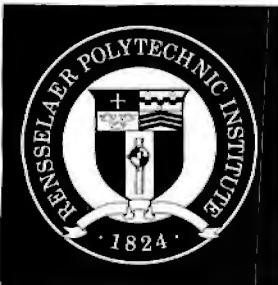

**RENSSELAER
POLYTECHNIC
INSTITUTE**
Troy, New York

Rensselaer Polytechnic Institute, though similar in size and curriculum to Clarkson and Stevens, is not yet prepared to require students to buy computers, though they will be strongly encouraged. So far, few faculty members have instructional uses for personal computers, and the micros on campus are being used as intelligent terminals to the mainframe, for word processing, a little personal research, and games.

Rensselaer traditionally has offered easily accessible and plentiful timesharing to students, but administrators feel that distributed processing will be the direction of the future.

Jim Moss, director of computer services at RPI, estimates that, of a total campus population of 6000, one thousand students already have personal computers. But until computers are an integral part of the instructional program, he says, and until a network is in place, Rensselaer will not require students to buy them. For now, there are two public microcomputer sites on campus to which students have free access. Every building on campus, including student housing, is wired to a digital PBX network, so that students with micros can access the campus mainframes or minis and eventually will be able to communicate micro to micro.

Moss stresses that an electronic information environment, not just a computing environment, will be important in the next decade. In the past, he says, the bulk of computing was geared to problem solving and calculations. Now the electronic movement and control of information is central, in the form of electronic mail, word processing, on-line libraries, and communication among faculty and students.

For several years, RPI has provided a unique scholarship program: 20 students a year are awarded a microcomputer in addition to their stipend. In a two-year study, psychologist Linnda Caporael has compared these students to a group who brought their own micros to college and to students with similar academic talents but without computers.

"There is this idea that computers are going to turn people into hackers or social isolates," Caporael says. "I was hardly prepared for the extent to which computer use was a social activity. Half of the students in our study reported that having a computer helped them to make friends. Most of the information students get about computers comes from people—nobody likes to read manuals, so they get information from each other. At RPI we have a microcomputer facility in a dormitory, which is damned inconvenient for faculty and staff, but great for students. I know students who own computers that go down there, because they've got a burning

question and they know they can find somebody there to answer it."

So far, according to Caporael, students are using computers to replace typewriters and calculators. "There's not so much of what we call 'emergent use' things the computer makes possible that wouldn't be happening otherwise. I think that will change over time. The niche for computing in education is there, but the software and applications just aren't there yet."



**CASE WESTERN
RESERVE**
Cleveland, Ohio

Case Western Reserve studied and rejected the idea of a computer for every student, at least for the present. Instead, DEC Pro 350s in a computer laboratory and in clusters around campus serve many of the students' computing needs. Case's mainframe had been overburdened and due for expansion until the microcomputers distributed some of the load.

Freshman and sophomore computing students are the computer lab's primary users. Upperclassmen tend to outgrow the microcomputers and move on to the mainframe, according to Case vice-president Don Schuele. That, he says, is the trouble with requiring students to buy microcomputers. Schuele believes that the school should provide the facilities necessary for an education, but if a student wants the comfort and privilege of a personal machine, the school will make it easy to get one.

Case has found the computer lab to be cost-effective. Within two and a half years, the savings in time bought from the mainframe will cover the entire cost of the lab. "Three years down the road, if it turns out that the 350s are not right for us, we can sell them and buy new machines. It won't have cost us a penny," says Schuele.

(text continued on page 170)

Announcing the Only 97 Function Key Detached Keyboard for Your Apple II/Apple II Plus



Enhance and Upgrade Your Apple II/Apple II Plus

The new detached keyboard from DATA SPEC™ offers you a convenient, cost-effective upgrade for your Apple II/Apple II Plus. Experience more versatility than ever before with 97 effortless pre-programmed functions. Functions include basic keywords, operating system commands, CP/M commands and much more. ① 20 of the most used functions are conveniently located on a separate keypad for handy access. And all four mathematical functions ② sit next to a 10-key numeric pad ③ for added ease-of-use. Eliminate the need to enter commands manually. Find your programming time cut by 50% or more.

State-of-the-Art Design Keeps You in the Forefront

The new, sleek low-profile design on the DATA SPEC detached keyboard includes a convenient 3-position tilt adjustment ④ to correspond to your ergonomic needs. Familiar "posi-touch", quality typewriter style keys give you "room to

work". Separate LED power-on ⑤ and "cap" lock ⑥ indicators add to your visual comfort. In addition, a handy 10 foot coiled cable ⑦ lets you move your keyboard without the burden



of relocating your computer. And, durability is never compromised in this scientifically formatted design.

You Can Depend On DATA SPEC

The APL-KB-825 detached extension keyboard is brought to you by DATA SPEC, from Alliance Research Corporation where quality, service and reliability have been our primary concerns. See the 97 Function Keyboard at a DATA SPEC dealer in your area, or contact us today for a retailer near you.

- Suggested List Price: \$299.95
- Warranty-One Year, Parts/Labor
- Watch for our Apple IIe and IBM PC Detached Keyboards Available Soon.
- Dealer and Distributor Inquiries Welcome.

Apple is a trademark of Apple Computer, Inc.
CP/M is a trademark of Digital Research
IBM is a trademark of
International Business Machines Corporation

DATA SPEC™

The Family of High Integrity Computer Support Products
18215 Parthenia Street • Northridge, CA 91325
(818) 993-1202

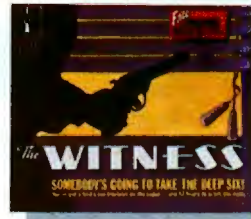
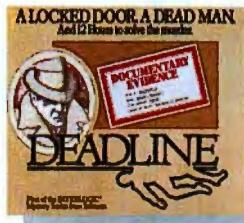



THE INCOMPLETE WORKS OF INFOCOM, INC.

Incomplete, yes. But it's not just because we're always bringing out new stories in the Infocom interactive fiction collection. Nor is it simply due to the fact that with all the writing and re-writing, honing and perfecting that we put into every one of our stories, our work is seemingly never done.

The real reason is: an Infocom work of fiction can never be complete until you become a part of it.

You see, as hard as we work at perfecting our stories, we always leave out one essential element—the main character. And that's where you enter in.

Once you've got Infocom's interactive fiction in your computer, you experience something akin to waking up inside a novel. You find yourself at the center of an exciting plot that continually challenges you with surprising twists, unique characters (many of whom possess extraordinarily developed personalities), and original, logical, often hilarious puzzles. Communication is carried on in the same way as it is in a novel—in prose. And interaction is easy—you type in full English sentences.

But there is this key difference between our tales and conventional novels: Infocom's interactive fiction is active, not passive. The course of events is shaped by the actions you choose to take. And you enjoy enormous freedom in your choice of actions—you have hundreds, even thousands of alternatives at every step. In fact, an Infocom interactive story is roughly the length of a short novel in content, but because you're actively engaged in the plot, your adventure can last for weeks and months.

In other words, only you can complete the works of Infocom, Inc. Because they're stories that grow out of your imagination.

Find out what it's like to get inside a story. Get one from Infocom. Because with Infocom's interactive fiction, there's room for you on every disk.

INFOCOM™

Infocom, Inc., 55 Wheeler Street, Cambridge, MA 02138

For your: Apple II, Atari, Commodore 64, CP/M8*, DECmate, DEC Rainbow, DEC RT-11, IBM PC* and PCjr, KAYPRO II, MS-DOS 2.0*, NEC APC, NEC PC-8000, Osborne, Tandy 2000, TI Professional, TI 99/4A, TRS-80 Models I and III.

*Use the IBM PC version for your Compaq, and the MS-DOS 2.0 version for your Wang or Mindset.

(text continued from page 166)



STANFORD UNIVERSITY
Palo Alto, California

Stanford University may well provide a model for microcomputer programs in the heterogeneous environments of large universities. No single microcomputer could meet the needs of all Stanford faculty, staff, and students, and no program to impose a single standard across the campus could ever be successful. Yet, if the proliferation of personal computers on campus were ignored, the result would be chaos. Stanford's approach is a kind of guided evolution, using the university's resources to encourage ordered development.

"Standardization and control aren't the style of the institution," says Michael Carter, director of instruction and research information systems (IRIS). "Our solution to the problem is to be flexible and adaptable in getting all of those

devices to be useful in the same environment."

The idea is to focus attention on a few microcomputer systems by providing discounts, training, maintenance support, and software development. "We want to focus the rather diffused enthusiasm on the campus for a wide range of products. What we're trying to do is select vendors and products that we think would be particularly useful in our academic and administrative computing environment, and then make them available to people," says Carter.

Through a program called Microdisk, Stanford will sell, service, and maintain microcomputers for faculty, staff, and students. So far, Microdisk has a contract with Apple and is negotiating with DEC, Hewlett-Packard, and IBM for equipment at academic discounts. Microdisk will offer a lab where prospective buyers can try hardware and software as well as consultants who will assure that they make informed purchases.

Carter intends to let the needs of the Stanford community guide the development of the microcomputer program. Questions that users ask through Microdisk are one source of information. "Our strategy is to learn as much as we can about where people want to go with their computing by providing support to questions," he explains. Experiments that get microcomputers to students

and faculty, such as instructional and demonstration labs or the Tiro project (in which 150 humanities professors received IBM PCs) are a comparatively inexpensive way to find out what works and what doesn't.

All Stanford students will have access to microcomputers whether they choose to buy them through Microdisk or not. Clusters of the more popular computers will be distributed around campus for public use. Stanford plans a combination of broadband and baseband networking for voice, video, and digital links to all academic buildings, including student residences.

Faculty members will be encouraged to develop instructional software for the approved machines. IRIS will provide development hardware, professional and student programmers, and consulting to faculty software developers—provided they write software for machines widely available to students, through Microdisk or in the public clusters.

"What we're trying to do is enhance academic achievement by applying computer technology. Our best bet is to try to focus it a little here, nudge it a little there, lead a little bit over here. With so many really smart faculty members out there, I want to give them enough devices so that they know exactly what they want to do, and then fol-

(text continued on page 172)

BYTE HIGH PERFORMANCE LEADER

GANG MULTIPROGRAMMER™

- Programs over 400 devices
- Detachable keyboard (opt.)
- Stand Alone - RS232
- Bipolar • Microchips (opt.)
- 3 Voltage EPROMS (opt.)

\$15-G \$995

UV MULTIERASER™

- Built-in safety switch
- Removable anti-static UNITRAY™ (opt.)
- 1 Hour Timer (opt.)

\$67 BUV-3C

CALL NOW or WRITE FOR BROCHURES ON OTHER SYSTEMS UNDER \$600

BYTEK® Computer Systems Corp.
4089 S Rogers Circle
Boca Raton FL 33431

(305) 994-3520
Telex: 5109527637

Distributor Inquiries Welcome

Powerful CP/M[®] Software.

For Apple, Osborne, Kaypro, Rainbow, NEC, Epson, Heath, Xerox and others.

Now only **\$39⁹⁵** each!

NEVADA COBOL[™]

When we introduced Nevada COBOL in 1979, it was loaded with innovations. Today's, Edition 2.1 is even better!

- Extremely Compact. You can compile and execute up to 2500 statements in 32K RAM, 4000 statements in 48K, etc.
- It's based upon the ANSI-74 standards with level 2 features such as compound conditionals and full CALL CANCEL.
- You get a diskette, 165-page manual with lots of examples and 16 complete COBOL source code programs.

Also available: COBOL Application Packages, Book 1 \$9.95

NEVADA PASCAL[™]

This newest addition to the 8-bit Nevada product line has many advanced features:

- 14-digit precision, BCD Math, no round-off errors with decimal arithmetic for business and floating point +63 - 64 for scientific.
- A very nice TRACE style debugging.
- Arrays up to 8 dimensions and 64K strings.
- External procedures and functions with dynamic auto-loading.
- One-step compile, no assembly or link required.
- No limits on size of procedure, nesting levels, recursion.
- Requires 60K RAM and one disk drive with at least 90K storage.
- You get a 184-page manual and diskette rev. 4.1.

NEVADA FORTRAN[™]

FORTRAN IV based upon ANSI-66 standards with some 1977 level features.

- IF . . THEN . . ELSE constructs.
- A very nice TRACE style debugging.
- 150 English language error messages.
- You get a diskette, including an 8080 assembler and Nevada FORTRAN rev 3.2, 214-page manual and five sample programs. Requires 48K RAM.

NEVADA BASIC[™]

- This interpreter has a built-in full-screen editor.
- Single- and Multi-line functions.
- BCD Math—no round-off errors.
- Full Matrix operations.
- Requires 48K RAM.
- You get 220-page manual and diskette rev. 2.5.

NEVADA EDIT[™]

- A full-screen video display text editor rev. 3.1 designed specifically to create COBOL, PASCAL and FORTRAN programs.
- See the review in May 1983 Microcomputing.

NEVADA PILOT[™]

- See review in January 1983 MICROCOMPUTING.
- You get a diskette rev. 6.1, 131-page manual and ten useful sample programs.



This is a limited time offer, so order yours today!

ELLIS COMPUTING, INC.

3917 Noriega Street
San Francisco, CA 94122

Phone (415) 753-0186

SINCE 1977
The CP/M Operating System, an 8080, 8085 or Z-80 microprocessor, and 32K RAM are required, unless stated otherwise above.

Diskette format:

8" SSSD (Standard CP/M IBM 3740)

5 1/4" Diskette for:

- Apple CP/M
- DEC VT 180
- DEC Rainbow
- Epson QX-10
- Heath Hard Sector (Z-89)
- Heath Soft Sector (Z-90, Z-100)
- IBM-PC (Requires Z-80, CP/M-80 card)
- Kaypro Double Density (NCR)
- Micropolis Mod II
- NEC PC 8001

- North Star Double Density
- North Star Single Density
- Osborne Single Density
- Sanyo 1000, 1050
- Superbrain DD DOS 3.X (512 byte sec)
- Televideo
- TRS-80 Model I Base 0 mapper
- Xerox 820 Single Density

Satisfaction is guaranteed—or your money back. If for any reason you're not completely satisfied, just return the package—in good condition with the sealed diskette unopened—within 30 days and we'll refund your money.

Please send me: Software Packages

COBOL FORTRAN EDIT PASCAL BASIC PILOT

Send my order for _____ packages @ \$39.95 each Total _____

COBOL Applications Package @ \$9.95 each Total _____

California deliveries add 6% or 6.5% sales tax _____

Outside North America, add \$6.00 per package for shipping. (Postage paid within North America.) _____

Checks must be in U.S. Dollars and drawn on a U.S. Bank.

Check enclosed COD if COD add \$4.00 _____

MasterCard VISA **TOTAL** _____

Card # _____ Exp. _____

Signature _____

Ship to: Name _____

Street _____

City/ST/Zip _____

CP/M is a registered trademark of Digital Research, Inc. Microsoft is a registered trademark of Microsoft Corp. TRS-80 is a registered trademark of Tandy Corp. Apple II is a trademark of Apple Computer, Inc. Osborne is a registered trademark of Osborne Computer Corp. Xerox 820 is a trademark of Xerox Corp. Kaypro is a trademark of Non-linear Sys. Health/Zenith is a trademark of Health Corp. IBM is a registered trademark of International Business Machines, Corp. Nevada BASIC, Nevada COBOL, Nevada FORTRAN, Nevada PILOT, Nevada EDIT, Nevada PASCAL, and Ellis Computing are trademarks of Ellis Computing, Inc. © 1984 Ellis Computing, Inc.

(text continued from page 170)

low them, rather than control the way they use computers. The trick really is to remove the obstacles so that those people can lead the way."



UNIVERSITY OF MICHIGAN
Ann Arbor, Michigan

"We are putting tools in students' hands that before were available only to teachers and scholars," says Karl Zinn of the University of Michigan. "With modeling or simulation tools, students can do more thorough research than scholars used to be able to do with graduate assistants cranking things out by hand. Students now have the resources to do more original and creative work."

The first segment of the University of Michigan to implement an extensive microcomputer program is the College of Engineering, with its Computer-Aided Engineering Network (CAEN). Associate dean Daniel Atkins says, "We are building what we see as the absolutely essential computing environment, highly distributed, with networks connecting everything." Apple Lisas and Macintoshes, IBM PC XTs, and Apollo Engi-

neering Workstations are distributed in "open computing clusters" across campus. Engineering students pay a usage fee of \$100 per term.

"We are on a schedule that will essentially equip all our faculty, staff, and students with the appropriate workstation within a couple of years," says Atkins. There will be computers in research labs and in every faculty member's office, as well as a computer on every desk in some classrooms. CAEN is working with housing administrators to get computer clusters into dormitories.

So far, there is no plan to issue computers to individual students, though that may happen later. Students are free to buy personal computers, of course, and as a member of Apple's University Consortium, the school provides Macintosh computers at about half the retail price. "We're not sure how many of our students will buy Macintoshes," says Atkins. "Macintosh is still not a powerful enough machine for all the needs that engineering students have, but it is beginning to get very interesting."

Microcomputer clusters will be connected to the university network, UMnet, to allow access to a variety of mainframes and to permit file transfer for storage on mainframes. Eventually, UMnet will have connections in every dormitory room for personal computers, adequate dial-up capabilities for off-campus users, and archival storage for the entire network.

How will easy access to computing change the way students learn? "We are saturating the environment with computers," says Atkins, "and seeing what

the students do with them. One of our criteria is that the machines support highly interactive graphics. This is a 'what if' environment for engineers, where they can have experience with many design iterations using a powerful industrial tool." When students in the technical communications course used Lisas to produce their papers, instructors noticed an enormous increase in the use of figures and graphics.

The key to the success of the program, Atkins says, is in convincing the faculty to make routine use of the computers. CAEN has provided each faculty member with an office workstation, and most professors are also buying computers to use at home. The college provides release time from teaching and student assistants to help an instructor develop applications. There is another motivation, according to Atkins: "The fact that the students have this environment readily available is creating pressure on the faculty from below. That was quite deliberate."

The College of Engineering is the testing ground for microcomputers for the rest of the university, and it is sharing information with deans of other colleges, the campus computing center, and the university's Center for Research on Learning and Teaching (CRLT). Atkins believes it will not be long before all University of Michigan students have ready access to personal computers.

Karl Zinn is heading a program within CRLT to introduce students to microcomputers, and he is enthusiastic about the Macintosh. Humanists react well to a screen that looks like a piece of paper,

(text continued on page 174)

DATA TRANSFER PROBLEMS?

Your Simple Solution is **REFORMATTER®** Diskette Conversion Software

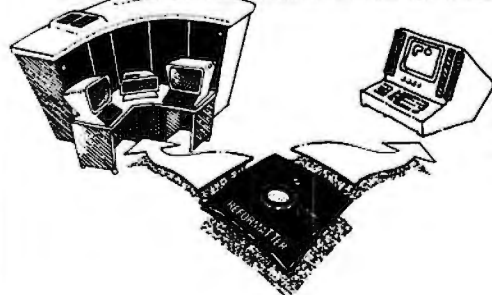

- Avoids serial communication protocols.
- Needs only one system to transfer data.
- Converts source code and data files.
- Allows 2-way transfer.
- Quick, reliable, and inexpensive.



VERSIONS	
Runs On	Reads/Writes
CP/M	↔ IBM 3740
CP/M	↔ DEC RT-11
CP/M-86	↔ IBM 3740
CROMIX	↔ DEC RT-11
DEC RT-11	↔ CP/M
MS-DOS	↔ IBM 3740
TRSDOS II*	↔ CP/M
TRSDOS II	↔ DEC RT-11
PRICE:	\$350 *\$249

Requires 8" floppy drive.

(415) 324-9114 TWX: 910-370-7457

467 Hamilton Avenue, Suite 2, Palo Alto, Calif. 94301

SYSTEMS OR BOARDS, YOU CHOOSE!



The S100-PC is a cost effective high performance floppy based system ideally suited to business and scientific applications.

The S100-PC by LOMAS DATA PRODUCTS:
Offering high performance at a "low" price . . .
and it's IBM-PC compatible.

The system offers the following standard features:

- 8 MHz 8086 CPU (8087 optional)
- 128K byte RAM (expandable to 1 megabyte)
- 2 RS232 serial ports and 2 parallel ports
- Battery protected clock calendar
- CONCURRENT CP/M-86* version 3.1, PERSONAL BASIC, CP/M 2.2 emulator and communications program.
- 2 double sided 5 1/4" floppy drives (720K bytes)
- Attractive 15 slot desktop enclosure

In addition to the above standard features many options are available: Winchester disk drives 10 to 40 Mbyte, 80286 microprocessor, and IBM-PC compatible graphics support (JUN84). If you're using an IBM-PC or other compatible and you want to improve the performance of your software, LOMAS DATA PRODUCTS is the solution.

S100 BUS boards products & support for the system integrator

■ LIGHTNING ONE *** 8086/8088 CPU

8086 or 8088, with 8087 and 8089 coprocessors. Up to 10 MHz operation **PRICES start at \$425.00**

■ HAZITALL SYSTEM SUPPORT BOARD

2 serial, 2 parallel ports, battery protected clock calendar, Hard disk controller host interface **PRICE \$325.00**

■ LDP 128/256K DYNAMIC RAM

Advanced dynamic RAM with LSI controller for failsafe operation, parity **PRICE 128K—\$495.00, 256K—\$795.00**

■ RAM67 HIGH PERFORMANCE STATIC RAM

High speed (100ns) low power CMOS static RAM. 128K bytes, extended addressing **PRICE \$995.00**

■ LDP72 FLOPPY DISK CONTROLLER

Single/double density, single/double sided disks, both 8" and 5 1/4" inch drives simultaneously **PRICE \$275.00**

■ LDP88 8088 SINGLE BOARD COMPUTER

8088 CPU, 1K RAM, 8 K EPROM, Monitor RS232 serial port, 8 vectored interrupts **PRICE \$349.00**

■ LIGHTNING 286—80286 CPU BOARD

Offers 4 times the performance of a 5MHZ 8086 CPU while maintaining software compatibility. **PRICE \$1395.00**

■ OCTAPORT 8 PORT SERIAL BOARD

8 serial ports 0 to 19200 baud operation real time clock interrupt. Ideal for multi-user systems such as MP/M-86.* **PRICE \$395.00**

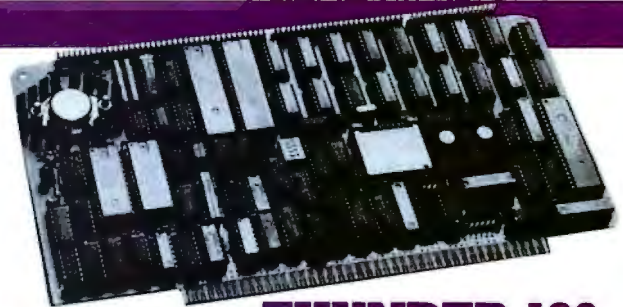

THUNDER 186

THUNDER 186 is the only complete S100 BUS, 16 bit single board computer available today. This board comes complete and ready to plug into an enclosure and run. It comes with the most advanced microprocessor operating system CONCURRENT CP/M-86, which in addition to running CP/M-86 programs also runs MS-DOS programs. This board offers the perfect combination of performance and cost. Price with 256K bytes of RAM only **\$1595.00**

All of LDP boards are fully tested to exacting standards and carry a one year warranty. We specialize in 16-bit products & support the four major operating systems for 16-bit processors: CP/M-86*, MP/M-86, CONCURRENT CP/M-86*, and MS-DOS (PC-DOS).

Dealer inquiries invited.



LOMAS DATA PRODUCTS, INC. □ 66 Hopkinton Road, Westboro, MA 01581 □ (617) 366-6434 □ Telex: 4996272

*CP/M-86, MP/M-86 and CONCURRENT CP/M-86 are trademarks of Digital Research
**MS-DOS is trademark of Microsoft
***Lightning One is trademark of Lomas Data Products, Inc.

C AS IN... "CARING"

YOU'LL GET MORE OUT OF PLUM HALL C LANGUAGE AND UNIX™ TRAINING SEMINARS...

BECAUSE WE PUT MORE INTO THEM.

Caring that you thoroughly understand and really learn to be proficient in C language or UNIX is what Plum Hall is all about.

Over 100 corporations and thousands of individuals nationwide have come to Plum Hall for expert C language and UNIX training. From beginners to advanced, from individual public seminars to in-house corporate sessions, Plum Hall offers a wide variety of intensive, hands-on C language and UNIX training seminars. Our instructors are experienced, dedicated experts who really care about your C and UNIX training needs. If you are ready to be proficient in C language and UNIX, it is time to call Plum Hall.

SEMINAR SCHEDULE

CITY	UNIX	C	Advanced C
Boston	Jun 25-29	Jun 18-22	Jun 11-15
New York	Jul 23-27	Jul 16-20	Jul 09-13
Raleigh NC	Aug 20-24	—	—
San Diego	—	Jun 11-15 Jul 16-20 Aug 20-24 Sep 17-21	—
Dallas	—	—	Sep 10-14

Tuition is \$1,000.00 for all 5-day Plum Hall Training Seminars.

Full payment or purchase order will reserve your place in the course. Full payment due by first of the Seminar. Substitution of alternates is freely permitted.

To enroll in a Plum Hall Training Seminar, or for more information, call Joan Hall at 609-927-3770.

PLUM HALL

1 SPRUCE AV
CARDIFF NJ 08232
609-927-3770

UNIX is a registered trademark of AT&T Bell Laboratories.

EDUCATION SURVEY

(text continued from page 172)

he says. A small, transportable machine like Macintosh makes an unthreatening demonstration possible: you can bring the machine to the person, rather than bring the person into a special computer room filled with unfamiliar equipment.

Zinn stresses the importance of activities that shift the user's focus from the machine itself to the process of communicating with other people through the computer. For several years CRLT has helped students and faculty use its computer-based conferencing software, first on the UM timesharing systems, and now on microcomputers. Convenient access to microcomputers, Zinn says, expands personal and academic communication possibilities.

"Computer centers are more and more going to become information centers," says Atkins. "If we end up going in the direction of lots of isolated, noncommunicating computers, that's going to be a step backward. We have to build a network that allows access to databases, to the technical library, to national networks, to electronic communities of people doing research together. The challenge is not really that of acquiring lots of personal computers. The challenge is integrating them in a distributed environment."



DREXEL UNIVERSITY
Philadelphia, Pennsylvania

"Our approach to microcomputing has been to enhance undergraduate education. We picked a machine that we felt would support that aim. We are not trying to serve every possible goal that computers could serve on an academic campus." Brian Hawkins, assistant vice-president for academic affairs, feels that Macintosh is an ideal tool for Drexel students. Half of the university's students commute to campus, and

(text continued on page 176)

THE SMART WAY TO CONNECT COMPUTER EQUIPMENT.

There's only one cable on the market that allows you to hook your computer to virtually any peripheral. It's the Smart Cable. Its on-board logic matches any RS-232 port to another. Instantly. And automatically. No other cable can do it. So don't face the problem of needing a new cable for every new connection. Buy the only cable you'll ever need to buy. The Smart Cable. Suggested retail \$89.95.



IQ TECHNOLOGIES, INC.

11811 N.E. First Street

Bellevue, WA 98005

(206) 451-0232

TELEX 701 472 IQTECH UD



Smart Cable

(text continued from page 174)

every term a third of them work in business and industry as part of Drexel's cooperative education program. Hawkins believes the Macintosh is powerful, flexible, and portable enough to meet their needs.

As of this spring, all freshmen are required to have access to a Macintosh. Although most Apple University Consortium schools will not have large numbers of Macintoshes until fall of this year, Drexel received a large shipment of them in February. According to Apple sources, this commitment was based on Drexel's aggressive and well-publicized plan to get computers to all students.

Students can buy the computer from the university for \$1000, with financing from the school if necessary, or they can work out independent arrangements. Disks and some peripherals will be available from the university bookstore at a discount.

A student advisory committee and a student-run users' group were in place before the computers were distributed on campus, running demonstrations and tutorials and raising student complaints and concerns. "We have been impressed with Drexel's planning," says Steven Weintraut of the Student Microcomputers Advisory Committee. "Every time we come up with a question, they have an answer."

Drexel freshmen are required to have access to a microcomputer.

There are no immediate plans to network the Macintoshes, partly because the student population is so mobile. Many will use the computer at home or at the job. "I can't hardwire that world," says Hawkins. "Certainly we have long-term plans for networks to support our academic program. Our approach for the first two years is based on the stand-alone capability of the machine. After that, we will network as needed."

Faculty training has run for more than a year to prepare for the onslaught of microcomputers. Applications and demonstrations, some of them designed on other computers, will be available immediately, and a software review center in the library will enable instructors to see what is already available in particular fields.

A fringe benefit of the microcomputer program, according to Hawkins, is the faculty's renewed interest in teaching methods. "Because of the change in technology, there seems to be a greater willingness to look at the educational technology as well as at how to best present concepts and ideas."

Drexel administrators share a concern voiced by educators at other schools: how will the computer change students' lives? Sociology professor Joan McCord is beginning a five-year study to measure changes in values, attitudes, stress, and time use among students and faculty. "You don't have to have an attitude toward the telephone, but you use it and it changes the way you approach problems. Just as the wide use of telephones changed lives, habits, and attitudes, so could the widespread use of computers."



BROWN UNIVERSITY
Providence, Rhode Island

Brown University is involved in a \$50 million research and development project with IBM. In a few years, students and faculty may be using graphics-based, fully networked IBM "scholars' workstations" designed at Brown. In the meantime, a lab full of Apollo computers is changing the way students learn, and the Macintosh will probably be a hit on campus.

Microcomputers are just beginning their incursion into students' lives at Brown. There is no overall plan to get a computer to every student, but Brown's participation in the Apple University Consortium means that the Macintosh will be readily available. Bill Shipp, director of Brown's Institute for Research in Information and Scholarship, says, "The fact that a student or faculty member can have an affordable machine makes all the difference in the world. The average student will think of refrigerators and computers in the same thought."

English professor George Landow believes that easy access to computing can give liberal arts students some of

(text continued on page 178)



FUTECH 2000 SERIES
ADVANCED INDUSTRIAL GRADE
S-100 MAIN FRAMES



The most advanced industrial grade high-tech, high quality, sleek style S-100 bus main frame.

- Front panel LED display for TIME/DATE and temperature of internal system air flow...
- Heavy duty power supply meeting today's standards for multi-user multi-tasking high speed CPU applications...
- A variety of front panels for floppy and winchester configurations...
- Synthesized warning voice indicator...



2100 N. Hwy. 360, Suite 1807, Grand Prairie, Texas 75050, (214) 660-1955, Telex 703033

D. J. Doss

The recent Datapro Microcomputer User Survey reported a 3.8 overall user satisfaction rating out of a possible 4.0 for Sage Computers.

Sure, we like to read about ourselves scoring high marks in market studies. Our users do also. We appreciate the positive comments written about us by writers and editors around the world. But, as much as we enjoy the reports, it doesn't really surprise us.

We've designed performance into every computer system we manufacture. Not just speed, but flexibility, functionality and reliability. Sage has been building high performance 68000 multi-user systems longer than anyone, and we know that designing performance into our product requires time, attention to detail and a non-compromising attitude of doing things right.

Sage systems are available with nine different operating systems, 23 languages and over 300 application programs in 50 different categories. All systems come with a 90-day warranty, extendable to 3 years. And we have hundreds of dealers worldwide.

If you would like to know more about Sage and our Sage II and IV microcomputer systems, call or write today for your free copy of the 28-page Sage Product Catalog. It offers all you need to know about Sage, and how we design performance into every product we sell.

Reno: 702-322-6868
Dallas: 214-392-7070
Boston: 617-229-6868



SAGE
 COMPUTER

(text continued from page 176)

the same research advantages that scientists have enjoyed. "With a scholar's workstation that could tie in to the university, or perhaps someday the Library of Congress catalog on line, someone doing research at a very sophisticated level could have a great many facts immediately available. One could teach students in the humanities to do the same kind of hands-on research that has been done for a long time in science courses."

Students in computer science courses at Brown are involved in a new sort of learning experience, one that may eventually be applied in other disciplines. In a lab equipped with 60 Apollo computers, students can watch dynamic graphic simulations of algorithms in operation. A typical lecture in this class includes a 20-minute "movie" illustrating an algorithm.

According to Bob Sedgwick, who teaches the class, more students learn

advanced material faster with the simulations. Enrollment in the course is twice what it was last year. He found, however, that there was a limit to the information people could absorb in the visual form. "Every once in a while the entire class would say 'Stop!' and we'd have to freeze everything for about 15 minutes to explain what was going on. Eventually the students in the class got to accept it, though someone coming in from outside would be bewildered." Sedgwick looks forward to next year, when he'll work with students who already have experience with the medium.

The simulation system may be adapted for other computers, including the IBM workstation and possibly the Macintosh. "There is a question of performance," Sedgwick says. "I think we can do a lot on the Mac, but we can't do everything." What's important, says Bill Shipp, is to get people in different disciplines to think about the ways they work and the kinds of tools they use.



DARTMOUTH COLLEGE
Hanover, New Hampshire

Dartmouth has a long tradition of student computing. In the sixties, when the school developed its timesharing system, students were the principle users, and computing was a service provided freely to all. Even before the advent of personal computers, 95 percent of students used computers while at Dartmouth. The move toward personal computers will draw from and build upon the timesharing system already in place.

(text continued on page 181)

BYTE Back Issues for sale

	1976	1977	1978	1979	1980	1981	1982	1983	1984
Jan.				\$2.75	\$3.25	\$3.25		\$3.70	\$4.25
Feb.			\$2.75	\$2.75	\$3.25	\$3.25		\$3.70	\$4.25
March			\$2.75		\$3.25		\$3.70	\$3.70	\$4.25
April			\$2.75	\$2.75	\$3.25	\$3.25	\$3.70	\$3.70	\$4.25
May		\$2.00	\$2.75	\$2.75	\$3.25		\$3.70	\$3.70	\$4.25
June		\$2.00	\$2.75	\$2.75	\$3.25		\$3.70	\$3.70	
July	\$2.00	\$2.00	\$2.75	\$2.75	\$3.25		\$3.70	\$4.25	
Aug.		\$2.00	\$2.75	\$2.75		\$3.25	\$3.70	\$4.25	
Sept.		\$2.75	\$2.75	\$2.75	\$3.25		\$3.70	\$4.25	
Oct.			\$2.75	\$2.75	\$3.25	\$3.25	\$3.70	\$4.25	
Nov.				\$3.25		\$3.25	\$3.70	\$4.25	
Dec.		\$2.75	\$2.75	\$3.25	\$3.25	\$3.25	\$3.70	\$4.25	

Prices include postage in the US. Please add \$.50 per copy for Canada and Mexico; and \$2.00 per copy to foreign countries (surface delivery).

Check enclosed

Payments from foreign countries must be made in US funds payable at a US bank.

VISA

Master Card

Card # _____

Exp. _____

Signature _____

Please allow 4 weeks for domestic delivery and 12 weeks for foreign delivery.

Circle and send requests with payments to:

BYTE Back Issues
P.O. Box 328
Hancock, NH 03449

NAME _____

ADDRESS _____

CITY _____

STATE _____ ZIP _____

ORDER DESK ONLY
(800) 292-3360
 TOLL FREE IN CALIFORNIA

ORDER DESK ONLY
(800) 292-3360
 TOLL FREE OUTSIDE CALIF.

"WHY PAY MORE"
COMPARE THESE PRICES
MC-P APPLICATIONS
Brings Software & Hardware
At Unbeatable Prices

SOFTWARE

	LIST	OUR
APPLIED SOFTWARE TECHNOLOGY		
VersaForm	\$389	\$269
ASHTON TATE		
Financial Planner	700	452
Friday	295	175
BPI ACCOUNTING SYSTEMS		
GL/AP/AR (Each)	395	285
CONTINENTAL		
Property Management	495	327
FOX & GELER Quick Code		
	295	174
FUNK SOFTWARE Sideways		
	60	45
HOWARD SOFT		
Real Estate Analyzer II Apple	199	135
HUMAN SOFT DB Plus		
		89
LATTICE C Compiler	500	325
LIFETREE Volkswriter Deluxe		175
LIVING VIDEOTEXT		
Think Tank	195	125
METASOFT Benchmark		
	499	295
MICROSTUFF Crosstalk		
	195	129
MICROPRO Spell Star		
Word Star w/Applicard	495	349
Mail Merge	250	162
Super Sort	250	149
Calc Star	145	86
Info Star	495	320
Word Star Pro	695	369
MICRORIM		
R Base 4000	495	325
MICROSOFT		
Flight Simulator (IBM)	50	35
Flight Simulator (Apple) Sublogic		29
Multi Plan	250	159
Multitool Word W/Mouse	475	295
Pascal Compiler	350	245
C Compiler	500	325
PBL CORPORATION		
Personal Investor	145	98
PETER NORTON		
Peter Norton Utility	80	55
PEACHTREE		
Peach Pack (AR, AP, GL)	595	249
ROSESOF PROKEY		
		95
SOFTWARE DIMENSIONS		
Accounting Plus		
GL, AR, AP, PR, INV - Each	495	295
SOFTWARE PRODUCTS INTERNATIONAL		
Open Access	575	369
SATELLITE SOFTWARE		
Word Perfect	495	325
SOFTWARE PUBLISHING		
Pfs: File		
Apple	125	85
IBM	140	95
Pfs: Report	125	85
SOFTWORD SYSTEM		
Multimate	495	275
SORCIM SuperCalc II		
	295	185
SuperCalc III	395	275
STATE OF THE ART (FM Series)		
GL/AP/AR/INV/PR-Each	595	375
SYNPSE File Manager		
	150	97
WOLF Move-It		
	199	125
VISICORP		
Visicalc IV	250	175
Visifile (Apple)	250	187
Visifile (IBM)	300	195
VisiSchedule	300	195
VisiWord w/free VisiSpell	375	285
Visitrend/Plot	300	195

Monthly Specials

Tandon TM 100-2
\$209⁰⁰

AST SIX PAK (64K)
\$265⁰⁰

AMDEK 310A
\$169⁰⁰

MULTIMATE
\$275⁰⁰

IRMA 3270
\$1045⁰⁰

OPEN ACCESS
\$369⁰⁰

Value Paks

LOTUS 1-2-3
\$299⁰⁰

PLANTRONIC +
 PRINCETON GRAPHIC
\$869⁰⁰

R:BASE 4000 +
 MULTITOOL WORD
 W/MOUSE
\$585⁰⁰

LOTUS 1-2-3 +
 HERCULES CARD
\$669⁰⁰

**ORDER STATUS &
 TECHNICAL
 SUPPORT — CALL
 (408) 293-3360**

**Call for Hardware &
 Software Prices Not
 Listed This Ad**

**Used PC's & Apples
 Bought & Sold**

HARDWARE

	LIST	OUR
HAYES MICROCOMPUTER PRODUCTS		
Hayes 300 Baud	\$289	\$199
Smart Modem 1200B	599	429
Smart Modem 1200	699	495
ADVANCED LOGIC SYSTEM (Apple II)		
Z-Card	169	115
Printer Mate (Parallel)	99	55
CP/M Card (W/ CP/M 3.0)	399	315
MPC PERIPHERALS (Apple)		
Parallel Interface Card (w/Cable)	90	68
MOUSE SYSTEMS		
PC Mouse w/Software	295	219
NOVATION		
Apple - Cat II	389	275
212 Auto Cat	695	595
Smart-Cat 103/121	595	445
Smart-Cat 103	249	187
PEGASUS		
Hard Disk 10 mgb (internal)		1195
PERSONAL COMPUTER PRODUCTS		
Applicard 6 MHz	375	280
KRAFT & TG Joystick		
IBM	70	49
Apple	65	45
STB Color Graphix Card		
		375
TALL GRASS Hard Disk 10 mgb		
	3495	2995
TEAC Half Height		
		199
VERBATIM DISC		
S/S D/D 10 Pk	49	24
D/S D/D 10 Pk	71	38
AMDEK MAI BOARD		
	599	459
ELECTRONICS PROTECTION DEVICES		
Orange	140	94
Peach	98	64
QUADRAM		
Quadboard II 64K	395	285
Quadcolor I	295	219
Quadlink	680	525
MEMORY CHIP SET (64K/9 chips)		
	95	55
PRINTERS		
NEC 7730 RO Parallel	2595	2295
Qume 1140	1685	1525
MONITORS		
Amdek 12" 310A	230	169
Princeton RGB Hi Res	795	495

**International
 Dealer Inquiries
 Welcomed**

Circle 208 on inquiry card.

MC-P APPLICATIONS, Inc.
 1630 Oakland Road, Suite D116
 San Jose, CA 95131, USA Phone (408) 293-3360
 Telex: 821396 MCPA UD
 HOURS: 8:30 a.m. to 5:30 p.m. — Mon. - Sat.
 Call for Prices in Australia at 02-929-8468

TERMS: All prices subject to change. Cashier's check/MO/
 Bank Transfer. Allow time for company or personal checks to
 clear. Prices reflect cash prepaid discount. VISA/MASTER
 CARD/COD/PO's -3%. California residents add sales tax.
SHIPPING: \$4 per item for UPS surface (\$8 for Blue Label);
 Monitors \$20, Printers \$25, within continental USA.

The Rixon PC212A... The Perfect Modem For Your IBM® PC ...Only \$499

The Rixon® PC212A offers you the only 300/1200 BPS full duplex card¹ modem with auto dial and auto answer that plugs directly into any of the IBM PC® * card slots. Because the Rixon PC212A was designed specifically for the IBM PC, it is loaded with user benefits.

The PC212A eliminates the need for an asynchronous communications adapter card and external modem cable, this alone saves you approximately \$190. The PC212A provides an extra 25 pin EIA RS232 interface connector, a telephone jack for alternate voice operation, and a telephone line jack for connection to the dial network. Without question, the PC212A is the most user friendly, most reliable, and best performing modem for your IBM PC. An internal microprocessor allows total control, operation, and optioning of the PC212A from the keyboard. A user friendly HELP list of all interactive commands is stored in modem memory for instant screen display. Just a few of the internal features are auto/manual dialing from the keyboard, auto dial the next number if the first number is busy and instant redial once or until answered. In the event of power disruption a battery back-up protects all memory in the PC212A. In addition, the PC212A is compatible with all of the communication programs written for the Hayes Smartmodem™** such as CROSSTALK.™†. Also available for use with the PC212A is the Rixon PC COM I,™‡ a communications software program (Diskette) and instruction manual to enhance the capabilities of the PC212A and the IBM PC. PC COM I operates with or replaces the need for the IBM Asynchronous Communications Support Program. The program is very user friendly and provides single key stroke control of auto log on to multiple database services (such as The Source^{SM&}), as well as log to printer, log to file transfer and flow control (automatic inband or manual control). PC COM I is only \$49.00 if purchased at the same time as the PC212A. The PC212A comes with a 2 year warranty. For more information contact your nearest computer store or Rixon direct at 800-368-2773 and ask for Jon Wilson at Ext. 472.

PC212A\$499.
PC212A WITH
ASYNCH PORT\$539.

SANGAMO WESTON
Schlumberger

RIXON INC.

2120 Industrial Pky., Silver Spring, Md. 20904
301-622-2121 TWX 710-825-0071 TLX 89-8347

The Rixon PC212A Card Modem

Another Modem Good Enough To Be Called RIXON

Circle 286 on Inquiry card.

- * IBM is a registered trademark of the International Business Machine Corp.
- ** Hayes Smartmodem is a product of the Hayes Stack™ series, a registered trademark of Hayes Microcomputer Products Inc.
- † CROSSTALK is a trademark of Microstuf Inc.
- ‡ PC COM I is a trademark of Rixon Inc.
- & The Source is a servicemark of Source Telecomputing Corp.

3043A © RIXON INC. 1983



Graphics for Zenith Terminals

(text continued from page 178)

Entering freshmen will be required to buy Macintoshes this September. "A personal computer will be one of the tools of the trade that every student has, like a textbook," says William Arms, vice-provost for computing and planning. Students can pay for their computers over time, as with any student cost, and financial aid will take the cost of the computers into account.

Macintoshes will be used both as free-standing computers and as terminals to the timesharing system, Arms says. Word and graphics processing, selected applications, and BASIC are the first priorities for the Macintosh as a stand-alone computer. For electronic mail, library access, and large programs, the Mac will serve as a terminal to the school's larger computers.

Although BASIC was developed at Dartmouth, Arms says that the comparatively crude versions of the language currently available are an embarrassment to the school. BASIC's original authors, John Kemeny and Tom Kurtz, have promised that a modern version will be available for the Macintosh by fall.

The high-speed communications network already in place at Dartmouth will be extended to all student dormitory rooms by September. Outlets in dorm rooms will link students' Macintoshes to each other, to computers in departments and administrative offices, and to the mainframes in the Kiewit Computation Center.

"The key to all of this is the faculty," says Arms. Many faculty members are already involved in software development, funded by a grant from the Sloan Foundation. When the Dean of Arts and Sciences surveyed the Dartmouth faculty, he found that a third had plans to use the computers in their courses within a year. The interested faculty were evenly distributed among the humanities, sciences, and social sciences divisions.

Many of the initial proposals for software development are based on materials already available on the time-sharing system. Conversion projects in mathematics, writing, philosophy, art, social science, literature, psychology, music, and physical sciences are well under way. Every faculty member who

(text continued on page 182)



Graphics-Plus transforms Z19 into super terminal

The GRAPHICS-PLUS enhancement board installs easily into your Zenith Z19 terminal to give you powerful graphics capability as well as expanded user features. For a small investment, your Z19 now rivals the horsepower of very expensive terminals.

You get Tektronix 4010 compatibility to run industry standard graphics software. In the text mode, you get DEC VT100 compatible 80 and 132 column formats and 24/49 line

displays. Plus seven pages of off-screen scrolling memory. A "plain English" Set-up mode. Sixteen programmable function keys. And many more convenience features.

Printer Port Option

To capture your graphs and text on hardcopy, you will also want our printer interface board for popular dot matrix printers. Specify if you need serial or parallel compatibility.

* Ask about GRAPHICS-PLUS for the Z-29

Northwest
Digital Systems

P.O. Box 15288
Seattle, WA 98115
(206) 524-0014

<input type="checkbox"/> Enter my Order	
<input type="checkbox"/> Send literature only	Quantity
<input type="checkbox"/> GRAPHICS-PLUS (GP-19) board	\$ 849
<input type="checkbox"/> Z19 Terminal with GP-19 installed	1495
<input type="checkbox"/> Printer I/O board	195
<input type="checkbox"/> Serial I/O <input type="checkbox"/> Parallel I/O	Total \$
Name _____	
Company _____	
Address _____	
City _____ State _____ Zip _____	
Telephone _____	

(text continued from page 181)

expects to do curriculum work will have a Macintosh or a Lisa, some of which have been donated by Apple. Software developed at Dartmouth will be shared with other universities through the Apple University Consortium and the Sloan Foundation.

"We have a very simple ambition," Arms says, "and that is to be an outstandingly good liberal arts university. I would hate to see computing seen as something special, rather than simply as a good tool."

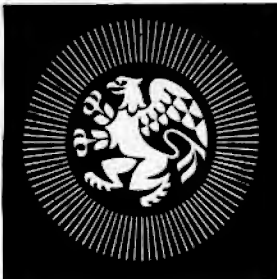

REED COLLEGE Portland, Oregon

Reed is the smallest member of Apple's University Consortium. A college with a reputation for rigid academic standards, it may serve as a proving ground for the impact of large numbers of microcomputers on a student population.

Reed will provide Macintoshes to the academic community without cost to students. This is to be accomplished through donations from friends of the college and corporations. No one, however, will be required to use the computer. Richard Crandall, chairman of the Technical Resource Committee, says, "If

a student finds a personal computer conducive to thinking, then it is welcome. If the personal computer is forced, it may not be welcome. If a liberal arts education is going to mean anything, it has to be supported with access, but not requirement."

In August of 1983, Reed published a five-year master plan for computing resources, covering the microcomputers, new mainframe and mid-sized computers, development of the Computer Center, and establishment of an Information Resource Center. The Information Resource Center will be a central location for printing facilities and graphics terminals. It will also be a place where people can meet to discuss their computer problems and techniques. "This should reduce some of the isolation that might be caused by many independent terminals," says Crandall.

The first Macintoshes that arrive at Reed will go to the Information Resource Center. After that, faculty members will get computers, then department and division support staff. Library workstations are the next priority, and individual allocations for students are last on the list.

Reed plans an icon-oriented network, which will link all the campus computers, from the mainframe to the integrated system level, to the Macintoshes. According to Crandall, "The Macintosh is ideal for this kind of network, because it's possible for an individual to visualize the entire Reed campus, academically and geographically." He adds, "Macintosh has many of the features we would have designed in if we had specified an academic computer."

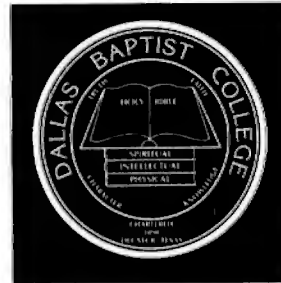

DALLAS BAPTIST COLLEGE Dallas, Texas

Dallas Baptist College is a small school, with only 1300 students. Dallas Baptist's microcomputer is small, too: in the fall of 1983 incoming freshmen were required to buy Radio Shack Model 100 portable computers.

The scope of the project at Dallas Baptist is certainly not small, however. The computers are used throughout the curriculum; in any freshman class, at least three assignments per term must make use of the computer.

Word processing is a primary concern at Dallas Baptist, according to Bill Moos, assistant professor of computer science. Students will have the opportunity to write more and will therefore learn to communicate better, he says. The word processor bundled with the Model 100, supplemented with third-party and in-house software, is adequate for students' needs, Moos says.

Computer literacy classes have been required at Dallas Baptist since 1982. Now that students have portable computers, introductory computer literacy is a hands-on course. Everyone learns

(text continued on page 184)

IN LESS THAN 3 MINUTES

Your IBM Model 50, 60, 65, 75, 85 or 95 Electronic Typewriter can be an RS232 PRINTER or TERMINAL using our Model 5060 Interface. Our Model 300 Interface can even connect your IBM Electronic typewriter directly into a phone connector to send or receive ELECTRONIC MAIL.

Both Versions can be easily installed and require NO modifications to the typewriter.

CMC CALIFORNIA MICRO COMPUTER
9323 Warbler Ave., Fountain Valley, CA 92708 (714) 848-3947



WE ALL AGREE



We can't think of anyone who isn't better off with A DX-15 DAISY WHEEL PRINTER.

Auto Cut Sheet Feed (option)

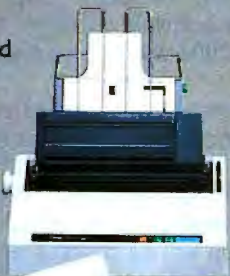

Tractor Feed (option)



Keyboard (option)



Dynax's DX-15. And if you want the kind of printer that lives in the fast lane, the DX-15 is your printer. It does it all, certainly all that far more expensive models can do. The DX-15 offers you some important options like Keyboard, Tractor Feed and Auto Cut Sheet Feed. Not only that, the DX-15 is a very durable unit, be it for business, home or word processing applications. And who says a great printer has to be expensive? Not us! What we say is you'll be dumbfounded when your dealer tells you just how inexpensive the DX-15 happens to be. Give him a call or drop by. Dynax's DX-15 says it ALL.

Dynax, Inc.TM

5698 Bandini Blvd., Bell, CA 90201
(213) 260-7121

Circle 120 on inquiry card.

(text continued from page 182)

at least the rudiments of BASIC programming, and the more advanced BASIC course, though not required, is well attended.

The goal of the microcomputer program is to produce students who will have a competitive advantage in business and industry, both because they will be familiar with computers and because they will be more experienced communicators. "We wanted a general support tool so that students can increase their overall productivity," said Moos. "This is not just something more to learn. We feel our students will have a head start in business."



DREW COLLEGE OF LIBERAL ARTS
Madison, New Jersey

The head of Drew's computer initiative, Richard Detweiler, is a psychology professor. Why a psychologist? "We are not doing something for computer scientists, or even for people who are interested in computers," Detweiler says. "We are doing something which is important for people in today's world."

Detweiler sees two purposes for introducing the computer: to enhance education in the short term and to prepare students for the computer-driven world they will face when they graduate. "If students are to function successfully and make a contribution to the society in which they live, the ability to use the microcomputer or computers in general as tools, as problem solvers in an everyday way, is absolutely crucial. The only way to accomplish that is through a per-

Drew will issue Epson QX-10s to freshmen matriculating this fall.

The Apple University Consortium

By the end of 1984, twenty-three American universities will have bought 50,000 Macintosh computers for faculty, students, and staff. As members of the Apple University Consortium, these schools will get a big price break on the machines—students will pay about \$1000 (plus tax) for a Macintosh at most Consortium schools.

One of the program's goals, according to Steve Jobs, chairman of the board of Apple, is to "help Apple discover new applications for its products." Software will be shared among Consortium members. "There will be a consortial spirit," says Drexel's Brian Hawkins. Consortium members, however, are not bound by contract to license to Apple the software they develop. In fact, some universities are planning to market their proprietary software and are beginning to consider in-house and third-party development schemes.

Most schools will have a full complement of Macintoshes by September. For now, many colleges have enough machines for demonstrations and software development, but not enough to pass out to students. The exception is Drexel University (see page 174), where students received their computers in February and began using them for classwork with the spring term.

Apple's retail dealers in university towns

have mixed reactions to the plan. They cannot match the Consortium's discount, and many feel they are losing business to the schools. Some retailers, however, see the program as a way to open previously untapped markets. In Provo, Utah, Brigham Young University has taken steps to protect the local dealers. Each student who buys a Mac signs over to the university the right to buy the computer if the student sells it within five years. "We are a small community, and we must be sensitive to dealers' needs," says BYU's Lynn McClurg.

No doubt a black market in Macintoshes will flourish for a time in many university towns. Already, ads are showing up in local papers, offering students a quick profit on the machines. Some will regret selling the computer, though. No school will sell more than one to a student, and, according to Hawkins, "A student who sells his or her Macintosh is committing academic suicide."

Apple University Consortium members are Boston College, Brigham Young, Brown, Carnegie-Mellon, City University of New York, Columbia, Cornell, Dartmouth, Drexel, Harvard, Northwestern, Princeton, Reed, Rice, Stanford, University of Chicago, University of Michigan, University of Notre Dame, University of Pennsylvania, University of Rochester, University of Utah, University of Washington, and Yale.

sonal ownership kind of approach."

Drew will issue an Epson QX-10 with a 16-bit 8088 coprocessor to each freshman matriculating this fall. Rather than charge students directly for the equipment, however, Drew will allocate funds from tuition to the project over the next several years. Students will take the machines with them when they graduate.

Any faculty member who wants a computer can have one, and much of the administrative staff will be using the Epson. Current students can buy an Epson at a Drew-supported discount or use the computers that will be scattered across campus in public clusters.

Drew settled on the Epson QX-10 after considering many other machines, including the Macintosh. "We decided against the Macintosh because of its proprietary operating system and the fact that it would lock us in to Macintosh and Macintosh descendants. We did not want to be tied to a specific ma-

chine for the future," says Detweiler. He believes that the large body of public-domain software available for MS-DOS and CP/M will be an advantage to students.

By September, when freshmen begin using their computers, software will be in place for introductory courses throughout the academic disciplines. Word processing will be a built-in part of freshman writing courses, so faculty can demand refinements and rewriting wherever necessary. Detweiler believes that students can absorb the routine parts of learning, such as names and dates in history or vocabulary in foreign languages, through computer drills outside of class, freeing class time for higher-level learning.

"We are a liberal arts institution," says Detweiler, "and we believe that for people to be liberally educated they need to know how to use the computer as a tool." ■

See Software.

Dick is a programmer. Dick is bored. Harried. Dick struggles with trace chores. Debugging routines. Nonexistent documentation. Hidden bugs. So Dick is four months behind schedule. And customers are upset when bugs slip through. They yell and make Dick upset. They make Dick's boss upset. Nobody is very happy.



See Software Run.

Jane is a happy programmer. She uses ANIMATOR™. It's a VISUAL PROGRAMMING™ aid for MICRO FOCUS™ LEVEL II COBOL™. It runs on a micro. It makes child's play of test and debugging tasks.



With ANIMATOR Jane sees a picture of the program explaining itself. In real time. In COBOL source code. ANIMATOR tracks the program's exact execution path. Including subroutine branches. Jane can have the program run fast. Or slow. Or stop. With one key. This makes it easy to spot problems. Insert fixes. Set breakpoints. Instantly.

Jane's programs are best sellers. They're delivered on time. With no hidden bugs. Jane's boss likes this about Jane. Because he doesn't like customers to yell at him.

Run, Software, Run.

This software vendor just went public. Because he doubled productivity. Eliminated bugs. Cut costs. Produced terrific applications. Beat the competition to market. And customers don't yell at him anymore. All thanks to ANIMATOR.



See ANIMATOR now.

Let ANIMATOR help you do better work. And speed your applications to market. Write for more information. Or call (415) 856-4161. Right now.

MICRO FOCUS

2465 E. Bayshore Rd., Suite 400, Palo Alto, CA 94303

© 1984 Micro Focus Inc. All Rights Reserved.
LEVEL II COBOL, ANIMATOR, VISUAL PROGRAMMING, MICRO FOCUS and the MICRO FOCUS Logo are trademarks of Micro Focus Ltd.

2465 East Bayshore Rd., Suite 400, Palo Alto, CA 94303
I'd like more information

Name _____ Title _____
Company _____ Phone _____
Address _____
City _____ State _____ Zip _____

BY 6/84

Tek's best-selling 60 MHz scopes: Now 25 ways better for not a penny more!

Now Tek has improved its 2213/2215 scopes with brighter displays. Greater accuracy. And more sensitive triggering. At no increase in price.

The 60 MHz 2213 and dual time base 2215 have been the most popular scopes in Tektronix history. Now, Tek introduces an "A" Series update with more than 25 specification and feature enhancements—things you have asked for such as single sweep—all included at no added cost.

A brighter display and new vertical amplifier design provides sharp, crisp traces.

That makes the 2213A/2215A a prime candidate for tasks like TV troubleshooting and testing, where fast sweeps are typical.

New features include 10 MHz bandwidth limit switch, separate A/B dual intensity controls (2215A only), and power-on light; additions customers have suggested for



1-800-426-2200

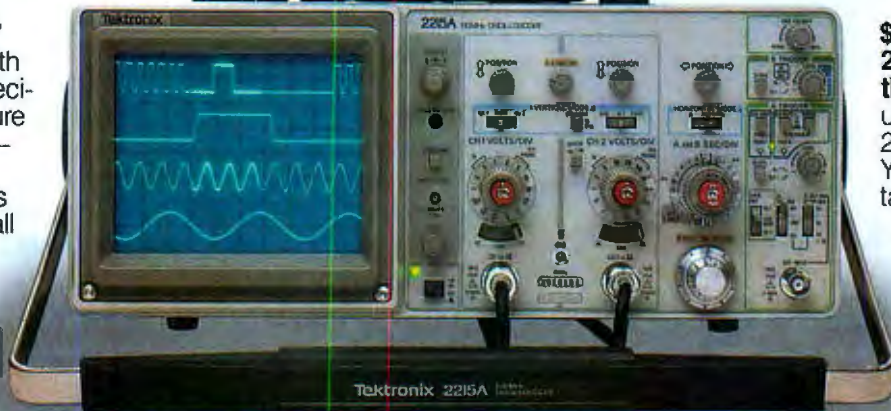

giving these scopes the final measure of convenience.

Triggering, sweep accuracy, CMRR and many more major specifications are better than ever. Check the performance chart: not bad for scopes already considered the leaders in their class!

The price: still \$1200* for the 2213A, \$1450* for the 2215A. Or, step up to the 100 MHz 2235 for just \$1650*! You can order, obtain literature, or get expert technical advice, through Tek's National Marketing Center. Direct orders include operator manuals, two 10X probes,

15-day return policy, world-wide service back-up and comprehensive 3-year warranty.

Talk to our technical experts.

**Call toll-free:
1-800-426-2200
Ext. 183.**

In Oregon call collect:
(503) 627-9000 Ext. 183.

Specification enhancement	2213/2215 "A" Series	2213/2215
CRT brightness	14 kv accel. potential	10 kv accel. potential
Vertical accuracy	3%, 0° to 50°C	3%, +20° to 30°C
Chop rate	500 kHz	250 kHz
Input capacitance	20 pF	30 pF
CMRR	10 to 1 at 25 MHz	10 to 1 at 10 MHz
Channel isolation	100:1 at 25 MHz	Not specified
A Trigger sensitivity (int)	0.3 div at 5 MHz	0.4 div at 2 MHz
TV triggering	1.0 div compos. sync	2.0 div compos. sync
Sweep accuracy (in 10X)	4%, 15° to 35°C	5%, 20° to 30°C
Delay jitter	20,000 to 1 (2215A) 10,000 to 1 (2213A)	10,000 to 1 (2215) 5,000 to 1 (2213)
Holdoff Range	10:1	4:1

*Price F.O.B. Beaverton, OR. All scopes are UL Listed and CSA approved. 3-year warranty includes CRT and applies to 2000 family oscilloscopes purchased after 1/1/83

PROGRAMMING BY REHEARSAL

BY WILLIAM FINZER AND LAURA GOULD

*An environment for developing
educational software*

PROGRAMMING BY REHEARSAL is a visual programming environment that nonprogrammers can use to create educational software. It combines many of the qualities of computer-based design environments with the full power of a programming language. The emphasis in this graphical environment is on programming visually; only things that can be seen can be manipulated. The design and programming process consists of moving "performers" around on "stages" and teaching them how to interact by sending "cues" to one another. The system relies almost completely on interactive graphics and allows designers to react immediately to their emerging products by showing them, at all stages of development, exactly what their potential users will see.

The process is quick, easy, and enjoyable; a simple program may be constructed in less than half an hour. The beginning set of 18 primitive performers, each of which responds to about 70 cues, can be extended as the designers create new composite performers and teach them new cues.

We were motivated to undertake this project by our desire to give programming power to those who understand how people learn; we wanted to eliminate the need for programmers in the design of educational software. Programming by Rehearsal is implemented

in the Smalltalk-80 programming environment and runs on a large, fast, personal machine: the Xerox 1132 Scientific Information Processor (the Dorado).

COMPUTERS AND INTUITION

In the spring of 1980 our attention was focused on a topic we called Computers and Intuition. It seemed to us that newly available, high-resolution computer images, combined with interactive control over these images, constituted a new medium for the presentation of information and concepts. We were particularly concerned with the implications that this interactive computer graphics medium might have for education.

We were also thinking about how paradoxical it was that the computer was often viewed as an engine for improving cognitive and analytical skills, while it might turn out that because of its

.....
William Finzer is a consultant with the System Concepts Laboratory at the Xerox Palo Alto Research Center and an instructor and curriculum developer in the mathematics department at San Francisco State University (1600 Holloway, San Francisco, CA 94132).

Laura Gould has been a member of the Smalltalk group at the Xerox Palo Alto Research Center for the past seven years. She is now National Secretary of Computer Professionals for Social Responsibility (POB 717, Palo Alto, CA 94301).

superlative dynamic graphics, its main new contribution to education might be in the enhancement of nonanalytical, intuitive thought.

Such ideas were certainly not new. Even 15 years ago, a few farseeing people proposed that computer graphics would have a profound effect on human learning. As Brown and Lewis wrote in 1968, "In the same way that books support man's linear and verbal thinking, machines will support his graphic and intuitive thought processes" (See reference 1.) Similarly, in 1969 Tony Oettinger wrote "Computers are capable of profoundly affecting science by stretching human reason and intuition, much as telescopes or microscopes extend human vision." (See reference 2.) It seemed that now we had both the software and hardware to realize these visions.

From these ruminations grew the design and implementation of a system called TRIP, which attempted to give students an intuitive understanding of algebra word problems through the manipulation of high-resolution pictures. (See reference 3.) TRIP, implemented in the Smalltalk-76 system (see reference 4) on research hardware, a Xerox Alto, took about two months to design and four months to implement. It was structured in the form of a kit so that

(text continued on page 188)

In the Rehearsal World, only things that can be seen can be manipulated

(text continued from page 187)

teachers could add new time-rate-distance problems fairly easily; it included a diagram checker, an animation package, an expression evaluator, and an extensive help system. Members of the computing profession were impressed that we were able to bring to life such a complex, general, graphical, yet robust and helpful system in such a short time. Educators, however, were usually aghast that so much time and effort were needed to produce a single system and that the result was, in their view, so limited.

After we had pilot-tested TRIP and were thinking about what project to take on next, we realized that our interest had shifted up one level, from the actual design of educational software to the design of a "design environment" for educators. As our colleagues were busy building the Smalltalk-80 environment (see references 5, 6, 7, and 8), we undertook the task of extending and reifying that environment to allow curriculum designers who did not program to implement their own creative ideas.

DESIGNER CONTROL

The work described here is based on the belief that it should be possible to place the control of interactive computer graphics in the hands of creative curriculum designers, those with an understanding of the power of such systems but not necessarily with the ability or willingness to write the complex programs that are necessary to control the systems.

Design and implementation constitute two phases of a feedback loop. In most design situations, in which programming is a separate and specialized skill, the designer must somehow convey embryonic ideas to a programmer, perhaps by sketching on paper or talking. Then the programmer goes away to write a program so that something shows on the screen to which the designer can respond. This process introduces inter-

ruption, distortion, and delay of creative design.

In the creation of educational software it is particularly important that the design decisions be made by someone who understands how students learn and what they enjoy rather than by someone whose expertise is in how computers work. Too much of the educational software we see today has a lot of fancy graphics but little real learning content. We hope that if educators have more direct control of the computer, they will create high-quality software.

In the environment we describe here, the designer begins by sketching the description, not in words or on paper, but directly on the computer screen. This sketching is not free-form but is done with the aid of specially provided graphical entities. If the designer's ideas are rather vague, the process of sketching may help to define them; if the ideas are well defined, they can be quickly accepted, rejected, or improved. In either case, nothing is lost in the translation process, as the only intermediary between the designer and the product is a helpful, graphical computer system that gives immediate response. Since there is no waiting, the designer is involved in a collaborative, creative process in which there is minimal investment in the current production; thus a poor production can be rejected quickly and easily, and a good one pursued and improved.

THE REHEARSAL METAPHOR

A large, supportive design environment needs a potent metaphor in which the unfamiliar concepts of programming will have familiar, real-world referents. Our goal was that the metaphor would serve as a guide to the designers without getting in their way.

Smalltalk is an object-oriented language. This means that all the basic elements of programming—strings, numbers, complex data structures, control structures, and procedures themselves—are treated as objects. Objects interact with other objects by sending messages. Logo is an example of a programming language with one object, a Turtle, which can be sent a limited number of messages such as FORWARD 20. Smalltalk has many kinds of objects that respond to a wide variety of messages.

Our immersion in Smalltalk led us to

extend the object-message metaphor to a theater metaphor in which the basic components of a production are performers; these performers interact with one another on a stage by sending cues. We call the design environment the Rehearsal World and the process of creating a production Programming by Rehearsal.

Everything in the Rehearsal World is visible; there are no abstractions and only things that can be seen can be manipulated. Almost all of the designer's interactions with the Rehearsal World are through the selection (with a mouse) of some performer or of some cue to a performer. Assuming that a designer has the germ of an idea, the creation of a Rehearsal World production involves:

- Auditioning the available performers by selecting their cues and observing their responses to determine which are appropriate for the planned production. If a production involves getting the student to write stories using pictures, the designer might choose a text performer and a picture performer because the former responds to the cues *setText*: and *readFromKeyboard* and the latter responds to *growBy*: and *followTheMouse*.
- Copying the chosen performers and placing them on a stage.
- Blocking the production by resizing and moving the performers until they are the desired size and in the desired place.
- Rehearsing the production by showing each performer what actions it should take in response either to student (user) input or to cues sent by other performers.
- Storing the production away for later retrieval.

A SCENARIO

Static words and pictures on paper are a poor substitute for direct experience with a dynamic, interactive, computer design environment. Nevertheless, we shall try to give the flavor of what it is like to use the Rehearsal World through a simple scenario involving two novice designers, Laura and Bill. Suppose that these designers are interested in language curriculum and would like to

(text continued on page 190)

Send 2000 Letters Per Hour via Your Personal Computer

Delivered in 48 hours or sooner at 26 cents a piece using MAIL-COM.™



Presenting E-Com

Two years ago the U.S. Postal Service quietly announced the E-Com® Service, enabling specially equipped personal computer users to bypass costly manual

mail preparation, by electronically submitting their messages and mailing lists directly to the Postal Service via modem.

This high speed computer originated mail arrives at its destination within 48 hours—often less—in an attention-grabbing blue E-Com envelope.

Announcing MAIL-COM.

Only from Digisoft Computers.

MAIL-COM is powerful software you can use with your personal computer to access E-Com. With your personal computer, a modem and MAIL-COM you can send from 200 to 2000 letters per hour for just 26¢ each. Typed, addressed, folded, inserted, sealed and delivered. Complete.

MAIL-COM is the complete integrated software available for E-Com operation. It's easy to use. No special training is necessary. And since Digisoft Computers developed MAIL-COM in accordance with U.S. Postal Service specifications, users are guaranteed certification for use upon purchase of MAIL-COM software.

MAIL-COM is the easiest and most economical way to do your mailings.

MAIL-COM includes a complete letter editor and address maintenance program, as well as communications software.

Directly interfaces with dBASE II, Wordstar, MailMerge and other databases.

Each letter in your mailing can be identical or all can contain variable insertions. MAIL-COM operates all the features offered by E-Com.

Thousands of Uses.

If you have need for fast, economical mass mailing capabilities, MAIL-COM puts you and E-Com together.



Use it for new product announcements, invitations to press events, invoicing, fund raising, collection, bulletins to your sales force, new business prospecting, reactivation of customers and much, much more. Every department in your company will have use for MAIL-COM.

Don't Delay

With MAIL-COM you could be saving time and money on fast, efficient E-Com letters. MAIL-COM software is available for the IBM PC, PCjr., Kaypro, CP/M, Apple II and other formats. Order today. Call 212-734-3875.



Digisoft

Digisoft Computers, Inc.

(212) 734-3875

Circle 105 on inquiry card.

Retail Dealer Inquiries Invited

Digisoft Computers Inc.
Attn: MAIL-COM Marketing
1501 Third Avenue
New York, NY 10028

Yes! I want to eliminate the 6 costliest steps in preparing my organization's business mail. Please RUSH my MAIL-COM software to me immediately.

I'll need software for:
 IBM PC (\$195) CP/M (\$195)
 Victor (\$195) (specify disk format)
 Alpha Micro (\$495) Other (specify)
 Apple II (\$195.00)

My check or money order is enclosed (residents of New York State add sales tax).

Charge my Visa or MasterCard:

Account No. _____ Exp. Date _____

Name _____

Address _____

City _____

State _____ Zip _____

Telephone(_____) _____

© 1983. Digisoft Computers, Inc.

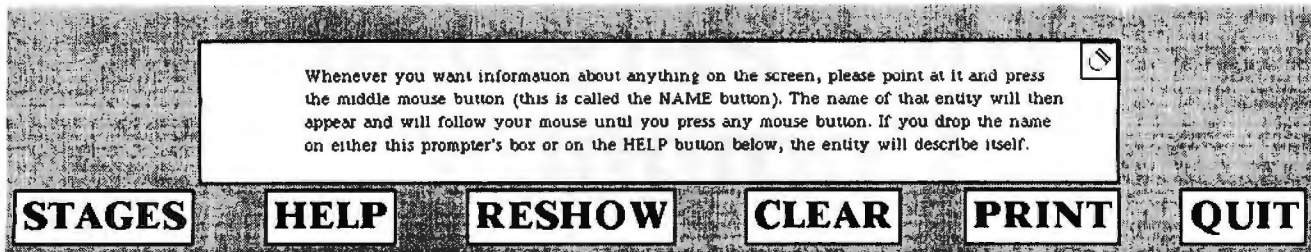

Figure 1: The control panel and the prompter's box, showing an initial help message. The icon in the corner is an eraser.

(text continued from page 188)

make some sort of word game. We'll follow their efforts, skimming over many of the details of their interactions with the Rehearsal World, with an eye to understanding some of the design decisions of Programming by Rehearsal itself. Although one person can manage both mouse and keyboard quite well, we'll assume that Laura is in charge of the mouse and Bill is typing on the keyboard. In what follows, the paragraphs describing the action of the designers have been italicized.

Bill and Laura know from their brief introduction to the Rehearsal World that all of the performers are clustered together in troupes waiting to be auditioned for parts in a production. They know also that the Rehearsal World includes a help facility that gives assistance and descriptive information about how to proceed.

Laura starts by selecting the HELP button from the control panel at the bottom of the screen (see figure 1). Selection of the HELP button causes the "prompter's box" to fill immediately with "procedural help" suggesting something that the designers might want to do next. When they select HELP initially, the procedural help message that appears explains that they can always obtain "descriptive help" about anything that they can see on the screen.

The fact that everything that can be seen is capable of self-description is an important component of the Rehearsal World and one that makes it accessible to nonprogrammers.

When they ask for descriptive help about the STAGES button, they learn that if they select the STAGES button, they will get a menu of troupes and productions. Laura selects the STAGES button which presents her with a menu of troupes and productions (see figure 2).

She finds a Text performer in the Basic Troupe that she wants to audition to learn what it can do. Laura starts by asking it to describe itself and is told by the help system that if she selects the Text performer, she can edit the text that it displays. This editing is the default action of the Text performer. Laura and Bill spend a minute becoming familiar with the simple editor that the Text performer provides.

The Rehearsal World uses a three-button mouse for pointing at things on the screen. The SELECT mouse button causes a performer to execute its default action. The NAME button always causes the name of the entity to appear at the cursor point; if this name is

dropped in the prompter's box, a description of the entity appears. Finally, the MENU button raises a pop-up menu for the performer, enabling the designer to send cues to it. In interacting with a finished production, only the SELECT button is used; that is, the NAME and MENU buttons are not needed by the student user.

Laura uses the MENU mouse button to see the category menu for the Text performer (see figure 3). Certain commonly used cues are at the top of this menu in lowercase, while others are grouped under categories in uppercase. Most of the cues and categories are shared by all performers. Only the

(text continued on page 192)

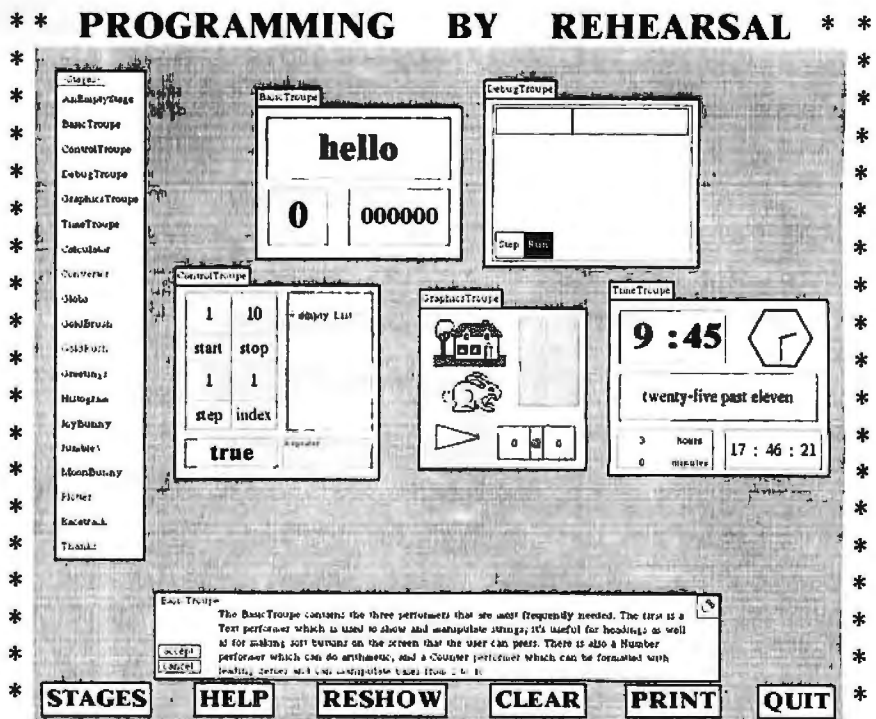

Figure 2: The entire Rehearsal World theater, showing the STAGES menu at the left, all the available Troupes, and a descriptive help message about the BasicTroupe.



Reliable.

You can count on 3M diskettes. Day after day.

Just like the sun, you can rely on 3M diskettes every day. At 3M, reliability is built into every diskette. We've been in the computer media business for over 30 years. And we've never settled in. We're constantly improving and perfecting our product line, from computer tape and data cartridges to floppy disks.

3M diskettes are made at 3M. That way, we have complete control over the entire manufacturing process. And you can have complete confidence in the reliability of every 3M diskette you buy.

Look in the Yellow Pages under Computer Supplies and Parts for the 3M distributor nearest you. In Canada, write 3M Canada, Inc., London, Ontario. If it's worth remembering, it's worth 3M diskettes.



Circle 331 on inquiry card.

3M hears you...

3M



Figure 3: A BasicTroupe, containing a Text, a Number and a Counter, and a category menu for the Text performer.

(text continued from page 190)
 categories at the bottom of the menu (in bold) are particular to the Text performer.

In its current prototype form, the Rehearsal World contains 18 primitive performers, each of which responds to a standard set of 53 cues and an average of 15 cues particular to that performer. To understand what this means, imagine a BASIC with a thousand reserved words. This complexity would be intolerable without a hierarchical organization and a simple way for the designer to browse that organization. The Smalltalk-80 system provides a window, called a Browser (see figure 4), whose visual structure reflects the hierarchical organization of the objects and methods in the system. In the Rehearsal World, functionality is organized around performers grouped together into troupes; the cues that each performer understands are grouped into categories. The result is that designers never have to scan too much information at a time, and, because each level in the hierarchy has a different screen appearance, they never lose track of where they are in that hierarchy.

Our novice designers proceed to rehearse the Text performer by sending it various cues. Laura tries move and resize and gets a pleasant surprise when the fonts change so that the text always fits within the performer's borders. She selects the SET category and gets a cue sheet showing the list of cues that have

to do with setting text (see figure 5). Some cues, like setText:, take parameters that are indicated by parameter lines next to the cue. They use the help system to discover that they can type any string as a parameter to the setText: cue. Bill types 'goodbye' on the parameter line. When Laura selects the cue, "goodbye" appears in the Text performer.

They discover through rehearsal that the setJumbled cue produces a random permutation of the characters in the text. They enjoy looking at the different bizarre configurations that jumbling a word can produce and decide to explore no more, but to make a jumble game as their first design exercise. As often happens, interaction with the design environment itself leads to a creative idea.

One would not expect jumbling of text to be a basic capability of a programming language. A programmer who encountered a need for such a function would expect to write a simple routine. In a design environment, however, we expect to find a great deal of high-level functionality, chosen with care by the implementors of the environment, so that the designer's attention is not diverted from the design task itself.

Laura and Bill's initial idea for their simple production is to use two Text performers, one to be placed above the

other on the stage. The top Text is to contain the word to be jumbled and the bottom one is to act as a soft button (a button on the screen which, when the student selects it with the mouse, causes something to occur). In this case its action will be to cause the jumbling of the top Text (see figure 6). Laura uses the copy cue to put a Text performer on an empty stage.

Any existing performer can be copied. Thus each performer acts as a prototype from which other performers can be generated; each new copy will have exactly the same characteristics as its prototype.

Laura and Bill use the resize cue to make the Text performer fill most of the top half of the stage, and then they copy it to make a second Text performer (exactly the same size as the first) in the bottom half of the stage. Bill types the word JUMBLE into it, as this is what they want the user to see. With the blocking thus completed, they decide to give each of their performers a mnemonic name that describes its purpose; they call the performers JumbledWord and JumbleButton. Now they are ready to define the action of the bottom Text, which they want to act as a button.

Any performer can become a button. By turning a performer into a button,

(text continued on page 194)

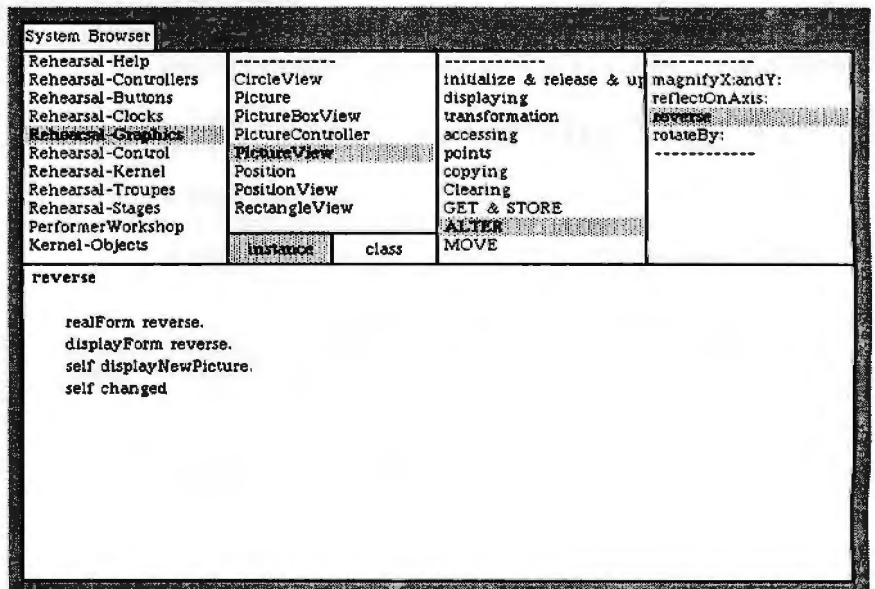

Figure 4: A Smalltalk browser showing the Rehearsal-Graphics category, the PictureView class, its ALTER category, the message named reverse from that category, and the method associated with that message.

Only from Topaz...

Powermaker[®] Micro UPS

**Uninterruptible, computer-grade power
— at half the cost**



It's in a class by itself.

For about half the cost of other Uninterruptible Power Systems, you can now get the same degree of protection with our Powermaker Micro UPS. This remarkable new system eliminates computer problems caused by blackouts, brownouts, voltage sags and power-line noise.

Providing up to 75 minutes of continuous computer-grade power, our Powermaker Micro UPS is compatible with microcomputers and PC's. It's fully automatic, maintenance-free, portable and compact. It fits neatly alongside or under your desk or workstation. And because you can't always tell when you've lost primary power, our little UPS even features an audible line-loss alarm.

But best of all is the price. The Powermaker Micro UPS is priced right and is ready for immediate shipment. Find out more about our Powermaker Micro UPS. Call us at (619) 279-0831, or contact your local Square D distributor.

TOPAZ[®]
Excellence in Computer Power

SQUARE D COMPANY

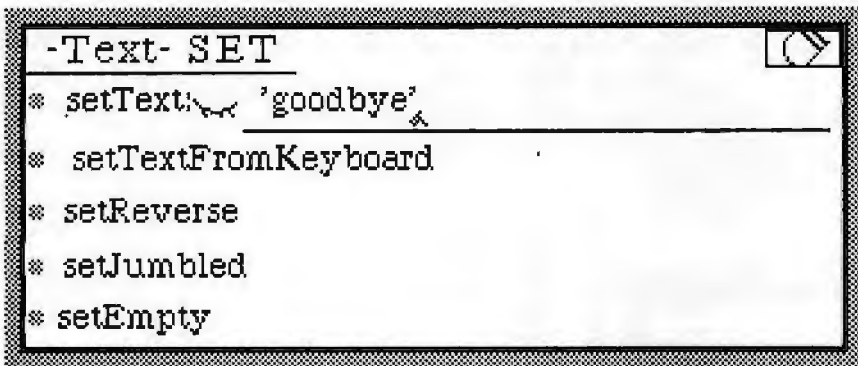

Figure 5: A cue sheet for the SET category of a Text performer. The string 'goodbye' has been typed on the parameter line of its first cue.

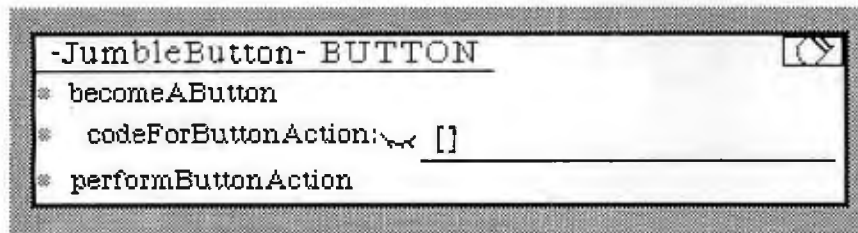

Figure 7: The cue sheet for the BUTTON category of the performer named JumbleButton. The square brackets on the parameter line indicate that the designer should write some code between them.

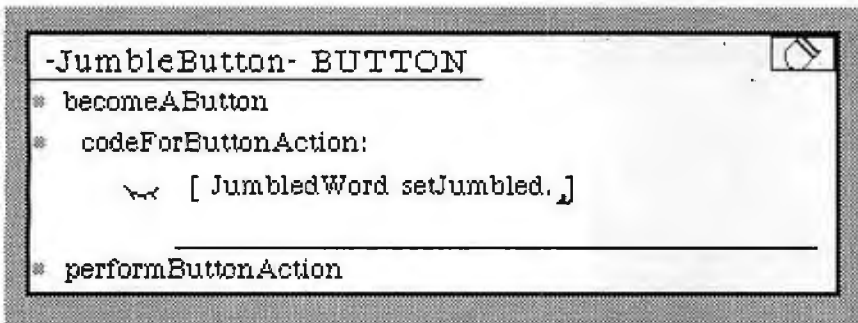

Figure 8: The code, written by watching, which indicates what the JumbleButton should do whenever it is selected by the user.

(text continued from page 192)

the designers get to decide what will happen when the user selects that performer. One of the categories on every category menu is BUTTON; its cue sheet contains the cue *becomeAButton* (see figure 7).

After Laura sends the *becomeAButton* cue to the *JumbleButton*, it no longer responds to selection by providing an editor; instead, it simply flashes. It is now a soft button on the screen, but it has no action. They must show it what to do.

They do this by using the cue *codeFor-*

ButtonAction:[] to which every performer responds. Bill and Laura understand that they are expected to provide a block of code between the square brackets to describe the action that should occur when the user selects the *JumbleButton*. The action they want is very simple; they just want the *JumbledWord* to receive the *setJumbled* cue. Bill knows that he does not have to type the code; instead the Rehearsal World will "watch" while they show it what to do.

To the left of each parameter line is a tiny icon representing a closed eye. When Laura selects it, the eye opens to

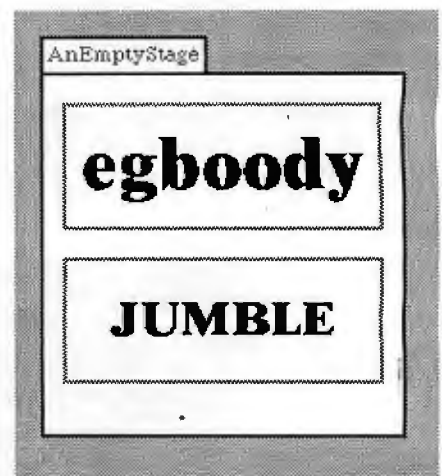

Figure 6: A stage containing two Text performers, the top one showing a jumbled word and the bottom one acting as a button which the user can select to cause the jumbling to occur.

indicate that the system is indeed watching. Then Laura sends the *setJumbled* cue to the *JumbledWord* by selecting it. The code *JumbledWord setJumbled* appears within the square brackets of the *codeForButtonAction:[]* cue of the *JumbleButton*, and the eye closes again (see figure 8).

Two significant obstacles to learning a programming language are mastering the language's syntax and learning the vocabulary. In the Rehearsal World, the designers rarely have to know either the syntax or the vocabulary as most writing of code is done by watching. While the eye is open, the designers rehearse a performer and the system makes a record of this rehearsal. The Rehearsal World's ability to watch, in combination with a mouse-driven interface, means that the designers do remarkably little typing. The designers know whether or not the code is correct not so much by reading it but by observing whether the effect produced on the stage is the desired one.

Immediately after Laura sends the *codeForButtonAction:[]* cue, she can select the newly defined button to see if it behaves as expected. Each time she selects the *JumbleButton*, it flashes and the *JumbledWord* jumbles its text.

In a traditional programming environment, the programmer moves back and forth between programming mode, in

(text continued on page 196)

COMPUTER WAREHOUSE

CALL TOLL FREE **1-800-528-1054**

PRINTERS

Blue Chip
M120/10 W/Commodore Interface \$279
M120/15 W/Commodore Interface \$349

C-Itch
A10-20 \$499
F-10-Parallel or Serial \$935
55 CPS Serial or Parallel \$1319
8510 Parallel (Prowriter) \$329
8510 SP \$455
8510 SCP \$525
8510 BPI \$415

Computer International
Daisywriter 2000 w/48K \$985

Comrex
CR-2 \$449
CR-2 Keyboard \$150

Datasouth
DS180 \$1150
DS220 \$1499

Diablo
620 \$815
630 AP \$1699
630 ECS/IBM \$2075
S-11 \$559
P-11 \$559

Epson
All Printer Models Call

Inforunner
Riteman \$249

IDS
Microprim 480 \$375
Prim 132 \$1310
Prim 132 Color \$1500

Juki
6100 Call

NEC
PC-8023A \$385
PC-8025 \$635
2010 \$775
2015 \$775
2050 \$899
3510 \$1365
3550 \$1710
7710 \$1900

Okidata
82A Call
83A Call
84P Call
84S Call
82 Call
83 Call
2350P Call
2410P Call

Panasonic
1090 Call
1081 Call
1082 Call

Qume
11/40 w/interface \$1369
11/55 w/interface \$1569
Letter Pro 20P \$609
Letter Pro 20S \$609

Silver Reed
EXP400 Call
EXP500P \$385
EXP500S \$420
EXP550P \$480
EXP550S \$499

Star Micronics
Gemini-10X Call
Gemini-15X Call
Delta 10 Call
Delta 15 Call
Radix Call

Tally
MT 180L w/Tractors Call
MT 180Lw/Tractors Call
Spint 80 Call

Toshiba
P1350 Serial or Parallel \$1429
1351 Serial or Parallel \$1579
1340 \$775

Transtar
120 Serial or Parallel \$395
130 Serial or Parallel \$549
T315 \$449

SANYO* EPSON SYSTEMS

DUAL DRIVE SYSTEM \$1525

SANYO MBC-555 • SANYO CRT-36
HI-RES GREEN MONITOR
EPSON RX-80 WordStar • CalcStar
• Mailmerge • InfoStar • Spell Star
• MS-DOS • Sanyo Basic

Above with Sanyo CRT-70
Color Monitor **\$1939**

SINGLE DRIVE SYSTEM \$1175

SANYO MBC-550 • SANYO
CRT-36 HI-RES GREEN
MONITOR • EPSON RX-80
WordStar • CalcStar
• MS-DOS • Sanyo Basic

Above with Sanyo CRT-70
Color Monitor **\$1629**

VIDEO TERMINALS

ADDS
A-2 Green \$490
Viewpoint 60 \$619

Altos
Smart II Call

Hazeltine
Esprit I \$475
Esprit II \$485
Esprit III \$575

Qume
OVT 102 Green \$535
OVT 102 Amber \$550
OVT 103 Green \$840
OVT 103 Amber \$850
OVT 108 Green \$680
OVT 108 Amber \$699

Televideo
910+ \$550
914 \$515
924 \$635
925 \$700
950 \$900
970 \$985
Personal Terminal \$410

Wyse
Wyse 50 \$489
Wyse 100 \$680
Wyse 300 \$1020

Visual
Visual 50 Green \$619
Visual 55 Green \$709

Zenith
Z-29 \$644

MONITORS

Amdek
Video 300 \$130
Video 300A \$145
310A \$160
Color I Plus \$275

Princeton Graphic
HX-12 \$499

Taxan
12" Amber \$125

Zenith
12" Green Screen \$95
12" Amber Screen \$95

DISK DRIVES

Rana
Elite 1 \$215
Elite 2 \$245
Elite 3 \$410
Controller (w/Drive only) \$65
1000 w/DOS (for Alan) \$305

DISKETTES

Maxell
MD-1 (Qty 100) \$189
MD-2 (Qty 100) \$295

Scotch
744-0 (Qty 100) \$200

Elephant
S/S S/D (Qty 100) \$155
D/S D/D (Qty 100) \$235

MODEMS

Hayes
Smartmodem \$199
Smartmodem 1200 \$485
Smartmodem 1200B \$430
Micromodem IIe \$235

US Robotics
212A Autodial \$420
Password 1200 \$310
IBM PC Modem \$320

COMPUTERS

Altos
All models Call

Columbia Call

Eagle
PC-2 w/Monochrome Monitor \$2699
Spirit-2 \$2525
Spirit-XL \$3675

NEC
PC-8201A CPU \$589
PC-8206A 32K Ram \$289
PC-8281A Recorder \$89
PC-8201A-90 Battery Pack \$15

Sanyo
MBC-550 System \$1175
MBC-555 System \$1525
1150 w/5000 printer \$1575

Televideo Systems
802 H \$4210
803 \$1765
803H Call
1803 \$2150
806/20 \$4599
800 A (user station) \$975
TPC-1 \$1525

Zenith
Z-100 Low Profile \$2625
Z-100 All-In One \$2800
Z-150 Single Drive Call
Z-150 Dual Drive Call
Z-150 10 Megabyte Call
Z-160 Single Drive Call
Z-180 Dual Drive Call

COMMODORE

64 \$227
1541 Disk Drive \$239
1702 Monitor \$239
1526 Printer \$274
1530 Datasette (only w/64) \$60

Order Line: 1-800-528-1054
Order Processing & Other Information: 602-954-6109



2222 E. Indian School Rd.
Phoenix, Arizona 85016

Store Hours: Mon-Fri 10-5:30 Saturday 9-1
Order Line Hours: Mon-Fri 8:30 -5:30 Saturday 9-1



Prices reflect 3% to 5% cash discount. Product shipped in factory cartons with manufacturer's warranty. Please add \$8.00 per order for UPS shipping. Prices & availability subject to change without notice. Send cashier's check or money order...all other checks will delay shipping two weeks.

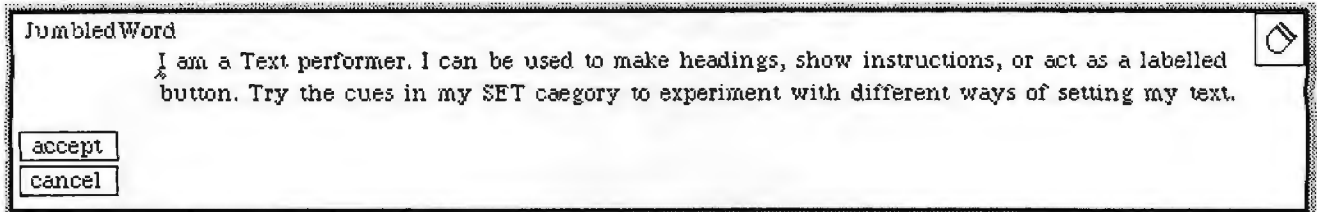

(9a)

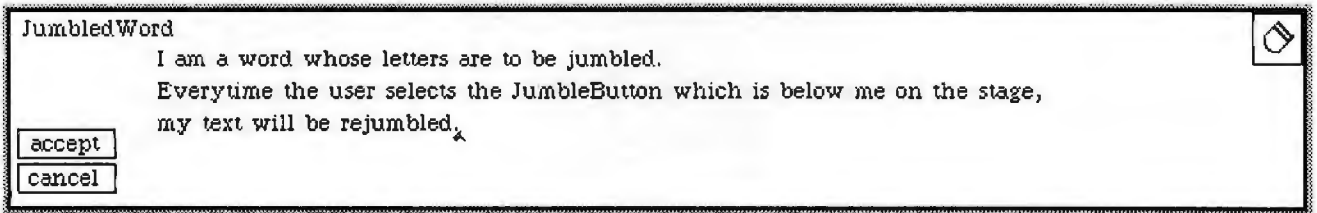

(9b)

Figure 9: The default comment associated with every Text performer (9a) and the edited comment to be associated only with the performer named JumbledWord (9b).

(text continued from page 194)

which typing code is the dominant activity, and running mode, in which testing takes place. In Programming by Rehearsal, the designer does not feel any

shift from one mode to another.

Even though their production is very simple, Laura and Bill decide to document it. They have already given the two Text performers appropriate names:

JumbledWord and JumbleButton. They use the help system to get the default comment for the JumbledWord and edit it to be more specific (see figure 9).

As a designer creates new productions and new performers, the Rehearsal World becomes more complex. The default descriptive help messages can be changed by the designer by simply editing what appears in the prompter's box and selecting the ACCEPT button. This provides a quick and pleasant method for providing descriptive comments for productions, performers, and cues.

It takes our two designers less time to produce their first jumble game than it takes to read about it. Although they have some ideas about how to make the game more interesting and educationally worthwhile, they decide to store what they have implemented so far. It is the stage itself that must be instructed to do the storing. The stage has its own category menu and one of its categories is STORE. They store their efforts under the name Jumble! (see figure 10).

No fixed set of functions provided in a design environment will ever be satisfactory; the designers will always run up against the limits of that set and wish for more capabilities. The fact that stages understand cues suggests one of the mechanisms for extensibility in the Rehearsal World: every stage can be

(text continued on page 198)

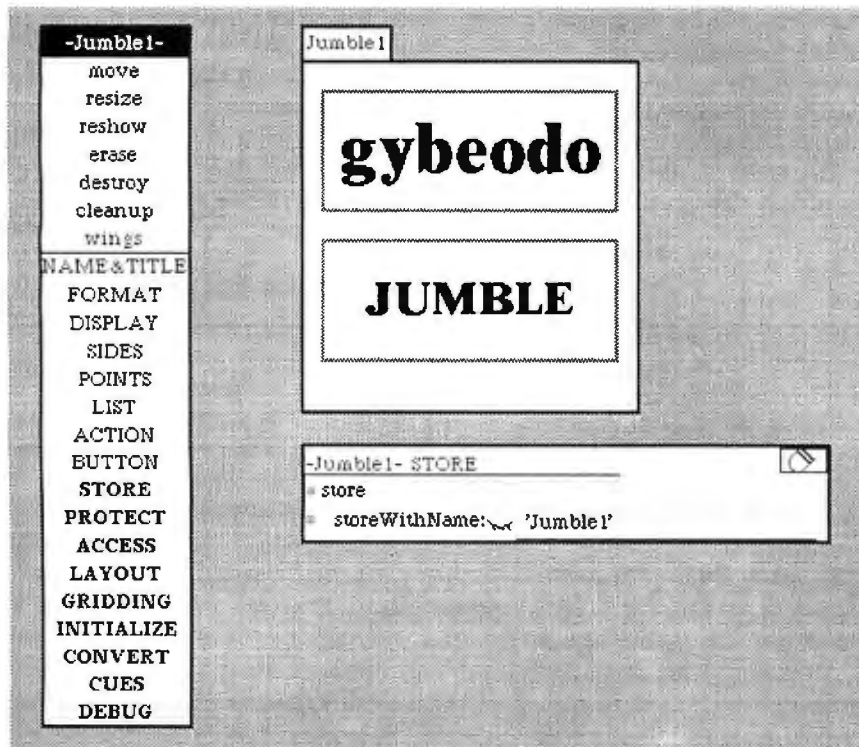
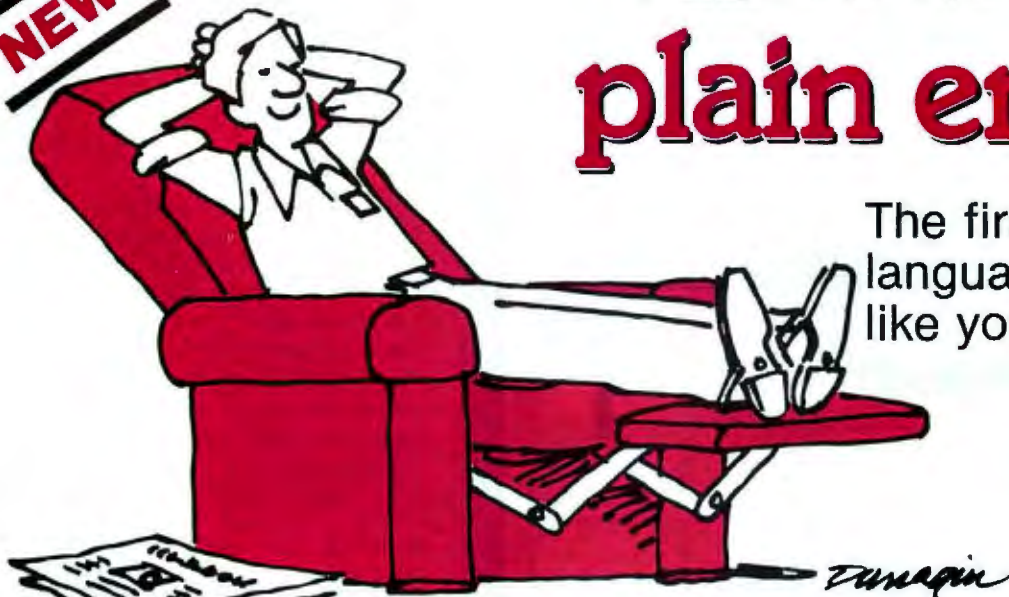

Figure 10: A stage named Jumble!; it's a category menu and cue sheet for its STORE category.

NEW!



FEEL AT HOME WITH **plain english**[®]

The first programming language that talks like you do!

```

LIST
10 REM #---ACREC010---
20 REM #---CUSTOMER NAME AND ADDRESS LOAD PROGRAM---
60 DIM BS(15)/DIM CS(20)/DIM DS(20)/AGS(1,8) = ZZ
70 J=D/OPEN #D CUSTMST ?
80 GOSUB 400
90 J=D
100 GOSUB 400
110 N=D
120 ' LAST CUST # ENTERED WAS F . . AS BS
130
140 ' TO END PROGRAM ENTER 9999 AT CUST # '
150 J=J51
160 ' ENTER FOLLOWING
170 GOSUB 520
180 INPUT 'CUT # ' F
190 IF F = 9999 THEN 490
200 IF F = N THEN 220
210 N = F /GOTO 240
220 ' SEQUENCE ERROR-RETYPE
230 GOTO 160
240 INPUT '1ST NAME ' AS(1,8)
250 IF AS = AGS THEN 380
260 INPUT 'LST NAME ' BS(1,15)
270 IF BS(1,2) = AS(1,2) THEN 380
280 INPUT 'ADRS LN1 ' CS(1,20)
290 IF CS(1,2) = AS(1,2) THEN 380
300 INPUT 'ADRS LN2 ' DS(1,20)
310 IF DS(1,2) = AS(1,2) THEN 380
320 INPUT 'TEL # ' ES(1,8)
330 IF ES(1,2) = AS(1,2) THEN 380
340 INPUT 'MO PMT AMT ' G
350 IF G = 999 THEN 380
360 GOSUB 420
370 GOTO 160
380 N = N - 1
390 GOTO 170
400 READ #D%96AJ A F AS BS CS DS ES G
410 RETURN
420 WRITE #D%96AJ A F AS BS CS DS ES G
430 K=D/G=J
440 WRITE #D%96AJ A F AS BS CS DS ES G NOENMARK
450 RETURN
460 J=D
470 GOSUB 420
480 GOTO 140
490 REM #---CLOSE ROUTINE---
500 CLOSE #D
510 END
520 CS(1,20) =
530 DS = CS/AS = CS/BS = CS/ES = CS
540 RETURN
/REM 20 BLANKS

```

Basic

```

ACCOUNTS RECEIVABLE is a file
1 Uses CUSTOMER NUMBER
2 and CUSTOMER NAME
3 and ADDRESS
4 and CITY STATE ZIP
5 and TELEPHONE NUMBER
6 and MONTHLY PAYMENT AMOUNT

ADD TO CUSTOMER FILE is a verb
1 Does MESSAGE What is the customer number?
2 and INPUT CUSTOMER NUMBER
3 and MESSAGE What is the customer's name?
4 and INPUT CUSTOMER NAME
5 and MESSAGE What is the street address?
6 and INPUT ADDRESS
7 and MESSAGE What is the City State and Zip Code?
8 and INPUT CITY STATE ZIP
9 and MESSAGE What is the customer's phone number?
10 and INPUT TELEPHONE NUMBER
11 and MESSAGE What will the customer pay monthly?
12 and INPUT MONTHLY PAYMENT AMOUNT
13 and SAVE BY CUSTOMER NUMBER in file ACCOUNTS RECEIVABLE
14 and REPEAT

```

plain english

```

IDENTIFICATION DIVISION
PROGRAM--ID
TEST
ENVIRONMENT DIVISION
CONFIGURATION SECTION
SOURCE--COMPUTER RMC
OBJECT--COMPUTER RMC
INPUT--OUTPUT SECTION
FILE--CONTROL
SELECT AR--MASTER ASSIGN TO RANDOM /g/Mes/arrmst
. ORGANIZATION IS INDEXED
. ACCESS MODE IS DYNAMIC
RECORD KEY IS CUSTOMER--NUMBER
DATA DIVISION
FILE SECTION
FD AR--MASTER LABEL RECORDS ARE STANDARD
01 AR--REC
05 CUSTOMER--NUMBER PIC X(4)
05 CUSTOMER--NAME PIC X(20)
05 CUSTOMER--ADDRESS PIC X(40)
05 CUSTOMER--CITY--STATE--ZIP PIC X(40)
05 CUSTOMER--PHONE PIC X(10)
05 CUSTOMER--PAYMENT--AMOUNT PIC 9(5)
WORKING--STORAGE SECTION
PROCEDURE DIVISION
RESIDENT SECTION 1
STAR--UP
OPEN OUTPUT AR--MASTER
LOOP
DISPLAY 'ENTER CUSTOMER NUMBER OR TO EXIT
ACCEPT CUSTOMER--NUMBER PROMPT
IF CUSTOMER--NUMBER = GO TO END--OF--JOB
DISPLAY 'ENTER CUSTOMER NAME
ACCEPT CUSTOMER--NAME PROMPT
DISPLAY 'ENTER CUSTOMER ADDRESS
ACCEPT CUSTOMER--ADDRESS PROMPT
DISPLAY 'ENTER CUSTOMER CITY STATE ZIP
ACCEPT CUSTOMER--CITY--STATE--ZIP PROMPT
DISPLAY 'ENTER TELEPHONE NUMBER
ACCEPT CUSTOMER--PHONE PROMPT
DISPLAY 'ENTER CUSTOMER PAYMENT AMOUNT
ACCEPT CUSTOMER--PAYMENT--AMOUNT PROMPT
WRITE AR--REC INVALID KEY GO TO BAD--ADD
DISPLAY 'CUSTOMER RECORD SAVED
GO TO LOOP
BAD--ADD
DISPLAY 'INVALID CUSTOMER
GO TO LOOP
END--OF--JOB
CLOSE AR--MASTER
STOP RUN

```

Cobol

Compare Plain English to any other language, as shown in the charts above. Straight forward plain english commands, using nouns and verbs are all that are necessary to create even the most sophisticated programs. Eliminate the complexities and rigid structures of the old traditional languages.

PERFECT FOR FIRST TIME PROGRAMMERS
Simple plain english statements are used to execute commands such as graphics, colors, sound and many more. An easy to understand TUTORIAL and helpful REFERENCE MANUAL (written in plain english by the way) will allow anyone to learn Plain English in as little as four hours.

FREE ACCOUNTING SOFTWARE.
For a limited time only, your Plain English package will include four accounting programs: Accounts Payable, General Ledger, Payroll and Mailing Lists. These programs may be customized by you to meet your requirements.

AVAILABLE TODAY AT YOUR LOCAL COMPUTER RETAILER . . . PLAIN ENGLISH runs on all PC or MSDOS personal computers including Tandy's Model 2000 and requires only 192K memory and one 320KB floppy drive. You can also contact us directly for additional information, dealer inquiries invited.
AVAILABLE SOON . . . Special series for software developers including Unix versions.



plain english

a product of Common Language Systems Inc.

100 E. SYBELIA AVE. SUITE 375 MAITLAND, FL 32751 (305) 628-5973

Circle 64 on inquiry card.

JUNE 1984 • BYTE 197

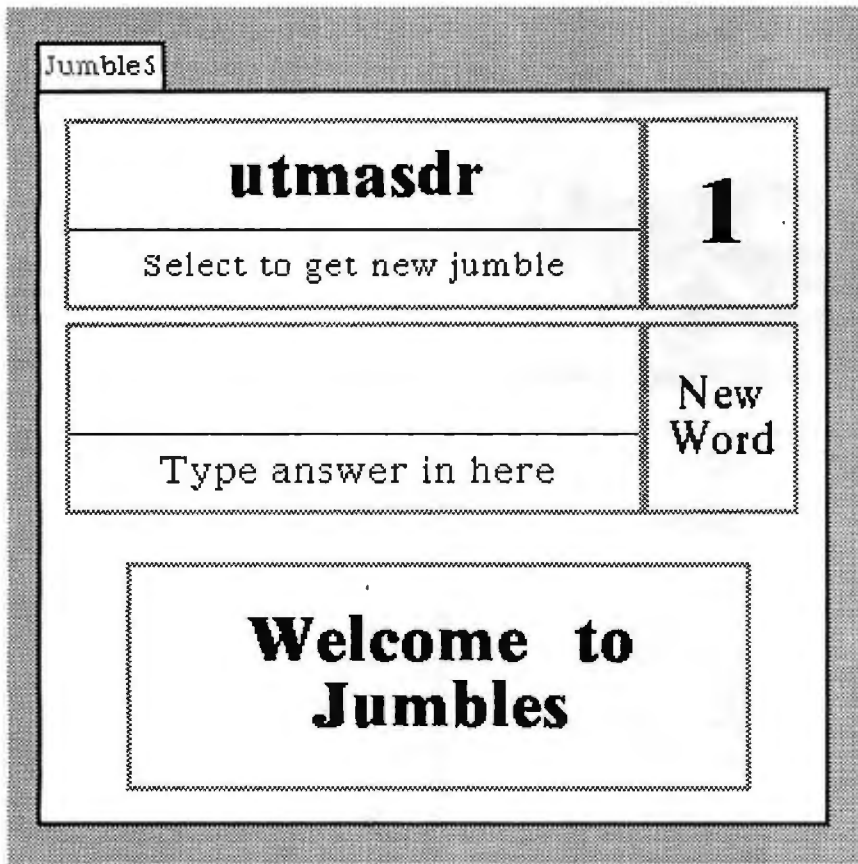

Figure 11: An improved game named Jumble5, which evolved from Jumble1.

(text continued from page 196)

converted into a new performer and every stage can be taught new cues. A designer who needs a new kind of performer can construct one by aggregating existing performers on a stage, teaching that stage some appropriate new cues, and converting the result into a new performer.

There are many circumstances in which the designers may wish to aggregate performers: several performers belong together as a logical and spatial unit; a group of performers are to be used repeatedly within a production or in several different productions; a production is very complex, and creating a new performer allows a factorization of the entire problem into smaller ones.

Bill and Laura's jumble game goes through four revisions until it finally becomes the one shown in figure 11. This improved game contains four Text performers and a Number performer. The large Text at the bottom is used simply to give feedback to the student.

The Text labeled "New Word" has been turned into a button; its button action is to cause a new secret word to be chosen from a List and presented in jumbled form in the top Text performer. This performer has also been turned into a button; its button action is to re-jumble itself. The number of re-jumbles is shown by the Number performer next to it. The Text performer in the center of the stage is to be edited by the student who will type the answer there. Every time that Text is changed, it will cause the answer to be checked against the secret word and suitable feedback to be provided. It does this by means of its change action.

When a performer changes in some fundamental way, as when a Number performer changes its value or a Text performer changes its text, it executes its change action. The default change action of a performer is to do nothing, but the designer can define this action for any performer. Certain other performers have additional possible ac-

tions: the Repeater performer has a repeat action, the List performer has a selection action, and the Traveler performer has a move action.

In the Jumble5 game, Laura and Bill use a List performer to keep a list of secret words. Since they don't want the user to see the List, they place it in the wings (see figure 12).

While everything should be visible to the designers, not everything should be visible to the user of the production. Wings can hold performers waiting to appear on stage, data structures like the List of secret words, or temporary variables used in computations.

A very simple game grew and prospered as our designers implemented it, changing in response to their new understanding of what they were doing, and to the needs and interests of users and other designers who experimented with it. It became something real that people wish to play with and from which they can get some increased intuitive understanding of the rules underlying English orthography.

BENEATH THE REHEARSAL WORLD — THROUGH THE TRAPDOOR

The Rehearsal World in some ways may be thought of as a visible Smalltalk. Although our original intention was to remove the need for programming at the Smalltalk level, it is paradoxically true that the Rehearsal World provides an excellent entry point for an incipient Smalltalk programmer. Designers may drop through the trapdoor of the Rehearsal World; beneath they will find all the tools of the Smalltalk-80 programming environment. A Rehearsal World tool found there is called the Performer Workshop. It looks like a simplified Smalltalk browser and provides a mid-level mechanism for creating new primitive performers and defining new cues.

For each kind of performer there is a corresponding Smalltalk class that is a subclass of class Performer. The inheritance mechanism of Smalltalk allows the subclass to inherit the message interface of class Performer. Each production corresponds to a subclass of class Stage. When designers store a production, the Rehearsal World defines a new subclass of class Stage. Interest-

(text continued on page 200)

THE WY-50. PRETTY SMALL

A NEW GENERATION OF LOW-COST TERMINALS FROM WYSE.

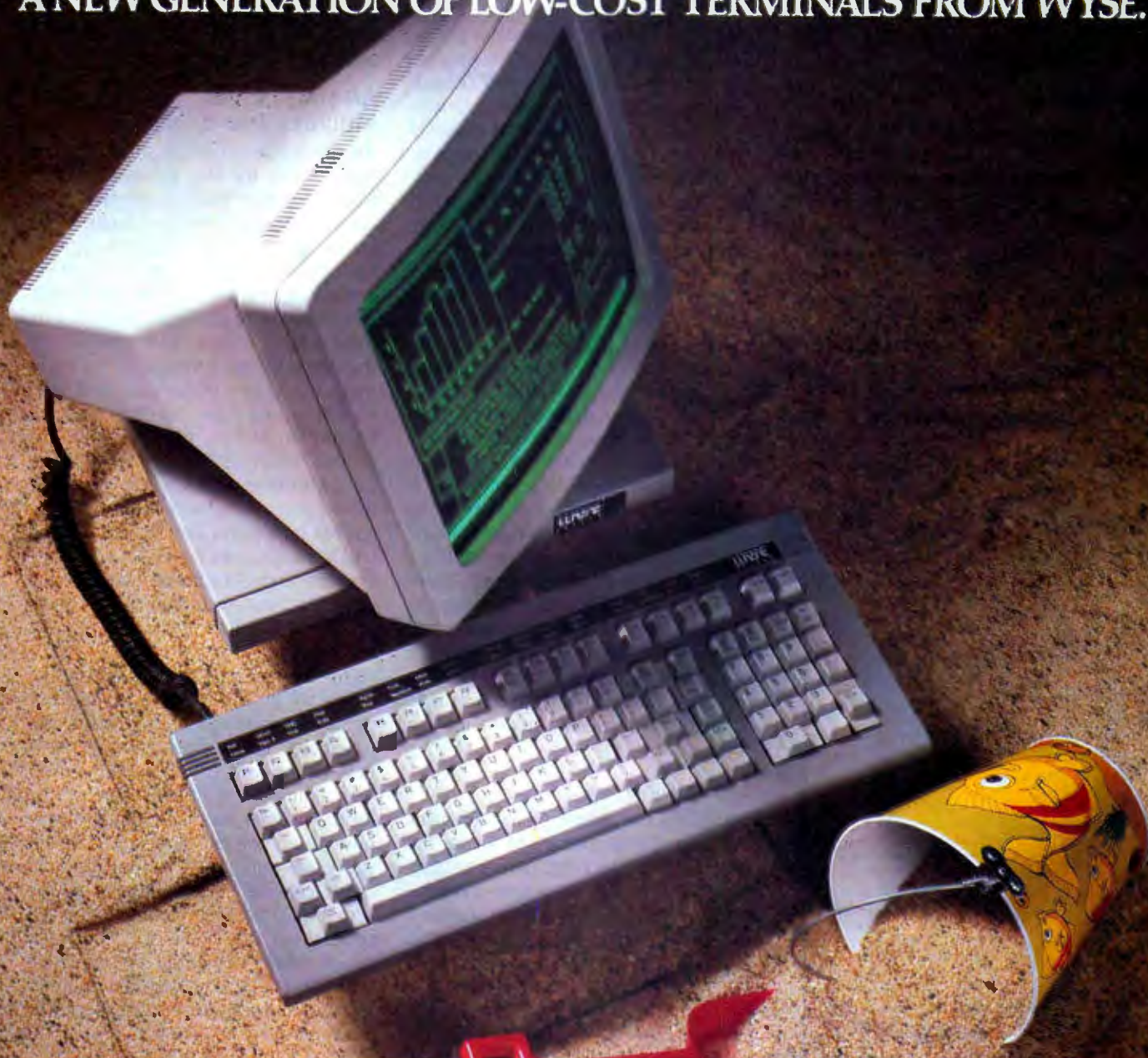

Never before has anyone put so much into something so small. The WY-50 gives you big terminal features without occupying your entire work-space. This took revolutionary design. Design a lot of people couldn't accomplish for the price. But we did.

In fact, the WY-50 introduces a new standard for low-cost terminals. You get a compact, full-featured design that meets the most advanced European ergonomic standards. 30% more viewing area than standard screens. And a price tag as small as they come.

The WY-50 sells for only \$695.00.

FEATURES:

- 14" screen.
- 80/132 column format.
- Soft-set up mode.
- High resolution characters.
- Low-profile keyboard.
- Industry compatible.
- Only \$695.00.

For more information on the revolutionary design, outstanding features and unique good looks of the new WY-50,

contact WYSE and we'll send you a brochure filled with everything you need to know. The WY-50. The full-featured terminal with the small price.

WYSE

Circle 359 on Inquiry card.

Make the Wyse Decision.

WYSE TECHNOLOGY 3040 N. First St., San Jose, CA 95134, 408/946-3075, TLX 910-338-2251, Outside CA call toll-free, 800/421-1058, in So. CA 213/340-2013.

(text continued from page 198)

ingly, a stage is so much like a performer that class **Stage** is actually a subclass of class **Performer**.

When designers create new performers, the Rehearsal World defines a new subclass of **Performer** and writes the code for the appropriate additional methods that the class will need for layout and for cues. Because the code written by the Rehearsal World is indistinguishable from code written by a programmer, one can inspect it and modify it in either a **Performer Workshop** or a **Smalltalk browser** (see figure 4).

There are two important features of **Smalltalk** that are not present in the **Rehearsal World**. The first is the ability to create a hierarchy of objects. In **Smalltalk**, when one constructs a new kind of object—that is, a class—one usually con-

structs it by defining a subclass of the existing class that is most like the new class. In that way the new class can inherit a great deal of the desired behavior. In the **Rehearsal World**, there is no concept of class. A designer who wants a new production that is similar to an existing one can modify the existing production and store it under a different name. A major weakness of this method is that modifications made to the first production will not be automatically reflected in the modified one. In contrast, a modification made to a **Smalltalk** class will be automatically reflected in its subclasses.

The second difference between **Smalltalk** and the **Rehearsal World** is that in **Smalltalk** there is a distinction between a class and an instance of that class. The class is the abstraction; an object is always an instance of some class. A class may have any number of instances. Any changes to the class will be immediately reflected in all its instances. In the **Rehearsal World**, there are no abstractions, thus no classes. Everything is visible. Any performer can serve as a prototype and one gets new performers through copying. What is lost is the ability to have changes made to the original reflected automatically in the copies.

DEBUGGING

Ordinarily, the sooner a program gives evidence that something is wrong, the easier it is for the programmer to diagnose the problem. Designers in the **Rehearsal World** find that bugs manifest themselves very quickly because nearly all state information is visible and because the flow of control from performer to performer is fairly obvious to the eye. Even so, a situation will occasionally arise in which the designer cannot easily account for some behavior on a stage.

It seems appropriate in **Programming by Rehearsal** that help should come in the form of another performer, the **Debugger performer** (see figure 13). A **Debugger**, when placed on a stage, intercepts all the actions that performers execute, shows their code, and waits for the designer to tell it to go on. While the actions of the production are thus halted, the designers can investigate the cause of a problem using any of the normal **Rehearsal World** activities such as

opening up cue sheets and sending cues. Additional actions that may be initiated are placed in the **Debugger's** queue for later execution.

ANIMATION AND MULTIPLE PROCESSES

An intuitively pleasing, though incorrect, model for the **Rehearsal World** would be that each performer goes about its business independently of the others except when it needs another performer to answer a question or do something. Performers would be like people in the real world, capable of independent action but interacting through requests. Animation, you might think, would be easy because each performer would have its own rules for moving around on the screen. In this model, which we call the **one-process-per-performer** model, each performer would essentially have its own processor for its private use. Trouble comes when performers have to share resources and coordinate that sharing. Several schemes for dealing with these problems have been developed over the years.

Our own solution to the problems introduced by having one process per performer was to allow each user action to initiate a single independent process that either runs to completion or, as with animation, continues in an infinite loop. A single production can, at any given time, have any number of different processes running in it. (Beyond that, there can be several stages on the screen at a time, each running its own processes.) This **one-process-per-user-action** model has so far proven to be both intuitive and powerful, though we see it as an area where further research is necessary.

DESIGNERS AT WORK

Since the **Rehearsal World** is a prototype system, very few designers have had a chance to experiment with it. The first one to actually use the system was Joan Ross, a curriculum designer from the University of Michigan. Joan created many interesting productions using the **Picture** and **Turtle** performers. She helped us to debug the system and to understand how to improve it on all levels as we prepared for a pilot study.

We spent a month responding to the

(text continued on page 202)

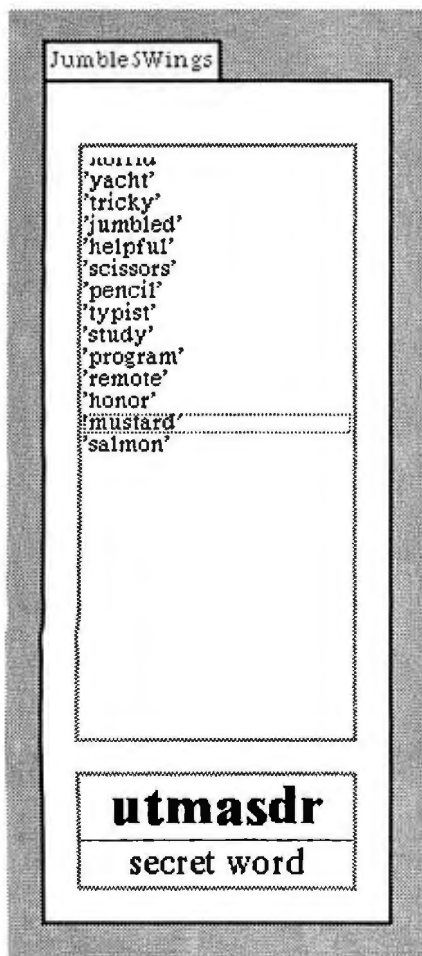

Figure 12: The wings of the **Jumble5** game, showing a **List** performer in which the current secret word is selected.



International Connections

With the industry's most popular data communications program, the world is at your command.

An import/export office in New Jersey can instantly check the London market for current dollar exchange rates ... send Hong Kong an updated production schedule ... print-out the week's sales results from the Dallas branch.

There's virtually no limit to how far you can reach with your microcomputer, ordinary telephone lines, and CROSSTALK.

Even if your own business and personal needs are closer to home, you'll appreciate CROSSTALK's compatibility with a wide user base ... smart terminal characteristics ... total modem control ... and the ability to capture data at a high speed for later off-line editing. CROSSTALK has extras you may not find in other programs. Data capture to memory buffer (and on-line display). Protocol error-checking file transfer. Modem/telephone hangup, and display of elapsed time of call. Command file power and flexibility. Remote takeover and operation. And much more.

There is a CROSSTALK version for almost every CP/M, CP/M-86, or IBM DOS based microcomputer system. See your dealer, or write for a brochure.

CROSSTALK™

MICROSTUF®

1845 The Exchange / Atlanta, Georgia 30339 / (404) 952-0267

CROSSTALK is a trademark of Microstuf, Inc., CP/M and CP/M-86 are trademarks of Digital Research, Inc., IBM is a trademark of International Business Machines, Inc.

Circle 224 on inquiry card.

JUNE 1984 • BYTE 201

(text continued from page 200)

issues that Joan raised as a result of her experiences and then invited Dan Fendel and Diane Resek, curriculum designers and faculty members of the Mathematics Department at San Francisco State University, to visit for three days to see what they could create in the Rehearsal World. They are very ex-

perienced designers, familiar with the power of interactive computer graphics, but they are not programmers.

We gave them a tour of the system and within 45 minutes Dan and Diane had taken over and were using the Rehearsal World themselves. They started by investigating a simple production we had made about probability and soon

suggested and implemented some improvements. They found out how it worked by looking at the button actions and change actions of the performers, both on stage and in the wings. By the end of the first afternoon, they had turned it into a game that bore only a slight resemblance to our original exploratory activity. In the process, they had auditioned Texts, Numbers, Lists, and Repeaters to discover their capabilities, dealt some with the blocking of the stage, written a fair amount of code by watching, and understood about button actions, change actions, and repeat actions.

Dan and Diane spent an hour the next morning away from the machine, designing with words and a pencil. In the course of this design session, they refined their embryonic ideas for a fraction game through discussion of both the pedagogical issues and the fantasy through which they should be transmitted. They also considered which Rehearsal World performers they would need in their proposed game. The fantasy involved a cave filled with gold dust. They envisioned the ceiling of the cave as an irregular set of stalactites; they saw the floor as tiled. The student's problem would be to sweep a vertical broom through this cave, one floor tile at a time, trying to collect as much gold dust as possible without ever allowing the broom to touch the ceiling. The broom would stretch or shrink by a certain fractional amount which the student would specify before each move. For example, if the student edited the fraction to read $2/1$, the broom would become twice as tall when it moved.

They had other design criteria as well. They wanted the game to configure itself differently every time the START button was selected, and they also wanted to make it easy for a designer to specify an easy cave, with broad floor tiles and very little variation in the ceiling, or a hard one. They wanted to have a score that was expressed as a percentage of the available gold dust; they wanted some sort of disaster to occur if the student made the fraction too large and the broom touched the ceiling. They decided to call their production GoldRush (see figure 14).

We found this description quite overwhelming for an initial project, as we

(text continued on page 204)

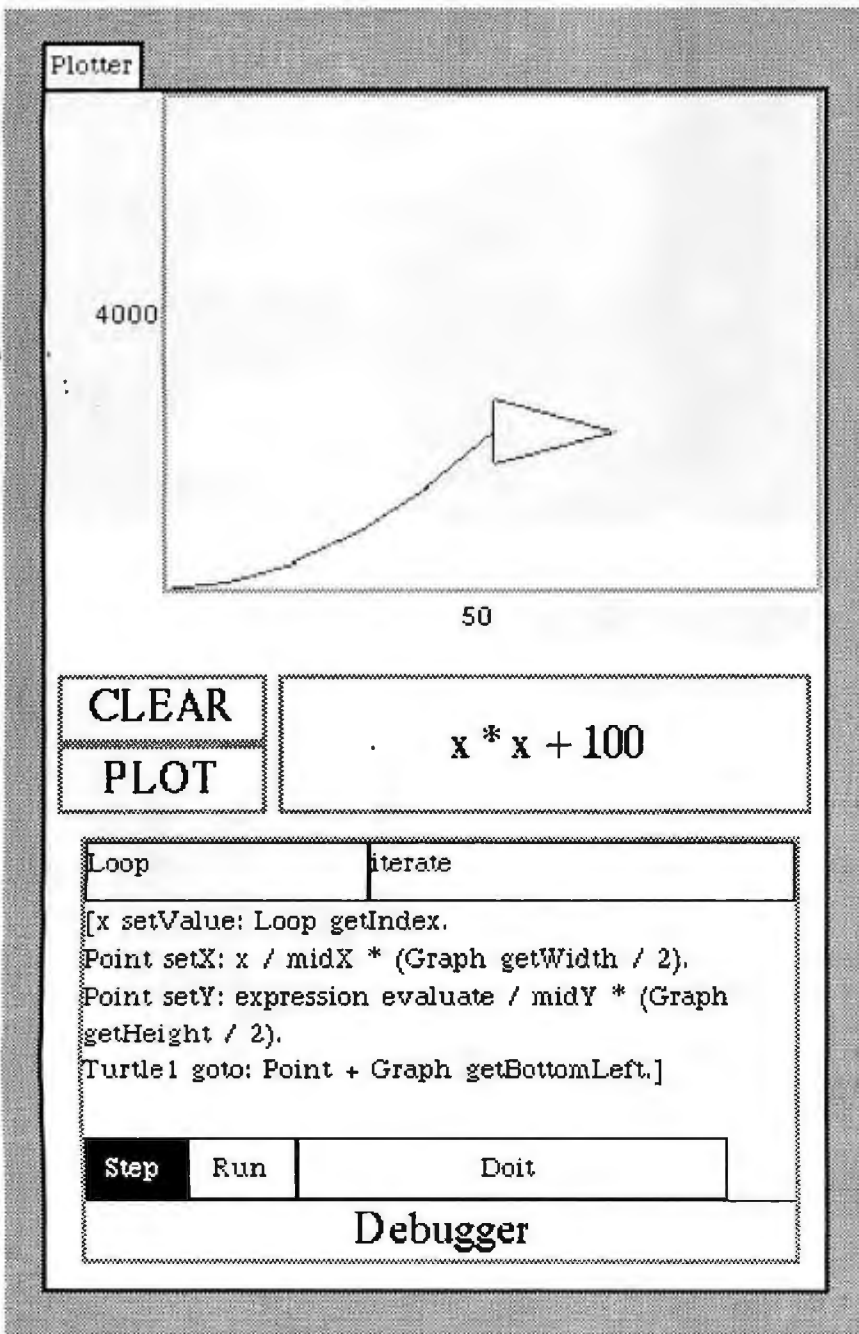

Figure 13: A stage on which a Debugger performer has been placed temporarily so that the designer may observe the code for each successive action.

COMPUTER HUT™

COMPARE
OUR
SERVICE & PRICE!

SPECIAL OF THE MONTH

IBM-PC & XT
CALL FOR
PRICE

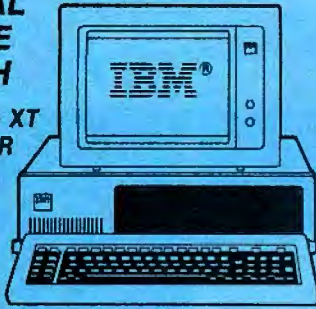

Tandon TM100-2 DS/DD \$225
PANASONIC JA 551
SHUGART SA-455 half-high **BEST**
TEAC FD-55B Slimline **PRICES**
AMDEK half-high
HITACHI half-high

MAYNARD ELECTRONICS

Floppy Disk Controller \$169
 FDC w/Par. Port \$219
 FDC w/Ser Port \$239
SANDSTAR SERIES CALL

QUADRAM

Quadboard-PP,SP,C/C,Mem + s/w
 Expandable to 384K CALL
 Quad 512 + SP,Mem with s/w
 64K \$249
 Quadcolor CALL

AST RESEARCH

MegaPlus II 4-Funct 64K + s/w \$279
 6-Pack 5-Funct 64K + s/w \$279
 I/O Plus \$129

TECMAR

Graphics 720 x 400 16 colors \$529

HERCULES

Hi Res Graphics 720 x 348 \$359

FREDRICKS ELECTRONICS

COLORPLUS 640 x 200,
 16-Color + s/w \$399

MA SYSTEMS

PC Peacock w/Par Port \$275

MICROLOG

Baby Blue \$359
 Baby Blue II 64K \$575

PARADISE

Multidisplay \$395

HARD DISK - IBM-PC & XT

MOUNTAIN — External Syst.
 5MB \$1539 10MB \$1799
 15MB \$2309 20MB \$2549
 20M Tape back up \$1695
MAYNARD CALL

PRINTERS

EPSON
 FX80 CALL FX100... CALL
brother
 HR1 A Par \$599
 HR-15 Par \$459
 HR-25 CALL

DYNAX

DX-15 Par \$459 Ser \$489

C-JTOH

STARWRITER A-10 CALL
 STARWRITER F-10P \$1095
 PROWRITER 8510 SP 180 CPS \$649

star MICRONICS

Gemini 10X ... \$299 15X ... \$399

OKIDATA

82A CALL 83A CALL
 84P 84S
 92P **BEST** 92S **BEST**
 93P **PRICES** 93S **PRICES**

NEC

3510 \$1485 7710 \$1995
 3515 \$1479 7715 \$2039
 3530 \$1575 7720 \$2495
 3550 \$1695 7730 \$1995
 2000 Series CALL

TOSHIBA

P1351 \$1649
 P1340 \$849

IDS, DAISYWRITER CALL

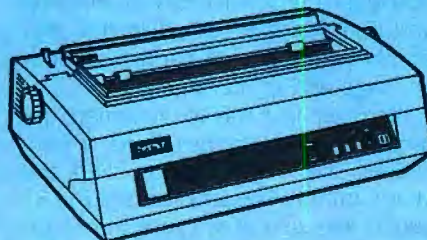

MODEMS

HAYES

Smartmodem 1200 \$489
 Smartmodem 1200B \$419

NOVATION, US ROBOTICS CALL

COMPUTERS

EAGLE

CALL

COLUMBIA DATA PRODUCTS, INC.

CALL

CORONA

CALL

TAVA PC

CALL

COMPAQ

CALL

MONITORS

AMDEK

Video 300G... \$145 300A... \$155
 Video 310A \$189

Color II \$429 Color II + CALL

PGS

HX12 Hi Res RGB monitor... **BEST**
 MAX-12 Hi Res Mono. **PRICES**

SR-12 Super Hi Res RGB



SOFTWARE FOR IBM-PC

Word Perfect \$299 WordStar \$275
 DBase II... \$389 VisiCalc ... \$189
 Multiplan... \$175 Multimate... \$299
 MICROSOFT Word \$269

AND LOTS MORE

CANADIAN COMPUTER HUT

AUTHORIZED DEALER

MICROCONTEXT INC.

5253 AVE DU PARC

MONTREAL

QUE H2V4P2.

(514) 279-7291

Published Prices are for U.S.A. Only
 Please call for Canadian Prices

ANY PRODUCT NOT LISTED? CALL

COMPUTER HUT
 OF NEW ENGLAND INC.
 101 Elm St., Nashua, NH 03060

ORDERS & INFORMATION
(603)889-0666

ORDER-LINE ONLY
 PLEASE
(800) 525-5012

All products usually in stock for immediate shipment and carry full manufacturers' warranty. Price subject to change — this ad prepared two months in advance. You get the lowest price. We honor personal checks — allow 10 days to clear. COD up to \$300 add 3%. Visa, MasterCard add 3%. For shipping & insurance add 3% or \$5.00 min. for small items and \$10 min for monitors, printers, etc. APO & FPO orders add 12%. Include phone number.

IBM is a trademark of IBM Corp.

Return authorization and order status (603) 889-7625

Circle 76 on inquiry card.

REHEARSAL

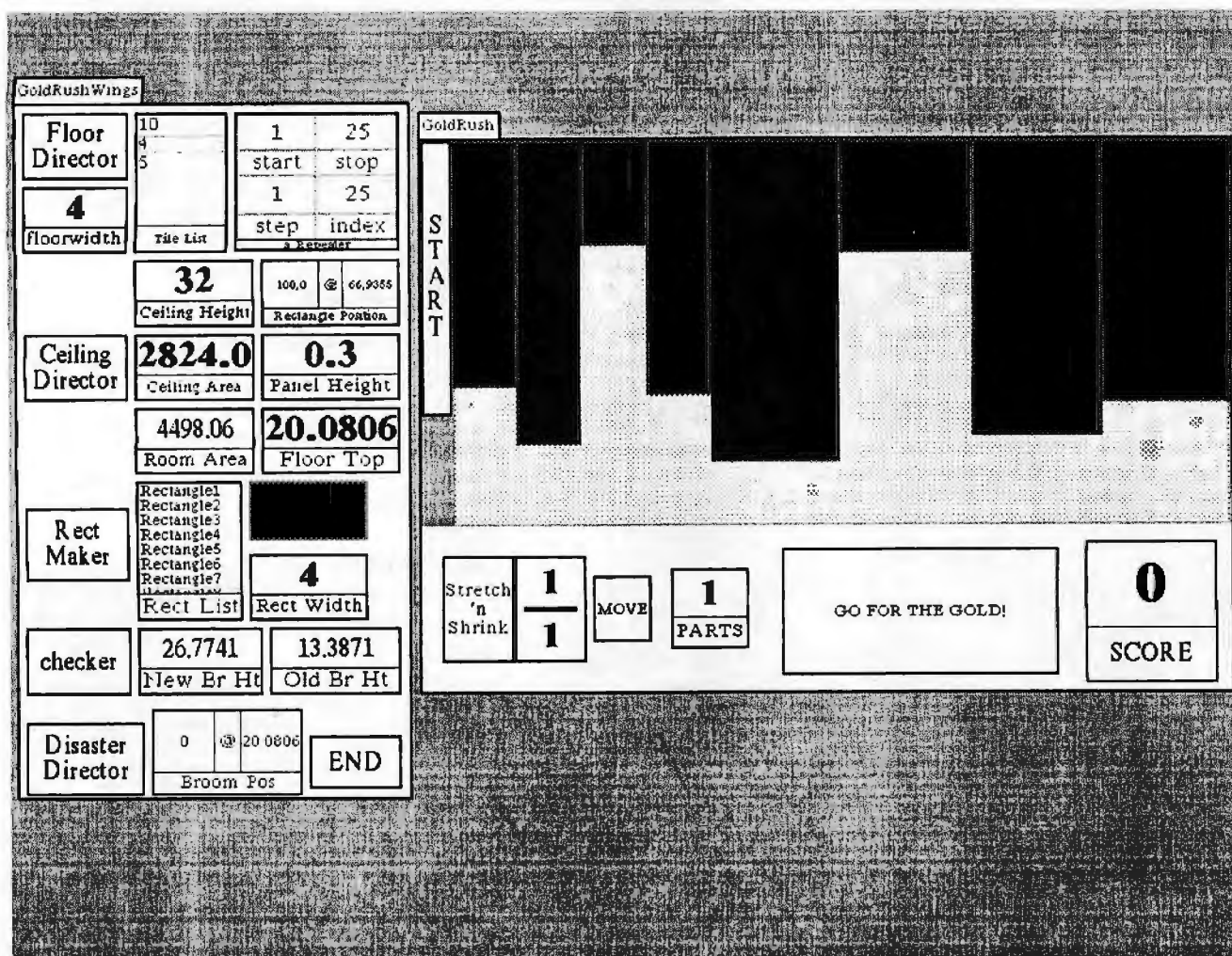

Figure 14: The GoldRush game and its complicated wings, showing more performers backstage than are on stage.

(text continued from page 202)

had expected them to embark on something at the level of the Jumble Game described earlier. Rather than starting with a toy example for practice, they were embarking on a real-world task after only one day's experience. We worried that they had chosen something too difficult for them to accomplish in the remaining two days.

By lunch time they had figured out how to use the Turtle to draw the floor. They said, "We need a Floor Director to be in charge of drawing the floor" and placed a button in the wings labeled FloorDirector for that purpose. They used this same strategy to make a CeilingDirector, a Checker to test whether or not the broom was touching the ceiling, and a DisasterDirector in charge of what should happen when it did. Certain performers had become, if you will, visible procedures. They invented this strategy on their own, led to it by the Rehearsal World's emphasis on buttons.

Next to these directors in the wings,

they placed the performers that would be needed by the directors to accomplish their tasks. These performers fulfill the role of variables; since everything in the Rehearsal World must be visible, all variables must be represented by performers. By grouping their performers in a logical manner, they could debug their program easily by selecting a button, like the CeilingDirector, and simply watching what happened, both on stage and in the wings.

Their next task was to implement the broom (for which they used a Rectangle), the START button, and the MOVE button. The action of the START button was simply to cause the FloorDirector and the CeilingDirector to perform their button actions. The action of the MOVE button was first to move the broom and then to ask the Checker to determine whether or not the broom was touching the ceiling. If it was, it asked the DisasterDirector to perform its action; if it wasn't, the Checker computed the score. That they had not yet

even designed the disaster didn't matter; they were using top-down programming techniques, realizing that they could return later and replace the empty code block of the DisasterDirector with whatever they wanted.

By the end of the day, the FloorDirector and the CeilingDirector were both working properly and they could move the broom through the cave. They started to plan the randomness that they wanted to build into the button action of the START button.

The next day they made a fraction to be edited by the user, creating it from two Numbers and two Rectangles, one to act as the line between the Numbers, the other to act as a frame. This looked and worked fine, but they soon discovered that it was a great disadvantage to be dealing with four independent performers instead of a single unified one: whenever they decided that their fraction was the wrong size or in the wrong place, they had to resize or move

(text continued on page 206)

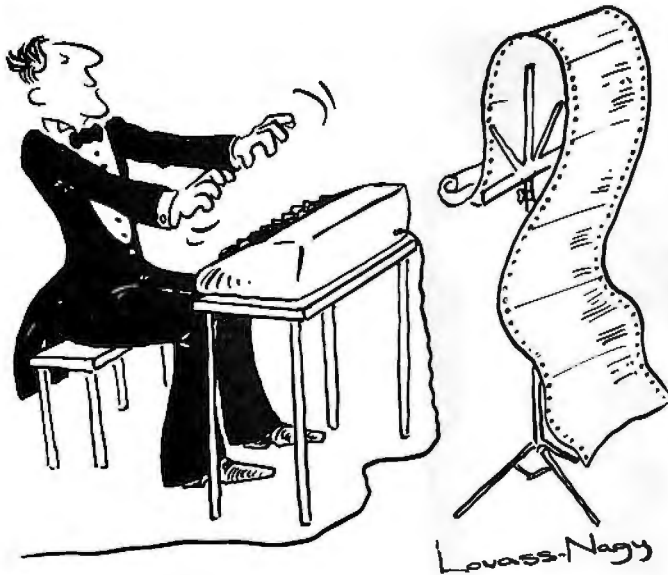

Before Johann Sebastian Bach developed a new method of tuning, you had to change instruments practically every time you wanted to change keys. Very difficult.

Before Avocet introduced its family of cross-assemblers, developing micro-processor software was much the same. You needed a separate development system for practically every type of processor. Very difficult and very expensive.

But with Avocet's cross-assemblers, a single computer can develop software for virtually any microprocessor! Does that put us in a league with Bach? You decide.

The Well-Tempered Cross-Assembler

Development Tools That Work

Avocet cross-assemblers are fast, reliable and user-proven in over 3 years of actual use. Ask NASA, IBM, XEROX or the hundreds of other organizations that use them. Every time you see a new microprocessor-based product, there's a good chance it was developed with Avocet cross-assemblers.

Avocet cross-assemblers are easy to use. They run on any computer with CP/M* and process assembly language for the most popular microprocessor families.

5¼" disk formats available at no extra cost include Osborne, Xerox, H-P, IBM PC, Kaypro, North Star, Zenith, Televideo, Otrona, DEC.

Turn Your Computer Into A Complete Development System

Of course, there's more. Avocet has the tools you need from start to finish to enter, assemble and test your software and finally cast it in EPROM:

Text Editor VEDIT -- full-screen text editor by CompuView. Makes source code entry a snap. Full-screen text editing, plus TECO-like macro facility for repetitive tasks. Pre-configured for over 40 terminals and personal computers as well as in user-configurable form.

CP/M-80 version \$150
 CP/M-86 or MDOS version \$195
 (when ordered with any Avocet product)

EPROM Programmer -- Model 7128 EPROM Programmer by GTek programs most EPROMS without the need for personality modules. Self-contained power supply ... accepts ASCII commands and data from any computer through RS 232 serial interface. Cross-assembler hex object files can be down-loaded directly. Commands include verify and read, as well as partial programming.

PROM types supported: 2508, 2758, 2516, 2716, 2532, 2732, 2732A, 27C32, MCM8766, 2564, 2764, 27C64, 27128, 8748, 8741, 8749, 8742, 8751, 8755, plus Seeq and Xicor EEPROMS.

Avocet Cross-assembler	Target Microprocessor	CP/M-80 Version	CP/M-86 IBM PC, MSDOS** Versions
XASMZ80	Z-80	\$200.00 each	\$250.00 each
XASM85	8085		
XASM05	6805		
XASM09	6809		
XASM18	1802		
XASM48	8048/8041		
XASM51	8051		
XASM65	6502		
XASM68	6800/01		
XASMZ8	Z8		
XASMF8	F8/3870		
XASM400	COP400		
XASM75	NEC 7500		\$500.00
Coming soon: XASM68K...68000			\$300.00 each

(Upgrade kits will be available for new PROM types as they are introduced.)

Programmer \$429

Options include:

Software Driver Package -- enhanced features, no installation required.
 CP/M-80 Version \$ 75
 IBM PC Version \$ 95
 RS 232 Cable \$ 30
 8748 family socket adaptor ... \$ 98
 8751 family socket adaptor ... \$174
 8755 family socket adaptor ... \$135

G7228 Programmer by GTek -- baud to 2400 ... superfast, adaptive programming algorithms ... programs 2764 in one minute.

Programmer \$549

Ask us about Gang and PAL programmers.

HEXTRAN Universal HEX File Converter -- Converts to and from Intel, Motorola, MOS Technology, Mostek, RCA, Fairchild, Tektronix, Texas Instruments and Binary formats.

Converter, each version \$250

Call Us

If you're thinking about development systems, call us for some straight talk. If we don't have what you need, we'll help you find out who does. If you like, we'll even talk about Bach.

CALL TOLL FREE 1-800-448-8500
 (In the U.S. except Alaska and Hawaii)

VISA and Mastercard accepted. All popular disc formats now available -- please specify. Prices do not include shipping and handling -- call for exact quotes. OEM INQUIRIES INVITED.

*Trademark of Digital Research **Trademark of Microsoft



AVOCET SYSTEMS INC.™

DEPT. 684-B
 804 SOUTH STATE STREET
 DOVER, DELAWARE 19901
 302-734-0151 TELEX 467210

To master the computer, master the software

Challenge your ability. Take charge of your computer. Take pride in the results.

You've invested in the computer. Now invest in yourself. Writing your own software lets you define your own boundaries, broaden your problem-solving resources and puts you in complete command at the keyboard. It's challenging. It's exciting. And now it's easier than ever before with Self-Study Computer Courses from Heathkit/Zenith.

Master today's most powerful contemporary languages including Microsoft BASIC, PASCAL and FORTRAN. And learn the popular CP/M and MS-DOS operating systems, too. When you need to know, we'll take you as far as you want to go.

For more information, send for our FREE colorful catalog below or circle the reader service number.

Our colorful catalog is FREE! If coupon is missing write: Heath Company, Dept. 334-182, Benton Harbor, MI 49022.



Send for yours today!
FREE CATALOG

Mail to: Heath Company
Dept. 334-182
Benton Harbor, MI 49022

Name _____

Address _____

City _____

State _____ Zip _____

CP-225

Heathkit
Heathkit/Zenith



(text continued from page 204)

four performers commensurately.

Consequently they felt the need to create a new Fraction performer, which they did by placing two Numbers and a Rectangle for the central line on an otherwise empty stage. Since other performers would need to use the values of the numerator and denominator of this Fraction performer, they taught this stage the new cues *getNumerator*, *getDenominator*, and *getValue*. Then they told it to convert itself into a new performer named Fraction and promptly used it in their production.

By the end of the third day, they had a game that worked, that they could respond to, that they liked, and that still needed improvement.

An extra day of work was devoted to adding new features. A Number performer called Parts was added that could be edited by the user; its change action was to show the broom divided into the number of parts indicated. This additional piece of design arose from their interaction with the production; had they been working entirely from a paper sketch, this improvement might not have occurred to them.

They then invited others in our research center to play. Although it had been designed for third-graders, our colleagues found the game interesting and fun to play. They were impressed with the quality of the game and especially with the fact that the designers were nonprogrammers, yet had implemented something so complicated in only a few days.

Eventually we found some children of an appropriate age to be students; they also enjoyed playing the game and spent many hours trying to make a perfect score. Diane now plans to reimplement GoldRush at San Francisco State using the Rehearsal World design as a prototype but changing it to run on different hardware, which might include color and have a different pointing mechanism.

RESEARCH QUESTIONS

Our experiences with designers have given us confidence that our general ideas about how to make the power of computers accessible to nonprogrammers are correct. We believe that interactive, graphical programs could and

(text continued on page 208)

FUJITSU PRINTERS

*You can't buy
more Performance
for the Price.*

Finally, there is a full line of quality printers available to meet a variety of needs. And all from a single manufacturer...

FUJITSU. From dependable dot matrix printing to advanced thermal printing, you can't buy more performance for the price.

Quality That's Built In: Fujitsu quality is built into every printer manufactured. That quality translates into high reliability (MTBF), versatile print capability, low maintenance, low noise,

and high speeds. And Fujitsu printers are serviced by TRW, a nationwide service organization.

A Complete Printer Line: Fujitsu's dot matrix printer, with its 24 wire head, offers letter quality printing at 80 CPS. With its ability to also produce draft quality, correspondence quality and high resolution graphics, the Fujitsu DPL24 leads dot matrix technology.

In daisy technology, Fujitsu's SP830 is the fastest letter quality printer in the industry at 80 CPS. Fujitsu's SP320 daisy-wheel printer also provides cost effective letter quality printing at medium speeds.

Fujitsu offers thermal printing with its TTP16 printer. The low-cost printer accepts a wide variety of papers and operates quietly at less than 50 dBA.

Call Us Today: Contact Fujitsu America, Inc., at 408-946-8777 for the printer distributor nearest you.

DISTRIBUTORS: Algram Computer Products (415) 969-4533, (714) 535-3630, (206) 453-1136, (916) 481-3466; Allen Edwards Associates, Inc. (213) 328-9770, (714) 552-7850, (619) 273-4771, (805) 498-5413; Four Corners Technology (602) 998-4440, (505) 821-5185; Gentry Associates, Inc. (305) 859-7450, (305) 791-8405, (813) 886-0720, (404) 998-2828, (504) 367-3975, (205) 534-9771, (919) 227-3636, (803) 772-6786, (901) 683-8072, (615) 584-0281; Hopkins Associates, Inc. (215) 828-7191, (201) 273-2774; Inland Associates, Inc. (913) 764-7977, (612) 343-3123, (314) 391-6901; Logon, Inc. (201) 646-9222; Lowry Computer Products, Inc. (313) 229-7200, (216) 398-9200, (614) 451-7494, (513) 435-7684, (616) 363-9839, (412) 922-5110, (502) 561-5629; MESA Technology Corp. (301) 948-4350; NACO Electronics Corp. (315) 699-2651, (518) 899-6246, (716) 233-4490; Peak Distributors, Inc., (An affiliate of Dytect/Central) (312) 394-3380, (414) 784-9686, (317) 247-1316, (319) 363-9377; R² Distributing, Inc. (801) 298-2631, (303) 455-5360; S&S Electronics, (617) 458-4100, (802) 658-0000, (203) 878-6800, (800) 243-2776; USDATA (214) 680-9700, (512) 454-3579, (713) 681-0200, (918) 622-8740.



PERIPHERAL PRODUCTS DIVISION

Quality Lives



Softline

FOR YOUR
BOTTOM LINE.

Lotus 1-2-3	\$319	dBase II	\$369	WordStar Professional	\$369	Multi Mate	\$279
-------------	-------	----------	-------	-----------------------	-------	------------	-------

WORD PROCESSING/ EDITORS

Easywriter I System (3 pak)	\$149
Easywriter II System (3 pak)	\$199
Edix/Wordix	\$279
Ernst Writer	\$199
Final Word	\$189
Microsoft Word	\$239
Microsoft Word/Mouse	\$299
Multimate	\$279
PeachText 5000	\$199
Perfect Writer/Speller	\$249
PFS: Write	\$ 95
Samna Word II	\$329
Select Word Processor	\$199
Spellbinder	\$249
SSI Word Perfect	\$Call
SuperWriter	\$179
Volkswriter	\$129
Volkswriter Deluxe	\$179
The Word Plus (Oasis)	\$109
WordPlus-PC with The Boss	\$329
WordStar	\$249
WordStar Professional (WS/MM/SS/SI)	\$369
WordStar Options Pak (MM/SS/SI)	\$189

ACCOUNTING MODULES

Ask Micro Accounting	\$299
BPI Accounting	\$369
IUS EasyBusiness System	\$319
MBA Accounting	\$369
Open Systems Accounting	\$459
Peachpak 4 (GL/AP/AR)	\$239
Peachtree Accounting	\$399
Real World Accounting	\$469
Star Accounting Partner (GL/AP/AR/PAY)	\$269

HOME/PERSONAL FINANCE

Dollars and Sense	\$119
Financier II	\$119
Home Accountant Plus	\$ 99
Tax Preparer 84	\$189

DATABASE SYSTEMS

Alpha Data Base	\$179
Manager II	\$329
Condor III	\$329
dBase II	\$369
DBplus	\$ 89
Easy Filer	\$219
Friday	\$179
InfoStar	\$269
Knowledgeman	\$309
Perfect Filer	\$159
Personal Pearl	\$199
PFS: File/PFS: Report	\$169
QuickCode	\$179
R-base 4000	\$299
T/Maker III	\$199
TIM IV	\$269
Versaform	\$249

PROJECT MANAGEMENT

Harvard Project Management	\$289
Scitor Project Scheduler	\$229
VisiSchedule	\$199

GRAPHICS

BPS Business Graphics	\$229
Chartman Combo (II&IV)	\$349
Chartmaster	\$259
dGraph	\$189
Fast Graphs	\$199
Graphwriter Extended	\$429
PC Draw	\$219
PFS: Graph	\$ 95
VisiTrend/Plot	\$199

SPREADSHEETS/MODELING

Jack 2	\$Call
Lotus 1-2-3	\$319
Multiplan	\$159
Perfect Calc	\$159
SuperCalc 3	\$239
TK! Solver	\$Call
VisiCalc IV	\$159

LANGUAGES/UTILITIES

Access Manager	\$239
Digital Research	
C Compiler	\$219
Display Manager	\$299
Microsoft C Compiler	\$329
MS Basic Compiler	\$249
MS Fortran	\$239
Pascal MT+86	\$249
Norton Utilities	\$ 59

COMMUNICATIONS/PRODUCTIVITY TOOLS

Crosstalk	\$119
Memory Shift	\$ 79
Move II	\$109
Prokey 3.0	\$ 95

HARDWARE PERIPHERALS*

AST Six Pack Plus (64k)	\$ 299
Quadboard (0k)	\$ 229
Hayes 1200B with Smartcom	\$ 439
Hayes Smartmodem 1200	\$ 549
Hercules Graphics Board	\$ 359
Epson FX-100 Printer	\$Call
Comrex II Printer	\$Call
NEC 3550 Printer	\$1899
C Itoh Prowriter	\$ 399
C Itoh Starwriter	\$1249

*Add 3% for shipping.

R-base 4000	\$299	Word & Mouse	\$299	Microsoft C	\$329	AST Six Pak Plus	\$299
-------------	-------	--------------	-------	-------------	-------	------------------	-------

EXTRA \$\$\$ SAVINGS

With each order, we offer discount coupons worth up to \$10 on your next order.



free!
Diskette Library Case

... with your order. This attractive case protects, indexes and stores 10 diskettes for quick retrieval. Normally a \$10 value, it is now available **FREE** to Softline customers

TERMS:
Checks—allow 14 days to clear. Credit processing—add 3%. COD orders—cash, M.O. or certified check—add \$3.00. Shipping and handling UPS surface—add \$3.00 per item (UPS Blue \$6.00 per item). NY State Residents—add applicable sales tax. All prices subject to change.

To Order call
1-800-221-1260
In New York State call (212) 438-6057

For technical support and information call (212) 438-6057

Monday thru Friday
9:00 AM - 7:00 PM
Sundays
10:00 AM - 4:00 PM



Softline Corporation
3060 Bedford Ave., Brooklyn, N.Y. 11210
TELEX: 421047 ATLN UI

(text continued from page 206)

should be built inside an interactive, graphical programming environment. We believe that for such programs, some sort of visual, spatial programming will eventually supplant the current process of writing lines of textual code. Nevertheless, we have many unanswered questions about the nature of visual programming.

An important aspect of the Rehearsal World is that everything is made visible; only things that can be seen can be manipulated. Thus, rather than thinking abstractly, as is necessary in most programming environments, a designer is always thinking concretely, selecting a particular performer, then a particular cue, then observing the cue's instant effect. We know that much of the initial accessibility of the system is due to this concrete, visual, object-oriented approach. What we don't know are its shortcomings.

As designers create increasingly large and sophisticated productions, they may find it a nuisance to have to instantiate everything (even temporary variables) in the form of a performer. There are problems with space on the screen and with visual complexity. Some of these problems are addressed by the ability to collapse a large set of performers into a single new one, which can be made very small while still retaining its original functionality. This helps not only with space but with factoring the production into significant pieces.

While beginning designers benefit from the concreteness, more experienced ones will benefit from being able to think in more general and abstract terms. They are led to think in general terms by the fact that all performers respond to a large set of common cues; they are led to think in abstract terms through the manipulation of Lists and Repeaters. Still, it may be difficult to build productions, for example, that need to access large amounts of data. At some point, the concreteness may become a barrier rather than an advantage.

We know that the "watching" facility is very important to beginners and makes it possible for them to "write" code without learning a language. But it's really very simple and is in no way "programming by example"; it employs

(text continued on page 210)



Save Your Memory Before It Blows!

Blackouts...Brownouts...Voltage Surges...Line Noise—
They Can Alter Data, Wipe Out RAM Memory,
or Damage Equipment.

The Datashield Backup Power Source Can Stand Between
Your PC and Disaster from Power Irregularities.

Protect Yourself Four Ways With Datashield

This rechargeable, battery-operated unit —
with built-in surge protector — provides
maximum protection against all four
commercial power problems that can impact
your PC: power outage, power drops, voltage
spikes, and electromagnetic or radio
interference (EMI/RFI).

PC-200. Designed for flexible
disc PC's and some hard disc styles.

NOW...ONLY \$359⁰⁰

XT-300. Designed for
most hard disc type
models and color monitors.

NOW...ONLY \$499⁰⁰

Never Say Never...

It can happen to any PC owner. It
probably will. Maybe it already did. But
it was blamed on something else. Listen:

"Nearly one million Florida homes and businesses lost electricity for 15-30 minutes
yesterday morning when a power outage..." Wall Street Journal

"Powerline irregularities cause problems for computers...you face hazards every
time you plug in a piece of electronic equipment..." Byte Magazine

"Powerline associated problems are estimated to cause nearly 70% to 90% of
malfunctions in microprocessor-based equipment." PC Magazine

"Computer crashes are giving businesses major headaches. The culprit is sudden
blackouts..." U.S. News & World Rep.

"Fifty percent of our service calls are power related." Televideo

"Computer service calls are reduced by 65% when surge protectors
are used." Digital Retail Magazine

There is one sure way to avoid becoming a statistic: Datashield.
The most technologically advanced product in its class. And
the most affordable.

What Was Once An Expensive Luxury Is Now An Affordable Necessity

Circle 99 on inquiry card.

Datashield[®]
Datashield is a U.S. registered trademark of PTI Industries

320 River Street, Santa Cruz, California 95060 (408) 429-6881



Technical Data	
Backup Time	
Min. 50% Load	20 Minutes
Min. 100% Load	5 Minutes
Output Rating	
PC-200	200 Watts
XT-300	300 Watts
Typical Transfer Time	
PC-200	4 Millisec. (1/4 Cycle)
XT-300	1 Millisec. (1/16 Cycle)
Energy Dissipation	100 Joules

(text continued from page 208)

no generalizations but merely makes a textual record of a performer being sent a cue, perhaps with parameters. Again, advanced designers might be led to think abstractly rather than specifically if the Rehearsal World provided a more powerful watching facility that was capable of some form of generalization.

In the Rehearsal World, button action and change action are the major mechanisms for expressing the interactions of all performers; a few performers, like the Repeater, the List, and the Traveler, have other special actions as well. Designers find these actions very natural and so far have had no difficulty describing their needs in these terms. However, the Rehearsal World does not provide designers with the facility to create new types of actions for new performers, and this may become a problem in the future.

The Rehearsal World supports multiple processes in such a natural way

that our designers are not surprised by the existence of this facility as they interrupt whatever they're doing to do something else. However, we have little experience with designers using multiple processes in some production and expect a variety of conceptual and mechanical difficulties to arise.

Designers express actions in a procedural fashion, instructing a performer to send a cue under certain conditions.

We are curious about how designers would deal with a constraint-based Rehearsal World in which the relationships between performers were expressed in terms of conditions that should always hold true (for example, that the value of a Number should always be twice that of another Number). We hope that researchers working on similar design environments will explore these questions. ■

REFERENCES

1. Brown, Dean, and Joan Lewis. "The Process of Conceptualization." Educational Policy Center Research Note EPRC-6747-9. SRI Project 6747. December, 1968.
2. Oettinger, Anthony, with Sema Marks. *Run, Computer, Run*. Cambridge, MA: Harvard University Press, 1969.
3. Gould, Laura, and William Finzer. "A Study of TRIP: A Computer System for Animating Time-Rate-Distance Problems." *International Journal of Man-Machine Studies* (1982) 17, 109-126.
4. Ingalls, Daniel H. H. "The Smalltalk-76 Pro-

- gramming System: Design and Implementation." *Conference Record of the Fifth Annual ACM Symposium on Principles of Programming Languages*. Tucson, AZ: 1978.
5. BYTE, August 1981.
6. Goldberg, Adele. *Smalltalk-80: The Interactive Programming Environment*. Reading, MA: Addison-Wesley, 1984.
7. Goldberg, Adele, and David Robson. *Smalltalk-80: The Language and its Implementation*. Reading, MA: Addison-Wesley, 1983.
8. Krasner, Glenn, ed. *Smalltalk-80, Bits of History, Words of Advice*. Reading, MA: Addison-Wesley, 1983.

DEALERS ONLY!

IBM PC™Compatible **SANYO**
Business Computer System

STANDARD FEATURES:

- MS DOS
- 16 Bit 8088 CPU
- SANYO BASIC
- 128K Internal Memory
- Centronics Printer Port
- Color Graphic Capabilities
- Diagnostics, Utilities, Speaker & Joystick Port



CALL FOR PRICING!

MBC 550

- 1 single sided/double density disk drive (160K)
- WordStar & CalcStar Included

RETAIL \$999.00

MBC 555

- 2 single sided/double density disk drives (320K)
- 128K memory expandable to 256K
- WordStar, CalcStar, DataStar, InfoStar, & MailMerge Included

Also available in double sided drives

MEC MICRO EQUIPMENT CORPORATION
245 West Wieuca Rd.
Suite 210
Atlanta, Ga. 30342
404/843-3128

BEFORE YOU BUY CABLE ASSEMBLIES,

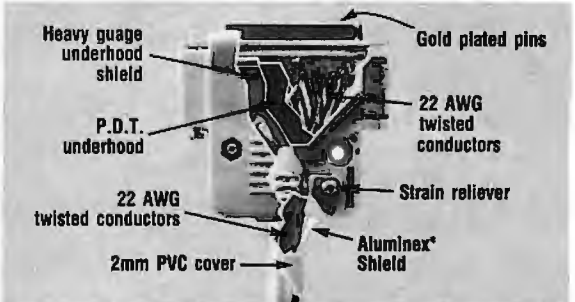

CHECK UNDER THE HOOD!

DATA SPEC™ cable assemblies are the very best. Each cable is fully shielded to exceed FCC EM/RFI emission requirements. Furthermore, the unique P.D.T. technique is employed beneath the hood shield for maximum integrity under the most adverse conditions. DATA SPEC™ was the first to use the P.D.T. process, and cable assemblies constructed with P.D.T. carry a lifetime warranty. DATA SPEC™ has interface cables for all your requirements: Modems, Monitors, Disk Drives, and much more. Insist on DATA SPEC™ cables in the bright orange package. Available at better computer dealers everywhere. For more information, call or write:

DATA SPEC™
A Division of Alliance Research Corporation
18215 Parthenia Street, Northridge, CA 91325 (818) 701-5853

KNOWLEDGE SYSTEMS INC.

Information Processing Components, Selected for Performance and Value.

FREE SHIPPING — NO EXTRA CHARGE FOR MASTER CARD AND VISA
PREPAID PRICES INCLUDE SHIPPING AND INSURANCE, UPS Ground Continental USA only.

MONITORS

Amdek		
300A	143	
300G	133	
310A	175	
Dynax		
12" Green	127	
12" Amber	138	
Taxan		
RGB III	446	
RGB 420	534	
PGS		
PCS HX12	473	
MAX 12	196	
SR 12	Call	
USI		
Pi 2 12" Green	125	
Pi 3 12" Amber	142	
Sanyo		
8112 Hi/Res	195	
NEC		
JB 1201	162	
JB 1205A	172	
JC 1410	817	

MODEMS

Hayes		
300	207	
1200	493	
1200B	432	
Micromodem IIe W/T	242	
US Robotics		
Password	307	
Autodial 212A	460	
Novation		
Access 1,2,3	454	
Apple Cat II	277	
Prometheus Products		
Promodem 1200	365	
Options Processor	78	
Memory \$30 per 16K up to 64K	64K	
Alphanumeric Display	78	
Procom Software-Apple, IBM	78	
Rixon		
PC212A	415	
P212A	415	

IBM ACCESSORIES

Ast Research		
6-Pack	225	
Combo Plus	225	
Mega Plus	225	
64 K Ram Set	55	
Plantronics		
Color Plus	375	
Hercules Computer		
Hercules Graphics Card	350	
Amdek		
MAI	477	
Koala		
Koala Graphic Tablet	Call	
Everex		
Dual Display	Call	
Number 9		
Number 9 1448X1448	Call	

PRINTERS

C. Itoh			
Prowriter 8510P	120 cps	340	
Prowriter 8510SP	180 cps	477	
Prowriter 8510SPC	180 cps color	552	
Prowriter 1550P	120 cps	552	
Prowriter 1550SP	180 cps	685	
Prowriter 1550SPC	180 cps color	777	
New CX4800 plotter		518	
New A10 18 cps Daisy Wheel		510	
Starwriter F10 40 cps Daisy Wheel		915	
Printmaster F10 55 cps Daisy Wheel		1265	
We Know How to Make Your Prowriter IBM Compatible			
Okidata			
92p	160 cps	427	
93p	160 cps	705	
IBM Printer Rom		45	
2350	350 cps	2000	
2410		2380	
Star Micronics			
Gemini 10X	120 cps	285	
Gemini 15X	120 cps	423	
Delta 10	160 cps	448	
Delta 15	160 cps	633	
NEC			
3550	40 cps	1698	
7710	55 cps	1899	
Brother			
HR1	16 cps	569	
HR25	23 cps	765	
HR35	34 cps	Call	
Dynax			
DX15	14 cps	477	
Keyboard		149	
IDS			
Prism 132 color		1535	
Prism 80 color		1419	
Transtar			
315 color		450	
Silver Reed			
550		595	
500		431	
Juki			
18 cps		450	
Teletex			
12 cps		455	
Mansman Tally			
Spirit	80 cps	315	
160	160 cps	641	

DISK DRIVES

For IBM			
Tandon TM100-2		180	
Teac 55B 1/2 Height		175	
Panasonic/Shugart 1/2 Height		194	
CDC		220	
For Apple			
Super 5 1/2 Height		203	
Quentin Ap 100-Y		242	
Quentin Ap 105-Y 1/2 Height		213	
Quentin Controller		48	
Rana 1		255	
Rana 1 with Controller		325	
Hard Disks			
		Call	

HAVE IT YOUR WAY

18 Slot Chassis
125 Watt Power
and
IBM Compatible CPU

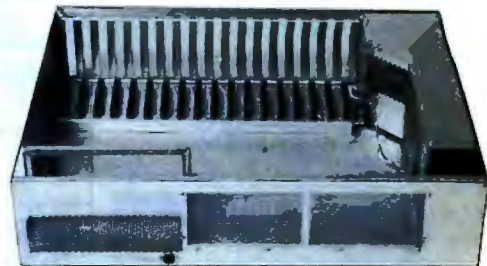

IMP SYSTEM — \$1,300

The S-100 Concept for IBM Compatible Systems

You want a computer. You like the flexibility and options of the IBM PC. EXCEPT there are some things that you want your way. YOU:

- Don't like the funny keyboard.
- Want 1/2 height drives so you can add a hard disk later.
- Want a powerful supply that is adequate for disk expansion.
- Want more than three additional slots.
- Want a faster or different CPU.
- Want higher resolution graphics.
- Want Dvorak or other keyboard layout.

	List	Our
TIME SPECTRUM	395	Call
APSTEK	369	Call
CRAMBO	359	Call
BIG BLUE	600	Call
EASIBOARD + 15 functions	350	~230
Maynard Sandstar		Call
PC GT 80186 8MHz	1195	Call
Scion	1595	150
Halo-Intlght High Res Graphics	150	1195
PROTIUM	1195	169
Keytronics Keyboard QWERTY	169	169
Keytronics Keyboard DVORAK	169	255
Keytronics Keyboard 5151	255	
Lotus 1-2-3 users, you need this keyboard.		

COMPUTERS

Franklin OMS 1200	1709
Columbia 1600-1	2600
TAVA PC	1900
Eagle I	1650
Eagle II	2050
Eagle III	2270
Eagle IV	3500
Eagle PC-2	2730
Eagle 1620	3400
Eagle 1630	5270
Eagle 1640	6400

TERMINALS

Teletext		
	563	
	717	
	914	
Wyse		
	569	
Teletex		
	460	
	3000	

SOFTWARE

Ashton Tate		
dBase II	389	
Friday	184	
Software Arts		
TK Solver	215	
Solver Pac	88	
Seasoned Systems		
Sure Stroke Dvorak Tutor	48	
Sorcim		
Super Calc III	189	
Micro Pro		
Wordstar	258	
Mail Merge	131	
Spellstar	131	
Pro Pack	475	
MBSI		
Realworld G1	533	
Realworld AR	533	
ATI		
For Most Software Programs	69	
Hayes		
Smart Com	72	
Micro Stuff		
Crosstalk	134	
Micro Rim		
RBase	344	
UNIX		
ONX System 5	Call	
De Smetc	Call	

(213) 344-4455

Knowledge Systems Inc.
19707 Ventura Blvd.
Woodland Hills, CA 91364

Circle 183 on inquiry card.

ORDERING TERMS

Prepaid: Money Orders, Cashier's Checks, Certified Checks, Bank Wire Transfers, Master Card, Visa, AMEX (add .3% for AMEX) and Personal Checks (allow 15 banking days for all personal checks). Please include Valid Driver's License # and Major Credit Card for Identification.

California Residents add 6.5% State Sales Tax
Shipping extra for outside USA, FPO and APO

Please include an address reachable by UPS, no P.O. boxes, and your phone number where you can be reached during the day.

OUR AD #B5

THE WORLD'S LARGEST COMPUTER MAIL ORDER FIRM

CONROY

ALL MAIL: Conroy-LaPointe, Inc. 12060 SW Garden Place, Portland, OR 97223
SHOWROOMS AT: PORTLAND, OR and SEATTLE, WA — BOTH OPEN M-SAT 10-6

HARDWARE for your APPLE

APPLE IIe, 128K, 80 COLUMN
APPLE IIe, STARTER SYSTEM BY APPLE

CALL CALL



APPLE MACINTOSH
UNITED WARRANTY is 100% Parts & Labor for 90 days by us.

CALL CALL

DISK DRIVES

Amdek 1.3" Micro-Floppy, 143K \$ 299 \$ 249

* CENTRAL PT., Fier, Utility & Apple DOS \$ 20 \$ 15

U-SCI
* A2, 1.43K Disk Drive \$ 479 \$ 229
* A2 Control Card \$ 100 \$ 79
* A4, 1.65K Drive \$ 449 \$ 299
* MICRO-SCI
* A70, 2.86K Drive \$ 599 \$ 299
* A4A70 Controller \$ 100 \$ 79

1/2 HIGH DRIVES
ALPS, A40, Belt Drive, 163K \$ 349 \$ 199
TEAC, 140, Direct Drive, 163K \$ 299 \$ 219
TEAC, 180, Double Sided, 320K \$ 449 \$ 329
Controller Card by ComX \$ 110 \$ 59

Rama
Elite 1, 1.63K, 40 Track \$ 379 \$ 259
Elite 2, 3.25K, 80 Track \$ 649 \$ 429
Elite 3, 6.52K, 160 Track \$ 849 \$ 539
Elite Controller \$ 145 \$ 89

RAM EXPANSION

* ALS, ADD Ram (1+) 16K \$ 100 \$ 49
* ComX, 80 col. +64K RAM/for (1e, 1) 16K \$ 199 \$ 99
* RAM Card, 1 Yr. Wty. (1+) 16K \$ 179 \$ 39
* Microsoft, RAM Card (1+) 16K \$ 100 \$ 69
* Titan/Saturn RAM Card (1+) 32K \$ 249 \$ 169
RAM Card (1+) 64K \$ 425 \$ 299
RAM Card (1+) 128K \$ 599 \$ 399

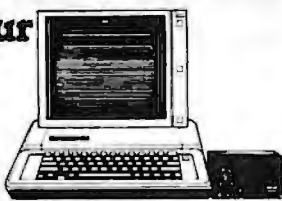

VIDEO CARDS

* ALS, Smartern II (+ or e) SPECIAL \$ 179 \$ 129
* ComX, 80 col. +64K RAM (1e) 1 yr. wty. \$ 199 \$ 99
* Video, VideoTerm 80 col. (+ or e) \$ 279 \$ 189
* UltraTerm (+ or e) \$ 379 \$ 279
* Soft Video Switch (1+) \$ 35 \$ 25
* Enhancer II (1+) \$ 149 \$ 99
* Function Strip (1+) \$ 39 \$ 29
We Have Full Video Line. Call. Up to 35% off.

MISCELLANEOUS

ALS, The CP/M Card V3.0 (+ or e) \$ 399 \$ 279
2-Card (+ or e) \$ 169 \$ 109
ASTAR, RF Modulator, to use TV \$ 35 \$ 25
* CCS, Serial Interface 7710 (Set BAUD) \$ 150 \$ 99
Chalkboard, Power Pad \$ 100 \$ 75
Eastside, Wild Card (copier, 1+ only) \$ 110 \$ 85
* Wild Card 2 (copier, + or e) \$ 140 \$ 99
Kensington, System Saver \$ 90 \$ 65
* Key Tronic, KB200 keyboard (1+) \$ 298 \$ 219
Koala, Touch Tablet w/Micro Illustrator \$ 125 \$ 85
Kraft, Joystick (Ap II/III+) \$ 65 \$ 49
* Paddle (Ap II/III+) \$ 50 \$ 39
* M&R, Sup Rfan (+ or e) \$ 50 \$ 39
* Microsoft, Z80 Software (+ or e) \$ 345 \$ 349
* * Z80 Software Plus (+ or e) \$ 465 \$ 465
* * Z80 Software Premium (1+) \$ 695 \$ 479
* * Z80 Software Premium (1e) \$ 495 \$ 339
* MicroTak, Dumping 64, Buffer \$ 349 \$ 269
* Orange Micro, Grappler Plus (e or +) \$ 175 \$ 119
16K Buffer Board for Grappler Plus \$ 175 \$ 119
Buffered Grappler Plus, 16K \$ 245 \$ 179
Paymar, Lower Case Chip, Rev. 7 (1+) \$ 50 \$ 39
* PCPI, Applicard, 14 features 6MHz \$ 375 \$ 275
RH Electronics, Super Fan II \$ 75 \$ 59
* Titan/Saturn, Accelerator II \$ 599 \$ 449
* Transend/S3M, AIOI, Serial/Para I/F \$ 225 \$ 169
TG Products, Game Paddles (1+) \$ 40 \$ 29
* Joystick (1+) \$ 60 \$ 45
Video, PSIO I/F Card \$ 229 \$ 169
WICO, Mouse, Complete \$ 179 \$ 119

SOFTWARE for your APPLE

BUSINESS

* Applied Soft Tech., VersaForm \$ 389 \$ 259
Artact, Magic Window II \$ 150 \$ 99
* Magc Combo (Wind, Mail & Words) \$ 225 \$ 149
* Ashton-Tate, dBase II (Req CP/M 80) \$ 700 \$ 385
Friday (Requires CP/M 80) \$ 295 \$ 199
* BPI Systems, GLAR, AP, PR or INV, each \$ 395 \$ 269
* Broderbund, Bank St. Writer or Spell, ea. \$ 70 \$ 45
Continental, GLAR, AP or PR, each \$ 250 \$ 165
* Home Accountant \$ 75 \$ 49
Tax Advantage \$ 70 \$ 47
Dow Jones, Market Analyzer \$ 350 \$ 275
Market Manager \$ 300 \$ 235
Market Microscope \$ 700 \$ 525
Fox & Geller, Quickcode or GGraph, ea. \$ 295 \$ 185
dUtility (for dBase II) \$ 95 \$ 66
Hayden, Pe Writer (Specify 80 col. bd) \$ 150 \$ 99
* Howard Soft, Tax Preparer, 1984 \$ 250 \$ 185
LJK, Letter Perfect w/Mail Merge \$ 150 \$ 99
Micro Pro, (all require 280-CP/M Card) \$ 695 \$ 295
* WordStar w/applicard & CP/M SPECIAL \$ 695 \$ 295
InfoStar w/applicard & CP/M SPECIAL \$ 695 \$ 295
WordStar™ + Training Manual SPECIAL \$ 495 \$ 239
SpellStar™ or MailMerge™, ea. SPECIAL \$ 250 \$ 129
* WordStar Professional, 4 Pak SPECIAL \$ 685 \$ 395
Options Pak, SS/MM/S \$ 295 \$ 175
Microsoft, Multi-Pan (CP/M or Apple DOS) \$ 250 \$ 169
* Osborne/ComX, (Disk and Book) (Bus. & Math) \$ 150 \$ 49
Some Common Basic Programs (75 ea.) \$ 100 \$ 49
Practical Basic Programs (40 ea.) \$ 100 \$ 49
Peachtree, Requires CP/M & MBasic, 64K Series 40 GL & AR & AP, all 3 \$ 395 \$ 239
Perfect, Perfect Writer/Speller-2 pak \$ 399 \$ 249
Perfect Form or Perfect Calc, each \$ 249 \$ 149
Perfect Writer/Speller/Calculator \$ 969 \$ 499
* Pearson, Personal Pencil \$ 295 \$ 195
Quark, Word Juggler & Lexicheck (1e) \$ 189 \$ 139
* Scribble, Sen. Speller or Bookends, ea. \$ 125 \$ 85
Sierra/On-Line, ScreenWriter Pro, 2 Pak \$ 290 \$ 135
ScreenWriter II \$ 130 \$ 89
The Dictionary NEW! \$ 100 \$ 69
Gen. Manager II-NEW! \$ 230 \$ 155
Homeward \$ 50 \$ 34
* Silicon Valley, Word Handler \$ 60 \$ 39
* List Handler \$ 50 \$ 35
* Handler Pak (Word, List & Spell) \$ 130 \$ 89
* Software Publishing, PFS: File (specify + or e) PFS: Report \$ 125 \$ 84
PFS: Graph \$ 125 \$ 84
PFS: Write (1e) \$ 125 \$ 84
Stoneware, DB Master Version 4.0 \$ 350 \$ 229
DB Utility for II \$ 129 \$ 87
Advanced DB Master \$ 595 \$ 495

VisiCorp, Visicalc 3.3 (1+) \$ 250 \$ 169
Visicalc Enhanced (1e) \$ 250 \$ 179
Visicalc Advanced (1e) \$ 295 \$ 210
Visicalc or VisiDex, each \$ 250 \$ 179

UTILITY & SYSTEM

Beagle, Apple Mechanic or DiskQuik, ea. \$ 38 \$ 22
Double Take or GPLE, each \$ 35 \$ 25
Typefaces (Req. Ap. Mechanic) \$ 20 \$ 15
DOSS Boss or Utility City, each \$ 30 \$ 22
Tip Disk #1 \$ 20 \$ 15
Pronto DOSS \$ 30 \$ 20
Alpha Plot \$ 40 \$ 27
Central Point, Filer, DOS 3.3 & Util. \$ 20 \$ 15
* Copy II Plus (for copier) \$ 40 \$ 30
* Einstein, Compiler—Applesoft BASIC \$ 129 \$ 85
Epson, Graphics Dump \$ 15 \$ 9
Hayes, Terminal Prog. (SM or MM, ea.) \$ 100 \$ 65
* Insoft, GraFORTH by Paul Lotus \$ 30 \$ 65
* Microsoft, Lotus 80 \$ 125 \$ 85
* * Jordan 80 \$ 195 \$ 135

COMPLETE MICROSOFT LINE IN STOCK

* Omega, Locksmith (for copier) Ver 5.0 \$ 100 \$ 75
Penguin, Complete Graphics System II \$ 70 \$ 53
Graphics Magnific \$ 60 \$ 41
Phoenix, Zoom Tracks \$ 40 \$ 34
Quality, Bag of Tricks \$ 40 \$ 29
Terrapin, Log \$ 150 \$ 99
UNICO, Essential Data Duplicator III \$ 80 \$ 49

HOME & EDUCATIONAL

Atari, Centipede, PacMan or Donkey K, ea. \$ 35 \$ 28
Beagle Bros., Beagle Bag \$ 30 \$ 22
Beachtop, Millionaire \$ 60 \$ 40
Broderbund, Choptop or Lode Runner, ea. \$ 35 \$ 25
Arcade Machine \$ 60 \$ 40
Apple Panic \$ 30 \$ 21
BudgeCo., Pinball Contest Set \$ 40 \$ 27
* Continental, Home Accountant \$ 75 \$ 49
Dorland, Atlas or Zaxxon, each \$ 40 \$ 27
Davidson, Math Blast! \$ 50 \$ 34
Edu-Ware, (Large Inventory) Call
Hayden, Sargon II (Chess) \$ 35 \$ 29
Sargon III (Chess) \$ 50 \$ 34
Infocom, Zork I, II, III, or Starcross, each \$ 40 \$ 27
Koala, Full line in stock, CALL
* Learning Co., (Large Inventory) Call
Micro Lab, Miner 2048er \$ 40 \$ 27
Microsoft, Typing Tutor \$ 25 \$ 17
Monogram, Dollars and Sense \$ 100 \$ 69
Origin, Ultima III \$ 60 \$ 40
Scarborough/Lightning, Mastertype \$ 40 \$ 27
Sierra/On-Line, Ultima II \$ 60 \$ 40
Sir-Tech, Wizardry \$ 50 \$ 39
Spinmaker, Kindergarten (others in stock) \$ 30 \$ 20
Sub Logic, Flight Simulator II \$ 50 \$ 37

PRINTER COMBO SALE

ONE TIME, QUANTITY LIMITED
* OKIDATA ML80



80 cps, Pin feed, 80 col., 132 col. condensed, 96ASCII, Graphics, Parallel

List Price \$299

COMBO A for Apple or IBM — \$549 save \$450
ML80 + dBase II

COMBO B for Apple or IBM — \$494 save \$500
ML80 + WordStar + Mail Merge + SpellStar + Star Index

COMBO C for Apple II +/e — \$474 save \$520
ML80 + Applicard (CP/M + 13 Features) + WordStar or InfoStar

COMBO D for IBM-PC — \$397 save \$550
ML80 + 50 Generik™ DS/DD diskettes + Bank Street Writer + Home Accountant Plus + 3 Insoft Trn educational games.

COMBO E for Apple II +/e — \$291 save \$420
ML80 + 50 Generik™ SS/SD diskettes + Bank Street Writer + Insoft 3 game pak + Home Accountant

NEC PC-8201A \$649
Includes word processing and 13 other programs; 32K ROM & 16K RAM both expandable to 64K; RS232C, Disk, Printer, Cassette and Bar Code interfaces built-in; AC or DC. Complete line in stock.

Computer, PC8201A, 16K (64K) \$ 800 \$ 649
Data Recorder, PC8261A \$ 115 \$ 99
Printer, PC8221A Thermal, 40 col. \$ 170 \$ 149

★ MEANS A BEST BUY

DISKETTES

	LIST PRICE	OUR PRICE
CDG, 100 ea SS/DD, 40T (Apple, IBM)	\$ 55	\$ 239
10 ea SS/DD, 40T (Apple, IBM)	\$ 55	\$ 26
100 ea DS/DD, 40T (IBM, H/P)	\$ 750	\$ 295
10 ea DS/DD, 40T (IBM, H/P)	\$ 75	\$ 35
DYSAN, 10 ea SS/SD (Apple, etc.)	\$ 69	\$ 39
10 ea DS/DD 48T (IBM/H/P/etc.)	\$ 89	\$ 49
MAXELL, 10 each, MD1, SS/DD	\$ 55	\$ 29
10 each, MD2, DS/DD	\$ 75	\$ 39
VERBATIM, 10 ea MD2S-01, SS/DD	\$ 49	\$ 25
10 ea MD34, DS/DD	\$ 84	\$ 39

GENERIK™ DISKETTES — AS LOW AS \$1

W/jackets, no labels, top quality, 90 day limited warranty by us.

10 ea SS/SD, 35 Track (Apple, Atari)	\$ 42	\$ 17
100 ea SS/SD, 35 Track (Apple, Atari)	\$ 415	\$ 130
1000 ea SS/SD, 35 Track (Apple, Atari)	\$ 4150	\$ 995
10 ea DS/DD, 48TPI (IBM, H/P)	\$ 63	\$ 25
100 ea DS/DD, 48TPI (IBM, H/P)	\$ 626	\$ 170
1000 ea DS/DD, 48TPI (IBM, H/P)	\$ 6260	\$ 1400

NO HASSLE MONEY BACK GUARANTEE ON GENERIK'S



GENERIK™ DISKETTES
Each at 1000 quantity.
SS/SD \$1.00 Each
DS/DD \$1.40 Each

©1983 by ComX Corp.

for the ATARI
RAMA 1000 Drive, 320K \$ 449 \$ 369
KOALA, Pad w/Micro Bus \$ 100 \$ 75

MODEMS AND ACCESSORIES

	LIST PRICE	OUR PRICE
ANCHOR, Signalman MK I (RS232)	\$ 99	\$ 75
Signalman Mark XI	\$ 399	\$ 269
HAYES, IBM-PC Smartmodem 1200B	\$ 595	\$ 439
IBM-PC Smartcom II Software	\$ 149	\$ 109
Stack Chronograph (RS-232)	\$ 249	\$ 189
Stack Smartmodem 300(RS-232)	\$ 289	\$ 225
Smartmodem 1200 (RS-232)	\$ 699	\$ 535
Microdemon 100 (S-100 bus)	\$ 399	\$ 275
Microdemon IIe w/Smartcom	\$ 329	\$ 239
IBM-PC to Modern Cable	\$ 39	\$ 29
NOVATION, IBM-PC Access 1/32 Pack	\$ 595	\$ 445
Apple Call II Modem, 300 BAUD	\$ 329	\$ 269
212 Apple Cal, 1200 BAUD	\$ 189	\$ 139
Cal	\$ 149	\$ 104
J-Cal	\$ 695	\$ 579
212 Auto Cal	\$ 595	\$ 415
Smart Cal 103/212	\$ 329	\$ 269
TRANSEND/S3M, Transend I for Apple II \$ 89 \$ 69 ModemCard for the Apple II \$ 299 \$ 229 Transmodem 1200 \$ 695 \$ 559		

SOFTWARE-SEE APPLE OR IBM UTILITY SOFTWARE SECTIONS

MONITORS

	TERMINALS AND ACCESSORIES	LIST PRICE	OUR PRICE
* AMDEK, 12" Green, #300G		\$ 200	\$ 135
* 12" Amber, #300A		\$ 210	\$ 149
* 12" Amber, #310A for IBM-PC		\$ 230	\$ 169
* 13" Color I, Composite		\$ 379	\$ 289
* 13" Color II, RGB, Hi Res		\$ 529	\$ 439
DVM, Color II or III to Apple II/F		\$ 199	\$ 175
13" Color IV, RGB, 720H/400V		Call	
NEC, 12" Green, Model 1260HA		\$ 150	\$ 109
12" Green, Model 1201HA		\$ 199	\$ 149
12" Amber, Model 1205MA		\$ 210	\$ 159
12" Color, RGB, 1216 FA (IBM/NEC-PC)		\$ 699	\$ 449
12" Color, Composite, 1215A (Apple)		\$ 399	\$ 299
* PRINCETON, RGB Hi Res, HX-12		\$ 795	\$ 499
* RGB Hi Res, SR-12		\$ 799	\$ 499
* Amber, MAX-12 (Mono Brd.)		\$ 249	Call
* QUADRAM, Quadchrome 12" RGBColor		\$ 695	\$ 495
Quadscreen 17" 960x512		\$ 995	\$ 595
ZENITH, 12" Green, ML ZVM123		\$ 200	\$ 99

PRINTERS AND ACCESSORIES

	LIST PRICE	OUR PRICE
DOT MATRIX:		
EPSON, RX80, 100 cps	\$ 399	\$ 299
FX80, 160 cps	\$ 699	\$ 495
FX100, 160 cps	\$ 895	\$ 689
MX100GF7, 80cps, w/Grafix+	\$ 995	\$ 495
Apple II Graphics Dump	\$ 15	\$ 9
MANNESMANN 160L, 80 col, 160 cps	\$ 798	\$ 568
TALLY, 180L, 132col, 160cps	\$ 1038	\$ 778
* Saito, 80 col, 80cps	\$ 399	\$ 289
NEC, PC-8023A, FT, 120cps, 80col, para	\$ 599	\$ 439
PC-8025, 120cps, 136 col, para	\$ 895	\$ 775
Cable, 8023/8025 to IBM-PC	\$ 50	\$ 40
OKIDATA, 824, 80 col, 120 cps, para.	\$ 349	Call
834, 132 col, 120 cps, para.	\$ 749	Call
92, 80 col, 160 cps, para.	\$ 589	Call
93, 136 col, 160 cps, para.	\$ 899	Call
2350P Pacemaker, 350cps, para	\$ 2656	Call
2410P Pacemaker, 350cps, para	\$ 2296	Call
ORANGE MICRO, Grappler+, for Apple	\$ 165	\$ 119
PRACTICAL, Microball In-Line 64K, Para.	\$ 349	\$ 259
Microball In-Line 64K, SR.	\$ 349	\$ 259
* STAR MIC, Gemini 107X, 120cps, 2.3K	\$ 499	\$ 289
Gemini 157X, 120cps, 2.3K	\$ 549	\$ 439

LETTER QUALITY:

NEC, 15.0, 14cps, Para/w/TF, 101col \$ 685 \$ 525
* TTZ, 1014, 13cps, Para, 8.5", Pin&Rnc. \$ 649 \$ 499

PRINTER INTERFACES & BUFFERS:

IBM-PC to Epson or Star Micro, Cable \$ 60 \$ 35
Apple I/F & Cable for Epson or Gemini \$ 95 \$ 59

QUADRAM, Microfazer, w/Copy, PP, BK, MWP8 w/PS \$ 189 \$ 139
Microfazer, w/Copy, PP, 64K, MWP6 w/PS \$ 319 \$ 239
Microfazer, w/Copy, PP, 128K w/PS \$ 465 \$ 345
Microfazer, Snap-on, BK, PP, Epson w/PS \$ 179 \$ 145
Microfazer, Snap-on, 64K, PP, Epson w/PS \$ 319 \$ 235
All Microfazers are expandable w/Copy to 512K (Snap-on to 64K)

SUPPLIES: Tractor Feed Paper, Ribbons, Daisy Wheels

hp 41CK, Calculator NEW \$ 325 \$ 275
41C, Calculator \$ 195 \$ 149
41CV, Calculator w/2.2K \$ 275 \$ 219

HYPERION, Portable Computer \$3690 \$2990

MAIL TO: 12060 SW Garden Place, Portland, OR 97223—Include telephone number and double check your figures for S&H
ORDERING INFORMATION AND TERMS: All items usually in stock. Cashiers Checks, Money Orders, Federal 1000 Checks and Government Checks, we immediately honor. Personal or other Company Checks allow 20 days to clear. No C.O.D. Prices reflect a 3% cash discount to ADD 3% to above prices for VISA or MC. For U.S. Mailing, add 3% (35 minimum) for shipping, insurance and handling (S&H) by UPS. UPS ground is standard so add 3% (8.0 minimum) more for UPS Blue for S&H. Add 12% (15 minimum) for S&H for US Postal, APO or FPO. For Hawaii, Alaska and Canada, UPS is in some areas only; all others are Postal so call, write, or specify Postal. Foreign orders except Canada for S&H add 18% (25 minimum) for S&H (except for monies add 30% (50 minimum) for S&H). All prices, availability and specifications subject to errors or change without notice so call to verify. All goods are new, include warranty and are guaranteed to work. Due to our low prices and our assurance that you will get new unused products, ALL SALES ARE FINAL. Call before returning goods for repair or replacement. Orders received with insufficient S&H charges will be refunded. ORDER DESK HOURS 6 A.M. to 6 P.M. PST, Monday through Friday and 10 to 4 Saturday. 6 A.M. here is 9 A.M. in New York
OUR REFERENCES: We have been in computers and electronics since 1958, a computer dealer since 1978 and in computer mail order since 1980. Banks, (503) 643-4678. We belong to the Chamber of Commerce (503) 644-0123 and Direct Marketing Association, in call Dunn and Bradstreet if you are a subscriber. EconoRAM™, FastRAM™, and Generik™ are trademarks of ComX Corporation

CASH & CARRY OUTLETS:
Over-the-counter sales only. Open Monday through Friday, 10:00 until 6:00 Saturday, 10:00 until 6:00.
PORTLAND, OREGON—NEW LOCATION! At Park 217, Tigard at intersection of 217 and 99W. Coming from Portland on 99W, make immediate left after 217 overpass and Texaco Station. Call 620-5595.
SEATTLE, WASH.—12000 Ave. SE, Bellevue, WA 98006 Tel: 641-4736. In Leehamm's Plaza near Factoria Square, SE of Hwy 405 & 90 and at SE 38th & Richards.

-LA POINTE™

Formerly **Computer Exchange™**

DEALERS
WE BUY
EXCESS
INVENTORIES

LOW PRICES TO PROFESSIONALS WHO KNOW WHAT THEY WANT AND KNOW HOW TO USE IT!

© 1984 by Conroy-LaPointe, Inc.
All Rights Reserved

256K IBM-PC or XT

320/360K Disk Drives by CDC
90 Day Warranty By Us
Call for Details

Coming soon—products for the PC Jr.
© 1984. Service Mark of Conroy-LaPointe, Inc.

DRIVES AND ACCESSORIES

for the IBM-PC or XT

320K/360K DS/DD DISK DRIVES
With Detailed Installation Instructions
30 Day Warranty by Factory Authorized Distributor

Same as now installed by IBM **\$219** \$229 For One.

HALF \$199 HEIGHT

	LIST PRICE	OUR PRICE
COTIX™ Disk Drive Power Cable	\$ 8	\$ 6
AMDEK		
Amdek V, 1/2 height internal, 320/360K	\$ 329	\$ 249
Amdek III, Dual 3 1/2 Micro Floppy, 320/360K	\$ 599	\$ 529
Cable, Amdek III to IBM-PC interface		Call
MAYNARD		
Floppy Drive Control Bnd-up to 4 drives	\$ 215	\$ 189
same with Parallel Port	\$ 300	\$ 239
Internal 10 meg Hard Disk	\$1395	\$1195

8" CP/M-80 SOFTWARE

MUCH MORE IN STOCK

	LIST PRICE	OUR PRICE
ASHTON-TATE, dBase II	\$ 700	\$ 385
INFOCOM, Starcross, Zork I, II or III, each	\$ 50	\$ 34
Deadline or Planetal, each	\$ 60	\$ 40
MICROPRO, WordStar*	\$ 495	\$ 285
MailMerge™	\$ 250	\$ 145
WordStar Prof., 4Pak(Call)	\$ 895	\$ 429

SUPPLY CENTER for IBM-PC or XT

	LIST PRICE	OUR PRICE
AMDEK MAI 4-in-1 Multiple Board, Color Graphics, Mono, 128K	\$ 599	\$ 519
AST ComboPlus, 64K, S/P/C	\$ 395	\$ 279
ComboPlus, 256K, S/P/C	\$ 695	\$ 495
MegaPlus II, 64K, 2S/P/C	\$ 495	\$ 375
MegaPlus II, 256K, 2S/P/C	\$ 795	\$ 595
256K MegaPlus II Expander	\$ 395	\$ 295
SxPakPlus, 64K, S/P/C +S/W	\$ 395	\$ 295
SxPakPlus, 256K S/P/C +S/W	\$ 695	\$ 495
SxPakPlus, 384K S/P/C +S/W	\$ 895	\$ 595
For SxPak w/ Game Port, add	\$ 50	\$ 39
I/O Plus II, S/P/CC	\$ 215	\$ 150
I/O Plus II, S/P/CC/G	\$ 265	\$ 185
I/O Plus II, 2 S/P/CC/G	\$ 315	\$ 215
CCS SuperVision, 132 col, mono, board Z Plus 64, fast 280B, 64K para port	\$ 799	\$ 599
	\$ 875	\$ 695
Chalkboard, Power Pad, Raq, Kit	\$ 100	\$ 73
* ComX EconRAM™ 256K RAM Card w/Fastrak™ RAM disk emulator and spooler software.	\$ 495	\$ 325
CURTIS UMH-1 Monitor tilt & swivel base	\$ 50	\$ 39
3 to 9 foot keyboard cable	\$ 40	\$ 30
Vertical CPU "System Stand"	\$ 25	\$ 19
Monochrome Ext. Cable Pair	\$ 50	\$ 35
HERCULES Graphics Card, Mono	\$ 499	\$ 349
Key Tronic KB5150 Std. keyboard	\$ 209	\$ 159
KB5151 Std. keyboard	NEW \$ 255	\$ 209
Koala Koala Pad™ w/PC Design Programmer's Guide	\$ 150	\$ 109
	\$ 15	\$ 12
MAYNARD Multifunction (4) Card, MFC	\$ 89	\$ 79
SANDSTAR Memory Card no RAM	\$ 230	\$ 169
Memory Card 256K	\$ 499	\$ 399
Modules for Sandstar in stock	Call	Call
Internal 10 meg Hard Disk	\$1395	\$1195

MICROSOFT RAMCard 256K	\$ 550	\$ 385
SystemCard 256K	\$ 625	\$ 469
SystemCard 64K	\$ 395	\$ 295
Mouse	\$ 195	\$ 145
MOUSE SYSTEMS, PC Mouse w/software	\$ 295	\$ 195
ORCHID PCNet™ Starter Kit, LAN	\$ 1490	\$ 1090
PCNet™ Circuit Board Kit	\$ 695	\$ 495
PLANTRONICS Color Board & Colormagic, 16 color, w/Para	\$ 559	\$ 395
Color Board & Draftsman, 16 color, w/Para	\$ 559	\$ 395
QUADRAM		
* Quadlink NEWEST VERSION	\$ 680	\$ 485
Quadboard no RAM, expand to 384K	\$ 295	\$ 215
Quadboard 64K, expand to 384K	\$ 395	\$ 279
Quadboard 256K, expand to 384K	\$ 675	\$ 525
* Quadboard, 384K	\$ 795	\$ 625
Quadboard II, no RAM, expand to 256K	Call	Call
Quadboard II, 64K, expand to 256K	\$ 395	\$ 285
Quadboard II, 256K, 6 function	\$ 595	\$ 395
Quad 512 x 64K plus serial port	\$ 325	\$ 265
Quad 512 x 256K plus serial port	\$ 550	\$ 420
Quad 512 x 512K plus serial port	\$ 895	\$ 625
Quadcolor I board, 16 colors	\$ 295	\$ 225
* Quadcolor II, board use with Quadcolor I	\$ 275	\$ 209
* Quadchrome, 17" RGB Monitor	\$ 795	\$ 499
Quadscreen, 17" 968 x 512 Monitor	\$ 1995	\$ 1595
Tecmar 1st MATE, 64K, S/P/CC	\$ 389	\$ 295
1st MATE, 256K, S/P/CC	\$ 589	\$ 439
Captain, 64K, S/P/CC	\$ 424	\$ 324
Captain, 384K, S/P/CC	\$ 795	\$ 595
Wave, 256K (short brd.)	\$ 499	\$ 369
Bosun, S/P/CC (short brd.)	\$ 195	\$ 145
Graphics Master	\$ 695	\$ 575
Titan Accelerator PC (8086 + 128K)	\$ 995	\$ 750
TG PRODUCTS Joystick	\$ 60	\$ 40
WICO, IBM-PC Mouse	\$ 100	\$ 69

Prices and availability subject to change. Call.

\$55
★ 9 Each, 64K, 200 ns, MEMORY CHIP KIT
90 Day Warranty by us

\$325
★ ComX 256K RAM BOARD
Fully Compatible 1 Year Limited Warranty by ComX
With Fastrak RAM Disk Emulator and Spooler Software
Works on DOS 1.1, 2.0 or 2.1

★ MEANS A BEST BUY

SOFTWARE for IBM-PC or XT

BUSINESS		LIST PRICE	OUR PRICE
ALPHA , Database Manager II		\$ 295	\$ 185
ASHTON-TATE			
dBase II, Req. PC-DOS & 128K	\$ 700	\$ 385	
dBase II User's Guide (Book)	\$ 15	\$ 12	
Everman's DB Primer (Book)	\$ 15	\$ 12	
The Financial Planner	\$ 700	\$ 395	
Friday	\$ 295	\$ 199	
APPLIED SOFT. TECH. , Versaform	\$ 389	\$ 285	
ASK MICRO , GLARAP, INV or PR, each	\$ 495	\$ 295	
BRODERBUND , Bank Street Writer	\$ 80	\$ 56	
BPI , Gen'l Acctg/ARAP or PR, each	\$ 595	\$ 395	
CHANG LABS , Micro Plan	\$ 495	\$ 335	
* CONTINENTAL , Home Accountant	\$ 150	\$ 89	
Tax Advantage	\$ 70	\$ 45	
FCM (Filing, Cataloging, Mailing)	\$ 125	\$ 89	
Property Management	\$ 495	\$ 329	
DOW JONES , Market Analyzer	\$ 350	\$ 279	
Market Manager	\$ 300	\$ 239	
Market Microscope	\$ 700	\$ 525	
FOX & GELLER			
Quickcode, dGraph, Grafax or Oz, each	\$ 295	\$ 195	
dUhl (MSDOS or CP/M/86, each)	\$ 99	\$ 59	
HAYDEN , IBM File Writer	\$ 200	\$ 135	
File Speller or Sargon II, each	\$ 50	\$ 34	
HOWARD SOFT.			
Tax Preparer, 1984 for 1983 year	\$ 295	\$ 220	
HUMAN EDGE , Management or Sales, ea	\$ 250	\$ 185	
IUS , EasyWrite II System	\$ 350	\$ 259	
EasySpeller II	\$ 225	\$ 149	
Business System, GL+AR+V	\$ 1495	\$ 995	
GLARAP, OE or INV, each	\$ 595	\$ 395	
* INSOFT , Data Design (easy to use DBMS)	\$ 250	\$ 189	
GrafORTH (animated 3D graphics)	\$ 125	\$ 95	
LIFETREE , Volkswriter	\$ 285	\$ 195	
* LOTUS , 1-2-3	\$ 495	\$ 329	
QUE , Using 1-2-3 (Book)	\$ 15	\$ 12	
MICRO LAB , Tax Manager for 1983	\$ 250	\$ 169	
MICROPRO , WordStar*	\$ 495	\$ 239	
MailMerge™	\$ 250	\$ 129	
SpellStar™	\$ 250	\$ 129	
* WordStar Professional , 4 Pak	\$ 695	\$ 395	
Options Pak, SS/MM/SI	\$ 295	\$ 179	
StarIndex™	\$ 195	\$ 105	
InfoStar™	\$ 495	\$ 259	
* MICROBIM , Rbase, Series 4000	\$ 495	\$ 335	
MICROSOFT , Multitask	\$ 250	\$ 169	
Word	\$ 375	\$ 259	
Word with Mouse	\$ 475	\$ 325	
MICROSOFT , Financial Statement	\$ 100	\$ 69	
Budget	\$ 150	\$ 99	

BUSINESS		LIST PRICE	OUR PRICE
MONOGRAM , Dollars & Sense	\$ 165	\$ 110	
OPEN SYS , GLARAP, PR, INV or PO, each	\$ 695	\$ 429	
* OSBORNE/COMX , (Book & Business, Statistics & Math Programs on DS/DD Disks)			
Some Common Basic Programs (70 ea.)	\$ 100	\$ 68	
Practical Basic Programs (40 each)	\$ 100	\$ 69	
PBL , Personal Investor 1.1	\$ 145	\$ 95	
PEACHTREE , Peach Pak (GLARAP)	\$ 395	\$ 239	
Peach Text 5000	\$ 395	\$ 239	
PEARLSOFT , Personal Pearl (DBMS & MIS)	\$ 295	\$ 195	
* PERFECT , Perfect Writer™	\$ 349	\$ 219	
Writer & Speller, 2 Pak	\$ 399	\$ 249	
Perfect Filer™ or Perfect Calc, each	\$ 249	\$ 149	
Perfect Writer, Speller, Filer, Calc (4)	\$ 699	\$ 499	
SATELLITE , Word Perfect	\$ 495	\$ 255	
SOFTWARE ARTS, TK! Solver	\$ 399	\$ 299	
SOFTWARE PUBLISHING , PFS:File	\$ 140	\$ 94	
PFS:Report	\$ 125	\$ 84	
PFS:Write	\$ 145	\$ 95	
PFS:Graph	\$ 140	\$ 95	
SOFTWARE SYSTEM , Multimate	\$ 495	\$ 395	
SORCIM , SuperCalc 2	\$ 295	\$ 195	
SuperCalc 3	\$ 395	\$ 265	
SSI/SATELLITE , WordPerfect	\$ 495	\$ 375	
Personal WordPerfect	\$ 195	\$ 149	
STC/SOFTec , The Creator	\$ 300	\$ 195	
STONEWAVE , Advanced D.B. Master	\$ 595	\$ 395	
SYNAPSE , File Manager	\$ 100	\$ 67	
SYNERGISTIC , Data Reporter	\$ 250	\$ 169	
T/MAKER , T/Maker III	\$ 275	\$ 169	
VISICORP , VisiCalc IV	\$ 250	\$ 179	
VisiFile or VisiSchedule	\$ 300	\$ 219	
Desktop Plan I	\$ 300	\$ 219	
VisiWord with VisiSpell (128K)	\$ 375	\$ 269	

UTILITY & SYSTEM		LIST PRICE	OUR PRICE
DIGITAL RESEARCH			
Concurrent CP/M-86™	\$ 350	\$ 225	
Call			
CP/M-86™	\$ 60	\$ 40	
CBASIC: 86™	\$ 200	\$ 135	
CBASIC Compiler (CP/M-86 or MSDOS, ea)	\$ 600	\$ 365	
Pascal/MT + CP/M-86	\$ 400	\$ 289	
Pascal/MT + MSDOS	\$ 600	\$ 399	
PL/1 (MSDOS or CP/M-86, each)	\$ 750	\$ 499	
Access Mng'r (MSDOS or CP/M-86, each)	\$ 400	\$ 269	
Display Mng'r (MSDOS or CP/M-86, each)	\$ 500	\$ 339	
Spread Prog. Pkg. (CP/M-86)	\$ 200	\$ 135	
CIS DOBOL-86	\$ 850	\$ 525	
DR LOGO-86	\$ 100	\$ 69	
HAVE'S, Smartcom II (Data Com.)	\$ 119	\$ 89	
INSOFT, GrafORTH (animated 3D graph)	\$ 125	\$ 95	
MICROSTUFF , Crossalk KV (Data Com.)	\$ 195	\$ 129	
MICROSOFT , muMath/muSimp	\$ 300	\$ 199	
Business BASIC Comp.	\$ 600	\$ 399	
Pascal Compiler	\$ 350	\$ 250	
C Compiler	\$ 500	\$ 339	
BASIC Compiler	\$ 395	\$ 269	
FORTRAN Compiler	\$ 350	\$ 250	
COBOL Compiler	\$ 750	\$ 495	
NORTON , Utilities 2.0, 14 programs	\$ 80	\$ 65	
ROSESOFT, Prokey	\$ 75	\$ 50	
HOME & EDUCATIONAL			
ATARI , Centipede, PacMan or Donkey, each	\$ 35	\$ 29	
EPYX/Auto, Siml., Temple of Aposha	\$ 40	\$ 29	
* ARMONK , Executive Suite	\$ 40	\$ 27	
BUE CHIP, Millionaire or Tycoon, each	\$ 50	\$ 39	
BPI SYSTEMS , Personal Accounting	\$ 195	\$ 139	
* BRODERBUND , Apple Panic (Color)	\$ 30	\$ 19	
Lode Runner or Serpentine, each	\$ 35	\$ 24	
COMPONENT , PC Tutor (1.1 or 2.0, ea.)	\$ 60	\$ 40	
CONTINENTAL , Home Accountant Plus	\$ 150	\$ 89	
DAVIDSON , The Speed Reader II	\$ 75	\$ 49	
INFOCOM , Deadline or Suspended, each	\$ 50	\$ 33	
Zork I or Zork II or Zork III, each	\$ 40	\$ 27	
* INSOFT , Mystrix, WordTrk or Quintrk, each	\$ 35	\$ 29	
MICRO LAB , Mimer 2049	\$ 40	\$ 26	
MICROSOFT , Flight Simulator	\$ 50	\$ 33	
MONOGRAM , Dollars & Sense	\$ 165	\$ 110	
ORIGIN , Ultima III	\$ 60	\$ 40	
PBL CORP. , Personal Investor	\$ 145	\$ 99	
SCARBOROUGH/LIGHTNING , MasterType	\$ 50	\$ 34	
SOFTWARE SYSTEMS Multimate	\$ 495	\$ 295	
SPINNAKER , Snooper Troops (1 or 2)	\$ 45	\$ 35	
Story Machine or Face Maker	\$ 35	\$ 24	
STRATEGIC , The Warp Factor	\$ 40	\$ 30	
SUBLOGIC , Night Mission Pinball	\$ 40	\$ 27	

OUR AD #B5

VISA

master charge

NO SALES TAX

NATIONAL ORDER DESK **TOLL FREE**
(800) 547-1289
Order Desk Hours: 6AM to 6PM PST

Oregon TOLL FREE (800) 451-5151
Hot Line For Information On Your Order (503) 620-9878

FREE GIFT

Use of our order forms qualifies you for a free gift with your order. Get on our mailing list now for order forms, and our new newsletter and sales specials announcement. Our customers are already on our list.

COUPON

MAIL TO: 12060 SW Garden Place, Portland, OR 97223

NAME _____

ADDRESS _____

CITY _____ STATE _____ ZIP _____



The \$14.95 Peripheral

That Puts Your Computer's Commands Where They Belong And Your Manuals On The Shelf.

Now, you can command new computer productivity. Discover how much easier your personal computer is to use when the commands are at your fingertips. PC-DocuMate keyboard templates can save you time and frustration. You can recall needed commands, options and formats. Quickly.

Professionally designed and comprehensive. Each PC-DocuMate template has been designed by a software expert. Commands are logically and functionally organized so you can get the most from your software. And our templates are comprehensive reference aids which use both sides to document a product or a system. Completely.

Durable and guaranteed. PC-DocuMate templates are silk-screened onto durable, non-glare plastic to our exacting specifications. Each template is printed on both sides and color-coordinated to complement your PC. And your satisfaction is guaranteed. Fully. Or your money back.

Save time and enjoy greater productivity. Order your PC-DocuMate without delay.

Lower prices for better design. With PC-DocuMates, you get two-sided templates for less than a single-sided template from other manufacturers. And you get a better designed template. Order direct or ask your local dealer.

PC-DocuMates now available... IBM PC/XT & COMPAQ — \$14.95

- DOS/BASIC 2.0 & 2.1 • DOS/BASIC 1.1 • Lotus 1-2-3 • WordStar • dBASE II • MultiMate 3.20 • VisiCalc
- Multiplan 1.00 or 1.06 • Volkswriter • SuperCalc2 • PeachText 5000 • EasyWriter II • Do-It-Yourself

COMMODORE 64 — \$12.95

- BASIC & more • Calc Result • EasyScript • Quick Brown Fox • Do-It-Yourself (CBM 64 templates are printed on one side only)

IBM PCjr. — \$12.95

- DOS/BASIC 2.1 • MultiMate • dBASE II • Do-It-Yourself

APPLE IIe — \$14.95

- WordStar • VisiCalc • dBASE II • AppleWriter II • Quickfile • Do-It-Yourself

If your favorite software package is not shown here, you can order our "Do-It-Yourself" template (which includes a special pen and eraser) and develop your own custom keyboard template.

Our Guarantee. Use your template for 20 days. If you are not completely satisfied return it to us (undamaged) for a full refund.

HOW TO ORDER: Send personal check, money order or MasterCard/VISA credit card information. Please add \$1.50 for shipping and handling per order; foreign orders must add \$5.00 per unit (except Canada). US funds only. Sorry, but no COD's. NC residents add 4% sales tax. Corporate quantity discounts available. Dealer inquiries invited. And for faster service on credit card orders...

Call Toll Free
1-800-762-7874
(In North Carolina) 919-787-7703



SYSTEMS MANAGEMENT ASSOCIATES
3700 Computer Drive, Dept. Y-1
Raleigh, North Carolina 27609

Circle 319 on inquiry card.

The following trademarks are acknowledged... IBM Corp.: IBM, IBM PC/XT & PCjr; Ashton-Tate: dBASE II; Information Unlimited Software, Inc.: EasyWriter II; Lotus Development Corp.: Lotus 1-2-3; SoftWord Systems, Inc.: MultiMate; Microsoft Corp.: Multiplan; PeachTree Software, Inc.: PeachText 5000; Sorcim Corp.: SuperCalc2; Litetree Software, Inc.: Volkswriter; MicroPro International Corp.: WordStar; QuikTex: Quick Brown Fox; Handic Software, ab: Calc Result; Commodore Business Machines, Inc.: EasyScript; VisiCorp: VisiCalc; Apple Computer, Inc.: Apple IIe, AppleWriter II, Quickfile.

GAME SETS AND BUILDERS

BY ANN PIESTRUP

Graphics-based learning software

ONLY RECENTLY ARE computer scientists and educators beginning to collaborate to create learning software that can fulfill the promise of the personal computer to transform education. A few educators have begun to think like computer scientists, and some programmers are beginning to understand children's learning needs.

Schools lag far behind business, science, medicine, and law in responding to changes in the culture. Children, for the most part, are getting a token exposure to the power of computing in schools, and only minimal exposure to the computer as a graphic, playful, interactive medium with which to learn concepts and skills.

Early educational software used in computer-aided instruction (CAI) has been primarily text-based. While useful for factual drill and effective at teaching what standardized tests measure, too often there is little in such software to engage the learner's imagination.

Much of the graphics-based "entertaining education" software now distributed for the home is like a slow video game, with a thin veneer of educational content and merely decorative graphics. The purpose of such programs is to teach a limited set of facts, such as math problems or spelling words. Many of these programs require only that a child press a single key,

then passively watch while the computer does tricks—the computer has all the fun. Once the child learns the minimal content and exhausts the limited bag of graphic tricks, interest in the program is gone.

In contrast, powerful learning software programs, such as learning game sets and builders, use graphics to convey meaning, not to decorate the screen. They teach *learning strategies* and fundamental, generalized skills upon which others can be built.

POWERFUL LEARNING

Powerful learning is carefully sequenced, with content that offers real value to the child. It is playful, with features of a game and characteristics of literature (themes, characters, elements of surprise), and it has a simple, clear user interface.

In effective learning games, play can begin in a very few minutes. To achieve this, commands for getting in and out of programs and for reaching instructions and the menu should be straightforward and consistent. A simple user interface frees the user from the details of man-

.....
Ann Piestrup is chairman and founder of The Learning Company (Suite 170, 545 Middlefield Road, Menlo Park, CA 94025). She holds a Ph.D. in educational psychology from the University of California at Berkeley.

aging the game and allows the child to focus on playing, and therefore learning.

Designers of learning software must be constantly aware of the cognitive "load" the mind can absorb and must present a carefully measured amount of new information with a proportional amount of familiar information.

Powerful learning software can offer several approaches to the same material and thereby encourage the learner to think flexibly. This flexible thinking can carry over outside the context of the game. There are no single correct answers; there are patterns to find and alternatives to consider.

Fascination with concepts can be an intrinsic motivation, leaving the child free to operate at his or her learning edge. The best learning software offers options, such as editors that enable children to create their own games or to create original graphics or text. Games need to have a smooth flow, with no barriers between steps. Children should be able to choose their own pathways through a set of games and to play any game as many times as it poses a challenge.

MOTIVATION

With a whimsical story line, humor, and a warm, nonjudgmental tone, learning games can be endearing and delightful

(text continued on page 216)

Photo 1a:
The first game in
the Bumble set,
Find Your
Number, presents
the concepts of
numerals, number
lines, and greater
than and less
than.



Photo 1b:
Find the Bumble
combines these
elements in a 4
by 4 array.
Columns and rows
are highlighted as
numbers and
letters are plotted.
Concepts are
represented both
in words and
symbols.



Photo 1c:
Butterfly Hunt
offers a larger grid
and removes arrow
clues, leaving only
text explanations.
The horizontal
axis is plotted
first, then the
vertical axis.

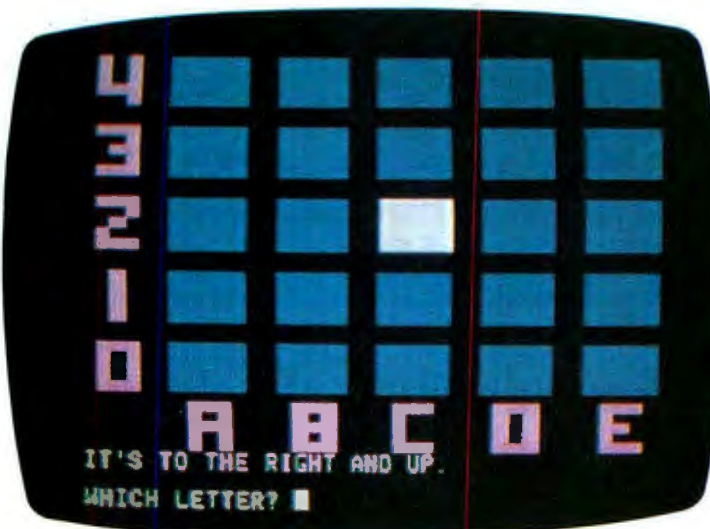

(text continued from page 215)

to younger children. A theme character can tie programs together in a fantasy-evoking way. The best games are elegantly simple, so that a small input has a dramatic output.

Exciting games may offer an element of chance, or competition with an opponent or against the clock; there is a sense of risk and the unexpected. Within a game, children can be encouraged to play cooperatively, to seek joint solutions to a problem.

Learning games, like other software, books, and movies, convey values. Designers must be sensitive to the values that schools and parents want to teach. Good learning software interests both sexes and avoids gratuitous violence.

LEARNING GAME SETS

A learning game set is a series of programs structured so that concepts and skills learned in earlier games form a foundation for later games. Learning game sets focus attention narrowly and offer manageable bits of new information, and they guide the learner with prompts throughout the learning experience. While working through the game set, children can learn complex skills and advanced concepts. In addition, they can learn strategies for approaching visual information.

All games in a set should have a unifying theme, which could include a character, story, and cohesive metaphor.

Bumble Games and Bumble Plots from The Learning Company (Menlo Park, California) are examples of learning game sets. These programs present a focused set of information and skills, such as using numerals, number lines, arrays, and grids (photos 1a through 1f). A fantasy character named Bumble from the planet Furrin guides the learning.

In these games, each time a child presses a key, some action is shown on the screen. The child can press another key within three seconds to make something else happen. The player sets the pace of the game and therefore has a sense of control over the medium.

Children playing games in the Bumble set work through fundamental concepts such as counting, greater than and less than, positive and negative numbers, columns and rows. When they can enter *x,y* coordinates fluently in a four-quadrant grid, they catch robbers in

moving cars, name coordinates for a sonar detector, and plot tic-tac-toe positions. Then they can plot their own graphics with a simple editor that is presented like a game.

These games encourage play because there is no way to lose. Children can cooperate or compete in guessing numbers and often transcend the issue of winning or losing by assuring that each child has a turn to play at alternate times when it is obvious that the next entry will win.

Children maintain interest in a program like Bumble Games for many months or even years. The concepts are very basic—how space relates to number. The concepts of row and column lay the foundation for beginning to use spreadsheets and to plot computer graphics. The programs also encourage children to build spatial awareness, to formulate strategies, and to experience success in learning.

Children can transfer skills learned in these games to new situations, such as finding points on a map from grid references. Thus young children can learn the skills that many of us struggled with in junior high school. Kindergarten children who can fluently plot graphics on a computer may present a challenge to the schools, but they show that computer learning games can teach important concepts in a playful, powerful way.

BUILDERS

A builder is a program with real-time, animated graphics, with which a user can put parts together to make something new. Nothing in text could simulate a builder program, with its functional graphics. Its purpose is to encourage learning by doing in an exploratory environment. A builder could teach a specific content, such as electronics, chemistry, biology, or music. Examples are Pinball Construction Set from Electronic Arts and our own Rocky's Boots.

Builders provide a metaphor to the real universe, with a defined and internally consistent geography, elements (often icons) such as building parts and connectors, and rules. For example, in Pinball Construction Set, the player uses icons to create a simulated pinball machine. The machine is a game board with movable bumpers and flippers.

(text continued on page 218)



Photo 1d: Visit from Space substitutes a grid for the array. For the first time in the set, numbers label both axes.



Photo 1e: In Tic Tac Toc, children must enter numbers in x,y format. Columns and rows are no longer highlighted as points are plotted. Children must plot many coordinates on the same grid, using a game strategy.



Photo 1f: In Bumble Dots, children use standard pair notation to plot original graphics on a 10 by 10 grid. These graphics become the basis of a game.

Photo 2a:
Players using
Rocky's Boots can
design machines
using AND, OR,
and NOT gates.

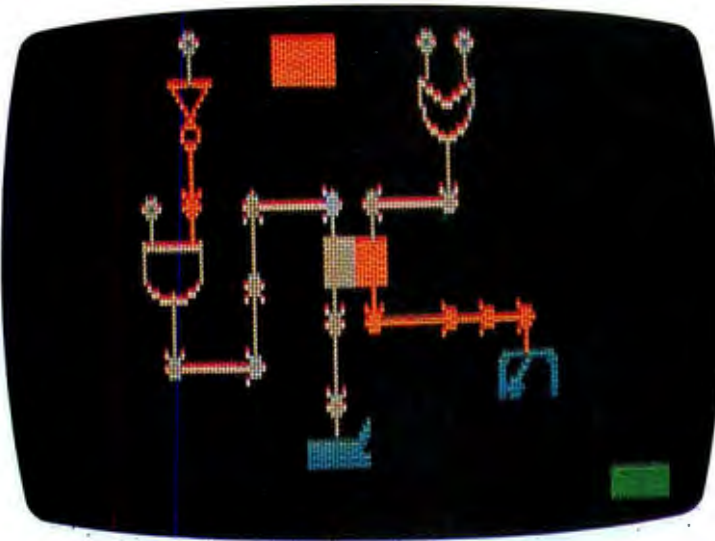

Photo 2b:
In the game room
in Rocky's Boots,
players build
logical kicking
machines to solve
problems.

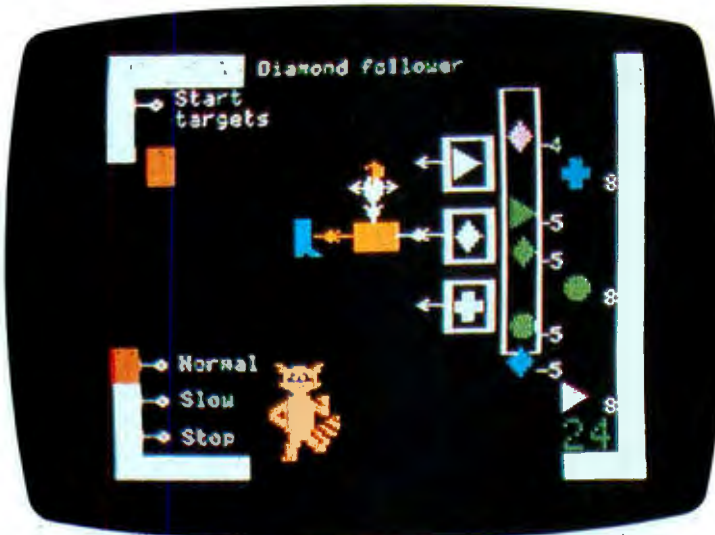

Photo 2c:
Rocky's Boots has
a graphics editor
that players use
to create new
games.



(text continued from page 217)

which can act according to the rules of real pinball machines or according to rules modified by the player.

The internal geography of Rocky's Boots is represented as a set of rooms with doors and walls (photos 2a through 2c). The player uses elements such as wires, logic gates, and sensors to build simulated electronic devices according to the internal rules of Rocky's world and the broader rules of combinatorial and sequential logic.

Within the parameters set by a builder, players can recombine elements according to structuring rules. They can create games, generate novel solutions to puzzles, edit and rework their creations, and in doing so explore fully the properties of the elements and rules. The program designer creates tools that are open to the player's exploration. At the same time, the limits of the program's universe (of the physical space, its elements, and rules) help structure learning. This permits both freedom and focus within the same environment.

The exploratory character of a builder encourages invention and divergent thinking. An ordinary computer-aided instruction program, in contrast, requires single, predetermined correct answers from a passive user. The builder says, "Use your mind. Here are some examples—now go make your own." A child experiencing a builder environment can develop persistence, self-confidence, a sense of mastery, and the ability to make choices.

Successful builder programs must not be punitive or judgmental, as some CAI programs are. Rather than operating in a binary, right-wrong mode, they present an environment in which any action has a natural consequence. A badly planned or clumsy action will produce unsatisfying results—an inelegantly designed machine doesn't do much—but it is up to the player to judge the outcome. The player can redesign the machine, seek new solutions, and improve upon the design until he or she is satisfied. Thus, the learner deals not only with information but with knowledge and insight.

The player can gain insight by trying many approaches to the same problem. The program designer presents an abstract concept in a builder whose

GAME SETS

elements make the concepts concrete. The player gains direct experience with the concepts, has time to think, to formulate and test hypotheses, approaching the building environment from many angles. The parameters of the builder focus attention on a small set of realities and allow the player to manipulate concrete objects in order to achieve a "felt" awareness of broader concepts. These new concepts are not empty words or mere labels but the beginnings of insight.

For example, the designer of Rocky's Boots wanted to convey logical concepts inherent in AND, OR, and NOT gates. He represented these as Tinkertoys-like parts with symbols used by electrical engineers. He added color and animation to model electric current flow. The player begins by working through structured tutorials, then combines and recombines elements, directly experiencing the abstract concepts of AND, OR, and NOT. After completing a series of puzzles, the player can create original games. Some people apply what they have learned in the context of the game to new situations in real life. These players have gained insight into very important concepts in electronics and logic.

Builders are simulations that can defy the laws of the physical universe. By suspending disbelief, the player can enter a special reality, then stand outside it to gain insight into the modeling process itself. For example, in Rocky's Boots, the presence of electric current in a wire or gate is represented in red, absence of current in white. Players use this color coding to understand the current flow in complex circuits, then some make the conceptual leap: this is a model, and like any model, it has limitations and is not a complete representation of reality. Children who can make this connection have learned an important principle in science: we are bound by our models.

A NEW GENERATION OF LEARNING SOFTWARE

Learning game sets and builders are new genres of educational software. Children using these programs explore powerful visual environments. Through their play with these tools, children can acquire not only skills and knowledge, but insights at a new level. ■

TOTAL CONTROL:

FORTH: FOR Z-80®, 8086, 68000, and IBM® PC
Complies with the New 83-Standard
GRAPHICS • GAMES • COMMUNICATIONS • ROBOTICS
DATA ACQUISITION • PROCESS CONTROL

● **FORTH** programs are instantly portable across the four most popular microprocessors.

● **FORTH** is interactive and conversational, but 20 times faster than BASIC.

● **FORTH** programs are highly structured, modular, easy to maintain.

● **FORTH** affords direct control over all interrupts, memory locations, and i/o ports.

● **FORTH** allows full access to DOS files and functions.

● **FORTH** application programs can be compiled into turnkey COM files and distributed with no license fee.

● **FORTH** Cross Compilers are available for ROM'ed or disk based applications on most microprocessors.

Trademarks IBM, International Business Machines Corp., CP/M, Digital Research Inc., PC/Forth+ and PC/GEN, Laboratory Microsystems, Inc

FORTH Application Development Systems include interpreter/compiler with virtual memory management and multi-tasking, assembler, full screen editor, decompiler, utilities and 200 page manual. Standard random access files used for screen storage, extensions provided for access to all operating system functions.

Z-80 FORTH for CP/M® 2.2 or MP/M II, \$100.00;
8080 FORTH for CP/M 2.2 or MP/M II, \$100.00;
8086 FORTH for CP/M-86 or MS-DOS, \$100.00;
PC/FORTH for PC-DOS, CP/M-86, or CCPM, \$100.00; **68000 FORTH** for CP/M-68K, \$250.00.

FORTH + Systems are 32 bit implementations that allow creation of programs as large as 1 megabyte. The entire memory address space of the 68000 or 8086/88 is supported directly.

PC FORTH + \$250.00
8086 FORTH + for CP/M-86 or MS-DOS \$250.00
68000 FORTH + for CP/M-68K \$400.00

Extension Packages available include: software floating point, cross compilers, INTEL 8087 support, AMD 9511 support, advanced color graphics, custom character sets, symbolic debugger, telecommunications, cross reference utility, B-tree file manager. Write for brochure.



Laboratory Microsystems Incorporated
Post Office Box 10430, Marina del Rey, CA 90295
Phone credit card orders to (213) 306-7412



Business as Usual?

Business as usual these days means a computer that's up and "humming." But if your computer were stolen or damaged, you wouldn't have business as usual. YOU'D HAVE TROUBLE!

You can get fast replacement for your entire system and be back in business in a hurry by protecting your computer with SAFEWARE Personal Computer Insurance. It's the only coverage designed specifically for personal computers used for business — in your office, shop or home.

SAFEWARE protects ALL hardware, ALL purchased software and ALL media against theft, damage or any other kind of loss, regardless of use, after a low \$50 deductible.

(Not without your computer it wouldn't be.)

Fast, courteous claims handling prevents your losing valuable business computing time.

Find the premium price for the coverage you need listed in the table below, available for as low as \$35 per year. Fill in the coupon today. Your coverage will begin as soon as your coupon application is received. Or for even faster coverage, call our toll free number.

1-800-848-3469

(In Ohio call 1-614/262-0559)
Phones open 8 a.m. to 8 p.m., Monday through Saturday

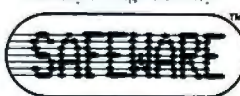

Total Hardware, Media & Software System Value	Annual Premium
Up to \$ 2,000	\$ 35
\$ 2,001-\$ 5,000	\$ 60
\$ 5,001-\$ 8,000	\$ 75
\$ 8,001-\$11,000	\$ 90
\$11,001-\$14,000	\$105

Call toll-free for rates on higher coverage. Coverage differs in Texas. It is an underwriting requirement that you insure your system for its full value.

Mail to: SAFEWARE, P.O. Box 02211, Columbus, OH 43202

Before I'm out of business,

please issue my SAFEWARE Insurance Coverage

Name _____

Street _____

City _____ State _____ Zip _____

System value \$ _____ Check Enclosed VISA MasterCard

Card # _____ Exp. Date _____

INT

Lucille Le Sueur made a name for herself.

She called herself Joan Crawford.
Because a star needs a star's name.
One that commands attention.
And gets it.

MultiMate International is that kind of a name. Replacing Softword Systems. A good name too, but one that no longer suits the company we've become.

Today, MultiMate International spans four continents. MultiMate, the word processor that redefined the IBM PC, has been translated into five languages. Its similarity to Wang has resulted in phenomenal growth, both in acceptance and sophistication, and fueled our own phenomenal growth as a company.

MultiMate International. It's the name we deserve. Because it's the name we've earned.

MULTIMATE
INTERNATIONAL

Circle 406 on inquiry card.

We've made a name for ourselves.



Professional Software for the Software Professional

DMA products operate on
the full range of
Z80, 8086, 8088 processors,
including the IBM-PC

Here's what you can do!

Application Creation

FORMULA II™

The Application Creator

The first and only Application Creator—a do-it-yourself concept for office automation. FORMULA II lets you define your files, forms, menus, and reports—FORMULA II then creates your program. FORMULA II includes a Database manager with an English Query language and a Form/Report Creator with word processing features.

Communications

ASCOM™

ASCOM™ is the most versatile asynchronous communication package for microcomputers on the market. It features interactive, menu-driven, and batch operations; supports auto-answer and auto-dial modems; includes most popular protocols; provides network simulation; and many other options. Xerox Corporation, NCR, Monroe Systems for Business, and the big 8 accounting firms use ASCOM™.

SYNC/COM™—A bisynchronous communication package that will be configurable for a variety of systems and includes a flexible interface to the operating system. 2780/3780/3270 protocols available on microcomputers with appropriate hardware.

TERMCOM™—A configurable terminal emulator allowing any personal computer to emulate most conversational and selected block mode terminals with asynchronous communications. Available December 1983.

Utilities

EM80/86™

This software emulator lets you use eight bit software on sixteen bit microcomputers without hardware modifications.

The 8086 O.S. Converter™

CP to MS—Permits execution of Digital Research's CP/M-86 programs under Microsoft's MSDOS (or PC DOS).

MS to CP—Permits execution of MSDOS programs under CP/M-86.

UT-86™

This package of user-friendly utilities for the IBM Personal Computer and similar systems includes copying, directory sorting, patching, and a general purpose file print utility.

Coming Soon

DMA."C"™—A "C" language compiler which will generate either Z80 or 8086 assembly language code. Due to a unique optimization routine which is based upon a functional "P-code" model, the efficiency of DMA."C" will far exceed that of existing compilers.

DMA DMA DMA

WE SPEAK YOUR LANGUAGE WE SPEAK YOUR LANGUAGE WE SPEAK YOUR LANGUAGE

DYNAMIC MICROPROCESSOR ASSOCIATES, INC.

545 FIFTH AVENUE, NY, NY 10017

Dealer Inquiries only • (212) 687-7115

CAUTIONS ON COMPUTERS IN EDUCATION

BY STEPHAN L. CHOROVER

Effects on the student-teacher relationship

"TO PROPHECY IS extremely difficult," says an old Chinese proverb, "especially with respect to the future." Nevertheless, the proliferation of personal computers in the educational environment seems certain to have a profound and far-reaching effect upon teachers, students, and the educational enterprise as a whole.

As a student of "psychotechnology," I am interested in the material and conceptual impact of sociotechnological change upon both the thought process and behavior of individuals, and the organization and development of human groups. What is the relationship between computer-based systems and the human social systems within which they develop or into which they are introduced? As an educator and psychologist, I am interested mainly in the human side of this question, as we make the transition to computer-based systems of instruction.

Only experience and time will tell whether or not the computerization of education will actually revolutionize the ways in which we teach and learn, but it will undoubtedly have many more or less profound effects upon how stu-

dents and teachers relate to one another.

Among the questions that I would like to see addressed are these: How will the evolution of computer systems affect the fundamental form and content of the educational enterprise? What effects will it have on the personal and professional lives of students and teachers? How will it affect relations between, and patterns of interactions among, individuals and groups?

Carnegie-Mellon University is developing an integrated computer network. CMU President Richard Cyert wrote in *Science* (November 11, 1982) that: "An environment that is densely populated with computers represents a new type of world. We need to know the impact of such an environment on social inter-
.....
Stephan L. Chorover (Department of Psychology, MIT, Cambridge, MA 02139) is a neuropsychologist and professor of psychology at the Massachusetts Institute of Technology. He is the author of *From Genesis to Genocide: The Meaning of Human Nature and the Power of Behavior Control* (MIT Press, 1979) and a frequent commentator on developments in the field of "psychotechnology."

actions. We also must study the effects of decisions made by the process of communicating over a network, as opposed to face-to-face meetings. There are, in fact, a large number of issues that require study at the inception of the radical change we are making."

At Carnegie-Mellon, he reports, the task of studying these questions has been assigned to a committee of social and computer scientists.

SCHOOLS AS FACTORIES

Ostensible experts, including many of this year's political candidates, are inclined to issue alarms about the declining "efficiency and productivity" of American commerce and industry, especially as compared to that of the Japanese. Equally expert analyses of the present state of our educational system tend to reflect and reinforce this perspective. I have been unable to find a single example of a recent, officially authorized review of American public school education that is not predicated upon the view that we are falling woefully behind our principal competitors in the international race for industrial

(text continued on page 224)

(text continued from page 223)

and commercial supremacy in the world. Once that premise is accepted it is easy to offer the conjecture that one reason for this sorry state of affairs is the failure of our educational institutions to provide a proper grounding in the skills required for national success and international leadership.

In the context of this conception of education, we should examine what the experts are telling us about the role of computers in education. In a recent paper entitled "Productivity and Technology in Education," Dr. Arthur S. Melmed, an official of the U.S. Department of Education, tells us that the problem of "how to improve productivity in education" will be "perhaps the central problem for education and educational research for the remainder of this decade." Failure to deal successfully with this problem, he continues, will have profound and far-reaching deleterious effects on our national economy. What is to be done? Here is his answer: "The key to productivity improvement in every other economic sector has been through technological innovation. Applications of modern information and communication technologies that are properly developed and appropriately used may soon offer education policy makers . . . a unique opportunity for productivity management."

Though some readers may think it strange to speak of education in such crassly materialistic terms, there is nothing new in the idea of the school as a kind of "factory." As early as 1916, Professor Ellwood Cubberly, Dean of Stanford's School of Education, proudly proclaimed our schools to be "factories in which the raw materials are to be shaped and fashioned into finished products" in accordance with "specifications for manufacturing (derived from) the demands of twentieth-century civilization."

Richard Cyert, in a Carnegie-Mellon press release of October 20, 1982, expressed his belief that the network of personal computers developed at Carnegie-Mellon "will have the same role in student learning that the development of the assembly line in the 1920s had for the production of automobiles. The assembly line enabled large-scale manufacturing to develop. Likewise, the network personal com-

puter system will enable students to increase significantly the amount of learning they do in the university."

DISPLACEMENT, DESKILLING, AND ALIENATION

My father would have said: "There is no free lunch." The improvement in productivity achieved in other economic sectors through the development and deployment of technological innovations always has effects upon the people whose productive activities are directly affected. Not all of the effects are reducible to measure and number. For the vast majority of men and women whose work lives have been signifi-

Though some may think it strange to speak in such terms, there is nothing new in the idea of the school as a kind of factory.

cantly affected by automation—the principal mode of industrial innovation—the response has not been entirely salutary. All too often automation has led to worker displacement, deskilling, and alienation. What reasons do we have to believe that technological innovation (computerization) will follow a different course and lead to a different outcome in the field of education?

Let us imagine ourselves to be educational policy makers involved in trying to decide which way to turn in the helter-skelter transition toward computer-based systems of instruction. Let us assume that ours is an underfinanced public school system in an American city and that our teachers feel they are underpaid and overworked.

Let's assume that we are responsible for determining whether (and if so, how) to introduce computers into the elementary school and high school curricula. Let us suppose further that we are concerned with "improving our productivity" and that we are already keeping track of our system's "inputs and outputs" through the use of standardized academic achievement tests.

Into this situation comes a well-trained and well-meaning team of computer experts and cognitive scientists. Perhaps they have come from a major scientific/technological university or computer-development corporation nearby. In any event, they bear what appears to be a carefully crafted proposal: one that they and others have been working on for some time in the laboratory. They believe it is time for a field test.

Precisely what have they been working on? "Improved educational productivity," says one. "Computer-aided instruction," says another. "Computer-based learning," claims a third.

They explain that the tutorial mode of teaching, using individualized instruction, is much more efficient than the classroom mode. They have designed a courseware package of both hardware and software, with which a student who has no prior computer experience can work in a self-paced manner. Subject matter is broken down into codable units and presented to the student at the appropriate time. Any information a student needs can be encapsulated in a computer program.

After an initial investment in the hardware and software, they point out, the system will be extremely cost-effective. Instead of teachers who are subject-area specialists, the school can hire relatively unskilled people to be "resource managers" and "system monitors," more commonly known as stockroom attendants and security guards. The university (or company) will provide all the expert assistance the school will need, including curricular material, lesson plans, and examinations. The school will be able to say "goodbye teacher," and good riddance to that skyrocketing professional payroll.

To the objections now arising, let me hasten to insist that what I have presented is more than a caricature. "Goodbye teacher" was, in fact, the title of an article written almost two decades ago by Professor Fred S. Keller, a behavioristically inclined psychologist who was one of the leading developers of an earlier system of automated instruction inspired by the work of B. F. Skinner. The so-called "Keller Plan" is one of the old theories that has died along with many other well-intended measures for increasing educational productivity through automation.

"Computer tutor" systems have the same form, content, and intended applications as that just described and are presently under development in many academic and corporate contexts. My scenario is based, in part, on a lecture presented recently at MIT by a visiting professor of cognitive science. The interpretation of the foreseeable effects of the computer tutor upon the quality of work life in the classroom (especially as it touches on the deskilling of the

teacher's role) is taken directly from a conversation with him.

A CRISIS IN EDUCATION

What is to be done? I do not presume to say what researchers and systems developers in this field should do, or how educational policy makers ought to respond when confronted with proposals of this kind. Nevertheless, I am convinced that developments in the rapidly evolving field of computers in educa-

tion are bound to have an effect on all of us who are part of the American educational system.

I hope that the problem of automation in education will give us a reason to stop, think, and reconsider the problem of sociotechnological transition in deeper and more humane ways. Meanwhile, let me suggest that the experience gained in many places thus far provides a provisional basis for saying

(text continued on page 226)

Another View from MIT

BY JOSEPH WEIZENBAUM

Joseph Weizenbaum, Ph.D., a Professor of computer science at the Massachusetts Institute of Technology, made the following comments in a telephone interview conducted by Donna Osgood, a BYTE associate editor, on the effectiveness of computers as learning tools.

We in the United States are in the grip of a mass delusion with respect to the education of kids with computers. The belief that it is very urgent that we put computers in primary and secondary schools is based on a number of premises, of which only one is true. The true premise is that the whole world is becoming increasingly pervaded by computers. But then people infer that in a world pervaded by computers, everybody must be "computer literate" in order to be able to cope with the world at all. A second inference is that a high degree of computer literacy assures one a good job, while computer illiteracy condemns one to life on the margin of the coming information society.

I think most people imagine computer literacy to consist largely of the ability to communicate with computers, to operate them and to be able to correctly interpret their output. Hence, computer literacy is generally interpreted to mean knowing a computer language or two, and probably involves facility with the computer's keyboard.

Another illusion is that computer-language learning is like other kinds of learning. That, of course, is best done very early in life, indeed, the earlier the better. This provides a lot of fuel for the pressure on the schools to begin computer training very early and to make it part of the school curriculum from kindergarten to grade 12.

Again, all of this is based upon the true assumption that the computer is beginning to pervade and will continue to pervade our society. I would like to draw an

analogy to something else that is ubiquitous in our society—the electric motor. There are undoubtedly many more electric motors in the United States than there are people, and almost everybody owns a lot of electric motors without thinking about it. They are everywhere, in automobiles, food mixers, vacuum cleaners, even watches and pencil sharpeners. Yet, it doesn't require any sort of electric-motor literacy to get on with the world, or, importantly, to be able to use these gadgets.

Another important point about electric motors is that they're invisible. If you question someone using a vacuum cleaner, of course they know that there is an electric motor inside. But nobody says "Well, I think I'll use an electric motor programmed to be a vacuum cleaner to vacuum the floor."

The computer will also become largely invisible, as it already is to a large extent in the consumer market. I believe that the more pervasive the computer becomes, the more invisible it will become. We talk about it a lot now because it is new, but as we get used to the computer, it will retreat into the background. How much hands-on computer experience will students need? The answer, of course, is not very much. The student and the practicing professional will operate special-purpose instruments that happen to have computers as components.

The emphasis on learning computer languages early is misplaced. It is clear to me that computer languages are not like natural languages. I think they are

more like mathematical languages or physics. They require a certain intellectual maturity, and when you have that intellectual or mathematical maturity, you can learn them relatively quickly. It isn't worth spending a lot of time on at an early age.

The counterargument that we should begin with baby steps early, like teaching BASIC to eight-year-olds, is going in exactly the wrong direction. BASIC is, from a pedagogic point of view, an intellectual monstrosity that we should start to eradicate and not attempt to use as a basis for anything.

I'm trying to argue that the introduction of computers into primary and secondary schools is basically a mistake based on very false assumptions. Our schools are already in desperate trouble, and the introduction of the computer at this time is, at very best, a diversion—possibly a dangerous diversion.

Too often, the computer is used in the schools, as it is used in other social establishments, as a quick technological fix. It is used to paper over fundamental problems to create the illusion that they are being attacked.

If Johnny can't read and somebody writes computer software that will improve Johnny's reading score a little bit for the present, then the easiest thing to do is to bring in the computer and sit Johnny down at it. This makes it unnecessary to ask why Johnny can't read. In other words, it makes it unnecessary to reform the school system, or for that matter the society that tolerates the breakdown of its schools.

BYTEWRITER®

DAISY WHEEL PRINTERS



- Praxis 35 portable BYTEWRITER \$495
- Praxis 40 office BYTEWRITER \$595
- Model 900 (no keyboard) 900 day warranty \$649
- Serial and parallel input. Tractor and friction feed.
- Interface only - wired and tested for Praxis 30, 35 and 40 \$165
- for ET-111 \$195

BYTEWRITER

125 NORTHVIEW RD., ITHACA, N.Y. 14850
(607) 272-1132

COMPUTER CAUTIONS

(text continued from page 225)

what should not be done. Computer-based systems should not be introduced from the top down.

Too many schools still follow a well-established recipe for disaster: first, policy makers choose the hardware, then decide on the software. They then teach teachers and other staff how to use the system, and finally, everybody tries to figure out what the goals of system utilization are to be and whether the system already in place can help meet those goals.

Instead, teachers and students should be involved at all stages of the process, including the initial and difficult (often

Too many schools still follow an established recipe for disaster: first, policy makers choose the hardware, then decide on the software.

neglected) one of defining the educational values and goals that any such system is intended to serve.

It would be a very serious error to look only at the technical aspects of computers in education and to think only in terms of quantifiable productive efficiency. It is only in the context of a supportive educational community—a human environment conducive to learning—that the hazards of automation can be avoided.

What then needs to be done in the design of educational systems that will include the use of computers? Without attempting to give a comprehensive answer, as the details will vary from case to case, I would suggest that we must take it as our goal to draw people into an intimate and creative human context. The people who are on the receiving end of the innovations have to be involved in the transition. We are at a turning point, if you will, a kind of crisis. The Chinese character for "crisis" is made up of two other characters: "danger" and "opportunity." ■

Order your personalized computer paper...NOW!

Printed with your name, business, club, anything. Paper is white, 20# bond. Choice of 5 ink colors. Fits all printers using 9½ x 11 continuous paper (8½ x 11 when detached). Limited offer of low prices, and special offer.

Satisfaction Guaranteed—
full refund if not satisfied by returning unused paper.

We pay shipping and handling for orders over \$45.00
Orders for different personalized names may be combined for free shipping to one address.

Special Offer
Order now and we'll send free samples of other computer paper specialties with your order.

Name _____

Street _____

City _____ State _____ Zip _____

Personalize as follows: Leave space between words.
(For more than one order use separate sheet for 30 character personalization)

Check ink color: Red Blue Gray Brown Canary

500 sheets at \$19.95 \$ _____
1000 sheets at \$34.95 \$ _____
2000 sheets at \$49.95 \$ _____
Shipping, handling \$ 4.00
(if under \$45.00)
Total order \$ _____

Enclose check or money order. No COD's. Texas residents add 5½% sales tax. VISA and MasterCard accepted. Send number, signature, and expiration date. Allow three weeks for delivery.
Mail order to: **Personalized Computer Paper/Dept. B**
P.O. Box 39716/San Antonio, Texas 78218
512-822-8712

BUSINESS PARTNERS WANTED

1st time offering. Major U.S. firm seeks partners for new business venture w/huge \$\$\$ potential. Prdct: complete family of 32-bit computers. Latest technology. 256K chips. CMOS microprocessors. Intelligent LANs. Ultra-high uptime architecture. Easy to use. UNIX™ System V based. Top-notch service/support. Manufacturer: Long experience in computers. Total commitment to market. Excellent prices/terms/discount schedules for right parties. For additional details, call 1-800-833-9333. Or turn the page.



3B2

It is small enough to sit on a desk top. Yet it can accommodate up to eighteen users.

It is a 32-bit super microcomputer running UNIX System V. But it has the power of a minicomputer.

It incorporates 256K DRAM chips for high-capacity main memory of up to 2 megabytes. So more is delivered than with the average microcomputer, and at a lower cost per station.

It's the 3B2/300. From AT&T.

Perfectly targeted for an office where several people need a desk-top computer, and there's a need to accommodate growth. And it can function as an intelligent network host or file server for PCs.

And the 3B2/300 is available in a variety of solutions packages with flexible growth options.

It is the most advanced super microcomputer your customers can buy today.

Circle 6 on inquiry card.



3B5

These general-purpose, midrange, true 32-bit, super minicomputers are designed to run UNIX System V and can accommodate up to sixty users without putting a dent in response time.

They are remarkably easy to use, and easy to maintain because they are self-diagnostic. They are flexible, powerful tools for a variety of applications, such as software development, office systems, and CAD/CAM.

They're the 3B5/100 and 3B5/200. From AT&T.

They can be configured to suit customer needs with a wide variety of I/O, peripheral, memory, and communications options for cost-effective growth. This makes them good investments for your customers.

These computers fit neatly into the office environment. And are incredibly quiet, cool, efficient, and plug into standard wall outlets.

Circle 7 on inquiry card.



3B20S

The 3B20S computer is the high-end supermini of the 3B family. It runs UNIX System V and is designed to meet the rigorous needs of data centers, developers, office service organizations, and manufacturing locations.

When a customer outgrows these capabilities, you simply add the attached processor forming the 3B20A. And add up to 80% to your performance range. Or you can begin serving your needs with the 3B20A right from the start.

And the growth from the 3B20S to the 3B20A occurs as painlessly as possible with only a modest increase in cost.

Both computers are energy efficient and easy to install. They perform without complex and expensive environmental controls. And unlike most computers of this capacity, the 3B20S and the 3B20A do not require air conditioning or raised floors.

Circle 8 on inquiry card.



3B20D

It is a powerful, 32-bit super minicomputer that will set a new standard for uptime. It runs the new UNIX RTR operating system, providing time-sharing and introducing real time and fault-tolerant features.

It operates continuously even during hardware faults, data-base mutilations, repair, software updates and growth.

It is the 3B20D. From AT&T.

It is ideal for applications requiring ultra-reliability and fast response such as reservation systems, command and control systems, on-line banking systems, and others where computer outage means serious or intolerable business losses.

Like the 3B20S and 3B20A, the 3B20D does not require air conditioning or raised floors.

For continuous computing, the 3B20D is unsurpassed in its class.

Circle 9 on Inquiry card.

AT&T COMPUTERS

AT&T has always been a leader in the field of computer science and computer applications.

We've proven this in the most demanding data processing environment in the world—the nationwide telecommunications network.

And we intend to remain a leader by meeting your needs. As well as the needs of your customers.

We are committed. Both in our products and our partnership.

Because we know our success rests on your success, and in turn on that of your customers. Working together as partners, we can share the promise of the 3B family of computers.

But our commitment doesn't end with state-of-the-art products. When you join hands with AT&T, you also receive superb service.

We offer complete marketing support packages; product service and maintenance; financial support; and a full range of consulting services.

This is a national support system that is second to none. And with the unsurpassed R&D capability of our own AT&T Bell Laboratories, you can market the 3B family of products with confidence and guarantee them to your customers.

To find out more about this remarkable family of computers, and our comprehensive and flexible OEM/VAR programs, call us at 1-800-833-9333.



LANGUAGES FOR STUDENTS

BY FRED A. MASTERSON

Evaluating programming languages for use in education

ONE OF THE MOST enlightened forms of computer-aided instruction (CAI) encourages students to use a programming language to explore problem domains, classes of related problems. In addition to enhancing computer literacy, such exploration helps students acquire strategies for learning about new problem domains. But all programming languages are not created equal; some are more appropriate for this application than others.

I have four requirements for a CAI programming language: simplicity, power, compatibility, and cognitive richness. "Simplicity" refers to the ease with which students can learn a programming language, at least to the degree that they can use it to solve simple problems. "Power" is a measure of the ease with which a programming language can be applied to complicated problems. Simplicity and power are relatively independent. Some programming languages are difficult to learn but provide relatively easy solutions to complex problems, while some simple languages do not.

The third requirement for a CAI programming language is that it be compatible with other computing applications. A programming language encountered in a CAI context may be the first computing experience for many students. There should be a positive

transfer between a CAI programming language and such common computing applications as word processing, statistics packages, and other popular programming languages.

"Cognitive richness" measures the extent to which the programming language facilitates thinking about various problems. Cognitively rich languages provide easy ways to represent and test hypotheses about the rules governing problem domains. In contrast, cognitively poor languages may actually block reasoning about a problem domain by producing an antagonism between natural ways of thinking and the representations allowed by the language. This requirement is closely related to those of simplicity and power. Indeed, ease of learning and ease of application necessitate a rich notation for representing problems.

MAINSTREAM LANGUAGES: NEITHER SIMPLE NOR POWERFUL

Such mainstream programming languages as FORTRAN, ALGOL, and Pascal are widely distributed and widely used in academia and industry. The same languages tend to be popular in

.....
Fred A. Masterson is a professor of cognitive sciences and psychology at the University of Delaware (Newark, DE 19711).

both settings, since industry hires the graduates of academia, and curriculum planners are sensitive to the needs of industry.

FORTAN (Formula Translation), because it was the first high-level language, established a dominance that still prevails in physical science and engineering, though most versions of it lack overall coherence and well-designed flow-of-control commands. FORTRAN programs make heavy use of conditional branching statements that send control to different parts of a program, so that programs for all but the simplest tasks must be read in a zigzag fashion, instead of in a smooth flow from top to bottom. (However, RATFOR, a UNIX version of FORTRAN, and FORTRAN 77 incorporate ALGOL-like flow-of-control commands.)

ALGOL (Algorithmic Language) shows a higher degree of internal consistency and sophisticated control structures. As a result, it became a universal language for communicating algorithms in computer science. ALGOL control structures such as BEGIN...END, IF...THEN...ELSE, FOR...DO, and WHILE...DO set a precedent for future solutions to flow of control in programming languages. However, ALGOL lacks a standard set of commands for reading and writing data.

(text continued on page 234)

(text continued from page 233)

Pascal, a descendant of ALGOL, is doing well in academia. Pascal is trim enough to run in the 48K- to 64K-byte memory limit that characterizes many of the personal computers commonly used in educational settings. It is small enough to be easily implemented, and its trimness makes its syntax and semantics easy to specify and relatively easy to grasp.

A major drawback to FORTRAN, ALGOL, and Pascal as programming languages for student use is that they are not interactive. In order to try even the simplest commands, a student must enter them in a source-code file, run a compiler to produce an object-code file, and then run a linker to make an executable program file. Consequently, experiments with one or a few commands consume disproportionately large amounts of time and effort. A much better environment would be an interactive one in which small sets of statements could be tested immediately.

A second major flaw in these programming languages is that all complex procedures must be broken down into steps that manipulate the contents of single memory locations in the computer. Although the computer is forced by its architecture to deal with memory locations one at a time, a programming language suitable for student use should disguise this limitation, making it seem that entire arrays or lists of numbers or characters can be manipulated by single commands.

The "one thing at a time" limitation is often built into programming languages as a limitation on the values of user-defined functions, which must be the contents of a single location in memory. Thus, functions cannot return arrays or lists as values—only single numbers or items. Subroutines in FORTRAN or procedures in ALGOL or Pascal must be used to compute more complicated data structures. As a result, procedure or subroutine calls are used much more frequently than functions. This is unfortunate, because a sequence of function applications can convey a clearer picture of a computation than an equivalent sequence of procedure or subroutine calls. For example, consider the problem of squaring each element of a matrix named MATRIX1 and then

transposing the result. If SQUARE and TRANSPOSE could be coded as functions, a solution would be

```
MATRIX2 := TRANSPOSE (SQUARE
                      (MATRIX1))
```

Since this is not possible in any of the aforementioned languages, the solution would have to look something like this:

```
SQUARE (MATRIX1,
        TEMPORARYMATRIX) ,
TRANSPOSE (TEMPORARYMATRIX,
          MATRIX2)
```

where the first argument of each procedure is the matrix to be operated upon and the second argument is the result of the operation. (In FORTRAN, "CALL" would precede "SQUARE" and "TRANSPOSE".) By comparison, the functional notation is considerably clearer.

BASIC: SIMPLE BUT NOT POWERFUL

A high degree of interactiveness is essential to the potential simplicity of a programming language. One of the best-known interactive programming languages is BASIC (Beginner's All-Purpose Symbolic Instruction Code). Successive lines of a BASIC program are typed directly to the BASIC system, and a program can be run immediately, without the delays interpolated by compiling and linking. In addition, most BASIC systems can execute single lines of commands outside of formal program definitions.

BASIC became *the* programming language for microcomputers during the middle to late 1970s because it was small enough to fit in the limited memories of early microcomputers. The price of this compactness was reduced performance.

Like FORTRAN, BASIC lacks adequate control structures. Many versions restrict variable names to no more than two characters, making the use of mnemonic names nearly impossible. However, BASIC's most egregious flaw is the absence of procedures or subroutines. Many manuals erroneously describe BASIC's "GOSUB" command as a subroutine facility. In fact, it is no more than an unconditioned branch from one to another block of code, with the ability to later return to the original block.

Fortunately, standards for an improved version have been drafted by the BASIC Committee of the American

National Standards Institute (ANSI). The proposed standard allows multicharacter names for variables and ALGOL-like flow-of-control commands. The new standard also supports true subroutines with calling parameters and local variables.

APL AND LISP: POWERFUL BUT NOT SIMPLE

All the languages we've looked at so far have only moderate power because they suffer from the "one thing at a time" limitation mentioned earlier. Restricting our search to readily available programming languages, two avoid this limitation—APL and LISP. Implementations of APL (A Programming Language) and LISP (List Processing language) are available for many mainframe and minicomputer systems and for some microcomputers. APL and LISP are highly interactive and extremely powerful, but their unusual notations have daunted many would-be users.

In some ways, APL and LISP are two of the best-kept secrets in computer software. While both have devoted users, neither has gained widespread acceptance, probably because of the notational problems mentioned above. Yet beneath those quirky notations lie programming systems that can be described as "futuristic" when compared to ALGOL, BASIC, FORTRAN, and Pascal.

APL and LISP let users think in terms of data structures. The data structures favored by APL are arrays (scalars, vectors, matrices, and arrays with more than two dimensions). In LISP, the data structures are lists (and the elements of a list may themselves be lists). Both APL and LISP enable the user to define functions that return entire data structures. Thus, embedded function applications can be used to clarify the hierarchical structure of a computation. Here is the APL command for the earlier example, squaring each element of a matrix and transposing the result:

```
MATRIX2 ← TRANSPOSE SQUARE
          MATRIX1
```

APL and LISP are also highly interactive. A function can be executed as soon as its definition has been entered. In addition, you can execute commands in "immediate execution mode" without embedding them in a function defini-

(text continued on page 236)

(text continued from page 234)

tion. Thus, it is very easy to try out various commands to see how they work. This is especially valuable in powerful languages such as APL and LISP, where the effects of one-line commands can be relatively far-reaching.

Both APL and LISP encourage a modular programming style in which problems are broken down into several short function definitions. Since each function can be tested separately, logic errors are relatively easy to detect and rectify. To further aid debugging, both languages enable the user to set "trace points" and "break points" in functions. Trace points enable the user to follow the flow of control from function to function or from line to line in the same function. Break points suspend execution at preselected locations in functions so that the user can check the state of the computation at those locations.

APL and LISP let the user store large numbers of function definitions and data objects in the user's core image, thus greatly reducing the need for disk file save and retrieve commands. The user's core memory image is allocated dynamically, expanding when additional functions or structures are created and contracting when functions or structures are reduced or eliminated. Memory allocation is completely transparent to the user, so that "dimension statements" are not required to warn the system of future memory requirements. At any time, the entire memory image can be saved as a single disk file and retrieved later. Thus, the user can load an entire core image from disk, modify, delete, or add functions and data structures to that image, then save the entire core image back to disk.

APL and LISP are self-contained programming-language environments. They have coordinated facilities for memory management, error recovery, and I/O formatting defaults that enable users to customize the environment to fit special requirements.

Although both APL and LISP are interactive and powerful, they use offbeat notations and eccentric built-in editors. APL uses unusual characters and requires special terminals outfitted with APL keyboards. LISP has standard characters but uses reverse Polish notation and uses parentheses often to delineate

the structure of a computation.

Neither APL nor LISP has structured commands for controlling iterations. Fortunately, both languages encourage programming styles that reduce the need for iteration, because both provide many commands that process entire data structures at once. Indeed, many of the applications of iteration in other languages involve the one-at-a-time processing of sequential elements of a list, vector, or array—processing that can be done in a single APL or LISP command. The use of recursive programming techniques further reduces the need for iteration in APL and LISP.

AMPL AND LOGO: SIMPLE AND POWERFUL

Fortunately, programming-language systems without notational difficulties can be based on APL and LISP. AMPL (A Modified Programming Language), developed at the University of Delaware, is a dialect of APL that avoids the special APL character set. [For a list of publications on AMPL, see the bibliography on page 238.] Logo, though inspired by LISP, does not rely as heavily on parentheses and allows the use of standard notation (in addition to reverse Polish) for arithmetic operators.

Despite notational simplification, AMPL and Logo retain many of the advanced features of their parent languages. In particular, both AMPL and Logo have the following features:

1. interactive, interpreted code
2. powerful primitives for creating and altering whole data structures
3. functional notation that often emphasizes the hierarchical structure of a computation
4. dynamic memory allocation
5. stored workspaces containing variables and function definitions
6. user access to system variables

The Logo programming language is a simple yet powerful tool that children can use to explore the worlds of geometry, mathematics, and physics. However, far from being just for children, Logo has many sophisticated features that will sustain the interest of advanced programmers.

We have used AMPL as part of an introductory college-level course in statistical data analysis. Our goals are

twofold. First, and most important, we want to provide our students with a simple yet powerful tool for exploring mathematical and statistical relationships in sets of experimental data. Our second goal is to further the cause of computer literacy. This is the first exposure of most of our students to computers. Thus, it is extremely important that the experience be interesting and that it transfer to other computer activities. Perhaps the strongest motive behind the design of AMPL was to rid APL of its major eccentricities and thus increase its commonality with other computing notations and systems.

AMPL enables students to experiment with the grammar of algebra. There is a close correspondence between the structure of AMPL expressions and the equivalent algebraic expressions. Thus, each time a student interactively tries an AMPL expression, he or she learns a little more about the rules governing the evaluation of algebraic expressions. The end result of such learning can be dramatic. Students with poor math backgrounds, who otherwise would have difficulty grasping algebraic evaluation rules, learn the rules relatively easily by interacting with AMPL.

In addition to computing the values of statistics, students use AMPL to do sampling experiments. The experiments simulate coin tossing, sampling from continuous distributions, sampling correlation scatter plots, and so on. Such experiments give students a dynamic understanding of sampling variability and illustrate the basic logic of statistical inference.

COGNITIVE RICHNESS: LANGUAGES TO THINK WITH

Cognitively rich languages let users think in terms of complete structures. APL and AMPL let users think in terms of whole arrays, and LISP and Logo let users think in terms of hierarchical list structures. While other languages support these types of data, they distract the programmer's attention to element-by-element processing details. Due to the built-in "one thing at a time" limitation, the net effect is to pull the programmer's perspective away from the whole structure.

The numerical array representations
(text continued on page 238)

A few smart reasons to buy our smart modem:

Features	Ven-Tel 1200 PLUS	Hayes
1200 and 300 baud, auto-dial, auto-answer	Yes	Yes
Compatible with "AT" command set	Yes	Yes
Can be used with CROSSTALK-XVI or Smartcom II software	Yes	Yes
Regulated DC power pack for cool, reliable operation	Yes	No
Eight indicator lights to display modem status	Yes	Yes
Speaker to monitor call progress	Yes	Yes
Attractive, compact aluminum case	Yes	Yes
Two built-in phone connectors	Yes	No
Compatible with The Source and Dow Jones News Retrieval	Yes	Yes
Unattended remote test capability	Yes	No
Phone cable included	Yes	Yes
Availability	Now	
Price	\$499	\$699

The Ven-Tel 1200 PLUS offers high speed, reliable telecommunications for your personal computer or terminal. Whether you use information services or transfer data from computer to computer, the Ven-Tel 1200 PLUS is the best product around. Available at leading computer dealers and distributors nationwide.

Also from Ven-Tel: internal modems for the IBM and HP-150 Personal Computers with all of the features of the 1200 PLUS.

You choose. The Ven-Tel 1200 PLUS—the smartest choice in modems.

Ven-Tel Inc.

2342 Walsh Avenue
Santa Clara, CA 95051
(408) 727-5721



(text continued from page 236)

of APL and AMPL make these languages ideal for representing problems in linear algebra and statistics. Arrays can be used in these languages to represent string data as well. For example, a book is easily represented as a three-dimensional array in which each two-dimensional slice represents a page of text. Simple commands can be used to access and rearrange pages, lines, columns, and individual characters.

The hierarchical list structures of LISP and Logo facilitate the representation of algebraic formulas and propositions in symbolic logic. List structures are also useful in natural-language programs, where they represent the grammatical parsing diagram of a sentence or, at a deeper level of processing, a propositional representation of the meaning of the sentence.

The ability to think in terms of whole structures comes as a delightful surprise to students who are used to "one thing at a time" languages. Data structures acquire an almost physical palpability as the user breaks them apart and reassembles them into new structures by means of simple commands.

Another contribution to cognitive power is the freedom these languages provide from disk file bookkeeping. All required procedures and data structures reside in a core workspace and are instantly accessible by name. In many other languages a source program may reside in one file, library procedures in another, and data in yet another. As a result, the user must move about from file to file to edit procedures and data. This is just one more source of distract-

tion from the cognitive goals of a programmer.

Another conceptually powerful feature of APL, AMPL, LISP, and Logo is the ability to write recursive procedures; that is, procedures that call themselves. For example, a recursive procedure to determine the length of a list would apply itself to the list with one element removed and then add 1 to the answer. This recursive procedure is shorter and conceptually more satisfying than an iterative one that steps through the list counting each element in turn.

WANTED: RESPONSIVE, CUSTOMIZABLE LANGUAGES

The result of my survey of widely available programming languages is distressing. One might well ask why so few programming languages are suitable for CAI. And since CAI suitability should be synonymous with "human efficiency," why are there so few human-oriented programming languages?

We are at a new frontier of programming-language design. The old, inflexible, noninteractive programming languages have catered to the large-scale computing needs of science, business, and government. What we need now are flexible, interactive, powerful programming languages for the student and the personal computer user.

The requirements of large-scale computing could hardly be farther from those of most students and individuals. Cost-effective programming languages, in the context of economies of scale, demand *machine* efficiency at the expense of *human* efficiency. Machine-efficient programming languages tend to be in-

flexible and picayune, requiring several lines of code to accomplish even the simplest tasks. Programming becomes a tedious task prone to mistakes.

An analogy can be made to ground transportation. Businesses use large trucks to transport goods as cheaply as possible. Who would claim that individuals should use the same vehicles to go to work or go shopping? FORTRAN, ALGOL, BASIC and Pascal seem like trucks. We need more "automobiles" and "bicycles": responsive, customizable programming languages for CAI and personal computing. ■

AMPL, a modification of APL designed at the University of Delaware, allows standard ASCII characters, mnemonic command names, and a simple editor. It runs on the DECsystem-10 mainframe. A VAX 780 version is due for release this summer, and an IBM PC version is projected for 1985.

The author thanks Ken Cowan, Elizabeth Rust Kahl, Suzanne McBride, and Tony Stavely for their helpful comments on earlier versions of this article.

Bibliography

Masterson, F. A. "Bringing APL Down to Earth on the DECsystem-10: Standard Characters and a Standard Editor." *Behavior Research Methods and Instrumentation*, 1981, Volume 13, pages 374-376.

Masterson, F. A. *DEC-10 AMPL Installation Guide*. Newark, Delaware: Software Psychology Project, Department of Psychology, University of Delaware. Technical Memorandum No. 3, August 15, 1981.

Masterson, F. A. *AMPL: A Modified Programming Language*. Newark, Delaware: Software Psychology Project, Department of Psychology, University of Delaware. Technical Memorandum No. 4, August 15, 1981.

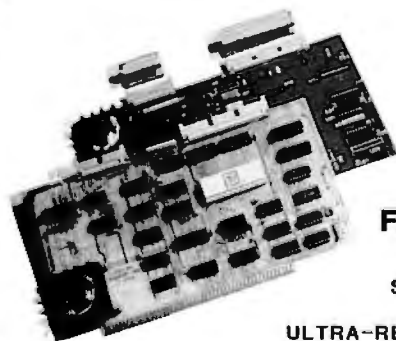

ULTRA-RES™ GRAPHICS

IEEE-696 S-100

- 1 X 512 X 512 \$495
- 3 X 512 X 512 \$1250
- 1 X 1024 X 1024 \$995

IBM-PC

- 1 X 512 X 512 \$495
- 1 X 1024 X 1024 \$995
- CONSOLE EMULATOR \$50
- PLOT 10 \$150

FEATURES

Software drivers, Hardware zoom, Programmable Display Resolution, Windowing, Multi-Controller Capability, NEC UPD7220 Graphic Controller

Starting Prices

ULTRA-RES Trademark CSD Inc.
IBM-PC Trademark IBM

C.S.D. Incorporated
P.O. BOX 253 Sudbury, MA 01776
(617) 443-2750

DATAEASE™

"95% of all PC information management needs can be handled by DATAEASE."

*Ira Krakow, Independent Consultant
Business Computer Systems Reviewer*

"DATAEASE enabled us to change files, records and reports with no fear of losing data — I can't begin to put a value on that."

*Peter J. Newcombe, Corp MIS Manager
General Defense Corporation*

"DATAEASE requires very little training or support... that means happy customers and lots of referral business."

*Nancy Lubecker, Assistant Manager
Softwaire Centre*



DATAEASE — The only fully integrated, fully relational information management system that successfully delivers ease-of-use without compromising power. Join the thousands of PC users who are turning to DATAEASE to get their information filed, sorted, analyzed and reported — including these corporate clients:

- AT&T
- Chase Manhattan Bank
- Exxon
- General Electric
- IBM
- Proctor & Gamble
- Prudential Life
- Stanford University
- Touche Ross
- United Technologies

DATAEASE Demonstration Diskette

- () Please send more information.
() \$10 check enclosed. Please send more information and a DATAEASE demonstration diskette.
() IBM () DEC () TI () Wang

Name _____

Title _____

Company _____

Address _____

City _____ State _____ Zip _____

Make checks payable to: Software Solutions, Inc.
40 Lindeman Drive, Trumbull, CT 06611 Or call: 800-243-5123

Get yourself a

This little critter comes with specially-designed software that flies through the maze of keystrokes on the most popular business programs faster than you can say "cheese."

Microsoft® Mouse puts the power to run Multiplan®, Lotus 1-2-3™, VisiCalc® and WordStar® in the palm of your hand. Click the left button on the mouse, a custom menu appears. In English, not hieroglyphics. Click the right button and execute your command: move text or data, edit, format, print. All at blinding speed without touching the keyboard.

It also lets you create your own menus for editing and formatting existing application programs. So people can learn programs quicker and do more productive work as they learn.

The mightiest mouse.

Microsoft Mouse runs circles around other mice. It is the high performance mouse for the IBM® PC and PC XT. From the company known for high

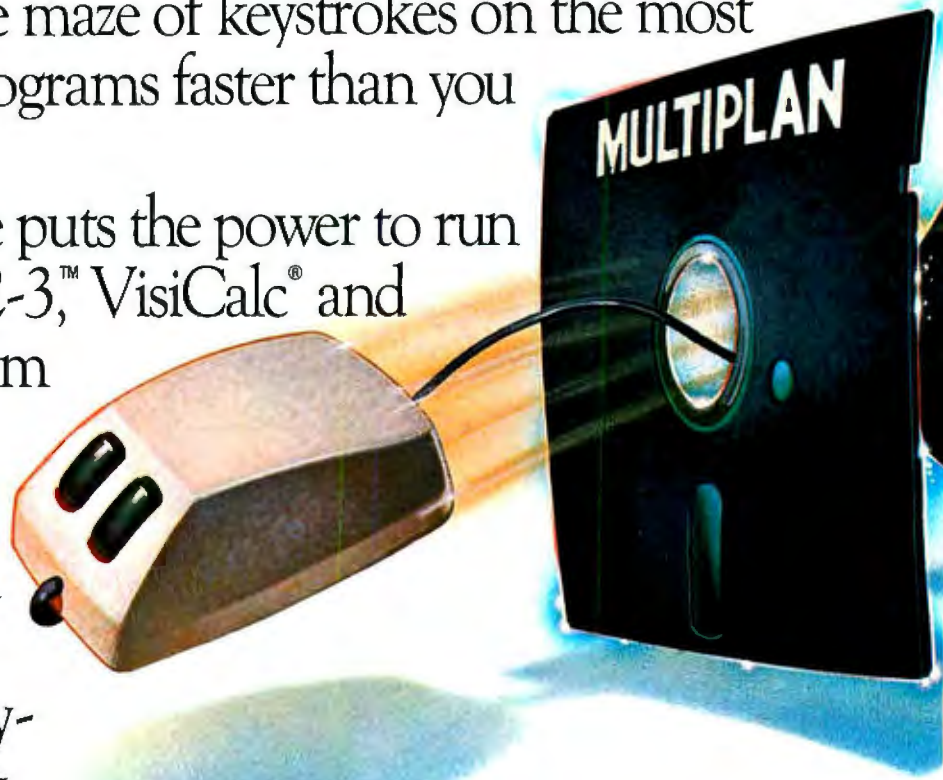

trained mouse.

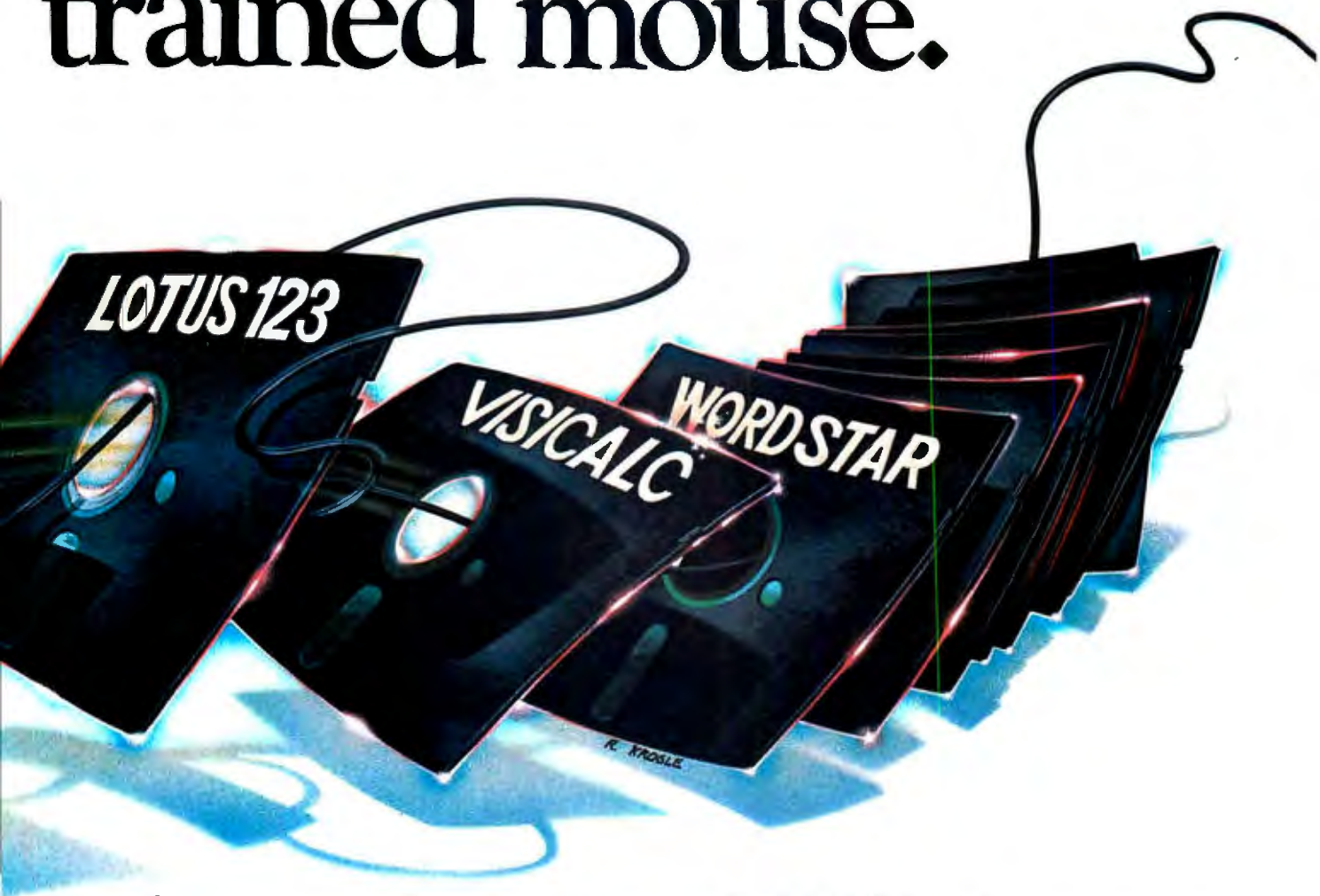

performance software. Microsoft BASIC is the language spoken by nine out of ten microcomputers worldwide.

MICROSOFT Our MS™-DOS operating system tells
The High Performance Software your IBM PC how to think.

So don't monkey around with any other mouse. Call 800-426-9400 (in Washington State call 206-828-8088) for the name of your nearest Microsoft dealer. Then go with Microsoft Mouse. The mouse that soars.

MICRO SOFT

Microsoft and Multiplan are registered trademarks and MS is a trademark of Microsoft Corporation.
Lotus 1-2-3 is a trademark of Lotus Development Corporation. VisiCalc is a registered trademark of VisiCorp. WordStar is a registered trademark of MicroPro.
IBM is a registered trademark of International Business Machines Corporation.

Want better output from your input?



IBM XY/749 Digital Plotter. Newest IBM plotter has simple, advanced design. Sheet size to 8½ x 11.

Use a Digital Plotter from IBM Instruments

You can turn volumes of business and technical data into easy-to-understand color graphics quickly and easily. The microprocessor in the plotter does all the hard work. Enter a few simple commands and it draws lines, shapes, circles, lettering—all kinds of graphics. You can communicate clearly with less time and effort.

Eight pens speed throughput

You get the full range of colors without constant attention and time consuming pen changes. Five line

types and five point marks, plus axis, grid and arc generation, make expression of complex concepts easy.

Quality that pays off

Durable construction provides long life and exceptionally quiet operation. Extensive built-in diagnostics verify both hardware and software operation.



IBM XY/750 Digital Plotter. Sheet size to 11 x 17. Optional roll feed.

Circle 163 on inquiry card.

Connect to most computers

RS-232C, IEEE-488 and 8-bit parallel interfaces provide connection to almost any computer. And you can use a wide variety of papers, vellums and foil transparencies.

Priced for outstanding value

You can get an IBM Digital Plotter for less than \$2,000. Find out more about this outstanding price/performance value. Call our toll-free number, 800-243-7054. In Connecticut, call 800-952-1073. Or write IBM Instruments, Inc., Orchard Park, PO Box 332, Danbury, CT 06810.

IBM Instruments Inc.

MICROCOMPUTERS IN THE FIELD

BY ROBERT P. CASE

Practical considerations

PORTABLE COMPUTERS ARE perfectly suited for use in anthropological and zoological in-the-field data-processing applications. Portables were designed, however, for use in friendly environments. Taking a portable into potentially hostile environments requires more than the usual planning for system organization. Introduction of unfriendly elements like extremes of temperature and humidity, contamination by dust and other foreign matter, and general abuse in the field, can quickly reduce a computer to electronic junk. This article describes the special selection and the "hardening" of a portable computer system for use in a research project in Central America.

Throughout this discussion I have taken a cookbook-like approach based on the presumption that field scientists interested in this application will have modest exposure to computers. A step-by-step presentation should be the most useful for the reader.

WHY USE A SYSTEM IN THE FIELD?

Field scientists in anthropology, environmental sciences, and zoology conduct research primarily through funding provided by a variety of public or private agencies. Research funds are traditionally in short supply and the competition is always strenuous. A proposed project

must promise much in the way of research, and once funded, it must deliver, especially if it is to receive future assistance. Most granting agencies monitor the research closely and require that the researcher provide preliminary reports on the progress made. Some of the advantages of an onsite computer should be readily apparent, given these conditions. I will draw upon experiences from my current project to illustrate various points.

The project is a three-year research program designed to investigate the pre-Columbian Mayan civilization of southern Mexico and northern Central America. My role is to direct laboratory and data-processing operations. A multiplicity of competing theories have been offered about the rise and fall of Mayan social, economic, and political organization, but very little has been done in the way of empirical testing. The primary objective of the project, then, is to collect and analyze sufficient data from our research area so that we can validate, modify, or reject some of these alternative theories.

We recognized from the beginning that it would be extremely slow and difficult to manually process such a wide
.....
Robert P. Case (7664 Madison Ave., Lemon Grove, CA 92045) is a lecturer in anthropology at San Diego State University.

variety of data; yet we wanted to be capable of doing some preliminary hypothesis testing in the field. So the decision was made to computerize data processing.

SYSTEM ANALYSIS AND DESIGN

After deciding to use a portable computer, the next step was to identify the specific tasks that the computer would perform. Software and, ultimately, hardware selection must be tailored to the user's needs.

In our case (and probably in the case of all research projects), the most critical need was for a database management system that could store, manipulate, and retrieve data. Second, we required the means to mathematically analyze our data. A third, but not essential, function included word-processing and hard-copy documentation capabilities.

The first consideration at this stage is whether it will be necessary to transfer data to a mainframe computer after returning from the field. We talked to the director of our university's mainframe facility to get some guidelines on the compatibility of different systems. Usually compatibility problems can be resolved by using special software. But this requires additional processing steps and should be avoided whenever possible. Also, many large data-processing

(text continued on page 244)

(text continued from page 243)

facilities have mainframe computers by more than one manufacturer, so there may still be a wide range of compatible microcomputers and software to choose from.

This brings us to the second step, selecting the software that will perform the specified tasks. A multitude of programs may exist for any given task, each with different strengths and weaknesses. Furthermore, these programs are designed to run on particular operating systems such as CP/M or MS-DOS. In effect, this stage of the system analysis involves simultaneously evaluating competing software/hardware configurations. That is, program X, which runs only on class X computers, must be compared to a similar program, Y, which runs only on class Y computers. If at all possible, get a demonstration of the different candidates. When evaluating similar programs, keep the following questions in mind: How well will it perform the tasks I need? How easy is it to learn and use? Has it been extensively tested and is it reliable? And, of course, how much does it cost? Based on this analysis, you should pinpoint the programs you require and be able to narrow down the selection of suitable hardware.

Your choice of a microcomputer is limited to the operating system your software will run on, but there will usually still be a number of portable computers to choose from (see "How to Choose a Portable," September 1983 *BYTE*, page 34). Important considerations include: the size, feel, and arrangement of the keyboard; the size and quality of the video monitor; the size of the memory; and the disk-storage capacity. The keyboard and monitor characteristics are a significant concern; a poor design in either can reduce input speed and accuracy. Another important factor is the amount of random-access read/write memory (RAM) and disk storage, which can place limits on data storage and processing. Naturally, mechanical reliability and cost are also important concerns.

Using these guidelines for our project we first examined database-management programs. On the basis of comparisons, dBASE II was chosen for its greater power and flexibility. We searched next for a suitable statistics

package to fill our second requirement. At the time of the analysis (May 1982) there were only a handful of such packages. Our choice, Statpak, was designed to be interfaced with dBASE II and other popular database-management systems. Statpak requires MBASIC and so this was added to our list. One other criterion added to our list was a minimum of 64K bytes of RAM for dBASE II; this is less important today since most suitcase-size and many briefcase-size portable microcomputers match or exceed 64K bytes of RAM.

We were concurrently studying the portable systems then on the market. We concluded that our three-year research program would require a tremendous amount of disk storage. We investigated the Kaypro 10, the first portable to have a 10-megabyte Winchester hard disk. This system has the 64K bytes of RAM required for dBASE II, it uses the necessary CP/M operating system, and, as a further benefit, it comes with bundled software including MBASIC (required for Statpak) and WordStar (a word-processing package that fulfilled our third general requirement). Finally, the close proximity of the Kaypro plant to our base at San Diego State University was an additional advantage. Subsequently, the peripheral devices were evaluated, with the Prowriter 8510 printer (C.Itoh Electronics) and the 500-watt Grizzly Uninterruptible Power System (Electronic Protection Devices Inc.) being selected.

Upon completion of the system analysis and design we would normally have gone out and bought the specified equipment and software. In our case, however, an unexpected reduction in our National Science Foundation award made this impossible. We were not willing to give up easily, so we contacted each manufacturer, first by telephone, followed by a written proposal in which we solicited their sponsorship. Each one graciously accepted and we owe them much gratitude.

FIELD CONDITIONS AND MICROCOMPUTERS

In spite of their portability, microcomputers imitate mainframes in requiring a relatively clean, climate-controlled room at home or in the office. Obviously, field scientists will not usually have such luxurious accommodations. It is

imperative that you identify the potential environmental perils that await and take the necessary preventive measures. A system failure in a remote location is extremely difficult, if not impossible, to recover from.

The most serious climate-related problems for the computer are excessive heat and extreme humidity or aridity. Equally serious is the problem of the equipment being infiltrated by dust or insects. Finally, the source and quality of electricity used to power the system has to be considered; a blackout, brownout, or power surge can ruin your whole day, not to mention your project. These, in fact, constitute the environmental problems that we anticipated adversely affecting our anthropology project in Central America. We wrote in our proposal to Kaypro that we expected daily temperatures to reach the mid-90s with humidity exceeding 90 percent. We also noted that dust and insects would be a problem, as would an inconsistent power supply. Kaypro recognized that there were significant risks to the operation of a computer and that modifications were called for. One of their engineers, Ron Morgan, took on the task of constructing a climate-resistant Kaypro 10.

Morgan's objective was to have a completely sealed cabinet in order to prevent dust and moisture from affecting components. This created additional problems, such as cooling and the need for data backup. The solution to the cooling problem was to build a special heat sink mounted to the top of the cabinet. Whisper fans mounted over holes in the cabinet circulate air through the components, out through the heat sink, and back into the cabinet again. This closed cooling system is designed to maintain the interior of the computer at a normal room temperature.

Second, sealing the cabinet required that all vents and the floppy-disk port be closed. Both the hard-disk and floppy-disk drives were removed together with the standard fan. Two of the new, thinner, 10-megabyte hard-disk drives and a Toshiba floppy-disk drive were installed, with the Toshiba in line with, but backset from, the floppy-disk port. The port was then sealed by screwing a piece of plexiglass over it. It was Morgan's intention to use the sec-

(text continued on page 246)

True or False: You Can Now Run Apple Software in Your IBM PC.

True. Introducing Quadlink by Quadram. The revolutionary enhancement board that turns your IBM Personal Computer into an Apple-compatible system.

Quadlink. Simply plug it inside your PC, press a few keys, and instantly run most Apple software packages available.

Quadlink greatly enhances your PC's capabilities.

True. Quadlink gives you access to the largest software library ever written. Business, educational, and entertainment packages. Software for any professional or home use. This means your PC can now do more than ever before. In more ways than ever before.

With Quadlink, there's no diskette reformatting needed.

True again. With Quadlink you'll never have to worry about "compatibility." Just put your Apple diskette in the PC drive and watch it go. It's that easy. Like having an Apple computer inside your IBM.



QUADLINK™ BY QUADRAM™

And every Quadlink comes with that traditional Quadram Quality built right in.

Absolutely true.

Quadlink is available at Quadram dealers worldwide.

True. So visit the Quadram dealer nearest you today and ask to see Quadlink in action. And while you're there ask about our full line of IBM PC enhancements. Including the popular six-function Quadboard.™ You'll agree: when it comes to quality engineering and dependable performance, Quadram passes the test.



QUADRAM
CORPORATION
An Intelligent Systems Company

4355 International Blvd., Norcross, GA 30092
(404) 923-6666 TWX 810 766-4975 (2) ADAM NCRS

© Copyright 1984
Quadram Corporation
All rights reserved

Apple and the Apple logo are registered trademarks of Apple Computer, Inc.

IBM and the IBM logo are registered trademarks of International Business Machines Corporation.

(text continued from page 244)

ond hard disk to back up the first, so status lights for each drive were attached to the clear plexiglass. To monitor internal conditions a small thermometer and humidity indicator were placed so that they would be visible through this port window.

The addition of a second hard-disk drive created problems. First, the power supply had to be modified. It was decided that the backup unit would normally be inactive. For files to be copied, a three-way switch mounted on the back panel would be used to power up the second drive. Beyond that, special firmware had to be created to allow communication between the hard-disk units, with one designated as primary and the other secondary. As an added precaution, provision was made for switching these designations in the event of primary-drive failure.

With these modifications, it was apparent that all data would be resident on the hard disks. This was viewed as an example of the "all your eggs in one basket" syndrome, an intolerable situation. Since we would probably have use of a climate-controlled building near the project site, we decided that we should also take along a Kaypro 4 computer. We realized that if this unit could be kept operational, there would be several important benefits, not the least of which was a backup for the Kaypro 10. Furthermore, by using the serial ports, the Kaypro 4 and 10 could be linked for uploading and downloading. This would provide an extra level of security since all data could then be backed up on floppy disks. Finally, the Kaypro 4 would give us a second data-entry station. Since this is the slowest aspect of any data-processing operation, a second workstation would prove quite valuable. One other emergency provision was made, that of the Toshiba floppy-disk drive sealed inside the Kaypro 10. If the Kaypro 4 were inoperable and the 10's performance degrading, we could remove the plexiglass window, power up the Toshiba disk drive, and download the data from hard disks to floppies.

From our perspective we had covered every reasonable contingency affecting the operational qualities of the computers. What remained was the worst possibility: a system failure. Ron Morgan assessed the various components with-

in the Kaypros on two criteria: (1) high or low risk of failure, and (2) reparability or nonreparability. Spare components of a high-risk but repairable nature were assembled and packaged for shipment. Repairing a computer in the field may seem like an impossible mission to anyone who has never looked inside a microcomputer. The Kaypros' modular design, however, makes replacing damaged boards eminently practical. Our parts kit consisted of a power-supply board, disk-controller board for both hard and floppy disks, LSI (large-scale integration) chips, fuses, and whisper fans. Naturally, an appropriate tool kit was assembled and I was given some training as well.

Having covered every conceivable angle concerning the computers, we next evaluated the environmental risks to the peripheral devices. The Prowriter 8510 is listed in the C.Itoh manual as being operational within a temperature range of 5° to 40°C (41° to 104°F) with relative humidity between 10 and 85 percent. This was judged to be adequate, so no modifications were needed. Of greater concern, actually, was the probability of the printer paper absorbing moisture from the air, which could potentially harm the printer as the paper passed through. This problem should be alleviated by keeping paper supplied in special storage except when the printer is used.

The second device, the Grizzly Uninterruptible Power System, was also deemed to be fieldworthy without modification. This essential tool "purifies" the electrical current and instantaneously provides up to 15 minutes of battery power to gracefully shut down in the event of a blackout. The only extra effort here was to make a dust cover to place over it when not in use, something we provided for all hardware.

OPERATIONAL PROCEDURES

Beyond mechanical modifications, adverse environmental conditions can be mitigated by thoughtful operational procedures. In fact, a well-designed, well-regulated operation is equally or more important than the hardware and software and can contribute much to the success or failure of any project. In essence, operational procedures should

answer the questions of who, what, when, why, where, and how.

Who has access to the equipment and what their responsibilities are might not be applicable to a small project with a one-man data-processing operation. But if more than one person will be working with the equipment then it is always best to establish the lines of authority and to explicitly identify each person's role and duties.

When and where data-processing operations take place are two important considerations in softening harsh environmental conditions. Careful selection of the physical facility where the operation will be established can go a long way toward minimizing subsequent problems. Similarly, by scheduling our operational time for the early morning and late afternoon or evening, we will avoid the high-risk peaks in heat and humidity and, hopefully, avoid damaging the equipment.

The most elaborate planning should be accorded to how the work will flow through the system; this should be done in a step-by-step fashion so that nothing is overlooked. To begin with, the field forms on which the data is recorded should be designed so that they are easy to key into the computer. The cleaner the input document, the more accurate the data entry will be.

Inevitably, errors will be entered, either because the source document was wrong or the key entry person erred. Data validation techniques must be developed to catch as many errors as feasible. Some kinds of error-trapping methods are built into various programs while others, like range and plausibility tests, can be specifically created to meet the user's needs. Ultimately, verification of data accuracy is best accomplished by spot-checking records against the original documents. It is advisable to spot-check a higher percentage of records in the early stages; subsequently, verification can be reduced and focused toward the most critical data, assuming, of course, that the overall error rate is not excessive.

Once the data is stored to the disk it should be backed up immediately. Probably one master and two working copies of each program or data disk is the optimum level of protection. If a printer is available, then hard-copy

(text continued on page 248)

Unlock the Power of your IBM PC with MDBS III



If you're like most of us, you bought your IBM PC/XT to perform a few simple functions. But with the right software, the PC can do much more.

Mainframe-quality solutions for your PC

With MDBS III and your PC, you can build mainframe-quality application systems. Integrated accounting systems. Order entry. MRP. Job costing. Library management. Banking. Logistics. To name a few.

MDBS III is the most advanced data base management system running under PCDOS, MSDOS, CP/M-86 and MP/M-86. In fact, many have said it's the only authentic DBMS available on 8 and 16 bit microcomputers. MDBS III provides many facilities otherwise available only on mainframe DBMSs.

MDBS III allows application developers to define data base structures in the most natural and logical way, without resorting to redundancy to describe data relationships. Its truly innovative data structuring capabilities surpass but also accommodate the older relational, hierarchical and CODASYL-network architectures. That means power for your PC and flexibility for you.

How to get the most from your PC

Get MDBS III and get more of what

you need to get the results you demand:

- Post-relational, extended network modeling of real-world data relationships for truly integrated application systems
- English-like non-procedural query language for spur of the moment questions
- Report generator for quickly specifying customized reports
- Automatic guarantees of data and relationship integrity
- Recovery and restart capabilities for physical data protection
- Active and passive locking down to the record level, supporting up to 127 simultaneous users
- Redundancy and chaining eliminated, plus full data compression for optimum efficiency
- Data independence for easy maintenance
- Compatibility with all major programming languages for flexibility and convenience
- Encryption and access protection down to the field level for unparalleled data security
- Fine-tuning features for optimizing performance
- Compatibility with SCREEN MASTER, the PC's most comprehensive screen management system
- Interface to KnowledgeMan, the first system to integrate third generation spreadsheet and relational data management

So if you want to improve your productivity and your PC's capabilities, get MDBS III.

Call 317-463-4561 today.

Please send me the following:

- Set(s) of documentation, including MDBS III manual and Data Base Primer and Guide for \$110.00 each plus \$55.00 shipping and handling per set.
- Set(s) of "How to Evaluate and Select a DBMS" for \$5.00 plus \$2.50 shipping and handling.
- Professional Training Course Information.
- Please have an ISE Account Representative contact me.

MDBS III information.

PRICES SUBJECT TO CHANGE WITHOUT NOTICE.

Name _____
 Company _____
 Address _____
 City _____
 Country _____
 Phone (____) _____

We accept VISA, MASTERCARD and American Express.

Card No. _____
 Expiration Date _____
 Bank No. (if M.C.) _____
 Signature _____



International Software Enterprises, Inc.

P.O. Box 600
 Lafayette, IN 47902 USA
 Telex: 209147 ISE UR

SFAF6XX

MDBS III, KnowledgeMan and SCREEN MASTER are trademarks of Micro Data Base Systems, Inc.; PCDOS and PC/XT are trademarks of IBM; MSDOS is a trademark of MICROSOFT; CP/M-86 and MP/M-86 are trademarks of Digital Research.

(text continued from page 246)

documentation of raw and processed data files is highly recommended. This is especially true in multistage processing where the intermediate results will be modified by the final processing step.

It follows from this that some basic housekeeping rules are required if the data-processing operation is to run smoothly and efficiently. A transaction log containing a running narrative of the daily activities is vital. This log should record the names of newly created files, what files were used in processing, what processing steps were used, and what was the disposition of the results. Furthermore, all disks and printouts should be unambiguously labeled and stored in a safe and logical manner when not in use. Never assume you will remember a filename or the location of a printout; this is the fastest way to sink the entire operation into chaos. Disks should be kept in a dustproof file with the various

generations of copies separated to minimize catastrophic loss. Likewise, printouts will be more useful if they are organized in labeled folders or binders, and they will last longer as well.

SYSTEM TESTING AND DEBUGGING

The entire system should be assembled at the earliest possible moment; this will allow you to become familiar with its operating characteristics prior to entering the field. Sufficient lead time is an extremely valuable asset. With it, you can develop applications programs, run test data, and uncover any bugs that may exist, all while you have technical support available. Without adequate lead time, there is a strong possibility that you will spend an inordinate amount of time on system basics, all to the detriment of the data-processing goals of the project.

Frequently, over-the-counter software is more than adequate for research pro-

grams and has the added advantage of being thoroughly tested. The specific procedures required can be tested with data similar to what you expect to collect. This can be accomplished either by creating artificial test data or, as we did, by extracting similar data from published reports within our discipline. In either event, tests should be made for any errors that appear to be likely or that would be disastrous. Tests using abundant normal data and some high and low values are recommended. Testing for a zero value in unexpected places may also uncover significant problems. Finally, checking for empty files or for errors in processing the first and last record should reveal any remaining difficulties.

MAINTENANCE IN THE FIELD

Maintenance requirements will vary with the kind of equipment selected, and the kind of environmental conditions that will be encountered is especially important. However, under every circumstance you will at least want to have dustcovers for all equipment, a head-cleaning kit (with refills) for the floppy-disk drives, and a very light (low-viscosity) oil for lubricating the printer. The only real variable is the maintenance scheduling for the floppy-disk drives. In our case, we have anticipated a severe and pervasive dust problem and so we have decided that the drive heads will be cleaned once each week. There is no hard and fast rule here; you must rely on your own judgment.

TRANSPORTATION

Despite their portability, microcomputers cannot withstand prolonged episodes of bumping and jostling about. Although more stable than mini-computers or mainframes, they are still relatively delicate. If they must be shipped, use sufficient packing to prevent damage. Probably the best assurance of your portable computer arriving safely is to hand-carry it onto jetliners. When traveling by air, have the computer hand-inspected at the airport rather than passed through electronic screening devices. The latter could potentially damage disks or, worse yet, the read-only memory (ROM) in the central processing unit. Also, while most portable computers are designed to fit

(text continued on page 250)

Put an Amber CRT in Your Computer

Now you can eliminate the strobe, flicker and fatigue from your computer terminal with a new **Soft-View™** replacement CRT from Langley-St. Clair.

Available for the TRS-80, TeleVideo, Kaypro, Heath, DEC, Zenith, IBM PC, Apple II and a wide variety of other monitors. These new replacement display tubes use amber phosphors which exceed the European standards for persistence and color. And the "decay" or fade-out rate of the phosphor is the same as the "refresh" or scanning rate of the computer screen, so the display glows gently, rather than flickering like a strobe light — an annoying problem with inexpensive green phosphor tubes.

- Available in medium decay "European Phosphor" (the standard in Europe).
- Made with Lead/Strontium Impregnated glass that stops X-ray emission.
- High-contrast double dark face glass that also cuts U.V. radiation.
- Face of tube is etched to stop glare.
- Easily installed...comes with pre-mounted hardware.
- Ideal for word processing and programming, yet fast enough for games and graphics.
- Warranted for one full year against manufacturing defects or tube failure.
- Comes with a 30 day money back guarantee.







Call now to order your **Soft-View™** CRT
from Langley-St. Clair — \$99.95*

800 221-7070
In New York call 212 989-6876

Please specify computer and model number when ordering. Dealer inquiries invited.



Instrumentation Systems, Inc.
132 W. 24th St. New York, NY 10011

TRS-80, TeleVideo, Kaypro, Heath, DEC, Zenith, IBM PC and Apple II are registered trademarks of Tandy Corp., TeleVideo Corp., Nonlinear Systems, Inc., Heath Co., Digital Equipment Corp., IBM, and Apple Computer, Inc. Soft-View is a Trademark of Langley-St. Clair Instrumentation Systems, Inc.

* Please add \$7.00 for packing and UPS shipping \$17.00 for overseas. Parcel Post or UPS Blue Label. Add sales tax where applicable.

\$75

PRINTERFACE CARD

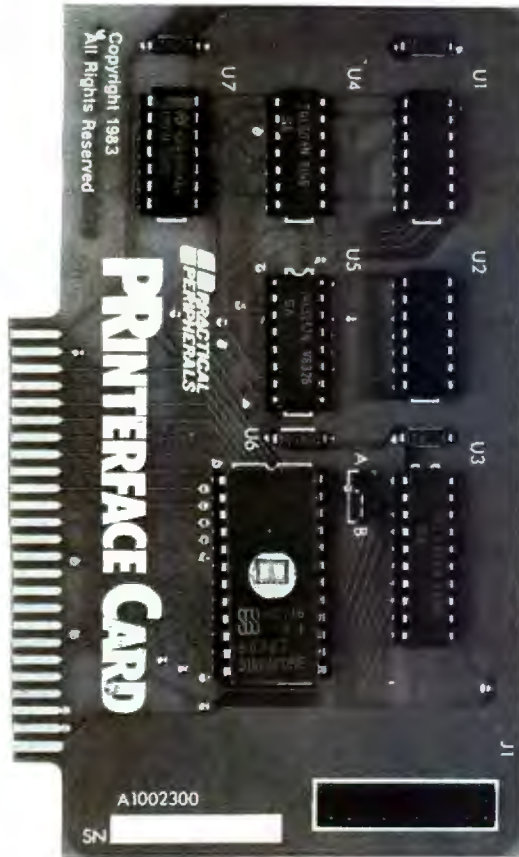

\$99

GRAPHICARD

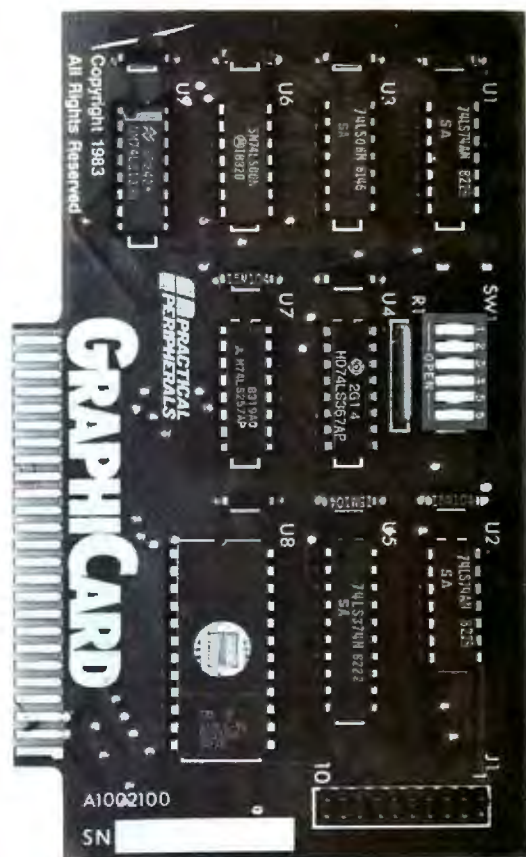

RIGHT FACE. RIGHT PRICE.

At \$75 and \$99* respectively, PRINTERFACE™ and GRAPHICARD™ are the right parallel interface products for your Apple** II, II+, IIe or Apple compatible system.

But don't be fooled by those low prices. High performance features and high reliability make them the right choice for serious printing requirements.

PRINTERFACE, for example, offers 27 easy commands that let you format text, send controls to the printer. You can even dump 80-column text screen from your Apple IIe.

GRAPHICARD gives you all that, plus graphics capabilities for 37 of the most popular printers. Eight additional commands permit a variety of graphics, screen dumps, including side-by-side, top-to-bottom, double size, inverse, emphasized, rotated and mixed text and graphics. For Apple II owners, the GRAPHICARD will give 80-column screen dumps from the Videx™ 80-column board.

By the way, if you buy PRINTERFACE and decide later that graphics would be nice, there's an easy-to-install upgrade kit that'll do the trick just fine.

Both cards clearly give you more for your money. And both are warranted for five years. That's right, **five years.**

So drop into your local dealer and ask about PRINTERFACE and GRAPHICARD today. Two more practical products from Practical Peripherals.

PRACTICAL PERIPHERALS

31245 La Baya Drive, Westlake Village, CA 91362
(818) 991-8200 • TWX 910-336-5431

*Suggested retail price. **Apple is a registered trademark of Apple Computer, Inc.

(text continued from page 248)

under airline seats, some computers may be slightly oversize. To prevent unfortunate encounters, check with the airline you will be traveling with before arriving at the airport. Even if your computer is slightly oversize, many airlines will allow it to be carried on and stored in one of the storage compartments in

the passenger area.

Finally, if the project destination lies outside of the United States, special documentation is required. Two separate documents are needed: a General Temporary Export license and a Shipper's Export Declaration, both obtainable from the U.S. Department of Commerce. The General Temporary Export

license (GTE) is necessary for exiting the United States, while the Shipper's Export Declaration demonstrates that the equipment was acquired in the United States and can thus re-enter without an import duty being imposed. Without a valid GTE in hand, a user going overseas may have his equipment confiscated at the point of embarkation.

PITFALLS AND PROSPECTS

Throughout this article I have pointed out numerous dangers that await the field scientist who would be bold enough to take a computer into the field. While the dangers are real, they are not insurmountable, and with sufficient planning they can be overcome. The importance of lead time cannot be stressed enough. Basically, the field scientist will be faced with two enemies. The first is system incompatibility, which can be either hardware that is incompatible with the software or the failure of the system to perform the user's tasks adequately. Careful system analysis and design will prevent this from occurring. The second enemy is a hostile environment; here the mitigating measures will depend on the anticipated field conditions. Again, thorough planning, combined with system testing under simulated conditions, should be sufficient to overcome this obstacle.

The benefits to be derived from a computer in the field are greater than the hazards faced. The turnaround time for data analysis is dramatically decreased. Multistaged research designs can be executed in a single season rather than over several seasons. As a planning tool, the computer permits the project staff and resources to be utilized to maximum potential. Preliminary reports can be started earlier, completed faster, and contain more substantive information than was possible ever before. We can hope that these prospects will encourage computer manufacturers to promote further development of fieldworthy portable microcomputers. ■

This material is based upon work supported by the National Science Foundation under grant number BNS83-10677. Any opinions offered are those of the author and do not necessarily reflect the views of the National Science Foundation. Additional support has been provided by San Diego State University and the Explorers Club.

Winchester power for your PC



The proven Winchester subsystem drives for your IBM or compatible PC. 10, 15, 25, or 33 megabytes of big system storage in a DiskSystem[®] you simply plug into your system and it's ready to use. At prices that make the speed and storage of a Winchester practical. Only \$1495 for a 10 megabyte DiskSystem, \$1795 for 15 megabytes, \$2245 for 25 megabytes, or \$2795 for 33 megabytes. DiskSystems can be bootable from the Winchester. See your dealer today for DiskSystem power for your PC.

I² INTERFACE INC

I² Interface Inc
7630 Alabama Avenue
Canoga Park, CA 91304
(818) 341-7914 Telex: 662949

Dealer Inquiries Invited
DiskSystems is a copyright of Interface
Inc. IBM is a registered trademark of
IBM Corporation. Prices are suggested
retail and are subject to change
without notice

SUMO-TESTED

WOULD YOU BELIEVE 3 OUT OF 4 SUMO WRESTLERS RECOMMEND CASES BY COMPUTER-MATE™?

Neither do we. But, it wouldn't surprise us. Because our cases are built with brute strength, able to take a beating from even the mightiest challengers.

Stop wrestling with your computer equipment. With our cases, you have ease of transportation plus maximum protection for all your components.

Standard cases available for IBM, DEC, Apple, TI, plus many others.

And with the new Computer-Mate™ media case, you can transport that priceless data (both disk pack and reels) with confidence. Custom built cases are also available to help protect almost any configuration of sensitive equipment. For loss prevention, each case has a

3" x 5" personal identification frame and individual serial number with toll-free telephone number. And like all

Computer-Mate™ products, each case is pre-screened for excellence and backed with a 100% unconditional guarantee.



For more information contact:

Computer Mate, Inc.

1006 Hampshire Lane
Richardson, Texas 75080
Dallas (214) 669-9370
Texas Residents (800) 442-4006
Out of State (800) 527-3643

Distributors and Representatives:
MSW Marketing, Inc.
500 Shepard Avenue East
Willowdale, Ontario, Canada M2N 6H7
(416) 221-5400

Tech Plus, Inc.
35 March Rd. • Needham, Mass. 02192-0212
(617) 449-5429

Dealer Inquiries Welcome.



Also available in beige.

Chances are your computer equipment will never undergo a heavy bout with a sumo wrestler, but with protection from cases by Computer-Mate™, the odds are 3 to 1 your equipment would win.

THE *Second* BYTE



COMPUTER SHOW

Los Angeles
Convention Center
June 14-17

If you're closer to Los Angeles than to San Francisco, come to our *second* BYTE Computer Show, in June. If you're closer to San Francisco, we're holding our *third* BYTE show there for you, in September. Why so many BYTE Shows? So that our subscribers don't have to travel too far!

The BYTE Shows are "selling" shows—where you can buy, not just look. BYTE subscribers enjoy special reduced admission prices to all BYTE shows, and conference seminars. These seminars are targeted to the interests of BYTE subscribers, and led by such BYTE favorites as Jerry Pournelle.

The BYTE Shows are professionally produced by The Interface Group—the same pros who bring you the Comdex Shows. Their show "know-how", combined with BYTE's editorial expertise, make the BYTE Shows ideal *information centers* and *shopping marts* for BYTE subscribers.

Further information on BYTE subscribers' exclusive benefits will be coming to you by mail. So, plan now to be in Los Angeles on June 14-17, or, at the BYTE Show nearest you!

BYTE

MC
Graw
Hill

1-2-3 from Lotus.

For everyone who won't buy a best seller without reading the reviews.

Ever since we introduced 1-2-3™ last year, it's received some pretty incredible press.

But that's only natural.

Because when you've got the number one selling PC business software in the world, you get a lot of critical attention. Here are a few significant examples:

"The first integrated package is a super spreadsheet with speed, power and graphing and data-management functions. Deservedly king of the hill."

InfoWorld
April 16, 1984

"For power and ease-of-use, 1-2-3's spreadsheet is hard to beat. Other programs do some things that 1-2-3 can't, but none seems to have been designed with comparable attention to detail and care for the user."

PC Magazine
April 17, 1984

"Sit down behind 1-2-3 from Lotus Development and you'll never again ask why this \$495 business program tops the best seller list month after month: it's fast, efficient, easy-to-use, and sometimes, even fun."

Computer Buyer's Guide and Handbook
May, 1984

"...two thirds of all United States companies buying business microcomputers last year chose 1-2-3 for making complex financial projections and displaying the results instantly in computer generated pie charts, bar charts and other graphic displays."

New York Times
February 13, 1984

"1-2-3 is still in a class by itself."

PC World
March, 1984

"Product of the Year 1983"

Fortune
December 12, 1983

What the critics have been saying recently about 1-2-3, our users have known all along. It's the most powerful productivity software available today.

To find out what 1-2-3 from Lotus™ can do for you just visit your local computer store, or call 1-800-343-5414 (in Massachusetts call 617-492-7870).

1-2-3 and Lotus are trademarks of Lotus Development Corporation.



 **Lotus**

The hardest working software in the world.™

Circle 197 on inquiry card.

KERMIT:
A FILE-TRANSFER
PROTOCOL
FOR UNIVERSITIES

PART 1: DESIGN CONSIDERATIONS
AND SPECIFICATIONS

BY FRANK DA CRUZ AND BILL CATCHINGS

RECENTLY, A GREAT deal of attention has been focused on developments in computer networking—the IEEE 802 committee, IBM's System Network Architecture (SNA), the latest Ethernet interfaces, fiber optics, satellite communications, and broadband versus baseband transmissions. But little attention has been given to the single working mechanism that may be the most widely used in the real world for direct interprocessor communication: the so-called asynchronous protocol, which is found in some form at most institutions that have a need to transfer files between microcomputers and central computers.

Columbia University has large time-sharing computers at a central site complemented by smaller systems scattered throughout laboratories, departments, homes, and dormitory rooms. As soon as these small machines began to appear, users asked for ways to exchange files with the central and departmental systems.

At the same time, student use of our central systems was growing at an astonishing rate. Because we could no longer afford to provide students with

perpetual on-line disk storage, we began to issue identification codes valid only for a course and term. The decreased longevity of the IDs caused a need for students to economically archive their files. Given a reliable way to transfer files to microcomputers from the central mainframes and back, microcomputers with floppy disks could provide inexpensive removable media ideal for this purpose.

The situation called for a file-transfer mechanism that could work among all our computers, large and small. Some such mechanisms were intended for use between microcomputers, others between large computers, but none specifically addressed our need for communication between microcomputers and IBM and DEC mainframes.

.....
Frank da Cruz is the manager of systems integration at the Columbia University Center for Computing Activities (612 West 115th St., New York, NY 10025) and is also planning the university's move toward personal computing in the coming years. Bill Catchings was the chief systems programmer of the file-transfer protocol and its principal designer. He is currently a systems analyst at Lehman Brothers Kuhn Loeb.

Most commercial packages served a limited set of systems, and their cost would have been prohibitive when multiplied by the large number of machines involved.

We thus embarked on our own project. Part 1 of this two-part article discusses some of the issues and tradeoffs that arose and illustrates them in terms of our result, the Kermit protocol for point-to-point file transfer over telecommunication lines. Because commercial local-area-networking products are expensive, not yet widely available, and unsuitable for one-shot or long-haul applications, humble asynchronous protocols such as Kermit are likely to be with us for a long time.

THE COMMUNICATION MEDIUM

The only communication medium common to all computers is the asynchronous serial telecommunication line, used for connecting terminals to computers. Standards for this medium are almost universally followed—connectors, voltages, and signals (EIA RS-232C); character encoding (ASCII, ANSI X3.4-1977); and bit-transmission

(text continued on page 256)

A communication protocol is a set of rules for handling packets of information.

(text continued from page 255)

sequence (ANSI X3.15-1976). Serial connections can be made in many ways: dedicated local cables ("null modem" cables), leased telephone circuits, and dial-up connections. Dial-up connections can be initiated manually from the home or office using an inexpensive acoustic coupler or automatically from one computer to another using a programmable dial-out mechanism. The asynchronous serial line offers the ordinary user a high degree of convenience and control in establishing inter-system connections—at relatively low cost.

Once two computers are connected with a serial line, information can be transferred from one machine to the other, provided one side can be instructed to send the information and the other to receive it. Right away, however, several important factors come into play:

1. *Noise*—It is rarely safe to assume that there will be no electrical interference on a line; any long or switched data-communication line will have occasional interference, or noise, that typically results in garbled or extra characters. Noise corrupts data, perhaps in subtle ways not noticed until it's too late.

2. *Synchronization*—Data must not come in faster than the receiving machine can handle it. Although line speeds at the two ends of the connection may match, the receiving machine might not be able to process a steady stream of input at that speed. Its central processor may be too slow or too heavily loaded or its buffers too full or too small. The typical symptom of a synchronization problem is lost data; most operating systems will simply discard incoming data they are not prepared to receive.

3. *Line Outages*—A line may stop working for short periods because of a faulty connector, loss of power, or

similar reason. On dial-up or switched connections, such intermittent failures will cause the carrier signal to be dropped and the connection to be closed, but for any connection in which the carrier signal is not used, the symptom will be lost data.

Other communication media, such as the parallel data bus, have safeguards built in to prevent or minimize these effects. For instance, distances may be strictly limited, the environment controlled, special signals may be available for synchronization, and so forth. The serial telecommunication line provides no such safeguards, and we must therefore regard it as an intrinsically unreliable medium.

RELIABLE COMMUNICATIONS

To determine whether data has been transmitted between two machines correctly and completely, the machines can compare the data before and after transmission. A scheme commonly used for file transfer employs cooperating programs running simultaneously on each machine, communicating in a well-defined, concise language. The sending program divides outbound data into discrete pieces, adding special information to each piece describing the data for the receiving program. The result is called a *packet*. The receiver separates the description from the data and determines whether they still match. If so, the packet is acknowledged and the transfer proceeds. If not, the packet is negatively acknowledged and the sender retransmits it; this procedure repeats for each packet until it is received correctly.

The process is called a communication *protocol*—a set of rules for forming and transmitting packets, carried out by programs that embody those rules. Protocols vary in complexity; our preference was for a simple approach that could be realized in almost any language on almost any computer by a programmer of moderate skill, allowing the protocol to be easily adapted to new systems.

ACCOMMODATING DIVERSE SYSTEMS

Most systems agree on how to communicate at the lowest levels—the EIA (Electronic Industries Association)

RS-232C asynchronous communication line and the ASCII (American National Standard Code for Information Interchange) character set—but agreement rarely extends beyond that. To avoid a design that might lock out some kinds of systems, we must consider certain important ways in which systems can differ.

Mainframes versus Microcomputers—A distinction must first be made between microcomputers and mainframes. These terms are not used pejoratively: a microcomputer could be a powerful workstation, and a mainframe could be a small minicomputer. For our purposes, a microcomputer is any single-user system in which the serial-communication port is strictly an external device. A mainframe is any system that is host to multiple, simultaneous users at terminals, who log into jobs, and where a user's terminal is the job's controlling terminal. Some mainframe systems allow users to assign another terminal line on the same machine as an external I/O (input/output) device.

Mainframe operating-system terminal drivers usually treat a job's controlling terminal specially. Full-duplex systems echo incoming characters on the controlling terminal but not on an assigned line. System command interpreters or user processes might take special action on certain characters on the controlling line but not on an assigned line (for instance, Control-C under CP/M or most DEC operating systems). Messages sent to a job's controlling terminal from other jobs could interfere with transmission of data. The ability of a system to test for the availability of input on a serial line might depend on whether the line is the job's controlling terminal or an assigned device; CP/M and IBM VM/370 are examples of such systems. CP/M can test for data only at the console; VM can test anywhere but the console.

Output to a job's controlling terminal may be reformatted by the operating system: control characters may be translated to printable equivalents, lowercase letters specially flagged or translated to uppercase (or vice versa), or tabs expanded to spaces. In addition, based on the terminal's declared width and length, long lines might be wrapped around or truncated, formfeeds translated to a series of linefeeds, and

(text continued on page 259)

BIG TIME STATISTICS GO SMALL



Statpro™ brings the power of mainframe statistics to your personal computer.

Until now, serious statistical analysis meant mainframes, computer centers and a lot of extra work for you.

Enter Statpro, the most powerful statistical software system ever developed for personal computers.

It lets you do almost everything you do on a mainframe on your IBM® or Apple® personal computer. Including descriptive statistics, regression, ANOVA, factor and cluster analysis, to name just a few capabilities.

And Statpro's awesome power isn't limited to number crunching. You can plot all your results in four-color graphics, such as scatter, triangle and regression plots, dendrograms, histograms and pie charts.

What's more, Statpro has sophisticated database management capabilities which make entering, manipulating, transforming and editing data quick and easy.

Most important of all, you get this incredible power in one integrated, fully documented, easy-to-use package.

Statpro for personal computers. Another example of why small is beautiful.

Contact your local dealer. Or Wadsworth Professional Software, Inc., Statler Office Building, 20 Park Plaza, Boston, MA 02116.

800-322-2208
In Massachusetts call (617) 423-0420.

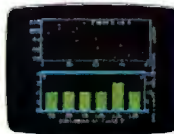

Wadsworth Professional Software

Statpro is a trademark of Wadsworth Professional Software, Inc.

Apple is a registered trademark of Apple Computer, Inc.

IBM is a registered trademark of International Business Machines, Corp.

Announcing
the sudden obsolescence
of the floppy disk.

NEW HELIX PC BUBBLE DISK™

HALF-MEGABYTE MEMORY BOARD

The first bubble memory board for
IBM PC/XT and compatible computers.

- NON-VOLATILE: You don't lose data when there is no power.
 - Eight times faster than a floppy disk.
 - For fixed or portable use without need for back-up storage.
 - Impervious to dust, dirt, humidity, cold— as reliable in the North Sea, the Sahara, a Space Station, as in your office.
 - Mean time between failure (MTBF) more than 20 years.
 - Rugged enough to withstand vibration and shock up to 200Gs.
- For complete details, see us in
New York at PC Expo,
Booth #2042. Or contact:



Helix Laboratories, Inc., 8123 Remmet Ave.,
Canoga Park, CA 91304
(818) 710-0300—outside California, 800-468-0004
Dealer Inquiries Welcome

© 1984, Helix Laboratories, Inc.

KERMIT

(text continued from page 256)

the system may pause at the end of each screen full of output. Input from a job's controlling terminal may also be handled specially: lowercase letters may be converted to uppercase, a linefeed may be supplied when a carriage return is typed, or control characters may invoke special functions, such as line editing or program interruption. The DECSYSTEM-20 is an example of a computer where any of these might happen.

The moral here is that care must be taken to disable special handling of a mainframe job's controlling terminal when it is to be a vehicle for inter-processor communication. But some systems simply do not allow certain of these features to be disabled, so file-transfer protocols must be designed around them.

Line Access—Line access is either *full* or *half duplex*. If full duplex, transmission can occur in both directions at once. If half duplex, the two sides must take turns sending, each signaling the other when the line is free; data sent out of turn is discarded, or it can cause a break in synchronization. On mainframes, the host echoes characters typed at the terminal in full duplex but not in half duplex. Naturally, echoing is undesirable during file transfer. Full-duplex systems can usually accommodate half-duplex communication but not vice versa. IBM mainframes are the most prevalent half-duplex systems.

Buffering and Flow Control—Some systems cannot handle sustained bursts of input on a telecommunication line; the input buffer can fill up faster than it can be emptied, especially at high line speeds. Some systems attempt to buffer *typeahead* (unrequested input); others discard it. Those that buffer typeahead may or may not provide a mechanism to test or clear the buffer.

Systems may try to regulate how fast characters come in using a flow-control mechanism, either in the data stream (XON/XOFF) or parallel to it (modem control signals), but no two systems can be assumed to honor the same conventions for flow control—or to do it at all. Even when flow control is being done, the control signals themselves are subject to noise corruption.

Our experiments with several host
(text continued on page 260)

Re-ink any fabric ribbon AUTOMATICALLY for less than 5¢. Extremely simple operation. We have a MAC INKER for any printer: cartridge/spool/harmonica/zip pack. Lubricant ink safe for dot matrix printheads. Multicolored inks, uninked cartridges available. Ask for brochure. Thousands of satisfied customers.

\$54⁹⁵ +

Mac Switch lets you share your computer with any two peripherals (serial or parallel). Ideal for word processors—never type an address twice. Ask us for brochure with tips on how to share two peripherals (or two computers) with MAC SWITCH. Total satisfaction or full refund.

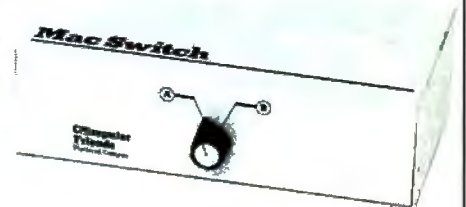
\$99⁰⁰

Order toll free 1-800-547-3303

Mac Inker & MacSwitch

Computer Friends

6415 SW Canyon Court
Suite #10
Portland, Oregon 97225
(503) 297-2321

Say goodbye to the Tower of Babel with...

XENO-DISK™

The disk production system
for your PC!

Read, write, format and duplicate
50 disk formats on your IBM-PC or
compatible under MS-DOS. Developed
from our popular Xeno-Copy™ utilities.



\$379.50

RUN CP/M-80 PROGRAMS FOR \$99.50!

80MATE, our CP/M emulator, will run almost any CP/M-80 program on your PC or compatible under MS-DOS. No need for expensive co-processor boards. Can be used with Xeno-Disk.

Write or call for additional information.

vertex systems

Dept. B, 7950 W. Fourth Street
Los Angeles, CA 90048
(213) 938-0857



IBM-PC/XT or PC compatible
IEEE-488 INTERFACE BOARD

IEEE - 488

- **Implements the entire IEEE-488 standard** — transfer commands and data, perform serial and parallel polling.
- **A resident firmware interpreter simplifies programming** and accepts any ASCII string or code including Tektronix Standard Codes and Formats and IEEE-488 command mnemonics. Interpreter routines support BASIC, PASCAL, C and other languages.
- **Supports the PrtSc (print screen) key**, and all BASIC print statements for IEEE-488 printers and devices.
- **Small size** — see BYTE 11/83, p. 314
- **Accepts a standard IEEE-488 cable.**
- **Uses only 16 bytes of RAM** and no I/O ports.
- **A 116 page Reference Manual** provides a tutorial and programming examples for digitizing, interactive bus control, bus diagnostics, and many other applications.
- **\$395 complete.** There are no extra software or cabling charges.



CAPITAL EQUIPMENT CORP

10 Evergreen Avenue
Burlington, MA. 01803
(617) 273-1818

IBM is a trademark of International Business Machines Corp.

(text continued from page 259)

computers revealed that a burst of more than a line's worth of characters (60 to 100) into a terminal port at moderate speed could result in loss of data—or worse—on some hosts. For instance, the communications front end of the DEC-system-2060 is designed on the statistical assumption that all terminal input comes from human fingers, and it cannot allocate buffers fast enough when this assumption is violated by

Kermit is not written in any particular computer language as it is not a portable program but a portable protocol.

sending continuous data simultaneously from several microcomputers attached to terminal ports.

Character Interpretation—Systems differ in how they interpret characters that arrive at the terminal port. A host can accept some characters as sent, ignore others, translate others, and take special action on others. Communications front ends or multiplexers might swallow certain characters (typically, DC1, DC3) for flow control, padding (NUL or DEL), or transfer of control (escape). The characters that typically trigger special behavior are the ASCII control characters, including the delete character. For instance, of these 33 control characters, 17 invoke special functions of our DEC-SYSTEM-20 command processor. However, all hosts and communication processors we've encountered allow any printable character to reach an application program, even though the character may be translated to a different encoding, like EBCDIC (extended binary-coded-decimal interchange code), for internal use.

Some operating systems allow an application to input a character at a time; others delay passing the characters to the program until a logical record has been detected, usually a sequence of characters terminated by a carriage return or linefeed. Some record-

oriented systems, like the IBM VM/370, discard the terminator; others keep it. And different ways of keeping it are used—UNIX translates a carriage return into a linefeed; most DEC operating systems keep the carriage return but also add a linefeed.

Timing Out—Hosts may or may not have the ability to time out. When exchanging messages with another computer, it is desirable to be able to issue an input request without waiting forever should the incoming data be lost. A lost message could result in a protocol deadlock in which one system is waiting forever for the message while the other waits for a response. Some systems can set timer interrupts to allow escape from potential blocking operations; others, including many microcomputers, cannot do so. When time-outs are not possible, they may be simulated by sleep-and-test or loop-and-test operations or deadlocked systems may be awakened by manual intervention.

File Organization—Some computers store all files in a uniform way, such as the linear stream of bytes that is a UNIX file. Other computers have more complicated or diverse file organizations and access methods—record-oriented storage with its many variations, exemplified in IBM OS/360 or DEC RMS. Even simple microcomputers can present complications when files are treated as uniform data to be transferred; for instance, under CP/M, the ends of binary and text files are determined differently. A major question in any operating system is whether a file is specified sufficiently by its contents and its name or if additional external information is required to make the file valid. A simple, generalized file-transfer facility can be expected to transmit a file's name and contents but not every conceivable attribute a file might possess.

Designers of expensive networks have gone to great lengths to pass file attributes along when transferring files between unlike systems. For instance, the DECnet Data Access Protocol supports 42 generic-system capabilities (such as whether files can be preallocated, appended to, accessed randomly, etc.), 8 data types (ASCII, EBCDIC, executable, etc.), 4 organizations (sequential, relative, indexed, hashed), 5 record for-

(text continued on page 262)

FOX & GELLER SHIPS OZ!

ADVERTISEMENT

OZ DOES FOR MANAGERS WHAT SPREADSHEETS CAN'T

Elmwood Park, N.J.—Fox & Geller today announced the shipping of OZ, their new stand-alone financial management software.

OZ is designed to do what managers have been trying to do with spreadsheets all along.

OZ can work with spreadsheet files or its own data files to perform managerial functions like: Organizational consolidation, Profit & Loss analysis, 3-dimensional financial analysis, built-in financial reports plus complete color graphics capability. Most of these functions are performed with a single keystroke.

Fox & Geller boast of a unique Budget Variance Analysis feature in OZ. Everytime you change a number OZ will allow you to give a reason for making the change. This makes it easy to spot and explain any variance in your company's key financial in-

dicators. You could never do this with spreadsheets. In fact, many of the features in OZ have never before been available on microcomputers.

OZ is written in plain English with an instructive, step-by-step manual and requires no programming or previous computer experience.

Big corporations are seen as a major market for OZ as are current users of popular spreadsheet like Lotus 1-2-3™, Multiplan™ and VisiCalc™.

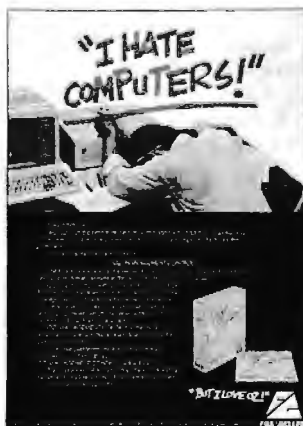

DEALERS EAGER FOR OZ!

Dealers today are spreading the news concerning OZ, the latest introduction from Fox & Geller, the creators of QUICKCODE.

OZ is a stand-alone financial management program specially tailored for managers. OZ enables the user to perform specific managerial tasks using data from OZ files or from existing spreadsheet data files.

Industry analysts predict the Fox & Geller name will guarantee OZ immediate success. "They are well respected", an industry spokesman said recently. "A lot of people are using their dBASE II enhancement packages", he said referring to QUICKCODE and dGRAPH by Fox & Geller.

OZ offers managers the ability to have complete control over their financials. OZ is the first and only software that can actually be used to (continued on page 44)

These ads for OZ have appeared in major computer magazines including Infoworld, Byte, PC Magazine, PC Week, Computer Retail News, Computer Merchandising, and Micro Market World.

ASK FOX & GELLER

Q: What is OZ?

A: OZ is a corporate financial management program that you can use by itself or as a companion to your existing spreadsheet. OZ is programed to give you control over budgets, actuals and forecasts with a variety of easy to use functions.

Q: Why do I need OZ?

A: By controlling the financials of an organization you control the organization. OZ gives you this ability. You will know why sales are down, why costs went up, what effect it will have on next year or the rest of this year and what can be done to control it in the future. Imagine, having this much information at your desk.

Q: How is OZ different than a spreadsheet?

A: As good as spreadsheets are, they are very general in their application. OZ was made for managers and is specifically tailored to perform functions managers need on a daily basis.

OZ does what managers have been trying to do with spreadsheets all along. Managerial functions like computer-aided variance analysis, updating and maintaining P&L, organization consolidations, budget forecast and actuals, 3-dimensional financial analysis, built-in reports of key financial indicators and complete color graphic capability to name a few.

Q: Do I have to be a Fortune 500 company to use OZ?

A: No. OZ is as useful for managers in small and medium size businesses as it is for the middle managers in large corporations. OZ is for anyone who wants complete financial information regarding all aspects of their business.

Q: Where do I get OZ?

A: OZ is available at most local computer stores. Or call Fox & Geller directly at

1 800-221-0156

Circle 141 on Inquiry card.

*Lotus 1-2-3 is a trademark of Lotus Corporation
*Multiplan is a trademark of Microsoft
*VisiCalc is a trademark of VisiCorp

PROTECT YOUR...

APPLE



The APPLE-CENTER model 12 protects your Apple from theft and unauthorized use. All metal construction, the APPLE-CENTER is available with or without fan and surge protection. Works with Apple's DUODISK.

IBM



The EMBLEM, for the IBM PC, protects both the keyboard and the computer. Foam lined keyboard tray flips up for complete security. Also available with surge protection.

PRINTERS & MORE



The SECURITY CORNERS will protect most printers, hard disks, stereos, test equipment, and other computers.

Available from your dealer or order direct.

DOSS INDUSTRIES

1224 Mariposa, San Francisco, CA 94107
415-861-2223

KERMIT

(text continued from page 260)

mats (fixed, variable, etc.), 8 record attributes (for format control), 14 file-allocation attributes (byte size, record size, block size, etc.), 28 access options (supersede, update, append, rewind, etc.), 26 device characteristics (terminal, directory structured, shared, spooled, etc.), and various access options (new, old, rename, password, etc.), in addition to the better-known file attributes like name, creation date, protection code, and so on. All this was deemed necessary even when the designers had only a small number of machines from one vendor to worry about.

The ARPA (Advanced Research Projects Agency of the Department of Defense) network, which attempts to provide services for many more machines from many vendors, makes some simplifying assumptions and sets some restrictions in its File Transfer Protocol (FTP). All files are forced into certain categories with respect to encoding (ASCII, EBCDIC, image), record-format control, byte size, and file structure (record or stream), and it is generally left to the host FTP implementation to do the necessary transformations. No particular provision is made, or can be made, to ensure that such transformations are invertible. Invertibility involves sending a copy of a file to another system, receiving a copy of that file back from the other system, and having all the attributes of this second copy of the file match the original file's characteristics.

DECnet is able to provide invertibility for operating systems like VMS or RSX, which can store the necessary file attributes along with the file. But simpler file systems, like those of TOPS-10 or TOPS-20, can lose vital information about incoming files. For instance, if VMS requires some type of file to have a specific block size, while TOPS-20 has no concept of block size, the block size will be lost upon transfer from VMS to TOPS-20 and cannot be restored automatically when the file is sent back, leaving the result potentially unusable.

Invertibility is a major problem with no simple solution. Fortunately, file transfer between unlike systems usually involves only textual information—data, documents, program source—which is sequential in organization, and for which any required transformations

(e.g., blocked to stream, EBCDIC to ASCII) are simple and not dependent on any special file attributes.

In fact, invertibility *can* be achieved if that is the primary goal of a file-transfer protocol. All the external attributes of a file can be encoded and included with the contents of the file to be stored on the remote system. For unlike systems, this can render the file less than useful on the target system but allows it to be restored correctly upon return. However, it is more commonly desired that textual files remain intelligible when transferred to a foreign system, even if transformations must be made. To allow the necessary transformations to take place on textual files between unlike systems, there must be a standard way of representing these files during transmission.

Binary Files versus Parity—Each ASCII character is represented by a string of 7 bits. Printable ASCII files can be transmitted in a straightforward fashion because ASCII transmission is designed for them: a serial stream of 8-bit characters, 7 bits for data and 1 bit for parity, framed by start and stop bits for the benefit of the hardware. The parity bit is added as a check on the integrity of a character. Some systems always transmit parity, some insist on parity for incoming characters, some ignore the parity bit for communication purposes and pass it along to the software, and some discard it altogether. In addition, communications front ends or common carriers might usurp the parity bit, regardless of what the system itself may do.

Computer file systems generally store an ASCII text file as a sequence of either 7-bit or 8-bit bytes. Eight-bit bytes are more common, in which the eighth bit of each byte is generally superfluous. Besides files composed of ASCII characters, however, computers also have binary files, in which every bit is meaningful; examples include executable core images of programs, numbers stored in internal format, and databases with embedded pointers. Such binary data must be mapped to ASCII characters for transmission over serial lines. When two systems allow the user-level software to control the parity bit, the ANSI (American National Standards Institute) standards may be stretched to

(text continued on page 264)

The Micro-world's Most Powerful Editor is also the Easiest to Use.

Easy to Use

VEDIT is an exceptionally easy to use, flexible and powerful full-screen editor. Now you can perform word processing quickly and easily, yet have command of editing tools created for the most sophisticated programmer.

VEDIT helps you concentrate on creativity instead of devoting your attention to operating the program.

VEDIT is also forgiving - it allows you to make mistakes or experiment. If you don't like what you've just typed, 'undo' it with a single keystroke.

Need Help? Just press the help key, a summary of commands and your keyboard layout will be displayed. Even include your own help messages



Powerful

VEDIT - the micro industry's most respected full screen editor - has evolved into a powerful programming language, with the flexibility, performance & features of SPF, TECO and other mainframe editors. The power of its command macro language is virtually limitless. Sophisticated search/replace with pattern matching of multiple strings in mul-

multiple files may be executed automatically. You can create a custom macro program to do virtually anything. Translate source code. Format printed output. Convert WordStar files to VEDIT. With a one line command you can selectively strip comments from programs. And macros may be loaded, saved and reused at a later time.

VEDIT is a 'virtual editor' with unlimited and automatic file handling capability - there is no limit to the size of files you can edit. Plus you can change disks at any time.



Other helpful features include a directory display, single key search and selective replace, line and column display, word wrap, adjustable margins, paragraph formatting & print functions, plus the unique ability to completely determine your own keyboard layout.

Acclaimed

VEDIT is highly acclaimed in every major computing journal. Reviewers say VEDIT is 'nothing short of outstanding', and 'the most flexible programming editor I've ever seen'. In InfoWorld's 1983 Report Card of word processing software, VEDIT scored highest of all CP/M-MSDOS word processors/editors reviewed.

VEDIT's Newest Features

- Horizontal Scrolling (Edit Spread Sheets)
- Single Key Search & Selective Replace
- Pattern Matching ● On-Line Help
- Numerical Capability

Expect a lot from VEDIT. While easy to use, VEDIT is specifically designed for complex text manipulations. VEDIT has 10 text registers for extensive 'cut & paste' on multiple files, plus special features for programming in Pascal, PL/I, C, Assembler and other languages.

- True Full Screen Editing
- Automatic Disk Buffering
- Compact (Only 16K) & Fast
- 'Undo' Key to Restore Line
- Automatic Indent/Undent
- Repeat Function Key
- Text Move and Copy
- Load, Save Buffers on Disk
- Powerful Command Macros
- Directory Display

- Insert Another Disk File
- Unlimited File Handling
- Recovery from Full Disk
- Change Disks While Editing
- Word Wrap
- Format Paragraph
- Printing
- 200 Page Indexed Manual
- Startup Command File
- Customizable Keyboard Layout



VEDIT - Disk and Manual
 8080, Z80 or IBM PC. \$150
 CP/M-86 or MSDOS \$195
 Manual Only. \$18

CP/M is a registered trademark of Digital Research Inc. MS-DOS is a trademark of Microsoft. IBM is a trademark of International Business Machines. WordStar is a trademark of MicroPro.

Circle 83 on inquiry card.

CompuView

PRODUCTS, INC.

1955 Pauline Blvd., Ann Arbor, Michigan 48103 (313) 996-1299 Telex - 701821
 Orders: P.O. Box 1349, Ann Arbor, Michigan 48106

(text continued from page 262)

permit the transmission of 8 data bits per character, which corresponds to the byte size of most machines. But since not all computers allow this flexibility, the ability to transfer binary data in this fashion cannot be assumed.

Software—Finally, systems differ in their application software. In particular, no system can be assumed to have a particular programming language. Even widespread languages such as FORTRAN and BASIC may be lacking from some computers, either because they have not been implemented or because they are proprietary and have not been purchased. Even when two different systems support the same language, it is unrealistic to expect the two implementations to be totally compatible. A general-purpose file-transfer protocol should not be written in or geared toward the features of any particular computer language.

THE KERMIT PROTOCOL

Kermit addresses the problems outlined above by setting certain minimal standards for transmission and providing a mapping among disk-storage organization, machine word and byte size, and the transmission medium. Kermit has the following characteristics:

- Communication takes place over ordinary terminal connections.
- Communication is half duplex. This allows both full- and half-duplex systems to participate, and it eliminates the echoing that would otherwise occur for characters arriving at a host job's controlling terminal.
- The packet length is variable, but the maximum is 96 characters so that most hosts can take packets in without buffering problems.
- Packets are sent in alternate directions; a reply is required for each packet. This allows half-duplex systems to participate and prevents buffer overruns that would occur on some systems if packets were sent back to back.
- A time-out facility, when available, allows transmission to resume after a packet is lost.
- All transmission is in ASCII. Any non-ASCII hosts are responsible for conversion. ASCII control characters are prefixed with a special character

and then converted to printable characters during transmission to ensure that they arrive as sent. A single ASCII control character (normally SOH [start of header]) is used to mark the beginning of a packet.

- Binary files can be transmitted by a similar prefix scheme or by use of the parity bit when both sides have control of it.
- Logical records (lines) in textual files are terminated during transmission with prefixed carriage return/linefeed sequences, which are transparent to the protocol and may appear anywhere in a packet. Systems that delimit records in other ways are responsible for conversion, if they desire the distinction between records to be preserved across unlike systems.
- Only a file's name and contents are transmitted—no attributes. It is the user's responsibility to see that the file is stored correctly on the target system. Within this framework, invertible transfer of text files can be assured, but invertible transfer of nontext files depends on the capabilities of the particular implementations of Kermit and the host operating systems.
- Kermit has no special knowledge of the host on the other side. No attempt is made to integrate the two sides. Rather, Kermit is designed to work more or less uniformly on all systems.
- Kermit need not be written in any particular language. It is not a portable program but a portable protocol.

Thus, Kermit accommodates itself to many systems by conforming to a common subset of their features. But the resulting simplicity and generality allow Kermit on any machine to communicate with Kermit on any other machine: microcomputer-to-mainframe, microcomputer-to-microcomputer, mainframe-to-mainframe. The back-and-forth exchange of packets keeps the two sides synchronized; the protocol can be called asynchronous only because the communication hardware itself operates asynchronously.

As far as the user is concerned, Kermit is a do-it-yourself operation. For instance, to transfer files between your microcomputer and a mainframe, you would run Kermit on your microcomputer, put Kermit into the terminal-emulation mode to let you "connect" to

the mainframe, log in and run Kermit on the mainframe, and then escape back to the microcomputer and issue commands to the microcomputer's Kermit to send or fetch the desired files. Any inconvenience implicit in this procedure is a consequence of the power it gives the ordinary user to establish reliable connections between computers that could not otherwise be connected.

PACKETS

Kermit packets need to contain the data that is being transferred, plus minimum information to ensure that the expected data arrives completely and correctly. Several issues arise when designing the packet layout: how to represent data, how to delimit fields within the packet, how to delimit the packet itself, and how to arrange the fields within the packet. Since the transmission medium itself is character oriented, it is not feasible to transmit bit strings of arbitrary length, as do the bit-oriented protocols like HDLC (high-level data-link control) and SDLC (synchronous data-link control). Therefore, the smallest unit of information in a packet must be the ASCII character. As we will see, this precludes some techniques used with other communication media.

Control Fields—Most popular protocol definitions view the packet as layers of information that pass through a hierarchy of protocol levels, each level adding its own information at the ends of an outbound packet or stripping its information from the ends of an incoming packet, and then passing the result along to the next level in the hierarchy. The fields for each layer must be arranged so that they can be found, identified, and interpreted correctly at the appropriate level.

Since Kermit packets are short, it is important to minimize the amount of control information per packet. It would be convenient to limit the control fields to one character each. Because we have 95 printable characters to work with (128 ASCII characters, less the delete character [DEL] and the 32 control characters), we can represent values from 0 to 94 with a single character:

- The *packet sequence number* is used to detect missing or duplicate packets. It is unlikely that a large number of

(text continued on page 268)



THE PRINTER TO PICK WHEN THE PACE QUICKENS.

It's happening all over the PC and micro worlds.

You're getting hit with a ton of increased throughput requirements. Your applications are generating a deluge of paper. You need more printer speed. A lot more.

You're also looking for more professional-looking presentations so you need better print quality. A lot better.

Who's got the best of both worlds for you?

Okidata's Pacemark 2350 and 2410 dot matrix printers.

They'll not only help you *keep* pace with your world, they'll help you set new and exciting ones. In print speed. In print quality. And in vastly increased compatibility and capability.

Take throughput. The 2350 and 2410 can quickly get you out of the waiting game to where you're *really* cranking it out. And with flexibility, too: up to 5 pages per minute.

But wait. Cranking *what* out, you may ask? A single, restrictive printing mode? No way. The 2410 can give you DP, draft,

and a correspondence quality that truly rivals the daisywheel.

And the 2350 and 2410 can both print at up to 350 cps. While producing 120 to 420 lines a minute for you. With bidirectional printing and short line seeking logic. And both high speed horizontal and vertical slew.

PC COMPATIBILITY. SOFTWARE COMPATIBILITY.

The 2350 and 2410 use industry standard interfaces making them hardware compatible with most mini and micro-systems on the market today. In addition, they are supported on the menus of most of the important software being offered to microsystem users like Visicalc, Lotus 1, 2, 3, DBASE 2, Peachtree 500 and General Ledger, Multi-Mate WP, Wordstar, etcetera, etcetera.

But wait, there's more. Like an outstanding all points addressable graphics capability with 144 x 144 dots per inch resolution.

Two color printing for highlighting. Down line loadable font sets for flexibility.

Subscripts and superscripts so your scientific and technical usage won't bog down. Six-part forms handling. The capability to print 132 columns on eight-inch paper using 17.1 characters per inch to save paper costs and make output easier to handle.

And—so that you can depend on getting all that good stuff, all the time—a mean time between failure of 2200 hours. A mean time to repair of only 30 minutes. An average printhead life of 200,000,000 characters. And an industry low warranty claim rate of less than 2%.

No doubt about it, the quicker the pace at your place, the more you need Pacemark from our place. For more information, call toll free 1-800-OKIDATA. In New Jersey, 609-235-2600. Or write OKIDATA, Mt. Laurel, NJ 08054.

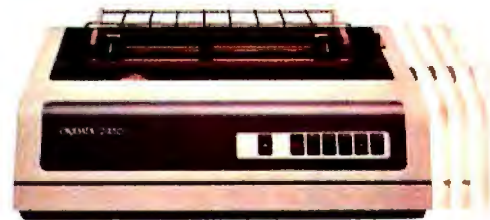

OKIDATA
an OKI AMERICA company

We're keeping pace with your business.

BASIC COMPILER

SuperSoft® Language Library

For PC DOS, MS DOS,
CP/M-86, and others



A programmer's most important software tool is the language compiler or interpreter he uses. He has to depend on it to work and work well.

At SuperSoft, we believe it. That's why we offer three fine compilers: SuperSoft FORTRAN, SuperSoft BASIC, and SuperSoft C, that answer the programmer's need for rock solid, dependable performance on 16 bit systems.



Compatible with Microsoft BASIC

The SuperSoft BASIC compiler, available under CP/M-86 and MS DOS, is compatible with Microsoft* BASIC and follows the ANSI standard.

Greater accuracy with BCD math routines

If you have used other languages without BCD math, you know how disconcerting decimal round off errors can be. For example:

With IBM PC* BASIC	With SuperSoft BASIC with BCD math
10 A=.99	10 A=.99
20 PRINT A	20 PRINT A
30 END	30 END
Output: .9899999	Output: .99

As you can see, SuperSoft BASIC with BCD provides greater assurance in applications where accuracy is critical.

SuperSoft's BASIC is a true native code compiler, not an intermediate code interpreter. It is a superset of standard BASIC, supporting numerous extensions to the language. Important features include:

- Four variable types: Integer, String, and Single and Double Precision Floating Point (13 digit)
- Full PRINT USING for formatted output
- Long variable names
- Error trapping
- Matrices with up to 32 dimensions
- Boolean operators OR, AND, NOT, XOR, EQV, IMP
- Supports random and sequential disk files with a complete set of file manipulation statements
- IEEE floating point available soon as an option
- No run time license fee

Requires: 128K memory
BASIC compiler: \$300.00

For CP/M-86®, MS DOS, and PC DOS

*SuperSoft BASIC is compatible with Microsoft BASIC interpreter and IBM PC BASIC. Due to version differences and inherent differences in compilers and interpreters some minor variations may be found. Machine dependent commands may not be supported. The vast majority of programs will run with no changes.

FORTRAN

SuperSoft FORTRAN is the answer to the growing need for a high quality FORTRAN compiler running under CP/M-86 and IBM PC DOS. It has major advantages over other FORTRAN compilers for the 8086. For example, consider the benchmark program used to test the IBM FORTRAN in *InfoWorld*, p. 44, Oct. 25, 1982. (While the differential listed will not be the same for all benchmark programs, we feel it is a good indication of the quality of our compiler.) Results are as follows:

IBM FORTRAN:	38.0 Seconds
SuperSoft FORTRAN	2.8 Seconds

In its first release SuperSoft FORTRAN offers the following outstanding features:

1. Full ANSI 66 standard FORTRAN with important extensions
2. Standard data types, double precision, varying string length, complex numbers
3. Free format input and free format string output
4. Compact object code and run time support
5. Special functions include string functions, dynamic allocation, time/date, and video access
6. Debug support: subscript checking, good runtime messages
7. Full IEEE floating point
8. Full 8087 support available as option (\$50.00).
9. Ratfor preprocessor available as option (\$100.00).

Program developers:

SuperSoft's family of FORTRAN compilers means you can write your programs once and they will run under CP/M-80, CP/M-86, and MS DOS. This lets you get your applications running fast no matter what the environment.

SuperSoft FORTRAN: available NOW and working great!

Requires:	128K with CP/M-86 or MS DOS, 32K with CP/M-80
FORTRAN:	\$425.00 (in each environment)
8087 Support:	\$ 50.00
Ratfor:	\$100.00

For CP/M-86[®], MS DOS, IBM PC DOS[®], and CP/M-80[®]

In conjunction with SuperSoft, SuperSoft FORTRAN was developed by Small Systems Services, Urbana, IL, a leader in FORTRAN development.

Japanese Distributor:

ASR Corporation International, TBL Building, 7th Floor
1-19-9 Toranomon, Minato-Ku, Tokyo 105, Japan
Tel (03)-5025550 Telex 222-5650 ASRTYO J

European Distributor:

SuperSoft International Ltd 51 The Pantiles,
Tunbridge Wells, Kent, England TN2 5TE
Tel 0892-45433 Telex 95441 Micro-G

C Compiler

In 1982 SuperSoft helped C programmers around the world move their applications from 8 to 16 bit operating systems with the first C compiler under CP/M-86,[®] PC DOS, and MS DOS.

Today there are several C compilers on the market, and you can look at them all. But if you want a C that's fully portable, syntactically compatible with UNIX version 7 C, rigorously tested, fast in both compilation and execution, packed with more library functions than any other, and produces a very highly optimized assembly code... then you'll find only one. The SuperSoft C compiler.

Professional Quality

SuperSoft started working on C over three years ago, and the work has never stopped. While others were struggling to put in features, SuperSoft was refining and polishing... adding the quality professionals depend on.

Thoroughly Tested

SuperSoft C has been tested with hundred of commercial application programs. And all this testing has paid off... with a compiler that's highly reliable in every phase of operation.

Portable

SuperSoft C is now available in most operating systems environments. Since we don't sell operating systems, we can support them all. And as new operating systems become popular, SuperSoft C will be there.

Packed with Library Functions

SuperSoft now has the most complete set of library functions available. All provided with source code.

Thorough User Manual

The new user manual is extensive—jammed with thorough explanations to help you every step of the way. And our technical hotline can help answer any additional questions.

SuperSoft C: \$350.00

SuperSoft[®]

FIRST IN SOFTWARE TECHNOLOGY

P.O. Box 1628 Champaign, IL 61820

(217) 359-2112 Telex 270365

Microsoft is a trademark of Microsoft Corporation

IBM PC is a trademark of International Business Machines Corporation

CP/M and CP/M-86 are registered trademarks of Digital Research

UNIX is a trademark of Bell Laboratories

Circle 313 on inquiry card.

Make your spooling network sing in six-port harmony.

Add MultiSpool—the hardware spooler that's truly flexible. Now, thanks to MultiSpool, there's no more need to buy individual spoolers, no more wasted computer time or memory. With its enormous memory-sharing power, this dynamic six-port switching device not only lets you network any combination of computers and printers; it also provides the spooling function within that network.

With its 60K of buffer memory, controlled by 4K of memory management firmware, MultiSpool can orchestrate up to five computers or

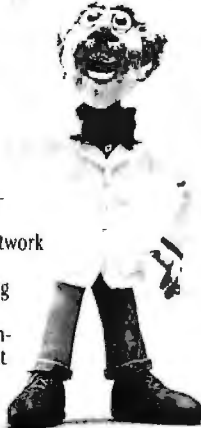

five printers simultaneously. Only this degree of flexibility can meet the ever-changing port-expansion needs of today's multiuser environment.

Note, too, that MultiSpool mixes four serial and two Centronics-compatible ports. It also handles X-on, X-off protocols and DTR. So, with the unit's dipswitch, you can configure each port to accommodate either a computer or printer; and you can define the discipline of that port.

Best of all, MultiSpool sells for just \$995.00—even less if you don't need all six ports. And that, we're sure, is music to your ears.

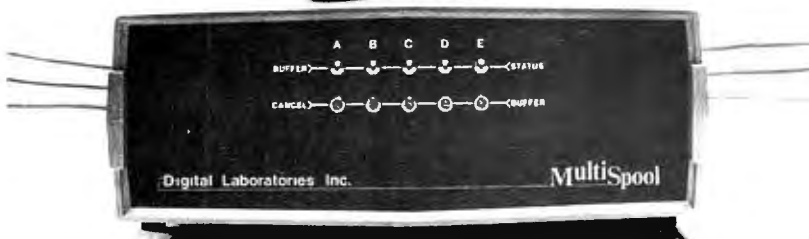

Digital Laboratories Inc.

600 Pleasant Street, Watertown, MA 02172. (617) 924-1680

KERMIT

(text continued from page 264)

packets could be lost, especially since packet n is acknowledged before packet $n+1$ is sent. The sequence number can thus be a small quantity, which wraps around to its minimum value when it exceeds a specified maximum value.

- To prevent long packets, a small maximum length can be enforced by specifying the *packet length* with a single character; since 95 printable ASCII characters can be transmitted, this would be the maximum length, depending on how we count the control fields.

- The *checksum* can be of fixed length. The actual length depends on the desired balance between efficiency and error detection.

The packet length and checksum act together to detect corrupted, missing, or extra characters. These are the essential fields for promoting error-free transmission. So far, however, we've considered only packets that carry actual file data; we will also require special packets composed only of control information, for instance, to tell the remote host the name of the file that is about to come or to tell it that the transmission is complete. This can be accomplished with a *packet type* field. The number of functions we need to specify in this field is small, so a single character can also suffice here.

Packet Framing—We chose to mark the beginning of a package with a distinguishing start character, SOH (Control-A). This character cannot appear anywhere else within the packet. SOH was chosen because, unlike most other control characters, it is generally accepted upon input at a job's controlling terminal as a data character rather than as an interrupt or break character on most mainframes. This is probably no accident, since it was originally intended for this use by the designers of the ASCII alphabet. Should a system be incapable of sending or receiving SOH, it is possible to redefine the start-of-packet character to be any other control character; the two sides need not use the same one.

Three principal options for recognizing the end of a packet are available: fixed length, distinguishing packet-end

(text continued on page 270)

8086/88/186
**SYMBOLIC
DEBUGGER**

CATCH YOUR BUGS ON THE FLY WITH MULTI-WINDOW VISIBILITY

**CodeSmith™-86
VERSION 1.8**

- Stop on data compare
- Cursor/Page thru disasm screens
- Single-step over CALL, INT & REPs
- Halt on subroutine/LOOP complete
- Counter-triggered breakpoints
- Execution path counters
- Nifty pushdown stack display
- Single keystroke commands throughout

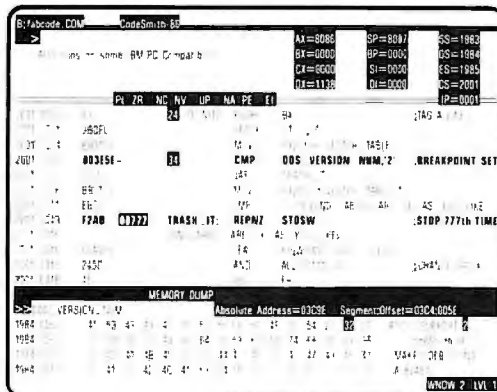

CALL US FOR TECHNICAL ANSWERS (213) 439-2414

- **SCREENSAVE**—We share CRT without clobbering your display (memory-mapped video only)
- **CodeSmith-86** is available for PC-DOS, MS-DOS, or Standalone CPU-control program suitable for ROM/downloading (.EXE format)

OEM inquiries invited

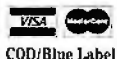

VISUAL AGE

642 N. Larchmont Blvd., Los Angeles, CA 90004 • (213) 439-2414

CodeSmith, TM International Arrangements, Inc.;
MS, TM Microsoft Corp.; IBM, TM International Business Machines Corp.

Call today to receive
and get \$500 value free
\$14500

THE FILE CONNECTION

8" DISKETTE SYSTEM FOR THE IBM PC



Our "FILE CONNECTION" programs provide 8" diskette file exchange between the IBM PC and most Micro-Mini-Main Frame computer systems.

Our "WORD CONNECTION" programs provide 8" diskette text document exchange between the IBM PC and many word processing systems.

Our "DISPLAYWRITER CONNECTION" programs transform documents from Wordstar, Multimate, etc. to the new Display Write 2 format.

Contact us for information about the hundreds of 5¼" and 8" diskette formats and systems which we currently support.

FLAGSTAFF ENGINEERING / 2820 West Darleen / Flagstaff, AZ 86001
Telephone 602-774-5188 / Telex 705609 FLAG-ENG-UD

(text continued from page 268)

character, and length field. Arguments are made for and against each involving what happens when characters, particularly a length or terminator, are lost or garbled. These will be mentioned later. Kermit uses a length field.

To take in a packet, Kermit gets characters from the line until it encounters the SOH. The next character is the length; Kermit reads and decodes the length and then reads that many subsequent characters to complete the packet. If another SOH is encountered before the count is exhausted, the current packet is forgotten and a new one started automatically. This strategy allows arbitrary amounts of noise to be generated spontaneously between packets without interfering with the protocol.

Encoding—When transmitting textual data, Kermit terminates logical records with carriage return/linefeed combinations (CR/LFs). On record-oriented sys-

tems, trailing blanks or length fields are removed and a CR/LF appended to outbound records, with the inverse operation performed on incoming records. On stream-oriented systems, incoming CR/LFs may be translated to some other terminator. Files, of course, need not have logical records, in which case record processing can be skipped altogether, and the file can be treated as a long string of bytes. This is known as image transfer, and it can also be used between like systems where no transformations are necessary.

In order to make each character in the packet printable, Kermit prefixes, or quotes, any unprintable character by transforming it to a printable one and precedes it with a special prefix character, normally #. The transformation is done by complementing the seventh bit (adding or subtracting 64 modulo 64). Thus, Control-A becomes #A and Control-Z becomes #Z. The prefix character is also used to prefix itself: ##.

Upon input, the reverse transformation is performed. Printable characters are not transformed. The assumption is that most files to be transferred are printable, and printable text files contain relatively few control characters; when this is true, the character stream is not significantly lengthened by quoting. For binary files, the average quoting overhead will be 26.6 percent more characters if all bit patterns are equally likely, since the characters that must be prefixed (the control characters, plus DEL and # itself) comprise 26.6 percent of the ASCII alphabet.

Kermit also provides a scheme for indicating the status of the eighth bit when transferring binary files between systems that must use the eighth bit for parity. A byte whose eighth bit is set is preceded by another special prefix character, &. If the low-order 7 bits coincide with an ASCII control character, a control-character prefix is also added.

(text continued on page 272)

softkit (soft-kit), *n.* 1 a book/disk package of programs in BASIC or C for science, engineering, business, or education for the IBMpc, Apple and Z-100. 2 all program listings are fully documented alongside theory, equations and operating instructions. They can be used as-is or modified for special applications. 3 topics include structural analysis, stress analysis, heat transfer, mechanisms, aircraft design, graphics, C-graphics, CAD/CAM, statistics, data plotting, demographics, curve fitting, forecasting, matrix operations, and other hi-tech applications of microcomputers 4 softkits are used by thousands of leading universities, corporations and institutions. 5 call or write for a free catalog

Kern International

433 Washington St. Box 1029, Duxbury, MA 02331 (617)934-0445

Extended Processing S100 Boards

POWER I/O

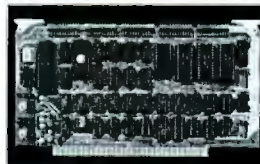

High performance S100/IEEE-696 smart slave computer with 64K RAM, 3 serial ports, 1 centronic port, comprehensive 4K operating system in EPROM and 1 timer. Host access is through a high speed parallel I/O port. Accepts 256K RAMs when available. Optional ADD-ON board doubles I/O and RAM. Standard software and hardware supports 6 serial ports, 2 parallel ports and 512K of RAM. Entire board is software programmable including all I/O buffer sizes.

POWER I/O w/64K and 3S+P:	\$375.00
64K RAM ADD-ON board:	\$175.00
3S+P ADD-ON board:	\$195.00
64K and 3S+P ADD-ON board:	\$295.00

BURNER I/O II



Multifunction S100/IEEE-696 board. Complete EPROM programmer handles 5 volt EPROMS: 2508, 2758, 2516, 2716, 2532, 2732, 2732A, 2564, 2764, 27128, 27256. Fully I/O mapped. EPROM selected totally with software. No switches or program modules. Menu driven software supplied in 4K EPROM. 2 independent serial ports with baud rate to 19,200. 1 centronic type parallel port. Memory management for address lines A16-A23.

Option A: Full board	\$355.00
Option B: Programmer	\$220.00
Option C: I/O (2S+P)	\$220.00
Option D: Programmer+I/O	\$330.00
Option E: Memory management	\$110.00
Memory management for B or C:	\$ 25.00

All E.P. boards are built with quality components and are fully assembled and tested. Full documentation including schematics and source code listings.

ep Extended Processing 3861 Woodcreek Lane,
San Jose, Ca, 95117 (408) 249-8248

The all new Freedom™ 110 VDT has just two things going for it.

The price, \$595. The new Freedom 110 Video Display Terminal is without question the price leader of all low-end smart terminals. And it doesn't stop there. In fact, the price is only the beginning.

The performance. It starts with distinctive styling, including a tilt and swivel screen, and a sculptured, detached European DIN-standard keyboard. We paid a little extra for the green phosphor (amber optional) non-glare high resolution screen so you get the best in crisp, easy to read characters. We've packed the ergonomic Freedom 110 with a long list of user-relevant features, too.

- 24 x 80 display with user-accessible 25th status line.
- 10 programmable non-volatile function keys (20 with shift) and 20 pre-programmed codes.
- Flexible non-volatile set-up modes (full page or status line).
- 15 thin-line graphic characters.
- Non-embedded character attributes.
- 9 cursor control and 8 editing keys.
- Screen time-out.
- Block, conversation, monitor and local communication modes.
- Bidirectional buffered auxiliary port.
- 8 standard foreign character sets.
- Self-test mode.
- TeleVideo 910, ADDS Regent 25, Lear Siegler ADM 3A/5 and Hazeltine 1420 emulation.
- Chassis-mounted PC board for the same easy serviceability and add-on board capability as the advanced Freedom™ 200 VDT.

You get all this, plus our industry leading six-month warranty and comprehensive third-party service. To find out more about what price and performance leadership really means, contact your nearest Liberty dealer or distributor. Or call Liberty direct at (415) 543-7000.

See us at NCC in Las Vegas. Booth C-3388, East Hall

Circle 189 on inquiry card.

 **LIBERTY**

© 1984 Liberty Electronics.

TeleVideo 910 is a trademark of TeleVideo Systems, Inc. Regent 25 is a trademark of Applied Digital Data Systems, Inc. ADM 3A/5 is a trademark of Lear Siegler, Inc. WorldStar, MailMerge and SpellStar are trademarks of MicroPro International Corp.

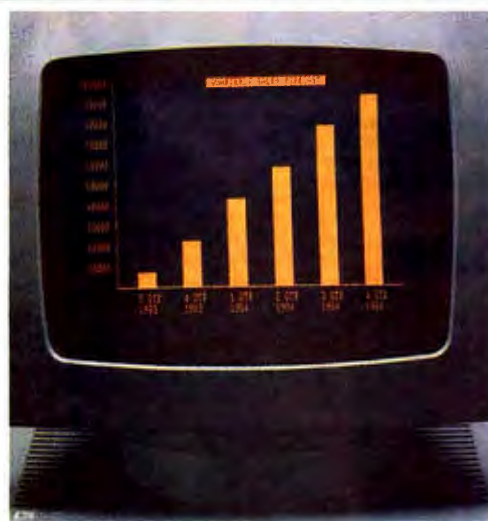

Sperry

in Albuquerque



Software Engineers

Discover the opportunities available with Sperry in Albuquerque, where our Defense operation is growing rapidly to meet the needs of worldwide aviation.

In this position, you will participate in the development of new control and display systems for military helicopters and airplanes.

To qualify, you must have a BSEE/CS and a minimum of three years of experience. Your background should include design, test and integration of real-time software with emphasis on modular and structured programming. Experience with high order languages also desirable.

Sperry will provide you with a competitive salary and benefits package in a modern, professional working environment. For consideration, send your resume and salary information, in confidence, to Brandon Harwood, Sperry, P.O. Box 9200, Albuquerque, NM 87119.



Equal Employment Opportunity/Affirmative Action Employer.
U.S. citizenship required.

KERMIT

(text continued from page 270)

For instance, the byte 10000001₂ would be transmitted as &#A. The & character itself can be included as data by prefixing it (#&), and the control-prefix character may have its eighth bit set (&##). Eighth-bit prefixing is done only when necessary; if both sides can control the parity bit, its value is preserved during transmission. If the eighth bit is set randomly on binary files, eighth-bit prefixing will add 50 percent character overhead. For some kinds of binary data, it could be less; for instance, positive binary numbers in two's-complement notation do not have their high-order bits set, in which case at least one byte per word will not be prefixed.

A third kind of prefix implements rudimentary data compression. At low speeds, the bottleneck in file transmission is likely to be the line itself, so any measure that can cut down on use of the line would be welcome. The special prefix character ~ indicates that the next character is a repeat count (a single character, encoded printably) and that the character after that (which may also have control or eighth-bit prefixes) is repeated so many times. For instance, ~}A indicates a series of 93 letter As; ~H&#B indicates a series of 40 Control-Bs with the parity bit set. The repeat count prefix itself can be included as text by prefixing it with #.

To keep the protocol simple, no other transformations are done. At this point, however, it might be worth mentioning some things we did *not* do to the data:

- *Fancy data compression.* If the data is known to be (or resemble) English text, a Huffman encoding based on the frequency of characters in English text could be used. A Huffman code resembles Morse code, which has variable-length characters whose boundaries can always be distinguished. The more frequent the character, the shorter the bit string to represent it. Of course, this scheme can backfire if the character distribution of the data is very different from the one assumed. In any case, variable-length characters and ASCII transmission don't mix well.
- *Error-correcting codes.* Techniques such as Hamming codes exist for detecting and correcting errors on a

(text continued on page 274)

**HOW TO CUT
YOUR COMPANY'S
LONG DISTANCE
PHONE BILL
50% OR MORE.**

RCA American Communications

Free.

WATS, MCI, SPC, AT&T, RCA, USTC, ITT, WU, SBS...our brochure unscrambles the alphabet soup facing every cost-conscious company seeking the best mix of long distance communications services.

In many cases, an RCA private line satellite channel is the solution to expensive long distance phone bills. But even if an analysis shows we can't help you, our brochure will.

To get it, write Walt Pioli, 400 College Road East,
Dept. K, Princeton, NJ 08540
or call (609) 734-4300. Ext. 111.

RCA American Communications

NOW AVAILABLE!

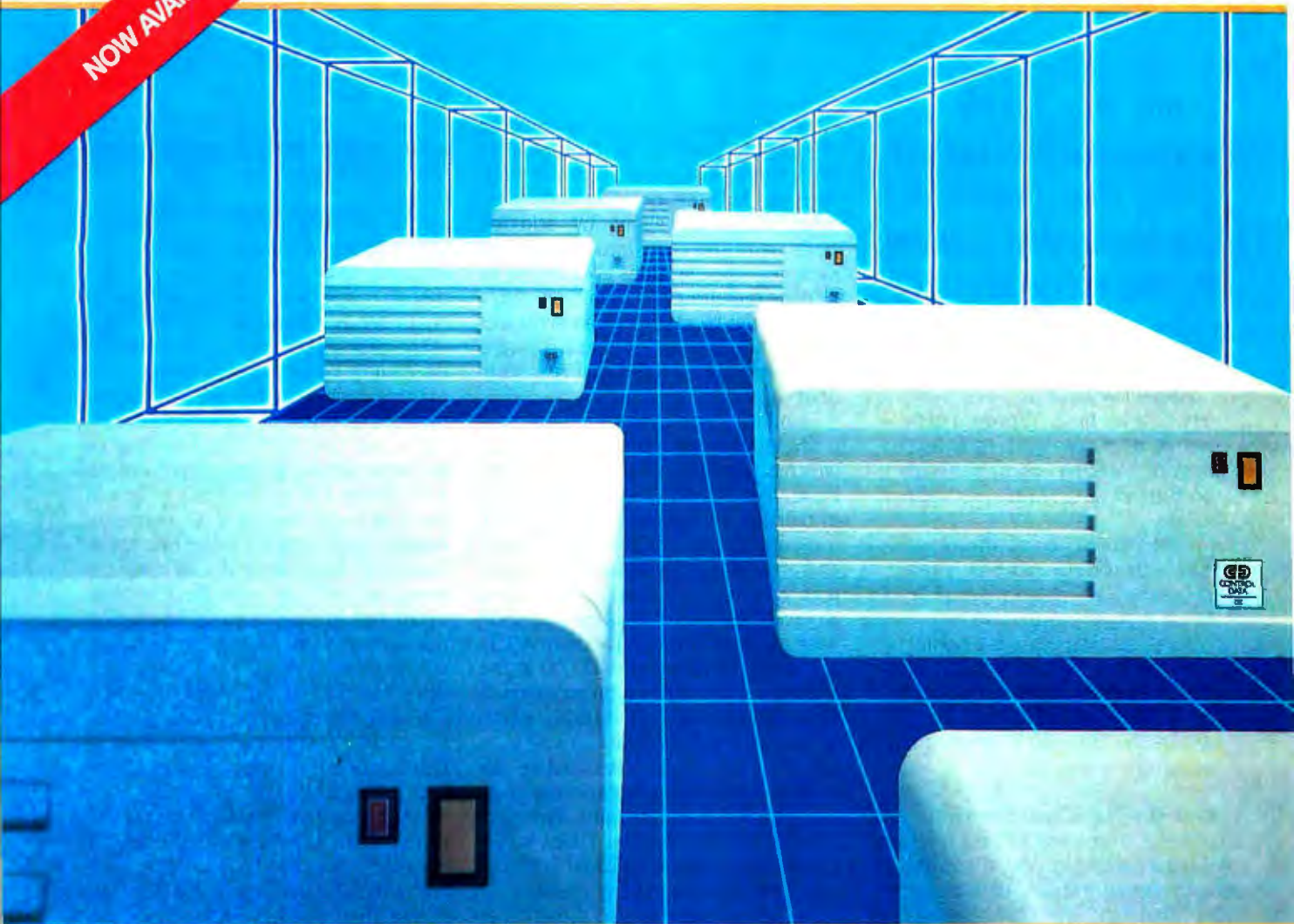

StorageMaster™ Fixed Disk builds stronger PCs three ways.

If you own an IBM PC, the new StorageMaster 500 Series Fixed Drives from Control Data give you three great advantages.

- Larger capacity than IBM's fixed disk drive. The StorageMaster 518 offers up to 18 megabytes of storage; the StorageMaster 530 capacity of 30 megabytes is the equivalent of 15,000

double-spaced typewritten pages.

- You can boot* (start up) from StorageMaster 500 Drives—no need to boot up from a flexible disk as with other drives.
- More byte for the buck. Dollar for dollar, StorageMaster gives you more bytes of storage than IBM's fixed disk drive.

There's more. The 500 Series Drives have an average seek time of only 45 milliseconds—about twice as fast as most other drives. They store your information in a sealed, contamination-free environment. They require no cleaning or preventive maintenance. And they

come ready to plug into your PC.*

Look for the 500 Series Drives at your local computer store. Or give us a toll-free call at 800/232-6789 (in Minnesota, call 612/921-4400, ext. 41) and we'll tell you where you can find our whole family of StorageMaster products.

*This capability requires the use of a StorageMaster 301 Controller.

Circle 88 on inquiry card.



GD
CONTROL
DATA

Kermit is a simple, generalized file-transfer facility that transmits a file's name and contents but not every attribute a file might possess.

(text continued from page 272)

per-character basis. These are expensive in resources and complex to program. Kermit uses per-packet block-check techniques (explained below).

- *Nybble encoding.* To circumvent problems with control and 8-bit characters, it would have been possible to divide every character into two 4-bit nybbles, sending each as a printable character (e.g., a hexadecimal digit). The character overhead caused by this scheme would always be 100 percent. But it would be an easy way to transfer binary files.

Error Detection—Character parity and Hamming codes are forms of vertical redundancy checks (VRCs), formed by combining all the bits of a character. The other kind of check that can be used is the longitudinal redundancy check (LRC), which produces a block-check character formed by some combination of each character within a sequence. The sending side computes the LRC and sends it with the packet; the receiving side recomputes it for comparison. Various forms of LRCs exist. One form produces a column-parity character, or logical sum, whose bits are the exclusive-ORs of the corresponding bits of the data characters. Another is the checksum, which is the arithmetic sum of all the characters in the sequence, interpreted numerically. Another is the cyclic redundancy check (CRC), which passes the characters through what amounts to a shift register with embedded feedback loops, producing a block check in which each bit is affected in many ways by the preceding characters.

All these techniques will catch single-bit errors. They do vary in their ability to detect other kinds of errors. For instance, a double-bit column error will

always go undetected with column parity, since the result of exclusive-ORing any 2 bits together is the same as exclusive-ORing their complements, whereas half the possible double-bit errors can be caught by addition because of the carry into the next bit position. The CRC does even better by rippling the effect of a data-bit multiply through the block-check character, but the method is complex, and a software implementation of a CRC can be inscrutable.

Standard, base-level Kermit employs a single-character arithmetic checksum, which is simple to program, low in overhead, and has proven quite adequate in practice. The sum is formed by adding together the ASCII values of each character in the packet except the SOH and the checksum itself and including any prefixing characters. Even non-ASCII hosts must do this calculation in ASCII. The result can approach 12,000 in the worst case. The binary representation of this number is 10111011100000₂, which is 14 bits long. This is much more than one character's worth of bits, but we can make the observation that every character included in the sum has contributed to the low-order 7 bits, so we can discard some high-order bits and still have a viable validity check.

The Kermit protocol also allows other block-check options, including a two-character checksum and a three-character 16-bit CRC. The two-character checksum is simply the low-order 12 bits of the arithmetic sum broken into two printable characters. The CRC sequence is formed from the 16-bit quantity generated by the CCITT-recommended polynomial $X^{16} + X^{12} + X^5 + 1$, which is also used in some form with other popular transmission techniques, such as International Organization for Standardization (ISO) HDLC and IBM SDLC. The high-order 4 bits of the CRC go into the first character, the middle 6 into the second, and the low-order 6 into the third.

Some care must be taken in the formation of the single-character block check. Since it must be expressed as a single printable character, values of the high-order data bits may be lost, which could result in undetected errors, especially when transferring binary files. Therefore, we extract the seventh and eighth bits of the sum and add them

back to the low-order bits; if the arithmetic sum of all the characters is S , the value of the single-character Kermit checksum is given by

$$(S + ((S \text{ AND } 300)/100)) \text{ AND } 77$$

(The numbers are in octal notation.) This ensures that the checksum, terse though it is, reflects every bit from every character in the packet.

The probability that an error will not be caught by a correctly transmitted arithmetic checksum is the ratio of the number of possible errors that cancel each other out to the total number of possible errors, which works out to $1/2^n$, where n is the number of bits in the checksum, assuming all errors are equally likely. This is $1/64$ for the single-character checksum and $1/4096$ for the two-character checksum. But the probability that errors will go undetected by this method *under real conditions* cannot be easily derived, because all kinds of errors are not equally likely. A 16-bit CRC will detect all single- and double-bit errors, all messages with an odd number of bits in error, all error bursts shorter than 16 bits, and more than 99.99 percent of longer bursts. These probabilities all assume, of course, that the block check has been identified correctly, i.e., that the length field points to it and that no intervening characters have been lost or spuriously added.

A final note on parity—a parity bit on each character combined with a logical sum of all the characters (VRC and LRC) would allow detection and correction of single-bit errors without retransmission by pinpointing the row and column of the bad bit. But control of the parity bit cannot be achieved on every system, so we use the parity bit for binary data when we can or surrender it to the communication hardware if we must. If we have use of the eighth bit for data, it is figured into the block check; if we do not, it must be omitted from the block check in case it has been changed by agents beyond the knowledge or control of Kermit.

Packet Layout—Kermit packets have the format, shown in figure 1, where all fields consist of ASCII characters, and the char function converts a number in the range 0 to 94 to a printable ASCII character by adding 32.

In terms of the seven-layer ISO net-

(text continued on page 276)



datavuplus™



A COMPLETE INFORMATION MANAGEMENT FACILITY

It constructs and customizes your own menu-driven application software.

Featuring:

1. Automatic Screen Design
 - Multi page free form • Calculated Fields
 - Search Fields • Wildcard & Continuous Search
 - User Definable Function Keys
2. Relational DBM
 - Select • Joint • Sort • Index • Add
 - Change • Delete, etc.
3. Report Generation
 - Multiple File Data Retrieval • Calculations
 - Posting • Over 30 Format Commands
4. Automatic Menu Generation
 - Free Form multi-page • Batch Processing
5. File Maintenance Programs
 - Multi Key Sort • Post • Reformat • Merge
 - Compress

datavuplus™

datavu™ plus needs no utility or program enhancements for ease of operation. It is a COMPLETE software package.

FREE!! inventory management system with the purchase of datavu™ plus.

All This. . .

for only

\$250

American Express, Visa and Mastercard Accepted

Available for

CP/M¹-80: DEC Rainbow, Kaypro, NEC, Sanyo, Heath 89/Z100, Epson Qx-10, Micro Decision, North Star, Osborne, Xerox, Apple II CP/M, Televideo, Superbrain, Eagle.

CP/M¹-86,

MS-DOS²,

IBM PC DOS

SPECIAL

\$50 Rebate with proof of purchase of any dBase II³ program.

Not applicable for Dealers/Distributors.

Expires September 1, 1984

¹CP/M is a registered trademark of Digital Research, Inc., ²MS-DOS is a registered trademark of Micro-Soft, Inc., ³dBase is a registered trademark of Ashton-Tate.

Thinkers Soft, Inc. P.O. Box 221, Garden City, NY 11530 (516) 294-8104

Circle 402 on inquiry card.

(text continued from page 274)

work reference model, 8-bit bytes are presented to Kermit by the hardware and operating-system software comprising the physical-link layer. Correct transmission is ensured by the packet-level routines that implement the data-link layer using the outer "skin" of the packet—the MARK, LEN, and CHECK fields. The network and transport layers are moot, since Kermit is a point-to-point affair in which the user personally makes all the required connections. The session layer is responsible for requesting retransmission of missing packets or ignoring redundant ones, based on the SEQ field; the presentation layer is responsible for any data conversions (EBCDIC/ASCII, insertion or stripping of CR/LFs, etc.). Finally, the TYPE and DATA fields are the province of the application layer; our application, of course, is file transfer. In any particular implementation, however, the organization of the program may not strictly follow this model. For instance, since transmission is always in an ASCII stream, IBM mainframe implementations must convert from EBCDIC and insert CR/LFs *before* checksum computation.

The six fields of a Kermit information packet are listed in table 1. The packet may be followed by any line terminator required by the host, a carriage return by default. Line terminators are not part of the packet and are not included in the count or checksum. Terminators are not necessary to the protocol and are invisible to it, as are any characters that may appear between packets. If a host cannot do single-character input from a terminal, a terminator will be re-

quired for that host.

Some sample Kermit data packets are shown in listing 1. The ^A represents the unprintable SOH (or Control-A) character. In the last packet shown, E is the length. The ASCII value of the E character is 69, less 32 (the unchar transformation, which is the opposite of char) gives a length of 37. The next character, 6, tells the packet sequence number, in this case 6. The next is the packet type D for Data. The next characters, "of#M#Jconstructing a theory conta", form the data; note the prefixed carriage return and linefeed. The final character, 5, is the checksum, which represents the number 21.

Effects of Packet Corruption—What are the consequences of transmission errors in the various fields? If the SOH is garbled, the packet will be treated as interpacket garbage and ignored. If any other character within the packet is garbled into SOH, the current packet will be discarded and a new (spurious) packet detected. If the length is garbled into a smaller number, a character from the data field will be misinterpreted as the checksum; if larger, the program will probably become stuck trying to input characters that will not be sent until one side or the other times out and retransmits. If the sequence number, type, any of the data characters, or the checksum itself is garbled, the checksum should be wrong. If characters are lost, there will most likely be a time-out. If noise characters are spontaneously generated, they will be ignored if they are between packets or will cause the wrong character to be interpreted as the checksum if they come during packet transmission.

Most kinds of errors are caught by the checksum comparison and are handled by immediate retransmission. Time-outs are more costly because the line sits idle for the time-out period. The packet design minimizes the necessity for time-outs due to packet corruption: the only fields that can be corrupted to cause a time-out are the SOH and the packet length, and the latter only half the time. Lost characters, however, can produce the same effect (as they would with a fixed-length block protocol). Had a distinguishing end-of-packet character been used rather than a length field, there would be a time-out every time it was corrupted. It is always better to retransmit immediately than to time out.

SUMMARY

We've covered the factors that should be considered in designing a simple, reliable, inexpensive, and yet comprehensive file-transfer protocol—Kermit. The asynchronous serial communications used by the Kermit protocol can accommodate a variety of diverse computer systems and their different ways of handling information and files. Kermit sets minimum transmission standards by providing a common subset of the machines' features. These features include transfer of the filename and contents for both textual and binary files, different error-detection methods, and time-out facilities if either end of the communication link experiences delays or difficulties. The encoding of the information in the packets, the error-detection checksums, and the layout of the fields in the packets were also presented.

(text continued on page 278)

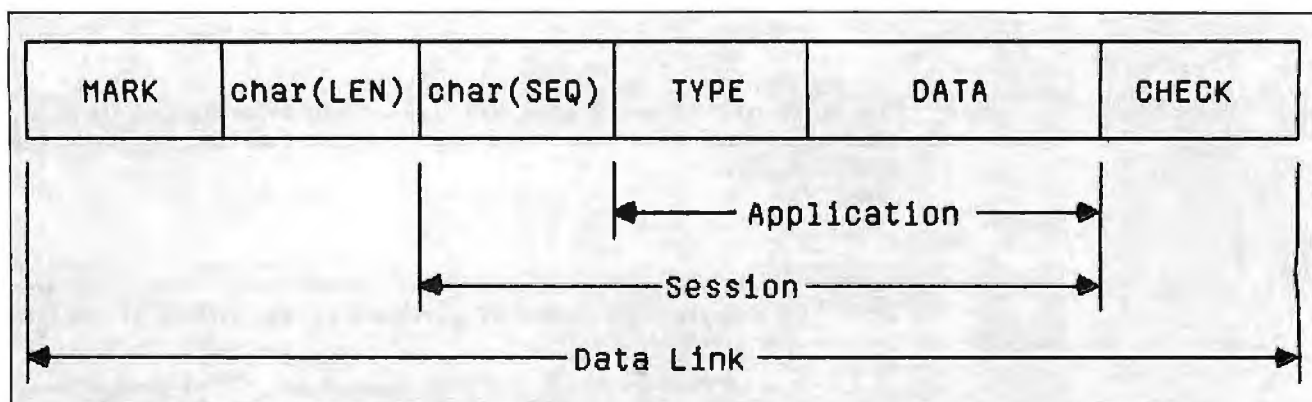

Figure 1: The format for a packet of information according to the Kermit protocol.

HOW TO GET 10 LBS. OF DATA IN A 5 LB. BAG AND FIND IT FASTER.

Alloy's PC-STOR gives high performance hard disk storage and file-oriented backup to users of IBM, Eagle, Columbia, and Corona.



In one compact, stack-able, attractive package, the remarkable PC-STOR from Alloy combines the latest Winchester hard disk performance with the industry's finest file-oriented tape backup system. It lets you locate, retrieve, and reposition data quickly, precisely, and easily. For IBM PC and IBM compatible users, PC-STOR's new Winchester hard disk has 52 or 104 megabytes of storage with access that's 4 times faster than the IBM-XT system. And it has been specially designed to be easy to use. Here are just some of its remarkable features: DOS 2.0 or CP/M 86 compatible.

38 millisecond access time. Integrated tape backup. TIP-SIX, powerful file-oriented backup software. Established network compatibility.

For the finest in hard disk storage with file-oriented backup, find out more about PC-STOR. It's available right now. Call Alloy today at (617) 875-6100, or ask your local dealer about PC-STOR.



ALLOY
Computer Products, Inc.

PC EXPO
New York Coliseum.
June 26-28, 1984
BOOTH 524

Alloy Computer Products, Inc., 100 Pennsylvania Avenue, Framingham, Massachusetts 01701. (617) 875-6100, TWX: 710-346-0394
In Europe: Alloy Computer Products (Europe) Ltd., Cirencester, Gloucestershire, England. Tel: 0285-68709, Tlx: 43340

Modula-2

Apple II \$295 Apple III \$395 IBM PC and XT \$395 Sage II and IV \$495

PO BOX 1236
Del Mar, CA 92014
(619) 481-2286

Volition Systems

Sage™ Sage Computer Technology, Apple™ Apple Computer, Inc. IBM™ IBM Corp.

Circle 385 on inquiry card.

KERMIT

(text continued from page 276)

In part 2, we'll look at how the Kermit protocol works and its uses: the different modes each side can be in when sending and receiving files, how initial connections take place and the exchange of initial packets of information that specify each side's setup requirements, the heuristics to improve efficiency and error recovery, examples of packets and a session using Kermit, performance figures, the user interface, and future directions for Kermit as a working network with file servers. ■

Listing 1: Some sample packets of information in the Kermit protocol. The ^A represents the unprintable ASCII start-of-header character.

```
^AE"D No celestial body has required J
^AE#Das much labor for the study of its#
^AESD#M#Imotion as the moon. Since CiaA
^AE%Dirault (1747), who indicated a way?
^AE&D of#M#|constructing a theory conta5
```

(Kermit is not an acronym. It was named after Kermit the Frog, star of the television series, The Muppet Show. Used by permission of Henson Associates Inc.)

Table 1: The six fields in a packet of information in the Kermit protocol.

MARK	Start-of-packet character, normally SOH (Control-A).
LEN	The number of ASCII characters, including prefixing characters and the checksum, in the rest of the packet that follows this field; in other words, the packet length minus two. Since this number is expressed as a single character via the char function, packet character counts of 0 to 94 are permitted, and 96 is the maximum total packet length, including the MARK and LEN fields.
SEQ	The packet sequence number, between 0 and 63. The sequence number wraps around to 0 after each group of 64 packets.
TYPE	The packet type, a single printable ASCII character, is one of the following: D Data Y Acknowledge (ACK) N Negative Acknowledge (NAK) S Send Initiate (Send-Init) R Receive Initiate B Break Transmission (EOT) F File Header Z End of File (EOF) E Error G Generic command. A single character in the data field, possibly followed by operands, requests host-independent remote execution of the specified command: L Log out, bye F Finish, but don't log out D Directory query (followed by optional file specification) U Disk-usage query E Erase (followed by file specification) T Type (followed by file specification) Q Query server status and others. C Host command. The data field contains a string to be executed as a system-dependent (literal) command by the host. X Text display header. To indicate the arrival of text to be displayed on the screen, for instance, as the result of a generic or host command executed at the other end. Operation is exactly like a file transfer.
DATA	The contents of the packet, if any contents are required in the given type of packet, interpreted according to the packet type. Nonprintable ASCII characters are prefixed with special characters and then converted to printable characters by complementing the seventh bit. Characters with the eighth bit set may also be prefixed, and a repeated character can be prefixed by a count. A prefixed sequence of characters may not be broken across packets.
CHECK	The block-check sequence, based on all the characters in the packet between, but not including, the mark and the check itself, can be one, two, or three characters in length as described previously, each character transformed by the char function. Normally, the single-character checksum is used.

SAN FRANCISCO'S EXPLORATORIUM

BY JOHN MARKOFF

A hands-on, interactive museum

AS A VISITOR to San Francisco's Exploratorium, you will be struck by what seems at first to be utter chaos. Entering the dim, cavernous space the Exploratorium occupies, you will see children darting to and fro, hear random sounds from strange devices that echo into the distance, and observe spectral lights that seem to shine in every corner.

Soon the confusion clears and you realize that you haven't entered some high-tech asylum. You have found your way into a wonderfully diverse free-form science museum.

The Exploratorium represents science for the general public. There is no right or wrong way to conduct an experiment and the exhibits here are intended to be used in ways their designers never imagined.

Each year more than 450,000 visitors, almost as many adults as children, make the trek to this unique learning center. They play with—and learn from—more than 500 interactive scientific exhibits

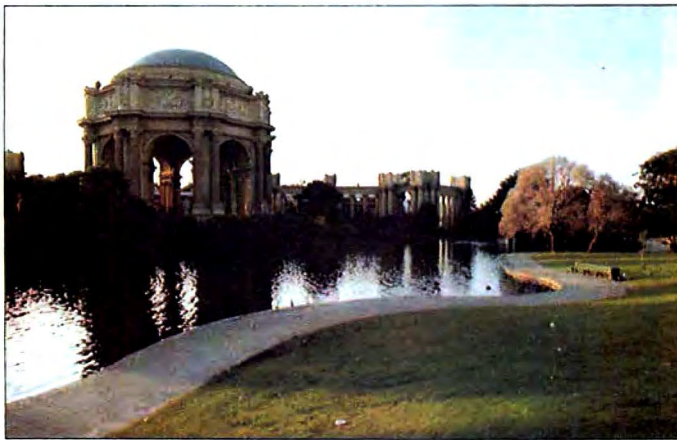

ranging from gravity wells to echo chambers to more esoteric computerized simulations.

The Exploratorium was founded in 1969 by physicist Frank Oppenheimer and has since gained an international reputation as a hands-on science museum. It has been called "the best science museum in the world" by the editor of *Scientific American*.

.....
John Markoff is a BYTE senior technical editor. He can be reached at 1000 Elwell Ct., Palo Alto, CA 94303.

As might be expected, a museum that intentionally disregards many of the established conventions of scientific good manners uses personal computers in an unorthodox fashion as well. In exhibits scattered around the Exploratorium floor, it's possible to find microcomputers ranging from simple John Bell Engineering controllers to full-blown Intel 8086 development systems. The difference is that at the Exploratorium there are no

personal computer exhibits per se. Computers are used to illustrate basic scientific concepts or to alter the perception of Exploratorium visitors about things around them that they haven't noticed before. Visitors may never realize that any particular exhibit is being guided by a personal computer.

Unlike other computer-literacy projects, teaching programming is not a first priority at the Exploratorium. Instead, the goal is to convey the idea that computers are just tools and that they can

(text continued on page 281)



The Exploratorium has received financial support and donations of equipment from a number of semiconductor and computer corporations. Intel Corporation has donated computer hardware and has permitted several of its engineers to spend three-month sabbaticals designing simulation exhibits based on Intel equipment. The children at this exhibit are controlling a simulated satellite in orbit around a planetary object. The simulation system is based on an Intel 8086 development computer with an 8087 math coprocessor.

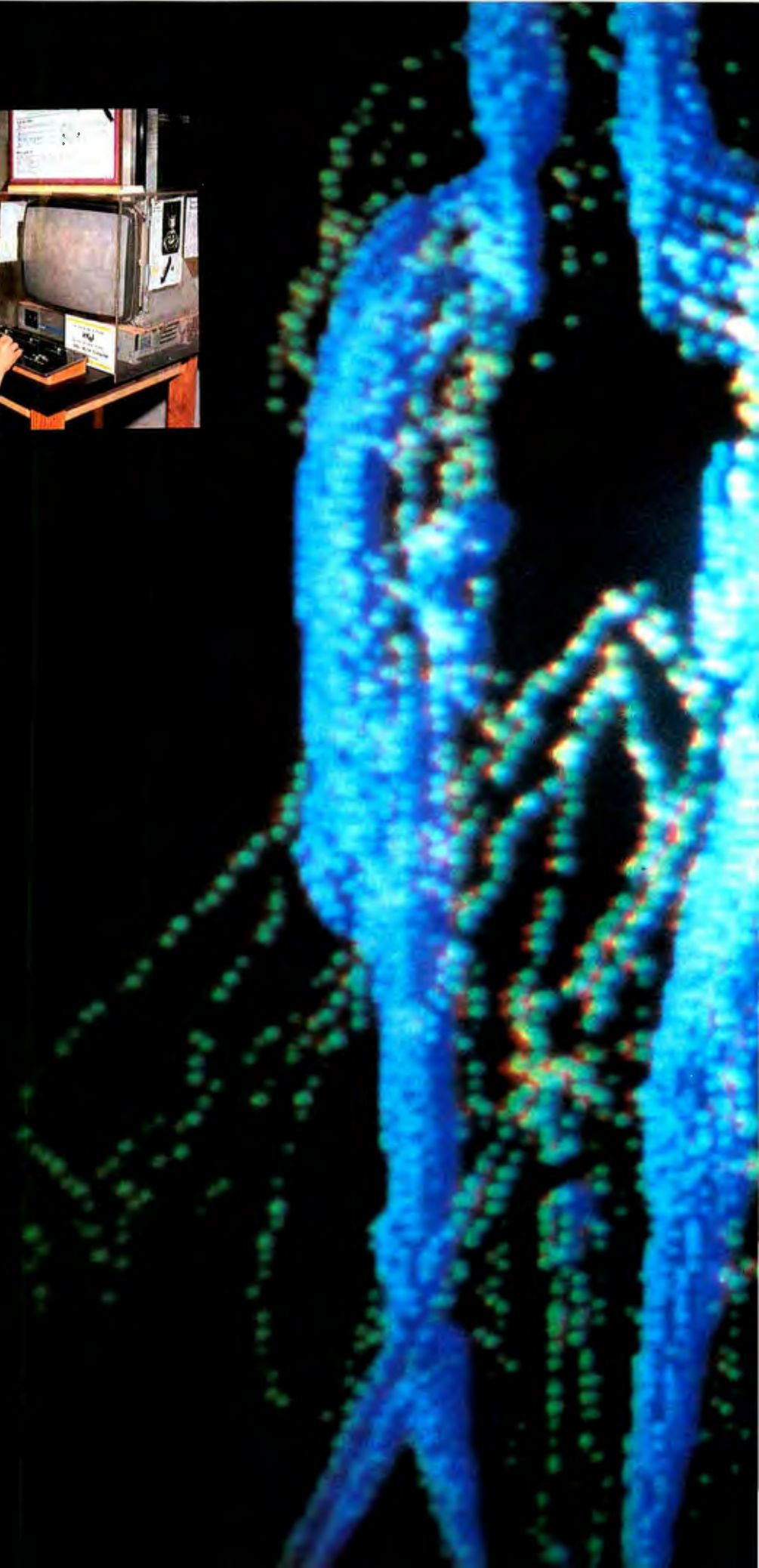

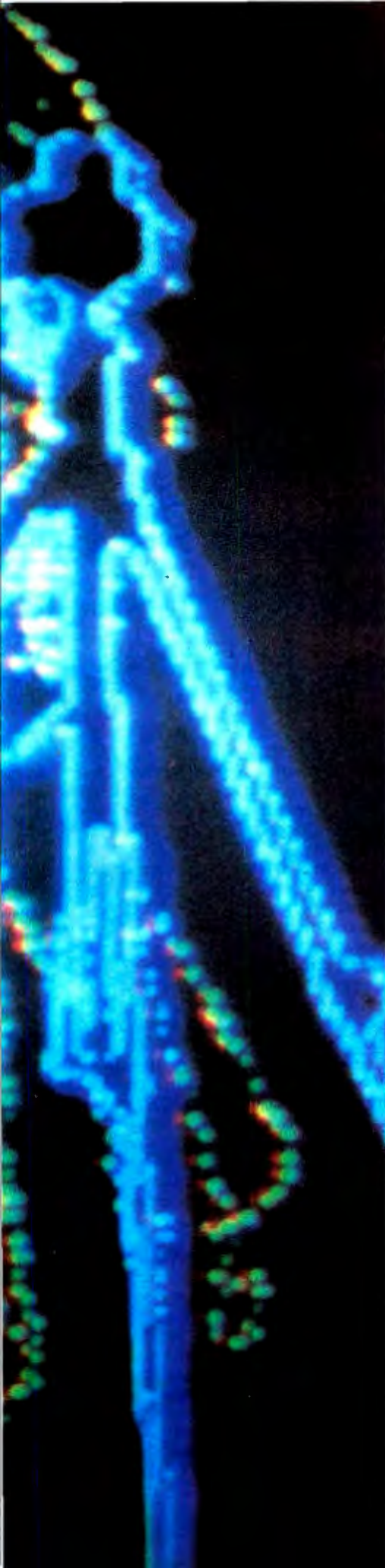

(text continued from page 279)
be used like any other tool.

"We try to show people that you typically do not break computers by touching them. There's nothing you can do that is wrong," says Ron Hipschman, a San Francisco physicist who serves as the Exploratorium's resident computer wizard. "Our science museum is based on that concept, too. You can't do anything wrong with our exhibits. You may not do what we intended, but if you do something different, so what?"

Hipschman began teaching computer courses at the Exploratorium years ago with borrowed IMSAI and North Star computers. More recently, donations of computers from Texas Instruments and Atari have made it possible to hold regular introductory classes in both BASIC and Logo.

Logo fits in well with the philosophy of the Exploratorium, as it has always been perceived as an exploratory and experimental language.

"The Exploratorium is designed to give people the ability to explore and play," he says, "so our classes are much less structured than school. You can't

Several computer-based Exploratorium exhibits have been designed by artists. Recollections, by Ed Tannenbaum, employs an Apple II computer that controls a frame buffer hooked to a video camera. Like all Exploratorium exhibits, this one is participatory. Visitors walk into a three-sided room. On one side the video camera tracks their movements, which are then transformed by the Apple II and the frame buffer and projected on a screen in front of the observer.

force-feed the kids in school and you can't force-feed them on the computer either."

Another thing that the children bring away from their introduction to computers at the Exploratorium is that if something goes wrong, it's usually their own fault, not the computer's. Hipschman strives to show the children that because the computer is a tool that doesn't often make mistakes, it's actually very reliable.

At the Exploratorium, the computer is viewed as a valuable instructional aid in demonstrating a system of scientific reasoning.

"It's a very logical process in finding your mistakes and it spills over into everyday life," remarks Hipschman. "You say, 'OK, something's not working here, what's going on?' You start at the beginning without any assumptions. It (the computer) has a logical sequence of events and it works everywhere."

In the future, the Exploratorium plans to use computers to simulate events that can't take place directly within the confines of the museum. *Already the Intel 8086 development systems are being used to simulate simple orbital mechanics and the backscattering of light. Another simulation running on an Apple II computer illustrates how different growth rates of competing populations can interact.*

What kinds of simulations are possible?

Recently Hipschman and Exploratorium co-worker Joe Ansel tried to envision a perfect computer simulation for

(text continued on page 282)

ERG/68000 MINI-SYSTEMS

- Full IEEE 696/S100 Compatibility

HARDWARE OPTIONS

- 8MHz, 10 MHz, or 12 MHz 68000/68010 CPU
- 68451 Memory Management
- Hardware Floating Point
- Multiple Port Intelligent I/O
- 64K/128K Static RAM (70 nsec)
- 256K/512K/1MB Dynamic RAM (150 nsec)
- Graphics-Digital Graphics CAT-1600
- DMA Disk Interface
- SMD Disk Interface
- 1/4" or 1/2" Tape Backup
- 5 1/4" or 8" Floppy Disk Drives
- 5MB-474MB Hard Disk Drives
- 7/10/20 Slot Back Plane
- 20 or 30A Power Supply
- Desk Top or Rack Mount Encl.

SOFTWARE OPTIONS

- 68KFORTH¹ Systems Language
- CP/M-68K²O/S with C, 68K-BASIC¹, 68KFORTH¹, FORTRAN 77, EM80 Emulator, Whitesmiths³ C, PASCAL
- IDRIS³ O/S with C, PASCAL, FORTRAN 77, 68K-BASIC¹, CIS COBOL⁴, INFORMIX⁵ Relational DBMS
- UNIX⁶ SYS V O/S with C, PASCAL, FORTRAN 77, BASIC, RM COBOL⁷, ADA⁸, INFORMIX⁵, Relational DBMS
- VED 68K Screen Editor
- Motorola's MACSBUG and FFP Package

Trademark ¹ERG, ²Digital Research, ³Whitesmiths, ⁴Micro Focus, ⁵RDS, Inc., ⁶Bell Labs, ⁷Ryan McFarland, ⁸U.S. DoD

30 Day Delivery - OEM Discounts



since 1974

Empirical Research Group, Inc.
P.O. Box 1176
Milton, WA 98354
(206) 872-7665

EXPLORATORIUM

(text continued from page 281)

the Exploratorium. They began with a simple water fountain in which water shoots up into the air and makes a nice parabola, then comes back down.

In the physical world there are really only a few variables you can change easily; you might vary the velocity of the water or the height and angle of the nozzle. But in Hipschman's and Ansel's fantasies it would be nice if you could

vary the viscosity of the air around the water to increase the friction. What would it look like if you varied the viscosity of the water or even changed the force of gravity?

Computer simulations will bring these physicists' fantasies to life in the Exploratorium. Perhaps Ansel says it best when he points out that "there is no pathway to walk through this museum." ■

Courses for Credit Through Electronic Mail

BY DONNA OSGOOD

As enrollments decline, colleges are looking for new ways to distribute their product—education. Personal computers with communications capabilities open new possibilities for away-from-campus learning.

A problem that's inherent in computer-based learning at home also plagues traditional correspondence courses: the student has no direct contact with the instructor. Without a human there to answer questions, direct discussion, and get the student "unstuck" when necessary, motivation can flag. If no one cares whether a student finishes the course, he may not.

One solution is offered by TeleLearning's Electronic University, which enrolled its first student in an accredited course last March. A student in the Electronic University studies course material and completes assignments using a personal computer, then transmits the work directly to the instructor's electronic mailbox. Within a day or two, the instructor sends a response to the student's mailbox. Instructors hold "office hours" when students can contact them directly.

TeleLearning provides a delivery system for courses developed and accredited by universities and community colleges. Instructors develop new courses using TeleLearning's authoring package. TeleLearning codes and digitizes lessons and graphics for each instructor. A student buys a software package and a simple modem from TeleLearning, and enrolls in

the course on line. The software package includes an operating system and a front end for communications, to reduce the sign-on procedure and protocols to a keystroke.

Colleges can offer courses for credit to students who otherwise could not enroll because of time, work, distance, or financial constraints, or physical disability. Textbooks and course disks can be distributed through department stores and computer specialty centers, further extending the university's reach. The course costs are usually less than similar traditional courses.

Students and instructors introduce themselves to each other at the beginning of the course. An instructor typically spends twenty minutes per lesson with each student's work and can individualize questions and problems to fit the student's interests. Students and instructors find the system convenient and flexible—they can complete the work wherever and whenever convenient.

TeleLearning uses the Tymnet, Telenet, and Uninet public packet-switching networks, switching automatically from one to the other in case of network problems. A communications-analysis system monitors all functions and handles routing and error corrections. By compressing data and batching complete files, the system cuts communications costs to a minimum. The TeleLearning system runs on the IBM PC, Apple II series, and Commodore 64.

SAM-86

STATISTICAL ANALYSIS

FOR MICROS

APPLE, IBM PC, COMMODORE
+ any micro using –
MSDOS, CP/M, CP/M 86

DATA INPUT –
ASCII or DBASE II files
Visicalc/Supercalc
Alpha Numeric
Frequency Tables
Correlation Matrices

**REGRESSION AND
MULTIVARIATE –**
Multiple and Stepwise
Regression Factor,
Discriminant and
Cluster Analysis.

SAM

**DATA MANAGEMENT
AND TABULATION –**
Editing, Transformations,
Standardization, Ranking,
Lagging, Cross Tabulation
and Non-Parametric
Statistics.

STATISTICAL ANALYSIS –
Descriptive statistics,
Histograms, Scatter Plot
Correlations, t and F Tests,
Anova (10 factors) etc.

- ☆ *The world's best, most advanced and easiest to use statistical analysis package – now available in the U.S.*
- ☆ *Used by most British Universities, Government Departments, large Corporations – Oxford and London Universities, UK Treasury, Ministry of Defense, BP and British American Tobacco etc.*
- ☆ *Special to BYTE readers – \$295 cash with order.*
- ☆ *International Software, Telephone England 07073 26633 (24 hours).*

P.O. Box 160, Welwyn Garden City, Hertfordshire, AL8 6TQ, England.

floppy disk drives

TANDON TM 100-2 FULLY IBM PC COMPATIBLE **\$209**
CALL FOR QUANTITY PRICING

1/2 HT. DISK DRIVES TOP NAMES **\$179**
SOUTH'S LARGEST SUPPLY • DEALER INQUIRIES INVITED . . .

networking/protocol conversion

PCnetPlus, PC Turbo BY ORCHID
ORCHID TECH'S NEW COMPLETE PRODUCT LINE
"STILL A BEAUTY"
IRMA REPLACES 3278's WITH PC's /IRMALINE
SRITEK 88000 Co-Processor with RM/COS
Converts PC to COBOL-oriented, Multi-user system
BLUE LYNX 5251/3276 EMULATOR
PCterminal LOW-COST Terminal W/Built-in LAN & Processors
• Serial and Parallel Ports • Four Extra Open Slots

SNA & BISYNC • 3780, 5251, 3274

hard disks

Peachtree Peripherals **P-10** Industry's Best Buy • 10 Meg/F. Auto Boot • Runs W/Out Ext. Power Internal or External Installation

printers



AMDEK AMPLLOT II Supports LOTUS 1-2-3 Graphics **\$799**
Houst. Inst. Plotters & Digitizer CALL!

DOT MATRIX

EPSON FX 80 & 100 (160 cps) Best Price!
EPSON RX 80 & 100 Best Price!
EPSON LQ 1500 NEW! Letter Quality in a Dot Matrix Best Price!
Mannesman Tally Spirit 80 **\$289**
ProWriter/MicroPrism 80 **\$275**
Prism Color IBM's Choice for LESS, 132 Col (200 cps) Color Graphics **\$1495**
OKIDATA 92&93 Opt IBM Proms 160 cps Best Price!
OKIDATA ML84 200 cps Best Price!
OKIDATA 2410 Pacemark (350 cps) Best Price!
TOSHIBA P-1351 & 1340 Best Price!
GEMINI 10X & 15X **\$285/\$425**
T.I. 855 24 WIRE PIN HEAD Best Price!
NEC P2 & P3 180 cps Best Price!
DIABLO P38 (400 CPS) Best Price!

LETTER QUALITY

NEC SPINWRITERS 2050, 3550 & 7730 Best Price!
DIABLO 620, 630, 630 ECS Best Price!
C-ITOH Starwriter (40 cps) Printmaster (55 cps) **\$1055/\$1455**
QUME SPRINT 11/40 PLUS SPRINT 11/55 PLUS Best Price!
BROTHER HR15 & HR25 **\$499/\$695**
LQ Feeders Great Cut Sheet Feeders for NEC 3550 & C-ITOH Starwriter **SAVE!**

micro modems

HAYES SMARTMODEM 300, 1200 & 1200B Starting at **\$205**
Ventel 1200 BAUD W/Crosstalk Internal Modem for IBM Portable CALL!
HAYES MicroModem IIe W/SmartCom CALL!
Access 1-2-3 Novation's PC 1200B, Crosstalk XVI, Cables plus "Great Bug" • Full 2 Year Warranty CALL!
RIXON 1200-4800 BAUD • IBM PC Compatible CALL!
Signalman Mark XII 300-1200 Direct Connect Quality at a Low, Low Price **\$259**

SYSGEN 10 & 20 MEG/F W/Streamer Tape CALL!
IOMEGA Bernoulli Box • 10 MEG Removable Cartridges • Double Drive **\$2695**
DAVONG 10 MEG/F (IBM) 15, 21, 35 Available • Ext. **\$1595**
SYSGEN IMAGE Streamer Tape Back Up For Your IBM XT CALL!

ALL NAME BRANDS AVAILABLE NOW! BEST PRICES!! IF YOU DON'T SEE IT— CALL!

multi-cards



#1-384K 64-384K • Clock Ser & Par Pts Ram Disk • Spooler • Opt Game Pt Best Price!
#1 MultiCard Max: 8 Func (64-512K) W/opt. Game Pt. Best Price!
#1 I/O Card Ser. Clk. Spooler Ram Disk (Opt. 2nd Ser. Par & Game) Best Price!
QUADBOARD New Version 64-384K **\$279/\$549**
CAPTAIN 64-384K **\$269**
SEATTLE RAM + 3 0-256K • Ser • Par Flash Disk • Clk • Spooler **\$199**
J-RAM II 512K Multifunction CALL!
PROFIT Systems 64-512K RAM Plus & Elite **\$299/\$680**
BABY BLUE II 64-256K • 280B • Par • 2 Ser • Clk RAM disk • Spooler • Extra Software Best Price!
PC Blossom ORCHID'S 6-Pak Clone with Optional PCnet Piggy Back Starting At **\$275**
MAYNARD SANDSTAR Floppy & Hard Disk Controller Cards Best Price!

graphic cards

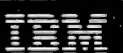

HERCULES Monochrome Graphics Supports LOTUS 1-2-3 **\$329**
PLANTRONICS Color+ Biplaner, Super HiRes With Color Magic CALL!
Graphics Master Tecmar Color & Mono Graphics Supporting Lotus Low Price!
QUADCOLOR I & II CALL!
Paradise Sys. Color Graphics/Monochrome Parallel Printer Port **\$379**
STB Graphix Plus Color & Mono Graphics • Par Port RAM Disk • Spooler • Lite Pen Port • Opt. Clk/Cal CALL!
Multigraph 132 Col in Mono W/Graphics 720h x 350v Color Graphics to 640h x 400v • Opt. Par. Port **\$375**

Grappler Parallel Interface CALL!
Quadram eRAM80 80 Col 64K RAM Card CALL!
Microtek Apple Dumping & Parallel Interface CALL!
Premium Softcard IIe CALL!

Apple and the Apple logo are registered trademarks of Apple Computer, Inc. IBM and the IBM logo are registered trademarks of International Business Machines Corporation. Advertised cash prices subject to change without notice.



software

Infoscope New Data Base!! Critically Acclaimed! . . . **CALL!**

- OPEN ACCESS** Spreadsheet, 3-D Graphics, Word Proc., Time Mgr., & Comm. in 1 Pkg. . . . **\$379**
- JACK 2** IBM Integrated Word Processing Spread Sheet, Data Base Management Chart on One Screen . . . **\$325**
- Decision Manager** All New Integrated Software by Peachtree . . . **CALL!**
- KEY II 1-2-3** Outstanding Utility for LOTUS Unlocks Information Management . . . **\$159**
- MultiPlan** IBM Microsoft's Super Spreadsheet At A Low, Low Price . . . **CALL!**
- SuperCalc** IBM World's most usable spreadsheet now has Superior Graphics than LOTUS . . . **\$239**
- Lattic C-Compiler** IBM Version 2.0 Supports One Meg RAM on PC . . . **\$299**
- MICROSOFT COMPILERS** IBM . . . **CALL!**
- DIGITAL RESEARCH COMPILERS** . . . **CALL!**
- Norton Utilities** A Must for Every IBM PC . . . **\$59**
- ProKey 3.0** IBM Adds Muscle to Your Keyboard by RoseSoft . . . **\$95**
- CROSTALK XVI** IBM No. 1 Communications Software from MICROSTUF . . . **CALL!**
- SMARTCOM II** IBM Communications Software from Hayes, The No. 1 Modem Manufacturer . . . **\$99**
- FINANCIER II** IBM Personal Series "Count All Your Eggs, Even If They Are Not In One Basket" . . . **\$119**
- Dow Jones** IBM Mkt. Analyzer/Mkt. Manager Call for Price on Mkt. Microscope . . . **\$249/\$219**
- IUS** IBM A.R., A.P., G.L., Inventory, Order Entry, Payroll . . . Starting at **\$299**
- Peachtree Accounting** IBM Peachtree Software . . . **CALL!**
- Open Systems** IBM A.R., A.P., G.L., Payroll, Job Cost Inventory, Order Processing . . . **CALL!**
- Multilink** IBM Multi User, Multi Tasking Package Supports Up to 8 Dumb Terminals off IBM PC . . . **\$249**
- Sideways** IBM Utility that Inverts Printout for Longer Spreadsheets . . . **\$49**
- ATI Training** IBM Critics Choice! Software Tutorials . . . **\$59**
- BPS Business Graphics** IBM SMC. . . Low Price!
- Chart-Master/Sign-Master** IBM . . . **CALL!**
- "CAD Systems"** IBM Best Selection Available of Computer Aided Design Graphics . . . **CALL!**
- PC Paint Brush** IBM Amazing Mouse Drive Graphics W/Screen Dump Utility . . . **\$109**

- HARVARD PROJECT MANAGER** IBM NEW CALL!
R:base 4000 or 6000 Report Writer & Clout Microrim Starts at **\$329**
- Power-base** IBM GMS Systems • Combination of Relational & Hierarchical Data Models . . . **CALL!**
- Knowledge Man** IBM Ver. 1.06 Now Available for this Highly Acclaimed Data Base . . . **\$295**
- dBasell** IBM Best Selling Data Base from Ashton Tate **\$389**
- DayFlo** Super New Data Base **CALL!**
- PFS** IBM Write, File, Report, Graph, Solutions, Access **\$99**
- MultiMate** IBM 3.2 "WANG" Style Word Processor With Spelling Checker **\$279**
- Microsoft Word** IBM W/Mouse • Fourth Generation Word Processor • Use Up to 8 Windows . . . **CALL!**
- VOLKSWRITER DELUXE** IBM **\$189**
- WordStar ProPak** IBM Now W/FREE Tutor! CorrectStar, MailMerge, **CALL!**
- WORDPLUS-PC** IBM With the "BOSS" Integrated, Spell, Check Plus MailMerge . . . **CALL!**
- WordPerfect** IBM SSI • Available Now by Popular Demand **\$299**
- Easy Writer II** IBM System Includes Speller & Mailer **\$219**
- Peach Text 5000** IBM **\$199**
- FRIDAY!** Ashton Tate **\$195**
- QUICKCODE/dGraph/dUtil** IBM **CALL!**
- Copyll PC** IBM **\$35**

- Habadex** IBM New Style Data Base for Macintosh **CALL!**
- Microsoft Chart** IBM Graphics For Macintosh . . . **CALL!**
- Microsoft File** IBM New for Macintosh **CALL!**
- Microsoft Basic** IBM New for Macintosh **CALL!**

IBM & Apple miscellaneous

- Keytronics 5151** IBM New Improved **CALL!**
- MOUSE** Optical Type LOTUS & VisiOn Compatible By Mouse Systems **\$209**
- CURTIS** Monitor Pedestal Keyboard Extension Cable, Monitor Extension Cable . . . **CALL!**
- MICROFAZER** (BK-128K) Stack Spooler Starting at **\$139**
- BACK UP Power Supply** 200 & 425 Watts . . . **CALL!**
- 7 Year Diskettes** OSDD Only • 2 Box Min. (20 Diskettes) \$59 plus \$2 shipping. . . **CALL!**
- ISOBAR** Surge Protectors • With Great Filtering Via Isolated Outlet Pairing • 4 & 8 Plug Starting At **\$59**

IBM chips

- INTEL 8087** High Speed Math Coprocessor **CALL!**
 - 64K RAMCHIPS** **\$55/\$159**
- (64K-9 Chip/Upgrade Kit) (192K-27 Chip/Upgrade Kit)
CALL FOR QUOTE ON QUANTITY CHIP PURCHASES

IBM & Apple monitors

- PGS-MAX 12** Amber • Runs off IBM Mono Card • 720h x 350v **Best Price**
 - PGS SR-12** 690x480 • Non-Interlaced Mode RGB W/HiRes Text. **Best Price**
 - PGS-HX 12** Hi Res 690 Dot RGB **Best Price**
 - QUADCHROME** Hi Res RGB **Best Price**
 - AMDEK Color II+** **\$39**
 - AMDEK Color IV** 720 Dot **\$579**
 - AMDEK 300A/300G** IBM 12" **\$149/\$139**
 - AMDEK 310A** Amber 12" Improved Alternate to IBM Green Screen **\$185**
- Micro Mart is a registered trademark of Micro Mart Inc.

ORDERS ONLY
1-800-241-8149
Monday Friday 9 00 AM 7 00 PM Saturday 9 00 AM 5 00 PM

MICROMART™
TECHNOLOGY CORPORATE CAMPUS
3159 Campus Drive • Norcross, GA 30071

For Information 1-404-449-8089
Technical Support 1-404-446-3836
Telex 880497

The Micromint Collection

Micromint. Supporting the varied projects that appear in Steve Ciarcia's monthly article in *BYTE Magazine*, "Ciarcia's Circuit Cellar." Offering a wide range of computers and peripherals designed to meet the exacting demands of the hobbyist as well as worldwide corporate clients.

TERM-MITE ST SMART TERMINAL BOARD

As featured in *Ciarcia's Circuit Cellar* *BYTE Magazine*, January & February 1984
All you need to build a Smart Video Terminal equivalent to the types advertised for \$1,000.00 or more is a Term-Mite ST circuit board, scanned or parallel keyboard, video monitor and power supply.

- Uses brand new Nat'l Semi NS455A Terminal Processor.
- 24 lines by 80 characters, 25th reverse-video status.
- Upper & lowercase. Line (block) graphics.
- Selectable data rate, parity & display options.
- Reverse video, half intensity, double height & width, underlined, blinking and/or blank character.
- Separate sync or composite video output. Self Test Term-Mite ST Video Display Terminal Board BCC22 Assembled & Tested \$204.
- BCC23 Complete Kit 244.

Z8 BASIC SYSTEM CONTROLLER NEW!!!

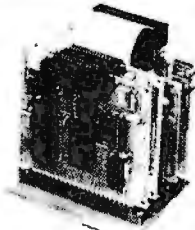

As featured in *Ciarcia's Circuit Cellar*, *BYTE Magazine*, July & August 1981
The Z8 Basic System Controller is an updated version of our popular BCC01. The price has been reduced and features added. The entire computer is 4" by 4 1/2" and includes a tiny BASIC interpreter, up to 6K bytes of RAM and EPROM, one RS-232C serial port with switchable baud rates and two parallel ports. BASIC or machine language programming is accomplished simply by connecting a CRT terminal. Programs can be transferred to 2732 EPROMs with an optional EPROM programmer for auto start applications. Additional Z8 peripheral boards include memory expansion, serial and parallel I/O, real time clock, an A/D Converter and an EPROM programmer.

- Uses Zilog Z8 single chip microprocessor.
- Data and address buses available for 124K memory.
- Can be battery operated.
- Cross assemblers for various computers.

BCC11 Assembled & Tested \$149.
New Low Price

COMING SOON! FORTH LANGUAGE VERSION OF THE Z8

With the new Z8 with on board 4K FORTH you can program high speed control functions in a few simple high level language commands. Perfect for data reduction, process control and high speed control applications.

BCC20 Z8 FORTH Microprocessor chip \$150.
BCC21 Z8 FORTH System Controller
(This board is a BCC11 with a BCC20 installed) 280.
Assembled & Tested

MICRO D-CAM DIGITAL TV CAMERA

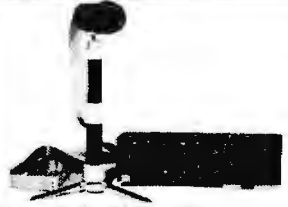

As featured in *Ciarcia's Circuit Cellar* *BYTE Magazine*, September & October 1983
GIVE YOUR COMPUTER THE DIMENSION OF SIGHT

- Interprets, enhances and stores images
- 256 x 128 digital image sensor
- Plug-in boards for the IBM-PC, APPLE II+ or e.
- Software includes utilities for auto exposure, multi-level greyscale, screen dump and image enhancement.
- Includes interface card, 4 foot extension cable, camera assembly, manual, and software on diskette

DC01 IBM PC Assembled & Tested \$299.
DC02 IBM PC Complete Kit 264.
DC03 APPLE II Assembled & Tested 299.
DC04 APPLE II Complete Kit 264.

MPX-16 MICROCOMPUTER IBM PC COMPATIBLE



As featured on the cover of *BYTE Magazine*. Also featured in *Ciarcia's Circuit Cellar* November, December 1982 & January 1983
The Computer With A Split Personality.
—Use it as an IBM PC look alike that directly boots PC DOS 1.1 and accepts all expansion boards designed for the IBM PC.

—Use it as a powerful 8088 single board computer for all your OEM applications. Just add serial terminal, disk drive and power supply. Directly boots CP/M-85.

Buy the MPX-16 in the form that best meets your needs or budget. As a bare board, as a wave soldered board that contains all components less ICs, as an assembled and tested circuit board or as a complete system.

- Directly boots PC DOS 1.1 and CP/M-85.
- Most IBM PC software executes with no modifications.
- IBM PC bus compatible + 9 expansion slots.
- Intel 8088 16-bit microprocessor.
- Optional Intel 8087 math coprocessor.
- 256K bytes on board memory.
- Up to one megabyte of system memory.
- Up to 64K bytes of system ROM/EPROM.
- 2 RS-232C Serial & 3 Parallel I/O ports.
- Disk controller for 5 1/4" or 8" drives.
- Sixteen levels of vectored interrupts.

MPX-16 Circuit Board Assembled w/64K RAM \$1,200.
OEM 100 quantity price 900.
MPX-16 Circuit Board Assembled w/256K RAM 1,400.
MPX-16 Semi-Kit (wave soldered circuit board w/all components) Less ICs 595.
Complete Kit of ICs w/256K RAM 595.
MPX-16 Unpopulated (bare) PC Board 300.
CP/M-85 Operating System + Manuals 80.
MPX-16 Switching Power Supply 300.
MPX-16 Technical Reference Manual 50.
MPX-16 Metal Enclosure with Fan 300.
Tandon TM 100-2 Double Sided/Density Drive 300.
IBM PC Keyboard Interface Adapter 100.

Shipping & handling additional on all MPX-16 orders.

IBM PC is a trademark of International Business Machines Inc.
CP/M-85 is a trademark of Digital Research Inc.
Z8 is a trademark of Zilog Inc.

Circle 218 on inquiry card.

Z8 MEMORY, I/O EXPANSION, CASSETTE INTERFACE

- 8K bytes of additional RAM or EPROM.
- Three additional 8 bit parallel ports.
- Cassette interface—300 baud K.C. Standard.
- Software real time clock.

BCC03 w/4K RAM Assembled & Tested \$150.
BCC04 w/8K RAM Assembled & Tested 180.

Z8 EPROM PROGRAMMER

- Transfer BASIC or Assembly Language application programs from RAM to 2716 or 2732 EPROM
- Comes with programming & utility routines on EPROM.
- Requires BCC03 Z8 Expansion Board for operation.

BCC07 Assembled & Tested \$145.

Z8 ANALOG TO DIGITAL CONVERTER

- Uses Analog Devices 7581 IC, 8-channel 8-bit.
- Adds process control capability to the Z8 system.
- Over 1,000 conversions per channel per second.
- Monitors 8 analog signals in one of two 10v ranges.

BCC13 Assembled & Tested \$140.

Z8 SERIAL EXPANSION BOARD

- Adds additional RS-232C and opto-isolated 20 ma. current loop serial port to the Z8 System.
- Runs at 75 to 19,200 baud in all protocols.
- Comes with listings of sample serial I/O routines.

BCC08 Assembled & Tested \$160.

Z8 16K MEMORY EXPANSION BOARD

- Add up to 16K of additional memory, RAM or EPROM, to your Z8 System Controller in any multiple.
- Accepts 2016, 6116, 2716, or 2732 memory types.
- Four 16K cards may be installed on the Z8 System bringing the total memory to 64K.

BCC14 Assembled & Tested w/8K RAM \$120.
BCC16 Assembled & Tested w/16K RAM 155.

Z8 CROSS ASSEMBLERS

From *Micro Resources*
IBM PC, APPLE, 6502 Systems 5V4;
CP/M 2.2 8" \$ 75.

From *Allen Ashley*
TRS-80 Model I, III, Northstar 5V4" 75.
CP/M 2.2 8" 150.

Z8 FIVE SLOT MOTHER BOARD

- Expand your Z8 BASIC System with minimum effort.
- Contains five slots complete w/44 pin connectors.

MBO2 Assembled & Tested \$69.

TRIPLE VOLTAGE POWER SUPPLIES

+5V @ 300 ma. +/- 12V @ 25 ma.
UPS01 Assembled & Tested \$35.
UPS02 Complete Kit 27.
+5V @ 1 Amp. +12V @ .5 Amp. -12V @ 50 ma.
UPS03 Assembled & Tested 60.
UPS04 Complete Kit 50.

SPEECH SYNTHESIZERS

MICROVOX TEXT-TO-SPEECH SYNTHESIZER



As featured in *Ciarcia's Circuit Cellar* *BYTE Magazine* September, October 1982.
Microvox is a second generation professional voice quality text-to-speech synthesizer that is easily interlaced to any computer, modem, RS-232C serial or parallel output device and provides speech of unbelievable clarity.

- Unlimited vocabulary
- 64 programmable inflection levels.
- 6K text-to-speech algorithm.
- Full ASCII character set recognition and echo.
- RS232C and parallel output
- 1000 character buffer, 3000 optional.
- Adjustable baud rates (75-9600).
- Spelling output mode.
- 7 octave music and sound effects.
- On board audio amplifier & power supply.
- X-On-X-Off handshaking.

MV01 Assembled with 1K buffer \$299.
MV02 Complete Kit with 1K buffer 219.
Add \$15.00 for 3K buffer option.

VOTRAX SC-01A PHONETIC SPEECH SYNTHESIZER IC

The SC-01A Speech Synthesizer is a completely self-contained solid state device that phonetically synthesizes continuous speech of unlimited vocabulary. Used in our Microvox and Sweet-Talker.

SC01A Quantity 1-99 \$44. ea.
100 + 32. ea.
1000 + 24. ea.

300 BAUD ANSWER/ ORIGINATE MODEM KIT

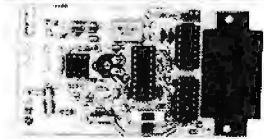

As featured in *Ciarcia's Circuit Cellar* *BYTE Magazine*, March 1983
Micromint's latest 300 Baud Modem Kit is crystal controlled, uses the TI TMS99532 IC, contains just 25 parts and requires no calibration or adjustments. Use with acoustic coupler or in direct connect mode.

MD04 Complete Kit as shown \$60.
MD05 Transformer for Direct Connect Mode .. 9.
AC01 Acoustic Coupler Kit 20.

E-Z COLOR GRAPHIC INTERFACE WITH SPRITES

APPLE II E-Z Color plug-in board with Graphics Editor on 3.3 disk
EZ01 Assembled & Tested \$150.
EZ02 Complete Kit 125.

APPLE II E-Z Color Plus
• Allows the use of a single monitor or TV set
EZ11 Assembled & Tested w/Graphics Editor \$200.

KRELL LOGO for E-Z Color and E-Z Color Plus Supports Sprite Graphics.
EZ21 Krell LOGO w/full documentation \$89.

Animation Software for E-Z Color Plus
• Draw with Sprites using Joystick or Koala Pad.
• Animate Sprites from your own BASIC program.
EZ21 Animation Software \$49.

\$100 E-Z Color Graphics Board
• With sound generator & joystick interface
• MBASIC Graphics Editor on 8" diskette.
EZ04 Assembled & Tested \$289.

MICROMINT INC. 561 Willow Avenue,
Cedarhurst, NY 11516
To Order: Call Toll Free 1-800-645-3479
For Information Call: 1-516-374-6793
Call: Monday-Friday, 9-5 PM



DESIGNING A SIMULATED LABORATORY

BY NILS PETERSON

*An example from
cardiovascular physiology*

THE DYNAMICS OF a medical laboratory spring to life with the aid of micro-computer simulation. Computer-simulated laboratories are increasingly valuable as teaching aids; without them, most medical students could only read about important discoveries. Laboratories are becoming too expensive and their maintenance too difficult to be practical. In today's fast-paced medical curriculum, it is hard for students to perform experiments that are a hundred years old but are still crucial to contemporary medical understanding. This creates a fundamental problem because the dynamics of a laboratory are an important supplement to the static explanations in textbooks. Simulated laboratories in the health sciences also serve to alleviate, in part, the need for experimental animals—an important ethical consideration. The laboratory must not be lost from medical training.

Photo 1 shows the simulation of an experiment first performed at the turn of the century. The experiment remains central to our understanding and treatment of heart disease. The computer provides an ideal environment for teaching the intellectual concepts of

cardiac function while omitting those things that make a real laboratory prohibitive as a teaching environment (the long hours of open-heart surgery, the animal-care facilities, the expensive modern apparatus).

The lack of laboratory training is a problem not unique to medicine. It affects all disciplines in which theory and technology have advanced rapidly. A simulated laboratory can fill the gaps in a student's understanding by providing concrete demonstrations in the manner of a real laboratory, but without the expense and without making demands on the student's already precious time. Today, a 16-bit microcomputer with high-resolution graphics and a numeric co-processor offers an enhancement that further increases the utility of laboratory simulation. This article is intended to show what we have done to take advantage of the microcomputer's growing prowess as a teaching aid.

.....
Nils Peterson is a knowledge interface designer for Learning Tools (NE 1050 Alfred Lane, Pullman, WA 99163) and a researcher in computer-based instruction at Washington State University.

DESIGN CONSIDERATIONS

The design of an educational program requires some fundamental decisions long before any code is written. Our first choice was to use simulation programs as the instructional vehicle. These differ greatly from drill and practice programs. In drill and practice, the computer attempts to program the student with certain facts. The student is a passive learner. Simulations, however, are active learning environments. They provide a world for the learner to explore (see reference 1). In addition to facts, simulations teach the skills of the explorer: scientific method, debugging, and hierarchically organized thinking.

Simulations come in several forms, and our second design choice involved deciding what type of simulation to use. One type is based on empirical observations and rules. This is the approach of many artificial-intelligence simulations (for example, expert medical diagnosis). Adventure games are also simulations based on empirical rules, except that the rules reside solely in the imagination of the program author.

Simulations also may be based on ap-
(text continued on page 288)

(text continued from page 287)

proximate equations. For example, an architect can design a small building that can withstand earthquakes by taking into account the maximum force that might push on each wall. Many earlier cardiovascular simulations used algebraic relationships to approximate the average behavior of the heart and arteries (see reference 2). These programs were forced to use approximate models because of the limited computational power of 8-bit microprocessors.

In the designing of a teaching simulation, the fundamental problem that constrains model complexity is the time required to update the system's outputs. To be lively and hold interest, the model must respond to parameter changes in 5 to 10 seconds. A 16-bit computer with a numeric coprocessor can do real-number arithmetic several hundred times faster than an 8-bit machine. This means that the model may be much more complex and still respond equally well.

The final type of simulation, and the one we chose, is based on dynamic causal principles. Large buildings and bridges must be designed using detailed descriptions of their oscillatory

properties because their internal swaying motions are important to their structural integrity. For systems with a significant dynamic character, this type of model provides the most detailed description. The simulation in our Isolated Heart Laboratory program is based on equations that relate instantaneous pressure and volume events in both the heart and the arteries (see reference 3).

SELECTING THE HARDWARE

Several issues are important in selecting hardware for a simulated laboratory. Machine power, both graphic and numeric, is paramount. We felt we needed memory-mapped graphics to make our animation ideas work (see the text box on the next page). Experience with other cardiovascular models on research minicomputers showed us that we would need to perform 5000 to 50,000 floating-point operations per second. The Intel 8087 is sufficient. Finally, the computer has to be a model that's widely distributed; other medical schools already own, or would be willing to buy, a popular machine. Distribution is important, we felt, because our ideas are useful to many medical programs.

At the time of our hardware decision,

the IBM Personal Computer (PC) was the only machine that satisfied all our demands. As with any choice, there were tradeoffs, but the IBM PC has proven quite adequate for the task. For example, many people might argue that the 8088's narrow bus and slow clock (5 MHz) are disadvantages, but no 68000-based machine was available that had both memory-mapped graphics and potential to be as popular as the IBM machine. In our numerically intensive application, we have found that the PC has a large numerical throughput and the capability to animate graphics quickly and smoothly without video-display flicker. In fact, its processor power enabled us to develop most of the code in UCSD Pascal. In the future, this will simplify transporting the program to a new architecture when one becomes available.

DESIGNING THE SOFTWARE

In a simulated laboratory, the computer must be transparent. Our experience shows that medical students and operating systems don't mix. The solution is to make the program auto-booting and uncrashable, which frees the student to focus on the course material and not on the computer.

In terms of presentation, current interactive video games provide a visual standard against which students judge educational programs. Further, electronic spreadsheets and other highly refined interactive programs raise expectations about user interfaces. Animations in science-fiction movies depict elaborate computer simulations that create the impression that this technology can reproduce and display complex events in near-real time. Designers of instructional programs must learn from these examples to grab and hold the student's attention. These standards motivated us to improve instructional computing along two paths: user interface and graphics. We found that the most natural way to explain a model is with a drawing. Specifically, we drew pictures of the laboratory environment where the discoveries that led to the model were made. The most intuitive way to show and control the settings of the apparatus is by animating the drawing. The heart model illustrated on these pages uses as its interface an

(text continued on page 290)

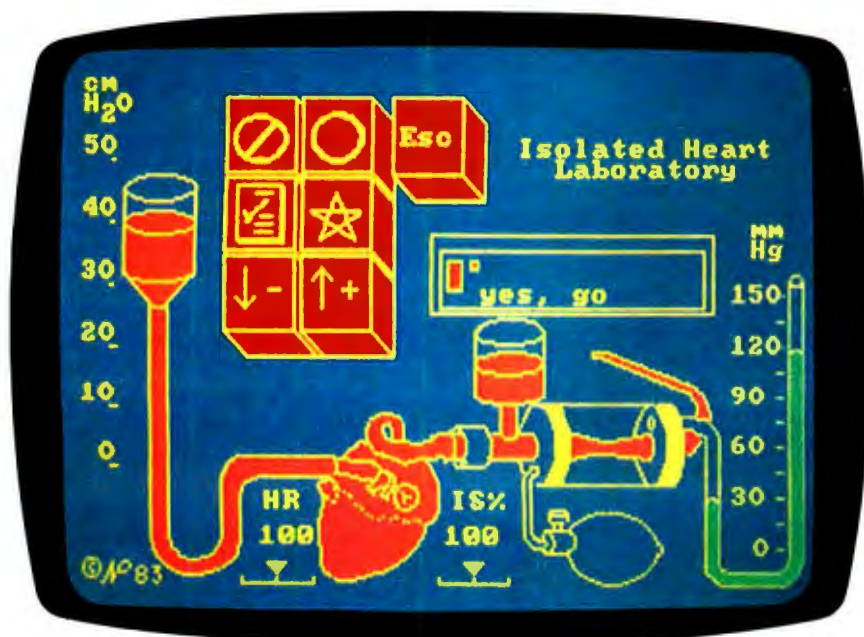

Photo 1: A simulated early laboratory for studying cardiac mechanics. The student may control the animated apparatus to change the conditions and perform experiments on the heart. Only seven keys are required to control the program, including all numeric inputs.

Graphics Displays and Animation

Graphics are commonly handled on microcomputers in one of two ways. An intelligent terminal may be used to receive high-level graphics commands, then plot and store the image in its private memory space. Alternatively, the main processor may have access to all the video memory and be responsible for drawing and modifying the figure. The penalty of this approach is the burden on the central processing unit. It must do all the low-level graphics operations. The advantage is greater flexibility in manipulating the graphics.

Some memory-mapped video displays use a small set of graphic shapes to build pictures. These shapes often are treated like characters and manipulated by PRINT statements. Usually they are assigned to the upper 128 values of the character set, above the standard ASCII (American National Standard Code for Information Interchange) sequence. The Pac-Man screen is an example of what is possible with this technique. The advantage is that it does not consume much memory, usually 2K bytes, and the graphic

figure may be quickly manipulated in BASIC. The disadvantage is that the simple shapes are too limited to represent a laboratory well.

The IBM Personal Computer (PC) uses a bit-mapped display in which each pair of bits in one section of memory is translated into a single color dot. Each dot may be one of four colors. This technique consumes 16K bytes of memory in the PC but yields figures of higher resolution. Drawing on the display is done by altering the appropriate bits in the video memory. It may be done in BASIC with PEEK and POKE statements, but this process is slow. We code drawing primitives in assembly language for maximum speed.

Several different drawings are stored on disk and may be recalled by the program for different experiments. To move a full screen image, the disk reads 32 blocks of 512 bytes, and the program transfers them to the video-display memory (see figure 1 in this text box). An 8088 assembly-language instruction, the repeated string move, makes this very simple. The string move copies a byte in memory from the source index (SI) to the destination index (DI). If the instruction is prefixed with the REP instruction, the CX register is used as a counter. After each move, the source and destination are incremented and the CX is decremented. As a result, a string of CX bytes long is moved from source to destination. To transfer a picture from disk to video, all you need to do is read blocks from the disk to a memory buffer and then use the string move to copy 512 bytes to the appropriate part of video memory.

The chart recorder in photo 2 is animated to move left as new data is written on its right-hand edge. To accomplish this, we have to move the "paper" to the left. The same string move is used, but this time both addresses are in video memory (see figure 2). We use shorter moves, one from the middle of each video line. It is critical to note that the designers of the video control chip organize the video data in memory differently than what is projected on the screen: all even screen rows (0 through 198) are placed together in memory, with the odd rows placed above them. This layout is slightly more awkward for programming, but conceptually it is no different.

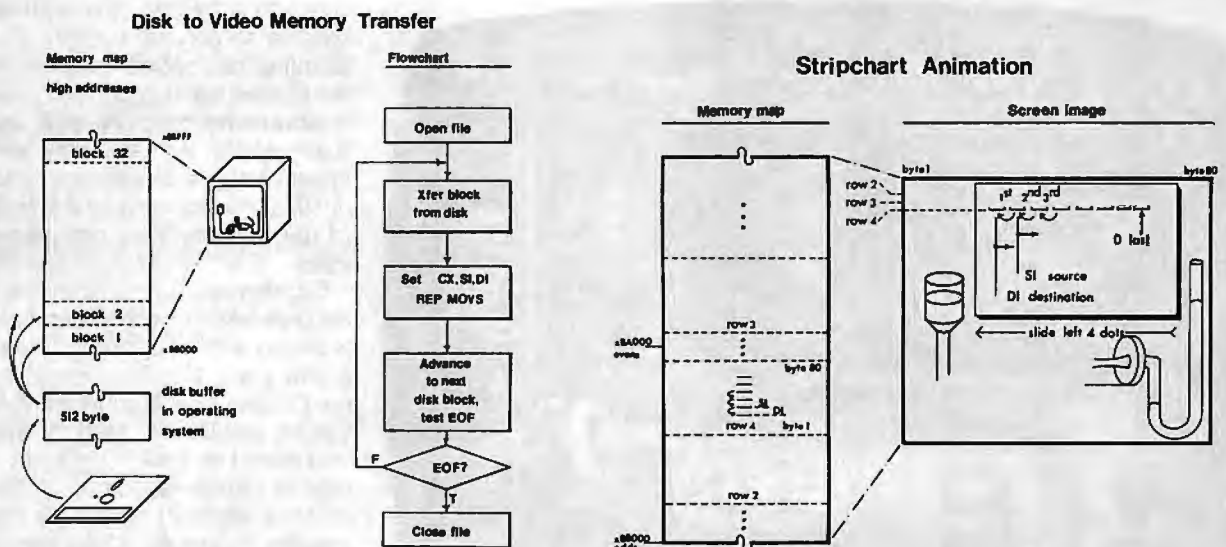

Figure 1: String moves facilitate transferring images from a disk buffer to video memory. The 8088 registers CX (counter), SI (DS) (source), and DI (ES) (destination) are involved. Whole images move in a fraction of a second from RAM or hard disk; floppy-disk drives are slower.

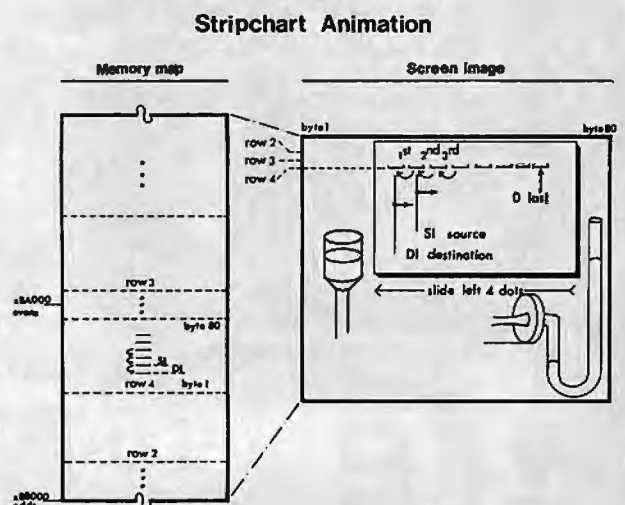

Figure 2: The chart paper is animated by overlapping string moves within video memory. Each byte is moved one position to the left; its neighbor to the right then occupies the old position. The last byte must be zeroed separately to blank the old data at that position.

(text continued from page 288)

animated drawing of an experiment patterned after the famous work of Patter-son and Starling in 1914.

Cardiovascular simulations have been developed for teaching purposes before, but they have not included both the research laboratory and the heart in the simulation. This was our third major design decision.

The technological intensification of medicine has placed a strain on the usefulness of student laboratories. The concepts taught in the laboratory are increasingly more involved, requiring students to perform more elaborate laboratory exercises. The modern experimental laboratory is difficult to use in teaching because it requires that the student have high technical skills and because the apparatus is expensive.

Nevertheless, the laboratory approach to teaching has not been abandoned for several good reasons. It provides experiences that textbooks and lectures are incapable of capturing. Specifically, the laboratory learning environment provides a sense of realism and immediacy; shows dynamic events as they occur; includes scientific methodology as part of everyday problem solving; allows for errors, correc-

tions, and rethinking; and, in contrast to lectures, is self-paced and flexible. We considered these features of the laboratory when we decided to design a new computer simulation.

KEYBOARD INPUTS

Mice and touchscreens notwithstanding, the primary input device for some time to come will be the keyboard. This raises a problem: keyboards are devices with 96 wrong buttons for every correct one. Many students are not comfortable with computers, nor are they good typists. The combination can make the computer learning experience intimidating. To eliminate the intimidating factors, we decided to use as few keys as possible, put all the keys together to eliminate hunting around the keyboard, make the program monitor the keyboard continuously for keypresses, and provide an immediate visual response to each keystroke.

Photo 1 shows the keyboard we use in the Isolated Heart Laboratory. We developed seven generic functions to provide all possible program control. We assigned each key a core meaning that can be applied usefully in every setting. The meanings are thus general enough that we can also use them in

future programs. This feature makes a student's knowledge of the interface transportable between different programmed laboratories.

We got the idea for the graphic symbols and core meanings from the Japanese *kanji*, or pictographic characters. The basic function of the *kanji* characters is to express meaning or concept, not sound or pronunciation. Arabic numerals also use this type of symbolic writing. The symbol 5 means the same quantity, no matter whether it is pronounced *five*, *cinco*, or *funf*. *Kanji* is slightly different in that each character may have a variety of meanings around a core concept. The exact meaning is inferred from context. The advantage of conceptual icons for our purpose is that the core concepts we need have many English words that, if spelled out, may seem contradictory or confusing. Graphic symbols are also more compact on the screen. Consider the circle-slash key. The symbol comes from international traffic signs, and its meaning on our keyboard is similar: no, stop (going), don't select that one, stop (pausing). At any point in the program, the key functions around its core meaning of "no:"

We thought it important to restrict the keyboard to seven keys. Five to seven concepts is the maximum a person can keep in short-term memory. To make learning the controls easier, it helps if the student can hold all the commands in short-term memory and compare their effects. As familiarity with the system grows, each person develops individual vocalizations of the meanings of the keys and their complementary roles.

Each key has several functions, which are dependent on context, and each key is paired with its opposite. The keys in photo 1 are: No, Stop/ Yes, Go; Enter (or Escape) Checklist/ Move, Advance Cursor; and Down, Less/ Up, More. We also added an Escape key in the upper right as a quick way to pop up one level in the program hierarchy. We built the program to have two menu levels, which the students operate by pointing with the star and pressing the Yes, Go key. The outer level offers general types of displays and experiments; the inner level offers specific laboratory activities.

(text continued on page 292)

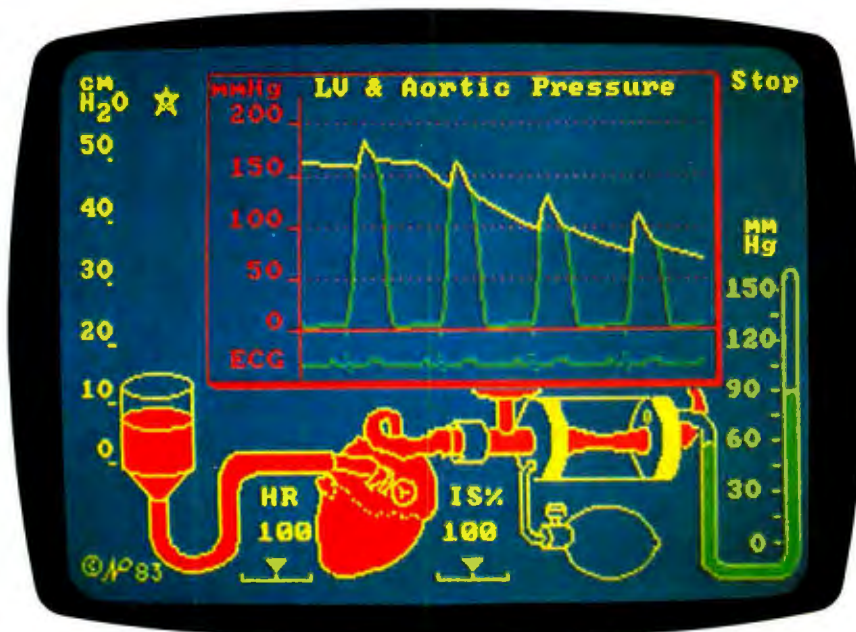

Photo 2: An animated strip-chart display, showing pressures in the heart and arteries. The electronic "paper" slides left, and new data is displayed as fast as it is recorded from the experiment. The star cursor is set to control the reservoir.

SoftCard squeezes the most juice out of your Apple.



Microsoft® Premium SoftCard IIe is the high-performance CP/M® board that really juices the Apple® IIe.

Hard facts on SoftCard.

It has a high speed (6MHz) Z-80 that runs CP/M up to three times faster than lesser boards. Plus 64K memory and 80-column display that fits the IIe auxiliary slot and acts like Apple's own Extended 80-column Card. So it works with CP/M, Apple DOS and ProDOS programs, too.

Microsoft BASIC is built-in, so it's compatible with more Apple CP/M software than any other board on the market: Thousands of the juiciest business programs including dBase II®, WordStar® and sophisticated Microsoft languages like

FORTRAN-80, COBOL and BASIC Compiler.

It also has a new low price.

Juicing up the performance of computers is nothing new for us. We invented the SoftCard and make versions for the entire Apple family. We wrote Applesoft for the Apple II.

MICROSOFT In fact, our The High Performance Software BASIC is the language spoken by nine out of ten microcomputers worldwide.

Get the Apple juicer from Washington. Call 800-426-9400 (in Washington State call 206-828-8088) for the name of your nearest Microsoft dealer.

Microsoft is a registered trademark of Microsoft Corporation. Apple is a registered trademark of Apple Computer, Inc. IBM is a registered trademark of International Business Machines Corporation. dBASE II is a registered trademark of Ashton-Tate. WordStar is a registered trademark of MicroPro. CP/M is a registered trademark of Digital Research, Inc.



(text continued from page 290)

THE ROLE OF GRAPHICS

The Isolated Heart Laboratory centers around a single graphic image. From left to right, in photos 1, 2, and 3, its components are: a filling reservoir, the heart, a surge capacitor, a variable hydraulic resistor, and a mercury manometer to measure the compression pressure around the resistor. We chose to measure pressure with a mercury manometer instead of a pressure gauge to emphasize the physical aspects of the laboratory apparatus. Two readings from the simulated meterstick must be subtracted to get the pressure reading. The heart rate (HR) and heart strength, or inotropic state (IS%), have no simple physical representation and are shown as scales with pointers. They, along with the manometer and the reservoir for filling, are animated and controlled by the student.

To be faithful to the early cardiac laboratories, we used a canine heart for the picture and model parameters. The dog has historically been used because it is a good model of the human circulatory system. Blood pressures in dogs are the same as in humans. The flows and volumes are proportionally less because of the size differences between the species.

As an interface-design tool, the laboratory concept is crucial. A focus on animated physical objects in the laboratory makes numeric inputs both simple and natural. Rather than have the student type new numeric parameter settings, the program lets the student manipulate the laboratory apparatus to realize the desired input results (as can be seen by comparing the settings of the reservoir on the left in photos 2 and 3). There are several benefits to this approach:

- it eliminates typographical errors such as using a small *l* for the digit *1*
- the screen graphically and immediately conveys the range of possible inputs and the student's relative change
- moving the apparatus heightens the student's physical intuition about the laboratory experience

Photo 2 shows a strip-chart data display. This is the raw data format as it would appear during a real experiment. Simulated chart paper slides from right to left across the window, and new data is recorded on the fresh right edge. This display does not run in real physiologic time, but it is lively, requiring less than 10 seconds for a complete beat to appear. The 8087 coprocessor chip makes this feat possible. Also, note the star in the upper left of the display, above the filling reservoir. This is a graphic cursor. Its position indicates which variable is currently controlled by the Down and Up function keys.

Having the laboratory always visible, despite the complexity of fitting in the data displays, is an important design consideration. It provides a visual landmark and a constant reminder of each student-controlled parameter setting. When a printer is attached, the student can make hard-copy "snapshots" of the screen in order to have a complete record of all experimental conditions.

A laboratory's visual presence adds

(text continued on page 294)

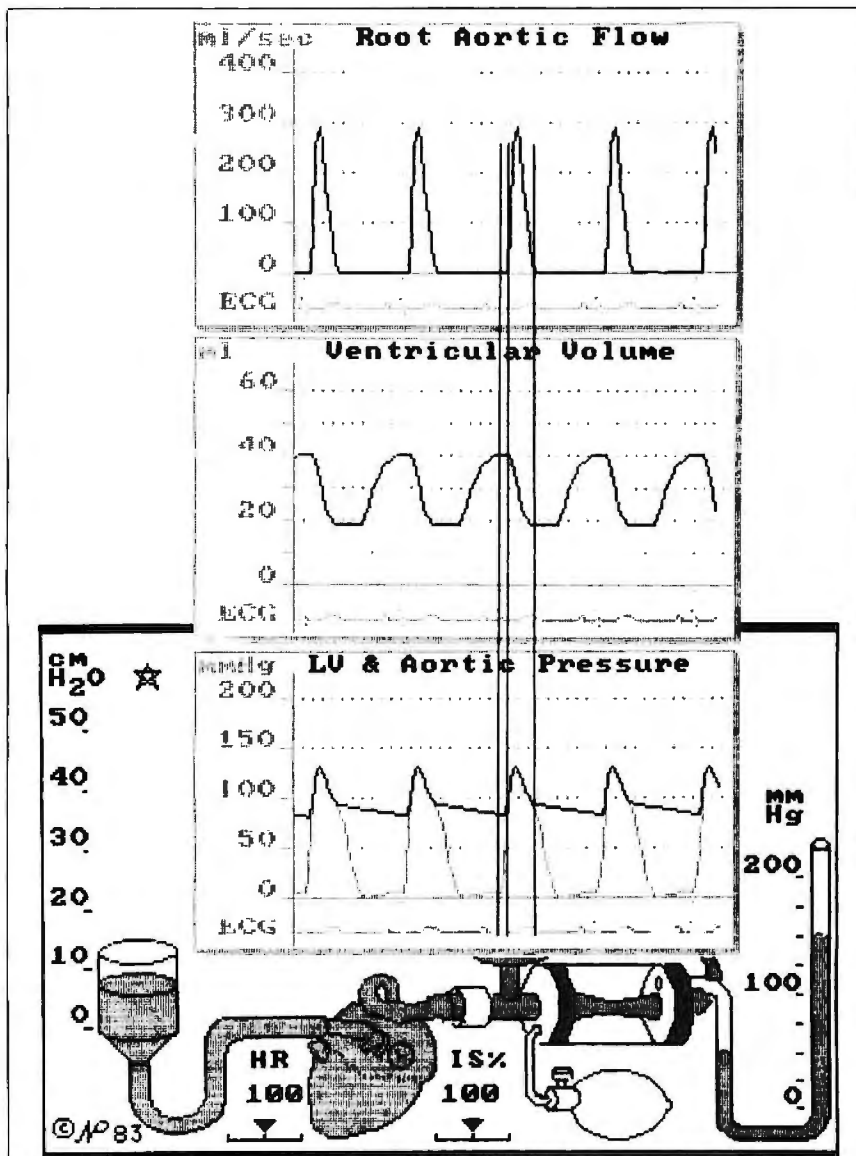

Figure 3: A typical textbook illustration showing cardiac-cycle events for four types of data: volume in the heart, flow leaving the heart, pressure in the heart, and pressure in the arteries. The ECG (electrocardiogram) in each graph provides a common timing reference. The student can create this figure for many possible states of exercise or disease.

Blazing BASIC.

Who said BASIC had to be slow?

Microsoft® BASIC Compiler lets you create MS™-DOS programs that are so fast users will never know they were written in BASIC.

The compiler produces fast, efficient native code. The result? Three to ten times faster operation than the same interpreted program. Even faster for programs that make maximum use of integers.

But it's not only fast in execution, it's fast for development. It's **MICROSOFT** the one BASIC compiler designed to work best with our BASIC interpreter — the de facto industry standard. Together, they let you develop and debug your programs interactively using the interpreter, then compile for speed.

And like all Microsoft languages, the standard linking

interface makes it easy to combine assembly language subroutines.

Microsoft BASIC Compiler is just one reason Microsoft is your best source for high performance languages for 8088/86 based micros.

Call 800-426-9400 to order the blazing BASIC compiler. \$395*

In Washington State, call 206-828-8088. Ask for operator A6, who will rush you your order, send you more information, or give you the name of your nearest dealer to see Microsoft BASIC in action.



(text continued from page 292)

to the multidimensionality of this educational tool. Many people, from

children to co-workers, have played with the program during its development. It is surprising and pleasing to see how

often they point to an illustrative picture while explaining an idea or result. In a real laboratory, it would not be possible to examine closely the data and the laboratory at the same time, to say nothing of stopping an experiment in order to discuss events. This is yet another advantage of the simulated laboratory as a teaching device.

The student may observe flow and volume using the same format employed to study pressure. Figure 3 demonstrates a classic textbook illustration that shows all the events in the cardiac cycle. It is a collage of printer output from pressure, flow, and volume records. The student may experiment freely with the heart and strip-chart display, setting the four parameters to achieve over 6000 operating conditions. Some of these conditions would kill a real experimental animal, but they obviously don't hurt the computer, and they can be very instructive.

Dynamic and lively output graphics are a tool for holding interest and focusing attention on an important feature. Photo 3 illustrates another classic textbook figure that we recreated in the laboratory. In this example, we aligned all pressure beats to begin at the same time. All the displays of time-varying data are animated as smoothly continuous functions. This graphic technique visually conveys a real-life quality of measuring data, even though the display runs at less than the real speeds. Although the simulation program creates figures that closely resemble those in cardiology texts, watching the animation during transients as the figure develops adds an instructional dimension that a book cannot reproduce.

BEYOND THE TEXTBOOK

In addition to reproducing textbook displays and experiments, simulation has other uses. Specifically, it can be used to create graphic displays of textbook figures that students find hard to grasp. One such example is the pressure-volume display in photo 4.

The pressure-volume loop is a modern tool for assessing the health of the heart. Students are comfortable with the strip chart but often are confused by the loop display in which the trace is circular. Photo 4 shows the laboratory set up to explain the pres-

(text continued on page 296)

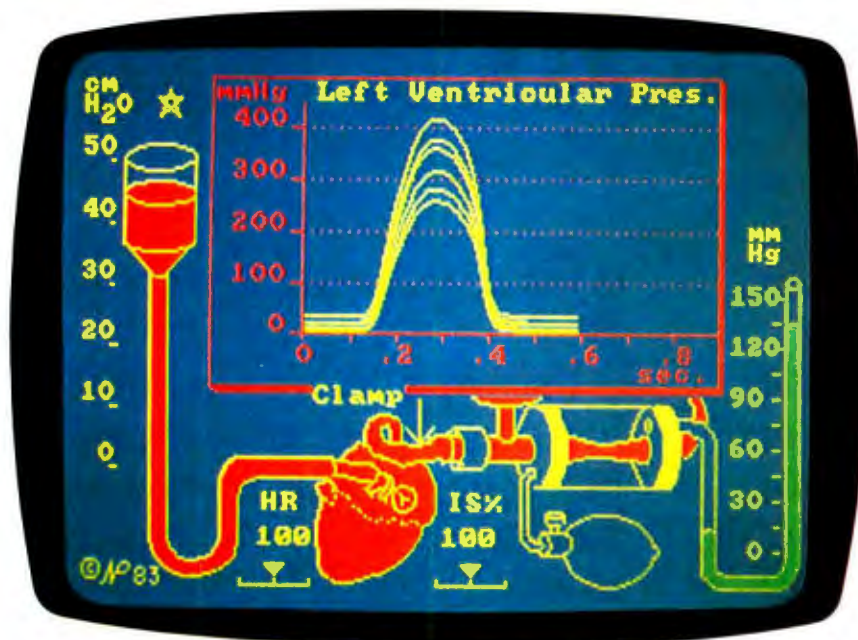

Photo 3: A classic textbook figure showing the pressure response of the heart to changes in filling pressure. All beats are aligned to start at the same time. This experiment was first performed by Otto Frank in 1896. Note the clamp to prevent any flow from the heart.

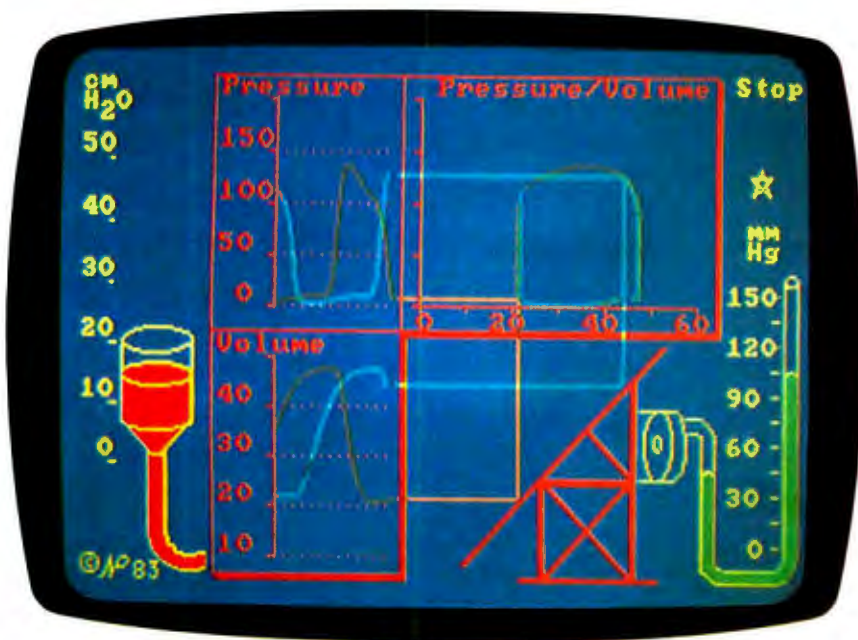

Photo 4: A pressure-volume loop tutor. Instantaneous pressure and volume in the heart (graphs on left) are plotted together to make a standard diagnostic tool (loop figure on the right). Yellow lines transfer the information from the familiar graphs to the new one. A mirror is used in the volume transfer to "reflect" the data onto a horizontal axis.

Raging C.

Concise structure and fast execution make C the ideal language for applications and system-level programming.

And compared with other MS-DOS C compilers, Microsoft® C consistently produces the fastest executable code.

It supports the full C language and includes an extensive library of subroutines that implement most UNIX™ compatible functions.

Small, medium, compact, and large memory models give you flexibility in selecting the addressing requirements of your software. Programs can be designed to make **MICROSOFT** effective use of the available memory of your computer, up to one megabyte.

Microsoft C Compiler provides you with a complete development system including the compiler, run time library, linker and library manager, and full support of

MS-DOS 2.0 directory structure (pathnames) and I/O redirection.

How do programmers feel about Microsoft C?

"In the top category for its quick compile and execution time, small incremental code, best documentation, and consistent reliability."**

—Ralph Phraner, *BYTE Magazine*

"Best for software development."

—Bill Hunt, *PC Tech Journal*

"Produces good, tight-running programs."

—Peter Norton, *Softalk*

Call 800-426-9400 to order the raging C. \$500*

In Washington State, call 206-828-8088. Ask for operator A6, who will rush you your order, send you more information, or give you the name of your nearest dealer to see Microsoft C in action.



*Price exclusive of handling and Washington State sales tax
Microsoft is a registered trademark and MS is a trademark of Microsoft Corporation.
UNIX is a trademark of Bell Laboratories.

**Reprinted with permission, *BYTE Magazine*, August '83.

(text continued from page 294)

sure-volume relationship. This display would never be available in a real laboratory because data processing is required concurrently with the experiment.

Three data windows appear in the display. In the upper left is the pressure strip chart from photo 2. It is sliding and showing instantaneous pressures in the heart. Below it is the volume strip chart, which shows the simultaneous volume data. To the right is a developing pressure-volume loop. In graphing the loop, pressure data is plotted on the vertical axis against volume data on the horizontal axis. The laboratory demonstrates this relationship by shooting a horizontal yellow line from the pressure strip chart rightward onto the loop graph. We call these data transfers "laser blasts." At the same time, volume is shot as a horizontal blast to the right. This bounces off a mirror in order to be correctly oriented for the horizontal volume axis. The two laser blasts intersect, and a new segment of the pressure-volume loop is drawn to the intersection.

We froze this figure at the point where the valve has just opened to let blood leave the heart. Note that volume in the heart has started to decrease. Photo 5

The student may watch the display loop continuously or single-step the display with the Stop and Go keys. This freeze action would never be possible with a real animal in a real laboratory.

shows the situation a few moments later. At this point, the heart has quit ejecting blood and is relaxing to fill again. Volume is at its lowest point and pressure is falling rapidly.

The student may watch this display loop continuously. It is also possible to single-step the display with the Stop and Go keys. This freeze action would, of course, never be possible with a real animal in a real laboratory. It represents the power of a simulated laboratory for medical education. The student can analyze each phase of the cardiac cycle. Two laboratory parameters may also be altered, enabling the student to examine the roles of filling pressure and hydraulic loading. Finally, when the student has mastered the pressure-volume concept, he may return to a smaller display window and the full set of variables.

We have found that problem-solving simulation can change some veterinary

students' understanding of the cardiovascular system, from one narrowly based on anatomical relations to one that also includes a component of dynamic interaction (see reference 4). Students have reported that, in addition to the changes that were measured in their mental models, they have enjoyed the computer experience, felt that they have learned from it, and would like more computer materials in the curriculum.

CONCLUSION

We designed a simulated cardiovascular laboratory for medical education. Certainly other medical laboratories can be simulated with microcomputers, and students can move from one to another easily and efficiently. The general idea of laboratory simulation, moreover, can be applied to learning situations ranging from fluid pumping in an oil refinery to the complex relationships of predator and prey in an ecosystem. Simulated laboratories teach the facts of the subject area and also provide intellectual tools and insights for true professional growth. ■

REFERENCES

1. Papert, Seymour. *Mindstorms: Children, Computers, and Powerful Ideas*. New York: Basic Books, 1980.
2. Randall, J. E. *The Use of Microcomputers for Physiological Simulation*. Reading, MA: Addison-Wesley, 1980.
3. Peterson, N., and K. B. Campbell. "Simulated Laboratory for Teaching Cardiac Mechanics." *The Physiology Teacher*, forthcoming.
4. Hopkins, R. H., K. B. Campbell, and N. Peterson. "Conceptualization of Cardiovascular Variables by Veterinary Students." Presented at a meeting of the Psychonomic Society, San Diego, CA, 1983.

ACKNOWLEDGMENT

I would like to thank Dr. Kenneth B. Campbell of the Department of Veterinary and Comparative Anatomy, Pharmacology, and Physiology, Washington State University. His cardiovascular expertise and criticism made the realism of this laboratory possible.

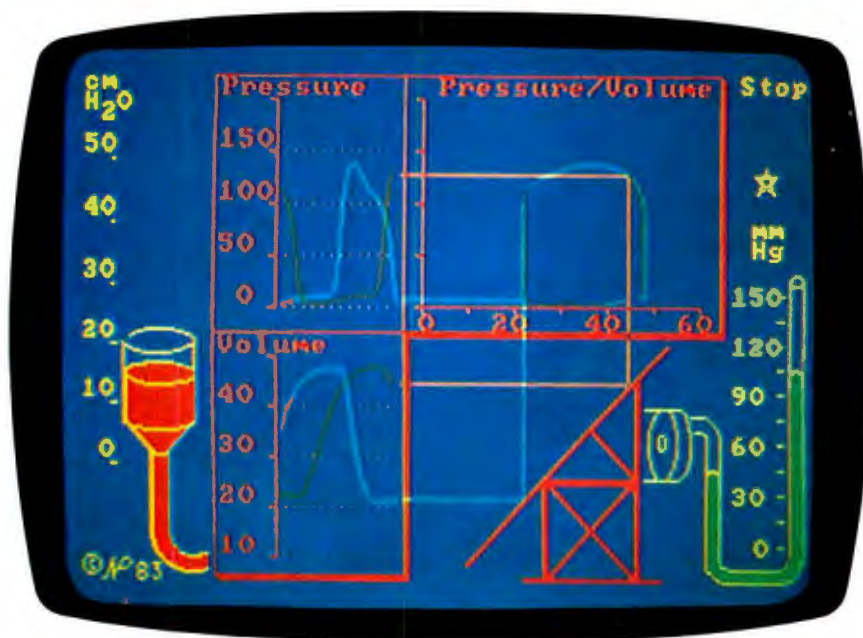

Photo 5: The loop tutor from photo 4 a few moments later. Compare it with photo 4 to see the fall in pressure and volume after the heart emptied and relaxed.

Just when all computer games have started to seem the same, here's a thrilling new twist – software matched up with an exciting boardgame!

Every step on the big colorful gameboard, and the action-packed, on-screen adventures that result, depends on your skill and luck – and your opponents! *Chivalry*™ confronts you with challenges demanding the skills of a master gamesplayer as you battle thieves, witches, and trolls in 20 arcade-style games. 1 to 4 players.

Developed by Optimum Resource, Inc. Designed by Richard Hefter and Janie and Steve Worthington.

For the Apple® computer.

Look for *Chivalry* in finer computer stores everywhere. Or order by calling toll free 1-800-852-5000, Dept. AE-25. Only \$49.95. Price includes disk, poster, gameboard, playing pieces, storage case and instructions.

Chivalry is a registered trademark of Optimum Resource, Inc. Apple is a registered trademark of Apple Computer, Inc. A/M44AE25

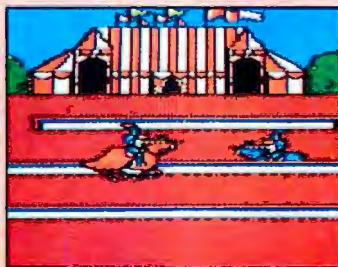

**Weekly Reader
Family Software**

A division of Xerox Education Publications
Middletown, CT 06457
Circle 363 on inquiry card.

Chivalry™ is alive!

DayFlo announces
a major revision
of the fundamental
law of computing.



Garbage in, garbage out.

Since computers were invented, the conventional wisdom has held that input that doesn't conform to the computer's highly structured needs will result in unintelligible output.

Which meant that you had to learn to think like a computer in order to use one.

Trouble is, the world isn't organized to suit computers. Data is never collected in the way you want to retrieve it. That's why traditional, rigidly structured databases often wind up hindering your work more than they help.

DayFlo offers a new approach to database management needs. It's a Fluid Format™ Personal Information Manager. Which means it approaches the world the same way you do: taking in unorganized data and organizing it into meaningful information.

DayFlo is a powerful tool for your IBM® PC XT. It accepts both structured and unstructured data. When you want to extract information, just type in the key words you're looking for. Instantly, DayFlo organizes the data according to your criteria. And reorganizes it according to new criteria whenever you wish.

Information from other programs, spreadsheets, word processing or accounting files, virtually any data in the system can be assimilated by DayFlo. And once the information is at hand, DayFlo lets you manipulate it at will to produce letters, memos, reports and much more. You can work at your computer the same way you work at your desk, even switching quickly from task to task, without ever losing your place.

DayFlo's concept is as simple as it is revolutionary. You no longer have to think for the computer. Instead, it can help you think better for yourself. Which leads, inevitably, to a brand-new version of computing's fundamental law.

DAYFLO
Software™

Garbage in. Information out.

DayFlo, Inc., 2500 Michelson Dr., Bldg. 400, Irvine, CA 92715. Call Now: (800) 7DAYFLO (Outside CA), (800) CDAYFLO (CA Only)
DayFlo and Fluid Format are trademarks of DayFlo, Inc. © 1984 DayFlo, Inc.

Ivan Chermayeff

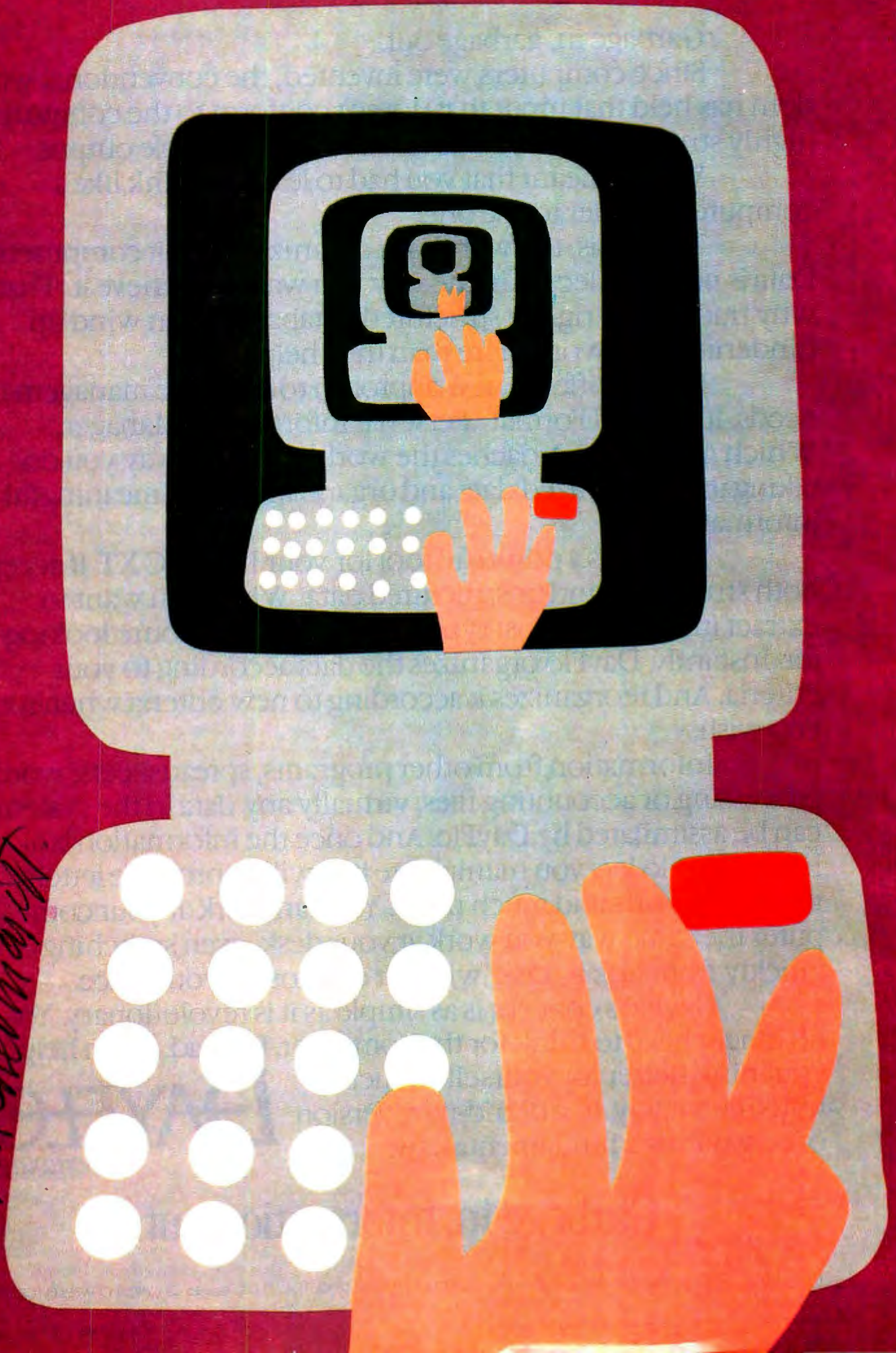

Reviews

ANOTHER LOOK AT CP/M-80 C COMPILERS <i>by Christopher Kern</i>	303
ARCHON <i>by Gregg Williams</i>	321
THE CHAMELEON PLUS <i>by Rich Krajewski</i>	327
THE TEXAS INSTRUMENTS SPEECH COMMAND SYSTEM <i>by Mark Haas</i>	341
VOLITION SYSTEMS' MODULA-2 <i>by Eric Eldred</i>	353
INFOSCOPE <i>by George Bond</i>	367
REVIEW FEEDBACK	374

REVIEWER'S NOTEBOOK

IF THE IBM PC WERE A MOVIE, the PCjr probably would be its spin-off TV situation comedy. And while some movie-based TV sitcoms (such as M*A*S*H) are very successful, others fall flat on their faces. The reason they fail is usually that too much of the original was lost.

As for the PCjr, we're not sure how it will fare. Almost all of the PC's features have been adulterated, but a few new ones have been thrown in to appeal to the home audience.

The chief deficiency of the PCjr is, of course, its keyboard. Worse than even the PC's keyboard, this should set a new standard for intentional product handicapping. The PCjr's second major deficiency is the way user memory has been usurped by video memory. Its 128K bytes of memory are not all available for user programs—32K bytes are used by the video display. The PCjr, thus, in IBM PC standards, is really a 96K-byte machine. And one more thing, whereas the Apple II is nice and quiet in your living room, the PCjr sounds like a small vacuum cleaner.

The PCjr does have some good features: its software is fairly good, broad ranging, and inexpensive. It has better graphics than the PC. The unit itself is also fairly inexpensive (by PC standards). And it has a fair degree of compatibility with its older sibling.

Need a good CP/M machine with a hard disk? You've probably already taken a brief look at the Morrow MD-11 with its 10-megabyte hard disk. Although they've raised the price to \$2950, it still seems a bargain. The Morrow package includes New Word, supposedly comparable to WordStar. Look for a review of both the Morrow MD-11 and New Word in the next few months.

About every other day we get a request for a review of one of the Columbia PC-compatibles. Please note that we have been wanting to review the Columbia MPC portable for about nine months now—if only Columbia would loan us one for a short time. Fortunately, one of our reviewers bought an MPC and a review is finally in the works. From what I hear, the machine runs very well.

Apple Mouse II and Mouse Paint for the Apple II arrived recently and should give owners of that machine a chance to try some of the things they've seen on Macintosh. Mouse Paint appears to have about 75 percent of MacPaint's capabilities with no sacrifice in speed.

The reviews in this issue start with Christopher Kern's continuing examination of C compilers for CP/M. In this article, he looks at C compilers from SuperSoft, Q/C, and Whitesmiths and compares them with Cs previously reviewed.

After a few hours thrashing about with a compiler, you may welcome some diversion. Senior Technical Editor Gregg Williams tells you what to expect from Archon, a game that combines the strategic elements of chess with the demands on dexterity made by arcade games.

For many of us, nothing is quite so diverting as a new personal computer. Technical Editor Rich Krajewski spent three months playing with the Chameleon Plus and gives his considered opinions of this IBM PC-compatible. Note BYTE's new benchmarks and format for system reviews.

We all have moments when we feel like telling a computer off. The TI Speech Command System for the TI Professional Computer may be able to listen. Mark Haas spoke to the TI Professional and reports on the results.

Eric Eldred compares Volition's Modula-2 for the Apple II to Pascal for the same machine. If you want to try Niklaus Wirth's latest language before reading our coming August Modula-2 issue, Volition's version could be for you.

George Bond, BYTE's Managing Editor for User News, used Microstuf's new data-management program for the IBM PC, Infoscope, and gives it high marks for many applications. The RAM-based system runs fast and exploits color well.

—Rich Malloy, Product-Review Editor

One good idea



deserves another



and another



and

another.



At IBM, we've been working to help your business keep up with its computer needs.

That's why we developed our innovative line of IBM Personal Computer Furniture. You'll find work stations, tables and chairs that are custom-designed to accommodate Personal Computers, as well as the people who use them.

And best of all, you'll find IBM's PC Furniture available in a variety of prices designed to accommodate your budget.

The IBM Synergetix® PC Work Station (pictured in pearl white) provides a convenient and compact workspace for the Personal Computer. In addition, it's completely mobile, so you can move it from office to office. But most important, the entire unit closes and locks, so you can secure and protect your system.

The IBM PC Table (pictured in walnut) is a stationary unit that's economically priced. It has the same durable construction as our PC Work Station, along with some basic security features. What's more, it's also perfect for the IBM PCjr.

The IBM PC Chair boasts a price tag you don't have to sit down for. This ergonomically engineered seating comes equipped with fingertip adjustments and features a contoured backrest for greater comfort and support.

You'll find our IBM PC Furniture in a variety of attractive colors at your IBM Product Center. The IBM PC Work Station is also available at participating retailers. To find out the location nearest you or to order by phone, call IBM Direct toll free at 1 800 IBM-2468, ext. 104.

IBM Personal Computer Furniture. It's designed with you and your PC in mind.





Another Look at CP/M-80 C Compilers

A
proliferation
of products
makes a
choice more
and more
difficult

CHRISTOPHER KERN

This article uses various benchmark programs, Sieve, Fibonacci, Copy, and Sort, to compare three new CP/M-80 C compilers—Q/C version 3.0, SuperSoft version 1.2.3., and Whitesmiths version 2.2—with three C compilers evaluated previously—Aztec version 1.05G, BDS version 1.5a, and C/80 version 2.0 (see "Five C Compilers for CP/M-80," by Christopher Kern, August 1983 BYTE, page 110). All are designed for 8080, 8085, and Z80 computers running under the CP/M-80 operating system.

When I first compared CP/M-80 C compilers last year, I did not find one that was clearly superior in both compilation speed and object-code quality. Since then, three new products—a significant update to Whitesmiths and two compilers that I did not cover, SuperSoft and Q/C—have made it even more difficult to choose the "best" 8080-family C compiler.

WHAT'S NEW

At the time of my original tests, the Whitesmiths compiler came with an idiosyncratic "standard" function library; now it has a library that really is standard. This update makes a crucial difference because C uses standard library functions to perform all input and output. It means that the Whitesmiths compiler is now compatible with the one available on Bell Laboratories' UNIX operating system—C's native habitat—and with the language definition published in the standard reference on C, *The C Programming Language*, by Brian W. Kernighan and Dennis M. Ritchie.

My latest tests also include SuperSoft C, distributed by SuperSoft Inc. of Champaign, Illinois, and Q/C C, distributed by The Code Works of Santa Barbara, California. The SuperSoft product is a fairly complete implementation of the language and performs well on the benchmark programs. The Q/C compiler was recently reviewed in BYTE ("Two More Versions of C for CP/M," by David D. Clark, May, page 246). I am including it here to provide a more comprehensive comparison.

THE BENCHMARK PROGRAMS

I base my evaluation on four benchmark programs that are short enough to type in

manually and simple enough to use with all the compilers (with minor modifications in a few instances).

Execution times for the Sieve, Fibonacci, and Copy programs are presented graphically on the "At a Glance" page for easy comparison among the various C compilers.

The prototype programs conform to the language definition in the Kernighan and Ritchie book—essentially the same syntax accepted by the current UNIX C compilers. The programs test a number of factors affecting the overall performance of a compiler on an 8-bit system with floppy-disk mass storage.

Sieve.C is the now familiar prime-number generator based on the Sieve of Eratosthenes algorithm. Generating prime numbers sounds like an exercise in number crunching; actually, it's not. As the source code in listing 1 shows, the Sieve program does not perform much difficult arithmetic. However, it does involve juggling a number of variables. The program is essentially a test of variable access.

You can place external variables, such as the flags array in listing 1, in absolute locations in memory and access them fairly easily. This is not true with automatic variables, which the program creates dynamically as it executes.

The program creates automatic variables when it enters a function and discards them when it exits that function. They are known only to the function in which they are declared. Automatic variables challenge the 8080-family compilers because these 8-bit central processors have only a few internal registers and limited addressing modes.

The benchmark programs also test the overhead associated with a function call. C programs typically contain a large number of functions. (Other programming languages refer to some of these as procedures; C doesn't distinguish between those subroutines that return a value and those that do not.)

It is important to determine how efficiently each compiler generates the code necessary

continued on page 304

.....
Christopher Kern (201 I St. NW, Apt. 839, Washington, DC 20024) is a journalist and a frequent contributor to BYTE.

continued from page 303

to enter and leave a function because any given program is likely to contain many functions and use some of them over and over again. The benchmark Fib.C (see listing 2) is designed to test each compiler's efficiency by computing a Fibonacci number recursively—an exercise involving only one local variable and little processing other than the function call. The Fibonacci function, $F(x)$, is defined as:

```
F(x) = 1
for x <= 2
  F(x) = F(x - 1) + F(x - 2)
for x > 2
```

The next benchmark program, Copy.C (see listing 3), tests file access. File input and output in C normally is performed by "buffered" I/O (input/output) functions from the standard library. These functions permit you to read or write a disk file one byte at a time. The Copy program simply copies its input directly to output with no intermediate processing.

Sort.C tests the string-handling ability of each compiler. It sorts a list of words alphabetically using a quicksort algorithm. Sort is a bit longer than the other benchmarks, as listing 4 illustrates, but is still a reasonable length to copy manually if you want to try these programs yourself.

String handling is a potential problem because C deals with strings somewhat differently than most programming languages. Strings in C are not distinct data types; they are just character arrays delimited by a *null*, or zero, byte. You access them through pointers—variables containing memory addresses. The standard library includes a number of primitive string functions that permit efficient string copying, string comparison, and length determination.

METHODOLOGY

I compared the compilers under conditions that were as similar as possible. First, I made a batch of identical disks containing the benchmark programs and some test data. Then, to test each product, I copied the programs and files necessary to perform the compilations onto one of the disks.

The test data for the Copy program

was a text file of 1000 lines, 80 columns each. The Sort program alphabetized a file composed of the first 1000 words of one of my previous BYTE articles, listed one word to a line in sequential order. I used Microshell, a UNIX-like command interpreter that permits input redirection to read the file prior to sorting (see "Microshell and Unica: Unix-Style Enhancements for CP/M" by Christopher Kern, December 1982 BYTE, page 206). This equalized the time required to get the file into memory with the different products.

In an attempt to minimize observational error, both the test compilations and the execution of the compiled benchmark programs were automated. A D.C. Hayes Chronograph (a clock that you can read as a serial device) measured the intervals. The benchmark programs were timed under Microshell so the commands to read the clock and execute the program could be put on the same line. I used CP/M's standard batch utility, SUBMIT, to perform the compilations because not all the compilers would operate under Microshell.

While these procedures guaranteed consistency, they also introduced some additional errors. Both Microshell and SUBMIT exact some overhead, and it takes some time to read the serial clock at 1200 bps (bits per second). The total error for the execution measurements was less than 1 second under Microshell. The overhead was greater for the compilation measurements—which involved more individual programs and were performed with the considerably slower SUBMIT utility—about 1 second for each program executed in a given command stream. There was no instance where the timing errors significantly altered the comparative ratings. The only practical effect of the timing procedure was to understate the BDS compiler's speed. The BDS product compiled the benchmark programs so much faster than its competitors that an error of a second or two was significant.

All the tests were performed on a CompuPro computer system with a Z80 microprocessor running at 6 MHz and one memory-request wait state. The

continued on page 307

Listing 1: The prototype Sieve program.

```
#include <stdio.h>

#define NTIMES      10      /* number of times to run sieve */
#define SIZE       8190    /* size of number array */

#define FALSE      0
#define TRUE       1

char  flag[SIZE + 1];

main()          /* compute primes using Sieve of Eratosthenes */
{
    int  i, j, k, count, prime;

    printf("%d iterations: ", NTIMES);

    for (i = 1; i <= NTIMES; i++) {
        count = 0;
        for (j = 0; j <= SIZE; j++)
            flag[j] = TRUE;
        for (j = 0; j <= SIZE; j++) {
            if (flag[j] == TRUE) {
                prime = j + j + 3;
                for (k = j + prime; k <= SIZE; k += prime)
                    flag[k] = FALSE; /* discard multiples */
                count++;
            }
        }
    }

    printf("%d primes.\n", count);
    exit(0);
}
```

AT A GLANCE

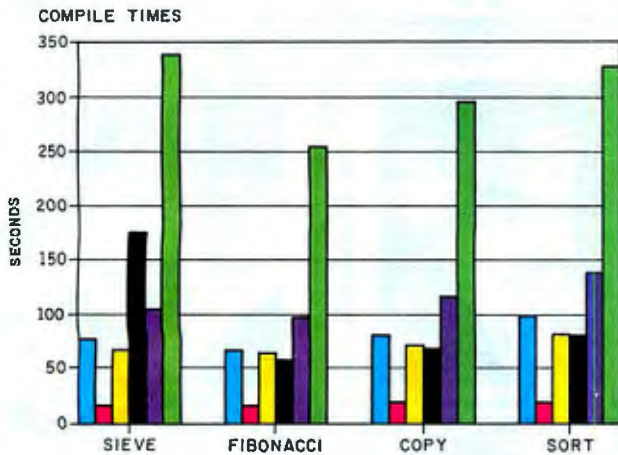
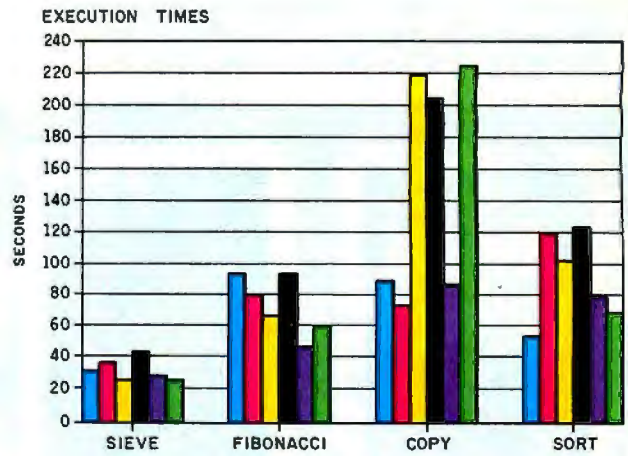
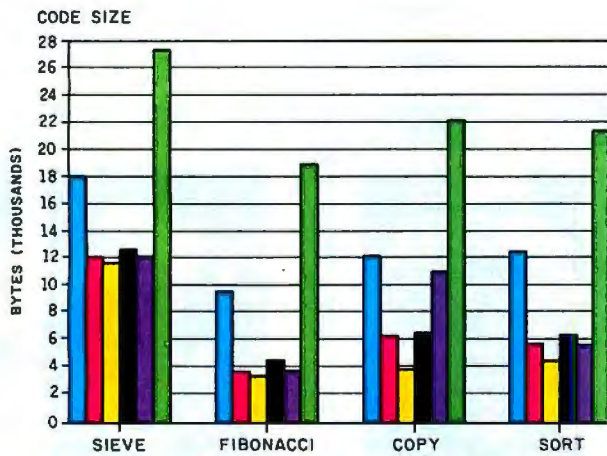

A comparison of Q/C C, SuperSoft C, and Whitesmiths C compilers for CP/M systems with the Aztec, BDS, and C/80 compilers. Four benchmark programs were used: the Sieve of Eratosthenes prime-number program, a Fibonacci Series program, a Copy program, and a simple Sort program. All tests were run on the same CompuPro S-100 system. More details on the benchmarks are given in the text.

■ AZTEC ■ BDS ■ C/80 ■ Q/C ■ SUPERSOFT ■ WHITESMITHS

Name	Q/C C	SuperSoft C	Whitesmiths C
Type	Compiler for the C programming language	Compiler for the C programming language	Compiler for the C programming language
Version	3.0	1.2.3.	2.2
Manufacturer	The Code Works 5266 Hollister, Suite 224 Santa Barbara, CA 93111	SuperSoft Inc. POB 1628 Champaign, IL 61820	Whitesmiths Ltd. 97 Lowell Rd. Concord, MA 01742
Price	\$95	\$275	\$550
Computer Needed	8080, 8085, and Z80 microcomputers running under CP/M-80 with floppy- or hard-disk mass storage and at least 56K bytes of main memory	8080, 8085, and Z80 microcomputers running under CP/M-80 with floppy- or hard-disk mass storage and at least 48K bytes of main memory	8080, 8085, and Z80 microcomputers running under CP/M-80 with floppy- and hard-disk mass storage and at least 60K bytes of main memory
Documentation	136-page manual	174-page manual	Manual of more than 300 pages
Audience	Systems and application software developers, hobbyists	Systems and application software developers, hobbyists	Systems and application software developers, hobbyists

continued from page 304

mass storage used was an 8-inch disk formatted into 1024-byte sectors (extended double-density). The summaries of the test results give the absolute measurements in "units" that correspond to seconds on the test computer system.

THE COMPILERS AND THE STANDARD

I had to customize the benchmark programs somewhat to compile them with each product. Only the Aztec and Whitesmiths compilers accepted the prototype source code essentially without change. Actually, the Whitesmiths compiler requires all external variables to be initialized; therefore, I had to explicitly set the first element in the Sort flags array to zero. However, I consider that change minor. It's fair to say that both Aztec C and Whitesmiths C are compatible with the UNIX compilers and the language defined in the Kernighan and Ritchie book.

All the other compilers are incomplete implementations of C, although SuperSoft C is relatively complete (see table 1 on page 312). BDS C makes up for some of its omissions by providing special library functions. You use these

to simulate the initialization of variables, simulate the initialization of variables, for example, and for floating-point and long-integer arithmetic.

Most changes to the prototype benchmark programs were minor. The Q/C compiler won't accept a function that returns anything other than an integer value, so I altered the Fib.C code slightly to compile the program.

The SuperSoft compiler comes with nonstandard buffered I/O library functions. When you open a file for buffered input or output in SuperSoft C, you must specify the buffer size you want to use (see listing 5a). In the Copy program I chose a buffer size of 1024 bytes, a reasonable memory expenditure for this type of program.

The Copy program required more significant changes to compile under BDS C because the BDS buffered I/O functions are different from the standard ones (see listing 5b).

The C/80 package does not provide the standard string comparison and string copy functions, so I had to add them to the source code of Copy and Sort.

None of the compilers that I tested

continued on page 309

Listing 2: The prototype Fibonacci program.

```
#include stdio.h>

#define NTIMES    10    /* number of times to compute Fibonacci value */
#define NUMBER    24    /* biggest one we can compute within 16 bits */

main()                /* compute Fibonacci value */
{
    int    i;
    unsigned value, fib();

    printf("%d iterations: ", NTIMES);

    for (i = 1; i <= NTIMES; i++)
        value = fib(NUMBER);

    printf("fibonacci(%d) = %u.\n", NUMBER, value);
    exit(0);
}

unsigned fib(x)        /* compute Fibonacci number recursively */
int x;
{
    if (x > 2)
        return (fib(x - 1) + fib(x - 2));
    else
        return (1);
}
```

Forever amber!

NEC's new amber monitor is so easy on your eyes, you'll feel you could look at it forever.

The JB-1205MA is a professional-quality computer monitor that gives you 80 characters by 25 lines of sharp, clear text. It's ideal for word processing and other work-intensive business applications. And it's amber, the color shown to be easiest on human eyesight.

Designed for use with NEC computers, the JB-1205MA is also easily adaptable for use with Apple, "Osborne" and most other popular computers. See it at your authorized NEC Home Electronics Dealer.

Compare these specs with your present monitor:

12-inch diagonal screen

80-character, 25-line display

8x8 dots, 8mhz video bandwidth

1.0-watt audio output



Productivity at your fingertips

NEC

NEC Home Electronics (U.S.A.), Inc.
Personal Computer Division
1401 Estes Avenue
Elk Grove Village, IL 60007
(312) 228-5900

NEC Corporation, Tokyo, Japan

Now... Draw On Your Imagination



Introducing The Gibson Light Pen System.[™]

The link between mind and machine has arrived. Suddenly you're free... free to translate your every thought into professional quality computer graphics... just by touching your screen.

The Gibson Light Pen System software features *icon* menus that offer easy access to powerful graphics tools such as symbol libraries, geometric shapes, mirror-imaging, magnification and complete color and pattern editing. Even if you're not a graphic artist, you can design, diagram and draw with precision at high-speed, in high-resolution, and in full-color... right on your screen.

COMPLETE WITH FIVE SOFTWARE SYSTEMS TO MAXIMIZE YOUR CREATIVE OPTIONS.

The Gibson Light Pen System comes complete with all you need to draw, paint, design, score music and learn animation.

DRAW FREEHAND WITH PENPAINTER.[™]

A full range of drawing tools, shapes, patterns and colors to draw or paint virtually anything on your screen.

DESIGN PRECISION DIAGRAMS WITH PENDESIGNER.[™]

Turn your computer into your own graphic design studio. A complete selection of templates make perfect business and architectural diagrams, technical drawings and engineering schematics a snap.

CREATE COMPUTERIZED ANIMATION WITH PENANIMATOR.[™]

All that you need to learn the basics of animation. Develop your own animation sequences, and bring your screen to life.

COMPOSE MUSIC WITH PENMUSICIAN.[™]

Score computerized melodies with incredible ease at the touch of your pen.

CREATE YOUR OWN LIGHT PEN APPLICATIONS WITH THE PENTRAK LANGUAGE SYSTEM.[™]

Take advantage of the software features, and customize your own light pen programs.

NOW AVAILABLE FOR THE APPLE II[®] SERIES

Coming soon for the IBM PC[™] and PCjr.[™]

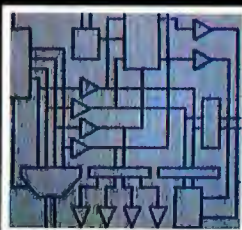

Koala Technologies
800-KOA-BEAR

The Gibson Light Pen System

Touch the Magic of Light

REVIEW: C COMPILERS

continued from page 307

Listing 3: The prototype Copy program.

```
#include <stdio.h>

main(argc, argv)          /* copy file a byte at a time */
int argc;
char *argv[];
{
    int    c;
    FILE  *infile, *outfile;

    if (argc < 3)
        errexit("Usage: copy oldfile newfile"; NULL);
    if (strcmp(argv[1], argv[2]) == 0)
        errexit("File names must be different"; NULL);
    if ((infile = fopen(argv[1], "r")) == NULL)
        errexit("Can't open", argv[1]);
    if ((outfile = fopen(argv[2], "w")) == NULL)
        errexit("Can't create", argv[2]);

    printf("File %s ", argv[1]);

    while ((c = getc(infile)) != EOF)
        putc(c, outfile);

    fclose(infile);
    fclose(outfile);

    printf("copied to %s.\n", argv[2]);
    exit(0);
}

errexit(s1, s2)           /* print error message and die */
char *s1, *s2;
{
    printf(s2 == NULL ? "%s\n" : "%s %s\n", s1, s2);
    exit(-1);
}
```

Listing 4: The prototype Sort program.

```
#include <stdio.h>

#define MAX    1001      /* maximum number of entries */
#define MAXLINE 135     /* longest line expected */
#define NTIMES  10      /* number of times to sort entries */

main()                  /* sort lines in memory */
{
    int    i, j, n, length;
    char  buf[MAXLINE], *sort[MAX], *unsorted[MAX], *alloc();

    for (n = 0; n < MAX; n++)
        if ((length = getln(buf, MAXLINE)) == 0) {
            n--;
            break;
        }
    else if ((unsorted[n] = alloc(length + 1)) == NULL) {
        printf("Sort: not enough room\n");
        exit(-1);
    }
    else
        strcpy(unsorted[n], buf);
}
```

listing 4 continued on page 311



Sound off!

Improve your present computer system with a high-resolution color monitor from NEC.

For superior color and clarity, you can hardly do better than NEC's JC-1215 Color Monitor. Use it to get a better picture on your present system or a truly first-rate picture with a complete NEC computer system. The JC-1215 is compatible with Apple II,* Apple II+,* Atari* 800 and 400,* VIC 20,* and others, including NEC's own NEC TREK™ [PC-6000]

Compare these specs with your present monitor:

12-inch diagonal screen

90-degree deflection

0.6 watts audio output power

Polarity Sync. negative

15.75 kHz x 60 Hz scanning frequency

40-character, 25-line display

Resolution of 250 lines at center

*Special interface required



Productivity at your fingertips

NEC

NEC Home Electronics (U.S.A.), Inc.
Personal Computer Division
 1401 Estes Avenue
 Elk Grove Village, IL 60007
 (312) 228-5900

Nippon Electric Co., Ltd., Tokyo, Japan

GET YOUR MESSAGE THROUGH.

EVEN WHEN YOUR MODEM SENDS IT BY WAY OF THE OKEFENOKEE SWAMP.

When you send data by telephone through nasty environments like this, it can run into problems tougher than just alligators. Problems like impulse noise. Chatter from the switchgear. Static from the atmosphere or bad weather. Distortion due to crosstalk or just plain white noise.

To get your message through, your IBM PC or XT needs the advanced performance features of the PC: IntelliModem.™ It's got the best receive sensitivity available today—actually down below -50 dBm. So now you can achieve a high level of data transmission integrity. Even with bad connections.

Get patented modem technology.

The PC: IntelliModem is elegantly simple. Its patented design does it all on a single microprocessor chip, with just one crystal. Other modems take

two, four or more μ Ps (and even more oscillators), and still accomplish less.

How do we do this? By creating architectural innovations in firmware, and by pushing the chip to its limit, close to 12 MHz. Since it uses fewer parts, the PC: IntelliModem's no-compromise design offers higher reliability, a more compact form factor, and lower costs.



This design elegance leads naturally to more elegant performance. Take line status detection, for example. The PC: IntelliModem's adaptive, decision-directed logic monitors line status more closely than other modems. Even at weak or degraded signal levels. So it can make connections with less chance of error, by detecting signals for dial tone, remote ringback, busy and voice—some of which other modems ignore.

Plan ahead with integrated voice and data.

For opening up a whole new world of integrated voice and data applications, there's nothing like the PC: IntelliModem. Literally. Its easy-to-use software package—PC: IntelliCom™—lets you switch repeatedly between talking or listening and sending or receiving data. All at

Make sure your modem has all these PC: IntelliModem features

Integrated Voice/Data

- Switch between voice and data communications
- Programmable telephone handset jack
- Status Reporting**
- Line status detection (dial tone, busy, remote ringback, voice answer, modem answer, incoming call)
- Audio monitor
- Programmable status LED
- PC: IntelliCom™ Software Included**
- 99-name on-line telephone directory
- Auto-dial, auto-repeat dial, auto-answer
- Link to another number if busy
- File transfer
- Data capture to diskette
- Programmable auto log-on sequences
- Compatible with Crosstalk™ and PC-Talk III™**
- Pulse and Tone Dialing**
- Receive Sensitivity: -50 dBm**
- Speeds: 110, 300, 1200 baud**

the touch of a single function key. That means now both you and your computer can talk on the same line. Without having to hang up, re-dial or plug and unplug a lot of cables.

So if you're designing microcomputer datacomm products—or just looking for a PC/XT modem for yourself, check out the PC: IntelliModem at your local dealer. You'll get the message. And so will they. Or contact: Bizcomp, 532 Weddell Drive, Sunnyvale, CA 94089; 408/745-1616.

Bizcomp: A history of innovation.

- | | |
|------|---|
| 1980 | Invented first command-driven modem |
| 1981 | Introduced proprietary line-status monitoring |
| 1983 | Designed first single- μ P 212A-compatible modem |
| 1983 | Introduced first integrated voice/data modem for IBM PC |
| 1983 | Granted patent on command-driven modem |

BIZCOMP®

We've got people talking.

REVIEW: C COMPILERS

listing 4 continued from page 309

```

    printf("%d iterations: ", NTIMES);

    for (i = 1; i <= NTIMES; i++) {
        for (j = 0; j <= n; j++)
            sort[j] = unsorted[j];
        quick(0, n, sort);
    }

    printf("%d entries\n", n + 1);
    exit(0);
}

getln(s, n)                /* get a line of up to n characters into s */
char s[];
int n;
{
    int    c, i;

    for (i = 0; n > 0; n--, i++)
        if ((c = getchar()) == EOF || c == '\n')
            break;
        else
            s[i] = c;

    s[i] = '\0';
    return (i);
}

quick(lo, hi, base)        /* quicksort */
int lo, hi;
char *base[];
{
    int    i, j;
    char   *pivot, *temp;

    if (lo < hi) {
        for (i = lo, j = hi, pivot = base[hi]; i < j; ) {
            while (i < j && strcmp(base[i], pivot) <= 0)
                i++;
            while (j > i && strcmp(base[j], pivot) >= 0)
                j--;
            if (i < j) {
                temp = base[i];
                base[i] = base[j];
                base[j] = temp;
            }
        }
        temp = base[i];
        base[i] = base[hi];
        base[hi] = temp;
        quick(lo, i - 1, base);
        quick(i + 1, hi, base);
    }
}

```

support two recent changes to the UNIX C language. One of these changes enlarges the number of legal operations on composite data types, known as "structures." Current UNIX C compilers allow structures to be assigned, passed as parameters to functions, and returned as function values. The other change is the creation of the "enumeration" data type, which takes on values enumerated by the programmer. For example, you might create a data type

called color with legal values of red, white, and blue. I didn't expect to find either of these features implemented under CP/M-80, but I was surprised that the BDS and SuperSoft compilers failed to generate an error when compiling a program where structures were passed to a function as parameters. Both compilers accepted the program without protest, even though neither one could compile it correctly.

continued on page 312



Get the total picture.

IBM COMPATIBLE - \$599!

Improve your present computer system with a high-resolution color monitor from NEC.

NEC's JC-1216 gives you the highest resolution you can get in a color monitor. And it can reproduce as many different colors and shades as the best microcomputers can generate. Compatible with a wide variety of computers, including IBM,* Zenith, H-P, and others, including NEC's own PC-8000 and PC-8800.

Compare these specs with your present monitor:

12-inch diagonal screen

RGB input signal with TTL level

Switchable Pos/Neg display characters

80-character, 25 line display

640[H] x 240[V] resolution

8 x 8 dots, 10MHz video bandwidth

*NEC CG-91 cable required



Productivity at your fingertips

NEC

NEC Home Electronics (U.S.A.), Inc.
Personal Computer Division
1401 Estes Avenue
Elk Grove Village, IL 60007
(312) 228-5900

NEC Corporation, Tokyo, Japan

continued from page 311

Table 1: Features of 8080 C Compilers.

	Q/C	SuperSoft	Whitesmiths
Kernighan and Ritchie complete			x
Kernighan and Ritchie standard library			x
library source	x	x	
run-time package source	x	x	
link compiled modules	[2]	[1]	x
preprocessor arguments			x
generates assembly code	x	x	x
in-line assembly code	x	x	
I/O redirection	x		x
library manager			x
debugging aids			
floating-point math		x	x
M80-compatible code	[2]	[3]	
requires CP/M 2.0			
minimum system size (kilobytes)	56	48	60
size of manual (pages)	136	174	> 300 [4]
list price	95	275	550

- [1] With relocating macro assembly language/linking loader (not supplied)
- [2] User must supply relocating assembly language/linking loader
- [3] Optional
- [4] Includes manual pages for several operating systems

Listing 5a: The SuperSoft Copy program.

```
#include <stdio.h>

#define BUFSIZ 1024
#define EOF -1

main(argc, argv) /* copy file a byte at a time, SuperSoft version */
int argc;
char *argv[];
{
    int c;
    FILE *infile, *outfile;

    if (argc < 3)
        fprintf(stderr, "Usage: copy oldfile newfile", NULL);
    if (strcmp(argv[1], argv[2]) == 0)
        fprintf(stderr, "File names must be different", NULL);
    if ((infile = fopen(argv[1], "r", BUFSIZ)) == NULL)
        fprintf(stderr, "Can't open", argv[1]);
    if ((outfile = fopen(argv[2], "w", BUFSIZ)) == NULL)
        fprintf(stderr, "Can't create", argv[2]);

    printf("File %s ", argv[1]);

    while ((c = getc(infile)) != EOF)
        putc(c, outfile);

    fclose(infile);
    fclose(outfile);

    printf("copied to %s.\n", argv[2]);
    exit(0);
}

errexit(s1, s2) /* print error message and die */
char *s1, *s2;
{
    printf(s2 == NULL ? "%s\n" : "%s %s\n", s1, s2);
    exit(-1);
}
```

continued on page 314

Where to buy Toshiba's P1351 and P1340 printers:

EASTERN

- R & D/CAMELOT ASSOCIATES, INC.
Northampton, MA (413) 253-7378
- DIGITAL ENTRY SYSTEMS
Waltham, MA (617) 899-6111
- MICROAMERICA
Frammingham, MA (800) 343-4411
In MA (617) 877-8500
- CYBER/SOURCE
Southfield, MI (313) 353-8660
- GENERAL BUSINESS COMPUTERS, INC.
Cherry Hill, NJ (609) 424-6500
- MONROE DISTRIBUTING COMPANY
Cleveland, OH (216) 781-4600
- ROBEC DISTRIBUTORS
Linc Lexington, PA (215) 822-0700

SOUTHERN

- SYSPRINT, INC.
Sarasota, FL (813) 924-8278
- MICROAMERICA
Tampa, FL (813) 623-6526
In FL (800) 282-3385
- Norcross, GA (800) 241-8566
In GA (404) 441-0515
- Rockville, MD (800) 638-6621
In MD (800) 492-2949
- ZAMOISKI COMPANY
Baltimore, MD (301) 644-2900

CENTRAL

- TEK-AIDS INDUSTRIES, INC.
Arlington Heights, IL (312) 870-7400
or (800) 323-4138
- KALTRONICS DISTRIBUTORS, INC.
Northbrook, IL (312) 291-1220
- MICROAMERICA
Schaumburg, IL (800) 323-6827
In IL (800) 942-4690
- Richardson, TX (800) 527-3261
In TX (800) 442-5847

ONE STOP MICROPRODUCTS

- South Bend, IN (219) 277-4972
- MIDTEC ASSOCIATES dba CRYSTAL COMPUTERS
Lenexa, KS (913) 541-1711
- B & W DISTRIBUTORS
St. Louis, MO (314) 589-2450
- SMC INTECH SYSTEMS CORP
Carrollton, TX (214) 446-9055
- COMPU SHOP
Richardson, TX (214) 783-1252
- SYSPRINT, INC.
Richardson, TX (214) 669-3666

WESTERN

- PG I. CORPORATION
Tempe, AZ (602) 967-1421
or (800) 528-1415
- MICROAMERICA
Carson, CA (800) 421-1485
In CA (800) 262-4212
- BYTE INDUSTRIES, INC.
Hayward, CA (415) 783-8272
or (800) 972-5948
outside CA (800) 227-2070
- PREMIER SOURCE DISTRIBUTING
Irvine, CA (714) 261-2011
- CYPRESS DISTRIBUTING COMPANY INC.
San Jose, CA (408) 297-9800
- MICROWARE DISTRIBUTORS, INC.
Aloha, OR (503) 642-7679
- Bellevue, WA (206) 451-8586
- ANACOMP, INC.
Salt Lake City, UT (801) 539-0158
- Redmond, WA (206) 881-1113
or (800) 426-6244

CANADA

- IRWIN ELECTRONICS
Etobicoke, Ontario (416) 626-6600

OR THESE TOSHIBA AMERICA, INC.

- REGIONAL OFFICES:**
- 177 Madison Avenue, Post Office Box 2331R
Morristown, NJ 07960 (201) 326-9777
 - 662 Office Parkway, The Colonnade Building
St. Louis, MO 63141 (314) 991-0751
 - 18017 Sky Park Circle, Suites P and O
Irvine, CA 92714 (714) 250-0151

TOSHIBA

Circle 336 on inquiry card.

Two ways to show off your IBM PC.™



There's no better way to show off your IBM PC – or any other micro – than with the new line of Toshiba printers. They offer state-of-the-art features, high reliability and low price.

P1351

The new Toshiba P1351 printer has a unique high-density 24-pin dot-matrix print head. It lets you print crisp, clean letter copy at 100 cps, draft copy at 192 cps. And with the software-selectable downloading fonts, you get to pick from a variety of type styles.

The P1351 has more stuff to show. Like 180 x 180 dots-per-

inch high-resolution graphics, 132-column-width platen (great for spreadsheets and Lotus™ 1-2-3™ data processing and graphics), Qume SPRINT 5™ emulation, and a choice of either a forms tractor or automatic sheet feeder.

P1340

For considerably less, the new P1340 gives you just a little less. But it still has the same high-density 24-pin dot-matrix print head, the 180 x 180 dots-per-inch graphics resolution, and the Qume SPRINT 5 emulation. In addition to true proportional spacing and a

built-in forms tractor. Whichever printer you choose, you also get nationwide service within 24 hours by Western Union technicians.

So the choice is yours. But when you choose Toshiba, you know you're putting on the best show possible.

For more information, call one of the distributors listed on the adjacent page.

IBM PC to P1340 and P1351 graphics utilizes PaperScreen and the IBM PC with color graphics adapter. IBM PC is a trademark of International Business Machines. Lotus and 1-2-3 are trademarks of Lotus Development Corporation. SPRINT 5 is a trademark of Qume Corporation.

©1984 Toshiba America, Inc.

In Touch with Tomorrow

TOSHIBA

Information Systems Division, TOSHIBA AMERICA, INC.

NEW!

RS-232 BREAK-OUT-BOX Interface Analyzer

only
\$149.95



Opens signal lines, rewires or monitors in one unit. Nine two-color LED's monitor 7 lines plus two spares. 20 wires included. 24 switches open any RS-232 line except pin 1. Requires no battery. In stock for immediate delivery. Money back guarantee. **Only \$149.95.** Add \$1.75 postage & handling. IL res. add 6% sales tax. MC, VISA accepted.

Free!

New illustrated catalog of RS-232 interface and testing equipment.



Phone: **815-539-5827**

B & B electronics
MANUFACTURING COMPANY
Box 68N, MENDOTA, IL 61342

REVIEW: C COMPILERS

Listing 5b: *The BDS Copy program.*

```
#include <bdsclo.h>

main(argc, argv)          /* copy file a byte at a time. BDS version */
int argc;
char *argv[];
{
    char    c;
    FILE    infile, outfile;

    if (argc < 3)
        errexit("Usage: copy oldfile newfile", NULL);
    if (strcmp(argv[1], argv[2]) == 0)
        errexit("File names must be different", NULL);
    if (fopen(argv[1], infile) == ERROR)
        errexit("Can't open", argv[1]);
    if (fcreat(argv[2], outfile) == ERROR)
        errexit("Can't create", argv[2]);

    printf("File %s ", argv[1]);

    do {
        putc(c = getc(infile), outfile);
    } while (c != CPMEEOF);

    fclose(infile);
    fclose(outfile);

    printf("copied to %s.\n", argv[2]);
    exit(0);
}

errexit(s1, s2)           /* print error message and die */
char *s1, *s2;
{
    printf(s2 == NULL ? "%s\n" : "%s %s\n", s1, s2);
    exit(-1);
}
```

continued from page 312

ASSEMBLY OPTIONS

During the tests, there were two procedural decisions I had to make concerning the use of optional relocating assembler. Both C/80 and SuperSoft C permit you to compile a program without a relocating assembler, which means that the compiler must read all your program's source code during a single compiler run. With an optional relocating assembler and linking loader, such as Microsoft's M80 and L80, you can compile different modules independently and link them together later.

A relocating assembler is a practical necessity with the SuperSoft compiler. While the SuperSoft manuals describe ways to compile programs for an absolute assembler, the results are disap-

pointing. You either must endure a cumbersome editing procedure to get the library routines you need, or accept a mammoth amount of object code. Therefore, all the SuperSoft C tests were performed with M80 and L80.

C/80 programs, on the other hand, are not impractically large when assembled without a relocating assembler—primarily because the C/80 function library is small. It also seems inappropriate to use a \$150 relocating assembly-language package for a \$50 compiler.

The O/C compiler *requires* that you supply a relocating assembler, and the remaining compilers all come with one.

THE TIMING TESTS

BDS C is much faster than any of the other products in compiling and linking

continued on page 316

^{new} The **CONCEPT AVT+** In a word: **capability.**



THE CONCEPT AVT+ DISPLAY TERMINAL

ANSI standard conformance, DEC software compatibility, eight pages of memory, 80/132 columns, windowing, multiple computer connections...and a full range of practical ergonomic features. Capabilities which enable all terminal users to maximize their productivity and explore their creativity. Only from Human Designed Systems.

Introducing the new *concept AVT+* display terminal from Human Designed Systems. Simply the smartest interactive display terminal available today. And at a very competitive price.

It starts with ANSI standard (X3.64-1979) conformance and DEC software compatibility, and incorporates superior human design features, advanced functionality and highest quality construction. A commitment to quality that is reflected in each of the individual components.

The *concept AVT+* keyboard is ergonomically designed for optimum operator comfort, incorporating a VT100-style numeric pad for DEC software compatibility. And it builds on those human design features with a range of capabilities that make the *concept AVT+* an ideal choice for smart terminal users.

The *concept AVT+* offers up to eight pages of display memory that eliminates unnecessary

*Quantity one DEC and VT are trademarks of Digital Equipment Corporation

\$1295*

hardcopy printouts and provides a powerful tool for applications requiring multiple formats and storage of large volumes of text; non-volatile memory that enables users to permanently configure a terminal for their needs or applications; windowing that allows users to create individual displays within display memory; programmable function keys which transmit data and/or execute terminal commands; up to three additional communications ports for connection to other peripherals and computers;

flexible user networking and functionality for use in a wide range of different applications, including multiple computer connections; and much more.

The new *concept AVT+*. More to offer at its price for terminal users than any other terminal available today.

human designed systems, inc.

3440 Market Street, Philadelphia, PA 19104
215-382-5000 Circle 161 on inquiry card.

Human Designed Systems. We're redefining terminal performance.

Atlanta — (404) 391-9763; Boston — (617) 449-6446; Chicago — (312) 625-2960; Dallas — (214) 437-1888; Delaware — Infocon: (302) 239-2942; Denver — (303) 469-1953; Hawaii — Gray Associates: (808) 261-3751; Houston — (713) 952-1403; Los Angeles — (213) 410-9454; Northern New Jersey — Infocon: (201) 624-1372; New York City Area — Infocon: (212) 689-8833; New York State — Naco Electronics: Rochester: (716) 223-4490; Syracuse: (315) 699-2651; San Francisco — (415) 692-4184; Washington, DC — International Systems Marketing: (301) 279-3775; Argentina — Itron SA: (01) 774-9369; Australia — Computer Clarity Pty. Ltd.: (02) 241 3385; Belgium — BELCOMP: 091-31.52.22; Canada — CALL Systems: Toronto: (416) 362-1063; Denmark — ADCOM Data Aps: 1-194466; Finland — Evumatic: 0594 141; France — Walton: (1) 226.06.90; Japan — Ampere: 03 (365) 0825; Singapore — DTS Singapore: (65) 33-88-666; Switzerland — Mitek ag: 01/461 22 52; United Kingdom — Shandell Systems Ltd.: 02407-2027; Venezuela — H. Blohm SA: 2 541.21.22; West Germany — COMKO Computersysteme, mbH: 0221-48 30 51. DISTRIBUTORSHIP INQUIRIES INVITED.

continued from page 314

a program (see table 2 and the graphs on the At-a-Glance page). This is because it is the only compiler that reads the entire source module into memory before beginning compilation, and it is the only one that keeps its intermediate output in main memory instead of placing it in a temporary file. As you can see in table 2 and on the At-a-Glance page, the C/80 object code is the most compact, but BDS, Q/C, and SuperSoft are not far behind. The Aztec programs require noticeably more memory than the others, and Whitesmiths requires the most memory of all the compilers tested. The Whitesmiths Sieve program, for example, took more than 27,000 bytes—almost half the main memory available on the average 64K-byte CP/M-80 system.

The results of the most important speed test—the execution speed of the compiled programs—are the most difficult to generalize about. The C/80 and Whitesmiths Sieve programs are the

fastest, but not by much, and the performance range in the Sieve test is narrow. Q/C is the slowest, though by less than a factor of two. The SuperSoft Fibonacci program is noticeably faster than the others, but again, the range from the slowest to the fastest is less than two-to-one.

The Copy program shows the greatest range of execution times, but the speed difference is largely attributable to the size of the disk buffer used for file I/O. This is characteristic of the buffered I/O functions supplied with each product, rather than an intrinsic quality of the code produced by the compiler. For Sort the Aztec compiler is the clear winner, followed by Whitesmiths, with the others spread out about evenly behind. But the Aztec object code for the Sort program is roughly twice the size of the slower SuperSoft, C/80, BDS, and Q/C programs, and the Whitesmiths object code is considerably larger than Aztec's.

continued on page 318

Table 2: Test results for six C compilers for CP/M systems using four benchmark programs. All tests were run under the Microshell operating environment program and CP/M's SUBMIT batch-processing utility program running on a CompuPro S-100-bus system with a 6-MHz Z80 processor. The Sieve program is the Sieve of Eratosthenes prime-number program (see "Eratosthenes Revisited: Once More through the Sieve," by Jim Gilbreath and Gary Gilbreath, January 1983 BYTE, page 283). The Fibonacci program determines a series of Fibonacci numbers (i.e., each number in the series is the sum of the two preceding numbers). The Copy program measures how long it takes to input and output an 80,000-character text file. The Sort program measures how long it takes to alphabetically sort the first 1,000 words in a BYTE article. A graphic comparison of these results is given on the "At a Glance" page.

Execution Time (seconds):

	Aztec	BDS	C/80	Q/C	SuperSoft	Whitesmiths
Sieve	32	37	26	45	29	26
Fibonacci	95	81	69	95	49	60
Copy	91	75	218	205	88	224
Sort	54	119	102	123	79	71

Compile Times (seconds):

	Aztec	BDS	C/80	Q/C	SuperSoft	Whitesmiths
Sieve	76	18	65	173	105	339
Fibonacci	65	18	62	57	97	253
Copy	80	20	70	67	116	296
Sort	99	20	81	80	139	327

Amount of Code Generated (K bytes):

	Aztec	BDS	C/80	Q/C	SuperSoft	Whitesmiths
Sieve	18	12	12	13	12	27
Fibonacci	10	4	3	4	3	19
Copy	12	6	4	6	11	22
Sort	12	6	4	6	6	21

Enter CompuServe's Electronic Mall™ and shop at your convenience in these exciting departments.

- The Micro Mart
- The General Store
- The Travel Agent
- The Book Bazaar
- The Record Emporium
- The Photo Booth
- The Software Shop
- The Financial Market
- The Magazine Kiosk
- The Gardening Shed
- The Newsstand

A sample of the companies participating in CompuServe's Electronic Mall™ includes:

- Amdek
- American Airlines
- American Express
- AST Research
- Bank of America
- Bantam
- Big T Automotive
- Buick
- CBS Publishing
- CDEX
- Colonial Penn
- Commodore
- Computer World
- Digital Equipment
- dilithium Press
- 800 Software
- 47th Street photo
- Grolier
- Harvard Business Review
- Heath
- Heinold Commodities
- Hertz
- E.F. Hutton
- Inmac
- Innovative Software
- Knapp Press
- Magazine Entree
- Magazine Supply House
- Manufacturer's Hanover Trust
- Max Ule
- McGraw-Hill
- Metropolitan Life
- Microsoft
- Miracle Computing
- Misco
- Newsnet
- Novation
- Official Airline Guide
- Pan American Electronics
- Peachtree Software
- Practical Peripherals
- Program Store
- Professional Color Labs
- RCA Record Clubs
- Record World
- Sears
- Select Information Exchange
- Sim Computer Products
- Simon and Schuster
- Small Computer Book Club
- Software Advisor
- Stark Brothers
- Supersoft
- Vanguard
- VisiCorp
- Waldenbooks
- Woman's Day Books
- Ziff-Davis

Merchants and manufacturers who want to participate in the Electronic Mall™ may contact: Stephen A. Swanson, L.M. Berry & Co., P.O. Box 6000, Dayton, OH 45401, (513) 296-2015.



BY THE YEAR 2000, THE WORLD MAY CATCH UP WITH THE WAY COMPU SERVE'S NEW ELECTRONIC MALL™ LETS YOU SHOP TODAY.

Introducing the first computer shopping service that brings you convenience, savings and enjoyment.

Here's your chance to expand the practical uses of your personal computer.

Sign up for CompuServe and shop in our new Electronic Mall. It's easy to use. It tells you more about the products you're buying. It lets you order faster. And it's totally unique.

CompuServe's new Electronic Mall™ offers you all these shopping innovations.

– It's enormous! So it gives you in-depth information on thousands of goods and services, and lets you buy even hard-to-find merchandise. – Its unique "Feedback" service lets you ask the merchants themselves specific questions. – It's incredibly efficient in ordering the products and services you want.

– Its special discount opportunities make it economical, purchase after purchase. – And its name-brand merchants assure you of top-quality merchandise.

Make the CompuServe Electronic Mall 15-Minute Comparison Test.

What you can do in 15 minutes shopping the Electronic Mall way:

- Call up on your computer screen full descriptions of the latest in computer printers, for instance.
- Pick one and enter the order command.
- Check complete descriptions of places to stay on your next vacation.
- Pick several and request travel brochures.
- Access a department store catalog and pick out a wine rack, tools, toys... any thing!
- Place your order.

What you can do in 15 minutes shopping the old way:

- Round up the family and get in the car.

The Electronic Mall, a valuable addition to the vast world of CompuServe.

CompuServe's Consumer Information Service brings you shopping information, entertainment, personal communications and more.

You can access CompuServe with almost any computer and modem, terminal or communicating word processor.

To receive your illustrated guide to CompuServe and learn how to subscribe, call or contact...

CompuServe

Consumer Information Service
P.O. Box 20212
6000 Arlington Centre Blvd.
Columbus, OH 43220

800-848-8199

In Ohio call 614-457-0802

continued from page 316

Listing 6a: *The string-length program.*

```

#include <stdio.h>

#define NTIMES 25000

#define S "Now is the time for all good men to come to the aid of the party."

main()                /* string: get length of string */
{
    int i;

    for (i = 1; i <= NTIMES; i++)
        string(S);

    exit(0);
}

string(s)
char *s;
{
    char *p;

    for (p = s; *s != '\0'; s++)
        ;
    return (s - p);
}

```

REGISTER VARIABLES

There are tricks you can use with the various compilers to optimize the object code they produce both temporally and spatially, but I wanted to keep the benchmark tests as similar as possible, rather than adapt each program to make it most efficient for a particular compiler.

However, I did perform a separate test of each compiler's ability to use register variables. This standard C feature allows you to specify that a particular variable be kept in a machine register whenever possible. Because data kept in the registers is more accessible than data stored in ordinary read-write memory, the intelligent use of register variables can substantially speed a program up.

To measure the effect of using register variables with each compiler, I wrote a short program to repeatedly count the number of characters in a string. Listings 6a and 6b show this program's regular and register versions.

TWA's 3 PAIR BEATS PAN AM



While the SuperSoft manual claims that the compiler generates true register variables, both SuperSoft test programs executed at the same speed. BDS C does not support register variables, but all the other compilers did generate faster object code for the register version of the program.

A TOUGH CHOICE

Some people may find these results disappointing because they don't clearly determine which compiler is "best." I think they are encouraging. They show that competition is indeed alive and well in program-development tools, a relatively small part of today's CP/M-80 software market.

A few years ago it was impossible to find a C compiler suitable for serious software development on an 8-bit microcomputer. I, for one, am not going to complain that the proliferation of these products now makes the choice among them increasingly difficult. ■

Listing 6b: *The string-length program using register variables.*

```
#include <stdio.h>

#define NTIMES 25000

#define S "Now is the time for all good men to come to the aid of the parity."

main() /* string: register version */
{
    int i;

    for (i = 1; i <= NTIMES; i++)
        string(S);

    exit(0);
}

string(s)
register char *s;
{
    char *p;

    for (p = s; *s != '\0'; s++)
        ;
    return (s - p);
}
```

's FULL HOUSE.



TWA'S INTERNATIONAL
BUSINESS CLASS HAS 6-SEATS ACROSS.
PAN AM'S HAS 8.



WHO'S YOUR MONEY ON?

For space and comfort across the Atlantic, the smart money's on TWA. Because TWA has 6-across seating. Pan Am and most others have eight. So on TWA, every seat is either an aisle seat or a window seat. That means there's never more than one person sitting next to you, so you'll have more room to work, and more room to relax.

And now you get comfortable 6-across seating on every widebody TWA flies overseas—our L-1011's as well as our 747's. That's because we've folded down the two middle seats and added more legroom in our L-1011's. So now, they're more comfortable than ever.

TWA's Ambassador Class®—it's the odds-on favorite to Europe and the Middle East.

You're going to like us





INTRODUCING
THE THREE
SMARTEST TOOLS
EVER CREATED
FOR THE
BUSINESS MIND.

THE SMART SPREADSHEET WITH GRAPHICS.

The name of the game in spreadsheets is power. The Smart Spreadsheet with Graphics offers unmatched power and pictures, in one convenient package.

A truly remarkable feature of this smart software is how it "thinks" about using space. It's based on the "waste not, want not" principle.

For example, when a user places a number in row 50, column 10 of any other spreadsheet program, 500 cells worth of memory are immediately allocated—even if no value is entered anywhere else in row 50 or



WORKSHEETS can have up to 999 columns and 9999 rows.

AUTOHELP LINE - A one-line explanation is displayed for the highlighted command (F1 will display additional help).

COMMAND LISTS - One of 5 command lists displayed when you are in command mode. The number of commands on each list varies depending on user "confidence" level.

WORKSHEET WINDOWS - Up to 32 windows may be created. Windows can view different parts of a single worksheet, or display different worksheets in each window. Any window can be temporarily expanded to fill screen by using the zoom command.

USER DEFINED MENU shown in a window. This menu displays 4 projects which can be executed.

column 10. Consequently, 499 cells of usable memory are "tied-up" unnecessarily.

The Smart Spreadsheet will never let this happen. Its unique "sparse matrix" data structure would have only allocated one cell worth of memory.

This "space-saving" approach benefits all spreadsheet users. The Smart Spreadsheet puts at their fingertips four to ten times more usable memory. It's the only spreadsheet that can boast the capacity for up to 999 columns by 9999 rows.

In addition to its frugal approach to memory allocation, business users will find The Smart Spreadsheet offers powerful math and decision-making functions. It is extremely flexible. It will handle huge amounts of data, in many formats, while performing an unprecedented combination of business tasks.

To make sure the process doesn't become overwhelming (nobody's memory is that good), up to 32 windows can be opened to review worksheet sections or sections of other worksheets.

When it comes to graphics, few programs can compare to the full-color, full-featured package offered by The Smart Spreadsheet, which gives users a wide variety of visually appealing options.

Graphics can be enhanced by multiple type styles on-screen and on printed or plotted output. Graphics options include: 1-, 2-, and 3-D bar charts; high-low charts; pie and cake charts; line, point, and scatter graphs; and histograms.

And just to keep things interesting, there's even a built-in slide show. Business users can show their business bosses some of their favorite pie-cake-bar-point-

Even with its unprecedented data capacity, math functions and graphics capabilities, *The Smart Spreadsheet with Graphics is still the easiest-to-use forecasting tool a business can own.*

high-low graphs in a crisp, informative presentation, in any order, any combination, any time.

Of course this wouldn't be smart software if it didn't make life easier with features like multiple help and menu levels, total integration with other smart software, and the knack for remembering how to repeat a complex project.

GENERAL	999 columns X 9999 rows Up to 80 characters/cell (values and text) Up to 1920 characters/cell (formulas) Sparse matrix data storage Relational spreadsheets
SPECIAL FEATURES	Information management in spreadsheet form Multiple spreadsheets in memory at once Extensive calculation and decision-making; math, trig, statistical, date/time and decision (if-then-else, etc.) functions Project processing through command files Three user "confidence" levels
GRAPHICS	Supports full color 1-, 2-, 3-D bar charts Pie and cake charts High-low charts, histograms Line, point and scatter graphs Merge graphs with text into word processing documents Edit graph capabilities before printing or plotting State-of-the-art printing and plotting Built-in "Slide Show" presentations

THE SMART DATA MANAGER.

All businesses have three things in common. They all accumulate more data than they realize. They can never seem to find it when they need it. And if they could find it, they probably couldn't make much out of it.

The Smart Data Manager is the most intelligent data base available to the micro user.

From these observations, the data processing industry was born. But access to DP capabilities was limited.

Now The Smart Data Manager puts the benefits of data processing into the hands of business decision

makers, providing them with an extremely efficient and versatile management tool.

Here, for the first time, is a relational data manager that can be operated by its own menus, user-defined menus, or built-in "common-sense" commands. Users can concentrate on what to ask rather than how to ask for information.

Because of its three "confidence" levels, users can start with the basics and work their way up with the peace of mind that they won't be inundated with menu options—until they're ready. They're also assured that HELP is always at hand.

Naturally, The Smart Data Manager does a masterful job of filing, organizing, locating, interrelating, and retrieving all sorts of facts and figures, names and addresses. And it will remember exactly how to repeat all tasks for any repeated project.

Lists, reports, and forms can be generated with unlimited versatility and in a variety of type styles and sizes. Users can give that "smart" look to even the most perfunctory business paperwork.

Put to work with The Smart Word Processor and The Smart Spreadsheet with Graphics, The Smart Data Manager becomes the cornerstone for the most powerful, most versatile, and most innovative information management system ever created.



GENERAL	1000 characters/field 4000 characters/record 255 fields/record 100,000 records/file Up to 15 key fields maintained Efficient B-tree organization
SPECIAL FEATURES	Up to 10 "screen views"/file with up to 15 pages each Security password entry at both screen and file levels Eight field types Character and numerical range verification Multiple criteria selects Prepared menus, custom-defined menus or command language Extensive calculation and decision-making capabilities Project processing through command files Three user "confidence" levels
RELATIONAL CAPABILITIES	Multiple file interaction Look-up data gathering Transaction data passing

WINDOWS
Up to 32 windows can be created. Windows can view: a) the same screen format, b) different screen formats for the same file, or c) screen formats from different files. Linking windows allow you to create relational files for screen display.

USER DEFINED MENU
shown in a window. This menu displays 3 projects which can be executed.

COMMAND LISTS
One of 5 command lists displayed when in command mode. The number of commands on each list varies depending on user "confidence" level.

COLOR - Data, Titles, Text/Graphics, and the window background can be painted any of 16 different colors.

BROWSE MODE allows you to view a number of records on a single screen. You can scroll the window horizontally and vertically to view additional fields in the records.

AUTOHELP LINE - A one-line explanation is displayed for the highlighted command (F1 will display additional help).

STATUS LINE - Displays the name of the current file, the currently active window, and the key field; plus the page #, record # and delete status of the current record.

The screenshot shows a window titled "Product Master File" with a list of products and their prices. A menu is open over the list, and a command list is visible at the bottom.

MORE SMART FEATURES

The Smart Data Manager does more than handle standard data base applications. It also has powerful field calculating abilities which help minimize data entry.

In addition, "if-then-else" logic can be applied to any field. And the report generator can print standard reports from any file, in any order. Or, users can output data to match pre-printed forms, labels, invoices, etc.

With these features, The Smart Data Manager solves virtually any data gathering problem, no matter how detailed or complex.

SMART SOFTWARE FROM INNOVATIVE SOFTWARE™

Until now, software has been designed to be powerful, versatile, and hard working. Unfortunately, this has usually meant hard work for the business user.

Despite technological feats, business software has not been known for meeting many human requirements.

Now with unmatched simplicity, smart software links the business user with the business system. It creates, for the first time, an environment that differentiates working hard from working smart.

Like a bright and resourceful assistant, smart software lets the user create, change, and duplicate tasks without constant supervision. It's eager to do the work. But always ready to learn more.

No longer is the user constrained by "unnatural" information flow, or a slave to reformatting data or commands. Nor is the user confronted with overwhelming study prerequisites before putting software to work.

Smart software is available in three applications: The Smart Word Processor, The Smart Spreadsheet with Graphics and The Smart Data Manager. Together, they provide an unlimited "applications bank." But each works powerfully by itself.

Smart software creates new meanings for "state-of-the-art," "integration," "user-friendly," and "full-featured." It sets new standards by which all other business software should be measured.

SMART SOFTWARE AT A GLANCE

GENERAL	Up to 32 windows/program
	Multiple files, documents, or spreadsheets in memory at once
	Supports mouse
	Supports full color
INTEGRATION	Supports most popular printers and plotters
	True integration - packages directly share information from each other and pass information automatically
SPECIAL FEATURES	Automatic project processing-remembers commands (not a macro)
	Three user "confidence" levels
	Prepared menus, custom-defined menus, or command language
	Multiple timesteps on-screen and in output
	Built-in time manager/appointment scheduler
	Built-in business/scientific calculator
	Extensive calculation and decision-making capabilities
HARDWARE	Keyboard macros
	Supports 8087 floating point processor chip
	IBM PC®, XT, COMPAQ™ or compatibles 128K RAM, two double-sided disks or a hard disk

These unique features are standard for all smart software products. Each program also offers many exclusive application-specific features.

A BUSINESS TASK MASTER

Successful businesses operate by performing tasks and projects well. Most of their information demands involve repetitive projects and tasks.

Now, with a single keystroke, multi-faceted information projects can be repeated — start to finish — without repeating commands.

Think of it as "project processing." Smart software makes it a reality for microcomputers. It lets the

software "learn" the user's chain of commands and repeat them, time after time, with a single prompt.

Using a unique "remember" mode, commands are recorded automatically.

Unlike a "macro" capability (which only remembers keystrokes), smart software has the "intelligence" to remember commands. It's the difference between remembering the letters in a word and knowing how to use the word.

INTEGRATION CUM LAUDE

Smart software integrates the user with the information system. It also integrates the programs — lets them "talk" to one another.

Smart software has the ability to pass information effortlessly between programs, and to store and retrieve information. The software (not the user) does the work of transferring data and translating instructions. Smart software lets the user concentrate on the task at hand rather than on how to make different programs work together.

THE STUDENT TEACHER

Despite its "learning" abilities, smart software has the patience to teach — in the school of "hands-on" experience. So even first time users can begin working immediately, and learn as they do.

Each program is structured into three ascending tiers of user "confidence." HELP is available at each level. No matter what's on the screen, one command presents detailed instructions.

HELP and menu information are consistent with the confidence level being used. Beginners work without confronting complex instructions and options. More advanced users can enter at any level they choose, and backtrack if they bite off too much.

But regardless of the "confidence" level, the user is continuously supported by full integration and project processing.

THE SMART BUSINESS DECISION.

There are countless numbers of software products available today to meet the spectrum of business applications. But nothing compares with the way smart software meets the needs of the business user.

Together, The Smart Word Processor, The Smart Spreadsheet with Graphics, and The Smart Data Manager accommodate virtually every business application. And, for the first time, these needs are met in a "business environment" rather than a "data processing" environment.

Here is software designed so that the user can concentrate more on the business at hand and less on the micro-computer system. Here is software that links the business user with the speed and efficiency of the business computer—without "computer literacy" prerequisites.

With unmatched simplicity, smart software rivals the power and features of all other leading software packages. It also rivals the after-purchase support offered by all others.

Here are a few more reasons why smart software is the smartest choice in business software.

FREE VIDEO LEARNING CASSETTES

Purchasers of any smart software program can request a video tape learning cassette, absolutely free.

Available in both VHS and BETA formats, these cassettes highlight many operational points and special application features. Each video cassette covers the complete smart software series. With the aid of sight and sound, users can work along with video lessons.

It's also a great way for the purchaser of a single smart software product to preview other smart software.

Cassettes are ordered when the product registration card is completed and returned. Learning cassettes are free to smart software owners, or can be borrowed from participating smart software dealers.

USER HOTLINE SUPPORT

Registered smart software owners also qualify for a toll-free telephone assistance service. Between regular business hours (central standard time), users can consult with customer assistance representatives, should the need ever arise.

FREE TUTORIAL DISKS

Each smart software product includes a useful tutorial disk to guide users, step-by-step, through on-screen examples of special features.

Tutorials make it easy for even first-time users to start working smarter, faster.

And they're free.

\$200 CASH-BACK OFFER

Purchasers of more than one smart software product are eligible to receive up to \$200 in cash refunds from Innovative Software, Inc.

This offer makes purchasing the family of smart software even more affordable.

Cash-back coupons are packed with each product along with complete redemption instructions.

FREE PRODUCT UPDATES

Innovative Software, like most software manufacturers, periodically releases new versions of certain software products, incorporating new or improved features.

Unlike other software manufacturers, Innovative Software will supply updates to registered smart software owners, free of charge, for one year.

PRODUCT REPLACEMENT

Innovative Software also offers a Product Replacement Plan which goes into effect after the original 90-day product warranty period.

The Product Replacement Plan allows for replacement, at a nominal charge, of the original program diskettes, should they become damaged through normal use.

THE SMART CONCLUSION.

There has never been a software offering to match the scope and simplicity of smart software. Everything about the software and the way it is supported has been created with the business user in mind.

Project processing allows it to perform repetitive tasks without constant supervision.

Integration allows each of the smart programs to work in harmony with one another, giving the user virtually unlimited application opportunities.

And three "confidence" levels assure fast start-up and worry-free operation.

Given these unique features, smart software is, without doubt, the ultimate information management system. It sets new standards by which all other business software will be measured.

Call a local computer dealer today for a free demonstration.

CALL TOLL FREE
800-GET-SMART
FOR THE NAME OF THE
SMART SOFTWARE DEALER
NEAREST YOU.



INNOVATIVE Software

9300 W 110th ST., SUITE 380, OVERLAND PARK, KS 66210 USA
IN KANSAS CALL 913-383-1089

THE SMART WORD PROCESSOR.

GENERAL	Automatic "Flying Reform" "Cut and Paste" in or between documents Supports mouse Document size limited only by disk space Footnoting capabilities On-screen math capabilities
SPECIAL FEATURES	Multiple type styles on-screen and in output STET-second thought editing (undo) On-screen page breaks Project processing through command files Three user "confidence" levels



The Smart Word Processor (with the help of a quality printer), will deliver the same professional-looking and graphically appealing documents associated with dedicated word processing systems. But that's where the similarity ends.

Most businesses aren't in the business of word processing. So their word processing needs are very special. What they need is an extremely versatile writing, editing, and composing tool.

Not only that, they need a tool that can be used without long hours of special training or pages of highly technical instructions.

The Smart Word Processor is all those things and much more. It offers users a variety of type styles and sizes, as well as features like

The Smart Word Processor is the most versatile writing, editing, and composing tool ever designed for the business mind and the micro-computer.

boldface, italics, small caps, underline, sub-script, super-script, even Gothic and Greek. Choices that meet the demands of the most fastidious, style-conscious writer.

Because bold is **bold**, italic is *italic*, and so on, the user can see the text on the screen

exactly the way it will look on paper. This constant visual feedback lets the user write with just the right emphasis.

To help the train of thought, The Smart Word Processor's multiple windows allow many parts of a document (or parts from many documents) to be referenced simultaneously as text is being written.

Good writing demands good editing. Changing words, rearranging paragraphs, copying between (or within) documents — even footnoting — are the stock and trade of The Smart Word Processor. It even includes a "stet" feature for undeleting (to correct editing mistakes).

And as text is added, deleted, or moved about, the "flying reform" feature makes sure that everything is reformatted, automatically.

Depending on the "confidence" level (there are three), menu options will address only the level being used. Of course, HELP can be called at any time, at any level.

The project processing feature makes organizing complex business reports a snap. Either with its own text files, or with other smart software, this word processor will remember how it's been told to prepare a document — and do it again at the touch of a key.

With the Smart Word Processor, what you see on the screen is what you get on paper.

You can make bold statements; give a unique slant to your writing; underline for emphasis; super-SCRIPT for mathematical equations ($E=mc^2$); sub-SCRIPT for footnoting₁; use ALL CAPS or SMALL CAPS.

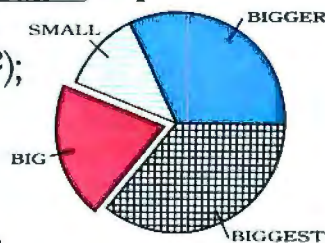

You can even wrap text around graphs for a picture-perfect look.

Because it's fully integrated, The Smart Word Processor doesn't have a problem dealing with "foreign" data, such as graphics or data files. So any information can be effortlessly retrieved from either The Smart Data Manager or The Smart Spreadsheet with Graphics (or both). Once retrieved, anything and everything can be merged with the text being processed.

For example, when used with The Smart Data Manager, the business manager can retrieve historical data to generate informative reports.

Then selected information can be summarized and used by The Smart Spreadsheet with Graphics to forecast future activity.

Finally, charts and graphs (from both historical and projected data) can be easily included in the document being prepared, either as stand alone items or surrounded by document text.

Just to round things out, The Smart Word Processor also includes a handy, on-screen calculator and a time manager/appointment scheduler. Business math calculations can be performed at any time, in a window on-screen, and inserted at any place in the document being processed. Appointments can be set, checked, re-checked, changed with the stroke of a key.

When you visit your dealer and compare the Princeton IBM-compatible HX-12 side-by-side with the IBM color monitor, your eyes will see the difference.

The HX-12 gives you higher resolution and finer dot pitch (.31mm) than the IBM 5153's medium resolution (.43mm) for a cleaner, sharper image.

Compare our full range of colors and our crisp whites without red bleed. You'll also see a difference in our non-glare screen—a feature your eyes will really appreciate in a long work session.

The Princeton HX-12 comes with a cable that plugs directly into the IBM PC, ready to burst forth into 16 superb colors. All at a suggested retail price (\$695) that's a pleasure for sore eyes and overworked budgets.

Apple IIe users: call us to learn how you, too, can now enjoy the visible superiority of the Princeton HX-12.

Ask your local dealer for a demonstration and let your eyes decide. Or call us at 800-221-1490 for more information and the name of your nearest dealer.

If you're ready to make the color graduate to the next level, the HX-12 is a high resolution color monitor.

Now available in computer stores and independent computer dealers.

Nationwide service provided by our field service company and MAJ service in New York.

PGS Princeton Graphic Systems
an International Systems Company

1101 L State Road Princeton New Jersey 08540
1609 683-1660 31X 6857009 PGS P311
800 221-1490

Circle 166 on inquiry card.

DON'T COMPROMISE:



OURS: .31mm dot pitch, 80 column text.



THEIRS: .43mm dot pitch, 80 column text.

THE PRINCETON HX-12 HIGH RESOLUTION RGB COLOR MONITOR

NEW: adapter available for PCs.

For the image
your eyes deserve.



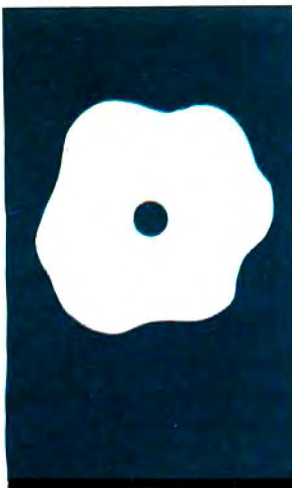

Archon

In this innovative game, animated pieces vie for control of a disputed square

BY GREGG WILLIAMS

I like games—board games, video games, word games, any kind. I browse in game and video stores the way most people browse in bookstores. I play and analyze the games I see (a lot of which come in to BYTE) and buy the few that are worth the money. I've even tried designing different kinds of games. I mention all this only to lend weight to what I'm about to say: that Archon (pronounced "ARK-on"), from Electronic Arts (see photo 1), is one of the best computer games I've ever played.

What makes a computer game good? For me, an original game concept, a strong design, and high repeat playability are all important, but I also value something many computer games don't address: appropriateness to the computer format. In other words, whether the game uses the computer to create something that couldn't be done without a computer. Sophisticated interactive adventures put the computer to good use; computer cribbage games do not.

Archon is special because it weds the strategy- and the arcade-style video game genres, and that makes for a very powerful synergistic combination. The playing pieces are mythological figures with different characteristics (photo 1). When one piece moves onto a square occupied by an enemy piece, the playing board becomes a battlefield, where the pieces battle to the death in best arcade fashion (photo 2). The object of the game is to capture five "power points" on the board or to eliminate all enemy pieces. Whether you play against another person or against the computer, you must use both strategy and arcade skills to win.

(My praise is for the Atari version of Archon. Electronic Arts is adapting the game to other machines, but I am not sure the game will play as well on other machines.)

THE BOARD

The pieces appear on a 9 by 9 playing board. Some squares are permanently dark, others are permanently light, and 33 of them (called *luminance squares*) continuously change from light to dark (through four shades of gray) and back again, one change per turn. There are five power points, one in the exact center and

one in the middle of each edge of the square board. The power points are also luminance squares; the other luminance squares trace a path from any power point to any other power point (making for a plus-sign-inside-a-diamond shape). When the game begins, the light pieces occupy the first two columns of squares and the dark occupy the last two.

THE PIECES

Each player has 18 pieces, two columns of nine each. The initial layout resembles a chess board; the innermost column consists mostly of pawn-like pieces (knights for the light side, golems for the dark), leaving the more powerful pieces behind them.

Each player has eight kinds of pieces, each with its own movement (walking, flying, or teleporting) and method of attack (throwing an object, thrusting with a short sword, or emitting a destructive circular aura). Players control piece selection, movement, and combat with joysticks. Each piece also has a fixed attack force (how damaging the attack is), attack speed (how fast the attack "moves"), attack interval (how long until the piece can attack again), and lifespan (how resistant the piece is to an attack). For example, the phoenix can fly up to five squares per turn, attacks by radiating a fireball, and has a long lifespan; its fireball is very powerful but radiates outward slowly and takes a long time to build up.

One piece on each side (the wizard on the dark side, the sorceress on the light) can cast a spell instead of moving. There are seven spells, and each can be used only once. Each spell is potent (for example, one revives a selected piece that has been killed), but you shouldn't necessarily hoard them for later use—you lose all remaining spells if your spell-casting piece gets killed.

The rule book offers a lot of information about the pieces, but be sure to read the Archon Command Summary Card packaged with the program disk. It contains information that doesn't appear elsewhere in the package.

(text continued on page 322)

.....
Gregg Williams is a senior technical editor at BYTE. He can be reached at POB 372, Hancock, NH 03449.

AS GOOD AS WHOLESALE PRICES

64K RAM Chips
(Min. 150) \$ 4.99
(Quantity Price)

IBM PC 64K FDC, 2x320KB Disk Drive, Monochrome Card, Monochrome Monitor, Parallel Port **\$2699.00**

TAVA System Unit with 128KB Memory, Floppy Drive Controller, Videoadapter, 2-320KB Slimline Drives, Monitor, Keyboard, Parallel Port & Serial Port **\$2395.00**

TAVA System Base Unit includes Power Supply, Parallel Port, Serial Port & Keyboard **\$1299.00**



TAVA 10MB System includes 128K Memory, 10MB Hard Disk Drive, Monitor, 360KB Floppy Drive, Keyboard, Parallel Port & Serial Port **CALL**

TAVA Floppy Drive Controller
\$ 199.00

TAVA Color Graphics Card
\$ 299.00

TAVA Video Adapter and Floppy Controller—Two in one \$ 499.00

TAVA Video-20 (Monitor Hi-Res) Green or Amber \$ 199.00

TAVA 320KB Disk Drive Slimline
\$ 199.00

10MB Hard Disk Sub-System
\$1595.00

Apple IIe Starter System
\$1499.00

Chassis \$ 399.00

ANI

17752 Sky Park Circle, Suite 210
Irvine, CA 92714
(714) 261-6226, 6227

AT A GLANCE

Name
Archon (Atari version)

Type
Arcade/strategy game

Manufacturer
Electronic Arts
2755 Campus Dr.
San Mateo, CA 94403
(415) 571-7171

Price
\$40

Authors
Anne Westfall, Jon Freeman, Paul Reiche III

Format
One 5¼-inch floppy disk

Number of Players
One or two

Language
Assembly language

Computers
Atari home computers with 32K bytes of memory (expanded Atari 400 and 600XL, standard Atari 800, 800XL, and 1200XL) (Also available for Apple and Commodore computers and the IBM PC.)

Documentation
A 14-page rule book, reference and command summary cards

Audience
People who want action, thinking, and human interaction in a video game

(text continued from page 321)

COMBAT

You are advised to choose the time and place of your combat well, because it is influenced by your opponent's piece, the combat history of both pieces, and the color of the square. You have an edge if your piece is "fresh" (i.e., unwounded), inherently powerful, or if it is fighting on a square of its own color. During combat, vertical bars called *lifelines* appear on both sides of the combat screen. These decrease in size every time a piece is hit (see photo 2) and tell you how close your piece is to being destroyed. The wounds from a previous battle leave a piece weakened until sufficient time passes or a "heal" spell is cast; pieces resting on power points heal faster than those on ordinary squares. Because pieces can be weakened by combat, several weak pieces, with some skill on the part of the player, can successively weaken and destroy a strong piece.

Combat is also affected by irregular barriers that appear, fade, and disappear cyclically. Depending on its solidity, a barrier can allow, retard, or prevent piece or projectile movement. To survive in the battlefield, you must make the best use of these barriers.

A final factor, square color, heavily influences combat. The lifeline of a piece is considerably lengthened if it faces combat on a square close to (or the same as) its own color—the closer the match, the greater the advantage. Regardless of your piece's strength, you'll usually want to do battle on your own color.



Archon, from Electronic Arts.

BALANCE AND DIVERSITY

Another feature that distinguishes Archon from other games is its attention to balance and diversity. Examples of its diversity are that there are two ways to win and that seven spells are available to the sorceress and wizard pieces. An example of balance is that, although opposing pieces are different from each other in shape and capabilities, neither player has an advantage.

Archon gains vitality from its diversity and playability from its balance. Without diversity, a game becomes repetitive and boring. Without balance, one player has an unfair advantage, and the game suffers.

Unfortunately, Archon suffers from an imperfect balance between arcade and strategy skills. Although the game calls on both strategy and arcade skills, it seems to favor the player with more of the latter. I know—I seem to constantly lose to the same people who beat me in arcade games.

EVALUATION

Archon can be played against either the computer or a human opponent. (In this respect, it reminds me of two of my favorite multiplayer games, M.U.L.E. from Electronic Arts and Cytron Masters from Strategic Simulations.) The version reviewed here runs on any Atari home computer with 32K bytes of memory (an expanded Atari 400 or 600XL or a standard Atari 800, 800XL, or 1200XL). I wish the authors had made it a 48K-byte game and used the extra 16K to provide some variant games, differently skilled computer opponents, or some kind of handicapping. The computer opponent is unmercifully skillful, making the single-player game an exercise in good sportsmanship (how can you be a good sport when you lose to a computer?). Some Archon players claim they can consistently beat the computer—I'd be interested in knowing how.

Archon's authors, Anne Westfall, Jon Freeman (cofounder of Automated Simulations and author of the award-winning game Temple of Apshai), and Paul Reiche III, all of Freefall Associates, are to be thanked for their contribution to the gaming community. (They're said to be working on a sequel, Archon II.) Electronic Arts deserves praise as well for its superior game packaging and rule book, which make a good game even

more enjoyable, and for the exceptionally high standards that mark this and other Electronic Arts products.

Although Archon would be better if it had some game options and if it

placed less of an emphasis on arcade skill, it is still a great game: fun, yet not mindless; involved, yet not hard to learn; and rewarding and varied enough to be played again and again. ■



Photo 1: The chess-like strategy board of Archon. When two pieces meet on the same square, the action transfers to a combat battlefield (see photo 2).

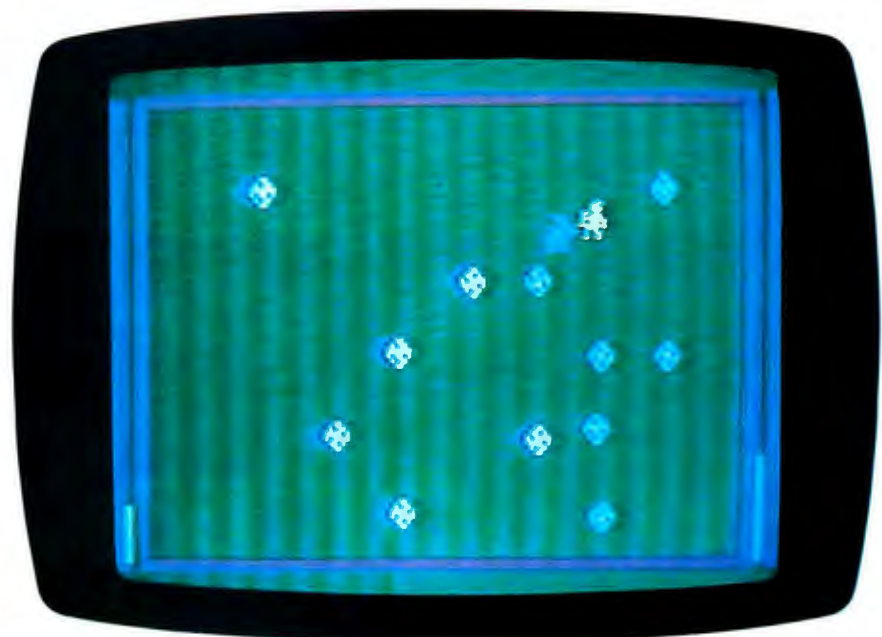

Photo 2: The Archon battlefield. Here, a dark goblin prepares to strike a light knight.

EPSON



EPSON LQ-1500

Minor miracle.

Absolut

You've never seen anything quite like the new Epson LQ-1500 Business Printer. It switches effortlessly back and forth between draft and letter-quality printing, on fanfold* or single sheet paper. And it does it at a price every office can afford.

Two for one.

With the LQ-1500 in draft mode, you can race

through a report at 200 characters per second. Then switch over to letter quality and polish off a pile of correspondence four times faster than the average daisy wheel.

Need graphics? The LQ-1500 gives you business charts with a crispness and definition you wouldn't think possible in a dot

matrix. And with the LQ-1500's 15.5-inch carriage, your spreadsheets and ledgers can take on a distinction they've never had before.

The secret.

The Epson LQ-1500 is the logical extension of Epson's outstanding dot matrix printers. Instead of nine "wires" forming each letter, however, the LQ-1500 has 24. So you get letter-quality characters to rival fine office typewriters. In proportional. Italic. And condensed, expanded, subscript, superscript and over 200 other different typefaces. All without changing a print wheel. With the LQ-1500, you can even create 128 characters or symbols of your own and add them to the printer's internal memory.

String of miracles.

For Epson, the LQ-1500 is just one more in a long line of miracles, many of which are also on display at your neighborhood computer dealer.

And like all products in the Epson line, the LQ-1500 is now backed by a one-year warranty on parts and labor, ready to go to work with just about any personal computer made, and available in more places than any other brand.

But that's not really miraculous. That's just Epson.

Or how Epson® got two astonishing printers to occupy the same space. The new LQ-1500.™

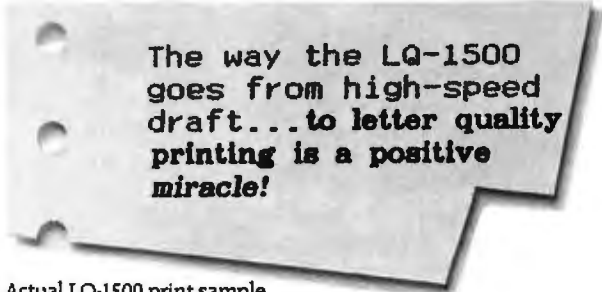

The way the LQ-1500 goes from high-speed draft... to letter quality printing is a positive miracle!

Actual LQ-1500 print sample.

Number one. And built like it.

EPSON
EPSON AMERICA, INC.

3415 Kashiwa Street, Torrance, California 90505

Call (800) 421-5426 for the Epson dealer in your area. In California call (213) 539-9140.

Epson is a registered trademark and LQ-1500 is a trademark of Epson America, Inc.

*With optional tractor unit

Circle 131 on inquiry card.

SemiDisk™ and SemiSpool:™ SURE-FIRE WAIT-REDUCTION!

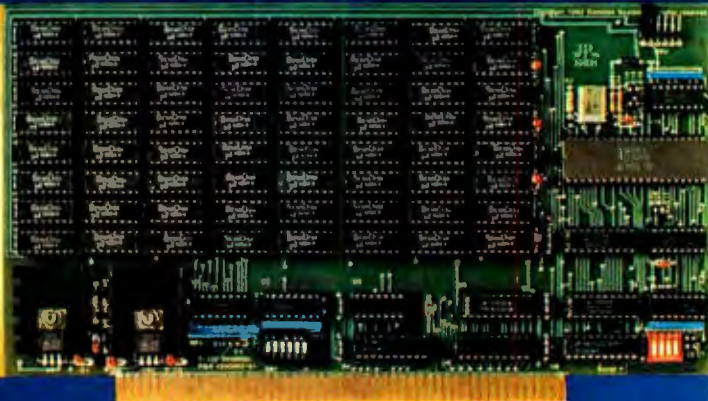

512Kbyte SemiDisk™ I \$1095

Time was, you thought you couldn't afford a SemiDisk. Now, you can't afford to be without one.

	<u>256K</u>	<u>512K</u>	<u>1Mbyte</u>
SemiDisk I, S-100	\$895	\$1095	\$1795
IBM PC		\$1095	\$1795
TRS-80 Model II		\$1095	\$1795
SemiDisk II, S-100		\$1395	\$2095
Battery Backup Unit	\$150		

Time was, you had to wait for your disk drives. The SemiDisk changed all that, giving you large, extremely fast disk emulators specifically designed for your computer. Much faster than floppies or hard disks, SemiDisk squeezes the last drop of performance out of your computer.

Time was, disk emulators were afraid of the dark. When your computer was turned off, or a power outage occurred, all your valuable data was lost. But the SemiDisk changed all that. Now, the optional Battery Backup Unit helps take the worry out of power interruptions. It keeps the SemiDisk powered for up to 5 hours during a power failure.

Time was, you had to wait until your printer finished printing to use your computer. That's changed, too. Now, the SemiSpool print buffer in our Version 5.0 software, running under CP/M 2.2, frees your computer for other tasks while your data is printing. With a capacity up to the size of the SemiDisk itself, you could implement an 8 Mbyte spooler!

But one thing hasn't changed. That's our continuing commitment to supply the fastest, highest density, easiest to use, most compatible, and most cost-effective disk emulators in the world.

SemiDisk.
It's the disk the others are *still* trying to copy.

SemiDisk Systems, Inc.

P.O. Box GG Beaverton, OR 97075 (503) 642-3100

Call 503-646-5510 for CBBB®/NW, a SemiDisk-equipped computer bulletin board. 300/1200 BAUD
SemiDisk trademark of SemiDisk Systems, Inc. Copyright © 1983 SemiDisk Systems, Inc. CP/M Trademark Digital Research.

Circle 295 on Inquiry card



NO WAITING

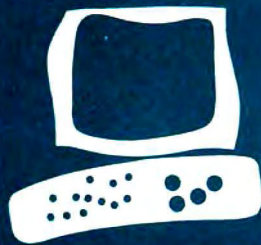

The Chameleon Plus

It's a good
mimic of the
IBM Personal
Computer,
but its
packaging
needs revision

BY RICH KRAJEWSKI

The Chameleon Plus is an enhanced version of the Chameleon, an IBM PC-compatible that was announced in 1982. Like the \$1995 Chameleon, the \$2895 Chameleon Plus is a portable computer that can run three different operating systems: MS-DOS, CP/M-86, and CP/M-80. Seequa Computer Corporation, based in Odenton, Maryland, designed the Chameleon Plus to be compatible with MS-DOS and IBM Personal Computer software in particular.

After using the Chameleon Plus for three months, I've come to believe that Seequa has almost succeeded. I loaded a wide variety of software—all marked "for the IBM PC"—into the Chameleon Plus, and it ran most of it without complaint or mistake.

The Chameleon Plus is intended for business people who want a computer and enough software to get running, and who want IBM compatibility, but who don't necessarily want an IBM. These people are willing to trade the security of the IBM name for a lower price. Hobbyists will reject the Chameleon Plus because it has no built-in expansion capability. Home computerists will be turned off by the price, which is lower than that of an IBM PC but is still too high for the home market.

The original Chameleon had only single-sided floppy-disk drives and 128K bytes of memory. The price of the Chameleon Plus includes 256K bytes of memory; a 9-inch green monitor; two 5¼-inch, double-sided floppy-disk drives; an IBM-style keyboard; a serial port; a parallel printer port; a 5-MHz 8088 microprocessor; and a 2.5-MHz Z80A microprocessor. In the software department you get MS-DOS version 1.25, Perfect Writer, Perfect Calc, Perfect Speller, and Microsoft's BASIC-86.

The Condor I database program and the GW BASIC interpreter are supposed to come with the machine, too, but so far Seequa has been substituting IOUs for these programs. Can you imagine buying a computer system that's supposedly bundled with software and getting an IOU instead of the software? Strangely enough, that's happening.

THE CASE OF THE CHAMELEON PLUS

Before I opened the Chameleon Plus, I had to

carry it home. Let me tell you, that machine is heavy—28 pounds heavy. I could probably have endured the weight if it weren't for the handle, which is cold, poorly shaped, and no friend to hands. If you grab the handle just a little off center, the machine tries to wrench itself out of your hands. The solution, if you do buy one of these things, or if your uncle gives you one for your birthday, is to purchase a Kaypro carrying bag. I've heard from reliable sources that the Chameleon Plus fits just dandy into it, and it makes toting the machine a bearable task.

The Chameleon Plus opens as shown in photo 1: place your finger between the latch and the knob, then pull the latch out and up. Notice in the photo how the finger strains. This latch was definitely not designed for arthritic hands, nor was it designed for frequent openings and closings. I would pass up the Chameleon Plus (as well as its fewer-featured relative, the Chameleon) because of that latch. There are plenty of inexpensive, easy-to-open latches available for a manufacturer to choose from. Why did Seequa purposely choose such a rotten one? I hope that someday the product designers at Seequa will replace this painful latch with a small, easy-to-open, metal latch.

And while they're doing that, they ought to redesign the case of the machine. It's a metal case, which has the virtue of durability, but unfortunately it mars the furniture. The unit does have some tiny rubber pads on its bottom, but they help only when the machine is lying flat. When you prop it up on its carrying handle, the case's unprotected rear edge engraves designs on your desk.

The display screen is like any other good monochrome display: it has fine contrast, a sharp 80-character by 25-line image, and comfortable brightness. It can also show high-resolution graphics with its 640- by 200-pixel matrix. Unlike good displays, though, this one tends to waver: the characters start undulating every so often, which is not on my list of desirable display characteristics. I suspect the

(text continued on page 328)

.....
Rich Krajewski is a technical editor at BYTE. He can be reached at POB 372, Hancock, NH 03449.

(text continued from page 327)

problem is an inadequate or poorly regulated power supply, but the system is no less guilty for that.

The Chameleon Plus has an outlet for connection to a composite color monitor. As with the IBM PC, the Chameleon Plus can display 16 different colors in the text, with up to 4 on the screen at one time in medium-resolution graphics mode. According to the *Chameleon Plus User's Manual*, the Chameleon Plus has 16K bytes set aside for display memory, which is enough to handle one screen of graphics.

The keyboard (made by Key Tronic) is much like the IBM PC's, except that the Chameleon Plus's keys are springier. It took me a while to get used to the different feel. Two improvements it has over IBM's keyboard are the Caps Lock key and Num Lock key indicator lights, which tell you when these keys are active.

The Chameleon Plus has an 8088 microprocessor (which has a 16-bit internal and an 8-bit external data path) and a Z80A microprocessor (which has 8-bit internal and external data paths). This lets the Chameleon Plus tap two major sources of business programs—the IBM PC world and the CP/M-80 world. At least it does *theoretically*. In real life, though, it is more an IBM work-alike than an 8-bit CP/M machine, as I'll explain



Photo 1: Opening the Chameleon Plus can result in digital pain.

later in this article.

The Chameleon Plus comes with 256K bytes of RAM (random-access read/write memory) and 16K bytes of ROM (read-only memory). The ROM contains initialization, booting, and some diagnostic routines. (It does not contain a BASIC interpreter as the ROM in the IBM Personal Computer does, but the intended market for the Chameleon Plus—business people—will probably not care.) According to Seequa, technically knowledgeable users can add 80K bytes of extra ROM to the Chameleon Plus for special applications. Seequa claims that extra RAM can be added, too, with an external expansion box. I have not seen the expansion box (and, it appears, neither has anyone else), so I don't know how it affects the operation or portability of the computer. It can't make carrying the Chameleon Plus any easier. Without the expansion box, you won't be able to expand memory, but 256K bytes of RAM is enough for most of today's personal computer applications.

The two double-sided, double-density disk drives that come with the machine, the same kind used in many IBM PCs, hold 320K bytes each with the version of MS-DOS that is provided. If you buy MS-DOS version 2.0 (which you'll probably have to buy from IBM because Seequa doesn't yet offer it), you'll be able to store 360K bytes on each drive.

Every computer should have one parallel port for connection to a printer and one RS-232C serial port for connection to a modem. The Chameleon Plus comes with these two ports standard. The utility program called Option lets you configure the ports, direct data from one port to another, set the speed of data transmission, and change the protocol of the data. For example, you can tell the computer to send printer output to the serial port at 1200 bits per second, with even parity, 7 data bits, and 1 parity bit.

A drawback of the ports is their lack of labeling. Once again, Seequa has made a packaging error. To be sure, this is a drawback that is easy to overcome, but only with the help of a dealer or the user's manual. It is a nuisance that Seequa could have easily avoided.

The power supply is designed to operate with either 110- or 220-volt power, but your dealer must make the switch for you. Seequa advertises an op-

tional battery pack for the computer, but a spokesman for the company told me that it's not yet available. I have no idea how long the battery pack will take to recharge or how long it will provide power, but guess what? Seequa doesn't know either.

THE MYSTERY OF THE MISSING OPTIONS

Seequa advertises several options for the Chameleon Plus: the expansion chassis, extra RAM, the battery pack that I've already mentioned, a hard disk, a second asynchronous-synchronous serial port, an IEEE-488 bus port, an analog-to-digital converter, an RGB (red-green-blue) color-monitor interface, and an 8087 math coprocessor. On the software side you can purchase two additional operating systems, CP/M-86 and CP/M-80.

This is an admirable selection of options that, surprisingly, seems geared to the scientist. For instance, the analog-to-digital converter is certainly not for business applications. The converter, the IEEE-488 bus port (which controls scientific instruments), and the 8087 math coprocessor are for the laboratory.

Though this is an admirable selection, it is also a misleading one: two dealers I spoke with said that they did not have in stock the expansion box nor about half of the other options. One said that the expansion box was not available, while the other said that he could order one for me. Whom to believe? I called Seequa, and a spokesman confirmed that the options in question were not available (see the "At a Glance" box on page 329), but he promised that eventually they would be. This leaves the last chapter in this mystery unwritten, for we do not know if Seequa's promise will be fulfilled. We shall have to wait and see.

You could, of course, tell yourself that you don't need options: the Chameleon Plus can handle the usual applications programs—word processors, spreadsheets, databases—without accessories.

SOFTWARE

MS-DOS version 1.25, standard on the Chameleon Plus, works exactly like PC-DOS version 1.1 as far as the business user is concerned. You can also buy CP/M-80 and CP/M-86. If you want, you can buy PC-DOS version 2.0 from an

(text continued on page 332)

AT A GLANCE

Name
Chameleon Plus

Manufacturer
Seequa Computer Corp.
8305 Telegraph Rd.
Odenton, MD 21113
(301) 672-3600 or
(800) 638-6066

Components

Size: 8 by 18 by 15½ inches

Weight: 28 pounds
Processor: 5-MHz 16-/8-bit 8088 and 2.5-MHz 8-/8-bit Z80A

Memory: 256K bytes
Display: 9-inch diagonal, green phosphor, built-in monitor; 80 characters by 25 lines; nonadjustable; composite color video jack

Keyboard: IBM PC-style
Mass storage: Two 5¼-inch floppy-disk drives, 320K bytes each

Expansion capability: None

I/O interfaces: One RS-232C serial port and one parallel printer port

Software

MS-DOS 1.25, BASIC-86, GW BASIC, Perfect Writer, Perfect Calc, Perfect Speller, Condor I, C-term communications program

Optional Hardware

Second RS-232C port \$49
4-channel, 8-bit analog-to-digital converter \$49
RGB monitor interface \$49
8087 coprocessor \$320

Optional Software

CP/M-80 version 2.2 \$150
CP/M-86 \$60
Perfect Filer (runs under MS-DOS) \$495

Documentation

User's manual, 147 pages;
MS-DOS, 154 pages;
Microsoft BASIC, 69 pages;
BASIC reference guide, 149 pages;
Perfect Writer/Speller, 377 pages;
Perfect Calc, 346 pages

Price

\$2895

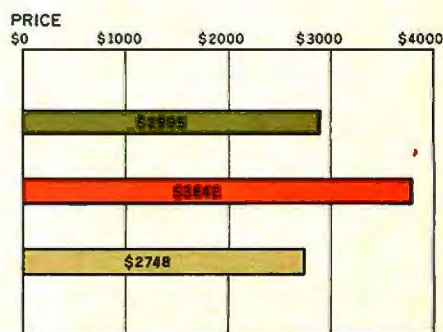
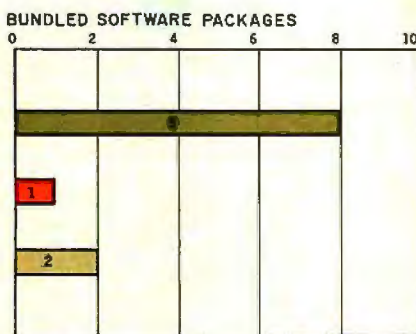
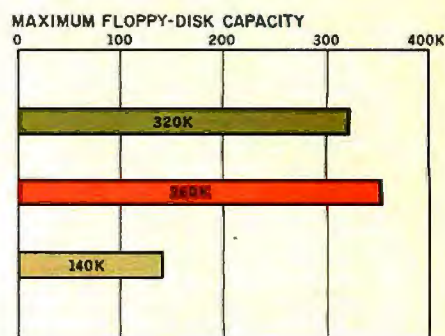
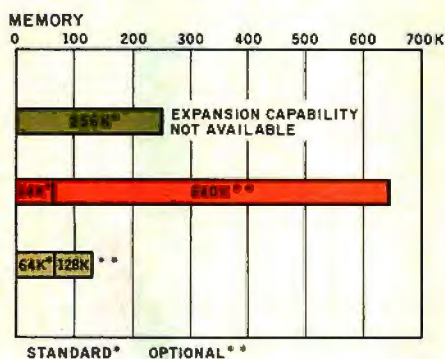

■ CHAMELEON PLUS ■ IBM PC ■ APPLE IIe

The memory graph shows the standard and optional memory available for the computers under comparison. The graph of disk storage capacity shows the highest capacity of a floppy-disk drive on each of the computers. The bundled software graph shows the number of software packages that are included with the system. The price graph shows the costs of the Chameleon and the IBM PC with two 5¼-inch, double-sided, double-density, floppy-disk drives; a monochrome monitor with connection apparatus; color-display capability; a printer port and a serial port; 256K bytes of memory; the standard operating systems for the computers being compared; and their standard BASIC interpreters. The Apple IIe includes a monochrome monitor, two disk drives, 64K bytes of memory, and a printer port and a serial port.

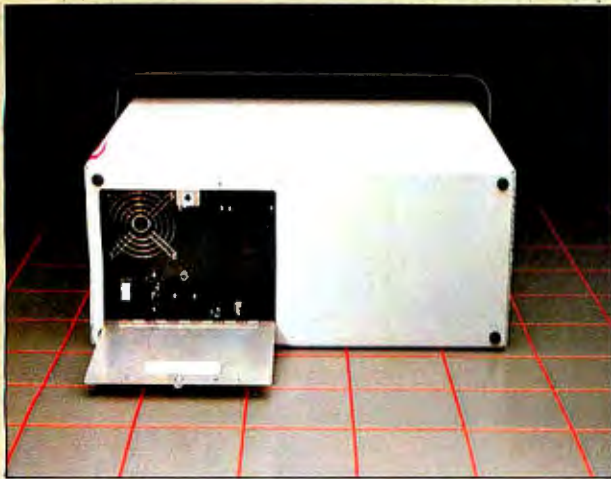

The rear of the Chameleon Plus, pictured on a 4-inch grid. Notice the lack of labels and the trap door.

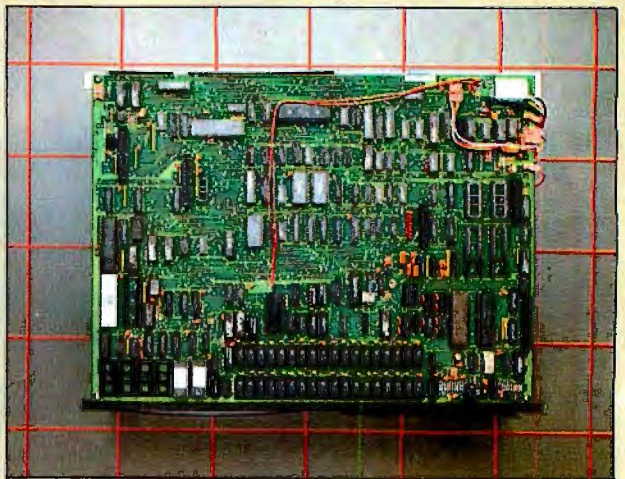

The top of the Chameleon Plus with the cover removed. Servicing the unit should be easy because of the accessibility of the components. Unfortunately, there is no room for expansion.

DISK ACCESS IN BASIC

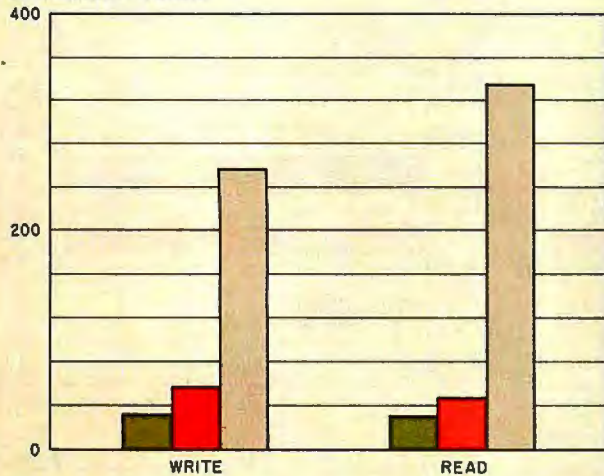

BASIC PROGRAM PERFORMANCE

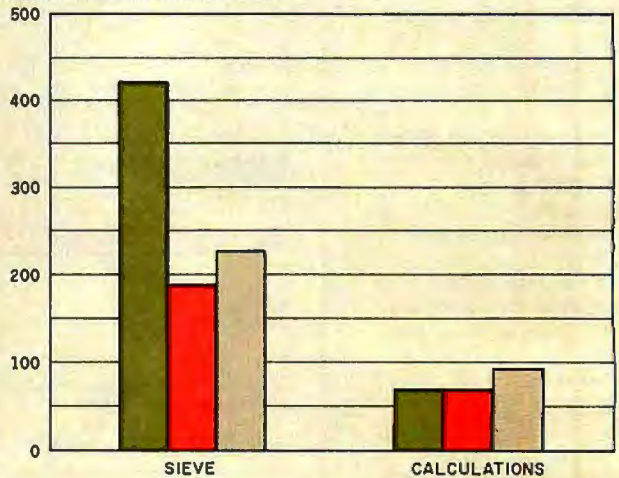

SYSTEM UTILITIES

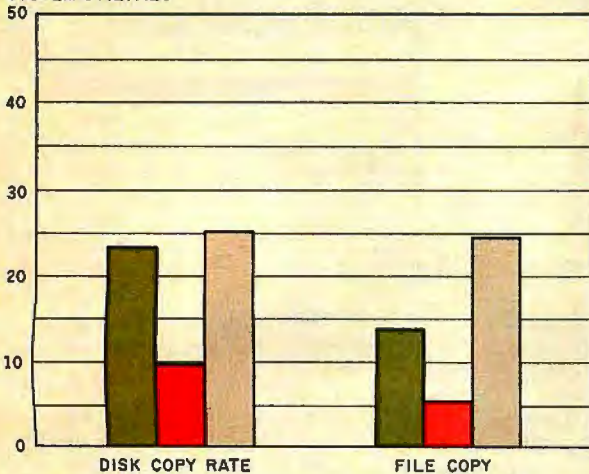

SPREADSHEET (MULTIPLAN)

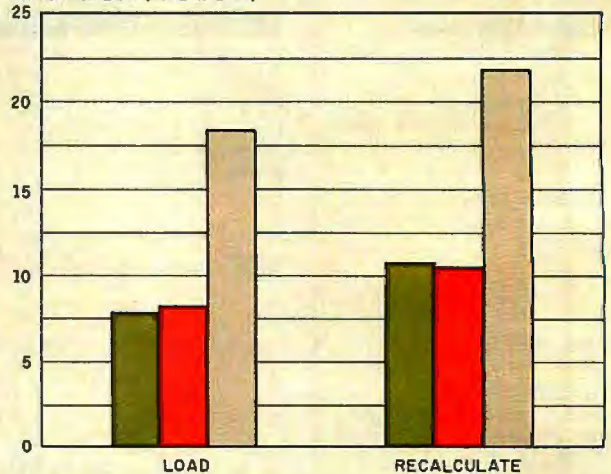

■ CHAMELEON ■ IBM ■ APPLE

The graphs of BASIC program performance and disk access in BASIC show the times for running the benchmarks in listings 1 and 2. The system utilities graphs show how long it took to format and copy a disk (adjusted for 40K bytes of disk data) and to transfer a 40K-byte file using the system utility programs. The spreadsheet graph shows how long the computers took to load and recalculate a 25- by 25-cell spreadsheet using Microsoft's Multiplan.

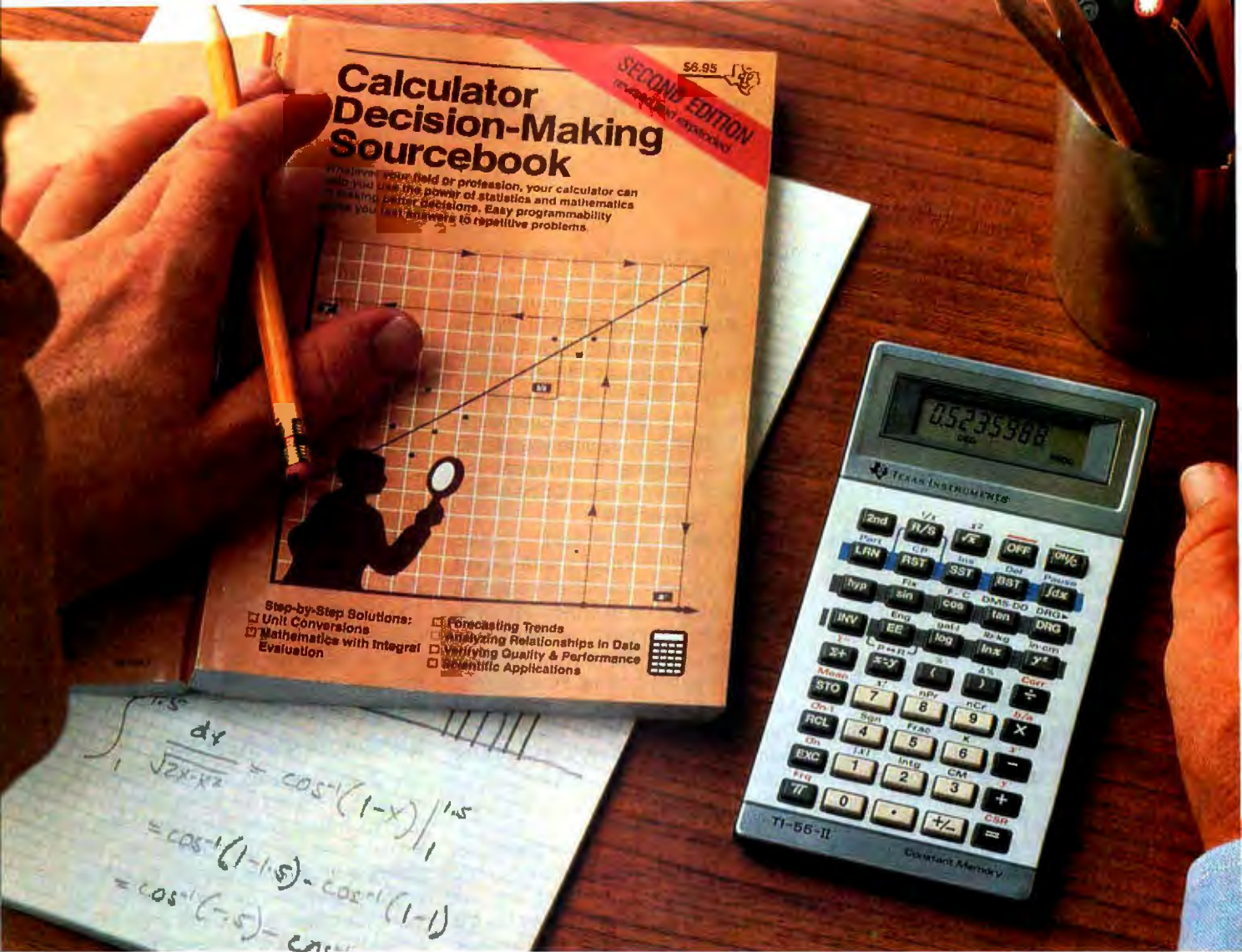

How the TI-55-II makes short work of long problems.

Whenever you can solve complex problems quickly and accurately, you're ahead of the game. And that's exactly what the TI-55-II does for you. By giving you 112 pre-programmed functions (like definite integrals), it allows you to take short cuts without losing accuracy. You'll accomplish a lot more in less time which means increased efficiency.

With our TI-55-II you can tackle problems you thought could only be solved with higher-priced programmables. You're not only getting the standard slide rule functions but also statistical

capabilities. This way you can work out linear regressions, permutations and combinations, just to name a few.

The TI-55-II also gives you enough programmability to eliminate a lot of repetitive key punching. Our Constant Memory™ keeps programs and data on tap, even when the calculator is turned off. So once you've entered a formula, you can simply put in the variables to get your solution. The Liquid Crystal Display shows your answers in standard, scientific or engineering notations — clearly and precisely.

We also help you get the most

out of your calculator with the Calculator Decision-Making Sourcebook. It gives you step-by-step examples of the best techniques used for solving mathematical, scientific and statistical problems. And we've included a special section on how to program your TI-55-II.

So next time you're facing another time-consuming problem, cut it down to size with the TI-55-II.



TEXAS INSTRUMENTS
Creating useful products and services for you.

(text continued from page 328)

IBM PC dealer. PC-DOS 2.0 gives you the advantage of additional disk space and slightly faster disk access time. It runs with no glitches on the Chameleon Plus, as far as I can tell. The only problem in the MS-DOS department is the TIME command. In either version of MS-DOS, TIME keeps terrible time; it loses about 2 seconds every minute. This means that programs that rely on time updates will run poorly.

Currently, Seequa provides BASIC-86 with the Chameleon Plus. This lets you run most IBM BASIC programs that do not use graphics. Seequa promises to send GW BASIC to its customers one of these days. GW BASIC, I understand, is completely compatible with IBM BASICA, but I haven't seen it yet.

The word-processing programs that come standard with the Chameleon Plus, Perfect Writer and Perfect Speller, are similar to other word-processing programs and are perhaps better. These two programs have a number of advanced features that you would expect to find on a dedicated word processor. For instance, Perfect Writer has commands that let you transpose words or letters. Most other word-processing programs require that you either type the items over again or use the command for moving blocks. However, these simpler programs are also simpler to learn than Perfect Writer and Perfect Speller.

Perfect Calc is a spreadsheet program that's also standard with the Chameleon Plus. I would rate it as average because there are several more sophisticated spreadsheets on the market (for example, Lotus 1-2-3).

As for the optional CP/M-80 operating system, a surprise awaits you: Seequa's version of CP/M-80 does not open the world of CP/M-80 software to you. At best, it lets you get your toe in the door. But in no way could anyone say it leaps ahead of you, opens the door wide, and bows low when you pass through; Seequa's version of CP/M can read only disks that are in the IBM PC CP/M-86 format. And good luck finding CP/M-80 software in CP/M-86 format. Even Seequa doesn't sell any. I understand Zenith Data Systems may carry some 8-bit software in this format, but what a patch quilt. I'd rather have a guaranteed source of software.

In its helpfulness, Seequa gives you the

name and address of a company that sells a disk-translation program, called Crossdata, for \$99. The program enables your computer to read different disk formats. So, if you want to "run software from the vast library of CP/M-80 software currently available," as Seequa's ads say you'll be able to do with its Chameleon Plus, you'd better make sure your dealer stocks the software in a format the Chameleon Plus can read. Or be willing to spend another \$99.

One Chameleon Plus dealer I spoke with said that he could transfer most CP/M-80 software onto Chameleon Plus disks. This is a point to remember if you intend to buy this machine—make sure the dealer can help you get CP/M-80 software if you plan to use 8-bit software. Actually, I talked to a couple of Chameleon dealers about this and they claimed that there is very little call for Chameleon Plus 8-bit software.

PERFORMANCE

The "At a Glance" box shows the results of a comparison of the Chameleon Plus, the IBM PC, and the Apple IIe. The BASIC benchmarks that I used to test the disk access and program performance of the computers are shown in listings 1 and 2. The benchmarks for system utilities and standard spreadsheets are quite different from our previous benchmarks and require some explanation.

Since much computer time is spent transferring files from disk to disk, I measured how quickly the system utilities (DISKCOPY, COPY, etc.) of the three computers were able to perform this function. The results are presented in the system utilities graphs. I also tested how quickly the machines ran a popular applications program, Multiplan.

Before you start writing letters to me, let me say I know that the times I measured are functions of the computer, the applications program, the operating system, and the test files. I know that if I had used different programs or files, the times might have been faster or slower. Don't get upset because you feel that your favorite applications program would have done the job better. This is not a comparison of applications programs; this is a comparison of computer systems. The numbers are for comparison only—to demonstrate whether one computer saves more time than another in typical applications.

I placed the test files on otherwise blank disks to avoid unknown delays due to random disk file arrangement. The applications program was in drive A, the test file in drive B. I always began timing from the last keystroke needed to begin the action under test; I stopped timing when the cursor reappeared.

I did the spreadsheet tests on a 25- by 25-cell spreadsheet. I didn't use the spreadsheet provided with the Chameleon because I wasn't as familiar with it as I am with Multiplan.

The IBM PC I used had 256K bytes of RAM on its motherboard and another 256K bytes on a QuadRAM board. I did not use any of the QuadRAM software, but that does not mean the board did not affect the operation of the IBM. The PC also had an IBM monochrome board.

IMPROVEMENTS NEEDED

The Chameleon Plus is basically a good machine. It served me well for the three months I used it. As a matter of fact, I wrote much of this review on the Chameleon Plus. However, as you've probably gathered by now, I feel that the machine could use a bit of improving. It needs a padded, balanced handle; a nondestructive case; a small, metal latch; a copy of Crossdata or a similar program thrown in when you buy CP/M-80; labeled I/O ports; and no IOUs. And Seequa ought to stop advertising accessories that aren't available and, indeed, may never be.

If Seequa doesn't or can't include Crossdata, then I think it ought to offer 8-bit applications software with the proper disk format for the Chameleon Plus. With the recent introduction of the IBM Portable Computer, Seequa will have to work extra hard to stay competitive; providing a convenient source of 8-bit software is one way to do it.

DOCUMENTATION

I received my first version of the Chameleon Plus several months ago. With that first machine came a typographically hard-to-read and incomplete manual that was utterly useless. Nevertheless, I thought that the machine itself was very useful. Before the latest version of the Chameleon Plus arrived, I was going to recommend to you cognoscenti who read BYTE that you shouldn't let the bad documentation steer you away from

(text continued on page 334)

Top Modem



The best price/performance ratio of any 212A modem on the market today for under \$500! That puts ProModem 1200 on top of the stack. Compare the 26 features. You'll see why. Only ProModem offers all 26. 15 are exclusive.

They're important features. The Real Time Clock/Calendar for example. Used with Applications Programs, or the OPTIONS PROCESSOR, gives you pre-set timed operation of the modem. Also, time and duration records of all calls. The convenient HELP command makes ProModem easy to use. It promptly displays the Instructions Menu whenever there's a question about what to do next. With Call Progress Detection, you can "tell" ProModem to do things like automatically "Redial When Busy."

It's the only modem that lets you expand into a full telecommunications center with add-ons. The OPTIONS PROCESSOR gives you Data Store and Time Base Continuity with battery backup, Personal/Business Telephone Directory, and Automatic Receipt/Transfer Buffer, expandable to 64K. The OPTIONS PROCESSOR also enables ProModem to operate unattended, with or without your computer.

The optional 12-character ALPHANUMERIC DISPLAY indicates modem operating status, system diagnostics, message status, phone numbers, and real time clock data. . . to name just a few.

Together, these standard and optional features give you a sophisticated electronic mail and communications capability unmatched by any other modem in this class. And, there's more. See your local dealer for additional information and a demonstration. He'll show you why ProModem 1200 is tops.

ProModem 1200 from ...

PROMETHEUS

Prometheus Products, Inc., 45277 Fremont Blvd., Fremont CA 94538, (415) 490-2370

NOW AVAILABLE

*IBM PC ProModem plug-in card

*ProCom Software

212A Modem Comparison Chart *

STANDARD FEATURES

300/1200 Baud (212A)	✓	✓	✓	✓	✓
Intelligent Microprocessor	✓	✓	✓	✓	✓
Tone and Pulse Dialing	✓	✓	✓	✓	✓
Hayes Command Compatible (Works with Smartcom™)	✓	✓	✓	✓	✓
Additional telephone jack with exclusion switching	✓	✓	✓	✓	✓
Analog loop back self test	✓	✓	✓	✓	✓
Self Test at Power Up	✓	✓	✓	✓	✓
Call Progress Detection (Busy, Dial Tones, Trunk Busy, etc.)	✓	✓	✓	✓	✓
Speaker and External Volume Control	✓	✓	✓	✓	✓
Full Complement of Status Lights	✓	✓	✓	✓	✓
8 Switch Selectable power-up defaults	✓	✓	✓	✓	✓
Adaptive Dialing	✓	✓	✓	✓	✓
Auto Redial on Busy	✓	✓	✓	✓	✓
Ergonomically designed easy to read front display panel	✓	✓	✓	✓	✓
Internal Stand-Alone Power Supply	✓	✓	✓	✓	✓
Built in Real Time Clock/Calendar	✓	✓	✓	✓	✓
Help Command	✓	✓	✓	✓	✓
300 baud connect while maintaining 1200 baud RS-232 link	✓	✓	✓	✓	✓

PRO

ANCHOR 1200

NOVATION SMARTCAT

HAYES STACK

US ROBOTICS PASSWORD

EXPANDABLE OPTIONS

Automatic Receiver Buffer	✓
Automatic Transmit Buffer	✓
On-board Personal/Business Directory	✓
Buffer, Expandable to 64K	✓
Auto Logon Macros	✓
Auto message transmission to groups of numbers	✓
Records call duration	✓
12-character Alphanumeric Display	✓

*Comparison made by Prometheus on the basis of the best information available to Prometheus at time of printing.



(text continued from page 332)

this computer because, for most purposes, all you have to do is buy a book about how to use the IBM PC and you'll learn how to use the Chameleon Plus. The difference in price between the IBM and the Seequa more than makes up for the additional cost of the books.

Fortunately, all that rigmarole is no longer necessary because the Chameleon documentation has been improved tremendously. The manual now includes unpacking and setup instructions, as well as enough information to get you started on the applications software.

The documentation for the optional CP/M-80 operating system is another story. The CP/M-80 user's manual supplied with the Chameleon Plus version of CP/M-80 is just a reprint of Digital Research's *CP/M Operating System Manual*. It is far from being a "user's guide"; it is, instead, a programmer's guide. The average purchaser of the Chameleon Plus with the CP/M-80 option will be on his own when it comes to using CP/M-80. Fortunately, several good CP/M-80 guides are available, but it's disappointing to be left in the lurch by Seequa.

THE MANUFACTURER

Seequa Computer Corporation has been in existence since 1979. It is a privately owned corporation. The firm seems to be growing, but that may change with the introduction of the IBM Portable Computer. If the company were to fold, the dealers that sold the Chameleon Plus will not, so you will probably still be able to obtain service for the machine. The Chameleon Plus uses no unique components as far as I can tell, so replacing parts should not be a problem. Of course, even if the IBM Portable becomes a big success, Seequa may still survive.

SERVICE

According to the warranty, service for the Chameleon Plus is available from authorized Seequa dealers. The machine has a warranty for 90 days. Since you know that all computers break eventually, you ought to check with your local dealer to find out what the repair costs might be. It may help swing your purchase decision either toward or away from the Chameleon Plus.

(text continued on page 336)

Listing 1: The IBM PC and Chameleon Plus benchmark programs.

LISTING 1

```
5 REM: THE DISK WRITE BENCHMARK FOR THE IBM PC
40 AS="12345678123456781234567812345678"
60 BS=AS+AS+AS+AS
80 NR=512
100 OPEN "b:test" FOR OUTPUT AS #1
140 FOR I=1 TO NR
180 PRINT #1, BS:
200 NEXT I
220 CLOSE
240 PRINT "DONE"
```

```
5 REM: THE DISK READ BENCHMARK FOR THE IBM PC
10 NR=512
20 OPEN "b:test" FOR INPUT AS #1
30 FOR I=1 TO NR
40 BS=INPUT$(128, I)
50 NEXT I
60 CLOSE
70 PRINT "done"
```

```
5 REM: THE SIEVE BENCHMARK
10 SIZE = 7000
20 DIM FLAGS(7001)
30 PRINT "start one iteration"
40 COUNT=0
50 FOR I=0 TO SIZE
60 FLAGS(I)=1
70 NEXT I
80 FOR I=0 THEN 170
90 IF FLAGS(I)=0 THEN 170
100 PRIME = I+1+3
110 K=I+PRIME
120 IF KSIZE THEN 160
130 FLAGS(K)=0
140 K=K+PRIME
150 GOTO 120
160 COUNT=COUNT+1
170 NEXT I
180 PRINT "done: ";COUNT;" primes found"
```

```
5 REM: THE CALCULATION BENCHMARK
10 NR=5000
20 DEFSNG A-Z
30 A = 2.71828
40 B=3.14159
50 C = 1
60 FOR I=1 TO NR
70 C=C*A
80 C=C*B
90 C=C/A
100 C=C/B
110 NEXT I
120 PRINT "done"
130 PRINT "error = ";C-I
```



C.ITOH ELECTRONICS HAS SOME NEW IDEAS ABOUT DOING BUSINESS IN THE WORLD.

We've long recognized that success in today's ever-changing marketplace requires a willingness to try something new. To bring the technology of marketing up to the technology of the 80's.

At C.Itoh Electronics, that means more than offering the latest product advancements. It means using the innovative marketing and capital resources necessary to bring those products to the world.

That's why, from the very beginning, C.Itoh Electronics has consistently maintained a strategy of total involvement in the high technology electronics industry. This includes marketing a wide variety of industrial electronic products, while at the same time, engaging in research

and development, cross licensing and venture capital investing.

In addition to developing and marketing its own unique products, C.Itoh Electronics buys products from many international manufacturers and sells them through U.S. sales offices, sales representatives, distributors and OEM's. More than 10 Japanese manufacturers who market their products in the U.S. are currently represented.

C.Itoh Electronics also procures products from more than 30 U.S. based manufacturers and markets them worldwide, mainly to Japan, where these products are then distributed through C.Itoh's affiliate companies. C.Itoh Electronics is always searching for new product

ideas to develop and bring to market.

No other company is better at bringing high technology to market. Perhaps, because in addition to exploring new ways of doing business, few other companies can draw on the experience and global resources of C.Itoh & Co., Ltd., our parent company. This multi-national organization has more than 125 years of business experience and thousands of employees linked through a worldwide network of 181 offices in 81 nations. These include 41 offices in Japan and 403 affiliated companies around the world—with annual sales exceeding \$50 billion.

It's no wonder that when it comes to bringing high technology to market, C.Itoh Electronics has the best ideas.

C.ITOH ELECTRONICS
A World of Quality

(text continued from page 334)

The two dealers I talked to offer repair service. Dealer A offered a service contract for \$245 per year; dealer B said he did not offer such a contract, but said he would replace inoperative parts at price plus a "small markup." He couldn't tell me what the small markup would be. I am not a suspicious man, but I tend to shy away when facts cannot be given. You would be wise to do the same.

AVAILABILITY

Certainly availability is a factor in deciding which computer to buy. At press time, the two dealers I spoke with said that Chameleon Plus computers were available. Seequa recently moved into larger quarters and expanded its work force to keep up with demand.

I also asked the dealers if they like the machine, its manufacturer, and if the machine is selling well. One said he sells 10 Chameleons for every 1 Columbia portable microcomputer. According to him, "Columbia doesn't care about its dealers or customers. Seequa has been more responsive. Seequa has had problems, but everybody is going to have startup problems." He said that the Chameleon also sells better than the Eagle, the Morrow, and the NEC APC, all of which he offers.

Here, I thought, is a testimony for Seequa. But further questioning cast doubt on its validity. "Do you," I asked, "make more money when you sell a Chameleon than when you sell one of the other brands?" I had him there. "Yes," he conceded, "but not always, and even when I do make more, it is only a small amount more."

SUMMARY

On its plus side, the Chameleon Plus is a reliable machine that offers more features and a lower price than the IBM Personal Computer. On the minus side, it is hampered by several errors in ergonomics and support—the case, the latch, and the unavailable options come to mind. If I could get quick delivery, if I didn't need to carry the computer, if there were a service facility nearby, and if I had a Formica desktop, I would consider buying the Chameleon Plus. But I wouldn't make up my mind until I had seen some of the other portables, such as the Panasonic Sr. Partner and the IBM Portable Computer. ■

Listing 2: The Apple IIe benchmark programs.

LISTING 2

```

5 REM: THE DISK WRITE BENCHMARK FOR THE APPLE II E
40 AS="12345678123456781234567812345678"
60 BS=AS+AS+AS+AS
80 NR=512
100 PRINT CHR$(4);"OPEN TEST"
120 PRINT CHR$(4);"WRITE TEST"
140 FOR I=1 TO NR
180 PRINT BS:
200 NEXT I
220 PRINT CHR$(4);"CLOSE TEST"
240 PRINT "DONE"
    
```

```

5 REM: THE DISK READ BENCHMARK FOR THE APPLE II E
10 NR=512
20 PRINT CHR$(4);"OPEN TEST"
25 PRINT CHR$(4);"READ TEST"
30 FOR I=1 TO NR
40 INPUT BS
50 NEXT I
60 PRINT CHR$(4);"CLOSE TEST"
70 PRINT "done"
    
```

```

5 REM: THE SIEVE BENCHMARK
10 SIZE = 7000
20 DIM FLAGS(7001)
30 PRINT "start one iteration"
40 COUNT=0
50 FOR I=0 TO SIZE
60 FLAGS(I)=1
70 NEXT I
80 FOR I=0 TO SIZE
90 IF FLAGS(I)=0 THEN I70
100 PRIME =I+1+3
110 K=I+PRIME
120 IF KSIZE THEN I60
130 FLAGS(K)=0
140 K=K+PRIME
150 GOTO I20
160 COUNT=COUNT+1
170 NEXT I
180 PRINT "done: ";COUNT;" primes found"
    
```

```

5 REM: THE CALCULATION BENCHMARK
10 NR=5000
30 A=2.71828
40 B=3.14159
50 C=1
60 FOR I=1 TO NR
70 C=C*A
80 C=C*B
90 C=C/A
100 C=C/B
110 NEXT I
120 PRINT "done"
130 PRINT "error = ";C-I
    
```

"The office automation I bought for everyone in the corporation doesn't incorporate everyone."

Stop the shock...with the new Exxon Business Support System.



An office automation system that can't support everyone in your corporation can lead to some very shocking experiences.

The right power to the right people

That's why Exxon Office Systems now offers more practical office automation solutions that help everyone in the corporation to be more productive. With the Business Support

System, Exxon extends its fully integrated line of office automation products to support managers, professionals, administrators, and secretarial staff.

Office automation for those who shape the corporation

The Exxon Business Support System features the new EXXON 750 Professional Workstation, designed with powerful, integrated software that lets you move instantly from

text to graphics to data processing — without changing programs.

Tying everyone together

At the core of the Business Support System is the EXXON 8400 Series controller. With its UNIX*-based operating system, it can integrate all levels of workstations to share information and programs. Everyone can keep track of schedules and meetings with time management and calendaring functions, whether their workstation is an EXXON 500 Series Information Processor or a new EXXON 750 Professional Workstation.

For more information

Call 800-327-6666, write Exxon Office Systems, P.O. Box 10184, Stamford, CT 06904-2184, or use the coupon below.

*UNIX is a trademark of Bell Labs.

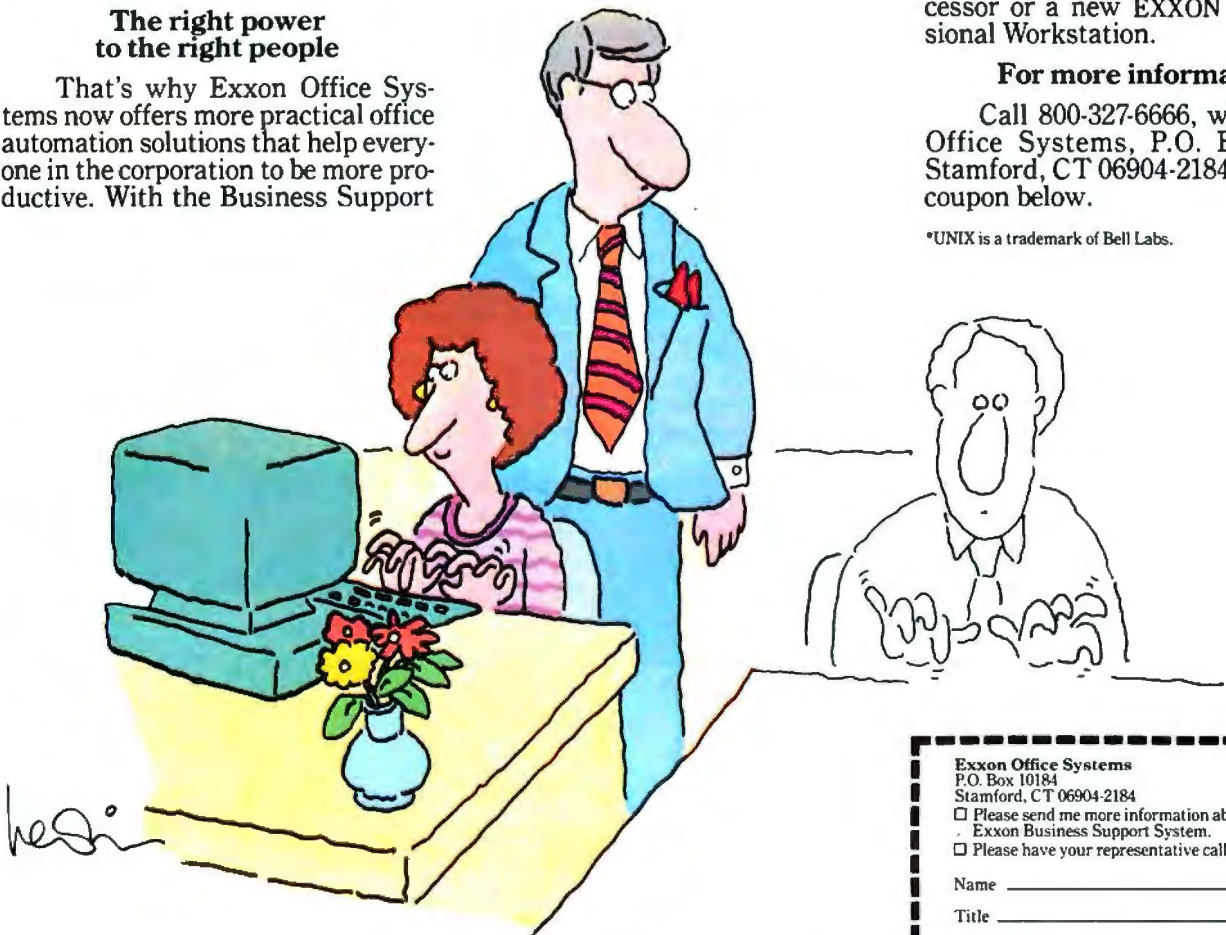

EXXON OFFICE SYSTEMS

The future...without the shock.

Exxon Office Systems
P.O. Box 10184
Stamford, CT 06904-2184

Please send me more information about the Exxon Business Support System.
 Please have your representative call.

Name _____
Title _____
Company _____
Address _____
City _____ State _____ Zip _____
Telephone _____

800-327-6666 (In CT, 800-942-2525)

It gets better and better.

Almost every 7 days we open a new Holiday Inn® hotel
in the locations you want the most.

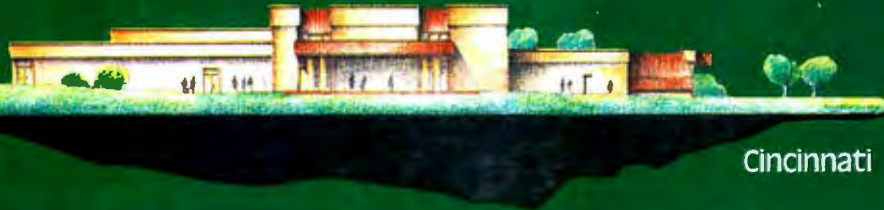

Cincinnati



Houston



Orlando



Baltimore



Miami



Dallas



Los Angeles
OPEN JULY 1984



Knoxville



New Orleans
OPEN MAY 1984

A better
place to beSM



Circle 158 on Inquiry card.



The Texas Instruments Speech Command System

You can now give voice commands to the TI Professional Computer or use it as an answering machine and a smart telephone

BY MARK HAAS

The TI Professional Computer can now listen to its master's voice and carry out the commands. The Texas Instruments Speech Command System is an advanced voice interface and communications package that provides a base for sophisticated voice and data integration. The piggybacked, two-board speech-processing system is built around proprietary components, occupies one of the TI Professional Computer's expansion slots, and provides a combination of communication functions never before offered to the personal computer user. These functions include:

- voice recognition
- voice storage
- voice playback
- integrated telephone functions
- pulse or tone dialing
- dual-tone multifrequency decoding
- selection of communications channel

By combining these functions with the proper software, it is possible to give voice commands to any application and have an intelligent telephone or a sophisticated telephone-answering machine, and more.

SETTING UP THE SPEECH COMMAND SYSTEM

The TI Speech Command System has three major components: the Speech Command System hardware, the Speech Command System software, and the Transparent Keyboard software. These components work together to combine the functions described above into useful tools. In addition, Texas Instruments is offering a Speech Design Kit to software developers to allow them to design additional applications around the hardware component.

The average user does not need to know what the various components of the Speech Command hardware do. It is really a special-purpose computer system with its own proprietary coprocessor, designed to perform a limited number of tasks. Texas Instruments provides the software necessary to program this computer to perform its special tasks. You only need to install this piggybacked board into a slot on the TI Professional Computer

system board and run a series of diagnostic tests.

Installation is fairly straightforward. I found it necessary to move some of the boards already installed in the system to accommodate this new thicker board. (I have already installed an internal modem, a Winchester hard-disk controller, and an asynchronous communications board.) The speech board cannot fit in either the first or last slots, leaving only three possibilities. Because it is a piggybacked system, it takes a bit of care fitting the board into the narrow space (see photo 1). A wire connecting this board to the speaker on the main system board must also be installed if you intend to use the internal speaker. It takes a steady hand and perhaps a pair of needle-nose pliers to do the job.

After the board is installed, the headset (or an external microphone and speaker) is connected and the diagnostics are run. Every function of this complex system is tested, even the voice quality. It was a bit of a shock when the computer first started talking to me. This is *not* synthesized speech but rather the reproduction of someone's voice that had been stored as data on the diagnostics disk. When the tests are successfully completed, the system is ready to be used.

The software for the Speech Command System is contained on two disks that in my case had to be copied first onto the hard disk. Before the system can actually be used, a number of commands must be issued from the operating-system level, and they must be used in the proper order. Some of these commands also have one or more arguments associated with them that may or may not be included, depending on how you will be using the system. It took me awhile to sort out the numerous software components.

First, a command file called CALIBRAT is used to determine the gain setting necessary for your particular voice and microphone. It can also be used to actually set the gain, too. Then, if your computer uses a Winchester

(text continued on page 342)

Mark Haas is the technical director at Osborne/McGraw-Hill (2600 Tenth St., Berkeley, CA 94710).

AT A GLANCE

Name
Speech Command System

Manufacturer
Texas Instruments
Data Systems Group
Austin, TX 78769

Price
\$2600

Hardware Required
Texas Instruments Professional Computer
with 192K bytes of RAM; hard disk
recommended

Documentation
Hardware installation and test manual;
Speech Command software users manual

Audience
Serious computer users or users with
special needs

(text continued from page 341)

hard disk, you invoke WINPATCH to modify the speech system for use on a hard disk. Next, you enter PCSPEECH to install interrupt vectors in the operating system and load the control software into the Speech Command hardware. PCSPEECH can also contain arguments for setting the gain (previously determined by using CALIBRAT), the output volume, and a switch to turn the Smartphone (described below) on or off. The manual accompanying this system presents several examples of batch files that can be used instead of invoking each of these commands individually. At this point you are finally ready to do something.

THE TRANSPARENT KEYBOARD

The Transparent Keyboard software provided by Texas Instruments allows the user to enter data into the computer by voice. What this data is and how it is used is left up to the individual, although a number of predefined vocabularies are provided for applications such as Lotus 1-2-3 and EasyWriter. I used the Transparent Keyboard and a vocabulary I designed to verbally enter commands into my word-processing software, PeachText, to write this article. I can insert and delete, scroll forward and back by line or page, perform block moves and cursor movements, and even save my file and return to the operating system without touching the keyboard. But not having to touch the keyboard is not the point here. What is important is that I can concentrate on writing this article without having to remember which function key is the one that will insert a line, which one will delete a line (they are next to each other), and then have to move my hand from the keyboard to enter it. All I have to do now is say "split" to insert a line and "line delete" to delete a line. All this does not come easily, however.

In order to use the Transparent Keyboard, you must first define a vocabulary (or use one of the prepared ones) and then teach the computer to recognize your voice. The Speech Command (SC) software allows you to accomplish this. After initializing the system with all the preliminary commands described above, entering "SC" will activate the Speech Command software.

The Speech Command software, by

the way, can do a number of things besides defining the vocabulary for the Transparent Keyboard. These include:

- activating a sophisticated telephone management system
- setting up a calendar/tickler manager
- setting up a dictation system

Defining a vocabulary comprises several steps. First, the words you want the system to recognize must be determined and typed into the system. The system uses these only as a prompt later when you are teaching it to recognize your voice. If, for instance, you type COPY but say "directory," it will recognize the word "directory." Of course, any language can be used, too.

Next, the equivalent keystrokes these words will activate must be defined. Alphanumeric keys, control codes, function keys (alone or in conjunction with Control, Shift, and Alternate), and even phone pad keys can be used. In fact, any key or legitimate combination of keys can be used because you can enter this data either literally (COPY for the word "copy"), as a hexadecimal code (using a caret [^] as a prefix), as a key code (using a tilde [~] as a prefix), or as a phone pad command (using two tildes [^^] as a prefix). All the codes are contained in an appendix to the users manual. A definition can contain up to 254 characters. Thus, it is possible for one voice command to activate a whole series of commands that would normally be entered manually.

Up to 50 words may be defined in any one vocabulary, but if more words are necessary, there is a mechanism that allows you to switch among several vocabularies. For example, during my test of this system I defined one vocabulary for the operating system and another for PeachText. The two vocabularies totaled more than 50 words. In my operating system vocabulary I included a command called EDIT. The equivalent keystrokes defined for EDIT look like this:

```
PT^ODED^OD^^2
```

PT is the name of the PeachText command file. The ^OD defines the hexadecimal code for a carriage return. This combination causes the PeachText program to start. ED and the second carriage return then tell PeachText that I want to edit a file. Finally, the ^^2 tells the Speech Command System to swap

vocabularies, turning off the operating-system vocabulary and turning on the PeachText vocabulary. Whenever I say "edit" at the operating-system level, these characters are presented to the system as if I had entered them manually.

Once the second vocabulary is activated, only the words contained therein will be recognized. It is possible, therefore, for the same word contained in two vocabularies to have different keystrokes specified for it, and thus obtain different results. For instance, the word "delete" in my operating-system vocabulary produces the string DEL, while the same word in my PeachText vocabulary produces the equivalent of the Delete key.

There must be another switch in the second vocabulary to get back to the first one (or to a third one that, in turn, will lead back to the first). In my case I have defined the command DOS to get me back. This keystroke definition ends with `^1` to switch back to the first vocabulary.

The vocabulary words and their equivalent keystrokes are entered in two columns on a series of screens in the SC software: words on the left, keystrokes on the right. After all definitions are entered, they are saved onto disk by pressing function key F8.

It is then necessary to teach the computer to recognize your voice. The SC software makes this an easy two-step process. First, words are entered by saying each one once as it is pointed to by the SC software. Since it is nearly impossible to say any word exactly the same way twice, the words are then updated by repeating each word a number of times to average the variations in the way a word is pronounced.

The degree to which the system is recognizing your voice can be tested using a built-in test function. All the words of a vocabulary are displayed on the screen and as you say each one, in any order, the system tries to recognize and point to it. The screen also displays a number from 0 to 9 as an indication of the degree of fit as each word is

recognized. In addition, the highlighting used to point to a recognized word will be either green (high degree of fit), yellow (moderate degree of fit), or red (marginal recognition). This information can then be used to update those words with marginal or moderate recognition until all words test green.

After all the vocabularies are determined, the equivalent keystrokes defined, and the system taught to recognize your voice, you still need to install these vocabularies into the system and turn on the Transparent Keyboard feature. Assuming you've already performed the steps outlined above (CALIBRAT, WINPATCH, and PCSPEECH), the next step involves a bit more user interaction.

From the operating system the command TPKSETUP is entered. TPKSETUP changes the keyboard interrupt vector. If you intend to use more than one vocabulary, it will be necessary to also add a numerical argument to the command, based on the size of the vocabulary files you want to include, plus some overhead figure to tell TPKSETUP how much memory to reserve. If you don't reserve enough memory, not all the vocabularies will be able to be installed at the next step in the process. It then will be necessary to start again from scratch by rebooting. I found this a rather roundabout way of dealing with this problem, but it seems that once

TPKSETUP is run, you can't run it again without rebooting.

Next, the command TPK is entered. Here you are asked for the number and names of the vocabularies you wish to use, whether you are using a headset or microphone, and which vocabulary you want to activate first. If you didn't reserve enough memory when using TPKSETUP, then TPK will not load all the vocabularies. But at least it will tell you how much memory you should have reserved. Assuming you did reserve enough memory, you can now begin using voice input.

USING VOICE INPUT

The first command I gave the computer was "directory return," which caused the directory of the entire hard disk to scroll by, all 317 files (actually, it was two commands). I noticed that it seemed to be scrolling a bit more slowly than usual. Then I noticed that if I issued another command, even just a "return," while the directory scrolled by, it started scrolling faster. This would appear to indicate that the Speech Command System, operating in the background, could degrade performance to some degree.

To test the degree to which performance was affected, I ran three of the standard BYTE benchmarks while the Transparent Keyboard was enabled. The first test I ran was the Sieve of

(text continued on page 344)

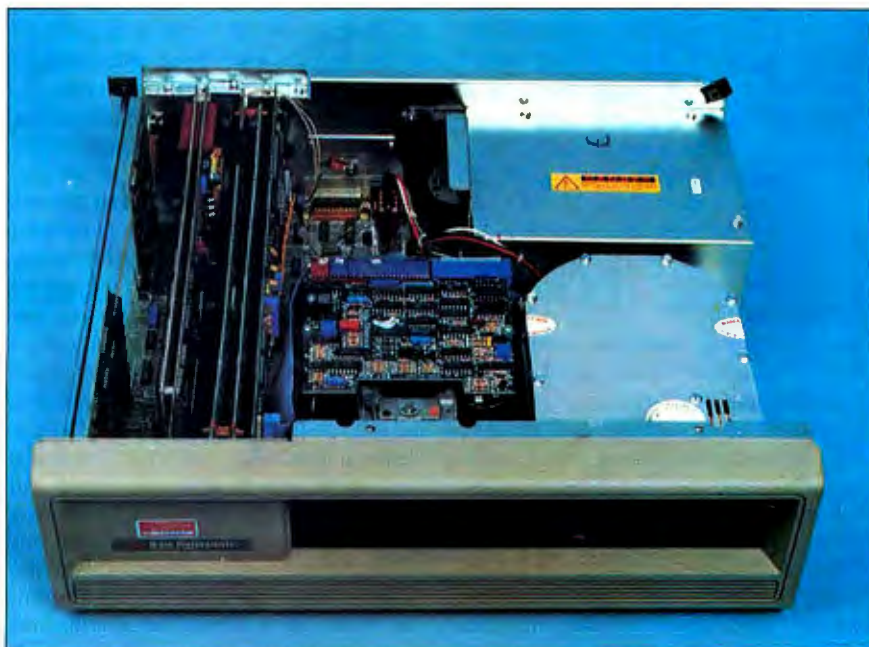

Photo 1: The TI Speech Command hardware consists of the plug-in circuit card, a headset and extension cord, and a modular phone cord to connect the circuit card to a telephone wall jack.

The system can pluck recognized words from a stream of words, and string together multiple recognized words.

(text continued from page 343)

Eratosthenes (see January 1983 BYTE, page 283). Surprisingly, it ran in 2 minutes 38.2 seconds, exactly the same time it ran in before the speech hardware was installed. Next, I ran the disk write and read benchmarks, using the hard disk for convenience. This time, however, the times were slower, running 7.8 and 5.5 seconds respectively, instead of the 7.1- and 5.1-second times recorded previously. These times represent 10 percent and 8 percent degradations. (See "The Texas Instruments Professional Computer" in the December 1983 BYTE, page 286, for a table listing all the benchmark times.)

Since I originally noticed the slowdown during display scrolling, I next issued a TYPE command from the operating system to display the contents of a 53K-byte file. Without the Transparent Keyboard enabled, the file scrolled by in 59.8 seconds. With the Transparent Keyboard enabled it took 1 minute 43.6 seconds, a 73 percent increase in time. Again, if I issued another command during the scrolling, the scrolling would speed up.

I brought this problem to the attention of Ken Bice of Texas Instruments while I was at the Fall 1983 COMDEX in Las Vegas. It turned out that TI was unaware of the slowdown but was extremely interested in my findings. The following week, Ken called me with a complete explanation of the problem. The Transparent Keyboard software, it seems, patches in its own keyboard decoding routine by changing an interrupt vector (see my December 1983 review). Every time application or system software checks for keyboard input, it has to pass through this extra code. The TYPE command does this after every character displayed, thus the significant slowdown. Reading and writing to disk does this less frequently. When a verbal command is uttered and recognized

by the speech system, the keyboard checks pass through less code since there is data in the keyboard buffer, and the processes then speed up. Apparently it would take a major revision of the Transparent Keyboard software to fix this.

DISTINGUISHING VOICES

An important factor to consider when evaluating a speech system is how well it recognizes your voice. I defined a simple vocabulary consisting of words beginning or ending in plosives, such as "type" and "edit," as well as words beginning or ending in sibilant essses such as "search" and "thesaurus." I also included combinations of similar words such as "delete," "line delete," and "word delete," and "scroll forward" and "scroll back." The results were interesting.

The system had no trouble distinguishing the similar word combinations. The words "delete," "line delete," and "word delete," as well as the two scroll commands were never confused. The sibilant essses proved to be no problem either. But I did have trouble with the plosives. I attribute this more to my diction, however, than to some shortcoming in the system, since further testing by another individual showed no problem, and a serious effort on my part to more clearly pronounce the words resulted in improved performance. Also the system has the ability to pluck recognized words from a stream of words, such as a sentence, and string together multiple recognized words.

I also wanted to test the system to see how well it recognized a female voice. Using the same vocabulary as before, I had my sister-in-law (who has a distinct midwestern accent but excellent diction) teach the system to recognize her voice. In most cases the recognition (closeness of fit) was greater, especially on the words that had given me trouble.

Next, I wanted to test how well voice recognition could be used as a security device, responding only to my voice. Using a vocabulary based on my voice data, I had my sister-in-law speak the contents of the vocabulary. There was no recognition whatsoever. Since our voices are markedly different, this didn't surprise me. I then had my brother-in-law try the same thing. Though our pronunciation is somewhat different, our

voice qualities are very similar. This time the system recognized every word. Using the built-in test facility of the SC software, I looked for closeness of fit. In most cases the closeness of fit was moderate to marginal, although one word did score a nine. I would not recommend using this system as a security device.

Ambient sounds are present in any office environment. Although I didn't test this system in an office, I did try to simulate it by having others talk in the background and make other loud noises while I used the system. I could detect no adverse effects on system performance.

Finally, I tried changing my voice, speaking in a moderately higher pitch as might be the case when one has a cold. This time the system did have trouble recognizing my voice and missed most words.

The only other problem I encountered concerned false triggers, the issuance of a command when none was spoken. Whether this was due to ambient sounds (the fan on the computer is quite noisy) or a bug in the software, it can become not only quite annoying but dangerous. There were enough of these false triggers that I would hesitate to recommend using the Transparent Keyboard feature for important work. I made sure there were no words defined in my vocabulary that could cause irreparable damage should they be invoked accidentally. For example, I did not include the QUIT command in my PeachText vocabularies because invoking it would cause the entire file to be lost. On several occasions during the writing of this article I found PeachText suddenly stopping when no command had been spoken. Fortunately, it was executing a normal END and saving the file on disk. It was annoying, but not disastrous. These false triggers occurred only when the microphone on the headset was on. I called TI to ask about this problem. According to TI, it seems to be a matter of a buffer overflowing, and they are working on it.

It should also be noted that the Transparent Keyboard feature will not work with TI's communications software unless a patch is installed. TI informs me that this is a temporary solution and that with the release of MS-DOS 2.0

(text continued on page 346)

THE BUFFER DID IT.

Who Stole The 1500 Letters From The Computer?

Let's just say you've got to send a letter to 1500 different people. Would you like to spend 22.5 hours* or 60 seconds of computer time?

With a garden-variety buffer, the computer has to mix, merge and send 1500 addresses and 1500 letters to the buffer. Trouble is, most buffers only store about 32 letters. So after 32 letters, the computer's down until the printer's done. Altogether, you're talking 22.5 hours.

In the case of our new (not to mention amazing) ShuffleBuffer, computer time is 60 seconds flat. Just give

ShuffleBuffer one form letter and your address list, and it takes care of the mixing, the merging, and the printing. But that's not all ShuffleBuffer's stolen from the computer. Oh, no.

Who Changed and Rearranged The Facts?

Again, ShuffleBuffer's the culprit. You want to move paragraph #1 down where #3 is? Want to add a chart or picture? No problem. No mystery, either. Any buffer can give you FIFO, basic first-in, first-out printing. And some

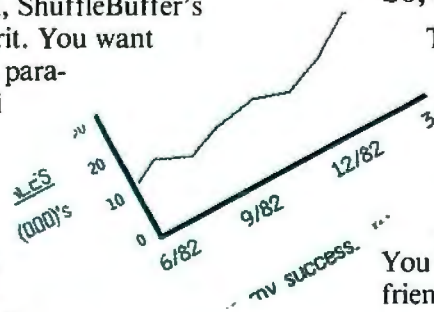

buffers offer By-Pass; the ability to interrupt long jobs for short ones. But only ShuffleBuffer has what we call Random Access Printing — the brains to move stored information around on its way to the printer. Something only a computer could do before. Comes in especially handy if you do lots of printing. Or lengthy manuscripts. Or voluminous green and white spread sheets. And by the way, ShuffleBuffer does store up to 128K of information and gives you a By-Pass mode, too.

And Who Spilled The Beans 239 Times?

Most buffers can't tell the printer to duplicate. If they can, they only offer a start/stop switch, which means you're the one who has to count to 239. Turn your back on your buffer, and your printer might shoot out a room full of copies. ShuffleBuffer, however, *does* control quantity. Tell it the amount, and it counts the copies. By itself.

So, What's The Catch?

There isn't any. Sleuth around. You won't find another buffer that's as slick a character as this one. You also won't find one that's friendly with any parallel or serial computer/printer combination. This is the world's only universal buffer. With a brain.

Who Wants You To Catch A ShuffleBuffer In Action?

You guessed it. We do. Just go to your local computer dealer and ask him to show you a ShuffleBuffer at work. Or, you can call us at (215) 667-1713, and we'll clue you in on all the facts directly.

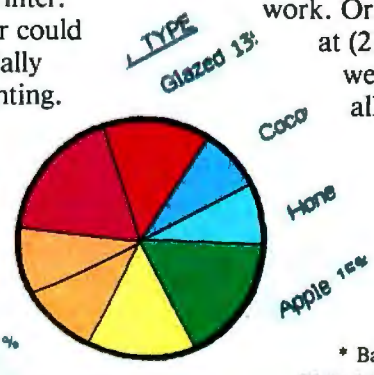

* Based on an average 4000 character letter & 128K buffer.

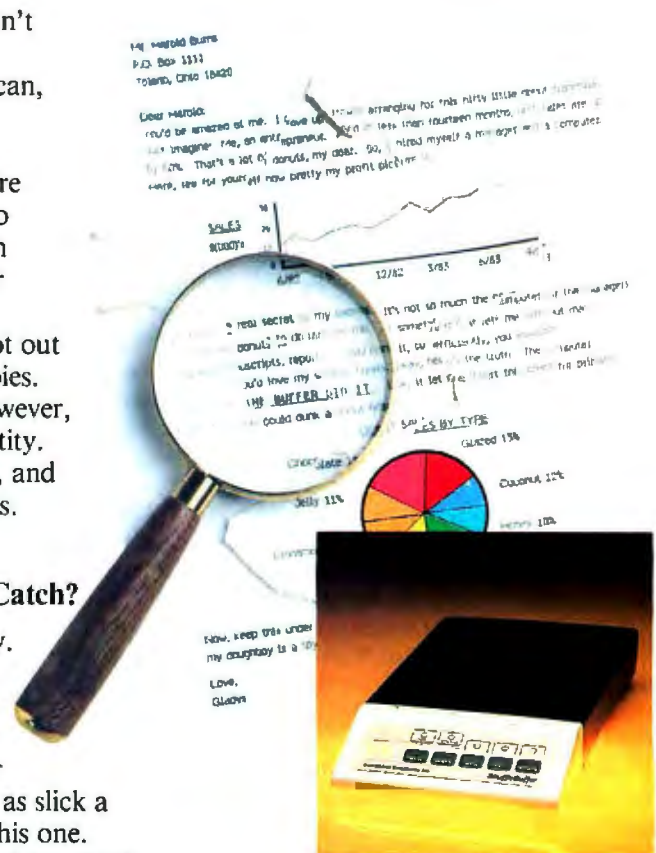

ShuffleBuffer
The Buffer with a Brain

Interactive Structures Inc.
146 Montgomery Avenue
Bala Cynwyd, PA 19004

The Speech Command software lets your TI PC send telephone messages and serve as an answering machine.

(text continued from page 344)

(due out by the time you read this) the problem will solve itself.

OTHER FEATURES OF THE SPEECH COMMAND SYSTEM

Besides allowing you to define vocabularies to be used with the Transparent Keyboard, the SC software can turn your TI Professional Computer into a sophisticated telephone messaging system.

In its most traditional role, SC software allows the TI PC to act like an answering machine. You can "record" up to five greeting messages of any length, provided you have enough disk space. You can then direct the system to play one of these messages whenever it answers the phone. You can program how many rings to wait before answering, too. When the computer picks up the line it immediately plays the chosen greeting message and then goes into record mode and awaits the caller's response. In most cases, the caller will simply leave a message of some arbitrary length. The message is saved after the caller hangs up, and the file is time and date stamped. Remember, the voice information is being digitized and stored as digital data on a disk as any other type of file would be, not recorded in analog form as with a tape recorder. Consequently, the file can be time and date stamped, copied, and combined with other information such as a text description of the contents of the message. TI's software allows you to do all these things and more.

The answering machine functions allow you to review the messages in two ways, either from the keyboard or remotely using a Touch-Tone keypad. Messages are stored in two groups: new messages that have been added since the last review, and older messages that have been previously stored. When performing this function from a remote location over the telephone, a four-digit

password must be entered first, and voice prompting then guides you through the rest of the process. You can even request the time and date of a message and the system will respond by voice. Again, this is not synthesized voice, but rather a real voice that has been processed and stored in a file and provided with the software.

The SC software also allows your TI PC to become a message-sending system. It will automatically deliver a message you have recorded to every phone number listed in a directory you create and then optionally record any reply the called party may have. You program the system to begin calling at a certain time, to allow each phone called to ring a certain maximum number of times before going on to the next number, and to keep trying unreached numbers until a certain cutoff time. The system will then start calling at the predetermined time, beginning with the first number in the directory, proceeding down the list. If a phone is not answered before the maximum number of rings programmed, the system will go on to the next number until the end of the directory is reached. At this point the computer attempts to call numbers not reached the first time, and so on until the cutoff time is reached.

One of the more mundane functions the SC software performs, but one that is fun to play with, is that of a dictation machine. You talk and it records. You can then play your words back. But you can also control the speed of playback without changing the pitch of the voice. Push a few buttons and you, too, can sound like the fast-talking man on the Federal Express commercials. As with any dictation machine, you can also move forward and back within the "recording" and pause at any point.

Lastly, the SC software provides a calendar/tickler system. You can enter appointments, birthdays, and such, along with an associated date and time. You can choose to have a reminder placed on the screen when you first use the SC software on any given day. But this functionality is low, in my opinion, since you could be wrapped up for hours designing, say, a Lotus 1-2-3 model and you won't be reminded of anything until you run the SC software again. This function could be quite useful if the tickler system were running

in the background with the ability to play back a verbal message or pop a message onto the screen at any time no matter what other program you were running.

QUALITY VERSUS QUANTITY

The quality of voice reproduction in a system such as this is closely associated with the rate at which the recorded voice is sampled. The higher the sampling rate, the more bits per second, the greater the fidelity on playback. The price paid for this fidelity is the amount of storage needed to hold all this data. The new compact disk stereo players use a laser to record music at a sampling rate of 55,000 samples per second, and each sample is a 16-bit word. When recording is limited to voice only, several "tricks" can be performed to greatly reduce the volume of data necessary to produce intelligible speech on playback.

When you consider that the recording rate of the Speech Command System is only 2400 bits per second, it's astounding that you can understand the playback at all. TI has done a remarkable job of providing adequate voice quality and high storage density. At this rate, a single 320K-byte disk is capable of holding up to 16 minutes of digitized speech, and a 5-megabyte hard disk can accommodate over eight hours of voice data. TI accomplishes this minor miracle with a technique called linear predictive coding, or LPC. Basically, LPC converts the incoming voice signal into a series of numbers representing the coefficients of an equation. This equation models the human vocal tract. Upon playback, these coefficients are then used to drive this artificial vocal tract, and speech is produced. One side benefit of this system is that long pauses between words or sentences are eliminated, and precious disk space is not used for "dead air." Also, this system is designed for voice recording only, and it does that very well. An attempt to record music resulted in a series of blips and squeaks, though they did have a definite rhythm.

THE SMARTPHONE

Another component of the Speech Command System is the Smartphone. The Smartphone provides a truly inte-

(text continued on page 348)

More For Your Micro

Qubie' offers a few select products at low prices, with service and support not available elsewhere.

1. Digital Signal Processing Modems

The Qubie' modems provide a high level of performance and quality at a price unmatched by competing modems. This is made possible by four microprocessors which measure the tones being transmitted digitally, eliminating the need for expensive analog filtering devices. Both modems are Bell 212A compatible, and are capable of transmitting and receiving at 300 and 1200 baud. These auto-dial and auto-answer modems recognize the Hayes software commands. If you already are using a software package written for Hayes modems, like CROSSTALK or even Hayes' SMART-COM, you can use it on the Qubie' modems.



**PC212A/1200
Internal Modem
for IBM PC®
and XT®**

Includes: internal modem, modular phone cable, card edge guide, instruction manual, and the highly rated PC-TALK III communications software. Its low profile design allows it to fit in just one slot, even on an XT. For just \$20 we can add an external serial port connector. This lets you use the serial port circuitry on the modem card to address external serial devices when you are not using your modem. PC212A/1200 \$299.



**The 212A
1200E
Standalone
Modem.**

The most economical way to get high speed data communications for any personal computer with a serial port. It supports all Hayes commands and can use any Hayes compatible software package. It comes standard with its own cable to connect it to your computer, a modular phone cable, and manual. \$329.

© Copyright Qubie' 1984

2. More Than Just Graphics on a Monochrome Monitor

Now you can get graphics on an IBM PC monochrome monitor along with parallel port, serial port, and battery powered clock/calendar. It is the ideal solution for those who wish to do graphics using Lotus 1-2-3™. The 720X348 Hercules compatible resolution of the MonoGraphPlus eliminates the eyestrain caused by the IBM graphics adapter with its lower 640x200 resolution.

Graphics is just the beginning. We have added some popular features from the AST® family of multifunction boards. Standard features include a parallel printer port, and a battery powered clock/calendar for automatic loading of the time and date. You can even order an optional serial port for a serial printer, plotter mouse, or modem. All functions are 100% IBM compatible. And of course there is a one year factory warranty from AST Research and the Qubie' Acid Test backing it all up. MonoGraphPlus \$449. Optional serial port, \$35.

3. 30 Minutes of Standby Power, with Surge and EMI Protection Too!

Have you ever had the misfortune to have the power fail or the lights blink right in the middle of doing something really important? You could have missed out on the frustration of losing all that work if your micro had a Qubie' SB200 Standby Power Supply. It is ready on just 1/100th of a second notice to run your PC for up to 30 minutes after a power failure. It will also go into action should the power dip below the minimum required (a "brown-out"). An audible alarm warns you to save your work to a disk and shutdown in an orderly manner. The SB200 also provides filtering of Electromagnetic Interference (EMI), and surge protection which can wreak havoc on your PC's internals or your data without you even noticing. SB200 200 watt standby power, \$329.

IBM, IBM PC and XT are registered trademarks of IBM Corp.

New from **AST**
RESEARCH INC.



**Qubie'
Bracket**

The Acid Test. If within 30 days of purchase you are not completely satisfied with our products you may return them for a complete refund including freight to ship it back. Each product is warranted for one year parts and labor. Should service be required during this period our inhouse service department will fix the problem within 48 hours or we replace the item.

Order Today!

All prices include UPS surface freight and insurance. Add \$5 for two day air on modems and AST, \$15 on SB200. For fastest delivery send certified check or credit card. Personal checks take 18 days to clear. Calif. residents add 6% sales tax. Corporations & Institutions call for purchase order details.

(800) 821-4479

Toll Free outside California

(805) 987-9741

Inside California

QUBIE'

4809 Calle Alto
Camarillo, Ca. 93010

Tempo House, 15 Falcon Road
London SW11 2PH, United Kingdom



**SB200
Standby Power Supply**

AST is a registered trademark of AST Research

(text continued from page 346)

grated phone system for your TI PC that is capable of completely "hands-off" phone operation.

The Smartphone is activated by a software switch when invoking the PC-SPEECH command from the operating system. By itself, the Smartphone allows you to make phone calls through your headset (or microphone) using the numeric keypad on the TI PC's keyboard to dial. It also allows any extension phone with a Touch-Tone keypad to use the Smartphone features. These features include:

- redialing of the last number called
- speed dialing any number in a directory using only three keys
- eliminating incoming calls (callers hear the phone ring, not a busy signal)
- switching between tone and pulse dialing
- dial tone detection

The Smartphone becomes even more impressive when used with the Transparent Keyboard.

Imagine yourself deeply immersed in an application, such as writing a review of a Texas Instruments product, when you suddenly realize you need to call someone at TI for information. While you're still using your trusty word processor you utter "Call TI" and a few moments later you hear the phone ringing in your headset. You get the information you need, jotting it down with your word processor as you talk, press a key to hang up, and complete your article. This is not a fantasy. What I just described is possible using the Smartphone in conjunction with the Transparent Keyboard.

DOCUMENTATION

Texas Instruments provides a comprehensive manual detailing every function of the Speech Command System. It does a decent job of familiarizing you with the use of a fairly complex system. It provides several examples to aid in understanding and even suggests methods for streamlining system operation, such as creating batch files for system initialization. A smaller, separate guide is provided for the physical installation of the processor card, and it, too, clearly describes the process, pointing out trouble spots and supplying illustrations for clarity.

CONCLUSIONS

Texas Instruments has provided a truly unique package of functions at a price that is only a fraction of that charged for less-capable, stand-alone voice-recognition systems. (If you don't think \$2600 is cheap, then you should see the prices on the other systems.) TI also provides a fair amount of software to allow you to do some useful things with your computer. But I think it will be the independent software vendors who determine whether this product succeeds or fails.

You have to understand one thing. The Speech Command System is basically another computer within your Texas Instruments Professional Computer. TI provides two levels of software. There is the systems software that gives this computer its basic smarts—digitize a voice, reproduce a voice, detect Touch Tones or produce them, and so on. The second level of software is the application that runs on the TI PC and accesses the functions of this second computer, in this case the SC software and the Transparent Keyboard software, and combines them with its own logic to produce a useful product. Without the proper software the hardware is useless. At the same time, however, the user has absolutely no access to this computer-within-a-computer and cannot develop any other applications for it. Instead, a software developer needs to invest about \$8000 to license the run-time software for integration into an application, and then needs to purchase a development kit to be used in conjunction with a high-level language to develop the application. Thus, any purchaser of this system will have to rely on (as yet nonexistent) third-party software developers to provide new ways in which to use it. (Software developers interested in designing applications for this system should contact Bill Smiers at Texas Instruments in Austin, Texas.)

The potential of voice input is exciting and could solve many of the problems now encountered with mice and touchscreens. There are perhaps dozens of specialized applications for this system (e.g., an aid to the disabled). All in all, I found the Speech Command System quite impressive. With the exception of the false triggering, which is a problem I suspect TI will solve, the system performed as advertised. ■



Imagine your PC with Apparat add-ons. Imagine where it could take you.

Special values from the hard disk experts. For example, imagine your IBM PC or Portable PC with hard disk capability. Apparat's external Hard Disk Subsystem is completely compatible, running DOS 2.0 or 2.1 without modification or device drivers. And now you can get more capacity—22 and 33 MB formatted configurations—for less money. 22 MB for **\$2,295**, 33 MB for **\$2,995**. Apparat also offers internal or external 10 MB drives at similarly low prices.

XT owners—trade in your 10 MB drive for a larger Apparat hard disk drive. Our 22 MB drive is **\$1,299**, but you pay just **\$899** with a trade-in of your existing 10 MB drive. Our 33 MB drive is just **\$1,799**, but you pay just **\$1,399** when you trade in your existing 10 MB drive. Call the Apparat ordering hotline for trade-in details and shipping instructions.

TEAC or Panasonic floppies. These half-height floppies are perfect for your PC, PPC, or XT. Call for trade-in prices on full-height floppies.

New 28 pin EPROM programmer. Now Apparat has a new Prom Blaster for the PC, XT, PPC and PCjr to program most 28 pin EPROMS (including the 2764, 128, 256), in addition to our original Prom Blaster that programs most 24 pin EPROMS...each **\$129**. We also make an EPROM cartridge for the PCjr to accept your newly programmed EPROMS.

PPC and PCjr. Apparat has developed new products for the IBM Portable PC. Now available is a 256K RAM card and a Combo card (P & S). Both fit the PPC short slots. New for the PCjr is a 128K RAM card and a Combo jr card (P & clk). Both fit the side attachment.

Other Apparat add-ons. RAM cards for the PC and XT—64K **\$189**, expandable to 512K. COMBO II card for the PC and XT, 5 functions on one card—**\$189**. CRAMBO card for the PC piggybacks COMBO II on 64K RAM card—**\$359**. 64K internal PRINT SPOOLER with parallel interface—**\$299**. Stand-alone at **\$319**.

Warranty. All Apparat manufactured PC boards sold after June 1, 1984 covered by our exclusive lifetime limited warranty covering parts and labor.



ADD ON AND ON AND ON AND ON AND ON

ORDERING AND DEALER INFORMATION

800/525-7674

Prices subject to change without notice.

APPARAT



APPARAT TAKES YOUR PC TO NEW REALMS.

4401 South Tamarac Parkway, Denver, CO 80237—Customer Service 303/741-1778
Apparat retail outlets—DENVER: 4401 S. Tamarac Pkwy. 303/771-2032 • 5224 W. Warren Ave. 303/985-1217
CHICAGO: 1844 S. Arlington Heights Rd. 312/640-0322

Pick a computer
any
computer...



They've all been advertised in BYTE

Hardware, software, peripherals. . . can you think of *any* microcomputer product that you haven't seen advertised in BYTE?

This is where success in the market begins. In BYTE. Where advertisers reach more than 430,000 paid readers. . . high-tech computer sophisticates who are the market's most active buyers.

And who are asked for tens of thousands of brand-name recommendations every month.

If you're an advertiser, either of an established small systems product, or of the next revolution in the market, talk to us — we're the people who wrote the book on micro-computer marketing. Just call Pete Huestis, Advertising Sales Manager, at 603/924-9281.

BYTE

THE INTERNATIONAL STANDARD

 BYTE is published monthly by McGraw-Hill, Inc., with offices at 70 Main St., Peterborough, N.H. 03458

PICKING DAISIES?

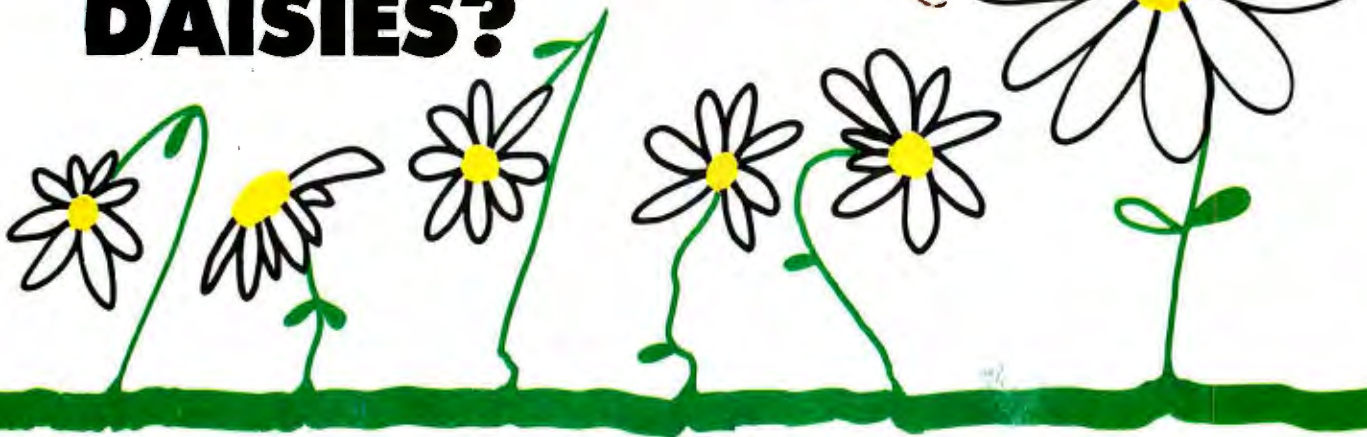

BROTHER HR15

Costs about the same—but it's slower, noisier, and needs its own brand of ribbon. To be fair, it's lighter.* (But JUKI eclipses the BROTHER totally!)

SILVER REED EXP500

Okay, it's lighter—but it's more than a whole word slower per second, it's noisier, lacks a buffer memory, and prints only a 10"-wideline.* (JUKI triumphs again!)

SILVER REED EXP550

You pay about \$100 more, and it's slower, noisier, has no buffer memory, and lacks the refinement of our linear stepper carriage motor. A little wider print line, yes. A bargain, no.* (JUKI by a mile.)

QUME LP20

Costs about \$300 more, needs its own brand of ribbon, and takes only a 96-character wheel. Is it worth it for just 2 more characters per second and a wee bit quieter machine?*(Sorry, QUME, JUKI gets the trophy.)

DIABLO 620

Costs about twice as much, weighs 19 lbs. more, and requires its own brand of ribbon. Pretty steep for a slightly quieter machine and 2 more characters per second.* (The winner: JUKI.)

JUKI® 6100

CONSIDER THESE FEATURES:

Compatible with most personal computers (IBM, Apple, Kaypro, etc.), prints graphics, 2K buffer (expandable to 8K), bidirectional tractor feed option, proportional spacing, lightweight, 11" print line, uses 100-character drop-in daisywheel and inexpensive, easy-to-find IBM Selectric II® ribbon! Interchangeable interface and easy-to-read manual. Feature for feature, dollar for dollar, JUKI—the best all-round letter-quality printer anywhere!

THERE ARE LOTS OF DAISYWHEEL PRINTERS IN THE FIELD. PICK SMART. PICK JUKI 6100.

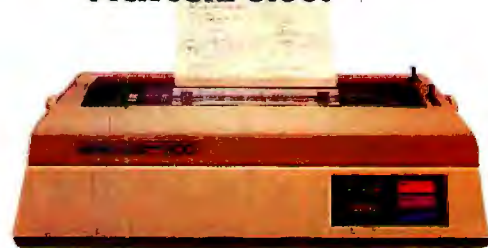

Circle 179 on inquiry card.

*Comparison based upon manufacturer's specifications rather than actual testing.

JUKI®

JUKI INDUSTRIES OF AMERICA, INC.

ACORN DATA PRODUCTS
7042 S. Revere Pkwy, Ste 50
Englewood, CO 80112
(303) 799-8900
Serving
MT, WY, CO, UT, NM

BUTLER ASSOCIATES, INC.
82A Winchester St
Newton, MA 02161
(617) 964-5270
Serving
ME, NH, VT, MA, CT, RI

CM DISTRIBUTION
7023 Little River Trpk.
Annandale, VA 22003
(703) 750-3885
Serving
MD, DE, DC, VA

COMPUTER SERVICES INTL
560 Sylvan Ave.
Englewood Cliffs, NJ 07632
(201) 569-6300
Serving
METRO NY, E PA, NJ

CYPRESS DISTRIBUTING CO.
1266 Lincoln Ave., Ste 109
San Jose, CA 95125
(408) 297-9800
Serving
N CA, NV, AZ

GENTRY ASSOCIATES INC.
7665 Currency Dr.
Orlando, FL 32809
(305) 859-7480
Serving
TN, NC, SC, MS, LA, AL, FL, GA

INFORMATION SYSTEMS INC.
2420 E. Oakton St., Unit K
Arlington Heights, IL 60005
(312) 228-5480
Serving
WI, IL, MN, IA, MO, NE, ND, SD, KS

MICRO SOURCE OF TEXAS INC.
670 International Pkwy
Richardson, TX 75081
(214) 690-5111
Serving
TX, OK, AR, LA

OSSMANN COMPUTER TECHNOLOGIES
6666 Old Collamer Rd.
East Syracuse, NY 13057
(315) 437-6666
Serving
UPSTATE NY

SOUTHERN MICRO DISTRIBUTORS
8708 Royal Lane
Irving, TX 75063
(214) 258-6636
Serving
TX, OK, AR, LA

STAR-TRONIC DISTRIBUTING CO.
23976 Freeway Park Dr.
Farmington Hills, MI 48024
(313) 477-7586
Serving
MI, IN, OH, KY, W PA, WV

TECHNOLOGY MARKETING CORP.
2300 Valley View Lane, Ste 109
Dallas, TX 75234
(214) 243-7994
Serving
TX, OK, AR, LA

VITEK
930G Boardwalk Ave.
San Marcos, CA 92069
(619) 744-8305
Serving
S CA

WESTERN MICRO TECHNOLOGY
10040 Bubba Road
Cupertino, CA 95104
(408) 725-1660
Serving
N CA, NV, AZ

NATIONAL HEADQUARTERS: JUKI INDUSTRIES OF AMERICA, INC. DA DIVISION
299 Market St
Saddle Brook, NJ 07662
(201) 368-3666

WEST COAST. JUKI INDUSTRIES OF AMERICA, INC. CALIFORNIA DIVISION
3555 Lomita Blvd.
Torrance, CA 90505
(213) 325-3093



Volition Systems' Modula-2

A version of Modula-2 for the Apple II

BY ERIC ELDRED

How does Volition Systems' implementation of Modula-2 stack up in the hands of a nonprofessional Apple Pascal programmer? This review should answer that question.

WHY MODULA-2?

Modula-2 was designed for systems programming, so it has speedy low-level facilities built into a readable high-level language. You don't have to restrict yourself to one microprocessor's assembly language. Modula-2 has interrupts and coroutines and can perform multi-tasking on the Apple II.

The language embodies the ideals of structured programming. Its module concept is superior to Apple Pascal's intrinsic units both in ease of use and efficiency. The definition module, which replaces the interface section of a unit, can be compiled separately and can make teams work well together. Only the data that must be shared need be exported; everything else will be inaccessible and, therefore, protected against accidental or malicious tampering. Modules maintain type checking, and version checking protects against changing the definition module without recompiling the programs that depend on it. It is possible to do some of this in Apple Pascal but it is never easy (see Michael Feldman's "Information Hiding in Pascal," November 1981 *BYTE*, page 493).

Modula-2 remedies some of the problems of Apple Pascal (few units, no open arrays, limited I/O (input/output), etc.) but it doesn't force you to abandon Pascal entirely. Pascal's block structure is still there because variables exist inside the same procedures. Yet there are some arbitrary differences as well as improvements in syntax, so it will take a Pascal programmer a few weeks to become comfortable thinking in Modula-2. For example, see the connected example of source code in listing 1. When you run this program, it will ask you to enter a real number, which must have a decimal point. If the number converts to integer 1, then the module Scheduler creates a status window and you can type anything into the top window while the trivia test is going on below. If what you type con-

tains either of the two uppercase characters not on the standard phone dial, you will create another silly process. Statements in the form (*\$.*) are directives to Volition's compiler. If you set (*SUPCASE:=TRUE;*), enter "|" (which divides CASE statements) as "I".

THE PRODUCT

Let's take a closer look at the Volition Systems package. Three disks come with it: M2SYS:, M2LIB:, and M2PROGS:. Volition's Advanced System Editor (ASE, pronounced "ace") and p-Shell (formerly "p-Nix") are available as options on separate disks.

On M2SYS:, there is a file called SYSTEM.MODULA that replaces Apple's SYSTEM.PASCAL. This is the standard Apple 6502 operating system, based on UCSD Pascal II.1, but the file is 40, rather than 41, blocks long (a block is two sectors, or 512 bytes). Your command prompt line will work exactly the same as in Apple Pascal.

M2SYS: also contains a p-code ("pseudo-code," or the instruction set of an imaginary, portable p-machine) interpreter, called SYSTEM.APPLE, written in 6502 assembly code. It is 32 blocks long and is not much different from the Apple Pascal file it replaces, except that it has extensions for Modula-2. Because it does not have the two UCSD support routines IDSEARCH and TREESEARCH, it cannot run the Apple Pascal compiler or any user-written Pascal programs containing TREESEARCH.

Volition does not supply a Pascal compiler with the Apple system; therefore, you must boot Apple Computer's SYSTEM.APPLE and SYSTEM.COMPILER on a separate disk if you wish to program in Pascal. Also, the system will crash if Pascal programs using long integers are run under the Volition interpreter; this problem may be resolved in a later release of Modula-2. Incidentally, many people who have made patches to the Pascal SYS-

(text continued on page 354)

.....
Eric Eldred is a chief pulmonary technologist for Massachusetts General Hospital in Boston, Massachusetts. He can be reached at RFD 2, English Range Road, Derry, NH 03038.

AT A GLANCE

Name

Modula-2

Type

Modula-2 one-pass p-code compiler, p-code interpreter, library modules, and utilities.

Version

0.3k

Manufacturer

Volition Systems
POB 1236
Del Mar, CA 92014
(619) 481-2286

Format

5¼-inch disks, Apple Pascal 1.1 format, unprotected

Computer Needed

Requires 64K-byte Apple II+ or IIe and two disk drives; 80-columns and lowercase input and display helpful but not essential; versions available for the Apple III, 64K-byte IBM PC (not XT or PCjr), Z80/8080, and Sage II and IV

Software Required

Apple Pascal 1.1 or 1.2 (not 1.0); Apple III version needs Pascal and SOS

Documentation

241-page user's manual, 8½- by 11-inch 3-ring binder; Niklaus Wirth, *Programming in Modula-2*, 2nd edition (NY: Springer-Verlag), 1983, 176 pages, hardcover

Price

\$295
with ASE, \$395;
Modula-2 User's Manual, \$35;
ASE User's Manual, \$25;
Wirth's book, \$16; p-Shell
available through UCSD p-
System Users' Society (USUS)
and the International Apple
Core

Audience

Systems and application
software developers, individuals
advanced in Pascal

(text continued from page 353)

TEM.APPLE for various reasons will find most will not work with the new interpreter unless done with SYSTEM.ATTACH.

The more recent Volition releases include a file called SMALL.APPLE, which uses significantly less memory than SYSTEM.APPLE, and SMALL.COMPIILER, with which you can compile larger Modula-2 programs—as long as you do not employ real numbers.

P-CODE COMPILER

The centerpiece Modula-2 compiler was written in Pascal and is one block shorter than Apple Pascal's 75. It is a fast, one-pass compiler that compiles to p-code.

Using a p-code compiler is significant because such programs can execute on other machines for which there is a suitable p-code interpreter. (Even Apple II Pascal code files can't run under the Apple III Pascal interpreter.) The Volition compiler has an option to flip the "byte-sex" of the code, so you can compile a program on a 6502-based system and then on a computer that has the high byte in opposite order, such as the 68000. I think the Volition Modula-2 system will be attractive to programmers who want to reach a majority of the business market (Apple, IBM, CP/M, 68000) with a single tested program.

The compiler has some other advanced features, including conditional compilation. I found it convenient to use with Volition's optional ASE edition. When the compiler caught a syntax error, it first reported an English phrase, not an error number. I then got a chance to enter the editor at the place the error was found, hit the space bar, and correct it. After finding and correcting the error, I still had to start the compilation all over again. If you set the (*\$DEBUG: -TRUE;*) compiler option, a run-time error will report the procedure name, rather than some cryptic number. But there is still no true debugger with breakpoints or single stepping.

The major difference between Volition's implementation and Wirth's Modula-2 standard is Volition's inclusion of PACKED variables, FORWARD declarations, and CODE procedures. PACKED variables and FORWARD declarations were included to save memory and disk space. (The FORWARD declara-

tion could have been dispensed with because it is logically possible to write mutually recursive procedures in a roundabout fashion, but its inclusion does simplify work for a one-pass compiler.) The CODE procedures, which allow you to perform low-level operations with p-code instructions, are not needed in standard Modula-2. Programs that use any of these extensions will not be directly compilable with a standard Modula-2 compiler. Other differences occur between Volition's and Wirth's Modula-2. Volition uses INTEGER, rather than the standard CARDINAL, values for FLOAT and TRUNC and integer size limits for the maximum CASE label, DIV, and MOD, but these are more limits than violations of the Modula-2 standard.

USING MODULA-2

Volition has added most of the I/O and string-handling features that have made UCSD Pascal so popular, but they are located in the utility library on the M2LIB; disk. Thus the standard language is sparse, pure, and elegant, and the user has access to as much power as desired. There are minor syntax differences from the Pascal versions of some procedures.

The utility library includes the module Decimals, which gives COBOL-like formatting "pictures" for business or scientific purposes.

You will need to put the library (97 blocks) and user files on the second drive because of the Apple's limited disk capacity. Much of the time it takes you to get used to Modula-2 will be spent in determining which module to import and which module is dependent on which. Because whenever you import a module you put it and its dependent modules in memory, you will quickly use up your workspace unless you are careful. The manual gives helpful hints on how to maximize either compilation or run-time space. I had to make up a map of module dependencies.

LIB.CODE, the library manager on M2LIB;, is an improvement over the similar Apple Pascal LIBRARY.CODE because

- You can hide and unhide modules in the library to speed up the compilation process.
- You can remove definition

modules after all the implementation modules and programs have been compiled and they are no longer needed.

- You can concatenate user modules into a program library that you can then compact by doing an update.
- You can go into compiled program code, extract a module, and reuse it in another program. You don't have to disassemble it to get the source text, you can make full use of it without its being a separate code fragment.
- You have 64 slots in the standard library versus 16 in Apple Pascal, and module overlays are much superior to Pascal's segments.

SOFTWARE BENCHMARKS

Is Volition Systems' Modula-2 any faster than Apple Pascal? To find out, I ran BYTE's Sieve of Eratosthenes prime-number generator program (see "Eratosthenes Revisited: Once More through the Sieve," by Jim Gilbreath and Gary Gilbreath, January 1983, page 283).

The Modula-2 program in listing 2 ran in 322 seconds (or about 11 percent faster) on the Volition system versus 363 seconds for the Apple Pascal version in listing 3. I couldn't resist tinkering with the declaration order of the original benchmark. I declared the integer or cardinal variables before the array, reversing the customary sequence of lines 9 and 10. Though it's not widely known, the UCSD p-machine was designed with more efficient storage instructions for the first 16 words of data in a procedure, so you should always declare the most-used scalar variables first and arrays (which take more space) last. Other Pascal compilers' times may not improve using the modified Sieve shown in listing 3.

The Modula-2 compiler also does not allocate storage in backward order as the Apple Pascal compiler does when you assign several variables the same type within the same statement. Thus, to be absolutely fair, I reversed the order inside the Pascal integer variable declaration (see line 9), but because those variables are still within the first 16 words of data, it made no difference in running time.

BYTE's original Modula-2 benchmark
(text continued on page 356)

FORTH COMPILER

For APPLE II & IIe

\$30.00 Shipped Free

Source Listing \$20.00

- FLEX-FORTH is a full-featured F.I.G. standard FORTH with
 - OPERATING SYSTEM
 - FIG SCREEN EDITOR
 - COMPILER/INTERPRETER
 - 6502 ASSEMBLER (with Macros)
- Compatible with DOS 3.2 or 3.3
*Apple is a trademark of Apple Computer Inc.

SURGE PROTECTOR 6-OUTLET

\$59.95

Plus \$3.50 shipping/handling

Dealer Inquiries Welcome

GEOTEC

1920 N.W. Milford Way
Seattle, WA 98177

Circle 395 on inquiry card.

ANNIVERSARY SALE

MBC 550 Computer System

only **\$999.00**

and get a monitor for only **\$1.00!**

Denver residents visit our retail store.



- Includes:** 16 bit 8088 Processor
128K RAM
Built in disk drive
Color Graphic board

Software: MS-DOS
Word-Star
Calc-Star

Optional: extra 64K—\$60.00 (max 256K)
second drive \$299.00



DEVI COMPUTERS, INC.

Buckingham Sq. Shopping Ctr.

1377 B South Joliet, Aurora, Co. 80012

1-(303)-337-7108, 1-(303)-337-9425

Terms: Visa, Mastercard, Choice, Cashier's Check, Money Order. Personal checks take 15 days to clear. Foreign customers: Letter of Credit and 10% overseas handling charge. Prices subject to change without notice. We reserve right to limit quantities. Not responsible for typos. Freight charges \$3.50 plus \$1.00 per pound, minimum \$3.50. Write for free catalog.

Circle 397 on inquiry card.

AFFORDABLE M-68000 COMPUTER SYSTEM

M68KCPU 6-10 MHz CPU, 20K static RAM, 16K EPROM, on board monitor, two RS-232 serial ports, 16-bit parallel port, 5 timer/counters expansion bus.

Bare board..... \$ 99.95
Complete Kit..... **\$615.00**

M6512K 128-512K static RAM, floppy disk controller & hard disk interface

Bare board..... \$ 99.95
Complete Kit (128K)... **\$725.00**

M68KE Enclosure with power supply, fan, filter, 4 slot card cage

..... **\$249.00**

M68KASM M68000 Macro Cross Assembler for CP/M80, IBM PC, TRS-80 and Apple II computers

..... **\$149.00**

UPS shipping & handling \$ 4.00

COD orders add \$ 3.00

Foreign orders add **\$20.00**

California residents add 6.5% tax

EMS Educational Microcomputer Systems (714) 556-0123
P.O. Box 16115 • Irvine, CA 92713

Circle 399 on inquiry card.

June Special

RENT SOFTWARE

dBase II 100.00

1-2-3 Lotus 75.00

Wordstar 75.00

PFS Software 20.00

FREE CATALOG

Games / Business / Utilities / Education

1-800-221-1031 California

1-800-221-4568 All Others

619-481-0559 San Diego



Circle 298 on inquiry card.

POWER PROTECTION FOR YOUR SYSTEM



The Datasaver™ AC Power Backup fits most desktop and portable microcomputer systems. Call Cuesta Systems, Inc. at (805) 541-4160 for product information and application literature.

VISA/Mastercard orders
INSTANT POWER

Circle 398 on inquiry card.

	List Price	*Evaluation Unit
Basic System Model PC-100**	\$895.00	\$795.00
Complete System (128K) Model PC-100	\$1995.00	\$1850.00

Everything for PC and Compatibles

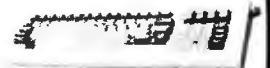

Computer Case with Power Supply & Fan (65 WATT)	\$299.00
Computer Case w/o Power Supply & Fan	\$149.00
Keyboard	\$149.00
Half Height DSDD Disk Drive (360K)	\$189.00
Disk Controller	\$ 99.00
Monochrome Graphics Board	\$299.00
Color Display Board	\$299.00
Hard Disk (w/ Software, Controller, Case, Power Supply) 10Mb	\$1295.00

Note: *Special Introductory Offer Expires Sept. 30, 1984
**Basic System PC-100 Includes Mother Board with 64K Expandable to 256K, Power Supply with Cooling Fan, Low Profile 96-Key or 83-Key IBM Compatible Detached Keyboard, 2 Serial Ports, 1 Parallel Port, and Metal Case with Hardwares.

MACROTRON SYSTEMS CORP.

8147 Delmar Blvd. • St. Louis, MO 63130

Tel: (314) 721-3356

Terms: Prepaid check or money order.

Visa or Mastercard

Circle 400 on inquiry card.

(text continued from page 354)

was not written in standard Modula-2 syntax, so it would not compile. (The Apple Pascal benchmark wouldn't compile either until I changed the name of the program from "Prime," which aliased one of the identifiers, to "prime.") When I tuned up the text, turned off range checking, and optimized both with addition instead of multiplication on line 18 (leaving the declaration order as in the originals), the benchmarks ran in 375 seconds for Volition's Modula-2 and 451 for regular Apple Pascal 1.1. Both might run faster if the arrays were initialized with FillChar, but that was specifically disallowed because of portability concerns. The Volition system has FillChar, but it should be used cautiously because it avoids some of the usual tight type checking. The Sieve article explained how to turn off range checking if that were available, and so I did.

The fourth column of the listings, which gives the offsets, or bytes, generated, shows that the way these compilers work is different from what you would expect from the text files. The Modula-2 compiler left the message shown below the listing; the program is compact, occupying 176 bytes. This doesn't count the module InOut, which will also be loaded into memory at run time, before the timing starts. Note that procedures such as WriteString don't generate more code than Pascal's WriteLn, they simply make the programmer do more of the work.

In particular, observe that the Volition Modula-2 compiler uses comparatively few bytes for a FOR loop. I understand that Volition's president, Joel McCormack, invented a new method of coding the FOR...TO...BY...DO...END loops that saves the p-machine much space and time. Because benchmarks such as BYTE's mainly use this control structure, Volition's programs test faster. Other constructs might not be as efficient, but Wirth claims that Modula-2's CARDINAL type and the built-in INC procedure, to name a few, are superior to Pascal's.

Please note that for some reason my benchmarks were slower than others BYTE gave for Apple Pascal, but some of my timings have been confirmed by Alan Anderson in an article submitted to *Apple Orchard* magazine.

In my experience, Volition's Modula-2

Listing 1: This program creates four windows on the screen to demonstrate some features of Modula-2. Each coroutine has memory space and processor time allocated by the modules Window and Scheduler. Note the similarities to Pascal (e.g., calling procedures by name or by value) as well as the differences (e.g., expressions and an ELSE within CASE labels, ELSIF, and two methods of module unqualifying: FROM...IMPORT or the alternative used in ReallnOut.ReadReal). See text for more information.

```

MODULE WindyDay;
(* multitask Modula-2 program "improved" from Joel McCormack's WindowDemo *)
(*SNOT "original, copyright 1982 by Volition Systems, all rights reserved" *)
(*SSET "Old stock Apple II keyboard?" FatherWoz *)(*SIF NOT FatherWoz THEN *)
FROM Windows IMPORT WINDOW, Open, Write, WriteString, Borders;
(*$TYPE "Remember, first compile definition and implementation modules" *)
(*$TYPE "you edit from Scheduler, and assign (*$SEG:=8;*) to definition." *)
FROM Scheduler (* in M2-LIB:WindDemo.text *) IMPORT CreateTask, Sleep, Start;
FROM Terminal IMPORT BusyRead; (* FROM Mouse IMPORT Swiss;*) IMPORT ReallnOut;
FROM ASCII IMPORT esc; (* all these must be in library modules, prefix #5: *)

PROCEDURE MaBell;
  VAR wind : WINDOW;
BEGIN
  Open (wind, 11, 18, 5, 22); (* appears in center of screen *)
  LOOP
    WriteString(wind, "You can't dial these 2"); Sleep
  END
END MaBell;

PROCEDURE IsaacWatts;
  VAR wind: WINDOW;
BEGIN
  Open (wind, 12, 1, 10, 16); (* toward left side *)
  LOOP
    WriteString(wind, "little busy bee "); Sleep
  END
END IsaacWatts;

PROCEDURE WriteItOnTheWind;
  VAR ch : CHAR; wind : WINDOW;
BEGIN
  Open (wind, 2, 24, 6, 15); (* type anything in top window *)
  Borders (wind, '+', '|', '-'); (* nice border around wind *)
  LOOP
    BusyRead(ch); (* checks for character typed *)
    IF ch = 0C THEN Sleep (* if not, continues *)
    ELSIF (ch = 'Q') OR (ch = 132C) (* 'Z': nC is octal *)
      THEN CreateTask (IsaacWatts, 'What?')
    ELSIF ch = esc THEN HALT
    ELSE Write(wind, ch) END
  END
END WriteItOnTheWind; (* if you have an Apple IIe 80-column card, *)
(* you get inverse wind when you hit CTRL-0*)

PROCEDURE OpenWindow;
  VAR number: REAL; choice: INTEGER; wind: WINDOW; CONST two = 1 + 1;
BEGIN
  Open (wind, 0, 1, 39);
  WriteString(wind, "Won't you really type one number? ");
  ReallnOut.ReadReal(number); choice := TRUNC(number);
  CASE choice OF
    two - 1 : CreateTask (MaBell, 'Phony');
              CreateTask (WriteItOnTheWind, 'Typer'); Start
    | 2..9 : HALT
    ELSE OpenWindow
  END (* CASE Swiss *) (* Scheduler creates status box, *)
END OpenWindow; (* 'Phony', etc., appear in box when created *)

BEGIN
  OpenWindow
END WindyDay
(*$SEND;*)(*If stock Apple II keyboard, set (*$SUPCASE:=TRUE;*) at top first*).

```

runs about 10 to 20 percent faster than Pascal on the p-System, if you do not include disk-access time. More informative comparisons could be obtained with other high-level languages. I believe that Modula-2 will run many times faster than BASIC or COBOL, but somewhat slower than most C or FORTH implementations, everything else being equal. But I think Modula-2 is the most readable.

It would be wise to heed the warning in the benchmark article, "Execution time of the Sieve program, of course, should be regarded as only one of several considerations in choosing a particular language, system, or processor." For example, it took about 40 seconds to compile (without listing to the printer) and then load the Modula-2 Sieve program, versus 22 seconds for Apple Pascal. The Modula-2 compiler accesses the disk more, to find modules to import from the standard library. But you can edit the standard library or even package necessary library modules directly into the program and so reduce

the disk access. You might also place your files on a RAM (random-access read/write memory) disk.

HASSLES

I had only a few minor problems with the Volition Systems' Modula-2 package. One was the documentation. Though complete, the manual is segmented into six parts, each with its own index, but there is no overall index and no common reference chart or summary. You have to read through the whole manual before it makes sense.

The last part of the manual is what you will need first—it is the implementation guide for your system. This guide has important differences from earlier sections of the manual. For example, section one of the user's manual says FLOAT and TRUNC work with CARDINAL numbers and even gives an example of how they work. That example will not compile as listed because, as we discover later, the Apple implementation uses the type INTEGER instead of the standard CARDINAL for those func-

tions. Also, some examples in the first part of the text do not assign segment numbers to definition modules; therefore, if you try to compile them as is, the compiler just breaks off. Later, the manual tells you what numbers to assign and how, but I wish I had been advised earlier not to try to type in the manual's examples. The ones that do work are on disk and can be compiled.

The sample programs on the PROG2: disk and on M2LIB: disk are an excellent tutorial to the Volition system. You should first print out the text files of these programs so you can follow along as you try to compile them.

The manual advises that you are limited to 10 significant characters for module names (the Modula-2 standard does not mention a limit). But two sample programs on PROG2:, namely LIBMODB:TEXT and OBJECTMODB:TEXT, have the same first 10 characters in their identifiers (NumberGenerator and NumberGenerators). When I compiled the second program it overwrote the file of the first one without any warning. I learned that it doesn't matter if you tell the compiler to give the code file a different filename because the compiler uses the identifier in the text file and then adds a suffix .SYM (or .MOD in the case of implementation modules). This procedure is different from the UCSD Pascal compiler's and deserves to be treated cautiously.

I also had one problem with the conditional compilation feature, using the (*SIF...THEN...\$ELSIF...\$ELSE...\$END*) directives. At first, I could not compile more than one module at a time, as was suggested by David Carlisle in the *Journal of Pascal and Ada* (May/June 1983). The compiler stops when it sees a period in the text. The compiler directive (*\$END*) to end the choice must come once, before the last period. Each separately compiled module or program usually ends with a period, and if there is more than one the compiler can't find either a (*\$END*) or a (*\$IF*), depending on which module I chose at compile time. When I inquired about this, Volition Systems told me the compiler had been changed somewhat from the 0.3a version Carlisle used, and that when using version 0.3k I should end each module prior to the last module with a semicolon instead of a period.

(text continued on page 358)

Listing 2: The Sieve of Eratosthenes prime-number program written in Modula-2. This program was compared to its Pascal equivalent, seen in listing 3.

```

1 7 1:D 0 (* STO "PRINTER;" *)
2 7 1:D 1 (* SRANGE:=FALSE; *) (* Note range checking off for speed *)
3 7 1:D 1 (* Eratosthenes Sieve prime-number program in Modula-2 *)
4 7 1:D 1 (* Original by Gunter Dotzel, ETH-Zurich, BYTE, January 1983, p. 290 *)
5 7 1:D 1 (* Modified by Eric Eldred *)
6 7 1:D 1 MODULE Prime;
7 7 1:D 1 FROM InOut IMPORT WriteLn, WriteCard, WriteString;
8 7 1:D 1 CONST Size = 8190;
9 7 1:D 1 VAR i, prime, k, count, iter : CARDINAL;
10 7 1:D 6 Flags : ARRAY[0..Size] OF BOOLEAN;
11 7 1:C 0 BEGIN
12 7 2:C 0 WriteLn; WriteString("10 iterations");
13 7 2:C 24 FOR iter := 1 TO 10 DO
14 7 2:C 27 count := 0;
15 7 2:C 30 FOR i := 0 TO Size DO Flags[i] := TRUE END;
16 7 2:C 49 FOR i := 0 TO Size DO
17 7 2:C 52 IF Flags[i] THEN
18 7 2:C 60 prime := i + i + 3;
19 7 2:C 67 k := i + prime;
20 7 2:C 72 WHILE k <= Size DO
21 7 2:C 80 Flags[k] := FALSE;
22 7 2:C 87 INC(k, prime)
23 7 2:C 92 END;
24 7 2:C 94 (* WriteCard(prime.6); WriteLn; *)
25 7 2:C 94 INC(count)
26 7 2:C 98 END;
27 7 2:C 98 END;
28 7 2:C 107 END;
29 7 2:C 114 WriteLn; WriteCard(count, 6); WriteString(' primes')
30 7 1:C 133 END Prime.

```

30 lines, 1750 words left
176 bytes generated

(text continued from page 357)

That worked fine. The documentation should be updated.

In addition to the user's manual and the tutorial disk, Volition includes Wirth's book, *Programming in Modula-2*,

which is hardly mentioned in the user's manual. Some of the modules in the manual are explained, with full source code, in the book. It's hard to know which to read first, but if you are just beginning programming you might study the first few chapters of the Wirth book before anything else. It is hard to find some things in the book because of its woeful index. Wirth not only wrote Modula-2, but also set the standard, helped develop hardware on which to run the new system, used the hardware to write the book about the language, then wrote a program to format the book's text, and finally typeset it with the computer and a Canon laser printer.

Wirth's book gives the definition module LineDrawing and states that it should be included in each implementation's standard library. It is not included in Volition Systems' library. Apple's Turtlegraphics unit (with minor syntax changes) is used instead, and it is somewhat different. It is not clear how Apple's high-resolution screen memory pages can be protected from user programs overwriting them. Some programs in Wirth's book can't run directly on an Apple because they were designed for the LineDrawing module or the Lilith's graphics screen. There is the module Windows on Volition's library disk, but it is not exactly the same as the WindowHandler in Wirth's book.

I must admit that I ran into these problems only because of my eagerness to get going with Modula-2. If I had approached it in a more organized fashion, I would have learned Modula-2 from the documentation rather than my own mistakes. If you have used Apple Pascal, it should not take more than a few weeks to feel comfortable with Volition's Modula-2.

I did experience some hardware problems.

When I attempted to install Modula-2 on my Corvus Winchester disk, the hard disk would no longer boot. Eventually, I had to completely reformat the disk and wipe out all its data in the process. Corvus customer support did not know about Modula-2 but I later learned that they were working on getting it up on the Corvus drive. Similar problems probably will occur if any hardware depends on patching Apple's SYSTEM.APPLE in a nonstandard way. The

(text continued on page 360)

Listing 3: The prime-number program in Apple Pascal. Both prime-number programs were modified from the originals found in "Eratosthenes Revisited: Once More through the Sieve," by Jim Gilbreath and Gary Gilbreath, January 1983 BYTE, page 283.

```

1 1 1:D 1 (*$L PRINTER:*)
2 1 1:D 1 (*$R-*) (* Note range checking turned off for speed *)
3 1 1:D 1 (* Eratosthenes Sieve prime-number program in Pascal *)
4 1 1:D 1 (* Original in BYTE, January 1983, p. 284 *)
5 1 1:D 1 (* Modified by Eric Eldred 25 Dec 83 to compare to Modula-2 *)
6 1 1:D 1 PROGRAM PrimePascal;
7 1 1:D 3
8 1 1:D 3 CONST Size = 8190;
9 1 1:D 3 VAR iter, count, k, prime, i: INTEGER
10 1 1:D 8 Flags: ARRAY[0..Size] OF BOOLEAN;
11 1 1:0 0 BEGIN
12 1 1:1 0 WriteLn; WriteLn('10 iterations');
13 1 1:1 43 FOR iter := 1 TO 10 DO BEGIN
14 1 1:3 57 count := 0;
15 1 1:3 60 FOR i := 0 TO Size DO Flags[i] := TRUE;
16 1 1:3 90 FOR i := 0 TO Size DO
17 1 1:4 106 IF Flags[i] THEN BEGIN
18 1 1:6 114 prime := i + i + 3;
19 1 1:6 121 k := i + prime;
20 1 1:6 126 WHILE k <= Size DO BEGIN
21 1 1:8 133 Flags[k] := FALSE;
22 1 1:8 140 k := k + prime
23 1 1:7 141 END;
24 1 1:7 147 (* WriteLn(prime); *)
25 1 1:6 147 count := count + 1
26 1 1:5 148 END;
27 1 1:5 159
28 1 1:2 159 END;
29 1 1:1 166 WriteLn; WriteLn(count, ' primes')
30 1 1:0 211 END (* PrimePascal *).
    
```

30 lines

Smallest available space = 2349 words

Table 1: These p-Shell utility programs add UNIX-like capabilities to the p-System. All of these shell utilities are written in Modula-2 and their source code is available.

cat	concatenates/copies input to output
cl	clears screen and home cursor
cp	copies any kind of file to another file
date	writes current date to standard output
echo	writes command arguments to output
ed	invokes editor, and edits file if listed (ASE is too large to fit in memory along with Modula-2 on the Apple II, but the original SYSTEM.EDITOR works fine here.)
f	invokes SYSTEM.FILER.
grep	searches input for string and writes lines to standard output; can search files listed
ls	catalogs files on disk
mc	invokes compiler (this won't work on Apple II)
mem	writes words of memory available
more	echoes input to terminal and writes "More?" when output reaches bottom of screen. If you then type "y", the screen will clear and the next 24 lines appear
mv	changes name of file
rm	removes file
sh	invokes shell (recursively)
sort	sorts lines of text file by ASCII (American National Standard Code for Information Interchange) order and writes to standard output; uses recursive quicksort in memory
wc	counts words, lines, and characters and writes totals to standard output

HIGH TECHNOLOGY AT AFFORDABLE PRICES

Columbia VP*

\$2159.88 UPS DELIVERED

(Offer good ONLY from June 1st through June 29, 1984)
Includes 1-year National Depot Warranty from Bell & Howell

- Compatible with IBM-PC
- 256K Bytes RAM (250 ns)
- 12K Bytes EPROM
- 8088 CPU (4.77 MHz)
- Socketed for 8087**
- Two ½ height Floppy Disk Drives (double-sided)
- One RS-232 Port
- One Parallel Port
- One expansion slot
- IBM-Style Keyboard
- 9" Monitor (640 x 200)
- RCA jack for external monitor
- Comes with MS-DOS, CP/M-86, Macro-86 (Macro Assembler/Linker), Basic-A, GW Basic, Perfect Writer/Speller/Calc/Filter/Link, Home Accountant Plus & Fast Graphs software package.

*Very Portable IBM-PC Compatible Computer System

**8087 chip not included



Volkmodem 300 baud modem

\$69.88 UPS DELIVERED

Includes FREE Log-on to "The Source" & your choice of cable.

- 300 baud, Full/half duplex
- RS-232 Interface
- Direct connect
- Auto Answer
- Manual dial
- Internal 9V battery*
- Cables for Apple, Atari, Columbia, Compac, Eagle, Franklin, IBM-PC, Kaypro, Osborne, TRS-80 (your choice)

Anchor Automation's **Volkmodem** lets you get on-line for less. Send or receive data at up to 300 baud, with full or half duplex operation. Ideal for the home computing enthusiast just beginning to explore communications.

*Battery not included. AC line power-pack optional



Microline 92 80 Column Dot Matrix Printer

\$469.88 UPS DELIVERED

National Depot Warranty from Xerox

- 160 chars/sec
- 10, 12 & 17 char/inch
- Correspondence font
- 120 x 144 dots/inch for graphics mode
- Double strike, double width
- bi-directional printing
- 9-wire printhead
- Friction/pin feed*

One of the best dot-matrix printers ever made! The **Microline 92** has superior correspondence-quality font, high speed draft mode, double-strike, graphics...everything a printer should have. A new version for the IBM-PC is also available (same price!). The **Microline 93**, a 136 column printer, costs only **\$769.88**, delivered.

*Adjustable tractor optional...\$59.88

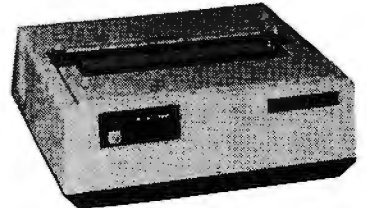

Roland DG Monitors Your choice of green or amber screen

\$149.88 UPS DELIVERED

- 12" diagonal screen
- 18 MHz Bandwidth
- Controls: On/Off Brightness/Contrast
- Composite video (NTSC)
- Green or amber
- RCA cable included
- If you're a musician, you've heard the name Roland before...they make one of the best synthesizers in the business. If you *haven't* heard of them, you will. Roland monitors are perfect for any system using composite video output. A superior product.

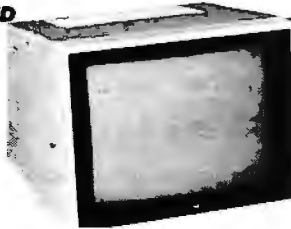

ADVANCED LOGIC SYSTEMS • ALLOY • AMDEK • ANADEX • AST • CCS • CARDCO • C ITOH • COMREX • COLUMBIA DATA PRODUCTS
CURTIS MANUFACTURING • DATA PRODUCTS (IDS) • DIABLO • DTC • EAGLE COMPUTER • EASIFEED • EPD • EPSON • FRANKLIN COMPUTER
HAYES MICROCOMPUTER PRODUCTS • HERCULES COMPUTER TECHNOLOGY • INFORUNNER • INTERACTIVE STRUCTURES • JMM
JUKI • KENSINGTON MICROWARE • LEADING EDGE • LQ • MANNESMAN TALLY • MA SYSTEMS • MICROSOFT • MILFORD NULL MODEM
MOUSE SYSTEMS • NOVATION • NEC • OKIDATA • ORANGE MICRO • PARADISE SYSTEMS • PERFECT DATA • PRINCETON GRAPHICS
QUADRAM • QUME • QCS • RANA SYSTEMS • ROLAND DG • SILVER REED • SMITH-CORONA • STAR MICRONICS • TANDON • TECMAR
TITAN • TOSHIBA • USI • US ROBOTICS • VIDEX

The right place for the right price

If you live in the New England area (or plan to visit there), you should drop by our **Discount Computer Store**. We're about one hour's drive from Boston, the ocean or the White Mountains. From Boston, just go up Route 3 to Nashua, NH, and take Exit 7W (Route 101A). We're 5.1 miles from that exit, in Amherst NH, right near Dexter Shoe. In fact, we're near a lot of New Hampshire's factory outlet stores, and with no sales tax you can save a bundle on computer equipment, shoes and whatever else strikes your fancy.

We have several systems on display, as well as printers, modems and monitors, all at the same prices you see in our ads. And if you can't fit a purchase into your car, don't worry...we'll ship it free anywhere in the 48 contiguous states.

No matter where you live—Boston or San Francisco—You don't have to strike out into the wilderness to save money. Take a short drive or drop us a line for the best advice and price for IBM-PC peripherals.



(603) 881-9855

TECHNICAL SALES DESK

(800) 343-0726

TOLL-FREE ORDER DESK

Hours: 9:00 to 5:30 EST, Mon-Fri

- FREE UPS ground shipping on all orders
- Shipments fully insured at no extra charge
- MasterCard, VISA, American Express, Diners Club & Carte Blanche credit cards accepted
- No surcharges on credit card
- Credit cards are not charged until your order is shipped from our warehouse
- CODs accepted up to \$1000 (add \$10 for COD handling). Payable with certified check, money order or cash.
- Full manufacturer's warranty on all products sold
- 1-year extended warranty service is now available for many products (just ask us)
- Sorry, no APO/FPO or foreign orders



THE BOTTOM LINE



MILFORD, NH 03055-0423 □ TELEPHONE (603) 881-9855

(text continued from page 358)

standard way is to use the SYSTEM.ATTACH utility, as described on a disk from the International Apple Core. For example, I was able to install my Saturn 128K-byte card as a RAM disk with no trouble.

To be fair, Volition Systems did not suggest that I could perform any such surgery on my Corvus. If I had checked with the company first, it would have warned me of the consequences. Modula-2 can be used with the Corona Starfire (with minor patches) and Xebec hard disks, but some early Videx Videoterm 80-column card ROM (read-only memory) chips may need to be updated before Modula-2 will work with them, according to a manual addendum.

Other difficulties I experienced using Modula-2 on the Apple are not Volition's fault. The Apple II has limited memory, speed, and disk space and Modula-2 pushes the machine to its limits. Apple has promised that Apple Pascal version 1.2, when released, will allow you to use Volition's Modula-2 more conveniently, at least on a 128K-byte Apple IIe.

The version of Modula-2 I tested (0.3k) did not support long integers. Volition Systems has been working on implementing them in two directions. First, Richard Gleaves revealed to me that he had worked out a zero-page change to allow Pascal long integers to run under Volition's Apple p-code interpreter, and this should be available in the next Modula-2 release. Second, Volition, together with the Modula Research Institute, is developing a standard long-integer approach, a natural tool on 16-bit machines, and hopes to persuade Wirth to include it in the standard language. Although Volition does include the Decimals module to do scientific and commercial mathematics, so many programs have been written using long integers in Pascal that it would be senseless to disregard them and start over.

There are several ways to use Pascal with this Modula-2 system. One is to run Pascal straight, as a completely separate program under the Modula-2 interpreter. ASE, a large Pascal program, does this. If the program works, there will be no need to waste time converting it. But if you wish to convert a Pascal

(text continued on page 362)

Table 2: A feature-by-feature comparison of Volition Systems' Modula-2 (version 0.3k) with Apple Pascal (version 1.1).

Feature	Language Comparison Chart Apple Pascal (version 1.1)	Volition Modula-2 (version 0.3k)
Separate compilation, information hiding	units, constricted; no true packages with local variables, user-defined opaque types	modules, flexible; definition modules give version control; locals, opaques
Large programs	26 segments, chaining	64 modules, overlays
Input/output	awkward, not standard	standard library
Machines access	machine language or variant records	type transfer, SYSTEM, fixed address variable
Concurrency, interrupts	not standard	standard, coroutines
Procedure variables	none	standard type
Functions	return only scalars	return any type
Arrays	fixed size, typed	open array parameters
Expression evaluation	not always clear order	AND, OR short-circuits
Constants	no expressions, fixed order of declaration	expressions too (also allowed in CASE labels); declare in any order
Declaration order	fixed, at beginning; all CONST, etc., together	any place before use; ok to group in any order
Identifiers	case-insensitive; no standard style among programmers	CaseSensitive (standard—unless SUPCASE directive)
Character significance	first_eight	AsManyAsItTakes
Underscore character	ignored, more_readable	NotAllowedAtAll
Predefined	GET, PUT, INTERACTIVE	not needed
ATAN	same as standard ARCTAN	arctan only
CAP	none; use nonstandard capitalization procedure	standard identifier, converts to uppercase
CONCAT	joins two or more strings	only two arguments
Log (base 10)	in TRANSCEND unit	not provided
NEW, DISPOSE	use MARK, RELEASE	standard identifiers
NIL	reserved word	standard identifier
ORD	returns INTEGER, value of CHAR is decimal	returns CARDINAL, but CHAR value is octal
PAGE	no UCSD ClearScreen	use ClearScreen
Power of ten	PWROFTEN	PowerOfTen
PRED, SUCC	standard	none, use INC, DEC
PROC	none; no procedure variables allowed	standard type, denotes parameterless procedure
ROUND	standard UCSD identifier (integer)	none, use FLOAT(integer) (standard is CARDINAL)

(table 2 continued on page 362)

"My IBM® PC XT writes monthly billings and statements to Maxwell & Sons' 1,893 customers, and tells me who owes what."

When you work with a lot of information, you can't afford to re-enter every file when your hard disk fails. And no hard disk is fail-safe.



"My Sysgen Image backs up the whole lot in less than five minutes. 10 megabytes on a single cassette..."

The Sysgen Image backs up the hard disk in your IBM PC XT. So you can protect your files in minutes—instead of spending hours re-entering them.



"For just \$995. That's cheap insurance. It lets me sleep at night."

The Sysgen Image for just \$995. It's the most affordable insurance you can buy for your two most important assets: Your information. And your time.



Sysgen. Because a hard disk without tape just doesn't make sense.

Sysgen products for the IBM® PC, PC XT, and other personal computers: Economical, 10- and 20-Megabyte hard disk systems with tape back-up. Or 10-Megabyte

tape back-up for the IBM PC XT.

Go to your local computer dealer. Ask for a demonstration of Sysgen back-up systems. And find out how to make sense of your storage.

47853 Warm Springs Blvd., Fremont, CA 94539
(415) 490-6770 Telex 4990843

SYSGEN
INCORPORATED

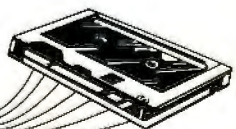

IBM is a registered trademark and PC XT is a trademark of International Business Machines Corporation. Sysgen Image is a trademark of Sysgen, Incorporated.

Circle 317 on inquiry card.

The p-Shell (formerly called p-Nix) is an optional replacement for the p-System command envelope.

(text continued from page 360)

procedure to Modula-2, as for example a software tool, then you can do so with the aid of CONVERTCODE, a program on M2LIB. This will not convert a program automatically. First you have to compile the program (or assemble an external procedure) and make it a Pascal intrinsic unit. Then you have to change the interface syntax by hand so it agrees with Modula-2's and make that part into a definition module. You do not even need the text of the unit. Finally, you can convert the unit code into a Modula-2 implementation module and use it in MODULA.LIBRARY. Unless you go through these steps, all carefully described in the manual, you cannot directly access a Pascal or assembly routine from Modula-2. It makes sense to start thinking in Modula-2 right away, but your Pascal programming need not all be wasted.

The p-Shell (formerly called p-Nix) is an optional replacement for the p-System command envelope. It adds commands like those in the UNIX operating system to the p-system. (See "The Software Tools: Unix Capabilities on Non-Unix Systems," by Deborah K. Scherrer, et al, November 1983 BYTE, page 430, for another implementation.) The p-Shell has pipes and redirection, but no hierarchical files and no control structures such as IF. .THEN. Also, it creates a temporary file on the root volume when needed, so it is rather slow and disk-intensive.

Volition has generously donated the full Modula-2 text files of many shell utilities (see table 1).

You may add commands of your own to the shell. Facing the disk and memory limits of Apple II version 1.1, you will need to use all the tricks suggested in the disk documentation when recompiling the shell programs. I'd like to see some utilities such as a style checker

(text continued on page 364)

(table 2 continued from page 360)

SQR	also SQR in TRANSCEND	sqrt only
STR	may convert long integers or integers to string	none; use Decimals, Conversions
TIME	not implemented	not implemented on Apple
TREESEARCH	fast binary tree search function	absent; thus can't run Pascal compiler
TRUNC	accepts long integer, but error if > 32767	returns INTEGER, no long; (standard is CARDINAL)
WriteLn	If followed by string, number, or character, then writes it and return, else return alone	carriage return and line feed only; import WriteString, WriteCard, etc. for other functions
Reserved words	case-INsensitive (more legible if in CAPS)	MUST BE ALL CAPS (but see SUPCASE directive)
Include	PROGRAM, FUNCTION, EXTERNAL, UNIT, USES, INTERFACE, SEGMENT	use modules instead; convert intrinsic units (assembly language too)
Also	PACKED, FORWARD	nonstandard but present
CODE procedure	none; use assembly language	p-code instructions
BEGIN	one for every END	most not needed
Terminator for procedure (module)	END; (END. for program) ok: END (* Big_Program *).	add identifier after END as END Stuff; END FooN
IF, FOR, WHILE, WITH, REPEAT	use compound statements each with BEGIN. .END	require only closing END; (UNTIL if REPEAT)
ELSE	none allowed in CASE	ok in CASE for otherwise
ELSIF	none; use maze of IF. .THEN	use for cascaded IF. .THEN
GOTO, LABEL	programming's Pittdown man; useful for multiple exits	streng verboten; use LOOP/EXIT, RETURN, HALT
DOWNT0	negative steps in FOR. .TO. .DO	none; step can be BY -1 or almost any value
Symbols	generate all needed from old Apple II keyboard	use nonstandard \$SPECIAL to transliterate some
","	"," expected to delimit all statements	also, " " delimits CASE statements and record variants
Extra delimiter	not before ELSE	no " " before ELSE
Pointer	^	declare POINTER TO
Set constant delimiter	[square, brackets]	{curly, braces}
Subranges, array Declarations	"[", "]" around subranges	"[", "]", also arrays if explicitly declared
AND	AND	"&" also used
Not equal	"<>"	"#'" also used
Comment delimiters	either "(*)" or "{"; if use both, then one-level nesting, not standard	only "(*)" multiple nesting is standard

(table 2 continued on page 364)



"Kaypro 2... \$1295... Complete..."

Oh, mentor of highest wisdom, help all mystified first-time buyers discover the ultimate truth about personal business computers.

Tell them that, unlike other computer companies, Kaypro does not advertise a low "starter system" price, then charge extra for so-called "options" like a monitor, software, disk drives or peripheral interfaces.

Tell them that Kaypro 2 has become the fourth largest-selling personal business computer because we sell it complete. For \$1295.

Tell them that Kaypro 2 comes with a highly readable, 9" green-screen monitor. A 64K RAM, Z-80 microprocessor. Two built-in disk drives with a 400K capacity. A more complete keyboard than Apple IIe. Interfaces for both a printer and a telecommunications modem. And a full complement of CP/M software to handle the overwhelming majority of Word Processing, Data Base Management and Financial Spreadsheets needs, with top quality programs such as Wordstar.

All for \$1295.

Then, tell them to call 800-447-4700 for their nearest dealer, or call Kaypro at 619-481-4318.



KAYPRO

The \$1595 computer that now sells for \$1295.

Volition Systems' Modula-2 for the Apple II has useful features to correct most of Pascal's problems.

(text continued from page 362)

and dictionary, and others have suggested that *lint*, a program syntax checker, would be welcomed.

Volition Systems is composed of a small group of programmers, many of whom worked on the original UCSD Pascal project. Their support ranks among the highest I have encountered. I found them approachable, patient, and anxious to fix all bugs. They are active in helping users groups, and they make you feel we are all in this together.

CONCLUSIONS

Volition Systems' Modula-2 for the Apple II is much more than enhancement to the Apple Pascal operating system and language. The system has useful features to correct most of Pascal's problems; the modules are a big improvement over units, especially for teams of programmers. It has advanced features such as multitasking and low-level access. See table 2 for a feature-by-feature comparison with Pascal.

The system is not intended for beginners, but it would be suitable for any advanced user who is reaching the limits of Apple or UCSD Pascal. Most students start with BASIC, go on to Pascal, and then on to Modula-2, C, etc.

This version of Modula-2 is designed to be portable. Not only will most existing Apple Pascal programs run unchanged under its interpreter, but you can easily convert most Pascal units to Modula-2 as well. You should be able to compile Modula-2 programs on the Apple II that will run directly on an Apple III, an IBM PC, a Sage, or a Z80 computer.

The Advanced System Editor and p-Shell are inexpensive and effective tools for software development. You may find you spend a lot of time using them for everyday purposes, even if you don't program in Modula-2. ■

(table 2 continued from page 362)

String delimiters	single quotes; contained single quotes can be expressed by doubling them	either single or double quotes; use other mark to express contained one
"0"	not allowed	empty parameter list
INTEGERS	decimal only; ok to mix with reals	also hex and octal; convert before mixing
MOD	unreliable with negatives; works with any INTEGERS	undefined for negative; no CARDINALs >32767
CARDINALs	none. use (long) Integers	unsigned units 0 to 65535
Long Integers	up to 36 BCD digits for business, scientific use	use Decimals (19 digits) no long Integers yet
Reals	no decimal point is required, "e" ok; ok to mix with integers	requires decimal point, "E" only, not "e"; don't mix with integers
Reading a real	mistaken string input will crash system; read string instead and then convert	ReadReal uses ReadString, so no crash, but you must check if it's real
Characters	standard Pascal maybe not standard ASCII sequence	In ISO, US ASCII order; ordinal value octal
Strings	UCSD: first byte is length of string	ARRAY, not predeclared, can convert to UCSD
One-character string	ok	allowed in versions after .3k
Constant, variable length	must match	constant can be shorter than ARRAY length
Sets	elements 0-511, Integer, maximum	same, up to 32 words on Apple, 255 on others
Type	determined by elements	can be explicitly typed
BITSET	lacking; (NB: PACKED ARRAY [0..7] OF BOOLEAN is 16 bits)	standard default type to fit in one machine word
Set operations	within same type	can also use INCL, EXCL; "/" for bitwise XOR
Record variants	very important, but only one variant part available "trick" variants for PEEK, POKE	can contain several variant parts, each terminates with END; use SYSTEM for machine-independent access
Compiler	supplies dots for each line	no dots
Swapping	compiler option	nonswapping
Even more swapping	S++ gives more memory	\$RECYCLE option
Conditionally compiles	no	yes
Byte-flip option	no	yes
Debugger	not implemented	minimal \$DEBUG
Version control	none or minimal	both at run and compile
Input-output check	(*\$I*) disables	not compiler option



Ad

Photo: Peter B. Kaplan

If you still believe in me, save me.

For nearly a hundred years, the Statue of Liberty has been America's most powerful symbol of freedom and hope. Today the corrosive action of almost a century of weather and salt air has eaten away at the iron framework; etched holes in the copper exterior.

On Ellis Island, where the ancestors of nearly half of all Americans first stepped onto American soil, the Immigration Center is now a hollow ruin.

Inspiring plans have been developed to restore the Statue and to create on Ellis Island a permanent museum celebrating the ethnic diversity of this country of immigrants. But unless restoration is begun now, these two landmarks in our nation's heritage could be closed at the very time America is celebrating their hundredth anniversaries. The 230 million dollars needed to carry out the work is needed now.

All of the money must come from private donations; the federal government is not raising the funds. This is consistent with the Statue's origins. The French people paid for its creation themselves. And America's businesses spearheaded the public contributions that were needed for its construction and for the pedestal.

The torch of liberty is everyone's to cherish. Could we hold up our heads as Americans if we allowed the time to come when she can no longer hold up hers?

Opportunities for Your Company.



You are invited to learn more about the advantages of corporate sponsorship during the nationwide promotions surrounding the restoration project. Write on your letterhead to: The Statue of Liberty-Ellis Island Foundation, Inc., 101 Park Ave, N.Y., N.Y.10178.

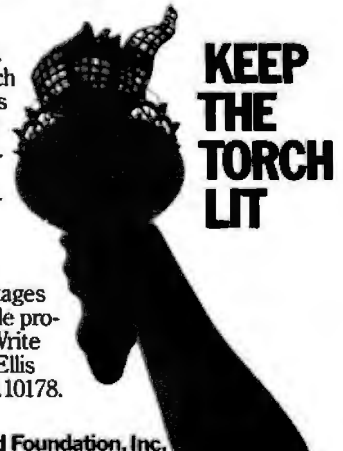

Save these monuments. Send your personal tax deductible donation to: P.O. Box 1986, New York, N.Y. 10018. **The Statue of Liberty-Ellis Island Foundation, Inc.**

MicroAge[®]

"THEY GAVE US THE COMPETITIVE EDGE!"

"Since opening our Orland Park store in 1981, we've doubled our square footage and are opening a second store in Oak Lawn; it's MicroAge's 100th store. MicroAge showed us how to develop a professional atmosphere, build a knowledgeable sales force, and provide the technical assistance needed to reach small to mid-size businesses in the Chicago suburbs."

"MicroAge is the franchise organization you like to have supporting you because they maintain high professional standards. With MicroAge, we've gained the type of reputation that brings referrals from satisfied customers."

"If we had to do it all over again, we'd do it with MicroAge!"

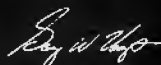

Gary W. Voogt
President



Garrett N. Voogt
Vice President

To build your own professional computer sales organization with MicroAge requires an initial investment of \$200,000 to \$350,000 which includes \$80,000 in liquid assets. Write to:

MicroAge[®] COMPUTER STORES "The Solution Store"[®]

1457 West Alameda • Tempe, Arizona 85282

(602) 968-3168



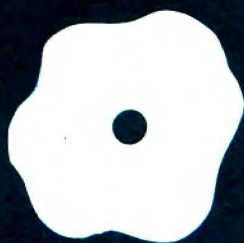

Infoscope

A RAM-based database- management system

BY GEORGE BOND

Infoscope is a database-management system for the IBM PC that is significantly different from other similar products. Unlike many other programs in the new generation of database-management systems (DBMSs), Infoscope is not relational. It does not handle huge data files. It does not do fancy formatting of reports. And, more than just incidentally, it does not cost over \$400.

What Infoscope does do is run extremely fast. The program is RAM (random-access read/write memory) based rather than disk based, giving it a faster operating speed without the usual wait for disk accesses for data retrieval. You can have as many as 12 "scopes" (the program's term for windows) on the screen and 8 files open at once. However, only one scope may be used at a time—the program does not offer multiple active windows in the sense that Concurrent CP/M-86 does. Infoscope does sophisticated, complex sorts and searches. It is as close to being truly "user friendly" as anything on the market today. Its use of color adds genuine utility to the program. It has an excellent on-line, interactive spelling checker and it can use files generated by other popular programs, such as dBASE II and Lotus 1-2-3. And Infoscope carries a retail price of \$225.

BASIC FUNCTIONS

The main program, written in assembly language, occupies almost 85K bytes of disk space. Help and other subsidiary files add about 150K bytes to the disk load. Infoscope allows a maximum of about 8000 records per file, 254 fields per record, and 254 characters per field. It can use straight ASCII (American National Standard Code for Information Interchange) text command and vocabulary files; these files can be created with MS-DOS's EDLIN editor or a compatible word processor.

The basic trade-off made in writing the Infoscope program seems to have been speed versus file size. The program runs entirely in RAM, which makes it exceptionally fast, but it requires a lot of memory, which limits the amount of data that can be used at one time. The specified minimum system requirement for RAM is 192K bytes. With the memory-

address space available to 16-bit microprocessors, such as the 8088 in the IBM PC, the large memory requirement for Infoscope is not a serious problem. For example, when the program is loaded into an IBM PC having 512K bytes of RAM, 392K bytes will be left for data-file manipulation. When a file of 1418 records, each containing 173 characters, is loaded on top of the Infoscope program, 153K bytes of RAM remain free. This means that Infoscope is not limited to files of trivial size, although it will never become the program of choice for running a population analysis of the People's Republic of China or an econometric model of the United States.

RAM limits also cause problems when using Infoscope's DOS command (under DOS 2.0 or higher, only). This command allows you to temporarily leave Infoscope, drop into MS-DOS, run another program, and return to Infoscope exactly where you left it. This is very handy but, unfortunately, if you leave Infoscope with, say, 240K bytes of RAM free and run a BASIC program from DOS, you may find only 100K bytes or so of RAM free when you get back to Infoscope. Infoscope generates a warning message if it is in danger of overwriting itself in memory.

THE QUICK SORT

If you are used to working with dBASE II or another DBMS that is I/O (input/output) intensive, sorting on Infoscope will be a pleasant surprise. The 1418-record file described previously can be sorted on one field, 40 characters long, in about 6 seconds. Sorting on two fields takes about 8 seconds, and on three fields takes about 10 seconds. Sorting the same file on the same single field using dBASE II (the file was originally created in dBASE II and converted by an Infoscope utility program) on a computer with an Intel 80186 microprocessor running at 8 MHz (instead of the 4.7 MHz of the IBM PC's 8088) took about an hour and five minutes. Multi-

(text continued on page 368)

.....
George Bond is managing editor of User News for BYTE. He can be contacted at POB 372, Hancock, NH 03449.

(text continued from page 367)

field sorts are not possible using the dBASE II sort program.

Sorting the BYTE standard benchmark file for DBMSs (see table 1) took about 3.2 seconds using Infoscope. In contrast, dBASE II took 6 minutes and 33 seconds on the same IBM PC using a 10-megabyte hard disk. On a DOS 2.1 formatted 5¼-inch floppy disk, the dBASE II sort took 12 minutes and 45 seconds. Lotus 1-2-3 required 12.8 seconds for the sort. (Both 1-2-3 and Infoscope work entirely in memory, so the type of disk you use has no effect except when loading and saving files.) Finding specific records within the file is equally fast. In Infoscope, it again takes about 0.5 second to find and display the 1000th record in the benchmark file as opposed to 0.3 second on the hard disk using the "locate" function in dBASE II (however, if the dBASE file is indexed, its "find" function slightly outperforms Infoscope, taking about 0.3 second to find the 1000th record, but not display it). On the floppy disk, the dBASE II "locate" took 43 seconds.

COLOR

Infoscope uses color to make the program more effective. The program dis-

plays information inside a scope. The scope is outlined by a white line when first displayed. Up to 12 scopes, containing information from different files, can be displayed on the same virtual screen. When multiple scopes are open, moving among them can be a problem. Infoscope helps you cope with this through its COLOR command. You can outline a scope in yellow, red, blue, cyan, magenta, or green (see photo 1). Once a scope is colored, you can refer to it in commands by its color instead of its filename. (For example, you can command the program to "move red here" rather than type "move payroll63.dat here.") The same method can be used on a monochrome screen, but instead of actually changing color the scopes are merely labeled with the color name.

The colors of all parts of the screen can be easily changed, albeit only for cosmetic reasons outside of naming scopes. Having black characters on a white background inside the scopes, however, does seem to make them easier to read and less visually fatiguing than the normal VDT (video-display terminal) light-on-dark screen. Black, incidentally, is an undocumented color; press K to get it from the PAINT menu.

WORKING ENVIRONMENT

When Infoscope is booted, it displays a "command box" on the bottom left of the screen and a "scanner" on the right (see photo 2a). The command box, which occupies about 80 percent of the horizontal space at the bottom of the screen, is where commands are entered and some basic system information is displayed. The scanner is a simulation of the program's workspace and is intended to show you where the cursor is located in that workspace. The workspace is 62 lines deep by 253 characters wide; the physical screen, which is a window into the workspace, is 22 lines deep by 78 characters wide.

Cursor movement in the workspace is slow compared to other Infoscope functions. It takes about 7 seconds to move from the left edge of the screen to the right edge using the right cursor key. The cursor movement can take even longer if a scope is wider than 80 characters (see photo 2b). Fortunately, there are alternatives. You can use the MAP command for an overall view of the workspace, showing the relative location of scopes from above the screen (see photo 2c) or from the left side or bottom of the screen. MAP also allows you to jump the cursor directly to a new

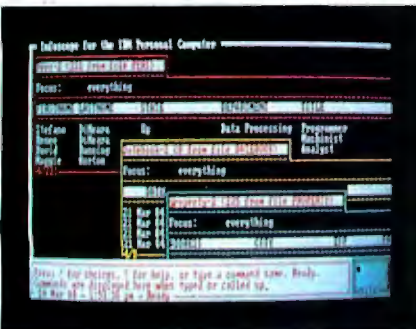

Photo 1: Scopes. Infoscope's name for windows, can be colored and then referenced by the color name rather than by the filename. On this screen, for example, the scope at top left could be moved to the cursor position with the command "move red here."

Table 1: These benchmarks were compiled using a standard BYTE benchmark file composed of 1000 records, each 100 characters long. The first field of the record is 4 characters long and contains a unique number from 1001 to 2000. The remaining three fields are also numeric, each containing four continuous strings of the characters "1" through "8" ("12345678123456781234567812345678").

The sort was done on the first field. It was sorted into normal order from reverse order. "Locate" is a dBASE II function that locates records in nonindexed files. The time shown is the time needed to find the last record in the file, using the four-numeral field as the search field. "Find" is the dBASE II procedure for finding a record in an indexed file; again, the four-numeral field was the search field. Neither Infoscope nor Lotus 1-2-3 require indexing, although Lotus 1-2-3 does require a look-up table for its "find" function. The dBASE II times for both "locate" and "find" are compared to nonindexed, nontabled procedures in Infoscope and to look-up table procedures in Lotus 1-2-3. All times are the average of four trials.

Note that three of the times are ½ second or less, and normal margins of error could make relatively large differences. However, these should be useful measures relative to each other.

	Infoscope	dBASE II (floppy disk)	dBASE II (hard disk)	Lotus 1-2-3
Sort	3.2	765	393	12.8
Locate	.5	43	13	1.8
Find	.5	.3	.3	1.8

(All times in seconds)

scope. The POINTER command lets you enter vectors to jump the cursor to a new location. For example, you can enter the command "pointer R 59 D 22" to move 59 columns to the right and 22 down. Finally, you can set up to 10 markers—"landmarks" in Infoscope jargon—anywhere in the workspace and jump directly to any one with a Control-Alt-number command. Using the numeric keypad's plus and minus keys in conjunction with the arrow keys also helps by causing the cursor to do a long tab, 10 characters at a time horizontally or vertically.

Infoscope's spelling checker should make entering long commands, such as the pointer strings and other data, less frazzling for the fumble-fingered. Type "poniter" in a command line and Infoscope politely asks if you really mean "pointer." Respond with a Y and the command is entered. In fact, the spelling checker is so effective and makes the program so much faster and easier to use, it's a wonder more programs don't have such an amenity.

Overall operation of Infoscope is straightforward. Most procedures can be run either by pointing to choices in a series of menus and submenus or by typed-in commands. Help screens are available for many functions (see photo 2d). New scope files can be made through a CREATE command. Data is entered into a scope from the keyboard by using the ADD RECORD command, and edited or deleted with the CHANGE and DELETE commands. Changes are permanently saved with a SAVE command and printed with a PRINT command. On-screen forms may be designed using a FORMS command and saved for later use. In all, there are 67 Infoscope commands; they can be displayed by typing "list commands" (see photo 3). If you don't like some of the command words, you can change them within the program. If you prefer the concept of rearranging data rather than sorting it, you can add the REARRANGE command to the system vocabulary as a synonym for SORT.

FEATURES

Infoscope can deal with several foreign file formats. It can read and write files for dBASE II and Lotus 1-2-3 by simply "loading" them before "looking" at them (LOAD converts the file format

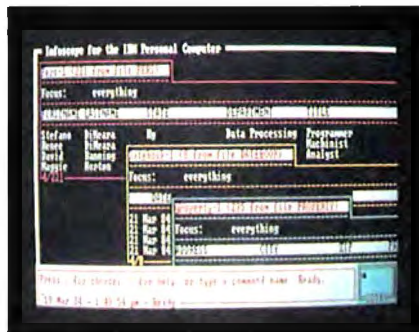

(2a)

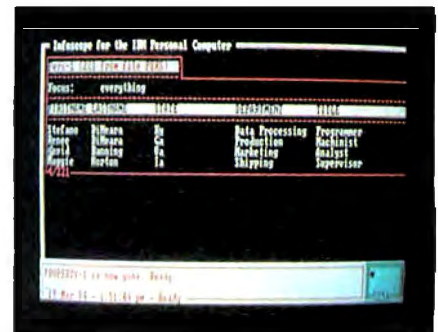

(2b)



(2c)



(2d)

Photo 2: Infoscope provides operating information in several ways. "Tiers" of commands can be displayed at the bottom of the screen (2a) by pressing the Tab or Slash key and individual commands can be selected by stepping to them with the space bar or by typing their first character. The blue square at the right is the "scanner" showing the cursor's relative position on the virtual screen. The colors of any screen section may be changed with a short series of commands. The scopes themselves may extend beyond the real screen boundaries (2b), requiring scrolling to be displayed fully. The program can provide a map of the virtual screen (2c), showing the position of multiple scopes on the virtual screen. You can jump directly to any screen by locating the cursor over it on the map. Help screens (2d) are available for many functions. An unusual feature of Infoscope's help screens is that they may be kept on the screen while the instructions are executed, eliminating the need for the user to remember a complex series of steps to do a task.

and LOOK puts an Infoscope file into memory). DataStar files can be read after having their extensions changed to conform to Infoscope requirements. After data is manipulated by Infoscope, it is semi-automatically converted back for use by one of these programs (you must "write" the file instead of "saving" it). Infoscope also can write but not read Multiplan SYLK files.

Two kinds of sorts are available. One is the ordinary sort-on-last-name variety to reorder an entire file. It works in the same manner as many other DBMS sorts, although much faster. The second sort is called Focus, and it creates temporary new files that contain only specific records within a file. The range of words you can use in focusing is much wider than the usual collection of Boolean terms (see table 2). These

words include several that use an algorithm to locate similar-sounding words—freed and Fried, for example. In a personnel file, all June hires could be found and placed in a special, temporary file (that can be saved if a permanent file is needed) by using the command "focus hired in june." The FOCUS command does not reorder the contents of the temporary file; it is a selection and creation command. But a Focus file can be reordered with the SORT command.

Infoscope procedures can be automated through the use of command files either from DOS or in the program. Also, function keys may be reprogrammed easily from the keyboard. Infoscope was written by Jeff Garbers, who wrote the Crosstalk telecommunications program, and its parentage

(text continued on page 370)

AT A GLANCE

Name
Infoscope

Type
In-memory database manager

Manufacturer
Microstuf Inc.
1845 The Exchange
Suite 140
Atlanta, GA 30339
(404) 952-0267

Price
\$225

Author
Jeff Garbers

Format
One 5¼-inch floppy disk

Language
Assembly language

Computers
IBM PC and PC XT

Documentation
IBM PC-style 162-page,
indexed manual

Audience
Anyone needing to
organize and analyze
moderate amounts of data

LOCATE TIMES (IN SECONDS)

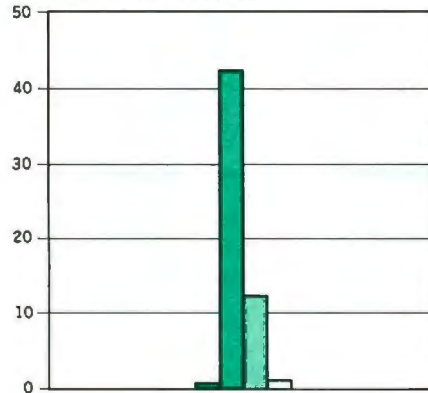

SORT TIMES (IN SECONDS)

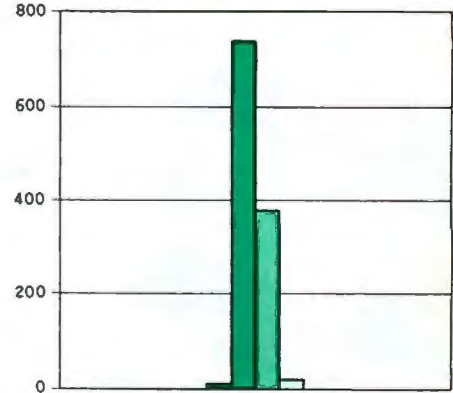

FIND TIMES (IN SECONDS)

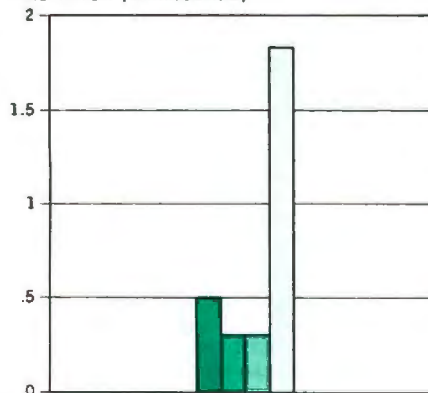

These are the results of three sets of benchmark tests comparing Infoscope, dBASE II, and Lotus 1-2-3. All were run on an IBM PC with 512K bytes of RAM (256K on the motherboard and 256K on a Quadboard I) and an external 10-megabyte hard-disk drive manufactured by Great Lakes Computer Peripherals. The operating system was PC-DOS 2.1.

The first test was to determine how long it takes to sort a file containing 1000 records, each 100 characters long, on a field containing four numeric characters. The second test was to determine how long it takes to access and display the last record in the file without using an index; the third test was for the same thing, but using an index. Creating the dBASE II index on the four-numeral field took about 96 seconds. Neither Infoscope nor Lotus 1-2-3 require indexing, but Lotus 1-2-3 requires a look-up table for its Find function. Also, when dBASE II executes a "locate" or "find" command, it does not automatically display the record found; that requires a second command.

All times listed were clocked by hand using a stopwatch, so they are not absolute. However, they should be accurate in relation to each other.



**You'll need
a full-feature
word processor to
list all of the
products in our
Spring/Summer
Catalog**

Send for free catalog today.

Strictly Soft Ware 1-614-587-2938

To receive your free catalog right away, send this coupon to the address below. Do you want our Apple or IBM Catalog? Overseas mailing - \$2.50.

NAME _____

STREET _____

CITY STATE ZIP

()
PHONE _____

Strictly Soft Ware
P.O. Box 338
Granville, OH 43023



REVIEW: INFOSCOPE

(text continued from page 370)

almost unheard of characteristics in computer documentation.

SUMMARY

Infoscope clearly is not the program for every use. There are better choices for dealing with mailing lists or complex

sets of related but separate data that will be combined into a multiplicity of unique databases or for dealing with data that requires sophisticated numerical manipulation. But for many, perhaps most, DBMS applications suited for microcomputers, Infoscope should provide an attractive solution. ■

Table 2: Focus commands for Infoscope. The commands, using "plain English," enable you to select the particular records based on specific criteria in any of a record's fields to create temporary new files. The temporary files can be saved if needed.

Word:	Example / Meaning:	
IS	Price IS 80,000	
EQUALS	Price EQUALS 80,000	(same as IS)
SAME	Price SAME AS 80,000	(same as IS)
BE	Price BE 80,000	(same as IS)
=	(abbreviation for IS, EQUALS, SAME, BE)	
BETWEEN	Price BETWEEN 80,000 and 100,000	
STARTS	Name STARTS with "fa"	
BEGINS	Name BEGINS "fa"	(same as STARTS)
ENDS	Name ENDS "y"	(similar to BEGINS)
BEFORE	Date BEFORE 12/31/83	
FROM	Date FROM 12/1/83 to 12/31/83	(similar to BETWEEN)
DURING	Date DURING March, 1983	
AFTER	Date AFTER 12/1/83	
TODAY	Date is TODAY	
LAST	Date is LAST MONDAY	
NEXT	Date is NEXT MONDAY	
OVER	Price OVER 80,000	
>	(abbreviation for OVER)	
GREATER	Price GREATER THAN 80,000	(same as OVER)
ABOVE	Price ABOVE 80,000	(same as OVER)
MORE	Price MORE THAN 80,000	(same as OVER)
LARGER	Price LARGER than 80,000	(same as OVER)
UNDER	Price UNDER 80,000	
LESS	Price LESS than 80,000	(same as UNDER)
<	(abbreviation for LESS THAN)	
BELOW	Price BELOW 80,000	(same as UNDER)
SMALLER	Price SMALLER than 80,000	(same as UNDER)
OR	(conjunction — used to express multiple conditions, i.e.: City is "morla" OR "Riveria")	
AND	(conjunction — used to express more than one focus condition at a time, i.e.: Price over 80,000 AND city is "Moria")	
&	(abbreviation for AND)	
INCLUDES	Features INCLUDES "school"	
\$	(abbreviation for INCLUDES)	
CONTAINS	Name CONTAINS "BERT"	(same as INCLUDES)
HAS	Name HAS "BERT"	(same as INCLUDES)
SOUNDS	Name SOUNDS "Freed"	(finds records which sound like "Freed"; "Freid", "Fried", etc. First letter MUST match)
LIKE	(alternate form of SOUNDS)	
NEAR	(alternate form of SOUNDS)	
NOT	City NOT "Moria"	
-	(abbreviation for NOT)	
REJECT	(alternative form of NOT, i.e. Focus reject city "morla" is the same as Focus city not "morla")	
BUT	(alternative form of NOT, i.e. Focus All BUT city "morla")	
EXCEPT	(same as BUT)	
AMONG	(include only items which are contained in a certain set; i.e. Focus company AMONG automakers will locate only those companies in the file that are also contained in the AUTOMAKERS set. The set must have been previously defined with the DEFINE command.)	
IN	(same as AMONG)	
CHANGED	(finds records that have been changed since last Infoscope session)	
MARKED	(focus on specially marked records)	
DELETED	(finds records that have been deleted during this Infoscope session)	
NEW	(finds records that have been added during this Infoscope session)	



Advancing the technology of data security

Introducing Data Sentry.[®] Computer security so advanced, even Mata Hari couldn't hack it.

Your most confidential files may be easy prey for the advances of an artful hacker.

That's why Lockheed used its years of experience with high-technology systems to create Data Sentry.

Protection for sensitive data

Its own internal computer gives you the telecommunications features of an intelligent modem. But unlike other modems, Data Sentry is smart enough to keep your secrets from the most persistent computer intruders.

Data Sentry puts an electronic wall around both large and small computers. And because its protection is external to your CPU, it can eliminate the expense of internal security software. It blocks the inquiries of would-be Mata Haris with a sophisticated security sequence.

Security for every situation

First, Data Sentry requests the phone number of a caller desiring access to your computer. Then it hangs up the phone and searches its list of authorized phone numbers. If the caller's number is authorized, Data Sentry dials the caller back and requests entry of a password. If the correct password isn't supplied within three tries, Data

Sentry disconnects and will not return further calls from that phone number.

Data Sentry also lets users select other lower levels of security if desired, including callback to any number with entry of password. And an option, Remote-ON,[®] lets you turn your computer's power on and off from a remote terminal after security has been cleared.

Versatile and confidential

Data Sentry logs all attempted contacts for audit trails and analysis of users. Its security set-up is locally controlled by a master password that is accessible only to authorized personnel. And its design includes high-reliability components, the latest LSI circuitry, plus Autodial 300/1200 baud full-duplex communications, with auto ranging for incoming data.

Data Sentry will deal with your toughest security problems.

And it'll never fall for just a pretty face.

For a list of your nearest Data Sentry distributors, call toll-free 1-800-443-0100, Ext. 471. Or write: Lockheed GETEX, Suite 945, 1100 Circle 75 Parkway, Atlanta, Georgia 30339.



Lockheed-GETEX
Leadership in Technology

Circle 191 on Inquiry card.

BASIS 108

.....
 I read with interest Seth Bates's informative review of the Basis 108 (January, page 354). I bought a Basis in August 1983 and agree with Bates's positive comments about its advantages. However, he failed to note some of the limitations of which your readers should be aware. Here are those we have discovered:

- The Basis 108 is *not* fully compatible with Apple II+ CP/M software, in much the same way that the Apple IIe is not.
- Technical support from the current Basis distributor (and Basis itself) has been very poor.
- Documentation is poorly organized and uneven in depth. Those professionals planning to add peripherals or do anything out of the ordinary should be aware that no assembly code of the CP/M BIOS is available. Since this is essential also for debugging and using advertised options, it is a distinct disadvantage that it has not been included in the documentation.

M. J. MAYER
*Associate Professor of
 Psychology/Psychobiology
 University of California
 Santa Cruz, CA 95064*

Your review of the Basis 108 computer in the January issue missed some features of this computer that I have found very helpful. It also overlooked some deficiencies and contained some errors.

On the positive side, the Basis does not normally require a fan for cooling purposes (because of the large metal housing and sufficient power supply). This means it is without the nerve-racking hum that many computers have. Other writers who work in a quiet environment, as I do, would appreciate this feature. The power supply also comes with surge protection built in.

One of the utility programs included is a "pseudo disk" that transforms the extra 64K bytes of RAM into a "RAM disk," a most useful feature that can speed up processing immensely and can automatically be booted upon power-up.

While the Basis has many improvements over its Apple counterparts, this also means some programs written for the Apple need to be specially configured ("optimized" in the words of the reviewer) for the Basis. This means you may be forced to buy the software from a Basis dealer. Some dealers will not provide computer help unless you are using their software.

Seth Bates is obviously a computer technician, since he didn't comment on the documentation of the Basis. The documentation that to date has come with the Basis is very technical. For a technician the manual is probably useful, but

for a layperson it is confusing and not helpful. Computer Systems Designs informs us that a new, more friendly manual is in process but not yet available.

We purchased our machines in 1982 and no documentation is available for the CP/M utilities (CP/M 2.2); this means you borrow an Apple/CP/M Softcard Manual from an Apple owner, or spend hours on the phone handholding a dealer, who you hope is patient and intelligible. Even then, some of these utility programs include the configuration program for the Basis, GBASIC, and MBASIC, which require documentation to use.

This makes it imperative to have Basis users groups. However, your review erred in listing a California Basis users group in Salinas, California. The gentleman listed is a former Basis dealer, period. The only Basis users group is the one listed in New Jersey, under Bill Cook.

The Basis is a well-built, powerful computer (like a well-designed German car), but the average driver needs a good drivers manual, not an electrical specs pamphlet. The average layperson will find it difficult to use the full powers of the Basis without more clear and simple documentation.

MARTIN THOMMES
 549 Auburn St.
 Ashland, OR 97520

BUGS IN THE PINBALL CONSTRUCTION SET

.....
 I was surprised to read Elaine Holden's review, "Pinball Construction Set" (January, page 282) and see that she could not find anything wrong with it. I have had the Commodore 64 version for two months now and find it extremely bug infested. Some of the problems, which were apparent the first day I had the product, are:

- The drop targets can "catch" a ball and jam. Also, hitting a drop target near the side can drop the target on the opposite side.
- The "multiball unit," the most advanced feature of the playfield, hardly works at all. With the default "world" settings, the balls tend to sit at the top of the unit but never enter it. Increasing the gravity (not always desirable) seems to reduce this, but the problem may still occur. However, after multiball play, if a ball re-enters the unit, the game may never detect that that player's turn is over.
- The construction mechanism itself is prone to hang or crash without apparent cause. I have talked with other users and found that this is a common problem. Anyone who works with the set for a few hours can expect to see such a crash. There's no restart mechanism, so you are back to zero when this happens. When play-

ing the game and bugs like those mentioned hang a player, there's no recourse but to cycle power and reload to continue to play.

There are also a number of limitations and design flaws I hoped the review would mention, but these are not truly bugs. Many show limitations of the Apple origin of the software, however, and could have been cleaned up quickly.

I have not seen the Apple or Atari versions of the Pinball Construction Set, but I expect they do not suffer the same problems. Apparently Electronic Arts rushed this product out for the Commodore 64. The package reads "Designed and programmed by Bill Budge," but when the disk is booted, we find a message that the 64 version has been programmed by someone else. (I doubt if Bill Budge, having spent the time he obviously did, would have let the bugs slip out.) Electronic Arts' "warranty" is a disclaimer; it claims the company will not be responsible for the bugs.

Pinball Construction Set is certainly a spectacular piece of software, and it is sure to be a big seller. It's unconscionable that Electronic Arts would push the Commodore version to market in the state that it's in.

HARRY J. KUHMANN
 6407 J The Lakes Drive
 Raleigh, NC 27609

THE IBM CS-9000

.....
 After reading Thomas R. Clune's review of the CS-9000 from IBM Instruments (February, page 278), I felt that he had left some things unsaid. We have had a CS-9000 in our laboratory since January 1983, and we have experienced every difficulty mentioned in the review and then some. The amount of time I have spent with that machine is just appalling.

We purchased the CS-9000 for two major reasons. First, because its multitasking operating system (OS) would let us acquire data from our two liquid scintillation counters and two gamma counters concurrently. These devices output digital data on multiple samples at sample intervals of several minutes over periods of several hours. Our plan was that after one counter had finished its samples we could massage the data via BASIC or Pascal programs while the other counters were still active. The second reason for purchasing the CS-9000 was to add the four RS-232C ports on the optional analog-sensor board to the three RS-232C ports on the motherboard, ending up with seven ports: four for the counters, one for a digital plotter, and two for future expansions.

When our CS-9000 arrived, we went through every problem that Clune noted (including
(text continued on page 376)

Why buy a VISUAL 102 instead of a DEC VT102?

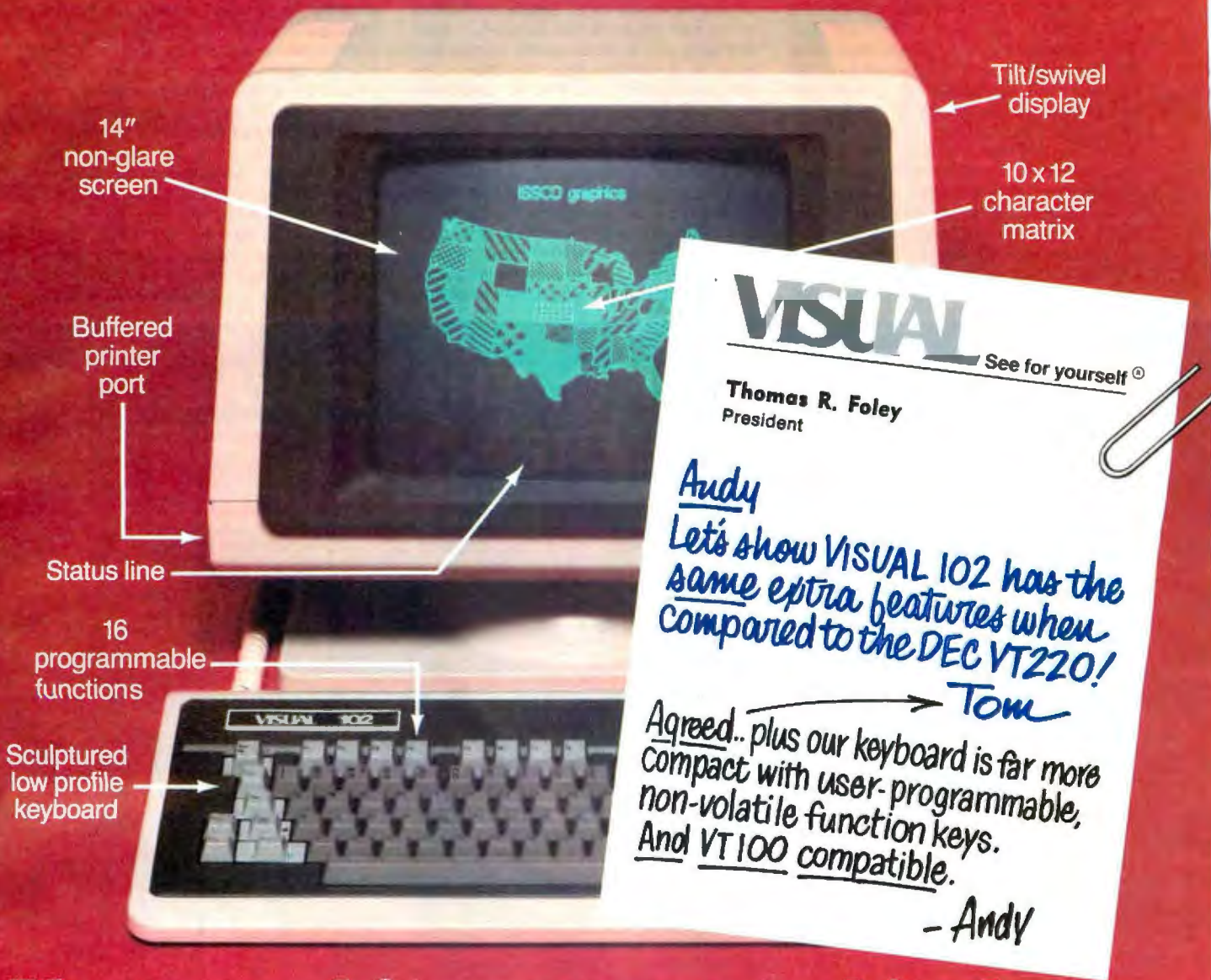

Plus...graphics now or graphics later.

The new VISUAL 102 gives full DEC VT102[®] performance and more features at a much lower price. Plus, when you need it, a Graphics Option card turns the VISUAL 102 into a 768 x 293 resolution graphics terminal emulating the Tektronix 4010/4014. Just insert the card and immediately you have high resolution graphics compatible with a variety of available software packages.

VISUAL 102. The low cost, DEC VT102 compatible terminal that lets you graph now or graph later.

The UL listed VISUAL 102 exceeds FCC Class A requirements and U.S. Government standards for X-ray emissions.

VISUAL See for yourself[®]

Visual Technology Incorporated
540 Main Street, Tewksbury, MA 01876
Telephone (617) 851-5000. Telex 951-539

Circle 347 on inquiry card.

(text continued from page 374)

breaking the plastic nut on the CRT ball joint). We discovered that the CS-9000 multitasks only with compiled programs. No compiler was available for months and the BASIC was interpreted. Then we got the Pascal compiler (so I learned Pascal) and discovered that the OS had some bug that effectively prevented multitasking. We finally got a multitasking OS and the long-awaited analog-sensor board. The RS-232C ports on the analog-sensor board never have been made to work with OS 1.0. However, we were successful in using the motherboard RS-232C ports in a multitasking mode.

Where are we now? The latest version of the OS, OS 1.1, which we received in January 1984, won't write BASIC files to disks formatted by

OS 1.0. The programs we wrote to input data via the motherboard RS-232C ports using OS 1.0 don't work with OS 1.1. Despite the fact that we do have programs that successfully input data using OS 1.0., we are unable to input data using OS 1.1 via either the motherboard or the new analog-sensor board RS-232C ports. Readers should also know that the XENIX operating system mentioned by Clune is only in the "intended" stage—it is *not* available now. Additionally, I know of no commercially available software for the CS-9000 other than the languages available from IBM Instruments. The OS for the CS-9000 is not compatible with *any* other computer. Service on the CS-9000 consists mostly of sending the owner new parts for installation by the owner. The CS-9000 is built to occupy

as little space as possible, and doing anything other than plugging in a new options board is not trivial. We have had several hardware problems. I can now gut, scale, and fillet a CS-9000 in about 10 minutes, but it took a lot of practice. The ergonomic problems noted by Clune are also not trivial. Our lab benches are standard for a biochemistry lab, but too narrow for the CS-9000—siting has been a problem.

But the cruelest blow was when a visiting scientist brought his Apple II+ to our lab. A few lines of Applesoft and it took in data from a counter on the first run.

To give the CS-9000 its due, it is very capable hardware. It might be the choice if you have a few highly repetitive tasks for which you are will-

(text continued on page 378)

IN THE BEGINNING, THERE WAS IBM & APPLE®. NOW THERE'S

Super 5™

THE FINEST QUALITY
PERIPHERALS FOR IBM/APPLE®
AND THEIR COMPATIBLES.



SLIM LINE DRIVE

- T-40 TEAC Direct Shaft Drive for Apple® with 5 write-protected options.
- C-40 Chinon Direct Shaft Drive for Apple®
- Double-Sided Direct Shaft Drive for IBM
- 32 mm Height, 3.5 inch Direct Shaft Drive for O.E.M.

10M BYTE HARD DISK SYSTEM

- Low Power Slim Line Hard Disk with Intelligent Controller & Cables, Internally Installed in IBM PC.

BLOCK MATRIX PRINTER

- CP-80 Block Dot Head with Friction Feed
- P109/120 cps with Letter-Quality & Draft Hard Print

HIGH QUALITY MONITORS

- 100A Amber with 20 MHZ Video Response for Apple®
- 500 A.G. Amber, Green with Rotary Stand for IBM.
- 55C 14 inch RGB Color with Rotary Stand for IBM.

Mitsuba Corporation

667 Brea Canyon Road, #25
Walnut, California 91789
Tel: (714) 594-6959
Outside Calif. 1-800-MITSUBA
Japan TLX: 23325 EI-EN ENT

Circle 228 on Inquiry card.
IBM is a registered trademark of IBM Corp.
Apple is a registered trademark of Apple Computer Inc.

Gifford has a lock on multiuser CP/M[®] 8-16.

It's 11:00 P.M. Do you know where your files are?

It's great when multiple local and off site users can run any 8- or 16-bit CP/M or MP/M[™] program. It's even better when they can share expensive resources like printers, hard disks, and tape drives. Best of all is when they can share your most precious resource — data. Gifford has been delivering systems with all these features for over two years.

But sometimes data is sensitive. How do you keep people from taking more than their fair share?

Gifford adds a new dimension to CP/M security.

With our new security features, you can control what resources and data are shared.

Gifford's proprietary security enhancements include user login with encrypted passwords, control over access rights of modem users, secure electronic mail, and the ability to restrict users to specified terminals, programs, and directory areas. Plus, an audit log utility that keeps a permanent record of system activity. And you also get all the standard security features of Digital Research's MP/M-86[™].

You select the level of security needed to get the best balance between file sharing and file safety.

Unleash productivity with Gifford's Virtual Terminals.

With our Virtual Terminals, each terminal on your system can monitor up to four different programs running concurrently. And at the touch of a key you can switch screens instantly from one program to another.

You could look up an address in dBASE II[™], jump over to SuperCalc[™] to make some projections, then switch instantly to WordStar[®] to use this information to update a letter. If you forget what's on a screen, just touch a key to refresh your memory. You won't need to go through the distracting process of loading and unloading programs.

And since your Virtual Terminal can run any 8- or 16-bit CP/M or MP/M program, you can choose the best programs for your job from the biggest software library in the world. It's easier than 1, 2, 3!

The Gifford Security Blanket: Total Solutions.

Gifford delivers solutions. This means professional pre-sale consultation, expert system integration with 200 hour system burn-in, complete training, and full after sale support.

For example, our three user CompuPro[®] based system with a 21-megabyte hard disk costs just \$9,990, and can be easily expanded for \$500 per

user. This includes MP/M 8-16, SuperCalc, and dBASE II.

Other Gifford solutions include systems with hard disks that range from 5 to 300 megabytes, 4 and 9 track tape backup, printers, plotters, and modems. Single- and multiuser 8086, 68000, and Z-80 based systems are available for immediate delivery, with 80286 and 16032 systems on the way.

Two year warranty protection.

In the unlikely event that you encounter a hardware related problem, we'll replace any defective S-100 part within 24 hours FREE for two full years. But chances are, it can be solved on the Gifford service hotline or diagnosed via modem. All at no cost to you.

Lock in on Gifford Security today.

If total support, training, on site service, obsolescence-proof upgradeable S-100 bus architecture, and complete system security sound appealing, cut the coupon or give us a call. We'll send you a free brochure that tells the whole story. Once you get it you'll see why Gifford has a lock on multiuser CP/M 8-16.

Gifford Computer Systems is a Full Service CompuPro[®] Systems Center.



The powerful Gifford System 321 shown with optional GCS-80 Virtual Terminals.

GIFFORD
COMPUTER SYSTEMS

2446 Verna Court, San Leandro, CA 94577
(415) 895-0798 A division of G&G Engineering
I'D LIKE THE WHOLE STORY.
Please send me your brochure.

Name _____ Title _____
Organization _____ M/S _____
Address _____
City _____ State _____ Zip _____
Phone _____
 Please have a representative call me. **BY-S**

GIFFORD COMPUTER SYSTEMS □ San Leandro, CA (415) 895-0798 □ Los Angeles, CA (213) 477-3921 □ Houston, TX (713) 680-1944
Amherst, NY (716) 833-4758 □ Telex: 704521

Multi-function RS-232 Transfer Switches

MFJ-1240
\$79.95

Choice of
8 models



Multi-function RS-232 transfer switches let you switch your computer among printers, modems, terminals, any RS-232 peripherals; monitor data/line failure, protect data lines from surges, and use as null modem for less cost than a switch alone.

Switches 10 lines (2, 3, 4, 5, 6, 8, 11, 15, 17, 20). LED data/line indicators monitor lines 2, 3, 4, 5, 6, 8, 20. Metal oxide varistors protect data lines 2, 3 from voltage spikes and surges. Push button reverses transmit-receive lines (2, 3). PC board eliminates wiring, crosstalk, line interference. Connects any one input to any one output.

Model	Price	In	Out	Model	Price	In	Out
MFJ-1240	\$79.95	1	2	MFJ-1244	\$139.95	3	3
MFJ-1241	\$99.95	2	2	MFJ-1245	\$169.95	3	5
MFJ-1242	\$119.95	2	3	MFJ-1246	\$199.95	5	5
MFJ-1243	\$119.95	1	4	MFJ-1247	\$99.95	1	2

Switches 20 lines

AC Power Centers

MFJ-1108
\$99.95

MFJ-1108, \$99.95. Add convenience, prevent data loss, head bounce, equipment damage. Relay latches power off during power transients. Multi-filters isolate equipment, eliminate interaction, noise, hash. MOVs suppress spikes, surges. 3 isolated, switched socketpairs. One unswitched for clock, etc. Lighted power, reset switch. Pop-out fuse. 3 wire, 6 ft. cord. 15A, 125V, 1875 watts. Aluminum case. Black. 18x23/4x2 in. MFJ-1107, \$79.95. Like 1108 less relay. 8 sockets, 2 unswitched. MFJ-1109, \$129.95. Like 1107 but intelligent. Switch on device plugged into control socket and everything else turns on. Others available.



Acoustic/Direct Coupled Modem



Use with any
phone anywhere \$129.95

MFJ-1233

MFJ-1233 Acoustic/Direct Coupled 300 baud modem. Versatile. Use with virtually any phone, anywhere. Use battery or 110 VAC. Direct connect mode: Plug between handset and base. Use with single or multi-line phones. Acoustic coupled mode: Use with phones without modular plugs. Quality muffs give good acoustic coupling, isolates external noise for reliable data transfer. Originate/answer. Self test. Carrier detect, ON LEDs. RS-232, TTL compatible. Reliable single chip modem. Crystal controlled. Aluminum cabinet. 9x17/2x4 in. Other models available.

Order from MFJ and try it. If not delighted, return within 30 days for refund (less shipping). One year unconditional guarantee.

Order yours today. Call toll free 800-647-1800. Charge VISA, MC. Or mail check, money order. Add \$4.00 each for shipping and handling.

CALL TOLL FREE . . . 800-647-1800

Call 601-323-5869 in MS, outside continental USA.

**MFJ ENTERPRISES
INCORPORATED**

921 Louisville Road, Starkville, MS 39759

REVIEW FEEDBACK

(text continued from page 376)

ing to write the software, and you have another computer for spreadsheets, general graphics, and the like. At present, the CS-9000 is definitely not a general-purpose laboratory computer. And it never will be one until it becomes dependable, easy to use, and begins to get a software base.

And, to give IBM Instruments its due, it has agreed to take back its computer and give us a refund.

PETER S. TOBIAS, PH.D.

Department of Immunology

Scripps Clinic and Research Foundation

10666 North Torrey Pines Road

La Jolla, CA 92037

After reading the article by Thomas R. Clune, I was amazed. Not as amazed as I have been by the lousy service we have received from IBM, however. It's terrible! Our research group ordered a CS-9000 in the fall of 1982, and the string of promises, inaction, and bugs that followed (and are continuing) has forever tarnished the IBM name for me.

First there were the delays in shipping, then the lack of documentation or a high-level language. When we finally did receive versions of Pascal and BASIC, they weren't compatible with the current (original) version of the operating system (OS). Similar problems plagued us for at least another year. Finally, after seven months of promises from our former marketing representative, the company replaced our unit. The new processing unit didn't work with the old disk drives or old software, so more waiting followed.

You call this customer service? There have been several updates of both the high-level languages and the OS since our new machine arrived last fall. We were not informed of them nor did we receive any of them. Most of our information about software updates and new offerings comes from the rumor mill, not from our current marketing representative.

Most recently we discovered yet another bug in the system. The editor has the habit of inadvertently overwriting parts of other files on the same track of the disk, leaving all of the affected files unusable and unretrievable. When I described this problem to Dr. John Tesch of IBM, he agreed that it does do that sometimes. Even though IBM is aware of this bug, it is still shipping an OS containing it, without warning customers.

I agree with Clune's description of the potential that this system possesses. That's what compelled us to purchase one when it was first introduced. Unfortunately, unlike Clune, we were not the beneficiaries of any significant attention from the customer service department at IBM Instruments. Without that support, and with this trouble-laden product, none of us are very fond of our CS-9000 system.

MICHAEL RIEBE

Chemistry Department

University of Wisconsin

Madison, WI 53706

I enjoyed your article on the IBM CS-9000 laboratory computer, but I feel the article grossly

understates the computing power of the CS-9000 system. The performance example cited in the article involved polling a device once per second, receiving, and averaging 2K bytes of data. In our application (high-performance NMR spectroscopy and medical imaging), a CS-9000-based system is used for polling several devices every 200 milliseconds, receiving, scaling, and graphically displaying 6K-byte data packets. In addition, the system is able to simultaneously transform the data to floating-point format and perform complex manipulations on it rapidly (for example, 1024-point complex floating-point Fourier transforms in 145 milliseconds). By way of comparison, a VAX 11/780 with DEC's floating-point accelerator requires 228 milliseconds of processing-unit time and an indeterminate amount of real time to perform the same 1024-point complex floating-point Fourier transform (IMSL scientific subroutine library "FFTCC").

To be fair, I must point out that my CS-9000s have been configured with extra hardware including 1 megabyte of RAM, a 10-megabyte Winchester disk, and a SKY MNKV floating-point processor. Even with all these goodies, the CS-9000 system can be purchased for \$20,000, an order of magnitude less than the cost of the VAX. The implications of this are quite remarkable, and they suggest that a new generation of supermicrocomputers is now available. These machines are desktop computers that offer real computing power, affordable by small laboratory or business groups. Only 5 or 10 years ago comparable performance figures would have been regarded as competitive for a low-end mainframe.

The ENIAC, a room-size behemoth that revolutionized the world of computing, required 200 milliseconds to perform one multiplication. The CS-9000 sitting on my desk does one multiplication in less than 2 microseconds. In other words, my little computer is 100,000 times faster than the ENIAC. I think it is impressive.

DAVID J. STATES, M.D., PH.D.

Staff Scientist

MIT

Building NW14-5122

Cambridge, MA 02139

THE WANG PROFESSIONAL COMPUTER

I was pleased to see the review, "The Wang Professional Computer," by Elaine Long in the December 1983 issue, page 360. This is the first article I have seen about the machine.

There are three Wang PCs at my place of employment. I have been using one almost daily since July for spreadsheet and word-processing applications (using Multiplan and Wang Word Processing). And I introduce new users to the computer and software. I like the hardware very much. The keyboard in particular is excellent. The arrangement of the keys favors the person with some typing experience, but the shape and response of the keys suit almost everyone except those with unusually large fingers. On the other hand, the lack of an Escape key is irritating.

REVIEW FEEDBACK

The menus make it easy for our users to spend time using the computer rather than learning how to command the operating system. If the menus are time-consuming to a regular user, they can be circumvented quickly.

Wang Labs' sales and support has been rather poor in my area; I feel it is not ready to sell the equipment. There is a toll-free PC hotline in Lowell, Massachusetts, for customers. Answers to questions are being delayed one to two days at this time. The people on the hotline are very diligent in their efforts to solve problems; however, they are still learning about the equipment.

Regarding quality, on the first two machines a memory-expansion board and a Winchester controller card failed to function on delivery. A floppy-disk drive failed in three days after delivery. Both of these machines were delivered to us before September of last year. We received an extensively configured machine in December; everything still functions. A board inside one of the older monochrome monitors was replaced recently. Service (on maintenance contract) has been painless, of the replace and test variety.

For us, delivery of hardware takes about eight weeks. We have waited for several months for delivery of our 2.0 version of Wang Word Processing and the *Program Development Manual*. The local sales office will not show us the Wang Data Base, explaining that it is too bug-ridden to be demonstrated.

When we purchase a system, the second drive and expansion boards arrive in separate packages. The customer is expected to install them or engage Wang (the fee is extra). There are instructions included, and the current set is correct. There are no caveats regarding static charge and the like, however. Installation is simple for the type of person who would fearlessly attack a broken toaster—and be able to avoid creating further damage.

I like the computer, and I will like Wang better in a few more months when, I hope, the newness of the product has been overcome.

By the way, the printer in photo 1 of the article is not a daisy-wheel model. It is the Wang Dot Matrix printer, correctly listed as model PC-PM010. The printer looks and acts remarkably like an Epson MX-80 F/T. The daisy-wheel printer available is model PC-PM012; it looks like a Diablo (640, I think). I recommend that any prospective Wang Word Processing user either purchase one of Wang's printers, an Epson or similar printer, or do some very thorough investigation. Wang's generic parallel-printer driver supports few of the word-processing package's features, not even the double line spacing. I have not worked with the generic serial printer driver.

KANDACE L. MYERS
17 East Factory St.
Mechanicsburg, PA 17055

VIDEX ULTRATERM

I would like to extend Videx's thanks for the recent review of the UltraTerm in the February BYTE (p. 310). There has been a change, how-

ever, in the VisiCalc preboot for the UltraTerm that occurred after the review was written. The 160-column mode of the preboot was replaced with another display mode that uses 80 columns and 32 lines. We feel that this display will better complement the UltraTerm with VisiCalc.

Videx is now sending a list of available software that utilizes the expanded features of the UltraTerm upon request.

WILLIAM LEINEWEBER
Customer Service
Videx Company
897 NW Grant Ave.
Corvallis, OR 97330

Z-100 DOCUMENTATION AND OTHER VIEWS

I have just read "The Zenith Z-100" (January, page 268) written by Ken Skier. I am a sophomore computer-science major at Clarkson University and have had a Z-100 for about six months. Mr. Skier's review was excellent in all aspects but one: the documentation. In my opinion, the documentation as a whole is lousy. It is often incomplete, difficult to use, and very confusing. The BASIC, FORTRAN, Pascal, Multiplan, CP/M, and Z-DOS manuals consist of one or two ring-bound binders. Almost all are lacking a detailed index consolidating both binders in a clear and concise fashion. Although, as Mr. Skier mentioned, the documentation is quantitative (in terms of pages), it certainly is not qualitative.

Other than this section, I think the review was very accurate and did justice to the underpublicized Z-100.

BRENT N. HUNTER
Clarkson University
Potsdam, NY 13676

I enjoyed reading Ken Skier's Z-100 review. (I've had my H-120 since last May.) I'm writing because of one small inaccuracy regarding the dual-processor configuration.

Any time you are running CP/M-85, you are using the 16-bit 8088 almost constantly. Briefly, all I/O (input/output)—disk, screen, keyboard, serial, and parallel ports—is being done in the bottom page of memory under the control of the 8088. Anytime there is I/O activity, the 8088 swaps out to the 16-bit side.

There are a couple of significant advantages to this, besides the fact that the 8088 is running more efficient code routines:

- The BIOS in the 8-bit memory page is considerably smaller; CP/M-85 therefore gives the user around 3K bytes more program and data workspace.
- Warm boots are extremely fast, as copies of the BDOS and CCP are kept in the bottom page of RAM and therefore do not have to be re-read from a bootable disk. A warm boot merely logs in the new disk, as the 8088 very quickly copies the BDOS and CCP from low RAM to the CP/M page of memory.

A couple of minor points—the separate video RAM banks are not parity-checked, and the

(text continued on page 380)

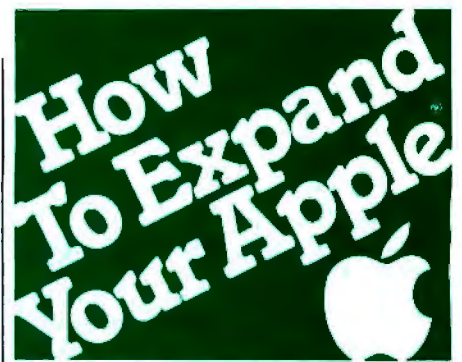

Only Titan's Neptune™ provides Apple IIe users with an 80-column video display and up to 192K memory—all in just one slot.

Now, Titan's exclusive Neptune extended 80-column card gives you increased video display and up to 192K memory using just one slot in your Apple IIe. Designed expressly for the auxiliary slot of the IIe, the Neptune is available with 64K, 128K or 192K of RAM memory. The RAM memory can be



utilized as a solid state RAM disk. Additionally, Titan's VC-EXPAND/80™ software supplied with each Neptune expands VisiCalc® up to 220K of workspace memory and provides many other VisiCalc enhancements. DOS, PASCAL and CP/M® PSEUDO-DISK™ patches and a DOS relocation program are also included with each Neptune card.

Let us help you expand your Apple's productivity. For information on the Neptune and other Titan microcomputer products, see your computer dealer or contact: Titan Technologies, Inc., P.O. Box 8050, Ann Arbor, MI 48107; Telephone (313) 973-8422.

Sales and Marketing by The
MARKETING RESOURCE GROUP,
Costa Mesa, CA.



Apple is a registered trademark of Apple Computer, Inc. VisiCalc is a registered trademark of VisiCorp, Inc. CP/M is a registered trademark of Digital Research, Inc. VC-EXPAND software is written by Micro Solutions, Inc. Neptune and PSEUDO-DISK are trademarks of Titan Technologies, Inc.

REVIEW FEEDBACK

(text continued from page 379)

11-megabyte Winchester upgrade has been announced at \$1799.

I thought the article was very good—comprehensive and well written. I have three Heath/Zenith micros; the H-120 is rapidly becoming my favorite because of its exceptional capabilities.

AL HEIGL
Mill City Records
POB 3759
Minneapolis, MN 55403

I would like to take this opportunity to comment on the Zenith Z-100 review. I own a Heath H-100, which is the kit version of the Zenith Z-100, and I am extremely pleased with this machine.

Ken Skier states that "8-bit CP/M software is hard to come by in the Z-100 5¼-inch format." I have found that almost all software that I am interested in comes in the Heath/Zenith format. Perhaps your author was not aware that the Zenith format is the same as the common Heath format. In particular, the complete CP/M User's Group and SIG/M public-domain CP/M libraries are available on Heath soft-sectored disks (two sources of these public-domain disks are: Robert Todd Jr., 1121 Briarwood, Bensalem, PA 19020, and Headware, 2865 Akron St., Atlanta, GA 30344).

Skier states that the Z-100 cannot transfer files between disks of different formats. Computer Consultants to Business (1033 Bishop Walsh Rd., Cumberland, MD 21502) sells several Z-100 programs that allow file transfers between the Heath/Zenith CP/M format, the Heath/Zenith Z-DOS (IBM PC-DOS) format, the Osborne CP/M format, and the Kaypro CP/M format. This company is also considering other formats, such as DEC Rainbow and North Star.

The author also stated that "although both processors [8088 and 8085] are present . . . I am not aware of any applications that transfer control from one processor to another." One such application, called "CP/Emulator," is available from the Heath User's Group, which produces hundreds of programs for the Heath/Zenith computers (and sells them, with source code, for about \$20 each). This program runs on the 8088 (Z-DOS) and allows the user to temporarily switch control to the 8085 (CP/M) to run CP/M programs. These CP/M programs may use Z-DOS files for I/O (input/output).

Skier states that "a light-pen port is available, but Zenith does not yet provide a light pen to go with it." While it is true that Zenith does not yet fully support this option, at least one third-party vendor does. Software Wizardry (122 Yankee Drive, St. Charles, MO 63301), a long-time supporter of the Heath/Zenith computer

line, sells a light pen that is compatible with the Z-100. This firm also sells a graphics software package for the Z-100 that optionally accepts input from this light pen.

The author mentioned that the Z-100 is not IBM PC compatible. While it is true that many programs written for the IBM PC will not run on the Z-100, almost all of the most popular applications programs are available in versions for the Z-100 or in MS-DOS versions (the Z-100 can run all MS-DOS programs). Many of the Z-100 applications are even superior to the IBM PC versions; for example, the Z-100 version of Lotus 1-2-3 supports more colors and higher-resolution graphics than the IBM PC version. Also, there are two programs available for the Z-100 that allow some incompatible IBM PC software to run on the Z-100. These programs are "IB-Em" from Wideman Computer Consulting (1320 Pepper Villa Dr., El Cajon, CA 92021) and "RUNPC" from Lindley Systems (21 Hancock St., Bedford, MA 01730).

I agree with Skier's conclusion that the Z-100 is an excellent machine. This is probably one of the best 8088-based microcomputers on the market today, and although third-party software support is not as large as for the IBM PC, the Z-100 hardware is far superior to the IBM PC (and its clones) in terms of hardware.

Also, please note that I am not affiliated with

AN ORDINARY DISK
CAN TAKE YOUR
BUSINESS AND
ZARNOUC BO
NOR ZINBE DAG.

any of the companies mentioned in this letter. I am a computer user and have used some of the products that I have described. Those I have used all operate as advertised.

KENTON LEE
2138 Aldrin Rd.
Apt. 5A
Ocean, NJ 07712

I appreciated Ken Skier's hardware review on the Zenith Z-100. While suitably glowing in its assessment of the machine, the review understandably omits mention of an immense resource that is readily available to users of Zenith computers—namely, users of Heath computers.

The omission is understandable because Zenith never mentions it either. From the company's advertising and its dealers one might think that a Z-100 has nothing in common with an H-100 (the kit version of the same machine). In fact, however, the only thing they *don't* have in common is 4 square inches of plastic on the front panel: the product logo.

The H-100 is one of the newest toys to capture the imagination of the rather large community of Heath computer builders and users and—equally important—to capture the attention of the rather large number of independent hardware and software vendors who provide sup-

port for Heath machines. The users themselves, to judge from the publications that cater to them, are hardware and software hackers in the fine old sense of the word: people who stay up until morning breathing solder fumes and banging on keyboards for the fun of it. The vendors provide what these people need: hardware and software that exploit the machine's capabilities and don't cost a mint. The journals provide information of use to everyone from beginners to professionals.

What H-100 users need is also what Z-100 users, including Mr. Skier, need. Almost everything his review says a Z-100 won't do, it will do—with the help of cheap or free things from the Heath users and their commercial allies.

Eight-bit CP/M software is *not* hard to come by in the Z-100 5¼-inch disk format. Several vendors, such as the Software Toolworks, sell very economical software—compilers, utilities, editors, games—in that format. Users groups and other sources provide a great deal more at lower prices.

For example, Z-DOS indeed can't write CP/M files—however, CP/M *can* be tricked into reading Z-DOS files, with identical results. RDZDOS, a \$20 program from an independent vendor, makes that possible. If you don't have \$20 left, you can trick the machine into doing the same thing using just the utilities that come with the

operating systems; the trick is explained in a letter to *REMark* magazine, issue 45 (October, 1983). *REMark* is the journal of the Heath Users' Group, which is actually a part of the Heath company.

That should be enough to make the point. Anybody considering a Z-100 should take into account its underground support system. You don't have to be a genius to use it. You just have to be inquisitive.

ARNOLD SEIBEL
621 Parcel St.
Monterey, CA 93940

FLIGHT SIMULATOR

.....
In regard to Stan Miastkowski's review "Microsoft Flight Simulator" (March, page 224), I realize that the programmers can, and did, take literary privilege in writing this software. But the comments of Miastkowski, who purports to be a pilot, are simply astounding.

On page 228, Miastkowski says that Meigs Field, in Chicago, is an uncontrolled airport. If he had checked with his "Jepp" manuals, he would have assuredly known that Meigs is indeed a controlled airport, to the extent that student pilots are forbidden to take off or land there.

(text continued on page 383)

Let the gibberish stop here.
The TDK No-Risk Disk.™

Because no matter how many times you play it, the TDK No-Risk Disk won't scramble your thoughts or play games with your words. Not once. Not ever.

Our lifetime replacement warranty guarantees that.

And our almost 50 years of experience in developing superior magnetic recording products support that.

That incidentally is more than you can say for any other disk.

Bringing us to our point.

Don't play games with an ordinary disk.

When you can play for keeps with an extraordinary disk.



TDK offers a complete line of the most popular disks in 5¼- and 8-inch formats.

TDK. THE NO-RISK DISK.™

Now you can sell to your European prospects and customers, *right here* in **BYTE's** **International Advertising Section!**

Among our 40,000 international BYTE paid subscribers are your prime European customers for microcomputer products:

- **79%** own/use a computer for personal applications
- **89%** of BYTE's European subscribers now own or use a microcomputer
- **91%** are involved in company computer purchase decisions
- **92%** are involved in company software purchase decisions
- **49%** have purchased a product from an ad in BYTE
- **28%** indicated they read no other English-language computer magazine
- The average full-page ad in BYTE generates nearly **1300** inquiries

Your ad will not only be read by these 40,000 buyers, but it will reach another 40,000 passalong BYTE readers! BYTE's *International Advertising Section* is now your most cost-effective and efficient advertising medium for European computer sales—every month. Make your space reservations today.

And, for complete details of our European readers, telephone your BYTE salesperson for our new BYTE *European Subscriber Profile Study*:

London: Arthur Scheffer at 01-493-1451

Frankfurt/Main: Fritz Krusebecker at 72-01-81

Paris: Kenneth Davey at 720-33-42

Milan: Savio Pesavento 86-90-656

Stockholm: Andrew Karnig at 08-51-68-70

Madrid: Maria Sarmiento at 45-52-891

Bat Yam, Israel: Gurit Gepner at 866-561-321-39

U.S.A.: Pete Huestis at 603-924-9281



BYTE
the international standard™



McGraw-Hill Publishing Company
34 Dover St.
London W1X 3RA England

(text continued from page 381)

Since its construction, Meigs Field has been plagued by crosswinds and burbles (disturbed winds coming from buildings and structures), as well as convection currents (from flying over water and then flying over heated concrete or other hard terrain). This is the result of the fact that Meigs has only two runways.

I find that the Flight Simulator software should not be used without a joystick control, which the IBM PC does not make allowances for.

LOVELL E. SWANIGAN JR.
2801 South King Dr. #517
Chicago, IL 60616

INTERRUPTING HERCULES

With reference to the review, "The Hercules Graphics Card" by Tom Wadlow (December 1983, page 343), I would like to point out a problem with the examples presented.

The assembler language interrupts will not work on an IBM XT running DOS 2.0 due to the fact that INT 40-4F are used by the system.

A close look at the technical reference manual will show that these interrupts are, indeed, reserved.

Hercules, it seems, has fallen into the same trap as so many others (including ourselves).

The only interrupts that are reserved for the user are 60-6F.

CHARLES ALLEN
Managing Director
Gulf Computing Systems
POB 25125
Safat, Kuwait

Hercules responds:

Since Mr. Allen took the trouble to send us a copy of the letter that he wrote to you, I will take the trouble to correct him. The Hercules Graphics Card uses interrupt 10, not any interrupts in the range 40-4F, as is his understanding. The fact that I am composing this letter on an XT running DOS 2.0 with a Hercules card in the system convinces me that there is no problem with this arrangement.

ANDREW FISCHER
Technical Support
Hercules Computer Technology
2550 Ninth St., Suite 210
Berkeley, CA 94710

APPLAUSE FOR APL

Thank you very much for the excellent article "STSC APL*PLUS and IBM PC APL: Two APLs for the IBM PC" by Jacques Bensimon (March, page 246).

REVIEW FEEDBACK IS a new column of readers' letters. We welcome responses that support or challenge BYTE reviews. Send letters to Review Feedback, BYTE Publications, POB 372, Hancock, NH 03449. Name and address must be on all letters.

The author established immediate empathy. I am sure, with every APL "true believer" when he recounted his disappointment that APL was not chosen over BASIC as IBM's premier language for the PC. Having established his credentials as an APLer, though, he did not go on to abandon those unfamiliar with the language, as I have seen many authors do. The section "A Brief Look at APL," with numerous clear examples, was worthy of publication all by itself.

The entire article was very well written, technically accurate, to the best of my knowledge (I have had professional exposure to both systems), and a fair and equitable comparison between the two implementations.

A heartfelt "keep up the good work" is in order for both you and Jacques Bensimon.

JIM FIEGENSCHUE
1805 High Meadow Cove
Carrollton, TX 75006 ■

**What do you get when you cross
1200 baud, free on-line time,
and extra features at a price Hayes
can't match?**

Data Rate?

The MultiModem gives you a choice—either 1200 or 300 bits per second. So you can go on-line with the information utilities. Check out bulletin boards. Dial into corporate mainframes. Swap files with friends.

On-Line Time?

With the MultiModem you get CompuServe's DemoPak, a free two-hour demonstration of their service, and up to seven more free hours if you subscribe. You also get a \$50 credit towards NewsNet's business newsletter service.

Features & Price?

Of course, the MultiModem gives you automatic dial, answer, and disconnect. Gives you the Hayes-compatibility you need to support popular communications software programs like Crosstalk, Data Capture, our own MultiCom PC, and dozens of others. Gives you a two-year warranty, tops in the industry.

But Better?

Yes. The MultiModem gives you features the Hayes Smartmodem 1200™ can't match. Features like dial-tone and busy-signal detection for more accurate dialing and redialing. Like a battery-backed memory for six phone numbers. All at a retail price of just \$549—compared to \$699 for the Smartmodem.

What do you get? The new MultiModem, from Multi-Tech Systems. Isn't this the answer you've been looking for?

For the name of your local distributor, write Multi-Tech Systems, Inc., 82 Second Avenue S.E., New Brighton, MN 55112. Or call us at (612) 631-3550.

MultiModem.



MultiTech
Systems

The right answer every time.

Trademarks — MultiModem: MultiCom PC, Multi-Tech Systems, Inc. — CompuServe: CompuServe Information Services, an H & R Block company — NewsNet: NewsNet, Inc. — Crosstalk: Microstuf, Inc. — Data Capture: Southeastern Software — Smartmodem: Hayes Microcomputer Products, Inc.

Circle 231 on inquiry card.

An Analog and Digital I/O board for your IBM PC™ at just \$295!*

Who does Molinari think he is?

Ho ho ho.

Don't laugh. We're not kidding. Data Translation is practically giving away a new single board plug-in that brings complete analog and digital I/O capabilities to your IBM Personal Computer.

Ordered in lots of 500 or more, you can enjoy full data acquisition capability for as little as \$295. And smaller unit orders also qualify for considerable savings...one unit is only \$495.

But what would you expect from an innovator like Data Translation? Whether you're working in laboratory research or industrial process control, our latest board can give you measurement and control capabilities at tremendous savings.

The DT2808 includes 16-channel 10-bit A/D, 2-channel 8-bit D/A, 16 lines of digital I/O, a programmable clock and direct memory access capability. And all of these functions are supported by PCLAB,™ our BASIC callable subroutine library running under PC DOS.™

A comprehensive user manual with many programming examples will get your application up and running fast.

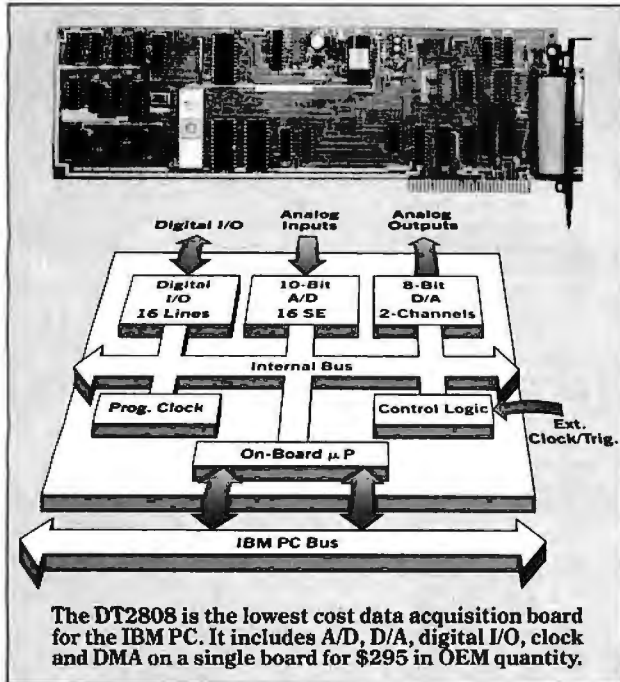

This easy to use, easy to program board is highly reliable, and of course, fully backed by Data Translation's service and support team.

The new DT2808. The lowest cost data acquisition for your IBM PC. And just one in a long line of software compatible analog I/O boards offered by the industry leader. Data Translation.

Yes Virginia, there is a Santa Claus. He's president of Data Translation.

For more information, call one of our elves.

(617) 481-3700.

*500 pcs., \$495: quantity one



Data Translation provides a full family of analog and digital I/O boards with software support for the IBM PC.

DATA TRANSLATION

World Headquarters: Data Translation, Inc., 100 Locke Dr., Marlboro, MA 01752 (617) 481-3700 Tlx 951 646.
 European Headquarters: Data Translation, Ltd., 430 Bath Rd., Slough, Berkshire SL1 6BB England (06286) 3412 Tlx 849 862.
 In Canada: (416) 625-1907.
 IBM PC, IBM Personal Computer and PC DOS are registered trademarks of IBM. PCLAB is a trademark of Data Translation, Inc.

Circle 377 on inquiry card.

Kernel

IN THE MONTHS TO COME, the Kernel will be a central and essential part of BYTE that will contain a variety of perspectives on the world of personal computing. One is Jerry Pournelle's unique and independent view from Chaos Manor. Immediately following Jerry's column, Chaos Manor Mail provides a forum for the hundreds of readers who write to Jerry. BYTE West Coast is our regular report from our West Coast staff—located in the part of the country that includes Silicon Valley and other founts of high technology. Next month will be the start of a column called BYTE Japan, written by Bill Raiké, a technically astute personal computer enthusiast living in Tokyo.

In future issues you will find in the Kernel a rotation of columns on telecommunications, artificial intelligence, mathematical recreations, computers and video, computers and the law, and perhaps other topics of enduring interest.

COMPUTING AT CHAOS MANOR: A SUPERBUSY MONTH <i>by Jerry Pournelle</i>	387
CHAOS MANOR MAIL <i>conducted by Jerry Pournelle</i>	400
BYTE WEST COAST: LESSONS LEARNED <i>by Ezra Shapiro</i>	405

Is BYTE too big for you?

Is the biggest monthly computer magazine in the world too big for your advertising? Are you concerned that your ad will be lost, unread among all those others? Consider these big-number facts:

Advertisers in BYTE receive an average of over 1,000 inquiries per page of advertising, an average of 1,300 for full-page or larger ads.

And as the number of ad pages goes up, the number of inquiries-per-page soars. When we broke the Folio 400 record by doubling our ad pages, we tripled ad response. And not just in preferred positions, but all through the magazine. Some back-of-book advertisers have received over 2,000 inquiries from a single ad.

One more big number: over a quarter of a million readers have bought products from ads they've seen in BYTE.

If you're an advertiser, or are just starting to think big, talk to us—we're the people who wrote the book on microcomputer marketing. Just call Pete Huestis, Advertising Sales Manager, at 603/924-9281.



BYTE

THE INTERNATIONAL STANDARD

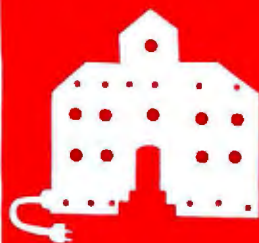

C·O·M·P·U·T·I·N·G A·T· C·H·A·O·S· M·A·N·O·R

A Superbusy Month

Apple-Franklin Case

CompuPro Hard Disk

Hudson 8087 Boards

Turbo Pascal

Rana Drives

Dilog RAM Disk

Disk Maker I

Quickon

Printer Optimizer

Helix Bubble Disk

Sage IV

BY JERRY POURNELLE

How do you manage to find so much to write about?" my sane friend asked.

I just looked at her. When your subject is small computers, the problem isn't finding enough to write about, it's knowing when to stop.

I thought I knew where to start. We've been expecting two new machines, the Sage IV and the CompuPro 10. Alas, both arrived today. The flu has blasted through Chaos Manor, and we're not likely to uncrate either machine until well after the deadline for this column, so this month maybe I can catch up on the backlog. Maybe.

THANKS

First, a pair of thank-yous. As some of you know, I've been heavily involved in the L-5 Society Promoting Space Development, which is an outfit that takes seriously Robert Heinlein's dictum that the earth is just too small and fragile a basket for the human race to keep all its eggs in. (You can join the L-5 Society by sending \$25 to L-5, 1060 East Elm St., Tucson, AZ 85719.)

The L-5 Society isn't broke, but I don't suppose it's much of a surprise that there's no surplus money, so when we found ourselves in need of some new computer equipment we had a problem.

Indeed, it was more of a problem than you might think. I'm fully aware that I could get any number of companies to donate equipment to L-5; but might someone see my request as attempted extortion?

Fortunately, there was a simple solution to the problem.

Some years ago the L-5 Society bought a CompuPro computer to keep the books and membership list on. CompuPro's Bill Godbout arranged to have that system completely updated, donating a new set of hardware with all the bells and whistles, including a new CompuPro hard disk.

Meanwhile, the Bay Area L-5 people were putting on the annual meeting, and their computer died; whereupon David Kay's company donated a Kaypro IV, which, I am pleased to report, arrived in time to bail our people out

of a mountain of paperwork.

Since what I think of those machines was in print long before I brought up the subject of L-5, I've no fear anyone will get the wrong idea. My thanks to both companies and their presidents.

THE COPYRIGHT DECISION

The papers announce that Apple and Franklin have settled out of court.

That's fine, but it means that for the moment we'll have no final and binding decision on the questions the suit posed. We do have a decision by the U.S. Court of Appeals for the Third Circuit. That's binding only in that area; judges in other circuits could rule otherwise, although in practice the Third Circuit decision is likely to be persuasive wherever the issue comes up.

What's at stake is the whole question of copyright protection for software.

The facts of the case were pretty simple. Franklin (of Philadelphia) wanted to market a computer that would run Apple software. It studied the situation and concluded that it wasn't feasible to rewrite the Apple operating system including the code in the boot ROM (read-only memory) because, in the words of Franklin's vice-president for engineering, "there were just too many entry points in relationship to the instructions in the program."

Franklin therefore copied Apple's ROM. According to the Circuit Court decision, "Apple produced evidence at the hearing . . . that programs sold by Franklin in conjunction with its ACE 100 computer were virtually identical with those covered by the fourteen Apple copyrights. The variations that did exist were minor, consisting merely of such things as deletion of reference to Apple or its copyright notice."

In fact, James Huston, an Apple programmer, found his name embedded in one of the programs sold by Franklin and the word "Applesoft" in another. Franklin didn't dispute that

(text continued on page 388)

.....
Jerry Pournelle holds a doctorate in psychology and is a science-fiction writer who also earns a comfortable living writing about computers present and future.

(text continued from page 387)

it copied the Apple programs. "Its factual defense was directed to its contention that it was not feasible for Franklin to write its own operating system programs."

In short, Franklin's defense was (1) it had to copy the Apple programs or it couldn't produce a machine that would run Apple software, and (2) operating systems and machine codes aren't subject to copyright because they're not literary works.

This isn't a totally unreasonable position. My late mad friend thought copyright law was sufficiently complicated already, and he was adamantly opposed to adding computer-program object code to the works protected by copyright. MacLean thought there ought to be special legislation based on patent law. I didn't agree with him, but he could be pretty persuasive.

Moreover, there are only so many ways to make computers do things. You can't copyright an idea: only its expression. Thus, it can certainly be argued that had Franklin been able to rewrite the Apple operating system in such a way as to keep all the same entry points but not have made an exact copy of the copyrighted Apple programs, it would have been home free.

This would be akin to taking a book of nonfiction and rewriting it so that the table of contents for the original and the rewrite were identical: on each page of both the same ideas would be expressed, but the actual words and sentences would be different. That would be a lot of work but certainly not impossible.

Franklin didn't do that. My reading of the Court's decision leads me to think that it would have won if it had, but in fact the Court specifically didn't address that issue in the decision. What it did do was rule that "a computer program in object code embedded in a ROM chip is an appropriate subject of copyright," and that "a computer program, whether in object code or source code, is a 'literary work' and is protected from unauthorized copying, whether from its object- or source-code version."

This can have some pretty far-reaching effects. For one thing, software publishers can't have it both ways: if they want to rely on *copyright* protection, they're going to have to give up those

ridiculous licensing agreements their lawyers are so fond of. That's probably just as well, because I suspect those agreements are worthless.

The idea of licensing software is a legacy of the mainframe and minicomputer days, when software could and did cost hundreds of thousands of dollars and was installed and maintained by experts. There was a time, after all, when you couldn't buy an IBM computer; they could only be leased, and severe restrictions on what peripheral equipment you could connect to the IBM were built right into the lease contract.

In those days, software licensing agreements were actual contracts, negotiated between independent entities that, if not in an equal bargaining position, were at least not as unequal as a consumer and a major software company.

That's no longer true. Now you go to a store and plunk down money for software exactly as you might buy a cable or an all-day sucker or a Jerry Pournelle science-fiction novel. The difference is that when you get your software home, there's this imbecilic licensing agreement under which the publisher warrants nothing at all and guarantees that his product isn't worth anything, and you "agree" not to copy the program, show it to others, or run it on more than one machine or during the dark of the moon. You also agree that this unwarranted and unmerchantable program is enormously valuable, and if you do violate the terms of the agreement you have done the publisher irreparable harm, and you'll sell your spouse and children into slavery in partial recompense to the poor damaged publisher.

I've never heard of a court trial based on one of those goofy licenses, and I find it hard to believe that any judge would take one seriously. Of course, one is never safe in relying on lawyers to exhibit common sense. Even so, I really doubt the enforceability of those agreements, and I suspect that software publishers would do much better to rely on copyright.

There are, however, some limits to copyright protection. For one thing, educational and nonprofit groups have some privileges under the Copyright Act. So do those outfits that translate and adapt works for use by the blind.

Educators, reviewers, and scholars have the right of "fair use." Finally, there's the question of backup copies. Under copyright law, you are prohibited from selling or distributing copies of a protected work without the owner's permission; but making a copy for your own use is a different story. You can't make a copy and sell the original, but I see nothing to stop you from making and keeping copies for your own use.

You can also lend books to friends, so long as they don't make copies. Indeed, as I've said before, the law requires me to pay taxes in support of institutions whose business is to lend people copies of my books.

Thus, one result of the Franklin-Apple case may be the demise of software licensing agreements in favor of something more sensible. I hope so. It's too bad, though: I can sympathize with both companies' desire to stay out of court and get this thing settled, but I wish it had gotten to the U.S. Supreme Court so we'd have some of the issues settled once and for all.

CP/M-8/16 REVISITED

It's hard to believe that I've had my CompuPro 40-megabyte hard disk and CP/M-8/16 for only a month now. In fact, it's hard to see how I ever lived without them. Not that it has all been smooth sailing. As I mentioned last month, it's just as well that Chaos Manor was a test site for the new BIOS (basic input/output system): we were still flushing bugs out of the system as late as last week.

None of them was fatal, but some were annoying. Diagnosing one of the errors was instructive. The directory of the E: segment of my hard disk kept going haywire. That is: the hard disk is divided by software into five logical disk drives. The A:, B:, C:, and D: drives have 10 megabytes each. The E: drive has 1.1 megabytes and is set up to look exactly like an 8-inch double-sided double-density floppy, making it possible to copy to and from it. However, whenever I'd put any great amount of data onto the E: drive, the directory would get trashed, and I couldn't even erase it. When I tried, it would tell me there were Read/Only files on it, but then STAT couldn't find them. It made the E: drive useless.

Then we had another glitch, some-

(text continued on page 390)

We're on Louis Nizer's Case

DHL, #1 Worldwide Courier Express, now makes time-critical deliveries overnight throughout the U.S.

The wheels of justice move slowly.
But Louis Nizer can't.

As one of America's leading trial lawyers, a best-selling author, a painter, and senior partner in the firm of Phillips, Nizer, Benjamin, Krim and Ballou, Louis Nizer can't afford to lose a minute.

"When it comes to overnight delivery, anywhere in the U.S., of time-critical documents," counsels Nizer, "DHL is fast and reliable."

You be the judge.

With over 30,000 locations, DHL makes more on-time deliveries to more places around the world than any other express courier.

DHL has invested millions in a state-of-the-art technology that encompasses 727s, Learjets, helicopters and fleets of trucks and vans to speed things on their way.

That's why 97% of the "Fortune 500" have reached the same verdict as Louis Nizer.

For information, call your local office of DHL Worldwide Courier Express.



*Louis Nizer
Senior Partner -
Phillips, Nizer, Benjamin,
Krim and Ballou*

NEXT BEST THING TO TAKING IT THERE YOURSELF.

(text continued from page 388)

thing like keyboard bounce, that would go away once the system had been running for a few minutes. Hardly fatal, but annoying, and as Bill Godbout is fond of saying, if the error rate is high enough to measure, it's too high. Little glitches can be symptoms of coming big trouble.

Tony Pietsch, the guru who maintains my systems, couldn't figure out what was happening and kept coming up with new hypotheses, most of which involved removing features from The Golem (our CompuPro Dual Processor). That's no bad way to proceed, of course. Get the system down to basics you understand. The relentless application of logic will generally solve the most puzzling problems.

Finally, he removed Jim Hudson's 8087 add-on board. That did clear up the cold-start glitch, and the E: drive seemed to be behaving itself.

However, it left me without an 8087 math-chip system, and that's not acceptable. Logitech's Modula-2, the language I've fallen in love with, doesn't do floating point unless you have an 8087. Thus, I found myself on the phone to tell Jim Hudson we'd yanked his board.

He wasn't happy and decided to come down with a new math board and his own Dual Processor's processor board, which was known to work in a system nearly identical to mine. Just to be sure he hadn't left anything out, he

brought Bob Greene, a troubleshooter from Intel, who carried a couple of new 8-MHz 8087 chips.

After a few tests it transpired that I had a very early 8088 chip, which doesn't surprise me since The Golem was one of the first Dual Processor systems to leave the CompuPro factory; it too began life as a test box, but we'd never had any trouble before. We replaced the 8088, at which point all seemed to work fine. Then, when we had everything swapped out, I needed a copy of Jim's Modula-2 disk. He'd brought down a lot of small program modules he'd got from Willy Steiger at Logitech: more than 200, in fact.

Fine, thought I. We'll use the newly working E: disk to copy onto. I started PIP going. Things went well for a while. Then, suddenly, error messages. Worse, when I checked the E: disk to see what had managed to get copied, there was that same old trash in the directory again!

I still didn't have a copy of Jim's disk. Alas, no one has yet written a copy program that understands that my 8-inch disks are I: and J:, respectively. (That's coming Real Soon Now.) It was lunchtime, and we were in a hurry, so I tried to use PIP to move Jim's disk off to the M: memory drive, which is certainly the fastest way. That didn't work either. Now what?

In fact, try as I liked, I couldn't use PIP

to move that disk to *any* part of my hard disk. It would go a long way, then come up with a BDOS (basic disk operating system) error, even on the D: segment, which had never given me any trouble. There was nothing for it but to fire up Zeke II, my superreliable Z80, and copy that disk.

Jim went home feeling much better: it wasn't his board causing the problem. Now it was Tony's turn to sweat.

We also knew it wasn't the processor board. Nothing for it, then: Tony brought over his own CompuPro hard disk and controller. We installed them. Everything worked fine. I breathed a sigh of relief. "Not yet," said Tony. "Where's that disk that kept crashing the system?"

We put that into the floppy-disk drive and started PIP going. File after file came across. Then—blooey. Same error messages. Tony sat down with a St. Pauli Girl to think. For some reason, I started to use PIP to move the disk to the M: memory drive while he was puzzling it out.

That provided the clue. After 128 files had been sent over, we got an error message. Tony thought for a second. "Oh, sure," he said. "There's no more directory space. There's not room for more than 128 files in the M: drive/H: RAM [random-access read/write memory] disk."

(text continued on page 392)

a message to our subscribers

From time to time we make the BYTE subscriber list available to other companies who wish to send our subscribers material about their products. We take great care to screen these companies, choosing only those who are reputable, and whose products, services, or information we feel would be of interest to you. Direct mail is an efficient medium for presenting the latest personal computer goods and services to our subscribers.

Many BYTE subscribers appreciate this controlled use of our mailing list, and look forward to finding information of interest to them in the mail. Used are our subscribers' names and addresses only (no other information we may have is ever given).

While we believe the distribution of this information is of benefit to our subscribers, we firmly respect the wishes of any subscriber who does not want to receive such promotional literature. Should you wish to restrict the use of your name, simply send your request to the following address.

BYTE Publications Inc
Attn: Circulation Department
70 Main St
Peterborough NH
03458

CONTROL 16 S-100 USERS WITH 1 ADIT BOARD



ADIT. There's nothing else like it on the market. It's an intelligent I/O board with its own operating system that lets you control up to 16 different terminals, modems or printers. Or link your local network up to four other systems simply and inexpensively. And all this from a single slot in your S-100 bus. Now that's efficient!

ADIT gives you many extras. It allows you to upgrade to a multi-user system and expand as your needs grow—without performance degradation. The on-board 6MHZ Z80B supports DMA operations to off-load the host CPU. Multi-tasking firmware supports UNIX, MP/M and AMOS operating systems. It complies fully with IEEE 696.

There's much more to tell you about ADIT than space allows. And it is only one of Macrotech's products designed to maximize the performance of your S-100 system. The MAX Dynamic Memory, for instance, gives you up to 1 Mbyte of memory for all your system memory and virtual disk applications—again from a single slot. And our newly developed dual-processor, CPU board. It uses a 16-bit 80286 and an 8-bit Z80B to provide unprecedented speed and power from a single slot. That's efficiency, too.

Call or write us today, and ask about these products.



**Macrotech
International Corp.**

9551 Irondale Avenue
Chatsworth, CA 91311

Phone: (818) 700-1501

Circle 201 on Inquiry card.

In England: Fulcrum (Europe) (0621) 828-765

Dealer/Distributors: Priority One Electronics, (800) 423-5922, (213) 709-5111 / John D. Owens Assoc., (212) 448-6298

UNIX is a registered trademark of Bell Laboratories, Inc. / MP/M is a registered trademark of Digital Research / AMOS is a registered trademark of Alpha Microsystems



(text continued from page 389)

I hadn't known that, and I guess Tony had forgotten it. "Hardly a serious limitation," I said. "Strange, though, the file just after that one is where we get the other problem . . ."

I stopped talking because Tony was scribbling madly.

It didn't take long to fix things after that. When Tony and the CompuPro people ginned up the new superfast BIOS, they'd managed to put in a wrong number in the part that allocates directory space. Five minutes with DDT fixed things. We phoned the fix up to CompuPro just in time: it was due to begin shipping the next day. No one had tested the new software's ability to use PIP on more than 129 files.

As I said, an instructive lesson: if I hadn't happened to notice precisely *where* things went wrong, we might still be wondering why this particular disk full of software would crash the system. The moral of the story is, if you have a problem, keep a log. Write down every bit of information you can get. What did you do, what error message did you get, what are the symptoms of the problem, what was happening just before the problem manifested itself; everything you can find out. It may seem trivial or irrelevant, but write it down anyway, before you forget. More often than not there's a powerful clue buried in among the details, and if you don't record the details, you may not spot the clue.

IT CAN CHANGE YOUR LIFE

That may have been the last bug in CompuPro-8/16. It does have some annoying "features," nearly all associated with user numbers, but they're endurable; and now I don't understand how I ever got along without 8/16 and a hard disk. I have a larger temporary program area (TPA), floppies work faster than ever before, and I can keep an enormous pile of stuff on the hard disk.

It has made some surprising changes in the way we do things here. When I find a minor problem in a program I've written, instead of logging it, often I fix it on the spot. It's easy, now that I don't have to go find the source, find the disk with the compiler, load the compiler, and load the source, all before I can start. Now I have source, programming editor, and compiler all on the hard disk.

Bookkeeping is easier, too. I keep the journal on the hard disk, and it's very easy to call up the Journal program and enter checks and cash as it happens, rather than save it all up for frantic entry just before April 15.

Hard disks are wonderful.

HUDSON'S Z-100 BOARD

One major application for microcomputers is spreadsheets, and the complaint I most often hear about them is that they're too slow. Since spreadsheets are often associated with financial calculations, which demand high accuracy combined with large numbers, it's understandable: floating-point calculations are inherently slow. Fortunately, though, there's a hardware remedy: the 8087 math chip, which does floating-point calculations at about 500 times the speed that the 8088 chip can do them.

I've already mentioned Jim Hudson's 8087 board for the CompuPro Dual Processor. It's a small board that rides piggyback on the processor board: to install, remove the 8088 chip, insert Hudson's board where the 8088 was, and insert the 8088 into the socket on his board.

It works fine. Of course, if you don't have an 8-MHz 8087 chip—they're still fairly rare and expensive—you have to slow your Dual Processor down. Hudson's board does that automatically, and it has provisions for letting you speed things back up when you get a faster 8087 chip.

The results of using an 8087 are impressive: some 120,000 floating-point math operations take less than 10 seconds. If you're doing much number crunching with an 8086 or 8088, you *must* get an 8087. The IBM PC has a slot on board for the 8087; just get one and plug it in. Ditto for the Eagle 1600, except that the Eagle needs one of the 8-MHz parts, and that will cost you some change. There's no way—at least none known to me—to slow the Eagle down, and an 8087 won't work in a system in which the microprocessor is running faster than the 8087.

Hudson's 8087 for the CompuPro was so successful that he designed a board for the Z-100. It uses one of the S-100 bus slots and has 256K bytes of RAM in addition.

Before you can make real use of the

memory on Hudson's board, you'll need to fill those empty memory sockets on the Z-100 motherboard with nine 4164 64K-bit dynamic-memory chips. You ought to do that anyway; it's easy enough. You can get the chips from Hudson when you buy his board; he isn't in the chip business, though, so to order separately, go to an outfit like California Digital. (You can also get a "kit" from Zenith, but there's nothing in it but nine chips and some instructions, and Zenith charges a lot.)

Hudson's board comes with programs to test both the memory and the 8087, and Hudson supplies source code to the tests. Installing the Hudson 8087 board in the Z-100 is simple, and it has given us no problems. I'd have been shocked if it had: I've known Jim for a couple of years now. He's one of the good guys, a perfectionist who would take it personally if something he supplied didn't work properly.

There's already a lot of support software for the 8087, and more is coming all the time. Borland's Turbo Pascal, for instance, has a Turbo87 version. If there are any spreadsheets that make use of the 8087's great speed, I haven't seen them yet, but it's only a matter of time. Within a couple of years they *all* will. Anyone developing new software for the IBM PC or Z-100 really ought to get in on the 8087 revolution.

TURBO!

I'm not fond of the name "Turbo," but that's about the only thing in Borland International's Turbo Pascal that I'm not mad about. So are my readers. I have tons of mail praising Turbo—and I have yet to get one complaint.

Borland's coming out with a new version, 2.0, that's a significant improvement over the old. Meanwhile, it has canceled that silly licensing-agreement policy. It's doing everything right and deserves the full support of the micro community.

Meanwhile, Microsoft is selling Potent Pascal. I hate that name. I don't care much for the product, either; it's IBM Pascal, essentially unchanged. The Microsoft ad speaks of a "software development environment." That's true in the same sense that any compiler is a "software development environment;" but not otherwise. If you believe "en-

(text continued on page 394)

..SORRY CHARLIE
FOR LEAVING
YOU OUT!



**FEATURES
INCLUDE:**

16 Bit CPU
With 128K RAM Memory
Expandable to 256K,
Two 320KB Slimline
Disk Drives,
Floppy Disk Controller,
Monochrome Monitor and
Adapter, Parallel and
Serial I/O's.

**BEST OF ALL!
TEN DAYS FREE TRIAL!
ALL YOU PAY IS
SHIPPING!**

**FOR MORE DETAILS
CALL OR WRITE
TO: TAVA CORPORATION
16861 Armstrong,
Irvine, California 92714
714/261-0200
Headquarters/Telex: 181667
Answer Back COMPDSHACK IRIN**



IBM® COMPATIBILITY AFFORDABLE PRICE TAVA PC

**THE SMART COMPUTER USER
WANTS REAL VALUE WITH
IBM COMPATIBILITY!**

Circle 323 on Inquiry card.

THE TAVA PC. The ultimate Personal Computer. It gives you IBM PC® Compatibility at a fraction of the cost. Choosing a personal computer is a difficult decision. But, when your decision is a TAVA PC, it's not hard at all! The TAVA PC runs under DOS 1.1, 2.0, CP/M86®, and p-System®. You can choose from a large library of all the most popular IBM PC software products such as dBaseII®, Lotus 1-2-3®, Visicalc® and thousands more.

CP/M86 is a registered trademark of Digital Research, Inc.
UCSDp is a registered trademark of Softech Microsystems

IBM PC is a registered trademark of IBM Corp.
Visicalc is a registered trademark of Visicorp

(text continued from page 390)

vironment" implies a compiler integrated with an editor, as with the MT+86 Speed Programming Package or Turbo Pascal's integrated editor. Potent Pascal isn't one. Kaypro's Tyler Sperry, who's here to deliver the 1984 model of the Kaypro IV (faster, new video, built-in modem; it's a real improvement), wonders if the company couldn't call Kaypro's S-BASIC an "environment." It compiles, doesn't it?

I remain impressed with Borland.

HOT TIPS

As I've said before, I'm in the middle of a storm: Rod Coleman of Sage Computer is certain that the Motorola 68000 chip and its successors are the real future for microcomputers. So, of course, does Apple. My son Alex tends to agree with Rod, and between them they make an awfully good case.

On the other hand, Bill Godbout and his people are just as convinced that the future lies with the Intel 8086 and its successors, and they can point to the success of the IBM PC for confirmation. When Jim Hudson and Bob Greene came down with the new Z-100 board, we spent some time talking about the future of the micro revolution. I didn't come to any conclusions, but I did get some hot tips on using 8088 equipment, particularly the IBM PC.

OOPS!

If you have a hard disk in your IBM PC, you can have a real problem when the time comes to format a new floppy disk. If you're logged onto the hard disk and invoke the format program without modifications, you get the message "Ready to format hard disk. Strike any key when ready."

Generally, you didn't want to format the hard disk. Formatting erases *everything*, permanently and irrevocably. If you don't do just the right thing, though, that's what will happen. Alas, many PC users see that message, panic, and hit either the Escape key or Control-C, both of which usually rescue them—but neither will rescue them this time. Nor will the ersatz "reset" of Ctrl-Alt-Del; that "Strike *any* key when ready" message really means it.

The only escape is to turn the machine off.

This is obviously an undesirable situa-

tion. Bob Greene suggests a permanent solution: on the hard disk, rename "FORMAT" to "DOFORMAT." Now create a batch file named FORMAT.BAT that has one, and only one, line in it:

```
DOFORMAT A:
```

The A: disk will be a floppy-disk drive.

Incidentally, when making up batch (.BAT) files for the PC, the proper termination for the last entry is not carriage return but Control-Z (Control-Zed, as Greene puts it; he spends too much time in England). If you don't use Control-Z, you get an extraneous carriage return in the command string, which produces an annoying extra prompt.

YOU'LL BE SORRY

One thing that annoys Intel are people who do original research in the 8086 instruction set.

Let me explain.

The 8088 and 8086 chips, like all micro chips, have an "instruction set" of commands to which they'll respond. These are such commands as "Move the contents of the C register to the A register" and "Add with carry"; the primitive commands from which assembly-language programs are built. These instructions are built into the chip in micro code and are actually part of the chip's very structure. The instruction set is a key feature of a microprocessor chip, and the manufacturer publishes a list of commands the chip will accept.

However, some "holes" are in the micro code that instructs the chip. Certain instructions, although not documented in the published command list, will in fact work, often to produce useful results, such as to clear a certain register without resetting the carry flag. Some programmers have zealously experimented with the 8086 and 8088 chips, finding a number of these "undocumented features," which they have made use of in programs.

This looks at first like a good idea. Why shouldn't you make use of all the chip features, whether documented or not?

Bob Greene says it's not a good idea at all. Since these features are not supported by Intel, there's no obligation on Intel's part to keep them: subsequent "editions" of the 8086 and 8088 chips may not have those features at all, and there's a good chance that another

manufacturer making the chips under license from Intel won't include them either.

Moreover, one of the strongest features of the 8086 family is that programs written for the 8086 and 8088 will work unchanged on upgrades such as the 80186 and 80286—that is, they'll work unless the program uses "illegal" instructions. Programs that use the undocumented features of the 8086 are guaranteed not to work on the 80186 and above, because all the upgrades check for illegal op codes before executing any instruction.

Intel reserves those unused instructions for new instructions of its own devising; so unless you intend unduly to restrict the portability of your programs, you'd be well advised not to make use of illegal op codes for the 8086 and 8088 chips.

RANA DRIVES

What do you say about products that quietly work, never giving any trouble?

We recently got an Apple IIe for Mrs. Pournelle; her school has one, and we thought we might find some good software for it. So far, though, I haven't seen anything very interesting, and neither has Roberta, but that's for another column.

What she got was a plain Apple IIe with a single Apple drive. Already I can see I'll have to upgrade that. The boys have an old Apple II out in back. Theirs is equipped with a Rana disk controller and drives.

Their machine does disk operations faster and more reliably than Roberta's.

If you're contemplating an Apple, get Rana disk drives. You won't regret it.

DILOG'S RAM DISK

Longtime readers of this column know I'm a fan of RAM disks, which fool the computer into thinking that a big chunk of memory is a disk drive. True, once you have a hard disk you may not use the RAM disk so much, but if you're confined to floppy disks, you'd do well to look into getting a RAM disk.

RAM disks make WordStar and other programs that routinely do disk accesses not only endurable, but very nearly a pleasure. They also take a lot of the delay out of games like Star Fleet that have overlays.

(text continued from page 392)

CompuPro...

for Performance, Quality and Reliability

Anyone can sell you a box full of hardware. But is it too much computer? Too little? Will it run the appropriate software? What about service? If you need the right answers both before and after the sale, call your nearest **Full Service CompuPro System Center**. For product information, see pgs.106-7.

ALABAMA

Birmingham
Cost Plus Computers
(205) 879-5976

ARIZONA

Scottsdale
S-100
(602) 991-7870

CALIFORNIA

Bakersfield
Creative Computing Serv.
(805) 835-1118

Berkeley
American Computers
& Engineers
(415) 849-0177

Track Computer Center
(415) 845-6366

Burlingame
Mentzer Computer
Systems
(415) 340-9363

Canyon Country
Creative Computing Serv.
(805) 251-9877

Chatsworth
Priority One Electronics
(818) 709-6789

Hayward
Best Computers Hayward
(415) 886-4732

Irvine
Priority One Electronics
(714) 660-1411

Los Angeles
American Computers
& Engineers
(213) 477-6751

**Gifford Computer
Systems**
(213) 477-3921

Mountain View
ACC
(415) 969-4969

Oakland
Track Computer Center
(415) 444-8725

Pacific Palisades
System Interface
Consultants
(213) 454-2100

Pasadena
Omni Unlimited
(818) 795-6664

Petaluma
Advanced Information
Management
(707) 763-7283

Pleasanton
Best Computers
Stoneridge
(415) 463-2233

Sacramento
Logic Systems
(916) 922-3377

San Leandro
Gifford Computer
Systems
(415) 895-0798

San Rafael
Computer House
(415) 453-0865

Santa Barbara
Data Bank
(805) 962-8489

Santa Maria
Data Bank
(805) 922-1333

Santa Rosa
Matrix Computers
(707) 542-0571

Sunnyvale
Pragmatic Designs Inc.
(408) 736-8670

COLORADO

Lakewood
Rocky Mountain
Microsystems
(303) 232-4545

FLORIDA

Gainesville
Online Computing
(904) 372-1712

Orlando
Data/Office
(305) 629-6776

Satellite Beach
Binary Magic, Inc.
(305) 777-7080

Tampa
Micro Computer
Technology
(813) 985-0919

West Palm Beach
Steve's Computer Works
(305) 683-5900

HAWAII

Kahului Maui
Capacity Plus
Computers
(808) 871-7984

ILLINOIS

Athens
Computers Plus
(217) 636-8491

La Grange Park
Small Business
Systems, Inc.
(312) 579-3311

Skokie
Lillipute Computer
Mart, Inc.
(312) 674-1383

INDIANA

Terre Haute
General Software, Inc.
(812) 234-9421

KANSAS

Ellinwood
Genesys Systems, Inc.
(316) 564-3636

MARYLAND

Bethesda
JR Systems
(301) 657-3598

MASSACHUSETTS

Boston
New England
Electronic Exch.
(617) 491-3000

Chestnut Hill
Key Micro Systems
(617) 738-7306

MISSISSIPPI

Pascagoula
Automated Accountants
(601) 769-2937

MISSOURI

Kansas City
BBRL
(816) 753-5900

MISSOURI

Kansas City
BBRL
(816) 753-5900

NEW YORK

Amherst
Gifford Computer
Systems
(716) 833-4758

Deer Park
Datapro Systems, Inc.
(516) 595-1311

New York
Park Plaza Computer
Center, Inc.
(212) 759-5820

**Park Plaza Computer
Center, Inc.**
(212) 505-8200

**Park Plaza Computer
Center, Inc.**
(212) 344-5151

**Park Plaza Computer
Center, Inc.**
(212) 595-5353

Staten Island
John D. Owens Assoc.
(212) 448-6283

NORTH CAROLINA

Greensboro
General Semantics
Computers
(919) 378-1500

OREGON

Portland
Microwest Computer
Products
(503) 238-6274

Reading
Fraser Business
Equipment
(215) 378-0101

PENNSYLVANIA

Reading
Fraser Business
Equipment
(215) 378-0101

RHODE ISLAND

Coventry
Key Micro Systems
(401) 828-7270

TEXAS

Austin
CPA Systems, Inc.
(512) 458-9281

Informa, Inc.
(512) 459-4216

Omegax Systems
(512) 476-6069

Dallas
Dator Systems
(214) 521-0915

Ft. Worth
Dalaworth Computer
Systems
(817) 877-4041

Houston
Gifford Computer
Systems
(713) 680-1944

Informa, Inc.
(713) 861-7612

San Antonio
RFCanon, Inc.
(512) 657-0444

Seguin
CPA Systems, Inc.
(512) 379-0660

VIRGINIA

Woodbridge
Office Networks Corp.
(703) 690-3312

WASHINGTON

Bellevue
North Ridge
Computer Systems
(206) 453-0596

Seattle
American Computers &
Engineers
(206) 583-0130

WISCONSIN

Greenfield
Byte Shop
of Milwaukee
(414) 281-7004

Madison
Beam International
(608) 255-2325

AUSTRALIA

Bankstown
Automation Statham
Pty., Ltd.
(02) 709-4144

AUSTRALIA

Bankstown
Automation Statham
Pty., Ltd.
(02) 709-4144

CANADA

Coquitlam, B. C.
CSC System Center Ltd.
(604) 941-0622

Vancouver, B. C.
Dynacomp Business
Computers Ltd.
(604) 872-7737

CANADA

Coquitlam, B. C.
CSC System Center Ltd.
(604) 941-0622

Vancouver, B. C.
Dynacomp Business
Computers Ltd.
(604) 872-7737

THE PHILIPPINES

Quezon City
Corona International Inc.
78-34-71

THE PHILIPPINES

Quezon City
Corona International Inc.
78-34-71

UNITED KINGDOM

Swansea
Comcen Technology Ltd.
(0792) 796000

CompuPro®

A GODBOUT COMPANY

3506 Breakwater Court, Hayward, CA 94545



PREVENT THE DISASTER OF HEAD CRASH AND DROPOUT.

The war against dust and dirt never ends. So before you boot-up your equipment, and everytime you replace a cassette, disk or drive filter, be sure to use Dust-Off® II; it counteracts dust, grit and lint. Otherwise you're flirting with costly dropouts, head crashes and downtime.

Dust-Off II is most effective when used with Stat-Off II. Stat-Off II neutralizes dust-holding static electricity while Dust-Off II blasts loose dust away. There's also the Dual Extender and Mini-Vac for vacuuming dust out of hard-to-reach places.

Photographic professionals have used Dust-Off brand products consistently on their delicate lenses and expensive cameras for over ten years. They know it's the safe, dry, efficient way to contaminant-free cleaning.



Cleaning not provided by liquid cleaners.

Dust-Off II's remarkable pinpoint accuracy zeros in on the precise area being dusted. And you have total control—everything from a gentle breeze for



Stat-Off II neutralizes dust-holding static electricity from media and machines.

delicate computer mechanisms to a heavy blast for grimy dirt.

Don't let contamination disrupt your computer operation. Stock up on Dust-Off II—the advanced dry cleaning system, at your local computer or office supply dealer.

Or send \$1.00 (for postage and handling) for a 3 oz. trial size and literature today.



Dust-Off® II

The safe dry cleaning system

Falcon Safety Products, Inc., 1065 Bristol Road, Mountainside, NJ 07092

(text continued from page 394)

They have one major drawback, of course: since they're only a kind of memory, whatever you put onto a RAM disk goes away when you turn off the computer. There are some remedies to that, the most obvious being a battery backup; but it takes considerable power to keep memory intact, and most batteries can't do it for long. (There are low-power memory chips on the market but they tend to be pretty expensive.)

An alternative is to give the RAM-disk board its own power supply. That won't do you any good in the event of a power failure, but it will save you if you've accidentally turned off the machine before copying your work to permanent storage. It also saves you the trouble of using PIP to move your editor and files each time you want to use the RAM disk.

The Dilog Model DP-100 Electronic Disk comes with its own power supply but no battery backup. There's also an RS-232C port, called an "Asynchronous Communications Adapter"; it's said to be functionally identical to the IBM Communications Adapter, and I'm willing to believe it, although I've not tested it.

The Dilog DP-100 comes with idiot-proof instructions, complete with pictures and diagrams; I can't imagine anyone being unable to install the board properly. The manual shows what a jumper plug looks like and tells precisely how to install them, as well as how to set the internal switches on the IBM PC. Dilog has covered every combination of floppy and hard disk, and tells precisely how to address its electronic-disk board for each.

We've had the DP-100 running for a couple of weeks now, and it goes fine. Indeed, it came in while I was out of town, and Peter Flynn installed it; I didn't even know it was aboard for the first week, and it was only by accident that I found out that when you turn off the IBM, the DP-100 RAM disk doesn't lose anything. It's well made, installs in a few minutes, and does everything Dilog says it will.

You still have to worry about power failures, playful kittens, and small children; writers should save early and often.

(text continued on page 398)

COHERENT™ IS SUPERIOR TO UNIX* AND IT'S AVAILABLE TODAY ON THE IBM PC.

Mark Williams Company hasn't just taken a mini-computer operating system, like UNIX, and ported it to the PC. We wrote COHERENT ourselves. We were able to bring UNIX capability to the PC with the PC in mind, making it the most efficient personal computer work station available at an unbelievable price.

For the first time you get a multi-user, multitasking operating system on your IBM PC. Because COHERENT is UNIX-compatible, UNIX software will run on the PC under COHERENT.

The software system includes a C-compiler and over 100 utilities, all for \$500. Similar environments cost thousands more.

COHERENT on the IBM PC requires a hard disk and 256K memory. It's available on the IBM XT, and Tecmar, Davong and Corvus hard disks.

Available now. For additional information, call or write,

Mark Williams Company
1430 West Wrightwood, Chicago, Illinois 60614
312/472-6659



(text continued from page 396)

DAY OF THE JACKPOT

Four long-awaited systems came in today. All come highly recommended. One, the Disk Maker I by New Generation Systems, is supposed to solve all my disk-format problems forever: it has one 5¼-inch drive that will do both 48 and 96 tpi (tracks per inch; IBM uses 48, while Eagle does 96) and an S-100 card. I'm to plug the card into Ezekial II, my CompuPro Z80, after which I can read all known 5¼-inch disk formats on the Disk Maker's 5¼-inch drive and transfer the files to my 8-inch disks. Disk Maker knows both CP/M and PC-DOS, and it will move files back and forth between them. Leor Zolman, the author of BDS C and an always reliable source, swears by it.

Meanwhile, Security Microsystems Consultants has sent a little gizmo, Quickon, that you install in an IBM PC, after which you can disable the mandatory memory test or let it run, as you prefer. I haven't installed mine yet, but Jim Baen swears by his. It ought to save considerable time.

I also have a printer buffer at long last. Applied Creative Technology's Printer Optimizer not only contains a box full of memory, but both serial and parallel input and output ports: you can cross-connect as you like. The Printer Optimizer is a handsome little box, and I'm looking forward to using it between The Golem and the NEC 7710; more next month.

As soon as I wrote all that, Daniel Benton brought over the new Helix Laboratories bubble-memory board for the IBM PC. I was really impressed with

it at COMDEX; it's in production now.

If that weren't enough, Shirley has yet to be uncrated; the Sage IV, complete with EMACS text editor, LISP, and a bunch of other new software, came in two hours ago; and Tyler Sperry came up from Kaypro with the 1984 model Kaypro 4.

All in all, it looks to be a superbusy month at Chaos Manor. ■

Jerry Pournelle welcomes readers' comments and opinions. Send a self-addressed, stamped envelope to Jerry Pournelle, do BYTE Publications, POB 372, Hancock, NH 03449. Please put your address on the letter as well as on the envelope. Due to the high volume of letters, Jerry cannot guarantee a personal reply.

Items Reviewed

CompuPro Hard Disk.....\$5495
CP/M-8/16 and BIOS.....\$250
 CompuPro
 3506 Breakwater Court
 Hayward, CA 94545
 (415) 786-0909

Disk Maker I.....\$1500
 96 tpi option.....\$385
 New Generation
 Systems Inc.
 2153 Golf Course Dr.
 Reston, VA 22091
 (800) 368-3359

DP-100 Electronic Disk.....\$1295
 Dilog PC Products
 12800 Garden Grove Blvd.
 Garden Grove, CA 92643
 (714) 534-8950

Helix PC Bubble Disk.....\$1495
 Helix Systems
 11601 Wilshire Blvd., Suite 720
 Los Angeles, CA 90025
 (818) 710-0300

Printer Optimizer.....\$499
 Applied Creative Technology Inc.
 2156 West Northwest Hwy., Suite 303
 Dallas, TX 77520
 (214) 556-2916

Quickon.....\$69.95
 Security Microsystems Consultants
 16 Flagg Place
 Staten Island, NY 10304
 (212) 667-1019

Rana Disk Drives Elite I (Apple)..\$379
 Rana Systems
 21300 Superior St.
 Chatsworth, CA 91311
 (213) 709-5484

Sage IV.....\$7300
 Sage Computer
 4905 Energy Way
 Reno, NV 89502
 (702) 322-6868

Turbo Pascal.....\$49.95
 Borland International
 4807 Scotts Valley Dr.
 Scotts Valley, CA 95066
 (408) 438-8400

8087 Math Board for Dual Processor.....\$495
8087 Math and Memory Board for Z-100
 memory only.....\$595
 complete.....\$995

James Hudson Associates
 POB 2957
 Santa Clara, CA 95055-2957
 (408) 554-1316



Through the Trap Door
 March 1979—\$35



Breaking the Sound Barrier
 September 1977—\$35

BYTE COVERS

The prints shown at left are beautiful Collector Edition Byte Covers, strictly limited to 750 prints each, and signed and numbered by the artist, Robert Tinney. Each print is 18 in. x 22 in., and is accompanied by its own Certificate of Authenticity. To order, use the coupon below. Visa and MasterCard orders may call 1-504-272-7266.

Please send _____ **Through the** Visa MasterCard
Trap Door prints (\$35) _____ Card No. _____
Breaking the Sound Barrier _____
 prints (\$35), or _____ sets of both prints Expires: _____
 (\$55). I have included \$3 per order shipping Name: _____
 and handling (\$8 overseas). Address: _____
 City: _____
 I have enclosed check or money order. State: _____ Zip: _____
 Please send me your color brochure.

Robert Tinney Graphics • 1864 N. Pamela Dr. • Baton Rouge, LA 70815

With one line you can draw a thousand conclusions.

Without a good line, it's difficult to draw much of anything. And Taxan has an extraordinary line.

It's a dozen computer display monitors (RGB and composite as well as monochrome), one printer buffer, a television conversion tuner, several coaxial cables and a multitude of PC cards long. All segments designed and manufactured to represent the utmost in computer

display technology.

The Taxan product line.

The only one of its kind. Backed by a solid reputation and 15 years in the computer display industry.

So, if you're in the market for a computer monitor or related accessory, just ask one of our dealers to demonstrate our full line.

You can draw your own conclusions.



TAXAN
TAXAN
TAXAN

Taxan Corporation

18005 Cortney Ct. City of Industry, CA 91748

(818) 810-1291

MAC AND (SIGH) VALDOCS

Dear Jerry,

I've seen the Apple Macintosh, and it is exactly what I hoped it would be: a little 68000 monster that takes up as much room as a stack of paper. Mac shows off its speed in MacPaint with good cut, paste, and copy performance. Take a look!

Why do you hate the Epson QX-10 so much? I think it's the best 8-bit computer for the money. If you want more speed, go into Help and turn on Quirks (this works only in the expert or advanced mode). Then turn on the Quick display and turn off the center line. You'll find your screen now looks like a "regular" terminal. All Valdocs attributes are still there when you turn Quick off. Valdocs II exists, but it won't be released till late spring. CP/M 3 or CCP/M could be configured for this computer. TP/M runs CP/M programs right out of Valdocs and will return with your document preserved (assuming you had one). Try it; select Menu; go for applications on the right drive. When Valdocs asks for an application, insert any CP/M disk with a program on it. Press Return twice, then you can use the cursor controls to select a program. When you're done, perform a Control-C and put the data disk back in. This also works with two-drive CP/M stuff. Just put the Valdocs disk back in before you drop out of your program.

As soon as someone optimizes the QX-10's 16-bit screen processor and gets those 8-bit subprocessors marching in step, we will get substantial performance in Valdocs. That may become less important with Epson's little sister Comrex offering an MS-DOS card and a 512K-byte semidisk. By the way, a Control-Print does a screen dump any time. Now quit being such a brat and get some good laser-cut fanfold paper for that FX-80. Then hook it up to something that will use it (like your Eagle or Sage) in the manner it would grow accustomed to.

FRANK MCCONNELL
Greendale, WI

You're not the only one who wants me to look at the Mac. As it happens, Dr. Michael Hyson and I have Macintoshes on order, and we're assured by Volition Systems that it will have a Modula-2 for the Mac (Mac Modula?) before the end of summer. We may write a book about the Macintosh.

We've had many letters about the Epson QX-10. A lot of readers feel I've been too hard on the machine. Others hate it.

For the record: I don't hate the QX-10. It has some of the best hardware I know of, especially the capability for really good graphics. Alas, it seems that Epson just didn't have its act

together when it released the machine.

If a company sends me a test model, hardware or software, I feel no compulsion to publish my opinions; but when the company is selling the product, I think I have more obligation to my readers than to any manufacturer or publisher. I do not believe customers should unwittingly be made into either venture capitalists or a quality-assurance department.

The first Epsoms were shipped with totally unsatisfactory software. As time went by, successive improvements were made to Valdocs, and what Epson is shipping now is enormously better than what I originally reviewed. However, Epson America officials tell me there will be an even bigger improvement (version 2.0) Very Soon Now, and other improvements, including 16-bit capabilities, Real Soon Now. I'm waiting for those before I do another evaluation.

Those in the market for a new machine in the Epson price range would be well advised to look at the QX-10. It has a lot of neat features. Valdocs 1.18 is usable. However, it's slower than I care for, especially if you want to use it as a substitute for a typewriter. It still hasn't a convenient way of dealing with business letters on letterhead. I advise people to see a demonstration before they buy.—Jerry

50-HZ HELP

Dear Jerry,

Howdy. I've been reading your columns for about three years, and your December 1983 column really hit home. I'm a noncommissioned officer in the Air Force and don't have a lot of money to spend on my computer: a Ferguson Big Board and a pair of Siemens 8-inch drives. I am stationed in Great Britain and am looking for motor-shaft pulleys to convert to 50-Hz operation. The drives are advertised to operate at 50/60 Hz, so the pulleys must be available somewhere. Could you please tell me where? I am thinking of purchasing the following low-cost software: Borland Pascal and Ellis Computing BASIC. I would appreciate any reviews of these products. Do they handle strings and overlays (chaining in BASIC)? I would appreciate any help. Please send addresses and not telephone numbers. Overseas calls cost quite a bit. Thanks.

SSGT CHRIS BEACHY
POB 4645
APO NY 09755

Alas, I haven't any clues about the pulleys; but I expect one or another reader can help you. We don't ordinarily print addresses, but I'll have yours listed.

Borland's Turbo Pascal may be the best soft-

ware deal going; while Ellis's Nevada products are certainly good value for the money.

The current version of Turbo Pascal doesn't allow overlays, but I'm told Borland will have a version that will by the time this is in print.—Jerry

DISK DOUBLER

Dear Jerry,

In the February "User's Column," you address the use of the Disk Doubler to enable the use of the back side of disks on single-sided drives. I was happy to see that you recommended against using this tactic, but I feel that you left out the most important reason for not using it.

What was not addressed is that the inside of the disk jacket is lined with a porous material that is designed to both lubricate and clean the disk as it rotates in the jacket. Many small particles are trapped by this material and held out of danger's way so that the disk will not be harmed. However, when the Disk Doubler is used and the disk is inserted in the drive upside down to use the back side, the disk rotates in the reverse direction. Thus, any and all particles that were trapped during the original rotation direction can now be released back onto the disk. Premature failure of the disk, or at least loss of data on the disk, is virtually guaranteed.

I have long recommended to my clients that this is not a worthwhile savings tactic, and the potential of lost data far outweighs the small dollar savings in disks.

LARRY C. HANSFORD
New Carlisle, OH

It's not a "guaranteed" way to lynch the disk, but spinning them in the wrong direction is a risk I'm not ready to take. The savings just can't be worth it.—Jerry

AN UNDERSTANDABLE DISCLAIMER

Dear Jerry,

My friend Bill Voglesong has begun to write computer programs and has asked me to edit them. I know nothing about computers, but as an unemployed English teacher, I do know something about grammar and punctuation.

After reading your thoughts in the "User's Column" in the June 1983 BYTE, specifically, "Again, the Piracy Problem," my friend consulted me again. He did not want his disclaimer to read as poorly as did those noted in your article. He wanted a disclaimer written in plain English, not in legalese. I tried. His attorney said

(text continued on page 402)

HIGH PERFORMANCE

LONG DISTANCE RACER



You can't win a race when you're not on the road. That's why you need a printer that does more than run fast. You need one that runs *long*. You need a Datasouth.

MORE CHARACTER

The printhead on a Datasouth printer is rated to live through 500 *million* characters. Even in the most demanding applications, this means years of service without an overhaul.

HEAVY DUTY CYCLE

For a Datasouth printer, "100% duty cycle" is something of an understatement. So far, over 35,000 Datasouth printers have hit the hard copy road, and so few have pulled into the garage for repairs, it's hard to say how close to forever any of them will last.

MORE THAN THE HUM OF ITS PARTS

There's less to go wrong with a Datasouth printer. With sophisticated microprocessor control and unusually

efficient design, Datasouth printers have few moving parts. They also don't need add-on "personality boards" to accommodate different computers.

TAKE YOUR CHOICE

Datasouth reliability comes in two high performance models. The DS180 is a legendary workhorse that delivers crisp data quality printing at 180 CPS. The new multimode DS220 cruises at 220 CPS for high speed data printing and at 40 CPS for letter-quality word processing. Both models print precision dot-addressable graphics.

If you have a high performance printing need, Datasouth has a high performance printer to fill it.

DRIVE ONE TO WORK

Test drive a Datasouth printer at your nearest showroom today. Then put it to work. With a Datasouth racing beside you, there's no way to lose.

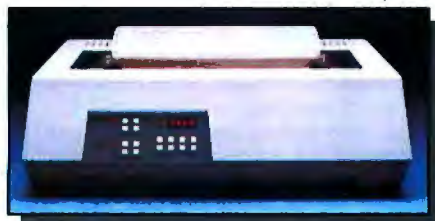
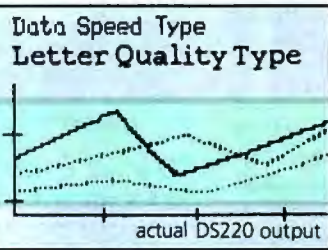

datasouth

H I G H P E R F O R M A N C E M A T R I X P R I N T E R S

Find Datasouth Printers At
Participating **ComputerLand** Stores
And Other Fine Dealers.

AVAILABLE NATIONWIDE
THROUGH OUR NETWORK OF
SALES AND SERVICE DISTRIBUTORS
CALL TOLL FREE:
1-800-222-4528

Datasouth Computer Corporation
Box 240947 · Charlotte, NC 28224
704/523-8500 · Telex 6843018 DASOU UW

(text continued from page 400)

what I wrote would even protect him legally (and commented that it must have been written by someone not of the legal profession).

I have enclosed a copy of this disclaimer (see table 1) for your consideration. If you could find the time to read it, Mr. Voglesong and I would be very interested in your opinion of it. If not, at least you know that you are being read and studied!

PENNY HETZER
Rochester, NY

This program falls under the Federal Copyright Law and may be used only by the purchaser for his own personal use. PSI designed this software for use in the Apple II and the Epson MX series printers using the Grafrax or Grafrax + character set. With proper application, this program will perform as promised in the manual; PSI, however, is responsible for neither the particular application nor any problems resulting from that input.

Updates and corrections will automatically be received by filling out the registration card packed in the manual. We at PSI invite you to contact us with any questions, problems, or suggestions you might have so that later versions may be even more useful in printing with your system.

Table 1: The PSI software disclaimer.

I think your disclaimer is great. I wish all the software outfits would pay attention to this sort of detail.—Jerry

MEDICAL DIAGNOSIS

Dear Jerry,

I find your monthly columns of great interest. Unfortunately, I don't file them, and therefore I am writing to request information on how to obtain the software Dr. Lawrence Weed has been developing.

As you probably know, his book on the medical record was a seminal contribution to the organization of medical information. Fifteen years ago he set the stage for the possibilities that microcomputer technology now makes available to us.

Thanks for any help you can give me.

ROBERT L. COHEN, M.D.
East Elmhurst, NY

Dr. Lawrence Weed's address is Problem-Knowledge Coupler, PKC Corporation, RR 1, Box 630, Cambridge, VT 05444.

We got more than a hundred letters asking about Dr. Weed's diagnostics programs; the address was listed under Problem-Knowledge Coupler, but I guess I wasn't clear enough in the article that that's what Dr. Weed calls it.—Jerry

TYPEWRITER REPLACEMENTS

Dear Jerry,

If you were starting out today as a fiction writer, what would be your ideal micro? And, considering a writer's need for large memory storage and quick access to a variety of documents for editing, how would micros offering multiple windows fit into your ideal?

STEVEN A. HARDESTY
Arlington, VA

Given that I have my choice of almost any system available, obviously I prefer the S-100 system I now use. What I have is a CompuPro "boat-anchor" box that houses a Z80 microprocessor, lots of memory drives, and 8-inch floppy-disk drives. It talks to me through a memory-mapped video board that drives a 15-inch monitor; I talk to it on an Archive keyboard. As soon as CompuPro releases its upcoming S-100 video board that emulates the IBM PC display (but will put it up on my 15-inch monitor), I'll change over to that.

I solve the problem of large storage and quick access to a variety of documents by having a separate S-100 8085/8088 System 8/16 with a 40-megabyte hard disk. That system also drives the printer.

You did say "ideal."

You also could build a "dream system" for writers around the Sage IV; we're even looking into the possibility of using a Macintosh as the terminal for the Sage!

Obviously, not everyone has access to so much equipment.

Writing with computers is so much faster, better, and easier than working with typewriters that it hardly matters what you get, so long as you get a reliable full-service computer, not a games-playing toy. I know writers who love: Zenith Z-100; Apple IIe; Sage; IBM PC; Eagle; Otrona; Osborne; Kaypro; Corvus; Wang; Altos; North Star; Vector Graphic; Epson QX-10; and one who's devoted to his Exidy Sorcerer.—Jerry

MAKING EAGLES

REMEMBER MORE

Dear Jerry,

As an Eagle 1600 user, I read with great interest your section in the January "User's Column" concerning beefing up the Eagle 1600 by the insertion of several 8K-bit memory chips on the motherboard.

I am interested in increasing my 1600's memory in a similar fashion and would be grateful if you could advise me of the chip's specifications and the cost of acquiring such chips. I note that the existing 128K bytes of my computer are made up of Mitsubishi 8K-bit chips, serial no. FMB 8264-20.

Second, should any special handling precautions be taken while inserting the chip, aside from careful use of an IC tool and correct orientation of the chip? Also, are they simply inserted in the IC sockets immediately adjacent to the existing chips? I note that there are 48 sockets.

DAVID W. FULLERTON
St. Catharines, Ontario, Canada

My apologies: I should have given those details then.

You want 8K-bit dynamic-memory chips (4164 types); California Digital lists them at \$5.95 in quantities of one. For the Eagle, you need them in sets of eight; for the Zenith Z-100 or IBM PC, you'll want them in sets of nine (the extra chip is for storage of the parity bits).

You must be careful of static electricity: do not work in a carpeted area, and be certain to ground yourself before removing the chips from the antistatic foam California Digital sends them in.

Eagle sells memory-upgrade kits with full instructions. That might be a good buy, since you'll also need a second memory-refresh chip (an exact duplicate of the 48-pin refresh chip that's already there; it goes in the empty socket.)—Jerry

ADA SUBSETS

Dear Jerry,

I think it was a great mistake when it was decided not to "permit" Ada subsets. The decision did not prevent subsetting; it just ensured there would be no control over subsets. No one has been able to do any Ada programming without spending a lot of time picking out the nonstandard features of one's particular implementation and finding out which parts of the standard were left out.

The proper approach would have been a phased development using compiler subsets, somewhat as the Stoneman document defined subsets for the Ada programming support environment. Phase 1 would be the kernel "Pascal subset," with strong typing the most important feature. It would include all data types except private and task types. The kernel would also include subprograms and high-level I/O.

Phase 2 would introduce packages—the minimal requirement for a language to call itself Ada—and the other aspects of separate compilation, such as private types and the separation of specifications and bodies. The minimum would also need type-checking across module boundaries—otherwise, the purpose of type-checking is subverted. The final element of the minimum would be representation specifications and low-level I/O to allow the machine-dependent data definitions required in any programming for embedded systems.

Phase 3 would be full Ada except for tasking, the most important features being generics and overloading—two aspects of the same topic.

Phase 4 (tasking) would be the final layer, adding all aspects of this difficult and controversial feature. (A lot of disagreement has arisen about the desirability of the rendezvous method of tasking specified in the standard. Its primary use is for networks of computers. However, nothing forces a programmer to use Ada's tasking; individual variations can be created, if necessary.)

The kernel and minimal Ada could be implemented on an 8-bit machine. RR Software has demonstrated that with its Janus compiler. Task-

CHAOS MANOR MAIL

ing may be possible only on a 16-bit micro with a multitasking operating system, but interpreter/compiler/OS hybrids like FORTH might be able to manage it.

LARRY CARROLL
Pasadena, CA

Agreed: the much vaunted Department of Defense "control" over subsets of Ada may bring about the opposite of what it intended. Your approach would have been better. Alas, it's too late now.

This is probably the right place to mention an excellent new book, Software Engineering with Modula-2 and Ada, by Richard Wiener and Richard Sincovec (Wiley, 1984). They give a good overview of what Ada is supposed to accomplish, as well as compare its approach with that taken by Modula-2.—Jerry

REAL SOON NOW BLUES

Dear Jerry,

I want to contribute my recent experience with mail order as a warning to other readers.

In the August 1983 BYTE, I found a very tempting ad on page 75. A company called XperSystems promised a database system called Base I for \$19.95. I called the toll-free number, ordered a copy for my 8-inch CP/M system, and charged it to my MasterCard. On August 10, XperSystems debited the \$19.95 to my MasterCard account. At the end of October, I still had not received the product. I called the 800 number again, which turned out to be a secretarial service that just accepted phone orders. I was given the address of XperSystems: POB 22, Drescher, PA 19025. I sent a letter asking for the software or my money back before the end of November. Nothing happened. In early December, I called the 800 number once more. This time I was given the number of XperSystems: (415) 526-7110. I should ask for Karen Hall and request a refund.

Curious: the phone number is in Albany, California. After many unsuccessful tries, a woman finally answered on December 7. I explained my case, and she promised that Karen Hall would call me the next day. She called me two days later with a thousand excuses. The best one: "The boss of XperSystems is a very fast and effective programmer. He thought all other programmers would be that fast. But they were much slower. This is why we miscalculated the needed time to develop the software." Karen promised a letter within the next couple of weeks to all customers of XperSystems explaining the delay and a planned delivery schedule.

Another two months later and nothing has happened. If XperSystems does still exist and should ever advertise any products, remember my experience.

I do not mind waiting some time for software. I do mind, however, if someone takes my money months before sending the merchandise—if it even exists.

HANNIS J. PROENEN
Culver City, CA
(text continued on page 404)

IBM PC & XT

IBM PC & XT Computers—Call

SOFTWARE FOR IBM PC

MS-DOS 1.1 \$369
Lotus 1-2-3 SCALL
Home Accounting Plus \$99
Peach Pak Series 4 (A/R, A/P, G/L) \$237
Peach Text 6000 \$237
PFS: Report \$70
PFS: Graph \$85
PFS: Write \$85
SuperCalc II \$189
SuperCalc III \$289
TKI Solver \$219
VersaForm \$249
Wordstar Professional \$369
Word with Mouse \$299
Hayes Smartcom II \$89
CrossTalk \$118
Multimap \$275
Multiplan \$189

STB

RIO PLUS Multi-Function memory expansion card for IBM PC/XT. 64K-384K parity checked memory. Complete with parallel port, RS-232C serial port, game port, clock/calendar, print/buffer/disk emulator software.

memory installed — 64K 128K 192K 256K 320K 384K
\$289 \$339 \$389 \$439 \$489 \$539

JRAM BOARD by Tall Tree Systems
The JRAM board provides usable memory above the 640K boundary with its unique software controlled hardware pager. Add 4 JRAM boards and increase the memory capacity to 2 MB. 512K JRAM board w/software \$649

AST

Multi-Function Cards for IBM PC and XT

(Each card now comes w/ SuperDrive & SuperSpool)

Memory installed on card — None 64K 128K 192K 256K 320K 384K
with parallel, serial ports & clock \$227 \$267 \$317 \$367 \$417 \$467 \$517
above plus game port \$282 \$302 \$362 \$402 \$462 \$502 \$552

COMPAQ

Compaq 128K, 1 drive SCALL
Compaq 256K, 2 drives SCALL
Compaq Plus, 128K, 1 drive, 10MB hard disk SCALL
Compaq Plus, 256K, 1 drive, 10 MB hard disk SCALL

COLUMBIA COMPUTERS

Model 1600-1, Two drive system. Call Model 1600-4, One drive & one 12MB hard disk system. Call Model 1600-VP, Portable unit with two drives, 9" monitor. Call

SANYO

DESK-TOP BUSINESS COMPUTERS

MBC-650, 128K, 1 drive CALL
MBC-655, 128K, 2 drives CALL
Sanyo game monitor \$179

KAYPRO CALL FOR PRICE!

MONITOR SALE
FREE interface cable included!

DAVONG Dynamics, Inc.

Hard Disks: 10, 15, 21, 32 MB SCALL
Telex Backup Systems SCALL
Networking Systems SCALL

IBM COMPATIBLE

Princeton MX-12, 12" RGB Color, high resolution 690-dot, 16 colors, super cabinet as IBM monitor. \$469

SCREENS

ELKA Green Monitor, 12", 1000-dot high resolution, 20 MHz \$118
DynaX BM-120, 12" green, high resolution 800-dot, 20 MHz \$129
Roland DG MB-122G, 12" green, 16 MHz, hi-resolution 720-350 dots, fully compatible with IBM monochrome display card \$CALL
LSI PI-2, 12" green, 1000-dot high resolution, 20 MHz \$149
Texas RG-1294, 12" green, 800-dot hi resolution \$149

SCREENS

DynaX AM-121, 12" amber, 600-dot hi resolution, 20MHz \$139
Texas KA-129, 12" amber, 800-dot hi resolution \$125
UBI PI-3, 12" amber, 1000-dot hi resolution, 20MHz \$148
Amdak 316A, 12" amber, 800-dot hi resolution, designed to run on IBM monochrome display card \$185
Princeton MAX-12, 12" amber, 720 x 350 dot, runs off IBM monochrome display adapter \$199

All merchandise is brand new & fully guaranteed. All prices reflect 2% cash discount for full payment by cash, cashier's check or money order. Personal or company check requires 2-3 weeks to clear. Visa, MasterCard, American Express cards & PO's accepted from qualified customers. COD's accepted with 20% paid deposit plus \$3 COD fee (by UPS only). No COD's to Canada or PPO/APO. Shipping/insurance/handling charges: 3% of total order value with UPS Surface, 5% by UPS Air & Parcel Post (Min. \$31. Calif. residents add sales tax. No sales tax on out-of-state orders. Prices & availability subject to change without notice.

EASTERN ENTERPRISES, INC.
Miss. Merch. Authority Since 1959
2937 S. VAIL AVE., LOS ANGELES, CALIF. 90040
Hours: Monday, Friday 9:30am-4:30pm Pacific Time

QUADRAM

QUADMASTER II - 9-Function memory expansion card for IBM PC

- Up to 384K
- Games port
- Chronograph
- Parallel port
- Serial port
- Games direct output to LPT-1, 2 or 3
- QuadRAM drive
- Master spool
- I/O bracket

AST

Multi-Function Cards for IBM PC and XT

(Each card now comes w/ SuperDrive & SuperSpool)

Memory installed on card — None 64K 128K 192K 256K 320K 384K
with parallel, serial ports & clock \$227 \$267 \$317 \$367 \$417 \$467 \$517
above plus game port \$282 \$302 \$362 \$402 \$462 \$502 \$552

AST

Multi-Function Cards for IBM PC and XT

(Each card now comes w/ SuperDrive & SuperSpool)

Memory installed on card — None 64K 128K 192K 256K 320K 384K
with parallel, serial ports & clock \$227 \$267 \$317 \$367 \$417 \$467 \$517
above plus game port \$282 \$302 \$362 \$402 \$462 \$502 \$552

AST

Multi-Function Cards for IBM PC and XT

(Each card now comes w/ SuperDrive & SuperSpool)

Memory installed on card — None 64K 128K 192K 256K 320K 384K
with parallel, serial ports & clock \$227 \$267 \$317 \$367 \$417 \$467 \$517
above plus game port \$282 \$302 \$362 \$402 \$462 \$502 \$552

HERCULES GRAPHICS CARDS - Create hi-resolution graphics on the IBM monochrome monitor plus 96K user memory expansion. \$469

Amdak MA1 Board - for both monochrome & color monitor plus 96K user memory expansion. \$469

Paradise Multi-Function Card - for both color and monochrome display, w/ parallel port. \$399

Vista Disk Master - Disk controller card for both 5 1/4" & 8" drives, IBM PC/XT compatible. \$169

TELEMAN GRAPHIC MASTER - Multi-function graphics board for both RGB color & monochrome displays and can do graphics on both. CALL

STB Color Graphics Board - The newest entry from STB. Operates RGB color or monochrome monitor. It can also do graphics on the monochrome display. SCALL

QUADLINK - An Apple emulator card enables the IBM PC to run Apple II software. No diskette reformatting necessary. \$479

MULTIGRAPH Monochrome & Color Display Adapter - 720x350 line monochrome graphics, Lotus 1-2-3 compatible. Capable of running software designed for color graphics on monochrome display. 32-bit internal architecture, 32K on board memory. \$499 Parallel Port option \$75

DYNAMIC RAM CHIPS

4116 (18K) 200 m \$1.50 ea. 9/812
4116 (84K) 200 m \$5.95 ea. 9/850
4164 (64K) 150 m \$8.95 ea. 9/890

DAVONG Dynamics, Inc.

Hard Disks: 10, 15, 21, 32 MB SCALL
Telex Backup Systems SCALL
Networking Systems SCALL

DAVONG Dynamics, Inc.

Hard Disks: 10, 15, 21, 32 MB SCALL
Telex Backup Systems SCALL
Networking Systems SCALL

DAVONG Dynamics, Inc.

Hard Disks: 10, 15, 21, 32 MB SCALL
Telex Backup Systems SCALL
Networking Systems SCALL

DAVONG Dynamics, Inc.

Hard Disks: 10, 15, 21, 32 MB SCALL
Telex Backup Systems SCALL
Networking Systems SCALL

EPSON

FX-80, 180 CPS, 80 Col., friction & tractor feed, parallel CALL
FX-100, 180 CPS, 132 Col., friction & tractor feed, parallel CALL
MX-80/FT, 80 cps, 80 col., tractor and friction feed, parallel CALL
MX-100/FT, 100 cps, 136 col., tractor/friction feed, parallel CALL
RX-80, 120 cps, 80 col., tractor feed only, parallel CALL
RX-80/FT, same as RX-80 but includes friction feed CALL

EPSON

8010AP Prowriter, 120 cps, 80 col., graphics, parallel \$235
8510-6P, above but 180 cps SCALL
8510-6CP, above but w/3 color ribbon (red, yellow, blue), also capable of doing orange, green, purple, ink. Call
1560 Prowriter-11, 120 cps, 136 col., 2K buffer, graphics, parallel, \$625
1850-6P, above but 180 cps SCALL
1850-6CP, similar to 8510-6CP but w/15" carriage SCALL

STAR GEMINI

Gemini-10X, 120 CPS, 80 Col., friction & tractor feed, parallel \$1,159
Gemini-15X, above w/15" platen. Call
Delta-10, 160 cps, 80 col., tractor. Call
Delta-15, above but 15" carriage. Call
PowerType, 18 cps daisywheel CALL
Rexlet-10, 200 cps, 80 col., parallel CALL

DAVONG Dynamics, Inc.

Hard Disks: 10, 15, 21, 32 MB SCALL
Telex Backup Systems SCALL
Networking Systems SCALL

DAVONG Dynamics, Inc.

Hard Disks: 10, 15, 21, 32 MB SCALL
Telex Backup Systems SCALL
Networking Systems SCALL

OKIDATA

ML-82A, 120 CPS, 80 col, pin & friction feed, serial & parallel. \$219
ML-82A, 120 CPS, 136 col, tractor & friction feed, parallel/serial \$695
ML-84P, 200 CPS, 136 col., friction & tractor feed, (parallel) \$695
ML-84B, above but serial. \$1,069
ML-92P, 160 CPS, 80 col., friction & tractor feed, 1600 dpi. \$CALL
ML-92S, above but serial. \$599
ML-93P, 160 CPS, 136 col., tractor & friction feed, (parallel). \$739
ML-93S, above but serial. \$799
2410P, 350 CPS, 136 col., friction & tractor, 2 color, (parallel) \$2,295

DAVONG Dynamics, Inc.

Hard Disks: 10, 15, 21, 32 MB SCALL
Telex Backup Systems SCALL
Networking Systems SCALL

DAVONG Dynamics, Inc.

Hard Disks: 10, 15, 21, 32 MB SCALL
Telex Backup Systems SCALL
Networking Systems SCALL

DAVONG Dynamics, Inc.

Hard Disks: 10, 15, 21, 32 MB SCALL
Telex Backup Systems SCALL
Networking Systems SCALL

DAVONG Dynamics, Inc.

Hard Disks: 10, 15, 21, 32 MB SCALL
Telex Backup Systems SCALL
Networking Systems SCALL

DAVONG Dynamics, Inc.

Hard Disks: 10, 15, 21, 32 MB SCALL
Telex Backup Systems SCALL
Networking Systems SCALL

DAVONG Dynamics, Inc.

Hard Disks: 10, 15, 21, 32 MB SCALL
Telex Backup Systems SCALL
Networking Systems SCALL

(text continued from page 403)

The other problem I find with Eaglewriter is that it doesn't label all the function keys and makes the user press two keys to use the powerful "indent" feature. And why Eagle allows the program to read and write files without making keys for the virtual-memory-architecture (g - get and gd - get done) commands, I have yet to figure out. Now that you have your Eagle PC, I suggest you get the SpellBinder manual.

Alas, it's a real problem: it will take months to get an advertisement in the pipeline. Surely, we'll have the software developed long before we get any orders, and we'll need the money as soon as we can get it.

Thus it's advertised; orders come; the product still isn't ready, but the programmers say it will be Real Soon Now . . .

I know. It has happened to me.

The only thing to do under those circumstances is tell the potential customer that the product isn't yet available.—Jerry

SOFTWARE GENEALOGY

Dear Jerry,

In a recent column you mentioned the "undocumented" features of Eaglewriter. Actually, there are quite a few if you depend on Eagle's

rewrite of the SpellBinder manual. Frankly, I suggest that anyone who gains Eaglewriter with their purchase should write to Lexisoft, the creator of SpellBinder, and buy the SpellBinder manual. It is far clearer, consisting of two volumes: an easy-to-learn manual for the casual user and a more detailed notebook of all the features. It is worth the investment.

The version to get is 5.12, since that is the one used by Eagle. The new version, which I have not seen yet, is said to be far improved and for the first time is generic; instead of having to tell Lexisoft which of the 50 versions you want (because of specific key assignments with each), it allows the user to define all the keys to preference. I haven't heard if Eagle plans to move up to the new version or not, but I am sure Eagle or Lexisoft would be willing to confide in you if you ask.

But this letter is prompted by the comment by Paul Chisholm in your February column. Ye gods, where did he find Word/125. I saw it on the HP 125 a couple of years ago. It was a lousy implementation of the old SpellBinder 5.04, which must be a minimum of three years old.

As you probably know now from your use of Eaglewriter, Mr. Chisholm can delete in either command or edit mode. In edit mode he can select character, word, sentence, paragraph, or mark (a great feature) for mode forward, mode

back, and mode delete. What could be easier? In command mode, if he wants to take out a line he only has to type ld (or how many lines he wants out) and it is done. Just like lp will print one line, etc. I suspect that he hasn't seen the manual or he is using Word/125 on something other than an HP 125.

In sum, perhaps it is about time to tell your readers that many manufacturers use older versions of word-processing software and then tell you it is "really" XYZ-brand. They just don't say why they were able to license it so inexpensively. Or, as in Eagle's case, it has tacked on a front end and done its own key assignments.

EDWARD F. SAYLE
Arlington, VA

Sigh.

Paul Chisholm was using a multiuser system at a major university; perhaps they need to be told to update?

Agreed: the latest SpellBinder is better than the older version of Eaglewriter. Eagle, fortunately, is doing an update, although I don't have it yet.

Some people love SpellBinder. Some just hate it. In my own case, if I had to use just one editor for everything (text creation, letters, documents, programming), SpellBinder would certainly be a major contender.—Jerry ■

MEASURE THE REAL WORLD WITH OUR SAV 10 MULTI CHANNEL

SERIAL ASCII VOLTMETER

The new voltage monitor with SERIAL ASCII output messages compatible with computers, data terminals and other devices with standard RS232C input interface.

FEATURES:

- STANDBY operation, no control messages from a host computer.
- 4 ANALOG VOLTAGE INPUTS of 0 - 2.55V, measured simultaneously at 8 bit resolution.
- SIMPLE INSTALLATION directly connects to a data display terminal.
- SELECTABLE OUTPUT DATA RATE.
- LOW POWER CONSUMPTION suitable for battery operation.
- RUGGED, COMPACT PACKAGE ideal for portable applications.
- NUMEROUS APPLICATIONS Remote data monitoring, Data logging and processing, Security systems, etc.

\$149.95

Introductory price
60 days money-back guarantee

Dealer and OEM inquiries invited.

MARON PRODUCTION INC.
DISCOVERY PARK, 105 - 3700 GILMORE WAY,
BURNABY, B.C. CANADA V5G-4M1.

Phone: (604)435-6211.

Please send me _____ SAV10 SERIAL ASCII VOLTMETERS at US\$149.95 each + shipping.

Enclosed is money order for US\$ _____ or charge VISA MASTERCARD

Card No. _____ Exp. _____

Name _____ Signature _____

Address _____

City _____ State _____ Zip _____

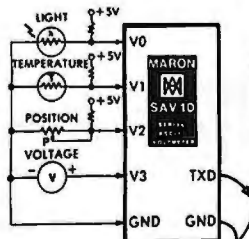

A typical SAV10 application



The Little Board®

Quantity One... \$349*

The world's simplest and least expensive single board computer

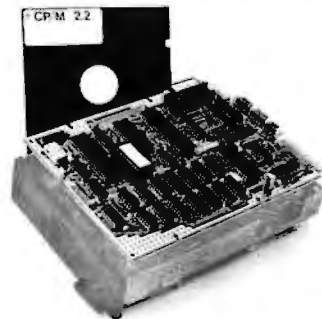

*Substantial Quantity discounts available

- 4MHz Z80A[†] CPU, 64K RAM
- Two RS232 serial ports
- Mini floppy controller
- Parallel printer port
- On-board -12V converter
- Only 5.75 x 7.75 inches
- Power Requirement: +5VDC @ .75A; +12VDC @ .05A
- Screws directly onto a mini floppy drive

All this... and CP/M^{††} 2.2 also!

AMPRO
COMPUTERS, INCORPORATED

† Z80A is a registered trademark of Z80, Inc.
†† CP/M is a registered trademark of Digital Research.

67 East Evelyn Ave. • Mountain View, CA 94041 • (415) 962-0230



Lessons Learned

SoftOffice, the
integrated
software
package that
almost wasn't

BY EZRA SHAPIRO

SoftOffice is an amiable and powerful integrated software package for word processing, spreadsheets, and database management on the IBM PC or XT, IBM-compatible computers, and the PCjr. It uses character graphics to create icons of familiar desktop items that can be manipulated with a mouse (or "pseudomouse," simulated with cursor-control keys). Windows for raw text or referenced data can be opened and closed easily. Designed to be learned quickly by a novice, SoftOffice also offers options for handling data that allow for a wide range of applications within the shell of the program.

The program first presents you with a familiar screen of a stylized desktop. The display contains a selection of icons—a piece of paper for data entry, a filing cabinet for storage, a wastebasket, a supply closet for duplicate icons or ones that you don't need on a regular basis, a clock and a calculator, a printer (when you want to print something, you place its icon "into" the printer icon), and Max, the Office Assistant.

The program uses a limited number of commands, including GRAB, DROP, POINT, MOVE, COPY, and CLOSE. To exercise a command, you can either click the mouse buttons or press one of the remaining keys on the IBM's numeric keypad that do not control the cursor.

Let's run through a simple text-entry process. You would use the command POINT to specify one of the icons (the sheet of paper, say) by placing the cursor on it. To produce a fresh sheet for yourself you'd use the COPY command on the icon. Then you would execute the GRAB command and MOVE the copy to a convenient position on the screen, where you would DROP it. Next, you would OPEN it (create a window) and enter your text by typing it on the keyboard. To finish, you would CLOSE the window. If you decided that you did not like what you had done, you could DELETE your sheet of paper. You can have as many windows open at one time as you want. Simple, isn't it?

The commands are available for several levels of the program. POINT can be used to mark the beginning and end of a section of text that you can then MOVE or COPY within

a document or between documents (of course, you could also DELETE the section). Using the OPEN command on a paragraph instructs the program to display a "dashboard," a short menu of formatting choices that can be used to modify the appearance of the paragraph. (SoftOffice assumes that you will want a basic format that will be changed infrequently. Once you have finished a paragraph with an unusual dashboard, the next paragraph reverts to the original styling guidelines.) Text re-forms with no intervention, and work is saved to disk automatically. (The program uses an algorithm that borrows small fractions of time from periods of keyboard inactivity to take care of maintenance.)

The program can handle two types of data, raw text and "data cells." You toggle between types by pressing the Insert key. Data cells can be indexed to one another and used to construct spreadsheets, databases, and form letters. What is more, data cells linked to other information can be dropped into text; it is possible, for example, to have a data cell in the middle of a paragraph related to spreadsheet data cells located well apart from the text (even in another document). Depending on how the formulas for the data cells are worded, changing the cell in text could cause automatic recalculation of the spreadsheet, or vice versa. The dashboard for data cells lets you enter formulas and references in straightforward, English-like syntax.

Items can be placed "inside" any container that makes sense; that is, you can open the filing cabinet and store a document in it, but you can't store the wastebasket in a document. Likewise, you can enter data in any logical spot—the front of the filing cabinet, a piece of paper, and so on. Max, the Office Assistant, is available for complex tasks; you can call on him to close all documents open on the screen and store them neatly in the filing cabinet. He also appears at appropriate moments to warn you of an impending calamity.

(text continued on page 406)

.....
Ezra Shapiro is a technical editor at BYTE's West Coast bureau. He can be reached at McGraw-Hill, 425 Battery St., San Francisco, CA 94111.

Venture capitalists turn you down by remaining enthusiastic forever, and that's essentially what happened to us.

(text continued from page 405)

THE HISTORY

SoftOffice wasn't always the integrated software package that it is now. In fact, the evolution of SoftOffice makes for an interesting case study of how things can change over the course of a software-development project. Late in 1982, Bruce Van Natta was introduced to a programmer from Orange County, California, who had an idea for an electronic-mail program that incorporated a fancy text editor with windows. Van Natta, a founder of IMSAI Corporation and later of MicroPro, had planned to retire but found that he couldn't stand not working. In addition, his complex tax picture required that he invest \$100,000 in something—anything. So in early 1983 he assembled a six-person team for the project in his living room. A few days later, the group rented office space (with Van Natta's money) and became the SoftOffice Company.

One of Van Natta's first acts as president of the new firm was to recruit a former associate from MicroPro, Phoebe Williams, who had been instrumental in the design and documentation of Starburst, MicroPro's umbrella program for word and data processing. She was asked to participate in the development of the final specifications for the program and to help draft a business plan. Williams flew in from Oklahoma for what she thought would be a long weekend as a consultant; instead, she stayed on as part of SoftOffice.

Williams recalls, "When I saw what they were doing and talked to them, I was convinced that it was a real hit. Plus I really wanted to work with Bruce again.

"We set out to follow the classic path of writing a business plan, trying to get around to venture-capital guys and get \$1.2 million and have a full-fledged company—develop the product, put a marketing team together, and have the thing introduced at COMDEX '83 in

November. The programmer said that he and perhaps 8 or 10 other guys could make the product in 11 months.

"So we wrote a business plan and had it ready the third week of February, but by this time we had already discovered that part of our team was neither competent nor willing to be part of a venture like this." Two members of the group were fired at the end of February, and a third at the end of March. The team dwindled to Van Natta, Williams, the programmer, and one other staffer handling legal and administrative affairs.

"By now," Williams continues, "Bruce and I are trudging out full-time to talk to venture capitalists. Did we talk to them! I'll bet we talked to between 35 and 50 firms. We weren't smart enough to realize that the fact that we talked to that many meant we were already doomed. I mean, within the first half-dozen, somebody had said to somebody else in the finance community, "These guys don't have the right stuff." But it took us six months to figure that out. Somebody early on said that venture capitalists turn you down by remaining enthusiastic forever, and that's essentially what happened to us."

Both Williams and Van Natta attribute their failure to a lack of the "correct" executive background. Van Natta feels that his bid to be president of the firm was the major stumbling block. Though he had played a major role in both the launch of the IMSAI 8080, one of the first business microcomputers, and the WordStar word-processing program, and though he had held high-level positions at MicroPro in operations and corporate planning, he had not had direct profit-and-loss responsibility. The venture-capital firms wanted a president with "the right marketing credentials," says Van Natta, "somebody who had marketed this stuff before, successfully."

By June of '83, neither Van Natta nor Williams had been paid for six months, but the firm had spent the initial \$100,000 and an additional \$20,000 besides. Williams goes on, "So here we are—our furniture is being repossessed, we're sitting in our office at the end of June, there's not a shred of money in the bank, we have no hope of getting money to fund the company, none of us has any personal resources left, and this is the end of it, right? So everyone departs the scene."

That was very nearly the end of SoftOffice, but both Van Natta and Williams had become fascinated with the idea of the editor that was to have been the icing on the cake of a slick electronic-mail system. A week after closing down the office, the two of them decided to move operations to an unused porch at Van Natta's house, borrow money to live on, and try to complete the project.

Very little had been finished—a product description, a few nonfunctional demonstration disks, and a small amount of actual program code. The first real task was defining the philosophy of the new product. Van Natta and Williams had already established several points. SoftOffice was to be a visual editor that used icons, windows, and a mouse, not an electronic-mail system. In Williams's words, "Granted, electronic mail was real sexy, but first of all, there wasn't a lot of application (there weren't that many networks installed and so forth), and we didn't think that it was a particularly hard thing to do." The editor would use the desktop metaphor, and commands would be derived from what users did in real-life situations rather than from programming convenience. And every command would have an immediate, on-screen effect. If nothing happens that you can't see, Van Natta reasoned, there would be no complex problems for you to untangle.

The basic guideline the two used was that if they experienced difficulty describing what was supposed to happen, the action itself was overly complicated and should be rethought. There were to be no error messages. "Every time you run into something where you have to give the user an error message," says Van Natta, "you have some sort of unnatural limitation. So the solution is not to have pretty, easy-to-understand error messages but to not have limitations that people are going to run into so that you have error messages." Finally, all commands would work the same way on all levels of the program.

"We had some experience with the windowing part of it," Van Natta explains. "In other words, opening and closing windows, making them bigger and smaller—and we knew we could do that with very few commands, in a very natural way. The real open question was whether the same philosophy and the

(text continued on page 408)

Sensible Solution™ software from O'Hanlon separates the business tools from the toys!

Finally, a computer language you can understand, and accounting software applications you can really use in your business. The SENSIBLE SOLUTION™ is not just another "file handler", it is not a toy, it's a brand new computer language. With it, you can modify any of the ready-to-run accounting applications from O'Hanlon to better fit the personality

of you and your business.

You see, everyone runs their

business just a little bit different. That's why there is a SENSIBLE SOLUTION™ in the first place.

My wife Tova, is president of the TOVA 9 Corporation. Hundreds of people call TOVA 9 everyday to order her secret beauty formulas. The SENSIBLE SOLUTION™ can help Tova record and track those sales, control her inventory, and handle her payroll. SENSIBLE knows exactly who and where Tova's customers are and remembers what they like.

Even if you've never used a computer before, you can be programming with The SENSIBLE SOLUTION™ right away. It speaks in English, and you don't have to

remember a long list of commands. The SENSIBLE SOLUTION™ isn't just user friendly, it's downright sociable!

Available at computer dealer stores near you!



O'HANLON
COMPUTER SYSTEMS
11058 Main Street, Suite 225, Bellevue, WA 98004
206/454-2261

(text continued from page 406)

same commands and the same simplicity—and it *had* to be the same commands and the same simplicity and the same metaphors—could go all the way into the editor. So there wouldn't be this shock as you passed from the desk into the editor. . ."

". . . into the windows and doing your actual work," Williams interrupts. "That was the part we were scared about. Then one weekend we talked about it for several hours each day, and we accomplished the design. In two days we realized how to do it, and we saw that we could do it consistently." She adds, "We looked at the kinds of things people put on paper, and we came up with two categories. First, paragraphs, stuff that you were going to type in; it was pretty much just going to sit there—it should re-form, you should be able to format in different ways, set the line spacing on it and stuff like that—but it wasn't going to do anything special.

"Then there was something other than plain old text—something that could be told to behave in special ways, told to recalculate itself, told to go and sit somewhere else in the system. I don't know how to describe it—one thing's sort of vanilla and the other's sort of a traveling medicine show on a real small scale. We decided that the second thing would be called a 'data cell,' for want of a better term, and it would be almost a little island that could hold a text reference, information from somewhere else, a formula, a number, a date, a percentage. It could display itself in about seven or eight different ways. We can fit everything you could possibly write into those two categories."

As Williams worked on refining the design specs for the program, Van Natta began to write the code for it in Pascal. He hadn't done much coding for several years, but after about a month the components of the program began to take shape. Initially, he borrowed routines that

the original programmer had contributed to the first stage of the project. As he went along, however, he found himself rewriting everything in simpler, tighter code. Work progressed, and Williams and Van Natta found two important things happening. First, their rules *did* work in all areas, and they could resolve any roadblocks by applying the rules carefully. Second, as the functionality of SoftOffice grew more complex, the actual program shrank in size.

"Instead of taking the easy way out and saying, 'Oh well, I guess we'll just have to have this edge be a little rough over here,' we just stayed at it until the problem solved itself inside the design criteria and the philosophies. We were pretty clear on what the philosophies were, which made it relatively easy to do things," says Van Natta.

The issue of error messages was a good case in point. In keeping with their general philosophy, there were to be no

(text continued on page 410)

Peripheral Networking Now



Buy ASCII Intelligent Port Expanders

- Eliminate Manual Switching by Remote Control
- Improve Productivity and Reliability
- Share Printers, Modems or Plotters
- Expand Computers or Terminals
- Use Matrix Switching for Multiple Transmission or Security
- Supports Polling and Queuing

INSTANT COMPATIBILITY with new computer devices and MAJOR OEM PRODUCTS:

Altos — Burroughs — Data General — DEC
H.P. — IBM — NCR — Northstar — Victor
and other key manufacturers.

Call 213-793-8979 to EXPAND YOUR SYSTEMS TODAY.



Advanced Systems Concepts Inc.
435 N. Lake Ave., Dept 86
Pasadena, CA 91101
800-824-7080 Telex: 701 215

Now YOU can repair your Apple II YOURSELF

apple patch

\$89.95

This kit contains:

- one of every chip found in an Apple II computer except ROMs (33 in all)
- one chip puller with holder so it can always be found
- a 66 page manual to help you find problems and prevent future failures
- an attractive binder and slipcover so the patch fits into any environment

To get your Patch contact:
ICC
460 N Univ. Ave. #1
Provo, UT 84601
(801) 373-1313

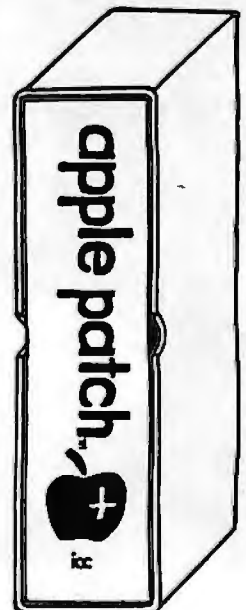

Dealers Welcomed

DIMENSION. THE MOST POWERFUL, MOST COMPATIBLE PERSONAL COMPUTER YOU CAN BUY.

(CRT not included)

Introducing the capability the world has been waiting for. A single personal computer able to handle Apple,[®] IBM,[®] TRS-80,[®] UNIX[™] and CP/M[®] based software.

The Dimension 68000 Professional Personal Computer does it all. It actually contains the microprocessors found in all of today's popular personal computers. And a dramatic innovation creates the environment that lets these systems function merely by plugging in the software.

Add to this the incredible power of a 32 bit MC68000 microprocessor with up to 16 megabytes of random access memory.

Dimension has the power of a main-frame at a personal computer price. It's obviously the best value you can find. For more information ask your dealer or call us at (214) 630-2562 for the name of your nearest dealer.

dimension™



68000

A product of
Micro Craft Corporation
4747 Irving Blvd., Suite 241
Dallas, Texas 75247. © 1983

Circle 213 on inquiry card



Apple is a registered trademark of Apple Computer, Inc.; IBM is a registered trademark of International Business Machines Corporation; TRS-80 is a registered trademark of Radio Shack, a Tandy Corporation company; UNIX is a trademark of Bell Laboratories, Inc.; CP/M is a registered trademark of Digital Research Corporation.

DEALER INQUIRIES INVITED



SAVE MORE THAN EVER ON...

3M Scotch® DISKETTES

AND OTHER COMPUTER NEEDS!

**LIFETIME WARRANTY!**

3M BULK DISKETTES AT TREMENDOUS SAVINGS!

These are genuine 3M diskettes with a lifetime warranty. But they are bulk packed in cartons of 50 with separate white Tyvec envelopes. No identification labels, write protect tabs or cartons are provided! A great buy for volume users.

\$160 ea. 5 1/4" SSDD
Qty. 50

\$202 ea. 5 1/4" DSDD
Qty. 50

5 1/4" SSDD-96TPI \$2.20 5 1/4" DSDD-96TPI \$2.75

All have reinforced hub.
SOFT SECTOR ONLY!

(for IBM, APPLE, KAYPRO, DEC and about 99% of all computers.)
Must be ordered in multiples of 50!

BOXED 3M DISKETTES WITH ALL THE TRIMMINGS!

Factory-fresh 3M packaging with envelopes, 3M logo labels, ID labels and write-protect tabs.

\$185 ea. 5 1/4" SSDD
Qty. 20

\$235 ea. 5 1/4" DSDD
Qty. 20

5 1/4" SSDD-96TPI \$2.60 8" SSDD \$2.05
5 1/4" DSDD-96TPI \$3.25 8" SSDD \$2.50
8" DSDD \$3.10

Minimum order of 20 diskettes. Additional diskettes in multiples of 10.

3M HEADCLEANING KITS

Stop swearing and start cleaning. This non-abrasive cleaning kit has everything you need for thirty applications.

\$23.00 + \$1.50 Shpng.

SAVE MONEY WITH A CLEAN COMPUTER! INTRODUCING MINI-VAC



Most computer malfunctions are caused by dust. MINI-VAC is ideal for cleaning keyboards, screens, drives and printers. (Great for photo equipment, too!) Equipped with an easy-empty bag, two directional wands and two fine-brush nozzles. Don't compute without it. (Requires 9-volt battery which is not included.)

\$21.95 + \$3.00 Shpng.

AT LAST: A DISK DRIVE DIAGNOSTICS SYSTEM THAT WORKS!

The Dymek Recording Interchange Diagnostic (RID) is a professional, but easy to use, drive diagnostic disk. It tests drive speed, radial position, hysteresis, write function, erase crosstalk, signal-to-noise and clamping. In short, it's a professional's system that will help you keep your machine in prime condition...and avoid the evils of data loss.

\$29.95 + \$1.50 Shpng.



MEDIA-MATE 50: A REVOLUTION IN DISKETTE STORAGE

Every once in a while, someone takes the simple...and makes it elegant. This unit holds 50 5 1/4" diskettes, has grooves for easy stacking, nipples to keep diskettes from slipping in the case and several other features. We like it.

\$10.95 + \$2.00 Shpng.



DISKETTE 70 STORAGE: STILL A GREAT BUY

Dust-free storage for 70 5 1/4" diskettes. Six dividers included. An excellent value.

\$14.95 + \$3.00 Shpng.

PRINTER RIBBONS AT BARGAIN PRICES.

EPSON MX-70/80 \$3.58 + .25 Shpng.
EPSON MX-100 \$6.99 + .25 Shpng.
Okidata Micro 84 \$3.66 + .25 Shpng.
Diablo 630 Mylar \$2.60 + .25 Shpng.
Diablo 630 Nylon \$2.93 + .25 Shpng.

THE END TO RS-232 CABLE PROBLEMS: SMARTCABLE

Now interfacing almost any two RS-232 devices is simple and quick. Just plug in SMARTCABLE and flip two switches. The logic of both devices is figured out immediately and you can get to work.

\$79.95 + \$1.50 Shpng.

Shipping: 5 1/4" DISKETTES—Add \$3.00 per 100 or fewer diskettes. 8" DISKETTES—Add \$4.00 per 100 or fewer diskettes. OTHER ITEMS: Add shipping charges as shown in addition to diskette shipping charges. Payment: VISA and Mastercard accepted. COD orders only, add \$3.00 handling charges. Taxes: Illinois residents, please add 8% sales tax.

WE WILL BEAT ANY NATIONALLY ADVERTISED PRICE ON THE SAME PRODUCTS AND QUANTITIES!

Nationwide: 1-800-621-6827

Illinois: 1-312-944-2788

Hours: 9AM - 5PM Central Time

Minimum Order: \$35.00

DISK WORLD!, Inc.
SUITE 4806
30 EAST HURON STREET
CHICAGO, ILLINOIS 60611

Authorized Distributor
Information Processing Products



BYTE WEST COAST

(text continued from page 408)

error messages because there were to be no obvious limitations on what the user could do. "An example of that is how long the name of a piece of paper can be," Van Natta says. "Well, I think there is some upper limit, something like 32 million characters. Nobody could type in that many. Why do you need that? Sixteen would have been plenty; Visi On gives you 12. The point is that if we don't have to have a limit, you never run into it, I don't have to have the code to check it, I don't have to have an error message, and I don't have to document it. The same philosophy is used throughout the entire system. We just don't have error conditions.

"A paragraph can be no longer than 32,000 characters. If somebody actually gets a paragraph longer than 32,000 characters, we're going to be in trouble. I don't think a single document can be longer than about 1500 pages. Of course, that would probably take up something like 7 megabytes—it would take a long time to get from one end to the other—but if someone put one in we might run into a bad error condition. It has limits way, way out there like that."

As Williams explains it, "We have what you probably consider 'warning conditions.' For instance, if you're running Soft-Office on a 128K-byte PCjr with a 360K-byte floppy, you're going to have more than one disk. You may run your office for a month on one disk, and then comes next month—you're full and it's time to move your office to another disk.

"The way the warning will occur is not that the machine will stop working and some error message will come up on the screen; what will happen is that Max will start waving his arms or pop up from beneath something on the screen. He'll have a piece of paper in his hand, and you'll open the paper and it will say, 'Disk is 92 percent full—you'd better do something about it now. Here's what to do—I'll help you.' And he will carry things from your current office disk to the next one."

Van Natta adds, "We wanted the system to be modeless, and we also wanted it never to trap you anyplace. If you're right in the middle of a paragraph doing something, you can move off and do something else and come back and you're right there. One of the problems

(text continued on page 412)

ENGINEERS

Some Of The Most Provocative Telecommunications Engineering Of The 80's Will Be Done Right Here With Hayes In Atlanta.



There's an energy level here at Hayes that fuels our confidence. An enthusiasm few engineering environments encourage or support. A unique blend of engineering and technological talents drawn together to move telecommunications technology further along. The projects... The programs and the confidence to roll our sleeves up — ask the questions that must be asked — and search out the answers.

If you're taking a closer look at your career, perhaps it's time to take an in-depth look at Hayes. There's a future in it.

- PROJECT MANAGER
- RESEARCH ENGINEER
- RELIABILITY/TESTABILITY ENGINEER
- SENIOR SOFTWARE ENGINEER
- PRODUCT ENGINEER
- SOFTWARE DEVELOPMENT PROGRAMMERS/ANALYSTS

Interested, qualified candidates should forward a confidential resume to: **Hayes Microcomputer Products, Inc., Dept. TJC-584, 5923 Peachtree Industrial Blvd., Norcross, GA 30092.**
An Equal Opportunity Employer M/F.

Opportunity for
the here and now.

 **Hayes**

Hayes Microcomputer Products Inc.

'The delay helped us make a better product because we were forced to think about it.'

(text continued from page 410)

with error messages is that, the way that they're normally done, you're trapped at the error message; you *must* do something to respond to that message before you're allowed to do anything else. When the office assistant jumps up, waves his piece of paper at you, and says, 'Disk is getting full,' you don't have to fix that problem right then. You can finish up what you're doing, and then—at a convenient time for you—solve the problem."

Williams adds, "There's no such thing as getting into the middle of something and not being able to leave it and do something else, which is true in no other program that I can think of. In SoftOffice, you're not required to finish something that you start. And if you leave it in the middle and come back, it'll be in the same state as when you left it."

"Internally, the way the system works is that keystrokes and commands sort of rain down on the objects," Van Natta explains. "The 'manager,' the code inside that manages this thing that you're typing into, every once in a while sees a character come at him and does something. Since he intrinsically doesn't have any sense of time, the fact that you went over and rained characters on another object—or went on vacation for a week—has no meaning for him.

"Because we've had everything work the same, I started off with 15 managers, and now there are just two—a manager that takes care of paragraphs and data cells, and a manager that takes care of papers, containers, everything else—objects. When the paper manager is over managing a piece of paper, he's not remembering he was over there and the next thing that needs to be done over there. He's a completely free-form manager, and he comes over here and picks up all the information here so that when this character rains down on this piece of paper, the system says, 'Okay, we're over a piece of paper. Let's call the paper manager and give him the character and tell him we're raining it on this particular object.' And if you move your cursor to another spot and rain over it, the system again just tells the paper manager, 'Here's your character, here's your object, now do it.'"

What started out as a program that required a hard disk and a large amount of RAM (random-access read/write memory) wound up as less than 128K bytes of compiled code that could conceivably (in cartridge form) run on a 64K-byte PCjr with no disk drives at all. Williams and Van Natta are excited about the possibilities of SoftOffice as a program for an environment with a larger computer, say a PC XT, as the mother to a cluster of satellite PCjrs. Because the program works the same way on any computer, they believe operators would experience little or no difficulty moving from one workstation to another. Electronic mail and networking, once the original purpose of the program, will be held back until the second or third version of Soft-

Office hits the market—and at that time, they figure, networking with small machines will make SoftOffice a very attractive package.

THE FINISHED PRODUCT

The story appears to have a happy ending. In March of this year, Van Natta and Williams were negotiating with a publisher interested in marketing the program and were confident that SoftOffice would appear as a finished product in midsummer, a bit less than two years after the first steps toward it were taken.

Looking back, Williams reflects, "We pretty much took the basic ideas that we'd developed during the first six months of '83 and started to build the design around those. It's now quite different from what the former programmer had originally conceived. But in a way, the delay—or what we think of as a crucial loss of six months' time—helped us to make a better product because we were forced to think about it. I'm sure that the design we had in the fall of '83 was far different from the one we had at the beginning of the year, and a far better one. We were forced into retreating to the basement, and now we're both glad of it and would do it that way again."

Van Natta comments, "If I had to do it over again, I would start off in the basement, with far fewer people. I might have gone to the venture-capital community, but only at the stage where the program was done developing." The lesson, and his advice to anyone with an idea for a program, is simple: "Learn a programming language, code it up, and find someone to publish it." ■

 A Public Service of This Magazine & The Advertising Council

Give Blood. Give Life.

Giving blood is everyone's business. After all, company blood drives provide a vital part of our nation's blood supply.

They benefit everyone. Your community gets much needed blood. Your employees get a lift when they give blood. And your company gets the good will.

So please have your firm start planning for a blood drive, today. And you can help save many lives tomorrow.

American
Red Cross



We'll Help. Will You?

O L Y M P I A

Before you pick a printer, make sure it's fully compatible with your computer. Make sure it's right for your software programs. Make sure it's flexible enough for the functions it must perform. And if the return on investment that you expect is durable construction, trouble-free performance and letter-quality printing, make sure it's Olympia.

Consider the Olympia printer portfolio: *Electronic Compact RO*. If you need an entry level printer, this is the one to consider. Compatible with every personal computer and low in price, it provides all the features needed for efficient day-to-day performance. *Electronic Compact 2*.

Combines excellent print quality with the versatility of a built-in typewriter keyboard. Perfect for business and personal use. *ESW102*. Excellent value in a medium-speed office printer, with broad flexibility for forms and letter formats. *ESW3000*. Your best investment in a fully featured, high-speed printer for a demanding work load. *Electronic Compact NP*. Our dot-matrix printer offers speeds of up to 165 CPS, as well as a correspondence mode, for a surprisingly low investment.

With Olympia, you can invest in the printer that's exactly right for you.



Before you invest in printers, make sure you consider Olympia.



Send for our booklet: "Olympia takes the mystery out of selecting a printer." Also request product information on any or all of these excellent printers.

- Electronic Compact RO
- Electronic Compact 2
- ESW102
- ESW3000
- Electronic Compact NP

Name _____

Title _____

Company _____

Address _____

City _____ State _____ Zip _____

Olympia USA Inc., Dept. 1-Y, Box 22,
Somerville, New Jersey 08876



Setting the standard for 80 years.

© 1984 Olympia USA Inc.

Circle 245 on inquiry card.

(text continued from page 113)

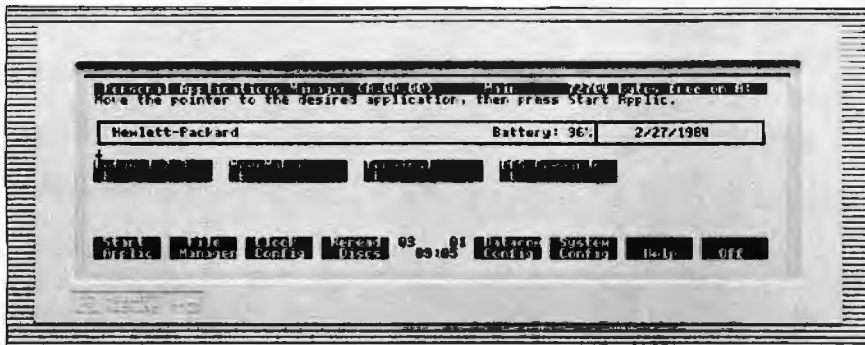

Photo 3: The HP 110's Personal Applications Manager, an operating-system shell for most configuration and file-manipulation functions. The blocks along the bottom of the screen are a map of the eight programmable soft function keys.

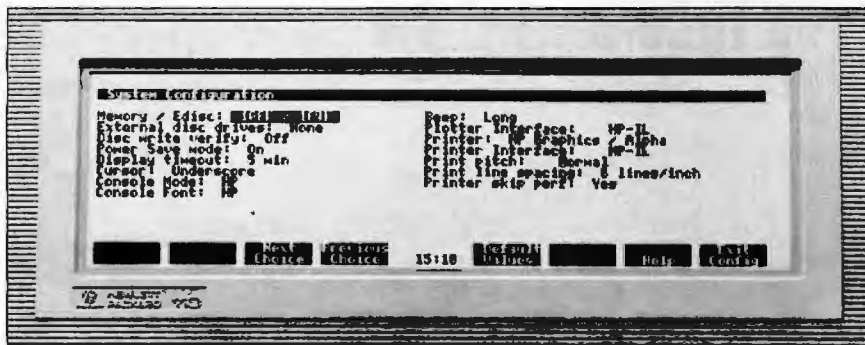

Photo 4: The system configuration menu. Using the function keys, it's possible to toggle among a full range of choices for each topic.

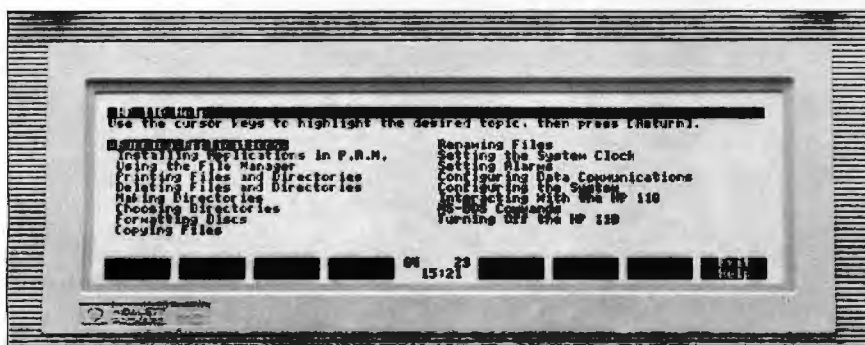

Photo 5: Each of the HP 110 Help categories is supported with a full screen of information.

(even the Lotus Help screens) exists in electronic memory, movement, recalculation, and graphics are all blindingly fast; in fact, the slowest part of the system is the LCD. Unless you're dealing with an extremely large spreadsheet and very complex formulas, chances are you'll wait longer for a screen update than for number crunching.

The Terminal program can be used for data transfer for all three of the HP 110's output interfaces, RS-232C, auto-dial/auto-answer modem, and HPIL.

The DOS Commands option lets you dispense with PAM entirely and operate the 110 as you would any standard MS-DOS machine.

You can, of course, load other soft-

ware into the electronic disk—within reason (a large program that needs full system RAM would be impossible). The HP 110 is essentially a "generic" MS-DOS computer; any programs that use only operating-system calls, rather than direct calls to the system ROM BIOS (basic input/output system), and can be configured to use the 110's smaller screen size should run acceptably. Also, any programs that are written for other Hewlett-Packard MS-DOS computers (significantly, the HP 150), that can be configured for the screen, and that use only HP escape sequences should be okay. Thus, the 110 isn't fully compatible with any other machine; it bears a family resemblance to the 150, but it's not an identical twin. Many programs that run on the 150 should run on the 110, but there are no guarantees.

Hewlett-Packard claims to have done more market research on this product than on any other HP device before it; much of that study went into determining the software bundle. The company apparently believes that the current package will best suit the needs of today's portable computer user.

Although the ROM chips that will be distributed in the product will be permanent (unerasable), the ROMs used during prototype production and testing were EPROM (erasable programmable ROM) chips, and the company candidly admits that it is working with potential high-volume customers to help those firms develop customized software packages for their employees. There is no talk at present of optional software configurations for single users, but Hewlett-Packard representatives will not rule out the possibility. It stands to reason that a skilled hardware/software hacker or entrepreneur could implement alternative firmware for the HP 110.

SYSTEM PERIPHERALS

The 110's HPIL interface enables you to connect the computer to two battery-powered peripherals specifically designed to be part of a component system: the Thinkjet printer (see the April BYTE West Coast, page 82) and the new HP 9114 portable disk drive. Both units weigh about 6 pounds, have the same exterior dimensions, and operate for about eight hours of continuous use

(text continued on page 416)

The Toughest Statistical Problems Now Have A Simple Solution.

ABstat.

Introduce yourself to ABstat.

It's the simplest solution to your statistical problems. And for several very good reasons, it may very well be the best statistical data analysis system on the market.

First, ABstat is comprehensive.

Whether your task is simple or complex, ABstat completes it quickly and efficiently. With powerful routines analyzing and manipulating your data. For starters, descriptive statistics for selected variables. Chi-square, analysis of variance, correlations, cross-tabulations, multiple regressions, and tests of hypothesis. Just to name a few.

ABstat is also very simple to use. And it's fast.

With ABstat, you don't need to enter a lot of commands to perform a function. And that means easier data manipulation, and more control. Plus, you've got a built-in editor that will simplify your data input. Or you can read data directly from your ASCII or dBase II files.

What's more, you don't need previous computer experience. ABstat is command driven. And even if you get stuck on a procedure, all you have to do is enter a "?" for immediate help.

ABstat is very much at home on the IBM PC. As well as many other makes of microcomputers. All you need is a CP/M, CP/M-86, MS-DOS, or PC-DOS operating system. And a reasonable \$395.

Right now, ABstat is solving problems in manufacturing, marketing, medical research, mining, petroleum, pharmaceuticals, and transportation. In major corporations from Xerox to Quaker Oats and British Petroleum. And in hundreds of small businesses, too.

One last bit of information. If you call 1-800-255-5550, ext 310, you'll get a free ABstat brochure and the name of your nearest ABstat dealer. Or write us at P.O. Box 191, Canon City, CO 81212, (303) 275-1661.

AndersonBell
TURNING INFORMATION INTO INSIGHT

Circle 29 on inquiry card.

dBASE II is a trademark of Ashton-Tate. IBM PC and PC-DOS are trademarks of International Business Machines Corp. CP/M and CP/M-86 are trademarks of Digital Research Corp. MS-DOS is a trademark of Microsoft Corp.

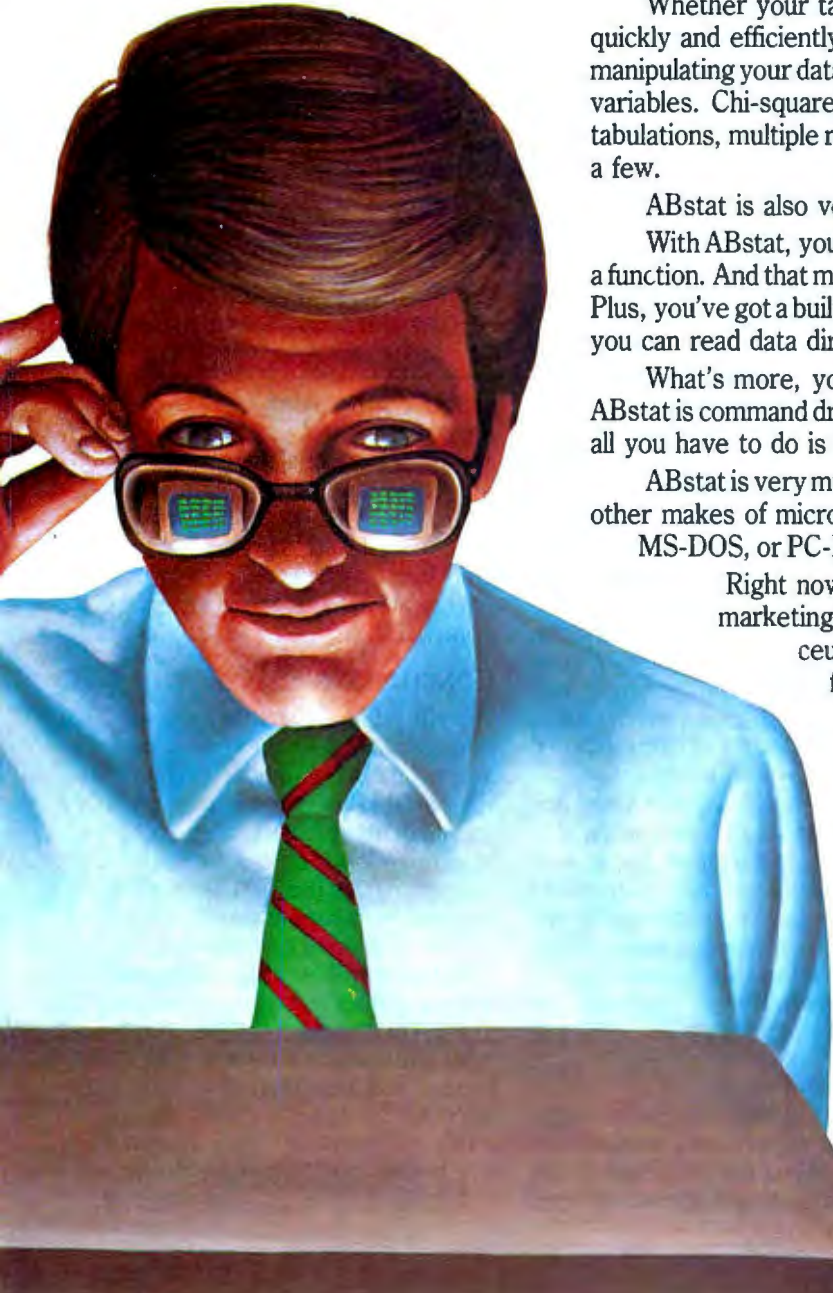

IBM PC & COMPATIBLES

INTERNAL 10 MB HARD DISK

W/ WESTERN DIGITAL Controller
 No change in BIOS, Boot from hard disk, Simple to install like a floppy, DOS 2.0. 1 Year factory warranty, tested & formatted, several installed. Complete kit \$895
 Additional 10 MB hard disk \$600;
 Fixed + Removable HD (10MB) - \$CALL
 Hard disk + Tape backup - \$CALL

FLOPPY DISK DRIVES PC EXPANSIONS:

AST, Maynard, 64K chips &
 JUKI Printer - \$CALL

SRI DATA SYSTEMS

9 E Pleasant Ave. Maywood, NJ 07607
 (201) 684-4518 Visa, MC, Check, COD

T & A SYSTEMS

MODEMS	LIST	COST
U.S. Robotics Passwork 300/1200 Autodial/Auto Answer	\$449	\$350
Nisus R212AI (300/1200 10 no. Autodial/Auto Log on)	\$499	\$399
Paullit (300/1200)	\$525	\$399
Hayes 1200 Smart Modem	\$699	\$510
Mac 224 (2400/1200/300 Selectable, 18 month warranty)	\$1195	\$890
General Data Comm 4800 (800 works multipoint)	\$1575	\$1395
Universal Data Systems 9600 A/B (9600 Dial-up)	\$2650	CALL \$

CRTS	LIST	COST
Liberty Electronics Freedom 100 (30 Function Keys, Full Editing)	\$495	CALL \$
Felicitas 3000 (7410 Matrix, Status Line)	\$599	\$495
Visual 50 (Green Phosphor screen)	\$695	\$595
TeleVideo 950	\$1195	CALL \$
Leas Ziegler ADM 11	\$695	CALL \$
Kimlion (New Product, Fully DEC Compatible)	\$795	CALL \$

PRINTERS	LIST	COST
Panasonic 1091 (120 CPS Dot Matrix, 3 Print Modes)	\$599	CALL \$
Teletex 1014 (20 CPS Daisy Wheel Serial & Parallel Ports)	\$649	\$457
Siemens P188 (Silent 150 CPS InkJet)	\$900	CALL \$
TeleVideo 740 (45 CPS Daisy Wheel)	\$1595	CALL \$

SWITCHES	LIST	COST
Giltronics (24 Wire A/B Switch)	\$159	CALL \$
Ida R/B Switch 24 Pin	\$130	CALL \$

HARD DISK	LIST	COST
Mountain (10 MEG for Apple, Franklin IBM)	\$2495	CALL \$

MONITOR	LIST	COST
Panasonic TR120 (High Resolution 1100 Lines)	\$220	\$150

P.O. Box 692 Wheeling, IL 60090
800-323-2666

*We stock a complete product line of above manufacturers.

Circle 404 on Inquiry card.

300 BAUD	MODEMS	1200 BAUD
SIGNALMAN.....Free 'SOURCE'		
300 BAUD direct connect \$ 69		
300 BAUD AUTO DIAL/ANS \$ 99		
300/1200 AUTO DIAL/ANS \$299		
US ROBOTICS . . . 300/1200 AUTO Hayes Compatible'		
'Password' with cables, spkr \$339		
'Auto 212' dbe.....\$399		
DOT MATRIX	PRINTERS	LETTER QUALITY
GEMINI 10x 120 cps graphics \$289		
PROWRITER 120 cps hi density \$359		
JUKI daisy wheel 18 cps \$565		
DAISYWRITER 40 cps \$999		

CPM	COMPUTERS	IBM
Eagle	\$CALL	Columbia P.C.
Kaypro	HARD DISKS	Corona P.C.
Televideo	PORTABLES	Eagle P.C.

IMAGE COMPUTERS

P.O. Box 1164, Cardiff, CA 92007

CALL TO ORDER:
 (619) 436-7669
 (619) 942-7373



VISA/MC
 ADD 3%

Circle 405 on Inquiry card.

THE HP 110

(6a)

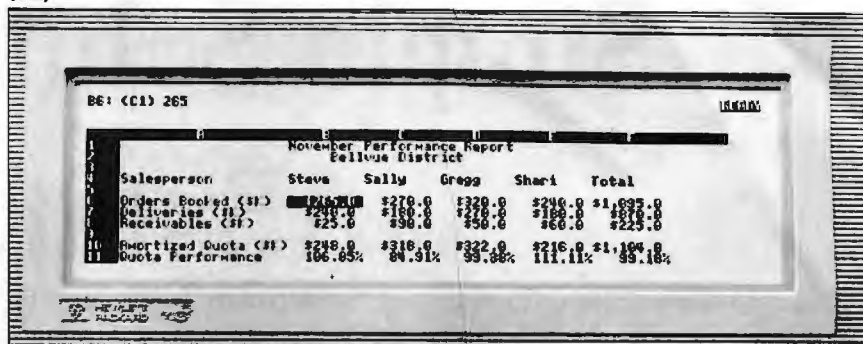

(6b)

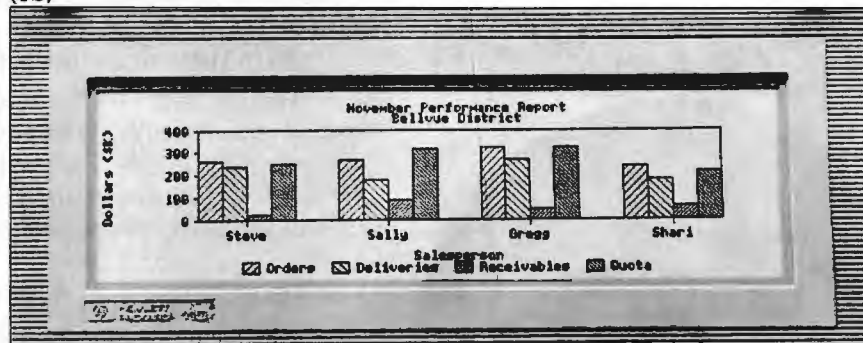

Photo 6: Lotus 1-2-3 on the HP 110 (6a). All Lotus features are fully implemented, including 1-2-3's Help system. 6b shows the bit-mapped graphics chart produced from the table in 6a.

(text continued from page 414)

without recharging. The Thinkjet is a high-speed dot-matrix ink-jet printer that handles 8½- by 11-inch single sheets or the equivalent tractor-feed fanfold paper; the 9114 uses one 3½-inch Sony microfloppy-disk drive that stores 710K bytes per disk. It's possible to set up the two peripherals and the 110 on a picnic table and run a full computer system without a single wall socket. Hewlett-Packard even sells a vinyl carrying case for all three units that fits under an airline coach seat.

HP is marketing (along with a card that drops into an IBM-PC expansion slot) software on a 5¼-inch PC format disk that enables the 110 to use the IBM's disk drives for mass storage. If the microcomputer industry has surrendered the Fortune 1000 personal computer market to IBM, as many analysts think, Hewlett-Packard is attempting to gain control of the Fortune 1000 portable computer market.

The HPIL can be connected to a wide variety of Hewlett-Packard interface converters, enabling the 110 to talk to the large range of HP peripherals (plotters,

controllers, hard-disk drives, etc.) and devices designed to link to other HP computers. To make things even easier, the 110's Terminal program includes emulation of the HP 2621 terminal. The 110 can be linked to up to eight peripheral drives or devices; one 110 could conceivably use eight others as temporary disk drives.

CONCLUSIONS

The HP 110 is a fast little computer, as functional as most desktop units, with a large line of peripherals available. But the portable computer market is mushrooming; new products are multiplying at a tremendous rate. What might very well distinguish the 110 from the rest of the pack is its simple approach to solving the problems of portability.

Software in ROM and disk emulation in RAM are not new ideas. As employed in the 110, though, they free you from both the constant fussing with mass storage and the waiting time associated with disk access.

Can a computer user accept that much freedom? The Hewlett-Packard 110 makes that a good question. ■

CAD SOFTWARE FOR ARCHITECTS

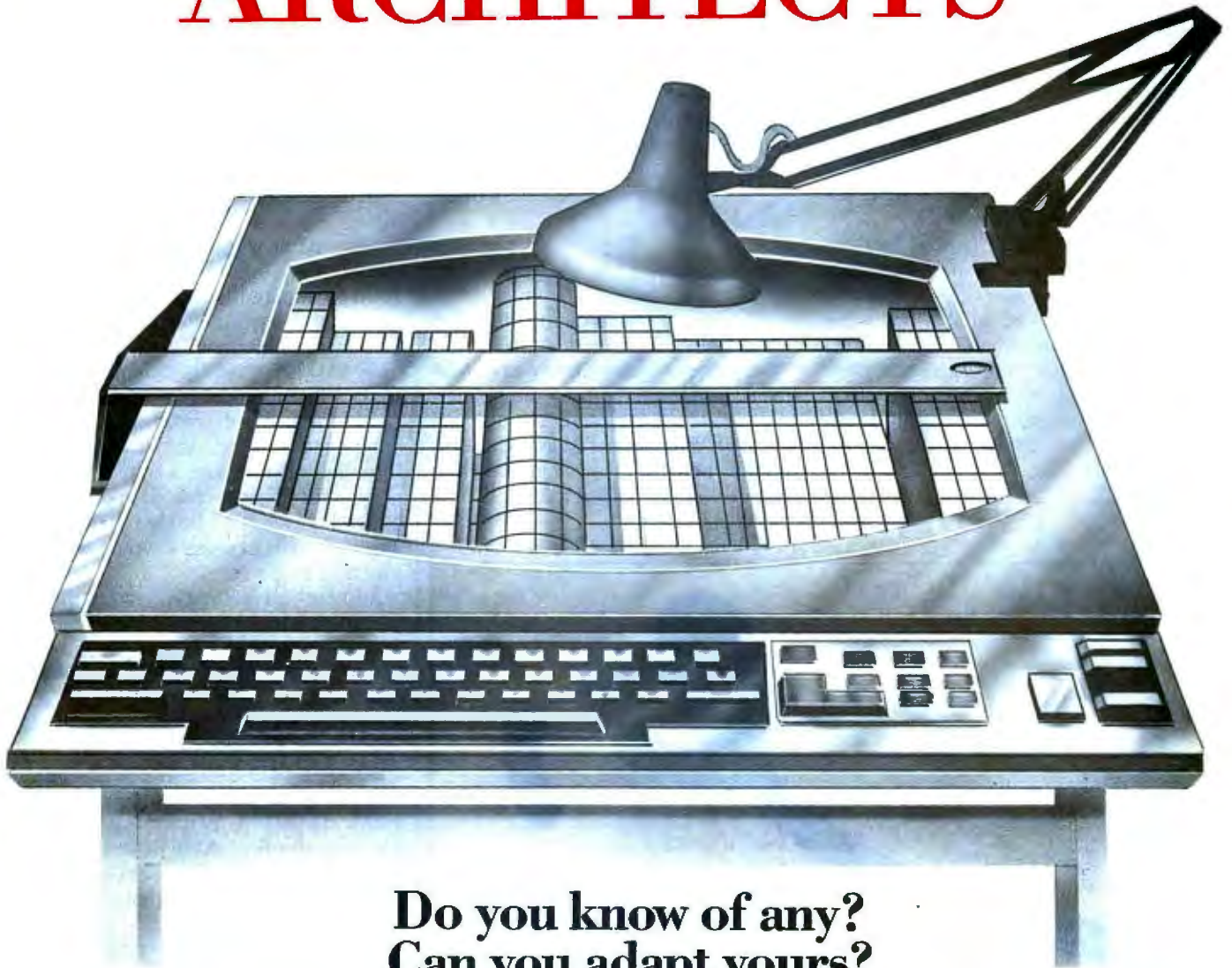

Do you know of any? Can you adapt yours?

Architectural Record, the largest and most influential business-to-business publication in the architectural field, regularly updates its architect and engineer readers on working with computers through features, columns, departments, even special issues.

Many of our readers already know about and use computers for estimating construction costs and time, business management, drafting and storing drawings.

But what they *really* want to know about is *design*.

And that means any Computer-Aided Design systems that

- are free and flexible enough to allow for true creativity;
- have database structures broad enough to accept a huge variety of seemingly unrelated facts;
- integrate graphic and non-graphic data;
- display perspective and axonometric projections;
- have wide-ranging color capabilities;
- are compatible with project management software;
- don't require a great deal of training.

In others words, *Architectural Record* readers are very interested in CAD software that was designed specifically for architects, to increase quality and control of design.

What do *you* have to sell architects—or just tell them about? Send complete details to: James B. Gardner, *Architectural Record*, 1221 Avenue of the Americas, New York, NY 10020. Or, tell us whom to contact for information by returning the postage-paid card.

ARCHITECTURAL RECORD



The kernel of a typical TIL system is relatively small (8K is not unusual).

(text continued from page 129)

2DUP cycles = NEXT + RUN + COLON
 + NEXT + RUN + DUP
 + RETURN + NEXT +
 RUN + DUP + RETURN
 + NEXT + RUN + SEMI
 = 358 + DUP + DUP
 (pointer-threaded)

Although 2DUP could obviously be more efficiently defined as a primitive, the point here is that each secondary call requires a minimum of 358 clock cycles beyond that required by the actual machine code for the operation. The DUP instruction takes 32 cycles in

8088 code, so that the 2DUP secondary word takes about five times as long to execute as the equivalent assembly code. This ratio is probably typical for secondary words.

By contrast, subroutine-threaded code is conceptually simple and efficient. The only overhead required for a primitive consists of a CALL instruction and a RET instruction. The CALL instruction replaces the NEXT and RUN routines of the pointer-threaded inner interpreter. The number of processor cycles required to execute a subroutine-threaded primitive is:

primitive cycles = CALL + body + RET
 = 43 + body
 (subroutine-threaded)

This overhead is only slightly more than half of that required using the pointer-threaded technique. Moreover, a simple primitive that ordinarily would be extremely inefficient may be invoked as a

macro. Doing so would eliminate the execution overhead entirely.

For secondary words there are similar savings. For example, the 2DUP word considered above would require three CALL/RET pairs for execution:

2DUP cycles = 129 + DUP + DUP
 (subroutine-threaded)

The overhead here is only about twice the machine code, rather than five times, as before. Furthermore, for time-critical applications, or if sufficient memory is available, the DUP operations could be selected to be macros as mentioned earlier, reducing the overhead to a quite respectable 43 cycles. Note that doing this effectively changes 2DUP to a primitive, even though it was defined by the user. Thus, in macro/subroutine-threaded code, true primitives can be created within the high-level language; this is not possible with pointer-threaded or pure subroutine-threaded code. These user-created primitives could themselves be treated as macros, although in most cases it would not be practical to do so.

Another advantage of subroutine threading is that it uses fewer dedicated processor registers. As you can see in listing 1, the pointer-threaded language discussed by Loeliger requires four registers beyond the program counter (PC) and stack pointer (SP) for efficient operation. Subroutine-threaded code, on the other hand, needs only one other dedicated register (e.g., SI) to serve as the data stack pointer.

Macro/subroutine-threaded code is clearly more efficient than pointer-threaded code from the point of view of execution speed and use of processor resources. However, it does use more memory. The primitives in each form of threading use about the same amount of memory, but the secondary words of subroutine-threaded code without macros are about 50 percent larger than the equivalent secondary words of pointer-threaded code because one byte is required for each CALL instruction. The additional memory requirement for subroutine-threaded code may not be a significant problem for three reasons:

- 1) The kernel of a typical TIL system
 (text continued on page 420)



BASIC Discovers Shorthand.

Programming in BASIC just got smarter, easier, faster . . . and five great reviews. Before you write another program in BASIC, you might be wise to start with a little reading.

Five major computer publications have something good to tell you. About the BASIC Development System (BDS). And about making your programming in BASIC more efficient than you ever dreamed.

BDS is a powerful, integrated set of software tools that quickly gets you beyond the BASIC basics. It gives you everything from Cross-Referencing to Scrolling Keys that let you scroll by page or line. It gives you Compress and Uncompress commands, Variable Dump, Single Step Trace and more.

BDS also gives you something else. A 30-day money back guarantee.

Finally, BDS gives you great references. From reviewers who've lived with it and loved it. For example: "I wonder how I ever got along without it." John M. Worum, PC Magazine, September 1983.

We'll send you the reviews just for writing us. Or, for only \$79, we'll send you BDS itself. And a 30-day money back guarantee.

BETA TOOL SYSTEMS
BTS

8972 E Hampden Ave • Suite 179
 Denver, Colorado 80231 • (303) 793-0145

BDS is available for IBM PC and COMPAQ computers. VISA/MC accepted. Please add \$3 for shipping.

DIRECT SOFTWARE

DISCOUNT DIGEST

TO ORDER CALL (415) 459-1282 • TOLL FREE (800) 533-3012 CA (800) 533-3011 USA

Direct Software™ Discount Prices Save \$\$ and Make Sense to Smart Buyers Who Know What They Want!!

DIRECT SOFTWARE™ is committed to being Number One in service and reliability, at low, low prices. Our satisfied customers include America's largest corporations, educational institutions, the U.S. government and thousands of individuals all around the world. Call on our courteous sales staff to find what we can do for you! We can beat any legitimate price advertised in this magazine, and still give you full technical support and personalized service, with same-day shipment on most orders.

	List	Sale
ALPHA SOFTWARE		
Apple-IBM Connection	250	159
Data Base Manager II	295	179
Typeface	125	79
ANDERSON—BELL		
ABSTAT	395	265
ASHTON-TATE		
dBASE II	700	379
Friday	295	185
ASPEN SOFTWARE		
Grammatik	75	56
Proof Reader	50	38
A.T.I.		
Training WordStar	75	55
Training dBASE II	75	55
Training Multiplan	75	55
BRUCE and JAMES		
Wordvision	80	69
CDEX		
MYB-Lotus 1-2-3	70	55
MYB-Visicalc	70	55
DIGITAL MARKETING		
Milestone	295	249
Datebook II	295	179
Footnote	99	84
Bibliography	99	84
Notebook	150	98
MICROLINK II	89	60

ACCOUNTING

I.U.S.

	List	Sale
General Ledger	595	309
Accounts Receivable	595	309
Accounts Payable	595	309
Inventory Control Analysis	595	309
Order Entry	595	309
Payroll	745	369

PEACHTREE

General Ledger	750	425
Accounts Receivable	750	425
Accounts Payable	750	425

CALL FOR OTHER ACCOUNTING PACKAGES

FOX & GELLER

Quickcode	295	169
dGraph	295	169
dUtil	99	58

CONDOR

Condor 3	650	299
----------	-----	-----

GAMMA PRODUCTION, INC.

Taxwizard 83 (IBM)	50	50
Taxwizard 83 (CP/M)	50	40

HUMANSOFT

DBPlus	125	84
--------	-----	----

IUS

Easy Filer	400	220
Easy Planner	250	164
Easy System II (writer, mailer, speller)	395	239

LEXISOFT

Spellbinder	495	239
-------------	-----	-----

LIFETREE

Volkswriter	195	109
Volkswriter Deluxe	245	179

LIVING VIDEO TEXT INC.

Think Tank (IBM)	195	165
Think Tank (Apple)	150	119

LOTUS

1-2-3	495	315
-------	-----	-----

MDBM

Knowledgeman	500	329
--------------	-----	-----

SPECIALS

	List	Sale
DBASE II + Quickcode	995	525
DBASE II + dUtil	799	429
DBASE II + DGraph	999	539
DBASE II + ABSTAT	1095	635
DBASE II + DBASE Window 949		529
DABSE II + WordStar	1195	619

WORDSTAR \$245 | dBase II \$379

SuperCalc 3 \$239 | LOTUS \$315

RBASE: 4000 \$319

METASOFT

Benchmark Word Processor	350	249
Benchmark Mail List	250	139

MICROPRO

WordStar	495	245
Professional Pak	845	365
InfoStar	495	248
InfoStar - CP/M Card	695	329
WordStar - CP/M Card	695	329
MailMerge	250	126
SpellStar	250	125
CalcStar	145	88
WordStar/Option	295	219

MICRORIM

R Base 4000	495	319
-------------	-----	-----

MICROSOFT

	List	Sale
Multiplan	250	159
BASIC Interpreter	350	249
Flight Simulator	50	38
Word/Mouse	475	319

MICROSTUFF

Crosstalk	195	109
-----------	-----	-----

OASIS

The Word Plus	150	105
Punctuation & Style	150	95

PEACHTREE SOFTWARE

Peachpak 4	395	275
Peachtext 5000	395	219

PERFECT SOFTWARE

Perfect Writer	349	218
Perfect Speller	129	98
Perfect Filer	249	175
Perfect Writer/Speller	399	298

PETER NORTON

Norton Utilities	80	58
------------------	----	----

SELECT Information Systems

Select Word Processor	295	199
SelectWrite	99	79

SOFTWARE SYSTEMS

Multimate	495	295
-----------	-----	-----

SORCIM

SuperCalc1	195	129
SuperCalc2	295	154
SuperCalc3	395	239

SSI

Word Perfect	495	315
--------------	-----	-----

TYLOG

dBase Window	249	155
dBase Door	149	94

VISICORP

VisiOn Graph	250	199
Visicalc IV	250	159
Visicalc Advanced (Apple)	400	249

WOOLF SYSTEMS

Move It	150	95
---------	-----	----

CALL FOR PRODUCTS NOT LISTED!

- Purchase orders accepted
 - Prompt UPS service
 - Dealer and institutional discounts
 - Quantity discounts available
 - Call for charges and return policy:
 - No credit card surcharge!
- Prices may change; No Refunds
ALL SALES FINAL

Call today for our free catalog

TO ORDER CALL

(415) 459-1282

TOLL FREE

(800) 533-3012 CA (800) 533-3011 USA

850 College Ave., Suite #3
Kentfield, CA 94904

LIBERTY GROUP, Inc.

4221 N. Winfield Scott Plaza • Scottsdale Arizona 85251

From **TOPAZ**

BACKUP Power for your Computer

**STANDBY
POWER**

Protects Against Blackouts

•Noise Transients•

•Brownouts•Sudden Voltage Dips

NEW!!

PANASONIC

NEW!!

DOT-MATRIX PRINTER

ASK About This MULTI-MODE PRINTER!!

PRICE QUOTES & ORDERING

(602) 949-8218 • • • 1 (800) 328-8905

2% SHIPPING TAX FOR PRE-PAID

3% SHIPPING TAX FOR C.O.D.'s

15% RE-STOCKING CHARGE

AMERICAN EXPRESS Welcome

C. ITOH SILVER-REED TAXAN DIABLO NEC EPSON

TELEVIDEO ADDS DEC TRANSTAR MICOM DATASOUTH

ALDOS PRINTEK HAYES NOVATION DAISYWRITER

OSBORNE GTC STAR AMDEK EAGLE MANY OTHERS

FASTER FORTH

(text continued from page 418)

is relatively small (8K is not unusual for compiler/interpreter, editor, and assembler).

2) Many newer microcomputers can address much more memory than previously possible.

3) Memory is significantly less expensive now than it was when FORTH was first introduced.

However, if macro capability is included in the subroutine-threaded language, things can quickly get out of hand. Unless you are careful to define as macros only relatively short or infrequently used words, the repetition of machine code as new words are defined can expand the program memory considerably. For this reason a good rule of thumb might be to avoid treating user-defined words as macros.

(text continued on page 422)

A new concept in sitting.



THE BACK CHAIR

1 CONVENTIONAL CHAIR - As shown above sitting in a conventional chair forces your lower back forward, creating excess stress on your spine & back muscles.

2 BACK CHAIR - The Back Chair allows you to sit comfortably with your spine & back muscles in perfect alignment.

THE FIRST INTELLIGENT CHAIR - reduces the effect of gravity on your back. Sitting regularly in a conventional chair your lower back is supporting the *total weight* of your body, plus additional weight due to the downward effect of gravity. No wonder millions of people complain about backaches every year! Unfortunately most chairs are designed for appearance not for the health of your back.

THE BACK CHAIR SOLUTION - Sitting on the Back Chair relieves your back from supporting the total weight of your body by distributing the weight between your lower back and legs. Your legs support you when standing, your lower back supports you when sitting, combine them both in a comfortable sitting posture and you relieve



the unnecessary stress on your back. When sitting on the Back Chair you'll feel more relaxed, sit up perfectly straight and with the pressure off your back - breathe deeper. Made of multiple layers of hardwood with a final layer of oak and camel seat.

ONLY \$89⁹⁵



----- MAIL COUPON WITH ORDER -----
1 - 805 - 966 - 7187

Or send a check or your credit card # (Diner's Club, VISA, MasterCard, American Express) for THE BACK CHAIR @ \$89.95 ea. plus \$5.95 shipping (Canada/Alaska add \$50.00 shipping). **SAVE \$20.00** - Order two BACK CHAIRS @ \$79.95 plus \$5.95 shipping ea. CA res. add 6% tax. Sorry no C.O.D. If not satisfied return within 15 days for a prompt refund (less shipping).

ITEM NO.	QUAN.	ITEM	PRICE EA.	SHIPPING	TOTAL
B25		BACK CHAIR	\$89.95		

STARSHINE OF SANTA BARBARA
8168 State Street, Dept. BC138, Santa Barbara, CA 93101

Listing 1: A translation of Loeliger's generic inner interpreter into 8088 assembly-language code.

:Assignment of Loeliger's generic registers to 8088 registers

```
: I  -> DI  Instruction register
: WA -> BP  Word address register
: CA -> CX  Code address register
: RS -> SI  Return stack pointer
: SP -> SP  Data stack pointer
: PC -> PC  Processor program counter
```

: Loeliger's inner interpreter translated to 8088 code

COLON: ; 39 processor cycles

```
DEC SI
DEC SI
MOV [SI],DI
MOV DI,BP
JMP NEXT
```

SEMI: ; 21 processor cycles

```
DW OFFSET SEMI+2
MOV DI,[SI]
INC SI
INC SI
```

NEXT: ; 21 processor cycles

```
MOV BP,[DI]
INC DI
INC DI
```

RUN: ; 46 processor cycles

```
MOV CX,DS:[BP]
INC BP
INC BP
CALL CX
```

RETURN: ; 15 processor cycles

```
JMP NEXT
```

THE 8087 IS IN STOCK!

Micro Ware is the world's leading retailer of 8087s. We also have the most accurate statistics on chip reliability. They are: .01% infant mortality, .00% adult mortality and .02% 8088 incompatibility. As for ease of installation, we have never had a customer return a chip because of bent pins. We are so confident that you will be able to successfully install and use the chip that we offer a 180-day warranty with every chip we sell. That's 90 days more than anyone else!

To support the 8087 we stock the largest selection of 8087 software anywhere. This includes: three FORTRANs, three PASCALs, APL, Intel's ASM86, PL/M-86, several Cs, 87BASIC, 87MACRO and MATRIXPAK. For real time or multi-user applications we offer RTOS™ - our implementation of Intel's iRMX executive. Our new products include a professional debugger with 8087 support, an interface library which enables MS Fortran users to call the IBM Basic

Compiler Library, and a translator that converts object modules into readable assembly language files. If you have a question about which computer, language, compiler, operating system or application package is best suited to your problem, we can answer it. Just call:
Information and Orders—
617-746-7341
University, Corporate and Government Buyers—
617-746-7364

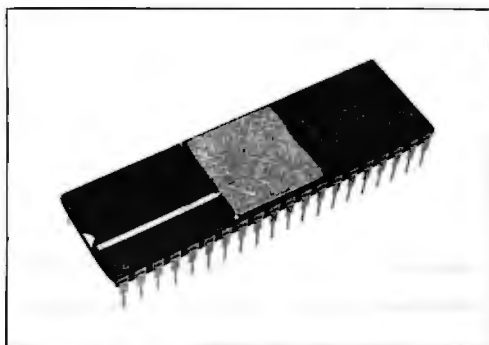

8087 Support from **Micro Ware**

87FORTRAN/RTOS™ - our adaptation of the Intel Fortran-86 Compiler generates in line 8087 code using all 8087 data types including 80-bit reals and 64-bit integers. The compiler uses the Intel large memory model, allowing code/data structures of a full megabyte, and supports overlays. Includes RTOS and support for one year **\$1350**

87PASCAL/RTOS™ is Intel's ISO-Standard Pascal with 8087-8088 exceptions. These make it possible to use all the 8087 data types directly, while generating modules in one of the three Intel Memory Models. Includes RTOS and support for one year **\$1350**

RTOS DEVELOPMENT PACKAGE includes 87FORTRAN, 87PASCAL, PL/M-86, Utilities, TXScreen Editor and RTOS... **\$2500**

RTOS— REAL TIME MULTI-TASKING/ MULTI-USER EXECUTIVE

RTOS is a Micro Ware configured version of iRMX-86. Includes ASM-86, LINK-86, LOC-86, LIB-86, and the ROM Hex Loader **\$600**

MWS-286™ Configured to your specifications, our computer runs RTOS-286 or XENIX. Includes one Intel compiler, seven slot multibus chassis, hard disk, streaming tape backup and Intel Service Contract. Six to twenty times faster than your PC **CALL**

Micro Ware not only provides quality products but also the support to make them work. Our users receive newsletters, free software updates, and have access to a hotline for 8087 related advice. Micro Ware is your complete clearing house for 8087 related products. We sell the chips, compilers and applications programs you need at affordable prices. Call for our complete catalogue.

PC TECH JOURNAL REVIEW:
 "The Micro Ware package is preferable ... it executes the basic operations more rapidly and Micro Ware provides a free update service."

87BASIC™ includes patches to the IBM Basic Compiler and both runtime libraries for USER TRANSPARENT and COMPLETE 8087 support. Provides super fast performance for all numeric operations including trigonometrics, transcendental, addition, subtraction, multiplication, and division **\$150**

87MACRO™ - our complete 8087 software development package. It contains a "Pre-processor," source code for a set of 8087 macros, and an object library of numeric functions including transcendental, trigonometric, hyperbolic, encoding, decoding and conversions **\$150**

87DEBUG™ - a professional debugger with 8087 support, a sophisticated screen-oriented macro command processor, and trace features which include the ability to skip tracing through branches to calls and software and hardware interrupts. Breakpoints can be set in code or on guarded addresses in RAM **\$150**

FOR→BAS™ - a library of interface routines which allow MS Fortran programs to call the IBM Basic Compiler library and access features such as the RANDOM NUMBER GENERATOR, SOUND, PLAY, DRAW and SCREEN commands **\$150**

OBJ→ASM™ - a multipass object module translator and disassembler. Produces assembly language listings which include public symbols, external symbols, and labels commented with cross references. Ideal for understanding and patching object modules and libraries for which source is not available **\$200**

8087-3 CHIP \$175
 - with 180-day warranty and 8088 exchange.

64K RAM Upgrade..... \$50

87/88GUIDE - an excellent tutorial on writing 8087 code and interfacing it with compilers. Full of code that runs! **\$30**

MATRIXPAK™ manages a **MEGABYTE!** Written in assembly language, our runtime package accurately manipulates large matrices at very fast speeds. Includes matrix inversion and the solution of simultaneous linear equations. Callable from MS Fortran 3.2, 87MACRO, 87BASIC, and RTOS..... each **\$150**

MICROSOFT FORTRAN 3.2 or PASCAL 3.2 - These IEEE compatible compilers support double precision and the 8087 each **\$259**

MICROSOFT C COMPILER includes Lattice C and the MS Librarian **\$350**

XENIX CALL

FLOAT87 for MS or LATTICE C **\$125**

SuperSoft Fortran 66 **299**

Computer Innovations C86 **345**

STSC APL★PLUS/PC **545**

TURBO PASCAL **45**

HALO GRAPHICS **CALL**

GRAPHMATIC **125**

ENERGRAPHICS **295**

Professional BASIC **295**

Kidger Optical Design Program **3000**

COSMOS REVELATION **850**

dBASE II **CALL**

MAYNARD WS1 HARD DISK **995**

MAYNARD WS2 HARD DISK **1170**

256K RAM CHIPS **CALL**

SuperCalc III with 8087 Support **CALL**

87BASIC+ **75**

DRAFT-AIDE **595**

MAYNARD Electronics Boards **CALL**

Micro Ware
 P.O. Box 79
 Kingston, MA
 02364
 (617) 746-7341

**You Can
 Talk To Us!**

IBM PC is a registered trademark of IBM Corp. 8087, iRMX-86, LINK-86, FORTRAN-86, ASM-86, LOC-86, PL/M-86 and LIB-86 are trademarks of Intel Corp. 87FORTRAN/RTOS, 87PASCAL/RTOS, 87BASIC, 87MACRO, FASTPAK, MATRIXPAK, 87/88GUIDE, RTOS and 87BASIC+ are trademarks of Micro Ware, Inc.

(text continued from page 420)

Nevertheless, being able to selectively use macros is such a great advantage that it is probably worth choosing subroutine threading over pointer threading. Add to this the speed advantage and conceptual simplicity of hardware CALL/RET over the software inner interpreter, and a fairly strong case can be made for the choice of subroutine threading.

COMMENTS ON THE DATA STACK

Aside from the overhead of threading, the major limitation to program efficiency is the use of an in-memory stack. Consider, for example, the simple task of taking two numbers from memory, adding them together, and storing the result in memory. For simplicity, I assume that the two numbers and their sum are each 2 bytes long and previously have been given names in a data segment. The 8086/8088 assembly code might be:

```
MOV AX, NUM1    ;LOAD THE 1ST
                ;NUMBER
ADD AX, NUM2    ;ADD THE 2ND
                ;NUMBER TO
                ;THE 1ST
MOV SUM,AX      ;PUT RESULT
                ;INTO
                ;MEMORY
```

This requires 53 cycles to execute on an 8088 processor.

Now consider doing the same thing with the intermediate use of the data stack. In FORTH the operation would be:

```
NUM1 @ NUM2 @ + SUM !
```

To illustrate the process in assembly language I'll use the mnemonics PUSH and POP to indicate pushing to or popping from the data stack. For pointer-threaded code these will be the same as the 8086/8088 PUSH and POP instructions. Listing 2 gives the translation of PUSH and POP for subroutine-threaded code. Using the stack for intermediate storage, an assembly-code translation of the above FORTH phrase might resemble listing 3.

This may be an extreme case, but it does illustrate the inefficiency of using the data stack in FORTH when data is frequently pushed to the stack and im-

mediately pulled from it to perform an operation. Excluding overhead, 224 machine cycles are necessary for the 8088 processor, primarily because of the many memory references. If the efficiency of a stack-oriented TIL such as

FORTH is to be further improved, it is imperative to speed up the stack operations or eliminate some of them entirely through the use of an optimizing incremental compiler. The latter alter-

(text continued on page 424)

Listing 2: PUSH and POP instructions in 8088 assembly-language subroutine-threaded code. The SI register acts as the data stack pointer.

```
:PUSH register to data stack

DEC SI
DEC SI
MOV [SI],register

:POP top of data stack to register

MOV register,[SI]
INC SI
INC SI
```

Listing 3: Assembly language program using PUSH and POP mnemonics, illustrating use of the stack.

```
MOV BX,OFFSET NUM1    ; Forth word NUM1
                      ; GET ADDRESS OF 1ST NUMBER
PUSH BX              ; PUSH ADDRESS TO STACK

POP BX               ; Forth word @
                      ; GET ADDRESS FROM STACK
PUSH [BX]           ; PUSH 1ST NUMBER TO STACK

MOV BX,OFFSET NUM2    ; Forth word NUM2
                      ; GET ADDRESS OF 2ND NUMBER
PUSH BX              ; PUSH ADDRESS TO STACK

POP BX               ; Forth word @
                      ; GET ADDRESS FROM STACK
PUSH [BX]           ; PUSH 2ND NUMBER TO STACK

POP AX               ; Forth word +
                      ; GET NUM2 FROM STACK
POP BX               ; GET NUM1 FROM STACK
ADD AX,BX            ; ADD NUM1 AND NUM2
PUSH AX              ; PUSH RESULT TO STACK

MOV BX,OFFSET SUM     ; Forth word SUM
                      ; GET ADDRESS TO STORE RESULT
PUSH BX              ; PUSH ADDRESS TO STACK

POP BX               ; Forth word !
                      ; GET ADDRESS OF SUM FROM STACK
POP AX               ; GET NUM1 + NUM2 FROM STACK
MOV [BX],AX          ; STORE RESULT
```

Listing 4: Modified PUSH and POP instructions. The data stack is now made up of the SI, BP, CX, and ES registers.

```
: PUSH register to data stack

MOV ES,CX
MOV CX,BP
MOV BP,SI
MOV SI,register

: POP top of data stack to register

MOV register,SI
MOV SI,BP
MOV BP,CX
MOV CX,ES
```

New.

Sentinel Color Diskettes.



Introducing a practical new time-saving approach to help you organize data storage. Classify information by diskette color: for example, receivables in *green*, payables in *red*, inventory in *blue*, purchasing in *orange*, and so on...

Each Sentinel Color Diskette has a lifetime guarantee; 100% certified at levels which meet or exceed all criteria necessary for accurate, error-free read/write operations.

Phone toll-free for the name of the dealer nearest you:
1-800-323-5005 (in Massachusetts 1-800-323-5001).

Sentinel

TECHNOLOGIES

One Sentinel Plaza, Hyannis, MA 02601.

Circle 296 on inquiry card

Subroutine threading can reduce execution overhead and at the same time use fewer processor registers than pointer threading of code. It can also be adapted to any microprocessor.

(text continued from page 422)

native is beyond the scope of this article.

One way to increase the speed of stack operations is to use some of the 8086/8088 registers for the data stack. For example, the registers I have used in my own TIL are SI, BP, CX, and ES. Excluding the program counter and stack pointer, this leaves four general-purpose registers and three segment registers for coding the primitives of the language. These are sufficient for all but a very few primitive operations. If one or more of the dedicated registers is required for a particular operation, their contents can be temporarily saved on the return stack and recovered before the return to the calling routine. The code for the four-register PUSH and POP mnemonics mentioned above is given in listing 4. Using the dedicated registers, pushing data from one of the general-purpose registers to the data stack requires only 8 machine cycles, compared to 22 cycles for the subroutine-threaded PUSH instruction of listing 2. The comparison for a POP instruction is very similar.

A four-element data stack is sufficiently large to handle all standard FORTH single-precision primitives as well as the binary double-precision operations. With careful planning it is also large enough for virtually any high-level TIL program. If necessary, the four-register stack can be supplemented by defining two new primitives, << and >>. The << word pushes the two lowest elements of the data stack to the return stack for temporary storage. The >> word reverses this by pulling two 16-bit numbers from the return stack and storing them in the two lowest registers of the data stack. The only caution for using them is that << must be followed by >> before the end of a loop

or end of the definition. This prevents other uses for the return stack, such as holding do-loop indexes, from being adversely affected. If a still faster stack is desired, and double-precision operations are not required, a three-register stack could be used, along with the << and >> words.

There are two additional advantages of using a register-based, three- or four-element data stack. First, it discourages the poor programming practice of stringing a lot of words together that push numbers to the stack, followed by a string of operators that act on those numbers. It is much easier to follow the flow of FORTH code in which only a few numbers are on the stack at any given time. The other benefit is that programming errors that overflow the stack do not halt processing, which sometimes occurs with stacks that are not limited in extent.

EVALUATION AND CONCLUSIONS

In order to evaluate the utility of the ideas discussed above, I modified the FORTH version of the Sieve of Eratosthenes program (see reference 2). In the modified program, the data stack contains no more than three numbers at any one time. This program was then run on a version of FORTH that uses macro/subroutine threading and a three-element data stack. Most of the primitives of the language used in the program were defined as macros. The program requires 21 seconds to execute 10 loops, compared to about 55 seconds for PC/FORTH and FORTH Level II (see text box). So far as I am aware, these two execute the FORTH Sieve program on the IBM PC faster than any other commercial versions. The improvement in execution speed by a factor of 2.5 results in a language that compares favorably with most of the C compilers

presently available for the IBM PC (see reference 4). Other benchmark programs produce similar relative comparisons.

It is obvious that the two techniques that I have suggested for improving the execution speed of a TIL are successful. Subroutine threading is probably the more important of the two. It can reduce execution overhead and at the same time use fewer processor registers than pointer threading of code. It can also be adapted to any microprocessor. Programmers interested in designing their own TIL will likely find these techniques easy to work with since the program flow is controlled by hardware subroutine calls rather than an additional layer of software. Moreover, since the implementation is transparent to the user, FORTH can be written to use it without any required change to the language. Finally, a simple extension lets the user choose macro substitution for more rapid execution.

The other suggestion, using three or four registers for the stack, should also be seriously considered. Since it requires some modification of the standard, it may not be suitable for FORTH. It may, however, prove useful to programmers who want to construct their own TIL for a 16-bit, multiregister microcomputer. ■

REFERENCES

1. Brodie, Leo. *Starting FORTH*. Englewood Cliffs, NJ: Prentice-Hall, 1981.
2. Gilbreath, Jim, and Gary Gilbreath. "Eratosthenes Revisited: Once More through the Sieve." *BYTE*, January 1983, page 283.
3. Loeliger, R. G. *Threaded Interpretive Languages*. Peterborough, NH: BYTE Books, 1981.
4. Phraner, Ralph A. "Nine C Compilers for the IBM PC." *BYTE*, August 1983, page 134.
5. Ritter, Terry, and Gregory Walker. "Varieties of Threaded Code for Language Implementation." *BYTE*, September 1980, page 206.
6. Scanlon, Leo J. *IBM PC Assembly Language Programming*. Bowie, MD: Robert J. Brady Co., 1983.

FORTH Level II is available from *The Software Works*, 1032 Elwell Court, Suite 210, Palo Alto, CA 94303.

PC/FORTH is available from *Laboratory Microsystems Inc.*, POB 10430, Marina del Rey, CA 90295.

THE BEST THING NEXT TO AN IBM PC IS A SPINWRITER.



Put a Spinwriter® next to your IBM® PC, or XT, and get the best letter-quality printing available anywhere. Spinwriter is totally IBM plug-compatible and works with every piece of IBM PC software. It also works with all popular third party applications packages.

Depending on your needs, you can choose between our popular 350 wpm model 3550, or our new 200 wpm model 2050.

Both give you world famous Spinwriter printing quality and reliability. And both were made for the IBM. That's why 55% of the letter-quality printers used with IBM PC's are Spinwriters.*

Spinwriter gives you over 60 different type styles. Each with up to 128 characters.

*PC WORLD Magazine, July 1983

Spinwriter is a registered trademark of NEC Corp. IBM is a registered trademark of International Business Machines Corp.

And there's a forms handling option for every paper and forms handling need. Which means no matter what form your business takes, Spinwriter can handle it.

So, if you want to get the most out of your IBM, get a Spinwriter. For more information, just call 1-800-343-4419; in Massachusetts call (617) 264-8635.

Also available at: Entré, 1-800-HI ENTRE, Computerland stores (in California) 1-800-321-1101; (outside California) 1-800-423-3008, Sears 1-800-228-2200 and IBM Product Centers.

Find out why most IBM PC users are saying, "NEC and me."

Yes! I want only the best for my IBM PC.

Please send me more information on:

spinwriter 3550 spinwriter 2050

Name _____ Title _____

Company _____

Address _____

City _____

State _____

Zip _____

NEC Information Systems, Inc.
1414 Massachusetts Avenue
Boxborough, MA 01719

NEC AND ME



COMPUTER MAIL ORDER



HOME COMPUTERS



- 1010 Recorder.....\$74.00
- 1020 Color Printer.....\$249.00
- 1025 Dot Matrix Printer.....\$349.00
- 1027 Letter Quality Printer.....\$309.00
- 1030 Direct Connect Modem.....\$119.00
- 1050 Disk Drive.....\$399.00
- CX30 Paddle.....\$12.00
- CX40 Joystick.....each.....\$8.00
- CX77 Touch Tablet.....\$64.00
- CX80 Trak Ball.....\$48.00
- CX85 Keypad.....\$105.00
- 488 Communicator II.....\$229.00
- 4003 Assembler Editor.....\$47.00
- 4011 Star Raiders.....\$33.00
- 4012 Missile Command.....\$29.00
- 4013 Asteroids.....\$29.00
- 5049 VisiCalc.....\$159.00
- 7079 Logo.....\$79.00

- 800XL.....\$189
- 800XL.....\$299
- 1200XL.....CALL
- 1400XL.....CALL

- 7101 Entertainer.....\$69.00
- 7102 Arcade Champ.....\$75.00
- 8026 Dig Dug.....\$33.00
- 8030 E.T. Phone Home.....\$33.00
- 8031 Donkey Kong.....\$39.00
- 8033 Robotron.....\$35.00
- 8034 Pole Position.....\$39.00
- 8036 Atari Writer.....\$79.00
- 8040 Donkey Kong, Jr.....\$39.00
- 8043 Ms. Pacman.....\$39.00
- 8044 Joust.....\$39.00

ALIEN VOICE BOX

- Atari.....\$119.00
- Apple.....\$149.00

PRINTERS

- ### AXIOM
- AT-100 Atan Interface Printer.....\$239.00
 - GP-100 Parallel Interface.....\$199.00
 - AT-846 Interface for Atari.....\$89.00

- ### BMC
- 401 Letter Quality.....\$589.00
 - BX-80 Doc Matrix.....\$269.00

- ### CENTRONICS
- 122 Parallel.....\$289.00
 - 738-1 Parallel.....\$199.00
 - 738-3 Serial.....\$249.00

- ### C.ITOH
- Gonite Benans.....\$209.00
 - Prowriter 8510P.....\$379.00
 - Prowriter 1550P.....\$599.00
 - A10 (18 cps).....\$589.00
 - 8600 P.....\$929.00
 - F10-40.....\$999.00
 - F10-55.....\$1349.00

- ### COMREX
- ComWriter II Letter Quality.....\$499.00

- ### DIABLO
- 620 Letter Quality.....\$949.00
 - 630 Letter Quality.....\$1749.00

- ### DAISYWRITER
- 2000.....\$949.00
 - Tractor Feed.....\$109.00

- ### EPSON
- FX-80, FX-80FT, FX-100.....CALL
 - FX-80, FX-100.....CALL
 - LQ 1500.....CALL

- ### IDS
- Prism 80...For Configuration.....CALL
 - Prism 32...For Configuration.....CALL

- ### JUKI
- 8100.....\$499.00

- ### MANNESMAN TALLY
- 180L.....\$388.00
 - 180L.....\$199.00
 - Spark 80.....\$309.00

- ### NEC
- 8023 Doc Matrix.....\$379.00
 - 8025 Doc Matrix.....\$689.00
 - 2010/15/30.....\$749.00
 - 3510/15/30.....\$1389.00
 - 7710/15/30.....\$1789.00

- ### OKIDATA
- ### OLYMPIA
- 82, 83, 84, 92, 93, 2350, 2410.....CALL
 - Compact 2.....\$479.00
 - Compact 80.....\$509.00
 - ESW 3000.....\$1449.00

- ### SMITH CORONA
- TP-1000.....\$399.00
 - Tractor Feed.....\$119.00

- ### SILVER REED
- 500 Letter Quality.....\$449.00
 - 550 Letter Quality.....\$589.00
 - 770 Letter Quality.....\$899.00

- ### STAR
- Gemin 10X.....\$299.00
 - Gemin 15X.....\$399.00
 - Delta 10.....\$449.00
 - Serial Board.....\$75.00
 - Radix 10.....\$599.00
 - Radix 15.....\$899.00

- ### TOSHIBA
- 1340.....\$889.00
 - 1351.....\$1899.00

- ### TRANSTAR
- 120P.....\$499.00
 - 130P.....\$699.00
 - 315 Color.....\$499.00

MEMORY BOARDS

- Axon 32K.....\$59.00
- Axon 48K.....\$99.00
- Axon 128K.....\$299.00
- Intec 32K.....\$59.00
- Intec 48K.....\$85.00
- Intec 64K.....\$99.00
- Intec Real Time Clock.....\$29.00

DISK DRIVES FOR ATARI

- | | |
|--------------------------|-----------------------|
| PERCOM | INDUS |
| AT 88-S1.....\$369.00 | GT Drive.....\$379.00 |
| AT 88-A1.....\$259.00 | |
| AT 88-S1 PD.....\$449.00 | RANA |
| RFD 40-S1.....\$369.00 | 1000.....\$329.00 |
| RFD 40-S2.....\$699.00 | TRAK |
| RFD 44-S1.....\$539.00 | AT-D2.....\$389.00 |

MODEMS

- | | |
|--|--------------------------------|
| ANCHOR | NOVATION |
| Volkmodem.....\$59.00 | J-Cat.....\$99.99 |
| Mark II.....\$79.00 | Cat.....\$139.00 |
| Mark VII (Auto Ang/Auto Dial).....\$119.00 | Smart Cat 103.....\$179.00 |
| Mark XII (1200 Baud).....\$299.00 | Smart Cat 103/212.....\$399.00 |
| TRS-80 Color Computer.....\$99.00 | AutoCat.....\$219.00 |
| 9 Volt Power Supply.....\$9.00 | 212 AutoCat.....\$549.00 |

- ### HAYES
- Smartmodem 300.....\$209.00
 - Smartmodem 1200.....\$499.00
 - Smartmodem 1200S.....\$449.00
 - Micromodem II.....\$269.00
 - Micromodem 100.....\$299.00
 - Smart Com II.....\$99.00
 - Chronograph.....\$199.00
- ### ZENITH
- ZT1.....\$339.00
 - ZT10.....\$309.00
 - ZT11.....\$369.00

DISKETTES

- | | |
|-----------------------------|--------------------------|
| MAXELL | ELEPHANT |
| 5 1/4" MD-1.....\$24.99 | 5 1/4" SS/SD.....\$18.99 |
| 5 1/4" MD-2.....\$34.99 | 5 1/4" SS/OD.....\$21.99 |
| 6" FD-1 (SS/OD).....\$39.00 | 5 1/4" FD/OD.....\$26.99 |
| 6" FD-2 (DS/OD).....\$49.00 | |
- ### VERBATIM
- 5 1/4" SS/OD.....\$26.99
 - 5 1/4" DS/OD.....\$36.99
- ### BIB
- 5 1/4" Disk Head Cleaner.....\$14.99

- ### DISK HOLDERS
- ### INNOVATIVE CONCEPTS
- Rip-n-File 10.....\$3.99
 - Rip-n-File 50.....\$17.99
 - Rip-n-File (400/800 ROM) Holder.....\$17.99

CONTROLLERS & JOYSTICKS

- | | |
|--------------------------------|--------------------------------|
| WICO | KRAFT |
| Joystick.....\$21.99 | Joystick.....\$41.99 |
| 3-way Joystick.....\$22.99 | Atan Single Fire.....\$12.99 |
| Power Grip.....\$21.99 | Atan Switch Hitler.....\$15.99 |
| BOSS Joystick.....\$17.99 | Apple Paddles.....\$34.99 |
| ATARI/VC Trak Ball.....\$34.99 | IBM Paddles.....\$34.99 |
| Apple Trak Ball.....\$4.99 | IBM Joystick.....\$48.99 |
| Apple Analog.....\$37.99 | |
- ### KOALA PADS
- Atan [ROM].....\$79.00
 - C-64 [ROM].....\$79.00
 - IBM.....\$99.00
 - Apple/Franklin.....\$85.00

MONITORS

- | | |
|-------------------------------|------------------------------------|
| AMDEK | PRINCETON GRAPHICS |
| 300 Green.....\$149.00 | HX-12 RGB.....\$529.00 |
| 300 Amber.....\$159.00 | |
| 310 Amber.....\$189.00 | SAKATA |
| Color 1.....\$279.00 | 100.....\$269.00 |
| Color 1 Plus.....\$299.00 | TAXAN |
| Color 2 Plus.....\$349.00 | 210 Color RGB.....\$299.00 |
| Color 3.....\$749.00 | 400 Med-Res RGB.....\$319.00 |
| | 415 Hi-Res RGB.....\$439.00 |
| BMC | 420 Hi-Res RGB (IBM).....\$489.00 |
| 12" Green.....\$89.99 | 100 12" Green.....\$125.00 |
| 12" Green Hi-Res.....\$119.99 | 105 12" Amber.....\$135.00 |
| 918-113" Color.....\$249.00 | |
| | USI |
| GORILLA | P 1, 9" Green.....\$89.99 |
| 12" Green.....\$89.99 | P 2, 12" Green.....\$119.99 |
| 12" Amber.....\$95.99 | P 3, 12" Amber.....\$149.99 |
| | P 4, 8" Amber.....\$139.99 |
| NEC | 1400 Color.....\$269.99 |
| JB 1260 Green.....\$109.00 | QUADRAM |
| JB 1201 Green.....\$149.99 | Quadchrome 8400 Color.....\$529.00 |
| JB 1205 Amber.....\$159.99 | ZENITH |
| JB 1215 Color.....\$259.00 | ZVM 122 Amber.....\$109.00 |
| JC 1216 RGB.....\$429.00 | ZVM 123 Green.....\$89.99 |
| JC 1460 Color.....\$359.00 | ZVM 135 Color RGB.....\$459.99 |

east
800-233-8950
 In PA call (717)327-9575, Dept. 100
 Order Status Number: 327-9576
 Customer Service Number: 327-1450
 477 E. 3rd St., Williamsport, PA 17701

canada
 Ontario/Quebec
800-268-3974
 Other Provinces 800-268-4559
 In Toronto call (416)328-0866, Dept. 100
 Order Status Number: 828-0866
 2505 Dunwin Drive, Unit 3B
 Mississauga, Ontario, Canada L5L1T1

west
800-648-3311
 In NV call (702)588-5654, Dept. 100
 Order Status Number: 588-5654
 P.O. Box 6689
 Stateline, NV 89449

No risk, no deposit on C.O.D. orders and no waiting period for certified checks or money orders. Add 3% (minimum \$5) shipping and handling on all orders. Large shipments may require additional charges. NV and PA residents add sales tax. All items subject to availability and price change. Call today for our catalog. CANADIAN ORDERS: All prices are subject to shipping, tax and currency fluctuations. Call for exact pricing in Canada.



COMPUTER MAIL ORDER

APPLE/FRANKLIN DISK DRIVES



ACE 1000 Color Computer.....CALL
ACE Family Pack System.....CALL
ACE PRO PLUS System.....CALL
ACE 1200 Office Mgmt. System.CALL
"NOT the EXPENSIVE"

MICRO-SCI	
A2.....	\$219.00
A40.....	\$289.00
A70.....	\$319.00
C2 Controller.....	\$79.00
C47 Controller.....	\$89.00
RANA	
Elite 1.....	\$279.00
Elite 2.....	\$389.00
Elite 3.....	\$499.00

APPLE IIe STARTER PACK
64K Apple IIe, Disk Drive & Controller,
80 Column Card, Monitor II & DOS 3.3
COMPLETE.....CALL

MBC 550.....CALL	
MBC 555.....CALL	
MBC 1100.....	\$1499.00
FDD 3200-320K Drive.....	\$389.00
MBC 1150.....	\$1899.00
MBC 1200.....	\$1849.00
FDD 6400-640K Drive.....	\$469.00
MBC 1250.....	\$2099.00
PR 5500 Printer.....	\$599.00

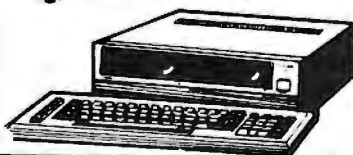

NEC	
PC-8201	
\$489	

NEC	
PC-8221A Thermal Printer.....	\$149.99
PC-8281A Data Recorder.....	\$99.00
PC-8201-08 8K RAM Chips.....	\$105.00
PC-8206A 32K RAM Cartridge.....	\$329.00

SHARP	
PC-1500A.....\$165**	
PC-1250A.....\$88**	

CE-125 Printer/Cassette.....	\$128.99
CE-150 Color Printer/Cassette.....	\$171.99
CE-155 8K RAM.....	\$33.99
CE-161 16K RAM.....	\$134.99
CE-500 ROM Library.....	\$29.99

HP 10C.....	\$51.99
HP 11C.....	\$69.99
HP 12C.....	\$89.99
HP 15C.....	\$89.99
HP 16C.....	\$89.99
HP 75C.....	\$749.99
HPA Module.....	\$98.99
HPD Cassette or Printer.....	\$359.99
Card Reader.....	\$143.99
Extended Function Module.....	\$63.99
Time Module.....	\$83.99



HP 71B	
41CV.....	\$449**
41CX.....	\$209**
41CX.....	\$248**

commodore	
CBM 8086.....	\$869.00
CBM 8000.....	\$999.00
8128-80.....	\$769.00
8032 to 9000 Upgrade.....	\$269.00
2031 LP Disk Drive.....	\$299.00
8050 Disk Drive.....	\$449.00
8250 Disk Drive.....	\$199.00
4023 Printer.....	\$379.00
8023 Printer.....	\$569.00
6400 Printer.....	\$1399.00
Z-RAM.....	\$499.00
Silicon Office.....	\$699.00
The Manager.....	\$199.00
SoftPROM.....	\$125.00
VisiCalc.....	\$159.00

SX-64	
Portable	
CBM 8032.....	\$589
CBM 84.....	\$189
C1541 Disk Drive.....	\$249.00
C1530 Datasette.....	\$69.00
C1520 Color Printer/Plotter.....	\$129.00
M-801 Doc Matrix Printer.....	\$219.00
C1526 Doc Matrix/Sens.....	\$299.00
C1702 Color Monitor.....	\$249.00
C1311 Joystick.....	\$4.99
C1312 Paddles.....	\$11.99
C1600 VIC Modem.....	\$59.00
C1650 Auto Modem.....	\$89.00
Logo 64.....	\$49.00
Riox 64.....	\$39.00
Word Pro 64 Plus.....	\$59.00
Parallel Printer Interface.....	\$49.00
Calc Result 64.....	\$65.00
Calc Result Easy.....	\$39.00
Codewriter 64.....	\$75.00
Quick Brown Fox.....	\$49.00
MCS 801 Color Printer.....	\$489.00
DPS 1101 Daisy Printer.....	\$459.00
Magic Voice Speech Module.....	\$54.00
Desk Organizer Lock.....	\$49.00
Vidtex Telecommunications.....	\$34.95

PROFESSIONAL SOFTWARE	
Word Pro 2 Plus.....	\$159.00
Word Pro 3 Plus.....	\$189.00
Word Pro 4 Plus/5 Plus.....each.	\$279.00
InfoPro.....	\$178.00
Administrator.....	\$399.00
Power.....	\$78.00
MSD	
SD1 Disk Drive.....	\$349.00
SD2 Disk Drive.....	\$599.00

IBM



NEC PRINTERS	
NEC 2050.....	\$899.00
NEC 3550.....	\$1639.00

PERCOM/TANDON DISK DRIVES	
5 1/4" 320K Floppy.....	\$229.00
5 Meg Hard w/Controller.....	\$1049.00
10 Meg Hard w/Controller.....	\$1349.00
15 Meg Hard w/Controller.....	\$1599.00
20 Meg Hard w/Controller.....	\$1899.00

AMDEK	
310A Amber Monitor.....	\$169.00
Color 2.....	\$419.00
Color 4.....	\$749.00

AST RESEARCH	
Six Pak Plus.....	from \$279.00
Combo Plus II.....	from \$279.00
Mega Plus.....	from \$309.00
I/O Plus.....	from \$139.00

QUADRAM	
Quadink.....	\$479.00
Quadboard.....	as low as \$289.00
Quad 512 Plus.....	as low as \$249.00
Quadcolor.....	as low as \$219.00
Chronograph.....	\$89.00
Parallel Interface Board.....	\$89.00
64K RAM Chips Kit.....	\$59.00

CONTINENTAL SOFTWARE	
1st Class Mail/Form Letter.....	\$79.00
Home Accountant Plus.....	\$88.00

MICROPRO	
WordStar Professional Pack.....	\$389.00
InfoStar.....	\$299.00
SpellStar.....	\$159.00
CalcStar.....	\$99.00

MICROSTUF	
Crossstalk.....	\$105.00

MICROSOFT	
MultPlan.....	\$159.00

ASHTON-TATE	
dBASE II.....	\$389.00
Friday.....	\$185.00

IUS	
EasyWriter II.....	\$249.00
EasySpeller.....	\$119.00
EasyFiler.....	\$229.00

LOTUS	
Symphony.....	CALL
1-2-3.....	\$329.00

PROFESSIONAL SOFTWARE	
PC Plus/The Boss.....	\$299.00

SYNAPSE	
File Manager.....	\$99.00

SOFTWARE

	C-64	Atari	IBM	Apple
Electronic Arts				
Axis Assassin	\$17**	\$17**	N/A	\$17**
M.U.L.E.	\$29**	\$29**	N/A	N/A
Pinball Construction	\$29**	\$29**	N/A	\$29**
Cut & Paste	\$39**	\$39**	N/A	\$39**
Hard Hat Mack	\$29**	\$29**	N/A	\$29**
InfoCom				
Witness	\$32**	\$32**	N/A	\$32**
Infidel	\$32**	\$32**	\$32**	\$32**
Starcross	N/A	\$29**	\$29**	\$29**
Planetfall	\$32**	\$32**	\$32**	\$32**
Enchanter	\$32**	\$32**	\$32**	\$32**
Zork	N/A	\$29**	\$29**	\$29**
AtariSoft				
Dig Dug	\$37**	N/A	\$29**	\$29**
Defender	\$37**	N/A	\$29**	\$29**
Robotron 2084	\$29**	N/A	\$29**	\$29**
PacMan	\$37**	N/A	\$29**	\$29**
Donkey Kong	\$37**	N/A	\$29**	\$29**
Spinnaker				
Story Machine	\$24**	\$24**	\$29**	\$29**
Cosmic Life	\$24**	\$24**	N/A	N/A
Up for Grabs	\$29**	\$29**	N/A	N/A
Kindercomp	\$21**	\$21**	\$24**	\$21**
Snooper Troops	\$29**	\$29**	N/A	\$29**
Delta Drawing	\$29**	\$29**	\$39**	\$39**
Kids on Keys	\$29**	\$29**	N/A	N/A
Hey Diddle Diddle	\$21**	\$21**	\$21**	\$21**
Facemaker	\$24**	\$24**	\$24**	\$24**
Rhymes & Riddles	N/A	\$21**	\$24**	\$24**
Dynatech				
Code Writer	\$79**	\$79**	\$175**	\$155**
VisiCorp				
VisiCalc	\$159**	\$159**	\$159**	\$159**
VisiCalc Advanced	N/A	N/A	\$169**	\$169**
VisiText/Plot	N/A	N/A	\$199**	\$199**
VisiFile	N/A	N/A	\$199**	\$199**
VisiSchedule	N/A	N/A	\$199**	\$199**
Desktop Plan	N/A	N/A	\$199**	\$169**
Business Forecast Model	N/A	N/A	\$75**	\$75**
StretchCalc	N/A	N/A	\$75**	\$75**
VisiTutor Calc	N/A	N/A	\$59**	\$59**
VisiTutor Advanced	N/A	N/A	\$75**	\$75**
VisiTutor Word	N/A	N/A	\$59**	\$59**
p/s:				
Write	N/A	N/A	\$89**	\$79**
Graph	N/A	N/A	\$89**	\$79**
Report	N/A	N/A	\$79**	\$79**
File	N/A	N/A	\$89**	\$79**
Solutions* as low as	N/A	N/A	\$16**	\$16**
*Call on Titles				

east
800-233-8950
In PA call (717)327-9575, Dept. 100
Order Status Number: 327-9576
Customer Service Number: 327-1450
477 E. 3rd St., Williamsport, PA 17701

canada
Ontario/Quebec
800-268-3974
Other Provinces 800-268-4558
In Toronto call (416)828-0868, Dept. 100
Order Status Number: 828-0866
2505 Dunwin Drive, Unit 3B
Mississauga, Ontario, Canada L5L1T1

west
800-648-3311
In NV call (702)588-5654, Dept. 100
Order Status Number: 588-5654
P.O. Box 6688
Stateline, NV 89449

INTERNATIONAL ORDERS: All shipments outside the Continental United States must be pre-paid by certified check only. Include 3% (minimum \$5) shipping and handling.
EDUCATIONAL DISCOUNTS: Additional discounts are available to qualified Educational Institutions.
APO & FPO: Add 3% (minimum \$5) shipping and handling.

Circle 78 on inquiry card.



Single Board Computer



**6 MHz
Z80**

Fast, Powerful and Compact Microcomputers

- 4 or 6 MHz Z80* CPU
- 2K to 64K ROM or EPROM
- Expandable RAM from 64K to 256K
- DMA for Floppy and Hard Disk Data Transfers
- 2/4 RS-232 Serial Ports
- Centronics Parallel Port
- 50 Pin Expansion Bus for Additional I/O Capability
- CP/M Operating System and Networking Available
- Custom Systems and Private Label Packaging Available



1951 Colony Street, Suite X
Mountain View, CA 94043
(415) 964-9497

*Z80 is a registered trademark of Zilog

U S C Proudly introduces Our New "PROFESSIONAL COMPUTER CHASSIS/ POWER SUPPLY" for IBM PC/XT & Compatibles

Designed to enable easy, straight-forward conversion of IBM PC/XT & compatibles board-level products into complete microcomputer-based systems meeting specific performance and installation requirements.



Features:

- More than just another pretty face
- Sturdy to withstand the rigors of use in the intended environment.
- Good RF attenuation to eliminate interference with adjacent electronic equipment.
- High efficient switching power supply, with all DC cables-plug right in.
- Built in fan, 2 additional AC sockets plus card racks with plastic guides.
- Assembled & Tested

\$199

- Professional PC-Chassis (85W) \$199.00
- Professional XT-Chassis (130W) \$259.00

Dealers & OEM inquiries invited.

U S Components

1055 Sunnyvale - Saratoga Rd.
Sunnyvale, CA 94086
TEL (408) 730-1399

Midwest Distributor:
Macrotron Systems Inc.
8147 Delmar Blvd.
St. Louis, MO 63130
(314) 721-3356

Terms: Prepaid check or money order, Mastercard or Visa.
Shipping Charges: U.S. FREE, Canada \$2.00, COD \$5.00 (No COD's to Canada)

ADA PRIMER

(text continued from page 134)

```
new_line;
end hello;
```

This version of the `hello` program should display the same result as before: `Hello, world!`

VARIABLES, ASSIGNMENT, AND OUTPUT

Variables in Ada may have long names (as long as a line) but must fit on a single line. All variables must be declared explicitly in the declaration part of a program or in a package. Look at the following example.

```
- var1.ada
- Introduce variables
with text_io; use text_io;
procedure variable is
- for integer io
package integer_io is
  new text_io.integer_io(integer);
use integer_io;
- declaration for integer variable
- named age
age : integer; -- declaration for integer variable named age
begin
  age := 40;
  put ("This year Sam is ");
  put (age,2);
  put (" years old. ");
  new_line;
end variable;
```

This program demonstrates several of Ada's features. First we tell the program we want to input and output integers. We do this by creating a new package, `integer_io`, based on the original `integer_io` package, a collection of subprograms in the package `text_io`. This original package can input and output data of all the integer data types—yes, there can be more than one integer data type. A statement that creates a package for a specific data type from a general package definition is called a *generic package instantiation*. The `use` statement `use integer_io` states that we want to use the new package.

The third statement in the declaration part of the program (before the `begin`) declares an integer variable named `age`. You must use the full name of the data type, not its abbreviation. The name of the variable comes first, then a colon (`:`), and then its data type. Integer is one of the predefined data types available in Ada as defined in the package `standard`. Other predefined data types are Boolean, float, character, and string. Package `standard` is always available to a user even though it is not called for in a `with` or `use` statement.

In the executable part of the program, the first statement assigns the integer value 40 to the variable named `age`. The assignment statement in Ada uses the combination of a `:` (colon) and an `=` (equal sign) to represent an assignment operator (e.g., `age := 40`).

Two forms of the `put` statement follow the assignment statement. The first form outputs a character string. The other

(text continued on page 430)

REPORT ON NEW PERIPHERAL HARDWARE:

CHOOSING A SERIAL INTERFACE FOR YOUR APPLE* COMPUTER.

The "Second Serial Hardware Decision"...

Once you've selected the right serial printer or modem for your Apple* system, your hardware decisions are over for a while. Right?

Wrong, of course! You still have to decide on an interface card. This "second serial hardware decision" is an important one—one made much simpler

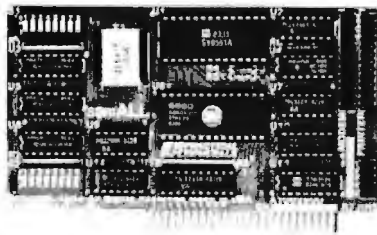

SERIALL Printer/Modem Interface by SERIALL™, the new serial interface for Apple computers.

At a significantly lower cost than Apple's own serial card—\$159.00 vs \$195.00—SERIALL gives you a bunch more features. Practical, everyday features, not useless extras.

For one, SERIALL is the only interface that provides graphics capabilities for serial printers including Apple's new dot matrix Imagewriter™.



Graphics capabilities for serial printers

SERIALL also offers 27 easy commands for text formatting and screen dumps, making it the most intelligent serial interface you can use with an Apple.

Equally important, SERIALL gives you complete communications interfacing capability. You can use it for modems or in the special terminal mode for timesharing and talking to other computers.

In fact, SERIALL completely emulates the Apple serial card as a communications interface.

No additional software or hardware modification is required.

Finally, consider the quality. SERIALL's five-year warranty is proof that this interface is built to work long and hard. No other serial card is backed by a guarantee like this.

After comparing SERIALL feature-for-feature with other serial interface products, we think you'll agree—SERIALL truly is the Do-It-All serial card for Apple computers.



Available from Practical Peripherals—makers of MICROBUFFER™, PROCLOCK™, PRINTERFACE™, and GRAPHICARD™.

*Apple and Imagewriter are registered trademarks of Apple Computers, Inc.

PRACTICAL PERIPHERALS

31245 La Baya Dr., Westlake Village, CA 91362 • (818) 991-8200 • TWX 910-336-5431

QUALITY PARTS AT DISCOUNT PRICES!

SUB-MINIATURE D TYPE CONNECTOR

SOLDER TYPE SUB-MINIATURE CONNECTORS USED FOR COMPUTER HOOD UPS.

DB 15 PLUG \$2.75
 DB 15 SOCKET \$4.00
 DB 15 HOOD \$1.50
 DB 25 PLUG \$2.75
 DB 25 SOCKET \$3.50
 DB 25 HOOD \$1.25

"PARALLEL" PRINTER CONNECTOR

SOLDER STYLE 36 PIN MALE USED ON "PARALLEL" DATA CABLES.

\$5.50 EACH

KEY ASSEMBLY

5 KEY
 \$1.00 EACH

CONTAINS 5 SINGLE-POLE NORMALLY OPEN SWITCHES MEASURES 3 1/4" LONG

6 KEY
 \$1.25 EACH

CONTAINS 6 SINGLE-POLE NORMALLY OPEN SWITCHES MEASURES 4 1/4" LONG

BCD DIP SWITCH

20 POSITION ROTARY SCREWDRIVER ADJUSTABLE 5/16" HOLE FITS 6 PIN DIP

\$1.85 EACH

SOLID STATE RELAYS

2 AMP
 MOTOROLA #MP 120D2 RATED

CONTROL - 1-5 BVDC
 LOAD - 120VAC 2 AMP
 TTL COMPATIBLE
 SIZE 1 1/2" x 1" x 1" HIGH

\$3.50 EACH 10 FOR \$32.00

120V INDICATOR

NEON INDICATOR RATED 120 V 1/3 W MOUNTS IN 5/16" HOLE RED LENS

75c EACH 10 FOR \$7.00
 100 FOR \$65.00

FREE! FREE! FREE! SEND FOR **NEW 1984 48 PAGE CATALOG**

MINIATURE TOGGLE SWITCHES
 ALL ARE RATED 5 AMPS @ 125 VAC

S.P.D.T. (on-on)
 P.C. STYLE, NON-THREADED BUSHING
 75c EACH 10 FOR \$7.00

S.P.D.T. (on-on)
 SOLDER LUG TERMINALS
 \$1.00 EACH 100 FOR \$9.00
 100 FOR \$80.00

S.P.D.T. (on-off-on)
 SOLDER LUG TERMINALS
 \$1.00 EACH 10 FOR \$9.00
 100 FOR \$80.00

S.P.D.T. (on-off-on)
 P.C. LUGS, THREADED BUSHING
 \$1.00 EACH 10 FOR \$9.00
 100 FOR \$80.00

D.P.D.T. (on-on)
 SOLDER LUG TERMINALS
 \$2.00 EACH 10 FOR \$19.00
 100 FOR \$180.00

EDGE CONNECTORS

22/44 22-44 GOLD PLATED CONTACTS
 156 CONTACT SPACING

\$2.00 EACH 10 FOR \$18.00

5 STATION INTERLOCKING

MADE BY ALPS
 3-2PDT AND 2-6PDT SWITCHES ON FULLY INTERLOCKING ASSEMBLY
 3/4" BETWEEN MOUNTING CENTERS.

\$2.50 EACH

5 STATION NON-INTERLOCKING

SAME AS ABOVE. EXCEPT EACH SWITCH OPERATES INDEPENDENTLY.

\$2.50 EACH

ALL ELECTRONICS CORP.

905 S. VERMONT • P.O. BOX 20406 • LOS ANGELES, CA 90008

TOLL FREE ORDERS • 1-800-826-5432

(IN CALIFORNIA: 1-800-258-6666)

AK, MI, OR INFORMATION • (213) 380-8000

QUANTITIES LIMITED
 MINIMUM ORDER \$10.00
 USA \$2.50 SHIPPING
 NO COD

FOREIGN ORDERS INCLUDE SUFFICIENT SHIPPING
 CALIF RES ADD 6 1/2%

ADA PRIMER

(text continued from page 428)

form, which has two parameters, outputs the value in age in two columns. The result of executing this program is:

This year Sam is 40 years old.

An Ada program rarely uses the plain integer data type for variables. In most cases, an integer subtype should be used instead to protect the program from erroneous data. When an integer data type is used, the variable can take on a wide range of values (e.g., -20,000,000 to +20,000,000). Such a large range is inappropriate for representing someone's age. A more typical range for this program might be 0 to 99. The following program shows how this is done.

```

- var2.ada
- Introduce variables and subtypes
with text_io; use text_io;
procedure variable is
- for integer_io
package integer_io is
    new text_io.integer_io(integer);
use integer_io;
subtype age_type is integer range 0..99;
- declaration for age_type variable
age : age_type;

```

begin

```

age := 40;
put ("This year Sam is ");
put (age,2);
put (" years old. ");
new_line;

```

end variable;

The statement that begins with the declaration subtype defines an integer data type that has a restricted range (or constraint) between 0 and 99. The two periods in a row (..) are used to represent a range, as in Pascal. Because the basic data type is still integer, integer_io can still be used to display the value of age, which could not be assigned to a negative value or to a value beyond 99.

LOOPING WITH while AND INCREMENTING

Here's a small looping program.

```

- while1.ada
- The while construct
with text_io; use text_io;
procedure while_loop is
- for integer_io
package integer_io is
    new text_io.integer_io(integer);
use integer_io;
subtype count_type is integer range 1..5;
count : count_type;

```

begin

```

count := 1;
while count <= 4 loop
    put (count * 10, 2);
- A
- B

```

(text continued on page 432)

5 Year Warranty

SPECIAL OFFER ON Verbatim Datalife Diskettes

Preserving your data is vitally important. Lose it and you've lost both time and money. That's why Verbatim Datalife Diskettes have 6 data-shielding improvements for greater disk durability and longer life. They come standard with the 5 year warranty that's 5 times longer than the industry standard—it guarantees trouble-free recording, storage, and retrieval. And to help introduce you to the Verbatim quality standard we're running a special on many of their products, including—
 Datalife and Verex Diskettes
 Cleaning Kits • Disk Drive Analyzers

PLUS! Specials on many other products in our full range discount catalog of computer supplies. Call, write, or utilize reader service to obtain your FREE catalog with special offer coupon enclosed.

LYBEN COMPUTER SYSTEMS
 1250-E Rankin Dr. • Troy, MI 48083 • Phone (313) 589-3440
Simply #1 in service and reliability.

**Datalife. The name is the promise.
 The warranty is the proof.**

THE SMALL BUSINESS MAINFRAME MuSYS NET/work 8816



Large Multi-user Capability

The NET/work 8816 is an 8/16 bit Multi-user, Multi-processor small business computer system that affords "**Mainframe Power at a Micro Price**". The major features of the system are:

- Expandable from 2 to 8 users, with **18 to 242 formatted Megabytes** of reliable high speed storage. Each user has their own computer with a minimum of 128K RAM and access to a common database of information.
- **Runs over 3,000 CP/M and MP/M software packages.** The NET/work 8816 operates under an enhanced version of the TurboDOS operating system, providing each user with **one of the industry's largest TPAs** (minimum 63 KB).
- You won't outgrow this system! **Room for growth** without costly changes. Networking via ETHERNET links up to 16

systems to accommodate 256 users with 3.8 GIGABYTES of high-speed online disk storage.

- **Easy to install**, boots from the hard disk with a Menu-driven System Configuration Program, **and even easier to use.**
- Plus, Cartridge or 9 Track Tape Back Up Subsystems are available.

Call toll free 1-800-852-5362 for literature (sent in 24 hours), inside California (714) 662-7387. Or write MuSYS Corporation, 1752-B Langley, Irvine, California 92714. TWX 910-595-1967. Cable MUSYSIRIN.

DEALER and OEM INQUIRIES WELCOME

NET/work is a trademark of MuSYS Corporation. TurboDOS is a trademark of Software 2000, Inc. CP/M is a trademark of Digital Research, Inc. Ethernet is a trademark of Xerox Corporation.

MUSYS
CORP
specialists in multi-user business systems

DISCOUNT PRICES COMPUTERS & EQUIPMENT

COMPUTERS

SANYO
FRANKLIN
ACE 1000 COMPUTER
ACE 1200 COMPUTER

EAGLE
COMPUTER

IBM COMPATIBLES
YOUR CHOICE

TRS-80
COMPUTERS

COLUMBIA
DATA PRODUCTS, INC.

EQUIPMENT

Hayes **Novation**

AMDEK

PLANTRONICS

Verbatim **AST**
RESEARCH INC.

PRINTERS

EPSON **C. Itoh** **star**

OKIDATA **TOSHIBA** **MANNESMANN**
TALIZY

Panasonic **daisywriter** **Transtar**

ORANGE MICRO
INC.

cardco, inc.

BOTEK

Since 1978

MicroManagement Systems, Inc.
3800 Thomasville Road East
Cairo, Georgia 31724
(912) 377-7120

1-800-841-0860

FREE Price List & Information Kit
Call For Your Discount Prices

ADA PRIMER

(text continued from page 430)

```

new_Line;
count := count + 1;
end loop;
end while_loop;
    
```

- C
- D

The loop consists of the statement between `loop` and `end loop` (beginning with the end of line A and ending with line D). Line A tests the expression `count < 4`. The loop continues to execute as long as `count` is less than or equal to 4.

The three statements in the loop display a two-column number, move to the next line, and increment the variable `count` with an assignment statement. Note that the `put` subprogram can display an arithmetic expression, in this instance, `count * 10`. The asterisk signifies multiplication.

The alignment of `end loop` with `while` and indentation of the statements within the loop is a matter of style. For an experiment, remove the statement that sets `count` to 1 to see how Ada treats an undefined value. You should not end up with a runaway program because the subrange `count_type` limits `count` to values between 1 and 5.

The next version of the looping program `while2.ada` uses the `succ` operation in line C to increment `count`. The `succ` stands for the "successor operation," which takes the next available value for the type named before the prime '. Thus, `integer'succ(25)` has the value 26. This operation is particularly useful for enumerated types that are not integers.

```

- while2.ada
- The while construct
with text_io; use text_io;
procedure while_loop is
- for integer io
package integer_io is
    new text_io.integer_io(integer);
use integer_io;
subtype count_type is integer range 1..5;
count : count_type;
begin
count := 1;
while count <= 4 loop
    put (count * 10, 2);
    new_line;
    count :=
        count_type'succ(count);
end loop;
end while_loop;
    
```

- A
- B
- C
- D

LOOPING WITH for

Ada's `for` statement has two parts between the `for` and the loop keywords.

```

- for1.ada
- The for construct
with text_io; use text_io;
procedure for_loop is
- for integer io
package integer_io is
    new text_io.integer_io(integer);
    
```

(text continued on page 434)

THE PURCHASING AGENT

We can buy any microcomputer product for you from our 299 participating wholesalers. Here are the net prices on a few of the 7,000 products we can buy for you, acting as your purchasing agent.

<h4>COMPUTERS</h4> <p>Allos 586-20 w/0 term 5,725 588-40 w/0 term 7,063 988-40 w/term. 9,027</p> <p>Compuro Godbout* Sys. 816A RAM 17" 4,065 Sys. 816A RAM 21" 4,179 Sys. 816AH* 6,459 Sys. 816C* 6,462 Sys. 816CH* 6,856 Sys. 816D* 6,887 Sys. 816E* 6,482 Sys. 816Z* 3,722</p> <p>*Completely Assembled</p> <p>Pragmatic 20 meg. 2,990 Pragmatic 40 meg. 4,888 Columbia Sys. 2-320K 2,779 Sys. 12 meg. 4,119 Sys., portable 2,320 Corvus Concept, 258K 2,999 Eagle 1820 2,999 Molecular 18X, 30 meg. 12,593 Morrow MD-3 w/term. 1,585 NEC APC-H03 w/softw. 2,899 8201 619 Northstar Advantage w/Dual Floppies w/5 meg. 2,107 3,249</p>	<h4>COMPUTERS</h4> <p>Northstar Horizon CALL Onyx 5001 MU, 21 meg. 6,813 8001 MU, 40 meg. 9,999 Sage II, w/2-840K 3,470 IV, w/12 meg. 5,830 IV, w/40 meg. 7,965 Sanyo 555, w/2-160K 1,100 Televideo 1S-1605PC 2,356 TPC-2, port. CALL Zenith ZF-100-21 2,157 ZF-110-22 2,685 ZW-120-32 4,245 All others CALL.</p> <h4>HARD DISKS</h4> <p>Corvus 12 meg. w/int. 2,299 Davong 10 meg. w/int. 1,832 Tallgrass 20 meg. w/tpas 3,097 All others CALL.</p> <h4>IBM PERIPHERALS</h4> <p>IBM PC, mono. 2-320K 2,950 Keytronic 5150 Keyboard 189</p> <h4>MODEMS</h4> <p>Hayes 1200 499 US Robotics Password 349</p>	<h4>MONITORS</h4> <p>Amdak RGB II 450 NEC 1203 532 Princeton RGB w/cable 486 All others CALL</p> <h4>PLOTTERS</h4> <p>Hitech HDG-2222 3,170 Houston Instr., DMP 29 1,778 DMP 41 2,321 461 Strobe M 100 461 All others CALL</p> <h4>PRINTERS</h4> <p>Anadex 9725B, par. 1,299 Brother HR-25 733 C. Itoh A-10-20 534 Diablo 630 API 1,815 NEC 7710 1,799 Okidata CALL Tohiba P-1340 799 All others CALL</p> <h4>TERMINALS</h4> <p>Televideo 925 715 WYSE WY-50 539 All others CALL</p> <h4>TAX SOFTWARE</h4> <p>Microtax CALL</p>
--	--	---

CALL US FOR THE NET PRICE ON ANY OF THE 7,000 OTHER PRODUCTS WE CAN BUY FOR YOU AS YOUR PURCHASING AGENT.

Since 1980

F.O.B. shipping point. Prices subject to change without notice. B-84-6



THE PURCHASING AGENT, INC.
574 Weddell Drive, Suite 5
Sunnyvale, CA 94089
(408) 744-0646

McGraw-Hill Bookstore



Do
you
know
ADA?

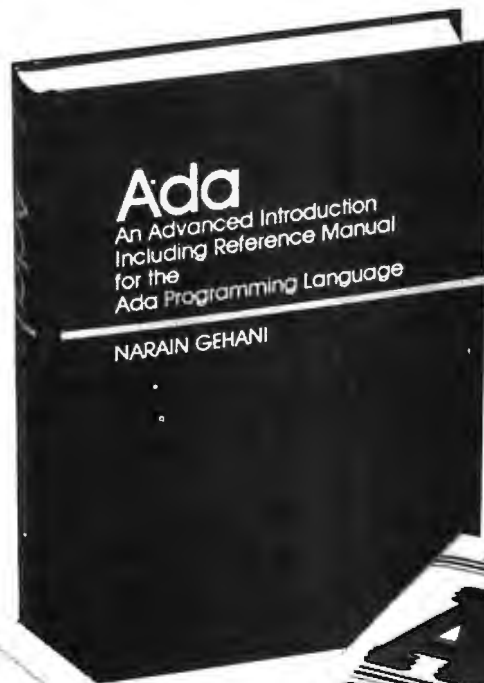

Designed at the initiative and under the auspices of the U.S. Department of Defense, ADA replaces the over 450 programming languages once used by DOD programmers. Adopted as an ANSI standard in February, 1983.



These books published by Prentice-Hall

Compare with other languages — what are the strengths and weaknesses?

1. Comparing and Assessing Programming Languages — ADA, C, and Pascal

by Feuer and Gehani. Introduces and compares each language; assesses each individually. Criticism and some alternative designs; methodology for comparing and assessing. 256 pp. \$16.95

Why you need ADA

2. ADA: Concurrent Programming

by Narain Gehani. ADA provides high-level concurrent programming facilities based on the rendezvous concept; how to use them effectively in writing concurrent programs. 272 pp. \$24.95 paper

Getting acquainted with ADA

3. ADA: An Advanced Introduction

by Narain Gehani. A quick intro to conventional aspects and an in-depth analysis of the novel aspects of ADA including encapsulation, concurrency, generic facilities, exception handling, and others. 352 pp. \$18.95 paper

Building a long-term relationship

4. ADA: An Advanced Introduction Including Reference Manual for the ADA Programming Language

By Narain Gehani. Written for those with knowledge of at least one programming language, it focuses on the novel aspects of ADA and contains many realistic and non-trivial examples. Programs tested. Differences from other languages noted. 672 pp. \$28.95

Look to the Professionals' Information Center — the McGraw-Hill Bookstore — for hardware, software, and computer books of all publishers.

Please print clearly.

McGraw-Hill Bookstore
1221 Ave. of the Americas, N.Y., N.Y. 10020

Send me (circle) book # 1 2 3 4
No. copies _____ MB4

Check, money order or credit card only
Visa _____ Amer Exp. _____ Master Chg. _____

Acct. No. _____ Expires _____

Name _____

Address _____

City _____ State _____ Zip _____

Add applicable sales tax, plus \$2.50 postage and handling for the first book, \$1.00 for each additional book.





Hard Disk Drive with Winchester Method of Recording
Hard Disk Drive with Whitney Recording Method
Hard Disk Drive with R.L.L. (Run Length Limited Coding)
I WILL BEAT ANY PRICE IN U.S.A.
Outstanding Quality Products • Latest Technology • Satisfaction Guaranteed
7 Days Trial • The Best Hard Disk Drive Subsystems in the World
Complete and Ready to Run • Full Year Warranty

10 MB 5 1/4"	\$ 1,200.00
* 16 MB 5 1/4"	\$ 2,100.00
* 25 MB 5 1/4"	\$ 2,400.00
30 MB 5 1/4"	\$ 2,200.00
* 40 MB 5 1/4"	\$ 3,500.00
* 65 MB 5 1/4"	\$ 4,000.00
* 92 MB 5 1/4"	\$ 4,900.00
*184 MB 5 1/4"	\$ 8,500.00
*368 MB 5 1/4"	\$17,000.00
MX-4 Multiple User Kits	\$ 400.00
PTR Server Automatic Despoils	\$ 1,100.00
Letter Quality Printer I/O Device 45CPS	\$ 700.00
Electronic Cash Register	\$ 250.00

Compatible with the following computers:
 Access Matrix (Actrix)/IBM & IBM Compatibles/Apple II, II+, IIe, III, III+ & Apple
 Compatible/Altos/Atari 800/Texas Instrument/Osborne/DEC/EPSON QX-10/
 S-100/NEC PC 8000/Kaypro/North Star/TRS 80 I, II, III/Zenith Z89, 90, 100/
 Xerox 820/Toshiba T300/Sanyo 550 & 555/Commodore VIC-20 & C-64/etc.

*Kits for multiple users available for these models.
 *Up to 64 users. Can run up to 7 languages on 1 drive.
 24 hours delivery anywhere in U.S.A. (option)
 Tape back up available • Removable hard disk available
FREE SHIPPING AND DELIVERY ANYWHERE IN U.S.A.
MANDINGO COMPUTERS & CAMERAS
 900 CASCADE DRIVE
 FORT WASHINGTON, MARYLAND 20744
 (301) 292-5632 (301) 292-6732

ADA PRIMER

(text continued from page 432)

```

use integer_io;
begin
  for count in 1..4 loop
    put (count * 10, 2);
    new_line;
  end loop;
end for_loop;
    
```

The first statement (line A) names the loop control variable `count`. Note that `count` does not appear in the declaration part of the program. It is declared by its appearance in the `for` statement and cannot be accessed outside the loop. The loop control variable cannot be changed inside the loop. It is automatically incremented by 1 every time through the loop. The range of the loop control variable makes up the second part of the `for` statement following the keyword `in`. In this example, the range of `count` is 1 to 4 as denoted by 1..4. The value of the loop control variable can be used in expressions, as done in this example with the expression `count * 10`.

The `for` loop statement is a better looping statement than the `while` statement: it is not possible to cause a `for` statement to loop indefinitely since the range is specified, the control variable is protected against inadvertent modification, and the incrementing of the control variable is always done monotonically. You should try to use `for` statements in preference to `while` statements wherever possible.

get AND put

`get` and `put` are two library subprograms that have many uses in Ada. They can be used to input and output a variety of data types, depending on how the packages in `text_io` are instantiated. (For variables of the character data type, you need not instantiate `get` and `put` because these procedures are already defined in the package `text_io`.)

The procedure `get` receives a single item, which can be a character from standard input (usually a terminal keyboard); the procedure `put` sends a single item, which can be a character to standard output (usually a terminal's display).

The following program uses `get` and `put` to copy one character at a time from input to output until it finds an end-of-file indicator.

```

-- copy1.ada
-- Copy input to output
with text_io; use text_io;
procedure copy is
  c : character;
begin
  loop
    get(c);
    put(c);
  if end_of_line then
    new_line;
  end if;
end loop;
exception
  when end_error
    
```

(text continued on page 436)

DECADES OF SERVICE
 FROM THE NATION'S LARGEST NEC DEALER

Where Do You Turn To Solve Your Computer Puzzle?



TURN TO US!

We'll show you
 the easiest way
 to put the
 pieces together.

Matched. Compatible. Proven—
 Use Someone Else's Engineering to Supplement Yours.

Our professional applications specialists are happy to assist you in configuring business and scientific computer systems from the thousands of hardware and software products we regularly handle.

- Our specialties include:
- CAD/CAM Graphics
 - Multi-user Databases
 - Foreign Language Processing
 - Communications

Our GSA Contracts:

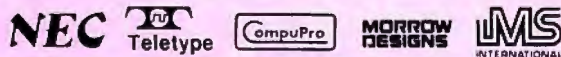

Washington Computer Services

97 Spring Street (212) 226-2121
 N.Y., N.Y. 10012

HOURS: 9 AM - 5 PM / Monday - Friday TELEX: 12-5606 CABLE: WASHCOMP NYK

PLEASE! Do not confuse us with mail order dealers. We are a full service distributor serving the data processing & installation needs of business and industry from micros to mainframes. System houses, educational institutions & governmental agencies given special consideration. Dealer and international inquiries welcome.

Discover the advantages of EasyLinkSM INSTANT MAIL

EasyLink service lets you use your computer or word processor to send your written correspondence. Easily. Instantly! Find out more with our free booklet.



The Instant Advantages of INSTANT MAIL

EasyLink

Now there's a low-cost way to correspond in writing, instantly. It's called EasyLink. And it works with your own personal computer, word processor or other equipment.

Find out how with our free booklet.

Just call 1-800-445-4444 or mail the coupon below to learn about EasyLink INSTANT MAIL service. There's no charge, no obligation.

You'll learn how simple EasyLink is to use...how quickly you can get started (within 72 hours in most cases)...and how many remarkable advantages EasyLink offers you and your company.

Instant compatibility with virtually any equipment.

If your existing equipment can communicate over phone lines, you've got all you need to start. You can correspond instantly with any other subscriber, and with Telex users in the U.S. and around the world.

And you *won't* have to worry about what type of equipment is at the other end of the line—EasyLink takes care of any differences for you, automatically.

EasyLink INSTANT MAIL has instant advantages.

With EasyLink, you have an "intelligent mailbox." You can send and receive messages simultaneously. You can even use your equipment for other purposes while mail is being sent to you, and read your mail at your convenience.

It's perfect for *all* your letters, orders, invoices, reports, messages...whatever you need to communicate. You can even reach people *without* equipment: thanks to EasyLink's instant access to Western Union's worldwide communications services, they'll have a copy of your correspondence in no time.

And EasyLink is a big benefit *within* your own company: any number of different computers, word processors or other communicating equipment, even at distant locations, can be linked together to form your *own* correspondence network.

Find out more about INSTANT MAIL.

EasyLink service is easy to get. Signing up is free. There's no monthly service charge. And EasyLink's 3-step security system assures your privacy. Find out more today!

**Find out more.
It just takes an instant.**

YES, I want to find out about EasyLink INSTANT MAIL! Send me a copy of your FREE booklet, at no charge and no obligation.

Please complete:

I do do not) have equipment that communicates over phone lines.

I do do not) have communications software.

To get your FREE booklet, just call

1-800-445-4444

or mail this coupon today.

Name _____

Title _____ Company _____

Business Address _____

City _____ State _____ Zip _____

Business Telephone (____) _____

Mail to: EasyLink INSTANT MAIL, P.O. Box 37472,
Dept. 109, Omaha, Nebraska 68137

WESTERN UNION **EasyLink**

(text continued from page 434)

= > null;

end copy;

The end-of-file indicator from a terminal under DEC's VMS operating system is a Control-Z. Thus, to get out of this program, you need only type a Control-Z.

Line A declares *c* as a character. In line B, a loop starts and will continue forever until an end-of-file marker causes an *exception*. An exception is something out of the ordinary. A predefined exception named *end_error* means an end-of-file has been reached. When this happens, the program transfers control to the statements following the exception, executes the statements in the *when* clause for the exception, and then exits the program. In the loop, line C reads a single character into variable *c*, and line D displays the value of variable *c*. Because Ada's *get* does not read the end-of-line character, there is a test for the end-of-line character that uses a built-in function. Also, because Ada does not read end-of-line or end-of-file characters but skips over them until the next character, we need to output the character that causes a new line to start with the built-in function *new_line*.

A number of useful Boolean functions such as *end_of_file* are already defined in *text_io*. Other useful functions are *end_of_line* and *end_of_page*. Such functions make a program more readable and have the advantage of being defined for every Ada compiler. Input and output have always made portability of programs difficult. Ada tries to improve this situation by specifying the same syntax for every computer.

It is quite likely that the same semantics will not occur, but at least we are getting one step closer to portability. One problem I have noticed with the NYU Ada/Ed compiler is the difficulty of keeping straight what it is trying to input and output.

In the example that follows, one Control-Z was not enough to cause the program to exit; it took two Control-Zs, and the order of input and output was confused. The program was an attempt to replace the exception with the use of the test for an end-of-file in a *while* loop. It still copied what was typed to the terminal. In part 2 of the Ada primer, I will discuss other ways to copy input to output to avoid this problem.

```

-- copy2.ada
-- Copy input to output
with text_io; use text_io;
procedure copy is
  c : character;
begin
  while not end_of__file loop
    if end_of__line then
      new_line;
    end if;
    get(c);
    put(c);
    if end_of__line then
      new_line;
    end if;
  end loop;
end copy;

```

(text continued on page 438)

WANTED

"Buyers," & We'll pay the shippin'

• CALL FREE (800) 654.4058 •

"Call For Reduced Prices At Various Quantities"

Verbatim.	Dysan CORPORATION	3M Scotch
5 1/4" sin-side dbi-den. 2 40	5 1/4" sin-side dbi-den. 3 20	5 1/4" sin-side dbi-den. 2 20
5 1/4" dbi-side dbi-den. 3 45	5 1/4" dbi-side dbi-den. 4 20	5 1/4" dbi-side dbi-den. 3 20
5 1/4" sin-side quad 3 20	5 1/4" sin-side quad 4 45	8" sin-side sin-den. 2 35
5 1/4" dbi-side quad 4 40	5 1/4" dbi-side quad 4 95	8" sin-side dbi-den. 2 95
8" sin-side sin-den. 2 75	8" sin-side sin-den. 3 45	8" dbi-side dbi-den. 3 90
8" sin-side dbi-den. 3 05	8" sin-side dbi-den. 4 45	
8" dbi-side dbi-den. 3 40	8" dbi-side dbi-den. 4 95	
Head Cleaning Kits... 5 20		
Refills... 9 55		

We Stock "Bulk-Packed" Diskettes

Disk Minder
- Smoked Plastic
- Holds 75 Disks
16 75 ea

Dealer Inquiries Welcomed

the **Diskette Connection**

P.O. Box 1674
Bethany, OK 73008



(Continental U.S. only. Add 3% on orders under 40#)

ONE PROGRAM YOU CAN'T AFFORD TO BE WITHOUT!

INQUIRY...

- Covers all hardware, software, and accessories in your home, or in transit.
- Insured on a replacement cost basis
- All Risk Coverage including flood, quake, and breakage
- Covers damage to DP equipment from short circuit, blow-out, or other electrical damage or disturbance — including wiring
- Automatic coverage for newly acquired property up to 60 days
- Can be used for business or personal use or combination
- Even covers equipment leased or rented from others.
- Low \$50 deductible
- VISA or MasterCard accepted.

Now you can protect your investment with Broad Form, low cost protection from Markel.

Policy Limit	Annual Premium
up to \$2,500	\$22.50
\$ 2,501-\$5,000	\$32.50
\$ 5,001-\$15,000	\$47.50
\$15,001-\$25,000	\$62.50

(Higher limits are available upon request)

Call today toll free for immediate coverage or more information!



MARKEL SERVICE, INC.

5310 Markel Road, Richmond, VA 23230
1-800-446-6678 or 1-800-552-3408 (VA)

THE AT&T INTERNATIONAL BUSINESS NETWORK: IT MAKES USING THE PHONE A SOUND BUSINESS DECISION.

Talking business around the world on the AT&T Network saves a lot of money.

First, it's the fastest way. And anything that saves time is like money in the bank.

Next, nothing gets attention

CHICAGO



body together more frequently.

Only with the AT&T Network can you talk business all over the world. So call when you can.

It's productive, easy, economical, private. The fastest way.

It provides instant feedback.

PARIS



audio teleconferencing.

More cost-effective services for your business from the AT&T International Business Network.

Contact your Account Executive at AT&T Communications or call toll tree: 1 800 821-2121.

International service to and from continental U.S.

like an international call.

And when you get attention, you get results...fast.

Calling adds a personal touch.

An informal conversation lets you exchange ideas, persuade, cajole, and convince.

Get a quick decision. Just the tone of a voice can set you on the right track. You can clear up possible misunderstandings.

And you can negotiate and close a profitable deal before you say goodbye.

AT&T international audio teleconferencing is cost-effective, too. Our operators

And improves your bottom line.

A network that takes you all over the world.

And operators to arrange

can put you in touch with as many as 60 locations at one time.

You'll be able to get every-



© AT&T 1984

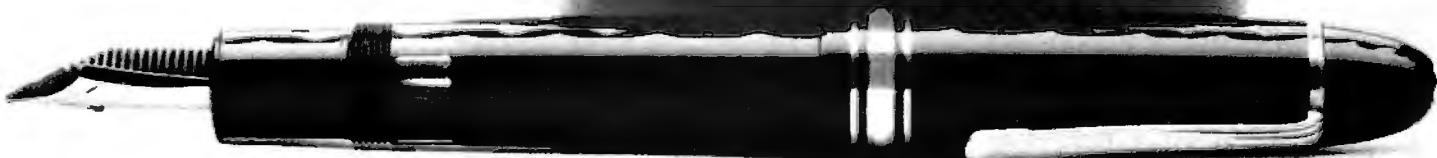

MORE POWER... MORE SPEED...

THE C86™ C COMPILER

C86, the leading C compiler for PC-DOS and MS-DOS is better than ever. **50% faster execution, highest portability, floating point math, strong support, and much more. Still only \$395.**

FOR MORE INFORMATION OR TO ORDER CALL:

800-922-0169

Technical Support: (201) 542-5920



COMPUTER INNOVATIONS

960 Shrewsbury Avenue, Suite B
Tinton Falls, NJ 07724

C86 is a trademark of Computer Innovations, Inc. MS-DOS is a trademark of Microsoft. PC-DOS is a trademark of International Business Machines.

ADA PRIMER

(text continued from page 436)

end copy;

if AND else AND elsif

Ada's if statement looks much like *if* statements in other programming languages.

```

- if1.ada
- Illustrate the if
- and else statements
with text_io; use text_io;
procedure if_statement is
  answer : character;
begin
  put (" Do you like Ada so far? ");      -- A
  new_line;
  put (" Type y for yes, or n for no: "); -- B
  new_line;
  get (answer);
  if answer = 'y' or answer = 'Y' then
    put (" Glad to hear it!");
  else
    put (" Hope it changes.");
  end if;
end if_statement;
    
```

This example asks a leading question and prints a response depending upon the answer. Note the semicolon that's required after the put statement (just before the **else**) as a statement terminator. In this example, the equality test operator (=) and the logical operator **or** are used to check if the response is equal to y or Y.

It is possible in Ada to keep the logic of if statements quite clean by avoiding nesting. Although Ada allows nesting of if statements, most nesting constructs can be rewritten to use the **elsif** construct. The **elsif** keyword is used to perform an additional test if the test above it is false. An if statement can have several **elsif** tests, but only one **else**.

```

- elsif1.ada      -- Illustrate use of if and elsif and else --
with text_io; use text_io;
package greeting is
  procedure greet;
end greeting;
package body greeting is
  procedure greet is
  begin
    put (" Do you like Ada so far?"); new_line;
    put (" Type y for yes, or n for no: "); new_line;
  end greet;
end greeting;
with text_io, greeting;
use text_io, greeting;
procedure elsif_statement is
  answer : character;
begin
  greet; -- greet the user
    
```

(text continued on page 440)

SPECIAL ORDER

...for Special Needs.
Quality • Service • Professional

- **Medical & Dental Systems** from \$249.95 to \$1,695.95 for Apple //, IBM, MS-DOS.
- **Educator Administrative Packages** Scheduling, Grading, Attendance
- **Construction and Job Cost** Accounting Systems
- **Office Automation** Integrated Applications with Networking Possible.

For further information contact your local dealer or call (619) 365-9718



MICRO COMPUTER DIVISION

55722 SANTA FE TRAIL
Yucca Valley, Ca. 92284

MEMORIES · SHOULD · ALL · — BE · MADE · LIKE · THIS — ·

All memories are good memories when they come from Cumana. Available for the Apple, Dragon, British Broadcasting Corporation and IBM personal computers, Cumana slimline disk drives are designed and manufactured to the highest standards to give outstanding performance and quiet operation.

Supplied with an extended 12 months warranty and fully assembled and tested before packaging, Cumana slimline drives are available in single and dual versions. All power and interface cables are supplied with the drives to enable you to plug in, switch on and go!



Orangewood Business Center,
1701 East Edinger, Suite E12, Santa Ana,
CA 92705. Call: (714) 953-7622.

International office: Pines Trading Estate,
Broad Street, Guildford, Surrey, England.
Tel: (0483) 503121. Telex: 859380.

Apple is a registered trademark of Apple Computer, Inc.
The British Broadcasting Corporation Microcomputer is
manufactured under licence by Acorn Computers Limited.
Acorn is a registered trademark of Acorn Computers
International PLC.

Dragon is a registered trademark of Dragon Data Ltd.
IBM is a registered trademark of International Business
Machines Corporation.

SUPER APPLE® COMPATIBLE

SUPERIOR TO APPLE. COMPARE FEATURES
AMERICAN SUPER COMPUTERS Elite 4

1. Dual CPU's 6502 & Z80, 64K RAM
2. Runs APPLE & CPM, detached keyboard
3. Numeric keypad, 90 key keyboard
4. No copyright problems, completely legal
5. SAVES YOU LOTS OF MONEY! ONLY \$499

Disk Drive \$199 - Controller \$49 - Monitor \$109

Complete System:

Computer + Controller + Drive + Monitor ONLY \$839

APPLE is T.M. of APPLE Computers, Inc.

WE HAVE ALL APPLE CARDS — CALL! SAVE!
 Phone **American Super Computers (919) 883-1105**

COMPUTERS	TERMINALS	PRINTERS - LETTER QUALITY
Advanced Digital Z806 6MHz	Televideo 910	Super Quality - Super Price!
Super Star 128 W/PS NET-1	Televideo 924	Smith-Corona TP-1
Super Slaves/128	Televideo 925	TEC A10
CompuPro 818C Demo (1 only)	Televideo 970	TEC 2010
Morrow D120	Adapt 3A	Televideo TP-220P
Headstart VPU-128	Vanguard Color	Silver Reed 500P
North Star Horizon or Advantage	Zenith Z-29	
BVI PC Copy of IBM PC	Visual 50	
Alcoa 588 30 S-User		PRINTERS - DOT MATRIX
Televideo 802		PrintWriter
Televideo 806/20	MONITORS	Epson RK-80PT
Sanyo 580	BMC BM-12AUW	Microgram
Pala 20/185	BMC Amber	Onidata 82 Par
Zenith ZF-181-21	BMC Color	Onidata 82 Par
Eagle PC Spirit II	Amdek Color-1 (1 Demo)	Tally Spirit
NEC PC 8201A	CALL	Anadek 95006
	836	946

IBM is T.M. of International Business Machines; CompuPro is a Godbout Company

We Sell Entire Line Of Most Companies
 Call For Latest Prices, Shipping & Availability
 Factory Warranties — WE BEAT PRICES!

WHICH COMPUTER IS BEST? - FREE BROCHURE



4167 Kivett Dr., Jamestown, North Carolina 27282
 Phone: (919) 883-1105 or (919) 889-4577

Prices & Specifications subject to change

ADA PRIMER

(text continued from page 438)

```

get (answer);
if answer = 'y' or answer = 'Y' then
    put(" Glad to hear it! "); new_line;
elsif answer = 'n' or answer = 'N' then      - A
    put(" Sorry to hear that. Hope it changes. "); new_line;
else
    put(" I don't understand "); put(answer); put(" . "); new_line;
end if;

and elsif_statement;
    
```

Line A shows that if the reply character is not y or Y, the program should check whether the answer was n or N. If this test also fails, it prints an error message that echoes the input character.

In Ada, any number of statements can be placed after an if, elsif, or else keyword. Its keywords are lined up and if statements are not nested.

Listing 1 shows what this example looked like as it was compiled and run under VMS with the NYU Ada/Ed system. The program printed the question by calling the procedure greet and then waited for a reply. In this example, the user responded y so that the first if was satisfied, the appropriate message was printed, and the program ended.

If the response had been n, the first if would have failed, the elsif test would have been satisfied, and the program would have printed a sympathetic message. If the response had been anything other than y, Y, n, or N, the else statement would have taken effect.

The program that follows plays a simple guessing game that tests for the correct response by using an if statement. If the user types the letter e, the program "points" to the reply and prints You guessed it! Congratulations!

```

- exit1.ada
- Illustrate the if and exit statements
with text_io; use text_io;
package greeting is
    procedure greet;
end greeting;

package body greeting is
    procedure greet is
        begin
            put(" If you type a certain letter ");
            new_line;
            put(" I'll congratulate you for guessing it. ");
            new_line;
            put(" If you get bored, type control-z twice. ");
            new_line;
        end greet;
    end greeting;

with greeting, text_io;
use greeting, text_io;
procedure exit_statement is
    c: character;
begin
    greet; - display a greeting to the user
    while not end_of_file loop
        get(c);
    
```



A Software Implementation within Your Product Hardware

If you manufacture a computer system or a computer based product, allow it to EMULATE COMMUNICATE by installing one or more of Systems Strategies "C" Language based communication packages.

- 3270 SNA SDLC Emulation
- 3270 BSC Emulation
- 2780 3780 HASP Emulation
- X.25 Levels 1, 2, 3 Communication

You can purchase these "C" Language packages with source code and license to distribute in your hardware product. Each package is available either "Port it Yourself" with instruction manual and training or ported to your hardware by Systems Strategies' communications staff.

Systems Strategies/Advanced Technology Division
 Specialists in Data Communications Software



Systems Strategies Inc.
 225 West 34th Street
 New York, New York 10001
 (212) 279-8400

The last of the American bald eagles?

The last passenger pigeon on earth died in a Cincinnati zoo in 1914.

We don't want the bald eagle—our national symbol—to face the same future. There are fewer than 1,400 breeding pairs of bald eagles left in the lower 48 states.

They have survived despite destruction of their nesting sites, indiscriminate shootings, and poisoning from insecticides like DDT.

We can keep these magnificent birds alive and free. And you can help.

Never approach an eagle's roosting or nesting place. Disturbing a nest is illegal—and it can cause adult eagles to abandon the nest for good. Learn to identify the eagle. Remember, it's against federal law to kill eagles, hawks, falcons and other birds of prey.

Learn about the needs of eagles. Volunteer to help your state conservation agency protect eagle habitat.

The National Wildlife Federation is working to save the eagle, too.

With the help of several American companies, the NWF purchased land where eagles roost and donated it to the American people for use as wildlife refuges.

Each year we conduct a census of the bald eagle population in the lower 48 states to help identify prime eagle habitats.

Through our Raptor Information Center the Federation conducts research on eagles, provides educational materials, and offers a \$500 reward for information that helps convict anyone who kills an eagle.

You can support the National Wildlife Federation's program to save the bald eagle. Join us. Write the National Wildlife Federation, Department 101, 1412 16th St., NW, Washington, DC 20036.



First in the New BYTE GUIDE Series!

BYTE

GUIDE to the IBM PCs

In addition to regular monthly issues, BYTE Magazine will publish a series of computer GUIDES. The first — "BYTE GUIDE to IBM PCs" — will be mailed to BYTE subscribers in late August, 1984. This GUIDE takes a definitive look into the complex and changing face of IBM — the most *objective* and complete survey ever of this "first family" of microcomputers.

Here is a singular opportunity for new or added exposure to BYTE's 438,000 paid readers: decision makers with the highest proven record of microcomputer products spending compared to any other computer magazine audience...a well-salaried readership with an eye on the current and future trends of IBM. And on you.

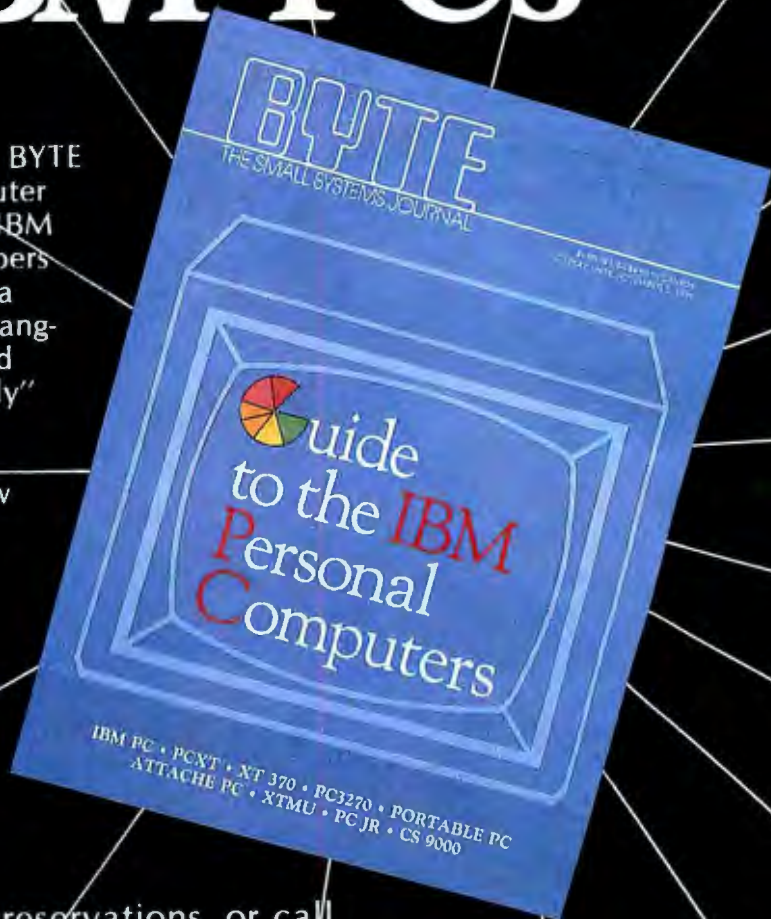

Call your local salesperson for reservations, or call Pete Huestis, Advertising Sales Manager, at (603) 924-9281.

Closing date for space reservations: **June 21, 1984.**



```

if c = 'e' then           - A
  put("~- You guessed it! Congratulations! "); - B
  new_line;
  exit;                  - C
end if;
end loop;
end exit_statement;

```

The statement on line A tests if the input character is an e. If the user has typed an e, the program executes the statements following the then keyword; line B prints the congratulatory message and points to the correct letter, e; and then line C causes an early exit from the loop. Some programmers do not think that the use of an exit statement is good programming practice; however, others believe that exit saves time in a loop and is a good statement to use. Ada provides both the exit statement and the exit when statement for loop exits and lets you make your own judgment.

Another version of the main part of this program that does not use the exit statement follows.

```

- exit2.ada
- Show how to eliminate an exit statement
with text_io; use text_io;
package greeting is
  procedure greet;
end greeting;
package body greeting is
  procedure greet is
  begin
    put(" If you type a certain letter ");
    new_line;
    put(" I'll congratulate you for guessing it. ");
    new_line;
    put(" If you get bored, type control-z twice. ");
    new_line;
  end greet;
end greeting;
with greeting, text_io;
use greeting, text_io;
procedure no_exit_statement is
  c: character := ' '; -- initialize to blank
begin
  greet; -- display a greeting to the user
  while c /= 'e' and not end_of_file loop
    get(c);
    if c = 'e' then           - A
      put("~- You guessed it! Congratulations! "); - B
      new_line;
    end if;
  end loop;
end no_exit_statement;

```

The argument in favor of this version is that the conditions for exiting the loop appear in one place: at the start of the loop in the while statement. A programmer testing or modifying this program does not have to search for exit statements. The major argument against this version is that there is an extra test on c every time the loop executes. This test occupies space and takes extra time. Another opposing argument is that the test in the while statement appears backward.

Listing 1: An Ada program run under the VMS operating system with the NYU Ada/Ed compiler.

```

1
2  -- elsif1.ada illustrate use of if and elsif and else
3
4  with text_io; use text_io;
5  package greeting is
6    procedure greet;
7  end greeting;
8
9  package body greeting is
10   procedure greet is
11   begin
12     put ("Do you like Ada so far?"); new_line;
13     put ("Type y for yes, or n for no: "); new_line;
14   end greet;
15   end greeting;
16
17   with text_io, greeting; use text_io, greeting;
18   procedure elsif_statement is
19
20     answer : character;
21
22   begin
23
24     greet; -- greet the user
25     get (answer);
26
27     if answer = 'y' or answer = 'Y' then
28       put ("Glad to hear it!"); new_line;
29     elsif answer = 'n' or answer = 'N' then
30       put ("Sorry to hear that. Hope it changes.");
31     else
32       put ("I don't understand"); put(answer);
33     end if;
34   end elsif_statement;
35

```

No translation errors detected
Translation time: 90 seconds

Binding time: 2.7 seconds

Begin Ada execution

Do you like Ada so far?
Type y for yes, or n for no:
>y

Glad to hear it!

Execution complete
Execution time: 6 seconds
I-code statements executed: 41

S

These Ada programs should give you a flavor of Ada program structure, Ada packages, basic input/output, variables and assignment, and control constructs such as while, for, if, elsif, and else. With a command of this much Ada, you can write small, useful programs.

Next month, in part 2 of this Ada primer, I will cover the more advanced topics of types, arrays, and communication between Ada programs, as well as show how a microcomputer subset of Ada performs. ■

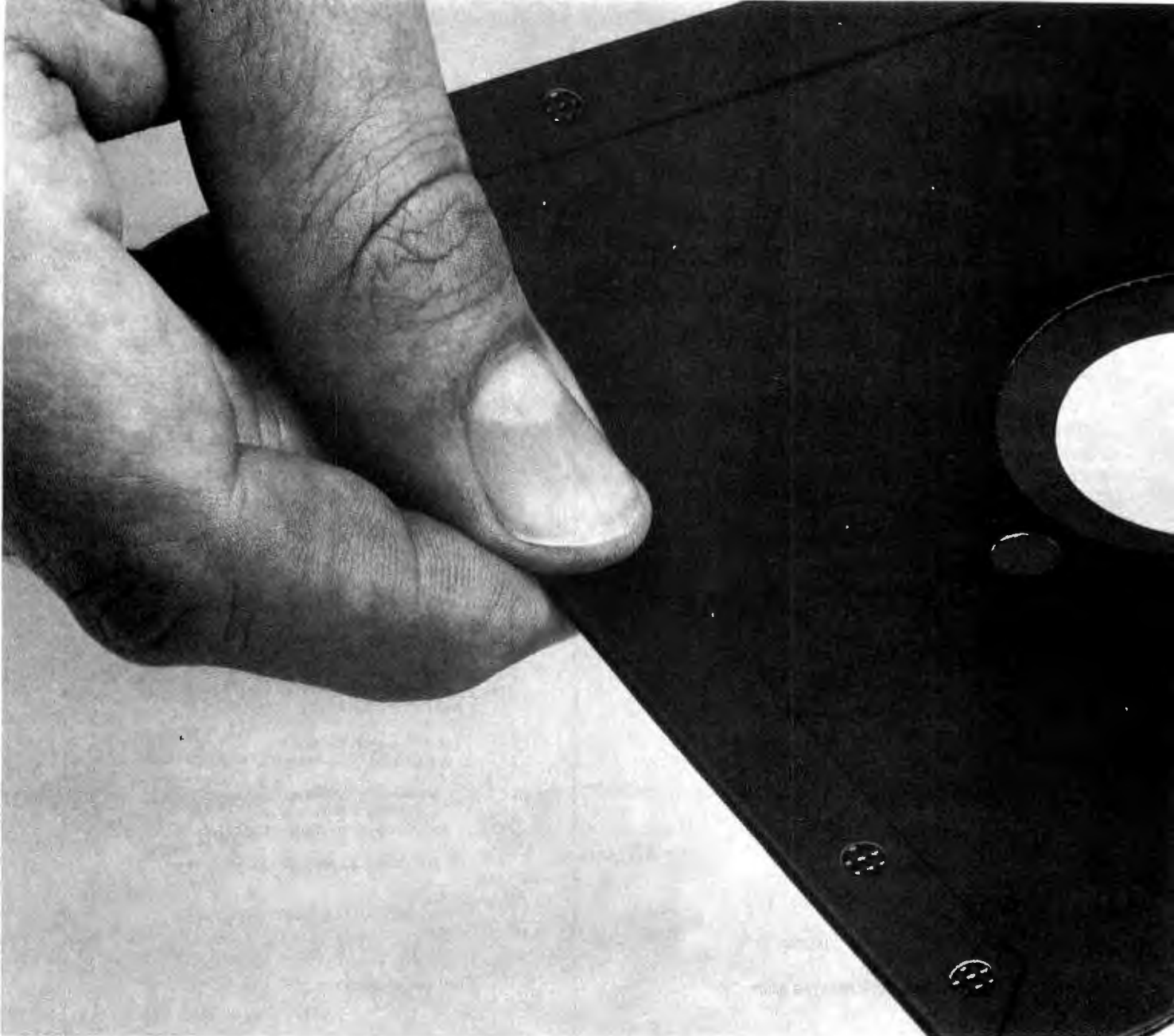

This one sloppy floppy can

THE SLOPPY FLOPPY

Most companies seal their discs with a spot here, a spot there. Leaving most of each seam not sealed at all.

Sooner or later, the seams might do what comes naturally: they bulge. Warp. Pucker. Open up.

You can prove it to yourself. Just take a floppy and twist it.

See those wide open spaces?

That's sloppy. And dangerous. Because if you put a sloppy floppy into your disc drive, it can jam the drive. Lose your data. Or ruin the drive head.

And there goes \$400.

Memorex is a registered trademark
of Memorex Corporation.
©1984 Memorex Corporation
A Burroughs Company



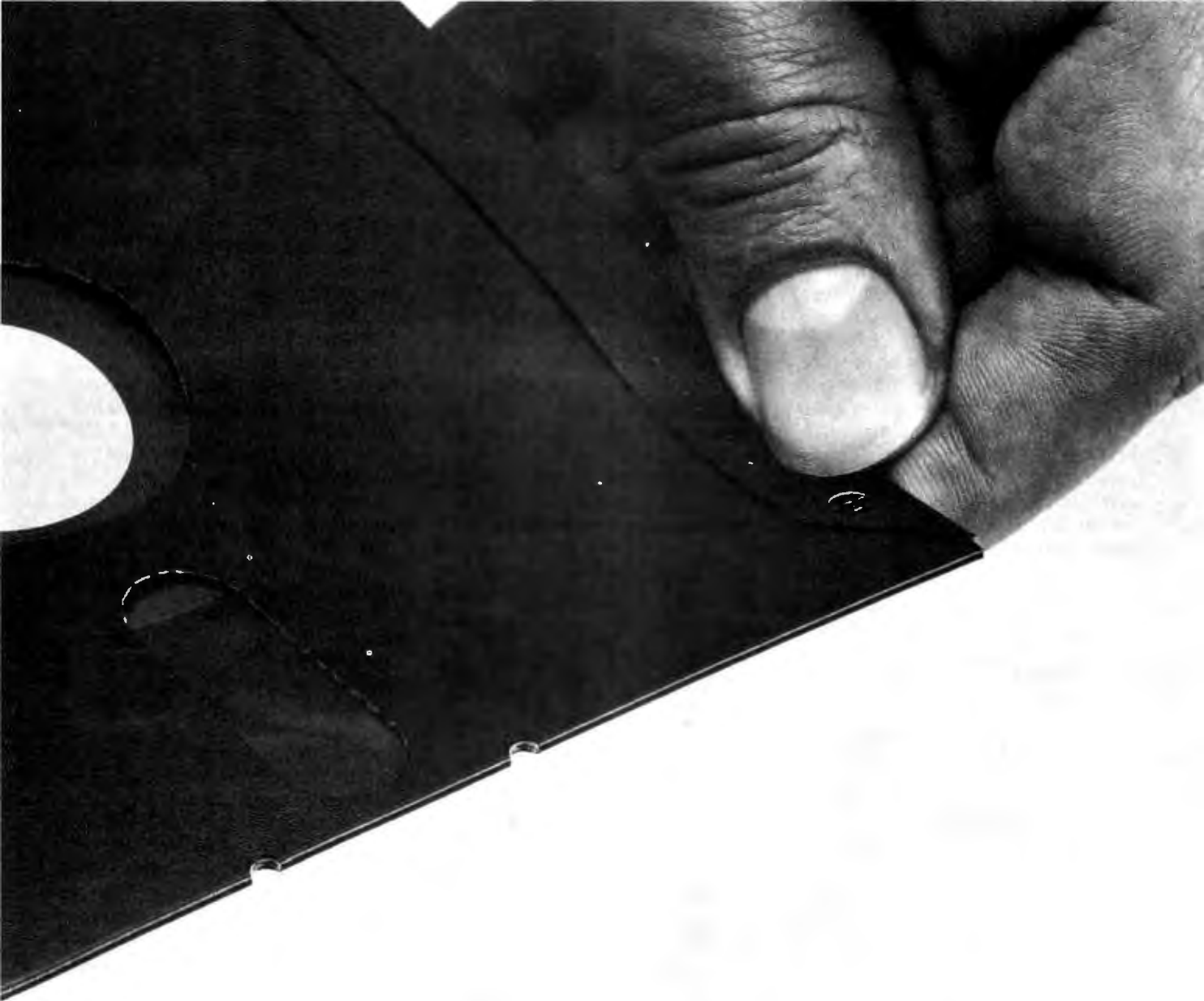

ruin your \$400 disc drive.

THE MEMOREX[®] SOLID-SEAM BONDED FLOPPY

Memorex seals its floppy discs with a process it developed, called Solid-Seam Bonding.

Solid-Seam Bonding seals shut every inch of every seam of every Memorex floppy disc. Tight as a drum. That makes the Memorex floppy stiffer. Stronger. And your data safer.

You can prove it yourself. Just take a Memorex floppy and twist it. You'll see no wide open spaces.

No wide open spaces that can jam your drive. Lose your data. Or ruin your drive head.

Which could cost you \$400.

So why risk it?

Protect your drive. And your data. Ask for Memorex floppy discs, with Solid-Seam Bonding.

It's always better to be safe than sloppy.

For more information on the full line of Memorex quality computer media products, including computer tape, call toll-free: 800-222-1150. In Alaska and Hawaii call collect: 408-987-2961.



Your Data. When it matters, make it Memorex.[™]

MEMOREX

Circle 209 on inquiry card.



PRINTER BUFFER

(text continued from page 143)

In addition to normal memory accesses, the RAM must be refreshed. Refreshing consists of sequentially accessing RAM locations to keep the memory cells active. To do this, only the row address and row-address strobe need be provided and only 128 locations need be accessed. The Z80 provides a REFRESH signal that occurs during an instruction decode and therefore is transparent to the software. This signal is combined with a MEMORY REQUEST signal to provide the RAS. The CAS signal that normally goes to the RAM

is inhibited by the NAND gates of IC12 so CAS never goes active. The Z80 has an internal register that is put out on the low-address bus during refresh and is automatically incremented after each refresh cycle; therefore, no refresh counter is needed to provide the sequential addresses to the RAM.

The interfaces to the host computer and printer are designed to be compatible with the Centronics protocol, which consists of the host computer sending the data byte and then the active low-data strobe. The printer sends back ACK (acknowledge) and BUSY signals.

IC13 is the decoder that provides the chip selects for the I/O (input/output) circuits. It is enabled whenever the Z80 does an I/O cycle. READ and WRITE signals are not used because separate addresses are used for the different I/O ports. IC9 is the 8-bit input-data latch. The host computer delivers data to the IC9 and then activates the strobe line causing the data to be latched. The strobe input going low also causes the 74LS74 flip-flop to be reset. The NOT Q signal goes back to the host computer as a BUSY signal from the printer buffer. The host computer then knows not to send another character. The BUSY signal can be read by the Z80 through three-state buffer IC14 to determine if a character has been received. When the BUSY signal is high, the Z80 knows that a character has been sent. The Z80 then reads the character by enabling IC9 to output data onto the data bus. When the character has been read, the IC10b flip-flop is reset. This produces the beginning, or falling, edge of the ACK signal to the host computer. The Z80 delays about 10 microseconds (μ s) and then clocks IC10b, causing the rising edge of the ACK signal. The rising edge clocks IC10a, causing the BUSY signal to go inactive (low). The host computer can send another character at this time.

The output to the printer works in the same manner except that the printer buffer acts as the host instead of the printer. Data is clocked into IC15, which feeds it out to the printer. The Z80 then activates the decoder IC13 to output a data strobe to the printer through its G4 output. The printer's ACK signal clocks the IC24 flip-flop and can be read by the Z80 through the three-state buffer IC14.

SOFTWARE CONTROL

The printer buffer, like any microprocessor-based system, could not do anything without a control program. The control software stored in the 2716 EPROM is quite simple. All it has to do is load characters to RAM and send characters to the printer. Pointers to RAM determine where the next character will be stored and from where the next character will be fetched. Three conditions must be accounted for: an empty buffer, a full buffer, and reaching the top of RAM. For the last condition, the software must check to see if the

(text continued on page 448)

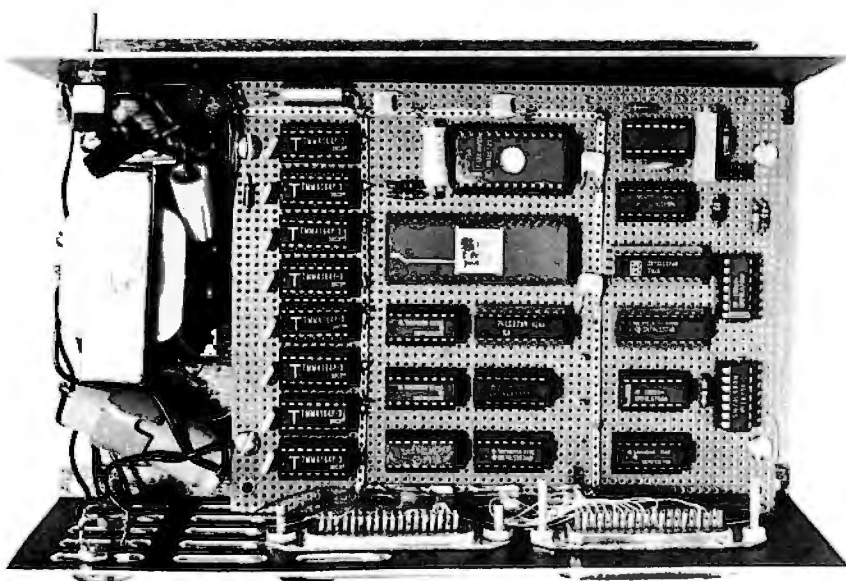

Photo 1: The inside of the completed printer buffer.

Quantity	Part Number	Description	Reference
1	MC4024	Clock Generator	IC1
1	Z80	Microprocessor	IC2
1	2716	EPROM	IC3
1	74LS151	Multiplexer	IC4
1	74LS373	Latch	IC5
2	74LS367a	3-State Buffer	IC6, IC14
2	74LS157	Multiplexer	IC7, IC8
2	74LS374	8-bit Flip-Flop	IC9, IC15
2	74LS74	Dual D Flip-Flop	IC10, IC24
2	74LS138	Decoder	IC11, IC13
1	74LS00	Quad NAND Gate	IC12
8	4164	64K-bit RAM	IC16-IC23
1	10,000 Ω	Potentiometer	
2	10,000 Ω , 1/4 W	Resistor	
1	10 μ F, 15 V	Capacitor	
1	68 μ F, 15 V	Capacitor	
1	0.001 μ F	Capacitor	
18	0.1 μ F	Bypass Capacitor	
1	57-20360	Connector	
1	57-10360	Connector	
1	JE200 (Iameco)	+5-V, 1-amp Power Supply	

Table 1: This table contains the components for this printer buffer.

ALL AT ONCE!

AND NEVER A "LOCKED OUT" USER!

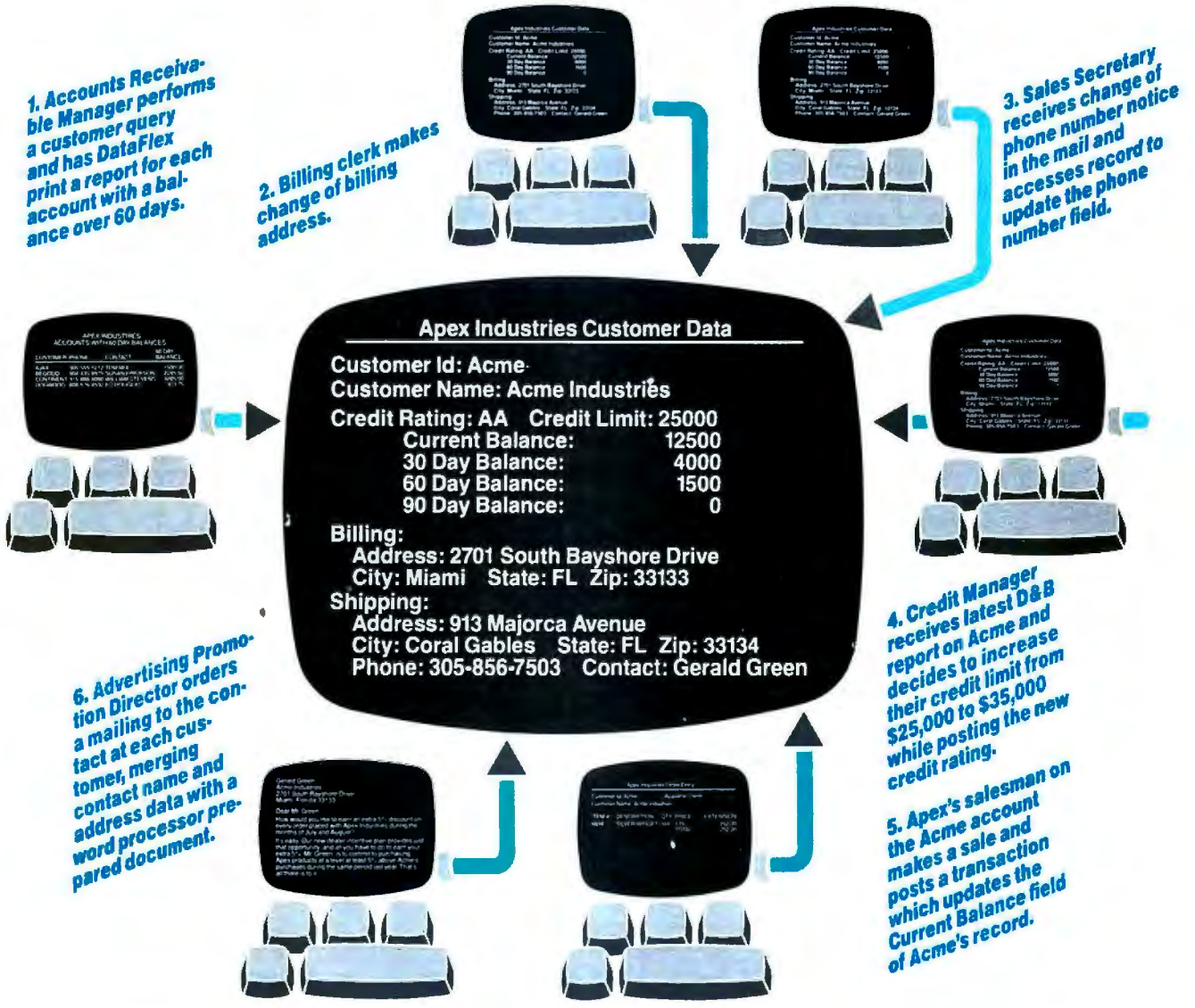

Apex Industries Customer Data

Customer Id: Acme
Customer Name: Acme Industries
Credit Rating: AA Credit Limit: 25000
Current Balance: 12500
30 Day Balance: 4000
60 Day Balance: 1500
90 Day Balance: 0

Billing:
Address: 2701 South Bayshore Drive
City: Miami State: FL Zip: 33133

Shipping:
Address: 913 Majorca Avenue
City: Coral Gables State: FL Zip: 33134
Phone: 305-856-7503 Contact: Gerald Green

DataFlex is the only application development database which **automatically** gives you true multi-user capabilities. Other systems can lock you out of records or entire files for the full time they are being used by someone else. DataFlex, however, locks only the data being changed, and **only** during the micro-seconds it takes to actually write it to the file! The updated record is then immediately available. The number of users who can access, and change, records at the same time is limited only by the number of terminals on your system or network. Call or write today for all the details on DataFlex...

the true multi-user database.

DATA FLEX

DATA ACCESS CORPORATION
 8525 SW 129 Terrace, Miami, FL 33156 (305) 238-0012
 Telex 469021 DATA ACCESS CI
 Circle 95 on inquiry card.

AUTHORIZED INTERNATIONAL DISTRIBUTORS

HOLLAND
 ADINFO 020-644605

AUSTRALIA
 Australian Business Solutions
 03-699-8377

Australian Microcomputer Solutions
 052-22-2099

Intelligence (Aust) Pty. Ltd.
 02-267-1711

ENGLAND
 Equinox Computers 01-739-2387/9

SWEDEN
 Offensivt Datorstod AB 030-006-2626

JAPAN
 SOFTEC 04808 (5) 6565

Compatible with CP/M-80, MSDOS networks, MP/M-86, Novell Sharenet, PC-Net, DMS Hi-net, TurboDOS multi-user, Molecular N-Star, Televideo MmmOST, Action DPC.OS, IBM PC w/Corvus, OMNINET, 3Com EtherSeries and Micromation M/NET.
 MSDOS is a trademark of Microsoft. CP/M and MP/M are trademarks of Digital Research.

PRINTER BUFFER

(text continued from page 446)

pointer has reached the highest address; if it has, the software must set it to the first RAM location. This is called wraparound.

The methods for checking the first two conditions are shown in figure 4 (page 455). If the pointer to the next character-load position equals the pointer to the next character-print position, then the buffer is considered empty (see figure 4a). There are two cases for a full buffer. The normal case is for the whole buffer to fill, including wraparound, until the next load position (i.e., a full buffer, see figure 4b). The second case occurs when the next print location is at the bottom of RAM and the next load position is at the top of RAM. You can see in figure 4c that by loading one more character, the two pointers would be made equal and thus erroneously signal an empty buffer. This condition is a special case of the buffer-full condition.

When the RAM is full, the input handshake will not take place until a character is printed and another RAM location is made available. The printer buffer will send the ACK signal when the byte is stored in RAM. The host computer will then put out characters at the same rate as the printer printing them.

Listing 1 (page 453) shows the assembled code. It probably looks different from the way you are used to seeing comments done in assembly language. I used a form of PDL (Program Design Language) to design the program and filled in the code between the commands. This method of program design greatly simplifies code generation and debugging, and I heartily recommend it.

The comments give a sense of pro-

gram flow because of the use of the structured construct:

```
IF (condition is true)
    execute this code
ENDIF
```

The code between the IF and ENDIF is not executed if the condition is false. Therefore, to follow program flow when a condition is not met, simply jump to the corresponding ENDIF statement.

The program initialization starts by loading the I register with 0FFH so that during refresh the Z80 outputs the con-

tents of the I register on the high-address bus so the EPROM is not selected. Register BC is used to point to the next character to be printed. Register DE points to the position of the next character to be loaded. After the pointers are loaded with their initial values, the program enters an endless loop. The loop consists of only two tasks: get a character and print a character. The *get character* and the *print character* sections are totally independent.

For inputting characters, the first thing

(text continued on page 456)

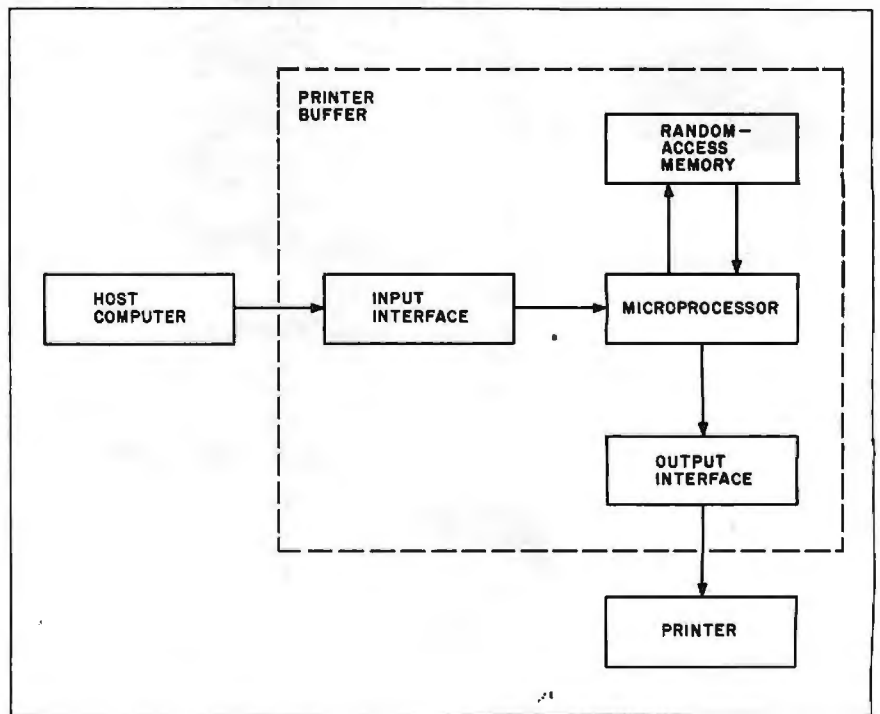

Figure 1: A block diagram of the data flow from the computer through the buffer to the printer.

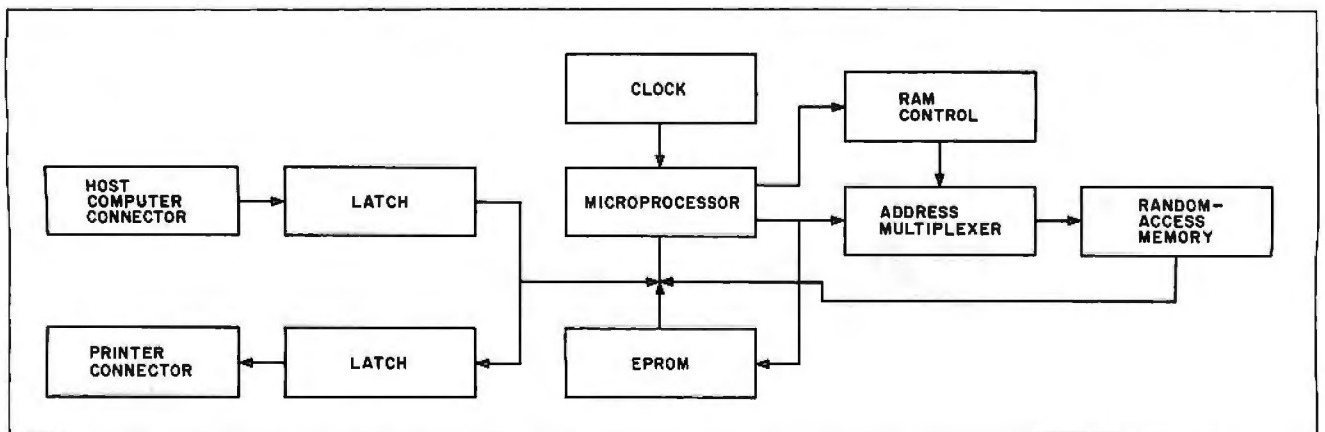

Figure 2: This is a block diagram of the printer buffer itself. The microprocessor is a Zilog Z80.

Three good reasons to try Encore™ diskettes.



1. It saves you money.

Encore diskettes meet the same high standards as the more expensive brands. In fact, they actually exceed system requirements.

That you can buy Encore disks for 1/3 the price of the high-priced diskettes. (Only \$1.99 for single-sided, single-density 5 1/4" diskettes, when you purchase 4 or more boxes, ten diskettes to a box.)

A diskette intended for a wide range of uses.

Whether you use a lot of diskettes or only a few, you need something more than guaranteed accuracy and reliability. You need economy.

Encore was designed to meet the demand for a reliable, low-cost diskette.

Encore's low price, it's ideal for memos, check drafts, spreadsheets, reports, even touchpad-type uses.

Designed for all major personal computers.

**IBM Apple Radio
Commodore Shack**

Encore was specifically designed to provide optimum performance and reliability on the leading computer systems. Inmac's Quality Assurance Department constantly monitors all Encore diskettes to ensure they meet or exceed media specifications for these systems. Our on-going testing program guarantees that the Encore diskette you buy tomorrow will be as good as the one you buy today.

Inmac is a manufacturer's registered trademark.



2. It's absolutely reliable.

Encore is guaranteed for one full year, or Inmac will replace it, free.

Inmac's Quality Assurance Department requires that Encore meet the media specifications for the most popular systems — Apple, Commodore, IBM, and Radio Shack — exactly. So you can rely on Encore diskettes in your system. They won't lose information or cause read/write errors.

45-day money-back trial.

We're backing our Encore diskettes with a 45-day money back trial because we're positive you'll be delighted with Encore's quality and performance.

And we're sure that once you try Encore, you'll agree that it's the most reliable economy floppy available.

If you don't agree for any reason, just return the three diskettes for a full refund.



3. And you can get one, free.

For a limited time only, we're offering a special trial pack of three 5 1/4" Encore diskettes. You pay the regular price for two of the diskettes, but the third one is free.

We'll send you 3 single-sided, single-density 5 1/4" diskettes for only \$5.19. (Single-sided, double-density for \$5.99. Double-sided, double-density for \$8.79.) Use all three Encore diskettes for 45 days.

Then, if you're not completely satisfied, return the three diskettes for a full refund.

Here's how it works.

Simply mail the attached postage-paid card, or phone our toll-free number,

1-800-538-8157

extension 987. In California, 1-800-672-3470, extension 987.

For this special offer, please include payment with your order. You may send a check, money order, or bill it to your Mastercard or Visa account. Company PO's accepted with verification.

Offer is limited to one trial pack per customer. Good only in U.S. Customer must be 18 years or older to order.

Offer expires September 30, 1984.

Remember to ask for your free Inmac catalog. It contains over 2,500 computer supplies and accessories, many not available anywhere except through the Inmac catalog or special offers like this one.

inmac™

2465 Augustine Dr., Santa Clara, CA 95051



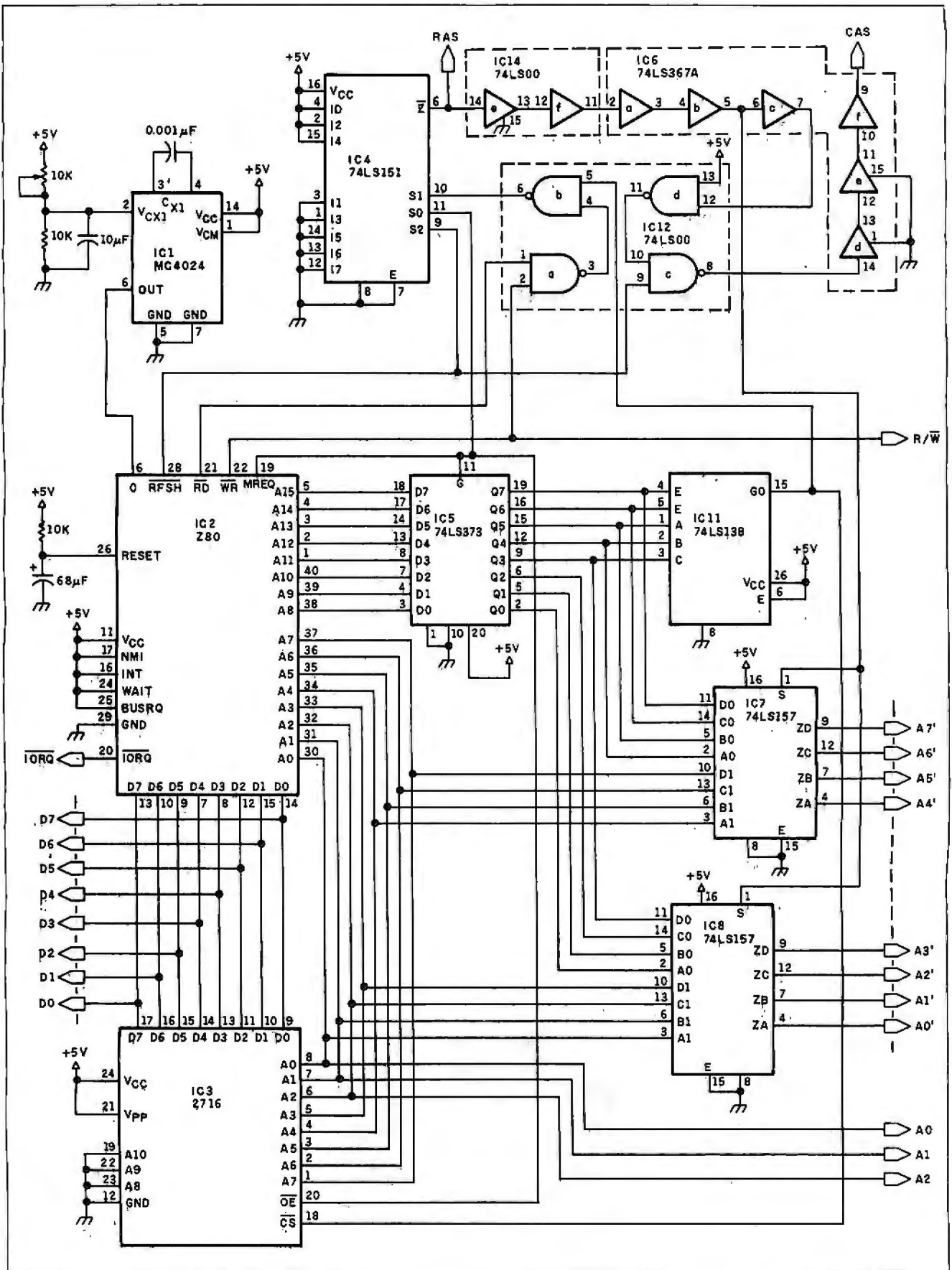
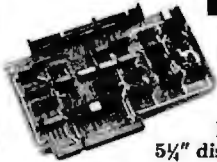

Figure 3a: This section of the printer buffer schematic shows these components of the printer buffer: the clock, the central processing unit, the EPROM, and the multiplexers. This is the control circuitry for the buffer.

ZENITH/Heath Users



Double Your
5 1/4" disk storage
capacity without adding a drive.

Get twice as much from your H88 or H89 microcomputer. Our FDC-880H floppy disk controller, in conjunction with your 5 1/4" drives, for example, expands memory capacity from 256 bytes to 512 bytes per sector.

And it handles single and double-sided, single and double-density, 8" and 5 1/4" drives — simultaneously.



C. D. R. Systems Inc.

Controlled Data Recording Systems Inc.
7210 Clairmont Mesa Blvd., San Diego, CA 92111
(619) 560-1272

Circle 55 on inquiry card.

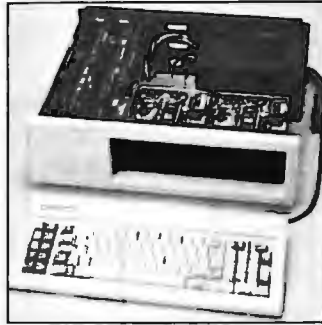

EDGE-PC: An Affordable IBM PC-Compatible System.

- PC-88 CPU card \$399
- Color/Graphic card \$189
- S-1/4" diskette adapter card \$145
- Multifunction card (64k) \$220
- Keyboard \$153
- System Enclosure \$129
- 65W Power Supply with fan box \$135

EDGE MICRO SYSTEMS, INC.
2350 WALSH AVE., SANTA CLARA, CA 95051
(408) 980-9866 TLX 3719075 EDGE UB

Circle 124 on inquiry card.

Electronic Circuit Analysis

- AC and DC analysis
- Very fast, optimized machine language
- Worst case, sensitivity analysis
- Sweep component values
- 64 Nodes
- Compare circuits
- Log or linear sweep
- Full file handling
- Full editing, error trapping
- Frequency response, magnitude and phase
- Complete manual with examples
- Transmission lines
- Complex y parameters
- Available for CP/M, MSDOS, TRSDOS
- Price - \$150.00

Tatum Labs

P.O. Box 698

Sandy Hook, CT 06482
(203) 426-2184

Circle 322 on inquiry card.

CLASSIC MEMORY CORP

Flexible Diskettes

Life Time Warranty - 100% Certified
33% Stronger Jacket Longer Life
High Density Oxide Better Performance
FREE CASE Protective Storage
Low Cost More Diskettes For Your Money

5 1/4" \$160 each SINGLE SIDE SINGLE DENSITY 48 TPI W/HUB RING Packed 10 per Soft Pack	BULK SSSD \$140 each 100/Case White Envelope W/HUB RING
5 1/4" \$189 each SINGLE SIDE DOUBLE DENSITY 48 TPI W/HUB RING Packed 10 per Soft Pack	BULK SSDD \$170 each 100/Case White Envelope W/HUB RING
5 1/4" \$247 each DOUBLE SIDE DOUBLE DENSITY 48 TPI W/HUB RING Packed 10 per Soft Pack	BULK DSSD \$225 each 100/Case White Envelope W/HUB RING

DELIVERED PRICES

Free shipping in continental USA. Call for quantity discounts. We accept money orders, certified checks, VISA and MasterCard. Personal checks accepted, but take two weeks to clear bank. N.D. add 4%.



Software Services™

1326 - 25th St. S., Suite H
Fargo, ND 58103
1-800-634-2248

Circle 303 on inquiry card.

APPLE COMPATIBLE HARDWARE

INTERFACE FOR TYPEWRITER, CENTRONICS AND WORDSTAR COMPATIBLE

Model #	Price
T1 Olivetti Praxis 30, 35, 40	\$99
T2 Olivetti Praxis 41	
T3 Silver Reed Ex 42, 43, 44 • Penman	
T4 Adler Satellite 11 and Alpha Royal 2001	
T5 Olympia Compact and Swinter 1146 CM	

INFRARED INTERFACE FOR REMOTE OPERATION WITHOUT CABLES

IRR Board, Receiver station for use with one or all	\$99
IRN Numerical Pad VisiCal compatible	\$49
IRK Full keyboard with lower case	\$129
IRC Four direction cursor control	\$29



TO ORDER CALL (408) 734-4631

or write

INTERFACE

Advanced Transducer Devices, Inc.
1287 Lawrence St. Rd., Sunnyvale, CA 94089
Additional \$2.50 per order for shipping
Calif. residents add 6 1/2% tax

Circle 17 on inquiry card.

Verbatim flexible disks

Call Free (800) 235-4137 for prices and information. Dealer inquiries invited. C.O.D. and charge cards accepted.

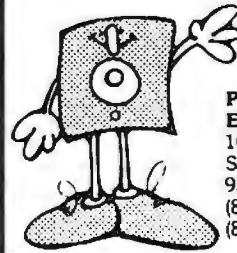

PACIFIC EXCHANGES

100 Foothill Blvd.
San Luis Obispo, CA 93401. In Cal. call (800) 592-5935 or (805) 543-1037.

Circle 248 on inquiry card.

GET ORGANIZED

WITH OUR NEW LINE OF QUALITY PRODUCTS

The "Get Organized" ergonomic chair. Features pneumatic lift and adjustable backrest. Comes in a choice of six colors — blue, red, camel, brown, light grey and charcoal grey.



\$99.95

To place your order today call anytime!

1-800-328-2977

We accept Visa and MasterCard. Add \$2.50 for shipping.

Mid America Wholesalers, Inc. Computer Accessories
8135 215 th St., Lakeville, MN 55044
Minnesota Residents Call Collect.

(612) 469-4666
Dealer inquiries invited.

6809 Single Board Computer

6809 MPU, 2 serial ports, 4 parallel ports, RAM, EPROM, real-time clock, watchdog timer, 44-pin 4.5" x 6.5" PCB
EXPANSION MODULES: RAM, EPROM, CMOS RAM/battery, analog I/O, serial I/O, parallel I/O, counter/timer, IEEE-488, EPROM programmer, floppy disks, cassette, breadboard, keyboard/display.



Wintek Corp.

1801 South Street
Lafayette, IN 47904
317-742-9428

Circle 356 on inquiry card.

EPROM PROGRAMMER KIT - MODEL 1409



- Programs, lists, reads and verifies 2508, 2516, 2532, 2564, 2758, 2716, 2732A, 2764, 27128, 68732, 68764, 68766, 8741, 8748, 9,9M
- RS 232 interface, supports XON-XOFF and/or hardware handshaking (RTS, CTS, DTR)
- Auto baud rate select (300-9600 baud)
- Accepts keyboard entry with line editing capability, ASCII, INTEL, MOTOROLA, or HEX files
- User friendly monitor for easy I/O debugging
- On board power supply
- 1409-1: PC board, Xformer, software (4KEPROM) & documentation: \$69.50
- 1409-2: 1409-1 + full set of parts: \$199.50
- 1409-3: Assembled and tested unit: \$299.50
- Communication software for IBMPC, APPLE, CP/M, TRS80: \$35.00

B&C MICROSYSTEMS

6322 Mojave Dr., San Jose, CA 95120
Tel. (408) 997-7685, Tx. 4995363

Circle 39 on inquiry card.

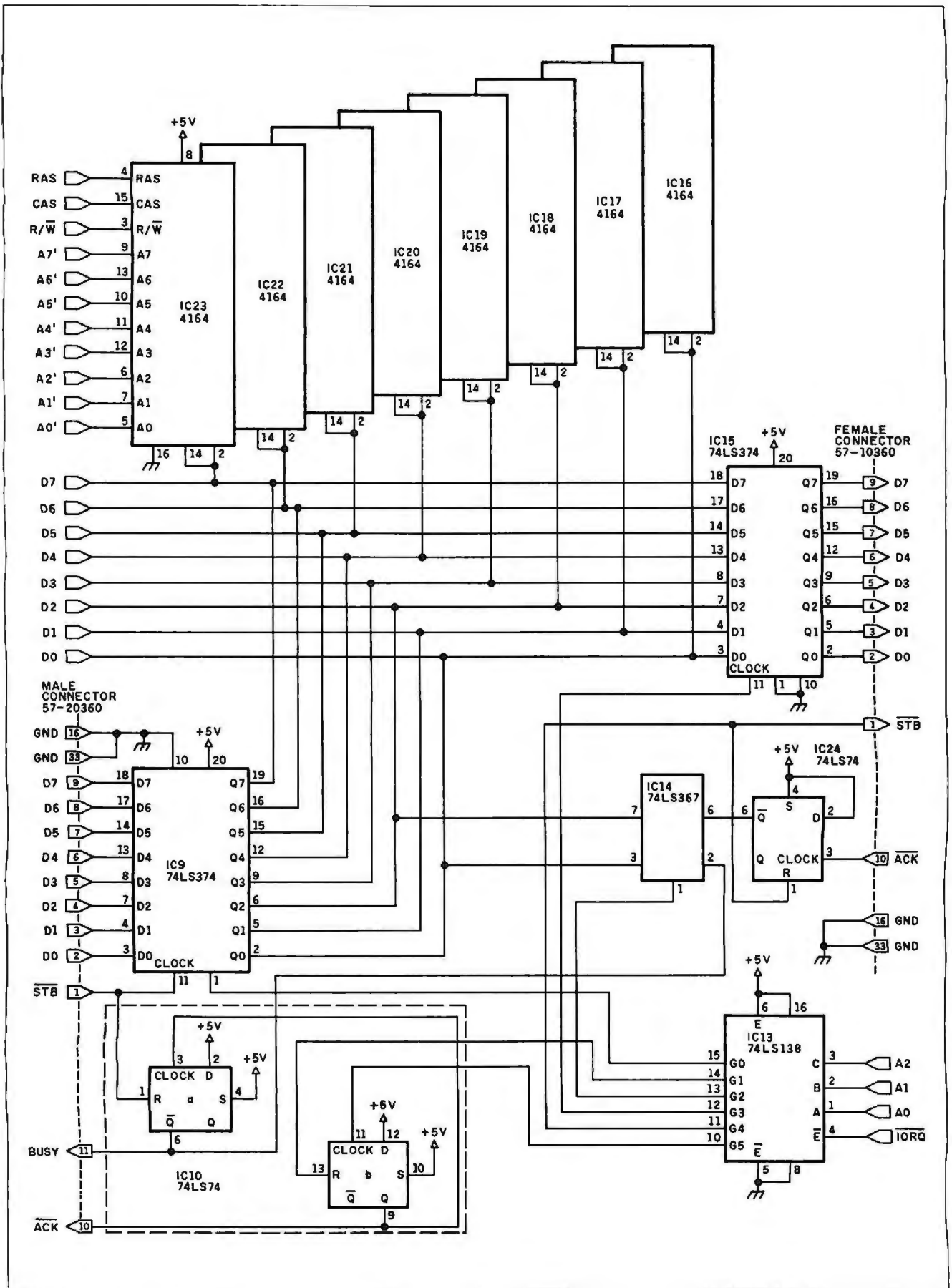

Figure 3b: This section details: the decoder, the RAM, the data latches, and the connectors for the buffer's I/O.

PRINTER BUFFER

Listing 1: This source-code listing in Z80 assembly language is the control software for the printer buffer. You will need to store the object code in a 2716 EPROM. (For more information on programming EPROMs, see "Build an Intelligent EPROM Programmer," by Steve Ciarcia, October 1981 BYTE, page 36.)

```

LINE ADDR B1 B2 B3 B4
1          : FIFO.SRC
2          :
3          : LAST REVISED: 6/23/83
4          :
5 0000     BYTEIN EQU 0       :INPUT PORT LOCATION
6 0001     ACKLO  EQU 1       :BUSY FLIP-FLOP CLEAR
7 0002     STATUS EQU 2       :EXTERNAL STATUS SIGNALS
8 0003     BYTOUT EQU 3       :OUTPUT PORT LOCATION
9 0004     STB    EQU 4       :OUTPUT PORT STROBE
10 0005    ACKHI  EQU 5       :ACKNOWLEDGE F/F CLOCK
11 0006    PRACK  EQU 6       :PRINTER'S ACKNOWLEDGE
                               F/F
12 0800     MINRAM EQU 800H    :FIRST RAM LOCATION
13 FFFF     MAXRAM EQU OFFFH   :LAST RAM LOCATION
14 0000
15 0000
16 0000
17 0000    3E FF          LD  A.OFFH  :I REG IS ON A8 -A15 DURING
18 0002    ED 4F          LD  I.A    :REFRESH.SO AVOID CHIP
                               SELECT
19 0004
20 0004
21          :CLEAR BUSY FLIP-FLOP
22 0004    03 01          OUT (ACKLO).A
23 0006    D3 05          OUT (ACKHI).A
24 0008
25          :RESET PRINTER'S ACKNOWLEDGE FLIP-FLOP
26 0008    D3 06          OUT (PRACK).A
27 000A
28          :INITIALIZE POINTERS
29 000A    01 00 08      LD  BC.MINRAM :BC HOLDS NEXT PR
30                                     :NEXT CHAR TO BE
                                     PRINTED POS
31 000D    11 00 08      LD  DE.MINRAM DE HOLDS NEXT LD
32                                     :NEXT CHAR TO BE
                                     LOADED POS
33 0010
34 0010
35          :DO
36          LOOP
37 0010
38          : IF NEXTLD+1 <> NEXTPR (IF BUFFER NOT FULL)
39 0010    62             LD  H.D
40 0011    6B             LD  L.E
41 0012    23             INC HL
42 0013    37             SCF
43 0014    3F             CCF
44 0015    ED 42          SBC HL,BC
45 0017    CA 47 00      JP  Z.FULL
46 001A
47          : IF (NEXTLD <> MAXRAM) or NEXTPR <> MINRAM)
48 001A    37             SCF
49 001B    3F             CCF
50 001C    21 FF FF      LD  HL.MAXRAM
51 001F    ED 52          SBC HL,DE
52 0021    C2 2E 00      JP  NZ.OKAY
53 0024    37             SCF
54 0025    3F             CCF
55 006 21 00 08      LD  HL.MINRAM
56 0029    ED 42          SBC HL,BC
57 002B    CA 47 00      JP  Z.FULL
58 002E

```

(listing continued on page 454)

HPBooks does computer books right.

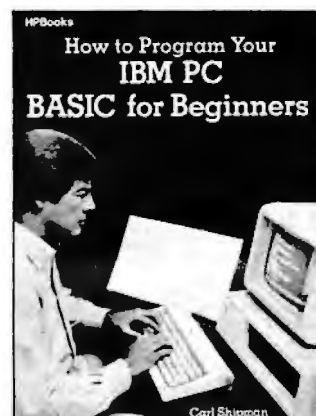

Learn BASIC the easy way and put your IBM Personal Computer to work for you. No experience necessary—this book starts at the beginning. Clear, straightforward example programs help you understand how programs work and how your computer works. You'll learn the basics of BASIC: How to write and use loops. Build and use arrays. Edit and improve programs. Find and fix problems. Covers math operations, strings, storing data on disk. How to display charts and tables, print out data, and more. Write programs to fit your needs exactly. Learn at your own pace and master your IBM PC! 192 pages. \$14.95 ringbound.

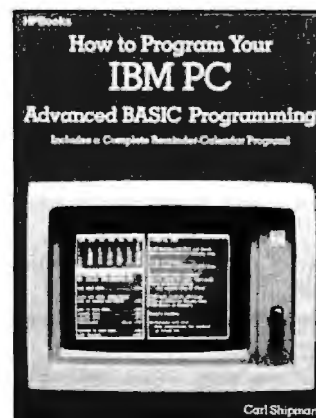

Put your ideas into practice. Short, simple program segments explain and demonstrate an amazing variety of clever programming techniques in BASIC. These segments fit together to make a complete reminder-calendar program to schedule appointments and store data. Learn how to plan your program. Make menus to control program flow. Set up professional-quality screen displays. Input data from keyboard and disk. Create, change and use disk files. How to use arrays to hold and manipulate data. Write successful error traps. How to use a printer, and much more. 272 pages. \$14.95 ringbound.

Purchase these and other fine HPBooks computer guides at your local bookstore or computer outlet, or call:
Toll Free 800/528-4923.
 Or send check or money order for price of book, plus \$1.95 p/h for each book to address below. Allow 4-6 weeks delivery.

HPBooks®
 Box 5367,
 Dept. BYT-64,
 Tucson, AZ 85703

APPLEWARE, INC.
The Apple Users Group[®] Software Library

For the first time enjoy your Apple to its fullest capacity using specially packed disks with over 60 outstanding programs each (not available from any other source)

Each packed disk includes an extensive variety of interesting, useful and entertaining programs indispensable to all computerists! Mixed category packed disks include:

BUSINESS • EDUCATIONAL • DATA BASE • GAMES • UTILITIES • SCIENCE • MUSIC • GRAPHICS • FINANCE

Library Disks I, II and III are mixed categories. Single category disks are **GAMES • UTILITIES • GRAPHICS • INTEGER • SCIENCE • TECH • MUSIC & AUDIO**

Individual disks available at \$59.95 each

Order direct from this ad and Save up to \$150. Buy Library Disks I, II and III and get a special bonus disk FREE over 250 programs for \$179.95 + \$4 shipping. BUT for the Best Value, receive any 9 disks featuring over 600 of our best programs for only \$54 each for a package price of \$389. Certified Postage plus handling paid!

*Send one-time membership fee of \$15. (no fee charged to institutions) for 1000+ program catalog and gain access to a library of over 10,000 programs at a special 18% discount (Foreign memberships \$28. U.S.)

For Orders Only Call now
TOLL FREE: 1-800-327-8684
 Florida: 1-305-887-8685

Or Write:
Appleware, Inc.
8400 Hayes Street
Hollywood, Fla. 33024

Program Disks compatible with Apple II, II+, IIx, III Emul., Franklin Ace and IBM Quad



Circle 33 on inquiry card.

PRINTER RIBBONS

	PRICE	PER RIBBON	PER DOZEN
ANADIX 9500	13.50	147.00
APPLE DMP	5.95	68.40
CENTRONICS 150/152	7.00	81.00
C. ITOH PROWRITER	5.95	68.40
COMMODORE PET 8023P	7.00	81.00
EPSON MX-FX 70/80	5.25	60.00
EPSON MX-FX 100	9.95	108.00
GEMINI - 10	2.50	27.00
IBM HARMONICA 1/2"	6.75	78.00
IBM HARMONICA 3/4"	7.95	92.40
IDS MICROPRISM - 480	6.00	69.00
IDS PAPER TIGER 460/560	6.75	78.00
IDS PRISM	7.95	92.40
NEC - 3500 M/S S/S/C	6.95	80.40
NEC - 3500 NYLON	9.75	114.00
NEC - PC 8023A	5.95	68.40
OKIDATA 80/82/83/92	2.50	27.00
OKIDATA - 84	5.00	57.00
RADIO SHACK D.W. II NYLON	6.75	78.00
RADIO SHACK DMP - 2100	7.50	87.00
RADIO SHACK LP VI & VIII	6.00	69.00
SILVER REED EX55 S/S	5.00	57.00
SILVER REED EX55 - NYLON	9.00	105.00
TOSHIBA - 1350	7.50	87.00
XEROX 810/620 M/S	7.75	84.00

Add \$2.00 Shipping — To Order Call
 (313) 569-3218 or Write for our Catalog
DWIGHT COMPANY, INC.
 15565 Northland Drive - West Tower
 Southfield, Michigan 48075-6496

Circle 119 on Inquiry card.

GILTRONIX SWITCHES ARE THE BEST CHOICE.

... and here are 10 good reasons why:

IBM PC	APPLE
1. Serial (RS232) or Parallel (Centronics)	7. F.C.C. Approved Units
2. Prompt Deliveries	8. Manual and Automatic Units
3. Nationally Advertised Products	9. Highest Quality PC Board Switch Technology
4. Broad Product Line	10. Buy Direct From Giltronix, or From Any Authorized Distributor
5. Over 30,000 Units Sold to Date	
6. Sales and Technical Support	

Manual Units—2 to 6 Ports
 Automatic Units—3 to 15 Ports

Apple is a registered trademark of Apple Computer, Inc.
 IBM is a registered trademark of International Business Machines Corporation.



3780 Fabian Way
 Palo Alto, CA 94303
 (415) 493-1300

ORDER HOT-LINE: 1-800-531-1300 (Outside of California)

Circle 147 on inquiry card.

PRINTER BUFFER

(listing continued from page 453)

59					IF CHARACTER RECEIVED
60	002E	DB 02		OKAY	IN A.(STATUS)
61	0030	E6 01			AND 01H
62	0032	CA 47 00			JP Z.NOCHAR
63	0035				
64					GET CHARACTER
65	0035	DB 00			IN A.(BYTEIN)
66	0037				
67					SEND ACKNOWLEDGE
68	0037	D3 01			OUT (ACKLO).A
69	0039	00			NOP
70	003A	00			NOP
71	003B	D3 05			OUT (ACKHI).A
72	003D				
73					SAVE CHARACTER IN RAM
74	003D	12			LD (DE).A
75	003E				
76					INCREMENT NEXTLD POINTER
77	003E	13			INC DE
78	003F				
79					IF NEXTLD POINTER OVERFLOWED
80	003F	7A			LD A.D
81	0040	63			OR E
82	0041	02 47 00			JP NZ.ENDIF1
83	0044				
84					NEXTLD = MINRAM
85	0044	11 00 08			LD DE.MINRAM
86	0047				
87					ENDIF
88	0047				ENDIF1
89	0047				
90					ENDIF
91					ENDIF
92					ENDIF
93	0047				FULL
94	0047				NOCHAR
95	0047				
96					IF BUFFER NOT EMPTY (NEXTLD <> NEXTPR)
97	0047	62			LD H.D
98	0048	6B			LD L.E
99	0049	37			SCF
100	004A	3F			COF
101	004B	ED 42			SBC HL.BC
102	004D	CA 65 00			JP Z.EMPTY
103	0050				
104					IF PRINTER READY
105	0050	DB 02			IN A.(STATUS)
106	0052	E6 04			AND 04H
107	0054	C2 65 00			JP NZ.BUSY
108	0057				
109					SEND CHARACTER
110	0057	0A			LD A.(BC)
111	0058	D3 03			OUT (BYTOUT).A
112	005A				
113					SEND STROBE
114	005A	D3 04			OUT (STB).A
115	005C				
116					INCREMENT NEXTPR POINTER
117	005C	03			INC BC
118	005D				
119					IF NEXTPR POINTER OVERFLOWED
120	005D	78			LD A.B
121	005E	B1			OR C
122	005F	C2 65 00			JP NZ, ENDIF2
123	0062				
124					NEXTPR = MINRAM
125	0062	01 00 08			LD BC.MINRAM
126	0065				
127					ENDIF

(listing continued on page 455)

PRINTER BUFFER

(listing continued from page 454)

```

128 0065      ENDIF2
129 0065      : ENDIF
130           : ENDIF
131 0065      BUSY
132 0065      : ENDIF
133           : ENDIF
134 0065      EMPTY
135 0065      : ENDIF
136           : ENDDO
137 0065 03 10 00  JP LOOP
138 0068      END

```

(4a)

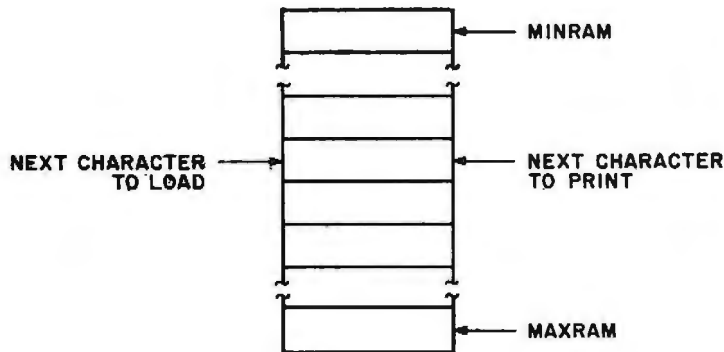

(4b)

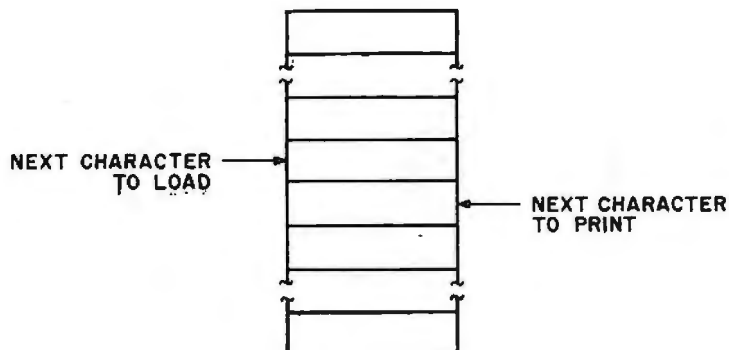

(4c)

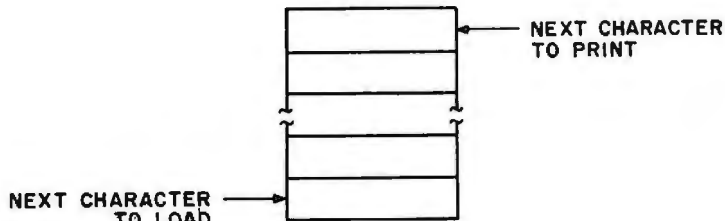
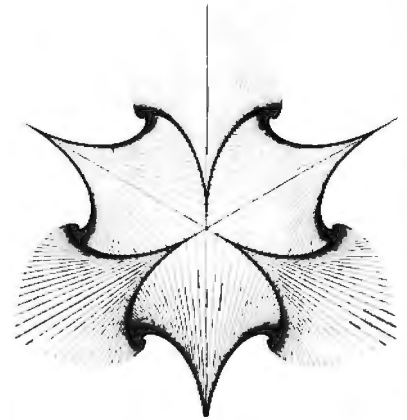

Figure 4: These diagrams show how the control software determines where to load the next character into RAM. In 4a, both pointers are equal, which indicates that the buffer is empty. In 4b, the next load position is one address less than the next print position, which means that the buffer is full. Figure 4c is a special case of the buffer-full condition in which one must compensate for the "wraparound" effect (see text).



V-GRAPH TEKTRONIX 4010 GRAPHIC EMULATOR FOR YOUR PERSONAL COMPUTER

V-GRAPH is your link into the world of powerful, high resolution graphics. Now your personal computer can act as a Tektronix 4010 terminal.

Not just an emulator, V-GRAPH can save graphics and text on disk and replay or print it later without reconnecting to the host computer.

V-GRAPH provides an equivalent for every function found on the Tektronix, including the cross-hair cursor used for graphic input. Plus, control and function keys may be programmed to emit commonly used character strings - saving you time with logon sequences and host computer commands.

V-GRAPH supports the highest resolution possible, and is currently available for the IBM PC, Zenith Z-100 and Victor 9000. Requires 64K of memory and MS-DOS. \$120

*Your link into the world
of high-resolution
graphics*

CompuView
PRODUCTS, INC.

1955 Pauline, Ann Arbor, Mi48103
Telephone (313) 996-1299

(text continued from page 448)

to check is to see if there is room in RAM to store the character. If the buffer is full, then this section of code is skipped. The section will eventually be executed and, from the host computer's point of view, it will look like the buffer is taking a lot of time to respond (the way a printer handshakes). Assuming

the buffer is not full, a check is made to see if a character has been sent. If no character has been loaded, then there is nothing to do but jump to the output section. When a character is in the input latch, it is input, the ACK signal is sent to the host computer, the character is stored in RAM, and the load-position pointer is incremented. The

pointer is checked for overflow. Upon overflow the load position is set to the start of RAM at location MINRAM.

When the input section is complete, the output section begins. The output portion only cares about the buffer-empty condition. Checks are made for buffer-empty and printer-not-ready conditions. If either condition exists, execution returns to the input routine. If the printer is ready, a character is sent to the output latch. The data strobe is sent to the printer. The next print location pointer is incremented and the overflow check is made as it was on the other pointer. The loop then starts over.

PRINTER BUFFER PERFORMANCE

This printer buffer has been successfully used on an Apple computer using an Apple interface card connected to an Epson MX-80 printer. It has also been used with my home-built parallel-port card tied to my Okidata Microline 82A printer. Other printers might require some minor handshaking changes but any Centronics-compatible interface should work well.

As for speed, I can't believe I ever lived without it. It is comparable to changing from cassette tape to disk storage. I wrote a BASIC program to fill the buffer, and it took about 2 minutes to execute. When program execution ended, the printer was still on the first page. It is also a joy to use during program debugging when most lines are short and the printer executes carriage returns slowly.

This article is over 15,000 characters long. My computer put it out to the printer buffer in only 17 seconds. My printer, at the relatively fast speed of 120 characters per second, took over 3 minutes to print it out.

OPERATIONAL ENHANCEMENTS

Because it is software programmable, this printer buffer can be greatly enhanced. For example, you could add a stop-on-form-feed switch for single-sheet printers. I would like to add a line-counting routine to automatically form-feed the paper so program listings don't come out on page edges. Another option would be to change the interface from parallel to serial for printers requiring that format. This would be fairly easy if the rest of the system remained the same. ■

PERFORMANCE, RELIABILITY AND LOW COST!

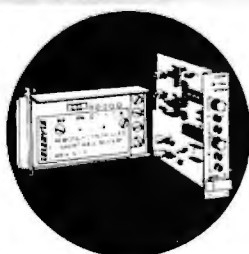

SHORT HAUL MODEMS (ASYNC & SYNC)

- 300 BAUD TO 19.2K BAUD FULL DUPLEX • 1 to 10 MILES ON TWO TWISTED PAIR • SWITCHABLE DTE-DCE • W/WO DTR/DCD HANDSHAKE • W/WO SIGNAL INDICATORS • OPTICALLY ISOLATED • STANDALONE & RACK MOUNTED • SELF/HOST POWERED • MALE/FEMALE CONNECTORS • DEC VT100 VERSION • STANDALONE UNIT 3.5" x 2.2" x 1" • CUSTOM REQUIREMENTS INVITED

INTERFACE CONVERTERS

- RS-232 TO RS-422: FOUR BI DIRECTIONAL SIGNALS • 100K BAUD @ 4K' - 9600 BAUD @ 3 MI. • STANDALONE UNIT: 3.5" x 2.2" x 1" • CUSTOM REQUIREMENTS INVITED
- RS-232 TO CURRENT LOOP: SWITCHABLE STATES & MODES • STANDALONE & RACK MOUNTED • STANDALONE UNIT: 3.5" x 2.2" x 1" • CUSTOM REQUIREMENTS INVITED

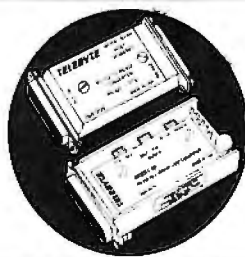

DATA COMM AIDS (RS-232 & CENTRONICS)

- PATCH BOXES • DATA LINE MONITORS • STUNT BOXES • BREAKOUT BOXES • GENDER CHANGERS • SURGE PROTECTORS • FULLY SHIELDED CABLES • CENTRONICS A-B SWITCH • CUSTOM REQUIREMENTS INVITED

DEALERS AND DISTRIBUTORS WANTED

TELEBYTE
TECHNOLOGY, INC

REMARK DATACOM DIVISION

A PUBLIC COMPANY

148 New York Ave., Halesite, N.Y. 11743 / (516) 423-3232 / TWX-510-226-0449

SPREADSHEET

CPM / 80 MACRO ASSEMBLERS

(listing continued from page 156)

```

1850 PRINT FNCS(HP%,VP%)WS(2)" > "FNCS(HP%+L%(HZ%)+1,VP%)" < "WS(3):RETURN
1851 '
1852 ' delete left bracket
1860 PRINT FNCS(HP%,VP%)" "":RETURN
1861 '
1862 ' delete right bracket
1870 PRINT FNCS(HP%+L%(HZ%)+1,VP%)" "":RETURN
1894 '
1895 '          print values in bottom lines
1896 '          #####
1897 ' HZ%=horizontal field number. I.e. # of field where the brackets are positioned (1 to 7)
1898 ' VP%=vertical position of brackets on CRT screen (2 to 16)
1899 '
1900 IF TP%(HZ%)=0 THEN PRINT FNCS(22,20)"text " ELSE PRINT FNCS(22,20)"numeric"
1920 GOSUB 300:PRINT FNCS(22,21)WS(1)FNCS(22,21)ARRS(P%,HZ%)
1950 PRINT FNCS(57,20)HZ% FNCS(71,20)VP%-(OFS%-1):RETURN
1995 '
1996 '          #####
1997 '          Calculate percentage
1998 '          #####
1999 '
2000 IF TOT#=0 THEN GOSUB 950:PRINT"Operation not allowed "WS(3):GOSUB 57000:
RETURN
2020 GOSUB 750:GOSUB 2500:FOR I%=1 TO MAX%:IF ARRS(I%,2)=" " THEN I%=MAX%
ELSE PERC(I%)=VAL(ARRS(I%,NN%))*100/TOT#
2040 NEXT I%:GOSUB 900:RETURN
2095 '
2096 '          #####
2097 '          Display percentage values
2098 '          #####
2100 GOSUB 350:FOR P%=VMIN% TO VMAX%:IF ARRS(P%,2)=" " THEN P%=VMAX%
ELSE GOSUB 320:PRINT FNCS(PQ%(NN%)+15,PS%)USING"###.###":PERC(P%)
2120 NEXT P%:RETURN
2495 '
2496 '          #####
2497 '          Calculate total
2498 '          #####
2499 '
2500 TOT#=0:FOR I%=1 TO MAX%:IF ARRS(I%,2)=" " THEN I%=MAX%
ELSE TOT#+=TOT#+VAL(ARRS(I%,NN%))
2520 NEXT I%:RETURN
4995 '
4996 '          #####
4997 '          Zero array & fill 1st column
4998 '          #####
4999 '
5000 GOSUB 750:FOR I%=1 TO MAX%:ARRS(I%,1)=RIGHT$(STR$(I%),LEN$(STR$(I%))-1)
5020 IF ARRS(I%,1)%>">" THEN FOR J%=2 TO NN%:ARRS(I%,J%)=" "":NEXT J%
5040 NEXT I%:GOSUB 900:RETURN
5095 '
5096 '          #####
5097 '          build/edit estimate
5098 '          #####
5099 '
6000 PRINT WS(0):GOSUB 5000: ' <— zero array
6015 '
6016 ' Initialize screen variables :SCR%=screen number DS=scratch string
6017 ' VMIN%=# of first array line to be printed
6018 ' HP%=abscissa, i.e. distance from leftmost CRT column
6019 ' HZ%=field # VP%=current vertical position of secondary cursor
6020 VMIN%=1:HP%=0:HZ%=1:VP%=OFS%:DS=" "":SCR%=0
6040 GOSUB 1400:GOSUB 1800:' <— display top & bottom titles
6060 GOSUB 1000:GOSUB 1500:' <— display array, if existing
6080 GOSUB 1850:GOSUB 1900:' <— print secondary cursor information
6100 PRINT FNCS(22,22)WS(2)STRINGS(L%(HZ%),95)WS(3)WS(1)FNCS(22,22)" "":
<— print dashes for input
6200 GOSUB 730:' <— Wait for cursor control code or command
6218 '

```

(listing continued on page 458)

We've been selling these industrial-quality assemblers to the development system market since 1978. They are now available for the CP/M market.

FEATURES:

- Fully relocatable
- Separate code, data, stack, memory segments
- Linker included
- Generate appropriate HEX or S-record formatted object file
- Macro capability
- Most 5¼" and 8" diskette formats supported
- Conditional assembly
- Cross reference
- Supports manufacturer's mnemonics
- Expanded list of directives
- 1 year free update

Assemblers now available include:

Chip	Price	Chip	Price
1802/1805	\$495	8085	\$495
8051	495	NSC800	495
6500/01/02	495	F8,3870	495
6800/01/02	495	Z8	495
6803/08	495	Z80	395
6804	495	9900/9995	595
6805	495	Z8000	695
6809	495	68000	695
6811	495		

Take advantage of leading-edge technology. Get your own Relms assembler today. Use your Master-card or order by phone: (408) 729-3011.

Or call toll free (800) 448-4880

Relational Memory Systems, Inc.
1650-B Berryessa Road
San Jose, CA 95133-1082
TWX: 910-379-0014

65 different diskette formats available. A signed object Code License Agreement required prior to shipping. Prices subject to change without notice. Software distributor inquiries invited.

relms®

BASF DISKETTES

BASF Diskettes at competitive price. Call TOLL FREE (800) 235-4137 for prices and information. Visa and Master Card accepted.

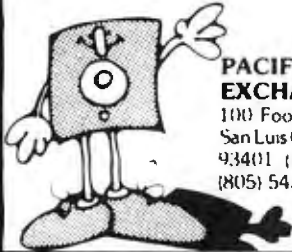

PACIFIC EXCHANGES
100 Foothill Blvd
San Luis Obispo, CA
93401 (In Cal call
(805) 543-1037)

Circle 248 on inquiry card.

6 times faster

Super Fast Z80 Assembly Language Development Package

Z80ASM

- Over 6000 line/minute
- Generates COM, HEX, or REL files
- Cross-Reference
- Zilog mnemonics
- Time and Date in listing
- Long labels

SLRANK

- One or two pass operation
- Cross-reference
- COM or HEX output
- Flexible address control

Most formats available for Z80 CP/M, CDOS, and TURBODOS

\$199.95

SLR Systems

For more information or to order, call:
1-800-833-3081 in Pa., (412) 282-0864
1622 North Main Street, Butler, PA 16001
VISA or MasterCard

Circle 297 on inquiry card.

**THE OFFICIAL
NUMBER TO CALL
TO FIND OUT
MORE ABOUT
THE UNOFFICIAL
APPLE LOGO:
617-492-8816**

Terrapin™
The Logo People

Terrapin, Inc., 380 Green Street,
Cambridge, MA 02139, (617) 492-8816

Circle 330 on inquiry card.

SPREADSHEET

(listing continued from page 457)

```

6219 * a new value has been entered — display it and recalculate if necessary
6220 IF (T%=13 AND LEN(DS)>0) THEN GOSUB 1300:DS=" " :GOTO 6080
6233 *
6234 *          #####
6235 *          2nd cursor routines
6236 *          #####
6237 *
6238 * a single carriage return has been entered
6239 * move brackets right or down depending on status of variable RD%
6240 IF (T%=13 AND DS=" ") THEN IF RD% THEN 7000 ELSE 6900
6258 *
6259 * move brackets down (^X) or left (^S) or up (^E)
6260 IF T%=24 THEN 7000 ELSE IF T%=19 THEN 7100 ELSE IF T%=5 THEN 7200
6278 *
6279 * wait for next command after entering a semicolon or go down to next row (^Z)
6280 IF T%=59 THEN 7400 ELSE IF T%=4 THEN 6900 ELSE IF T%=26 THEN 7250
6297 *
6298 * backspace one character if rubout or left arrow has been hit or
6299 * interpret character as new value and print it
6300 IF T%=127 OR T%=8 THEN GOSUB 400:GOTO 6200 ELSE IF T%>31 THEN 7300
6318 *
6319 * wrong key
6320 PRINT BLS::GOTO 6200
6898 *
6899 * move brackets right
6900 IF HZ%=NN% THEN 7250 ELSE GOSUB 1860:HZ%=HZ%+1:HP%=HP%+1:(HZ%-1)
+1:GOTO 6080
6991 *
6992 * move brackets down, displaying next screen if necessary
7000 GOSUB 300:IF P%=MAX% THEN 7990 ELSE IF P%=VMAX% AND P%<MAX% THEN
VP%=OFS%:GOTO 7500
7040 GOSUB 1860:GOSUB 1870:VP%=VP%+1:GOTO 6080
7091 *
7092 * move brackets left
7100 IF HZ%=1 THEN 7990 ELSE GOSUB 1870:HZ%=HZ%-1:HP%=HP%-(L%(HZ%)+1):
GOTO 6080
7191 *
7192 * move brackets up, displaying previous screen if necessary
7200 GOSUB 300:IF VP%=OFS% and VMIN%=1 THEN 7990 ELSE IF VP%=OFS% AND
SCR%>0 THEN VP%=GAP%+OFS%-1:GOTO 7600
7241 *
7242 * move brackets to next row, displaying next screen if already at bottom
7250 GOSUB 300:IF P%=MAX% THEN 7990 ELSE GOSUB 1860:GOSUB 1870:HZ%=1:
HP%=0
7260 IF P%=VMAX% AND P%<MAX% THEN VP%=OFS%:GOTO 7500 ELSE VP%=VP%+1:
GOTO 6080
7291 *
7292 *          #####
7293 *          Build up new value for single cell of array
7294 *          #####
7295 *
7300 IF TP%(HZ%)AND(CS<" "OR CS>" "OR CS=" ")THEN 7990
7320 DS=DS+CS:PRINT CS:IF LEN(DS)>L%(HZ%) THEN GOSUB 400:GOTO 7990 ELSE
6200
7391 *
7392 *          #####
7393 *          process command
7394 *          #####
7395 *
7400 GOSUB 950:PRINT V05::GOSUB 730:GOSUB 900:IF CS=" " THEN 6100
7420 T%=INSTR("HNP%YOIDMQ",CS):IF T%=0 THEN 7490 ELSE IF T%=10 THEN RETURN
7440 ON T% GOTO 7900,7500,7600,9000,8200,8400,9300,9400,9500
7481 *
7482 * wrong command
7490 PRINT BLS::GOTO 6100
7491 *
7492 * N=display next page
7500 IF VMAX%>=MAX% THEN 7490 ELSE GOSUB 250:VMIN%=VMIN%+GAP%:SCR%=
SCR%+1:GOSUB 1000:GOSUB 300:GOTO 6080

```

SPREADSHEET

```

7591 *
7592 * P=display previous page
7600 IF VMIN%=1 THEN 7490 ELSE GOSUB 250:VMIN%=VMIN%-GAP%:SCR%=SCR%-1:
      GOSUB 1000:GOTO 6080
7891 *
7892 * H=display command menu
7900 PRINT FNCS(0.18)"-----cursor movements-----|-----commands (; followed by)-----"WS(1)
7920 PRINT FNCS(0.19)WS(2)"      ^E=up          | N=next page P=previous page "WS(1)
7930 PRINT FNCS(0.20)"      ^S=left ^D=right    | %=calc. percent Y=print"WS(1)
7940 PRINT FNCS(0.21)"      ^X=down          | O=order      Q=quit"WS(1)
7950 PRINT FNCS(0.22)"      ^Z=next row  CR=right/down
      | D=delete row I=insert row"WS(1)
7960 PRINT FNCS(0.23)"      | M=modify paging parameters"WS(3):
7970 GOSUB 5900:PRINT FNCS(0.23)WS(1)::GOSUB 1800:GOSUB 1500:GOSUB 1600:
      GOSUB 1900:GOTO 6100
7981 *
7982 * the screen limits have been reached
7990 PRINT BLS::GOTO 6200
8195 *
8196 * Y=print estimate on hardcopy device
8200 GOSUB 2000:NOL%=0:PG%=1:GOSUB 8750:GOSUB 8850
8220 FOR I%=1 TO MAX%:IF ARRS(I%,2)="" THEN I%=MAX%:GOTO 8300 ELSE T%=0
8240 FOR J%=1 TO NN%:T%=T%+L%(J%-1)+1:IF TP%(J%)THEN LPRINT TAB(T%+1)USING
      MSKS(I%):VAL(ARRS(I%,J%)): ELSE LPRINT TAB(T%+1)USING MSKS(I%):ARRS(I%,J%):
8260 NEXT J%:LPRINT TAB(PO%(7)+1)USING"###.###":PERC(I%)
8280 GOSUB 9200:IF QT% THEN I%=MAX%
8300 NEXT I%:IF QT%=0 THEN GOSUB 8900:GOSUB 9240
8320 GOTO 6080
8397 *
8399 * O=toggle order (left/right or top/bottom)
8400 RD%=NOT RD%:GOSUB 1820:GOTO 6080
8747 *
8748 * check if printer is turned on
8750 GOSUB 950:PRINT"Turn printer on & hit <space> to continue":GOSUB 710:IF
      T%<>32 THEN 8750
8798 *
8799 * & print centered title(s)
8800 GOSUB 950:PRINT"Title > ":GOSUB 700:IF CS="" THEN RETURN ELSE LPRINT
      TAB((80-LEN(CS))/2)CS:NOL%=NOL%+1:GOTO 8800
8847 *
8848 * Print top title
8850 LPRINT T1S:LPRINT T2S:NOL%=NOL%+2:RETURN
8898 *
8899 * Print total
8900 LPRINT TAB(PO%(7))STRINGS(13,45):LPRINT"Total----->>>TAB(PO%(7))USING
      MSKS(7):TOT#:LPRINT TAB(PO%(7))STRINGS(13,45):RETURN
8998 *
8999 * %=calculate percentage
9000 GOSUB 2000:GOSUB 2100:GOTO 6080
9198 *
9199 * Count # of lines printed on hardcopy device
9200 NOL%=NOL%+1:IF MXL%=0 OR NOL%<MXL% THEN RETURN ELSE GOSUB 9220:
      IF QT% THEN RETURN ELSE GOSUB 8850:RETURN
9219 * Print page #
9220 LPRINT:LPRINT:LPRINT TAB(35)"Page #":PG%:LPRINT:LPRINT:GOSUB 5900:NOL%=0:
      PG%=PG%+1:RETURN
9239 * Print page # on last sheet
9240 IF MXL%>0 OR NOL%<MXL% THEN FOR I%=1 TO MXL%-NOL%:LPRINT:NEXT:
      GOSUB 9220
9260 RETURN
9297 *
9298 * I=insert new row
9300 GOSUB 5800:GOSUB 900:IF QT%=0 THEN 6080 ELSE GOSUB 300:GOSUB 6190:IF
      P%>CNT% THEN 7490 ELSE I%=CNT%
9320 WHILE I%>P%:ARRS(I%+1,1)=RIGHT$(STR$(I%+1))-1:FOR J%=2 TO NN%:
      ARRS(I%+1,J%)=ARRS(I%,J%):NEXT J%:I%=I%-1:WEND
9340 ARRS(P%,1)=RIGHT$(STR$(P%),LEN(STR$(P%))-1):FOR J%=2 TO
      NN%:ARRS(P%,J%)="" :NEXT J%
9360 GOSUB 250:GOSUB 1000:GOTO 6080
  
```

(listing continued on page 460)

Scotch Diskettes

Rely on Scotch® diskettes to keep your valuable data safe. Dependable Scotch diskettes are tested and guaranteed error-free. The low abrasivity saves your read/write heads. They're compatible with most diskette drives.



(800)235-4137

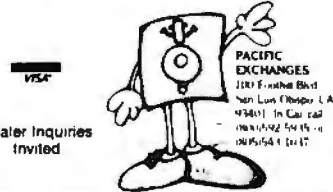

Dealer Inquiries Invited

Circle 248 on inquiry card.

WE SELL WHAT YOU NEED... NOT JUST WHAT WE STOCK. PLUS... LOW PRICES, TECH SUPPORT AND RELIABILITY.

DISKETTES	3M	MEMOREX
SSDD - 8 IN	\$2.20/50	\$2.35/100
SSDD - 8 IN	\$2.70/50	\$3.05/100
SSDD - 5 1/4 IN	\$2.10/50	\$2.10/100
DSDD - 5 1/4 IN	\$2.85/50	\$2.85/100
DSDD - 98 TPI 5 1/4 IN	\$4.30/50	\$4.45/100

PLASTIC STORAGE BOX WITH KEY FOR 100 DISKETTES ... \$24.00

TAPES AND CARTRIDGES (DM)		
DC100A	\$16.20/1-10	\$14.10/10-
DC300XL	\$24.75/1-10	\$21.50/10-
2400 FT TAPE SEAL	\$15.00/10-50	\$14.35/50-
BLACK WATCH		
2400 FT TAPE SEAL	\$16.25/10-50	\$15.60/50-

WINCHESTER DRIVES	
10MB (FORMATTED)	\$535
15MB (FORMATTED)	\$750
20MB (FORMATTED)	\$980
32MB (FORMATTED)	\$1155

FLOPPY DRIVES	INTERNAL	EXTERNAL
IBM/RADIO SHACK S. SIDE	\$195	\$255
IBM/RADIO SHACK O. SIDE	\$245	\$335
APPLE		\$210

HARD DISK SUBSYSTEMS	5MB	10MB	15MB
APPLE	\$1250	\$1450	\$1650
IBM	\$1300	\$1500	\$1700

Met-Chem
Met-Chem International Corporation
2811 Dixwell Avenue, Hamden, Conn. 06518
Phone: (203) 248-3212 or 1-800-638-2436

Circle 210 on inquiry card.

FREE SOFTWARE

RENT THE PUBLIC DOMAIN!

User Group Software isn't copyrighted, so no fees to pay! 1000's of CP/M and IBM software programs in .COM and source code to copy yourself! Games, business, utilities! All FREE!

CP/M USERS GROUP LIBRARY
Volumes 1-92, 46 disks rental - \$45

SIG/M USERS GROUP LIBRARY
Volumes 1-90, 46 disks rental - \$40

Volumes 91-162, 30 disks rental - \$45
SPECIAL! Rent all SIG/M volumes for \$80

MOST FORMATS AVAILABLE! SPECIFY.

IBM PC-SIG (PC-DOS) LIBRARY
Volumes 1-135, 5 1/4" disks \$135

Public Domain User Group Catalog Disk \$5 pp. (CP/M only) (payment in advance, please)
Rental is for 7 days after receipt, 3 days grace to return. Use credit card, no disk deposit.

Shipping, handling & insurance - \$7.50 per library.
(619) 941-0926 Information,

(619) 727-1015 anytime order machine
Have your credit card ready!
Public Domain Software Center



P.J.S. Co.
1062 Taylor St.
Vista, CA 92083



Circle 255 on inquiry card.

HOFACKER

Books • Software • Hardware Add-Ons • for your ATARI 600XL/800 XL, Commodore 64, VIC 20, Sinclair, Timex, Apple II, Osborne-O/S!

- BOOKS for ATARI 400/800XL/800XL SOFTWARE IN MACHINE LANGUAGE FOR ATARI:**
- ATARI BASIC - Learning by Using**
An excellent book for the beginner. Many short programs and learning exercises. All important features of the ATARI computers are described (screen changes, special sounds, keys, paddles, joystick), specialized screen routines, graphics, sound applications, peeks, sockets and special I/O!
Order-No. 164 \$7.95
 - Small Business Software for all ATARI computers**
SUFERMAIL (500 addresses on 1 disk) Completely written in FORTH. Comes on softdisk disk. No cartridge, no DOS, no FORTH language required.
Order-No. 7212 \$49.00
 - SUPERINVENTORY (1000 items priced)**
Completely written in FORTH. Same as above (Disk only).
Order-No. 7220 \$49.00
 - BUSPACK-1 (written in FORTH)**
Complete order entry, inventory, making and invoicing (Disk only).
Order-No. 7213 \$99.00
 - ATASAS**
Convert your ATARI 800 into a powerful cash register (Disk only).
Order-No. 7253 \$49.95
 - Inventory program in BASIC**
Order-No. 7281 (CI) \$29.95
Order-No. 7290 (DI) \$39.95
 - Marketing List in BASIC**
Order-No. 7212 (CI) \$19.95
Order-No. 7212 (DI) \$24.95
 - Inventory program in BASIC**
Order-No. 7214 (CI) \$19.95
Order-No. 7218 (DI) \$24.95
- Dealer and Distributor inquiries are invited.**
EBCOMP PUBLISHING, INC.
55 Rockport Lane
Pawnee, CA 91766
Phone: (714) 823-8214, Telex: 29 81 81

Circle 125 on inquiry card.



Solve your disc problems, buy 100% surface tested Dyan diskettes. All orders shipped from stock, within 24 hours. Call toll FREE (800) 235-4137 for prices and information. Visa and Master Card accepted.



PACIFIC EXCHANGES
100 Foothill Blvd.
San Luis Obispo, CA
93401 (In Cal call
(805) 543-1037.)

Circle 248 on inquiry card.

The Statistician

CPM IBM-PC
TRS-DOS XENIX

- Multiple Regression
- Stepwise Ridge
- All Subsets
- Backward Elimination
- Time Series Analysis
- Descriptive Statistics
- Transformations
- Survey Research
- Nonparametrics
- XY Plots
- ANOVA
- Random Samples
- Data Base
- Search & sort
- Hypothesis tests

Please call TOLL FREE
1-800-334-0854 (Ext. 814)



for more information
or write:
Quant Systems
Box 628
Charleston, SC 29402
VISA/MC Accepted

Circle 277 on inquiry card.

SPREADSHEET

(listing continued from page 459)

```

9397 *
9398 * D=delete row
9400 GOSUB 58000:GOSUB 900:IF QT%=0 THEN 6080 ELSE GOSUB 300:GOSUB 61900:IF
P%>CTN% THEN 7490
9420 I%=P%:TOT#=TOT#-VAL(ARRS(P%,7))
9440 WHILE I%<=CNT%:FOR J%=1 TO NN%:ARRS(I%,J%)=ARRS(I%+1,J%):NEXT J%:I%=I%
+1:WEND
9460 GOSUB 250:GOSUB 1000:GOSUB 1600:GOTO 6080
9497 *
9498 * M=modify paging parameters
9500 GOSUB 950:PRINT" # of lines per page (0=no paging):"MXL%,WS(3)FNCS(35,0)" "":
GOSUB 700:IF C$<">" THEN MXL%=VAL(C$)
9520 GOSUB 900:GOTO 6080
14995 *
14996 * #####
14997 * Display main menu
14998 * #####
14999 *
15000 PRINT FNCS(20,6)"Estimate - (c) '83 - R. Cerati, Arch."
15020 PRINT FNCS(2,12)"Main functions"FNCS(30,12)"Disk operations"FNCS(58,12)"Other"
WS(2)FNCS(2,13)STRINGS(75,45)
15040 PRINT FNCS(2,14)"<B>=build new estimate"FNCS(30,14)"<R>=read file from
disk"FNCS(58,14)"<L>=load program"
15060 PRINT FNCS(2,15)"<E>=edit existing estimate"FNCS(30,15)"<W>=write file to
disk"FNCS(56,15)"<esc>=exit"WS(3):RETURN
56995 *
56996 * #####
56997 * Delay routine
56998 * #####
56999 *
57000 FOR I%=1 TO DELAY%:NEXT:RETURN
57995 *
57996 * #####
57997 * Verify routine
57998 * #####
57999 *
58000 QT%=0:GOSUB 950:PRINT VS::GOSUB 710:IF C$="Y" OR C$="y" THEN QT%=-1
58020 RETURN
58995 *
58996 * #####
58997 * Pause
58998 * #####
58999 *
59000 GOSUB 950:PRINT"Hit <space> to continue "WS(3)::GOSUB 710:IF T%=27 OR T%
=21 THEN QT%=-1 ELSE IF T%<>32 THEN PRINT BLS::GOTO 59000
59020 GOSUB 900:RETURN
59991 *
59992 * #####
59993 * initialization of terminal dependent attributes :
59994 * FNCS( )=direct cursor addressing via x-y coordinates
59995 * WS(0)=clear screen WS(1)=erase to end of line
59996 * WS(2)=reduced intensity display WS(3)=normal intensity display
59997 * #####
59998 *
60000 WIDTH 255:DEF FNCS(X%,Y%)=CHR$(27)+CHR$(61)+CRHS(Y%+32)+CHRS(X%+32)
60020 DIM WS(3):WS(0)=CHR$(27)+CHR$(42):WS(1)=CHR$(27)+CHR$(84):WS(2)=CHR$(27)+
CHRS(41):WS(3)=CHR$(27)+CHR$(40)
60030 WIDTH LPRINT 132:ON ERROR GOTO 65000: <— setup hardcopy width & error
trap for disk operations
60033 *
60034 * #####
60035 * Initialize variables
60036 * #####
60037 *
60038 * Define commonly used values & prompts
60039 *
60040 DELAY%=2000:BLS=CHR$(7):VOS="Command: " + WS(3):VS="Verify (Y/N): " + WS(3):
VIS=WS(2) + " - ("K=menu) " + WS(3)
60056 *

```

SPREADSHEET



Apple II + Paper Tape I/O Is This Easy
 10101011010001010.....
 01010101010010100.....
 One minute you're without, the next you're up and running! Just plug into your APPLE II PLUS. A neat and complete package.

- Model 600-1 Punch — 50cps, rugged
- Model 605 Reader — 150cps
- Parallel Interface Board/Cable
- Data Handling Program

Code conversion available. TRS-80 package soon. ADDMASTER CORP. 416 Junipero Serra Dr., San Gabriel, CA 91776 • 213/285-1121.

Circle 14 on inquiry card.

dyjan Dysan DISKETTES

5 1/4" Specify Soft. 10 or 16 Sectors \$10 \$50 \$100

104-10	SSDD	29.00	142.50	280.00
104-20	DSDD	40.00	197.50	390.00
204-10	SSDD	40.00	197.50	390.00
204-20	DSDD	48.50	240.00	475.00

8" Unformatted \$10 \$50 \$100

3740-1	SSDD	34.00	167.50	330.00
3740-10	SSDD	42.50	210.00	415.00
3740-20	DSDD	50.00	247.50	490.00

CALL TOLL FREE 800-824-7888 OPERATOR 906 (VISA, M.C., COD. ORDERS ONLY) 7Days a Week, 24Hours a Day

(408) 252-4210 M-F, 8:00 AM - 5:00 PM FOR NEXT DAY SHIPMENT Inquiries Also

Creativity Unlimited
 • Add \$2.00 Shipping Per Order
 • CA Residents Add Sales Tax

1741 Saratoga Avenue, Suite #100 San Jose, California 95128

Send for Our Free Catalogue • Dealer Inquiries Invited

Circle 91 on inquiry card.

wabash®

When it comes to Flexible Disks, nobody does it better than Wabash.

MasterCard, Visa Accepted.
 Call Free: (800) 235-4137

PACIFIC EXCHANGES
 100 Foothill Blvd
 San Luis Obispo, CA
 93401 (In Cal call
 (805) 543-1037)

Circle 248 on inquiry card.

```

60057 ' Define max.# of array rows (MAX%), columns (NN%), col. length (L%)
60058 ' screen abscissas (PO%), formatting masks (MSK%) & type of data (TP%)
60059 '
60060 MAX%=100:NN%=7:DIM ARR$(MAX%,NN%),PERC(MAX%): PERC=percentage
      values array
60080 DIM L%(NN%),PO%(NN%),MSK$(NN%),TP%(NN%)
60091 '
60092 ' Define initial parameter values :
60093 ' OFS%=offset to make room for prompts and titles
60094 ' SCR%=# of screen the cursor is currently at
60095 ' GAP%=# of displayable lines for each screen
60096 ' PG%=page # NOL%=# of lines already printed on hardcopy device
60097 ' MXL%=Max. # of printable lines per page
60099 '
60100 OFS=3:SCR%=0:GAP%=17-OFS%:NOL%=0:PG%=1:MXL%=50
60117 '
60118 ' Define title strings
60119 '
60120 T1$=" # Code Job type u.m. Unit cost Quantity Amount %"
60140 T2$="-----|-----|-----|-----|-----|-----|-----"
60197 '
60198 ' Read screen parameters
60199 '
60200 FOR I%=1 TO NN%:READ TP%(I%),L%(I%),PO%(I%),MSK$(I%):NEXT I%
60219 '
60220 DATA 1,4,1,"###-": <---Row number parameters
60230 DATA 0.5,6,"\|": <---Code
60240 DATA 0.16,12," \|": <---Job type
60250 DATA 0.3,29," \|": <---Unit of measure
60260 DATA 1,13,33,"#####": <---Unit cost
60270 DATA 1,12,47,"#####": <---Quantity
60280 DATA 1,13,60,"#####": <---Amount
60995 '
60996 ' #####
60997 ' Process main menu command
60998 ' #####
60999 '
61000 PRINT WS(0)
61020 QT%=0:GOSUB 15000: <---clear screen & print menu
61040 GOSUB 950:PRINT VOS::GOSUB 710
61060 IF T%=27 THEN GOSUB 58000:IF QT% THEN PRINT WS(0):END ELSE 61020
61080 IF CS="L" THEN 63000
61100 T%=INSTR("BERW",CS):IF T%=0 THEN PRINT BLS::GOTO 61040
61120 ON T% GOSUB 61200,61300,61400,61500
61140 GOTO 61000
61197 '
61198 ' B=build new array
61199 '
61200 GOSUB 58000:IF QT% THEN GOSUB 6000
61220 RETURN
61297 '
61298 ' E=edit existing array
61299 '
61300 PRINT WS(0):IF ARR$(1,2)=" " THEN GOSUB 950:PRINT "Empty array "BLS::GOSUB
      57000:GOTO 61000 ELSE GOSUB 6020:RETURN
61397 '
61398 ' R=read values from disk
61399 '
61400 GOSUB 61800:IF QT% THEN RETURN ELSE GOSUB 5000:OPEN "T".#1.FILS:INPUT#1,
      CNT%,TOT#
61420 FOR I%=1 TO CNT%:FOR J%=1 TO NN%:INPUT#1,ARR$(I%,J%):NEXT J%:CLOSE
      #1:GOSUB 6020:RETURN
61497 '
61498 ' W=write values on disk
61499 '
61500 GOSUB 61800:IF QT% THEN RETURN ELSE GOSUB 750:GOSUB 61900:OPEN "O".#1,
      FILS:WRITE#1,CNT%,TOT#
61520 FOR I%=1 TO CNT%:FOR J%=1 TO NN%:WRITE#1,ARR$(I%,J%):NEXT J%:CLOSE
      #1:RETURN
    
```

(listing continued on page 462)

The "Get Organized" copy holder is made of bronze acrylic and features copy clip, swing arm and sturdy base. Works with any system.



GET ORGANIZED
WITH OUR NEW LINE OF QUALITY PRODUCTS



Sturdy 1/4" bronze acrylic printer stand. Featuring bottom feed slot and padded rubber feet to protect surfaces and reduce noise. Available in two sizes.

PR #1 16x11 1/4 1/4 80 column printers \$29.95
PR #2 24x11 1/4 1/4 110 larger printers \$39.95

To place your order today call anytime!

1-800-328-2977

We accept Visa and Mastercard. Add \$2.50 for shipping.

Mid America Wholesalers, Inc. Computer Accessories
8135 215 th St., Lakeville, MN 55044

Minnesota Residents Call Collect.

(612) 469-4666

Dealer inquiries invited.

FLOPPY DISK-DRIVE REPAIR

Command Services exclusively repairs Tandon and Shugart disk drives. We are affordable, fast and experienced.

For service, call toll free:
M-F, 9 a.m.-5 p.m., 7-9 p.m.
1-800-782-5500
In New York State call:
1-800-328-1800

Command Services Corporation
7143 Henry Clay Blvd.
Liverpool, New York 13088
315-457-1432



Circle 62 on inquiry card.

maxell®

Floppy Discs

CALL NOW - TOLL FREE

1-800-328-3472

Dealer inquiries invited. C.O.D.'s and charge cards accepted.

All orders shipped from stock, within 24 hours. Call toll FREE.

NEW LOWER PRICES



North Hills Corporation

3564 Rolling View Dr.
White Bear Lake, MN 55110
1-800-328-3472

MN Call Collect 1-612-770-0485

(listing continued from page 461)

```
61797 '
61798 ' select file for read/write operations - it will have .VAL extension
61799 '
61800 PRINT WS(0):GOSUB 950:PRINT"File name > "WS(2)"_____""WS(3)FNCS(12,0)" "":
GOSUB 700
61820 IF CS="" THEN QT%=-1:RETURN
61840 IF (LEN(CS)>10)OR((MID$(CS,2,1)=""')AND((LEFT$(CS,1)<>"A")AND(LEFT$(CS,1)
<>"B'))))THEN PRINT BLS::GOTO 61800
61860 ' Calculate # of valid terms
61899 '
61900 CNT%=0:FOR I%=1 TO MAX%:IF ARR$(I,2)=""AND ARR$(I,3)="" THEN I%=
MAX% ELSE CNT%=CNT%+1
61920 NEXT I%:RETURN
61987 '
62995 '
62996 ' #####
62997 ' Load external program
62998 ' #####
62999 '
63000 PRINT WS(0):GOSUB 950:PRINT"Filename ? "WS(3)::GOSUB 700:IF CS="" THEN
61000
63020 IF(LEN(CS)>10)OR(MID$(CS,2,1)<>"')AND LEN(CS)>8)THEN 63100
63040 IF MID$(CS,2,1)=""AND(LEFT$(CS,1)<>"A" OR LEFT$(CS,1)<>"B") THEN 63100
63060 GOSUB 750:CHAIN CS
63100 GOSUB 950:PRINT BLS"Invalid file name ""::GOSUB 57000:GOTO 63000
64995 '
64996 ' #####
64997 ' Error checking routine
64998 ' #####
64999 '
65000 IF ERR<>53 THEN 65100
65020 IF ERL=63060 THEN GOSUB 950:PRINT"Program not on disk "BLS::GOSUB 57000:
RESUME 63000
65040 IF ERL=61400 THEN CLOSE#1:GOSUB 950:PRINT"File not on disk "BLS::GOSUB
57000:RESUME 61400
65100 ON ERROR GOTO 0
```

B-Y-T-E'S B-I-T-S

DISPLAY FLICKER

Flicker on monitor screens is preventing me from buying a computer! If you aren't bothered by it yourself, you may be able to see the flicker by looking off to one side so that the screen is in your peripheral vision; the corner of the eye seems more sensitive to flicker than the center. I've found, though, that while some people see the flicker peripherally, some still do not. Obviously there's a wide range of sensitivities.

The IBM PC monochrome screen and the PC Portable's amber monitor have enough flicker to make them uncomfortable for me. The Compaq appears to have very little; the Macintosh has a huge amount. This is extremely frustrating to me because I'm ready to buy a Macintosh for use in writing a book; but using MacWrite for 45 minutes left me a little queasy.

How much is due to the flicker of the ubiquitous fluorescent lighting is questionable. I've tried to view the various screens in the daylight from huge storefront windows, but the store lighting still contributes something, of course. Would the problem be less with the incandes-

cent lighting at home? In case it's relevant, I am not subject to seizures of any sort.

On another subject, I want a machine that is powerful, user-oriented, and humane, one that doesn't get on my nerves or interfere with my thinking. In this context, I welcome the Macintosh. But even Mac has many of the common problems. Those that bother me most are noise, flicker, and keyboard feel. The noise of the Mac itself is commendably low, but like all printers, the Imagewriter is very annoying, not just in the sound level but in the character of the sound, that high-pitched metallic ripping noise. It's impossible to imagine having it near a workstation, unless an enclosure were constructed for it. The keyboard feel is something I'm probably extra-sensitive to, as a professional pianist. My Selectric II typewriter, when properly adjusted—and you almost never find one that is—feels very good. The Macintosh keyboard is much better than some. What they all seem to be missing, though, is a feeling of cushioned motion after the point of electrical contact.

JAMES BOYK
2135 Holmby Ave.
Los Angeles, CA 90025

B.O.O.K.S R.E.C.E.I.V.E.D

THE APPLE IIe USER'S GUIDE, Mark Andrews. New York: Macmillan Publishing Co., 1983; 128 pages, 13.5 by 20.8 cm, softcover, ISBN 0-02-008680-6, \$5.95.

APPLYING SOFTWARE ENGINEERING PRINCIPLES, David Marca. Boston, MA: Little, Brown and Company, 1984; 288 pages, 18.5 by 24 cm, hardcover, ISBN 0-316-54574-0, \$14.50.

BASIC FOR IBM PERSONAL COMPUTERS, Harriet Morrill. Boston, MA: Little, Brown and Company, 1984; 270 pages, 17.8 by 23.5 cm, softcover, ISBN 0-316-58402-9, \$14.50.

BASIC TRICKS FOR THE APPLE, Allen Wyatt. Indianapolis, IN: Howard Sams & Co., 1983; 144 pages, 13.8 by 21.3 cm, softcover, ISBN 0-672-22208-6, \$8.95.

THE BEST APPLE SOFTWARE, the editors of *Consumer Guide* and Roe R. Adams III. New York: Beekman House, 1984; 160 pages, 13.5 by 21 cm, softcover, ISBN 0-517-42475-4, \$4.98.

THE BEST ATARI SOFTWARE, the editors of *Consumer Guide*. New York: Beekman House, 1984; 192 pages, 13.5 by 21 cm, softcover, ISBN 0-517-41474-6, \$4.98.

THE BEST TEXAS INSTRUMENTS SOFTWARE, the editors of *Consumer Guide*. New York: Beekman House, 1984; 160 pages, 13.5 by 21 cm, softcover, ISBN 0-517-42476-2, \$4.98.

THE BEST VIC/COMMODORE SOFTWARE, the editors of *Consumer Guide*. New York: Beekman House, 1984; 192 pages, 13.5 by 21 cm, softcover, ISBN 0-517-42473-8, \$4.98.

BUYING THE RIGHT COMPUTER THE FIRST TIME, Pablo E. Silverio. Miami, FL: Silma Data Research Inc., 1983; 152 pages, 14 by 21.5 cm, softcover, ISBN 0-913223-01-8, \$9.95.

COLOR COMPUTER APPLICATIONS, John P. Grillo and J. D. Robertson. New York: John Wiley & Sons, 1983; 160 pages,

17 by 25.3 cm, softcover, ISBN 0-471-86922-8, \$10.95.

THE COMMODORE 64 USER'S GUIDE, Jonathan Sacks with Mark Andrews. New York: Macmillan Publishing Co., 1983; 128 pages, 13.5 by 20.8 cm, softcover, ISBN 0-02-008690-3, \$5.95.

COMPASS PROGRAMMING, Freeman L. Moore. Dubuque, IA: Gorsuch Scarisbrick Publishers, 1983; 240 pages, 21.5 by 27.8 cm, softcover, ISBN 0-89787-400-5, \$16.95.

COMPUTER ALGEBRA, SYMBOLIC AND ALGEBRAIC COMPUTATION, 2nd ed. B. Buchberger, G. E. Collins, and R. Loos, eds. New York: Springer-Verlag/Wein, 1983; 294 pages, 17 by 24.3 cm, softcover, ISBN 0-387-81776-X, \$24.50.

COMPUTER BUYERS PROTECTION GUIDE, L. J. Kuttan. Englewood Cliffs, NJ: Prentice-Hall, 1983; 160 pages, 15.3 by 22.8 cm, softcover, ISBN 0-13-164187-5, \$12.95.

COMPUTER GAME-PLAYING, M. A. Bramer, ed. New York: John Wiley & Sons, 1983; 306 pages, 15.5 by 23.5 cm, hardcover, ISBN 0-470-27466-2, \$59.95.

COMPUTER POWER FOR YOUR LAW OFFICE, Daniel Remer. Berkeley, CA: Sybex, 1983; 160 pages, 17.8 by 22.8 cm, softcover, ISBN 0-89588-109-8, \$19.95.

COMPUTER-SECURITY TECHNOLOGY, James Arlin Cooper. Lexington, MA: D. C. Heath and Co., 1984; 192 pages, 17 by 23.5 cm, hardcover, ISBN 0-669-06436-X, \$25.

COMPUTERS FOR BUSINESS, 2nd ed. Hugh J. Watson and Archie B. Carroll, eds. Plano, TX: Business Publications Inc., 1984; 440 pages, 16.5 by 23.8 cm, softcover, ISBN 0-256-03135-5, \$15.95.

.....
THIS IS A LIST of books recently received at BYTE Publications. The list is not meant to be exhaustive, its purpose is to acquaint BYTE readers with current titles in computer science and related fields. We regret that we cannot review or comment on all the books we receive; instead, this list is meant to be a monthly acknowledgment of these books and the publishers who sent them.

CONTROLLING FINANCIAL PERFORMANCE FOR HIGHER PROFITS, Dennis P. Curtin and Jeffrey R. Alves. Somerville, MA: Curtin & London, 1983; 200 pages, 21.5 by 27.8 cm, softcover, ISBN 0-930764-73-0, \$17.50.

DATAPRO/MCGRAW-HILL GUIDE TO APPLE SOFTWARE, New York: Datapro/McGraw-Hill, 1983; 288 pages, 21.5 by 27.8 cm, softcover, ISBN 0-07-015403-1, \$19.95.

DATAPRO/MCGRAW-HILL GUIDE TO CP/M SOFTWARE, New York: Datapro/McGraw-Hill, 1983; 264 pages, 21.5 by 27.8 cm, softcover, ISBN 0-07-015404-X, \$19.95.

DATAPRO/MCGRAW-HILL GUIDE TO IBM PERSONAL COMPUTER SOFTWARE, New York: Datapro/McGraw-Hill, 1983; 216 pages, 21.5 by 27.8 cm, softcover, ISBN 0-07-015424-4, \$19.95.

DATATRAN, Harvey J. Gonzalez and Lois Fein. Englewood Cliffs, NJ: Prentice-Hall, 1984; 400 pages, 22 by 28.5 cm, hardcover, ISBN 0-13-196493-3, \$32.50.

DECISION SUPPORT SYSTEMS, William C. House, ed. Princeton, NJ: Petrocelli Books, 1983; 480 pages, 15.5 by 23.5 cm, softcover, ISBN 0-89433-208-2, \$20.

DESIGNING WITH THE 8088 MICROPROCESSOR, John Zarrella. Fairfield, CA: Microcomputer Applications, 1984; 304 pages, 15.3 by 22.8 cm, softcover, ISBN 0-935230-07-6, \$19.95.

DICTIONARY OF COMPUTERS, DATA PROCESSING & TELECOMMUNICATIONS, Jerry M. Rosenberg. New York: John Wiley & Sons, 1984; 630 pages, 18 by 26 cm, hardcover, ISBN 0-471-87638-0, \$29.95.

A DICTIONARY OF MINICOMPUTING AND MICROCOMPUTING, Philip E. Burton. New York: Garland STPM Press, 1983; 368 pages, 15.3 by 22.8 cm, softcover, ISBN 0-8240-7286-3, \$17.95.

DIGITAL IMAGE PROCESSING, Gregory A. Baxes. Englewood Cliffs, NJ: Prentice-Hall, 1984; 192 pages, 21.5 by 27.8 cm, softcover, ISBN 0-13-214056-X, \$14.95.

DR. C. WACKO'S MIRACLE GUIDE TO DESIGNING AND PROGRAMMING YOUR OWN ATARI COMPUTER ARCADE GAMES, David L. Heller, John F. Johnson, and Robert Kurcina. Reading, MA: Addison-Wesley, 1983; 244 pages, 18.8 by 23.5 cm, spiral-bound, ISBN 0-201-11490-9, \$24.95. Includes floppy disk.

ELECTRONIC PROTOTYPE CONSTRUCTION, Stephen D. Kasten. Indianapolis, IN: Howard W. Sams & Co., 1983; 400 pages, 13.5 by 21.3 cm, softcover, ISBN 0-672-21895-X, \$17.95.

ELEMENTARY PROGRAMMING FOR KIDS IN BASIC, Eugene Galanter. New York: A GD/Perigee Book, 1983; 208 pages, 18 by 23.5 cm, softcover, ISBN 0-399-50867-8, \$7.95.

FAMILY COMPUTERS UNDER \$200, Doug Mosher. Berkeley, CA: Sybex, 1984; 164 pages, 11 by 18 cm, softcover, ISBN 0-89588-149-7, \$3.95.

FUZZY SETS, NATURAL LANGUAGE COMPUTATIONS, AND RISK ANALYSIS, Kurt J. Schmucker. Rockville, MD: Computer Science Press, 1984; 194 pages, 15.5 by 23.7 cm, hardcover, ISBN 0-914894-83-8, \$32.95.

GOSUBS, Ewin Gaby and Shirley Gaby. New York: McGraw-Hill, 1984; 176 pages, spiral-bound, ISBN 0-07-022677-6, \$9.95.

GRAPHICS FOR THE IBMPC, B. J. Korites. Duxbury, MA: Kern Publications, 1983; 288 pages, 17.8 by 22.5 cm, softcover, ISBN 0-940-254-31-X, \$28.50. Floppy disk available, \$21.50.

(text continued on page 464)

BOOKS RECEIVED

(text continued from page 463)

HOME APPLICATIONS AND GAMES FOR THE ATARI HOME COMPUTERS, Timothy P. Banse. Boston, MA: Little, Brown and Company, 1983; 144 pages, 21.5 by 27.8 cm, softcover, ISBN 0-316-08044-6, \$14.50.

IBM BASIC, Donald T. Payne and William R. Beck. Englewood Cliffs, NJ: Prentice-Hall, 1983; 240 pages, 15.3 by 22.8 cm, softcover, ISBN 0-13-448688-9, \$15.95.

IBM PC BASIC PROGRAMMING, Richard Haskell and Glenn A. Jackson. Englewood Cliffs, NJ: Prentice-Hall, 1984; 190 pages, 21.5 by 27.8 cm, softcover, ISBN 0-13-448424-X, \$13.95.

THE IBM PC-DOS HANDBOOK, Richard Allen King. Berkeley, CA: Sybex, 1983; 320 pages, 17.8 by 22.8 cm, softcover, ISBN 0-89588-103-9, \$16.95.

INTERFACING TO THE TRS-80 COMPUTER MODELS I, III, AND 4, Jerry R. Lambert. Reston, VA: Reston Publishing Co., 1984; 222 pages, 15 by 22.5 cm, softcover, ISBN 0-8359-3115-3, \$16.95.

INTRODUCTION TO THE COMPUTER, 2nd ed. Jeffrey Frates and William Moldrup. Englewood Cliffs, NJ: Prentice-Hall, 1984; 576 pages, 18.3 by 24.3 cm, hardcover, ISBN 0-13-480319-1, \$23.95.

KAHN ON CODES, David Kahn. New York: Macmillan Publishing Co., 1983; 352 pages, 16.4 by 24 cm, hardcover, ISBN 0-02-560640-9, \$19.95.

THE KISS PRINCIPLE, Ronald B. Smith. Princeton, NJ: Petrocelli Books Inc., 1983; 221 pages, 14.5 by 21.5 cm, hardcover, ISBN 0-89433-198-1, \$19.95.

LEARNING LOGO ON THE APPLE II, Anne McDougall, Tony Adams, and Pauline Adams. Englewood Cliffs, NJ: Prentice-Hall, 1982; 264 pages, 17 by 23.5 cm, softcover, ISBN 0-7248-0732-2, \$19.95.

LOCAL AREA NETWORKS, V. E. Cheong and R. A. Hirschheim. New York: John Wiley & Sons, 1983; 208 pages, 15.5 by 23.5 cm, hardcover, ISBN 0-471-90134-2, \$29.95.

MAKING INFORMATION SYSTEMS WORK FOR YOU, Trevor J. Bentley. Technical revision by Irvine H.

Forkner. Englewood Cliffs, NJ: Prentice-Hall, 1983; 192 pages, 15 by 22.8 cm, softcover, ISBN 0-13-547216-4, \$8.95.

MATHEMATICS APPLIED TO ELECTRONICS, 2nd ed., James H. Harter and Wallace D. Beitzel. Reston, VA: Reston Publishing Co., 1984; 688 pages, 18.3 by 24.3 cm, hardcover, ISBN 0-8359-4283-X, \$24.95.

MECHANICS AND MATERIALS FOR DESIGN, Nathan H. Cook. New York: McGraw-Hill, 1984; 496 pages, 16.8 by 24 cm, hardcover, ISBN 0-07-012486-8, \$31.95.

MECHANISM DESIGN: ANALYSIS AND SYNTHESIS, vol. 1, Arthur G. Erdman and George N. Sandor. Englewood Cliffs, NJ: Prentice-Hall, 1984; 544 pages, 18.3 by 24.3 cm, hardcover, ISBN 0-13-572396-5, \$39.95.

MICRO COOKBOOK, MACHINE LANGUAGE PROGRAMMING, vol. 2, Don Lancaster. Indianapolis, IN: Howard W. Sams & Co. Inc., 1983; 458 pages, 13.5 by 21.5 cm, softcover, ISBN 0-672-21829-1, \$15.95.

THE MICROSOFT BASIC IDEA BOOK, David H. Ahl. Morris Plains, NJ: Creative Computing Press, 1983; 152 pages, 13.8 by 21.3 cm, softcover, ISBN 0-916688-67-4, \$8.95.

MOONLIGHTING WITH YOUR PERSONAL COMPUTER, Robert J. Waxman. New York: World Almanac Publications, 1984; 160 pages, 15.3 by 23.5 cm, softcover, ISBN 0-345-31652-5, \$7.95.

MOSTLY BASIC: APPLICATIONS FOR YOUR ATARI, Book 2, Howard Berenbon. Indianapolis, IN: Howard W. Sams & Co. Inc., 1983; 264 pages, 21.5 by 28 cm, spiral-bound, ISBN 0-672-22092-X, \$15.95.

MULTIPLAN MODELS FOR BUSINESS, Douglas Ford Cobb, Gena Berg Cobb, and Thomas B. Henderson. Indianapolis, IN: Que Corp., 1983; 288 pages, 18.5 by 23.5 cm, softcover, ISBN 0-88022-037-6, \$14.95.

THE NEW ALCHEMISTS, Dirk Hanson. New York: Avon Books, 1982; 384 pages, 10.5 by 17.5 cm, softcover, ISBN 0-380-65854-2, \$4.50.

THE OSBORNE/MCGRAW-HILL GUIDE TO YOUR APPLE III, Stanley

M. Miastkowski. Berkeley, CA: Osborne/McGraw-Hill, 1983; 288 pages, 16.3 by 23.3 cm, softcover, ISBN 0-88134-101-0, \$17.95.

OVERCOMING COMPUTER FEAR, Jeff Berner. Berkeley, CA: Sybex, 1984; 114 pages, 11 by 18 cm, softcover, ISBN 0-89588-145-4, \$3.95.

A PARENT'S GUIDE TO PERSONAL COMPUTERS & SOFTWARE, the editors of *Consumer Guide* with Danny Goodman. New York: Simon & Schuster, 1983; 64 pages, 21 by 27.3 cm, spiral-bound, ISBN 0-671-49173-3, \$6.95.

PASCAL AS A SECOND LANGUAGE, Vardell Lines. Englewood Cliffs, NJ: Prentice-Hall, 1984; 208 pages, 17.3 by 23.5 cm, softcover, ISBN 0-13-652925-9, \$18.95.

PC DOS USER'S GUIDE, Chris DeVoney. Indianapolis, IN: Que Corp., 1984; 358 pages, 18.3 by 22.8 cm, softcover, ISBN 0-88022-040-6, \$12.95.

PICTURE PERFECT PROGRAMMING IN APPLESOFT BASIC, Thomas Mason, Steve Payne, and Barbara Black. Reston, VA: Reston Publishing Co., 1984; 240 pages, 17.8 by 23.3 cm, softcover, ISBN 0-8359-5549-4, \$14.95.

PLANNING AND BUDGETING FOR HIGHER PROFITS, Jeffrey R. Alves and Dennis P. Curtin. Somerville, MA: Curtin & London, 1983; 224 pages, 21.5 by 27.8 cm, softcover, ISBN 0-930764-74-9, \$17.50.

PORTABLE COMPUTERS, Sheldon Crop and Doug Mosher. Berkeley, CA: Sybex, 1984; 128 pages, 15 by 22.8 cm, softcover, ISBN 0-89588-144-6, \$7.95.

THE POWER OF FINANCIAL CALCULATIONS FOR LOTUS 1-2-3, Robert E. Williams. Portland, OR: Management Information Source Inc., 1983; 176 pages, 21 by 27 cm, softcover, ISBN 0-943518-10-5, \$14.95.

POWER SUPPLIES, Jeffrey D. Shepard. Reston, VA: Reston Publishing Co., 1984; 190 pages, 15.5 by 23.5 cm, softcover, ISBN 0-8359-5568-0, \$21.95.

A PRACTICAL GUIDE TO THE UNIX SYSTEM, Mark G. Sobell. Menlo Park, CA: The Benjamin/Cummings Publishing Co., 1984; 448

pages, 15.8 by 23.5 cm, softcover, ISBN 0-8053-8910-5, \$21.95.

PROBLEM SOLVING USING PL/I AND PL/C, Keith Harrow. Englewood Cliffs, NJ: Prentice-Hall, 1984; 464 pages, 17.3 by 23.3 cm, softcover, ISBN 0-13-711796-5, \$19.95.

RS-232 MADE EASY, Martin D. Seyer. Englewood Cliffs, NJ: Prentice-Hall, 1984; 240 pages, 15.3 by 22.8 cm, softcover, ISBN 0-13-783472-1, \$15.95.

THE SATELLITE TV HANDBOOK, Anthony T. Easton. Indianapolis, IN: Howard W. Sams & Co., 1983; 440 pages, 13.8 by 21.3 cm, softcover, ISBN 0-672-22055-5, \$16.95.

SIMULATION OF WAITING-LINE SYSTEMS, Susan L. Solomon. Englewood Cliffs, NJ: Prentice-Hall, 1983; 464 pages, 18 by 24 cm, hardcover, ISBN 0-13-810044-6, \$27.95.

STRAIGHT FORWARD BASIC, R. Barry Genzlinger, David L. Baker, John A. Devino, David D. Ressler, and Douglas J. Ryan. Burlington, VT: Champlain College Press, 1984; 168 pages, 18 by 25.5 cm, spiral-bound, ISBN 0-9612704-0-3, \$12.95.

SUPERCALC HOME & OFFICE COMPANION, Elna Tymes and Peter Antoniak. Berkeley, CA: Osborne/McGraw-Hill, 1984; 304 pages, 21.3 by 27.5 cm, softcover, ISBN 0-88134-113-4, \$15.95.

SYSTEMS RELIABILITY, MAINTAINABILITY MANAGEMENT, Balbir S. Dhilon. Princeton, NJ: Petrocelli Books, 1984; 288 pages, 16 by 24 cm, hardcover, ISBN 0-89433-195-7, \$29.95.

TALKING CHIPS: IC SPEECH SYNTHESIS, Nelson Morgan. New York: McGraw-Hill, 1984; 192 pages, 15.8 by 23.5 cm, hardcover, ISBN 0-07-043107-8, \$24.50.

TELEVISION THEORY AND SERVICING, Charles G. Buscombe. Reston, VA: Reston Publishing Co., 1984; 848 pages, 18.5 by 24.3 cm, hardcover, ISBN 8359-7544-4, \$34.95.

THINGS TO DO WITH YOUR APPLE COMPUTER, Jerry Willis, Merl Miller, and Nancy Morrice. New York: The New American Library, 1983; 208 pages, 10.5

BOOKS RECEIVED

by 17.8 cm. softcover, ISBN 0-451-12848-6, \$3.95.

THINGS TO DO WITH YOUR ATARI COMPUTER. Jerry Willis, Merl Miller, and Nancy Morrice. New York: The New American Library, 1983; 240 pages. 10.5 by 17.8 cm. softcover, ISBN 0-451-12850-8, \$3.95.

THINGS TO DO WITH YOUR COMMODORE 64 COMPUTER. Jerry Willis, Merl Miller, and Deborah Willis. New York: The New American Library, 1983; 192 pages. 10.5 by 17.8 cm. softcover, ISBN 0-451-12843-5, \$3.95.

THINGS TO DO WITH YOUR COMMODORE VIC 20. Jerry Willis, Merl Miller, and Deborah Willis. New York: The New American Library, 1983; 192 pages. 10.5 by 17.8 cm. softcover, ISBN 0-451-12844-3, \$3.95.

THINGS TO DO WITH YOUR OSBORNE COMPUTER. Jerry Willis, Merl Miller, and D. LaMont Johnson. New York: The New American Library, 1983; 192 pages. 10.5 by 17.8 cm. softcover, ISBN 0-451-12852-4, \$3.95.

THINGS TO DO WITH YOUR TI-99/4A COMPUTER. Jerry Willis, Merl Miller, and D. LaMont Johnson. New York: The New American Library, 1983; 192 pages. 10.5 by 17.8 cm. softcover, ISBN 0-451-12842-7, \$3.95.

THINGS TO DO WITH YOUR TRS-80 COLOR COMPUTER. Jerry Willis, Merl Miller, and D. LaMont Johnson. New York: The New American Library, 1983; 224 pages. 10.5 by 17.8 cm. softcover, ISBN 0-451-12854-0, \$3.95.

THINGS TO DO WITH YOUR TRS-80 MODEL 4 COMPUTER. Jerry Willis, Merl Miller, and Cleborne D. Maddux. New York: The New American Library, 1983; 224 pages. 10.5 by 17.8 cm. softcover, ISBN 0-451-12845-1, \$3.95.

TRS-80 DATA FILE PROGRAMMING. Leroy Finkel and Jerald R. Brown. New York: John Wiley & Sons, 1983; 316 pages. 17 by 25.3 cm. softcover, ISBN 0-471-88486-3, \$14.95.

TRS-80 FOR KIDS FROM 8 TO 80. vol. 2. Michael P. Zabinski.

Indianapolis, IN: Howard W. Sams & Co., 1983; 208 pages. 21.3 by 28 cm. softcover, ISBN 0-672-22070-9, \$9.95.

THE TRS-80 MODEL 100 PORTABLE COMPUTER. David A. Lien. El Cajon, CA: Compusoft Publishing, 1983; 576 pages. 17.8 by 22.8 cm. softcover, ISBN 0-932760-17-1, \$19.95.

TURING'S MAN. J. David Bolter. Chapel Hill, NC: The University of North Carolina Press, 1984; 280 pages. 16 by 23.5 cm. hardcover, ISBN 0-8078-1564-0, \$19.95.

THE UNIX BOOK. Mike Banahan and Andy Rutter. New York: John Wiley & Sons, 1983; 224 pages, 17 by 25 cm. softcover, ISBN 0-471-89676-4, \$16.95.

THE UNIX PROGRAMMING ENVIRONMENT. Brian W. Kernighan and Rob Pike. Englewood Cliffs, NJ: Prentice-Hall, 1984; 368 pages. 18.5 by 24.3 cm. hardcover, ISBN 0-13-937699-2, \$26.95.

THE UNIX SYSTEM GUIDEBOOK. Peter P. Silvester. New York: Springer-Verlag, 1984; 224 pages. 15.5 by 23.3 cm. softcover, ISBN 0-387-90906-0, \$14.50.

THE VIC-20 CONNECTION. James W. Coffron. Berkeley, CA: Sybex, 1983; 296 pages. 17.8 by 23 cm. softcover, ISBN 0-89588-128-4, \$9.95.

WORDSTAR AND CP/M MADE EASY. John D. Lee. New York: John Wiley & Sons, 1983; 238 pages. 15 by 23 cm. softcover, ISBN 0-471-90188-1, \$17.95.

YOUR IBM PC. Lyle J. Graham and Tim Field. Berkeley, CA: Osborne/McGraw-Hill, 1984; 608 pages. 16.3 by 23.3 cm. softcover, ISBN 0-88134-120-7, \$17.95.

YOUR IBM PC MADE EASY. Jonathan Sachs. Berkeley, CA: Osborne/McGraw-Hill, 1984; 448 pages. 18.5 by 23.3 cm. softcover, ISBN 0-88134-112-6, \$12.95.

YOUR TELEPHONE: OPERATION, SELECTION, AND INSTALLATION. Martin Clifford. Indianapolis, IN: Howard W. Sams & Co., 1983; 336 pages. 13.5 by 21.3 cm. softcover, ISBN 0-672-22065-2, \$13.95. ■

64K \$100 STATIC RAM

\$199⁰⁰
KIT

NEW!

LOW POWER!
RAM OR EPROM!

**BLANK PC BOARD
WITH DOCUMENTATION
\$55**

**SUPPORT ICs + CAPS
\$17.50**

**FULL SOCKET SET
\$14.50**

**FULLY SUPPORTS THE
NEW IEEE 696 \$100
STANDARD
(AS PROPOSED)
FOR 56K KIT \$185**

**ASSEMBLED AND
TESTED ADD \$50**

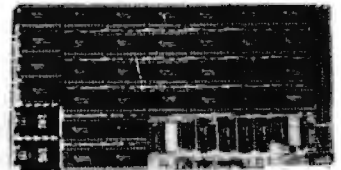

FEATURES:

- Uses new 2K x 8 (TMM 2016 or HM 6116) RAMs.
- Fully supports IEEE 696 24 BIT Extended Addressing.
- 64K draws only approximately 500 MA.
- 200 NS RAMs are standard. (TOSHIBA makes TMM 2016s as fast as 100 NS. FOR YOUR HIGH SPEED APPLICATIONS.)
- SUPPORTS PHANTOM (BOTH LOWER 32K AND ENTIRE BOARD).
- 2716 EPROMs may be installed in any of top 48K.
- Any of the top 8K (E000 H AND ABOVE) may be disabled to provide windows to eliminate any possible conflicts with your system monitor, disk controller, etc.
- Perfect for small systems since BOTH RAM and EPROM may co-exist on the same board.
- BOARD may be partially populated as 56K.

256K S-100 SOLID STATE DISK SIMULATOR!

WE CALL THIS BOARD THE "LIGHT-SPEED-100" BECAUSE IT OFFERS AN ASTOUNDING INCREASE IN YOUR COMPUTER'S PERFORMANCE WHEN COMPARED TO A MECHANICAL FLOPPY DISK DRIVE.

FEATURES:

- 256K on board, using +5V 64K DRAMS.
- Uses new Intel 8203-1 LSI Memory Controller.
- Requires only 4 Dip Switch Selectable I/O Ports.
- Runs on 8080 or Z80 \$100 machines.
- Up to 8 LS-100 boards can be run together for 2 Meg. of On Line Solid State Disk Storage.
- Provisions for Battery back-up.
- Software to mate the LS-100 to your CP/M* 2.2 DOS is supplied.
- The LS-100 provides an increase in speed of up to 7 to 10 times on Disk Intensive Software.
- Compare our price! You could pay up to 3 times as much for similar boards.

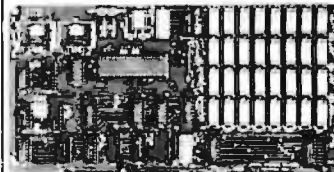

**BLANK PCB
(WITH CP/M* 2.2
PATCHES AND INSTALL
PROGRAM ON DISKETTE)**

\$69⁹⁵

\$399⁰⁰

#LS-100 (FULL 256K KIT)

THE NEW ZRT-80

CRT TERMINAL BOARD!

A LOW COST Z-80 BASED SINGLE BOARD THAT ONLY NEEDS AN ASCII KEYBOARD, POWER SUPPLY, AND VIDEO MONITOR TO MAKE A COMPLETE CRT TERMINAL. USE AS A COMPUTER CONSOLE, OR WITH A MODEM FOR USE WITH ANY OF THE PHONE-LINE COMPUTER SERVICES.

FEATURES:

- Uses a Z80 and 6845 CRT Controller for powerful video capabilities.
- RS232 at 16 BAUD Rates from 75 to 19,200.
- 24 x 80 standard format (60 Hz).
- Optional formats from 24 x 80 (50 Hz) to 64 lines x 96 characters (60 Hz).
- Higher density formats require up to 3 additional 2K x 8 6116 RAMS.
- Uses N.S. INS 8250 BAUD Rate Gen. and USART combo IC.
- 3 Terminal Emulation Modes which are Dip Switch selectable. These include the LSI-ADM3A, the Heath H-19, and the Beehive.
- Composite or Spill Video.
- Any polarity of video or sync.
- Inverse Video Capability.
- Small Size: 6.5 x 9 inches.
- Upper & lower case with descenders.
- 7 x 9 Character Matrix.
- Requires Par. ASCII keyboard.

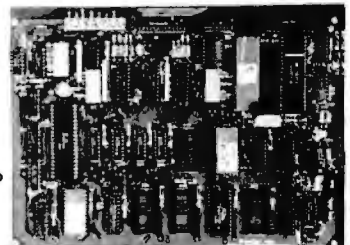

**BLANK PCB WITH 2716
CHAR. ROM, 2732 MON. ROM**

\$59⁹⁵

**SOURCE DISKETTE - ADD \$10
SET OF 2 CRYSTALS - ADD \$7.50**

**WITH 8 IN.
SOURCE DISK!
(CP/M COMPATIBLE)**

\$129⁹⁵

**(COMPLETE KIT,
ZRT-80
2K VIDEO RAM)**

Digital Research Computers

P. O. BOX 461565 • GARLAND, TEXAS 75046 • (214) 271-3538

TERMS: Add \$3.00 postage. We pay balance. Orders under \$15 add 75¢ handling. No C.O.D. We accept Visa and MasterCard. Texas Res. add 5% Tax. Foreign orders (except Canada) add 20% P & H. Orders over \$50 add 85¢ for insurance.



CRAFTSMEN OF THE NEW TECHNOLOGY.
BEST PRICES WITH QUALITY SUPPORT* ON SOFTWARE AND HARDWARE.

ORYX SYSTEMS

QUALITY DISCOUNTS

Check Oryx's
New Ad Listings!

APPLE/ FRANKLIN

- ASHTON-TATE**
d-Base II \$ Call
- ASPEN/WANG SOFTWARE**
Grammatik \$ 60
Proofreader 42
- BEAGLE BROS.**
Apple Mechanic \$ 22
DOS Boss 17
Utility City 22
- BRODERBUND**
Bank Street Writer ... \$ 45
- CDEX**
All Training Prog. \$ 45
- CENTRAL POINT**
Copy II + \$ 34
- CONTINENTAL SOFTWARE**
Home Accountant ... \$ 49
- DIGITAL RESEARCH**
Excellent selection on current and the exciting new products \$ Call
- DOW JONES**
Market Analyzer \$ 245
Market Manager 219
Microscope 525
Spreadsheet Link \$ 199
- LIVING VIDEOTEXT**
Think Tank \$ 99
- LOGO CORNER**
Krell Logo \$ 75
Terrapin \$ 99
- MICROPRO**
Wordstar (Special w/ CP/M Card, 70 col. & 64K) \$ 329
Infostar (Includes CP/MA, 70 col., 64K) ... \$ 329
Pro Pak (W/S/MS/Index) ... 399
- MICROSOFT**
Cobol-80 \$ 499
Fortran-80 145
TASC Compiler 119
A.L.D.S. 79
Multiplan (DOS) 139
- OMEGA**
Locksmith \$ 79
- PEACHTREE** \$ Call
- PROMETHEUS**
Applesurance \$ 99

- PENGUIN SOFTWARE**
Complete Graphics ... \$ 50
Graphics Magician ... 39
Complete Graphics/
Apple Tablet 86
- PROMETHEUS**
Applesurance \$ 99
- SIERRA ON-LINE**
Homeward \$ Call
- SOFTTECH**
Basic Compilers
Runtime \$ 169
Softteach 94
UCSD P-system Set ... 469
- SOFTWARE PUBLISHING**
PFS: File, Gr. Rep. ea. \$ 79
- SYSTEMS PLUS**
Landlord \$ 375
- VISICORP**
Visicalc (II or IIE) \$ 165
Visischedule 195
VisiOn Series \$ Call

CP/M SOFTWARE

FORMATS AVAILABLE

All prices below are for 8" standard. Other formats are available. Some formats subject to "Download" fee and require minimum 2 weeks for delivery. Please inquire.

- ATI**
All Training Prog. ea. \$ 60
- COMPUVIEW**
*V-Edit 8080 Z80, IBM/PC \$ 130
*V-Edit CP/M 86 \$ 160
Systran 99
- DIGITAL RESEARCH**
*Pascal MT + w/SPP \$ 389
DR Assembler & Tools ... 149
CP/M 2.2 125
C Basic 2 95
PL/1-80 375
Personal Basic 120
CP/M Plus 3.0 262
CP/M Gold Card \$ Call
Access or Display Mgr. 260
C Language/compiler
Concurrent CP/M 2.0 ... Call
All 8" - 86 Version
of Above \$ Call
- INFOCOM**
*Deadline \$ 49
*Starcross 39
*Suspended 39
*Zork, I, II, III ea. 39

EDUCATIONAL AIDS for the 1984-85 School Year

- ADMINISTRATIVE**
BPI Systems
Bertomax, Inc.
Charles Mann
Cam Press (Div of Science Books Int'l)
Xerox
Personal Software (Visicorp)
IMS - Int'l Micro Systems

- CURRICULUM**
Beagle Bros.
Bertomax, Inc. (includes Skills for Handicapped)
EdWare Services
Career Publishing
CBS
George Earl
Krell
Muse
Reader's Digest Services
Micro Power & Light Co.
Plato
Scarborough
Xerox
PLUS MANY MORE
FOR INFORMATION \$ Call



PEACHTREE CORNER

- PeachPak 4 (GL, AP, AR) \$ 215
Series B (GL, AP, AR, Sales Inv., Inv. Control, Job Cost, Client Post. & Acct. ... each mod. \$ 389

MARK OF THE UNICORN

- *Final Word \$ 199
- MICROPRO**
*WordStar \$ Call
*InfoStar \$ Call
*Pro-Pack (W/S/MS/SS Index) ... \$ Call
All others \$ Call

- MICROSOFT**
Basic 80 \$ 239
Basic Compiler 249
Fortran 80 330
Cobol 80 449
Macro 80 130
MuMath/MuSimp 179
*Multiplan 139

MICROSTUF

- *Crasstalk \$ 109

NORTHWEST ANALYTICAL

- *Stratpak \$ 365

OASIS

- The Word Plus \$ 120
Punctuation and Style \$ 99

- SORCIM**
*Supercalc II \$ 169
Superwriter (w/Speller & Mailer) ... \$ 169
- SELECT**
Select Word Processor \$ 209
- SUPERSOFT**
*Diagnostic II \$ 89
Disk Doctor 74
Fortran 4 299
Basic-8086 225
C Cross Assembler ... 400
*ScratchPad 187
T MAKER III \$ 195

IBM/PC

Please see CP/M listing. All products with an * in front are also made for PC/DOS and are priced the same unless otherwise specified.

- ALPHA SOFTWARE**
Data Base Mgr. II \$ 179
Executive Pkg. 105
Apple-IBM Connection \$ 169
- AMERICAN INT'L COMMUNICATIONS**
Tlx A-Syst \$ 199
Gram-A-Syst 199
- AUTODESK**
Autocad \$ Call
- B&L**
Multi-Job (runs nine programs at once) ... \$ 145
- BULLISH INVESTMENT**
Net Worth \$ Call
- CENTRAL POINT**
Copy II PC \$ 34
- CONTINENTAL**
Home Accountant ... \$ 89
- CTek**
PC Calculator \$ 29
Prog. PC Calculator ... 49
Prog. PC Calculator w/ Fin. Mod. 55
- DIGITAL RESEARCH**
Concurrent CP/M 86 ... \$ Call
Pascal MT + 86
CP/M 86 w/SPP 375
Pascal MT+ (PC/DOS) ... 385
DR Logo \$ Call
- DOW JONES**
Market Analyzer \$ 245
Market Manager 219
Connector 39
- ECO-SOFT**
Microstat \$ Call
- ENERTRONICS**
Energraphics \$ Call
- FINANCIER**
Tax Series 105
Financier II \$ 119
- FOX & GELLER**
Grolox \$ 199
Quick Codes 175
D Util 58
- FYI**
Superfile \$ 139
FYI 3000 287

- GRAPHIC/MOSAIC SOFTWARE**
Super Chartman II ... \$ 299
Super Chartman IV ... 199
Combo II & IV 350
Integrated 6 369
- LIFETREE**
Volkswriter Deluxe ... \$ 199
- LIGHTHOUSE SOFTWARE**
Key II (Data Mgmt 123) ... \$ Call
- LIVING VIDEOTEXT**
Think Tank (256K) ... \$ 139
- MICROPRO**
Starburst \$ Call
MICROIR
R-base \$ Call
- NORELL DATA SYSTEMS**
Systems Backup \$ 42
- PEACHTREE**
See CP/M listing.
PeachText 5000 \$ 225
- ROSESOFT**
ProKey 3.0 \$ 99
- SATELLITE SOFTWARE**
Word Perfect w/ Sp ... \$ 299
- SORCIM**
Supercalc III \$ 239
- SPI**
Open Access \$ 399
- STAR SOFTWARE SYSTEMS**
*Legal Time, Billing, Property Mgmt. 787
787
- SUPERSOFT**
C Compiler - 8086 ... \$ 350
Basic Compiler 225
8087 Support 40
- SYSTEMS PLUS**
Landlord (prop mgmt) \$ 375
Runtime Basic (req'd for above) ... 45
- VISICORP**
VisiOn Line \$ Call
... and many more!

d-BASE II CORNER

- Anderson-Bell**
Abstat \$ 329
- Ashton-Tate**
d-Base II \$ 389
FPL 410
Friday 179
- Fox & Geller**
Quick Code \$ 175
D Util 58
- Human Soft**
d-Base Plus \$ 90
- Sensible Designs**
D-Programmer ... \$ 249
- Software Banc**
Advanced d-Base
User's Guide \$ Call
Report Writer w/
d-Base II purchase \$ 10
- Tylog Systems**
d-Base Window ... \$ 179
d-Base Door \$ 109
- *All above available on PC-DOS

STAR SOFTWARE SYSTEMS ACCOUNTING PARTNER

Easy to use menu-driven programs for the beginner that can be linked with a sophisticated system as needed.

Your "Partner" includes: general ledger, accounts receivable, accounts payable and payroll. Also included for a nominal fee is an "800" number for access to the Star Question Center Back-Up Support Unit.

ORYX PRICE \$ 269

APPLE/ FRANKLIN BOARDS

ALS CP/M Card	\$ 299
ALS Smarterm II	145
ALS 2-Card II	120
ABT Keypad	99
Axlon Ramdisk 128K	309
Bit 3 Dual Comm-plus	209
CCS 2710 Asynch Serial	119
East Side	
Wild Card II	\$ 117
Microsoft 16K Ramcard	69
Microsoft Softcard	219
Microsoft Softcard +	419
Microsoft Premium	
Softcard (IIE)	\$ 335
Microtek Printer I/F	75
Microtek Dumping 16K	169
Microtek Dumping GX	89
Mountain A-D/D-A	Call
Mountain	
Music System	\$ 299
PCP 4 MHz	
Appl. Card + 88 Card	Call
PCP 88 Card	
16 Bit + 64K	\$ 425
Prometheus Versacard	159
SSM ASIO Serial I/F	
w/cable	\$ 129
SSM AIO-2 Serial/	
Parallel	\$ 179
Tymac Parallel I/F	
w/cable	\$ 79
Videx Display	
Enhancer	\$ 99
Videx Display	
Enhancer II	\$ 99
Videx Func. Strip	35
Videx Videoterm	
V1-600	\$ 179
Videx Ultraterm	249

IBM/PC BOARDS

AST RESEARCH	
Six Pak Plus 64K (exp	
384K - Ser, Par, Clk)	\$ 279
MegaPlus 64K, (Cl/Col,	
Ser Port, 512K capacity	
w/ Megapak)	\$ 269
Monograph Plus	Call
PC Net II Bus Sys	Call
Extra ports available	
for Megapack and I/O	
Plus II (Game, P/S)	\$ 40

Below are several of the terminals available at ORYX.
Adds - Qume - Televideo - Liberty - Teletex - Wyse
For technical assistance call (715) 848-1374
To order, use our toll free line.

AST RESEARCH (Cont'd)	
Megapak 256K upgrade	
for Megapack	\$ Call
I/O Plus II Cl/Col	
and Ser Port	\$ 115
MA SYSTEMS	
PC Peacock Clr Bd	\$ 325
MAYNARD ELECTRONICS	
Floppy Drive Cntrlr	\$ 160
w/ Par Port	209
w/ Ser Port	219
Sandstar Floppy	
Drive Cntrlr	\$ 194
Sandstar Mem Card	
- 3 modules cap.	\$ 145
Sandstar Multifunction	
Card-6 modules cap.	\$ 71
Sandstar Modules	\$ Call

DISPLAY CARDS CORNER

Hercules Gr Bd	\$ 359
Plantronics	
Colorplus	\$ Call
Paradise/USI	
Display Card (color/	
monochrome)	\$ 399
Ardek MAI Card	\$ 420
Tecmar	
Graphic Master	\$ 499

QUADRAM	
Quadboard 64K, (exp 384K	
Clk/Col, Ser & Par	
Ports, Software)	\$ 279
Quadboard 384 (0K)	212
Microfazer Stack Printer	
Par/Par 8K (exp 512K)	\$ 132
Ser/Par 8K	
(exp 64K)	\$ 156
Ser/Ser 8K	
(exp 64K)	\$ 156
Quadlink 64K Mem	
(allows Apple SW to	
run on IBM/PC)	\$ 469
Other Quadram Prods	Call
TECMAR Products	Call

XEDEX/MICROLOG	
Baby Blue	\$ 325
Baby Blue II	\$ 525

MONITORS

Ardek 300A Am	\$ 149
Ardek Color II +	425
NEC JB1201 - 12" Gr	\$ Call
NEC JB1260 - 12" Gr	\$ 119
NEC JC1216 RGB	435

Panasonic CT160	
10" comp	\$ Call
PGS HX12 RGB Clr	\$ Call
PGS MAX 12	\$ 199
Quadram	
Quadchrome	\$ Call
Sony 8112 12" HR Gr	\$ Call

SONY

Proelec 12"	\$ Call
Proelec 19"	\$ Call
Proelec 25"	\$ Call

Toscan	
KG12N UY 12" HR Am	\$ 139
KG12N 12" HR Gr	\$ 132
RGB Vision I	
12" LR Clr	\$ 323
RGB Vision-3	
12" HR Clr	\$ 459
USI 1200A 12" HR Am	\$ 159

MODEMS

Hayes 300	\$ Call
Hayes 1200	\$ Call
Hayes 1200B (Int'l)	\$ 449
Hayes Chronograph	189
Novation	
Apple Cat II	\$ 259
PC Cat w/ Crosstalk	
(also known as	
Access 1,2,3 1200B)	\$ Call
Orchid Technology	
Orchid Blossom 64K	\$ Call
PC Net Daughterboard	
(add on to Blossom)	\$ Call
Prometheus	
Promodem	\$ 449
US Robotics	
Auto Dial 300-1200	\$ 459
S-100 Modem	339
Password	\$ 325
Zoom Telephonics	
Networker	\$ 109

PC NETWORKING by SANTA CLARA

Starter Kit -	
Special Price	\$1,245
Add'l Adapter Cards	
& Cabling Available.	
For Pricing	\$ Call

DISK DRIVES

CDC 1800	\$ 229
Corona	
5 MB Hard w/cntrlr	\$1,395
10 MB Hard w/cntrlr	1,795
Corvus	\$ Call
Davong 10/15/20 MB	\$ Call
Santa Clara	\$ Call
Tandon TM 100-2	\$ 219
Vista	
Dynaframe Systems	
w/ 5 to 40 MB Primary	
Disk Drive	\$ Call

HALF HIGHS

Matsushita	\$ 199
Panasonic	199
Shugart	225
Super 5 (Apple)	\$ 210
Teac w/brackets	\$ 210

PRINTERS

Anadex	\$ Call
Diablo 630 ECS	\$ Call
Diablo 630 API	\$ Call
Epson	\$ Call
IDS/Data Products	
Prism 80 w/4 options	\$1,399
Prism 132 w/4 options	\$1,547
Microprism	\$ Call
Mannesman Tally	
MT180L	\$ 810
MT160L	595
Spirit	\$ 330
NEC 3550	\$1,745
Okidata 82-93	\$ Call
Quadram Quadjet	\$ Call
Siemens	
Ink Jet Printer PT88	\$ 749
Silver-Reed	
Daisy Wheel	\$ Call
Star Micronics	\$ Call
Teletex T1014	\$ 499
Transtar	
T 130 P&S	\$ 665
T 315 P - Dot Matrix	489
T-120 P&S	475

... and much more.

DISKETTES

BASF w/ library case	\$ 28
3M 5" DS, DD, Box	\$ 40
CDC	\$ 28
Maxell 5" DS, DD,	
MD2, Box	\$ 40
Verbatim 5"	
DS, DD, Box	\$ 35
Ultra Magnetics 5"	
DS, DD, Bonus Box	
(12 Diskettes)	\$ 35
(3 Boxes Diskettes Minimum)	

We offer the following complete systems w/ full support on our technical line:

Franklin 1000 & 2000	NEC APC & 8800
Corona	Columbio
Televideo	Hyperion

PLOTTERS

Enter P100 Sweet P	
Apple/Franklin,	
IBM/PC	\$ 545
Enter's 6-Shooter	\$ Call
Strobe M100 Plotter	\$ 499
w/ I/F Apple/Franklin	\$ 499
Strobe M100 Plotter	\$ 499
(RS 232)	\$ 499
Panasonic	
VP6801P Plotter	\$1,375

MISC.

Alpha-Delta 'MACC'	
Surge Protector	\$ 69
Chalkboard	\$ Call
Curtis PC Products	\$ Call
Electronic	
Protection Devices	
Surge Protectors	\$ Call
Hauppauge	
8087 Math Pkg	\$ 195
87 Chip	169
Others	\$ Call
Keytronic	
Keyboard 5150	\$ 175
WP KB5151	219
WP KB5151 Dvorak	\$ Call
Koala Technologies	
Graphic Tablet	\$ Call
Orange Micro	
Grappler Plus	\$ 117
Grappler Plus w/Buffer	175
Street Electronics	
Echo Speech Synth IBM	\$ 179
Echo II Speech Synth	129
Echo Word	\$ Call
TG	
Joystick IBM/PC	\$ 49
Joystick Apple/FRK	46
Wico	
Analog Joystick	\$ 39
Apple Adapter	18
IBM/PC I/F Card	\$ Call
Versa Computing	
VersaWriter	\$ 239
SDI, Inc.	
STOPLOCK	
Completely STOPS computer	
in boot mode - LOCKS IT UP	
INTERNALLY. OPENS only to	
valid user with I.D. code.	
(Check money-back guaran-	
tee by SDI, Inc.)	\$ Call

Please:

- Wisconsin residents add 5% for sales tax.
- Add \$3.50 for shipping per software and light items. For multiple and other items, call.
- Foreign - add 15% handling & shipping for prepayment. (Int'l money order.)
- Prices are subject to change without notice.
- All items subject to availability.

ORYX SYSTEMS, INC.

CRAFTSMEN OF THE NEW TECHNOLOGY

425 First Street • P.O. Box 1961
Wausau, Wisconsin 54401

*For technical assistance, order status and in Wisconsin:
715-848-1374

Int'l Telex: 260181
ORYX SYS WAU

We Welcome:

- COD (Add \$2.00 per shipment. Cash or certified check required.)
- Visa, MasterCard (Add 3%) & American Express (Add 4%).
- Checks. (Allow 1-2 weeks for clearing.)

Working Hours: Central Time
Mon. - Fri. 8:30 - 6:00 / Sat. 10:00 - 2:00

If at first you don't succeed
In finding products that you need,
Use our phone line... it's toll free
For great prices... availability!

ORDER TOLL FREE OUTSIDE WISCONSIN 1-800-826-1589



NEW SYSTEMS

Z80 and 80186 Built into Poly

A multiuser, dual-processor S-100 computer, the Poly 8/16 from PolyMorphic Systems is built with Z80 and 80186 microprocessors. A two-board set, the Poly 8/16's master board carries the 8-bit Z80 processor, 64K bytes of RAM, and the PC-DOS-compatible CP/M-80 operating system. The slave board uses the 8-MHz 16-bit Intel 80186 processor, provides 256K bytes of RAM (expandable to 1 megabyte), and runs under Concurrent CP/M-86.

The Poly 8/16 supports up to

four users, each running 80186 slaves. Each additional 80186 slave card has 256K bytes of RAM, two serial ports, and a parallel port. (The 80186 single-board computers can be added to PolyMorphic computers installed since 1977.) Options include floppy-disk drives, printers, plotters, a CAD/CAM color terminal, UNIX, and half- or full-sized fixed-disk or removable-cartridge Winchester drives with storage capacities from 5 to 80 megabytes.

The basic Poly 8/16 comes

with master and slave cards on a 5-slot motherboard, a half-height 800K-byte floppy-disk drive, four RS-232C/RS-422 serial ports, two parallel ports, a detached keyboard, and a serial terminal with a 14-inch monochrome display. Supplied software includes Digital Research's GSX graphics extension, CP/M-80, and CP/M-86. Prices start at \$4495. Contact PolyMorphic Systems, 5330 Debbie Lane, Santa Barbara, CA 93111, (805) 967-0468.

Circle 750 on inquiry card.

6-MHz Z80B at Heart of Computer

The Servo 8's Z80B runs at 6 MHz. It has 64K bytes of 150-nanosecond dynamic RAM and 2K bytes of monitor/debugger EPROM on board. A self-adjusting disk controller can handle four 5¼- and four 8-inch drives simultaneously. A parallel printer port, SASI bus, two serial ports with software-selectable data rates, and a 50-pin Servo expansion bus are provided. Either CP/M or OASIS serves as its operating system. Power requirements are 5 V at 1400 mA.

Options include 10- and 20-megabyte drives, two serial ports, a real-time clock/calendar, and a memory board with two 64K-byte banks of RAM. The single-unit price is \$495. Contact Servo Computer Corp., 360B North Ellensburg St., POB 566, Gold Beach, OR 97444, (503) 247-2021.

Circle 754 on inquiry card.

16032 Multibus Computer

The GVC-16 Multibus computer is a 32-bit demand-paged, virtual-memory system using National Semiconductor's 10-MHz NS16032 microprocessor. This single-board computer combines the NS16000 chip set with up to 2 megabytes of RAM and a Winchester hard-disk interface. Its key specifications are 512K bytes of dual-ported RAM with parity, a 16081 floating-point unit, twin sockets for up to 32K bytes of EPROM, time-of-day clock with battery backup, 4 serial I/O ports, 16 vectored interrupts, 4 user-definable DIP switches, and an EPROM-based interper BASIC interpreter. A system monitor resides in ROM.

The basic configuration, which comes with 512K bytes of memory and an interrupt-control unit, costs \$3295. Contact GVC Inc., 222 Third St., Cambridge, MA 02142, (617) 576-1804. Circle 753 on inquiry card.

Portable Has Hard and Floppy Drives

The C2600 portable computer from Jonos International comes with a 10-megabyte 3½-inch hard-disk drive and a 322K-byte

3½-inch floppy-disk drive. The C2600, which is designed around the 8-bit Z80B microprocessor, features 128K bytes of

RAM, a 9-inch high-resolution display, and CP/M 3.0 Plus. Its I/O capabilities are made up of two serial RS-232C ports, a single parallel printer interface, and a composite-video jack. The C2600's detachable IBM Selectric-type keyboard is augmented with 10 function keys and a 10-key numeric pad. Its dimensions are 17¼ by 13¼ by 7¼ inches. It weighs 27 pounds.

For expansion, the C2600 has three STD bus slots. Currently the manufacturer offers controllers, graphics, modem, and memory cards. The list price is \$5695. Contact Jonos International Inc., 1835 Dawns Way, Fullerton, CA 92631, (714) 999-6661.

Circle 751 on inquiry card.



Dual Processors Standard with Eve

Featuring Z80A and 6502 microprocessors, the S2195 Eve II Personal Computer comes with a monitor, a dot-matrix printer, a floppy-disk drive, and a bundle of software. Eve II, a 64K-byte system, runs under CP/M while offering AppleDOS compatibility. Its 12-inch orange monitor can produce 40- or 80-column by 24-line displays and generate 16 colors. The bi-directional printer operates at 80 cps and handles both fan-

fold and single-sheet paper through tractor- and friction-feed mechanisms.

Eve II has a standard QWERTY keyboard, eight programmable function keys, a self-test key, and separate numeric pad and cursor controls. Mass storage is provided by a 163K-byte single-sided, double-density floppy-disk drive. Additional hardware features include a digital clock and eight Apple-compatible expansion

slots. Word-processor, file-manager, financial-planning, and budgeting packages from Sam's Software are supplied.

Up to 256K bytes of RAM and a variety of peripherals and applications programs are optional. Contact Computer Technology International Inc., 200 Murray Hill Parkway, East Rutherford, NJ 07073, (201) 935-9300.

Circle 752 on inquiry card.

PERIPHERALS

Video-Capture System for IBM

A video-capture system for the IBM PC is available from Chorus Data Systems. The PC-Eye Series 1000 interface board seizes images from a video camera or recorder at speeds of up to eight frames per second. Images can be digitized with 1 or 2 bits of intensity for use with the IBM high-resolution graphics adapter, or they can be digitized with 4 bits (i.e., 640- by 400-pixel resolution) for use with PC-compatible graphics adapter boards. The standard resolution at 2 bits is 320 by 200 pixels, while at 1 bit it's 640 by 200 pixels. Other resolutions and partial image transfers can be achieved under program control.

The Series 1000 transfers images under DMA control directly to the PC's main memory at rates approaching 1 megabyte per second. Successive frames can be captured and stored for off-line comparison or postprocessing. Both noninterlaced and interlaced scanning are supported. A crystal-controlled clock and a



digital driver ensure accurate timing and stable synchronization. Software support for hard-copy outputs, annotation, storage, comparison, compression, and transmission of video information is offered.

The PC-Eye Series 1000 requires PC-DOS 2.0, a single PC or PC XT expansion slot, and a camera or recorder with an EIA RS-170 or NTSC inter-

face. Copy stands, graphics adapters, cameras, lenses, and applications software are optional. PC-Eye is \$495, which includes the interface card, utility software, and documentation. Address inquiries to Chorus Data Systems Inc., POB 810, Hollis, NH 03049. (603) 465-2290.

Circle 755 on inquiry card.

New Low-End Terminal Boasts High-End Features

The Freedom 110 video display terminal from Liberty Electronics is an ergonomically styled unit with a 12-inch green or amber tilt/swivel monitor and a detached DIN-standard keyboard. The nonglare CRT displays 96 ASCII characters, 32 control characters, and 15 line-graphics characters in a 7- by 9-dot matrix format in a 9 by 12 field. Eight foreign-language character sets are also available.



Display size is 24 lines by 80 columns, with a twenty-fifth status line. A screen-saver feature will shut off power to the CRT, without loss of data, if fifteen minutes have elapsed with no activity. The keyboard has 94 keys, including a QWERTY layout, numeric keypad, 4 cursor movement keys, 6 editing keys, 8 command keys, and 10 nonvolatile programmable function keys that can be used in conjunction with the Shift key to produce 20 user-defined sequences totaling up to 256 bytes.

The unit has two independently configured RS-232C ports and supports both XON/XOFF and DTR handshaking at rates up to 19.2K bps. The Freedom 110 can be set up to emulate the

TeleVideo 910, the Lear Siegler ADM-3A/5, the Hazeltine 1420, the ADDS Regent 25, and Liberty's higher-priced model, the Freedom 100. Nonvolatile setup parameters can be input from the keyboard using either a full-screen menu or the status line, or downloaded from the host computer. There is room in the base of the monitor for an additional printed-circuit board of about 7 by 11 inches that could be used for a single-board computer or other device. The Freedom 110 lists at \$595 for the green-phosphor model; the amber display costs an additional \$25. Further information is available from Liberty Electronics, 625 Third St., San Francisco, CA 94107. (415) 543-7000.

Circle 756 on inquiry card.

Voice/Data Storage and Retrieval Line Unveiled

Dialogic Corporation recently unveiled a series of real-time voice and/or data storage and retrieval I/O boards for the IBM PC. Designed for voice-annotation of text, digital voice transmission, remote messaging and data entry, and computer/human interface applications, the Dialog family comes in three implementations: basic voice I/O, a version with auto-answer/auto-dial firmware, and a model with a 300-bps modem and digital-transmission firmware. Each board comes with a set of software drivers that digitize, store, and recreate sounds. Only one PC expansion slot is used.

Three data-sampling rates—4, 6, or 8 kHz—are standard. At 4 kHz, the maximum data storage requirement per second is 2K bytes, 1.5K bytes is typical, and 3 bytes is minimum. Polled or interrupt-driven handshake modes, 32-sample buffer, and eight selectable I/O addresses (two used) make up the Dialog-to-IBM interface.

Dialogic boards will accept, compress, and store on disk any sound that can be recorded on tape. Inputs are entered from a microphone, a telephone, or a local-network interface. Outputs can be directed to your PC's speaker, an external speaker, or earphones. Sounds are recreated in real time.

Demonstration programs and PC-DOS drivers for BASIC, Pascal, and C are supplied with each board. The basic system, Dialog/1, is \$295. With a telephone interface and auto-answer/auto-dial capabilities, Dialog/2 is priced at \$495. The fully configured Dialog/3 is \$595. Further information can be obtained by contacting Dialogic Corp., 164 McKinley Ave., East Hanover, NJ 07936. (800) 221-0393; in New Jersey, (201) 386-0202.

Circle 757 on inquiry card.

(text continued on page 470)

A D D - I N S

Internal Modem for Portable PC

The PC Modem Half Card from Ven-Tel provides the IBM Portable PC with a very important accessory—an internal 300/1200 bps auto-dial/auto-answer modem that fits into one of the computer's half-length expansion slots. The product accepts the widely used Hayes Smart-modem control codes and is distributed with Crosstalk-XVI telecommunications software

from Microstuf Inc. Buyers should note that this is *not* the same product as Ven-Tel's earlier PC Modem Half Card for the IBM PC XT (which has a similar card bus)—the two modems are not interchangeable. Retail price is \$549. For more information, contact Ven-Tel Inc., 2342 Walsh Ave., Santa Clara, CA 95051, (408) 727-5721. Circle 758 on inquiry card.

Combo S-100 Board Has Z80 and 286 Processors

Macrotech International has announced the MI-286, a dual-processor S-100 CPU board with both a Zilog Z80B and an Intel iAPX 80286. The board is designed as a replacement for earlier multitasking and multi-user dual-processor CPU boards running under the MP/M-8/16 operating system, such as the CompuPro CPU 8085/8088. Because of the increased addressing capability of the MI-286, the new board can sup-

port up to 16 megabytes of random-access memory. Single-unit price of the MI-286 is \$1395; an optional upgrade including the 80287 math coprocessor and related PAL (programmed array logic) is available for \$650. More information can be obtained from Macrotech International Corp., 9551 Irondale Ave., Chatsworth, CA 91311, (818) 700-1501. Circle 759 on inquiry card.

PC Color Graphics Adapter

Persyst has announced BoB (Best of Both), a color-display adapter board for the IBM PC and PC XT. A single-board adapter compatible with the IBM color-display adapter's features, BoB supports either a standard color mode with 16 colors or a black-and-white mode with 16 levels of gray. It produces an 8- by 12-dot character in a 10- by 16-dot grid. Two graphics screen modes are standard: 320- by 200-pixel medium resolution with four colors and 640- by 200-pixel high resolution with one color. For higher resolutions, it supports a 24.83-kHz horizontal rate that sustains 400 vertical-scan lines. DMA operations and

access to display memory in any mode are permitted. BoB has direct-drive intensity RGB and composite-video outputs, a light-pen interface, and provisions for up to 32K bytes of display memory. It supports the PC's user-selectable character attributes and the 256-character IBM set. Optionally, 320- by 400-pixel medium-resolution with four colors and 640- by 400-pixel high-resolution single-color graphics modes are available. Prices begin at \$425. Contact Personal Systems Technology Inc., Persyst Products, Suite A, 15801 Rockfield Blvd., Irvine, CA 92714, (714) 859-8871. Circle 760 on inquiry card.

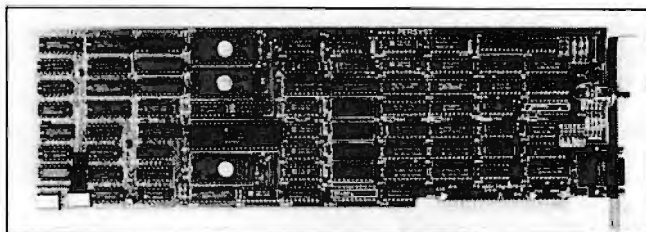

S O F T W A R E • I B M P C

Linear Programming for the PC

LP88 is a general-purpose system for solving linear programs with up to 255 constraints and 2255 variables (including slacks). You can input linear programs as they are formulated without converting to a standard form. Both maximization and minimization problems are accepted, and LP88 accepts any combination of <=, >=, or = constraint relations. Applications include production, mixing, scheduling, inventories, cash management, transportation, and network problems. LP88 uses the Revised Simplex algorithm. It computes and stores the inverse of the matrix of basis columns as the linear program is solved. LP88 can be configured at run time. Operator controls are ex-

ercised by means of function keys, and four menus provide options for input, solution, output, and interrupting execution. A display editor uses spreadsheet-like inputs and permits editing and modification of a problem's features. The Simplex algorithm can be interrupted during program execution. Minimum requirements are a display, a single disk drive, a printer, DOS 1.1 or 2.0, and a 128K-byte IBM PC or PC XT. For large problems, 192K bytes and a RAM disk or hard disk are recommended. It costs \$88. A version that supports the Intel 8087 costs \$11 more. Contact Eastern Software Products Inc., 4804 Tarpon Lane, Alexandria, VA 22309, (703) 360-6942. Circle 761 on inquiry card.

A Little Blues for the PC

The SongWright Music Processor for the IBM PC lets you compose, save, edit, transcribe, play back, and print out music. It also aligns lyrics and chord notations with notes. SongWright features a two-octave range, seven key signatures, multiple time signatures, and chordal harmony. DOS 1.1 or 2.0 and an IBM or Epson graphics printer are required. The suggested price is \$24.95. Contact SongWright, 928 Fillmore St., Denver, CO 80206, (303) 321-0481. Circle 762 on inquiry card.

The PC Talking Program is a machine-language program that modifies the IBM PC so that it becomes a fully functional talking computer. The Talking Program lets you choose total or spelled speech, and it can identify uppercase and lowercase characters as well as line and column numbers. It can read or spell out an entire page, current line, or the character under the cursor. All its major functions are controlled by 10 function keys, and no hardware modifications are required. To use the Talking Program, you need a 64K-byte IBM PC, an asynchronous RS-232C communications adapter, a speaker

SOFTWARE • IBM PC

or headphones, a specially configured RS-232C cable, and a Votrax Type 'N Talk, Echo PC, or other voice synthesizer. The talking program uses only about 2K bytes of memory. Also available is a version of the Talking Program that works with IDEAssociates IDEAComm 3278 board, which permits the talking IBM PC to emulate an IBM 3278. A Talking Proofreader can be obtained. The Talking Program can be obtained for Radio Shack computers and the Lobo MAX-80. Write Computer Conversations, 2350 North 4th St., Columbus, OH 43202, or call (614) 263-4324 after 6 p.m. Circle 763 on inquiry card.

Building Blocks for Numeric Control

Novum Organum's C Building Blocks are a set of functions and subsystems suitable for such applications as numeric control and telecommunications. They interface with PC-DOS and provide access to all the features and peripherals on the IBM PC.

C Building Blocks I provides access to all system services and DOS features and control over peripherals. The database version handles keyed access to variable-length records, while the mathematics version gives you the most commonly used arithmetic functions. Communications Building Blocks allows data transfers with interrupt-driven ports control and protocol file transfer. Advanced Building Blocks extends Building Blocks I by allowing filed input, Julian dates, and data compression.

C Building Blocks are delivered on MS-DOS-compatible 5¼-inch floppy disks with comprehensive manuals. The source code is provided or available. Mathematics and Advanced Building Blocks cost \$99 each. The others are \$149. Add \$4.50 for shipping (\$6.50 for UPS air delivery). Contact Novum Organum, 29 Egerton Rd., Arlington, MA 02174, (617) 641-1650. Circle 764 on inquiry card.

NAPLPS Software

TVOntario's NAPLPS page/frame creation software, Createx-C, runs on the IBM PC. This program is said to generate graphics at high speed, make database storage more economical, and reduce transmission costs. Createx-C can scan a page to produce a shorter byte length while retaining the essential content suitable for both on-line and broadcast transmission. It can define up to 262,000 colors, limited only by the terminal. Because it uses NAPLPS blinks and color-mapping codes, Createx-C is suitable for animation. Other features include single-keystroke editing, access to NAPLPS text features, and full user control over character path, character rotation, and text size.

Createx-C requires a NAPLPS decoder and color monitor. It costs \$1450 for the first license. Contact TVOntario, POB 200, Station Q, Toronto, Ontario M4T 2T1, Canada, (416) 484-2606. Circle 765 on inquiry card.

Word Processor Merges Lists, Defines Keyboard

The XyWrite II-plus word processor lets you merge mailing lists and define the IBM PC's keyboard. With its mail-merge feature, you can integrate names, addresses, and data fields. The keyboard definition function proffers single-keystroke command-and-text combinations. XyWrite II-plus has horizontal and vertical split-screen displays, simultaneous multiple-file access, and horizontal scrolling. Editing functions include column moves, indexing, superscripts, subscripts, footnotes, endnotes, foreign-language and mathematics characters, pagination, and automatic word wrap. Background printing, directory call-up, and on-line help are provided.

For forms generation, XyWrite II-plus will protect fields. Pre-printed forms and documents can be filled out. On-screen page and line indicators, page-break indicator, tab ruler and column indicator, micro-justification, underlining, and what-you-



see-is-what-you-get printing are other highlights.

XyWrite II-plus runs under PC-DOS versions 1.0, 1.1, 2.0, and 2.1. It's compatible with text files from assembly languages, BASIC, Lotus 1-2-3, Pascal, VisiCalc, and FORTRAN. It costs \$295, plus \$5 shipping, and is available from XyQuest Inc., POB 372, Bedford, MA (617) 275-4439.

Circle 766 on inquiry card.

SOFTWARE • IBM PCjr

Integrated Software for PCjr Has Windows

Alpha Software's Electric Desk, an integrated, multitasking software package with windows for the IBM PCjr, combines word processing, spreadsheet analysis, database management, and communications functions in a single package. Several functions can be operated simultaneously, and switching from one task to another or dividing the display screen into a pair of windows can be accomplished with two or three keystrokes.

An integral macro language lets you program frequently needed functions, such as a repetitive series of calculations, into two-keystroke commands. Data can be transferred to and from functions; disk-switching is not necessary.

Electric Desk's word processor

provides the features available on most stand-alone word processing programs, while the 255-row by 255-column spreadsheet is said to match any electronic spreadsheet for the IBM PC. The database manager gives you extensive indexing and can accommodate up to 65,000 records. In addition to electronic mail and commercial database-access capabilities, the communications option lets you automatically dial telephone numbers stored in the database.

Electric Desk requires 128K bytes of RAM and a disk drive. Most of its code is on ROM cartridge. The list price is \$295. Contact Alpha Software Corp., 30 B St., Burlington, MA 01803, (617) 229-2924.

Circle 767 on inquiry card.

Speaking Software

PC Speak jr. provides an audio display screen replacement. When coupled with the IBM PCjr and a speech synthesizer, such as the Votrax Type 'N Talk, PC Speak jr. will vocalize word processors, applications packages, games, and programming languages. It can say what is on the screen or be used to review the display. Individual lines or words can be selected, and it can echo data as it is input.

PC Speak jr. requires a disk drive, the PCjr's serial adapter, PC-DOS, and a voice synthesizer. An optional parallel printer adapter can be used. It costs \$149. Contact Solutions By Example, POB 307, New Town Branch, Boston, MA 02258, (617) 244-5880.

Circle 768 on inquiry card.

(text continued on page 472)

SOFTWARE • IBM PCjr

Program-Chaining Monitor for PCjr

Exec implements program chaining using the PC-DOS loader. It permits programs in one language to effectively chain programs written in another language or DOS batch file. A common data area of the size necessary to transfer data structures between programs can be specified, although only one program is memory resident at a time.

Exec requires less than 9K bytes and runs on the IBM PCjr and other MS-DOS 2.0-based computers. The list price is \$95. Contact Blaise Computing Inc., 2034 Blake St., Berkeley, CA 94704, (415) 540-5441. Circle 769 on inquiry card.

Pascal Compiler for Jr

A Pascal language compiler for the IBM PCjr. Turbo Pascal is available from Borland International. This high-level language features a single-pass native-code compiler, bit/byte manipulation, direct access to the central processor's memory, dynamic strings, include files, and random-access files. It can compile more than 2000 lines of code per minute. Turbo Pascal's combination compiler/editor occupies 33K bytes of the PCjr's memory.

The list price for Turbo Pascal for the PCjr is \$49.95. Contact Borland International, 4113 Scotts Valley Dr., Scotts Valley, CA 95066, (408) 438-8400. Circle 770 on inquiry card.

SOFTWARE • APPLE

Apple in Print Shop

The Print Shop from Broderbund Software lets you write, design, and print your own greeting cards, stationery, letterhead, signs, and banners with your Apple II+ or IIe. It offers eight different type styles in two sizes and in solid, outline, and three-dimensional formats. The Print Shop has nine border designs, 10 abstract patterns, and more than a dozen pictures and symbols with which to work. A built-in graphics editor lets you create your own symbols and modify the supplied ones. You can print illustrations generated with other programs.

The Print Shop will produce a greeting that has messages both inside and outside and full-page signs. Its text-editing features include automatic centering, left and right justification, and proportional spacing.

This program comes with an assortment of pin-feed paper and matching envelopes. It requires 48K bytes of memory and a printer. It costs \$49.95. Contact Broderbund Software, 17 Paul Dr., San Rafael, CA 94903, (415) 479-1170. Circle 771 on inquiry card.

PractiCalc Spreadsheet for Apple II

PractiCalc II is a spreadsheet program for 48K-byte Apple II+ and IIe computers. In addition to traditional spreadsheet functions, PractiCalc has word-processing capabilities, advanced editing functions, variable column widths in all columns, automatic and manual recalculation, the ability to do long labels, and an on-screen default menu. When running on the Apple IIe, it has 80-column, uppercase and lowercase data-entry, and printing capabilities. Other features include alpha and numeric sorting and search, prompts for entry during calculation, and printing of list formulas.

PractiCalc II costs \$69.95. Contact Micro Software International, The Silk Mill, 44 Oak St., Newton Upper Falls, MA 02164, (617) 527-7510. Circle 773 on inquiry card.

SOFTWARE • OTHER COMPUTERS

Word Processor Links Rainbows to PDP

CT*OS/86 is a word processor that lets you transfer word-processor files from DEC VAX and PDP-11 host computers to the Rainbow. When in its image-transfer mode, CT*OS/86 maintains full document and message-format compatibility between computers running any member of the CT*OS family. This menu-driven system provides global search and replace,

cut and paste, list processing, a spelling corrector, ASCII file handling, 132-column document width, stored text libraries, right-justified margins, scientific character set, and user-defined function keys.

A single-user license is \$950. Contact CompuTome Inc., 234 East Colorado Blvd., Pasadena, CA 91101, (213) 796-9371. Circle 775 on inquiry card.

Keyed Files for Rainbow

Applications BASIC gives the DEC Rainbow keyed-file access, which facilitates the preparation of business applications programs. This utility provides file- and data-handling functions, programming aids, and debugging tools. Its file-handling feature has dynamically allocated files that can be accessed by a 1- to 58-character alphanumeric keyword. The file-handling capabilities support ISAM; random and serial files with automatic field separation to accommodate up to 65,535 records per file; more than

32,760 characters per record; and over 32,760 fields per record. Up to 63 files can be simultaneously open.

Its data-handling abilities include automatic variable passing to other program segments, automatic decimal rounding, 32,767 character-string lengths, and numeric-to-string conversion.

Applications BASIC is \$395. Contact Soft Gold Inc., POB 2718, Newport Beach, CA 92663, (714) 476-3004.

Circle 776 on inquiry card.

MasterFORTH on Your Apple

MasterFORTH for the Apple II series meets all the provisions of the FORTH-83 International Standard. It comes with a built-in macro assembler with local labels, a screen editor, and a string-handling package. Its I/O streams are fully redirectable. Floating-point and high-resolution are options.

MasterFORTH costs \$100 to \$160, depending on options. It's supplied with a FORTH textbook, reference manual, and a full listing of the MasterFORTH nucleus. Contact MicroMotion, Suite 506, 12077 Wilshire Blvd., Los Angeles, CA 90025, (213) 821-4340.

Circle 772 on inquiry card.

CAD Program for Apple

Cascade I is a CAD system for Apple computers. It features a 0 to 255 "level" range that allows you to place up to 256 different overlays on the system and display each one separately. It has the ability to group objects into a conglomerate, move objects as a group, add or delete objects to or from the group, and perform other tasks. Pan and zoom capabilities are provided.

Drawings can incorporate aligned, directional, and multi-directional text. Its drafting/graphics menu has more than 20 items, each with multiple options. It has six ways to input arcs; full, quarter, or half eclipses; four ways to input circles; and three line configurations.

Cascade I is £656. It runs on the Apple II+ and IIe. Contact Cascade Graphics Development Ltd., 185 Lower Richmond Rd., Richmond, Surrey TW9 4LT, England; tel: (01) 878-7661; Telex: 929964.

Circle 774 on inquiry card.

SOFTWARE • TANDY / RADIO SHACK

E-COM Interface for Tandy 2000

Flash-COM interfaces your Tandy 2000 to the U.S. Post Office's E-COM electronic mail service. It comes with such modules as word/text-processing, forms/screen file management, mailing-list manager, and communications. Also provided are more than a dozen standard business letters and forms. Flash-COM works with applications written in a variety of productivity tools, including Lotus 1-2-3, dBASE II, WordStar, Volkswriter, and Perfect Writer.

Flash-COM is \$299, which includes a tutorial for first-time users. It's also available for the Apple II/II+, IBM PC and PCjr, Sanyo MBC550, and CP/M-80 systems. Contact Omni Computer Systems Inc., POB 162, Chestnut Hill, MA 02167, (617) 825-6700. Circle 777 on inquiry card.

Mail-List Manager for TRS-80

The Mail Pro program is designed for small businesses or clubs that maintain their mailing lists on a Radio Shack TRS-80 Model I or III. It's particularly suited for those lists that exceed a single disk because its report- or label-printing abilities can span records on more than one drive. Mail Pro can read identical filenames on different disk drives and multiple names on the same drive. It can sort

and print a master list or set of labels from nine different lists on up to four drives. User-defined sorts can be on any field or within a defined range. The multiple-access sort creates its own file while maintaining the individual file's integrity. Once a sort is completed, subsequent printings do not require a new sort, except if new information is added.

Mail Pro features five- and

nine-digit ZIP codes and Canadian codes, batch addition mode, a repeat key, global search and replace, machine sort for individual files, two remark code fields, and a BTree file structure. The capacity is 1400 names per 40-track double-density disk. The list price is \$39.95. Contactushman Publishers, 7720 Brandeis Way, Springfield, VA 22153. Circle 779 on inquiry card.

Super-Bug for CoCo

Super-Bug is a relocatable machine-code generator for the Radio Shack Color Computer. Suitable for novices and experts alike, Super-Bug features hexadecimal and alphanumeric memory display and modify;

character string search; a memory-test facility; a mini object-code disassembler; and a 64K-byte mode setup.

Super-Bug is available on cassette and floppy disk for \$29.95 and \$32.95, respectively.

Documentation is supplied. A 16K-byte or larger system is required. Contact Mark Data Products, 24001 Alicia Parkway #207, Mission Viejo, CA 92691, (714) 768-1551. Circle 780 on inquiry card.

Reference List Program

Bib/Rite helps you prepare reference lists quickly and accurately. With Bib/Rite, you can enter citations randomly and later sort them by author or category. You can add, delete, and merge citations as well as edit individual citations. Bib/Rite also provides automatic paging and margins, menus and prompts, and semiautomatic entry of frequently cited journals or magazines. Its capacity is 100 to 150 citations.

Bib/Rite requires a printer and a minimum of 32K bytes of memory. Versions of Bib/Rite will be available for the following computers: Radio Shack TRS-80 Models I, III, and 4, Apple, IBM PC, and CP/M systems. It's offered on disk or tape for the TRS-80. The single-user price is \$45.95, plus \$2.50 for handling. For multiple users, it's \$150. The manual is \$3.50, plus \$1 for handling. Order directly from Robert Litke, 432 Cottage Ave., Vermillion, SD 57069, (605) 624-2948. Circle 778 on inquiry card.

SOFTWARE • CP/M / MS-DOS

MC68000 Cross-Assembler Package

A68K, a cross assembler for the Motorola 68000 series, comprises an assembler, linker, and library utility. The assembler and linker are source- and object-compatible with the VERSAdos assembler and linker used in Motorola's development systems. A68K accepts all the op codes and extensions as defined in the MC68000 users manual, and it supports nested macros, nested conditional assembly, nested structured programming constructs, absolute and relocatable code generation, and a nested include facility. The size of source files is not limited because the symbol table overflows to disk when the main memory capacity is exceeded.

A disk-resident macro library (not supported by Motorola assemblers) can be created with the library utility. The library provides for the interactive editing of macro or object libraries. Any number and size of macros can be used in a

single assembly, permitting the assembly of arbitrarily large files on small machines.

The linker accepts a control file that determines how the load file is to be constructed. Its commands determine which object files are to be included and what areas of memory are to be assigned to relocatable sections of code. Any number of object-library files created by the library utility can be used in a single link. The linker produces Motorola S records, Intel Hex records, or a binary format. A memory map and the version and modification levels from IDNT directives in the source-assembly modules are produced. On CP/M-86 and PC-DOS systems, the time and date of assembly is listed.

A68K comes on 5¼- or 8-inch disks for CP/M-80, CP/M-86, and IBM PC-DOS. The CP/M-80 version is \$200; the others are \$250. Contact Farware, 1329 Gregory, Wilmette, IL 60091. Circle 782 on inquiry card.

Scientific Subprograms

Three ANSI-standard FORTRAN subprograms for scientific applications are available: Linear Least Squares (LLSQ), Large-Integer Programming (LIPS), and Linear Programming (LPSUBS).

LLSQ provides routines for singular-value decompositions, banded or constrained least-squares problems, and Householder's method for linear least squares. For applications that must arithmetically manipulate integers with many digits, LIPS has routines to perform addition, subtraction, multiplication, division, modular exponentiation, and order relations. LPSUBS lets you use the mathematical methods in the interactive LP-2000 Linear Programming System in your own applications.

MS-DOS is required. LPSUBS is \$99; the others are \$80. Contact Software Designs 2000, Mathematical Products Division, POB 13238, Albuquerque, NM 87192, (505) 294-2165. Circle 781 on inquiry card.

(text continued on page 474)

PUBLICATIONS

UNIX Software Directory

Onager Publishing has announced the availability of the second edition of the *UNIX Applications Software Directory*. This edition lists more than 400 packages in 27 categories. Information on the cost, hardware requirements, and the name, address, and telephone number of the suppliers for each package is provided. Other pertinent details necessary to obtain the package are given. The directory also includes a cross-reference matrix where software is listed by function and application. Among the categories are DOSes, diagnostic tools, graphics, word/text processors, network handlers, database managers, spreadsheets, and BASIC, C, COBOL, and Pascal compilers.

The *UNIX Applications Software Directory*, second edition, is \$50. Contact Onager Publishing, 6451 Standridge Court, San Jose, CA 95123, (408) 225-3541. Circle 783 on inquiry card.

Apple Software Book for 1984

The *Book of Apple Software*, 1984 edition, is available from The Book Company. This reference and review guide describes, evaluates, and rates more than 100 programs for the Apple II and IIe. It has reports on recently introduced programs as well as updated reviews on the latest versions of previously announced packages. Programs are graded in such areas as ease of use, documentation, value for the money, and vendor support. In addition, overall grades are assigned to each program. Evaluations and ratings are performed by independent reviewers, each purported to be an expert in her or his field. Also included is a list of software vendors and advice on obtaining maximum use of your Apple.

The *Book of Apple Software* is

UNIX and C Journal from Down Under

An Australian UNIX and C journal, *IUSER* includes a regular section on medical informatics on systems running UNIX. Annual overseas subscriptions are \$30. Australian subscriptions are \$24. Contact Structured Language Resources, 121 Borg St., Scoresby 3179, Victoria, Australia. Circle 785 on inquiry card.

Indicator/Lamp Catalog

A full-color, short-form catalog covering a complete range of miniature lamps and indicators for printed-circuit boards, instrument panels, push-button switches, legend illumination, telephones, switchboards, control panels, and industrial controls is available free of charge. Contact Ledtronics Inc., 4009 Pacific Coast Highway, Torrance, CA 90505, (213) 373-5437. Circle 786 on inquiry card.

available at bookstores and computer retailers. The suggested price is \$19.95. Other publications offered by The Book Company cover Atari and IBM PC software and Commodore 64 color graphics. For further information, contact The Book Co., 11223 South Hindry Ave., Los Angeles, CA 90045, (213) 410-9466. Circle 784 on inquiry card.

WHERE DO NEW PRODUCT ITEMS COME FROM?
 The new products listed in this section of BYTE are culled from the thousands of press releases, letters, and telephone calls we receive each month from manufacturers and distributors. The basic criteria for selection for publication are a) does a product match our readers' interests, and b) is it new or simply a "reintroduction" of an old item. If you want your product to be considered for publication (at no charge), send full information about it, including its price and an address and telephone number where a reader can get more information. Send this to the New Products Editor, BYTE, POB 372, Hancock, NH 03449.

Guide Lists Nearly 24,000 ICs

Nearly 24,000 different integrated circuits are profiled and cross-indexed in the I. C. *Functional Equivalence Guide* from D.A.T.A. Inc. Chips are grouped on the basis of a pin-for-pin equivalence, which simplifies selection, substitution, and purchasing. The primary specifications for each device are listed, and devices with the same technologies and electrical characteristics are batched together. Categories include gates,

latches, flip-flops, counters, RAMs, ROMs, shift registers, interfaces, memory/clock drivers, logical buffers/drivers, and digital multiplexers.

A one-year, two-edition subscription costs \$95. Contact D.A.T.A. Inc., POB 26875, San Diego, CA 92126, (800) 854-7030; in California, (619) 578-7600. In Canada, call (800) 268-7742, operator 83. Circle 787 on inquiry card.

Power Conditioners Described in Catalog

Oneac Corporation has produced a 16-page catalog that discusses power-supply problems and provides detailed descriptions of its power conditioners. This two-color catalog presents product specifications in easy-to-read charts illustrated by photographs. A chart of applications and detailed information on sizing conditioners for different applications are supplied. Illustrations showing plugs

and receptacles serve as an aid to finding a power conditioner compatible with your system.

The conditioners outlined in the catalog, Oneac's Condition One and Compact, are said to be suitable for all computers and computerized telecommunications and test equipment. Contact Oneac Corp., 2207 Lakeside Dr., Bannockburn, IL 60015, (312) 295-2800. Circle 788 on inquiry card.

MISCELLANEOUS

Premium Quality "Universal" Disks

Platinum Series disks from Capitol Data Systems, a division of Capitol Records Inc., run on any 5¼-inch disk drive. Both sides of all disks are certified error-free across the full surface of the recording medium. This means that they can be used in

single- and double-sided configurations at single, double, or quad density. The disks are manufactured with two index holes and write-protect notches cut into both edges of the jacket, so that they can be flipped over for doubled capacity on single-sided systems. Capitol is manufacturing the Platinum Series to exceed ANSI standards and warrants them "forever, if maintained properly." Suggested price for a box of 10 disks is \$55. For more information, contact Capitol Data Systems, 1750 North Vine St., Los Angeles, CA 90028, (213) 462-6252; in California, (800) 821-7140. Circle 789 on inquiry card.



NEED A BREAK?

Come on down to Apple Country!

We make it our business to offer **ROCK BOTTOM PRICES** on quality computers and programs. We invite you to join our high volume of satisfied users.

CHECK US OUT TODAY—CALL 1-800-222-2602

MONITORS

AMDEK COLOR I PLUS	309.95
AMDEK COLOR II PLUS	454.95
AMDEK COLOR IV	819.95
AMDEK VIDEO 300 (GREEN)	139.95
AMDEK VIDEO 300 (AMBER)	154.95
AMDEK VIDEO 310 (AMBER)	174.95
BMC 12" GREEN	89.95
BMC 13" COLOR	249.95
BMC 13" RGB AP2 COLOR	379.95
BMC 13" RGB IBM	449.95
COMREX 9" HI-RES AMBER	119.95
COMREX 13" COLOR W/SOUND	289.95
COMREX 12" HI-RES AMBER	139.95
COMREX 12" HI-RES GREEN	134.95
COMREX 13" RGB COLOR	274.95
GORILLA 12" AMBER	99.95
GORILLA 12" GREEN	89.95
NEC 12" HI-RES GREEN	154.95
NEC 12" ECONO GREEN	109.95
NEC 12" LO-RES COLOR	294.95
NEC 12" AMBER SCREEN	164.95
NEC 12" COLOR - IBM	439.95
PRINCETON GRAPHICS HK-12	519.95
SAKATA 13" COLOR	294.95
SAKATA 13" RGB COLOR	549.95
SAKATA SUPER RGB	749.95
SAKATA 12" GREEN	119.95
SANYO CTR-70 HRES COLOR	629.95
TAXAN 12" GREEN	129.95
TAXAN 12" AMBER	139.95
TAXAN RGB VISION I	329.95
TAXAN RGB VISION III	464.95
TAXAN RGB 420 IBM	549.95
ZENITH 12" AMBER	119.95
ZENITH 12" GREEN	99.95
ZENITH RGB ZYM-135 COLOR	524.95
USI 9" AMBER PI-4	129.95
USI 9" GREEN PI-1	119.95
USI 12" AMBER PI-3	144.95
USI 12" GREEN PI-2	129.95
USI 14" LO-RES COLOR	309.95

MODEMS

ANCHOR MARK I (RS-232)	84.95
ANCHOR MARK II (ATARI)	84.95
ANCHOR MARK VII (RS-232)	119.95
ANCHOR MARK XII (RS-232)	289.95
ANCHOR VOLKSMODEM	64.95
NOVATION J-CAT	119.95
NOVATION 212 AUTO CAT	624.95
RIXON R212A 1200 BAUD	429.95
SMARTCAT 103/212	429.95
SMARTCAT 103	199.95
SMARTMODEM 300 BAUD	219.95
SMARTMODEM 1200 BAUD	484.95
SMARTMODEM 1200B - IBM	419.95
US ROBOTICS AUTODIAL 212	499.95
US ROBOTICS PASSWORD	379.95

DISKETTES

SS/SD ELEPHANT 16.95 OPUS 17.95	
SS/DD ELEPHANT 19.95 OPUS 20.95	
DS/DD ELEPHANT 25.95 OPUS 26.95	

PRINTERS

ANADEX DP-9501B	1099.95
ANADEX DP-9625B	1299.95
ANADEX DP-9620B	1179.95
ANADEX WP-6000	2299.95
ANADEX DP-6500TR 500CPS	2529.95
ANADEX 9725B COLOR	1394.95
C-ITOH A10 DAISY WHEEL	569.95
C-ITOH B510SP	499.95
C-ITOH B600BP	849.95
C-ITOH 8510 SCP COLOR	579.95
COMREX CR-II DAISY WHEEL	499.95
DAISYWRITER 2000 48K	1129.95
DELTA-10	429.95
DELTA-15	624.95
EPSON FX-80 W/TRACTOR	529.95
EPSON FX-100 F/T	719.95
EPSON MX-100 F/T	449.95
EPSON RK-80	284.95
EPSON RK-80 F/T	339.95
EPSON RK-100	719.95
EPSON LQ-1500	1189.95
GEMINI 10X	284.95
GEMINI 15X	409.95
GORILLA BANANNA	189.95
IDS MICROPRISM 480	429.95
IDS PRISM 132	1459.95
JUKI 6100 PRINTER (P)	464.95
MANNESMANN TALLY MT160L	639.95
MANNESMANN TALLY MT180L	879.95
MANNESMANN TALLY SPIRIT	349.95
NEC 3550 SPINWRITER-IBM	1999.95
OKIDATA MICROLINE 80	279.95
OKIDATA PACEMARK 2350S	2129.95
OKIDATA PACEMARK 2410P	2569.95
OKIDATA PACEMARK 2410S	2639.95
OKIDATA 82A W/OKIGRAPH	379.95
OKIDATA 83A W/OKIGRAPH	664.95
OKIDATA 84P	1099.95
OKIDATA 84S	1199.95
OKIDATA 92P	484.95
OKIDATA 93P	799.95
OKIDATA 93S	894.95
PANASONIC P1090	334.95
PANASONIC P1091	394.95
PRINTMASTER (DAISY)	1439.95
PROWRITER I (8510P)	354.95
PROWRITER II (1550P)	569.95
QUME SPRINT 11/40+	1439.95
SANYO PR5500 DAISY WHEEL	719.95
STAR POWER-TYPE DAISY	409.95
STARWRITER DAISY WHEEL	1139.95
TOSHIBA P-1351 LP	1719.95
TRANSTAR 315 COLOR	499.95
TRANSTAR 120P 14CPS	464.95
TRANSTAR 130P 18CPS	679.95
TRANSTAR 140P 40CPS	1329.95
MICROBUFFER (EPSON RS232)	129.95
GRAFITTI CARD (APPLE)	89.95
GRAPPLER + (APPLE)	119.95
MICROBUFFER II 16K (APPLE)	154.95
PKASO PRINTER I/F (APPLE)	139.95
WIZARD BPO 16K (APPLE)	139.95
WIZARD SOB 16K (APPLE)	199.95

OTHER PRINTERS AVAILABLE

COMPUTERS

APPLE IIe STARTER SYSTEM LOW!!	
APPLE MACINTOSH COMPUTER LOW!!	
ATARI 600XL COMPUTER	199.95
ATARI 800XL COMPUTER	309.95
ATARI 850 INTERFACE	199.95
ATARI 1027 PRINTER	299.95
COMMODORE 64 COMPUTER LOW!!	
COMMODORE 1541 DISK DRIVE LOW!!	
EAGLE PC PLUS-2 SYSTEM	3399.95
128K, 2-DS/DD DRIVES, MONITOR, EAGLEWRITER, MS-DOS, EAGLECALC, & CP/M-86	
EAGLE SPIRIT-II	2559.95
EAGLE SPIRIT-XL	3959.95
PORTABLE 128K EXPANDABLE TO 640K ON BOARD, 1 320K FLOPPY, 10 MEGABYTE HARD DISK, IBM COMPATIBLE KEYBOARD, 2 SERIAL 1 PARALLEL PORT, MS-DOS 2.0, MONOCHROME MONITOR, CP/M 86	
NEC APC-H01	2239.95
NEC APC-H02	2799.95
NEC 8201 COMPUTER	649.95
SANYO 550-1 1SS/DD DRIVE	819.95
SANYO 555-1 2SS/DD DRIVE	1124.95
SANYO 550-2 1DS/DD DRIVE	999.95
SANYO 555-2 2DS/DD DRIVE	1429.95
ZENITH IBM COMPATIBLE	2649.95
ZENITH W/10 MEG DSK	3999.95
WILDCAT STARTER SYSTEM	1329.95
APPLE II COMPATIBLE SYSTEM 64K, DETACHABLE KEYBOARD, 2 APPLE COMPATIBLE DISK DRIVES, HI-RES 12" AMBER MONITOR, RGB & COMPOSITE COLOR OUTPUT, 2 CPU'S (Z-80 A & 6502), 80-COLUMN CARD & JOYSTICK	
TAVA PC - IBM COMPATIBLE 1999.95 128K-RAM, 2 SERIAL PORTS, 1 PARALLEL PORT, 2 DS/DD DRIVES, COLOR GRAPHICS CARD, & MORE.	
WALNUT PC - IBM PC COMPATIBLE SPECIAL \$1799.95 128K RAM, 2 DS/DD DRIVES, SERIAL, PARALLEL, COLOR CARD & SOFTWARE.	

IQ TECHNOLOGIES, INC.

SMART CABLES

INSTANT RS-232 CONNECTIONS

#817 (WORKHORSE)	79.95
#821 DIAGNOSTIC FEATURES	164.95
* ONE CABLE FITS ALL *	

APPLE HARDWARE & SOFTWARE

4TH DIMENSION DRIVE-ONLY	199.95
4TH DIMENSION DRIVE+CTRL	299.95
ALS CP/M CARD	299.95
APPLE-CAT II MODEM	284.95
BANK STREET WRITER	49.95
BUFFERED GRAPPLER+ d-BASE II (REG Z-80)	199.95
HAYES MICROMODEM IIe	499.95
MACH II JOYSTICK IIe	234.95
MACH III JOYSTICK IIe	34.95
MACH III JOYSTICK IIe	41.95
MASTERTYPE	29.95
MICROBUFFER II+ 16K (P)	199.95
PFS:FILE	89.95
PKASO/U PRINTER I/F	139.95
PREMIUM SOFTCARD IIe	384.95
QUADRAM 64K80COL CRD IIe	124.95
VIDEX VIDEOTERM W/SFTSW	239.95
VIDEX ULTRATERM	294.95
IBM	
HERCULES GRAPHICS CARD	389.95
KOALA PAD TOUCH TABLET	119.95
KRAFT JOYSTICK	49.95
MICROPRO PRO PACK	419.95
MICROSOFT SYSTEMCRD 256K	479.95
MICROSOFT MOUSE	139.95
MOUSE SYSTEMS PC MOUSE	219.95
QUADROCHROME MONITOR	589.95
QUADLINK APPLE EMULATOR	519.95
QUADRAM QUADBOARD I 64K	299.95
QUADRAM QUADCOLOR I	229.95
RANA DS/DD DISK DRIVE	274.95
STB SUPER I/O MULTIFUNCT	184.95
TG JOYSTICK W/TOGGLE	44.95
TRANSEND P.C. MODEM 1200	439.95
VERSAWRITER GRAPH TABLET	249.95
WIZARD SPOOLER P/S 16K	249.95
COMMODORE 64	
CARDBOARD/5 5 SLOT EXPAN.	64.95
CARD? GRAPHICS INTERFACE	69.95
DATA20 Z-80 VIDEOPAK	229.95
DELPHI'S ORACLE DATA BASE	89.95
DISKEY	34.95
DONKEY KONG	34.95
EASY SCRIPT64	34.95
EASY SPELL 64	34.95
FLIGHT SIMULATOR II	39.95
HOME ACCOUNTANT	54.95
HOMEMORD WORD PROCESSOR	49.95
JOUST	35.95
KOALA PAD TOUCH TABLET	79.95
MERLIN 64 ASSEMBLER	35.95
MSD-SD1 DISK DRIVE	399.95
MULTIPLAN	74.95
ONNI-CALC	34.95
PAPER CLIP W/P	64.95
PAC-MAN	37.95
POPEYE	39.95
ROBOTRON	37.95
S.A.M.	44.95
SARGON II	27.95
VOICE BOX	84.95

We will try to meet or beat any advertised price! ... WE CAN HELP 1-800-222-2602

For technical assistance, order status and California calls (619) 765-0239 Apple Country, Ltd., P.O. Box 1099, 2602 Washington St., Julian, Calif. 92036

We accept AmEx. Prices reflect 2% discount for VISA/MC cash & check (2 weeks to clear). S&H in continental US 5% (\$5 min) Monitors \$10 min. APO/FPO & others call. Calif add 6% tax. P.O. must include check. No COD. All orders prepaid. All items are new with Mfg's warranty. Prices, products & terms subject to change without notice. All sales final. Returns require RMA#. No returns on software. Volume discounts available.

Apple Country, Ltd. is a **DISCOUNT MAIL ORDER HOUSE** for the micro computer industry and is a California corporation not affiliated with Apple Computer Inc. Apple is a trademark of Apple Computer Inc.



MEGA-BYTES FOR MICRO-BUDGETS

expand your system...shrink your cost.

Why pay more for top quality peripherals and accessories when our prices are consistently among the lowest anywhere?
We invite you to compare prices, then call us.

MICROSOFT.	SALE PRICE
MULTIPLAN	\$176.00
MULTIWORD WITH MOUSE	339.63
MULTITOOL FINANCIAL STATEMENT.....	70.49
MULTITOOL BUDGET	104.96
SOFTCARD SYSTEM CARDS.....	CALL

VIDEX	SALE PRICE
UL-00 ULTRATERM	\$270.00
VT-600 VIDEOTERM 60 Hz.....	197.50
VT-601 VIDEOTERM 60 Hz SOFTSWITCH	218.71
VT-602 VIDEOTERM 60 Hz SOFTSWITCH INVER	225.80
PS-000 PSIO	162.10
ENH-FS-001 ENHANCER II, FUNCTION STRIP.....	126.70

DYSAN DISKETTES (Boxes of 10 each)	SALE PRICE
104/1 5 1/4" SINGLE SIDE, SINGLE DENSITY	\$31.20
104/1D 5 1/4" SINGLE SIDE, DOUBLE DENSITY	32.98
104/2D 5 1/4" DOUBLE SIDE, DOUBLE DENSITY	38.99
3740/1 8" SINGLE SIDE, SINGLE DENSITY	32.39
3740/1D 8" SINGLE SIDE, DOUBLE DENSITY.....	40.19
3740/2 8" DOUBLE SIDE, SINGLE DENSITY	40.19
3740/2D 8" DOUBLE SIDE, DOUBLE DENSITY.....	46.89

MISC. ITEMS	PRICE	MISC. ITEMS	PRICE
92P OKIDATA PRINTER	\$485.10	93P OKIDATA PRINTER	812.70
NEC JB1260 MONITOR	172.50	NEC JB1205 MONITOR	177.50
FX 80 EPSON PRINTER	535.00	FX 100 EPSON PRINTER	689.00
SHARP PC-5000	CALL	PENCEPT INC PENPAD 320	850.00
AMDEK COLOR II MONITOR.....			466.50
HAYES SMARTMODEM 1200B (IBM PC)			425.00
HAYES SMARTMODEM 1200 (RS-232)			499.00
IBM PC 256K, 2 FLOPPY DRIVES.....			CALL
BAUSCH & LOMB DMP-29 PLOTTER.....			1,885.00

LEADING EDGE Personal Computer \$ CALL
 • 50% Faster than IBM PC! • 256K • Clock
 • 2 Floppy Disk Drives • 12" Hi-resolution Monitor
 • DOS, BASIC and Word Processing Software Included!

GREAT LAKES (PEGASUS) HARD DISK SYSTEMS	SALE PRICE
10 MEGABYTE INTERNAL.....	\$1149.00
10 MEGABYTE EXTERNAL	1295.00
23 MEGABYTE EXTERNAL	1895.00
40 MEGABYTE EXTERNAL	2449.00
65 MEGABYTE EXTERNAL	3249.00
140 MEGABYTE EXTERNAL	4995.00
TAPE DRIVE 23 MEGABYTE INTERNAL	950.00
TAPE DRIVE 23 MEGABYTE STAND ALONE.....	1249.00

ORDERS ONLY 800-858-4810
IN CALIF. 800-821-6662



COMMERCIAL BUSINESS SYSTEMS
2858 S. ROBERTSON BLVD., LOS ANGELES, CA 90034



INFORMATION
(213) 559-0596

Phone orders accepted on Visa and Mastercard only. California residents add 6.5% sales tax. No C.O.D. Actual shipping and handling charge added to all orders. Prepaid orders as follows: Money orders or cashier's check—merchandise shipped upon receipt. Personal checks must clear before shipping. 20% restocking fee. Prices and availability subject to change. \$100 minimum order.

SUNNY LOW LOW COST POWER SUPPLIES (LINEAR & SWITCHING) FOR S-100, DISK DRIVES



S-100 & DISK POWER SUPPLIES:

No. 806 & No. 516 Mainframes Kit 1, 2 & 3 for S-100 R₂, R₃ for 2 Drives (Floppy & Hard)

ITEM	IDEAL FOR	+5V OVP	-5V (or -12V)	+24V (or +12V)	+8V	±16V	SIZE W x D x H	PRICE
S ₃	12 SLOT & 2 FLOPPY (1 Floppy & 1 Hard Disk)	5A	1A	5-7A PEAK	13A	3A	10" x 6" x 5"	105.95
S ₄	6 SLOT & 2 FLOPPY	4A	1A	4-5A PEAK	8A	3A	8 1/2" x 5" x 4 3/4"	95.95

DISK POWER SUPPLIES: OPEN FRAME, ASSY. & TESTED, REGULATED, ADJUSTABLE & FUSES PROTECT.

ITEM	IDEAL FOR	+5V OVP	-5V (or -12V)	+24V (or +12V)	+8V Unreg.	±12V	SIZE W x D x H	PRICE
R ₀	2 x 8" SLIMLINE	2.5A		2.5A - 5A Peak			5" x 4" x 4"	51.95
R ₁	2 x 8" or 2 x 5 1/2" DISK	4A	1A	3A - 5A Peak	2A		8" x 4" x 3 3/4"	56.95
R ₂	3 x 8" (or 5 1/4") FLOPPY	6A	1A	6A - 8A Peak			10" x 4 7/8" x 3 3/4"	71.95
R ₃	or 1x Floppy & 1x Hard	6A	1A	6A - 8A Peak		1A	9" x 6 1/2" x 4 3/8"	98.95

AC & DC POWER CABLES WITH CONNECTOR FOR 2 DRIVES 8.00

S-100 POWER SUPPLY KITS (OPEN FRAME WITH BASE PLATE, 3 HRS. ASSY. TIME)

ITEM	(IDEAL FOR)	+8V	-8V	+16V	-16V	+28V	SIZE: WxDxH	PRICE
KIT 1	15 CARDS	15A	---	2.5A	2.5A	---	12" x 5" x 4 7/8"	54.95
KIT 2	20 CARDS	25A	---	3A	3A	---	12" x 5" x 4 7/8"	61.95
KIT 3	DISK SYSTEM	15A	1A	3A	3A	5A	13 1/2" x 5" x 4 7/8"	69.95

6 SLOT MAINFRAME ASSY. & TESTED ONLY ~~\$399.95~~ \$299.95 + SHIPPING \$18.00

EACH MAINFRAME (ITEM NO. 806 OR 516) CONTAINS: EMI FILTER • FUSE HOLDER • AC POWER CORD • POWER SWITCH & INDICATOR • RESET SWITCH • 4" COOLING FAN • S-100 BUS 6 SLOT CARD CAGE • (110/220 VAC, 50/60 HZ.) POWER SUPPLY FOR DISK DRIVES & S-100 SLOTS • 2 EA DC POWER CABLES WITH CONNECTOR AND MOUNTING HARDWARE FOR DISK DRIVES • 9 EA. CUT-OUTS; 7 FOR DB25 CONNECTOR, 1 FOR 50 PIN CONNECTOR & 1 FOR CENTRONICS • CUSTOM FINISH & LOGO-LESS • COMPACT SIZE • LIGHTWEIGHT, 28 LBS. ITEM #806 FOR 2 EA. 8" THINLINE FLOPPY (TANDON TM848-1 & 848-2 OR EQUIV.), OR ONE HARD DISK, POWER SUPPLY: +8V/8A, ±16V/3A, +5V/5A OVP, -5V/1A & 24V/5A SIZE: 12" (W) x 19 5/8" (D) x 9 8/16" (H).

SHIPPING FOR EA. PWR SUPPLY: \$5.50 IN CALIF.; \$8.00 IN OTHER STATES; \$18.00 IN CANADA. FOR EA. TRANSFORMER: \$5.00 IN ALL STATES; \$12.00 IN CANADA. CALIF. RESIDENTS ADD 6.5% SALES TAX.

DEALER INQUIRIES INVITED

No. 806
Mainframe

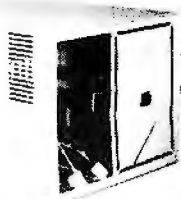

MAILING ADDRESS:
P.O. BOX 4296
TORRANCE, CA 90510
TELEX: 182558

SUNNY INTERNATIONAL
(TRANSFORMERS MANUFACTURER)
(213) 328-2425 MON-SAT 9-6

SHIPPING ADDRESS:
22129 1/2 S. VERMONT AVE
TORRANCE, CA 90502





COMPUTER DISCOUNT PRODUCTS

HUGE Inventories of APPLE & IBM Products IN STOCK

★ ASK ABOUT OUR FAIR PRICE POLICY - IT'S GUARANTEED! ★



koala TOUCH PAD \$85.99
Apple, Atari, Commodore, IBM, For Other KeyboardWare & Co!



CDP SPECIALS

16K UPGRADE 4116 200 NS (Set/8)	9.99
64K UPGRADE 4164 200 NS (Set/9)	79.99
APPLE FAN w/Surge, 2 Outlets	39.99
PAR PRINTER CARD & CABLE	39.99
16K RAM CARD	39.99
POWER STRIP w/Surge	17.99

VCR TRAINING TAPES \$CALL

DISKETTES

DYSAN 5" SSDD (10)	31.99
DYSAN 5" DSDD (10)	38.99
MAXELL 5" SSDD (10)	27.99
MAXELL 5" DSDD (10)	37.99
VERBATIM 5" SSDD (10)	24.99
VERBATIM 5" DSDD (10)	36.99

10% OFF CASE QUANTITIES

EDUCATIONAL SOFTWARE SPECIAL

Additional 10% OFF your order of any 5 educational programs from DLM, EDUWARE LEARNING COMPANY or SPINNAKER.

MIX OR MATCH



SPINNAKER

ALPHABET ZOO	19.99
DELTA DRAWING	32.99
FACEMAKER	21.99
FRACTION FEVER	21.99
HEY DIDDLE	19.99
KINDERCOMP	19.99
MOST AMAZING TH NG	26.99
RHYME & RIDDLE	19.99
SNOOPER TROOPS I & II	27.99
STORY MACHINE	21.99

APPLE SOFTWARE

BPI (GL, AP, AR, PAY, INV)	ea269.99
BRODERBUND Arcade Machine	39.99
Bank Street Writer	44.99
Drol, Lodenanner	ea24.99
CENTRAL POINT Copy II +	25.99
DATAMOST Aztec	26.99
DATASOFT Zaxxon	24.99
DLM Alien Addition	Sch - 37.99, H - 27.99
Alligator Mix	Sch - 37.99, H - 27.99
Demolition Division	Sch - 37.99, H - 27.99
Dragon Mix	Sch - 37.99, H - 27.99
Meteor Multiplicaton	Sch - 37.99, H - 27.99
Minus Mission	Sch - 37.99, H - 27.99
Verb Viper/Word Invasion	ea37.99
Word Man/Word Master	ea37.99
Word Radar/Spelling Wz	ea37.99
EDUWARE Algebra I-III	31.99
Counting Bee	23.99
Decimals/Fractions 3 0	ea39.99
Hands on Basic	61.99
PSAT Word Attack	39.99
SAT Word Attack	39.99
FLIGHT SIMULATOR II	37.99
HAYDEN Pewriter	94.99
Sargon II	24.99
Sargon III	34.99
JACK REPORT	74.99
KENSINGTON Format II	119.99
LEARNING CO Bumble Games	26.99
Bumble Plot/Magic Spell	ea26.99
Genivides Puzzle/Secret	ea29.99
Juggles Rainbow	19.99
Mopdown Parade/Hotel	ea26.99
Rocky's Boots	34.99
MASTERTYPE	29.99
MICROLAB Mmer 20-49er	27.99
MICROSOFT Multiplan	165.99
ODESTA Chess	45.99
Odn	37.99

ACCESSORIES

FLIP N FILE (orig nat)	17.99
FLIP N FILE w/Locktray (25)	17.99
FLIP N FILE w/Locktray (50)	27.99
HAYES 300 Baud Smartmodem	199.99
1200 Baud Smartmodem	474.99
LIBRARY CASE	1.99
KENSINGTON PC Saver	29.99
PRINTERS C-TOUCH	379.99
Epson FX80	549.99
Epson FX80	349.99
Okidata 82-93	\$CALL
PRINTER STAND Sm (pkg/3)	24.99
PRINTER STAND Lg (pkg/3)	29.99
RIBBONS-Brother	\$CALL
MX & FX 80	4.99
MX & FX 100	7.99
OKI 82, 83, 92, 93 & Gemini	34.99

FINGERPRINT: Epson Upgrade
RX, FX, MX 44.99

IBM

1/2 Height DS/DD Drive	239.99
ALPHA Typefaces	79.99
ASHTON TATE dBase II	399.99
Friday	184.99
Encyclopedia	59.99
AST Combo Plus	299.99
Six Pack Plus	279.99
BRODERBUND Serpentine	26.99
Loote Runner	24.99
CAI Masters	ea31.99
Subjects	ea16.99
CENTRAL POINT Copy II PC	25.99
EDUWARE Algebra I	29.99
HAYDEN Pewriter	129.99
HAYES 1200B Modem	439.99
KRAFT Joystick	44.99
LIFETREE Volkswrizer	119.99
MASTERTYPE	26.99
LOTUS 1-2-3	329.99
MICROLAB Mmer 20-49er	27.99
MICROSOFT Mouse	129.99
Multipian	165.99
NORTON Utilities	55.99
PC CRAYON	49.99
Tutor	47.99
PS Write	109.99
File	109.99
Report	109.99
Graph	109.99
POOL 1.5	27.99
SERRA ON-LINE Frogger	26.99
SIR-TECH Wizardy	44.99
SUBLOGIC Pinball	29.99
TG Joystick	44.99
TITAN 64K BOARD	499.99
VISICORP Viscalc	164.99
Schedule	ea199.99

PLANTRONICS ColorPlus 375.99

Beagle Bros Micro Software Inc.

ALPHA PLOT	24.99
APPLE MECH, FLEX TEXT	ea19.99
BEAGLE BASIC	24.99
DOS BOSS	15.99
DOUBLE TAKE	24.99
FRAME-UP	16.99
PROMTO DOS	18.99
TIP DISK #1	14.99
TYPEFACES	14.99
UTILITY CITY	19.99

Continental

APPLE GRAPHICS BOOK	14.99
CPA (GL, AP, AR, PAY)	ea149.99
FCMPL 1st CLASS MAIL (AP)	59.99
FCMPL 1st CLASS MAIL (IBM)	71.99
HOME ACCOUNTANT + (IBM)	84.99
HOME ACCNT + (KAYPHO, OSB)	59.99
HOME ACCNT + (TI PRO)	119.99
PROPERTY MANAGEMENT	295.99
TAX ADVANTAGE (Ap)	39.99
ULTRAFILE (IBM)	155.99
HOME ACC'NT (AP)	44.99

KENSINGTON MICROWARE



SYSTEM SAVER

- Surge Suppression
 - Fits Apple Stand
 - Dual Outlet
 - U.L. Listed
- \$65**

INFOCOM

DEADLINE (Ap/IBM)	32.99
ENCHANTER (Ap/IBM)	32.99
PLANETFALL (Ap/IBM)	32.99
SUSPENDED (Ap/IBM)	32.99
WITNESS (Ap/IBM)	32.99
STARCROSS or ZORK I, II, III	ea24.99

APPLE HARDWARE

AUTO REPEAT KEY	19.99
BASIS 198	\$CALL
DAN PAYMAR Lower Case 1 (rev 1-6)	25.99
Lower Case 2 (rev 1)	19.99
DARK STAR Snapshot II	69.99
FOURTH DIMENSION Drive	219.99
HAYES Micromodem Ie	\$CALL
KOALA PAD	85.99
KRAFT Joystick	44.99
Paddes	31.99
LEGEND 128K Ram	359.99
MICRO-SCI A-2 Drive	209.99
MOUNTAIN Rampus + 32K	199.99
ORANGE MICRO Grapper +	114.99
Bufferboard	119.99
Buffered Grapper +	179.99
PADDLE ADAPTE	24.99
SATURN 128K Ram	379.99
Accelerator II	44.99
Neptune 64K	199.99
WILD CARD II	119.99

ALS CP/M 3.0 259.99

Sierra ON-LINE INC

FROGGER (Ap)	21.99
GENERAL MANAGER	46.99
HOME WORD	49.99
SCREENWRITER II	81.99
ULTIMA II	36.99
BC QUEST FOR TIRES	NEW!
OILS WELL	NEW!

Videx

ENHANCER II	99.99
FUNCTION STRIP	34.99
HARDSWITCH	15.99
MICROMODEM CHIP	24.99
PSIO	169.99
PRE-BOOTS Apple Writer	14.99
Apple Writer for Ultraterm	23.99
Viscalc	39.99
Viscalc/Memory Expansion	71.99
Viscalc for Ultraterm	54.99
SOFTSWITCH	25.99
ULTRAPLAN	\$CALL
ULTRATERM	249.99
VIDEOTERM w/SS + INV	219.99



MicroPro.

MAILMERGE	139.99
SPELLSTAR	139.99
WORDSTAR PRO	389.99
INFOSTAR & WORDSTAR	ea. 259.99

MONITORS

PRINCETON RGB MX 12	485.99
TAXAN 420 RGB	499.99
USI P 1 9" Green 20 mh	99.99
USI P 1 12" Green 20 mh	119.99
USI P 3 12" Amber 20 mh	129.99
USI P 4 9" Amber 20 mh	109.99
USI 1400C Color Composite	279.99

Novation

103 Smart Cal	169.99
109/212 Auto Cal	399.99
J Cal	99.99
Access 123 (IBM)	469.99
Appelcal II	249.99
Appelcal Upgrade 1200 Baud	309.00
Cal Modem	135.99
Expansion Module	29.99

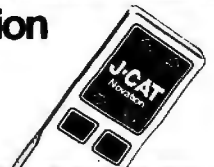

MAIL & PHONE ORDER DESKS:

Open At 6AM (PST)
860 S. Winchester Blvd.
San Jose, CA 95128
(408) 985-0400

COMPUTER DISCOUNT PRODUCTS

SAN JOSE
860 S. Winchester Blvd.
San Jose, CA 95128
(408) 241-2300

SAN MATEO
4228 Olympic Ave.
San Mateo, CA 94403
(415) 571-1658

SAN FRANCISCO
1230 Market St.
San Francisco, CA 94102
(415) 626-2244

San Jose Store Open Daily At 8AM • Call for All Stores' Convenient Shopping Hours

- No Charge For Credit Cards
- Prices Subject To Change
- Software Sales Are Final
- International Orders Welcome
- Min. UPS Chg. \$4 + Ins.
- Min. US Postal Chg. \$10
- P.O.'s Welcome - Call First



Our specialty: 68000, DEC, graphic, database, communication, export
Come visit us in our New York City Showroom *IBM COMPATIBLE

Computer Channel

PRINTER	
MICRO-PRISM	110 cps, 84x84, graphic... 379
EPSON	RS-232/parallel, pin & friction
BANANA	FX-80, FX-100, CALL
OKIDATA	50 cps 195
PRISM 132	Full Line CALL
TOSHIBA	200 cps, 132 col. 1,100
DEC	160 cps 24-wire 1,425
GEMINI	LA50 599
DIABLO	Delta 10 525
M.T.	P11 100 cps, 80 col. 488
	P38 400 cps, 132 col. 1,795
	Spirit 80 cps 350
Letter Quality	
NEC	2050 20 cps for IBM 965
	3550 35 cps for IBM 1,775
	7710 55 cps for serial. 2,150
DYNAX	HR25 23 cps parallel 799
	DX15 13 cps 475
COMREX	Comwriter II 475
C.I.TOH	F-10 40 cps Excellent 930
	A-10 18 cps 530
DIABLO	630 API w/interface 1,735
QUME	11+ 40 cps 1,350
	50 cps 1,550
STAR	18 cps 399
TRANSTAR	315 graphic 479
MODEMS	
HAYES	Smartmodem 300/1200 bps 499
	Micromodem II w/software 270
NOVATION	Smartmodem 300/1200 bps 415
	PC cat 300/1200 bps 450
LEXICON	300 bps acoustic coupler 125
USR	Password 1200/300 339
KEYBOARD WITH MODEM	
Zenith ZT-1, ZT-11 CALL

COMPUTER	
ZENITH	Z-150-PC
IBM	Best computer
Compatible 128K RAM, two floppy	
LEADING	128K RAM, two drives
EDGE	software
COLUMBIA	* 128K RAM, two floppies, monitor keyboard, softwares
EAGLE	* 128K RAM, two floppies, software monitor
SANYO	MBC 550, 555
TELEVIDEO	1605 256K RAM
CORONA	* 128K RAM, two drives, 256K RAM, monitor,
EPSON	keyboard, two floppies
QX-10	printer, CP/M, Valdocs
(Local)	IBM compatible option
NEW	
AST, PERSYST, PLANTRONIC	
TECMAR, QUADRAM, HERCULES	
Cromemco * C-10 64K RAM, monitor, Z-80 CPU keyboard, software	
DEC	64K RAM, Z-80 & 8088 CPU,
RAINBOW	monitor, CP/M keyboard
NEC APC	Color APC 128K RAM
Dual 8" drives	
ALDOS, NORTHSTAR, OSM	
POWERFUL 68000 CPU	
Cromemco	68000/Z80 CPU,
option	Fast Floating Point Processor
DUAL	68000 CPU, 80MB SMD
	hard disk, intelligent I/O,
	UNIX, Database
1 to 12 users, 68000 CPU,	
256K to 4.5MB RAM, 10MB	
to 474MB hard disk, graphic	
WICAT	

PLOTTER/DIGITIZER	
HOUSTON INSTRUMENT DMP 29 CALL
DMP 40 795
DMP 41, DMP 42 CALL
HIPAD digitizer 725
AMDEK XY plotter 1 pen 665
6 pens 1,095
MT PLOTTER PIXY-3 3 pens 650
TERMINAL/MONITOR	
ZENITH Z-29 smart terminal	.BEST PRICE
ZVM 135 *RGB color/green monitor	... 475
ZVM 123 *green monitor 87
124 22 MHZ, for IBM CALL
Amber Monitor: Panasonic, Comrex	
HAZELTINE Esprit II 540
Esprit III 625
WYSE 50 545
VISUAL 55 725
VT-100/VT-102 compatible	... 895
QUME 102 548
103 132 col. 835
PORTABLE ON-THE-GO	
Columbia, Corona, Eagle Televideo (8-bit, 16 bit) NEC PC 8021, ZENITH	
Prices subject to change. American Express, Visa/Mastercard add 3%. F.O.B. point of shipment. 20% restocking fee for returned merchandise. Personal checks take 3 weeks to clear. COD on certified check only. N.Y. residents add sales tax. Manufacturers' warranty only. International customers, please confirm price before order. Accept P.O. from Fortune 500, schools and gov't.	
Computer Channel	TELEX:
21-55 44th Road	429418
Long Island City, NY 11101	CSTNY
For information CALL (212) 937-6363	
To order CALL 1-800-331-3343	

CHECK SUNTRONICS NEW LOW PRICES TOLL FREE (ORDERS ONLY) 1-800-421-5775
Calif. orders and all info Call 213-644-1149

IBM Compatible Products



QUADRAM-2 (2) Ser. Ports w/64K... \$355.00
QUADBOARD (1 ea) Par/Ser. w/64K... 355.00
QUAD 512+ w/64K... 305.00
QUAD 512+ w/512K... 665.00
CLOCK/CALENDAR BOARD... 105.00
MODEM Signalman Mark 5... 215.00
ADD-ON Hard Disk Drive System
 6Mb w/Power Supply & Cabinet... 1799.00
 Controller for above Hard Drive... 279.00

MICROLOG BABY BLUE II
Z80 Coprocessor
Multifunction Board
 Runs CP/M-80 Software... 489

MSI DUAL I/O (2 ea) Ser/Par. & Clk... 175.00
MSI 256K RAM Board
 256K RAM Board with 64K... 199.00
 256K RAM Board with 256K... Call
MSI 256K w/Parallel or Serial Port
 256K w/Parallel Port and 64K... 259.00
 256K w/Parallel Port and 256K... Call
 256K w/Serial Port and 64K... 259.00
 256K w/Serial Port and 256K... Call

VISTA DISKMASTER DMA
 Diskmaster Interfaces Sub 4", 5 1/4", 8" & V1200 6Mb Hard Disk... 225.00
IBM TEAC Disk Drive DSDD
 40 Track Slimline... 215.00
APPRAITE IBM PROM Blaster... 129.00
CABLE Serial or Parallel for IBM
 Eagle & Columbia... 29.95
IBM Prototype Board-SUN-208 double sided glass with gold plated terminals... 29.50

AFDC-1 Floppy Disk Drive Controller... **\$595**
 Runs DOS 3.3 with any standard Shugart compatible 5 1/4" disk drive. (2 drives each card). Does not read 1/2 track.

Apprate PROM Blaster... 119.00
 "ALS" 80 Column Card... 159.00
 "ALS" Z-CARD (Z80 CPU)... 149.00
API Apple Parallel Printer Interface card
 Centronics Compatible... \$39.00
Apple Compatible Drives (40
 Track, 163K Slim Line)... 195.00
SUN-Z-80 CARD (Softcard
 Compatible)... 55.00
SUN-80 COLUMN CARD... 97.00
POWER SUPPLY (5 amp)... 59.95
COOLING FAN... 42.00

Software

Formats for Software Include:
 IBM, MS DOS, Apple CPM, 8" CPM 2.2
WORD PROCESSOR (Benchmark)... \$299.00
MAILING LIST (Benchmark)... 140.00
VISICALC... CALL
TELECOM (Benchmark)... 85.00
WORDSTAR... CALL
PEARL Data Manager. See reviews...
 Easy-To-Use... Powerful... 199.00

General Products

5 1/4" Diskettes 10 up 100 up
 SS/DD (100% certified) 1.75 1.55
 DS/DD (100% certified) 2.50 2.30

MODEM Novation 103 Smart-Cat... \$210.00
MODEM Signalman Mark 7 (RS232)... 115.00

NEW MODEL SAMWOO DISPLAY HI-RESOLUTION VIDEO MONITORS



Features: • Anti glare screen • Attractive case • Std composite video input, also output for second monitor • 22 MHz video bandwidth • High resolution; 1,000 lines or 132 characters across • Adjustable contrast, brightness, V/H-hold, V-size, H-center • Input impedance: high or 75 ohm • Passes FCC test for computer equipment • UL approved

Compatible With: IBM, IBM PCjr, Apple II, Apple Ite, Commodore, Columbia MPC, Eagle, Radio Shack, Sinclair/Timex, and more.

Each 3-up
 DM-216 12" Green... \$135.00 Call
 DM-216 12" Orange... \$139.00 Call

DEALER INQUIRY INVITED

MX COMPATIBLE PRINTER
SX-80 dot matrix printer... 259.00

RAM & ROM IN STOCK ... Call

Mother Boards & Card Cages

SLOTS	Bare Bd	KIT	A & T	w/CAGE
6	\$19.00	\$44.00	\$59.00	\$84.00
8	24.00	56.00	81.00	116.00
12	29.00	75.00	110.00	150.00

10MHz. No termination. Includes power indicator and wiring for muffin fan. Uses OK connector for solderless installation and removal of power & reset lines.

S-100 Products



64KSM A&T without RAM... **\$155.00**
64KSM A&T w/64k RAM (32-6116's)... 339.00
S-100 Board Uses 6MHz 6116's. 1/2 Amp max. power, Bank Select plus Extended Addressing allows for multi-memory board set-up. 4 independent 16K Blocks make easy use with multi-user systems. Any 2K RAM may be replaced by a 2716 EPROM.

SBC-880 Z80A CPU, A&T... \$149.00
SBC-880 Z80A CPU, Kit... 129.00
 4MHz Z80A CPU boards with RAM, ROM & Serial/Parallel Ports.

UFDC-1 Floppy Controller, A&T... 245.00
UFDC-1 Floppy Controller, Kit... 225.00
 The UFDC-1 Floppy Controller uses the WD1795 chip which runs either and/or 8" 5 1/4" Disk Drives.

CLOCK CALENDAR A&T... 115.00
CLOCK CALENDAR Kit... 95.00
 This S-100 Clock Calendar Board has 4 interrupts, Time, Day of Week and Battery Backup.
 Call for S-100 Quantity Discounts

Special Sale Items

SUN-721 S-100 Prototype Board... 9.95
SUN-722 Apple Prototype Board... 5.95
 See our January 1984 BYTE Ad for above item descriptions. Quantities are limited.

Corporate & Institutional Buyers Welcome

We accept purchase orders from well qualified corporations & institutions. Place us on your bid list. Call for our Buyer's Guide.

SERVICE • SELECTION • SATISFACTION • SAVINGS

Those are four very important words. To you as a customer and to us as a business. If you're just shopping price you'll find dozens of outlets to buy from. But if you're shopping value you'll search for a supplier with those four words to offer, not just one! We've been in business longer than 90% of our competition. Wonder why? We practice those four words; we offer a wider more popular collection of hardware and software, we have one of the best satisfaction guarantees, and of course our prices are very competitive. Go ahead . . . shop around. When you want more than just a price, shop with us.

TOLL-FREE FOR CREDIT CARD ORDERS Only

If you have a major credit card, call our Credit Card Order Department, Toll-Free, 24 hours a day, 7 days a week. During the hours of 7:30 A.M. to 6:00 P.M. PST (Mon-Fri) an operator will take your order; other hours, just give your order to our automatic ordering service. In most cases, we'll process and ship that same day. This Toll-Free number connects to the order desk only. For other business, inquiries, or technical information please call our Customer Service Department, weekdays, 9:00 A.M. to 5:00 P.M. PST: (619) 460-6502.

800-854-6654

IN CALIFORNIA, ALASKA & HAWAII

CALL 619-460-6502

Circle 1 on inquiry card.

IBM ADD-ONS

AST Research	
All AST Boards come with SuperDrive SuperSpeed, and one year warranty	
SixPakPlus 64K upgradable to 384K with clock calendar, serial and parallel ports (game port optional)	265
MegaPlus II 64K upgradable to 256K (or more with MegaPak) with clock calendar and serial (parallel, game, or second serial port optional)	265
MegaPak 128K (not upgradable)	225
MegaPak 256K	275
I/O Plus II with clock calendar and serial (parallel, game, or second serial port optional)	115
Parallel, Game, or second Serial Port for any board (specify board)	AST
40ea	
64K Memory upgrade increments for any board (that is upgradable)	60ea
Connectall connector bracket	15
Amdak	
MAI Board	459
Hercules Computer	
Hercules Graphics Card (with parallel port)	339
Graph-X Software	45
Keytronic	
Typewriter style keyboard (KB5150)	call
Deluxe keyboard	call
Keala Touch Tablet w/software (Connects to game port)	95
Maynard Electronics	
Floppy Disk Controller	175
Floppy Disk Controller (with parallel port)	229
Paradise Systems	
MultiDisplay Card (color & mono)	389
Persyst	
Color Graphics Board	229
S86A 64K Multifunction Card	309
Plantronics/Frederick	
COLORPLUS (with Color Magic)	389
Quadram	
We are a full line Quadram Dealer	
New Expanded Quadboard 64K	
expandable to 384K, with clock calendar, parallel, serial & game port, I/O bracket, and Quadmaster software	259
64K Memory upgrade increments for Quadram boards and buffers	60ea
Microfazer Printer Buffer (par) w/copy MP 64 (64K)	229
upgradable to 512K	210
Quadcolor I color graphics card	210
Quadcolor II (add-on to Quadcolor I)	205
Quadlink—Newest Version follows your IBM-PC to run most Apple II programs	489
Quadisk (various size to 72 meg)	call
STB	
RIOPlus 64K (upgradable to 384K) with PC accelerator, clock calendar, serial and parallel port, and "Connectall" type bracket (game cable optional)	259
Graphix Plus (color & monochrome)	349
Call for prices on other STB products	
Tecmar	
Graphics Master	539
SK DISKETTES Lifetime Warranty DS/DD	
	26

SURGE PROTECTORS

Lemon wall unit with 6 receptacles	45
Line power cord with 6 receptacles	59
Peach wall unit, line filter & 3 receptacles	69
Orange power cord, line filter & 6 receptacles	99

PRINTERS

Unless otherwise noted, all of the printers listed have parallel interfaces.

Dot Matrix

C. Itoh	
8510P 120 cps 10" crg	369
1550P 120 cps 15" crg	639
Epson	
All Epson printers include GRAFFRAX-PLUS	
RX-80 100 cps 10" crg	call
RX-80 F/T 100 cps 10" crg	call
FX-80 160 cps 10" crg	30
FX-100 160 cps 15" crg	30
Tractor for FX-80	30
Epson to IBM Parallel Cable	30
Okidata	
Microline 82A 120 cps 10" crg	call
Microline 92 160 cps 10" crg	call
Microline 83A 120 cps 15" crg	call
Microline 93 160 cps 15" crg	call
Microline 84AP 200 cps 15" crg	call
Quadram	
Quadjet 40 cps 8.5" crg color	699
Star Micronics	
Gemini 10X 120 cps 10" crg	280
Gemini 15X 120 cps 15" crg	379
Delta 10 180 cps 10" crg	419
Delta 15 180 cps 15" crg	589
Toshiba	
1340P 160 cps 10" crg	769
1351P 160 cps 15" crg	1529
Translar	
315 color 50 cps 10" crg SPECIAL	429
We also carry Mannesman Tally and NEC.	

Letter Quality

C. Itoh	
Starwriter 40 cps 15" crg	999
Printmaster 55 cps 15" crg	1245
Daisywriter 2000 40 cps 18" crg	995
Dynax	
HR-15 13 cps 13" crg	435
HR-25 23 cps 16" crg	699
Juki 6100 18 cps 13" crg	435
Silver Reed	
EXP 500 16 cps 10" crg	429
EXP 550 20 cps 17" crg	500
NEC	
2050 (for IBM)	830
3550 (for IBM)	1605
We also carry Diablo & Translar.	

MONITORS

Monitors suggesting monitors for IBM are compatible with IBM PC compatible systems.

Amdak	
300G 12" Green monochrome	149
300A 12" Amber monochrome	159
310A 12" Amber or green mono (IBM)	169
Color I Plus 12" composite color	299
Color II Plus 12" RGB	419
Comrex	
5600 12" Amber or green mono (IBM)	149
Princeton Graphics	
HX-12 12" RGB (690 x 240)	469
SR-12 12" RGB (690 x 480)	call
MAX-12 12" Amber monochrome (for IBM)	169
Quadram Quadchrome RGB (690 x 240)	call
USI	
PI-3 12" Amber or green mono (IBM)	155
Tazan	
12" Amber or green monochrome	135
Vision III 12" hi-res RGB	449
RGB 42D Super hi-resolution RGB	479
We also carry NEC, BMC, and ZENITH.	

COMPUTERS

IBM	
PC with 256K or XT	call
Columbia	
1600-1 or 1600-4 10mb w/software	call
Columbia VP complete portable	call
Compaq or Compaq plus portable	
Eagle	
PC 2 PC+ & PC+ w/10mb	call
Franklin Apple compatible systems	
NEC	
APC color & monochrome systems	call
NEC 8201 portable computer	599
Tava PC compatible system	
	call

IBM SOFTWARE

American Training Intl	
Applications software training packages specify the application each only 55	
Alpha Software	
Database Manager II	199
Apple-IBM Connection	144
Ashton Tate	
dBase II	385
Friday	199
BPI Personal Accounting	
Continental	139
Home Accountant Plus	109
FCM (First Class Mail)	99
UltraFile (file/report/graph)	129
The Tax Advantage	49
Lulus 1-2-3	319
MicroPro International	
WordStar Professional	369
WordStar	259
InfoStar	259
Microim R: Base 4000	329
Microware	
Multi-tool Word with Mouse	319
Multi-tool Word	249
Microsoft Crosstalk	139
Norton Utilities	59
Prokey by Rosssoft	59
Software Products Intl	
Open Access	389
Software Publishing	
p/s Write	99
p/s File	99
p/s Report	99
p/s Graph	99
Peachtree Peachtext 5000	239
We have many more software packages available for the IBM PC. Send for our 1984 Buyer's Guide.	

APPLE ADD-ONS

ALS	
Dispatcher serial RS-232 card	85
CP:M Card Plus (2-Card w/ CP/M 3.0)	279
Z-Card II	119
Darkstar Snapshot II copy card	65
Microsoft	
Solifcard w/ CP/M	239
Solifcard Plus w/80 col card w/o 16K	425
Premium System w/80 col card & 16K	459
Orange Micro	
Grappler Plus	129
Buffered Grappler	189
Buffer Board (for use with Grappler)	129
Videx	
Videnterm 80 column w/split switch	229
UltraTerm 132 column card	269
We also carry many popular software packages for the Apple.	

MODEMS

Anchor Automation	
Mark VII 300 baud	115
Mark XII 1200 baud	275
Hayes	
Smartmodem 300	210
Smartmodem 1200	479
Smartmodem 1200B (IBM internal model with Smartcom II software)	419
Smartcom II software	75
Smartmodem to IBM cable	25
Micromodem IIe	235
Novation	
Access 1-2-3 (IBM internal model with Crosstalk software)	395
Smartcal 103 300 baud	175
Smartcal 103/212 1200 baud	415
Appical II	249
Prometheus	
Promodem 1200	369
\$SM	
Transmodem 1200	499

DISK DRIVES

CDC 9409 (IBM)	239
Tandon TM 100-2 (IBM)	219
CDC 9428 (1/2 height) (IBM)	229
Teac FD55B (1/2 height) (IBM)	189
LMS SA-390 (Apple)	194
10 meg Hard Disk with Controller Internal or External (IBM)	1249

INFORMATION

FREE! BUYER'S GUIDE

Our Buyer's Guide has all of our current products and all of our too low to advertise prices and some handy comparison charts. To receive your free copy, please write us with your name, address and type of computer you own or plan to buy, or call (619) 460-6502. NOTE: Operators cannot accept requests for the Buyer's Guide on our toll-free order line. Thank You.

SATISFACTION GUARANTEE

We guarantee every item in this advertisement for 30 days. If, for any reason whatsoever, you are not satisfied with any merchandise purchased from us, we want you to return it to us. We will exchange it for exactly what you want, or will refund your money. Defective software may only be exchanged for replacement due to copyright laws. For a full disclosure of our policies and terms of sales please write or call (619) 460-6502.

TERMS: All prices listed reflect a 5% cash discount for pre-paid (non-credit related) cash orders. For fastest service, send a money order, cashiers or certified check. Personal checks allow 3 weeks to clear. We accept VISA, MasterCard, American Express, Diner's Club and Carte Blanche (add 3%). Purchase orders from well qualified corporations and institutions are accepted; if not pre-paid with PO add 5% to ad prices, terms are 2% 10, Net 30. Shipping, handling & insurance charges add 3% of merchandise total (min. \$5.00). California destinations add 6% sales tax. Foreign customers please call or write. Returns must include all original materials and be in new and resalable condition for full refund. All equipment is new, complete, and warranted by the manufacturer. Prices and availability subject to change without notice. We are not responsible for typographical errors or omissions.

NATIONAL COMPUTER PRODUCTS

A division of Synectics Corporation

8338 Center Drive • La Mesa, CA 92041-3791 (619) 460-6502



COMPUTER CONNECTION



PRICES SLASHED BELOW ALL COMPETITORS!!

PERSONAL SYSTEMS		DISK DRIVES	
APPLE		SIEMENS	
Apple IIE Starter System	\$1325	FD 100-8	\$ 154
FRANKLIN		TANDON	
Ace 1000 w/color	\$ 799	TM: 00-2 for IBMPC	\$ 219
Ace 1200 w/drive	1399	TEAC	
IBM		Double Sided 320K for Sanyo	\$ 175
IBMPC 64K, 1 Drive	\$1995	Drives For Apple & Franklin	
IBMPC 64K, 2 Drives	2224	MICRO-SCI	
SANYO		A2	\$ 209
MBC 550 w/1 drive & software	\$ 795	QUENTIN RESEARCH	
MBC 555 w/2 drives, more softw.	1179	Apple Mate	\$ 199
TAVA		RANA SYSTEMS	
1 Par. & 2 Ser. Ports, 128K, 2 320K Drives, Color Card & Composite Monitor	\$ 1845	Elite I	\$ 229
		Elite II	349
		Elite III	429

PRINTERS

OKIOATA	
MLB2A, 10" carriage	\$ 299
MLB3A, 15" carriage	559
ML92P, 160 cps	429
ML93P, 160 cps	699
C. ITOH	
Prowriter 8510 AP, 120 cps	\$ 329
Prowriter II 1550 AP, 15" 120 cps	545
Starwriter F10-40PU, 40 cps	989
Printmaster F10-55PU, 55 cps	1299
EPSON	
RX80FT, 120 cps	\$ 389
FX80, 10" 160 cps	520
FX100, 15" 180 cps	699
JUKI	
6100 LQ 15", 18 cps w/propor. spac.	\$ 449
TOSHIBA	
P1350 (1) Dot Matrix, L.Q., graphics	\$1485
MANNESMANN TALLY	
160L, 160 cps	\$ 575
180L, 180cps	795

DISPLAY MONITORS

USI	
PI 2 (12" Green)	\$ 125
PI 3 (12" Amber)	129
GORILLA	
Hi-Res. 12" Green	\$ 85
Hi-Res. 12" Amber	95
AMDEK	
V300G	\$ 135
V300A	145
V310A for IBMPC	165
Color I, 13" Color Composite	289
Color II, RGB	399
BMC	
12 UW (12" Green)	\$ 89
9191 Color Composite	229
NEC	
JB 1201M, 80 col.	\$ 155
JB 1205M(A) w/audio	165
JC 1203 Hi-Res Color IBM comp.	465
TAXAN	
12N (12" Green)	\$ 109
12NUV (12" Amber)	119
PRINCETON GRAPHICS	
HX12, RGB for IBM	\$ 479

IBM/APPLE ACCESS.

AST RESEARCH	
Six Pak Plus	\$ 269
Mega Plus II	279
Combo Plus	269
64K MEMORY UPGRADE	
64K, 9 chips	\$ 55
MICROMAX	
Viewmax 80E, 128K 80 col. card for Apple IIE	\$ 129
for Apple II & II+	139
PC PEACOCK	
Color Graphics Card w/Printer Port	\$ 269
PLANTRONICS	
Color + Board	\$ 379
MODEMS	
HAYES MICRO	
1200 Baud Smart Modem	\$ 499
1200 B for IBMPC	409
Micro Modem IIE w/Term. pkg.	259

PRINTER ACCESSORIES

ORANGE MICRO	
Grappler +	\$ 119
Buffered Grappler +, 16K exp. 64K	169
FOURTH DIMENSION	
Par. Card & Cable for Apple	\$ 49
TRACTORS	
Okidata for 82A & 92	\$ 49
Juki Bi-Directional	129
Toshiba Bi-Directional	199
MICROTEK	
Dumpling GX Graphic Interface	\$ 99
Dumpling GX w/16K	149
Additional Buffering, 16K	16
PRACTICAL PERIPHERALS	
Mic/Buf IIP, 16K	\$ 145
Mic/Buf IIS, 16K	149
CABLES	
Any Computer to Parallel Printer	\$ 29

IF YOU SEE IT ADVERTISED FOR LESS, CALL US FIRST FOR LOWEST QUOTE!

MAIL ORDER:
12841 S. Hawthorne Blvd., No. 585
Hawthorne, California 90250

ORDER DESK:
[VISA] [MasterCard] [Discover] [AmEx]
[213] 514-9019

Mon.-Fri. 8 a.m. to 6 p.m.
Saturday 11 a.m. to 3 p.m.

We accept VISA, MasterCard, CDD (wire deposit), Certified Checks or Wire Transfers. Shipping minimum \$4.00. Some items subject to back order. CA Res. add 6 1/2% Tax. Prices subject to change.

Savings\$ DO IT YOURSELF!

An IBM® PC/XT Compatible

To start, you need a high-quality Switching Power Supply and a heavy duty Mainframe to cabinet your Cpu Board, Power Supply, Cards, Drives, etc.



#HSC 130-40
\$189.00/ea.
130 WATT.
Switching Power Supply

- +5V/15A, +12V/4.2A, -12V/0.25A, -5V/0.3A
- Built-in Fan
- Power Switch
- Cables w/Connectors for Cpu Board and 4 Disk Drives
- 2 Switched AC Outlets for Printer & Monitor
- One Full Year Warranty

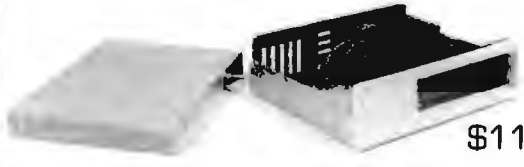

Cabinet only
\$119.00/ea.

- Heavy duty welded steel
- 2 Full or 4 Half Height Disk Drives allowed
- IBM® Look-alike

64K D-RAM
150ns 84/TI
\$49.00/9 pcs.
8088 Family
74LS xx
TMS 9980
\$19.00/ea

DEALER & OEM'S INQUIRY INVITED

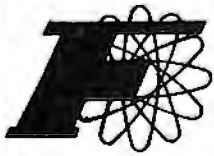

FORTRON CORP.
4447 ENTERPRISE ST.
FREMONT, CA 94538

Dealer & OEM 415-490-8403
End User 415-490-8171
Foreign 415-490-3265
TLX 176632

Terms: Shipping immediately from stock usually, or within 4 weeks if run out of inventory. Minimum \$5.00 shipping + handling. Personal check requires 2 weeks clearance before shipping. 6.5% sales TAX required for CA. residents.

74LS00

74LS00	.60	74LS166	2.50
74LS01	60	74LS168	1.35
74LS02	60	74LS169	1.35
74LS03	60	74LS170	2.50
74LS04	75	74LS173	1.50
74LS05	75	74LS174	1.50
74LS08	75	74LS175	1.50
74LS09	75	74LS181	2.50
74LS10	65	74LS190	1.45
74LS11	75	74LS191	1.45
74LS12	75	74LS192	1.35
74LS13	95	74LS193	1.35
74LS14	1.25	74LS194	1.45
74LS15	75	74LS195	1.35
74LS20	60	74LS196	1.35
74LS21	75	74LS197	1.35
74LS22	75	74LS221	1.35
74LS26	75	74LS240	1.85
74LS27	75	74LS242	1.85
74LS28	75	74LS243	1.85
74LS40	75	74LS244	2.25
74LS42	95	74LS245	3.95
74LS48	95	74LS247	1.65
74LS51	60	74LS248	1.65
74LS54	60	74LS249	1.65
74LS55	60	74LS251	1.75
74LS73	95	74LS253	1.75
74LS74	1.42	74LS258	1.50
74LS75	95	74LS259	2.95
74LS76	95	74LS260	1.15
74LS78	95	74LS261	3.75
74LS83A	1.15	74LS266	1.35
74LS85	1.25	74LS273	1.75
74LS86	75	74LS275	4.95
74LS90	95	74LS279	95
74LS92	95	74LS283	1.25
74LS93	95	74LS290	1.25
74LS95	95	74LS293	1.25
74LS96	1.25	74LS295	1.65
74LS107	75	74LS298	1.65
74LS109	75	74LS323	4.95
74LS113	95	74LS324	2.15
74LS114	95	74LS347	2.55
74LS122	1.05	74LS348	2.55
74LS123	1.35	74LS352	1.65
74LS124	1.35	74LS353	1.95
74LS125	95	74LS363	1.95
74LS126	95	74LS365	1.25
74LS132	1.35	74LS366	1.25
74LS133	95	74LS367	95
74LS136	95	74LS368	95
74LS138	1.10	74LS373	2.50
74LS139	1.10	74LS374	4.95
74LS145	1.75	74LS375	1.25
74LS148	1.75	74LS377	1.95
74LS151	1.25	74LS378	2.55
74LS153	1.25	74LS385	1.95
74LS154	1.70	74LS379	2.55
74LS155	1.25	74LS386	1.25
74LS156	1.35	74LS381	3.95
74LS157	1.25	74LS390	2.55
74LS158	1.25	74LS393	2.95
74LS160	1.25	74LS395	2.55
74LS161	1.25	74LS424	3.95
74LS162	1.25	74LS640	3.95
74LS163	1.25	74LS668	2.75
74LS164	1.65	74LS645	4.95
74LS165	1.25	74LS670	2.50
		74LS690	2.50

74S00

74S00	75
74S02	75
74S03	75
74S04	75
74S05	75
74S08	95
74S09	95
74S10	95
74S11	95
74S15	95
74S20	95
74S22	95
74S30	95
74S32	95
74S38	1.95
74S40	95
74S51	95
74S64	95
74S65	95
74S74	1.50
74S86	1.25
74S112	1.25
74S113	1.25
74S114	1.25
74S124	3.65
74S133	95
74S134	1.25
74S135	1.65
74S136	2.25
74S138	1.95
74S139	1.95
74S140	1.25
74S151	1.95
74S153	1.95
74S157	1.95
74S158	1.95
74S160	2.95
74S161	3.95
74S163	3.95
74S174	2.25
74S175	2.25
74S188	3.55
74S194	2.55
74S195	2.55
74S196	2.55
74S225	7.75
74S240	2.95
74S241	2.95
74S242	3.95
74S243	3.95
74S251	2.25
74S257	1.95
74S258	1.95
74S260	1.25
74S280	2.95
74S283	3.95
74S287	3.95
74S288	3.95
74S289	4.95
74S373	3.95
74S374	3.95
74S387	3.95
74S471	7.95
74S472	7.95
74S473	7.95
74S474	9.95
74S475	9.95

GENERAL PURPOSE BOARDS

BLANK BOARD — HOLES ON 100" GRID, No ETCHED CIRCUIT EXCEPT CONTACT FINGER

No Contacts	Size	Contact Centers	Price	
P 441-1	22-44	4.5" x 6"	156	9.95
P 442-1	22 44	4.5 x 9"	156	10.95
P 721-1	36 72	4.5 x 6	100	9.95
P 722-1	36 72	4.5 x 9	100	10.95

D-- SUBMINIATURE CONNECTORS

Description	Solder Cup		Right Angle PC Mounting		Hood		
	Pin	Socket	Pin	Socket	Grey	Black	
Part No	DXXP	DXXS	RDXXP	RDXXS	DXXCGY	DXXC	
Contacts	9	2 05	2 65	3 90	3 20	1 55	----
	15	2 05	3 60	3 70	5 40	1 55	----
	25	2 50	3 25	4 50	4 80	1 55	1 25
	37	4 75	7 10	9 40	10 95	2 95	----
	50	6 00	9 25	----	----	3 50	----

MODEMS

SIGNALMAN	MARK I	RS 232C, 300 BAUD DIR CONN	89 00
	MARK VI	IBM COMPATIBLE 300 BAUD, DIR CONN. AUTO ANS DIAL	199 00
MARK VII		RS 232C, 300 BAUD DIR CONN	139 00
		CONN. AUTO ANS DIAL	
MARK XII	RS 232C, 300 1200 BAUD, DIR CONN. AUTO ANS DIAL	359 00	
ADAPTER		115VAC TO 9V DC	9 00
HAYES	IBM PC SMARTMODEM 1200B Plug-in		449 00
	SMARTCOM II COMMUNICATIONS SOFTWARE		99 00
	SMARTMODEM 300 AUTO ANS DIAL, 300 BAUD RS232		199 00
	SMARTMODEM 1200 AUTO ANS DIAL, 1200 BAUD, RS232		475 00
	SMARTMODEM IIe 300 BAUD AUTO ANS DIAL Plug-in		279 00
	SMARTCOM I COMMUNICATIONS SOFTWARE		79 00

BARE BOARDS

P 25 x 45	2.5 x 4.5"	2.50
P 45 x 65	4.5" x 6.5"	4.95
P 45 x 85	4.5 x 8.5	6.50
P 45 x 170	4.5" x 17.0"	11.95
P 85 x 170	8.5" x 17.0"	19.95

EDGE CARD CONNECTORS

44 PIN WW	4.95
44 PIN ST	2.95
72 PIN WW	5.95
72 PIN ST	6.95

S - 100 BOARD (5.3" x 10") HOLES ON 100 GRID

P 100-1	Blank Board	15 95
P 100-2	Horizontal Busses	22 95
P 100-3	Vertical Busses	22 95

FLOPPY DISK DRIVES

FOR IBM PC				
Shugart	SA455L	5.1"	320 KB High	209 00
Panasonics			320KB High	199 00
Toshiba			320KB High	209 00
Handon	TM100-2A		320KB Full High	209 00
FOR APPLE II AND IIe				
Handwell	HD-40	5.1"	Full High	175 00
Handwell	HSD-80	5.1"	High	185 00
MONITORS				
Taxan	12 in	green		130 00
Taxan	12 in	amber		135 00
Taxan		color monitor	Vision 420	550 00
Taxan		color monitor	Vision III	500 00

RESISTORS

1/8 WATT 5% CARBON FILM FROM 1 OHM TO 10M OHM			
50 pcs	99		02 ea
100 pcs	1 89		019 ea
1000 pcs	9 50		010 ea
5000 pcs	42 50		009 ea
1/4 WATT 5% CARBON FILM			
50 pcs	1 25		025 ea
100 pcs	2 35		024 ea
1000 pcs	11 50		012 ea
5000 pcs	52 50		011 ea

RIBBON CABLE

Contacts	GREY		COLOR CODED	
	3	10	3	10
10	4 45	4 50	1 95	5 95
14	1 95	4 70	4 40	7 25
16	1 75	4 90	2 50	7 50
20	2 10	5 50	3 10	9 25
24	2 70	6 50	2 95	8 50
25	1 75	6 50	3 05	10 05
40	3 95	11	3 75	18 30
50	4 15	12 00	1 50	22 75
60	4 35	15 50	9 00	27 30

CENTRONIC PRINTER CABLE 12 95

JOYSTICK

FOR APPLE II
\$32.00

FOR APPLE II & IIe

16K RAM CARD
Compatible with DOS 3.3 CP M
Visicalc PASCAL
1 YR WARRANTY
\$39.95

Apple II/IIe Compatible Disk Drive

\$175.00

CONTROLLER CARD

\$49.95

Speedy EPROM Programmer for Apple II

\$149.00
Programming 2716, 2732, 2732A, 2764, 27128, 2516, 2532, 2564
in 30 seconds, software control programming, no additional hardware required

U/V EPROM ERASER

General Industries
\$37.50

SUPER COOLING FANS For APPLE WITH SURG

\$39.50

FOR IBM P/C

MULTIFUNCTION BOARD WITH 128K, 2 Serial Port 1 Parallel Port, Real Time Clock
\$399.00

Color Graphic Display Card

\$270.00

64K MEMORY EXPANSION KIT for IBM/PC

\$52.95

Joy Stick for IBM P/C

\$35.00

8087 MATHEMATICS CO-PROCESSOR

\$199.00

VISA MasterCard

7400 SERIES CALL FOR PRICE

MOS EPROM

2708	5.95
2716-450	3.95
2732-450	5.95
2732-250	6.95
2764-450	7.95
2764-250	9.95
2764-300	9.95
27128-250	25.95
TMS2516	4.95
TMS2716	7.95
TMS2532	5.95

STATIC RAM

2101	2.95
5101	4.95
2114-450	1.95
2114-200	2.15
2147	4.95
6116-4	5.75
6118-3	6.75
6116-2	7.95
6116LP-4	6.75
6116LP-3	6.95
6116LP-2	8.95

SOUND CHIPS

76477	2.95
76489	8.95
AY3-8910	9.95
AY3-8912	12.95

CRYSTALS

32 758khz	1.75
1 0mhz	3.95
1 8432	3.95
2 0	2.95
2 097152	2.95
2 4576	2.95
3 2768	2.95
3 579535	95
4 0	2.95
5 0	2.95
5 0688	2.95
5 185	2.95
5 7143	2.95
6 0	2.95
6 144	2.95
6 5536	2.95
8 0	2.95
10 0	2.95
10 738635	2.95
12 00	2.95
14 31818	2.95
15 0	2.95
16 0	2.95
17 430	2.95
18 0	2.95
18 432	2.95
20 0	2.95
22 1184	2.95
32 0	2.95

MISC

8502	4.95
86000	49.95
8748	24.95
8255-5	5.95
82S123	2.55
82S129	

SPECIALS on INTEGRATED CIRCUITS
 6502 @ 4.90 6520 @ 4.00 6522 @ 5.00 4116 @ 1.85
 2532 @ 5.90 2716 @ 4.45 6116 @ 6.45 4164 @

**Anchor
Automation
Signalman
MODEMS**

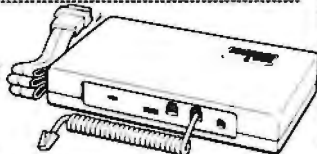

FREE SOURCE MEMBERSHIP WITH SIGNALMAN
 All Signalman Modems are Direct Connect, and provide the best price-performance values. Dealer and OEM inquiries invited

Yolksmodem with computer cable	68
Mark VII Auto Dial/Auto Answer	99
Mark XII Smart Model 1200/300	279
DC HAYES Smartmodem	219
DC Hayes Smartmodem 1200/300	519



PROM QUEEN for C64 or VIC	130
SM-KIT 64 program & disk utilities	45
STAT Statistics Package for C64	95
Solid Oak 2 Level Stand for C64 or VIC	29
C64/VIC Switch (networking)	129
BACKUP VI.0 tape copier for C64 or VIC	20
CARDBOARD/6 Motherboard - VIC	64
CARDBOARD/5 Motherboard - C64	56
CARD PRINT G Printer Int. with Graphics	79
CARD PRINT B Printer Interface—C64/VIC	48
CARDBOARD/3s Motherboard - VIC	22
CARDCO C64/VIC Calculator Keypad	32
CARDRAM/16 RAM Expansion - VIC	49
Complete CARCO Line in stock	
CIE and VIE IEEE Interfaces in stock	
MSD Dual SuperDisk for C64 or IEEE	570
MAE Assembler for C64	50
Keala Pad Touch Tablet—C64 or VIC	75
CBC 4/12 Analog to Digital 4 chan/12 bit	179
MULTIPLAN for C64	79
Dust Cover for C64 or VIC	6
Grand Master Chess for C64	19
COMAL Language for C64	14
with sprites, color graphics, sound, turtle graphics.	
BusCard II from Batteries Included	159
ULTRA BASIC - 64 with Turtle Graphics	37
Super Disk Utility - C64 - includes backup	19
MicroChess - C64 - 8 levels of play	17
HES MODEM with software for C64	45
Commodore 64 Programmers Reference Guide	16
WordPro 3+/64 with Spellright	85
VICController (also C64) - BSR Controller	50
COM VOICE Synthesizer for C64 or VIC	139
VIC products in stock - call for extra discounts.	
Victory Software for VIC and C64 in stock.	

APPLE—FRANKLIN ITEMS

FRANKLIN—complete line in stock	
QUENTIN Drives for Apple/Franklin	189
Swapper Stopper	26
automatic switch between paddles and joystick	
KRAFT Apple Joystick	40
Kraft Apple Paddle Pair	30
Keala Pad Touch Tablet—Apple/Franklin	90
SPINNAKER Software in stock	
Broderbund Software in stock	
16K RAM Card for Apple	59
Multiplan—Microsoft	179
Solid Oak 2 Level Stand for Apple	29
Serial Card for Apple	89
MPC RAM/80 column card for IIe (AP/TXT)	139
Z80 Softcard and CP/M (Microsoft)	235
AB 80 Column Card with Softswitch	95
Parallel Printer Interface/Cable	69
Microtek and MPC Interfaces in stock	
Grappier + Interface	135
DC Hayes Micromodem II, IIe with Smartcom	245
PFS: File or PFS: Report or PFS: Graph	95
Videx 80 Column Card	209
Apple Blue Book	19

Commodore

See us for Personal, Business, and Educational requirements. Educational Discounts available.

PETSCAN I \$245 base price

Allows you to connect up to 30 CBM/PET Computers to shared disk drives and printers. Completely transparent to the user. Perfect for schools or multiple word processing configurations. Base configuration supports 2 computers. Additional computer hookups \$100 each.

COMPACT/STCP \$115

Intelligent Terminal Package for PET, CBM, C64
 Includes ACIA Hardware / STCP Software

MSD Dual Super Disk for IEEE or C64 570

replaces 4040 drive

SCREENMAKER 80 Column Adapter for C64 139

Provide big screen capability for business applications.

Copy-Writer Word Processor for C64 49

Full-featured package with 800 lines of text in memory. Includes double column printing, graphic capability, full printer support.

Special Screenmaker/Copy-Writer Combo 179

VICTORY Software for VIC and C64

Metamorphosis	16	Creator's Revenge	16
Labyrinth of Creator	16	Galactic Conquest	16
Kongo Kong	16	Annihilator	16
Chomper Man	16	Grave Robbers	13
Bounty Hunter	16	Adventure Pack I or II	16

PAPER CLIP Word Processor - CBM/C64 60

ORACLE Data Base from Batteries Included 89

SPINNAKER Software C64, Apple, IBM, Atari

Compute's First Book of PET/CBM

POWER ROM Utilities for PET/CBM

WordPro 4+ - 8032, disk, printer

VISICALC for PET, ATARI, or Apple

Compute's First Book of 64 Sound & Graphics

SM-KIT enhanced PET/CBM ROM Utilities

PET Spacemaker II ROM Switch

Compute's First Book of Games

Dust Cover for PET, CBM, 4040, or 8050

CmC Interfaces (ADA1800, ADA1450, SADI in stock)

Compute's Reference Guide to 64 Graphics

Compute's Machine Language for Beginners

HES Software and Hardware in stock

FlexFile for PET/CBM/C64 \$59

DataBase, Report Writer with calculations, Mailing Lists. Easy to use, and can be modified.

FORTH for PET/C64 full FIG model - Cargile/Riley 50

includes all FORTH 79 Standard extensions, structured 6502 assembler with nested decision macros, standard 16x64 screens, ability to read/write BASIC sequential files, sample programs, introductory + reference manual.

Metacompiler for FORTH for independent object code 30

Floating Point for FORTH 20

KMMH PASCAL IV for PET/CBM/C64 99

Virtually full Jensen-Wirth implementation is now suitable for advanced placement courses.

EARL for PET/CBM/C64 disk-based ASSEMBLER 59

SuperGraphics - BASIC Language Extensions 45

Fast graphics, sound, turtle graphics routines for PET/CBM.

RAM/ROM for PET/CBM 4K \$75 8K \$90

COMAL Language for C64, CBM, PET 14

Smart Terminal Software for C64/VIC 10

CBM Public Domain Software - C64 27 disks 75

STAT for PET/CBM/C64 and Apple 95

Comprehensive Statistical Analysis Routines

Includes complete file handling capabilities, summary statistics, confidence intervals, hypothesis tests, exponential mean tests, multiple and power series regression, analysis of variance, histograms, and non-parametric tests.

PageMate 60 Command Word Processor 20

Full-featured package for all Commodore computers. Full screen editing, and supports disk, tape, and all printers.

DISK SPECIALS



Scotch (3M) 5" ss/dd	10/ 2.10	50/ 1.90	100/ 1.86
Scotch (3M) 5" ds/dd	10/ 2.65	50/ 2.45	100/ 2.40
Scotch (3M) 8" ss/sd	10/ 2.20	50/ 2.00	100/ 1.98
Scotch (3M) 8" ss/dd	10/ 2.80	50/ 2.50	100/ 2.47

We stock VERBATIM DISKS

Write for Dealer and OEM prices.

Sentinal 5" ss/dd	10/ 1.80	50/ 1.75	100/ 1.65
Sentinal 5" ds/dd	10/ 2.40	50/ 2.35	100/ 2.25

We stock Dyan disks

Wabash 5" ss/sd	10/ 1.45	50/ 1.40	100/ 1.35
Wabash 5" ss/dd	10/ 1.60	50/ 1.55	100/ 1.50
Wabash 5" ds/dd	10/ 1.95	50/ 1.90	100/ 1.80

We stock MAXELL DISKS

Write for dealer and OEM prices.

Disk Storage Pages	10 for \$4	Hub Rings 50 for \$6
Disk Library Cases	8"—3.00	5"—2.25
Head Disk Cleaning Kits	12	
AMARAY Disk Storage Systems in stock		
Innovative Concepts FLIP 'N' FILES in stock.		

CASSETTE TAPES—AGFA PE-611 PREMIUM

C-10	10/ .61	50/ .58	100/ .50
C-30	10/ .85	50/ .82	100/ .70



data systems

ZVM-122A	99	ZVM-123G	89
ZVM-131	300	ZVM-135	490
Z100 16-bit/8-bit System			CALL
Z29 Terminal (DEC and ADM compatible)			680

Z-150 IBM PC COMPATIBLE CALL

Z-16D PORTABLE PC CALL

We stock entire Zenith line.

USI Video Monitors - Green or AMBER 20 MHz hi-res

Dealer and OEM inquiries invited

WRITE FOR IBM PC COMPATIBLE PRICES

Multiplan—IBM or Apple	179
Quadboard for IBM available	
KOALA PAD Touch Tablets—Apple, Atari, IBM, CBM	
Peachtex 5000 Software Package	199
PFS Software for IBM and Apple in stock	
SPINNAKER Software C64/VIC, Apple, IBM, Atari	
VOTRAX Personal Speech System	269
BMC 9191 Color Monitor	229
BMC 12A 12" Green Monitor	79
Dynax (Brother) DX-15 Daisy Wheel Printer	459
Brother HR-25 Daisy Wheel Printer (25 cps)	749
Itoh Prowriter Parallel Printer	379
Panasonic 1090 Printer with Correspondence Mode	279
Gemini 10X	289
EPSON, Okidata, Star Micronics printers in stock	
USI ComputMOD 4 R/F Modulator	29
We Stock AMDEK Monitors	
A P Products	15% OFF
COMPUTER COVERUPS IN STOCK	
BROOKS 6 Outlet Surge Suppressor/Noise Filter	54
Surge Suppressor-6 outlet	29
Electrohome 1302-2 13" Hi-res RGB Monitor	335
Panasonic 12" Monitor (20 MHz) with audio	137
Synertek SYM-1 Microcomputer	189

Hewlett Packard



Write or call for prices.

DATASHIELD BACKUP POWER SOURCE \$265

Battery back up Uninterruptible Power Supply with surge and noise filtering. The answer to your power problems.

ATARI - WE STOCK ENTIRE LINE

SPINNAKER and Broderbund Software in stock.

215-822-7727
 252 Bethlehem Pike
 Colmar, PA 18915

A B Computers

WRITE FOR CATALOG. Add \$1.50 per order for United Parcel. We pay balance of UPS surface shipping charges on all prepaid orders (add extra for mail, APO/FPO, air). Prices include cash discount. Regular prices slightly higher. Prices subject to change.

MICROMAIL™

THE PC SYSTEM SPECIALIST

PRICES AND AVAILABILITY SUBJECT TO CHANGE WITHOUT NOTICE



SPECIAL OF THE MONTH!



A Superior quality IBM PC Compatible Personal Computer. Runs DOS 1.1, 2.0, 2.1, CP/M86® UCSD p-System® Runs Lotus 1-2-3® Multiplan® Word Star® PFS® dBASEII® and many more! Hardware includes 128K CPU, Floppy Controller, Two DS/DD Disk Drives, Video Monitor, Video Adaptor, Parallel & Serial Ports.



IBM®
PERSONAL
COMPUTER

Special of the Month!

IBM PC® COMPLETE LINE

COMPLETE SYSTEM VERY SPECIAL PRICE

64K, Two Disk Drives, Floppy Disk Controller, Video Card and High Res Monitor **\$2590**

256K RAM, 360KB Disk Drive, FDC, Video Monitor & Adaptor 10MB Hard Disk Sub-System. **\$3990**

CALL FOR LOW PRICE

Suggested List \$2395.00

HARD DISKS FOR IBM PC®



10 MB Hard Disk Sub-System by TAVA CORP. includes Software, Cables, etc. Internal. **\$1295**

SLIMLINE DISK DRIVE FOR IBM PC

DS/DD 320KB By TAVA CORP **\$190**

ADD-ON Disk Drive for IBM PCjr® **CALL**

MEMORY BOARDS

CONOGRAPHIC

High Res. Color Graphics Card **\$995**

QUADRAM

Quad Card. Fully pop. 256K **\$450**

QUADLINK **CALL**

AST SIXPAK 384K **CALL**

HERCULES Graphics Card **\$490**

PRINTERS

DAISYWRITER 2000 **CALL**

OKIDATA

82A **\$425** 84A **\$975**

83A **\$650** 92A **\$525**

93A **\$850**

BROTHER

HR-25 **\$795**

DX-15 **\$450**

MONITORS

AMDEK

300A **\$190.00** I **\$340.00**

300G **\$160.00** II **\$690.00**

310A **\$190.00** III **\$390.00**

PRINCETON GRAPHICS SYSTEMS

Hi-Res Color **\$490**

APPLE IIe

Computer System, Controller, Two Disk Drives, Monitor **\$1590**

DISK DRIVE FOR APPLE

Slimline, or Standard **\$190**

NEC TANDON TAVA IBM APPLE QCS MAYNARD — LNW ROMAR TOSHIBA PRODUCTS AVAILABLE

MICROMAIL

631 E. First St., Tustin, CA 92680

(714) 838-9100

*IBM PC is a registered trademark of IBM Corp.
dBASE II is a registered trademark of Ashton-Tate, Inc.
LOTUS 1-2-3 is a registered trademark of Lotus Development
Wordstar Spellstar Mailmerge are registered trademarks of Micropro International
Visicalc is a registered trademark of Visicorp

Multiplan is a registered trademark of Microsoft Corp.
PFS is a registered trademark of Software Publishing Co.
CP/NBS is a registered trademark of Digital Research, Inc.
MS-DOS is a registered trademark of Microsoft Corp.
UCSDp is a registered trademark of Softech Microsystems

Super

Computer



SUPER XT/SUPER PC

- FEATURES:**
- *8088 16 Bit Micro Processor W/8087 Co-processor
 - *256K on board dynamic RAM with parity
 - *4 CHANNEL DMA
 - *8 CHANNEL INTERRUPT
 - *8 I/O SLOT FOR SUPER XT 5(7) I/O SLOT FOR SUPER PC
 - *Same power connector as IBM PCTM

SUPER PC/SUPER XT BARE BOARD W/ MANUAL	\$100.00
LOADED BOARD W/128K RAM W/O ROM	\$526.00
EASY BOARD	\$225.00
MANUAL ONLY	\$ 25.00
8K BIOS	\$ 25.00
LIMITED TIME OFFER COMPLETE SYSTEM: 2-360K DRIVE W/ COLOR BOARD AND DYNAX MONITOR	\$1995.00



SUPER 2000

- FEATURES:**
- *128K RAM ON BOARD
 - *Z-80/6502 DUAL CPU
 - *RGB OUTPUT
 - *DETACKABLE KEYBOARD
 - *CPM/APPLE COMPATIBLE

Diskette Box \$23.95

1. 64K RAM COMPUTER \$675.00
2. DRIVE SYSTEM I 64K COMPUTER \$945.00
3. DRIVES SYSTEM II 64K COMPUTER \$1150.00
4. DRIVES SYSTEM III 64K COMPUTER W/80 COLUMN & MONITOR 64K COMPUTER \$1375.00

CAN-80	CAN-80 TRAINING KIT	
Z-80 CPU	8 BIT Z-80 CPU MICROPROCESSOR BASE WITH EPROM	\$249.00
WITH EP	PROGRAMER \$375.00 ADD ON: X-PRINTER CARD	
EPRON P	\$95.00 8K RAM CARD \$95.00 SOUND CARD \$85.00	
MANUAL	MANUAL ONLY \$25.00	\$ 79.00
CAN-88	CAN-88 TRAINING KIT	\$ 25.00
8088 CPL	16 BIT 8088 CPU MICROPROCESSOR BASE \$450	\$350.00
	*25% OFF FOR STUDENT (WITH PROVE)	
	*40% OFF FOR 10 OR MORE EDUCATIONAL GROUP PURCHASE DISCOUNTS FOR TRAINING KITS ONLY	



SUPER XT/ SUPER PC COMPATIBLE TO IBM PC/XT POWER SUPPLY
COMPUTER CASE
1METAL) \$150.00

65 W POWER SUPPLY	\$170.00
100W POWER SUPPLY	\$200.00
130W POWER SUPPLY	\$220.00



IBM™ COMPATIBLE
83key Keyboard \$200.00



*PCjr™
JOYSTICK \$35.00
GAME CARTRIDGE
BARE PCB \$8.00
GAME CARTRIDGE
BOX \$8.00

ATTENTION: SOFTWARE HOUSE, CARTRIDGE PRODUCTION AND MASK ROM SERVICE AVAILABLE



COMPUTER CASE
(METAL) \$99.00



SUPER 5 35/40T \$195.00
Teac Drive 35/40T \$225.00



KEYBOARD \$150.00



Monitor Stand \$32.00

APPLE COMPATIBLE ADD ON

ADD-ON BOARDS

128K RAM CARD	\$199.00
16K RAM CARD	\$ 39.00
80 Column Card	\$ 69.00
Auto Term	\$ 99.00
Disk Controller	\$ 45.00
Parallel Graphic Card	\$ 69.00
Message (RS-232)	\$ 85.00
Z-80 Card	\$ 59.00
EPROM Programmer	\$ 79.00
I.C. TESTER	\$150.00

OTHERS

Joy Stick	\$ 29.00
RF Modulator	\$ 15.00
Cooling Fan	\$ 39.00
Koala Pad	\$ 89.00
Power Supply (5A)	\$ 69.00
Micromodem IIe	\$269.00

DISK DRIVE

Shugart Drive	\$185.00
Super 5 35/40T	\$199.00
Teac Drive 35/40T	\$225.00

MONITOR

Dynax Amber	\$139.00
Dynax Green	\$129.00

SEND \$2.00

FOR FULL PRODUCTS CATALOG

BUILD YOUR OWN COMPUTER SUPER 2000

* Case	\$ 99.00
* Keyboard	\$150.00
* Case/KB	\$240.00
* Case/KB/PS	\$309.00

BARE BOARD

* 128K RAM Card	\$ 25.00
* Mother Board (DUAL CPU)	\$ 75.00
* Other Interface Cards	\$ 18.00

PRINTERS

Genio 10X	\$279.00
Riteman (120CPS)	\$275.00
EPSON FX-80	\$525.00
EPSON FX-100	\$750.00
Juki-6100	\$499.00
Brother DX-15	\$469.00
Brother HR-25	\$749.00

MODEM

Hayes 300 (Baud)	\$199.00
Hayes 1200 (Baud)	\$499.00
U.S. Robotics Password (1200)	

ACCESSORIES

Monitor Stand	\$ 38.00
Diskette Box	\$ 23.95
50-Pin Connector	\$ 2.50
40/80 Column Switch	\$ 10.00

IBM PC/XT, SUPER XT/PC COMPATIBLE ADD ON

ADD-ON BOARDS

	BARE BOARD	LOADED BOARD
*DISK PLUS I/O: DISK CONTROLLER W/SERIAL & PARALLEL	\$60.00	\$295.00
*MONOCHROME GRAPHIC BOARD: HI-RES. MONOCHROME W/720x348 GRAPHICS & PRINTER PORT	\$60.00	\$399.00
*SUPER COLOR I: COLOR GRAPHICS BOARD	\$75.00	\$240.00
*ASYNC & BLASTER PROGRAM UP TO 128K EPROMS	\$70.00	\$245.00
*PARALLEL PRINTER BOARD	\$40.00	\$100.00
*EXTENSION BOARD	\$25.00	\$ 35.00
*PROTO-TYPE BOARD	\$25.00	

OTHERS

*INTERNAL HARD DISK 10MB W/PS	\$1395.00
*EXTERNAL WINCHESTER 10MB W/PS	\$1495.00
*MOUSE SYSTEM W/SOFTWARE	\$ 249.00
*HAYES 1200B MODEM	\$ 429.00
*QUADLINK-RUN APPLE PROGRAM	\$ 449.00
*AST 6 PACK PLUS W/64K	\$ 299.00
*TEAC SLIM DRIVE 360K	\$ 225.00
*PANASONIC 320K SLIM DRIVE	\$ 199.00
*MPI 320K FULL SIZE	\$ 199.00
*AMDEK 310A	\$ 179.00
*PRINCETON PGS RGB	\$ 499.00
*NEC RGB 1216	\$ 499.00
*82 PIN CONNECTOR	\$ 4.00
*QUAD RAM COLOR BOARD	\$ 240.00
*QUAD BOARD W/O	\$ 249.00
*QUAD DENSITY 1/2 HEIGH DRIVE FOR IBM PC\$	\$ 299.00

SUPER COMPUTER, INC.

1101 S. GRAND AVE. STE J SANTA ANA CA92705

Dealer & OEM Inquiries Invited: (714) 543-2927

Mail Order: (714) 543-2901

Circle 312 on inquiry card.

TERMS: CALIFORNIA RESIDENTS ADD 6% TAX
ADD \$5 FOR PACKING & SHIPPING IN
NORTH AMERICA COMPUTER, PRINTER,
AND MONITOR ADD \$5 EXTRA EACH.



FLOPPY DISK SERVICES, INC.
39 Everett Dr., Bldg D
Lawrenceville, NJ 08648

LEADERS IN INNOVATIVE DISK DRIVE ENCLOSURES!

The **FD-PC8™** is a new 8" double-sided disk drive sub-system



IBM PC styling.

The FD-PC8 looks like your other IBM PC components. Same styling. Same color. Same dimensions. It stacks neatly under, on top of, or next to your IBM PC, and better still, is only one-half the height of standard 8" drives. Matches Z100 & others also.

2 Drive System—\$1495 complete with cables.

SPECIFICATIONS

- Full one year warranty on materials and workmanship.
- Two fully assembled and tested Shugart double-sided 8" drives also available in one drive configuration.
- Exactly 1/2 the height of standard 8" drives.
- IBM PC styled and painted cabinet.
- All cabling included.
- IBM 3740 format compatible.
- No-mar rubber feet.
- Sturdy construction easily supports PC or monitor.
- Power supply designed for long life, trouble-free operation.
- Requires Maynard controller for use on PC.

NEW! FD-PC5™

This versatile new disk drive enclosure comes completely tested and assembled with a 4" cooling fan, and is designed to offer a variety of mounting options, with the power supply rated for any of the following:

- full-size floppy disk drive
- full-size hard disk
- one or two half-height floppy disk drives
- one or two half-height hard disks
- one or two 3.5" drives

Full 1 year warranty—cable choice optional



DISK DRIVES and other Goodies!

Shugart (1 year war.)	
sa-860 ds/dd half hgt 8"	\$505.00 2 @ 495 ea
sa-455 ds 48tpi 1/2 hgt 5.25"	245.00 2 @ 230 ea
sa-465 ds 96tpi 1/2 hgt 5.25"	295.00 2 @ 275 ea
sa-300 ss 96tpi 3.5 inch	265.00 2 @ 250 ea
sa-851 ds 8" full size	495.00 2 @ 480 ea
W.S.T. (formerly SIEMENS)	
FDD-100-5B4 floppy 5.25"	235.00
FDD-211-5 DS 48tpi for PC	265.00
FDD-221-5 DS 96tpi full size	335.00
FDD-100-5C3 (sa-400 compatible)	175.00
Heath H-89 TWOET kit ...	
put 2 half height floppies internal to the H-89 with our exclusive mounting kit, call for details!	
Maynard Electronics for the IBM-PC	
Memory module (bare)	210.00
64K	305.00
128K	410.00
192K	510.00
256K	615.00
With serial port add	100.00
With 2 serial ports	160.00
Controller w/mod ports	265.00
FDC8 8" controller	245.00

Standard controller	\$195.00
Controller w/par port	275.00
Controller w/ser port	285.00
Hard disk module	495.00
Modular board	110.00
Multidisplay (mono & color board)	575.00
PGS, HX-12 RGB color monitor	525.00
Magnolia controller for the H-89	375.00
Data connectors of all types	CALL
Power connectors for all drives	CALL

We offer a wide assortment of enclosure sizes, styles and systems, including both 5 1/4" and 8" IBM look-alikes, and more. All are well constructed, attractive and immediately available at competitive prices. Call for details and prices.

IMPORTANT NEWS!

We are moving, please take note of our address. Our new and expanded facilities will permit us to offer a higher level of service than ever before. Our growth is the result of your patronage; we thank you for it sincerely.

TERMS: M.C. VISA, PREPAID. NO COD'S. PERSONAL CHECKS HELD FOR 10 DAYS. WE ALSO ACCEPT P.O.'S FROM MAJOR BUSINESSES & UNIVERSITIES, CALL FIRST.

Toll Free Order Line 800-223-0306 Ask for our free catalog.

****More Computer for Your Calculating Dollar****

Try the New

XPC-XT by **XOR**

Introductory Offer

(Offer expires May 31, 1984)

\$1995⁰⁰
SYS-8100-00

"Need a 16-bit IBM-PC™ to process your data?"

The first IBM™ compatible that IS compatible! A complete system including the PC-DOS™ operating system from IBM™. Two thinline double-sided 5 1/4" Disk Drives hold 360K of formatted storage each, the other drive opening is fitted with a close-out plate. Removal of the plate will allow room for a Winchester Hard Disk. The Power Supply is like that of an IBM-PC XT™. Hard Disk ready! How compatible is the XPC-XT? It will run 1-2-3™, Flight Simulator™, dBASE II™, WordStar™, SuperCalc™, VisiCalc® and hundreds of others. The system will also support MS-DOS™ 1.1 and 2.1, PC-DOS™ 2.2, CP/M-86™ and Unix Operating Systems. Add-on an additional 192K of RAM for a full 256K of on-board Memory for only \$195.00. This computer comes standard with 2 Serial and 1 parallel ports (IBM™ COM1 and COM2). No need to purchase Add-On cards.



Standard Features:

- PC-DOS™ Operating System Vers. 2.1
- 64K of parity checked RAM, expandable on-board to 256K
- 8088 16-bit CPU
- 5 IBM compatible expansion slots
- 4 DMA and 3 Timer channels
- Up to 32K of EPROM (supplied with full 8K)
- DOS BIOS on EPROM
- Full size capacitance touch keyboard with 10 function keys and calculator type numeric keypad
- 8087 Math Co-Processor ready
- 110-220 VAC, 50-60 Hz
- High resolution, 12" Monitor with Green Screen and 18MHz bandwidth.
- Two Slimline 5 1/4" DS/DD 48 TPI Floppys @ 360K storage each.
- Floppy Disk Controller expansion card, runs up to four SS or DD Floppys
- ALSO supports MS-DOS™ and CP/M-86® Operating Systems
- Power Supply is Hard Disk ready, no need to add-on additional power
- Full One Year Parts and Labor Warranty on all XDS Manufacturing products!

BASIC XPC SYSTEM

If that incredibly LOW Total System price doesn't suit you, try this "Do it Yourself System" and take your pick of the wide range of options listed below.

The Features: •64K RAM •Expandable to 256K

•4 DMA channels •5 Expansion Slots

•Runs MS/DOS™ and CP/M-86™ (not included)

•Multi-function Keyboard and Cable

•Hard Disk Ready Power Supply

•2 Serial and one Parallel Port

•and MORE! •SYS-8000-00

Only \$895



The following are registered Trademarks and their Companies: 1-2-3-Lotus Development Company; MS-DOS, PC-DOS, Flight Simulator-MicroSoft; dBase II-Ashton-Tate; WordStar-MicroPro International Corp.; SuperCalc-Sorcim, Inc.; VisiCalc-VisiCorp, Inc.; CP/M-86-Digital Research Inc.; IBM, IBM-PC, IBM-PC XT-International Business Machines.

Call or Write for Nearest Dealer and Full Catalog

FLOPPY INTERFACE

This is the standard Floppy Interface Card supplied in all systems not using Tape Back-up. It can access up to four drives in 48 or 96 TPI formats. The same high quality data separator as used in IBM™ counterparts, insures data integrity. BOA-6001-00.....\$255.00

EXPANSION MEMORY

This super reliable, four layer design Memory Card can be expanded from 64K to 576K in 64K increments (at \$75.00 ea.). We've tested them all and can recommend this one with confidence. The price below is with 64K and includes Spooler and RAMDISK software. BOA-8650-00.....\$255.00

CALENDAR CLOCK

This simple but effective Card should be ordered with every system. Battery Back-up (naturally) keeps your Disk Log right up to date. Saves typing in the date everytime you "boot up" the system. BOA-8700-00...\$149.00

300/1200 BAUD MODEM

If this is your first computer, you will soon want it to Communicate. CompuServe and The Source are on your screen minutes after you plug-in this Custom Made Unit. Supplied with cable to plug into any wall outlet. Auto-Dial Software "remembers" phone numbers and log-in sequences to ease operation. Software included for each operating system. BOA-8725-00.....\$295.00

SUPER 12 PAK MULTI-FUNCTION

Now we need a full page to describe this fantastic Card! Since we only have a little room, here are the features: IBM™ compatible Joystick Port (2), Real-Time Chronograph (Battery Back-up), Parallel Port, Serial Port, 64K to 384K of Parity Memory, Print Spooler and RAM-DISK software, and supplied with OK of Memory. BOA-8680-00.....\$345.00

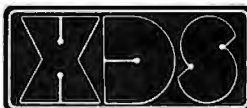

MANUFACTURING

HARD DISK ADD-ON Complete Packages

Includes BIOS Software, 5 1/4" Winchester Hard Disk, mounting hardware, Interface P.C.B. for expansion slot, and all the necessary power and data cables (the Power Supply in the XPC-XT is Hard Disk ready).

10 Megabyte	65 Megabyte
\$995	\$2495
20 Megabyte	105 Megabyte
\$1295	\$3295
40 Megabyte	140 Megabyte
\$1795	\$4195

Archive Tape Back-up unit shown above is of 20 and 40 megabyte capacity. Memtek unit will soon be available at 10 megabyte capacity at approximately One-Half the cost! Circle 360 on inquiry card.

MONOCHROME ADAPTOR

If you are impressed with all the rave reviews that the Hercules Graphics Card gets, you will love ours! Made expressly for the XPC-XT by Hercules themselves, it runs everything the Hercules Card does (1-2-3™, dBase II, etc.). BOA-8500-00...\$395.00

COLOR ADAPTOR

Color and monochrome combinations, can be run simultaneously. Flight Simulator™, 1-2-3™ all perform without modifications. NO FLICKER! Besides performing perfectly, included are: Light Pen Interface, Print Spooler, and RAM Disk options! BOA-8400-00.....\$495.00

COLOR

MON-1500-00 \$345.00

Three models of Color to choose from, each with higher and higher resolution. Price from \$345.00 to \$750.00. Monochrome Unit is outstandingly clear and easy on the eyes. In Green or Amber screens.

HARD DISK ONLY INTERFACE

A simple, quick solution to adding a Hard Disk to your XPC. All you need is this card, a Cable, and the Drive. Handles from 5 to 140 megabytes with minimum software configuration. Order with your System now or order later. Compatible with all the operating systems. BOA-8050-00.....\$375.00

H.D./TAPE CONTROLLER

This package consists of a combination Interface Adaptor having SCSI H.D./TAPE Connector as well as the Floppy Controller. Two additional 5" form factor Boards are included and mount over the Tape Drive and Hard Disk. 10, 20, & 40 megabytes of Back-up is added to your Hard Disk. BOA-8675-00.....\$750.00

Lyc0 Computer Marketing & Consultants

TO ORDER
CALL US

TOLL FREE 800-233-8760
In PA 1-717-327-1824

SAVE on these in-stock PRINTERS

PRINTER INTERFACING AVAILABLE
Available for IBM PC, Apple, Atari, Vic 20 & Vic 64

EPSON

LETTER QUALITY

SMITH CORONA TP2...\$449.00
DIABLO 630 ..\$1719.00

ALPHACOM 42\$89.00
ALPHACOM 81\$129.00
NEC 8023\$369.00
NEC 8025\$699.00
NEC PC-8200
COMPUTER\$CALL

RX-80\$SAVES
RX-80FT.....ON
FX-80In-Stock
FX-100.....EPSON
MX-80FTPRINTERS
MX-100.....\$CALLS

MANNESMANN TALLY

SPIRIT 80\$CALL
MT 160L.....\$CALL

OKIDATA

80\$SAVES
82ACALL for
83ALOWEST
84PRICES
92on these
93In-Stock
PACEMARK 2350...PRINTERS

ATARI 850 REPLACEMENTS IN-STOCK

CITOH

GORILLA GX100\$179.00
PROWRITER 8510 ...\$339.00
PROWRITER II\$659.00
8800\$1025.00
STARWRITER\$1099.00
PRINTMASTER\$1499.00

STAR MICRONICS

GEMINI 10X\$269.00
GEMINI 15X\$CALL
DELTA 10.....\$479.00

MODEMS

ANCHOR MARK I ..\$79.00
ANCHOR MARK II..\$79.00
HAYES SMART ...\$239.00
HAYES MICRO II \$309.00
Micro Bit
MPP-1000.....\$129.75
NOVATION
CAT\$144.00
D-CAT\$155.00
J-CAT\$115.00
APPLE CAT II ...\$279.00
212 APPLE CAT ..\$589.00

MONITORS

Sakata Color\$229.00
Amdek Color I\$275.00
Amdek 300 Green.....\$149.00
Amdek 300 Amber\$149.00
Gorilla Green\$99.00

HES 64

Sound Box\$9.95
84Forth\$55.75
Hesmon\$25.75
Turtle Graphics.....\$37.75
Heswriter\$28.75
Gridrunner.....\$19.75

DUST COVERS

800\$3.99
400\$3.99
1200\$3.99
410\$3.99
810\$3.99
1050.....\$5.99
PROWRITER\$5.99
GEMINI 10X.....\$5.99
PERCOM DISK\$5.99

SSI

Battle of Shilo\$26.75
Tigers in the Snow...\$26.75
Cosmic Balance\$26.75



APPLE DUMPLING GX \$99.75
APPLE DUMPLING 64 (16 Buffer)\$179.75
INFOCOM
Zork I, II, or III\$26.75
Deadline\$33.75

CARDCO

Cardprinter / LQ1\$499.00
Cardprint DM1\$109.00
5 Slot Expansion 64\$54.00
64 Write NOW\$39.00
64 Mail NOW\$29.00
2J Write NOW\$29.00
64 Keypad\$29.00
Universal Cass. Int.\$29.75
Printer Utility\$19.75
6 Slot Expansion\$79.95
3 Slot Expansion\$24.95
PRINTER INTERFACE.....\$39.75
PRINTER INTERFACE with
full graphics\$65.75
LIGHT PEN\$29.75

SPINNAKER 64

Kindercomp\$21.75
Story Machine\$23.75
Face Maker\$23.75
Snooper Trooper.....\$29.75
Delta Drawing\$34.75
Shamus II c/d\$24.95
Pinhead c/d\$22.95

SYNAPSE 64

ZEPELIN C/D\$24.75
BLUE MAX C/D\$24.75
DIMENSION X C/D\$24.75
EPYX 64
ASPHI R.....\$28.75
JUMPMAN JR R\$28.75
PIT STOP R\$28.75

commodore

BRODERBUND 64

BANK STREET
WRITER\$49.75
CHOPLIFTER\$24.75
LODE RUNNER\$24.75
DROL\$24.75
KOALA TOUCH TABLET...\$69.75

ATARI

Computers for people:
Voice Box 2 ..\$99.75

600XL ...\$CALL
800XL.....for
1400XL...Lowest
1450Prices
1050 DISK DRIVE\$SAVES
1010 RECORDER.....\$74.75

PARKER BROTHERS

Tutankham R.....\$33.75
Super Cobra R ...\$33.75
Astro Chase R.....\$33.75
Frogger R\$33.75
QBert R\$33.75
Popeye R.....\$33.75

Monkey Wrench 2 \$52.75
SPINNAKER
Story Machine R ..\$26.75
Face Maker R\$24.75
Kinderomp R\$20.75
Fraction Fever R ..\$24.75
Delta Drawing R...\$26.75

BLANK DISKETTES ELEPHANT

Single Side SD (10).....\$17.75
Single Side DD (10).....\$21.75
Double Side DD (10).....\$26.75
MAXELL
MD I (10)\$28.75
MD II (10)\$38.75

CERTRON CASSETTES

CC-10 12 for\$15.99
CC-20 12 for\$17.99

INNOVATIVE CONCEPTS

Disk Storage (holds 10).....\$4.95
Disk Storage (holds 15).....\$9.95
Disk Storage (holds 30).....\$26.95

TRAK DISK DRIVES

AT-D1\$379.00
AT-D2\$399.00
PRINTER CABLE\$22.95
Software for ATD-2\$22.95

RANA DISK DRIVE

COMPUTER CARE

BIB
5 1/4 DISK DRIVE
CLEANER\$12.75
COMPUTER CARE
KIT\$19.75

HARD DISK DRIVES for

APPLE IBM-PC

5MEG.....\$1349.00
10MEG ...\$1599.00
15MEG ...\$1999.00
20MEG ...\$2359.00

TEXAS INSTRUMENT

Disk Drive...\$245.00

PERCOM

FOR ATARI COMPUTERS

AT88S1\$299.00
AT88S2\$535.00
AT**S1PD...\$439.00
RFD40S1...\$399.00
RFD40S2...\$675.00
RFD44S1...\$449.00
AT88 doubler



TO ORDER



CALL TOLL FREE

800-233-8760

or send order to
Lyc0 Computer
P.O. Box 5088

Customer Service 1-717-327-1825 Jersey Shore, PA 1774C

Circle 200 on inquiry card.

POLICY

In-stock items shipped within 24 hours of order. Personal checks require four weeks clearance before shipping. No deposit on C.O.D. orders. Free shipping on prepaid cash orders within the continental U.S. PA residents add sales tax. All products subject to availability and price change. Advertised prices show 4% discount offered for cash, add 4% for MasterCard or Visa. DEALER INQUIRIES INVITED.

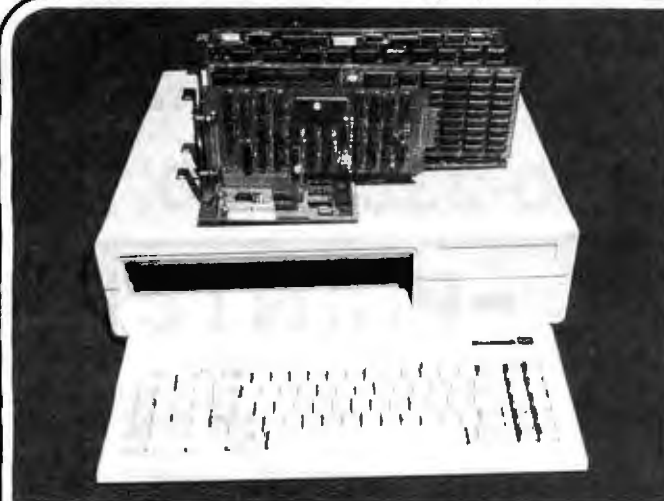

Build Your IBM™ Compatible PC at Competitive Prices

MULTIFUNCTION BOARD

- 2 serial ports, 1 parallel port real time clock, 64k RAM up to 256k RAM **299.00**
- Floppy disk drive controller board **189.00**
- Hard disk controller board **399.00**
- Color graphic board **239.00**
- Monochrome + color + graphic board **Call**
- Panasonics disk drive, 320k, half height **199.00**
- Hard disk drive 10 MB **799.00**
- 100W power supply with fan **199.00**
- Case **169.00**
- Manual **25.00**
- Keyboard **169.00**
- High resolution color RGB monitor **499.00**
- High resolution green monitor **129.00**
- Monitor stand **39.00**
- Hayes 1200B modem **449.00**
- Hayes 1200 modem **475.00**

MOTHER BOARD:

- 8088 CPU with socket for co-processor 8087
- 8088 is supported by 8259A interrupt controller and 8237 DMA controller
- 2 (two) 28 pin sockets for ROM
- 8 (eight) expansion slots
- No RAM on board (RAM is on multifunction board)

Bare Board	69.00
Ready Board	199.00
(with IC sockets, resistors, capacitors, connectors, crystals, transistors soldered)	
Tested Board (w/o ROM)	399.00
IC kit	199.00

IBM is the trademark of International Business Machines.
Prices subject to change without notice.



4962 El Camino Real • Los Altos, CA 94022
(415) 962-9265 1-(800) 821-3628
TLX: 171947 HANDWELL LTOS

IBM PC 256K 2X 320 KB DS/DD DISK DRIVES FLOPPY DISK CONTROLLER, COLOR CARD ALL FOR \$2599

IBM MULTIFUNCTION BOARD

Quadboard 64K Expandable to 384K Parallel, Serial Port Game Port, I/O Bracket	\$289.00
Quadboard II 64K Memory expansion 2 Serial ports	\$289.00

Profit Systems **\$ CALL**
Run 9 programs simultaneously.
Serial, Port
Expandable to 512K
ALSO AVAILABLE
Excellent prices on
STB, AST, MAYNARD

MONITORS

Amdek 300G	\$144.50
Amdek 300A	\$155.00
Amdek 310A	\$ CALL
Amdek Color II +	\$385.00
PGS HX-12	\$495.00
PGS MAX 12 Amber	\$179.00
Quadchrome	\$549.00

ALSO AVAILABLE
w/10 MB INTERNAL HARD DISK
\$3,599.00
IBM PORTABLE (Available)
\$ CALL
(Call for other configurations)

**"99 44/100% SYSTEM COMPATIBLE"

P.C. World April 84

TAVA PC

SYSTEM I

128K 2 DS/DD Disk Drives Color Graphic Board Printer Port 2 Serial Ports Keyboard Amdek Monitor DOS 2.1	\$1,995.00
--	-------------------

SYSTEM II

256K 1 DS/DD Disk Drive Color Graphic Board Printer Port 2 Serial Ports Keyboard Amdek Monitor DOS 2.1 10 MB HARD DISK	\$2,995.00
--	-------------------

SPECIAL

LOTUS 1-2-3
\$295.00
with the purchase
of any IBM or
TAVA PC

RBASE
\$ CALL

SOFTWARE

IUS
MICROPRO
MICROSOFT
CONTINENTAL
PEACHTREE
PERFECT
SORCIM
VISICORP

We carry over 100
different lines of
APPLE & IBM Software
10%-45% below retail.

CALIFORNIA
22110 Clarendon Street
Woodland Hills, CA 91367
(818) 999-1183

ALL PRICES SUBJECT TO CHANGE WITHOUT NOTICE

**SUPPORT SELECTION SAVINGS
TO THE MAX...**

MISSISSIPPI
175 East Capitol
Landmark Center
Jackson, MS 39201
(601) 355-8204



NEC

NEC ADVANCED PERSONAL COMPUTER - THE APC

STANDARD HARDWARE PACKAGE INCLUDES:

- 8086 16BIT CPU
- 128K RAM, EXPANDABLE TO 512K
- 640 x 475 PIXEL CRT
- 8" FLOPPIES WITH 1 MBYTE EACH
- GREAT KEYBOARD
- 48 DEFINABLE FUNCTION KEYS

STANDARD SOFTWARE PACKAGE INCLUDES:

- MS-DOS 2.0
- WORDSTAR 8.3
- dBaseII
- MULTIPLAN

NEC APC-1 DRIVE, GREEN #H01	\$2095
NEC APC-2 DRIVE, GREEN #H02	\$2550
NEC APC-2 DRIVE, COLOR #H03	\$3150
NEC APC-1 DRIVE, COLOR #H04	\$2575
NEC 10MBYTE WINCHESTER #H26	\$2175

LIMITED TIME GRAPHICS SPECIALS:

ALL GRAPHICS PACKAGES INCLUDE ADDITIONAL 128K USER RAM, AND HIGH PERFORMANCE GRAPHICS VIDEO INTERFACE, WHICH CREATES 1000 x 1000 GRAPHICS. THE DOT MATRIX PRINTER, WHERE INCLUDED, IS THE #H16, AKA PC-8023.

- GPKG #1 GRAPHPLAN, CP/M-86, PRINTER
- GPKG #3 VIDEOGRAPH, GRAPHWRITER, SCREENSHOOTER
- GPKG #2 CONTEXT MBA, PRINTER
- GPKG #4 AUTOCAD, CP/M-86

NEC GPKG-xx-MONO	\$685
NEC GPKG-xx-COLOR	\$775



**NEC
AND
ME**

IBM

IBM PC SYSTEMS

- #1 SYSTEM: 2-360K DRIVES, 256K RAM, GRAPHICS VIDEO CARD \$2565
- #2 SYSTEM: 2-360K DRIVES, 256K RAM, MONOCHROME VIDEO CARD, AMBER CRT \$2825

IBM PC-XT SYSTEMS

- #1 SYSTEM: STANDARD UNIT - LIST \$4995 \$4400
- #2 SYSTEM: 256K, GRAPHICS VIDEO, AMBER CRT \$4945
- #3 SYSTEM: 256K, MONOCHROME VIDEO, AMBER CRT .. \$5090



TAVA PC

TAVA PC SYSTEMS

ALL TAVA'S INCLUDE 2 SERIAL PORTS, 1 PARALLEL PORT, 2 DSDD THINLINE DRIVES, A VIDEO INTERFACE (EITHER GRAPHICS OR MONOCHROME), 256K RAM, AND A 12" MONOCHROME CRT.

TAVA #1: GRAPHICS VIDEO	\$2145
TAVA #2: MONOCHROME VIDEO	\$2195
TAVA PC-XT #1: 10 MBYTE HARD, GRAPHICS VIDEO	\$3295
TAVA PC-XT #2: 10 MBYTE HARD, MONOCHROME VIDEO	\$3345

SANYO

SANYO MBC550 SYSTEMS

MBC550-STD	\$745
MBC555-STD	\$1085
RECOMMENDED OPTIONS:		
128K EXTRA RAM (256K TOTAL)	\$100
TEAC DSDD DRIVE, w/DOS PATCH	\$245
SERIAL PORT	\$80
AMBER CRT	\$140
COLOR RGB CRT	\$535
DOS PATCH	\$75

Corona

The Compatible Company

CORONA SYSTEMS

- #PC-2: DESKTOP, 128K, 2 DRIVES \$2350
- #PPC-2: PORTABLE, 128K, 2 DRIVES \$2335
- #PC-2-XT: DESKTOP, 10MBYTE HARD \$3585
- #PPC-2-XT: PORTABLE, 10MBYTE HARD \$3560

LETTER QUALITY PRINTERS

C. ITOH/TEC: THESE DAISYWHEEL PRINTERS USE DIABLO WHEELS, INK CARTRIDGES, AND SOFTWARE CODES.

F-10-18 18cps	\$485
F-10-40 40cps	\$950
F-10-55 55cps	\$1275
ARATI LQ-20P 20cps, 132 COLUMN	\$395
DYNAX-BROTHER HR-15	\$450
DYNAX-BROTHER HR-25	\$780
JUKI 6100 20cps	\$465
NEC SPINWRITERS #2050	\$485
NEC #8650	\$1785
NEC #7780	\$2100
SILVER-REED EXP500P	\$475
SILVER-REED EXP550P	\$555

DOT MATRIX PRINTERS

BMC 80P-90 w/CANON INK	\$265
C. Itoh 2000 18cps	\$485
180cps-WIDE	\$695
180cps-COLOR	\$575
180cps-COLOR-WIDE	\$795
EPSON FX-80	\$535
EPSON FX-100	\$730
GEMINI 10-X	\$279
GEMINI 15-X	\$415
MANNESMANN-TALLY MT160L	\$615
MT180L	\$825
OKIDATA 92	\$435
OKIDATA 93	\$700
PROWRITER 120cps, STD	\$345
PROWRITER 2 120cps, WIDE	\$575

Sakata

SAKATA MONITORS

SC-100 COLOR COMPOSITE 13"	\$275
SC-200 COLOR RGB FOR IBM 13"	\$460
SC-300 COLOR RGB FOR IBM 13"	\$695
SC-1000 GREEN 12"	\$125
SC-1000 AMBER 12"	\$135

NEC PC8201 LAP COMPUTER \$575

COMPAQ

COMPAQ 2 DRIVE, 256K \$2465

MICROSOFT

MICROSOFT "WORD" w/MOUSE \$295

QUEBEC MODEM 1200B INTERNAL \$295

EXPERT COMPUTERS

21804 ROSCOE BLVD., SUITE 18
CANOGA PARK, CA 91304

(213) 344-6063
(800) 528-9537

ADD 4% FOR AMERICAN EXPRESS. ADD 2% FOR VISA/MASTER-CARD. 20% PREPAID DEPOSIT REQUIRED ON COD ORDERS. CALIFORNIA RESIDENTS ADD SALES TAX. PRICES MAY CHANGE - CALL TO VERIFY PRICES AND DELIVERY.

TSENG LABORATORIES ULTRA-PAK

- 132 x 44 COLUMN VIDEO INTERFACE WITH GRAPHICS FOR THE IBM MONOCHROME CRT. INCLUDES PARALLEL PORT, SERIAL PORT, CLOCK. OPTIONAL FLOPPY DISK CONTROLLER OR 64K-384K RAM PACK
- ULTRA-PAK LIST \$680 \$485
- DISK-PAK LIST \$520 \$385
- RAM-PAK (64K EXPANDABLE TO 384K) LIST \$245 \$205

PRINTER SYSTEMS

- MULTIGRAPH (80 x 40 VIDEO w/GRAPHICS & PRINTER PORT) \$455
- MULTIGRAPH OPTION BOARD (132 COLUMNS, 16 COLORS) \$185
- MULTI-USER SUBSYSTEM: FOR 4 USERS, HARDWARE & SOFTWARE \$650

DISKETTES

VERBATIM VEREX SSDD	\$ 17
DATALIFE SSDD	\$ 25
DATALIFE DSDD	\$ 33
HEAD CLEANER KIT	\$ 8
FLOPPY (USE BACK SIDE OF DISKS)	\$ 17
DISKETTE HAMPER	\$ 24
LIBRARY CASE-HOLDS 10 DISKS	\$ 2.25

MODEMS

ANCHOR AUTOMATION "SIGNALMAN"		
MARK II (ATARI)	\$ 89
MARK III (TT)	\$ 110
MARK IV (COMMODORE PET-CBM)	\$ 120
MARK V (OSBORNE)	\$ 100
MARK XII (1200 BAUD SMARTMODEM)	\$ 345
THE NETWORKER FOR APPLE w/SOFTWARE	\$ 159
THE NETWORKER - NO SOFTWARE	\$ 110
HAYES SMARTMODEM 300	\$ 215
HAYES SMARTMODEM 1200	\$ 505
HAYES MICROMODEM II-E	\$ 295
NOVATION ACCESS 1-2-3	\$ 445

"When you know
enough to buy mail order,
you're wise enough to
buy from an expert."

Circle 132 on inquiry card.

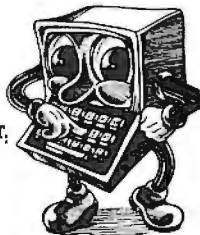

Computers for Less

Hayes Smartmodem 1200 \$469.00
 Hayes Micromodem //c \$290.00
 Gemini 10X \$269.00
 Epson FX-100 \$699.00
 Okidata 92P \$420.00
 Tava P.C. \$1895.00
 IBM P.C. \$2395.00
 Lotus 1-2-3 \$309.00
 Maxell 55/DD \$20.00
 Maxell DS/DD \$32.00

(619) 579-2730

2855 Avocado Blvd., Suite 140-227 • La Mesa, California 92041
 Prices reflect 7 1/2% Cash Discount. Quantities Limited



Circle 82 on Inquiry card.

SAVE MORE THAN EVER ON 3M Scotch® DISKETTES

LIFETIME WARRANTY!

\$185 ea. 5 1/4" SSDD
--(744)
Qty. 20

\$235 ea. 5 1/4" DSDD
(745)--
Qty. 20

5 1/4" SSDD—96TPI (746)	\$2.60 ea.
5 1/4" DSDD—96TPI (747)	\$3.25 ea.
8" SSDD (740)	\$2.05 ea.
8" SSDD (741)	\$2.50 ea.
8" DSDD (743)	\$3.10 ea.

Shipping: 5 1/4" DISKETTES—Add \$3.00 per 100 or fraction thereof. 8" DISKETTES—Add \$4.00 per 100 or fraction thereof. OTHER ITEMS: Shipping charges as shown in addition to diskette shipping charges. Payment: VISA or MasterCard. COD orders only, add \$3.00. Taxes: Illinois customers, please add 8%.

Hours: 9 AM-5 PM Central Time
 For fast service call
Nationwide: 1-800-621-6827
 In Illinois: 312-944-2788

DISK WORLD!
 Suite 4806 • 30 East Huron Street • Chicago, Illinois 60611

Authorized Distributor
 Information Processing Products **3M**

Circle 111 on Inquiry card.

LOW-COST DATA LOGGING FOR APPLE II®

UP TO 128 CHANNELS OF VOLTAGE,
 CURRENT OR THERMOCOUPLE INPUTS
 16-CHANNEL STRIP CHART OR LOG
 ON PRINTER - FAST DISK STORAGE
 INPUTS ARE OVER VOLTAGE-PROTECTED
 SAMPLE RATES UP TO 110,000 SAM/SEC
 MANY OTHER ADVANCED FEATURES

ALSO: TIMER/CLOCK WITH CALENDAR
 1 MILLISECOND RESOLUTION . . . \$175

12-BIT A/D 40,000 SAM/SEC . . . \$325

8-BIT A/D 110,000 SAM/SEC. . . . \$165

13-BIT A/D 12 SAM/SEC \$175

THERMOCOUPLE THERMOMETERS
 2 OR 6 CHANNELS \$135 or \$155

MULTIPLEXERS, OUTPUT CONTROLLERS
 AND CUSTOM SYSTEMS AVAILABLE.

LAWSON LABS, INC.

5700 RAIBE ROAD
 COLUMBIA FALLS, MT 59912
 406-387-5355

Circle 187 on Inquiry card.

*IBM PC Compatible PC PIPELINE

E-PROMS — CALL! Lowest Prices Anywhere

*4164-150P \$530
 *4164-200/250 515/469
 *6116-P3 599
 *IBM Ex/Color Boards... CALL
 IBM PC, XT's ... Below Market/
 CALL

Disk Drives: (F.O.B. Tampa)

*TM-100-2 21924
 *Half-Heights - 2 21924
 *10 mb Win 1,38547

(MS/DOS 2.0 IBM plug in & go)
 Add \$2.95 shipping to all orders • Prices subject
 to change • P.O.'s on approval • C.O.D. OK • All
 new, no surplus, no seconds
 4920 Cypress St., Tampa, FL 33607
 In FL and for info, call 813-875-0299
FOR ORDERS ONLY, 800-237-8910



8 AM-8 PM EDT

Circle 252 on Inquiry card.

BOARD REPAIR

Flat rate repair of Combo cards for IBM-PC
 made by AST, Indigo, STB, TecMar, or Quadram
\$85
 Includes parts & labor (except memory ICs)

**OTHER FLAT RATE
BOARD REPAIR PRICES:**

IBM-PC Motherboard (84-256K)	\$200
IBM-PC Power Supply (83 watt)	\$125
IBM-PC Color Graphics Adapter	\$125

CALL FOR QUOTES ON OTHER MODULES

ALSO TEAC FD55-B

5 1/4" DS DD disk drive	\$189 each
pair with stacking kit	\$385

MC/VISA accepted, add 4%

Com-Tec Services, Inc.

1110 N. POST OAK ROAD, #340
 HOUSTON, TEXAS 77055
 (713) 680-3300

Circle 61 on inquiry card.

COBOL CROSS REFERENCE \$95

Required:
 IBM-PC, DOS-2.0, 128K memory, & one disk drive.

Limits:
 1,400 data names & 11,000 references.

Prints cross reference and/or source code.
 Accepts most versions of COBOL as input.
 This is a stand alone program which will flag
 duplicate data names and invalid references.
 Your name will appear in the report heading.
 Please print your name and address distinctly.

Your Name _____
 Street Address _____
 City, State, Zip _____

Send a check or money order (\$95.00) to:

META SYSTEMS INC. ALASKA
 200 W. 24th Ave., Suite 115
 Anchorage, AK 99503

Circle 394 on inquiry card.

S-100 EPROM PROGRAMMER EPROM-32

- Field-proven board meets IEEE-696 standard
- Programs 1K through 32K (byte) EPROMs.
- Textool zero-insertion-force programming socket.
- EPROM is programmed through I/O ports and can be verified through I/O ports or located in memory space for verification.
- Programming voltage generated on-board.
- Personality Modules adapt board to EPROMs.

PM-1—2508, 2758	PM-3—2732, 2732A	PM-6—68764
2516, 2716	PM-4—2564	PM-8—27128
PM-2—2532	PM-5—2764	PM-9—27256

- Feature-packed CP/M-compatible control software includes fast programming algorithm.
- One year warranty.

\$269.95*
(A & T)

**MicroDynamics
Corporation**

Suite 245 • 1355 Lynnfield Road • Memphis, TN 38119
 (901) 682-4054

* Price includes EPROM-32, documentation and two Personality Modules (specify). Additional Modules—\$7.95. Control software on 5 1/4" SSDD diskette—\$29.95. UPS ground—\$2.00. UPS air—\$4.00. COD—\$1.65. foreign add \$15.00. VISA and MASTERCARD welcome.

Circle 220 on inquiry card.

IBM® XT COMPATIBLE OEM COMPONENT SALE

Computer Case	\$150.00
Key Board	\$199.00
Power Supply	\$225.00
Mother Board-Bare	\$ 95.00
Mother Board without ICs	\$225.00
Mother Board with ICs	\$525.00

Dealers/OEM Buyers
 Quantity Discounts Available.

All items are 100% XT Compatible as replacement kits. Case with interchangeable rear panel for PC Users. Bare board comes with complete instruction with part list. 1 year manufacturers warranty on most items.

VISA and MasterCard welcome
 Price change without notice
 IBM is a trademark of
 International Business Machine



HiTech International, Inc.
 4966 El Camino Real, Suite 101
 Los Altos, CA 94022 (415) 949-0141
 T.L.X. 171854 IBC

Circle 157 on inquiry card.

COMPUTER USERS... FREE ADVERTISING NATIONWIDE

When You Subscribe to NETWORK

**INTRODUCTORY
OFFER
\$19.95**

1 Full Year - 12 Issues
 Newsletter Pr. \$2.25
 \$27.00 Year

You can place up to 3 Free Classified Ads (up to 30 words ea.) in every issue of NETWORK for the lifetime of your subscription. NETWORK offers you (end users) a Nationwide marketplace to buy and sell your new or used personal computer, Hardware, Software, Peripherals and information. Call now or send \$19.95 (or your Visa/Mastercard No. and exp. date) for your 1-year subscription. You'll receive your classified ad forms by return mail.

**RISK FREE!
SATISFACTION GUARANTEED
YOUR MONEY BACK**

NETWORK
 2320 Kansas Ave.
 Suite 1108
 Topeka, Ks. 66611

CALL TOLL FREE
 1-800-233-2322
 or 913-357-6331

Circle 239 on inquiry card.



S-100
ESTABLISHED 1977

SALES 800 - 528-3138
TECHNICAL 602-991-7870
MODEM ORDERS 602-948-1387
TELEX: 16 5025 FTCC SEC PHX.

CompuPro

A GORDONVILLE COMPANY

SYSTEM 816/A A&T	\$3,999
SYSTEM 816/B A&T	\$4,999
SYSTEM 816/C A&T	\$6,399
SYSTEM 816/D A&T (8086)	\$9,899
SYSTEM 816/E A&T (88000)	\$6,399
TO ADD 40Mb H.D. TO ANY SYSTEM 816	\$2,475
S-100's 40Mb HARD DISK SUBSYSTEM W/DISK 3 & CP/M 80 & 86	\$2,895
100 HOUR SYSTEM "BURN-IN"	
*XEROX ON-SITE SERVICE WHERE AVAILABLE	

CPU 2 6MHz A&T	\$229
CPU 8086/88 A&T	\$349
CPU 8086 10MHz A&T	\$569
CPU 86/87 5MHz A&T	\$739
CPU 68K W/MMU OPTION A&T	\$629
CPU 68K 10MHz CSC	\$600
RAM 17 64K STATIC A&T	\$349
RAM 16 64K STATIC 8&16 A&T	\$389
RAM 21 128K STATIC 8&16 A&T	\$699
RAM 22 256K STATIC 8&16 A&T	\$1,229
M-DRIVE/H 512K RAM-DISK	\$895
INTERFACER 3-8 SERIAL A&T	\$489
INTERFACER 4-3 SERIAL/2 PARALLEL	\$319
SYSTEM SUPPORT 1 A&T	\$319
DISK 1 A&T	\$349
DISK 2 A&T 8" H.D. CNTRL	\$559
DISK 3 5 1/4" H.D. CNTRL W/CP/M80 & 86	\$659
6 SLOT MOTHERBOARD W/TERMINATION	\$99

MORROW

DJ/DMA 5 1/4" & 8" FLYP CNTRL/DEC.1	\$556
MD2 SYSTEM W/MDT60 TERMINAL AND TALLY "SPIRIT" PRINTER	\$1,699
MD3 AS EQUIP. ABOVE W/PEARL DBMS	\$1,999
MD3-MDCP88-256 AS EQUIP. ABOVE W/ 8088 CO-PROC. & 256K RAM UPRGRD.	\$2,498
MDP-3 PORT. SAME AS MD3 EXCEPT 5X7"	
SCRN. & INCLD. TALLY "SPIRIT"	\$1,899
MD11 SYSTEM W/11 Mb H.D., CP/M 3.0, 128K RAM, MDT60 TERMINAL, EPSON RX80FT PRT.	\$2,995



CPZ 48000 CLOSE OUT	\$639
CPZ 48006 6MHz MASTER	\$739
256KMB MEMORY BOARD	\$709
CPS-MX 64K RAM SLAVE 4MHz	\$339
CPS-MX 64K RAM SLAVE 6MHz	\$389
CPS-8MX 128K RAM SLAVE 4MHz	\$495
CPS-8MX 128K RAM SLAVE 6MHz	\$529



SUPER SIX/128-6 MHz	\$675
SUPER SLAVE/128-6 MHz	\$619
CP/M 3.0	\$350
TURBODOS MULTI USER W SPOOLER	\$500
DMA-MICROMAGNUM 5Mb 5Mb FIXED & 5Mb RMOV CARTG	\$1,595
HDC-1001-DMA W DRIVERS	\$429

Litton JEFFERSON ELECTRIC

TRUE SINE WAVE. 100% BATTERY OPER. W/NO SWITCH-OVER, BYPASS STATIC SWITCH	
750 WATTS @ 15 MIN #370-811-100	\$1,575
< 1 HR. W/AUXILIARY BATTERY	\$149

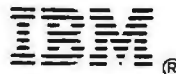

IBM-PC W/FLPY CTRL, STB GRAPHICS +
CRT CTRL, 256K RAM, PC DOS 2.10
2 DSDD DRVS., 12" AMBER MON. \$2,995

TECMAR FOR IBM-PC

TIMEMASTER WITH BATTERY BACK-UP	\$101
DYNAMIC MEMORY 256K	\$342
1st MATE 256K, SERIAL, PARA. CLOCK	\$412
CAPTAIN SAME AS 1st MATE W/384K	\$557
GRAPHICS MASTER HI-RES RGB	\$521
IEEE 488 BOARD W/SOFTWARE	\$367
5Mb H.D. CARTRIDGE INSTALLS IN P.C.	\$1,496
33Mb FIXED H.D. W/5Mb REMOVABLE CART. IN AN EXPANSION CHASSIS	\$4,121
LAB MASTER W/MANY OPTIONS AVAIL.	\$746
EXPANSION CHASSIS W/8 SLOTS	\$725
BASE BOARD - DO-IT YOURSELF	
MULTIFUNCTION	\$259
80SUN XT MULTIFUNCTION BD.	\$149
SCRIBE TENDER W/PRT & SERIAL CABLES	\$179
jrCAPT. 128K W/TREASURE CHEST	\$319
jrWAVE 256K	\$399
jrCADET 384K PIGGY-BACK BD. ADD-ON FOR jrCAPT. & jrWAVE	\$479



SUPER "RIO" 256K W/PARA., 2 SERIAL & GAME PORTS, CLOCK-CAL./BATT. PARA. & SERIAL CABLES	\$448
PIGGYBACK 512K FOR SUPER "RIO" 256	\$571
RIO PLUS W/384K SAME AS SUPER "RIO" EXCEPT ONLY 1 SERIAL AND NO PIGGYBACK BD.	\$549
SUPER I/O LIKE RIO PLUS WITHOUT RAM FOR XT	\$149
I-384 MEMORY EXPANSION BD.	\$484
GRAPHICS PLUS, RGB OR MONO, PRT AND LT. PEN PORTS	\$259



QUASI-DISK 512K RAM-DISK W/ON-BD. DRV. STATUS LED'S, WRITE PROTECT, DMA E-Z INSTALL W/SAMPLE CP/M BIOS	\$895
512K PIGGY-BACK EXPANSION	\$595
BATTERY BACK-UP W/PWR. SUPPLY	\$189
64K CMOS RAM OR ROM LOADS OF FEATURES	\$409

MFIO ALL-IN-ONE I/O BD. 8 ASYNCH. SERIAL, 2 PARALLEL BAUD RATE GENERATOR, CLOCK-CAL. W/BATT., PROG. PRIOR. INTERRUPT	\$489
SERIAL OPTION BD. FOR MFIO	\$25
CENTRONICS PARALLEL BD. FOR MFIO	\$39
STD. PARALLEL OPTION BD. FOR MFIO	\$25



U.S. ROBOTICS

FREE TELPAC SOFTWARE INCLD. S-100 BD. MODEM 300/1200	\$359
PASSWORD 1200 AUTO ANS./DIAL	\$369
AUTO DIAL 212A (HAYES COMPAT.)	\$459

PRINTERS

BROTHER HR-15 SERIAL	\$509
BROTHER HR-25 SERIAL	\$819
DAISYWRITER 2000 W/48K	\$998
EPSON MX, RX & FX IN STOCK	CALL
OKIDATA 92	\$439
OKIDATA 93	\$729
TALLY MT160L	\$695
TALLY MT180L	\$819
TALLY 'SPIRIT' N.L.Q. @ 80 C.P.S.	\$299

TERMINALS & MONITORS

COMREX CR6600-Y, HI-RES, P-39	\$126
FREEDOM 100 TERMINAL	CALL
FREEDOM 200 TERMINAL (EMUL TELEVIDEO 950 & ADM 31)	CALL
PRINCETON GRAPHICS HX12 HI-RES RGB	\$495
QUME QVT102A	\$545
QUME QVT102G	\$529
TAXAN RGB 420 (IBM LOOK-ALIKE)	\$495
USI AMBER 12" HI-RES MONITOR (20MHz)	\$109
WYSE-50 14", 132 COL., EMUL. TVI 910, 920, 925, ADDS-VP & HAZELTINE 1500	\$625
ZENITH Z29	\$695
ZENITH ZVM-135, 13 INCH, HI-RES RGB	\$505

DISK DRIVES

S-100's DMA 5Mb REMOV. CART. W/5Mb FIXED WINCH. SUBSYSTEM	\$1,995
S-100'S SUBSYS. - DUAL DSDD 8" FLOPPY, QUANTUM 40Mb H.D., DISK 1 & 3, CP/M80 & 86	\$3,999
S-100's 5 1/4" 40Mb QUANTUM H.D. SUB- SYSTEM W/DISK 3 & CP/M80 & 86	\$2,895
MAXTOR XT-1065 5 1/4" 65Mb H.D.	\$2,249
MAXTOR XT-1105 5 1/4" 105Mb H.D.	\$2,995
MAXTOR XT-1140 5 1/4" 140Mb H.D.	\$3,749
QUANTUM Q540 5 1/4" 40Mb H.D.	\$1,895
SEAGATE ST419 5 1/4" 20Mb H.D.	\$1,195
SEAGATE ST212 5 1/4" 12Mb	\$679

ZOBEX 5 1/4" H.D. CNTRL FOR IBM-PC
SUPPORTS ST508 INTERFACE DRIVES \$319

ASK ABOUT SUBSYSTEMS FOR IBM or S-100 BUS

Tandon 100-2 5 1/4" DSDD \$199

Qume 270 DAY WARRANTY

142 DSDD 5 1/4" 1/2 HI	\$179
242 DSDD 8" 1/2 HI	\$395
842 DSDD 8" STD HI	\$455

INDUSTRIAL QUALITY CABINETS

DUAL 1/2 HI HORIZ. 5 1/4" FLYP	\$75
SINGLE STD HI HORIZ. 5 1/4" FLYP	\$69
DUAL 1/2 HI VERT. 8" FLYP	\$195
SINGLE STD. HI VERT. 8" FLYP	\$185

SOFTWARE

ACCOUNTING PEARL FOR IBM-PC	\$635
ASHTON-TATE dBASE-2 CP/M-85 8 INCH	\$449
BDS "C" COMPILER	\$99
COMP. INNOVAT. "C" COMPILER	\$299
COMPVIEW VEDIT-80	\$135
COMPVIEW VEDIT-86/MS-DOS	\$185
FOX & GELLER dUTIL	\$69
FOX & GELLER QUICKCODE	\$205
KNOWLEDGEMAN 8086 DATA BASE MGR.	\$345
MICROPRO'S PRO PAK	\$435
MICROSOFT'S BASIC COMPILER	\$292
PERSONAL PEARL DATA BASE MGR.	\$215
SORCIM SUPERCALC-3/IBM-PC	\$245
SORCIM SUPERCALC CP/M 2.2 8 INCH	\$121

DIGITAL RESEARCH

MP/M-86	\$419
"C" COMPILER/IBM-PC	\$219
DR. LOGO/IBM-PC	\$82
CBASIC COMPILER-80	\$310
PL/1-86	\$465
DR ASSEMBLER PLUS TOOLS	\$124
PASCAL MT+	\$217
DISPLAY MANAGER-80	\$249
ACCESS MANAGER-80	\$188
PC ACCOUNTING PACK /IBM-PC	\$697
SELECT (WORD PROC.) MSDOS	\$307

S-100 DIV./696 CORP.
14425 North 79th Street
Scottsdale, Arizona 85260

FULL DEALER SUPPORT
VISIT OUR SHOWROOM
Hrs. 8:30 AM-5:00 PM M-F
PACIFIC STANDARD TIME

Subject to Available Quantities
Prices Quoted Include
Cash Discounts
Shipping & Insurance Extra

HALF PRICE

Locking Diskette File

List \$49.00
~~Now \$24.50~~
NOW ONLY \$24.50



Holds up to 100 5 1/4" Diskettes

- Key Lock
- Space Age Design
- Dividers and Tabs
- Quality Guaranteed
- Free Shipping and Handling in Continental U.S.

Order Toll Free 1-(800) 821-5339 or Call 1-(801) 298-0872
or Rush Check or Money Order To: C. R. E. Wholesale
P. O. Box 361 North Salt Lake, Utah 84054

NOW YOU CAN Save Up To 50% On

RIBBONS

Ribbon Type	3	8	12
C. Itoh Prowriters.....	5.9 ^{ea}	5.9 ^{ea}	4.9 ^{ea}
Epson/IBM FX/RX/MX-80.....	5.9 ^{ea}	5.9 ^{ea}	4.9 ^{ea}
Epson/IBM FX/RX/MX-100.....	7.9 ^{ea}	6.9 ^{ea}	5.9 ^{ea}
Gemini 10/10X/15/15X.....	2.9 ^{ea}	2.9 ^{ea}	2.9 ^{ea}
Okidata 80/82/83/82/93.....	2.9 ^{ea}	2.9 ^{ea}	2.9 ^{ea}
Ship & Hand in Cont. U.S.....	3.9 ^{ea}	Free	Free
Others: Diablo, Oums, Nec, Dec, T.I. etc.....	CALL		

DISKETTES

5 1/4" Soft Sector	10	50	100
OPUS SS/DD 18"	17.9 ^{ea}	17.9 ^{ea}	16.9 ^{ea}
OPUS DS/DD 23"	21.9 ^{ea}	21.9 ^{ea}	19.9 ^{ea}
Verbatim SS/DD 22"	20.9 ^{ea}	20.9 ^{ea}	18.9 ^{ea}
Verbatim DS/DD 29"	27.9 ^{ea}	27.9 ^{ea}	25.9 ^{ea}
Maxell MD1 SS/DD 23"	22.9 ^{ea}	22.9 ^{ea}	21.9 ^{ea}
Elephant SS/SD 16"	18.9 ^{ea}	18.9 ^{ea}	17.9 ^{ea}
Elephant SS/DD 19"	19.9 ^{ea}	19.9 ^{ea}	18.9 ^{ea}
Ship & Hand in Cont. U.S.	2.9 ^{ea}	3.9 ^{ea}	4.9 ^{ea}

Order Toll Free 1-(800) 821-5339
or Call 1-(801) 298-0872
or Rush Check or Money Order To:
C. R. E. Wholesale Products
P. O. Box 361 North Salt Lake, UT. 84054

—MODEMS—

*Signalman MARK XII **\$259.95**
1200/300 Baud Auto Dial/Ans
Hayes™ Compatible

*VOSKMODEM 300 Baud **\$59.95**
Limited Offer/FREE Source Memb.

*The Computer Phone Book **\$9.95**

*The Complete Handbook of
Personal Computer Comm. **\$12.95**

—COMPUTER—

Sanyo MBC-550 **\$795**

Printers & MBC-555 Package

Order: (800) 235-6646 OP 555

Calif. (800) 235-6647 OP 555

VISA/MC ACOM Electronics

Add 3% Dept. 120

Shipping 4151 Middlefield Rd.

Add 2% Palo Alto, CA 94303

Circle 12 on inquiry card.

DISK DRIVES

(For PC, Mod I, III & IV)

Qume 142A.....	\$209
Teac FD55B.....	\$209
Tandon TM100-2.....	\$209
Tandon TM101-4.....	\$315
CDC 9409.....	\$235
Case and PS.....	\$ 45

PC EXPANSIONS

Maynard Disk Controller.....	\$159
Sandstar Series.....	\$call
Internal 10 MB HD systems from.....	\$959
Quadboard (64K).....	\$265
Quadcolor I.....	\$199
AST SixpackPlus (64K).....	\$265
MegaPlus (64K).....	\$265
I/O Plus.....	\$114
2nd SP, PP or Game.....	\$ 35
HERCULES graphics board.....	\$349
HAYES Modems.....	\$call
Set of 9 chips (64K).....	\$ 55

VLM Computer Electronics
10 Park Place • Morristown, NJ 07960
(201) 267-3268 Visa, MC, Check or COD.

WordStar with dot matrix printers

More capability than
ever before with

WS-PRINT

Italics, Bold, bolder, sub,
supers, wide, narrow, index,
multiple fonts, characters
you design, variable line
heights, logos, equations...

\$39.95 + \$5 P&H. Spec. CP/M,
Z-100 or PC-DOS with Epsoms,
ProWriter, or Ok ML92. Viso/MC

WHEATLAND DESIGN LAB

2601 Belle Crest
Lawrence, Kansas 66044

Circle 353 on inquiry card.

GREAT DISKETTES Super low prices SYNCOM

The low priced, high quality diskette with a LIFETIME WARRANTY. Packed in polybags of 10 with Tyvek envelopes, labels and reinforced hubs. One of the best buys we've seen.

\$139 ea. 5 1/4" SSDD
QTY. 20 **\$185** ea. 5 1/4" DSDD
QTY. 20

OTHER GREAT VALUES:

DISKETTE 70—Holds 70 5 1/4" diskettes in dust free safety \$14.95 ea. + \$3.00 Shpg.

DISK CADDIES—Flip up style holds 10 5 1/4" diskettes \$1.65 ea. + 20 Shpg.

\$15.00 Bonus Offer!

For the lowest priced, highest quality diskettes, storage cases, printer ribbons and paper products, send for our catalog FREE with your order: \$1.00 otherwise. BONUS! Every catalog includes \$15.00 worth of bonus coupons.

Shipping: 5 1/4" DISKETTES—Add \$3.00 per 100 or fraction thereof. OTHER ITEMS: Shipping charges as shown in addition to diskette shipping charges. Payment: VISA or MC. COD orders, add \$3.00. Taxes: Illinois customers, please add 8%.

Nationwide: 1-800-821-8827
In Illinois: 1-312-944-2788

Minimum Order: \$35.00

WE WILL BEAT ANY NATIONALLY ADVERTISED PRICE!

DISK WORLD

Suite 4806 • 30 East Huron Street • Chicago, Illinois 60611

SYNCOM

Circle 112 on inquiry card.

PRINTER CABLES

\$30.00

SHIPPING INCLUDED

INTERFACE CABLES	INTERFACE CABLES
Parallel Printer Interface Cable	RS232 Serial Interface Cable
Apple	TELEVIDEO
Centronics	
Columbia	DB 25
Epson	Male/Female
Eagle	
IBM PC	Cable Length up to 10 feet
Kaypro	
NEC	
WANG	
Zenith	

SPECIAL PRICING AVAILABLE TO DEALERS
CUSTOM CABLES AVAILABLE ON REQUEST



**FABRICATION
CONCEPTS,
INC.**

8230 Miralani Drive • San Diego, CA 92126
(619) 271-4522

Circle 136 on inquiry card.

HALF HEIGHT DRIVES



SHUGART: SA 455
Double Sided, 40 TRK/Side **\$189**

CDC: 9428
Double Sided, 40 TRK/Side **\$195**

PANASONIC: 551-2
Double Sided, 40 TRK/Side **\$179**

- 120 Day Warranty
- Free Shipping
- No Charge For Credit Cards
- Order Toll Free



1-800-531-5475 (Outside Of Texas)
(512) 250-1489 (In Texas)

Texas Residents Add 5% Sales Tax.

CompuAdd Corp.

13010 Research Blvd., Suite 101
Austin, Texas 78750

Circle 68 on inquiry card.

ICs PROMPT DELIVERY!!! SAME DAY SHIPPING (USUALLY)

DYNAMIC RAM

256K	150 ns	\$49.90
64K	200 ns	5.67
64K	150 ns	5.87
64K	120 ns	7.50
16K	200 ns	1.21

EPROM

27128	300 ns	\$22.50
2764	250 ns	9.25
2732	450 ns	5.40
2716	450 ns	3.60
2532	450 ns	4.80

STATIC RAM

5565P-15	150 ns	\$43.00
6264LP-15	150 ns	45.50
6116P-3	150 ns	6.56

MasterCard VISA or UPS CASH COD

Factory New, Prime Parts

MICROPROCESSORS UNLIMITED

24 000 South Peoria Ave

BEGG'S OK 74421 (918) 267-4961

Prices shown above are for April 13, 1984

Please call for current & volume prices. Prices subject to change. Please expect higher prices on some parts due to world wide shortages. Shipping and insurance extra. Cash discount prices shown. Great orders received by 6 PM CST. Cash usually be shipped to you by the next morning, via Federal Express Standard Air - \$5.00*

Circle 223 on inquiry card.

EXPOTEK

"WE TURN AROUND FOR YOU"

1-800-528-8960 (INCLUDING ALASKA AND HAWAII)

CUSTOMER SERVICE (602) 482-0400 • 10439 N. CAVE CREEK RD., #111 • PHOENIX, AZ 85020

All prices are for cash, cashiers check or money order. Allow 3 weeks bank clearance for personal checks. C.O.D.'s, Visa/MC, and P.O.'s accepted at additional charge. Prices subject to change. Returns must have authorization number (call 602-861-1141), and are subject to a restocking charge.

TERMINALS	FOR IBM PC		PRINTERS
Adds A-1 Green \$485 A-2 Green 490 Viewpoint 60 619 Hazeltine Espirit I 485 Espirit II 540 Qume QVT 102 Green 535 QVT 102 Amber 550 QVT 103 Green 840 QVT 103 Amber 850 Televideo 910 + 549 925 699 950 899 970 975 Wyse Wyse 100 680 Wyse 300 1020 Expirt III 735 Visual Visual 50 Green 599 Visual 55 Green 720 Zenith Z-29 635	IBM PC Call Save \$ AST Research Six Pak Plus—from \$279 Combo Plus II—from 279 Mega Plus—from 309 I/O Plus—from 139 Quadram Quadlink 489 Quadboard 289 Quad 512 Plus 249 Quadcolor 229 SOFTWARE Lotus 1-2-3 \$319	Micropro WordStar MailMerge 349 InfoStar 299 SpellStar 159 CalcStar 99 Microstuf Crosstalk 105 Microsoft Multiplan 159 Ashton Tate dBASE II 389 Friday! 185 Ram Memory 4164-150 59/9 per set	Comrex ComWriter II Letter Quality \$459 C. Itoh Pro-writer I (8510A) Par 319 Pro-writer (8510A) Serial 419 1550 Parallel 499 1550 BCD SERIAL 549 F-10 40CPS (Letter Qual.) .. 899 F-10 55CPS (Letter Qual.) . 1179 A-10 20CPS (Letter Qual.) . 449 Daisywriter Daisywriter 2000 999 Daisywriter Cable 40 Datasouth DS120 595 DS180 1155 DS220 1590 Diablo 620 (25CPS/Serial) 875 630 (40CPS/Multi-F) ... 1710 IDS Save \$ Juki 6100-18 439 Mannesman-Tally 160L 589 180L 829 NEC 3550 (For IBM PC) 1499 3510 1219 7710 1649 Qume 1140 W/IBM Interface . 1359 1155 W/IBM Interface . 1489 Riteman Portable 279 Star Micronics Gemini 10X Call Gemini 15X Call Silver Reed EXP 550P 575 Transtar 120 P 499 315 Color Printer 499 Sheet Feeders & Tractors Call
COMPUTERS Altos 580-10 3550 586-10 6598 586-14 7680 8600-12 8399 Columbia Call Eagle Call Franklin Call Quasar Call NEC Portable Call Northstar Advantage 2160 Advantage w/5MB 3345 Advantage w/15MB 4315 Televideo Systems 802H 4210 803 1815 1603 2150 806/20 4775 800 A (user station) 999 Teleport Call Zenith Call	MODEMS Anchor Mark I (RS-232) \$ 79 Mark II (Atari) 79 Mark III (TI-99) 109 Mark IV (CBM/PET) 125 Mark V (Osborne) 95 Mark VI (IBM-PC) 169 Mark VII (Auto Ans./Auto Dial) 119 Mark XII (1200 Baud) 299 TRS-80 Color Computer 99 9 Volt Power Supply 9 Hayes Smartmodem 300 219 Smartmodem 1200 509 Smartmodem 1200B 459 Micromodem II 265 Micromodem II Plus 299 Micromodem IIE 269 Micromodem 100 299 Smart Com II 89 Chronograph 199 Novation J-Cat 99 SmartCat 103 179 SmartCat 103/212 399 AutoCat 219 212 AutoCat 549 Apple Cat II 249 212 Apple Cat 569 Apple Cat 212 Upgrade 309 Cat 139 D-Cat 149 PC-Cat 339 U.S. Robotics 212A Auto Dial 469 Password 375	ACCESSORIES 3M 5 1/4" SS/DD 19 5 1/4" DS/DD 34 Verbatim 5 1/4" SS/DD \$26 5 1/4" DS/DD 36 Elephant 5 1/4" SS/SD 16 5 1/4" SS/DD 22 5 1/4" DS/DD 28 Head 5 1/4" Disk Head Cleaner (2 Disk) 14 5 1/4" Disk Head Cleaner (1 Disk) 9 Koala Pad Atan, Commodore 64 75 Apple 85 IBM 95 Kraft Joystick 41 Apple Paddles 34 IBM Paddles 34 IBM Joystick 46 TG IBM Joystick 47 Apple Joystick 47 DISK DRIVES CDC 5 1/4" 9409-DS/DD 379 Tandon 5 1/4" TM 100-1-SS/DD 160K 150 5 1/4" TM 100-2A DS/DD 320K 225 TM101-4(96 TPI Quad Den) 339 8" TMB48-2(DS/DD) 1.2 MG 400 Indus GT—Apple 239 GT—Atan 349 Micro-Sci A-2 (35TR) 225 A-40 (40TR) 269 A-70 (Quad) 329 Rana Elite I 249 Elite II 399 Elite III 509 1000 319	General Semiconductor Industries, Inc.  \$99⁹⁵ \$63⁰⁰ Transient Protection With A Solid Reputation™
MONITORS Amdek Video 300 GREEN 129 Video 300 AMBER 145 Color I Plus 275 Color II Plus 425 Comrex 9" Green 69 9" Amber 69 NEC JB 1201 155 JB 1260 115 Taxan 12" Amber 125 Zenith 12" Green Screen 95 12" Amber Screen 120	"STRONG ENOUGH TO STAND ON" LOCKING FILE CASE Can Stack, Hang on Wall, and Has Carrying Handle. SPECIAL \$18⁹⁰ 		
SPECIAL PRICES Okidata Save \$ Epson Save \$ Toshiba (1351) Save \$			

C SOFTWARE DEVELOPMENT

MSDOS

FULL C COMPILER PER K&R

- Inline 8087 or Assembler Floating Point
- Full 1MB Addressing for Code or Data
- Transcendental Functions

MSDOS 1.1/2.0 LIBRARY SUPPORT

- Program Chaining Using Exec
- Environment Available to Main

c-window™ C SOURCE CODE DEBUGGER

- Variable Display & Alteration Using C Expression

COMBINED PACKAGE—\$199

Call or write:

c-systems Fullerton, CA 92634
P.O. Box 3253 714-637-5362
TM c-systems



wabash
wabash
wabash

Value Priced Diskettes!

6 Year Warranty! Hub Rings! 100% Error-Free!

5 1/4" Diskettes Soft or Hard Sector — Boxed
SS SD \$1.39 Each*
SS DD \$1.89 Each*
DS DD \$2.29 Each*
R DD (Flippy) \$2.48 Each*

Similar savings on 8", quad density and special format diskettes.

Bulk Diskettes, with envelopes deduct 5¢ per diskette.

*Per Diskette—Quantities of 50 or more.
10% Surcharge for quantities less than 50 diskettes.

MI Residents, add 4% Sales Tax.

Shipping & Handling \$3.00/50 Diskettes.

TO ORDER: Call or Write...

Precision Data Products

P.O. Box 8332
Grand Rapids, MI 49508-0332
(616) 452-3457
Michigan 1-800-632-2468
Outside Mich. 1-800-258-0028



C.O.D.

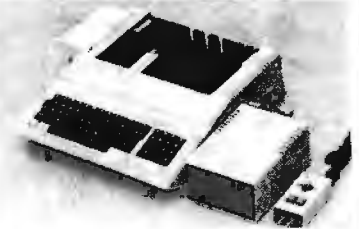

APPLE COMPATIBLE

Disk Drive \$150.00 ea.
Controller Card \$35.00 ea.
Computer Case \$55.00 ea.
Keyboard \$70.00 ea.
(Numeric and Function Keys)
Switching Power Supply . . \$49.50 ea.
Joystick (Heavy Duty) . . . \$17.50 ea.
Slim Fan \$25.00 ea.

Prices for dealers in quantities of 25 or more.
End Users Inquiries welcomed.

ELECTRADE CO. (408) 946-2541
780 Trimble Rd. Suite 605
San Jose, CA 95131

Circle 126 on inquiry card.

5 1/4" DISK DRIVES



TANDON: TM 100-2
Double Sided, 40 TRK/Side. . . . \$209

TANDON: TM 100-1
Single Sided, 40 TRK \$169

CDC: 9409
Double Sided, 40 TRK/Side. . . . \$219

- 120 Day Warranty
- Free Shipping
- No Charge For Credit Cards
- Order Toll Free



1-800-531-5475 (Outside Of Texas)
(512) 250-1489 (In Texas)
Texas Residents Add 5% Sales Tax.

CompuAdd Corp

13010 Research Blvd., Suite 101
Austin, Texas 78750

Circle 69 on inquiry card.

EPROM PROGRAMMER



ONLY
\$295.95

COMPLETE WITH
PERSONALITY
MODULE

110V AC POWER-RS232 3 WIRE
-6 BAUD RATES

ALLOWS READ, WRITE & VERIFY

Comes complete with BASIC Driver Program Listing for most small micros (for easily adapted)

Full 1 Year Warranty

Programs the following: 5 Volt 24 or 28 pin devices: 2716, 2732, 2732A, 2764, 27128, 27256, 28xx series, 68766 plus others.
Specify Personality Module desired with order.
Additional Personality Modules only \$19.95 ea.

CALL OR WRITE FOR DETAILS

APROPOS TECHNOLOGY

1071-A AVENIDA ACASO Add
CAMARILLO, CA 93010 \$4.00 Shipping
(805) 482-3604 VISA or MC Add 3%

Circle 35 on inquiry card.

MEMORY MODULES

8Kx8
CMOS
RAM

**Radio Shack Model 100
NEC PC-8201**

* Suggested List \$120.00.

Purple price **\$69.95**

- Low power CMOS design.
- Simple installation
- 30 day satisfaction guarantee or your money back.
- 1 Year warranty.
- Next day shipment via UPS included in price.
- Optional Memory Test program \$15. (Cassette)
- No frills direct connect Modem Cable - \$9.95

Shipping: From stock. Free UPS surface Cont. USA—Add \$4.00 for UPS 2 day Air—Add \$7.00 for Canada—Payment: VISA or M/C. Checks held 14 days. —Tax: 6% (Calif. only).

PURPLE COMPUTING CALL NOW
2068 Ventura Blvd.
Camarillo, Ca. 93010 (805) 987-4788

Circle 272 on inquiry card.

IBM FLEXIBLE DISCS

WE WILL NOT BE UNDER-SOLD!! Call Free (800)235-4137 for prices and information. Dealer inquiries invited and C.O.D.'s accepted.

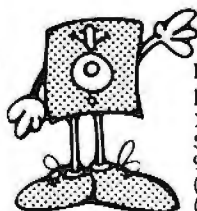

PACIFIC EXCHANGES
100 Foothill Blvd.
San Luis Obispo, CA
93401. In Cal. call
(800)592-5935 or
(805)543-1037

Circle 248 on inquiry card.

SAVE ON MEMOREX DISKETTES

\$180 ea. 5 1/4" SSDD Qty. 20 **\$235** ea. 3 1/2" DSDD Qty. 20

5 1/4" SSDD-96TPI \$2.49 ea 5 1/4" DSDD-96TPI \$3.25 ea
Boxed in 10's with Tyvec sleeves, reinforced hubs and labels.

DISKETTES FOR MACINTOSH & HP-150 AT TERRIFIC SAVINGS!

3 1/2" Memorex \$3.99 ea.

See our big ad in this issue for other great values!
Shipping: 5 1/4" or 3 1/2" DISKETTES—Add \$3.00 per 100 or fewer diskettes. Payment: VISA and Mastercard accepted. COD orders only, add \$3.00 handling charge. Taxes: Illinois residents, please add 8% sales tax.

WE WILL BEAT ANY NATIONALLY ADVERTISED PRICE ON THE SAME PRODUCTS AND QUANTITIES!

Nationwide: 1-800-621-6827

Illinois: 1-312-944-2788

Hours: 9AM - 5PM Central Time

Minimum Order: \$35.00

DISK WORLD, Inc.

Suite 4806 • 30 East Huron Street • Chicago, Illinois 60611

MEMOREX

Circle 113 on inquiry card.

PRAM PERMANENT RAM

64K CMOS STATIC RAM

256K CMOS STATIC RAM

LITHIUM BATTERY BACKUP

GUARANTEED IN YOUR SYSTEM
CROMIX-D • MPM • CCS • OASIS • AMOS

✓ PLUS: 8/16 BIT TRANSFERS • 24-BIT ADDRESSING
8-12 MHZ • 2K DESELECTS • RAM-EPROM MIX
IEEE 696S-100 • LOW POWER • FULLY STATIC

LITHIUM BATTERY BACKUP avoids power failure crashes intelligently. Unique POWER-FAIL-SENSE circuit allows processor to save register information and disable board before POWER FAILURE CRASHES memory.

80 BANK 256K \$1,499 Battery Backup \$99
80 BANK 64K \$499 Battery Backup \$99
80 COMPUTER APPLICATIONS, 208 Brookside, Bryan, Texas 77801. International orders add 30%.
(409) 775-5008

Circle 45 on inquiry card.

MEGA-BOARD™

new!

Ideal for

- **COMPUTERISTS**
- **OEM MANUFACTURERS**
- **DEVELOPMENT LABS**
- **UNIVERSITIES**
- **INDUSTRIAL APPLICATIONS**

**THE ULTIMATE OEM/PC
COMPATIBLE SINGLE
BOARD COMPUTER**

**FULL IBM - PC*
COMPATIBILITY!**

**DEALERS AND OEM MANUFACTURERS
QUANTITY DISCOUNTS AVAILABLE**

**Standard Key-
board Interface**
(Full PC compatible)

Hardware Reset
(Overcomes reset flaw
in PC)

**Eight Compatible
I/O Interface
Connectors**
(Full PC compatible)
(compatible with all
IBM-PC* plug-in cards)

Power Connector
(Full IBM* pinout
compatible)

**Special J1
Interface**
(Allows horizontal mount-
ing of compatible expan-
sion cards for easy bus
expansion and custom
configuring) (Board has
62 pin gold plated compat-
ible connector)

8088 Processor
(Same as PC)

**8087 Numeric
Processor**
(Same as PC)

**Peripheral
Support Circuits**
(Same as PC)

**Extended ROM
Capability**
(Runs all compatible PC
ROMS) (Jumper program-
mable to accommodate all
popular 8K, 16K, 32K and
64K ROM chips and NEW
EE ROMS! VPP power pin
available for EP ROM
burning!) (External
VPP voltage required)

**Configuration
Switches**
(Same as PC)

**Speaker/Audio
Port**
(Same as PC)

Board Size
10.5 inch X 13.5 inch

Wire Wrap Area
To facilitate special custom
applications!

ORDER NOW!!!

**Full Mega-Byte Ram Capacity!
On board!**

- (With parity)
- 256K Bytes using 64K chips
 - 1 Mega Bytes using 256K chips

ONLY!
\$99.95
**Evaluation
Board Kit**

MEGA-BOARD™ Evaluation Board Kit!
(Blank board with full assembly
instructions and parts list.)

Includes highest quality PC board
with gold plating, silk screen,
solder mask

- MEGA-BOARD™** with full assembly instructions \$99.95
- USERS MANUAL** with theory of operation,
schematics, block diagram, application notes \$19.95
- MEGA-BIOS™** fully compatible MS-DOS/PC-DOS BIOS \$29.95

ORDER NOW!!!

SATISFACTION GUARANTEED!
10-day money back guarantee if not completely satisfied.

DTC™ DISPLAY
TELECOMMUNICATIONS
CORPORATION

4100 SPRING VALLEY ROAD
SUITE 400
DALLAS, TX 75234
(214) 991-1644

TERMS: Shipment made 2 to 5 weeks from
receipt of order. VISA, MC, money order,
company check accepted. COD'S require
\$25 deposit. Balance UPS COD. Please
add \$2.00 shipping and handling per order.



MagiKey★

THE FULL-FEATURED KEYBOARD EXPANDER
 Redefine any key to send a string of characters. MagiKey™ does more ...

- ★ automates application software, integrates function or cursor keys
- ★ "help" menus displayed at any time
- ★ built-in batch processing more powerful than SUBMIT or XSUB
- ★ strings can redefine keys, pause for fill-the-blanks keyboard input, or contain nested key definitions
- ★ invisible to system and software
- ★ for any 8080-8085-280-CP/M 2.2, no system or software modifications

\$100
 8 SSSD, Kaypro 5 1/4" - inquire about other 5 1/4" formats check, VISA, MC add 6% tax in CA

PRO microSystems
 16609 Sagewood Lane
 Poway, California 92064
 (619) 693-1022

CP/M (tm) Digital Research

Circle 268 on inquiry card.

CONVERSE WITH YOUR COMPUTER

AT LAST! A FULL IMPLEMENTATION of the original ELIZA program is now available to run on your microcomputer!

Created at MIT in 1968, ELIZA has become the world's most celebrated artificial intelligence demonstration program. ELIZA is a non-directive psychotherapist who analyzes each statement as you type it in and then responds with her own comment or question—and her remarks are often amazingly appropriate!

Designed to run on a large mainframe, ELIZA has never before been available to personal computer users except in greatly stripped down versions lacking the sophistication which made the original program so fascinating.

Now, our new microcomputer version possessing the FULL power and range of expression of the original is being offered at the introductory price of only \$25. And if you want to find out how she does it for teach her to do more!, we will include the complete SOURCE PROGRAM for only \$20 additional.

Order your copy of ELIZA today and you'll never again wonder how to respond when you hear someone say, "Okay, let's see what this computer of yours can actually do!"

ELIZA IS AVAILABLE IN THE FOLLOWING FORMATS:

- 5 1/4 inch disk for the 48K Apple II, II Plus, IIe or III
 \$25 for Protected Version—\$45 for Applisoft Source Version
- 5 1/4 inch disk for the 64K IBM Personal Computer
 \$25 for Protected Version—\$45 for IBM Disk BASIC Source Version
- 5 1/4 inch disk or tape cassette for the Commodore 64 (specify which)
 \$25 for Protected Version—\$45 for C-64 BASIC Source Version
- Standard 8 inch single density disk for all CP/M based computers
 \$25 for ELIZA.COM—\$45 with Microsoft BASIC-80 Source
- 5 1/4 inch disk for most CP/M based computers (specify computer)
 \$25 for ELIZA.COM—\$45 with Microsoft BASIC-80 Source

Please add \$2.00 shipping and handling to all orders
 (California residents please add 6% sales tax.)

ARTIFICIAL INTELLIGENCE RESEARCH GROUP
 921 North La Jolla Avenue, Dept. B
 Los Angeles, CA 90045
 (213) 656-7388 (213) 654-2214
 MC, VISA and checks accepted

Circle 37 on inquiry card.



IBM PC/XT COMPATIBLE

Computer Case \$140.00
 Keytronic Style Keyboard \$160.00
 PC 65 Watt Power Supply \$150.00
 XT 100 Watt Power Supply \$190.00
 PC/XT Bare Board \$ 90.00
 Shugart SA465 320KB Floppy Disk \$185.00
 Shugart SA712 10MB Hard Disk \$675.00
 Shugart SA606 10MB Hard Disk \$475.00
 Hard Disk Controller \$350.00
 Floppy Disk Controller w/Serial,
 Parallel, Game Ports \$250.00
 Color Graphic Card \$210.00
 Monochrome Card \$225.00

OEM/DEALER INQUIRIES WELCOME

ELECTRADE CO. (408) 946-2541
 780 Trimble Rd., Suite 605
 San Jose, CA 95131

Circle 127 on inquiry card.

12 Bit A/D Convertor FOR YOUR APPLE™



AD1GB 16 CHANNEL \$299⁹⁵

- ★ I/O OR NMI INTERRUPT
- ★ EXTERNAL START CONVERT
- ★ HIGH SPEED - 25,000 CONV./SEC
- ★ 7 VOLTAGE RANGES
- ★ PRECISION SAMPLE & HOLD

Bolt On Signal Conditioning FITS INSIDE APPLE™

A16G \$79⁹⁵

- ★ 16 OP AMPS- EACH WITH SEPARATE GAIN & FILTERING

A8D from \$149⁹⁵

- ★ TRUE DIFFERENTIAL INPUTS
- ★ 2 to 8 CHANNELS
- ★ SEPARATE GAIN EACH CHANNEL

Hollywood Hardware (818) 989-1204
 6842 Valjean Ave. *APPLE is a registered trademark of APPLE Computers, Inc.
 Van Nuys, CA 91406

Circle 159 on inquiry card.

EASI Software, Inc.

Software tools for Architects and Consulting Engineers

Structural Analysis
 finite element w/plates, frames, & out of core solver

Concrete Steel Design
 columns, beams, & slabs

Project Scheduling (PERT Method)
 w/ cost analysis

2-D Drafting System (high performance)

Coded Pressure Vessel Design

Commercial Air Conditioning

Piping Design

EASI Software, Inc.
 2891 LIVONIA CENTER ROAD
 LIMA, NEW YORK 14485
 (716) 346-2022

Circle 121 on inquiry card.

PAL, EPROM PROGRAMMERS & UV ERASERS FROM \$49.95

LOGICAL DEVICES INC.

Where Reliability and Customer Support is of Outmost Importance

SEE OUR AD ON PAGE 26

LOGICAL

ORDER TOLL FREE 1-800-EEI-PROM
 (1-800-331-7766)

Circle 193 on inquiry card.

wabash® Flexible Diskettes

6 Year Warranty - 100% Certified DELIVERED PRICES

5 1/4" \$160 each SINGLE SIDE SINGLE DENSITY 48 FT W/ HUB RING Packed 10 per Soft Pack	BULK SSSD \$140 each 100 Case White Envelope W/HUB RING
5 1/4" \$189 each SINGLE SIDE DOUBLE DENSITY 48 FT W/ HUB RING Packed 10 per Soft Pack	BULK SSDD \$170 each 100 Case White Envelope W/HUB RING
5 1/4" \$247 each DOUBLE SIDE DOUBLE DENSITY 48 FT W/ HUB RING Packed 10 per Soft Pack	BULK DSSD \$225 each 100 Case White Envelope W/HUB RING

Free shipping in continental USA. Call for quantity discounts. We accept money orders, certified checks, VISA and MasterCard. Personal checks accepted, but take two weeks to clear bank. N.D. add 4%.

Software Services™
 1326 - 25th St. S., Suite H
 Fargo, ND 58103
1-800-634-2248

Circle 304 on inquiry card.



INDUSTRIAL CONTROL MICROCOMPUTERS

We have six single board computers, two video boards and 20 other control products. You can use our products for security systems, heat control, light control, automated slide show, traffic lights, irrigation systems, home computer systems, automated process control, and robot control just to name a few. OEM prices available. For catalog call or write to:

JOHN BELL ENGINEERING, INC.
 1014 CENTER STREET
 SAN CARLOS, CA. 94070
 (415) 592-8411

Circle 43 on inquiry card.



flexible disks

Call Free (800)235-4137 for prices and information. Dealer inquiries invited. C.O.D. and charge cards accepted.



PACIFIC EXCHANGES
 100 Foxhill Blvd
 San Luis Obispo, CA
 93401 (In Cal call (805) 543-1037)

VISA

Circle 248 on inquiry card.

**TOLL-FREE
ORDERING:
800-222-8686**

CCT[®] CUSTOM COMPUTER TECHNOLOGY

1 CRAFTSMAN COURT — BOX 4160 — SEDONA, ARIZONA 86340

**FOR TECHNICAL SUPPORT/
SERVICE / IN ARIZONA:
602-282-6299**

Purchase your Hardware and Software directly from an OEM / Systems Integrator. Take advantage of our buying power! We stock a full line of Board Level Components, Software and Peripherals. Call for your needs. We'll give you the Lowest Prices, and the Technical Support and Know-How we are quickly becoming well-known for: Satisfied Customers Nationwide. The Nation's Custom Systems House for Business, Education and Science. Call for a system quote.

• FOREMOST QUALITY • ADVANCED SUPPORT • REASONABLE COST •



LIBERAL DEALER PRICING
ON ALL CCT PRODUCTS.



THE CCT EXCLUSIVE WARRANTY

With any system we build, we provide, in writing, an unconditional 12 month **direct** warranty on the entire system, including mainframe, boards, drives, power supplies, cabling and peripherals! We offer guaranteed 24-hour in-house repair and/or replacement with just a tech-line phone call. We can offer this, since we are so sure of our level of quality and reliability. It's great to know that in the event of a problem, you're not out of business waiting on service turnaround. We deliver!

Our various OEM contracts with all the manufacturers of the components we integrate, allow us this unprecedented flexibility. No factory O.K.'s necessary — just get it running - NOW!

• 8" CP/M SOFTWARE SPECIALS •

- dBASE II - Latest Version 2.4 \$349
 - Supercalc 86 - for CP/M 86 & MP/M .. \$ 99
 - Wordstar \$299 Pro-Pak \$429
 - Microsoft BASIC .. \$299 Compiler .. \$339
 - Supersoft FORTRAN IV \$339 C Comp \$399
 - Peachtree Series 8 Modules each \$599
- ### • TOP SELLING PERIPHERALS •
- CCT-90K Parallel S-100
Amber Screen - 90K Baud \$749
 - Wyse 100-14" Green \$699
 - Wordstar Prom Option \$ 75
 - Wyse 50 \$529 75 \$609
 - 200/300 \$1069
 - Visual 50 ... \$599 Televideo 925 ... \$749
 - 950 \$950 970 \$1099
 - Liberty Freedom 100 — \$479 200 — \$679
 - Dkidata 82 — \$349 83 — \$619 84 — \$1029
 - 92 \$459 93 \$779
 - NEC 7710 \$2150 7730 \$2150
 - Diablo 620 \$969 630 \$1899

INDUSTRIAL GRADE SUPERIOR QUALITY CCT DISK DRIVE SYSTEMS ROLLS ROYCES OF THE INDUSTRY

S-100 HARD DISK SUBSYSTEMS

Professionally engineered ST-506 type systems for the business market S-100 Computer user. Includes industry top quality drives, CompuPro Disk 3 DMA controller, all cabling, A&T, formatted, burned-in. Provisions for up to two hard disks in each system. We include operating system update. CP/M 80, CP/M 86, CP/M 8-16, MP/M 8-16, CP/M 68K. Soon to be supported - MS-DOS. (/1 Systems are CCT innovated hard/floppy combinations, with Mitsubishi DSDD 8" drive.)

CCT-10 (11 + MEG)	\$2349	CCT-10/1	\$2849
CCT-20 (22 + MEG)	\$2749	CCT-20/1	\$3249
CCT-40 (36 + MEG)	\$3349	CCT-40/1	\$3849

Drive capacities shown are after formatting! We are working on tape cartridge back-up units.

FLOPPY SYSTEMS

CCT-2.4 • Dual 8" DSDD

Mitsubishi 2.4 Megabyte in Extra Heavy horizontal enclosure, removable filter air system, all cabling, A&T, Burned in. The fastest system available:

..... \$1199
with (2) half-height - CCT-2.4S
..... \$1229

Special configurations available — Call!

CCT-5 • 5 1/4" DSDD

IBM Compatible Tandon 320K. Extra Heavy Cabinet accommodates two drives, hard or floppy. All cabling, A&T, Burned-in. Perfect for our MS-DOS Package

..... \$369
with Hard Disk Power Supply
..... \$389
Two Drive Unit (720K) CCT-5/2
..... \$649

★ SUPER PRICES ★ COMPUPRO COMPONENTS ★ IN STOCK ★

- SYSTEM SPECIAL—ALL CCT A&T, BURNED IN: 816A - \$4299 816B - \$4999 816C - \$6499
- CCT-2 - \$6799 • CCT-3 - \$6699 • Disk 1 w/CP/M - \$469 • CPU 8086/87 - \$819 • M-Drive/H - \$1099
- CPU 8085/88 - \$329 • CPU 8086 - \$559/10Mhz - \$599 • CPU 68K - \$519/10Mhz - \$639
- CPU-Z - \$249 • Disk 1 - \$369 • Disk 2 - \$579 • Disk 3 - \$539 • RAM 16 (12Mhz) - \$369 • RAM 21 (128K) - \$779
- RAM 22 (256K) - \$1359 • Interfacer 3 - \$459 • Interfacer 4 - \$349 • System Support 1 - \$329
- Enclosure 2 Desk - \$599/Rack - \$649 • CP/M 80 (CCTHMX) - \$125 • CP/M 86 (CCTTMX) - \$175
- CP/M 8-16 (CCTTMX) - \$199 • MP/M 8-16 (CCTSX) - \$499 • CP/M 68K (CCTCX) - \$279

CP/M 86 Upgrade Kit: CP/M 86, RAM 16, Sys. Supt. 1, Cable - \$829

Call for CSC Boards — New Releases — CCT Mods Updates - \$30/O.S.

CCT-1 — ENTRY LEVEL S-100 BUSINESS SYSTEM

- Enclosure 2-Desk-20 Slot Mainframe •
- CPU 8085/88 - 6Mhz 8085/8Mhz 8088 •
- Disk 1 - DMA Floppy Disk Controller •
- RAM 16 - 64K Static RAM - 12Mhz •
- Interfacer 4 - 3 Serial/2 Parallel I/O •
- CCT-2.4-Dual 8" Mitsubishi DSDD Drive System - 2.4 Megabytes •
- CP/M 80 - 2.2 HMX - CCT Modified •
- All Cabling, Complete CCT Assembly, Testing, and Minimum 20 Hour Burn-in •

**SPECIAL PRICE
\$3,449**

RUNS ALL STANDARD 8" CP/M SOFTWARE - INCLUDES OUR EXCLUSIVE 12 MONTH DIRECT WARRANTY

OPERATING SYSTEM NOTE: Latest CP/M, CP/M 86, MP/M 8-16, CP/M 68K, have each been restructured and optimized by CCT, for utmost flexibility, power and speed.

MS-DOS FOR COMPUPRO - IBM COMPATIBLE CCT MODIFIED SYSTEM

For any CP/M 86 CompuPro System — Includes MS-DOS Version 2.0 and 5 1/4" DMA Disk Controller, All Manuals - \$699

Prices & availability subject to change. All products new, and carry full manufacturer's warranties. Call for catalog. Free technical help to anyone. All products we sell are CCT individually tested and set up for your system - Plug-In & Go! Arizona residents add sales tax CCT[®] Trademark — Custom Computer Technology; MS-DOS[®] Trademark — Microsoft; IBM[®] Trademark — International Business Machines; CompuPro[®] Trademark — W.J. Godbout; CP/M[®] MP/M[®] Trademarks — Digital Research



Scotch DISKETTES

Call Toll-Free
1-800-328-3472 for prices and information. Dealer inquiries invited. C.O.D. and charge cards accepted. All orders shipped from stock, within 24 hours. Call toll FREE

NEW LOWER PRICES



North Hills Corporation

3564 Rolling View Dr.
White Bear Lake, MN 55110
1-800-328-3472
MN Call Collect 1-612-770-0485

NOW INCLUDES
TINY BASIC
IBM PC DEVELOPMENT
KIT AVAILABLE

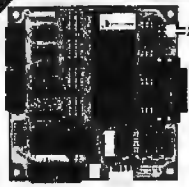

SIBEC 51

8051-Based Single-Board Computer with
Monitor/Debugger

- 4 28-pin byte-wide sockets; monitor will program EEPROMS
- Perfect for System Development and Educational Applications



\$335



Binary Technology

P.O. BOX A 59 • HANOVER NH 03755 • 603 643 2881

MEMOREX FLEXIBLE DISCS

WE WILL NOT BE UNDER-SOLD! Call Free (800)235-4137 for prices and information. Dealer inquiries invited and C.O.D.'s accepted

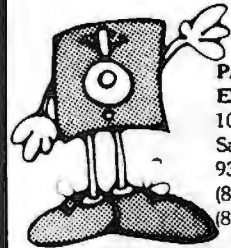

PACIFIC EXCHANGES
100 Foothill Blvd.
San Luis Obispo, CA
93401. In Cal. call
(800)592-5935 or
(805)543-1037

Circle 47 on inquiry card.

Circle 248 on inquiry card.

DATA ACQUISITION and control for ANY computer



The Model 8232 communicates via RS-232, and has 8 analog inputs (0-5 VDC; 8 bits), 8 digital inputs and outputs, and a 2000 point buffer. Suitable for field data logging or lab use, the 8232 costs only \$540. Direct bus-connect unit for TRS-80/III & 4 is \$295. Detailed manual, \$6. Phone our applications engineer or write:

★★ STARBUCK DATA COMPANY ★★

PO Box 24, Newton, MA 02162 (617) 237-7695

Circle 308 on inquiry card.

ELECTRONIC COMPONENTS

MOUSER ELECTRONICS
NEW PRODUCTS

FREE 160 PAGE CATALOG

MANUFACTURERS OF QUALITY ELECTRONIC COMPONENTS
OVER 15,000 DIFFERENT ITEMS IN STOCK!

MOUSER ELECTRONICS
11433 WOODSIDE AVE. SANTEE, CA 92071
PHONE: (619) 449-2222 TWX: 910-331-1175

Circle 230 on inquiry card.

SMAL/80

SMAL/80	Assembler
HL=M (PTR);	LHLD PTR
DE=9;	LXI D,9
HL=HL+DE;	DAD D
IF A=L EQUAL	CHP L
THEN	JNZ L1
A=A-14	SUI 14
ELSE	JMP L2
A=L;	L1:MOV A,L
M(BC)=A;	L2:STAX B

New! Z-80 version (runs on 8080's): \$175. 8080 version only: \$150. Macro-processor only: \$75. Available on CP/M disks. Add \$4 for shipping. Complete tutorial text: "Structured Microprocessor Programming" (Publ; Yourdon Press) \$20 plus \$2 shipping. Send for your free button and literature or try the Ultimate Demo: SMAL/80 is Guaranteed!

Chromod Associates,
1030 Park Ave., Hoboken, N. J. 07030
Telephone: (201) 653-7615

Circle 58 on inquiry card.

dy Jan Dysan CORPORATION

SPECIAL DISKETTE OFFER

The Dysan quality difference is yours to try with advanced production techniques that assure every diskette to be 100% error-free.

PLUS! If you call, write, or utilize reader service in response to this ad—we'll send you our full-range catalog of computer supplies with Special Offers good for further savings on Dysan diskettes and many other quality products.

LYBEN COMPUTER SYSTEMS
1250-E Rankin Dr., Troy, MI 48083
Phone: (313) 589-3440

Simply #1 in Service & Reliability

DISCOVER THE DYSAN DIFFERENCE

Circle 199 on inquiry card.

Apple II/IIe® Robotic Development Package

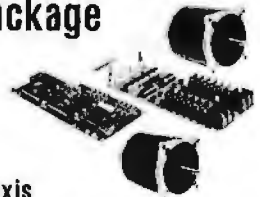

2 Axis Stepper Motor System
• A6 T/D Plug-In Interface
• R2 D23 Dual Axis Driver (35 oz. in.)
• (2) Size 23 Motors
• Positioning Command with Ramping from Applesoft® BASIC

\$420

Also Available with:
(2) Size 34 Motors (220 oz. in.) & R2 D34 Dual Axis Driver

\$684

ROGERS LABS (714) 751-0442
2710 S. Croddy Way, Santa Ana, CA 92704

Circle 287 on inquiry card.



Best Prices On TRS-80 Computers

Our 7th year of discounts
Ed or Joe McManus
Fgt. Prepaid. Save Tax.
Toll Free 800-231-3680

Marymac Industries, Inc.
22511 Katy Fwy., Katy
(Houston) Tx 77450
1-713-392-0747
Telex 774132

See us in the Wall Street Journal every Tues. and Thurs.

Circle 206 on inquiry card.

SPECIAL PRICES FOR THE SUMMER SHOPPER

We Will Beat All Competitor's Prices!

TAVA PC

- ★ 16 Bit CPU, Exp. to 256K
- ★ Two 320K Slimlines
- ★ Parallel & Serial Ports
- ★ PC Compatible

\$1779

Microtek

- ★ Dumpling GX
- ★ Grappler Compatible
- ★ Full Graphics for Apple
- ★ 2 Year Warranty

\$79

Keytronics Keyboard

- ★ For your Apple or IBM

Apple **\$249**
PC **\$199**

Quadram

- ★ Quad Board I
- ★ 64K Exp. to 384K
- ★ Parallel, Serial & Clock

\$249

IBM PC System

- ★ PC w/64K
- ★ Two 360K Drives
- ★ Hi-Res. Amber Monitor
- ★ Color Interface Card

\$2400

Taxan Monitor

- ★ Model No. 420
- ★ 640 x 262
- ★ Hi-Res. RGB

\$469

Hayes Microcomputer

- ★ Micro Modem IIE
- ★ Software

\$239

C. Itoh

- ★ 8510AP
- ★ 120 cps
- ★ Friction & Tractor Feed

\$339

Co Processor

- ★ 8087
- ★ The Arithmetic Chip

\$179

Okidata

- ★ OKI 92A
- ★ 160 cps
- ★ Correspondence Quality

\$429

Bonanza Specials

8" Disk Drives

	QUANTITY		
	1	2	10
Siemens			
FDD-100-8	\$150	\$140	\$130
FDD-200-8	300	290	280
Shugart			
801R, Sgl./Dbl.	\$360	\$350	\$340
851R, Dbl./Dbl.	470	460	450
Tandon			
TM848-1, Sgl./Dbl. 1/2 Ht.	\$350	\$340	\$330
TM848-2, Dbl./Dbl. 1/2 Ht.	400	390	380
Mitsubishi			
M2894-63, Dbl./Dbl.	\$420	\$410	\$400
M2896-63, Dbl./Dbl. 1/2 Ht.	420	410	400
Qume			
DT8, Datatrak 8	\$450	\$440	\$430

5 1/4" Disk Drives

	QUANTITY		
	1	2	10
Teac			
FD55A, 160K	\$160	\$150	\$140
FD55B, 360K	180	170	160
FD55F, Quad Density	200	190	180
All Teac's are Half Heights			
Tandon			
TM100-1, 160K	\$200	\$190	\$180
TM100-2, 360K	220	210	200
TM101-4, Quad Density	280	270	260
TM55-2, 360K 1/2 Height	220	210	200
MPI			
B-52, 360K PC Compatible	\$200	\$190	\$180
Shugart			
SA400, 160K	\$200	\$190	\$180
SA455, 360K 1/2 Height	220	210	200
SA465, Quad Den. 1/2 Height	230	220	210
Mitsubishi			
4851, 1/2 Height	\$250	\$240	\$230
4853, Quad Den. 1/2 Height	320	310	300
Control Data Corp.			
CDC 9409, 360K	\$230	\$220	\$210
CDC 9409T, Quad Density	300	250	200
Panasonic			
JA-155	\$175	\$165	\$155
Chinon			
FD55A (same as Teac 160K)	\$150	\$140	\$130

Apple Compatible Drives

	QUANTITY		
	1	2	10
Micro Sci			
A-2, 35 Track Controller	\$200	\$190	\$180
	80	70	65
Quentin Research			
Apple Mate Controller	\$195	\$185	\$175
	65	55	45
Rana Systems			
Elite I	\$240	\$235	\$225
Elite II, Dbl. Head	35	345	335
Elite III, Quad Density	455	445	435
Controller Controls 4 Drives	90	80	75
Half Height			
FD525A Fully Apple com.	\$150	\$140	\$130
5 1/4" & 8" Power Supply & Cabinets			
QUANTITY			
1 2 10			
PC Products 5 1/4"			
Single Cabinet w/ pwr	\$ 70	\$ 60	\$ 50
Dual Thinline Cab w/ pwr	80	70	60
Dual Cabinet & Power	80	70	60
All have 6 month Warranty			
PC Products 8"			
Sgl. Cabinet w/ pwr & fan	\$220	\$210	\$200
Dual w/ pwr for 2 thinlines	220	210	200
Dual w/ pwr & fan	270	260	250

Computer Components Unlimited

A California Corporation

800-847-1718

OUTSIDE CALIFORNIA

RETAIL STORE:

11976 Aviation Blvd.
Inglewood, CA 90304

MAIL ORDER:

P.O. Box 1936
Hawthorne, CA 90250

Circle 65 on inquiry card.

This Ad Supersedes All Others



(213) 643-5188



All merchandise new. We accept MC, Visa, Wire Transfer, COD Call, Certified Check, P.O. S from qualified firms, APO accepted, Shipping: Minimum \$4.50 first 5 pounds. Tax: California Res. Only add 6 1/2% sales tax.

Prices Subject to Change

**Mon. — Fri. 7 a.m. to 6 p.m.
Sat. & Sun. 10 a.m. to 5 p.m.**

COMPUTER COMPONENTS MONTH ONLY FREE SHIPPING

MONITORS

Amdek

Color I + Composite Video	\$ 289
Color II + RGB Video	419
300G, 12" Green	139
300A, 12" Amber	149
310A, Monochrome Amber	179

BMC

12 AUW, 80 column	\$ 79
12 EUN Hi-Res Green	109
9191 Color New Version	239

IBM

Monochrome Hi Res Green	\$ 319
RGB Color	699

Princeton Graphics

PGS HX12, IBM Copy	\$ 469
PGS SR-12, Hi-Res Color	649
PGS MAX-12, 12" Monochrome	199

USI

PI 1, 9" Green, Hi Res, 20MHz	\$ 100
PI 2, 12" Green, Hi Res, 20MHz	100
PI 3, 12" Amber, Hi Res, 20MHz	100
PI 4, 9" Amber, Hi Res, 20MHz	100

Zenith

ZVM122, Hi-Res Green	\$ 109
ZVM123, Hi-Res Amber	109

PRINTERS

Dynax

DX15, Letter Quality	\$ 449
DX25	729

Epson

RX-80 (120 cps)	\$ 319
RX-80FT (120 cps) Friction & Tractor	419
FX-80 (160 cps)	519
FX-100 (160 cps) 15" Carriage	729

NEC

8023A-C New Version (120 cps)	\$ 399
8025 (15" Carriage)	699

Okidata

82A (120 cps) Par & 5er inter.	\$ 299
83A (15" Carriage)	569
84P (200 cps) Friction & Tractor	999

New Series Okidata

92P (160 cps)	\$ 429
93P (15" Carriage)	739

Star Micronics

Gemini 10X (120 cps)	\$ 279
Gemini 15X (120 cps) 15" Carriage	399
Power type (18 cps) Ltr. qual.	479

COMPUTER SYSTEMS

Apple

IIE Starter System	\$1326
CPU Only	999
McIntosh	2295
Portable	1150

Compaq

Portable (PC Compatible)	\$1995
--------------------------	--------

Franklin

Ace 1000, 64K	\$ 789
Ace 1200 OM5	1589

Kaypro

Kaypro II	\$1149
Kaypro 4+	1695
Kaypro 10	2495

IBM

PC 64K, 2-Drives	\$2150
XT Hard Disk Drive, 128K	4595
PC Portable	Call

SANYO

MBC-550 PC Compatible	\$ 789
MBC-555 2-Drives, more software	1199

5 1/4" DISKETTES

CCU

Sgl/Dbl reinforced hub	\$17
100 for 150	
Dbl/Dbl reinforced hub	22
100 for 200	

Not Bulk Packed

Dysan

Sgl/Dbl	\$33
100 for 300	
Dbl/Dbl	39
100 for 370	

Maxell

MD1 Sgl/Dbl	\$25
100 for 235	
MD2 Dbl/Dbl	38
100 for 360	

Memorex

Sgl/Dbl	\$26
100 for 230	
Dbl/Dbl	35
100 for 320	

Verbatim

Sgl/Dbl	\$26
100 for 240	
Dbl/Dbl	36
100 for 340	

8" DISKETTES

Dysan

Sgl/Sgl	\$34
100 for 320	
Dbl/Dbl	53
100 for 480	

Maxell

Sgl/Dbl	\$44
100 for 380	
Dbl/Dbl	50
100 for 469	

Memorex

Sgl/Sgl	\$27
100 for 250	
Dbl/Dbl	38
100 for 350	

Verbatim

Sgl/Sgl	\$30
100 for 280	
Dbl/Dbl	40
100 for 360	

Wabash

Sgl/Sgl	\$24
100 for 220	
Dbl/Dbl	34
100 for 320	

DISK ACCESSORIES

Verbatim

8" or 5 1/4" Head Cleaning Kit	\$ 9
--------------------------------	------

Flip Tub

5 1/4" Holds 50 disks, plexiglass	17
5 1/4" Holds 70 disks, plexiglass	21

APPLE DRIVES

Apple

Disk 2	\$ 299
Disk 2 controller w/DOS 3.3	89

Micro Sci

A-2 Fully compatible	\$ 199
Controller w/diagnostics	80

Quentin Research

Applemate	\$ 189
Controller	65

Rana Systems

Elite I	\$ 240
Elite II Dbl Sided	355
Elite III Quad Density	455
Controller, controls 4	90

CCU 1/2 Height

Slimline	\$ 189
Controller	75

FOR YOUR LARGEST SINGLE COMPUTER OUTLET
and the LOWEST PRICES in this Magazine



CALL 800-847-1718



UNLIMITED IS OFFERING THIS FOR ALL ORDERS OVER \$1000!

DISK DRIVE CABINETS

5 1/4" Cabinets

Single Cab. w/ power supply	\$ 70
Dual Cab. w/ power supply	80
Dual Thinline Cab. w/ pwr. sup.	80

8" Cabinets

Single Cab. w/ fan & power supply	\$ 220
Dual Cab. w/ fan & power supply	270

**Federal Express
Shipping Available!**

5 1/4" DISK DRIVES

CDC

9409 dbi/dbi	\$ 230
--------------	--------

Panasonic

Simline 320K PC comp.	\$ 175
-----------------------	--------

Tandon

TM100-1, 160K	\$ 200
TM100-2, 320K	220
TM101-4 Quad Density	220

8" DISK DRIVES

Mitsubishi

2894 Dbi/Dbi	\$ 420
--------------	--------

Qume

DT8 Dbi/Dbi	\$ 450
-------------	--------

Shugart

801R Sgl/Dbi	\$ 360
851R Dbi/Dbi	470

Siemens

FDD 100-8 Sgl/Dbi	\$ 150
-------------------	--------

Tandon

TM848-1 Sgl/Dbi Thinline	\$ 350
TM848-2 Dbi/Dbi Thinline	400

**Fantastic
Buys!!!**

PRINTER INTERFACES

Cables

IBM to Printer	\$ 29
Kaypro to Printer	29
RS232 Cables	29

Fourth Dimension

Card & Cable	\$ 49
--------------	-------

Microtek

Dumpling GX (Grappler Compatible)	\$ 89
Dumpling GX exp to 64K	149
Dumpling GX 16K w/16K exp to 64K	169
for each additional 16K	15

Okidata Options

Tractor for 82 & 92	\$ 59
Serial Interface	99

Orange Micro

Grappler +	\$ 114
Grappler + w/16K	179

Star or Epson

Epson Serial Interface	\$ 119
Star Serial Interface	59

Wesper Micro

Wizard Full Graphics Interface	\$ 89
--------------------------------	-------

**LOOK at
our LOW
PRICES!!**

MODEMS

Anchor

Mark VII 300 Baud	\$ 119
Mark XII, 1200 Baud	279

Hayes Micro Computer

Smart Modem 300 Baud	\$ 199
Smart Modem 1200 Baud	489
Smart Modem 1200B for PC	389
Micro Modem IIE	239

Novation

J-Cat	\$ 119
Apple Cat II	259

APPLE ADD ON'S

ALS

Z Card	\$ 119
CPM 3.0 Card	269

Apple

Disk II	\$ 299
Monitor II	99

Astar

RF Modulator	\$ 15
Fan w/Surge	29

Kensington

System Saver	\$ 69
--------------	-------

Koala

Graphics Tablet	\$ 89
-----------------	-------

Kraft

Joystick	\$ 49
----------	-------

Micro Max

Viewmax 80, 80 col. card	\$ 139
Viewmax 80E (F for IIE) 64K	129

Micro Soft

16K Card	\$ 69
Premium Soft Card IIE	369
Multiplan	189
Soft Card (Z80)	239

Micro Tek

Bam 16, 16K Memory	\$ 59
Serial Interface	89

TC

Joystick	\$ 44
Select-A-Port	31
Paddles	34

IBM ADD ON'S

Ast Research

Six Pack +	\$ 274
Mega +	274

IBM

Monochrome Adapter	\$ 319
Color Card	245

Plantronics

PC + w/Software	\$ 389
-----------------	--------

Quadram

Quad Color Card	\$ 219
Quad Link	479

64K Upgrade

64K of Memory	\$ 49
---------------	-------

USI Research

Paradise Systems multi-display card	\$ 399
-------------------------------------	--------

Sales Desk

(800) 847-1718 (213) 643-5188

Outside California Inside California

Customer Service & Technical

(213) 643-5191

All merchandise new. We accept MC, Visa, Wire Transfer, COD, Call, Certified Check, P.O.'s from qualified firms, APO accepted. Shipping: Minimum \$4.50 first 5 pounds. Tax: California Res. Only add 6 1/2% sales tax.

Prices Subject to Change

**Computer
Components
Unlimited**
A California Corporation

Circle 66 on inquiry card.

RETAIL STORE:

11976 Aviation Blvd.
Inglewood, CA 90304

MAIL ORDER:

P.O. Box 1936
Hawthorne, CA 90250

Mon.—Fri. 7 a.m. to 6 p.m.

Sat. & Sun. 10 a.m. to 5 p.m.

This Ad Supersedes All Others

No Surcharge for Credit Cards

Specials of the Month

EPD Surge Protectors

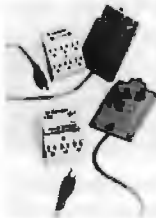

• Dealer Inquiries Welcomed •

The Lemon or EC-1 Regular \$ 59.95 Now \$ 44.95
 The Lime or EC-11 Regular \$ 89.50 Now \$ 74.50
 The Peach or EC-1V Regular \$ 97.50 Now \$ 82.50
 The Orange or EC-V Regular \$139.95 Now \$124.95
 The Ground Hog Regular \$ 89.95 Now \$ 74.50
 Static Dissipative Mat

1-(817)-284-2190

USA **UNIQUE SUPPLIES & ACCESSORIES**
 2890 GRAVEL FORT WORTH, TEXAS 76118

Circle 341 on inquiry card.

TeleVideo USERS

RETAIL

- Fast Dump/Restore CP/M, TurboDOS over 600k per disk \$90.00
- New! • Basic/Z with Graph/Z \$345.00
- TurboDOS for TeleVideo from \$300.00
- LYNC Communications Package \$195.00
- 8" Disk Drive for 802 and 800A Drive, board and software \$1200.00
- RM/COBOL Systems from \$250.00
- New! • DataFlex 2.0 from \$750.00
- New! • 803, 803H, TPC-1 and MOUSE programs:
 Draw! \$90.00
 Games Pak I \$34.95
 • 816 and 806C Tape Backup from \$175.00
- Soft Standby Power Systems:
 200VA/400VA/800VA from \$550.00
- New! • Anti-Static Products from \$39.95
- RM/COBOL trademark of Ryan-McFarland Co.
- CP/M trademark of Digital Research
- TurboDOS trademark of Software 2000
- LYNC trademark of Norton-Lambert
- DataFlex trademark of Data Access

PLUS OTHER GOOD TELEVIDEO STUFF!

COGITATE, INC.

SPECIALISTS IN UNIQUE TELEVIDEO SOFTWARE
 24000 Telegraph Road, Southfield, MI 48034
 (313) 352-2345
 VISA/MASTERCARD Accepted

Circle 60 on inquiry card.

ATTENTION OSBORNE COMPUTER OWNERS!



REPLACEMENT KEYBOARD
FOR
OSBORNE 1
AND
EXECUTIVE MODELS
IDENTICAL TO ORIGINAL KEYBOARDS

Send Check
Or
Money Order

\$79.00

Includes Shipping

Illinois Residents Add 8 1/4% Sales Tax

HASCO, INC.
 6916 Huntley Road
 Crystal Lake, Illinois 60014
 Phone (815) 459-3626

Circle 152 on inquiry card.

NEW LOW PRICES

MEDIA CONVERSION

We Put Your Data Where
YOU Want It!

Your data can be copied from and/or to any of the following: 1/2" mag tape, 8" Diskette, 5 1/4" Diskette.

- 1/2 Inch Magnetic Reel Tape:
 800 / 1600 B.P.I.
 ASCII / EBCDIC
- 8 Inch Diskette:
 CP/M, IBM 3740, DEC RT-11
- 5 1/4 Inch Diskette:
 Apple II—DOX, CP/M, Pascal
 IBM PC/XT — MS-DOS, CP/M

PLUS

Virtually ALL Soft-sectored Formats
PROFESSIONAL DATA SERVICES

385 Woodley Road

Santa Barbara, CA 93108

805/969-6993 9:00-5:30 PST

NEW FORMATS AVAILABLE

Circle 269 on inquiry card.

Serial Parallel



Convert What You Have
To What You Want!

- RS232 Serial
- 8 Baud Rates
- Latched Outputs
- Centronics Parallel
- Handshake Signals
- Compact 3x, 4x, 5x

No longer will your peripheral choices be limited by the type of port you have available! Our new High Performance 700 Series Converters provide the missing link. Based on the latest in CMOS technology, these units feature full baud rate selection to 19.2K, with handshake signals to maximize transfer efficiency. Detailed documentation allows simplified installation. Order the Model 770 (Ser/Par) or Model 775 (Par/Ser) Today!

Buffer Products Coming Soon! **igertronics** only \$89.⁹⁵
 1501-B Pine Street Post Office Box 2223
 Concord, California 92009

CALL (805) 487-1665 or 487-1666

For FAST Delivery

Circle 129 on inquiry card.

Let your fingers do
the shopping in the

"Electronic Mall"



For all of your Radio Shack
and TRS-80™ Needs
Save Time - Save Money!

GO PE-1
Now on CompuServe

Pan American Electronics

(800) 531-7466/(512) 581-2766

Telex 767339

1117 Conway Ave.

Mission, Texas 78572

Circle 249 on inquiry card.

COMPUTER SUPPLIES DISKETTES

WABASH 5 1/4" S/S S/D
MIN. ORDER 50 **\$1 54** ea

RIBBONS

DEC LA 34 CARTRIDGE
MIN. ORDER 6 **\$3 60** ea

HARDWARE

TRS 80/MODEL II 64K w/3 DRIVES **1995⁰⁰**

PeachText 5000 REG 425⁰⁰ **235⁰⁰**
 complete line of

ACCOUNTING SOFTWARE
 plus other major brands

- Terms: Visa, M.C. or C.O.D.
- Dealer Inquiries Invited

COMPU-MEDIA

SUPPLIES, INC.

159 Main St. S.I.N.Y. 10307

CALL TOLL FREE 1-800-248-2418

1st in N.Y. State 212-867-1700



Maxell Floppy Disks

The Mini-Disks
with maximum quality.



Dealer inquiries
invited. C.O.D.'s
accepted. Call
FREE (800) 235-4137.



PACIFIC EXCHANGES

100 Foothill Blvd., San Luis

San Luis Obispo, CA 93401

In Cal. call (800) 592-5935 or

(805)543-1037.

Circle 248 on inquiry card.

MAKE YOUR OWN BANNERS

Make your



APPLE II+ and IIe* USERS:

Easy-To-Use Software with Upper and Lower Case Capability DOS 3.3 and printer. II+ requires Videx** Videoterm Card for lower case capability.

ONLY \$24.95

To order phone our Order Desk at (217) 359-5888 and use your Mastercard or Visa or send check or money-order for \$24.95 (IL Residents add 6% tax) plus \$2.50 for postage and handling to:

Advanced Analytics Technology Corp.
 Business and Technology Center

701 Devonshire Dr. C-30

Champaign, Illinois 61820

*Apple is a registered trademark of Apple Computer Inc.

**Registered trademark of Videx, Inc.

Circle 393 on inquiry card.

Circle 358 on inquiry card.

U.S. MANUFACTURER
ONE YEAR WARRANTY!

10 MEGABYTE HARD DISK FOR IBM PC!

\$995⁰⁰



10 MEGABYTE HARD DISK FOR IBM PC

Plug-n-Run, ready to go • complete with controller card, data cable, and mounting hardware • totally PC/XT compatible • faster than XT • handles 4 different operating systems • streamer tape back-up available

	List	Your Price
10 mbyte internal	\$1795	\$995.00
10 mbyte external	\$2095	\$1195.00
15 mbyte internal	\$1995	\$1395.00
15 mbyte external	\$2295	\$1595.00
26 mbyte internal	\$2495	\$1995.00
26 mbyte external	\$2795	\$2249.00

Tape Back-up option CALL FOR BEST PRICE

HI-RES MONITORS

	List	Your Price
AMDEK 310A	\$230	\$169.95
AMDEK 300G	\$179	\$129.95
AMDEK 300A	\$199	\$149.95
AMDEK COLOR I	\$379	\$259.95
AMDEK COLOR II	\$559	\$419.95
AMDEK COLOR IV	\$985	\$774.95
PGS MAX-12	\$269	\$199.95
PGS HX-12	\$699	\$469.95
PGS SR-12	\$799	\$649.95
QUADCHROME	\$795	\$499.95
COMREX CR6800	\$649	\$499.95

KEYTRONICS KEYBOARDS

	List	Your Price
5150	\$269	\$189.95
5151	\$299	\$239.95

STB BOARDS FOR IBM PC

	List	Your Price
RIO PLUS 64K	\$395	\$329.95
GRAPHICS PLUS	\$495	\$379.95
RIO PLUS 128K	\$495	\$349.95
RIO PLUS 256K	\$595	\$449.95
RIO PLUS 384K	\$795	\$549.95
SUPER RIO 64K	\$419	\$329.95
SUPER RIO 128K	\$519	\$379.95
SUPER RIO 256K	\$619	\$479.95
SUPER 10	\$229	\$179.95

SOFTWARE FOR IBM PC

	List	Your Price
LOTUS 1 2 3	\$495	\$329.95
SYMPHONY	\$695	\$549.95
dBASE II	\$700	\$429.95
R:BASE 4000	\$495	\$319.95
SMART KEY	\$89	\$69.95
MOVE-IT	\$125	\$89.95
MULTIPLAN	\$250	\$169.95
ACCOUNTING PARTNER	\$395	\$249.95
CROSSTALK	\$195	\$129.95
PROKEY	\$75	\$54.95
MULTIMATE	\$495	\$299.95
SUPERCALC III	\$395	\$249.95
TRANSEND PC	\$189	\$139.95

MICROSOFT FOR IBM PC

	List	Your Price
MOUSE	\$199	\$129.95
SYSTEM CARD 64K	\$395	\$279.95
SYSTEM CARD 256K	\$625	\$429.95

320K DISK DRIVES

DOUBLE-SIDED, DOUBLE-DENSITY
FOR IBM PC

\$199⁹⁵

CHOICE OF

Tandon Tec
Teac Epson
Panasonic Shugart

DISKETTES For IBM PC

High quality double-sided, double-density diskettes, certified to be absolutely error free. Box of ten, warranted for one year

Box of 10 w/FREE plastic case - \$39 \$19.95

HIGH SPEED 8087 APU

Math co-processor chip
List Price \$295 SALE PRICE \$199.95

AST FOR IBM PC

	List	Your Price
SIX PAK PLUS 64K	\$395	\$269.95
SIX PAK PLUS 256K	\$695	\$489.95
SIX PAK PLUS 384K	\$945	\$569.95
MEGA PLUS 64K	\$395	\$269.95
MEGA PLUS 256K	\$665	\$429.95
MEGA PLUS 512K	\$1095	\$799.95
I/O PLUS	\$165	\$119.95
MP 64K	\$295	\$199.95
MP 128K	\$395	\$249.95
MP 192K	\$495	\$299.95
MP 256K	\$595	\$349.95

IBM VIDEO BOARDS

	List	Your Price
HERCULES GRAPHIC	\$499	\$339.95
PLANTRONICS COLOR+	\$549	\$379.95
STB GRAPHICS+	\$495	\$379.95
QUADCOLOR I	\$295	\$209.95
AMDEK MAI	\$649	\$495.95
AST MONOGRAPH+	\$595	\$449.95

64K RAM UPGRADE FOR IBM PC

High speed RAM upgrade kit with FREE! parity (error detection) and one year warranty

	List	Your Price
64K KIT For IBM PC	\$90	\$49.95
128K KIT For IBM PC	\$180	\$95.95
192K KIT For IBM PC	\$270	\$143.95
256K KIT For IBM PC	\$360	\$199.95
384K KIT For IBM PC	\$540	\$289.95

QUADRAM FOR IBM PC

	List	Your Price
QUADBOARD No RAM	\$295	\$214.95
QUADBOARD 64K	\$395	\$275.95
QUADBOARD 128K	\$495	\$339.95
QUADBOARD 256K	\$595	\$399.95
QUADBOARD 384K	\$795	\$595.95
QUADLINK	\$680	\$449.95
QUAD 512 PLUS 64K	\$325	\$219.95
QUAD 512 PLUS 256K	\$550	\$389.95
QUAD 512 PLUS 512K	\$895	\$549.95
QUAD COLOR I	\$295	\$209.95
QUAD COLOR II	\$275	\$199.95
AST MONOGRAPH+	\$595	\$449.95
QUAD VIEW	\$345	\$259.95

PLACE ORDERS TOLL FREE

Continental USA
(800) 421-5500

Inside California
(800) 262-1710

Los Angeles Area
(213) 973-7707

We accept cash, checks, credit cards, or purchase orders from qualified firms and institutions.
Minimum prepaid order \$15.00 California residents add 6 1/2% tax. Export customers outside the US or Canada please add 10% to all prices. Prices and availability subject to change without notice. Shipping and handling charges via UPS Ground 50¢/lb. UPS Air \$1.00/lb. minimum charge \$3.00 Prices quoted are for pre-paid orders only

APPLE ACCESSORIES ON SALE!

	List	Your Price
Full Height Disk Drive	\$299	\$189.95
Half-Height Disk Drive	\$249	\$184.95
Controller	\$100	\$59.95
8 inch 2 Meg. system	\$2495	\$1395.00
CP/M 3.0 Card	\$399	\$259.95
Z-Card with CP/M	\$169	\$139.95
16K RAM Card	\$99	\$39.95
Best 80 Column Card	\$219	\$139.95
64K Ite 80 Column	\$199	\$129.95
Fan w/surge protect	\$99	\$59.95
Koala Pad	\$125	\$89.95
Grappier Plus	\$175	\$119.95
Buffered Grappier/16K	\$245	\$175.95
Buffered Grappier/64K	\$345	\$239.95

SUPER DISKETTE SPECIAL!

We bought out a major manufacturer's overstock and we are passing the savings on to you! Single-sided, double-density package of ten with FREE! plastic case
Box of 10 w/FREE! case — \$34 **\$18.95**

SMARTMODEM Hayes

Sophisticated direct-connect auto-answer/auto dial modem, touch tone or pulse dialing. RS232C interface programmable

	List	Your Price
Smartmodem 1200	\$699	\$475.00
1200B for IBM PC	\$599	\$399.95
Smartmodem 300	\$289	\$199.00
Hayes Cronograph	\$249	\$199.95
Micromodem 100	\$399	\$299.95
Micromodem Ite	\$299	\$239.95

J-CAT MODEM

1/5 the size of ordinary modems, Bell 103, manual or, auto-answer. Automatic answer/originate, direct connect, built-in self-test, two LEDs and audio beeps provide status information

	Your Price
Novation J-Cat	\$149 \$114.95

ULTRA-VIOLET EPROM ERASERS

Inexpensive erasers for industry or home

	List	Your Price
Spectronics w/o timer	\$99	\$69.95
Spectronics with timer	\$139	\$94.95
Logical Devices	\$89	\$49.95

ISOBAR

The ISOBAR looks like a standard multi outlet power strip but contains surge suppression circuitry and built-in noise filters, plus 15amp circuit breaker

	List	Your Price
4 receptacle	\$89	\$59.95
8 receptacle	\$99	\$69.95

THE BUS PROBE

Best selling inexpensive S-100 diagnostic analyzer

	List	Your Price
Bare board	\$89	\$59.95
Kit	\$249	\$179.95
A & T	\$299	\$199.95

EXPANDORAM III

High density memory board, 64K, 128K, or 256K

	List	Your Price
64K	\$475	\$398.95
128K	\$595	\$464.95
192K	\$709	\$524.95
256K	\$825	\$589.95

64 STATIC RAM—Jade

Uses new 2K x 8 static RAMs, fully supports IEEE 696

	List	Your Price
Bare board	\$69	\$49.95
Kit less RAM	\$149	\$89.95
32K kit	\$229	\$169.95
56K kit	\$299	\$225.95
64K kit	\$399	\$265.95
Assembled & Tested	\$50 add	\$30.00

Complete Computer \$400.00!

THE LITTLE BOARD with FREE! CP/M 2.2

Miniature single board CP/M computer designed to mount directly on top of a 5 1/4" floppy disk drive (7.75" x 5.75"). Contains Z 80A CPU, 64K RAM, Boot Eprom, terminal port, modem port, parallel printer port, floppy disk controller, and CP/M 2.2 included FREE!

Little Board with CP/M	\$400	\$348.95
Support package	\$50	\$48.95
Serial Cable	\$13	\$11.95
Diskless Monitor Eprom	\$30	\$24.55

5 1/4 inch DISK DRIVES

TANDON TM 100-1 SS/DD 48 TPI	List \$349	\$225.00 ea 2 for \$195.00
SHUGART SA 400L SS/DD 48 TPI	List \$299	\$209.00 ea 2 for \$199.95
TANDON TM 100-2 DS/DD 48 TPI	List \$399	\$219.00 ea 2 for \$199.95
5 1/4" Cabinets/Power Supply		
Single cab w/power supply	\$99	\$69.95
Dual cab w/power supply	\$129	\$85.00

8 inch DISK DRIVES

SIEMENS FDD 100-8 SS/DD	List \$399	\$179.00 ea 2 for \$175.00
SHUGART SA 801R SS/DD	List \$502	\$355.00 ea 2 for \$349.00
SHUGART SA-851R DS/DD	List \$605	\$459.00 ea 2 for \$455.00
TANDON TM 848-1 SS/DD thin-line	List \$499	\$369.00 ea 2 for \$359.00
TANDON TM 848-2 DS/DD thin-line	List \$599	\$439.00 ea 2 for \$435.00
NEC FD1165 DS DD thin-line	List \$599	\$450.00 ea 2 for \$440.00

DISK SUB-SYSTEMS

Handsome metal cabinet with proportionally balanced air flow system, rugged dual drive power supply, cable kit, power switch, line cord, fuse holder, cooling fan, nevermar rubber feet. All necessary hardware to mount two 8" disk drives, power supply, and fan. Does not include signal cable

	List	Your Price
Dual 8" Sub-Assembly Cabinet		
Bare cabinet	\$75	\$49.95
Cabinet kit	\$299	\$199.95
A & T	\$349	\$249.95

8" Sub-System—Single sided, Double density		
Kit w/2 Siemens FD100-8Ds	\$950	\$579.00
A & T w/2 Siemens FD100-8Ds	\$995	\$595.00
Kit w/2 Shugart SA-801Rs	\$1195	\$939.00
A & T w/2 Shugart SA-801Rs	\$1295	\$969.00

8" Sub-Systems—Double sided, Double density		
Kit w/2 Shugart SA-851Rs	\$1495	\$1199.00
A & T w/2 Shugart SA-851Rs	\$1595	\$1219.00

DUAL SLIMLINE SUB-SYSTEMS

	List	Your Price
Dual 8" Slimline Cabinet		
Bare cabinet	\$75	\$59.95
A & T w/o drives	\$249	\$164.95

Dual 8" Slimline Sub-Systems		
Kit w/2 DS/DD drives	\$1395	\$1060.00
A & T w/2 DS/DD drives	\$1495	\$1099.00

PLACE ORDERS TOLL FREE!

Continental USA (800) 421-5500 Inside California (800) 262-1710 Los Angeles Area (213) 973-7707

SUPER PRICES ON PRINTERS!

High Performance, New Lower Price! DTC-380Z

True letter quality Daisywheel printer up to 32 CPS, with a built-in 48K buffer. The 380Z comes with RS232 serial, parallel centronics, and IEEE-488 interfaces built-in

Full one-year factory warranty!	List	Your Price
DTC-380Z	\$1495	\$999.95
Sheet feeder	\$895	\$579.95
Forms Tractor	\$195	\$129.95
Cable (specify)	\$85	\$49.95

EPSON CALL US FOR OUR BEST PRICE!

EPSON RX-80 100 CPS w/tractor, graphics
CALL FOR OUR BEST PRICE

EPSON RX-80FT 100 CPS w/FREE! graphics
Friction & tractor feed **SAVE \$150.00**

EPSON MX-80FT 80 CPS w/FREE graphics
Friction & tractor feed **SAVE \$150.00**

EPSON FX-80 160 CPS w/FREE graphics
Friction & tractor feed **SAVE \$50.00**

EPSON FX-100 160 CPS 15" platten
Friction & tractor feed **SAVE \$150.00**

OKIDATA PRICES SLASHED!!

160 CPS, true correspondence quality printing, full graphics, IBM PC compatible (optional), handles single sheet as well as fan-fold paper, professional design construction and quality

Oki 92 parallel	\$599	\$429.95
Oki 93 parallel	\$995	\$699.95
2K serial board	\$120	\$99.95
IBM PC ROMs for 92	\$59	\$49.95
IBM PC ROMs for 93	\$59	\$59.95
Extra Ribbon (2)	\$19	\$9.95
Tractor for Oki 92	\$89	\$54.95

MICROLINE 82, 83, 84

120 CPS (82, 83) 200 CPS (84), industry standard printers, serial and parallel interfaces, true lower case descenders, handles single-sheet as well as fan fold

Oki 82	\$499	Now on SALE for \$349.95
Oki 83 w/FREE tractor	\$775	\$569.95
Oki 84 parallel	\$1395	\$1095.00
Oki 84 serial	\$1495	\$1195.00
2K serial board	\$150	\$120.00
Extra Ribbons 82/92, 83/93	\$19	\$9.95
Tractor for Oki 82	\$89	\$54.95
Ribbons for 84	\$19	\$9.95
IBM PC ROMs for 82 or 83		\$39.95
IBM PC for 84		\$89.95
Commodore Interface & Cable		\$59.95

MANNESMAN-TALLY

Spirit 80 CPS 10 inch	\$399	\$329.95
160L 160 CPS 10 inch	\$798	\$579.95
180L 160 CPS 15 inch	\$1098	\$799.95

OPEN SATURDAYS
10:00am—4:00pm PST

OKIDATA PRINTER

(One hundred ninety-nine dollars and ninety-five cents)

THIS IS NOT A MISPRINT!

►80 CPS
►Friction & pin feed
►80 or 132 columns

►Block mode graphics
►Full ASCII character set
►Standard centronics parallel

We bought several truck loads of these printers at a one time special price. Hurry and place your order. We've got lots now but the demand will far exceed the limited supply. Includes full manufacturer warranty

\$199⁹⁵

LETTER QUALITY PRINTERS ON SALE!

	List	Your Price
Diablo 630 40 CPS	\$2340	\$1699.95
Tractor For 630	\$250	\$219.95
Starwriter F-10 40 CPS	\$1895	\$899.95
Starwriter F-10 55 CPS	\$1995	\$1299.95
Tractor For F-10	\$250	\$219.95
Comrex CR-II 5K parallel	\$599	\$489.95
Comrex CR-II 5K serial	\$644	\$589.95
Tractor For CR-II	\$120	\$99.95
Keyboard For CR-II	\$199	\$179.95
Sheet Feeder For CR-II	\$259	\$199.95
Silver Reed 500 14 CPS	\$599	\$499.95
Tractor For 500	\$149	\$124.95
Silver Reed 550 18 CPS	\$699	\$599.95
Tractor For 500	\$159	\$129.95
Juki 6100 18 CPS	\$599	\$499.95
Tractor For 6100	\$149	\$124.95
NEC 3550 33 CPS	\$2250	\$1699.95
Tractor For 3550	\$265	\$229.95

CLOSE OUT PRICES! ON ALL STAR-MICRONICS PRINTERS!

Gemini 10X and 15X Radix 10 and 15
Delta 10 and 15 Power Type LQ

CALL US FOR CHEAP PRICES!
(Only Manufacturer's warranty applies)

A-B PRINTER SWITCH

Allows your computer to run either of two printers. Standard parallel switch box

Printer Switch	\$149	\$99.95
Extra Cable	\$40	\$29.95

PRINTER STANDS WITH PAPER CATCH

	List	Your Price
Universal 80 Column Stand	\$30	\$24.95
Paper Tray For Abv.	\$30	\$24.95
Universal 132 Col Stand	\$35	\$29.95
Paper Tray For Abv.	\$35	\$29.95
Okidata 82/92 Stand	\$25	\$19.95
Paper Tray For Abv.	\$35	\$29.95
Okidata 83/84/92 Stand	\$35	\$29.95
Paper Tray For Abv.	\$40	\$34.95
Universal Floor Stand	\$125	\$79.95

SPECIAL SALE PRICE!

EPSON MX-100FT FREE Graftrax-Plus

With FREE! GRAFTRAX-PLUS
100 CPS, friction and tractor feed, 15 inch platten, one year warranty

List Price \$749.00 -
\$489⁹⁵

SALE PRICED AT

MICROFAZER— Quadram

The Microfazer stand-alone printer buffers are available in any configuration of serial or parallel input, with serial output. All are expandable up to 64K of memory (about 30 pages of 8½ x 11 text). The parallel-to-parallel version is expandable to 512K copy and pause feature included

Parallel/Parallel	List	Your Price
8K	\$169	\$139.95
32K	\$225	\$164.95
128K	\$445	\$269.95

Serial/Parallel	List	Your Price
8K	\$199	\$169.95
32K	\$260	\$199.95

Parallel/Serial	List	Your Price
8K	\$199	\$169.95
32K	\$260	\$199.95

Serial/Serial	List	Your Price
8K	\$199	\$169.95
32K	\$260	\$199.95

MICROBUFFER Practical Peripherals

Stand-alone Microbuffers	List	Your Price
Parallel, 32K	\$299	\$229.95
Parallel, 64K	\$349	\$269.95
Serial, 32K	\$299	\$229.95
Serial, 64K	\$349	\$269.95
64K add-on board	\$179	\$149.00

Microbuffers for Apple II	List	Your Price
Parallel, 16K	\$259	\$189.95
Parallel, 32K	\$299	\$229.95
Serial, 16K	\$259	\$189.95
Serial, 32K	\$299	\$229.95

Microbuffers for Epson Printers	List	Your Price
Parallel, 16K	\$159	\$129.95
Serial, 8K	\$159	\$129.95

JADIE

Computer Products

4901 West Rosecrans Ave. Hawthorne, California 90250

The Source For All IBM Compatible Products

**SANYO
UPGRADE
KIT**

- ★ One Teac 360K Disk Drive
- ★ Software for 360K Drive
- ★ Twice the Storage Capacity

List \$399 **\$239**

**APPRICORN
PORTS**

- ★ Parallel Card or Serial Card

List \$149 **\$89**

**IBMPC
SYSTEM
W/10 MEG**

- ★ 256K, 2-360K Disk Drives
- ★ 10 Meg Hard Disk
- ★ Interface Card & Monitor

Other Configurations Available

List \$4795 **\$3495**

**JUKI
PRINTER**

- ★ Model No. 6100
- ★ Bidirectionally 18 cps
- ★ Proportionally spacing

List \$599 **\$449**

**IDEA
MODEM**

- ★ PC Internal 1200 Baud
- ★ Hayes Compatible
- ★ Complete w/software

List \$495 **\$349**

**MAYNARD
HARD DISK**

- ★ 10 Meg Internal
- ★ Controller
- ★ Software Included

List \$1495 **\$998**

**COMPAQ
SYSTEM**

- ★ 2 Drives, 360K
- ★ 256K of Ram

List \$3495 **\$2395**

**64K
MEMORY
EXPANSION**

- ★ 1 Year Warranty
- ★ 9 to a Set

List \$89 **\$49**

**EPSON
PRINTER**

- ★ FX80
- ★ 160 cps

List \$699 **\$489**

**PC DUST
COVERS**

- ★ Covers Monitor
- ★ Keyboard & Mainframe

List \$29 **\$19**

**TEAC
DISK DRIVE**

- ★ FD55B
- ★ 360K Slimline
- ★ PC Compatible

List \$299 **\$169**

**TAVA
PC**

- ★ 16 bit cpu
- ★ 128K Ram
- ★ Two 360K Drives
- ★ Mono Monitor
- ★ Parallel & Serial Ports

List \$2495 **\$1789**

The Source!



- We Accept MC, Visa, Wire Transfers, Certified Checks
- COD's Available
- All Prices Reflect a Prepaid Discount

- Shipping Minimum 4.50
- Purchase Orders Accepted
- This Ad Supersedes all Others

Prices Subject to Change

The Source!

Circle 254 on inquiry card.



CALL TOLL-FREE (800) 841-0905 For Lowest Prices & Fast Delivery

IBM COMPATIBLE DISK DRIVES

TANDON

TM-55-2, 1/2 Height (360K) \$ 209
TM-100-2 (360K) \$ 209

TEAC

FD55A Sgl. Head (160K) \$ 149
FD55B Dbl. Head (360K) \$ 169

PANASONIC — SHUGART

SA455-Panasonic \$ 159

CDC

9409 Dbl. Head (360K) \$ 229

PRINTERS

OKIDATA

ML 82A (120 cps) \$ 319
ML 92A (160 cps) 429
ML 93A (160 cps) 15" carriage 729
82 & 92 Tractor Option 59
92 & 93 Plug & Play 49

C. ITOH

8510AP Prowriter \$ 339
F10-40 Starwriter 979
F-10-55 Printmaster 1319

JUKI

6100, 18 cps ltr. qual. \$ 449
Tractor Feed 129

MODEMS

HAYES MICRO INC.

Smart Modem 300 \$ 205
Smart Modem 1200 489
Internal 1200B 399

ANCHOR

Mark VII 300 Baud \$ 94
Mark XII 1200 Baud 269

PROMETHEUS

ProCom 1200 \$ 369

RIXON

PC212A, 1200 Baud Stand Alone .. \$ 409
P212A, 1200 IBMPC 409

U.S. ROBTICS

Password, 1200 Baud \$ 339

NOVATION

Access 123 \$ 449

MONITORS

AMDEK

300G, 12" Green \$ 129
300A, 12" Amber 139
310A, 12" Amber Monochrome .. 169
Color I + Color Composite 299
Color II + RGB w/Cable 409

PRINCETON GRAPHICS

HX12, RGB PC Copy \$ 479

DISKETTES

PIPELINE

Dbl./Dbl. Reinforced Hub 1 year
warranty \$ 19
Flip File Holds 70 (smk. plexiglass) . 16

IBM & COMPATIBLE COMPUTERS

IBM

PC w/64K, 1 Drive (128K) \$1975
PC w/64K, 2 Drives 2195
PC XT, 128K 10 Meg Disk 4495
PC Jr. 1199

COMPAQ

Compaq 128K, 1 Drive \$1895
Optional Drive 229

EAGLE

PC-2, 128K, 2-320K Drives \$2550
PC-2 + 2250

COLUMBIA

1600-1, 2-Drives (360K) \$2595
1600-4, 12MB Hard Disk 3875
MPC-XP Portable 2395

SANYO

MBC 550, 1-Drive, software \$ 789
MBC 555, 2-Drives, more software . 1099
MBC 550-2 949
MBC 555-2 1295
Optional Serial Port 99

TAYA

2-Drives, 128K, 2 Ser. 1 Par. Port, Color
Graphics Card & Hi-Res. Green
Monitor \$1895

INTERFACE CARDS FOR IBM & COMPATIBLES

AST RESEARCH

SixPac + 64K Par. & Ser. Software . \$ 269
Mega + 64K exp. to 512K Ser. Port . 269
MegaPack 256K option for Mega . . 279
I/o + Ser. & Optional Par. Game .. 149
Additional Ports 49

QUADRAM

Color I \$ 219
Color II 229
Quadlink 449
Quad Board I 239
Quad Board II 269

HERCULES

Color Graphics Card \$ 339

PLANTRONICS

Color + \$ 379

IBM

Dos 1.1 \$ 39
Dos 2.1 59
Monochrome Monitor or Adaptor . 309

FLOPPY DISK CONTROLLERS

Maynard \$ 169
Maynard w/Ser. Port 229
Maynard w/Par. Port 229
Sigma Controller 159
Vista 159

PC PRODUCTS

Rainbow Color Card \$ 369

AMDEK

MAI Card \$ 489

DUST COVER

Covers Monitor, Mainframe &
Keyboard \$ 19

MORE ACCESSORIES

Koala Graphics Tablet \$ 89
8087 Co-Processor 179
Kraft Joystick 39
Par. Printer Cable 39

The Source!

Circle 254 on inquiry card



ORDER DESK:
(213) 970-0177
(800) 841-0905
(OUTSIDE CALIFORNIA)

MAIL ORDER:
1142 Manhattan Avenue, CP21
Manhattan Beach, CA 90266

CUSTOMER SERVICE:
(213) 970-0177

Mon.-Fri. 8:00 a.m. to 6:00 p.m.
Saturday 9:00 a.m. to 1:00 p.m.

Do Kay

COMPUTER
PRODUCTS,
Inc.

ORDER TOLL FREE

(800)
538-8800

(CALIFORNIA RESIDENTS)

(800)
848-8008



TERMS: Minimum order \$10.00. For shipping and handling, include \$2.50 for UPS ground or \$3.50 for UPS Blue (air). For each additional air pound, add \$1 for UPS Blue shipping and handling. California residents must include 6% sales tax; Bay area and LA residents include 6½% sales tax. Prices are subject to change without notice. We are not responsible for typographical errors. We reserve the right to limit quantities and to substitute manufacturers. All merchandise subject to prior sale.

HOURS: Mon. - Fri. 7:30 to 5:00
Saturdays 10:00 to 3:00

VISIT OUR RETAIL STORE

2100 De La Cruz Blvd.
Santa Clara, CA 95050
(408) 988-0697

ALL MERCHANDISE IS
100% GUARANTEED

Do Kay

STATIC RAMS

2101	256 x 4 (450ns)	1.00
5101	256 x 4 (400ns) (emas)	3.90
2102-1	1024 x 1 (450ns)	.88
2102L-1	1024 x 1 (450ns) (LP)	.98
2102L-2	1024 x 1 (250ns) (LP)	1.45
2111	256 x 4 (450ns)	2.45
2112	256 x 4 (450ns)	2.95
2114	1024 x 4 (450ns)	8/7.95
2114-25	1024 x 4 (250ns)	8/8.95
2114L-1	1024 x 4 (450ns) (LP)	8/9.95
2114L-3	1024 x 4 (300ns) (LP)	8/10.95
2114L-2	1024 x 4 (200ns) (LP)	8/11.95
2147	4096 x 1 (55ns)	4.00
TMS4044-4	4096 x 1 (450ns)	3.45
TMS4044-3	4096 x 1 (300ns)	3.85
TMS4044-2	4096 x 1 (200ns)	4.45
MK4118	1024 x 8 (250ns)	9.80
TMM2016-200	2048 x 8 (200ns)	4.10
TMM2016-150	2048 x 8 (150ns)	4.60
TMM2016-100	2048 x 8 (100ns)	6.10
HM61016-4	2048 x 8 (200ns) (emas)	4.70
HM61016-3	2048 x 8 (150ns) (emas)	4.90
HM61016-2	2048 x 8 (120ns) (emas)	8.90
HM6116LP-4	2048 x 8 (250ns) (LP)	5.99
HM6116LP-3	2048 x 8 (150ns) (LP)	6.90
HM6116LP-2	2048 x 8 (120ns) (LP)	8.95
Z-6132	4096 x 8 (300ns) (Qstat)	31.95

LP = Low Power Qstat = Quasi-Static

DYNAMIC RAMS

TMS4027	4096 x 1 (250ns)	1.95
UPD411	4096 x 1 (300ns)	2.95
MM5280	4096 x 1 (300ns)	2.95
MK4108	8192 x 1 (250ns)	1.90
MM5298	8192 x 1 (250ns)	1.90
4116-250	16384 x 1 (250ns)	.48
4116-200	16384 x 1 (200ns)	.88
4116-150	16384 x 1 (150ns)	1.20
2118	16384 x 1 (150ns) (5v)	4.80
4184-250	65536 x 1 (250ns)	4.45
4184-200	65536 x 1 (200ns) (5v)	5.45
4184-150	65536 x 1 (150ns) (5v)	6.45

5V = Single 5 Volt Supply

EPROMS

1702	256 x 8 (1µs)	4.45
2708	1024 x 8 (450ns)	2.49
2732	1024 x 8 (450ns)	2.49
2758	1024 x 8 (450ns) (5v)	5.90
2718	2048 x 8 (450ns) (5v)	2.99
2716-1	2048 x 8 (350ns) (5v)	5.90
TMS2516	2048 x 8 (450ns) (5v)	5.45
TMS2716	2048 x 8 (450ns)	7.90
TMS2532	4096 x 8 (450ns) (5v)	5.90
2732	4096 x 8 (450ns) (5v)	3.95
2732-250	4096 x 8 (250ns) (5v)	8.90
2732-200	4096 x 8 (200ns) (5v)	10.95
2764	8192 x 8 (450ns) (5v)	5.95
2764-250	8192 x 8 (250ns) (5v)	13.95
2764-200	8192 x 1 (200ns) (5v)	23.95
TMS2564	8192 x 8 (450ns) (5v)	16.95
MCS86764	8192 x 8 (450ns) (5v) (24 pin)	38.95
27128	16384 x 8 Data	19.95

5v = Single 5 Volt Supply

74LS00

74LS00	.23	74LS92	.54
74LS01	.24	74LS93	.54
74LS02	.24	74LS95	.74
74LS03	.24	74LS96	.88
74LS04	.23	74LS107	.38
74LS05	.24	74LS109	.38
74LS08	.27	74LS112	.38
74LS09	.28	74LS113	.38
74LS10	.24	74LS114	.38
74LS11	.34	74LS122	.44
74LS12	.34	74LS123	.78
74LS13	.44	74LS124	2.85
74LS14	.58	74LS125	.48
74LS15	.34	74LS126	.48
74LS20	.24	74LS132	.58
74LS21	.28	74LS133	.58
74LS22	.24	74LS136	.38
74LS26	.28	74LS137	.98
74LS27	.28	74LS138	.54
74LS28	.34	74LS139	.54
74LS30	.24	74LS145	1.15
74LS32	.28	74LS147	2.45
74LS33	.54	74LS148	1.30
74LS37	.34	74LS151	.54
74LS38	.34	74LS153	.54
74LS40	.24	74LS154	1.85
74LS42	.48	74LS155	.68
74LS47	.74	74LS156	.88
74LS48	.74	74LS157	.84
74LS49	.74	74LS158	.58
74LS51	.24	74LS160	.88
74LS54	.28	74LS161	.64
74LS55	.28	74LS162	.68
74LS63	1.20	74LS163	.64
74LS73	.38	74LS164	.88
74LS74	.34	74LS165	.84
74LS75	.38	74LS166	1.90
74LS76	.38	74LS168	1.70
74LS78	.48	74LS169	1.70
74LS83	.59	74LS170	1.45
74LS85	.68	74LS173	.88
74LS86	.38	74LS174	.54
74LS90	.54	74LS175	.54
74LS91	.88	74LS181	2.10

74LS189	8.90	74LS363	1.30
74LS190	.88	74LS364	1.90
74LS191	.88	74LS365	.48
74LS192	.78	74LS366	.48
74LS193	.78	74LS367	.44
74LS194	.68	74LS368	.44
74LS195	.68	74LS373	1.35
74LS196	.78	74LS374	1.35
74LS197	.78	74LS377	1.35
74LS221	.88	74LS378	1.13
74LS240	.94	74LS379	1.30
74LS241	.98	74LS385	1.85
74LS242	.98	74LS386	.44
74LS243	.98	74LS390	1.15
74LS244	1.25	74LS393	1.15
74LS245	1.45	74LS395	1.15
74LS247	.74	74LS399	1.45
74LS248	.98	74LS424	2.90
74LS249	.98	74LS447	.36
74LS251	.58	74LS490	1.90
74LS253	.58	74LS624	3.95
74LS257	.58	74LS640	2.15
74LS258	.58	74LS645	2.15
74LS259	2.70	74LS668	1.65
74LS260	.58	74LS669	1.85
74LS266	.54	74LS670	1.45
74LS273	1.45	74LS674	9.80
74LS275	3.30	74LS682	3.15
74LS279	.48	74LS683	3.15
74LS280	1.95	74LS684	3.15
74LS283	.68	74LS685	3.15
74LS290	.88	74LS688	2.35
74LS293	.88	74LS689	3.15
74LS295	.98	74LS783	23.95
74LS298	.88	81LS95	1.45
74LS299	1.70	81LS96	1.45
74LS323	3.45	81LS97	1.45
74LS324	1.70	81LS98	1.45
74LS352	1.25	25LS2521	2.75
74LS353	1.25	25LS2569	4.20

6500 1 MHZ

6502	4.90
6504	8.80
6505	8.80
6507	9.80
6520	4.30
6522	6.80
6532	9.80
6545	21.50
6551	10.85

2 MHZ

6502A	6.90
6522A	8.90
6532A	10.85
6545A	26.95
6551A	10.85

3 MHZ

6502B	9.90
-------	------

6800

68000	58.95
6800	3.90
6802	7.90
6808	12.90
6809E	18.95
6809	10.95
6810	2.90
6820	4.30
6821	3.20
6828	13.95
6840	11.95
6843	33.95
6844	24.95
6845	13.95
6847	10.85
6850	3.20
6852	15.70
6860	8.90
6862	10.95
6875	8.90
6880	2.20
6883	21.95
68047	23.95
68488	18.95

6800

1MHZ

68B00	9.95
68B02	21.25
68B09E	28.95
68B09	28.95
68B10	6.90
68B21	6.90
68B45	18.95
68B50	5.90

APPLE ACCESSORIES

80 Column Apple II+	149.95
80 Column Apple IIE	129.95
Z80 Apple II+	89.00
Z80 Apple II+ Kit	59.00
Z80 Apple IIE	89.00
Z80 Apple IIE Kit	59.00
16K Card	39.95
16K Bare Board	13.95
Cooling Fan	38.95
Power Supply	74.95
Joystick	29.95
RF Modulator	13.95
Disk Drive	199.00
Controller Card	59.95

The Flip Sort PLUS™

The Flip Sort Plus™ adds new dimensions to storage. Designed with similar elegant lines as the original Flip Sort™, in a transparent smoked acrylic. Holds over 100 diskettes and has all the outstanding features you have come to expect from the Flip Sort Family.

\$24.95



The FLIP SORT™

The new Flip Sort™ has all the fine qualities of the original Flip Sort™, with some added benefits. Along with a new design, capacity has been increased 50% to hold 75 diskettes and the price is more reasonable than ever - **\$19.95**

Z-80

2.5 MHZ

Z80-CPU	3.90
Z80-CTC	3.95
Z80-DART	10.85
Z80-DMA	13.95
Z80-PIO	3.95
Z80-SIO/0	11.95
Z80-SIO/1	11.95
Z80-SIO/2	11.95
Z80-SIO/8	11.95

4.0 MHZ

Z80A-CPU	4.29
Z80A-CTC	4.90
Z80A-DART	9.95
Z80A-DMA	12.95
Z80A-PIO	4.29
Z80A-SIO/0	12.95
Z80A-SIO/1	12.95
Z80A-SIO/2	12.95
Z80A-SIO/8	12.95

6.0 MHZ

Z80B-CPU	9.95
Z80B-CTC	12.95
Z80B-PIO	12.95
Z80B-DART	12.95

ZILOG

Z6132	33.95
Z8671	36.95

DISC CONTROLLERS

1771	15.95
1791	23.95
1793	25.95
1785	48.95
1797	48.95
2791	53.95
2793	53.95
2795	58.95
2797	58.95
6843	33.95
8272	38.95
UPD765	38.95
MB8876	28.95
MB8877	33.95
1691	16.95
2143	17.95

UARTS

AV3-1014	6.90
AV5-1013	3.90
AV3-1015	6.90
PT1472	9.90
TR1602	3.90
2350	3.90
2651	8.90
TMS6011	5.90
IM8402	7.90
IM8403	8.90
INS8250	9.95

INTERFACE

8T26	1.54
8T28	1.84
8T95	.88
8T96	.88
8T97	.88
8T98	.88
DM8131	2.90
DP8304	2.24
OS8835	1.34
OS8836	.98

VOLTAGE REGULATORS

7805T	.74	7905T	.84
78M05C	.34	7908T	.84
7808T	.74	7912T	.84
7812T	.74	7915T	.84
7815T	.74	7924T	.84
7824T	.74	7905K	1.44
7805K	1.34	7912K	1.44
7812K	1.34	7915K	1.44
7815K	1.34	7924K	1.44
7824K	1.34	79L05	.78
78L05	.68	79L12	.78
78L12	.68	79L15	.78
78L15	.68	LM323K	4.90
78H05K	9.90	UA78S40	1.90
78H12K	9.90		

C.T. = TO-220 K = TO-3 L = TO-92

DIP SWITCHES

4 POSITION	.84
5 POSITION	.89
6 POSITION	.89
7 POSITION	.94
8 POSITION	.94

IC SOCKETS

	1-99	100
8 pin ST	.12	.10
14 pin ST	.14	.11
16 pin ST	.16	.12
18 pin ST	.19	.17
20 pin ST	.28	.26
22 pin ST	.29	.26
24 pin ST	.29	.26
28 pin ST	.39	.31
40 pin ST	.48	.38
64 pin ST	4.20	call

ST = SOLDERTAIL

8 pin WW	.58	.48
14 pin WW	.68	.51
16 pin WW	.68	.57
18 pin WW	.98	.89
20 pin WW	1.04	.97
22 pin WW	1.34	1.23
24 pin WW	1.44	1.30
28 pin WW	1.64	1.44
40 pin WW	1.94	1.75

WW = WIREWRAP

16 pin ZIF	5.90
24 pin ZIF	7.90
28 pin ZIF	8.90

ZIF = TEXTTOOL (Zero Insertion Force)

CRYSTALS

32.768khz	1.69
1.0 mhz	3.69
1.8432	3.69
2.0	2.69
2.097152	2.69
2.4576	2.69
3.2768	2.69
3.579535	2.69
4.0	2.69
5.0	2.69
5.0688	2.69
5.185	2.69
5.7143	2.69
6.0	2.69
6.144	2.69
6.5536	2.69
8.0	2.69
10.0	2.69
10.738835	2.69
14.31818	2.69
15.0	2.69
16.0	2.69
17.430	2.69
18.0	2.69
18.432	2.69
20.0	2.69
22.1184	2.69
32.0	2.69

RESISTORS

1/4 WATT 5% CARBON FILM, ALL STANDARD VALUES FROM 1 OHM TO 10 MEG OHM

50 pcs	1.25
100 pcs	2.00
1000 pcs	15.00

5 1/4" DISKETTES ATHANA

SSSD	18.95
SDDD	22.95
DSDD	27.95

BULK DISKETTES 5 1/4" DISKETTES NO LABEL

SINGLE SIDED DOUBLE DENSITY
(WITH JACKETS AND HUB RING)

Pack of Ten	\$ 16.95
Pack of 100	\$149.00

SPRING SPECIALS

4116	250ns	49¢/ea
4116	200ns	89¢/ea

2708	8K EPROMS	2.49
2716	16K EPROMS	2.95
2732	32K EPROMS	3.95
2764	64K EPROMS	5.95
27128	128K EPROMS	19.95

4164	64K DYNAMIC 250ns	4.45
4164	64K DYNAMIC 200ns	5.45
4164	64K DYNAMIC 150ns	6.45

2114	450ns	8/7.95
------	-------	--------

QUV-T8/1 EPROM Eraser

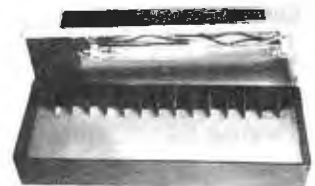

\$57.95

QUV-T8/1 Economy Model: This is a low cost EPROM Eraser housed in a plastic enclosure. The UV element and components are installed in the top lid and you place the EPROMS in the bottom half. No timer or switch option is included.

- Erases up to 8 EPROMS in 15 to 20 minutes.
- 12,000 u Watts at 1" distance.
- 90-Day Warranty

Do Kay

2100 De La Cruz Blvd.
Santa Clara, CA 95050

ADVANCED COMPUTER PRODUCTS

SEND \$2.00 for 1984 CATALOG

APPLE™ COMPATIBLE DISK CONTROLLER Only \$49.95

Apple Computer Authorized Dealer

IBM PC MULTICARD™
 "MULTICARD" multifunction card for the IBM PC & XT expandable to 256K. Thousands of this popular card have already been shipped by ACP.

- 64-256K
- Parallel Port
- Serial Port
- 1 Year Warranty
- Disk Emulator Software
- Printer Spooler Software
- Clock/Calendar
- Clock Software

\$229.00 w/64K \$229.00

S-100 64K "CMOS" RAMCARD
 Unbelievable Price!
\$299.00
 Assembled and Tested

- ACP has sold over 1000 of these IEEE compatible, low-priced, high-reliability 64K Static RAM Cards.
- Single 5-Volt operation.

SIEMEN'S SALE
 You can now purchase Shugart compatible 8" Disk Drives below your existing factory direct pricing!

These Prices are the lowest ever published
***Siemen's SSSD FDD100-8... \$169.00**

Also, with purchase of Disk Drives you can buy the Vista V-1000 Dual Case with Power Supply and Cable for only \$375.00... Regular Price \$495.00
 Offer Limited! Factory Warranty 90 Days!
 Shipped Immediately from Stock! OEM Quantities

8" Disk Drives \$169.00

DOT MATRIX PRINTER COEX 80-Ft

- 9x7 Dot Matrix, 80 CPS, Bi-Directional Printing
- 2K Buffered Memory
- 80, 96, 132 Columns, Graphics and Bold Printing
- Selectable Char Pitch, Line Spacing and Feed

\$199.00
 COEX Interface Card to Apple... \$49.95

APPLE II™ COMPATIBLE APPLE COMPATIBLE DISK DRIVES

Thin Line Drive **\$199.00**

VISTA Solo 5 1/4" Std	\$199.00
CUMANA 5 1/4" Std	219.00
RANA Elite 1	249.00
Elite 2	399.00
Elite 3	499.00
Eato Controller	82.00
SUPER 5 Alps A40 Thinline	199.00
TEAC T40 Thinline	229.00
TEAC T80 Doublesided Controller	329.00
Controller	58.00

TANDON 100-2
 PC Compatible • Double Sided
\$229.00
 Mounting Kit for IBM PC \$4.95

TOSHIBA Half-High
 PC Compatible • Double Sided
\$179.00

Apple Compatible Software BUSINESS

APPLIED SOFTWARE	Versalorm	ACP PRICE
Versalorm Hard Disk	399.00	
ARTSYS Magic Window II	149.00	
Magic Combo	149.00	
ASHTON-TATE dBASE II (CP/M)	285.00	
Friday (CP/M)	198.00	
BPI (GL, AR, AP, Pay, Inv)	ea. 299.00	
BRODERBUND Bank Street Writer	49.00	
BUSINESS SOLUTIONS The Incent Jack	149.00	
CONTINENTAL (GL, AR, AP, Pay)	ea. 189.00	
Home Accountant	49.00	
DATAMOST Real Estate Inv	99.00	
DOW JONES Market Manager	249.00	
Market Analyzer	289.00	
Market Microscope	549.00	
EAGLE Money Decisions	149.00	
FOX & GELLER Outlook	199.00	
d Utility	69.00	
d Graph	199.00	
HAYDEN Pte Writer	99.00	
Compiler Plus	79.00	
Basic Compiler	45.95	
HOWARD'S Tax Preparer	149.00	
Real Estate Analyzer	139.00	
KENSHINGTON Format II	99.00	
LIGHTNING Mastertyp	35.00	
LIVING VIDEOEXT Think Tank	135.00	
MICROPRO Wordstar	149.00	
Maintenance or Spellstar	139.00	
Wordstar Prof. 4 Pak	448.00	
Info Pak or InfoStar	Call	
MICROSOFT Multiplan	179.00	
Multifit Financial	79.00	
Multifit Budget	79.00	
MEGALUX Management	119.00	
PEACHTREE Series 40 (GL, AR, AP)	379.00	
Series 9 (Text, Spell, Mail)	399.00	
PERFECT SOFTWARE	Call	
QUARK Word Juggler (ite)	199.00	
Lexachek (ite)	99.00	
Call for Apple III		
SIERRA ON-LINE		
Screenwriter II	99.00	
Screenwriter Professional	149.00	
General Manager II	169.00	
Dictionary	79.00	
SOFTWARE PUBLISHING PFS File	89.00	
PFS:Graph or PFS:Playoff	249.00	
STATE OF THE ART	Call	
STONEWARE DB Master 4.0	249.00	
BB Utility 1 or 2	79.00	
SYSTEMS PLUS Acti Plus (GL, AR, AP)	Set 599.00	
VISICORP Visicalc 3.3	179.00	
Visicalc Enhanced	199.00	
Visible or Visidraw	179.00	
HOME & EDUCATION		
BRODERBUND Chopmaster	\$28.00	
Drot or Lodenumer	28.00	
Arcade Machine	44.00	
AppleLink	249.00	
BUDGET Plus (Budget & Saver)	24.00	
Pinball Construction Set	28.00	
COUNTERPOINT SOFTWARE		
Easy Games for Young Children	28.00	
DATAMOST Aztec	28.00	
Phy Pan or Shark Attack	23.00	
DATAMOST Zaurus	31.00	
EDU-WARE Compumath	37.00	
Algebra I, II or III	30.00	
Compuword or CompuSpell	23.00	
EINSTEIN Memory Trainer	73.00	
ELECT. ARTS Music Construction	Call	
HARCOURT Computer SAT	Call	
HAYDEN Sargent II	29.00	
INFOCOM Zork I, II or III	28.00	
Deadline	38.00	
KOALA Modules (8 available)	Call	
LEARNING COMPANY		
Juggles Rainbow	36.00	
Bumble Game	48.00	
Gertrude's Secrets	59.00	
L & S Crossword Magic	41.00	
MICROFUN Miner 2049er	Call	
MICROLAB	Call	
MICROSOFT Decatron	25.00	
Typing Tutor II	18.00	
MONDRIAN Dollars & Sense	74.95	
ORIGIN Exodis: Ultima III	41.95	
PENQUIN The Quest	18.00	
SENSIBLE Sensible Speller	99.00	
SIERRA-ON-LINE Frogger	28.00	
SIRTECH Legacy of Lygia/Myra	29.00	
Knights of Diamonds	29.00	
SOUTHEASTERN Data Capture 4.0	54.95	
MONDRIAN Dollars & Sense	20.00	
Delta Drawing	35.00	
Fraction Fever	23.00	
Kindercomp	21.00	
Fingerprint	28.00	
SUBLOGIC Flight Simulator or Pinball	26.00	
SUNDEX-No 1 Rated Home Finance	74.95	
CPA Personal Accountant	74.95	
CPA Personal Investor	74.95	
Personal Payables	42.95	
TERMINAL Logic	28.00	
TRANSEND Transend	75.00	
VIRTUAL Micro Cookbook	28.00	
UTILITIES-SYSTEM		
Apple Plot or Pronto DOS	26.00	
Beagle Basic	26.00	
DOSS Boss	17.00	
Double Take or Utility City	26.00	
CENTRAL POINT Filer	16.00	
Locky Plus	31.00	
COCKSMITH	79.00	
MICROSOFT A.L.D.S.	85.00	
Cobol 80	575.00	
Fortran 80	155.00	
PENQUIN CGS System	79.00	
PHOENIX Zoom Graphix	31.00	
SOUTHWEST Merlin	49.95	
Send for Complete Catalog of Software		

Apple Compatible Printer Interface \$49.95
 w/Apple to Epson Cable

Apple IIe Compatible 80 Column Card w/64K \$99.95

APPLE COOLING FAN
 with Surge Suppression
\$49.95

VISTA "SOLO"
 Apple II/IIe Compatible Disk Drive
 Totally compatible to Apple Drives.
Only \$199.95
 Controller \$49.95
 Just plug in and run.

Apple II 16K RAM CARD
 Compatible with Z80 Softcard™ . PASCAL CP/M™
 Full 1 year Warranty. Top Quality by COEX
NEW LOW \$49.95
 ACP PRICE
 Also from COEX, NEW EPSON Parallel Interface for Apple.
 With cable \$49.95

VISTA A800 8" Disk Controller \$299.95
 for Apple

VISTA "DISKMASTER" IBM Compatible
 3", 5", 8" and V1200 Compatible **\$169.95**

MONITORS TAXAN

MODEL	ACP PRICE
210 RGB Composite, Sound (Apple)	\$329.00
400 RGB Vision II Med res. (Apple, IBM, etc)	329.00
410 RGB Med res (Avaz) Mat	429.00
415 RGB Vision III Hi Res. (Apple w/IO, IBM)	559.00
420 RGB III Hi Res. (IBM Cabinet)	559.00
121 TTL Green 12" (IBM Cabinet)	179.00
122 TTL Amber 12" (IBM Cabinet)	189.00
100/105 Green Amber	139.00/149.00

CLEARANCE SALE
 (Quantities Limited)

QTY	LIST	ACP
120 Apple II Switching Power Supplies	\$59.95	
13 Zenith 289X Computer	2199	1749.00
26 Zenith 290-D Computer	2499	1299.00
22 Zenith 237 Disk Drive	1699	999.00
12 Zenith 287 Disk Drive	999	549.00
1 Zenith 287 Hard Disk	5995	3199.00

• All Zenith New in original boxes with 90 day Factory Warranty from nearest dealer.

QTY	LIST	ACP
4 TI 840R0 w/retro	995	578.00
4 TI 840R0 w/retro	1045	599.00
2 TI 840R0 Package Opt Intron	1265	699.00
5 TI 840R0 Package Opt Intron	1315	749.00
7 TI 850 Sonal Printer	449.00	
7 TI Professional Multiplan	350	179.00
20 TI Prof 64K exp to 192K Ramcard	149.00	
1 Fortune System 10	7995	2995.00
1 Fortune System 20	10990	3995.00
3 Fortune 256K Ramcard	1095	999.00
35 Olivetti M20 Computer	2495	995.00
200 General Terminals CTC RS232	269.00	
40 Zentac 8003-9003 Terminals	249.90	

Complete Apple Support Facility
 Complete Apple Service Center
 We service most Floppy Disk Drives

Apple IIe w/128K, 80 columns \$1195.00
 Apple IIe Starter System \$1395.00
 Includes: Apple IIe w/64K, 80 Column Card, Monitor II & Disk II w/Controller
 Disk II w/Controller 299.00
 Disk II 329.00
 Monitor II Green III 179.00
 Super Serial Card 189.00
 80 Column Text Card w/64K 189.00
 Imagegrabber w/Host Printer 549.00
 Apple Products Available In-store Only

Apple Compatible Hardware

ALS CP/M 3.0 Plus Card	LIST	ACP
COMPUTER ACCESSORIES	\$399.00	\$299.00
Power Control Center P12		99.00
COEX Ram Card		99.00
Parallel Printercard w/Cable		49.95
Apple II Prototype Card		29.00
Apple I Extender Card		29.00
64K Extended 80 Column		199.00
CORVUS Hard Disk Omninet		Call
EASTSIDE Wildcard (11" w/64)		89.00
Wildcard 2		119.00
Wildcard Plus (84K in 10 sec)		149.00
FINGERPRINT Epson Enhancer		49.00
GIBSON Light Pen		249.00
IS PKASO Interface (II/III)	199.00	139.00
PKASO Interface (III)	199.00	159.00
KENSHINGTON System Saver	89.95	69.95
PC Saver	49.95	39.95
KEYTRONICS KB200 II + Keyboard	298.00	225.00
KOALA Graphics Pad	125.00	95.00
KRAFT Joystick	65.00	49.00
Game Paddles	50.00	39.00
MCT Speed Demon	295.00	249.00
MPC 128K Bubble Memory	875.00	899.00
MAR Sup/Mod II RF Modulator	69.00	49.00
Sup/ Fan	50.00	38.00
MICROPRO 6MHz Appicard + Word	Call	
MICROSOFT Z-80 Softcard	399.00	249.00
Z-80 Softcard Plus	645.00	479.00
Softcard Premium Pak (II +)	695.00	549.00
Softcard Premium Pak (Ite)	495.00	395.00
MOUNTAIN COMPUTER		
CPS Multifunction	238.00	189.00
Music System	395.00	335.00
A/D Plus D/A	350.00	299.00
MICROTEC Dumping Bul w/64K	349.00	265.00
ORANGE MICRO		
Grappler Plus	175.00	129.00
18K Bufferboard	175.00	129.00
Grappler Buffered w/16K	245.00	199.00
PCPI Appicard w/128K, 6MHz	595.00	495.00
8088 Coprocessor	595.00	499.00
ATC w/128K, 4MHz	495.00	429.00
PERISOFT (All w/1 Year Warranty)		
PrinterKit Install. Printer I O	99.00	79.00
Messenger Univ. Serial I/O	135.00	109.00
TimeLink Realtime Clock	110.00	89.00
Griffin Graphics I/O	175.00	139.00
BufferKit w/16K Buffer	189.00	159.00
PARADISE PERIPHERALS		
Microbuffer 16K (Epson Parallel)	159.00	Call
Microbuffer 32K (Epson Parallel)	199.00	Call
Microbuffer 16K (Epson Serial)	179.00	Call
Microbuffer 32K (Epson Serial)	219.00	Call
Microbuffer In-line 64K (Parallel)	349.00	279.00
Microbuffer In-line 64K (Serial)	349.00	279.00
PROMETHEUS Versacard 4 in 1	199.00	169.00
QUADRAM Quadlink	680.00	499.00
MicroLazer 16K (Parallel)	189.00	169.00
MicroLazer 16K (Serial)	220.00	195.00
MicroLazer 32K (Parallel)	225.00	199.00
SATURA/TITAN		
32K Ramcard	219.00	199.00
64K Ramcard	349.00	289.00
128K Ramcard	495.00	399.00
Accelerator II Card	599.00	449.00
Neptune 64K + 80	189.00	
Neptune 128K + 80	299.00	
Neptune 192K + 80	389.00	
STREET Echo II (Apple)	149.00	99.00
Echo II Serial (In-line)	249.00	199.00
SYNETIX Sprite I	149.00	129.00
Sprite II	249.00	224.00
Supersprite	395.00	359.00
Flashcard 144K	449.00	389.00
Flashcard 288K	629.00	549.00
TG PRODUCTS		
Joystick	59.95	49.95
Select-a-port	59.95	49.95
TrackBall	64.95	54.95
VideoLink Toggle Ite	154.95	129.00
JODYS JOYSTICK (80)	345.00	199.00
Ultimate (132)	379.00	279.00
Enhancer II	148.00	99.00
VISTA COMPUTER		
A800 8" Disk Controller	379.00	299.00
A500 5 1/4" Disk Controller	359.00	49.95
V1200 Analyt 5 2 1/2	1549.00	1099.00
VOTRAX Type II Talk	259.00	199.00
Personal System	395.00	329.00

ROBOTS

ANDROBOT	LIST	ACP
Topo w/Speech	\$199.00	Call
Andrewgaw	159.00	Call
Topoach II, (Ite)	100.00	Call
Topoach III, (Ite)	159.00	Call
TopoTopo	Call	
F R E D. (Educational Robot)	349.00	Call
F R E D. Soft II, (Ite)	79.00	Call
REBX		
REBX Robot w/8K	1795.00	Call
16K Memory Add-in	125.00	Call
Robot Arm Option	895.00	Call
Voice Option	195.00	Call
Power Pack	94.00	Call
Robot Control Language (II, Ite)	995.00	Call
ZENTH HERO I	2495.00	Call

Apple™ Apple Trademark of Apple Computer
 IBM™ IBM Trademark of International Business Machines

OTHER DRIVES WE STOCK

TANDON 648-2 Thinline	\$479.00	SHUGART 801R	\$399.00
TEAC F055B	199.00	QUICM Datatrack 6	449.00
SEAGATE 10mb Hard Disk	699.00	QDC 1800 DS (320K)	249.00
MPI B52	239.00	SEAGATE ST506 (6MB Win.)	499.00

800-854-8230
 TOLL FREE
 Mail Order: P.O. Box 17329 Irvine, CA 92713
 Retail: 1310B E. Edinger, Santa Ana, CA 92705
 (714) 558-8813
 542 W. Trimble, San Jose, CA 95131
 (408) 946-7010

TERMS: We accept VISA, MC, AM, Discover and Personal checks. School and Government PO's. We do not charge post and handling charges. Domestic orders ship within 48 hours and are shipped in the original factory shrink wrap. We reserve the right to change prices without notice. We reserve the right to refuse orders from state manufacturers. We are not responsible for typographical errors.
 Retail Sale Prices May Vary

ADVANCED COMPUTER PRODUCTS

Serving Computer Professionals Since 1976

TOLL FREE 800-854-8230

IBM PC



★ **COLOR SPECIAL** ★
THE COLOR GRAPHICS CARD
(same designer as Colorplus Card)
 PRICE BREAKTHRU!
\$269.00 1 year Warranty **\$269.00**

MULTI CARD II™ (exp. 0K-384K) \$199.00

(INTRODUCTORY OFFER)

Advanced Computer Product's best selling multifunction card for the IBM PC & XT (plus compatibles) now has been improved with expansion capability to a full 384K and at no charge an additional game port. You also get Print Spooler and Disk Emulation Software plus a full year SWAP-OUT Warranty at no extra charge. Why pay more when you can get the same function and performance as Quadboard II™ and AST Sixpak Plus™ for substantially less money. You compare! Try it at no obligation. 10 day no questions asked return privilege.

FUNCTION	Multicard II	Quadboard II	Sixpak Plus
Memory	0 to 384K	0 to 384K	0 to 384K
Parallel Serial	Yes	Yes	Yes
Clock/Calendar	Yes	Yes	Yes
Game Port	Yes	Yes	No (\$50 list Opt.)
Software	Yes	Yes	Yes
Warranty	1 Year	1 Year	1 Year
ACP Price with 0K	199.00	229.00	229.00

EXPANSION MEMORY

- 64K Upgrade (Set of 9 64K RAMS) \$50.00
- 256K RAM's (256K x 1)..... \$79.00
- 16K RAM's (16K x 1) 10/\$9.99
- 8087 CPU (Arithmetic Processor) \$199.00

IO/XT (Serial, Parallel, Clock/Calendar) ... \$129.00

The most popular expansion card for the short slot of your IBM XT. All these functions on one card optimized to fit in one slot. 1 year warranty.

COLOR/GRAPHICS/COLOR/GRAPHICS

- Plantronics COLORPLUS™ \$429.00
- Hercules GRAPHICS CARD \$375.00
- Quadram QUADCOLOR I&II..... Call
- Scanoptik COLORGRAPHICS \$269.00
- Amdek MAI \$479.00
- Paradise MULTIDISPLAY \$489.00
- CONOGRAPHIC CARD \$895.00
- MA Sys PEACOCK \$349.00

IBM PC COMPATIBLE DISK DRIVES

1/2 High Mounting Hardware \$4.95/set Mounts (2)

- Tandon TM-100-1 Single Sided (160K) ... \$179.00
- Tandon TM-100-2 Double Sided (320K) ... 229.00
- Control Data 9409 Double Sided (320K) ... 259.00
- TEAC* 55B 1/2 high Double Sided (320K) 199.00
- Toshiba* 1/2 high Double Sided (320K)..... 179.00
- *IBM PC Mounting Hardware for 1/2 highs..... 4.95
- Vista "Diskmaster" 5 1/4" & 8" Diskcontroller 169.00

HARDWARE

- AST Sixpakplus w 0K(SPC) \$229.00
- Megapius II w 0K(SC) 229.00
- IO Plus II (CS) 115.00
- Game Serial Parallel Options 35.00
- 64K Memory Upgrade 50.00
- CHALKBOARD Call
- COEX IBM PC Extender Card 29.00
- IBM PC Prototype Card 38.00
- DAYONG Hard Disk Drives Call
- KENSINGTON PC Saver 39.00
- KEYBOARD IBM PC Compatible 149.00
- KEYTRONICS WP Keyboard KB5150 199.00
- KOALA 99.00
- KRAFT or TG Call
- IBM PC Joystick 49.00
- Game Paddles 39.00
- MICROSOFT Mouse 169.00
- M&R PC/XT Exp Chassis (6 slots) 439.00
- MOUSE SYS Mouse for PC 239.00
- PERSYST Time Spectrum w 64K 289.00
- PTI Back-up Power 200 400W Call
- QUADRAM Quadboard II w 0K 229.00
- Quadlink (Apple Prog) 499.00
- Quadisk (up to 72Mb) Call
- Microzisk MP64 w 64K 199.00
- VISTA TurboBoard w 0K Call
- Magicard w 64K (up to 576K) 229.00
- PC Master (10 I/O) 329.00
- Diskmaster (Floppy Cont.) 169.00
- Dynafirm Hard Disk Call
- PC Clock I/O 129.00

SOFTWARE

- dBASE II/Friday \$389.00/\$179.00
- Condor \$389.00
- SuperCalc I/II/III \$79.00/\$159.00/\$249.00
- Multiplan Vers. 1.1 \$179.00
- Microsoft Mouse/Word \$369.00

PRINTERS/MONITORS

- BROTHER HR-25 (23cps daisy) Call
- HR-1A (16cps daisy) Call
- COEX 80FT (80cps) Sale \$199.00
- DYNAX DX-15 (daisy, 2-color) 529.00
- DAISYWRITER 2000 (17cps) 1049.00
- EPSON RX-80 (100cps) 299.00
- FX-90 FX100 Call
- NEC Spewriter 3550 1875.00
- OKIDATA Model 82 83 399.00/619.00
- Model 84P 84S 919.00/989.00
- Model 92P-82S 495.00/595.00
- Model 93P-93S 769.00/899.00
- SILVER REED EXP550 (17cps) 649.00
- STAR Gemini 10X (120cps) 309.00
- Gemini 15X (120cps) 429.00
- Delta 10 15 (160cps) Call
- TTX Model 1014 (12cps) 529.00
- TRANSTAR 130P (18cps daisy) 699.00
- 315 Color Printing 519.00
- AMDEK Video 3000 A 145.00/155.00
- Video 318A amber (IBM) 163.00
- Color I (composite) 299.00
- Color I Plus (earphin nonglare) 329.00
- Color II RGB (IBM) analog 449.00
- Color II Plus 479.00
- Color III RGB (IBM) 399.00
- Color IV RGB (IBM) analog 779.00
- BMC 12" Green-Low cost 89.00
- PGS HX-12 RGB (IBM) 499.00
- ZENITH ZVM-121 12" green 99.00
- ZVM-134 12" RGB color 399.00

DISKETTES

- DYSAN 5 1/4" SS DD 10 \$55 \$38
- DYSAN 5 1/4" DS DD 10 65 46
- IBM 5 1/4" SS DD 10 60 43
- IBM 5 1/4" DS DD 10 65 47
- VERBATIM 525-01 SS DD 10 45 23
- VERBATIM 550-01 DS DD 10 55 34
- MAXELL M01 SS DD 10 50 29
- MAXELL M02 DS DD 10 60 39
- Flop Storage Box 5 1/4" (80 disks) 19
- BULK SPECIAL SS 10 25 19
- With Sleeve and Box 100 195 149

IBM ACCESSORIES

- COMPUABLE \$16.00
- Keyboard/dive dust covers 9.00
- Computer keyboard vinyl cover 6.00
- CURTIS PC Pedestal 66.00
- PGS Adapter 11.00
- Vertical PC Stand 20.00
- Mono Extension Cable 45.00
- Keyboard Ext Cable (3-9') 35.00
- EDP PROTECTION DEVICES 43.00 68.00
- The Orange Line 122.00 78.00
- GLTRONIX SWITCH BOXES 90.00
- 2 Way 8 Lines 179.00
- 4 Way 8 Lines 199.00
- 2 Way Centronics 199.00
- RIBBONS Each Dozen
- Epson MX-80 5.75 59.00
- Epson MX-100 10.95 128.00
- Star Gemini 10 15 2.50 26.00
- Okidata 80 82 83 3.95 44.00
- Okidata 84 92 93 4.95 55.00
- NEC 3550 11.95 135.00

MODEMS

- BIZCDMP Model 2120 (Internal) Call
- HAYES Smartmodem 1200 \$475.00
- Smartmodem 1200B 445.00
- (w Smartmodem II) 199.00
- Smartmodem 300 99.00
- Smartmodem IBM Cable 25.00
- NOVATION Access 1-2-3 Call

TERMS: We accept VISA, MC, MD, Cashiers and Personal checks. School and Company P.O.'s. We do not charge your card until we ship. Personal checks require drivers license and credit card. *No Surcharge Added on VISA or MC CDO's over \$500 require 20% deposit with order. Add 3% shipping and handling for UPS. We offer same-day shipment. Prices subject to change without notice. We reserve the right to substitute manufacturer. We are not responsible for typographical errors. Retail Sale Prices May Vary. IBM™ trademark of International Business Machines. Quadboard II™ trademark of Quadram Corp. Super Plus™ trademark of AST Research, Inc.

MAIL ORDER: P.O. Box 17329 Irvine, CA 92713
 Retail: 1310 E. Edinger, Santa Ana, CA 92705 (714) 558-8813
 542 W. Trimble, San Jose, CA 95131 (408) 946-7010

TOLL FREE

800-854-8230

TWX 910-595-1565

WE STOCK CABLES • RIBBONS • DISKETTES • SPARE PARTS

1984 CATALOG AVAILABLE SOON • 64K UPGRADE KITS - ONLY \$50.00

64K UPGRADE - ONLY \$50.00 • CUSTOM CABLES AVAILABLE

LOWER PRICES-BETTER SERVICE

WYSE 50



Emulates TeleVideo 910/920/925, ADDS Viewpoint, and Hazeltine 1500.

- 14" Green Screen
- 132/80 Column Display
- 16 Function Keys (Sh. wt. 34 lbs.)

BFWY550
List Price:
\$695.00

OUR PRICE **\$569**



Dual QUME 8" Floppy Drive Subsystem With S-100 DMA Controller and CP/M 816™ !!!



2.4 Mbytes of On-Line Storage!

SALE PRICE **\$1495**

SAVE OVER \$1500 !!
BFSPP02 (Shipping weight 55 lbs.)



Auto Dial/
Answer
1200
Baud
Modem

PASSWORD

BFUSRASSWORD List Price: \$449.00

SALE PRICE **\$295**

(Sh. wt. 3 lbs.)

Buy From The World's Largest Supplier of S-100 Boards!

CompuPro CPU BOARDS

Part Number	Description	List Price	OUR PRICE
BFB8T51068	CPU 68K A&T 8MHz	\$ 695.00	\$ 488.95
BFB8T51568	CPU 68K CSC 10MHz	\$ 850.00	\$ 785.00
BFB8T51068	Co-Processor w/8086 only A&T	\$ 750.00	\$ 484.95
BFB8T51586	Co-Processor w/8086 only CSC	\$ 850.00	\$ 888.95
BFB8T51067	CPU 8086/8087 A&T	\$1050.00	\$ 938.00
BFB8T51567	CPU 8086/8087 CSC	\$1150.00	\$1085.00
BFB8T51080	CPU 8085/88 A&T	\$ 495.00	\$ 348.95
BFB8T51580	CPU 8085/88 CSC	\$ 595.00	\$ 497.87
BFB8T51080	3/6MHz CPU-Z A&T	\$ 325.00	\$ 226.95
BFB8T51580	3/6MHz CPU-Z CSC	\$ 425.00	\$ 347.87

DISK CONTROLLER BOARDS

BFPBB171ACPM	DISK 1 (A&T) w/CP/M® 2.2 <i>When purchased with two 8" disk drives: \$450.00</i>	\$670.00	\$488.00
BFB8T54018	DISK 1 Floppy controller (A&T)	\$495.00	\$425.00
BFB8T41000	CP/M® 2.2 for Z80/8085 w/manuals & BIOS, 8" S/D Disk		\$148.95
BFB8T41050	CP/M-86® for CPU 8085/88 & CPU 8086/87 CPUs w/manuals, BIOS 8" S/D Disk		\$249.00
BFB8T54025	DISK 2 8" hard disk controller w/CP/M® 2.2 (A&T)	\$795.00	\$558.95
BFB8T54030	DISK 3 ST-506 type 5 1/4" hard disk controller w/CP/M-80® & CP/M-86® (A&T)	\$795.00	\$558.95

I/O BOARDS

BFB8T56018	System Support 1 Multifunction I/O (A&T)	\$450.00	\$318.95
BFB8T56018/56531	SS1 w/8231 Math Chip A&T	\$645.00	\$570.00
BFB8T56018/56320	SS1 w/8232 Math Chip A&T	\$645.00	\$570.00
BFB8T53030	Interfacer 3 - 8 port serial (A&T)	\$699.00	\$488.95
BFB8T53040	Interfacer 4 - 3 Serial, 1 Centronics Parallel, 1 Parallel (A&T)	\$450.00	\$318.95

8/16 BIT MEMORY BOARDS

BFB8T52018	RAM 16 12MHz 32K Static A&T	\$ 550.00	\$ 458.95
BFB8T52021	RAM 21 12 MHz 128K Static A&T	\$ 995.00	\$ 895.00
BFB8T52022	RAM 22 12MHz 256K Static A&T	\$1750.00	\$1228.95
BFB8T52012	M-Drive/H 512K RAM Disk A&T	\$1475.00	\$ 884.25



Manufactured by Vector Electronic Co.
under license from CompuPro

BFB8T5800BFB	Interfacer 1, 2-Serial (A&T)	\$295.00	\$219.00
BFB8T5800BFBZB	Interfacer 2, 3-Par., 1-Ser. (A&T)	\$325.00	\$239.00
BFB8T5800BR17B	RAM 17 64K 10MHz Static RAM (A&T)	\$450.00	\$389.00

CompuPro is a registered trademark of CompuPro

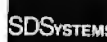

IEEE/696 S-100 PRODUCTS

BFS0S38005	SBD-300 4MHz Z80A CPU A&T	\$ 741.00	\$ 819.00
BFS0S38002	SBD-300 6MHz Z80B CPU A&T	\$ 825.00	\$ 889.00
BFS0S38007	Z80 Starter System A&T (Not IEEE/696)	\$ 450.00	\$ 399.00
BFS0S38008	ExpandoRAM IV 256K A&T	\$1145.00	\$ 975.00
BFS0S38009	ExpandoRAM IV 256K w/EDC A&T	\$1990.00	\$1075.00
BFS0S38007	ExpandoRAM III/696 256K	\$ 825.00	\$ 749.00
BFS0S38070	PROM-100 w/software A&T	\$ 285.00	\$ 219.00
BFS0S38082	RAM Disk 256K A&T	\$ 875.00	\$ 775.00
BFS0S38081	ROM Disc 128K A&T	\$ 350.00	\$ 319.00
BFS0S38086	I/O-8 4-Port Async Ser. A&T	\$ 600.00	\$ 549.00
BFS0S38093	I/O-8 8-Port Async Ser. A&T	\$ 695.00	\$ 589.00
BFS0S38094	I/O-8 4 Sync, 4 Async, Serial I/O A&T	\$ 795.00	\$ 699.00
BFS0S38099	Versafloppy III	\$ 895.00	\$ 759.00
BFPDBVF339145*	w/5 1/4" unbanked CP/M® 3.0	\$1083.00	\$ 888.00
BFPDBVF339146*	w/8" unbanked CP/M® 3.0	\$1083.00	\$ 888.00
BFPDBVF339147*	w/5 1/4" banked CP/M® 3.0	\$1083.00	\$ 888.00
BFPDBVF339148*	w/8" banked CP/M® 3.0	\$1083.00	\$ 888.00
BFS0S38098	Versafloppy II/696 (A&T)	\$ 400.00	\$ 344.00
BFPDBVF239141*	w/5 1/4" unbanked CP/M® 3.0	\$ 588.00	\$ 424.00
BFPDBVF239142*	w/8" unbanked CP/M® 3.0	\$ 588.00	\$ 424.00
BFPDBVF239143*	w/5 1/4" banked CP/M® 3.0	\$ 588.00	\$ 424.00
BFPDBVF239144*	w/8" banked CP/M® 3.0	\$ 588.00	\$ 424.00

*CP/M-Plus™ (3.0) configured for the SBC-300



Z80 SINGLE BOARD COMPUTERS

BFBDCSUP6128	Super Six 6MHz 128K Master w/1 ADC PS1 RS232 Serial Adapter	\$995.00	\$849.00
BFBDCSPRSLV6128	Super Slave 6MHz 128K	\$695.00	\$595.00
BFBDCSBC15	Super Quad for 5 1/4" drives	\$750.00	\$695.00
BFBDCSBC18	Super Quad for 8" drives	\$750.00	\$695.00

Software & I/O Port Adapters For Above CPUs

BFBDCP81	PS/Net1 RS232 Serial Adapter		\$ 35.00
BFBDCP8P	Centronics Parallel Port Adapter		\$ 35.00
BFBDCCPM22*†	Advanced Digital CP/M® 2.2		\$150.00
BFBDCCPM30*†	Advanced Digital CP/M Plus™ (3.0)		\$350.00
BFBDCDOS4U*†	TurboDos® 1, 2, or 4 Multi-user		\$550.00

*Replace * with 0 to specify Super Quad, 3 for Super Six
† Replace † with 8 for 8" IBM® 3740 format, 48 for 5 1/4" 48 TPI format or 96 for 5 1/4" 96 TPI format

HARD DISK CONTROLLER

BFBDCMDC10015	ST506 5 1/4" Winchester Cont.	\$500.00	\$395.00
BFBDCMDC10018	8" Winchester Cont.	\$500.00	\$385.00
BFBDCMDCINSTL	Install program for use with non-ADC CPU board (Supplied on 8" CP/M® compatible disk)		\$ 10.00

Circle 267 on inquiry card.

PRINTERS



\$289

Part Number	Description	List Price	Our Price
BFSTRBEM10X	120 cps, 80 col. (20 lbs.)	\$399.00	\$289.00
BFSTRBEM15X	120 cps, 132 col. (26 lbs.)	\$649.00	\$399.00
BFSTRBERINTX	Serial Interface for 10X and 15X		\$ 59.00
BFSTRBERINTXAK	Same as above with 4K Buffer		\$119.00
BFSTRDELTA10	160 cps, 80 col. (20 lbs.)	\$649.00	\$489.00
BFSTRDELTA15	160 cps, 132 col. (20 lbs.)	\$799.00	\$609.00
BFSTRPOWERTYPE	18 cps Letter Quality (25 lbs.)		\$440.00

MANNESMAN-TALLY

Letter Quality Dot Matrix Printers

BFALMT160L	160 cps, 80 col. (21 lbs.)	\$579
BFALMT180L	160 cps, 132 col. (28 lbs.)	\$799
BFALMT180B	Replacement Ribbon for MT160L	\$15.75
BFALMT180D	Replacement Ribbon for MT180L	\$17.80

PRINTER CABLES

BFPGC36CP72CP	Centronics Male to Male 6'	\$24.95
BFPGC25DP72CP	IBM PC™ to Centronics Parallel 6'	\$34.85
BFPGC261P6P	6' 9 conductor shielded RS-232	\$19.95



PRINTER DUFFERS



MICROBUFFER - Stand Alone Duffer

BFPRPMB1804	64K Serial	\$349.00	\$289.00
BFPRPMB1P84	64K Parallel	\$349.00	\$289.00
BFPRPMEM84	64K Expansion Module	\$179.00	\$145.00

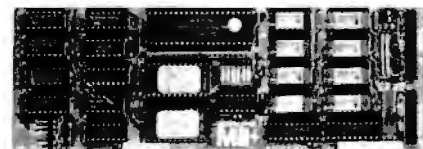

MICROBUFFER II+ For Apple II/IIe

16K, Expandable to 64K. Extensive Graphics. Serial & Parallel Ports.

BFPRPMB2PLUS16S	w/Serial Cable	\$259.00	\$189.00
BFPRPMB2PLUS18P	w/Parallel Cable	\$259.00	\$189.00
BFPRPGRAPHICARD	Graphics Only Card	\$ 99.00	\$ 85.00
BFPRPPRINTERFACE	Centronics Parallel I/O Card	\$ 75.00	\$ 69.00

DUFFERS FOR EPSON PRINTERS

Compatible with EPSON MX, FX, RX Series' and IBM Printers

BFPRPM056	Serial 8K buffer	\$159.00	\$129.00
BFPRPM016	Parallel 16K buffer	\$159.00	\$129.00

SANYO VIDEO MONITORS

12" 80 x 24 18MHz

Part Number	Description	List Price	Sale Price
BFSTODM8012CX	Black & White Display	\$240.00	\$149.00
BFSTODM8012CX	B&W w/Audio	\$260.00	\$165.00
BFSTODM8112CX	Green P31 Display	\$240.00	\$149.00
BFSTODM8112CX	Green P31 w/Audio	\$260.00	\$165.00
BFSTODM8212CX	Amber Display	\$240.00	\$149.00
BFSTODM8212CX	Amber w/Audio	\$260.00	\$165.00

13" RGB COLOR w/AUDIO

BFSTODM8500	Medium Res 350 x 350 lines	\$495.00	\$349.00
BFSTODM7500	High Res H480 x U240 dots	\$725.00	\$499.00
BFSTODM8500	Ultra High H690 x V240 dots	\$1085.00	\$799.00

(Shipping Weights on above monitors: 12" 24 lbs. ea. / 13" color: 30 lbs. ea.)

15M Byte Hard Disk For IBM PC™

50% More Capacity Than The XT™!



International Instrumentation Incorporated

- Plug and Run — ready to go right out of the box!
- Complete with controller card, data cable, & internal mounting hardware
- Total PC/XT compatible — will boot directly from the hard disk under DOS 2.0™
- No special software needed
- 8K BIOS emulates XT command set
- Controller will support any 2 hard drives (ST506 Compatible)
- Hard disk can be partitioned into 4 operating systems
- 2:1 interleaving (data transfer rate 3 times faster than XT™)

INTERNAL 15M Byte Hard Disk With Controller

\$1395

BFIIHDPC115 (Sh. Wt. 11 lbs.)

EXTERNAL 15M Byte Hard Disk With Controller

The 15Mbyte drive is mounted in a IIHD5001 cabinet with power supply. All hardware specifications are the same.

\$1595

BFPOBIIHDPCX15 (Sh. Wt. 16 lbs.)
External 15 Mbyte Hard Disk w/Controller & Data Cable



Backed By a 6-Month Warranty!

BEIIHDPCSDBT \$50.00

Required disk boot program for older original PCs with 128K memory. Using 4116 - 16K memory chips



U.S. ROBOTICS

MODEMS

1200 Baud, Auto Dial/Auto Answer

Part Number	Description	List Price	Our Price
BFUSRADIALZ12A	1200 baud w/ LEDs	\$599.00	\$459.00
BFUSRS100	1200 Baud S-100 Card	\$449.00	\$395.00

TELPAC COMMUNICATIONS SOFTWARE

BFUSRTELPAC5A	Software on Apple 5 1/4" Format	\$ 79.00
BFUSRTELPAC8	Software on 8" SSSD CP/M® Disk	\$ 79.00

D.C. HAYES

BFDCM400P	1200 Baud Smartmodem	\$695.00	\$479.95
BFDCM200P	300 Baud Smartmodem	\$279.00	\$229.00
BFDCM100P	MicroModem 100	\$399.00	\$299.00
BFDCM000P	MicroModem II	\$379.00	\$299.00
BFDCM1200B	IBM-PC™ Modem Card with Software included	\$695.00	\$479.00

RIXON

1200 Baud Direct Connect w/10 Number Memory

BFRIXR212A	1200 Baud Stand-Alone Unit	\$495.00	\$399.00
BFRIXPC212A	1200 IBM PC™ Modem (2 lbs.)	\$495.00	\$399.00
BFRIXPC00M1	IBM PC™ Modem Software (1 lb.)	\$ 69.00	
BFPOBRIXIBM	IBM Modem & Software Together (3 lbs.)	\$449.00	

MURA

BFMURMM100	300 Baud Modem (2 lbs.)	\$99.95	\$79.00
------------	-------------------------	---------	--------------------

Circle 267 on inquiry card.



PRIORITY



ELECTRONICS

9161 Deering Ave., Chatsworth, CA 91311-5887

ORDER TOLL FREE (800) 423-5922 - CA, AK, HI CALL (818) 709-5111

Terms: U.S. VISA, MC, BAC, Check, Money Order, U.S. Funds Only. CA residents add 6 1/4% Sales Tax. MINIMUM PREPAID ORDER \$15.00. include MINIMUM SHIPPING & HANDLING of \$3.00 for the first 3 lbs. plus 40¢ for each additional pound. Orders over 70 lbs. sent freight collect. Just in case, include your phone number. Prices subject to change without notice. We will do our best to maintain prices through June, 1984. Many quantities are limited. Sorry, no rainchecks, no refunds or exchanges on sale merchandise. Credit card orders will be charged appropriate freight. Sale prices for prepaid orders only. We are not responsible for typographical errors.

FLIP 'N' FILE

50 Capacity

Stores 50 5 1/4" Diskettes (Sh. Wt. 9 lbs.)

BFINC03513139

~~\$29.95~~



5 1/4" Double Density Soft Sector, 40 Track

Use with IBM, Sanyo, Apple and Most Personal Computers

Part Number	Manufacturer	Sides	PRICE	
			1 Box	2 or More Boxes
BFULT51401	ULTRA	1	\$19.95	\$18.95
BFULT52401	ULTRA	2	\$32.00	\$30.00
BFMLXMD1M	MAXELL	1	\$26.00	\$24.00
BFMLXMD2M	MAXELL	2	\$39.00	\$37.00
BFDSN1041D	DYSAN	1	\$34.00	\$32.00
BFDSN1042D	DYSAN	2	\$41.00	\$39.00

CALL FOR HARD SECTOR & 77 TRACK DISKS NOT LISTED HERE

8" Double Density, Soft Sector

BFMFLF01120M1200	MAXELL	1	\$44.00	\$38.00
BFMFLF02X0M1200	MAXELL	2	\$51.00	\$47.00



MS-DOS™ Computer with Monitor, Printer, and Software



Hardware
SANYO MBC555

- 16 Bit 8088 CPU
- Socketed for Optional 8087 MPU
- 128K of RAM expandable to 256K
- Centronics Printer Port
- 2 Single Sided Disk Drives (160K Bytes Each)
- 10 Programmable Function Keys
- Speaker and Joystick Port
- Video and printer cables included
- **AMBER or GREEN Screen Monitor**
- **GEMINI 10X Dot Matrix Printer**

List Price: \$2034.00
(Shipping weights on above items:
3 boxes: 30 lbs., 30 lbs., and 20 lbs.)

Software

- MS-DOS™ Operating system
 - SANYO BASIC
- MicroPro Software:**
- WordStar®
 - SpellStar®
 - CalcStar®
 - DataStar®
 - ReportStar®
 - InfoStar®
 - MailMerge®

Runs Many Off-The-Shell Programs for IBM-PC™

- BFPDB555SP1 w/Green Screen
- BFPDB555SP3 w/Amber Screen



\$1495

RGB Color Monitors and Letter Quality Printers may be substituted at additional cost.



UNINTERRUPTABLE POWER SYSTEM!

- All The Features as a Minicomputer Regulator!
- AC Power Delivered When Power Fails!

Part Number	Shipping Wt.	VA Rating	List Price	SALE PRICE
BFLA280050750300	95 lbs.	750VA / 10 min.	\$1862.00	\$1497.00
BFLA280050400301	125 lbs.	400VA / 20 min.	\$1665.00	\$1406.00

THE CLEAN POWER SOLUTION!

Short-Circuit SOLA's Price-Increase!

A UNIT OF GENERAL SIGNALS

SOLA

WE MAINTAIN OUR LOW PRICES THROUGH SOLA'S PRICE INCREASE!

MINICOMPUTER REGULATORS

- Constant Voltage • EMI/RFI Filtering
- Total AC Isolation • Better Than Dedicated AC Power!

Part Number	Shipping Weight	VA Rating	List Price	SALE PRICE
BFLA8313070	10 lbs.	70 VA	\$ 169.40	\$149.00
BFLA8313114	80 lbs.	140 VA	\$ 259.44	\$219.00
BFLA8313125	31 lbs.	250 VA	\$ 309.18	\$261.00
BFLA8313150	47 lbs.	500 VA	\$ 428.84	\$362.00
BFLA8313175	60 lbs.	750 VA	\$ 546.08	\$461.00
BFLA8313210	75 lbs.	1000 VA	\$ 632.56	\$534.00
BFLA8313220	108 lbs.	2000 VA	\$ 1075.54	\$895.00

NOW! The Affordable UPS For Your Personal Computer!

\$359.00

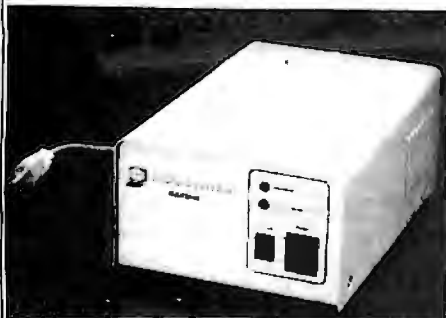

200 Watts For 5 Minutes of Uninterruptable Power With AC Surge and EMI/RFI Filtering Built-In!
Perfect for Morrow Micro Decision, IBM PC™, Apple IIe, and many, many more!

BFTIPC200 (Sh. wt. 21 lbs.) **\$359.00**

NOT FOR USE WITH LINEAR POWER SUPPLIES!

Disk Drives For Atari & Apple

INDUS



Software Included!

- Word Processor • Data Manager
- Spreadsheet • DOS

For ATARI For APPLE II & III
Provides 400% Increase In Data Transfer Speed!
Compatible With APPLE II, IIe, and APPLE III

BFINDBTATARI List Price: \$449.00 BFINDBTAPPLE List Price: \$399.00

\$379 \$269

(Shipping wt. 13 lbs.) (Shipping wt. 13 lbs.)

Each INDUS Disk Drive comes with a carrying case that easily converts to a protective case for 80 diskettes, using the provided partitions!

Circle 267 on inquiry card.

CONCORDE

Apple-Compatible Add-On



- 163K @ 40 Tracks
- Apple II, II+ and IIe compatible

BFCRDC111
List Price: \$279.00

\$179
Includes One-Year Over-The-Counter Replacement Warranty!

CONCORDE APPLE II COMPATIBLE 5 1/4" FLOPPY CONTROLLER

- PRO-DOS Compatible
- Controls Up To 4 Drives
- Single or Double-Sided
- Will Support Up To 1.3M Bytes of Storage!

BFCRDC130 List Price: \$89.00

\$75
(Shipping weight 1 lb.)

DRIVES & ENCLOSURES

5 1/4" FLOPPY DISK DRIVES

BFTNDTM1001	Tandon Full Height SS 48TPI	\$178.00
BFTNDTM1002	Tandon Full Height DS 48TPI	\$218.00
BFTNDTM1014	Tandon Full Height DS 96TPI	\$328.00

8" Floppy Disk Drives

BFCW001R	Shugart Full Height SS (18 lbs)	\$348.00
BFSHU851R	Shugart Full Height DS (18 lbs)	\$478.00
BFSIEFDD1000	Siemens Full Height SS (18 lbs)	\$129.00
BFSMETRAK042	Qume Full Height DS (18 lbs)	\$458.00
BFMITR209463B	Mitsubishi Full Height DS (18 lbs)	\$375.00
BFTNDTM8481	Tandon 1/2-Height SS (9 lbs)	\$325.00
BFTNDTM8482	Tandon 1/2-Height DS (9 lbs)	\$388.00

JMR



5 1/4" Disk Drive Cabinets

BFJMR1CS	Single Drive Cabinet (5 lbs)	\$ 78.00
BFJMR2CS	Dual Drive Cabinet (9 lbs)	\$ 98.00
BFJMR2CSC	Dual w/Internal Data Cable (9 lbs)	\$115.00



International
Instrumentation
Incorporated



Dual 8" Disk Enclosures

All of these rugged enclosures feature forced, filtered air cooling, hefty power supply, with the heat producing elements mounted to outside for cool, reliable operation. The rear panels are punched for the appropriate data cables.

FDE002, Economical design for two standard size 8" floppies. Hinged lid for easy drive access. Power supply 5V@4A, -5V@8A, +24@3A.
DTL002, Cabinet for two 1/2-height 8" drives or 1 full height 8" floppy or Winchester. Includes Shugart type AC power cable.

Part Number	Description	List Price	SALE Price
BF111FDE002	FDE002 Dual Enc (35 lbs)	\$359.95	\$325.00
BF111DTL002SHU	DTL002 Dual Thin Line (12 lbs)	\$225.00	\$175.00
BF111DTLWPKIT	MPI 1/2-Height DTL adapter kit	\$ 24.85	
BF111CBL0K304FM	Shugart to Qume AC Cable	\$ 4.95	

BUY CABINETS WITH DRIVES AND SAVE!

Combinations with FDE002

BFPP0111FDE2B2	w/2 SHU801R Drives	\$ 869.00
BFPP0111FDE2B2	w/2 MFM289463BS Drives	\$1049.00
BFPP0111FDE2Q2	w/2 QMETRAK842 Drives	\$1199.00
BFPP0111FDE2B51	w/2 SHU851R Drives	\$1238.00
BFPP0111G1E	w/2 FDD1008 Drives	\$ 489.00

Combinations with DTL002

BFPP0111TND1	w/2 TNDTM8481 Drives	\$ 878.00
BFPP0111TND2	w/2 TNDTM8482 Drives	\$1038.00

5 1/4" Hard Disk

BFTNDTM501	Tandon 5 Mb (9 lbs)	\$ 899.00
BFTNDTM502	Tandon 12 Mb (9 lbs)	\$ 795.00
BFTNDTM503	Tandon 19 Mb (9 lbs)	\$ 895.00

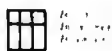

DUAL 5 1/4" HARD DISK DRIVE CABINET

All of the necessary power for two TANDON TM500 series or equivalent hard disk drives. Just imagine, you can have 100Mbytes of storage using two of the Micropolis 5 1/4" Winchester disk drives and this cabinet! Power supply +5V@6A and +12V@6A. The rear panel is punched for two 20, two 34, and one 50 pin header connector. Fan cooled.

BF111DS002	Dual Hard Disk Enclosure (Sh. Wt. 20 lbs)	\$369.00
BF111DS001	Single Hard Disk Enclosure (Sh. Wt. 15 lbs)	\$248.00

BUY CABINET WITH DRIVES AND SAVE!

BFPP0501HDS	w/2 TM501 Drives	\$1589.00
BFPP0502HDS	w/2 TM502 Drives	\$1889.00
BFPP0503HDS	w/2 TM503 Drives	\$2149.00

Disk drives will be shipped separately from cabinets.
Don't forget to include shipping for each disk drive cabinet.

BUY DRIVE AND CABINET TOGETHER AND SAVE!

DUAL SIEMENS FDD1008's with IIIFDE002 Cabinet



\$499.00
SAVE \$84.00!!

BFPDBIISIE

(Drives are shipped separate from cabinet. Package shipped in 3 containers)

SIEMENS



FDD1008
8" Drive
Single Sided
Double Density

\$129.00 Each

BFSIEFDD1008 (Be sure to include \$7.00 per drive for shipping)

ADD-ON DRIVE FOR IBM PC™

Tandon JMR



TM1002-1 Full
Height 5 1/4" 40 Track
48 TPI Drive
DOUBLE SIDED!

\$219

BFTNDTM1002
(Sh. wt. 4 lbs)

5 1/4" Floppy Cabinet
Holds 2 Half or 1 Full
Height drive with
Power Supply

\$69

BFJMR2SV5
(Sh. wt. 7 lbs)

FLUKE DIGITAL MULTIMETERS

**Autoranging
SERIES 70**

**3 1/2 Digit
Analog Bar Graph**

- Full 3200 count instead of the normal 2000
- ULTRA-Fast analog bar graph
- Instant autoranging power-up self test and power-down step mode
- Beeper included in the 75 & 77
- True touch and hold on the 77



BFFLU73	.7% accuracy, autoranging DMM (2 lbs.)	\$85.00
BFFLU75	5% accuracy auto/manual w/beeper (2 lbs.)	\$99.00
BFFLU77	.3% w/touch & Hold and Holster (2 lbs.)	\$129.00
BFFLU70	Custom Holster (included w/FLU77)	\$ 9.00
BFFLU71	Soft Vinyl Case	\$ 9.00

3 YEAR WARRANTY!

HITACHI
Hitachi Denshi, Ltd.



**2 YEAR
WARRANTY!**
**PROBES
INCLUDED!**

**DELAYED SWEEP
w/TRIGGER VIEW**

**100MHz
3rd & 4th TRACE**
BFHITY050F

\$1295

List \$1595.00 (13 lbs)

**60MHz
3rd TRACE**
BFHITY050F

\$995

List \$1195.00 (13 lbs)

**40MHz
DUAL TRACE**
BFHITY422

\$695

List \$895.00 (17 lbs)

**20MHz
DUAL TRACE**
BFHITY222

\$549

List \$695.00 (17 lbs)



**NEW! LOW PROFILE
DUAL CHANNEL**

**40MHz
DUAL TRACE**
BFHITY422

\$695

List \$895.00 (17 lbs)

**20MHz
DUAL TRACE**
BFHITY222

\$549

List \$695.00 (17 lbs)

Circle 267 on inquiry card.



PRIORITY

**1
ONE**

ELECTRONICS



9161 Deering Ave., Chatsworth, CA 91311-5887

ORDER TOLL FREE (800) 423-5922 - CA, AK, HI CALL (818) 709-5111

Terms: U.S. VISA, MC, BAC, Check, Money Order, U.S. Funds Only. CA residents add 6 1/2% Sales Tax. MINIMUM PREPAID ORDER \$15.00. Include MINIMUM SHIPPING & HANDLING of \$3.00 for the first 3 lbs. plus 40¢ for each additional pound. Orders over 50 lbs. sent freight collect. Just in case, include your phone number. Prices subject to change without notice. We will do our best to maintain prices through June, 1984. Credit card orders will be charged appropriate freight. We are not responsible for typographical errors. Sale prices for prepaid orders only.

ORDER TOLL FREE (800) 423-5922 - CA, AK, HI CALL (818) 709-5111

California Digital

Post Office Box 3097 B • Torrance, California 90503



FREE
Plastic library case supplied with all diskettes purchased from California Digital.

DISKETTES AS LOW AS **\$16.50**

FIVE INCH SINGLE SIDED DOUBLE DENSITY

	Soft Sector Ten Sector Siden	Each box	10 Boxes	100 Boxes
CAL DIGITAL	CAL-501 CAL-510 CAL-516	19.95	18.50	16.50
SCOTCH	MMM-744/0 MMM-744/10 MMM-744/16	26.50	24.50	21.75
VERBATIM	VRB-525/01 VRB-525/10 VRB-525/16	26.50	25.25	23.50
MEMOREX	MRX-3481 MRX-3482 MRX-3485	26.50	22.25	18.75
MAXELL	MXL-MD1 MXL-MM1/10 MXL-MM1/16	26.50	24.50	23.25
DYSAN	DYS-104/10 DYS-107/10 DYS-105/10	35.00	33.00	30.50

FIVE INCH DOUBLE SIDED DOUBLE DENSITY

	CAL-551 CAL-561 N/A	24.95	22.75	20.50
CAL DIGITAL				
SCOTCH	MMM-745/0 MMM-745/10 MMM-745/16	39.95	37.95	31.25
VERBATIM	VRB-550/01 VRB-550/10 VRB-550/16	39.95	37.95	32.75
MEMOREX	MRX-3491 MRX-3492 MRX-3495	35.00	31.25	26.25
MAXELL	MXL-MD2 MXL-MD2/10 MXL-MD2/16	39.95	37.95	34.75
MAXELL / 96	N/A	45.00	43.00	41.25
DYSAN	DYS-104/2D DYS-107/2D DYS-105/2D	42.50	40.50	35.50
DYSAN / 96	N/A	49.95	47.95	45.75

EIGHT INCH SINGLE SIDED SINGLE DENSITY

SCOTCH	MMM-740/0	29.50	27.50	23.80
MEMOREX	MRX-3062	27.75	26.60	22.25
VERBATIM	VRB-34/9000	31.50	29.50	25.60
DYSAN	DYS-3740/1	35.75	32.75	29.75

EIGHT INCH SINGLE SIDED DOUBLE DENSITY

SCOTCH	MMM-741/0	37.75	35.15	29.15
MEMOREX	MRX-3090	35.50	33.50	27.15
VERBATIM	VRB-34/8000	35.25	33.25	28.75
DYSAN	DYS-3740/1D	40.75	38.75	32.25
MAXELL	MXL-FD1	45.50	39.75	35.15

EIGHT INCH DOUBLE SIDED DOUBLE DENSITY

SCOTCH	MMM-743/0	47.50	44.25	37.50
MEMOREX	MRX-3102	39.25	36.75	31.50
VERBATIM	VRB-34/4001	41.75	37.50	32.25
DYSAN	DYS-3740/2D	54.65	49.75	40.50
MAXELL	MXL-FD2	52.50	48.75	40.45

MITSUBISHI \$179
96 TPI • 4853



California Digital has purchased over one thousand factory new Mitsubishi M4853 5 1/4" disk drives from the Eagle Computer Company. The drives are half height double sided 96 track per inch. The M4853 interfaces the same as the Shugart SA465. We are currently offering these drives at only \$179.00. This is far below distributor cost. Offer is subject to remaining inventory on hand at time of order. MIT-4853

MEMORY

16K DYNAMIC	2732 EPROM
1.95	4.95
4116 150ns.	450ns.
2764 EPROM	16K STATIC
6.95	4.95
350ns.	6116 200ns.

4164 DYNAMIC MEMORY 150ns
\$5.95

DYNAMIC MEMORY		1.31	33 +	100 +
4027 4K dynamic 280ns.	ICM-4027250	1.98	1.85	1.75
4116 150ns. 16K	ICM-4116150	1.78	1.65	1.45
4116 200ns. 16K	ICM-4116200	1.78	1.65	1.45
4164 150ns. 64K 128 refresh	ICM-4164150	5.98	5.85	5.58
41256 150ns. 256K	ICM-41256150	Available		
DP8469 dynamic controller	ICP-8469	38.00	35.00	29.00
EPROMS				
2708 450ns. 1K x 8	KCE-2708	4.95	4.75	4.55
2716 450ns. 2K x 8	KCE-2716	4.55	4.25	3.97
2716TMS 450ns. Tri-voltage	KCE-2716TMS	7.95	7.65	7.25
2732 450ns. 4K x 8	KCE-2732	4.50	3.78	3.55
2732 450ns. 4K x 8	KCE-2732S	1.98	1.85	1.75
2752 450ns. 4K x 8	KCE-2752	10.50	9.80	9.58
2764 250ns. 8K x 8	KCE-2764	8.95	8.95	6.95
27128 350ns. 16K x 8	KCE-27128	18.95		
STATIC MEMORY				
21102 200ns. 1K static	ICM-21102200	1.48	1.29	1.15
21102 450ns. 1K static	ICM-21102450	1.29	1.15	.99
2112 450ns. 2K static	ICM-2112450	2.99	2.85	2.75
2114 300ns. 1K x 4	ICM-2114300	1.98	1.85	1.75
40441MS 450ns. 4K x 1	ICM-4044150	3.49	3.25	2.99
5257 300ns. 4K x 1	ICM-5257300	3.50	2.25	1.99
8116 P4 200ns. 2K x 8	ICM-8116200	4.85	4.65	4.50
6116 P3 150ns. 2K x 8	ICM-6116150	3.25	3.05	2.85
6187/2167 100ns. 16K x 1 (20 pin)	ICM-6187100	9.95	8.50	

CONNECTORS



S-100 Gold		DB25P		
GOLD S-100 EDGE CARD CONNECTORS	'D' TYPE	catalog	each 10-99 100+	
Minim S12 250	CHD 3P	1.50	1.40	1.30
Suplex Hi-Riser	CHD 5P	2.25	2.05	1.90
S-100 Wire W	CHD 15P	1.50	1.35	1.20
Minim S12 51	CHD 15P	2.25	2.05	1.90
156" CENTER EDGE CARD CONNECTORS	CHD 15P	1.50	1.35	1.20
20-44 Edge	CHD 15P	1.50	1.35	1.20
43-72 Male & CHD 25S	CHD 25P	1.90	1.75	1.55
20-44 Edge	CHD 25P	1.90	1.75	1.55
RIBBON CONNECTORS	CHD 50P	5.00	4.50	4.00
DB25P male	CND 25P	5.55	5.25	4.15
DB25S female	CND 25S	5.55	5.25	4.50
57-30360 male	CNP 36P	7.95	6.75	5.90
57-30360 female	CNP 36S	7.95	6.75	5.90
20 pin edge	CNI DS20	4.35	3.90	2.50
20 pin socket	CNI DS20	2.75	1.85	1.60
28 pin edge	CNI DS28	4.95	3.90	2.70
28 pin socket	CNI DS28	3.50	2.40	2.15
34 pin edge	CNI DS34	4.95	4.00	3.50
34 pin socket	CNI DS34	4.50	3.75	3.15
50 pin edge	CNI DS50	5.95	5.60	5.00
50 pin socket	CNI DS50	4.95	4.60	3.80
8 pin D.C.	CNP 6DC	1.95	1.29	80
9 3AC Sep S	CNP 3SS	1.69	1.09	69
9 3AC Sep S	CNP 3SS	1.69	1.09	69
3* 4 pin D.C.	CNP 4DC	1.79	1.19	99
3 pin DIN recept	CNP 3DP	2.59	1.99	1.59

BLOWOUT SALE
\$129



California Digital has recently participated in the purchase of several thousand Siemens FDD 100-8 floppy disk drives. These units are electronically and physically similar to that of the Shugart 801R. As units are new and shipped in factory sealed boxes. Manual and power connectors supplied free upon request. Your choice 115 Volt 60 Hz or 230 Volt 50Hz.

REMEX DOUBLE SIDED \$219
California Digital has just purchased a large quantity of Remex RFD-4000 Eight inch double sided disk drives. Remex is the only double sided disk drive that has a double gimbal mounted head assembly that guarantees lower head tracking. This drive is mechanically solid. Remex has always been known for producing premiere products for the floppy disk market. The Remex company is a subsidiary of the Ex-cel-o Corporation, a Fortune 500 Company.

Eight Inch Single Sided Drives		One	Two	Ten
SHUGART 801R		385	375	365
SIEMENS FDD 100-8		129	125	119
TANDON 848E-1 Half Height		369	359	349
Eight Inch Double Sided Drives				
SHUGART SA851R		495	485	475
QUME 842 "QUME TRACK 8"		459	459	449
TANDON 848E-2 Half Height		459	447	435
REMEX RFD-4000		219	219	209
MITSUBISHI M2894-63		447	439	433
MITSUBISHI M2896-63 Half Ht.		459	449	409
Five Inch Single Sided Drives				
TEAC FD-55A half height		159	149	139
SHUGART SA400L		199	189	185
SHUGART SA200 1/2 Height		159	149	139
TANDON TM100-1		189	179	175
Five Inch Double Sided Drives				
TEAC FD55B half height		179	169	165
CONTROL DATA 9409 IBM/PC		229	219	215
SHUGART SA450		319	309	299
SHUGART SA455 Half Height		259	249	239
PANASONIC JA551/2N (SA455)		169	159	155
SHUGART SA465 Half Ht. 96TPI		289	279	269
TANDON TM50-2 Half Height		215	209	199
TANDON TM55-4 half Ht. 96TPI		329	319	309
TANDON 100-2		279	269	259
TANDON 101-4 96TPI 80 Track		369	355	350
MITSUBISHI 4851 Half Height		259	249	245
MITSUBISHI 4853 1/2 Ht. 96TPI		179	175	169
MITSUBISHI 4854 1/2 Ht., 8" elec.		465	449	439
QUME 142 Half Height		239	229	219
Three Inch Disk Drives				
SHUGART SA300 with diskette		229	219	209
Five Inch Winchester Hard Disk Drives				
FUJITSU M2235AS 27 M/Bytes		999	959	889
RODINE R0-208 53 M/Byte		1589	1493	1427
SHUGART 717 13 M/Byte 1/2 Ht.		795	765	725
TANDON 503 19 M/Byte		715	775	755

Upon request, all drives are supplied with power connectors and manual enclosures.

ENCLOSURES

Horizontal mount two 8 full height drives	\$279.00	Horizontal mount one full height or two half height 8 disk drives	\$239.00
Vertical mount two full height 8 disk drives	\$299.00	Vertical mount two full height 5 1/4 disk drives	\$139.00

23" COMPOSITE MONITOR \$159



Every year a classroom of students around a 12" monitor have in your opportunity to purchase a 23" high resolution monitor at a reasonable price. These units accept standard composite video signals generated by most personal computers including the Apple and IBM PC. Attach to your computer and it records plus and shooting down 40 lines in wide screen video. MOT BW21 1/2 Lbs. Monitors are open frame and for safety should be enclosed. Wood grained enclosure for about \$13.00 additional. CAL ENG23 1/2 Lbs.

Telex 753607



Shipping: First five pounds \$3.00, each additional pound \$.50. Foreign orders: 10% shipping, excess will be refunded. California residents add 6 1/2% sales tax. • COD's discouraged. Open accounts extended to state supported educational institutions and companies with a strong "Dun & Bradstreet" rating. Retail location: 17700 Figueroa Street, Carson CA. 90248.

TOLL FREE ORDER LINE
(800) 421-5041
TECHNICAL & CALIFORNIA
(213) 217-0500

ALL CALIFORNIA DIGITAL

Post Office Box 3097 B • Torrance, California 90503

DRAGON

\$139

Your Choice
Second Drive or Monitor
SANYO
IBM COMPATIBLE
\$895

The world famous Dragon computer is now available in the United States. Manufactured by the Tano Corporation under license of the British Broadcasting Company. The Dragon comes complete with 64K Byte of memory, serial modem port along with a Centronics printer interface. This unique microcomputer features Motorola's advanced 6809E microprocessor and comes standard with Microsoft Color Basic, data base manager, and a complete word processing package. The computer outputs color composite video along with R.F. video that allows the unit to be used in conjunction with any color television. The Dragon is fully compatible with the Radio Shack Color Computer. This is the ideal low cost computer to be used with any dial up information system such as the Source, Western Union's EasyLink or any other time share service. California Digital has agreed to act as exclusive agent for North America in an effort to assist The Tano Corporation in reducing their overstock. For a limited time California Digital can offer the Dragon computer for only \$139.



Sanyo Electronics has just released the long awaited IBM/PC look-a-like, the MBC-550. This is a complete microcomputer that includes 128K/byte of memory, a 5 1/4" 160K/byte disk drive upgradeable to 320K/byte drives. Also includes both color composite and RGB graphics interface, low profile keyboard, and parallel printer port. Extensive software such as Sanyo Basic, disk utilities, Wordstar word processing software, Calcstar spread sheet & Easy Writer I. MS-DOS is supplied with the Sanyo computer. Most programs written for the IBM/PC will operate on the MBC-550. Along with all this California Digital offers "FREE" your choice of either a second disk drive, or a high resolution green or amber screen monitor. All at the super low price of only \$895.



\$277
Star Gemini

MATRIX PRINTERS

Star Gemini 10x120 char/sec.	STR-G10X	270.00
Star Gemini 15x160 char/sec. 15 paper	STR-G15X	369.00
Star Gemini Delta 10x120 Char/sec.	STR-D10	369.00
Star Coxe 8071 tractor & tractor	VST-C8071	195.00
Tronica P1350, 182 char/sec. letter quality	120S-1350	1495.00
Okidata 82A letter & parallel 911 paper	OKI-82A	347.00
Okidata 82A parallel interface, 160 char/sec.	OKI-82A	427.00
Okidata 83A & parallel 15 paper	OKI-83A	467.00
Okidata 84A & parallel 15 paper	OKI-84A	497.00
Okidata 2350 11 pin 250 char/sec.	OKI-2350	1995.00
Epson FX-80 120 Char/sec.	EPS-FX80	317.00
Epson FX-80 120 Char/sec. with graphics	EPS-FX80	529.00
Epson FX 100 15 180 char./sec. with graphics	EPS-FX100	719.00
Epson MX100 with graphics, 15 paper	EPS-MX100	989.00
NEC8022A parallel 911 paper graphics	NEC-8022A	389.00
Analog 9501B high speed with graphics	ADR-9501B	1029.00
Analog 9608B 200 char/sec. par & serial	ADR-9608B	1129.00
Quantar 7030 correspondence quality 180 char/sec	QTX-7030	1529.00
Printer 8510 parallel 911 paper	PRO-8510P	359.00
Printer II parallel 15 paper	PRO-8P	689.00
Dataproducts S-800-3, band printer 600 LPM	DPS-S800	6995.00
Printronic P3000 high speed printer 300 lines per minute	PTX-P3000	4290.00
Printronic P600 ultra high speed 600 lines per minute	PTX-P600	5795.00

TERMINALS

California Digital has recently purchased an OEM liquidation of new Hazletline 1420 video terminals. These units feature direct cursor addressing, full 62 key keyboard with numeric cluster, RS-232C with baud rates selectable to 9600 Self diagnostics and escape sequences function mode make this terminal an excellent value at only \$299.00. HZL-1420



\$299

Hazletline 1420 Video Display Terminal	HZL-1420	299.00
Freedom 100, split screen, detachable keyboard	L-B-F100	499.00
Quint 102 green phosphor terminal	QUIN-102	539.00
Visual 50 Green screen	VIS-50G	659.00
Amper Dialogue 125 green screen	APX-D125G	719.00
Amper Dialogue 115 amber screen, two page func. keys	APX-D124A	719.00
Wyse 300, 81 char. display, split screen	WYS-300	579.00
Wyse 100, 80 char. & vert. split screen, metal enclosure	WYS-100	799.00
Wyse 300, 81 char. display, split screen	WYS-300	1169.00
Televideo 9110 Plus block mode	TVI-910P	579.00
Televideo 9225 detachable keyboard, 22 function keys	TVI-925	759.00
Televideo 950, graphic char. split screen, 25 line	TVI-950	859.00
Televideo 970 14 green screen 132 column European	TVI-970	1099.00
Zenith 29 terminal V152 compatible, detachable keyboard	ZTH-29	785.00

IBM PC

\$1899



System I includes 64K byte of memory one 320K byte double sided disk drive, and keyboard. Monitor and monitor interface available. System II includes 256K byte of memory two 320K byte disk drives, Sakata color monitor, Peacock color card with printer port all for only \$2899.

WORD PROCESSING PRINTERS

NEC7710 55 char/second, serial interface	NEC-7710	1979.00
NEC7730 55 char/sec. par1 interface	NEC-7730	1979.00
NEC3550 popular printer designed for the IBM/PC	NEC-3550	1799.00
NEC2050 designed for IBM/PC 20 char/sec. par1	NEC-2050	999.00
Silver Reed EPX500 114 char/sec. par1 interface	SRD-EPX500	459.00
Silver Reed EPX550 17 char/sec. par1 interface	SRD-EPX550	659.00
Dualio 630 40 char/sec. serial	DBL-630	1795.00
Dualio 630 proportional spacing, horiz & vert tab 20 cps	DBL-630	1795.00
Apple II 110, 18 char./sec. graphic mode	JKL-6100	493.00
Brother HPA A glass wheel, parallel interface	BTH-HR1P	699.00
Brother HPA serial interface	BTH-HR1S	699.00
Starwriter F10 serial 40 char/sec.	PRO-F10S	1125.00
Starwriter F10 parallel 40 char/sec.	PRO-F10P	1125.00
Comstar CFI word processing printer serial int.	CRX-CFI15	729.00
Comstar CFI 5x letter proportional spacing, par1	CRX-CF2P	499.00



APPLE \$929

Apple II/e, 64K computer only	APL-2E	\$989
Apple II/e starter kit, monitor, disk, 80 col card	APL-2E5K	1385
Advanced Bus Logic Tech. 13 Key Pad	ABT-13B	109
Calif. Computer 7710A Async. Serial Interface	CCS-7710	125
Calif. Computer 7710B same but for modem	CCS-7710B	125
Calif. Computer 7710A 12K PROM module	CCS-7711A	99
Calif. Computer 7720A parallel interface	CCS-7720	99
Calif. Computer 7720A Calendar/clock module	CCS-7728	99
Calif. Computer 7720A Centronics interface	CCS-7729	99
Calif. Computer 7740A programmable timer	CCS-7740	99
California Digital 16K card for standard Apple II	CAL-AM16	39
Hayes Microterminal II for Apple II	HYS-MME2	279
Kennington Micro, System saver fan	KEN-SF1	7
Microsoft Softcard with CP/M, Z-80	MSF-SFT CD	239
Mountain Computer The Clock	MTN-CLK	225
Mountain Computer AD/DA 16 bit input, 8 bit	MTN-ADA	269
Mountain Computer ROM Plus with keypad filter	MTN-RMF	169
Mountain Computer ROM writer/socket	MTN-RMW	139
Omega Micro GRAPPLER parallel interface	OMS-G2	135
Sorrento Valley 8 80 column double side D/D	SV223	395
TEAC S-1 disk drive for Apple II	TEA-A2	269
Vista Vision 80, 80 controller card for std Apple II	VSA-VIS80	289
Vista 8 disk controller double side D/D	VSA-AB00	389

MONITORS

BMG 12A green resolution 15 MHz composite video	BMG-12A	79.00
BMG 12 high resolution, 20MHz	BMG-12EN	134.00
Zenith ZVM122 Amtek Phosphor 12 40/80 column search	ZTH-122	99.00
Zenith ZVM123 green phosphor 12 40/80 column search	ZTH-123	99.00
NEC JB1201 green phosphor 18 MHz composite video	NEC-JB1201	189.00
NEC JB1200 compact frame color composite video	NEC-JB1200	129.00
USI Amber screen 12" composite monitor	USI-12A	87.00
Motrolora 23 open frame full white composite video	MOT-BW23	87.00
Motrolora 23 open frame requires horiz sync and power	MOT-BW23	89.00
Conrad C 920 frame requires horiz sync & 12v supply	CON-BW9	59.00
COLOR		
BMG ALP19 H Color composite video with sound	BMG-9191	249.00
BMG 9191M RGB designed for use with the IBM computer	BMG-9191M	399.00
NEC JC1203M RGB color monitor	NEC-1203	699.00
NEC JC1201 color composite	NEC-JC1201	339.00
Starwriter 13M RGB color suitable for IBM PC	ZTH-2134	379.00
Comstar color composite with sound	CON-6200	329.00
Amtek Color 1 composite video	AMK-100	329.00

MODEMS

DIRECT CONNECT \$75

Huac Smart Modem 1200 baud auto answer auto dial	HYS-12140	499.00
Huac 1200B for use with the IBM/PC 1200 baud	HYS-1200B	449.00
Huac Smartmodem 1200 baud only auto answer auto dial	HYS-1034A	229.00
Huac Microterminal 1200 baud direct connect	HYS-1034B	229.00
Huac Microterminal 110, 5 1/4 floppy auto answer auto dial	HYS-100	319.00
Huac 1200 baud auto answer auto dial	HYS-CH232	199.00
Huac 1200 baud auto answer auto dial	USP-12A	429.00
U.S. Robotics Passport 300 1210 baud	USP-PW12	369.00
U.S. Robotics 1200 baud auto answer auto dial	USP-12AD	699.00
Universal Data 160, 1200 baud auto answer & originate	UDS-103LP	169.00
Universal Data 160, 1200 baud auto answer	UDS-103LPJ	219.00
Universal Data 160, 1200 baud half duplex only	UDS-103LPK	219.00
Universal Data 121P full 1200 baud duplex full power	UDS-212LP	359.00
Novation CA direct connect auto answer	NOV-CACT	159.00
Novation CA auto answer auto answer	NOV-CACT	159.00
Novation SmartCAL 103 auto answer auto dial	NOV-SC103	219.00
Novation SmartCAL 103 auto answer auto dial	NOV-SC103	219.00
Novation Mark I direct connect with terminal cable	NOV-MC12	529.00
Novation Mark I direct connect with terminal cable	NOV-MC12	529.00

ASCII KEYBOARD \$49

California Digital has purchased over 3000 of these function keys		
Keyboards from the General Dynamics Corporation 33 ASCII encoded flat effect switches includes 8 function keys and 14 key numeric cluster this keyboard an excellent value at only \$49. MAC-9100 5 lbs		
We also have available a matching General Dynamics steel terminal \$10		
Not enclosed VHS 58 key metal contact keyboard. VHS-58 \$29.95 Matching 15 key numeric cluster \$9.95. Both for only \$29.95. HYS-5815		
Not pictured 49 key eight bit modified Horenz coded Macintosh flat effect keyboard. REMOVED from punch card equipment \$14.95. DIT-1849 ASCII encoder available		

S-100 BOARDS

16 BIT MICROPROCESSORS		
Octagon dual CPU 8088 780 & controller	OC1-887A	795.00
Godbout 8088-8087 microcom 16 bit	GBT-8687	495.00
Godbout dual processor 8085 8088 & 16	GBT-8588	354.00
SINGLE BOARD COMPUTERS		
High 10-4 176k 4 serial ports 100	HS-104	395.00
Advanced Data, Floppy & Disk	ABD	750.00
Freem System master 765 floppy 64k	TEL-SM1	895.00
Telex 110C 1 single board no memory	TEL-FDC1	675.00
8 BIT MICROPROCESSORS		
Godbout 280 21 bit extended bus	GBT-280	250.00
California Computer 280 microprocessor	CCS-280	275.00
Tabtel 280 with two RS232 ports	TAR-280	309.00
FLOPPY DISK CONTROLLERS		
Godbout Disk 1 double density	GBT-D5H1	395.00
California Computer 2422A with CPU	CCS-2422	339.00
Morrow Disk Jockey II with CP/M 2	MOS-DJ2	350.00
Morrow Disk Jockey I with CP/M 2	MOS-DJ1	275.00
Turbel Electronics double density	TAR-DCC	419.00
Turbel Electronics single density	TAR-SDC	279.00
Furum DMA OmegaDisk 1 10 to hard disk	FDM-001	399.00
STATIC MEMORY BOARDS		
Godbout Ram 16 64k 16 bit data bytes	GBT-16A	459.00
Godbout Ram 17 64k 8 bit 24 beaddress	GBT-17	359.00
Godbout Interface II with 8 serial ports	GBT-801	859.00
Furum OmegaRam 16 transfer back	FDM-16A	355.00
California Computer 2116 8 bit only	CCS-2116	249.00
DYNAMIC MEMORY BOARDS		
California Digital 256k expand to 1Meg	CAL-D256	995.00
California Computer 256k 64k bank select	CCS-256	299.00
INTERFACE BOARDS		
Godbout Interface I 1 serial 2 par1 ports	GBT-133A	279.00
Godbout Interface II 1 serial 2 par1 ports	GBT-133B	299.00
Godbout Interface III with 8 serial ports	GBT-133A	495.00
Godbout Interface IV with 8 serial ports	GBT-133B	565.00
Godbout Interface V 3 serial 2 parallel	GBT-187A	495.00
California Computer 2710 4 serial ports	CCS-2710	279.00
California Computer 2715 2 serial 2 par1	CCS-2715	299.00
California Computer 2720 4 serial ports	CCS-2720	279.00
California Computer 2430 8 port serial	CCS-2430	729.00
Morrow Design Kit-board 1 3.5 CP	MDS-WT1	379.00
SPECIAL FUNCTION BOARDS		
Hayes 5 100 Microterminal 300 baud	HYS-M100	329.00
OT Computer clock calculator battery	OTC-CC100	139.00
Godbout System support board 4X EPROM/GBT-SYS1	GBT-SYS1	339.00
Godbout System support board 9511 math 581-59511	GBT-SYS11	509.00
Dual System 4 channel 12 bit D/A conv.	DSC-MSB12	619.00
Dual System 12 bit resolution 32 ch A/D	DSC-AM12	629.00
Multi-Port-Digital-processor 8 ch	MUP-10B10	179.00
Media's interface board with logic & probe	MIL-164	79.00
OT Technology wave trap prototype	OT-WR100	49.00
Artex Electronics wave trap prototype	ART-WR100	79.00
Artex Electronics general purpose socket	ART-GP100	25.00
MAINFRAMES & MOTHER BOARDS		
Edgco Data streamers 22 slot	EDP-100	699.00
Godbout Enclosure 2, 20 slots	GBT-ENC20	875.00
California Computer 2200 12 slot	CCS-2200	429.00
California Digital 18 slot mother board	CAL-MB18	39.00
Godbout 17 slot mother board assembled	GBT-MB17	149.00

CPM OPERATING SYSTEM

Digital Research CP/M 3.0 6 1/2 flp disk	DRC-CPM30	249.00
Godbout CP/M 2 2 for Disk I	GBT-CMP2	159.00
Godbout CP/M for 8088 and 8086	GBT-CM86	269.00
Turbel Electronics CP/M 2	TAR-CMP22	159.00
HARD DISK CONTROLLERS		
Octagon hard disk controller w/ 8 C	OC1-MH1	475.00
Godbout Disk 2 8 5 1/4 hard disk	GBT-D5K2	569.00
Godbout Disk 3 for 5 1/4 Winchester	GBT-D5K3	569.00
Godbout Disk controller for 5 1/4	MDS-W658	495.00
Western Digital new WD-1001 req 5 1/4	WDI-1001	495.00
EPROM BOARDS		
Inner Access EPROM Board programs 27128 MAC-P100	MAC-P100	465.00
Digital Research Prom board 2K	DGR-P2	119.00

CP/M SOFTWARE

AdaSoft CP/M ADA-445C	395.00	Supersoft	MFR-309C	149.00	
D-Base II	ASH-015C	429.00	MAC	DGR-401C	85.00
Wordstar	MFR-187C	309.00	CP/M 3.0	DGR-410C	249.00
Mailmerge	MFR-392C	169.00	Despool	DGR-367C	45.00
Spillster	MFR-429C	169.00	Pascal Plus	DGR-04AC	429.00
Multiplan	MSF-483C	189.00	CP/M 86	DGR-186C	239.00
Macro 80	MSF-187C	139.00	MP/M II	DGR-208C	379.00

Additional Software available for Apple, IBM/PC and Atari. Please telephone for price and availability.

Telex 753607



Shipping: First five pounds \$3.00, each additional pound \$ 5.00. Foreign orders: 10% shipping, excess will be refunded. California residents add 6 1/2% sales tax. COD's discouraged. Open accounts extended to state supported educational institutions and companies with a strong "Dun & Bradstreet" rating. Retail location: 17700 Figueroa Street, Carson, CA. 90248.

TOLL FREE ORDER LINE
(800) 421-5041
TECHNICAL & CALIFORNIA
(213) 217-0500

The Great Salt Lake
Computer Company, Inc.

IBM ACCESSORIES

AST PRODUCTS
Combo Plus (Serial/Par/CLK 64 to 256K) 259.00

OUR BEST BUY

Six Pak Plus (Serial/Par/CLK/64K
Expands to 384K) 269.00
Six Pak Plus (Serial/Par/CLK/384K) 569.00

Meg-A-Plus (Serial/CLK/64K
Expands to 256K) 269.00
Meg-A-Pak I (Expands Meg-A-Plus
to 512K) 270.00

D.C. HAYES

Smartmodem 1200B-Smartcom 2
w/software 389.00
Smartcom II 79.00

KEYTRONICS

Enhance your PC-with a superior
keyboard 210.00

MAYNARD

Floppy Controller 160.00
Floppy Controller (Serial) 230.00
Floppy Controller (PAR) 210.00

Sandstar MOD-FDC (for 5 1/4" or 8" drives) 205.00
MODULAR ADD-ONS FOR SANDSTAR MOD-FDC
Parallel MOD 60.00
Serial-MOD 79.00
Clock Calendar MOD 69.00
Game Adapter MOD 49.00

Sandstar Multi-Function Bd (Holds up to
6 modular add-ons) 82.00
NEW 10 MG Hard Disk (Internal)
w/ Controller 1,195.00

IBM COLOR CARDS

P.C. PRODUCTS CORP

Rainbow Color Card 375.00
• 4 Times Better Than IBM Color
• Expands to 128K RAM • PAR Port
• Serial Port • Game Adapter • Light Pen Intf
• Mono Output • Composite Output

PC Peacock 299.00

PRINCETON GRAPHICS

NEW PGS HX12-Hi-Res Color. The Best 469.00
PGS-SR-12 NEW CALL
PGS-MAX 12 NEW CALL

QUADRAM

Quadlink—Allows Apple Software to be used in
IBM PC HAS 64K Ram-Game Port Display
Gen-Disk Intf w/software 450.00
Quadcolor 219.00
Quadboard I w/64K CALL
Quadboard II w/64K CALL

OUR BEST BUY

IBM UP-GRADE KIT

INCLUDES 9 EA. 4164-200NS FOR EXPANSION
ON ALL IBM PRODUCTS WITH PARITY

\$48.00 per Set

E-PROM ERASERS

E-PROM ERASERS

QUV-T8/1H (hobby) 49.95
QUV-T8/2 I (Industrial version) 68.95
QUV-T8/2P (w/timer & safety switch) 97.50

MAIL ORDER TOLL FREE

1-800-545-2633

1-801-972-2717

IBM DISK DRIVES

CDC
CDC 5 1/4" 9409 DS/DD 320K Quest Drive 225.00

QUME

5 1/4" #142 (40 TR) 320K 1/2 HGT Bell Drive
w/Brackets 200.00

PANASONIC — BEST BUY IN 1/2 HGT

5 1/4" JA-155 (40 TR) 320K 1/2 HGT Direct Drive
w/Brackets 199.00 ea.
2 for 385.00

TEAC

5 1/4" F-55B (40TR) 320K 1/2 HGT Direct Drive
(For Sanyo & IBM) w/Brackets 199.00 ea.
2 for 385.00

SHUGART DISK DRIVES

SA455L-1/2 HGT 320K DS/DD
w/BRACKETS 200.00 ea.
2 for 385.00

TANDON DISK DRIVES

TM 100-2A 320K DS/DD 209.00
TM55-2 1/2 HGT 320K DS/DD 249.00 ea.
w/BRACKETS 440.00 for 2

MODEMS

Hayes 300 219.00
Hayes 1200 499.00

OUR BEST BUY

ANCHOR MARK XII

300/1200 Band Auto Answer/Auto Dial Direct
Connect Intelligent Modem w/RS 232 Cable
Included 2 Telephone Jacks, Low Power (60 MA)
Dial Tone Detect 279.00

DISKETTES

15% Discount for Qty 100

FOR APPLE, ETC.

5 1/4" Soft Sector SS/DD 17.00/10
For IBM PC & PARTNERS
5 1/4" Soft Sector DS/DD 22.00/10
• Lifetime Warranty
• All have Hub Rings and PLASTIC CASE

OUR BEST BUY

MAXELL

Sgl side/dbl. den 5 1/4", 48 TPI 24.00
Dbl side/dbl. den 5 1/4", 48 TPI 36.00
Dbl side/quad. den 5 1/4", 96 TPI 45.00

DATA CABLES

8" DSC 88-2SKT-for 2-8" drvs w/skt conn 20.00
5 1/4" DSC55-2SKT-for 1-5 1/4" drvs
w/skt conn 20.00
RS232MM-5' (male to male) 19.00
IBM to PAR or COLUMBIA to PAR 26.00
Osborne to PAR 26.00
Kaypro to PAR 26.00
Many Others Available

AC SURGE ELIMINATORS

Lemon (6AC outlets-3 prong) 44.00
Lime (5-3 prong pwr cord w/on-off switch) 69.00
Orange-AC surge + EMI filter (6 outlets) 95.00
Peach (3 outlets) AC surge/EMI filter 69.00
Grizzly (200W) uninterruptible power system
+ surge protection 799.00
Grizzly (500W) uninterruptible power system
+ surge protection 1850.00

Prices subject to change without notice

APPLE FRANKLIN

ACCESSORIES

ALS

CPM 30 Card 269.00
Z-Card II 119.00
Smarterm 2 139.00

COOL TIME

Fan, Surge Protection, Real Time Clock 2 Outlets
for Printer & Monitor 85.00

GENERIC

16K RAM Add-on 40.00

HAYES JOYSTICKS

Mach II (For II & IIE) 33.95
Mach III (with firing button) 42.95

HAYES MODEM

Micro-Model IIE w/terminal package 279.00

KENSINGTON

System Saver/Fan & Surge Protection 75.00

KOALA

Graphics Tablet 89.00

MICRO-MAX

View Max 80 (80 Col for II +) 149.00
View Max 80E (80 Col w/64K Memory
Expands to 128K) 139.00

ORANGE MICRO

Parallel Interface (No Graphics) 61.00
Grappler + (Graphics Interface) 119.00
Grappler + 16K (Buffer and 5 to 64K) 175.00
Buffer Board 135.00

TG PRODUCTS

Joy Stick—For Apple II + 38.00
Paddles 29.00
Selecta Port 38.00

VIDEX

Ultraterm 279.00
Videterm 179.00

APPLE DISK DRIVES

STANDARD SIZE

Micro Sci A-2 (35TR) 199.00

OUR BEST BUY

Micro-Sci XL (35TR) NEW 179.00
Same as A-2 Except Plastic Case

1/2 SIZE

Super 5" "Green" Thinline 163K 40TR
Bell Drive 189.00
Super 5" "Blue" Thinline 163K 40TR
Direct Drive 199.00
Super 5" "Red" Thinline 163K 40TR
Teac Drive 225.00

RANA

RANA 1 245.00
RANA 2 Dbl Sided 359.00
RANA 3 Quad Density 469.00

ALL DRIVES 1 YR. WARRANTY

APPLE DISK CONTROLLERS

Micro-Sci (35TR) 60.00
Generic (35TR) 50.00
Micro-Sci (40TR) 89.00
RANA 85.00

Minimum Shipping \$3.00
in the Continental U.S.A.

TERMS

Open account to state supported universities &
companies with high Dun & Bradstreet rating.

Visa, MC, Check or Money Order
U.S. funds only.
Minimum order \$15.00.

4164 64K DYNAMIC \$5.95
200 ns

4116 16K DYNAMIC 8/\$7.95
250 ns

STATIC RAMS

2101	356 x 4	(450ns)	1.95
5101	256 x 4	(450ns) (cmos)	3.95
2101-1	1024 x 1	(450ns)	.85
2102L-4	1024 x 1	(450ns) (LP)	.99
2102L-2	1024 x 1	(250ns) (LP)	1.49
2125	1024 x 1	(45ns)	2.95
2111	256 x 4	(450ns)	2.49
2111L	256 x 4	(250ns) (LP)	2.95
2112	256 x 4	(450ns)	2.99
2114	1024 x 4	(450ns)	8/9.95
2114-25	1024 x 4	(250ns)	8/10.95
2114L-4	1024 x 4	(450ns) (LP)	8/12.95
2114L-3	1024 x 4	(300ns) (LP)	8/13.45
2114L-2	1024 x 4	(200ns) (LP)	8/13.95
TC5514	1024 x 4	(650ns) (cmos)	2.49
TC5518	2048 x 4	(250ns) (cmos)	9.95
2147	4096 x 1	(55ns)	8/9.95
TMS4044-4	4096 x 1	(450ns)	3.49
TMS4044-3	4096 x 1	(300ns)	3.99
TMS4044-2	4096 x 1	(200ns)	4.49
UPD410	4096 x 1	(100ns)	3.95
MK4118	1024 x 8	(100ns)	9.95
TMM2016-200	2048 x 8	(200ns)	4.15
TMM2016-150	2048 x 8	(150ns)	4.95
TMM2016-100	2048 x 8	(100ns)	6.15
HM8118-4	2048 x 8	(200ns) (cmos)	4.75
HM8118-3	2048 x 8	(150ns) (cmos)	4.95
HM8118-2	2048 x 8	(120ns) (cmos)	8.95
HM8116L-P-4	2048 x 8	(200ns) (cmos) (LP)	5.95
HM8116L-P-3	2048 x 8	(150ns) (cmos) (LP)	6.95
HM8116L-P-2	2048 x 8	(120ns) (cmos) (LP)	10.95
TMS4018	2048 x 8	(200ns) (cmos)	6.95
Z-6132	4096 x 8	(300ns) (Qstat)	24.95
HM8284P-15	8192 x 8	(150ns) (cmos)	39.95
HM8284P-15	8192 x 8	(150ns) (cmos)	49.95

LP = Low Power Qstat = Quasi-Static

DYNAMIC RAMS

TMS4027	4096 x 1	(250ns)	1.99
2107	4096 x 1	(200ns)	1.95
MM5280	4096 x 1	(300ns)	1.95
TMS4030	4096 x 1	(300ns)	1.95
UPD411	4096 x 1	(300ns)	1.95
TMS4050	4096 x 1	(300ns)	1.95
MK4108	8192 x 1	(200ns)	1.95
MM5298	8192 x 1	(250ns)	1.85
4118-300	16384 x 1	(300ns)	8/11.75
4118-250	16384 x 1	(250ns)	8/7.95
4118-200	16384 x 1	(200ns)	8/12.95
4118-150	16384 x 1	(150ns)	8/14.95
4118-120	16384 x 1	(120ns)	8/29.95
2118	16384 x 1	(150ns) (5v)	4.95
MK4332	32768 x 1	(200ns)	9.95
4184-200	65536 x 1	(200ns) (5v)	5.95
4184-150	65536 x 1	(150ns) (5v)	6.95
4184-120	65536 x 1	(120ns) (5v)	8.95
MCM6665	65536 x 1	(200ns) (5v)	8.95
TMS4184-15	65536 x 1	(150ns) (5v)	8.95
TMS4416	16384 x 4	(150ns) (5v)	9.95
41258	282144 x 1	(200ns) (5v)	CALL

5v = Single 5 volt supply

EPROMS

1702	256 x 8	(1us)	4.50
2708	1024 x 8	(450ns)	3.95
2758	1024 x 8	(450ns) (5v)	5.95
2716-6	2048 x 8	(650ns)	2.95
2716	2048 x 8	(450ns) (5v)	3.95
2716-1	2048 x 8	(450ns) (5v)	5.95
TMS2516	2048 x 8	(450ns) (5v)	5.50
TMS2716	2048 x 8	(450ns)	7.95
TMS2532	4096 x 8	(450ns) (5v)	5.95
2732	4096 x 8	(450ns) (5v)	4.95
2732-250	4096 x 8	(250ns) (5v)	8.95
2732-200	4096 x 8	(200ns) (5v)	11.95
2732A-4	4096 x 8	(450ns) (5v) (21vPGM)	6.95
2732A	4096 x 8	(250ns) (5v) (21vPGM)	9.95
2732A-2	4096 x 8	(200ns) (5v) (21vPGM)	13.95
2764	8192 x 8	(450ns) (5v)	6.95
2764-250	8192 x 8	(250ns) (5v)	7.95
2764-200	8192 x 8	(200ns) (5v)	19.95
TMS2564	8192 x 8	(450ns) (5v)	14.95
MCM68764	8192 x 8	(450ns) (5v) (24pin)	39.95
MCM66766	8192 x 8	(350ns) (5v) (24pin)	42.95
2712B-30	16384 x 8	(300ns) (5v)	29.95
2712B	16384 x 8	(250ns) (5v)	34.95

5v = Single 5 Volt Supply 21vPGM - Program at 21 Volts

★ ★ ★ ★ HIGH-TECH ★ ★ ★ ★

SSI 263 SPEECH SYNTHESIZER

★ MICROPROCESSOR COMPATIBLE
★ 5 8-BIT CONTROL REGISTERS
★ ENHANCE YOUR MOCKINGBOARD OR BUILD STEVE CIARCIA'S SWEET TALKER II (BYTE MARCH '84) **\$39.95**

★ ★ ★ ★ SPOTLIGHT ★ ★ ★ ★

★ Computer managed inventory — virtually no back orders!
★ Very competitive prices!
★ Friendly staff!
★ Fast service — most orders shipped within 24 hours!

CRYSTALS

32.768 khz	1.95
1.0 mhz	3.95
1.8432	2.95
2.0	2.95
2.097152	2.95
2.4576	2.95
3.2768	2.95
3.579545	2.95
4.0	2.95
5.0	2.95
5.0688	2.95
5.185	2.95
5.7143	2.95
6.0	2.95
6.144	2.95
6.5536	2.95
8.0	2.95
10.0	2.95
10.738635	2.95
14.31818	2.95
15.0	2.95
16.0	2.95
17.430	2.95
18.0	2.95
18.432	2.95
20.0	2.95
22.1184	2.95
32.0	2.95

CMOS

4000	.29	4528	1.19
4001	.25	4531	.95
4002	.25	4532	1.95
4006	.89	4538	1.95
4007	.29	4539	1.95
4008	.95	4541	2.64
4009	.39	4543	1.19
4010	.45	4553	5.79
4011	.25	4555	.95
4012	.25	4556	.95
4013	.38	4581	1.95
4014	.79	4582	1.95
4015	.39	4584	.75
4016	.39	4585	.75
4017	.69	4702	12.95
4018	.79	74C00	.35
4019	.39	74C02	.35
4020	.75	74C04	.35
4021	.79	74C08	.35
4022	.79	74C10	.35
4023	.29	74C14	.35
4024	.65	74C20	.59
4025	.29	74C30	.35
4028	1.65	74C32	.39
4027	.45	74C42	1.29
4028	.69	74C48	1.99
4029	.79	74C73	.65
4030	.39	74C74	.65
4034	1.95	74C76	.80
4035	.85	74C83	1.95
4040	.75	74C85	1.95
4041	.75	74C86	.39
4042	.69	74C89	4.50
4043	.85	74C90	1.19
4044	.79	74C93	1.75
4046	.85	74C95	.99
4047	.95	74C107	.89
4049	.35	74C150	5.75
4050	.35	74C151	2.25
4051	.79	74C154	3.25
4053	.79	74C157	1.75
4060	.89	74C160	1.19
4066	.39	74C161	1.19
4068	.39	74C162	1.19
4069	.29	74C163	1.19
4070	.35	74C164	1.39
4071	.29	74C165	2.00
4072	.29	74C173	.79
4073	.29	74C174	1.19
4075	.29	74C175	1.19
4076	.79	74C192	1.49
4078	.29	74C193	1.49
4081	.29	74C195	1.39
4082	.29	74C200	5.75
4085	.95	74C221	1.75
4086	.95	74C244	2.25
4093	.49	74C373	2.45
4098	2.49	74C374	2.45
4099	1.95	74C901	.39
11C90	13.95		
95H90	7.95		
2513-001 UP	9.95		
2513-002 LOW	9.95		
14409	12.95	74C902	.85
14411	11.95	74C905	10.95
14412	12.95	74C906	.95
14419	7.95	74C907	1.00
14433	14.95	74C908	2.00
4502	.95	74C909	2.75
4503	.85	74C910	9.95
4508	1.95	74C911	8.95
4510	.85	74C912	8.95
4511	.85	74C914	1.95
4512	.85	74C915	1.19
4514	1.25	74C918	2.75
4515	1.79	74C920	17.95
4516	1.55	74C921	15.95
4518	.89	74C922	4.49
4519	.39	74C923	4.85
4520	.79	74C925	5.95
4522	1.25	74C926	7.95
4526	1.25	74C928	7.95
4527	1.95	74C929	19.95

UARTS

AYS-1013	3.95
AY3-1015	6.95
PT1472	9.95
TR1602	3.95
2350	9.95
2651	8.95
IM6402	7.95
IM6403	8.95
INS8250	10.95

GENERATORS

MC14411	11.95
BR1941	11.95
4702	12.95
COM5016	16.95
COM8116	10.95
MM5307	10.95

FUNCTION

MC4024	3.95
LM566	1.49
XR2206	3.75
8038	3.95

MISC.

UPD7201	29.95
TMS99532	29.95
ULN2003	2.49
3242	7.95
3341	4.95
MC3470	4.95
MC3480	9.00
11C90	13.95
95H90	7.95
2513-001 UP	9.95
2513-002 LOW	9.95

CLOCK CIRCUITS

MM5314	4.95
MM5369	3.95
MM5369-EST	4.25
MM5375	4.95
MM58167	12.95
MM58174	11.95
MSM5832	3.95

KEYBOARD CHIPS

AY5-2376	11.95
AY5-3600	11.95
AY5-3600 PRO	11.95

6800

68000	49.95
6800	2.95
6802	7.95
6803	19.95
6808	13.90
6809E	14.95
6809	11.95
6810	2.95
6820	4.35
6821	2.95
6822	14.95
6840	12.95
6843	34.95
6844	25.95
6845	14.95
6847	11.95
6850	3.25
6852	5.75
6860	7.95
6875	6.95
6880	2.25
6883	22.95
68047	24.95
68488	18.95

6800 = 1MHZ

68B00	10.95
68B02	22.25
68B08E	29.95
68B09	29.95
68B10	6.95
68B21	6.95
68B40	19.95
68B45	19.95
68B50	5.95

68B00 = 2 MHZ

6500

6502	1 MHz	4.95
6504		6.95
6505		8.95
6507		9.95
6520		4.35
6522		6.95
6532		9.95
6545		22.50
6551		11.85

2 MHz

6502A	6.95
6522A	9.95
6532A	11.95
6545A	27.95
6551A	11.95

3 MHz

6502B	9.95
-------	------

DISC CONTROLLERS

1771	16.95
1791	24.95
1793	26.95
1795	29.95
1797	49.95
2791	54.95
2793	54.95
2795	59.95

TMM2016

2K x 8 STATIC \$4¹⁵
200 ns

HM6264

8K x 8 STATIC \$39⁹⁵
150 ns

74LS00

74LS00	.24	74LS173	.89
74LS01	.25	74LS174	.55
74LS02	.25	74LS175	.55
74LS03	.25	74LS181	2.15
74LS04	.24	74LS189	8.95
74LS05	.25	74LS190	.89
74LS08	.28	74LS191	.89
74LS09	.28	74LS192	.79
74LS10	.25	74LS193	.79
74LS11	.35	74LS194	.89
74LS12	.35	74LS195	.89
74LS13	.45	74LS196	.79
74LS14	.59	74LS197	.79
74LS15	.35	74LS221	.89
74LS20	.25	74LS240	.95
74LS21	.29	74LS241	.99
74LS22	.25	74LS242	.99
74LS26	.29	74LS243	.99
74LS27	.29	74LS244	1.29
74LS29	.35	74LS245	1.49
74LS30	.25	74LS247	.75
74LS32	.29	74LS248	.99
74LS33	.55	74LS249	.99
74LS37	.35	74LS251	.59
74LS38	.35	74LS253	.59
74LS40	.25	74LS257	.59
74LS42	.49	74LS258	.59
74LS47	.75	74LS259	2.75
74LS48	.75	74LS260	.59
74LS49	.75	74LS266	.55
74LS51	.25	74LS273	1.49
74LS54	.29	74LS275	3.35
74LS55	.29	74LS279	.49
74LS63	1.25	74LS280	1.98
74LS73	.39	74LS283	.89
74LS74	.35	74LS290	.89
74LS75	.39	74LS293	.89
74LS76	.39	74LS295	.99
74LS78	.49	74LS298	.89
74LS83	.60	74LS299	1.75
74LS85	.69	74LS323	3.50
74LS86	.39	74LS324	1.75
74LS90	.55	74LS352	1.29
74LS91	.89	74LS353	1.29
74LS92	.55	74LS363	1.35
74LS93	.55	74LS364	1.95
74LS95	.75	74LS365	.49
74LS96	.89	74LS368	.49
74LS107	.39	74LS367	.45
74LS109	.39	74LS368	.45
74LS112	.39	74LS373	1.39
74LS113	.39	74LS374	1.39
74LS114	.39	74LS375	.95
74LS122	.45	74LS377	1.39
74LS123	.79	74LS378	1.18
74LS124	2.90	74LS379	1.35
74LS125	.49	74LS385	3.90
74LS126	.49	74LS388	.45
74LS132	.59	74LS390	1.19
74LS133	.59	74LS393	1.19
74LS138	.39	74LS395	1.19
74LS137	.89	74LS399	1.49
74LS138	.55	74LS424	2.95
74LS139	.55	74LS447	.95
74LS145	1.20	74LS490	1.95
74LS147	2.49	74LS624	3.99
74LS148	1.35	74LS640	2.20
74LS151	.55	74LS645	2.20
74LS153	.55	74LS668	1.89
74LS154	1.90	74LS669	1.89
74LS155	.69	74LS670	1.49
74LS156	.89	74LS674	14.95
74LS157	.85	74LS682	3.20
74LS158	.59	74LS683	3.20
74LS160	.69	74LS684	3.20
74LS161	.85	74LS685	3.20
74LS162	.89	74LS698	2.40
74LS163	.85	74LS689	3.20
74LS164	.89	81LS95	1.49
74LS185	.95	81LS96	1.49
74LS186	1.85	81LS97	1.49
74LS188	1.75	81LS98	1.49
74LS189	1.75	25LS2521	2.80
74LS170	1.49	25LS2569	4.25

74S00

74S00	.32	74S124	2.75	74S197	1.45
74S02	.35	74S132	1.24	74S201	6.95
74S03	.35	74S133	.45	74S225	7.95
74S04	.35	74S134	.50	74S240	2.20
74S05	.35	74S135	.89	74S241	2.20
74S08	.35	74S138	.85	74S244	2.20
74S09	.40	74S139	.85	74S251	.95
74S10	.35	74S140	.55	74S253	.95
74S11	.35	74S151	.95	74S257	.95
74S15	.35	74S153	.95	74S258	.95
74S20	.35	74S157	.95	74S260	.79
74S22	.35	74S158	.95	74S273	2.45
74S30	.35	74S161	1.95	74S280	1.95
74S32	.40	74S162	1.95	74S287	1.90
74S37	.68	74S163	1.95	74S288	1.90
74S38	.85	74S166	3.95	74S289	6.89
74S40	.35	74S169	3.95	74S301	6.95
74S41	.35	74S174	.95	74S373	2.45
74S44	.40	74S175	.95	74S374	2.45
74S45	.40	74S181	3.95	74S387	1.95
74S47	.50	74S182	2.95	74S412	2.98
74S49	1.99	74S188	1.95	74S471	4.95
74S66	.50	74S189	6.95	74S472	4.95
74S112	.50	74S194	1.49	74S474	4.95
74S113	.50	74S195	1.49	74S570	2.95
74S114	.55	74S196	1.49	74S571	2.95

VOLTAGE REGULATORS

7805T	.75	7905T	.85
78M05C	.35	7908T	.85
7808T	.75	7912T	.85
7812T	.75	7915T	.85
7815T	.75	7924T	.85
7824T	.75	7905K	1.49
7805K	1.39	7912K	1.49
7812K	1.39	7915K	1.49
7815K	1.39	7924K	1.49
7824K	1.39	79L05	.79
78L05	.69	79L12	.79
78L12	.69	79L15	.79
78L15	.69	LM323K	4.90
78H05K	8.95	UA7854K	1.95
78H12K	9.95		

C, T = TO-220 K = TO-3
L = TO-92

SOUND CHIPS

78477	3.95	AY3-8910	12.95
78488	5.95	AY3-8912	12.95
78489	8.95	MC3340	1.49
SSI-263			39.95

7400

7400	.19	74123	.49
7401	.19	74125	.45
7402	.19	74128	.45
7403	.19	74132	.45
7404	.19	74136	.50
7405	.25	74143	4.95
7406	.29	74145	.60
7407	.29	74147	1.75
7408	.24	74148	1.20
7409	.19	74150	1.35
7410	.19	74151	.55
7411	.25	74153	.55
7413	.35	74154	1.25
7414	.49	74155	.75
7416	.25	74157	.55
7417	.25	74159	1.65
7420	.19	74160	.85
7421	.35	74161	.69
7425	.29	74163	.89
7427	.29	74164	.85
7430	.19	74165	.85
7432	.29	74166	1.00
7437	.29	74167	2.95
7438	.29	74170	1.65
7442	.49	74173	.76
7445	.89	74174	.89
7446	.69	74175	.89
7447	.89	74177	.75
7448	.89	74181	2.25
7451	.23	74184	2.00
7473	.34	74185	2.00
7474	.33	74191	1.15
7475	.45	74192	.79
7476	.35	74193	.79
7482	.95	74194	.85
7483	.50	74195	.85
7485	.59	74197	.75
7486	.35	74198	1.35
7489	2.15	74221	1.35
7490	.35	74246	1.35
7492	.50	74247	1.25
7493	.35	74259	2.25
7495	.55	74273	1.95
7497	2.75	74276	1.25
74100	1.75	74279	.75
74107	.30	74366	.85
74109	.45	74367	.85
74118	1.55	74368	.85
74121	.29	74393	1.35
74122	.45		

BYPASS CAPS

.01 UF DISC	100/6.00
.01 UF MONOLITHIC	100/12.00
.1 UF DISC	100/8.00
.1 UF MONOLITHIC	100/15.00

INTERFACE

8T26	1.59
8T28	1.89
8T95	.89
8T96	.89
8T97	.89
8T98	.89
DM8131	2.95
DP8304	2.29
DS8833	2.25
DS8835	1.99
DS8838	.99
DS8837	1.65
DS8838	1.30

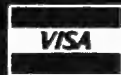

EPROM ERASERS SPECTRONICS CORPORATION

	Timer	Capacity Chip	Intensity (uW/Cm ²)	
PE-14		9	8,000	83.00
PE-14T	X	9	8,000	119.00
PE-24T	X	12	9,600	175.00
PL-265T	X	30	9,600	255.00
PR-125T	X	25	17,000	349.00
PR-320T	X	42	17,000	595.00

DATA ACQUISITION

ADC0800	15.55	DAC0800	4.95
ADC0804	3.49	DAC0808	2.95
DAC0806	1.95	DAC1020	8.25
ADC0809	4.49	DAC1022	5.95
ADC0816	14.95	MC1408L8	1.95
ADC0817	9.95	MC1408L8	2.95

CONNECTORS

RS232 Male	2.50
RS232 Female	3.25
RS232 Hood	1.25
S-100 ST	3.95

EXAR

XR 2206	3.75
XR 2207	3.75
XR 2208	3.75
XR 2211	5.25
XR 2240	3.25

INTERSIL

ICL7106	9.95
ICL7107	12.95
ICL7660	2.95
ICL8038	3.95
ICM7207A	5.59
ICM7208	15.95

9000

9316	1.00
9334	2.50
9368	3.95
9401	9.95
9601	.75
9602	1.50
96S02	1.95

LINEAR

LM301	.34	LM348	.99	LM567	.89	LM1612	8.25
LM301H	.79	LM350K	4.95	NE570	3.95	LM1830	3.50
LM307	.45	LM350T	4.80	NE571	2.95	LM1871	5.49
LM308	.69	LM358	.69	NE580	2.50	LM1872	5.49
LM308H	1.15	LM359	1.79	NE582	2.75	LM1877	3.25
LM309H	1.95	LM378	3.75	LM709	.59	LM1889	1.95
LM309K	1.25	LM377	1.95	LM710	.75	LM1896	1.49
LM310	1.75	LM378	2.50	LM711	.79	ULN2003	2.49
LM311	.64	LM379	4.50	LM723	.49	LM2877	2.05
LM311H	.89	LM380	.89	LM723H	.55	LM2878	2.25
LM312H	1.75	LM380N-8	1.10	LM733	.98	LM2900	.85
LM317K	3.95	LM381	1.80	LM741	.35	LM2901	1.00
LM317T	1.19	LM382	1.80	LM741N-14	.35	LM2917	2.95
LM318	1.49	LM383	1.95	LM741H	.40	LM3900	.59
LM318H	1.59	LM384	1.95	LM747	.89	LM3905	1.25
LM319H	1.90	LM386	.89	LM748	.59	LM3909	.98
LM319	1.25	LM387	1.40	LM1014	1.19	LM3911	2.25
LM320 (see 7900)	LM389	1.35	LM1303	1.95	LM3914	3.95	
LM322	1.65	LM390	1.95	LM1310	1.49	LM3915	3.95
LM323K	4.95	LM392	.69	MC1330	1.69	LM3918	3.95
LM324	.59	LM393</					

2764 8K x 8 EPROM \$6⁹⁵
450 ns

27128-30 16K x 8 EPROM \$29⁹⁵
300 ns

BARGAIN HUNTERS CORNER

2732A 350ns

- "A" VERSION PROGRAMS AT 21 VOLTS.
- FAST! 350ns ACCESS TIME

4.95 EACH **100/4.45** EACH

Z-80 SPECIALS!

- Z-80A-CPU 2.95
- Z-80A-CTC 2.95
- Z-80A-PIO 2.95

SPECIALS END 7/31/84

TRANSISTORS

2N918	.50	MPS3706	.15
MPS918	.25	2N3772	1.85
2N2102	.75	2N3903	.25
2N2218	.50	2N3904	.10
2N2218A	.50	2N3906	.10
2N2219	.50	2N4122	.25
2N2219A	.50	2N4123	.25
2N2222	.25	2N4249	.25
PN2222	.10	2N4304	.75
MPS2369	.25	2N4401	.25
2N2484	.25	2N4402	.25
2N2805	.50	2N4403	.25
PN2907	.25	2N4857	1.00
PN2907	.125	PN4918	.25
2N3055	.79	2N5086	.25
3055T	.69	PN5129	.25
2N3393	.30	PN5139	.25
2N3414	.25	2N6209	.25
2N3563	.40	2N6028	.35
2N3565	.40	2N6043	1.75
PN3565	.25	2N6045	1.75
MPS3638	.25	MPS-A05	.25
MPS3640	.25	MPS-A06	.25
PN3643	.25	MPS-A55	.25
PN3644	.25	TIP29	.65
MPS3704	.15	TIP31	.75
		TIP32	.79

IC SOCKETS

1-99	100
8 pin ST	.13 .11
14 pin ST	.15 .12
16 pin ST	.17 .13
18 pin ST	.20 .18
20 pin ST	.29 .27
22 pin ST	.30 .27
24 pin ST	.30 .27
28 pin ST	.40 .32
40 pin ST	.49 .39
64 pin ST	4.25 call
ST = SOLDERTAIL	
8 pin WW	.59 .49
14 pin WW	.69 .52
16 pin WW	.69 .58
18 pin WW	.99 .90
20 pin WW	1.09 .98
22 pin WW	1.391.28
24 pin WW	1.491.35
28 pin WW	1.691.49
40 pin WW	1.991.80
WW = WIREWRAP	

ZIF SOCKETS

ZIF =
Zero
Insertion
Force

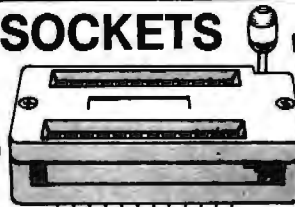

LEADS	UNIT PRICE
14	5.95
16	5.95
24	7.95
28	8.95
40	10.95

OPTO-ISOLATORS

4N26	1.00	MCA-7	4.25
4N27	1.10	MCA-255	1.75
4N28	.69	IL-1	1.25
4N33	1.75	ILA-30	1.25
4N35	1.25	ILQ-74	2.75
4N37	1.25	H11C5	1.25
MCT-2	1.00	TIL-111	1.00
MCT-6	1.50	TIL-113	1.75

RESISTORS

1/4 WATT 5% CARBON FILM
ALL STANDARD VALUES
FROM 1 OHM TO 10 MEG OHM

50 PCS. SAME VALUE	.025
100 PCS. SAME VALUE	.02
1000 PCS. SAME VALUE	.015

BYPASS CAPS

.01 UF DISC	100/6.00
.01 UF MONOLITHIC	100/12.00
.1 UF DISC	100/8.00
.1 UF MONOLITHIC	100/15.00

DIODES

1N751	5.1 volt zener	.25
1N759	12.0 volt zener	.25
1N4148	(1N914) switching	25/1.00
1N4004	400PIV rectifier	10/1.00
KBP02	200PIV 1.5amp bridge	.45
KBP04	400PIV 1.5amp bridge	.55
VM48	Dip-Bridge	.35

MUFFIN FANS

4.68" Square	14.95
3.125" Square	14.95

HEAT SINKS

TO-3style	.95
TO-220style	.35

SWITCHES

SPDT mini-toggle	1.25
DPDT mini-toggle	1.50
SPST mini-pushbutton	.39

LED LAMPS

	1-99	100-up
JUMBO RED	.10	.09
JUMBO GREEN	.18	.15
JUMBO YELLOW	.18	.15
LED MOUNTING HARDWARE	.10	.09

LED DISPLAYS

HP 5082-7760	.43"	CC	1.29
MAN 72	.3"	CA	.99
MAN 74	.3"	CC	.99
FND-357 (359)	.375"	CC	1.25
FND-500 (503)	.5"	CC	1.49
FND-507 (510)	.5"	CA	1.49
TIL-311 4x7	.270"	HEX W/LOGIC	9.95

DIP SWITCHES

4 POSITION	.85
5 POSITION	.90
6 POSITION	.90
7 POSITION	.95
8 POSITION	.95

CAPACITORS TANTALUM

	8V	10V	16V	20V	25V	35V
.22uf						.40
.27						.40
.33						.40
.47			.35			.50
.66						.45
1.0		.40	.40	.45	.45	.50
1.5				.45		.50
1.8						.75
2.2		.35	.40	.45		.65
2.7		.40	.45			.90
3.3		.45	.50	.55	.60	.65
3.9			.45			
4.7	.45	.55		.80	.65	.85
6.8			.70		.75	
10	.55	.65	.80	.85	.90	1.00
12	.65		.65	.90		
15	.75	.85	.90			
18				1.25		
22		1.00	1.35			
27			2.25			
39		1.50				
47	1.35					
56	1.75					
100		3.25				
270		3.75				

DISC

10pf	50V .05	470	50V .05
22	50V .05	560	50V .05
25	50V .05	680	50V .05
27	50V .05	820	50V .05
33	50V .05	.001uf	50V .05
47	50V .05	.0015	50V .05
56	50V .05	.0022	50V .05
68	50V .05	.005	50V .05
82	50V .05	.01	80V .07
100	50V .05	.02	80V .07
220	50V .05	.05	50V .07
330	50V .05	.1	12V .10
		.1	50V .12

MONOLITHIC

.1uf-mono	50V .18	.47uf-mono	50V .25
.047uf-mono	50V .15	.01uf-mono	50V .14

ELECTROLYTIC

	RADIAL		AXIAL	
.47uf	50V .14	1uf	50V .14	
1	25V .14	4.7	18V .14	
2.2	35V .15	10	16V .14	
4.7	50V .15	10	50V .16	
10	50V .15	22	18V .14	
47	35V .18	47	50V .20	
100	18V .18	100	15V .20	
220	35V .20	100	35V .25	
470	25V .30	150	25V .25	
2200	18V .60	220	25V .30	
		330	18V .40	
		550	18V .42	
		1000	18V .80	
		1500	18V .70	
		44,000uf	30V 3.95	
		6000	18V .85	

VISIT OUR RETAIL STORE

HOURS: M-W-F, 9-5 T-Th., 9-9 Sat. 11-3

PLEASE USE YOUR CUSTOMER NUMBER WHEN ORDERING
TERMS: For shipping include \$2 for UPS Ground or \$3 for UPS Blue Label Air. Items over 5 pounds require additional shipping charges. Foreign orders, include sufficient amount for shipping. There is a \$10 minimum order. Bay Area and Los Angeles Counties add 6 1/2% Sales Tax. Other California residents add 6% Sales Tax. We reserve the right to substitute manufacturer. Not responsible for typographical errors. Prices are subject to change without notice. We will match or beat any competitor's price provided it is not below our cost.

JDR Microdevices

1224 S. Bascom Avenue, San Jose, CA 95128
800-538-5000 • 800-662-6279 (CA)
(408) 995-5430 • Telex 171-110

© Copyright 1984 JDR Microdevices

CABINETS FOR 5 1/4" DISK DRIVES

CABINET #1 \$29.95

- ★ Dimensions 8" x 5 1/4" x 3 1/4"
- ★ Color matches Apple
- ★ Fits standard 5 1/4" drives, inc. Shugart

- ★ Includes mounting hardware and feet

CABINET #2 \$79.00

- ★ Complete with power supply, switch, line cord, fuse & standard power connector

- ★ Dimensions: 11 1/2" x 5" x 3 1/4"
- ★ +5V @ 1 AMP, +12V @ 1.5 AMP
- ★ Please specify gray or tan

NOTE: Please include sufficient amount for shipping on above items.

TRANSFORMERS FRAME STYLE

12.6VAC	2amp	4.95
12.6VAC CT	2amp	5.95
12.6VAC CT	4amp	7.95
12.6VAC CT	8amp	10.95
25.2VAC CT	2amp	7.95

PLUG CASE STYLE

12VAC	250ma	3.95
12VAC	500ma	4.95
12VAC	1amp	5.95
12VAC	2amp	6.95

DC ADAPTER

6, 9, 12 VDC selectable with univolar adapter 8.95

Please include sufficient amount for shipping on above items.

DISK DRIVES

TANDON	
TM100-1 5 1/4" (FOR IBM) SS/DD	199.00
TM100-2 5 1/4" (FOR IBM) DS/DD	219.00

MPI	
MP-52 5 1/4" (FOR IBM) DS/DD	249.00

TEAC	
FD-55B 1/2" HEIGHT DS/DD	189.00

SHUGART	
SA 400L 5 1/4" (40 TRACK) SS/DD	199.95

8" DISK DRIVE

FD 100-8 BY SIEMENS, SHUGART 801 EQUIV.	\$169.00
---	----------

FD 200-8 BY SIEMENS, SHUGART 851 EQUIV.	\$239.00
---	----------

Please include sufficient amount for shipping on above items.

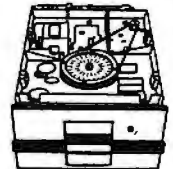

TANDON 5 1/4"

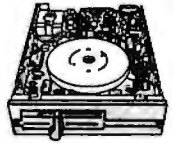

TEAC HALF HEIGHT

MICROCOMPUTER HARDWARE HANDBOOK FROM ELCOMP — \$14.95

Over 800 pages of manufacturers data sheets on most commonly used IC's.

Includes:

- ★ TTL — 74/74LS and 74F
- ★ CMOS
- ★ Voltage Regulators
- ★ Memory — RAM, ROM, EPROM
- ★ CPU's — 6800, 6500, Z80, 8080, 8085, 8086/8
- ★ MPU support & Interface — 6800, 6500, Z80, 8200, etc.

ORDER TOLL FREE

800-538-5000

800-662-6279

(CALIFORNIA RESIDENTS)



CENTRONICS

IDCEN36 Ribbon Cable	38 Pin Male	8.95
IDCEN38/F Ribbon Cable	38 Pin Female	8.95
CEN36 Solder Cup	38 Pin Male	7.95

RIBBON CABLE

CONTACTS	SINGLE COLOR		COLOR CODED	
	1'	10'	1'	10'
10	.50	4.40	.83	7.30
16	.55	4.80	1.00	8.80
20	.65	5.70	1.25	11.00
25	.75	6.60	1.32	11.60
26	.75	6.60	1.32	11.60
34	.98	8.60	1.65	14.50
40	1.32	11.80	1.92	16.80
50	1.38	12.10	2.50	22.00

BEST SELLING BOOKS

OSBORNE/MC GRAW-HILL

Apple II User's Guide	18.95
CRT Controller's Handbook	9.95
68000 Assembly Language	
Programming	18.99
CBASIC User Guide	15.00

SYBEX

Z-80 Applications	15.95
IBM PC PRO DOS Handbook	18.95
Programming the 8086/8088	15.95
The Best of IBM PC Software	18.95
Microprocessor Interfacing Techniques	17.95

EDGECARD CONNECTORS

S-100 ST	3.95
S-100 WW	4.95
72 pin ST	6.95
72 pin WW	7.95
50 pin ST	4.95
44 pin ST	2.95
44 pin WW	4.95

DIP CONNECTORS

DESCRIPTION	ORDER BY	CONTACTS								
		8	14	16	18	20	22	24	28	40
HIGH RELIABILITY TOOLED ST IC SOCKETS	AUGATxx-ST	.99	.99	.99	1.69	1.89	1.89	1.99	2.49	2.99
COMPONENT CARRIERS (DIP HEADERS)	ICCxx	.85	.75	.85	1.00	1.25	1.25	1.35	1.50	2.10
RIBBON CABLE DIP PLUGS (IDC)	IDPxx	—	1.45	1.65	—	—	—	2.50	—	4.15

For order instructions see "IDC Connectors" below.

D-SUBMINIATURE

DESCRIPTION	ORDER BY	CONTACTS				
		9	15	25	37	50
SOLDER CUP	MALE DPxxP	2.08	2.69	2.50	4.80	6.06
	FEMALE DBxxS	2.66	3.63	3.25	7.11	9.24
RT. ANGLE	MALE DBxxPR	1.65	2.20	3.00	4.83	—
PC HOLDER	FEMALE DBxxSR	2.18	3.03	4.42	6.19	—
IDC RIBBON CABLE	MALE IDBxxP	3.37	4.70	6.23	9.22	—
	FEMALE IDBxxS	3.69	5.13	6.84	10.08	—
HOODS	BLACK HOOD-B	—	—	1.25	—	—
	GREY HOOD	1.80	1.80	1.25	2.95	3.50

MOUNTING HARDWARE — \$1.00

For order instructions see "IDC Connectors" below.

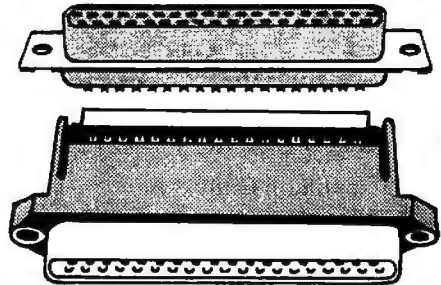

IDC CONNECTORS

DESCRIPTION	ORDER BY	CONTACTS					
		10	20	26	34	40	50
SOLDER HEADER	IDHxxS	.82	1.29	1.68	2.20	2.58	3.24
RT. ANGLE SOLDER HEADER	IDHxxSR	.85	1.35	1.76	2.31	2.72	3.39
WW HEADER	IDHxxW	1.86	2.98	3.84	4.50	5.28	6.63
RT. ANGLE WW HEADER	IDHxxWR	2.05	3.28	4.22	4.45	4.80	7.30
RIBBON HEADER SOCKET	IDSxx	1.15	1.86	2.43	3.15	3.73	4.65
RIBBON HEADER	IDMxx	—	5.50	6.25	7.00	7.50	8.50
RIBBON EDGE CARD	IDExx	2.25	2.36	2.65	3.25	3.80	4.74

ORDERING INSTRUCTIONS: Insert the number of contacts in the position marked "xx" of the "order by" part number listed. Example: A 10 pin right angle holder style header would be IDH10SR.

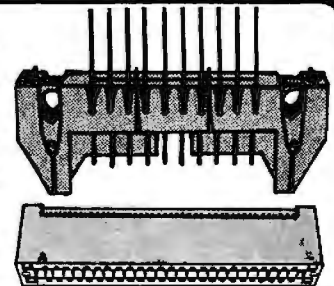

FOR APPLE COMPUTER USERS

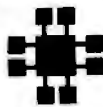

JDR Microdevices

THOUSANDS SOLD!

JDR 16K RAM CARD FOR APPLE II+

- * Expand your 48K Apple to 64K
 - * Fully compatible with Apple Language System — Use in place of Apple Language card
 - * Highest quality card features: gold edge connector, sockets for all IC's.
 - * 2 YEAR WARRANTY
- Kit with Instructions \$40.95 **\$44.95**
 Bare PC Card..... \$14.95

GET SLIM IN 1984! JDR HALF-HEIGHT DISK DRIVE

- * 35 Track if used with Apple Controller
- * 40 Track Controller and DOS Available (Call for Price)

\$209.95

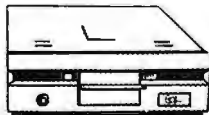

MA SYSTEMS FD-35 DISK DRIVE



\$199.95

- * Shugart Mechanism — Made in U.S.A.
- * Direct Replacement for Apple Disk II
- * Compatible with Apple Controller or other Apple compatible controllers
- * Specially designed electronics with low power consumption
- * DOS 3.3 and 3.2 compatible
- * One Year Warranty

CONTROLLER CARD \$69.95



APPLE COMPATIBLE POWER SUPPLY

- * Use To Power Apple Type Systems
- * +5V@4A +12V@2.5A
 -5V@.5A -12V@.5A
- * Instructions and Apple Power Connector Included.

\$79.95

BMC BMX-80 PRINTER

- * 80 CPS Dot Matrix Printer
- * Prints Bi-Directional in 40, 80, 71 or 142 Columns in Normal, Double Width or Compressed Text.
- * Print Superscript As Well As Superb Graphics in Character or Bit Image

\$279



micromax

VIEWMAX-80

NOW ONLY \$159.95

- * 80 Column Card for Apple II+
- * Video Soft Switch
- * Inverse Video
- * 2 Year Warranty

VIEWMAX-80e

NEW \$129.95

- * 80 Column Card for Apple IIe
- * 64K RAM Expandable to 128K
- 64K RAM Upgrade \$47.60**

GRAPHMAX \$129.95

- * Hi Resolution Graphics
 - * Printer Card
 - * Centronics Parallel Interface
 - * Zoom, Rotation and More
- Graphmax with Color Option..... 149.95**

NASHUA DISKETTES

5 1/4" WITH HUB RING

MD1 SOFT SECTOR, SS/SD	19.95
MD1D SOFT SECTOR, SS/DD	26.25
MD2D SOFT SECTOR, DS/DD	30.75
MD2F SOFT SECTOR, DS/QUAD DENSITY	45.00
MD110 10 SECTOR HARD, SS/SD	19.95
MD210D 10 SECTOR HARD, DS/DD	30.75

8" WITHOUT HUB RING

FD1 SOFT SECTOR, SS/SD	24.75
FD1D SOFT SECTOR, SS/DD	30.00
FD2D SOFT SECTOR, DS/DD	36.75

VERBATIM DATALIFE DISKETTES

SS/DD SOFT SECTOR

\$29.95

SS/DD 10 HARD SECTOR

\$29.95

5 1/4" DISKETTE FILE

- * ATTRACTIVE, FUNCTIONAL DISK STORAGE SYSTEM
 - * 75 DISK STORAGE CAPACITY
 - * MOLDED FROM DURABLE SMOKED PLASTIC WITH FRONT CARRYING HANDLE
- \$16.99**

OTHER ACCESSORIES FOR APPLE II

THUNDERCLOCK \$129.95

- * Real-Time Clock Calendar
- * Software Included
- * Mountain Software Compatible
- * BSR Control Options Available

KRAFT JOYSTICK \$39.95

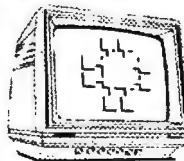

MONITORS

**BMC MONITOR STAND
 MODEL PA-900**

Your Display Will Tilt & Swivel **\$29.95**

MONOCHROME

BMC BM 12AUW GREEN 12"	\$89.95
BMC BM 12EUY 18 MHZ AMBER	\$139.95
BMC BM 12EUN 18 MHZ HIGH RES GREEN	\$115.00
NEC JB1201M-20 MHZ GREEN	\$169.00
ZENITH ZVM-123-15 MHZ GREEN NEW	\$105.00

COLOR

BMC BM-AU9191U COMPOSITE 13" ... \$279.00

NO C.O.D. ORDERS PLEASE

VISIT OUR RETAIL STORE

HOURS: M-W-F, 9-5 T-Th., 9-9 Sat. 10-3

PLEASE USE YOUR CUSTOMER NUMBER WHEN ORDERING

TERMS: Minimum order \$10. For shipping and handling include \$2.50 for UPS Ground and \$3.50 for UPS Air. Orders over 1 lb. and foreign orders may require additional shipping charges — please contact our sales department for the amount. CA residents must include 6% sales tax, Bay Area and LA residents include 6.75%. Prices subject to change without notice. We are not responsible for typographical errors. We reserve the right to limit quantities and to substitute manufacturer. All merchandise subject to prior sale.

© Copyright 1984 JDR Microdevices



JDR Microdevices

1224 S. Bascom Avenue, San Jose, CA 95128
 800-538-5000 • 800-662-6279 (CA)
 (408) 995-5430 • Telex 171-110

Apple is a trademark of Apple Computer Corporation

U·N·C·L·A·S·S·I·F·I·E·D A·D·S

BYTE is concerned about software piracy. Unclassified ads proposing exchanges of software must specify that the software was written by the individual or is in the public domain. BYTE reserves the right to reject any unclassified ad that does not meet this criterion.

WANTED: Tax-exempt, nonprofit organization seeks computer, disk drives, printers, or whatever peripherals are available to institute listing and cross-indexing of individuals needing food, clothing, and shelter in their areas. References and IRS information available on request. Jesse F. Estlock, 132 Franklin St., Tiffin, OH 44883.

WANTED: Nonprofit organization that provides inexpensive, wholesome meals to the elderly and incapacitated in their own homes in the Germantown area of Philadelphia, needs a donation of a small computer to do payroll and inventory control. Help in learning to use it also needed. IRS information and references on request. Meals on Wheels Inc., c/o Margaret Steigler, 32A Brookside Dr., Lansdale, PA 19446, (215) 362-6197.

WANTED: Teacher of 20 educable, mentally disabled students with less than a \$200 budget per year, needs a computer to help teach students. George Tassey, Windsor Forest High School, 12419 Largo Dr., Savannah, GA 31499.

WANTED: Tax-exempt, nonprofit Chamber of Commerce seeks tax-deductible donations of computers, modems, printers, and terminals. Certified receipts can be furnished. Indianola Chamber of Commerce, 201 West Salem, Indianola, IA 50125, (515) 961-6269, call Alan collect.

WANTED: Apple IIe or equivalent for church use. Parts or complete system. Receive a tax deduction; we pay shipping. Rev. David Massey, First-Meridian Heights Presbyterian Church, Indianapolis, IN 46205.

NEEDED: The National Institute for Adult Education in Yucatan, Mexico, will receive any hardware or textbooks in English and Spanish to initiate computer education. Alan Handleman, Apartado Postal #422, Merida, Yucatan, Mexico.

WANTED: An Apple users club in the vicinity of River-ton, Wyoming. I cannot connect by modem. Rod Ahlbrandt, 1104 Big Horn, Riverton, WY 82501.

WANTED: Student would greatly appreciate an unwanted, new, or used copy of *6502 Assembly Language Programming* (L. Leventhal), and/or a copy of *Beneath Apple DOS* (Worth & Lechner). Willing to pay shipping. Michael Whitman, American Embassy—Buenos Aires, APO Miami, FL 34034.

FOR SALE: Wicat 150-3, three-user system, CRT, floppy disk, 1/4-megabyte memory, graphics board, MCS operating system, 10-megabyte disk, recently upgraded, 90-day factory-warranty intact. \$14,100 list, asking \$10,000 or best offer. Ed Neugass, Apt. A-1707, 1400 South Joyce, Arlington, VA 22202, (703) 892-4225 evenings.

WANTED: BYTE #4 (December 1975), Gary Case, 585 Big Sky Court, Colorado Springs, CO 80919, (303) 599-0744.

WANTED: Nonworking 9-wire pinthead for Centronics 737/739 printer. I need the round magnet that rotates under the Hall-effect transistor. Bob Swirsky, POB 122, Cedarhurst, NY 11516, (516) 295-4344.

FOR SALE: Z-80 starter kit with manual and expansion bus, very good condition: \$200. Would also like to correspond with other 6800 people. Robert Smith, POB 41-10016, Michigan City, IN 46360.

WANTED: Would like to digitize pictures for educational applications. Have Shiba black-and-white video camera (Model AV15) and an Apple IIe. Need to know what hardware we need, and where and how to get it. T. Rapp, c/o Summit School Inc., 611 East Main St., Dundee, IL 60118.

FOR SALE: IBM 3101 terminal. Two years old, excellent condition: \$800. Dr. Neer, Massachusetts General Hospital, Mineral Metabolism Unit, Bulfinch 4, Boston, MA 02114 (617) 726-3288.

WANTED: People to form an international Apple III user group. George H. Buch, c/o Buchan, Ravnsborggade 19, Copenhagen 2200 N, Denmark.

FOR SALE: IBM Selectric typewriter, Model 745 (Redaction), complete with transistor drivers and solenoids. Also includes 10-pitch type element, IBM Selectric I/O typewriter manual, maintenance manual, Redaction interface-building instructions, and Redaction Interface EPROM. Selling for \$375 or best offer. Dennis Kamin, 104 Timber Lane, Collinsville, CT 06022, (203) 693-0043 evenings.

FOR SALE: S-100 computer system, CPM, 5-slot, SD Systems 3-card set, 64K, dual 8-inch drives, one serial, Centronics parallel with manuals: \$1500. Also, 200-LPM—Tally 2200 Line Printers, full 132-column, upper- and lowercase, ASCII, Centronics parallel interface: both for \$1500; one in perfect condition, other needs work. Frank Bennett, 5758 East Willowview Dr., Camarillo, CA 93010, (805) 987-9879.

FOR SALE: Three unused Multi-Tech modems, Model 212A, 1200/300 switchable data rate, originate, answer, auto-answer, full-duplex, synchronous, or asynchronous. Over \$700 each new, will sell for \$400 each. George F. Weiss, 127 Michael Dr., Red Bank, NJ 07701, (201) 530-9553.

WANTED: APL mathematics public-domain programs that may be in cassettes for a recently acquired IBM 1500 D with 64K to solve polynomial equations with complex coefficients that will plot simultaneous equations (f(x,y)=0, plot x=f(t), and y=g(t)). Harry D. Ruderman, 2624 Davidson Ave., New York, NY 10468, (212) 933-933-2650.

FOR SALE: Brother EP-20 personal electronic printer (5 by 7 dot matrix, correction, extra ribbons, and protective cover) brand new, barely used; asking \$125, negotiable. Willing to exchange for Atari equipment especially interface module or other parallel printer interface or Votrax SC-01-based speech-synthesis system. Ravi Subrahmanyam, Electrical Engineering Department, Duke University, Durham, NC 27706.

WANTED: High school student wishes to buy new or used Mountain Computer Music Boards for Apple. Price negotiable. Also interested in other computer and electronic music paraphernalia like music boards, keyboards, and synthesizers. Pay postage. Eric Rose, 18 Floral Dr., Hastings-on-Hudson, NY 10706, (914) 478-1418 weekdays after 5 p.m.

FOR SALE: TI-99 and TI-99/4A cassette-interface cables: \$10. Send check or money order. Tim Anderson, 215 3rd Ave. S., Saint Cloud, MN 56301.

WANTED: Any unwanted computers or peripherals, for Apple IIe or a TRS-80 Model III. I will pay for shipping and handling. Christopher C. Caron, Stonewall Lane, Madison, CT 06443.

FOR SALE: Seawell maxi-motherboard (hobby version for AIM, SYM, SIM); Seawell 16K RAM board; Seawell floppy-disk controller and Problem Solvers 8K Memory Board. Will sell separately or as a package (\$600) or will exchange for IBM PC boards. J. Hofstee, Box 108, Windmill Point, Cornwall, Ontario K6H 4Z1, Canada, (613) 933-6080 ext. 334.

FOR SALE: Back issues of BYTE 1977 through 1983 (volumes 2 through 8) except January and September 1979, and November 1982. All in excellent condition: \$100 plus shipping. J. E. Burchfield, 6 Bonus Hill Dr., Scotch Plains, NJ 07076, (201) 757-9441.

FOR SALE: LNW computer Model II equivalent, recently factory reconditioned. Two 5 1/4-inch drives (40t Lobo, 80t Tandon), dual Shugart 8-inch drives, BMC KG-12C monitor, FACIT (Data Royal 9001) printer, 5/8 switch: \$3600. Bruce Armstrong, 423 South Poplar St., Centralia, IL 62801, (618) 533-3009.

FOR SALE: TRS-80 Model II with 64K memory and 416K storage, plus Radio Shack Model 500 high-speed printer: \$3200 or best offer. Loren China, 313 West 105th St., New York, NY 10025, (212) 841-2475 days, (212) 866-5404 evenings.

WANTED: Information exchange with users of TRS-80 MC-10 computer. Jim Robinson, Apt. 220, 2915 Baseline Rd., Boulder, CO 80303, (303) 444-4437 after 2 p.m.

WANTED: High school student would like donated computer equipment, cards, peripherals, and any high-tech electronics. I will pay all postage. Bernard Boivin, 691 Rue des Cormiers, Dolbeau, Quebec G8L 1B4, Canada, (418) 276-2402.

WANTED: WordStar Customization Notes to buy or borrow. Need to patch WordStar for Dvorak keyboard layout—change menus, echos on menu selections, and CTRL key entries. Ben Cohen, Box 1674, Chicago, IL 60690.

FOR SALE: HP 87 personal computer 288K RAM, 5-megabyte Winchester disk drive, 5 1/4-inch floppy-disk drive, dot-matrix printer, direct-connect modem, RS-232C serial interface, plotter, and I/O ROMs. Covered by HP services contract. Originally over \$10,000, asking \$6250. R. G. Adelson, Burlington Woods Dr., Burlington, MA 01803, (617) 229-2440 days.

FOR SALE: Four Tandon TM100-1A disk drives, \$88 each, any or all. Cume OVF102 terminal, green: \$475. Like new. L. Bassat, 9639 Dorothy Ave., South Gate, CA 90280, (213) 567-8758.

FOR SALE: Optimal Technology EP-2A-88 stand-alone EPROM programmer. Makes up to four copies of a master EPROM. 2732 and 2732A modules included; will program many other types: \$400. Martin Kennedy, 309 Rena Dr., Lafayette, LA 70503, (318) 233-8240 ext. 509.

FOR SALE: Back issues of BYTE, 1976 to present. \$1 per issue plus postage. Available for 50¢ per issue: *Interface Age*, *Kilobaud Microcomputing*, *QST*, *Ham Radio*, and *73*. Send SASE. Joe Dubner, 865 South Haskett St., Mountain Home, ID 83647, (208) 587-9383.

WANTED: College student seeks computer and peripherals. Will pay shipping charges. Ed Crowley, 602 College Ave., Columbia, MO 65201, (314) 875-9061.

WANTED: Would like to trade noncopyrighted software for the TRS-80 Model 100 or Model III. Mark Deavut, Box 105, Churchview, VA 23032, (804) 758-2865.

FOR SALE: Heath H-27 floppy-disk subsystem: dual 8-inch drives, cabinet, power supply, controller, interface board for DEC LSI-II, cable: \$200 freight collect. Paul Abrahams, 214 River Rd., Deerfield, MA 01342, (413) 774-5500.

FOR SALE: Apple II+, 48K, 16K (4116's) RAM card, Apple drive with controller, DOS 3.3, manuals: \$950 or will sell separately. Also, modified MEK 6800D2 kit, with 6802 MPU, 1-MHz crystal, 2716 EPROM programmer, employing a 6846 counter-timer—I/O and Z1-F socket, fully buffered, MPU board fully socketed, fully documented revisions: \$350. Nate Wright, 3244 Blaisdell Ave. S #202, Minneapolis, MN 55408, (612) 827-3314.

FOR SALE: Paper Tiger 440 dot-matrix printer plus Apple II parallel-interface card. Includes printer ribbons, cables, and all documentation: \$300 or best offer. Also, Trendcom 100 thermal printer plus Apple II interface card and cable: \$100 or best offer. Art Mena, 10414 Rutgers Court, Cypress, CA 90630, (714) 761-2585.

FOR SALE: Apple Extended 80-column cards for Apple IIe: \$99 each, 16K RAM cards with cable: \$49 each. Dynamic RAMs 4164-200ns: \$4.50 each, 4116-200ns: \$1 each. IC sockets 16-pin high-quality solder-tail: 100/\$10. All items are new and are in original packages. Ersin Caner, 2330 North Oliver #516, Wichita, KS 67220, (316) 683-2619.

UNCLASSIFIED POLICY: Readers who have computer equipment to buy, sell, or trade or who are requesting or giving advice may send a notice to BYTE for inclusion in the Unclassified Ads section. To be considered for publication, an advertisement must be noncommercial and nonprofit (individuals or bona fide computer clubs), typed double-spaced, contain 60 words or less, and include name and address. This is a free service; notices are printed as space permits. Your confirmation of placement is appearance in an issue of BYTE as we engage in no correspondence. Please allow at least four months for your ad to appear. Send your notices to BYTE, Unclassified Ads, POB 372, Hancock, NH 03449.

B·O·M·B

BYTE'S ONGOING MONITOR BOX

ARTICLE#	PAGE	ARTICLE	AUTHOR(S)
1	111	The HP 110.....	Shapiro
2	115	Trump Card, Part 2: Software.....	Ciarcia
3	126	Faster FORTH.....	Greene
4	131	An Ada Language Primer, Part I.....	Salo
5	136	Macintosh Pascal.....	Vose
6	142	Build a Printer Buffer.....	Bono
7	146	Apple FAX: Weather Maps on a Video Screen.....	Sueker
8	154	Spreadsheet in BASIC.....	Cerati
9	162	A Computer on Every Desk.....	Osgood
10	187	Programming by Rehearsal.....	Finzer, Gould
11	215	Game Sets and Builders.....	Piestrup
12	223	Cautions on Computers in Education.....	Chorover
13	233	Languages for Students.....	Masterson
14	243	Microcomputers in the Field.....	Case
15	255	Kermit: A File-Transfer Protocol for Universities, Part I: Design Considerations and Specifications.....	da Cruz, Catchings
16	279	San Francisco's Exploratorium.....	Markoff
17	287	Designing a Simulated Laboratory.....	Peterson
18	303	Another Look at CP/M-80 C Compilers.....	Kern
19	321	Archon.....	Williams
20	327	The Chameleon Plus.....	Krajewski
21	341	The Texas Instruments Speech Command System.....	Haas
22	353	Volution Systems' Modula-2.....	Eldred
23	367	Infoscope.....	Bond
24	387	Computing at Chaos Manor: A Superbusy Month.....	Pournelle
25	405	BYTE West Coast: Lessons Learned.....	Shapiro

THE WINS OF MARCH

Jerry Pournelle's User's Column (beginning this issue, retitled Computing at Chaos Manor), "New Machines, Networks, and Sundry Software" won top billing in BYTE's March tally. \$100 will be delivered to the prolific author. The Circuit Cellar project on how to "Build a Third-Generation Phonetic Speech Synthesizer" placed second, providing Steve Ciarcia with the \$50 bonus. In third place is Peter R. Sørensen's "Simulating Reality with Computer Graphics." "Computer Simulation: What It Is and How It's Done" by Richard Bronson placed fourth in the March countdown, and in fifth place is Stan Miastkowski's review on "Microsoft Flight Simulator." BYTE congratulates these authors.

BYTE ADVERTISING SALES STAFF:

J. Peter Huestis, Advertising Sales Manager, 70 Main Street, Peterborough, N.H. 03458 Tel (603) 924-9281

NEW ENGLAND

ME, NH, VT, MA, RI
Paul McPherson, Jr. (617) 262-1160
McGraw-Hill Publications
607 Boylston Street
Boston, MA 02116

ATLANTIC

NJ (NORTH), NY, NYC, CT
Eugene Duncan (212) 512-2096
McGraw-Hill Publications
1221 Avenue of the Americas—39th Floor
New York, NY 10020

Dick McCurk (212) 512-3588

McGraw-Hill Publications
1221 Avenue of the Americas—39th Floor
New York, NY 10020

EAST

PA (EAST), NJ (SOUTH),
MD, VA, W.VA., DE, D.C.
Daniel Ferro (215) 496-3833

McGraw-Hill Publications

Three Parkway
Philadelphia, PA 19102

SOUTHEAST

NC, SC, GA, FL, AL, TN
Maggie McClelland (404) 252-0626
McGraw-Hill Publications
4170 Ashford Dunwoody Road—Suite 420
Atlanta, GA 30319

MIDWEST

IL, MO, KS, IA, ND, SD, MN, WI, NB
Jack Anderson (312) 751-3740
McGraw-Hill Publications
Blair Building
645 N. Michigan Ave.
Chicago, IL 60611

GREAT LAKES, OHIO REGION

MI, OH, PA (ALLEGHENY), KY, IN,
EASTERN CANADA
Dennis Riley (313) 352-9760

McGraw-Hill Publications

4000 Town Center—Suite 770
Southfield, MI 48075

SOUTHWEST, ROCKY MOUNTAIN

UT, CO, WY, OK, TX, AR, MS, LA
Alan Morris (214) 458-2400
McGraw-Hill Publications
Prestonwood Tower—Suite 907
5151 Beltline
Dallas, TX 75240

SOUTH PACIFIC

Southern CA, AZ, NM, LAS VEGAS
Page Goodrich (714) 557-6292
McGraw-Hill Publications
3301 Red Hill Ave
Building #1, Suite 222
Costa Mesa, CA 92626
Karen Niles (213) 480-5243, 487-1160
McGraw-Hill Publications
3333 Wilshire Boulevard #407
Los Angeles, CA 90010

NORTH PACIFIC

HI, WA, OR, ID, MT, NORTHERN CALIF,
NV (EXCEPT LAS VEGAS), W. CANADA
David Jem (415) 362-4600
McGraw-Hill Publications
425 Battery St.
San Francisco, CA 94111

Bill McAfee (415) 964-0624

McGraw-Hill Publications
1000 Elwell Court—Suite 225
Palo Alto, CA 94303

WEST COAST SURPLUS AND

RETAIL ACCOUNTS
Tom Harvey (805) 964-8577
3463 State St.—Suite 256
Santa Barbara, CA 93103

Post Card Mailings National

Bradley Browne (603) 924-6166
BYTE Publications
70 Main Street
Peterborough, NH 03458

International Advertising Sales Representatives:

Mr. Hans Csokor
Publmedia
Reisnerstrasse 61
A-1037 Vienna, Austria

Mrs. Gurit Gepner
McGraw-Hill Publishing Co.
115 Yosephthal St.
Bat Yam, Israel
866 561 321 39

Mr. Fritz Krusebecker
McGraw-Hill Publishing Co.
Liebigstrasse 27C
D-6000 Frankfurt/Main 1
West Germany
72 01 81

Mrs. Maria Sarmiento
Pedro Teixeira 8, Of. 320
Iberia Mart 1
Madrid 4, Spain
45 52 891

Mr. Andrew Karnig
Andrew Karnig & Associates
Kungsholsgatan 10
112 27 Stockholm, Sweden
08 51 68 70

Mr. Ken Davey
McGraw-Hill Publishing Co.
17 rue Georges Bizet
F 75116 Paris
France
720 33 42

Mr. Arthur Scheffer
McGraw-Hill Publishing Co.
34 Dover St.
London W1X 3RA
England
01 493 1451

Mr. Savio Pesavento
McGraw-Hill Publishing Co.
Via Flavio Baracchini 1
20123 Milan, Italy
86 90 656

Seavex Ltd.
05-4950 Tanglin Shopping Center
19 Tanglin Rd. Singapore 1024
Republic of Singapore

Seavex, Ltd.
Room 102, Yu Yuet Lal Bldg.
43-55 Wyndham St. Central
Hong Kong

Hiro Morita
McGraw-Hill Publications
Overseas Corp.
Room 1528
Kasumigaseki Bldg.
3-2-5 Kasumigaseki,
Chiyoda-Ku
Tokyo 100, Japan

R.E.A.D.E.R S.E.R.V.I.C.E

Inquiry No.	Page No.	Inquiry No.	Page No.	Inquiry No.	Page No.	Inquiry No.	Page No.	
1	1st NATIONAL COMPUTER	479	358	COMPU-MEDIA SUPPLIES	502	399	EDUCATIONAL MICROSYSTEMS	355
2	1st PLACE SYSTEMS	62	70	COMPUPRO	106, 107	125	ELCOMP	460
4	800 SOFTWARE	69	*	COMPUPRO	395	126	ELECTRADE CO.	494
5	A.S.T. RESEARCH	25	71	COMPUERVE	316, 317	127	ELECTRADE CO.	496
*	A.T.&T. TECHNOLOGY	227	73	COMPUTER CHANNEL	478	128	ELLIS COMPUTING INC.	171
6	A.T.&T. TECHNOLOGY	228	73	COMPUTER CONNECTION INC.	480	*	EMPIRICAL RESRCH GRP.	282
7	A.T.&T. TECHNOLOGY	229	74	COMPUTER DISCOUNT PROD.	477	131	EPSON AMERICA	324, 325
8	A.T.&T. TECHNOLOGY	230	75	COMPUTER FRIENDS	259	132	EXPERT COMPUTERS	489
9	A.T.&T. TECHNOLOGY	231	76	COMPUTER HUT OF N.E.	203	133	EXPOTEK	493
*	A.T.&T. TECHNOLOGY	232	77	COMPUTER INNOVATION	438	134	EXTENDED PROCESSING	270
10	AB COMPUTERS	482	78	COMPUTER MAIL ORDER	426, 427	135	EXXON OFFICE SYS.	337
12	ACOM ELECTRONICS	492	79	COMPUTER PRICE CLUB	102	136	FABRICATION CONCEPTS INC.	492
14	ADDMASTER CORP.	461	*	COMPUTER WAREHOUSE	195	137	FALCON SAFETY PROD.	396
393	ADV. ANALYTICS TECH.	502	80	COMPUTER-MATE, INC.	251	138	FLAGSTAFF ENGINEERING	269
15	ADV. COMP. PROD.	510, 511	81	COMPUTERS AND MORE	139	139	FLOPPY DISK SERV. INC.	485
16	ADV. SYS. CONCEPTS	408	82	COMPUTERS FOR LESS	490	381	FORTRON, INC.	480
17	ADV. TRANSDUCER DEVICES	451	83	COMPUVIEW PROD. INC.	263	382	FORTRON, INC.	480
*	ALF PRODUCTS, INC.	40	386	COMPUVIEW PROD. INC.	455	141	FOX & GELLER INC.	261
18	ALL ELECTRONICS CORP.	430	84	CONDOR COMP. CORP.	135	142	FUJITSU AMERICA	207
19	ALLENBACH INDUSTRIES	27	85	CONROY-LAPOINTE	212, 213	143	FUTECH INT'L. CORP.	176
20	ALLOY COMPUTER PRODUCTS	277	86	CONROY-LAPOINTE	212, 213	144	GENERAL TECHNOLOGY	149
21	ALPHA NUMERIC INT'L.	322	87	CONROY-LAPOINTE	212, 213	395	GEOTEC	355
22	ALPHA OMEGA COMPUTER	66	88	CONTROL DATA	273	146	G&G ENGINEERING	377
23	AMARAY CORP.	100	89	CORONA DATA SYS.	36, 37	146	GIFFORD COMP. SYS.	377
24	AMDEK CORP.	31	90	COSMOS	81	147	GILTRONIX, INC.	454
26	AMER. SQUARE COMP.	440	*	CRE WHOLESAL. PROD.	492	148	GREAT SALT LAKE COMP.	518, 519
27	AMPRO COMPUTERS INC.	404	*	CRE WHOLESAL. PROD.	492	149	GTEK INC.	46
28	ANDERSON JACOBSON	80	91	CREATIVITY UNLTD.	461	*	H&E COMPUTRONICS	105
29	ANDERSON-BELL	415	92	CROMEMCO	5	151	HANDWELL CORP.	481
31	APPARAT INC.	348, 349	398	CUESTA	355	407	HANDWELL CORP.	488
*	APPLE COMPUTER INC.	CII, I	379	CUMANA LTD.	499	152	HASCO, INC.	502
32	APPLE COUNTRY LTD.	475	93	CUSTOM COMP. TECH.	497	153	HAYES MICROCOMP. PROD.	32, 33
33	APPLEWARE, INC.	454	94	DAISY NET INT'L.	18	*	HAYES MICROCOMP. PROD.	411
35	APROPOS TECHNOLOGY	494	190	DANA COMPUTER DISCOUNT	82	155	HEATH COMPANY	206
36	ARCHITECTURAL RECORD	417	95	DATA ACCESS CORP.	447	374	HELIX SYS. & DEVL'R. CORP.	258
37	ARTIFICIAL INT'L. RESEARCH	496	96	DATA SPEC	167	375	HELIX SYS. & DEVL'R. CORP.	258
*	AT&T LONG LINES	437	97	DATA SPEC	210	157	HITECH INT'L. INC.	490
38	AVOCET	205	98	DATA SPEC	210	158	HOLIDAY INNS, INC.	338, 339
39	B & C MICROSYSTEMS	451	377	DATA TRANSLATION	384	159	HOLLYWOOD HARDWARE	496
40	B&B ELECTRONICS	314	99	DATASHIELD	209	160	HP BOOKS	453
41	BA5F SYSTEMS	47	365	DATASOUTH COMP. CORP.	70	161	HUMAN DESIGNED SYSTEMS	315
42	BAY TECHNICAL ASSOC.	74	366	DATASOUTH COMP. CORP.	401	371	I.B.C.	17
43	BELL, JOHN ENGR.	496	102	DAVIDGE CORP.	428	372	I.B.C.	17
44	BETATOOOL SYSTEMS	418	368	DAYFLO SOFTWARE	298	163	IBM INSTRUMENTS	242
45	BG COMPUTER APPLICATIONS	494	369	DAYFLO SOFTWARE	299	164	IBM NDD-SYS. SUPPLIES	302
47	BINARY TECHNOLOGY	498	397	DEVI COMPUTER	355	405	IMAGE CORP.	416
48	BIZCOMP	310	104	DHL WORLDWIDE COURIER	389	376	INFOCOM	168, 169
49	BORLAND INT'L.	72, 73	105	DIGISOFT COMPUTERS INC.	189	*	INMAC	97
*	BORLAND INT'L.	95	106	DIGITAL LABORATORIES	268	*	INMAC	449
50	BOTTOM LINE, THE	85	107	DIGITAL RESEARCH	28, 29	*	INNOVATIVE SOFTWARE (INSERT)	320 A-F
401	BOTTOM LINE, THE	359	*	DIGITAL RESEARCH COMP.	465	165	INTEGRAND	84
*	BYTE BACK ISSUE	178	*	DIRECT SOFTWARE	419	*	INTEL CORP.	20, 21
*	BYTE COMPUTER SHOW	252, 253	*	DISKETTE CONNECTION	436	166	INTERACTIVE STRUCT.	345
*	BYTE ADV. MESSAGE	350, 351, 386	110	DISKWORLD, INC.	410	404	INTERBUSINESS CORP.	416
*	BYTE IBM ISSUE	442	111	DISKWORLD, INC.	490	167	INTERFACE INC.	250
*	BYTE INT'L. ADV. SECTION	382	112	DISKWORLD, INC.	492	168	INTERFACE INC.	250
*	BYTE SUBSCRIBER NOTICE	390	113	DISKWORLD, INC.	494	169	INTERNATIONAL SOFTWARE	283
51	BYTEK COMP. SYS. CORP.	170	114	DISPLAY TELECOMMUNCN. TS.	495	170	INTERTEC DATA SYS.	15
52	BYTEWRITER	226	116	DMA	222	171	IO TECHNOLOGIES	175
*	C WARE	370	117	DOKAY COMP. PROD. INC.	508, 509	172	IVIE COMPUTER CORP.	408
*	C-SYSTEMS	494	118	DOSS INDUSTRIES	262	173	JADE COMP. PROD.	503
*	C. ITOH	335	119	DWIGHT CO., INC.	454	174	JADE COMP. PROD.	504, 505
53	C.S.D. INC.	238	120	DYNAX, INC.	183	175	JAMECO ELECTR.	140, 141
*	CALIF. DIGITAL	516, 517	121	EASI SOFTWARE	496	176	JDR MICRODEVICES INC.	520, 521
*	CALIF. MICRO COMP.	182	122	EASTERN ENTERPRISES	403	177	JDR MICRODEVICES INC.	522, 523
54	CAPITAL EQUIPMENT CORP.	260	123	ECOSOFT	156	178	JDR MICRODEVICES INC.	524
55	CDR SYSTEMS	451	124	EDGE MICRO SYSTEMS	451			
392	CENNA TECHNOLOGY	87						
58	CHROMOD ASSOC.	498						
59	CMA MICRO COMP. DIV.	438						
60	COGITATE, INC.	502						
61	COMTEC SERVICES, INC.	490						
62	COMMAND SERVICES CORP.	462						
63	COMMERCIAL BUSINESS SYS.	476						
64	COMMON LANGUAGE	197						
65	COMP. COMPNTS. UNLTD.	499						
66	COMP. COMPNTS. UNLTD.	500, 501						
67	COMPETITIVE EDGE	102						
68	COMPUADD	492						
69	COMPUADD	494						
*	COMPUAMAX	488						

TO GET FURTHER information on the products advertised in BYTE, fill out the reader service card with your name and address. Then circle the appropriate numbers for the advertisers you select from the list. Add a 20-cent stamp to the card, then drop it in the mail. Not only do you gain information, but our advertisers are encouraged to use the marketplace provided by BYTE. This helps us bring you a bigger BYTE. The index is provided as an additional service by the publisher, who assumes no liability for errors or omissions. *Correspond directly with company.

READER SERVICE

Inquiry No.	Page No.	Inquiry No.	Page No.	Inquiry No.	Page No.	Inquiry No.	Page No.
242	O'HANLON COMP. SYS. 407	276	QUADRAM CORP. 245	*	STARSHINE INC. 420	341	UNIQUE SUPPLIES & ACCESS. 502
243	OKIDATA 63	277	QUANT SYSTEMS 460	309	STRICKLY SOFTWARE 372	342	UNISOURCE 53
244	OKIDATA 265	278	QUARK INCORPORATED 57	310	SUNNY INT'L 476	343	VENTEL INC. 237
245	OLYMPIA U.S.A. INC. 413	279	QUBIE DISTRIBUTING 347	311	SUNTRONICS 478	344	VERTEX SYSTEMS 259
246	OPEN SYSTEMS INC. 88, 89	280	QUCES 30	312	SUPER COMP. INC. 484	345	VIDEX 4
384	OREGON SOFTWARE 123	281	RADIO SHACK CIV	313	SUPERSOFT 266, 267	346	VISUAL AGE 268
247	ORYX SYSTEMS 466, 467	390	RCA 272	317	SYSGEN INC. 361	347	VISUAL TECH. INC. 375
248	PACIFIC EXCHANGES 451, 458, 459, 460, 461, 494, 496, 498, 502	283	RELMS 457	319	SYSTEMS MANAGEMENT ASSOC. 214	*	VLM COMPUTER ELECTR. 492
249	PAN AMERICAN ELEC. INC. ... 502	284	RING KING VISIBLES. INC. ... 64	*	SYSTEMS STRATEGIES 440	385	VOLITON SYSTEMS 278
250	PANASONIC SENIOR PARTNER. 77	285	RINGER PRODUCTS 92	321	TALLGRASS TECH. 65	349	WADSWORTH PROFFSNL SFTW. 257
252	PC PIPELINE 490	286	RIXON 189	322	TATUM LABS 451	370	WANG ELECTRONIC PUB. 24
*	PERSONALIZED COMP. PAPER. 226	287	ROGERS LABS 180	323	TAVA CORP. 393	130	WAREHOUSE. THE 96
373	PERSYST 144, 145	288	ROLAND CORP. 55	324	TAXAN, CORP. 399	*	WAREHOUSE SOFTWARE 16
254	PIPELINE COMPUTER 506, 507	289	S-100 DIV. 696 CORP. 491	325	TAXAN, CORP. 399	350	WASHINGTON COMP. SYS. 434
255	P.J.S. 459	290	S-100 DIV. 696 CORP. 491	332	TDI SYSTEMS 78	351	WESTERN UNION 435
256	PLUM HALL INC. 174	*	SAFWARE 219	327	TDK ELECTRONICS 380, 381	352	WESTICO INC. 68
257	POLAROID CORP. 158, 159	291	SAGE COMP. TECH. 177	*	TEKTRONIX INC. 186	353	WHEATLAND DESIGN LAB. 492
260	PRACTICAL PERIPH. 61	292	SAKATA 130	388	TELEBYTE TECH. 456	354	WHITESMITHS LTD. 90
261	PRACTICAL PERIPH. 249	*	SCM CORP. 75	328	TELETEK ENTERPRISES. INC. ... 39	355	WILLIAMS, MARK CO. 397
262	PRACTICAL PERIPH. 429	*	SCOTTSDALE SYSTEMS 71	329	TELEVIDEO SYSTEMS 98, 99	356	WINTEK CORP. 451
263	PRECISION DATA 494	294	SEQUA COMP. CORP. 7	330	TERRAPIN INC. 458	357	WOOLF SOFTWARE 101
264	PRENTICE HALL INC. 152, 153	295	SEMIDISK SYSTEMS 326	*	TEXAS COMP. SYS. 138	359	WYSE TECHNOLOGY 199
265	PRIMAGES INC. 93	296	SENTINEL TECHNOLOGIES 423	*	TEXAS INSTRUMENTS. 11, 12, 13	360	X.D.S. 486
266	PRINCETON GRAPHIC SYS. 320	*	SILICON SPECIALTIES 44	*	TEXAS INSTRUMENTS 331	362	XEROX CORR. (AMERICARE) 41, 42, 43
267	PRIORITY ONE 512, 513	297	SLR SYSTEMS 458	402	THINKER SOFT 275	363	XEROX EDUCATION PUBL. 297
267	PRIORITY ONE 514, 515	*	SOFTLINE CORP. 208	331	THREE M COMPANY 191		
268	PRO MICROSYSTEMS 496	298	SOFTRENT 355	129	TIGERTRONICS 502		
269	PROFESSIONAL DATA SERV. ... 502	299	SOFTWARE ARTS 35	*	TINNEY, ROBERT GRAPHICS 306, 398		
270	PROMETHEUS PRODUCTS 333	303	SOFTWARE SERVICES 451	334	TITAN TECHNOLOGY 379		
271	PURCHASING AGENT. THE. 432	304	SOFTWARE SERVICES 496	335	TOPAZ, INC. 193		
272	PURPLE COMPUTING 494	305	SOFTWARE SOLUTIONS INC. ... 239	336	TOSHIBA AMERICA INC. 312		
273	QANTEX DIV. 340	306	SORD COMPUTER OF AMERICA. 67	337	TOSHIBA AMERICA INC. 313		
274	QUADRAM CORP. 19	*	SPERRY 272	*	TRANS WORLD AIRLINES. 318, 319		
275	QUADRAM CORP. 114	*	SRI DATA SYSTEMS 416	339	U.S. ROBOTICS 51		
		308	STARBUCK DATA CO. 498	340	UNIPRESS SOFTWARE INC. 134		

* Correspond directly with company.

INTERNATIONAL ADVERTISING SECTION

600 AMER. BUYING & EXPORT. ... 352B
601 SORD COMPUTER CORP. 352A

No domestic inquiries, please.

Coming Soon!

BYTE will offer a revolutionary computerized program to service our subscribers and our advertisers.

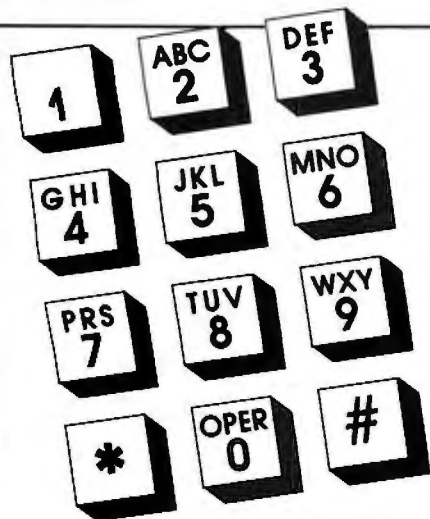

■ Teamed with Berkshire Computer Processing Center of Pittsfield, MA, BYTE can assist in information turn-around from advertiser to reader within a few days' time.

■ The system—Automated Inquiry Management System (AIMS)—works by Touch-Tone phone. Subscribers can phone Berkshire Computer and key in advertisers' reader service numbers. Advertisers can then access the system directly, obtain inquirers' names and respond to them within days of the reader's requests.

■ This new service will be available to SUBSCRIBERS ONLY. If you are not a subscriber fill out the subscription card bound in this issue now and take advantage of this valuable new service. Or, call BYTE circulation at (800) 258-5485.

■ The standard reader service card is still available for use by subscribers and non-subscribers.

BYTE

BYTE READER SERVICE



JUNE 1984
4164

For fastest service transfer mailer label from wrapper to coupon provided at the right. Requests cannot be honored unless zip code is given. This card valid for 6 months from cover date.

NOTE—If label is missing or defaced fill out coupon carefully—**PLEASE PRINT**—this is the only way to get requested material to you.

Name _____
 (Title) _____ (Company) _____
 Address _____ Telephone _____
 City _____ State _____ Zip _____

I purchased this copy by Subscription Newsstand, computer store, or bookstore

1	23	45	67	89	111	133	155	177	199	221	243	265	287	309	331	353	375	397	419	441	463	485	507	529	551	573	595	617	639	661	683	705	727	749	771	793
2	24	46	68	90	112	134	156	178	200	222	244	266	288	310	332	354	376	398	420	442	464	486	508	530	552	574	596	618	640	662	684	706	728	750	772	794
3	25	47	69	91	113	135	157	179	201	223	245	267	289	311	333	355	377	399	421	443	465	487	509	531	553	575	597	619	641	663	685	707	729	751	773	795
4	26	48	70	92	114	136	158	180	202	224	246	268	290	312	334	356	378	400	422	444	466	488	510	532	554	576	598	620	642	664	686	708	730	752	774	796
5	27	49	71	93	115	137	159	181	203	225	247	269	291	313	335	357	379	401	423	445	467	489	511	533	555	577	599	621	643	665	687	709	731	753	775	797
6	28	50	72	94	116	138	160	182	204	226	248	270	292	314	336	358	380	402	424	446	468	490	512	534	556	578	600	622	644	666	688	710	732	754	776	798
7	29	51	73	95	117	139	161	183	205	227	249	271	293	315	337	359	381	403	425	447	469	491	513	535	557	579	601	623	645	667	689	711	733	755	777	799
8	30	52	74	96	118	140	162	184	206	228	250	272	294	316	338	360	382	404	426	448	470	492	514	536	558	580	602	624	646	668	690	712	734	756	778	800
9	31	53	75	97	119	141	163	185	207	229	251	273	295	317	339	361	383	405	427	449	471	493	515	537	559	581	603	625	647	669	691	713	735	757	779	801
10	32	54	76	98	120	142	164	186	208	230	252	274	296	318	340	362	384	406	428	450	472	494	516	538	560	582	604	626	648	670	692	714	736	758	780	802
11	33	55	77	99	121	143	165	187	209	231	253	275	297	319	341	363	385	407	429	451	473	495	517	539	561	583	605	627	649	671	693	715	737	759	781	803
12	34	56	78	100	122	144	166	188	210	232	254	276	298	320	342	364	386	408	430	452	474	496	518	540	562	584	606	628	650	672	694	716	738	760	782	804
13	35	57	79	101	123	145	167	189	211	233	255	277	299	321	343	365	387	409	431	453	475	497	519	541	563	585	607	629	651	673	695	717	739	761	783	805
14	36	58	80	102	124	146	168	190	212	234	256	278	300	322	344	366	388	410	432	454	476	498	520	542	564	586	608	630	652	674	696	718	740	762	784	806
15	37	59	81	103	125	147	169	191	213	235	257	279	301	323	345	367	389	411	433	455	477	499	521	543	565	587	609	631	653	675	697	719	741	763	785	807
16	38	60	82	104	126	148	170	192	214	236	258	280	302	324	346	368	390	412	434	456	478	500	522	544	566	588	610	632	654	676	698	720	742	764	786	808
17	39	61	83	105	127	149	171	193	215	237	259	281	303	325	347	369	391	413	435	457	479	501	523	545	567	589	611	633	655	677	699	721	743	765	787	809
18	40	62	84	106	128	150	172	194	216	238	260	282	304	326	348	370	392	414	436	458	480	502	524	546	568	590	612	634	656	678	700	722	744	766	788	810
19	41	63	85	107	129	151	173	195	217	239	261	283	305	327	349	371	393	415	437	459	481	503	525	547	569	591	613	635	657	679	701	723	745	767	789	811
20	42	64	86	108	130	152	174	196	218	240	262	284	306	328	350	372	394	416	438	460	482	504	526	548	570	592	614	636	658	680	702	724	746	768	790	812
21	43	65	87	109	131	153	175	197	219	241	263	285	307	329	351	373	395	417	439	461	483	505	527	549	571	593	615	637	659	681	703	725	747	769	791	813
22	44	66	88	110	132	154	176	198	220	242	264	286	308	330	352	374	396	418	440	462	484	506	528	550	572	594	616	638	660	682	704	726	748	770	792	814

BYTE's BOMB is your direct line to the editor's desk. Each month, the two top-rated authors receive bonuses based on your evaluation. First look at the list of this month's articles and corresponding article numbers (located in the unclassified ads section on the page preceding the Reader Service list), then rate each article you've read as **Excellent**, **Good**, **Fair**, or **Poor**, based on your overall impression of the article, by circling the appropriate number in each column below. Your feedback helps us produce the best possible magazine each month.

Article No.	1	2	3	4	5	6	7	8	9	10	11	12	13	14	15	16	17	18	19	20	21	22	23	24	25
Excellent	1	5	9	13	17	21	25	29	33	37	41	45	49	53	57	61	65	69	73	77	81	85	89	93	97
Good	2	6	10	14	18	22	26	30	34	38	42	46	50	54	58	62	66	70	74	78	82	86	90	94	98
Fair	3	7	11	15	19	23	27	31	35	39	43	47	51	55	59	63	67	71	75	79	83	87	91	95	99
Poor	4	8	12	16	20	24	28	32	36	40	44	48	52	56	60	64	68	72	76	80	84	88	92	96	100

Article No.	26	27	28	29	30	31	32	33	34	35	36	37	38	39	40	41	42	43	44	45	46	47	48	49	50
Excellent	101	105	109	113	117	121	125	129	133	137	141	145	149	153	157	161	165	169	173	177	181	185	189	193	197
Good	102	106	110	114	118	122	126	130	134	138	142	146	150	154	158	162	166	170	174	178	182	186	190	194	198
Fair	103	107	111	115	119	123	127	131	135	139	143	147	151	155	159	163	167	171	175	179	183	187	191	195	199
Poor	104	108	112	116	120	124	128	132	136	140	144	148	152	156	160	164	168	172	176	180	184	188	192	196	200

BYTE READER SERVICE



JUNE 1984
4164

For fastest service transfer mailer label from wrapper to coupon provided at the right. Requests cannot be honored unless zip code is given. This card valid for 6 months from cover date.

NOTE—If label is missing or defaced fill out coupon carefully—**PLEASE PRINT**—this is the only way to get requested material to you.

Name _____
 (Title) _____ (Company) _____
 Address _____ Telephone _____
 City _____ State _____ Zip _____

I purchased this copy by Subscription Newsstand, computer store, or bookstore

1	23	45	67	89	111	133	155	177	199	221	243	265	287	309	331	353	375	397	419	441	463	485	507	529	551	573	595	617	639	661	683	705	727	749	771	793
2	24	46	68	90	112	134	156	178	200	222	244	266	288	310	332	354	376	398	420	442	464	486	508	530	552	574	596	618	640	662	684	706	728	750	772	794
3	25	47	69	91	113	135	157	179	201	223	245	267	289	311	333	355	377	399	421	443	465	487	509	531	553	575	597	619	641	663	685	707	729	751	773	795
4	26	48	70	92	114	136	158	180	202	224	246	268	290	312	334	356	378	400	422	444	466	488	510	532	554	576	598	620	642	664	686	708	730	752	774	796
5	27	49	71	93	115	137	159	181	203	225	247	269	291	313	335	357	379	401	423	445	467	489	511	533	555	577	599	621	643	665	687	709	731	753	775	797
6	28	50	72	94	116	138	160	182	204	226	248	270	292	314	336	358	380	402	424	446	468	490	512	534	556	578	600	622	644	666	688	710	732	754	776	798
7	29	51	73	95	117	139	161	183	205	227	249	271	293	315	337	359	381	403	425	447	469	491	513	535	557	579	601	623	645	667	689	711	733	755	777	799
8	30	52	74	96	118	140	162	184	206	228	250	272	294	316	338	360	382	404	426	448	470	492	514	536	558	580	602	624	646	668	690	712	734	756	778	800
9	31	53	75	97	119	141	163	185	207	229	251	273	295	317	339	361	383	405	427	449	471	493	515	537	559	581	603	625	647	669	691	713	735	757	779	801
10	32	54	76	98	120	142	164</																													

PLACE
STAMP
HERE

BYTE

READER SERVICE
PO BOX 298
DALTON, MA 01226
USA

PLACE
STAMP
HERE

BYTE

READER SERVICE
PO BOX 298
DALTON, MA 01226
USA

BYTE

SUBSCRIPTIONS



4164

For a subscription to BYTE, please complete this card.

Name _____

Address _____

City _____

State _____ Zip _____ Country _____

Card No. _____

Expiration date _____

Four digits above name—Master Charge only _____

Signature _____ Date _____

Please allow eight weeks for processing. Thank you.

- | | | |
|----------------------------------|-------------------------------|-------------------------------|
| <input type="checkbox"/> 1 year | <input type="checkbox"/> \$21 | <input type="checkbox"/> \$23 |
| <input type="checkbox"/> 2 years | <input type="checkbox"/> \$38 | <input type="checkbox"/> \$42 |
| <input type="checkbox"/> 3 years | <input type="checkbox"/> \$55 | <input type="checkbox"/> \$61 |

- \$53 Europe (air delivery) payment enclosed
 \$37 Elsewhere (surface mail) payment enclosed

(Air mail rates available upon request)

Please remit in US funds drawn on a US bank. Thank you.

- Check enclosed (**Bonus** [North America only] one EXTRA issue—receive 13 issues for the price of 12)



- Bill me (North America only)

BYTE

SUBSCRIPTIONS



4164

For a subscription to BYTE, please complete this card.

Name _____

Address _____

City _____

State _____ Zip _____ Country _____

Card No. _____

Expiration date _____

Four digits above name—Master Charge only _____

Signature _____ Date _____

Please allow eight weeks for processing. Thank you.

- | | | |
|----------------------------------|-------------------------------|-------------------------------|
| <input type="checkbox"/> 1 year | <input type="checkbox"/> \$21 | <input type="checkbox"/> \$23 |
| <input type="checkbox"/> 2 years | <input type="checkbox"/> \$38 | <input type="checkbox"/> \$42 |
| <input type="checkbox"/> 3 years | <input type="checkbox"/> \$55 | <input type="checkbox"/> \$61 |

- \$53 Europe (air delivery) payment enclosed
 \$37 Elsewhere (surface mail) payment enclosed

(Air mail rates available upon request)

Please remit in US funds drawn on a US bank. Thank you.

- Check enclosed (**Bonus** [North America only] one EXTRA issue—receive 13 issues for the price of 12)



- Bill me (North America only)

*Note our special offer!
 Send cash with your order
 and receive 13 issues
 for the price of 12 for
 each year you subscribe.
 (North America only, please.)*

Don't Miss An Issue!

Have BYTE delivered to your door.

Each month BYTE will bring you the latest in microcomputer technology.

DISCOVER and IMPLEMENT new ideas. Don't miss the original information presented in the pages of BYTE.

With BYTE you'll always be among the first to know about the important breakthroughs, worthwhile new equipment, and innovative projects in the world of computing.

CHALLENGE US to deliver the very best ideas in microcomputers and advanced technology to you. Return the attached card today!

Subscribe to BYTE—the world's leading computer magazine.

PLACE
STAMP
HERE

BYTE SUBSCRIPTIONS
PO Box 590
Martinsville NJ 08836
USA

PLACE
STAMP
HERE

BYTE SUBSCRIPTIONS
PO Box 590
Martinsville NJ 08836
USA

SON OF STARWRITER™

HALF THE SPEED, FOR HALF THE MONEY.



First there was the **Starwriter 40 CPS** by C. Itoh, one of the world's most popular letter-quality printers.

And deservedly so. Because it gives you more of just about everything than any other printer in its price range (mid-teens). And it churns out copy at a very brisk 40 characters per second, or about half a minute for an average business letter.

Now, there's the **Starwriter 18 CPS**. It takes after its father, in that it's simply the finest printer you can buy for anywhere near the price—which in this case is just about half what Daddy charges.

The only major difference is speed.

Instead of 40 characters per second, this Starwriter trots along at just over 18 cps—which costs you about 30 seconds per average business letter.

But it retains the rest of the family resemblance, like low profile and low noise, plug-in compatibility with just about any serial or parallel microcomputer on the market, making it a perfect companion in a typical office environment.

And perfect for typical office chores, like letters, memos, announcements... in fact the vast majority of stuff that can afford to wait a few seconds to get typed.

Enough said?

If not, then this the Starwriter 18 CPS gives you crisp, letter-quality copy (including boldface, underlining, sub and superscripts) with your choice of friction feed or optional tractor feed for precise print positioning of tabular and graphic data, using easily available industry-standard ribbon cartridges and long-lasting plastic daisy wheels.

But it also gives you something that's far from industry-standard.

A full-year warranty.

And for a mere half-a-minute per letter.

We think it's well worth the wait.

Marketed exclusively by
Leading Edge Products, Inc.
225 Turnpike Street
Canton, MA 02021
1-800-343-6833 or
in Massachusetts
(617) 828-8190



Circle 188 on inquiry card.

The New Tandy 2000

“Simply Incredible.”



Meet the incredible new Tandy® 2000 Personal Computer. A truly remarkable machine that you should get to know. Why? Because the Tandy 2000 offers more than other MS-DOS computers on the market.

For instance, it's faster than the others. It offers more disk storage, and more detailed graphics. Expansion couldn't be easier. Even the IBM PC can't compare.

With the Tandy 2000, you get to choose from the

most popular and advanced MS-DOS software around, from word processing to electronic filing to spreadsheet analysis.

The beautiful, ergonomic design makes the Tandy TRS-80 Model 2000 a wonder to look at and a breeze to use. And don't forget Radio Shack's extensive service network.

Ultra-High performance Tandy TRS-80® Model 2000 systems start at \$2999. Incredible? You bet!

Available at over 1100
Radio Shack Computer Centers and at
participating Radio Shack stores and dealers

Radio Shack
COMPUTER CENTERS
A DIVISION OF TANDY CORPORATION

Prices apply at Radio Shack Computer Centers and participating stores and dealers. MS is a registered trademark of Microsoft. IBM is a registered trademark of International Business Machines Corp.

Circle 281 on inquiry card.